

*1/4hd*

*U113*

*-2  
TM*

*1942*

**TM 9-783B**

**WAR DEPARTMENT**

*U.S. Dept. of Army*

**TECHNICAL MANUAL**

**MEDIUM TRACTOR M1**  
**(ALLIS-CHALMERS HD-7W)**

**DECEMBER 22, 1942**

**MEDIUM TRACTOR M1**  
**(ALLIS-CHALMERS HD-7W)**

U113  
12  
TM 9-783B  
194.  
X222

Prepared under the direction of the  
Chief of Ordnance

(with the cooperation of the Allis-Chalmers Manufacturing Company)

**CONTENTS**

**PART ONE—Operating Instructions**

SECTION		Paragraphs	Pages
I.	Introduction . . . . .	1- 3	1- 7
II.	Description and tabulated data . . .	4- 5	8- 16
III.	Operating instructions and controls	6- 24	17- 30
IV.	Lubrication . . . . .	25- 30	31- 39
V.	Preventive maintenance . . . . .	31- 40	40- 46
VI.	General care and preservation . . .	41- 42	47
VII.	Painting . . . . .	43- 48	48- 50
VIII.	Materiel affected by gas . . . . .	49- 52	51- 53

**PART TWO—Organization Instructions**

IX.	General information on maintenance . . . . .	53	54- 56
X.	Standard tools and equipment . . .	54- 55	57- 59
XI.	Engine . . . . .	56- 60	60- 90
XII.	Fuel and air system . . . . .	61- 69	91-121
XIII.	Cooling system . . . . .	70- 76	122-135
XIV.	Lubrication system . . . . .	77- 80	136-143
XV.	Electrical system and equipment . .	81- 92	144-174
XVI.	Nonelectrical instruments . . . . .	93- 96	175-179
XVII.	Master clutch . . . . .	97-100	180-185

**MEDIUM TRACTOR M1**

	<b>Paragraphs</b>	<b>Pages</b>
<b>SECTION XVIII. Steering clutches</b> .....	101-104	186-190
<b>XIX. Steering clutch brakes</b> .....	105-106	191-193
<b>XX. Final drives</b> .....	107-109	194-196
<b>XXI. Tracks and truck frame assembly</b>	110-114	197-206
<b>XXII. Winch and power take-off</b> .....	115-116	207-210
<b>XXIII. Cold weather lubrication and             service</b> .....	117-122	211-215
<b>XXIV. Storage and shipment</b> .....	123-129	216-228
<b>XXV. References</b> .....	130-132	229-230
<b>INDEX</b> .....		231-238

## PART ONE—Operating Instructions

### Section I

#### INTRODUCTION

	Paragraph
Purpose and scope .....	1
Arrangement .....	2
References .....	3

#### 1. PURPOSE AND SCOPE.

a. Complete information and instructions are contained in this manual for the personnel charged with the operation, lubrication, and light maintenance of the Medium Tractor M1 (Allis-Chalmers HD-7W). The performance of all maintenance requiring special facilities or particular skill is the responsibility of ordnance personnel.

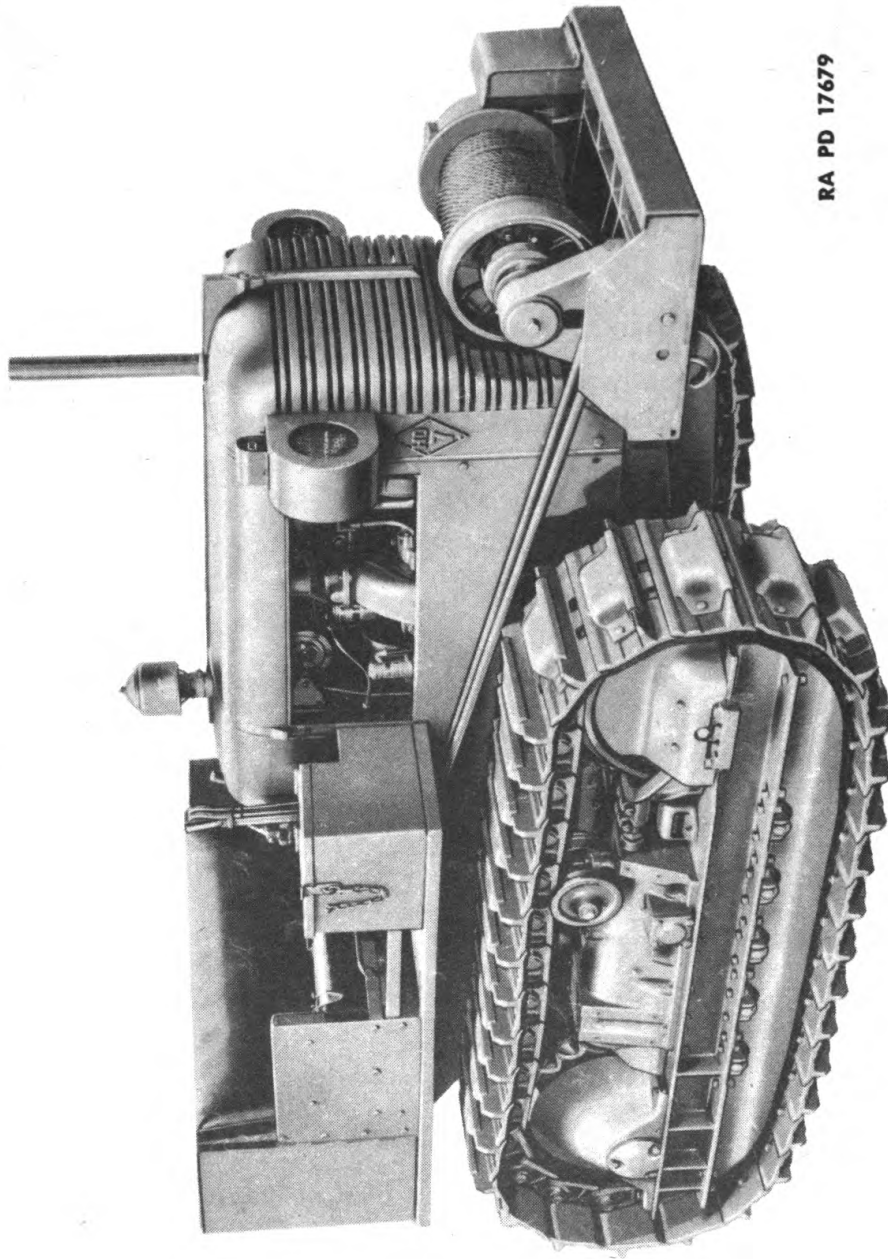
#### 2. ARRANGEMENT.

a. Part One consists of instructions for operating and caring for the vehicle. Part Two consists of instructions for making adjustments and other minor repairs. All instructions should be followed in detail to insure continuous reliable performance.

#### 3. REFERENCES.

a. A list of useful references is available in section XXV.

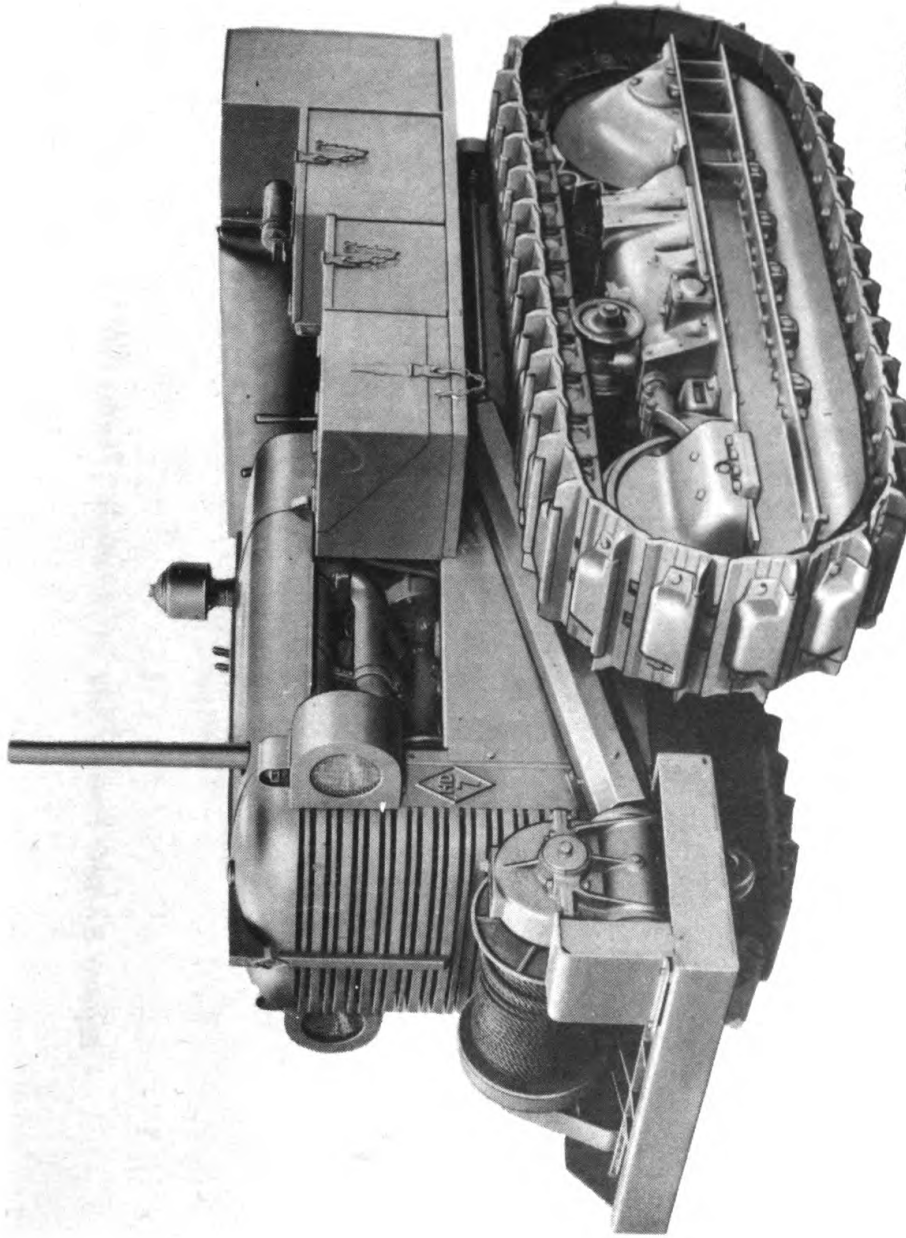
MEDIUM TRACTOR M1



RA PD 17679

Figure 1—Right Front View of Medium Tractor M1

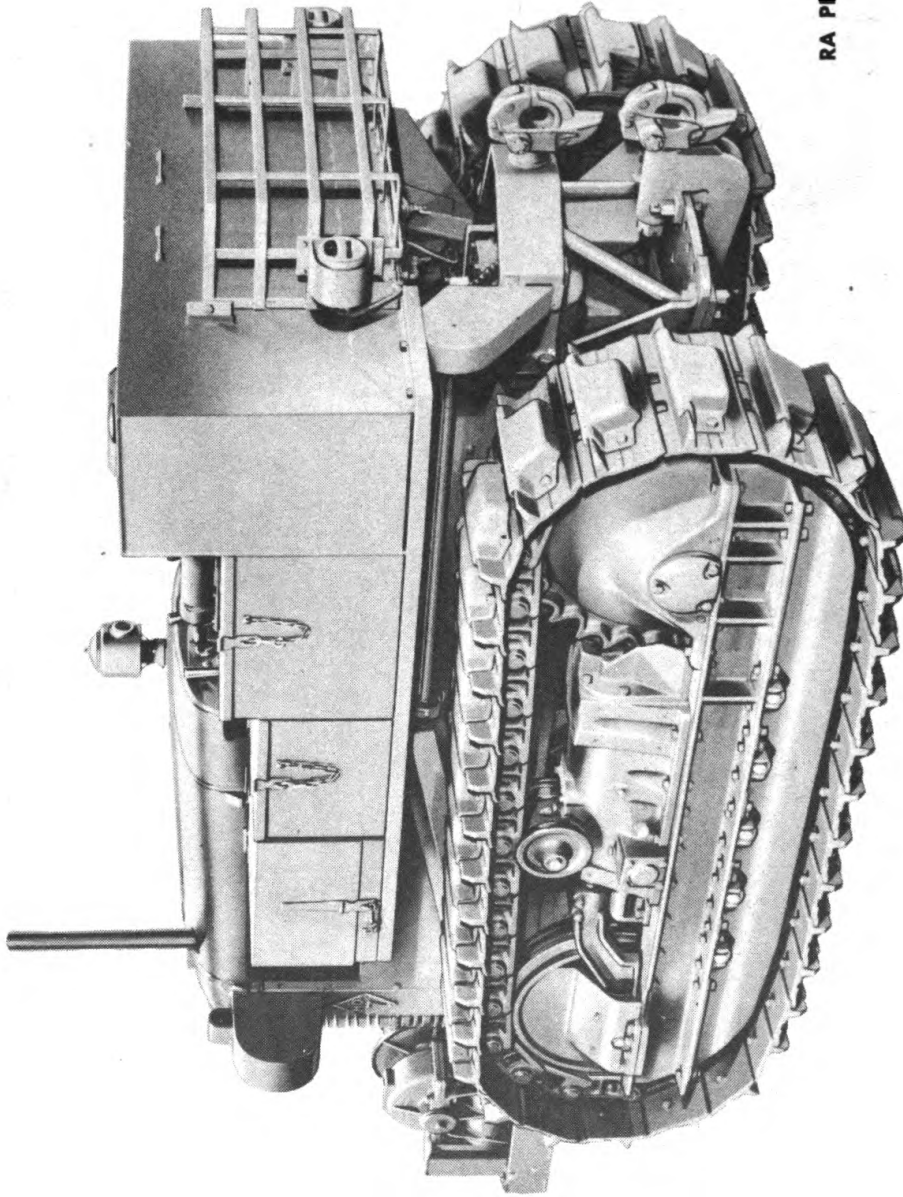
INTRODUCTION



RA PD 40725

**Figure 2—Left Front View of Medium Tractor M1**

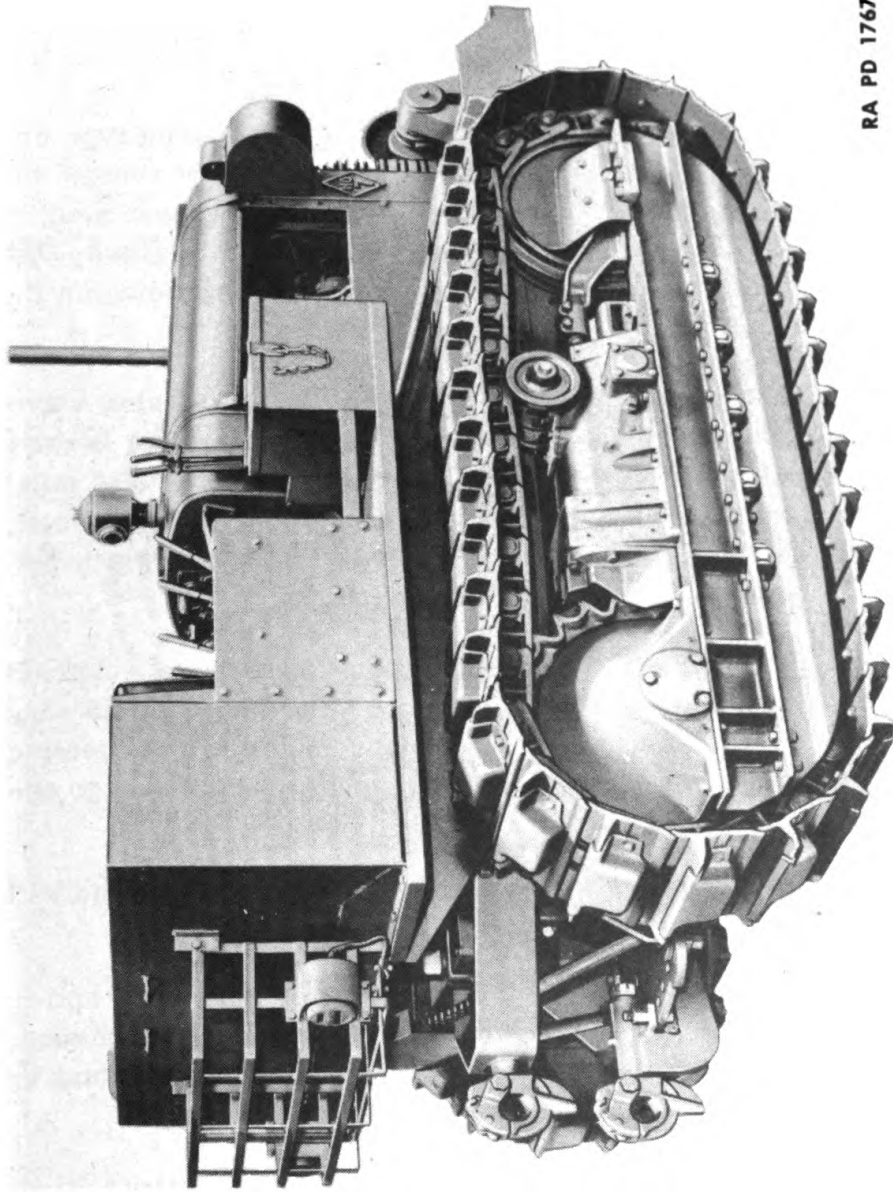
MEDIUM TRACTOR M1



RA PD 17678

Figure 3—Left Rear View of Medium Tractor M1

INTRODUCTION



RA PD 17672

**Figure 4—Right Rear View of Medium Tractor M1**



MEDIUM TRACTOR M1

Section II

DESCRIPTION AND TABULATED DATA

	Paragraph
Description .....	4
Tabulated data .....	5

4. DESCRIPTION (figs. 1 to 10).

a. **General.** This tractor is of the crawler or track-laying type and may be used for either highway or cross country travel even under the difficult operating conditions presented by mountains, swamps, sand, or unbridged ditches. Because of its relatively low center of gravity, the tractor can easily climb slopes as steep as 30 degrees depending on the kind of footing available and the load being pulled.

b. **Engine.** Power is supplied by a water-cooled, 3-cylinder, valve-in-head, 2-cycle Diesel engine. A multiple speed transmission is used, offering 4 forward speeds ranging from 2.64 miles per hour to 8.35 miles per hour and a reverse speed of 3.14 miles per hour at full throttle engine speed. The fuel tank has a capacity of 120 gallons which permits about 20 hours of operation without refueling.

c. **Steering.** Steering is accomplished by means of steering clutches operated by 2 levers mounted in the center of the tractor within easy reach of the operator. Each lever controls a multiple disk steering clutch through which power is delivered from the transmission to the drive sprockets.

d. **Seat.** The seat has removable cushions and safety straps and will accommodate the operator and one other man.

e. **Winch.** The winch is mounted on the front of the tractor and is driven by a reversible power take-off from the tractor transmission. A control lever for the power take-off is just ahead of the seat and in easy reach of the operator.

f. **Equipment.** Equipment on the tractor includes batteries, electric starter, generator, lights, mile meter (odometer), engine air heater and engine preheater for cold weather starting, fire extinguisher, snatch block, tow chain, and loose tools.

g. **Tractor and Engine Numbers.** The serial number of the tractor is stamped on the master clutch inspection cover, and also on the rear

DESCRIPTION AND TABULATED DATA

RA PD 17676

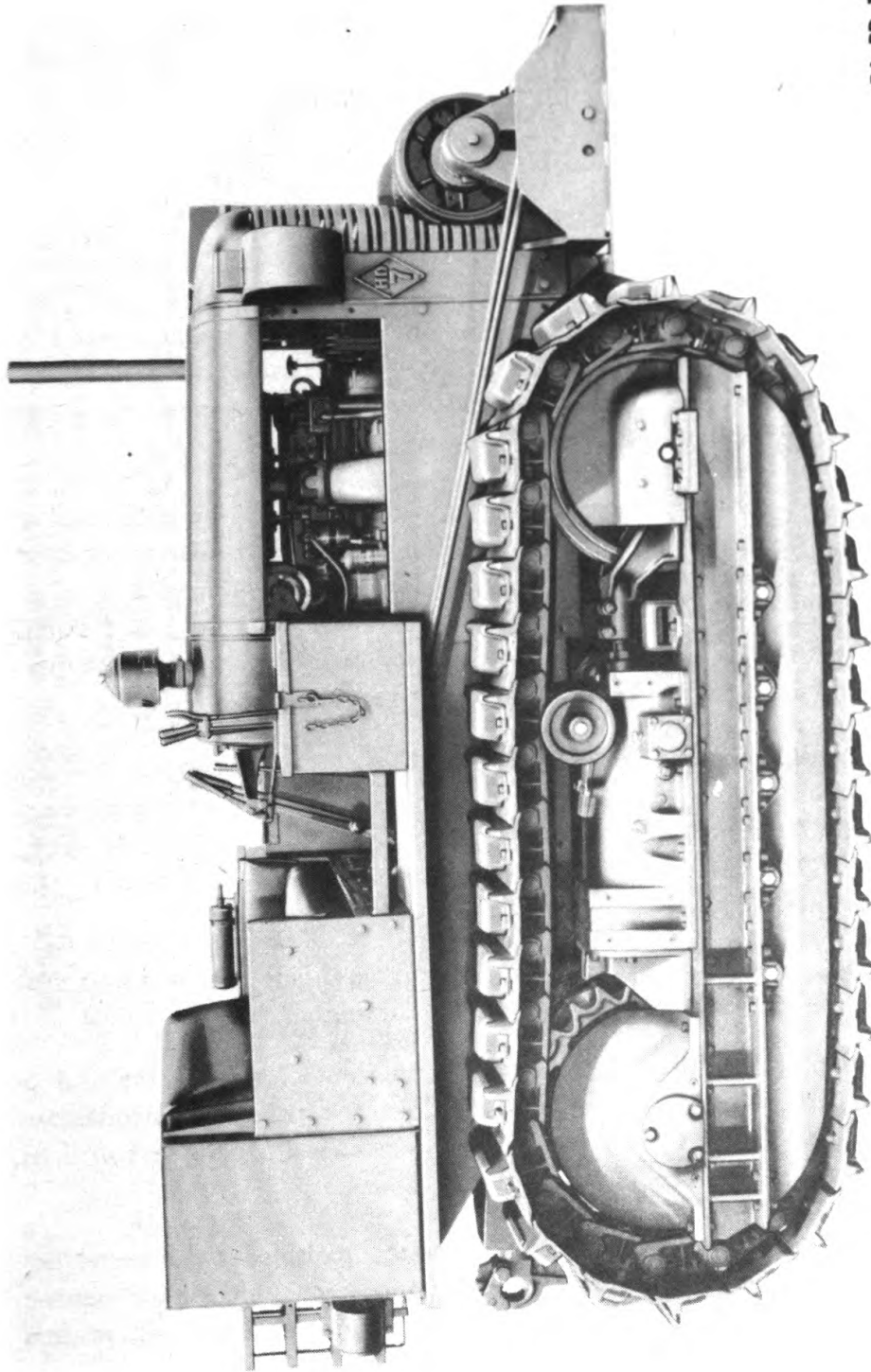
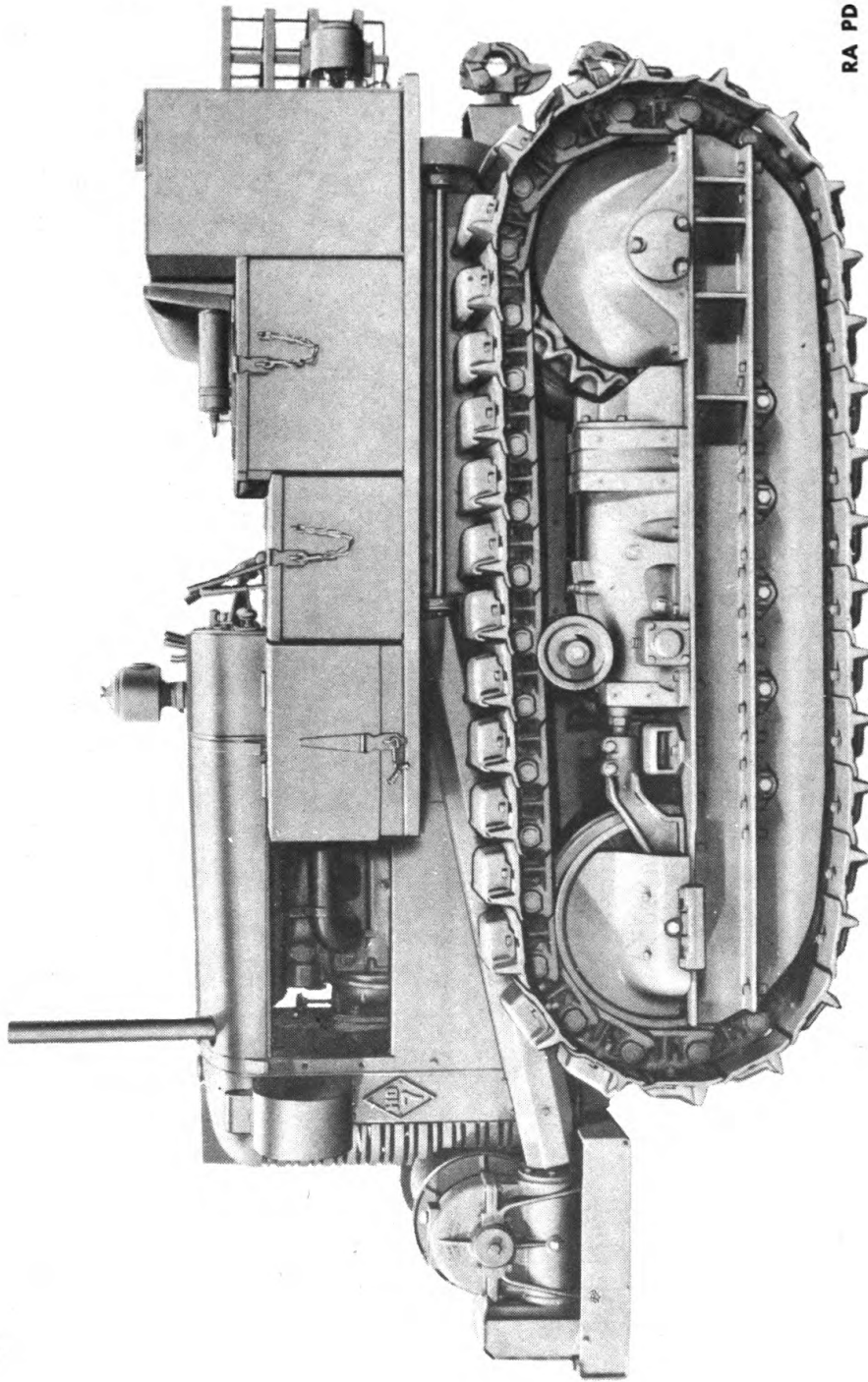


Figure 5—Right Side of Medium Tractor M1

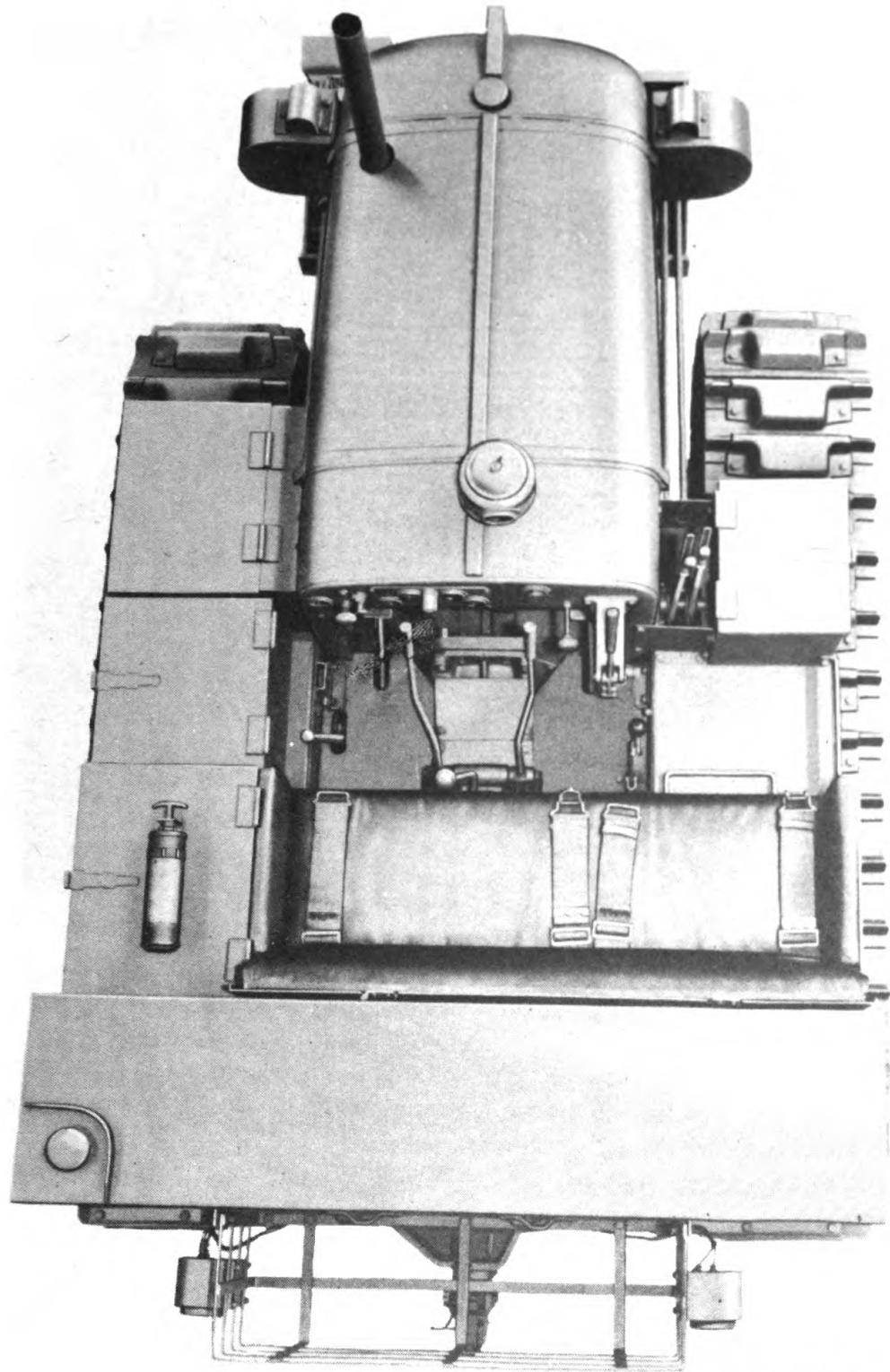
MEDIUM TRACTOR M1



RA PD 17677

Figure 6—Left Side of Medium Tractor M1

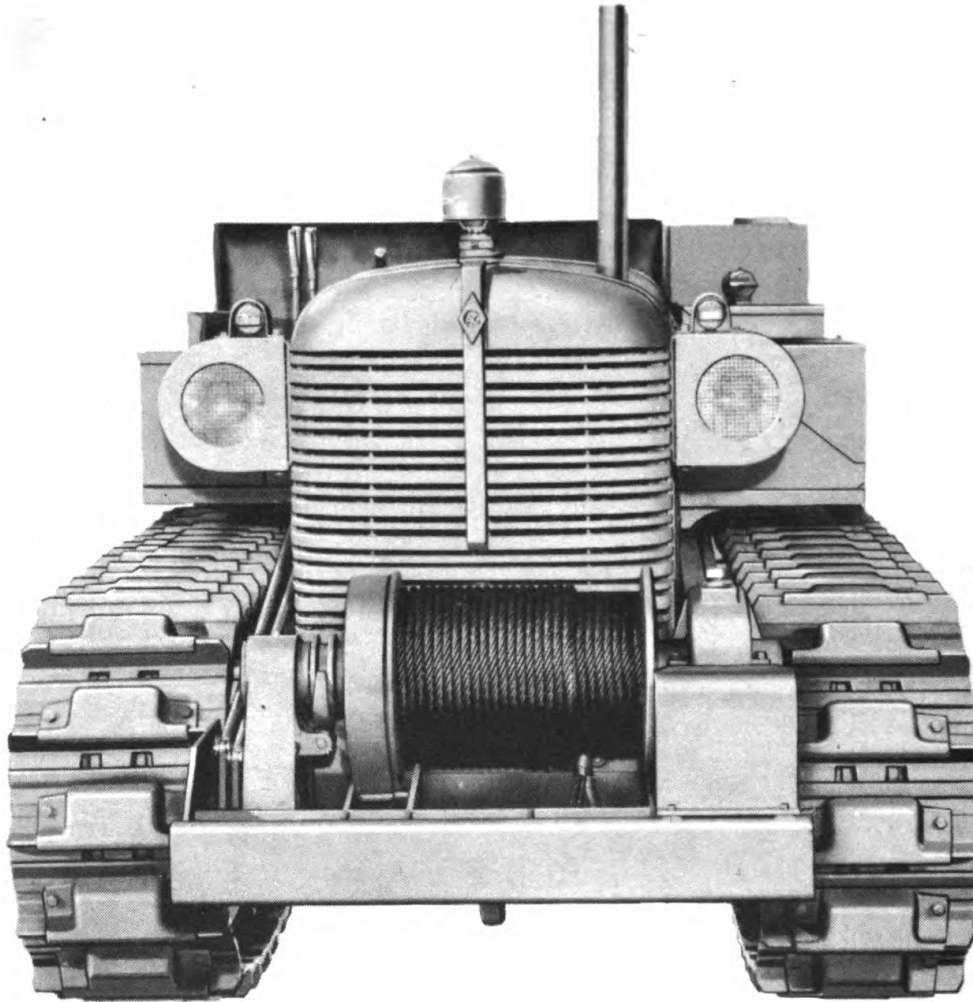
DESCRIPTION AND TABULATED DATA



RA PD 17673

**Figure 7—Top of Medium Tractor M1**

**MEDIUM TRACTOR M1**



RA PD 17674

**Figure 8—Front of Medium Tractor M1**

of the transmission case on the right side just below the top. The engine number can be found on a bronze plate on the right side of the engine in back of the governor.

**5. TABULATED DATA.**

**a. General.**

Maximum drawbar horsepower:

At 2,000 rpm (full throttle) . . . . . 63.9

At 1,750 rpm (throttle in "STOP" notch) . . . . . 61.6

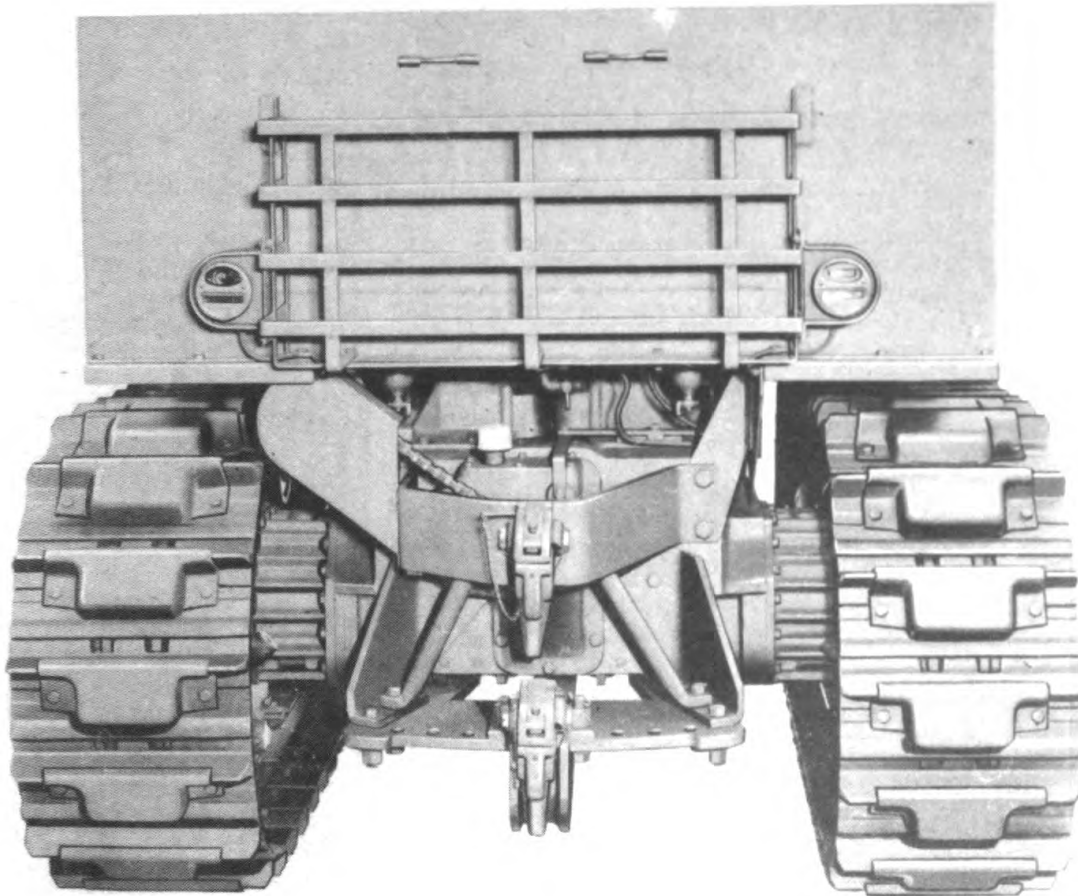
Maximum drawbar pull:

At 2,000 rpm (full throttle) . . . . . 9,310 lb

At 1,750 rpm (throttle in "STOP" notch) . . . . . 10,320 lb

Shipping weight (approx.) . . . . . 16,300 lb

DESCRIPTION AND TABULATED DATA



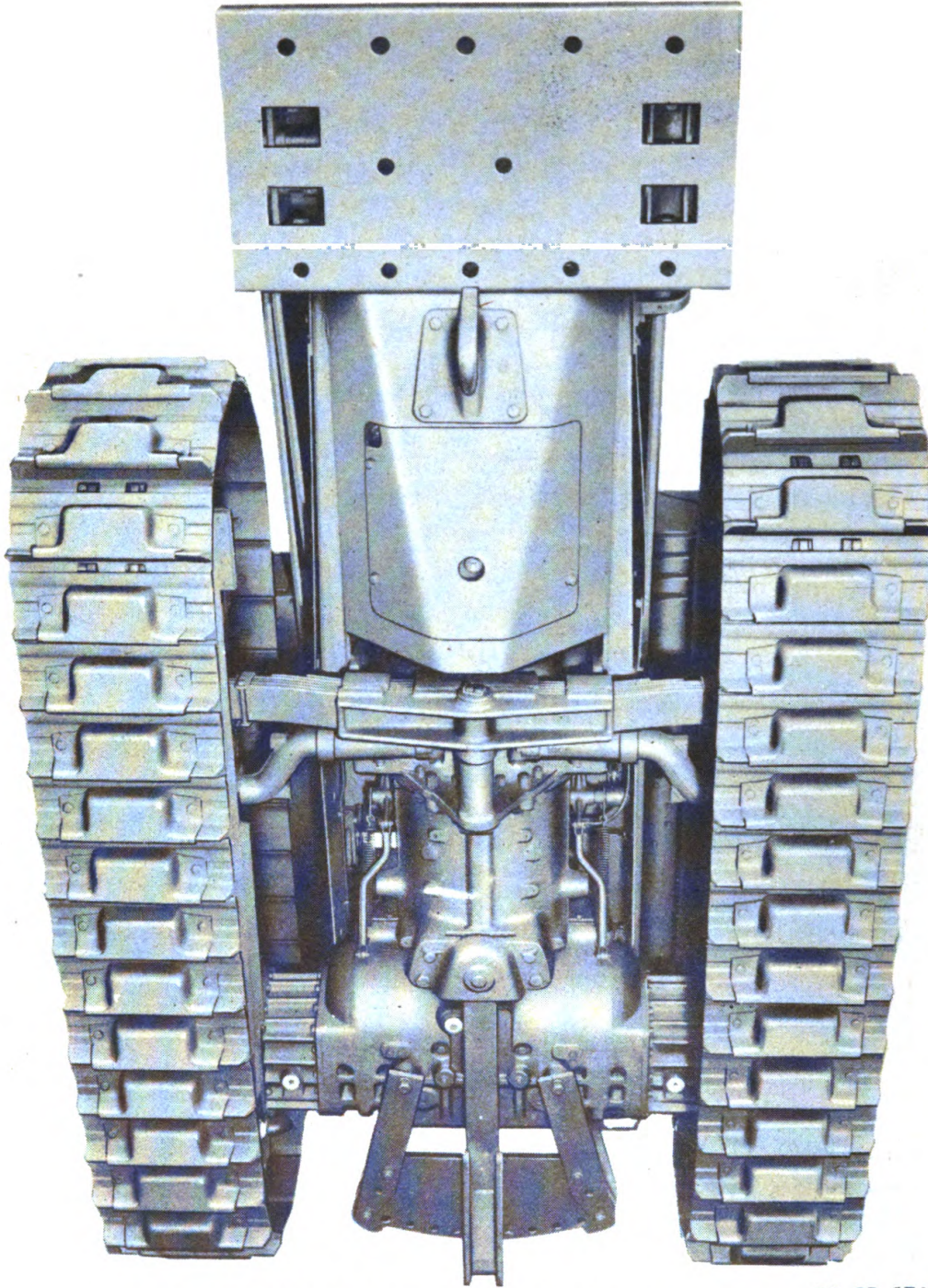
RA PD 17675

**Figure 9—Rear of Medium Tractor M1**

**b. Dimensions.**

Over-all length . . . . .	12 ft 1 in.
Over-all width . . . . .	6 ft 10 in.
Over-all height . . . . .	7 ft 2 in.
Tread width (center to center of tracks) . . . . .	5 ft 3 in.
Ground clearance . . . . .	10 <sup>3</sup> / <sub>8</sub> in.
Height of lower pintle . . . . .	18 <sup>9</sup> / <sub>16</sub> in.
Height of upper pintle . . . . .	31 <sup>1</sup> / <sub>16</sub> in.
Lateral movement of drawbar . . . . .	20 <sup>5</sup> / <sub>8</sub> in.
Turning radius . . . . .	8 ft 9 in.

**MEDIUM TRACTOR M1**



**Figure 10—Bottom of Medium Tractor M1**

RA PD 17484

**c. Performance.**

At 2,000 rpm (full throttle) (speeds and drawbar pull):

First gear .....	2.64 mph	9,310 lb
Second gear .....	3.66 mph	6,340 lb
Third gear .....	4.95 mph	4,260 lb
Fourth gear .....	8.35 mph	1,780 lb
Reverse gear .....	3.14 mph	

**DESCRIPTION AND TABULATED DATA**

At 1,750 rpm (throttle in "STOP" notch) (speeds and drawbar pull):

First gear	2.31 mph	10,320 lb
Second gear	3.21 mph	7,125 lb
Third gear	4.32 mph	4,920 lb
Fourth gear	7.32 mph	2,190 lb
Reverse gear	2.76 mph	
Maximum trench crossing (estimated)		3 ft
Maximum fording depth (at minimum speed):		
Without drain plugs in master clutch and steering clutch compartments		17 in.
With drain plugs in master clutch and steering clutch compartments		36 in.
Maximum grade ascending ability (estimated)		27 deg
Maximum grade descending ability (estimated)		30 deg
Allowable list (side slope) (estimated)		30 deg
Maximum vertical obstacle		17 in.

**d. Engine (General Motors 3-71 RC14).**

Number of cylinders	3
Firing order	1-3-2
Bore and stroke	4 <sup>1</sup> / <sub>4</sub> x 5 in.
Piston displacement (cu in.)	213
Rated speed (rpm at full throttle)	2,000
Rated speed (rpm throttle in "STOP" notch)	1,750
Rpm at maximum torque	800 to 1,200

**e. Steering.**

Method	Clutches
Number of friction surfaces (each clutch)	22
Total area of friction surfaces (each clutch, sq in.)	914.5

**f. Tracks.**

Length of track on ground	5 ft 7 in.
Ground contact area (sq in.)	2,412
Width of shoes	18 in.
Grouser height	2 in.
Number of track shoe bolts (per shoe)	4
Diameter of track shoe bolts	<sup>9</sup> / <sub>16</sub> in.
Diameter of track pins	1 <sup>9</sup> / <sub>16</sub> in.
Diameter of track pin bushings	2 <sup>5</sup> / <sub>16</sub> in.
Number of shoes per track	34
Ground pressure (approx. psi)	6.75
Type of bearings in truck wheels and idlers	Tapered roller or spherangular



MEDIUM TRACTOR M1

**g. Winch.**

Length of drum .....	18 in.
Diameter of drum .....	6½ in.
Length of cable .....	300 ft
Diameter of cable .....	5/8 in.
Maximum cable speed (bare drum) .....	38 fpm
Maximum pull .....	25,000 lb

**h. Power Take-off.**

Rpm at rated engine speed (maximum) .....	562
---	-----

**i. Capacities.**

Fuel tank (U. S. std gal) .....	120
Engine crankcase (U. S. std gal) .....	2¾
Cooling system (U. S. std gal) .....	5¾
Transmission case (U. S. std gal) .....	6½
Final drive case (U. S. std gal) .....	1¾
Track release spring housing (U. S. std gal) .....	1
Winch gear housing (U. S. std qt) .....	2½
Power take-off housing (U. S. std qt) .....	2

**Section III**

**OPERATING INSTRUCTIONS AND CONTROLS**

	Paragraph
Inspection of new tractor . . . . .	6
Prepare new tractor for use . . . . .	7
Prepare new batteries for use . . . . .	8
Operation of new tractor . . . . .	9
Engine starting instructions (temperature normal) . . . . .	10
Engine starting instructions (temperature 40 F to 0 F) . . . . .	11
Engine starting instructions (temperature below 0 F) . . . . .	12
Stopping engine . . . . .	13
Use of master clutch . . . . .	14
Transmission . . . . .	15
Steering . . . . .	16
Steering clutch brakes . . . . .	17
Steering downhill . . . . .	18
Operating in mud or water . . . . .	19
Use of winch and controls . . . . .	20
Parking vehicle . . . . .	21
Lighting system . . . . .	22
Hour meter . . . . .	23
Mile meter . . . . .	24

**6. INSPECTION OF NEW TRACTOR.**

a. Make a complete inspection for any shortage or damage which may have occurred while in transit or in storage.

**7. PREPARE NEW TRACTOR FOR USE.**

a. Remove the air cleaner oil bath cup to make sure it contains the correct amount and grade of oil (par. 69).

b. Inspect the oil level in the engine crankcase, transmission case, final drive gear cases, track release spring housing, winch gear housing, and power take-off housing.

c. Lubricate all other parts of the tractor with the grease prescribed in section IV with the exception of truck wheels, track support rollers, and front idlers. These require the grade of engine oil (*not Diesel oil*) prescribed in section IV and must be filled by means of a special flushing lubricator supplied with the tractor. These rollers have been filled with oil at the factory; but before tractor is put into operation, they should be thoroughly flushed and refilled to remove any metal particles which might remain from manufacturing operation and have loosened during

**MEDIUM TRACTOR M1**

shipment. Refer to topics on truck wheel, front idler, and support roller lubrication under section IV. **NOTE:** All lubrication points are painted red.

d. Check and fill fuel tank, if necessary, with the correct fuel oil. Special care must be taken to prevent the entrance of dirt or foreign materials while filling the tank.

e. Fill the cooling system with clean water. **CAUTION:** Remove the pipe plug (fig. 28) in the thermostat housing while filling cooling system. This allows the air to pass out of motor block while water is put in. Replace the plug when water comes out of the hole and finish filling. In winter weather, use a standard antifreeze solution in the cooling system. The solution should be tested daily and kept to the proper strength for the prevailing temperatures. The antifreeze used should have a higher boiling point than the engine operating temperature.

**8. PREPARE NEW BATTERIES FOR USE.**

a. The batteries shipped with the tractor contain dry plates but no electrolyte. Vent plugs are screwed in tight and must remain so until the cells are filled with electrolyte. Keep vent plugs and sealing disks tight until ready to prepare battery for service; then discard disks.

(1) Remove sealing disks, located on top or under vent plugs, and make certain ventholes in all plugs are open.

(2) Fill cells to  $\frac{3}{8}$  inch above separators with electrolyte of not warmer than 70 F. (Electrolyte is furnished with tractor.)

(3) Let battery stand one hour; then if liquid level has fallen, add electrolyte to restore level. Screw vent plugs in place. Wipe off any spillage.

(4) Charge battery for 16 to 20 hours at 14 amperes before placing in service. Use series charging (never a constant potential charger) for this initial charging.

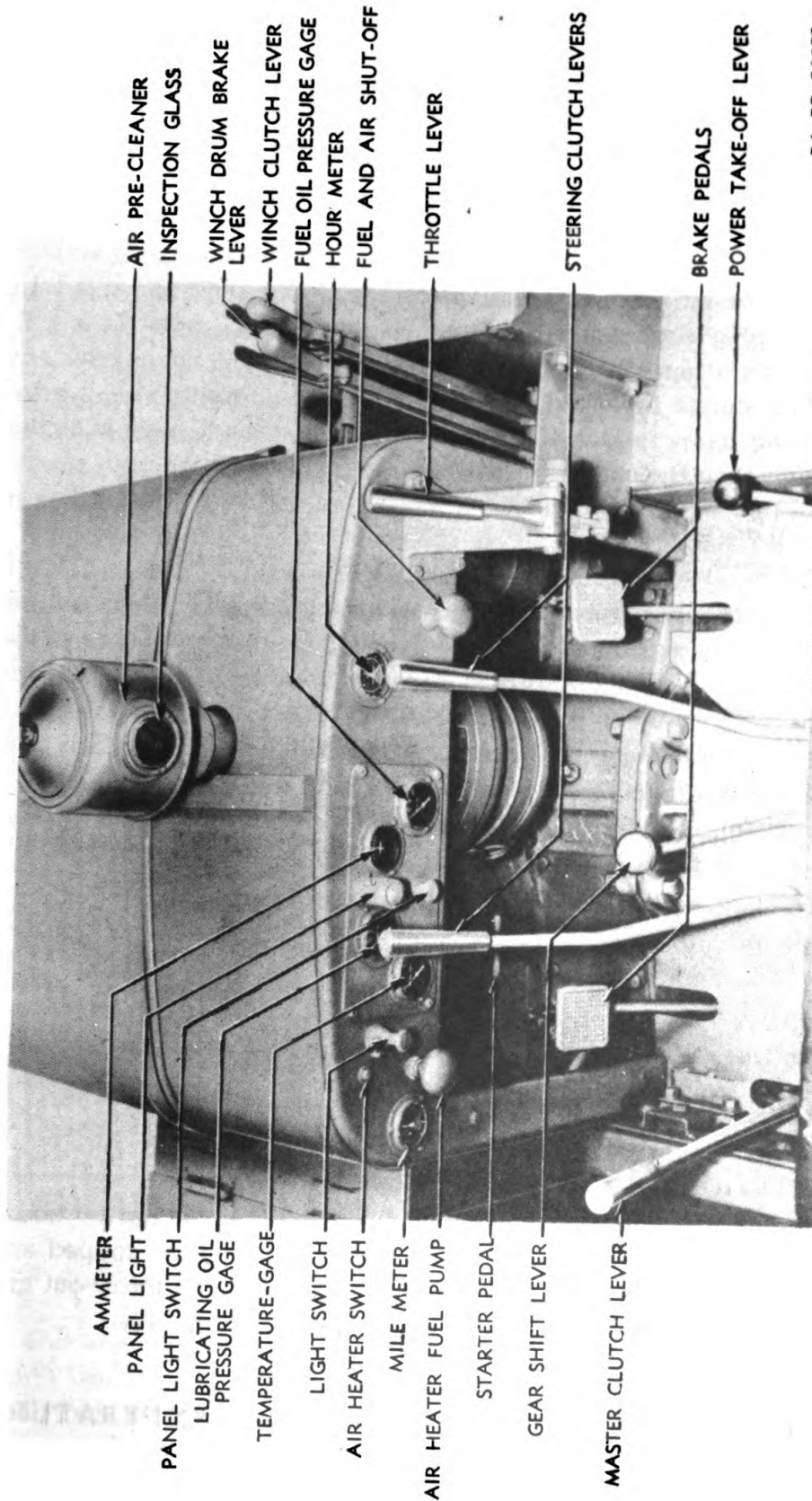
**9. OPERATION OF NEW TRACTOR.**

a. Operate a new tractor with a light load during the first 60 hours. After the first 10 hours of operation, the tractor should be stopped and inspected for loose bolts and nuts, and the steering clutch throw-out and the master clutch adjustments checked (pars. 104 b and 100).

**10. ENGINE STARTING INSTRUCTIONS (TEMPERATURE NORMAL).**

a. Figure 11 shows the operating controls and instruments.

### OPERATING INSTRUCTIONS AND CONTROLS



RA PD 56453

Figure 11—Operator's Controls

**MEDIUM TRACTOR M1**

b. Each time before starting engine, the operator should check the following points on the tractor:

- (1) Check fuel supply.
- (2) Check engine crankcase oil level.
- (3) Check water or antifreeze solution in cooling system.
- (4) Check entire unit for loose bolts and nuts. This is especially necessary when repairs have been made since the previous operating period.
- (5) Close radiator shutter by pulling back on shutter control lever.
- (6) Push fuel shut-off control forward.
- (7) Open throttle control to "STOP" notch. **CAUTION:** See that master clutch and power take-off are disengaged and gear shift lever is in neutral position.
- (8) Push starter pedal. As soon as engine fires and begins to run, close throttle to about  $\frac{3}{4}$  engine speed and allow engine to warm up. When engine temperature reaches 160 F, open radiator shutter; shutter should be adjusted so that an operating temperature of 160 F to 180 F is maintained at all times.
- (9) Check oil pressure. Oil pressure should be between 25 and 35 on the gage with engine running at full governed speed and heated to normal operating temperature. Pressure may drop to 5 on the gage when engine is idling. If the oil is cold, no pressure may register for about 15 seconds after the engine starts. If the pressure does not rise to between 25 and 35 under normal operating conditions, the engine should be stopped and the cause determined.
- (10) Check fuel pressure. Fuel pressure at full governed engine speed should be from 20 to 30 on the gage. Operate throttle to meet various operating conditions.

**11. ENGINE STARTING INSTRUCTIONS (TEMPERATURE 40 F TO 0 F).**

a. Engine can be started in temperatures of zero or a little below by using the air heater if both engine and batteries are in good condition and lubricating oil used is of the proper viscosity.

**b. Operation of Air Heater.**

- (1) Push fuel shut-off to its "IN" position and open throttle to "STOP" notch.
- (2) Release air heater fuel pump plunger by turning  $\frac{1}{4}$  to  $\frac{1}{2}$  turn counterclockwise.
- (3) Close air heater switch by pressing on the button at left side of dash, engage starter, and operate pump with smooth even strokes. *These three operations must be performed simultaneously* in order that practically all the fuel pumped through the air heater will be burned, reducing collection of raw fuel in the air box to a minimum. If the starter is not

**OPERATING INSTRUCTIONS AND CONTROLS**

used with the air heater, oxygen in the engine will soon be exhausted; then the flame will go out and raw fuel will be pumped into the engine. The air heater should be operated for a short period after engine starts to keep the engine operating smoothly.

**12. ENGINE STARTING INSTRUCTIONS (TEMPERATURE BELOW 0 F).**

a. In temperatures below zero, it may be necessary to use the engine preheater (fig. 13).

b. Install heater intake assembly on engine in place of one of the air box inspection covers if this has not been done previously (fig. 14). This intake elbow is divided into two parts by a baffle. The heater extension tube will fit into upper part. The lower opening is for exhaust of heater gases after circulation through the air box.

**c. Operation of Engine Preheater.**

(1) Remove filler plug and fill case about  $\frac{2}{3}$  full of fuel oil, the same as is used in the fuel tank of the tractor.

(2) Replace filler plug securely to prevent leakage.

(3) Close needle valve.

(4) Pump up to about 120 pounds pressure with hand pump.

(5) Close air regulator plate next to preheater fan.

(6) Plug heater fan wire into the socket on front of cowl which is directly connected to the battery. The heater fan should start immediately and run as long as the connection is maintained.

(7) Raise heater extension tube or spout, and open needle valve until a good spray or mist is ejected. Ignite spray with a match or other means. Then lower heater extension tube.

(8) Loosen wing nuts on the top of intake elbow and turn cover back. Place end of heater extension tube into intake elbow (fig. 14). Open air regulator plate. Heater will blow hot gases into engine air box and will circulate them around all cylinders. For the proper length of time to leave heater on, refer to the following chart:

Atmospheric Temperature	Leave Heater On
0 F	10 to 15 minutes
- 10 F	10 to 15 minutes
- 20 F	10 to 20 minutes
- 30 F	15 to 20 minutes
- 40 F	15 to 30 minutes

(9) After preheater has been in operation for the proper length of time, remove it, close needle valve and air regulator plate, remove plug

MEDIUM TRACTOR M1

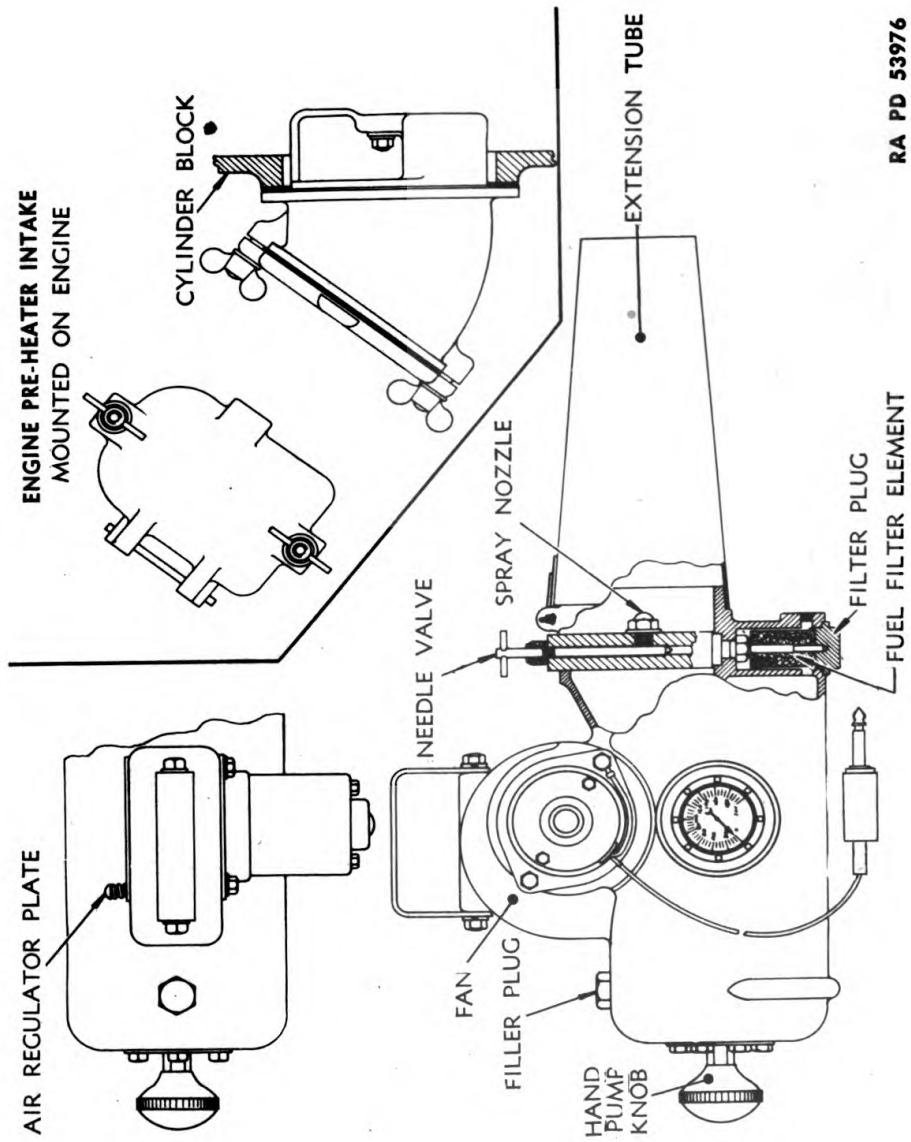
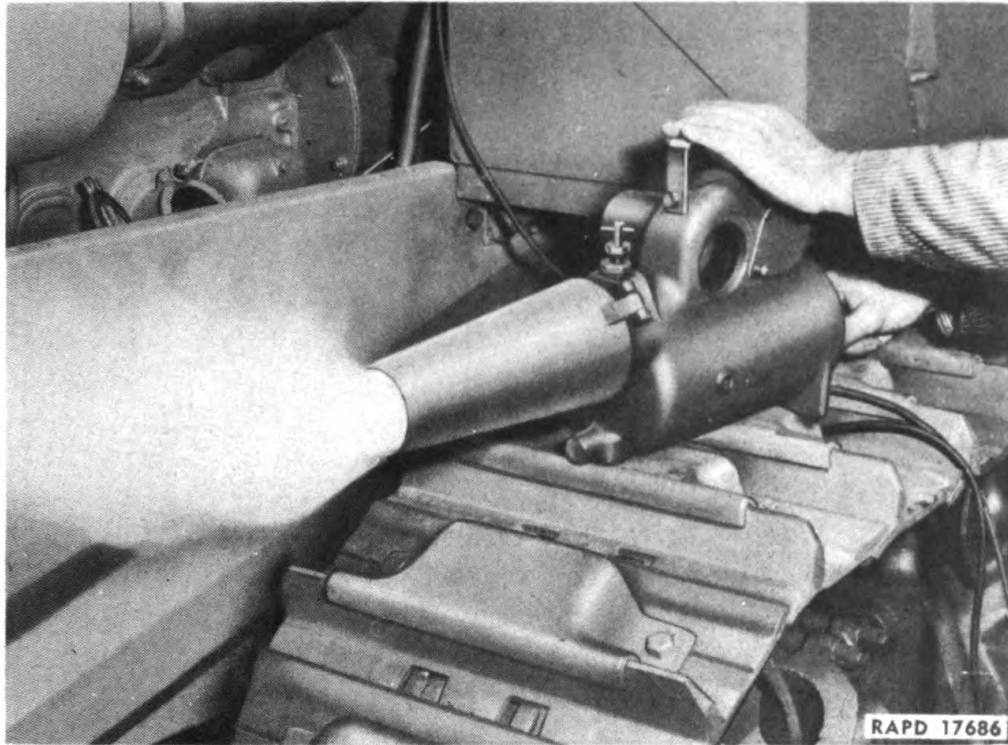


Figure 12—Engine Preheater

**OPERATING INSTRUCTIONS AND CONTROLS**



**Figure 13—Engine Preheater**

from socket, close cover on intake elbow and fasten it securely. Start the engine immediately using the engine air heater in the same manner as starting in mild cold weather conditions. **CAUTION:** Do not attempt to start the engine until the engine preheater has been removed and the intake cover has been securely replaced.

d. The engine preheater is used to warm up engine for easy cranking only and will not aid combustion by furnishing warm air to the cylinders. For this reason, it is necessary to use the engine air heater as this unit heats the cold air before it is drawn into the combustion chamber.

e. Place heater back in box on tractor.

**13. STOPPING ENGINE.**

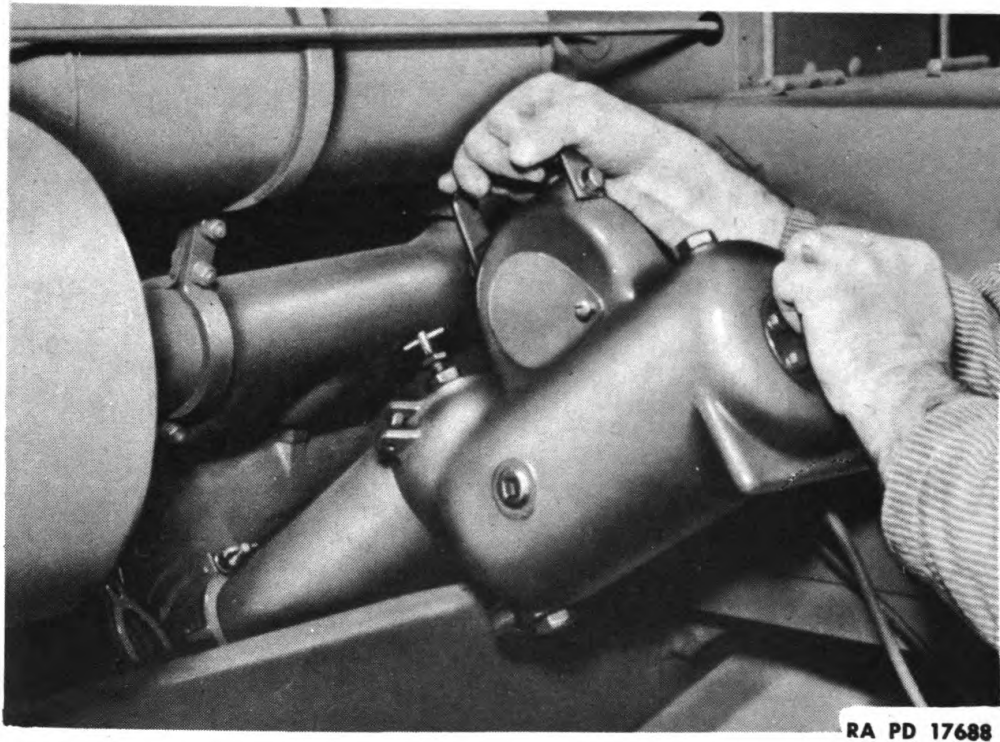
a. Close the throttle control and pull fuel shut-off control all the way out.

**14. USE OF MASTER CLUTCH.**

a. When the correct gears are engaged, open the throttle and pull back on master clutch lever steadily until all slack is taken up between tractor and load; then pull lever back quickly to full extent to lock clutch in its engaged position.



MEDIUM TRACTOR M1



**Figure 14—Engine Preheater in Use**

b. Do not slip the master clutch in an effort to pull an overload at high speeds. Avoid excessive wear on the clutch disk facings by shifting to a lower speed when necessary. Do not let engine idle except when necessary or with master clutch disengaged. If it is necessary to keep engine running when tractor is not in motion, shift gears into neutral and engage master clutch.

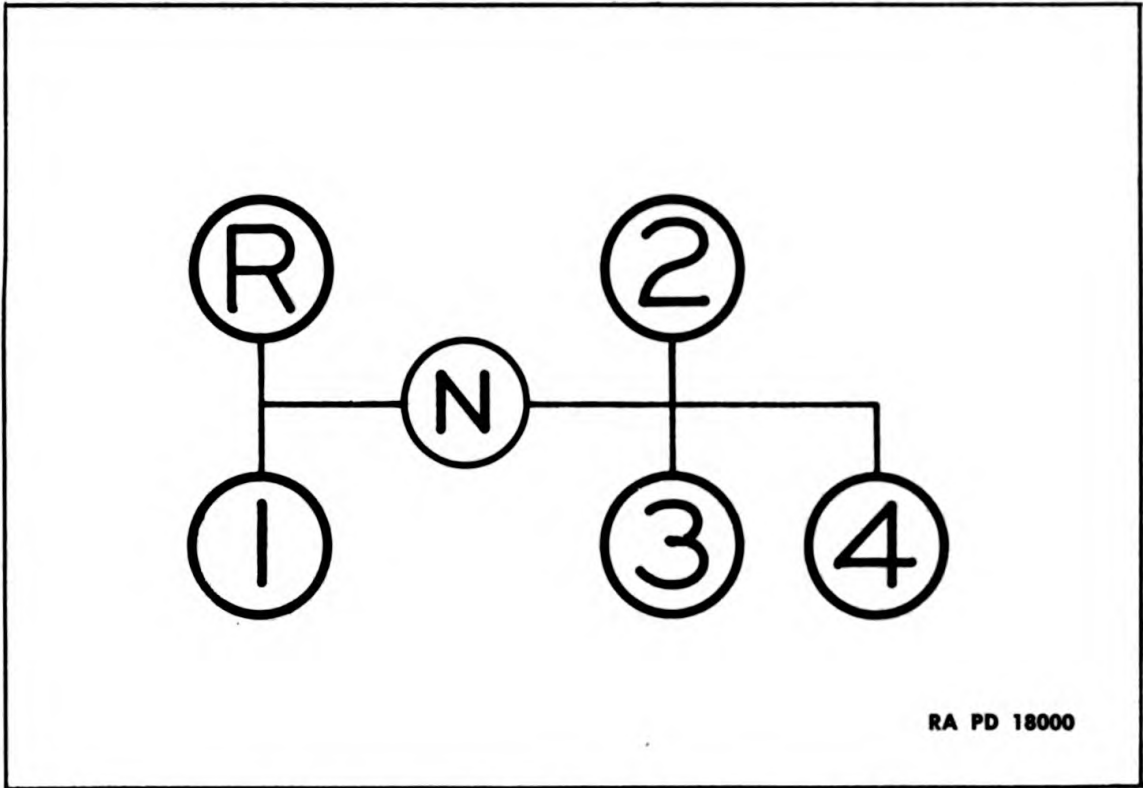
**15. TRANSMISSION.**

a. **Description.** The transmission has four forward and one reverse speeds.

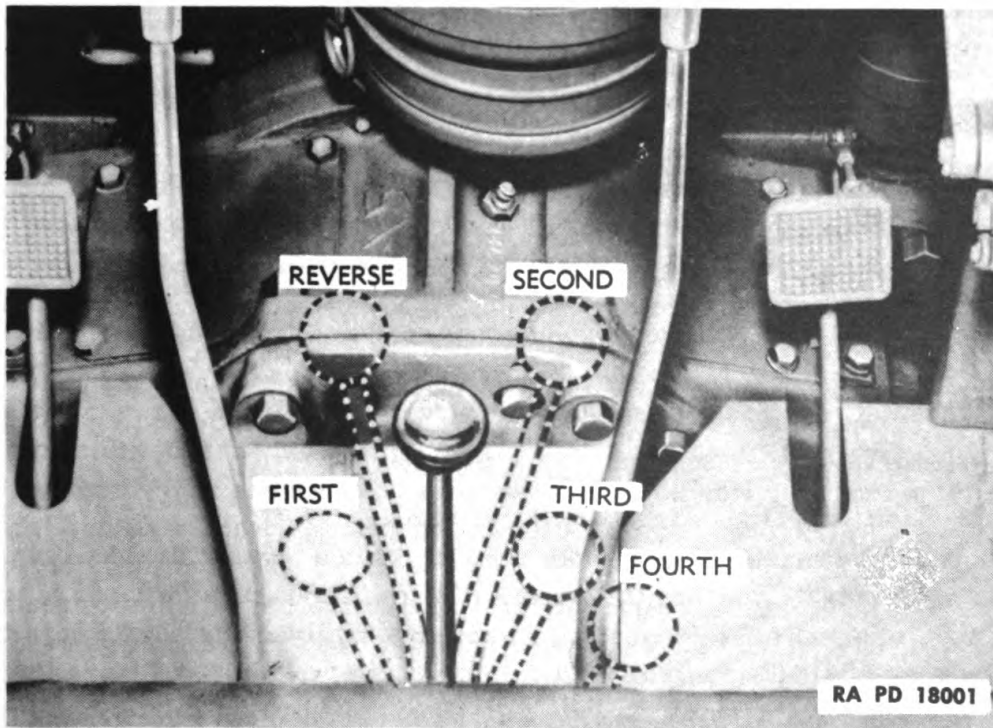
b. **Use of Gear Shift Lever.** The gear shift lever has 5 positions. The following illustrations (figs. 15 and 16), show the position of the gear shift lever to obtain any of the 4 forward speeds or reverse.

c. To shift gears, push master clutch lever forward and shift gears to the desired speed. When the master clutch lever is pushed forward, it forces the release bearing carrier against the clutch brake assembly fastened to the clutch shaft, thus bringing the transmission gears to a rapid stop. This quick stopping of the gears enables the operator to shift without clashing the gears. Once a speed has been selected and the tractor is in operation, further gear shifting should not be done until the clutch has been disengaged and the tractor stopped.

**OPERATING INSTRUCTIONS AND CONTROLS**



**Figure 15—Gear Shift Diagram**



**Figure 16—Gear Shift Lever Positions**

**MEDIUM TRACTOR M1**

d. **Care of Transmission.** The transmission requires little attention other than maintaining proper oil levels. Lubricating instructions are covered in section IV. The transmission case should be washed with OIL, engine, SAE 10, at the time the grease is changed. Fill to the proper level with the engine oil, operate the tractor in low gear for a few minutes, drain and lubricate.

**16. STEERING.**

a. Steering the tractor is accomplished by the use of steering clutches which are operated by steering levers to disconnect power from either track. Turn the tractor in the desired direction by pulling back to the full extent the steering lever on the side toward which the turn is to be made. This disengages the clutch on that side and should be done quickly and evenly to avoid excessive clutch wear. **CAUTION:** Do not release the levers and let them fly forward. Do not operate tractor with steering clutches partially disengaged. Avoid excessive wear of the steering clutches by releasing and engaging the steering clutches smoothly and completely.

**17. STEERING CLUTCH BRAKES.**

a. The steering clutch brakes are for retarding the speed or holding the track on the inside of the turn stationary when the steering clutch on that side is released for making the turn. Always release the steering clutch before depressing the brake when making a turn. The steering brakes are also used as service brakes for retarding the speed of the tractor when going down grade and to hold tractor stationary.

**18. STEERING DOWNHILL.**

a. In steering the tractor down steep grades with the load pushing the tractor, the use of the steering clutches is opposite to that of a tractor pulling a load. If it is desired to make a turn toward the right, the left steering clutch should be released. The engine being connected to the right track acts as a brake retarding its progress while the left track is released and free to travel faster.

b. If a shorter turn is desired when the load is pushing the tractor, apply the brake on the side opposite the side on which the clutch is released.

**19. OPERATING IN MUD OR WATER.**

a. The master clutch and steering clutch compartments are dry compartments and are provided with drain holes to drain out any oil that might leak into the compartments by overlubrication or other causes (fig. 10). In normal operation, these holes are to be left open. When operating in mud, water, or extreme dusty or sandy conditions, these drain holes should be plugged with the plugs provided with the tractor to prevent the entrance of dirt or water.

## OPERATING INSTRUCTIONS AND CONTROLS

b. Before driving the tractor into water, the operator should estimate what the maximum depth will be, the kind of footing the tractor will have for traction, and the length of time the tractor will be in the water. If the water is over 17 inches deep, and time permits, the 2 large pipe plugs should be installed in the 2 drain holes in the bottom of the transmission case. This will prevent water from getting into the steering clutch compartment. The small pipe plug should be installed in the drain hole of the master clutch compartment. With these plugs installed, the tractor is capable of operating in water up to a depth of about 35 inches. The ends of the fan blades when at the lowest point are 36 inches above the ground (measured from the tip of the grousers). As long as the fan blades do not hit the water, no damage will result. If the fan blades do hit the water, the angle of the blades is such that they will bend out and cut into the radiator.

c. In normal operation, the plugs should be removed daily to allow any oil or grease that might accumulate in the compartments to drain out, preventing it from getting on the brake bands or clutch facings. If the tractor is idle at night, the plugs may be removed to drain the compartments, then reinstalled in the morning. Inspect the final drives frequently, and drain, wash, and refill the case as often as the lubricant shows the presence of any mud or water.

d. The plugs used in the master clutch and steering clutch compartments should *always* be put in tractor tool box when removed to prevent loss and insure having them with tractor when needed again.

## 20. USE OF WINCH AND CONTROLS.

a. **To Attach Cable to Load.** With gearshift lever in neutral position and master clutch disengaged (lever pushed forward), engage winch clutch by pushing forward on outside lever on right fender. (It may be necessary to roll the winch drum slightly by pulling back lightly on the master clutch lever in order for the winch clutch jaws to engage.) Then pull the power take-off shift lever back until the lock on the lever engages in the front notch (unwinding position for unreeling cable from drum). Release the hand brake, engage the master clutch, and the cable will unreel from the drum. Unreel just enough cable so that the hook can be attached to the load and disengage the master clutch.

b. **To Pull Load.** After cable is attached, push power take-off control lever ahead until lock catches in rear notch (winding position). Set the foot brakes by pushing the brake pedals down hard and lock them by lifting up on pedal lock lever. Engage master clutch and cable will wind up and pull load. **NOTE:** Winch can be operated in either of 2 speeds by shifting the tractor auxiliary gear shift lever. In "DIRECT"

**MEDIUM TRACTOR M1**

position, of course, the winch runs at highest speed. In "INDIRECT" position, the winch runs at 44 percent of the speed when in "DIRECT" position and a corresponding increase in line pull is obtained. Use caution in engaging master clutch so that slack in cable will be taken up gradually to prevent cable breakage or excessive strain on winch. Always try to keep cable wound evenly and smoothly on the drum. Stop winch by disengaging master clutch. If load is to be moved a little at a time, cable will be held taut when master clutch is disengaged by the automatic safety brake on the winch worm shaft. If cable is tight when pull is completed, move tractor ahead to relieve strain so cable may be released. Wind cable up, release winch clutch, and pull power take-off control lever into neutral position (lock in middle notch). Set winch hand brake (inside lever on fender) by pushing it forward. **CAUTION:** Never pull out winch clutch when winch is under load.

c. **Winch Hand Brake.** This brake is used only to control the drum when reeling off cable by hand or if another machine is pulling on the cable to unreel it. **CAUTION:** Be sure winch clutch is disengaged if cable is unreeled in this way.

**21. PARKING VEHICLE.**

a. If tractor and trailer are to be parked, especially on a slope where there is a possibility of rolling, the tractor foot brake should be set by depressing pedals as far down as possible and lifting pedal lock levers to lock them in position.

**22. LIGHTING SYSTEM.**

a. The lighting control system on the tractor is designed to operate both the lights on the trailed vehicle and those on the tractor. Proper connections are located at the rear of the tractor.

b. **Light Switches.** The light switch at left of dash has three positions for turning on the various lights. When the knob is pulled out to the first stop, only the blackout lights are turned on. For regular service lights, the small button on the top of the switch must be pressed down and knob pulled out to the second stop. To use the stop light only, for day driving, press top button and pull knob full out. This light goes on automatically when the master clutch lever is pushed forward to disengage clutch.

c. The panel light is turned on by pulling out on knob marked "PANEL LIGHT." This will not light unless other lights have been turned on also.

d. Turn off all lights by pushing knobs all the way in.

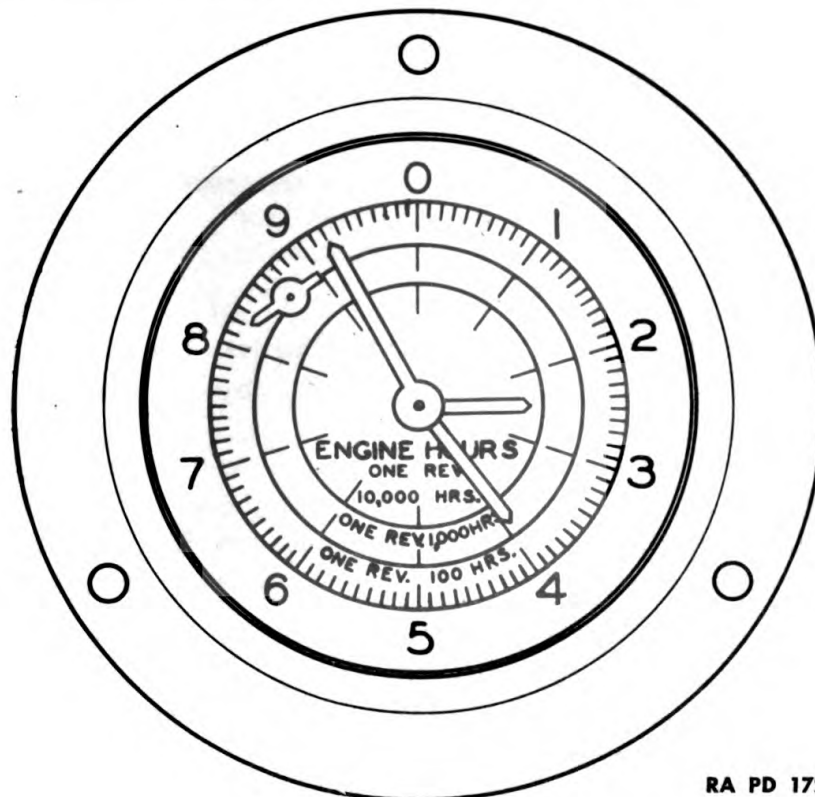
**OPERATING INSTRUCTIONS AND CONTROLS****23. HOUR METER (fig. 17).**

a. **Description.** This meter is electrically operated. A small automatic pressure switch is closed by oil pressure as soon as the engine is started and the oil pressure reaches 5 pounds. The small hand at the top left of the dial will then start rotating. This hand is to indicate when the meter is operating.

**b. How to Read Hour Meter.**

(1) The three hands in the center of the dial record the number of hours the tractor has operated and are of three different lengths. Total hours are determined by reading the number each hand has passed in the same way as we look at a clock to see which number the hour hand, the minute hand, and the second hand have passed and thereby tell the time.

(2) The shortest hand requires 1,000 hours of operation for it to pass each numeral or 10,000 for a complete revolution. As shown in illustration, it stands between "2" and "3," which indicates over 2,000 hours of operation. This indicates that the first numeral in the number of hours operated will be "2," followed by three other numerals indicated by the position of the other two hands which in turn show how many hours more than 2,000 that the tractor has operated.



RA PD 17214

**Figure 17—Hour Meter**

**MEDIUM TRACTOR M1**

(3) The middle length hand requires 100 hours of operation for it to pass each numeral or 1,000 hours for a complete revolution. In this illustration it stands between "3" and "4," which indicates over 300 hours that must be added to the 2,000. The second numeral then will be "3." Now observe the position of the longest hand to determine in the same manner how many hours must be added to the 2,300 indicated by the other two hands.

(4) This longest hand requires 1 hour of operation for it to pass each mark on the outer circle, 10 hours to pass each numeral or 100 hours for a complete revolution. Here it stands on the second mark past "9" which indicates 92 hours to be added to the 2,300 so that the correct meter reading is 2,392.

c. The small hand at top left of dial will continue to rotate for approximately a minute after engine is stopped or until oil pressure drops below 5 pounds.

**24. MILE METER.**

a. **Description.** This meter (odometer) is located at the left side of the dash. Distances traveled should be entered in log book for record purposes. The mile meter is driven by a flexible cable extending from the back of meter into the transmission case to a spur gear driven by a worm gear on the front end of the lower transmission shaft.

b. **How to Read Mile Meter.** Refer to paragraph 23 on reading of hour meter. The mile meter should be read in exactly the same way as the hour meter except that miles will be noted instead of hours.

## Section IV

### LUBRICATION

	Paragraph
General .....	25
Lubrication guide .....	26
Detailed lubrication instructions for using arms .....	27
Points to be serviced and/or lubricated by ordnance maintenance personnel only .....	28
Reports and records .....	29
Supplementary lubrication illustrations .....	30

#### 25. GENERAL.

a. The following lubrication instructions for the Medium Tractor M1 (Allis-Chalmers HD-7W) are published for the information and guidance of all concerned, and supersede all previous instructions.

#### 26. LUBRICATION GUIDE.

a. Lubrication instructions for all points to be serviced by the using arms are shown in lubrication guide, which specifies the types of lubricants required and the intervals at which they are to be applied.

#### 27. DETAILED LUBRICATION INSTRUCTIONS FOR USING ARMS.

a. Figures 18, 19, and 20 and accompanying notes give detailed lubrication instructions for using arm personnel.

#### 28. POINTS TO BE SERVICED AND/OR LUBRICATED BY ORDNANCE MAINTENANCE PERSONNEL ONLY.

a. **Water Pump.** The water pump is packed at assembly. If disassembled, clean and repack bearings with GREASE, ball and roller bearing.

b. **Starter.** Clean and repack all ball bearings with GREASE, special, high temperature.

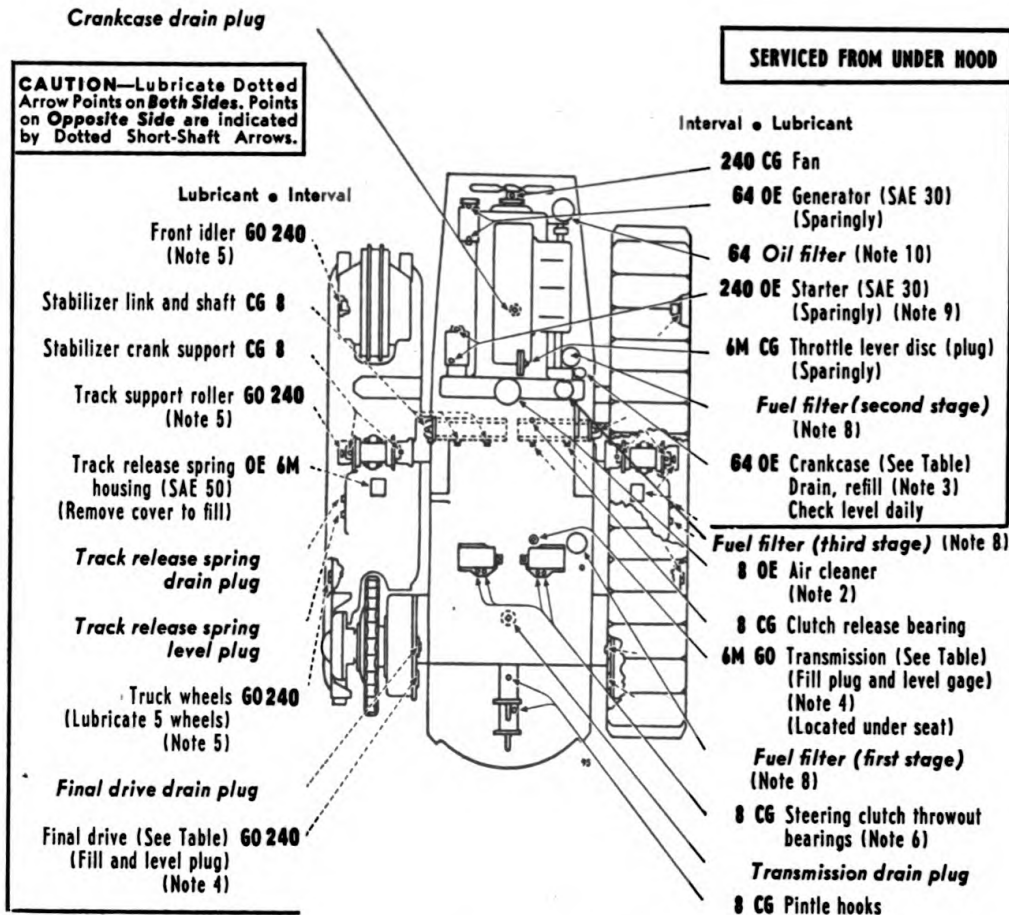
c. **Generator.**

(1) Clean and repack ball bearings with GREASE, special, high temperature.

(2) Coat pole and exposed armature shaft surfaces with OIL, engine, SAE 30, to prevent rusting.



MEDIUM TRACTOR M1



NOTE—See page 4 for lubrication of WINCH

KEY

LUBRICANTS	
<b>OE</b> —OIL, engine Crankcase grade (unless otherwise specified)	<b>CG</b> —GREASE, general purpose No. 0 (+32° to 0°)
<b>GO</b> —LUBRICANT, gear, universal	

INTERVALS
8— 8 HOURS
64— 64 HOURS
240—240 HOURS
6M—6 MONTHS
<b>CHECK DAILY</b> Crankcase Air cleaner

TABLE OF CAPACITIES AND LUBRICANTS TO BE USED

	CAPACITY (APPROX.)	ABOVE +32°	+32° to 0°	BELOW 0°
CRANKCASE	11 QTS.	OE SAE 30	OE SAE 10	REFER TO SECT. XXIII
TRANSMISSION	26 QTS.	GO SAE 90	GO SAE 80	
FINAL DRIVE (EACH UNIT)	4 QTS.			

RA PD 56451

Figure 18—Lubrication Guide

## LUBRICATION

### Additional Lubrication and Service Instructions on individual Units and Parts.

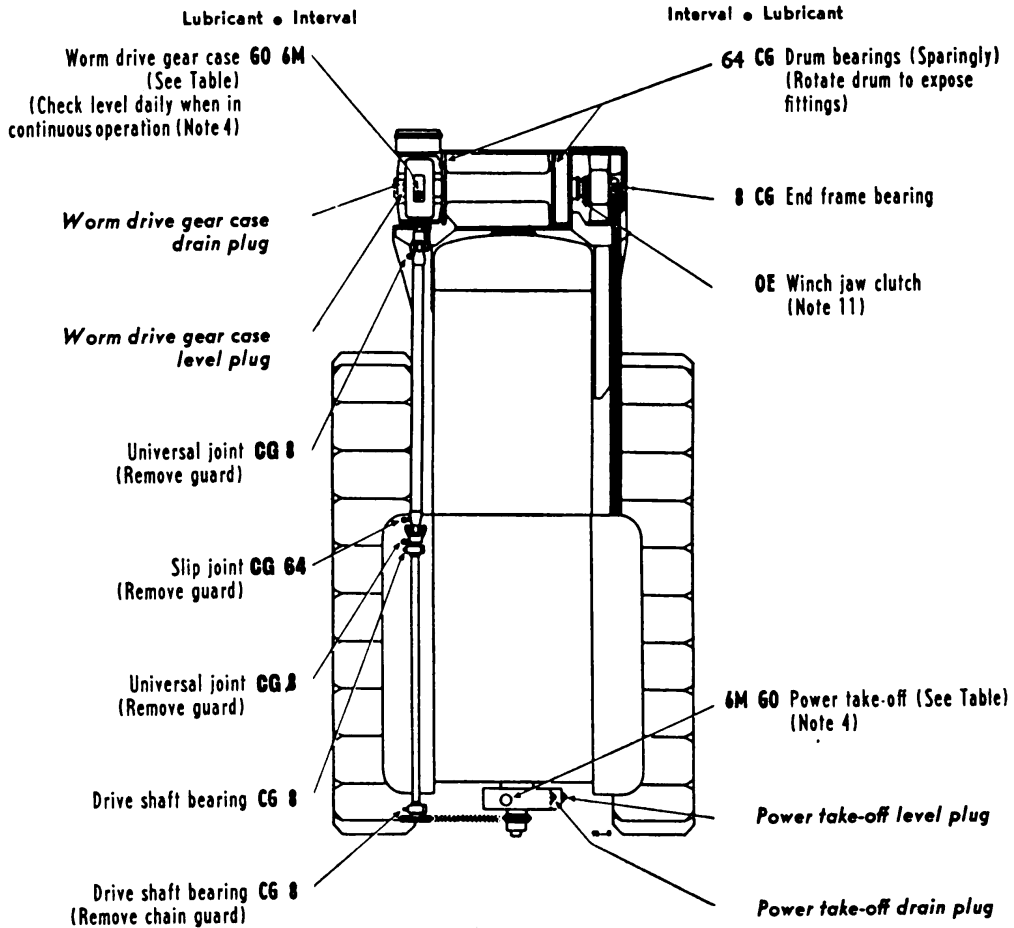
#### COLD WEATHER: For Lubrication and Service below 0°, refer to Section XXIII.

1. **FITTINGS** — Clean before applying lubricant. (Winch fittings only) Lubricate until new lubricant is forced from the bearing, unless otherwise specified. CAUTION: Lubricate after washing tractor.
2. **AIR CLEANER** — Every 8 hours, check level. Every 8 to 30 hours, depending on dust conditions, clean and refill to circular level mark with used crankcase oil or OE, crankcase grade. Twice a year, remove entire air cleaner, wash and reoil. Clean air pipes and reassemble. Keep all connections tight. Every 8 hours or more frequently if required, empty precleaners. CAUTION: Do not allow dirt level to rise above top of glass.  
Proper maintenance of air cleaners is essential to prolonged engine life.
3. **CRANKCASE** — Drain only when engine is hot. Refill to FULL mark on gage. Run engine a few minutes and recheck oil level. CAUTION: Be sure pressure gage indicates oil is circulating. See Table.
4. **GEAR CASES** — Weekly, check level with tractor on level ground and, if necessary, add lubricant to correct level; also make visual inspection for leakage and report leakage to Ordnance Maintenance Personnel. Drain, flush and refill as indicated at points on guide. When draining, drain immediately after operation. Every 64 hours, clean and reoil gauze in power take-off fill pipe with OE, crankcase grade.  
To flush, fill cases to about one-half capacity with OE, SAE 10. Operate mechanism within cases slowly for several minutes and drain. Replace drain plugs and refill cases to correct level with lubricant specified on guide. CAUTION: Bearings on the upper power take-off shaft are splash lubricated. If the tractor is used with the power take-off disengaged, these bearings will receive no lubrication. Power take-off should be engaged at least once a day and operated for a few minutes to insure that these bearings receive lubrication.
5. **TRACK SUPPORT ROLLERS, IDLERS AND TRUCK WHEELS** — Remove plugs and flush with GO, transmission grade. CAUTION: Service front idlers with 5 strokes each, track support rollers with 3-1/2 strokes each and truck wheels with 4 strokes each, using AC flushing lubricator.
6. **STEERING CLUTCH THROWOUT BEARINGS** — To reach fittings, remove driver's seat and tool box.
7. **ENGINE AND STEERING CLUTCH COMPARTMENTS** — Daily, after using tractor remove plugs to drain accumulated oil. Replace plugs. CAUTION: Be sure that plugs are in place when operating in deep mud or water.  
Steering clutches and master clutch — Washing of clutch units about every 240 hours is essential to efficient operation. Use the following procedure: Lubricate throwout bearings until they are filled. Install plugs in drain holes of steering clutch compartment. Fill compartment with 5 gal. of SOLVENT, dry-cleaning, bringing level to about 4 in. below steering clutch shaft. Start engine and run tractor back and forth for several minutes without releasing steering clutches. Stop tractor and drain each compartment. Replace plugs and refill with same amount of clean SOLVENT, dry-cleaning. Operate tractor with no load for 5 minutes, releasing both steering clutches as often as possible. Drain and permit clutches to dry. Lubricate clutch throwout bearings and mechanism. Drain, flush and refill final drive compartments with GO as specified on Lubrication Guide.
8. **FUEL FILTERS** — First stage fuel filter located under seat; second stage filter on dash; third stage filter on engine. Every 300 to 500 hours, depending on operating conditions, remove and renew elements. Keep gaskets around the filter shells in good condition. Daily, open drain cocks to remove sediment and water.
9. **STARTER** — If removed, lubricate outboard bearing through oiler with OE, SAE 30.
10. **OIL FILTER** — At each crankcase oil change, clean the oil filter. After cleaning filter, refill crankcase to FULL mark on gage. Run engine a few minutes and recheck oil level.  
To clean, remove drain plug in filter base and drain filter body. Remove nut from top of filter body and lift off center shell. Remove filter elements. Wash elements in SOLVENT, dry-cleaning, being careful not to scratch or distort elements. Dry all parts and reassemble filter.
11. **WINCH JAW CLUTCH** — If sliding clutch sticks, wash and reoil with OE, crankcase grade.  
When operating in dusty or muddy conditions, the sliding jaw clutch must be cleaned frequently and oiled with OE, crankcase grade, to insure smooth operation.
12. **OIL CAN POINTS** — Every 60 hours, lubricate control shafts and clevises with OE, crankcase grade.
13. **POINTS REQUIRING NO LUBRICATION SERVICE** — Water pump, tracks, clutch, pilot bearing, chain.

RA PD 56451B

### Figure 19—Notes for Lubrication Guide

MEDIUM TRACTOR M1



KEY

LUBRICANTS	
OE—OIL, engine Crankcase grade	CG—GREASE, general purpose No. 1 (above +32°) No. 0 (+32° to 10°)
GO—LUBRICANT, gear, universal SAE 90	

INTERVALS
8—8 HOURS
64—64 HOURS
6M—6 MONTHS

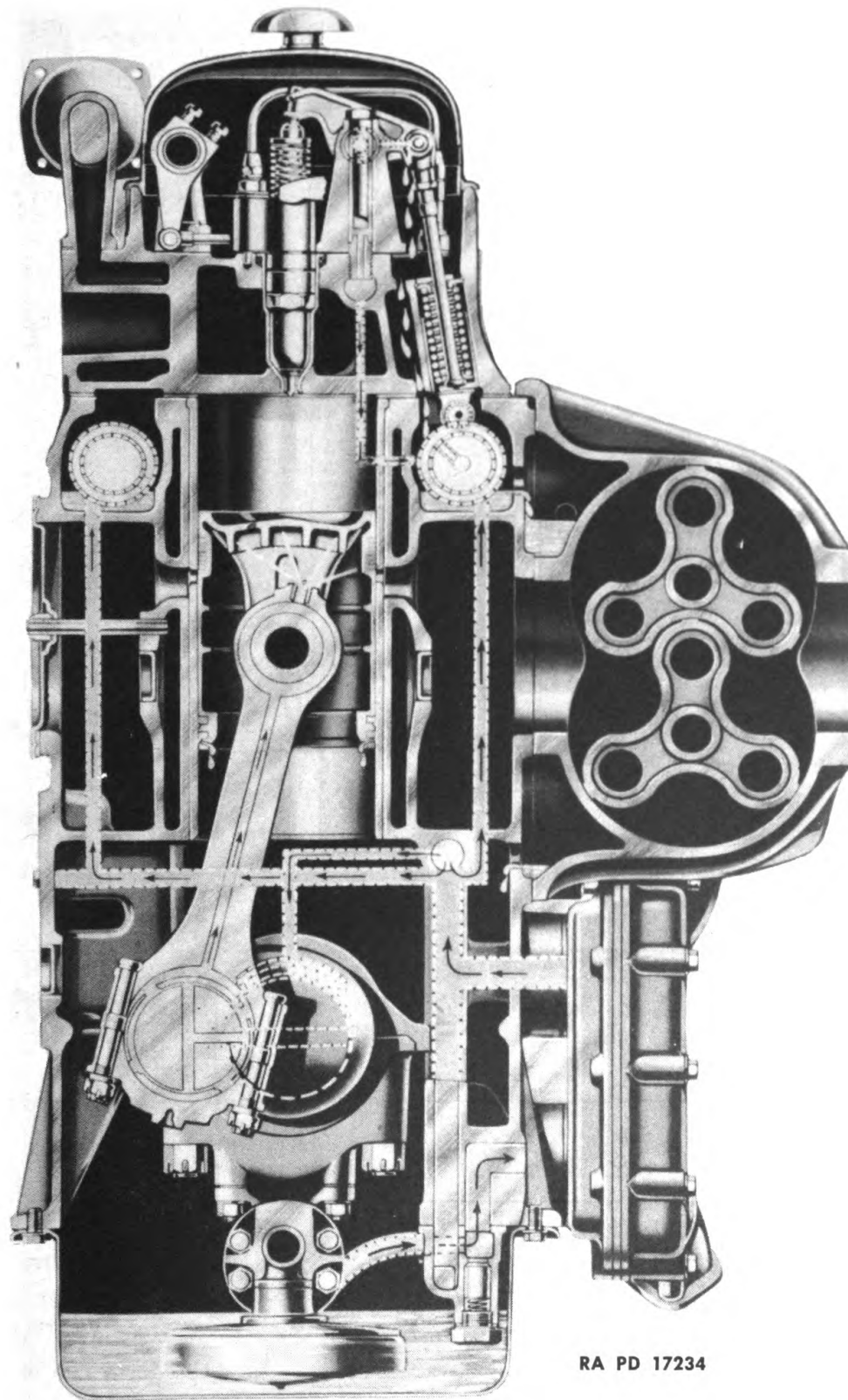
TABLE OF CAPACITIES AND LUBRICANTS TO BE USED

	CAPACITY (APPROX.)	ABOVE +32°	+32° to 0°	BELOW 0°
POWER TAKE-OFF	1-3/4 QT.	GO	GO	REFER TO
WORM DRIVE GEAR CASE	4 QT.	SAE 90	SAE 90	SECT. XXIII

RA PD 56452

Figure 20—Lubrication Guide

LUBRICATION



RA PD 17234

**Figure 21—Engine Lubrication**

MEDIUM TRACTOR M1

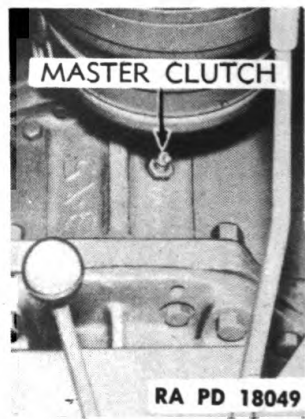
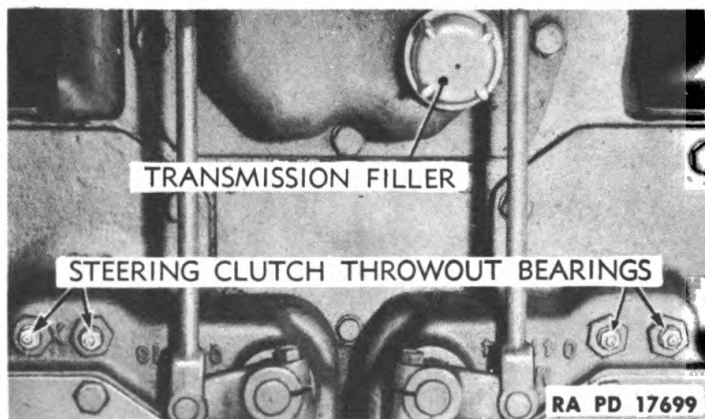
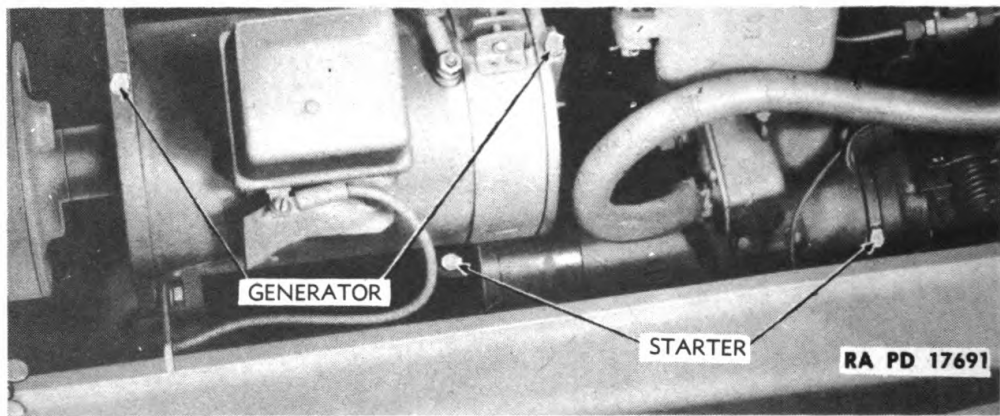
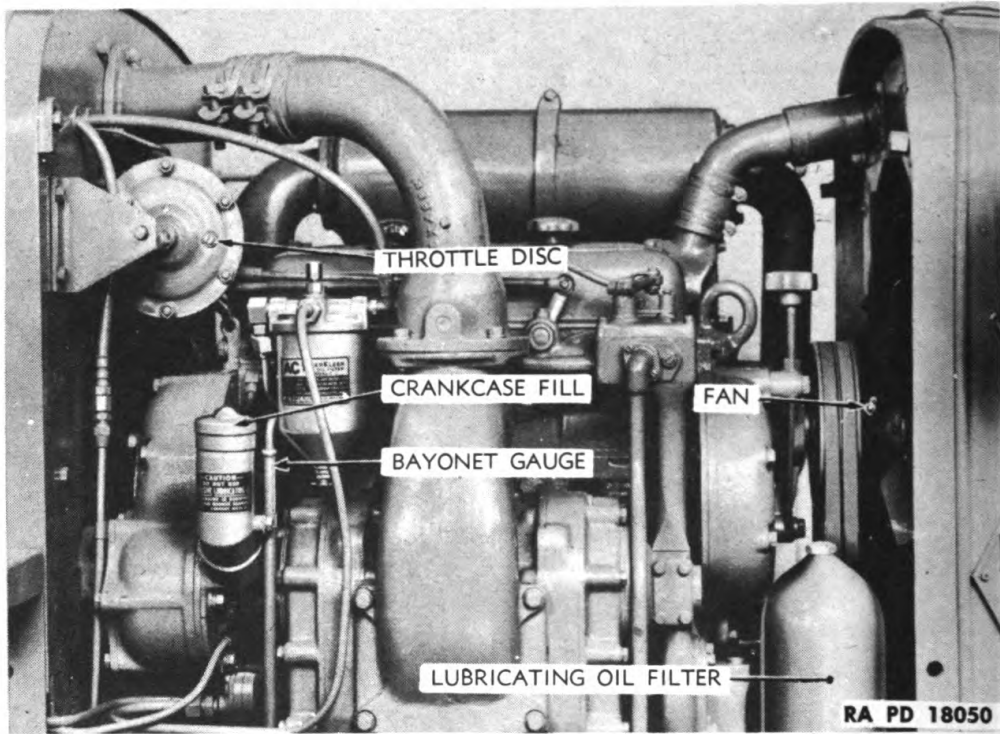
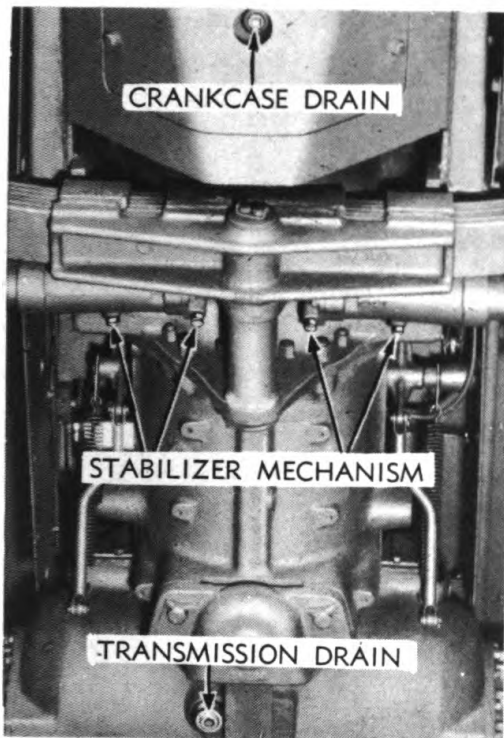
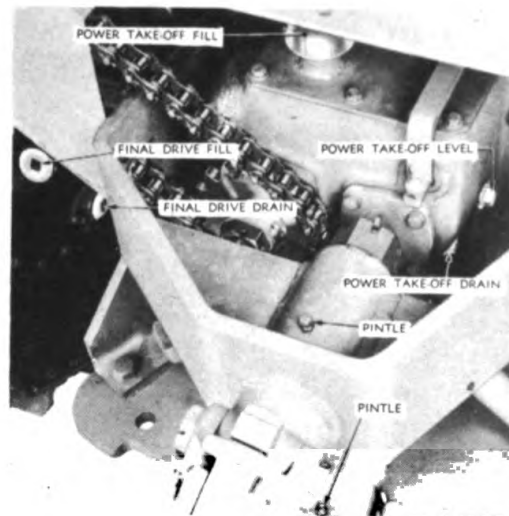


Figure 22—Lubrication Fittings

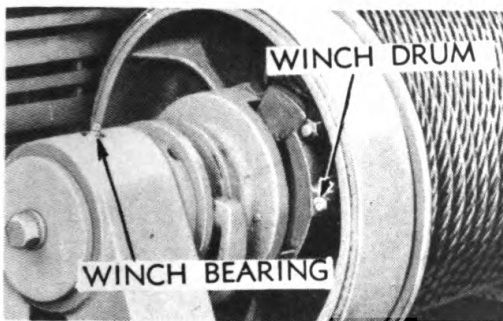
LUBRICATION



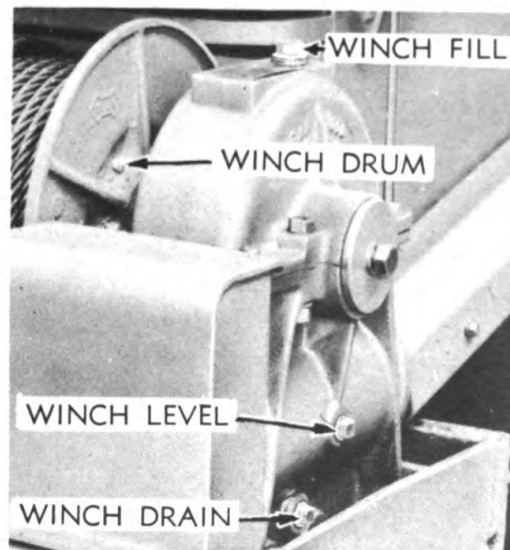
RA PD 18058



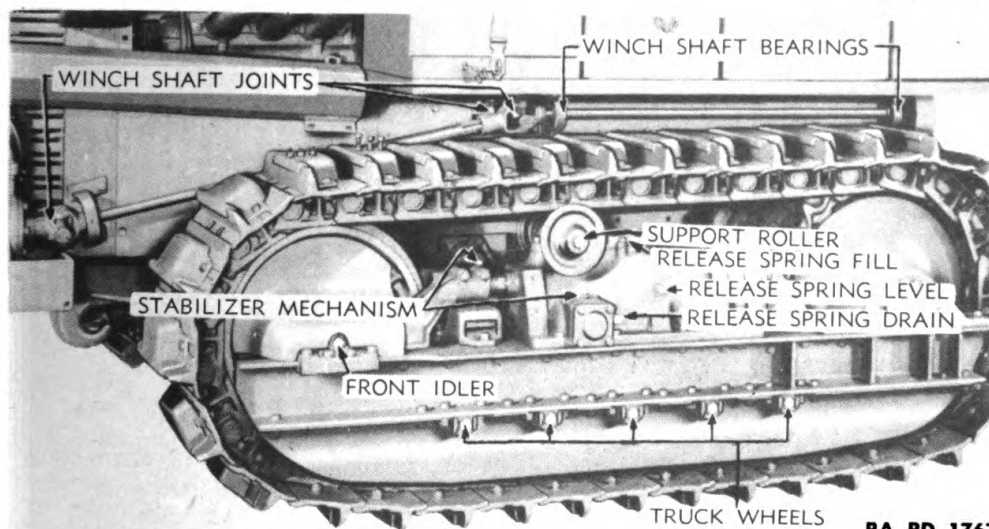
RA PD 17628



RA PD 17668



RA PD 17666



RA PD 17671

Figure 23—Lubrication Fittings

Generated on 2013-09-04 10:43 GMT / http://hdl.handle.net/2027/uc1.b3243756  
Public Domain, Google-digitized / http://www.hathitrust.org/access\_use#pd-google

MEDIUM TRACTOR M1

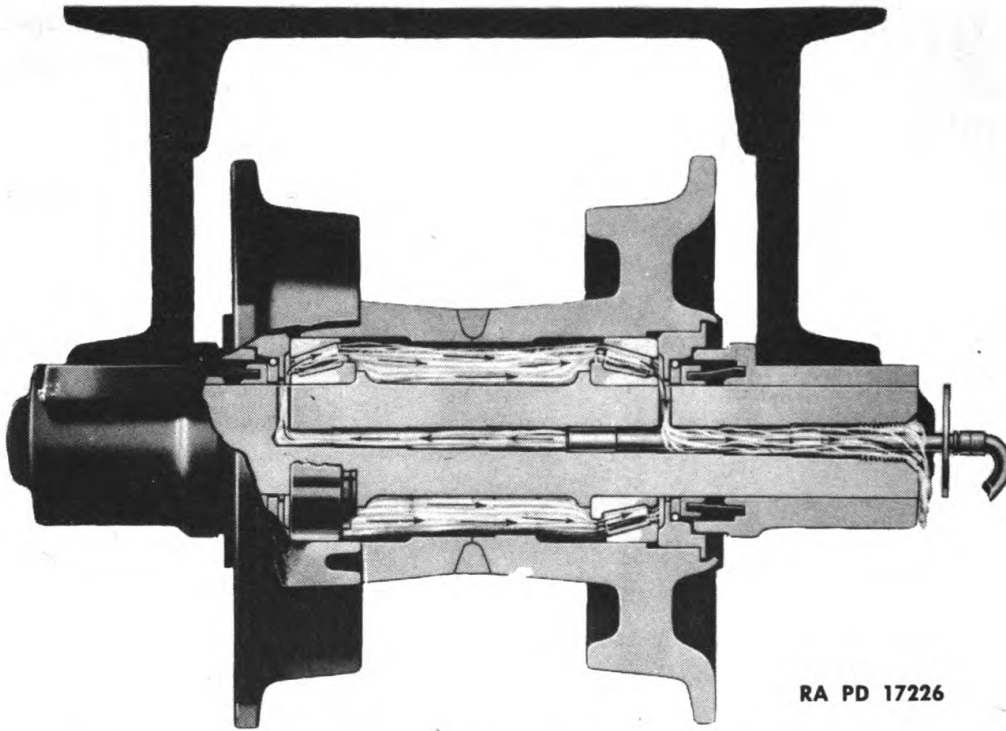


Figure 24—Cutaway Truck Wheel With Flushing Lubricator

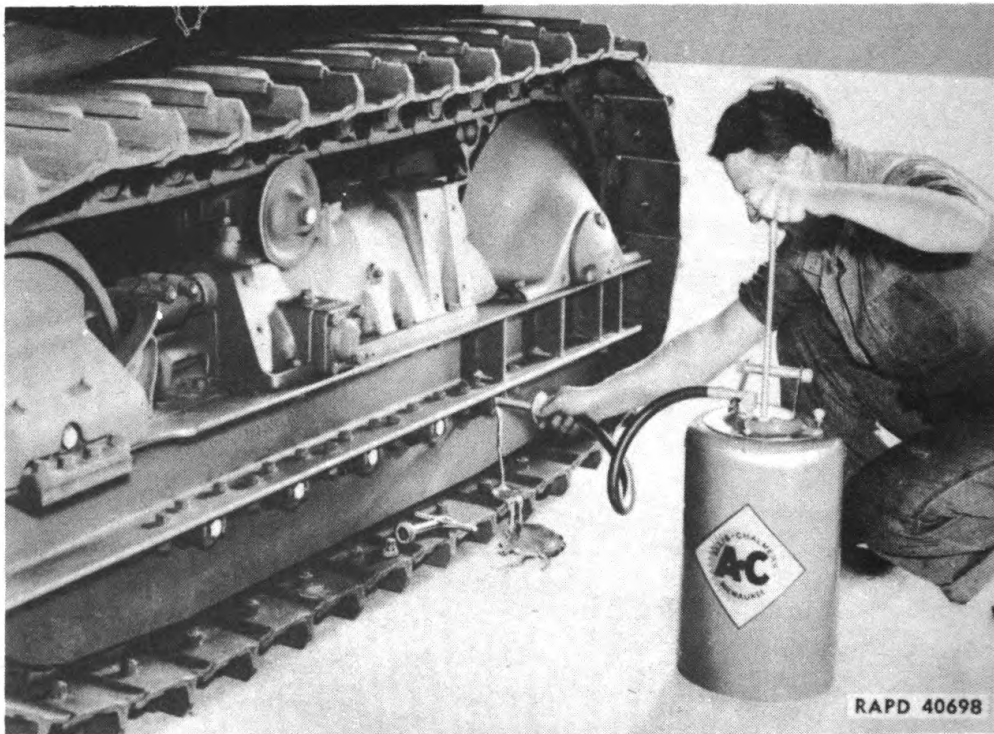


Figure 25—Lubricating Truck Wheels

**LUBRICATION**

**29. REPORTS AND RECORDS.**

**a. Reports.** If lubrication instructions are closely followed, proper lubricants used, and satisfactory results are not obtained, a report will be made to the ordnance officer responsible for the maintenance of the materiel.

**b. Records.** A complete record of lubrication servicing will be kept for the materiel.

**30. SUPPLEMENTARY LUBRICATION ILLUSTRATIONS.**

**a. Figures 21 to 25** show the location of lubrication fittings and the way in which various points are lubricated.



**MEDIUM TRACTOR M1**

**Section V**

**PREVENTIVE MAINTENANCE**

	Paragraph
General .....	31
Prestarting inspection .....	32
Inspection during operation .....	33
Inspection after operation .....	34
Inspection after each 50 hours of operation .....	35
Inspection after each 100 hours of operation .....	36
Inspection after operation in deep snow .....	37
Inspection after operation in sandy terrain .....	38
Inspection after operation in deep mud .....	39
Inspection after operation in water .....	40

**31. GENERAL.**

a. To insure mechanical efficiency, it is necessary that the tractor be systematically inspected at regular intervals in order that defects may be discovered and corrected, and the necessary adjustments made before damage results.

b. Cracks that develop in castings or other metal parts may often be detected by dust and oil deposits after the completion of a run. General wear of all parts should be noted at all inspection periods, and parts needing replacement because they are nearly worn out should be reported before break-down occurs.

**32. PRESTARTING INSPECTION.**

a. Before the engine is started, the operator or organization personnel should check the following:

- (1) Check the fuel supply.
- (2) Remove the bayonet gage to determine engine crankcase oil level; if found to be below "FULL" mark, add 1 quart of the correct oil for each mark level is below "FULL." See section IV for correct lubricant.
- (3) Inspect water or antifreeze solution in cooling system. Add water or antifreeze solution if no water can be seen when radiator cap is removed.
- (4) Inspect the entire unit for loose bolts or nuts, especially if repairs have been made since the previous operating period.
- (5) Check oil level in final drives. Keep filled to level of filler plug. See section IV for correct lubricant.
- (6) Check transmission oil level. This level should be kept between

## PREVENTIVE MAINTENANCE

“LOW” and “FULL” marks on bayonet gage. See section IV for correct lubricant.

(7) Make inspection of tractor tool equipment. Report any tools or special equipment missing.

(8) Inspect for presence of fire extinguisher.

(9) Make sure all operating levers work freely and correctly.

(10) Make sure all lights and brakes are in operating condition.

(11) Make sure equipment, which tractor is pulling, is securely hitched, and that safety cables or chains are in place.

(12) Observe operating instruments. Oil pressure gage should read zero, fuel pressure gage zero, ammeter zero, etc.

(13) Drain fuel tank sediment sumps (figs. 26 and 27).

### 33. INSPECTION DURING OPERATION.

a. An operator should make it a habit to glance often at the operating instruments to be sure all parts of tractor are functioning properly. He should be alert for indications of abnormal operation of the engine and tractor. If instruments fluctuate, the cause should be immediately determined. After engine reaches operating temperature (170 to 180 F), oil pressure should be 25 to 35 pounds, fuel pressure 20 to 30 pounds at  $\frac{3}{4}$  or full throttle. Radiator shutter should be regulated to keep engine at operating temperature.

b. Operator should note if master clutch engages and disengages properly and if pull required to engage clutch is as it should be (50 to 55 pounds when engine is running).

c. The steering levers and foot brakes should be checked for clearances and operation.

d. Any slippage of clutches should be detected and corrective measures taken immediately.

### 34. INSPECTION AFTER OPERATION.

a. The following points should be inspected after each day of operation and all oil levels brought up to “FULL.”

(1) Engine crankcase oil level.

(2) Transmission case oil level.

(3) Final drive gear cases oil level.

(4) Winch gear housing oil level.

(5) Power take-off oil level.

(6) Cooling system (fig. 28).

(7) Batteries (fig. 26). Keep water level  $\frac{3}{8}$  inch above separators.

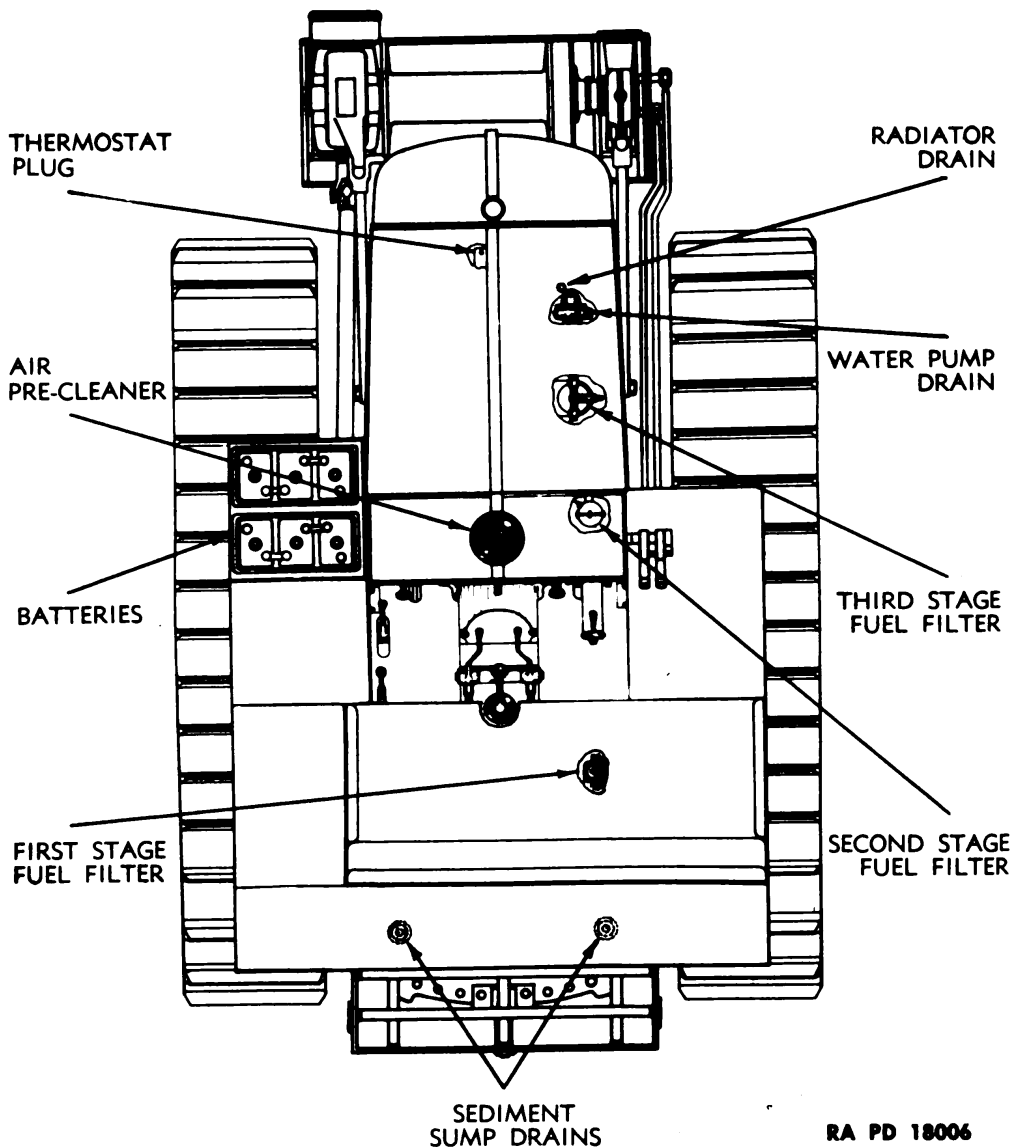
(8) Precleaner (figs. 26 and 27). Empty dirt out of compartment.

(9) Air cleaner. Remove oil cup, clean, and refill to proper level.

(10) Drain fuel tank sediment sumps (figs. 26 and 27).

(11) Inspect for loose bolts, nuts, or broken parts.

MEDIUM TRACTOR M1



RA PD 18006

Figure 26—Service Chart

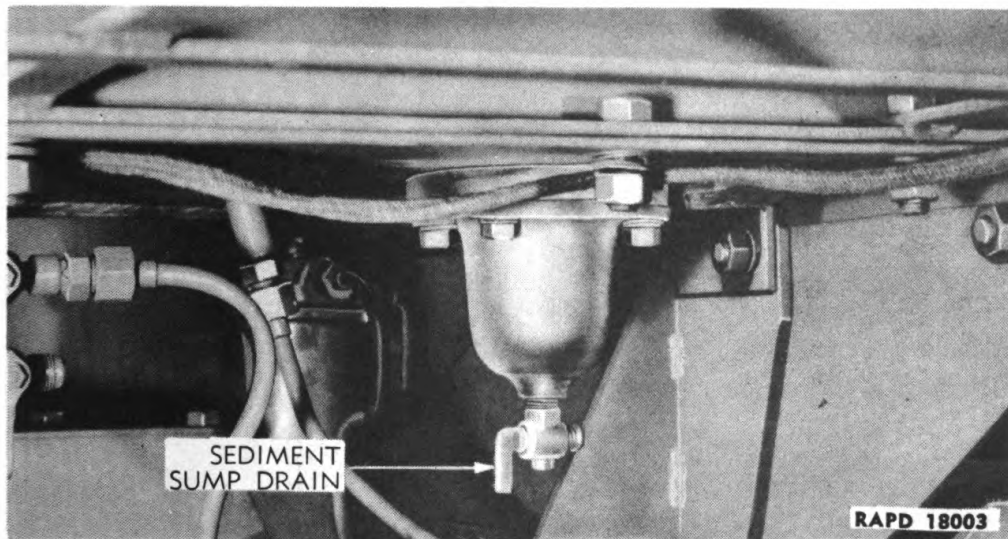
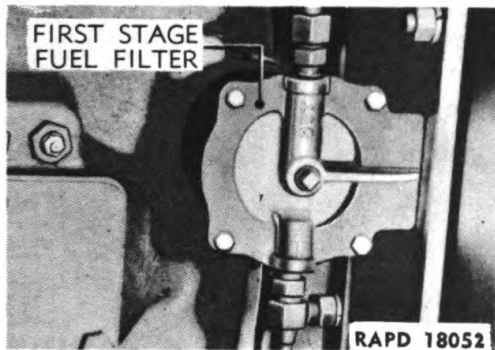
**35. INSPECTION AFTER EACH 50 HOURS OF OPERATION.**

**a. Check the following:**

- (1) Master clutch adjustment (par. 99).
- (2) Steering clutch throw-out adjustment (par. 103 b).
- (3) Brake adjustment (par. 106).
- (4) Front idler and track adjustment (par. 111 b).
- (5) Winch worm shaft safety brake (par. 116 b).

**b. Drain and refill engine crankcase and clean lubricating oil filter and magnetic drain plug.**

## PREVENTIVE MAINTENANCE



### SERVICE

#### Tractor, Medium, M1

(Hours denote engine operating hours recorded on hour meter.)

**Air Pre-Cleaner**—Remove and clean dirt compartment after operation or more often in extremely dusty condition. Level of dirt in compartment should never be allowed to become higher than top of glass.

**Fuel Filters**—Replace fuel filter elements in first stage fuel filter, second stage fuel filter and third stage fuel filter whenever a drop in fuel pressure indicates fuel filters are clogged.

**Batteries**—Check water level in batteries, after operation and add distilled water regularly to keep water level 3/8" above separators. Keep top of batteries and terminals clean.

**Cooling System**—Both water pump drain and radiator drain should be opened to completely drain system. When filling system thermostat plug must be removed, until water reaches level of plug, to allow air to escape. Drain, flush, and refill cooling system every month.

**Sediment Sumps**—Drain water and dirt from sediment sumps, located under fuel tank, after operation. This should be done before each operating period.

RA PD 56454

Figure 27—Service Instructions

MEDIUM TRACTOR M1

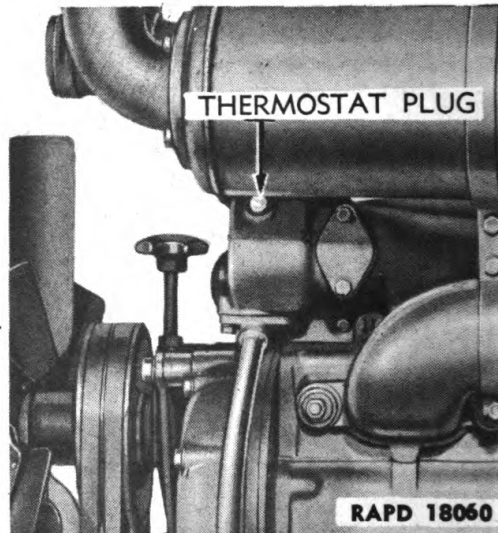
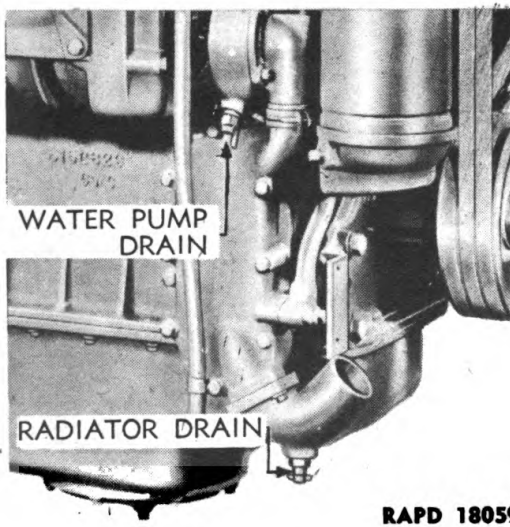
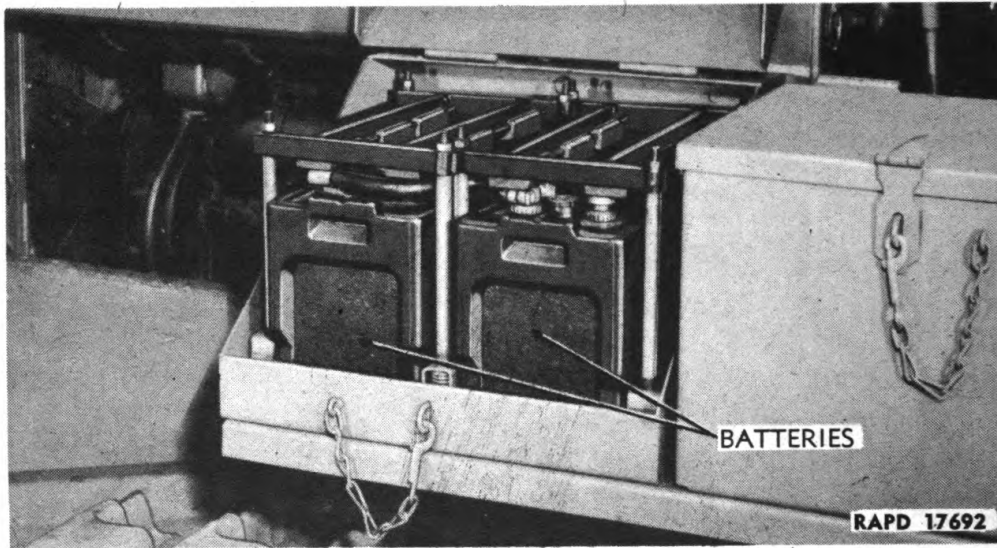
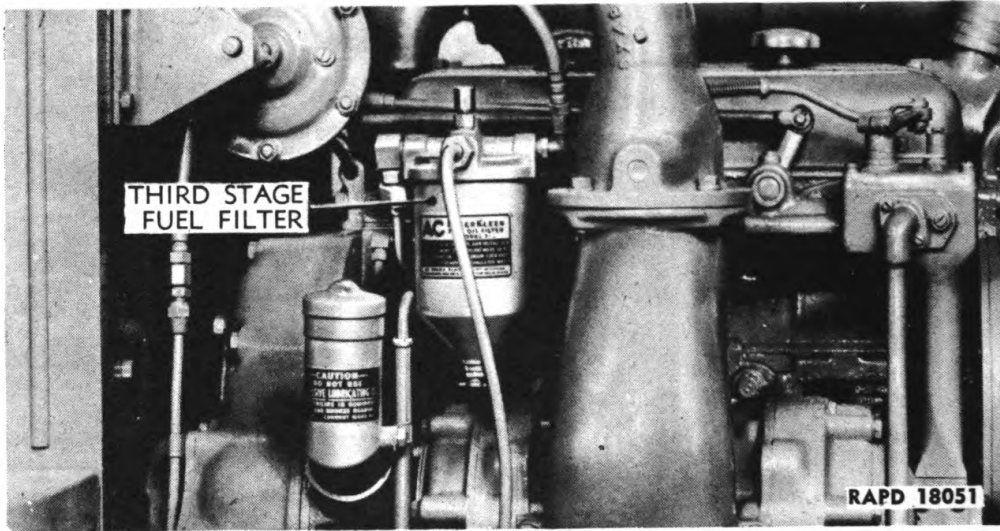


Figure 28—Service Points

## PREVENTIVE MAINTENANCE

### 36. INSPECTION AFTER EACH 100 HOURS OF OPERATION.

a. Check the following:

- (1) Generator belt adjustment (par. 83 i (2) ).
- (2) Fan belt adjustment (par. 76 e).
- (3) Wire insulation and connections.
- (4) See that air box vent tube is not clogged. Remove and clean, if necessary.
- (5) Check first stage fuel filter under seat (figs. 23 and 24). Install new filter element, if necessary.

### 37. INSPECTION AFTER OPERATION IN DEEP SNOW.

a. After the vehicle has been operated in deep snow, the following inspections should be made:

- (1) Before driving in deep snow, install the 2 large pipe plugs in the drain holes in the bottom of the transmission case to prevent snow from getting into the steering clutch compartment. The small pipe plug should be installed in the drain hole of the master clutch compartment.
- (2) Remove snow which has become hard-packed in the track openings and inspect track, rollers, and truck wheels for any damage.
- (3) Inspect bottom of vehicle for any damage which may have been caused by striking objects hidden in the snow.

### 38. INSPECTION AFTER OPERATION IN SANDY TERRAIN.

a. After the vehicle has been operated in sandy terrain or dust laden atmosphere, the following inspections should be made:

- (1) Inspect precleaner and remove any accumulated dirt.
- (2) Inspect air cleaner and clean and refill with new oil, if necessary.
- (3) Inspect fuel and oil filters. Clean filters or replace filtering element where required.

### 39. INSPECTION AFTER OPERATION IN DEEP MUD.

a. After the vehicle has been operated in deep mud, it should be thoroughly washed, all mud removed, and the following inspections made:

- (1) Inspect lubrication fittings to determine if they have become clogged with mud. Remove any mud present and lubricate part.
- (2) Check rollers and truck wheels for free movement to determine if any mud has found its way into bearings.

**MEDIUM TRACTOR M1**

**40. INSPECTION AFTER OPERATION IN WATER.**

a. After operating in water for any length of time, the tractor should be stopped and allowed to stand for a short while. The drain plugs in the final drive cases and track release housing should be loosened and removed partially to see if any water or dirt has entered these housings. This is especially important in cold weather when the water might freeze. If any water or dirt has entered these compartments, they should be drained, flushed out, and refilled with clean oil.

Section VI

GENERAL CARE AND PRESERVATION

	Paragraph
Records .....	41
Cleaning .....	42

**41. RECORDS.**

a. **Use.** An accurate record must be kept of each motor vehicle issued by the Ordnance Department. For this purpose the Motor Book for Ordnance Vehicles (O. O. Form No. 7255), generally called "Log Book," is issued with each vehicle and must accompany it at all times. This book furnishes a complete record of the vehicle from which valuable information concerning operation and maintenance costs, etc., is obtained, and organization commanders must insist that correct entries be made. This book will habitually be kept in a canvas cover to prevent it from being injured or soiled.

b. **Assignment Record.** The page bearing a record of assignment must be destroyed prior to entering a combat zone. All other references which may be posted regarding the identity of the organization must also be deleted.

**42. CLEANING.**

a. **Grit, dirt, and mud** are the sources of greatest wear to a vehicle. If deposits of dirt and grit are allowed to accumulate, particles will soon find their way into bearing surfaces, causing unnecessary wear and, if the condition is not remedied, will soon cause serious difficulty. When removing engine parts or any other unit in making repairs and replacements, or, if in the course of inspection, working joints or bearing surfaces are to be exposed, all dirt and grit that might find its way to the exposed surfaces must first be carefully removed. The tools must be clean, and care must always be taken to eliminate the possibilities of brushing dirt or grit into the opening with the sleeve or other part of the clothing. To cut oil-soaked dirt and grit, hardened grit, or road oil, use SOLVENT, dry-cleaning, applied with cloths (not waste) or a brush. Care should be taken to keep water from entering electrical accessories such as starter, generator, etc. Detailed information on cleaning is included in TM 9-850.

b. **Oil cups or grease fittings** which have become clogged should be opened or reamed out with a piece of wire. Wood should never be used for this purpose as splinters are likely to break off and permanently clog these passages. Particular care should be taken to clean and decontaminate vehicles that have been caught in a gas attack. See section VIII on materiel affected by gas for details of this operation.



MEDIUM TRACTOR M1

Section VII

PAINTING

	Paragraph
General .....	43
Preparing for painting .....	44
Painting metal surfaces .....	45
Paint as a camouflage .....	46
Removing paint .....	47
Painting lubricating devices .....	48

43. GENERAL.

a. Ordnance materiel is painted before issue to the using arms and one maintenance coat per year will ordinarily be ample for protection. With but few exceptions this materiel will be painted with ENAMEL, synthetic, olive-drab, lusterless. The enamel may be applied over old coats of long oil enamel and oil paint previously issued by the Ordnance Department if the old coat is in satisfactory condition for repainting.

b. Paints and enamels are usually issued ready for use and are applied by brush or spray. They may be brushed on satisfactorily when used unthinned in the original package consistency or when thinned no more than 5 percent by volume with THINNER. The enamel will spray satisfactorily when thinned with 15 percent by volume of THINNER. (Linseed oil must not be used as a thinner since it will impart a luster not desired in this enamel.) If sprayed, it dries hard enough for repainting within 1/2 hour and dries hard in 16 hours.

c. Complete information on painting is contained in TM 9-850.

44. PREPARING FOR PAINTING.

a. If the base coat on the materiel is in poor condition, it is more desirable to strip the old paint from the surface than to use sanding and touch-up methods. After stripping, it will then be necessary to apply a primer coat.

b. PRIMER, synthetic, refinishing, should be used on wood as a base coat for synthetic enamel. It may be applied either by brushing or spraying. It will brush satisfactorily as received or after the addition of not more than 5 percent by volume of THINNER. It will be dry enough to touch in 30 minutes, and hard in 5 to 7 hours. For spraying, it may be thinned with not more than 15 percent by volume of THINNER. Lacquers must not be applied to the PRIMER, synthetic, refinishing, within less than 48 hours.

## PAINING

c. **PRIMER**, synthetic, rust-inhibiting, for bare metal, should be used on metal as a base coat. Its use and application is similar to that outlined in paragraph (b) above.

d. The success of a job of painting depends partly on the selection of a suitable paint, but also largely upon the care used in preparing the surface prior to painting. All parts to be painted should be free from rust, dirt, grease, kerosene, oil, and alkali, and must be dry.

### 45. PAINTING METAL SURFACES.

a. If metal parts are in need of cleaning, they should be washed in a liquid solution consisting of  $\frac{1}{2}$  pound of **SODA ASH** in 8 quarts of warm water, or an equivalent solution, then rinsed in clear water and wiped thoroughly dry. Wood parts in need of cleaning should be treated in the same manner, but the alkaline solution must not be left on for more than a few minutes and the surfaces should be wiped dry as soon as they are washed clean. When surface of the tractor is in fair condition and only marred in spots, the bad places should be touched with **ENAMEL**, synthetic, olive-drab, lusterless, and permitted to dry. The whole surface will then be sandpapered with **PAPER**, flint, No. 1, and a finish coat of **ENAMEL**, synthetic, olive-drab, lusterless, applied and allowed to dry thoroughly before the materiel is used. If the equipment is in bad condition, all parts should be thoroughly sanded with **PAPER**, flint, No. 2, or equivalent, given a coat of **PRIMER**, synthetic, refinishing, and permitted to dry for at least 16 hours. They will then be sandpapered with **PAPER**, flint, No. 00, wiped free from dust and dirt, and a final coat of **ENAMEL**, synthetic, olive-drab, lusterless, applied and allowed to dry thoroughly before the materiel is used.

### 46. PAINT AS A CAMOUFLAGE.

a. Camouflage is now a major consideration in painting ordnance vehicles, with rust prevention secondary. The camouflage plan at present employed utilizes three factors: color, gloss, and stenciling.

(1) **COLOR**. Vehicles are painted with **ENAMEL**, synthetic, olive-drab, lusterless, which was chosen to blend in reasonably well with the average landscape.

(2) **GLOSS**. The new lusterless enamel makes a vehicle difficult to see from the air or from relatively great distances over land. A vehicle painted with ordinary glossy paint can be detected more easily and at greater distances.

(3) **STENCILING**. White stencil numbers on vehicles have been eliminated because they can be photographed from the air. A blue-drab stencil enamel is now used which cannot be so photographed. It is illegible to the eye at distances exceeding 75 feet.

**MEDIUM TRACTOR M1**

**b. Preserving Camouflage.**

(1) Continued friction or rubbing must be avoided, as it will smooth the surface and produce a gloss. The vehicle should not be washed more than once a week. Care should be taken to see that the washing is done entirely with a sponge or a soft rag. The surface should never be rubbed or wiped, except while wet, or a gloss will develop.

(2) It is not desirable that vehicles, painted with lusterless enamel, be kept as clean as vehicles were kept when glossy paint was used. A small amount of dust increases the camouflage value. Grease spots should be removed with SOLVENT, dry-cleaning. Whatever portion of the spot cannot be so removed should be allowed to remain.

(3) Continued friction of wax-treated tarpaulins on the sides of a vehicle will also produce a gloss, which should be removed with SOLVENT, dry-cleaning.

(4) Tests indicate that repainting with olive-drab paint will be necessary once yearly, with blue-drab paint twice yearly.

**47. REMOVING PAINT.**

a. After repeated paintings, the paint may become so thick as to crack and scale off in places, presenting an unsightly appearance. If such is the case, remove the old paint by use of a lime-and-lye solution (see TM 9-850 for details) or REMOVER, paint and varnish. It is important that every trace of lye or other paint remover be completely rinsed off and that the equipment be perfectly dry before repainting is attempted. It is preferable that the use of lye solutions be limited to iron or steel parts. If used on wood, the lye solution must not be allowed to remain on the surface for more than a minute before being thoroughly rinsed off and the surface wiped dry with rags. Crevices or cracks in wood should be filled with putty and the wood sandpapered before refinishing. The surfaces thus prepared should be painted according to directions in paragraphs 44 and 45.

**48. PAINTING LUBRICATING DEVICES.**

a. Oil cups, grease fittings, oilholes, and similar lubricating devices, as well as a circle about  $\frac{3}{4}$  inch in diameter at each point of lubrication will be painted with ENAMEL, synthetic, gloss-red, in order that they may be readily located.

**Section VIII**

**MATERIEL AFFECTED BY GAS**

	Paragraph
Protective measures .....	49
Cleaning .....	50
Decontamination .....	51
Special precautions for automotive materiel .....	52

**49. PROTECTIVE MEASURES.**

a. When materiel is in constant danger of gas attack, unpainted metal parts will be lightly coated with engine oil. Instruments are included among the items to be protected by oil from chemical clouds or chemical shells, but ammunition is excluded. Care will be taken that the oil does not touch leather or canvas fittings. Materiel not in use will be protected with covers as far as possible. Ammunition will be kept in sealed containers.

b. Ordinary fabrics offer practically no protection against mustard gas or lewisite. Rubber and oilcloth, for example, will be penetrated within a short time. The longer the period during which they are exposed, the greater the danger of wearing these articles. Rubber boots worn in an area contaminated with mustard gas may offer a grave danger to men who wear them several days after the bombardment. Impermeable clothing will resist penetration more than an hour, but should not be worn longer than this.

**50. CLEANING.**

a. All unpainted metal parts of materiel that have been exposed to any gas except mustard and lewisite must be cleaned as soon as possible with SOLVENT, dry-cleaning, or ALCOHOL, denatured, and wiped dry. All parts should then be coated with engine oil.

**51. DECONTAMINATION.**

a. For the removal of liquid chemicals (mustard, lewisite, etc.) from materiel, the following steps should be taken:

**(1) PROTECTIVE MEASURES.**

(a) For all of these operations a complete suit of impermeable clothing and a service gas mask will be worn. Immediately after removal of the suit, a thorough bath with soap and water (preferably hot) must be taken. If any skin areas have come in contact with mustard, if even a very small drop of mustard gets into the eye, or if the vapor of mustard has been inhaled, it is imperative that complete first-aid measures be given within 20 to 30 minutes after exposure. First-aid instructions are given in TM 9-850 and FM 21-40.

**MEDIUM TRACTOR M1**

(b) Garments exposed to mustard will be decontaminated. If the impermeable clothing has been exposed to vapor only, it may be decontaminated by hanging in the open air, preferably in sunlight, for several days. It may also be cleaned by steaming for 2 hours. If the impermeable clothing has been contaminated with liquid mustard, steaming for 6 to 8 hours will be required. Various kinds of steaming devices can be improvised from materials available in the field.

**(2) PROCEDURE.**

(a) Commence by freeing materiel of dirt through the use of sticks, rags, etc., which must be burned or buried immediately after this operation.

(b) If the surface of the materiel is coated with grease or heavy oil, this grease or oil should be removed before decontamination is begun. SOLVENT, dry-cleaning, or other available solvents for oil should be used with rags attached to ends of sticks.

(c) Decontaminate the painted surfaces of the materiel with bleaching solution made by mixing one part AGENT, decontaminating (chloride of lime), with one part water. This solution should be swabbed over all surfaces. Wash off thoroughly with water, then dry and oil all surfaces.

(d) The instrument panel and all unpainted metal parts exposed to mustard or lewisite must be decontaminated with AGENT, decontaminating, noncorrosive, mixed one part solid to fifteen parts solvent (ACETYLENE TETRACHLORIDE). If this is not available, use warm water and soap. Bleaching solution must not be used, because of its corrosive action. Coat all metal surfaces lightly with engine oil.

(e) In the event AGENT, decontaminating (chloride of lime), is not available, materiel may be temporarily cleaned with large volumes of hot water. However, mustard lying in joints or in leather or canvas webbing is not removed by this procedure and will remain a constant source of danger until the materiel can be properly decontaminated. All mustard washed from materiel in this manner lies unchanged on the ground, necessitating that the contaminated area be plainly marked with warning signs before abandonment.

(f) The cleaning or decontaminating of materiel contaminated with lewisite will wash arsenic compounds into the soil, poisoning many water supplies in the locality for either men or animals.

(g) Leather or canvas webbing that has been contaminated should be scrubbed thoroughly with bleaching solution. In the event this treatment is insufficient, it may be necessary to burn or bury such materiel.

(h) Detailed information on decontamination is contained in FM 21-40, TM 9-850, and TC 38, 1941, Decontamination.

**MATERIEL AFFECTED BY GAS****52. SPECIAL PRECAUTIONS FOR AUTOMOTIVE MATERIEL.**

a. When the tractor has been subjected to gas attack with the engine running, the air cleaner should be serviced by removing the oil, flushing with SOLVENT, dry-cleaning, and refilling with the proper grade of oil.

b. Contaminated seat cushions will be discarded.

c. Washing the compartments thoroughly with bleaching solution is the most that can be done in the field. Operators should constantly be on the alert, when running under conditions of high temperatures, for slow vaporization of the mustard or lewisite.

d. Exterior surfaces of vehicles will be decontaminated with bleaching solution. Repainting may be necessary after this operation.

MEDIUM TRACTOR M1

PART TWO—Organization Instructions

Section IX

GENERAL INFORMATION ON MAINTENANCE

	Paragraph
Scope .....	53

53. SCOPE.

a. The scope of maintenance and repairs by the crew and other units of the using arms is determined by the ease with which the project can be accomplished, the amount of time available, weather conditions, temperatures, the equipment available, the skill of the personnel, and other circumstances which may be present.

b. The definitions given below are included in order that the name of the operation may be correctly interpreted by those doing the work.

(1) SERVICE. Consists of cleaning, lubricating, tightening bolts and nuts, and making external adjustments of subassemblies or assemblies and controls.

(2) REPAIR. Consists of making repairs to a part, subassembly or assembly without completely disassembling the subassembly or assembly, and does not require heavy welding or riveting, machining, fitting, and/or alining.

(3) REPLACE. Consists of removing the part, subassembly, or assembly from the tractor and replacing it with a new or reconditioned or rebuilt part, whichever the case may be.

c. The following are the maintenance duties which may be performed by the using arm personnel:

ENGINE

Engine .....	Clean and service
Engine (par. 56) .....	Replace
Exhaust manifold and muffler (par. 60) .....	Replace
Valve clearance (par. 58) .....	Adjust
Valve rocker assembly (par. 57) .....	Replace

**GENERAL INFORMATION ON MAINTENANCE**

**FUEL AND AIR SYSTEM**

Air cleaner (par. 69) ..... Service  
 Fuel filters (par. 64) ..... Service or replace  
 Fuel lines and connections (par. 67) ..... Repair or replace  
 Fuel pump (par. 65) ..... Replace  
 Fuel supply tank (par. 62) ..... Clean  
 Injectors (par. 66) ..... Adjust or replace  
 Precleaner (par. 68) ..... Service or replace  
 Sediment sumps (par. 63) ..... Replace

**COOLING SYSTEM**

Fan assembly (par. 76) ..... Replace  
 Fan belt (par 76) ..... Service or replace  
 Hoses, pipes (par. 75) ..... Replace  
 Radiator (par. 73) ..... Clean and flush  
 Thermostat assembly (par. 74) ..... Replace  
 Water manifold (par. 72) ..... Replace  
 Water pump assembly (par. 71) ..... Replace

**LUBRICATING SYSTEM**

Oil cooler (par. 80) ..... Replace  
 Oil filter (par. 79) ..... Replace  
 Oil lines ..... Replace

**ELECTRICAL SYSTEM**

Air heater (par. 88) ..... Replace  
 All lights (pars. 90-91) ..... Aline, service, or replace  
 All switches (pars. 89-91) ..... Replace  
 All wires (par. 92) ..... Repair or replace  
 Ammeter (par. 86) ..... Replace  
 Batteries (par. 82) ..... Service or replace  
 Generator (par. 83) ..... Replace  
 Generator voltage control unit (par. 84) ..... Replace  
 Hour meter (par. 87) ..... Replace  
 Starting motor assembly (par. 85) ..... Replace

**NONELECTRICAL INSTRUMENTS**

Fuel pressure gage (par. 94) ..... Replace  
 Lubricating oil pressure gage (par. 93) ..... Replace  
 Mile meter (odometer) (par. 96) ..... Replace  
 Temperature gage (par. 95) ..... Replace



**MEDIUM TRACTOR M1**

**MASTER CLUTCH**

Master clutch assembly (par. 99) ..... Adjust or wash  
Master clutch brake assembly (par. 100) ..... Adjust

**STEERING CLUTCHES**

Steering clutches (pars. 103-104) ..... Adjust or wash

**TRACTOR BRAKES**

Steering brakes (par. 106) ..... Adjust

**FINAL DRIVE ASSEMBLY**

Rear axle bearings (par. 109) ..... Adjust

**TRACKS AND TRUCK FRAME ASSEMBLY**

Front idlers (par. 30) . . . . . Service and aline  
Pintle assembly (par. 114) . . . . . Replace  
Track release assembly (par. 111) . . . . . Adjust  
Track support rollers (par. 113) . . . . . Replace  
Truck wheel guard (par. 112) . . . . . Replace  
Truck wheels (pars. 30 and 112) . . . . . Service or replace

**WINCH**

Winch assembly (par. 116) . . . . . Adjust  
Winch cables (par. 116) . . . . . Replace

**MISCELLANEOUS**

Lubrication (pars. 25-30)  
Tractor cleaning (par. 42)  
Tractor painting (pars. 43-48)

**Section X**

**STANDARD TOOLS AND EQUIPMENT**

	Paragraph
Equipment and location .....	54
Care of equipment .....	55

**54. EQUIPMENT AND LOCATION (fig. 29).**

a. The items listed below are furnished as standard equipment with each tractor.

List of Equipment	Where Carried
BLOCK, snatch (1) .....	In box
BOOK, instruction, model HD-7 (1) .....	In box
BOOK, parts, model HD-7 (1) .....	In box
CAP SCREW (for attaching seat back cushions) (4) .....	In box
CHAIN, tow (1) .....	In box
CLIP (for attaching seat back cushion) (2) .....	In box
FULCRUM, VALVE LIFTER (used with valve lifter and injector remover tool) (1) .....	In tool box
GUN, hand grease, push type (1) .....	In box
GUN, pressure grease, with hose, lever type (1) .....	In box
HAMMER (1) .....	In tool box
KIT, injector service (1), consisting of:	
BRUSH, large (1)	GAGE, injector timing (1)
BRUSH, small (1)	STONE (1)
DRILL (1)	VICE, pin, and WIRE, probing (1)
GAGE, feeler (1)	
KIT, wrench (1), consisting of:	
WRENCH, open-end, $\frac{7}{16}$ -in. and $\frac{1}{2}$ -in. (1)	In tool box
WRENCH, open-end, $\frac{9}{16}$ -in. and $1\frac{1}{16}$ -in. (1)	
WRENCH, open-end, $1\frac{9}{32}$ -in. and $2\frac{5}{32}$ -in. (1)	
WRENCH, open-end, $\frac{5}{8}$ -in. and $\frac{3}{4}$ -in. (1)	
WRENCH, open-end, $\frac{7}{8}$ -in. and $1\frac{1}{16}$ -in. (1)	
WRENCH, open-end, 1-in. and $1\frac{1}{4}$ -in. (1)	
LIST, approved lubricating oils for use in positive seal assemblies, transmission, and final drives (1) .....	
	In box
LUBRICATOR, flushing, with hose (1) .....	In box
PLIERS (1) .....	In tool box
PLUG, pipe, $\frac{1}{2}$ -in., std (3) .....	In box



**STANDARD TOOLS AND EQUIPMENT**

<b>List of Equipment</b>	<b>Where Carried</b>
PREHEATER, engine (1) .....	In box
SCREWDRIVER (1) .....	In tool box
TOOL, valve lifter and injector removal (1) .....	In tool box
WASHER, lock, 3/8-in. (for attaching seat back cushion) (4) .....	In box
WRENCH, engine cranking (1) .....	In tool box
WRENCH, fan adjusting (1) .....	In tool box
WRENCH, fuel pump, and PUMP, water (1) .....	In tool box
WRENCH, hex., plug (1) .....	In tool box
WRENCH, hex., 1/2-in. (1) .....	In tool box
WRENCH, injector nut (1) .....	In tool box
WRENCH, socket, track bolt (1) .....	In tool box
WRENCH, square plug (1) .....	In tool box
WRENCH, track adjusting (1) .....	In tool box
WRENCH, water pump drain (1) .....	In tool box

**55. CARE OF EQUIPMENT.**

a. An accurate record of all tools and equipment should be kept in order that their location and condition may be known at all times. Items becoming lost or unserviceable should be immediately replaced. All tools and equipment should be cleaned and in proper condition for further use before being returned to their location.

MEDIUM TRACTOR M1

Section XI

ENGINE

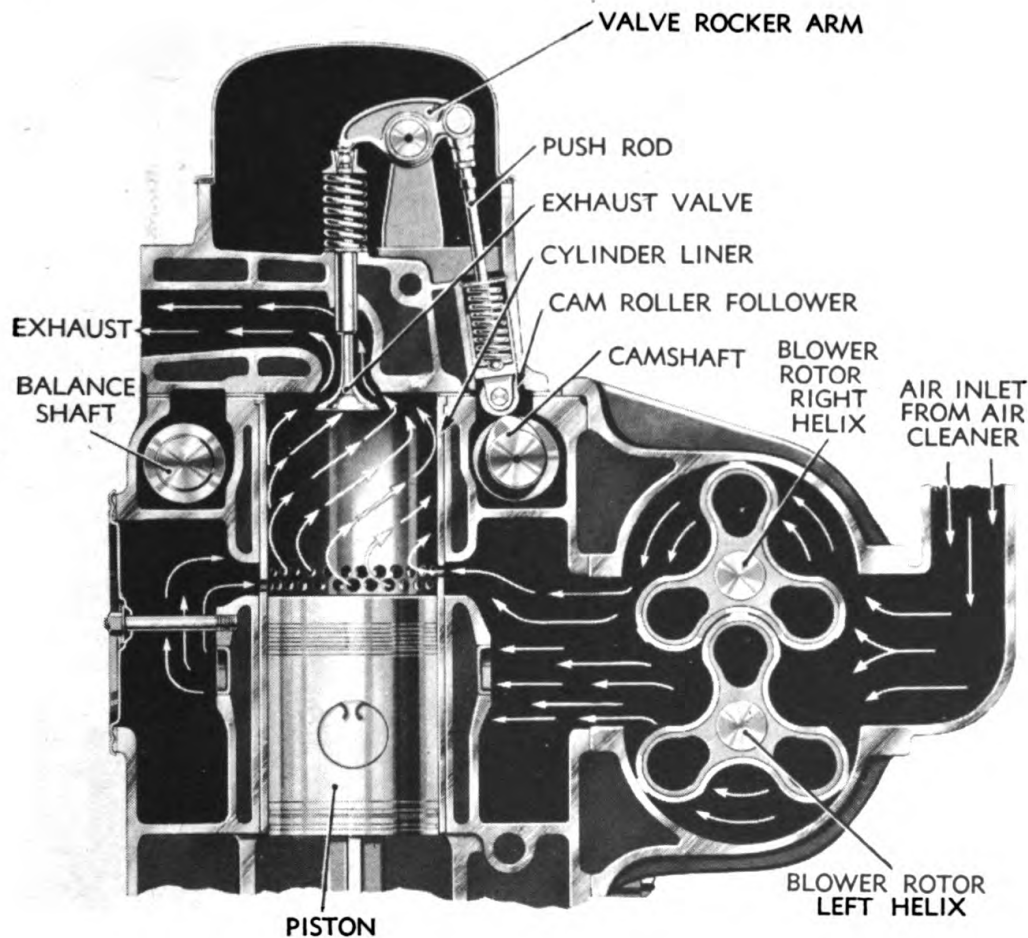
	Paragraph
General description, data, trouble shooting, removal, and installation .....	56
Rocker arm assembly .....	57
Valve clearance .....	58
Governor .....	59
Exhaust manifold and muffler .....	60

**56. GENERAL DESCRIPTION, DATA, TROUBLE SHOOTING, REMOVAL, AND INSTALLATION.**

**a. Description.**

(1) The engine in this tractor is a water-cooled, 2-cycle Diesel with 3 cylinders. This engine differs from the conventional 4-stroke cycle engine in that it requires only 2 strokes of the piston, 1 up and 1 down, to complete an operating cycle instead of 4 strokes as in the 4-cycle engine. In the 2-cycle engine, intake and exhaust occur together when the piston is at the bottom of its stroke; every upstroke is a compression stroke; every downstroke delivers power. Thus the intake and exhaust strokes of the 4-cycle engine are eliminated. The 2-cycle engine exhausts burned gases and fills its cylinders with fresh air, not by the pumping action of the engine itself, but by means of a rotary blower mounted on the right side of the engine and driven from the engine crankshaft. As the piston nears the end of its power stroke, the exhaust valves (2 for each cylinder) in the cylinder head open to allow the burned gases to escape, and the piston uncovers the intake ports in the lower part of the cylinder wall (64 holes in each cylinder liner) to permit fresh air from the blower to rush in, forcing burned gases out through the exhaust valves and filling the cylinder with a new charge of fresh air (fig. 30). As the piston rises on the compression stroke, it closes off the intake ports; the exhaust valves close, and the charge of air is compressed into  $\frac{1}{16}$  of its former volume. This compression causes the air to become extremely hot. A charge of Diesel fuel is injected into this hot compressed air by the injector, just before the piston reaches the top of its stroke. The fuel is ignited by the hot air and burns. The expansion caused by the combustion of the gases formed forces the piston down on its power stroke.

ENGINE



RA PD 56398

**Figure 30—Cross Section of Engine Showing Circulation of Air**

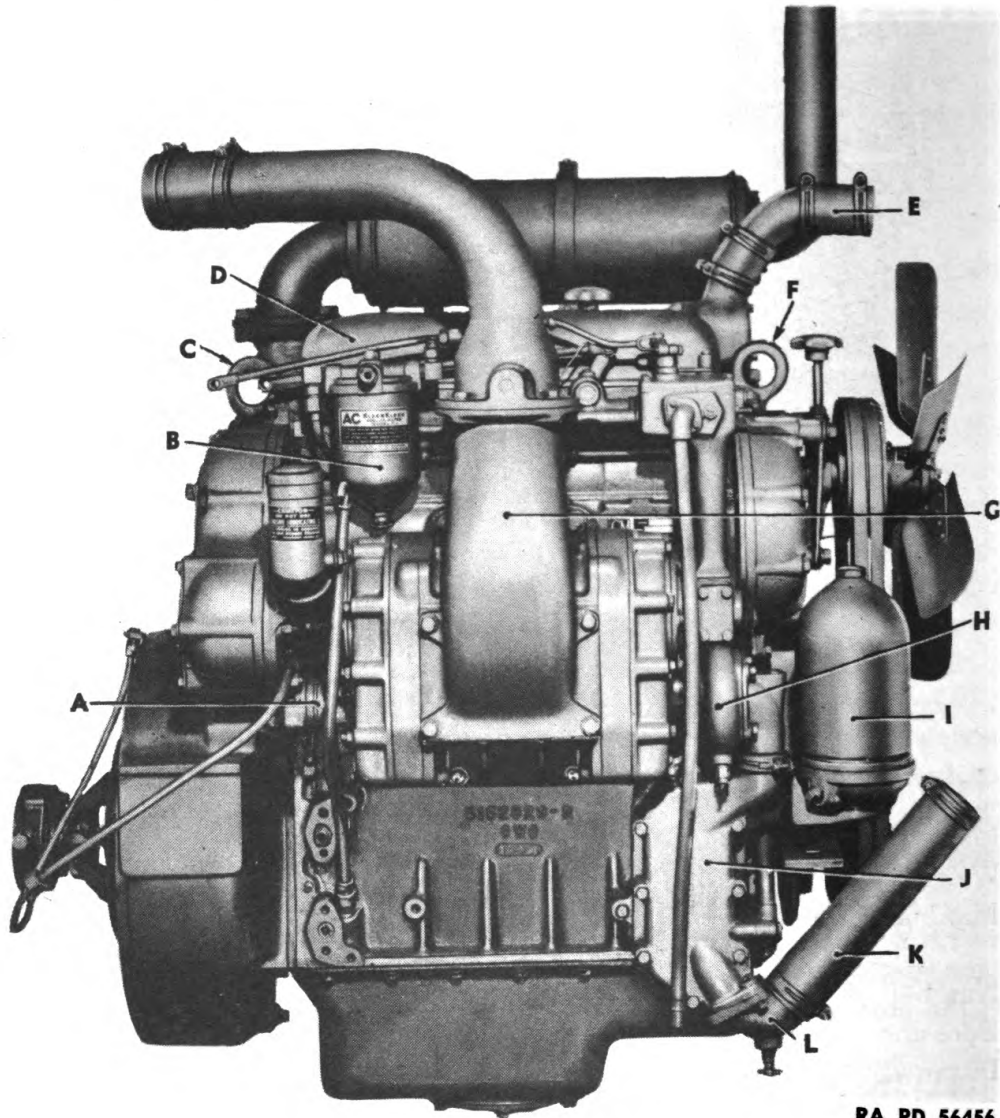
(2) Basic engine parts are readily accessible. On the right-hand side, as viewed from the operator's seat, is located the blower, engine governor, fuel pump and filters, oil filter and cooler, and water pump (fig. 31). The starting motor, air heater, and generator are mounted on the left-hand side (fig. 32).

(3) The fuel pump and water pump are driven by the lower blower rotor shaft. The fan and generator are driven by V-belts from a pulley on the crankshaft (fig. 33).

(4) The flywheel housing and timing gear cover are bolted directly to the rear end of the cylinder block (fig. 34). Lifter hooks are provided, attached to the top of the cylinder head. These assist greatly in the removal or installation of the engine.

MEDIUM TRACTOR M1

- A — FUEL PUMP
- B — THIRD STAGE FUEL FILTER
- C — LIFTER BRACKET EYE
- D — ROCKER ARM COVER
- E — RADIATOR INLET HOSE
- F — LIFTER BRACKET EYE
- G — BLOWER
- H — WATER PUMP
- I — LUBRICATING OIL FILTER
- J — LUBRICATING OIL COOLER
- K — RADIATOR OUTLET HOSE
- L — LOWER RADIATOR HOSE AND OIL COOLER CONNECTION



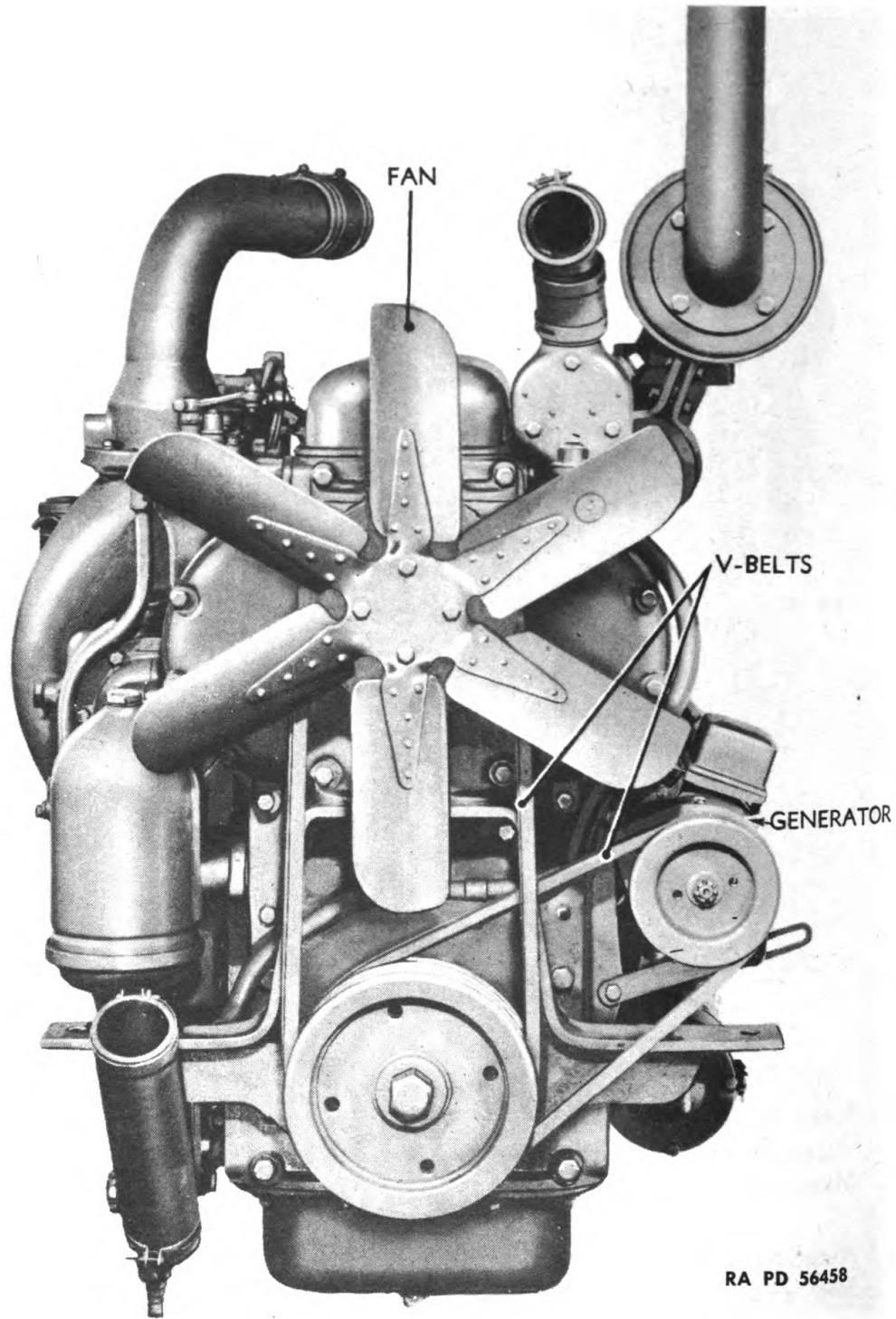
RA PD 56456

Figure 31—Right Side of Engine





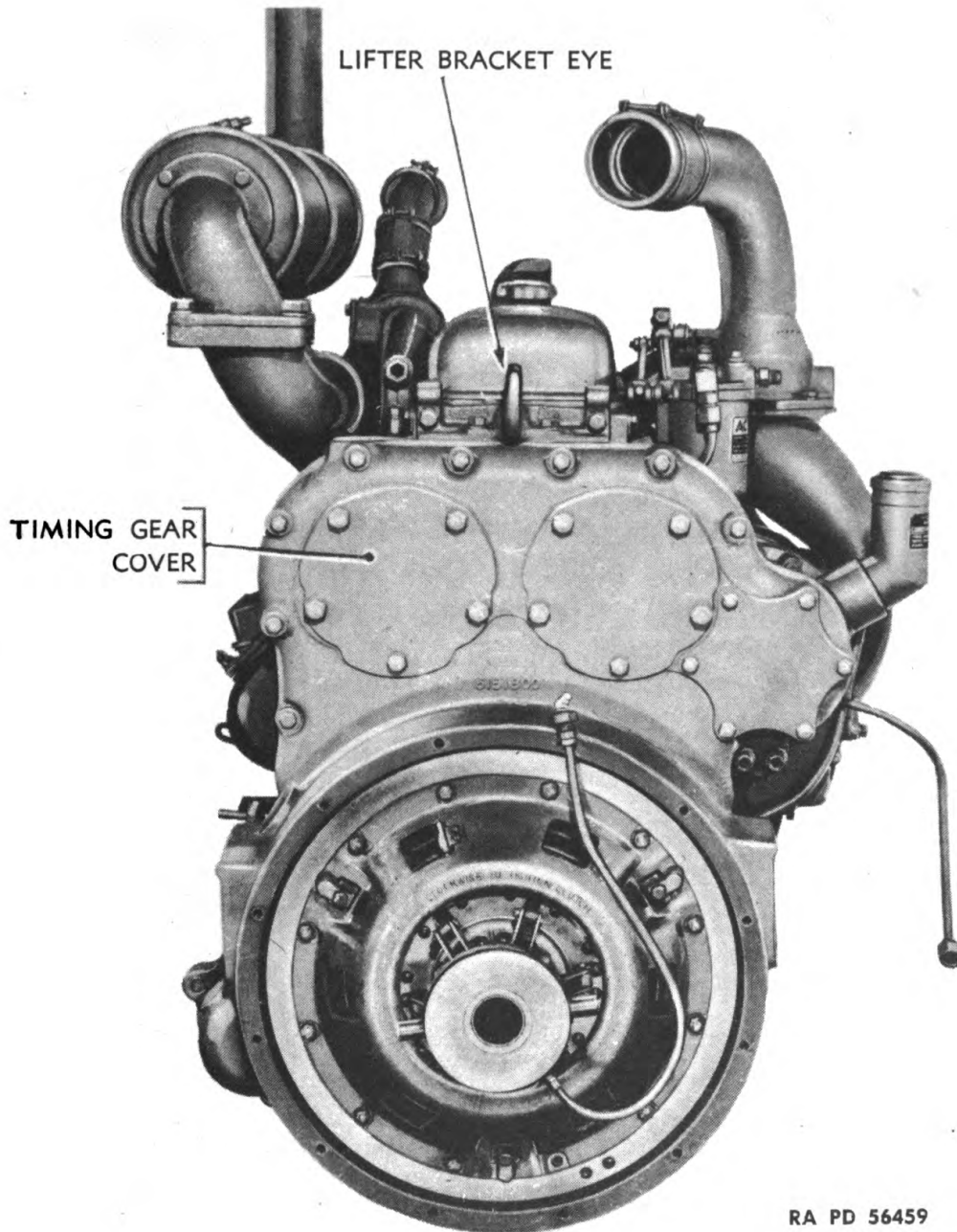
MEDIUM TRACTOR M1



RA PD 56458

**Figure 33—Front of Engine**

**ENGINE**



**Figure 34—Rear of Engine**

<b>Crankcase capacity, U. S. std</b> .....	<b>11 qt</b>
<b>Direction of rotation (viewed from operator's seat):</b>	
<b>Crankshaft</b> .....	<b>Counterclockwise</b>
<b>Starting motor</b> .....	<b>Clockwise</b>
<b>Generator</b> .....	<b>Counterclockwise</b>
<b>Fuel pump</b> .....	<b>Clockwise</b>

Generated on 2013-09-05 06:52 GMT / http://hdl.handle.net/2027/uc1.b3243756  
Public Domain, Google-digitized / http://www.hathitrust.org/access\_use#pd-google

**MEDIUM TRACTOR M1**

Water pump .....	Clockwise
Oil pump .....	Counterclockwise
Blower .....	Counterclockwise
Ratio of accessory drive to crankshaft speed:	
Starting motor .....	9.27 to 1
Generator .....	1.7 to 1
Fuel pump .....	1.94 to 1
Water pump .....	1.94 to 1
Oil pump .....	1.39 to 1
Blower .....	1.94 to 1

**c. Trouble Shooting.**

**(1) UNEVEN RUNNING, EXCESSIVE VIBRATION OF ENGINE.**

Probable Cause	Probable Remedy
Insufficient fuel supply.	Check fuel supply and filters.
Injectors out of time.	Time injectors (par. 66 f).
Injectors not equalized.	Equalize injectors (par. 66 g).
Valves out of adjustment.	Adjust valve clearance (par. 58 b).
Broken valve spring.	*Replace spring.
One or more cylinders misfiring.	Inspect fuel supply.
Air leaks in fuel system.	Inspect for loose connections.
Clogged fuel filters.	Replace filter elements (par 64).
Fuel lines cracked.	Replace lines (par. 67).
Surging governor.	Bring engine up to operating temperature; check for binding in governor linkage.

**(2) ENGINE RUNS HOT.**

Insufficient cooling water supply.	Check water in radiator.
Radiator tubes clogged.	Clean radiator (par. 73 c).
Rotten hoses.	Replace hoses.
Radiator fins clogged.	*Blow chaff, etc., out of fins.
Fan belts loose or broken.	Adjust or replace (par. 76 e, f, and g).
Water pump inoperative.	Replace water pump (par. 71 c and d).
Thermostat stuck in closed position.	Replace (par. 74 c and d).
Lack of oil pressure.	*Inspect for causes.
Carbon accumulation in engine.	*Clean out carbon and sludge.
Radiator shutter closed.	Open shutter.

\* Corrections not within the scope of operating organization. Notify ordnance personnel.

**ENGINE**

**(3) LOSS OF POWER.**

Probable Cause	Probable Remedy
Insufficient fuel.	Check fuel system.
Injectors out of time.	Time injectors (par. 66 f).
Injectors not equalized.	Equalize injectors (par. 66 g).
Governor out of adjustment.	*Adjust governor.
Butterfly valve out of adjustment.	*Adjust valve.
Air cleaner plugged.	Clean air cleaner (par. 69).
Port holes in cylinder liners plugged.	*Clean holes.
Burned valves.	*Recondition valves.
Defective fuel pump.	Replace (par. 65 h and d).

**(4) BLACK SMOKE FROM EXHAUST.**

Poor grade of fuel.	Change to better fuel.
Air cleaner improperly serviced.	Check air cleaners (par. 69).
Muffler plugged.	Replace muffler (par. 60 c and d).
Hand hole cover loose or gaskets blown.	Tighten cover or replace gasket.
Precleaner plugged.	Remove and clean (par. 68 h, c, and d).
Port holes in cylinder liners clogged.	*Clean port holes.
Air box drain tube plugged.	Remove and clean.
Injectors out of time.	Time injectors (par. 66 f).
Injectors not equalized.	Equalize injectors (par. 66 g).
Defective injector.	Replace injector (par. 66 d and e).
Valves out of adjustment.	Adjust valve clearance (par. 58 h).
Poor compression.	*Recondition engine.

**(5) BLUE SMOKE FROM EXHAUST.**

Insufficient fuel to injectors.	Check fuel system.
Lubricating oil entering combustion chamber.	*Inspect for causes.
Injectors not equalized.	Equalize injectors (par. 66 g).

**(6) ENGINE DETONATES (KNOCKS).**

Injectors out of time.	Time injectors (par. 66 f).
Injectors not equalized.	Equalize injectors (par. 66 g).
Faulty injector.	Replace injector (par. 66 d and e).
Damaged main or connecting rod bearings.	*Replace bearings.

\* Corrections not within the scope of operating organization. Notify ordnance personnel.

**MEDIUM TRACTOR M1**

Probable Cause	Probable Remedy
Incorrect valve clearance.	Adjust valve clearance (par. 58 b).
Lubricating oil entering combustion chamber.	*Inspect for causes.

**d. Removal of Engine from Tractor.**

BAR, pry	WRENCH, 5/8-in.
HOIST, chain	WRENCH, 3/4-in. (2)
PLIERS	WRENCH, 7/8-in.
ROPE	WRENCH, 1 5/16-in.
SCREWDRIVER, 6-in.	WRENCH, open-end, 1 1/16-in.
SCREWDRIVER, 8-in.	WRENCH, open-end, 7/8-in.
WRENCH, 3/8-in.	(2)
WRENCH, 7/16-in.	WRENCH, open-end, 1-in.
WRENCH, 1/2-in.	WRENCH, socket, 1/2-in.
WRENCH, 9/16-in. (2)	

**(1) PREPARE TRACTOR FOR REMOVAL OF ENGINE.**

PLIERS	WRENCH, 3/4-in.
--------	-----------------

Drain cooling system, drain engine crankcase, and shut-off fuel at valve underneath fuel tank.

**(2) REMOVE HOOD.**

BAR, pry	WRENCH, 9/16-in.
----------	------------------

Loosen hold-down bolts at each corner of hood. Pry bolts from clips. Lift hood off over exhaust pipe. **NOTE:** Remove bolt at left rear corner from inside battery box (figs. 70 and 71).

**(3) REMOVE FRONT FENDERS.**

WRENCH, 3/4-in. (2)
---------------------

Remove 3 bolts and 2 cap screws from left front fender, also 1 bolt and 3 cap screws from right front fender. Remove fenders.

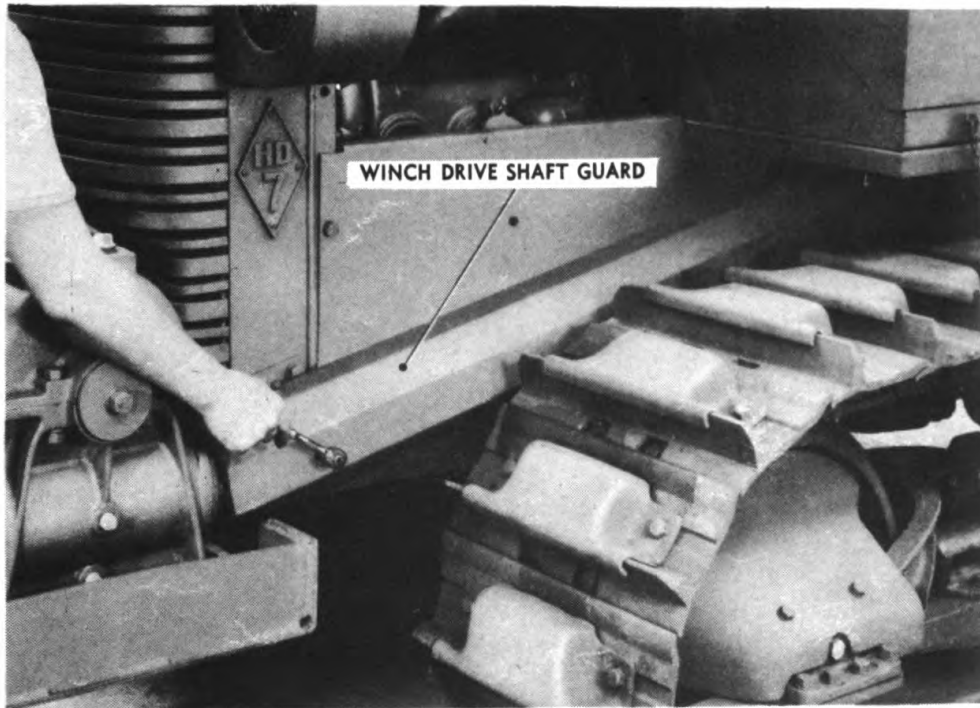
**(4) REMOVE WINCH DRIVE SHAFT GUARD AND BRACKET.**

WRENCH, 9/16-in. (2)	WRENCH, 7/8-in.
WRENCH, 3/4-in. (2)	

Remove 3 cap screws from front end of winch drive shaft guard (9/16-in. wrench). Remove 3 bolts from rear of guard (two 3/4-in. and two 9/16-in. wrenches). Lift off guard (fig. 35). Remove the 2 cap screws holding guard bracket to engine support (fig. 36), (7/8-in. wrench). Remove bracket. Remove the corresponding 2 cap screws from opposite side of radiator. Loosen the 2 remaining cap screws holding radiator to engine support (7/8-in. wrench).

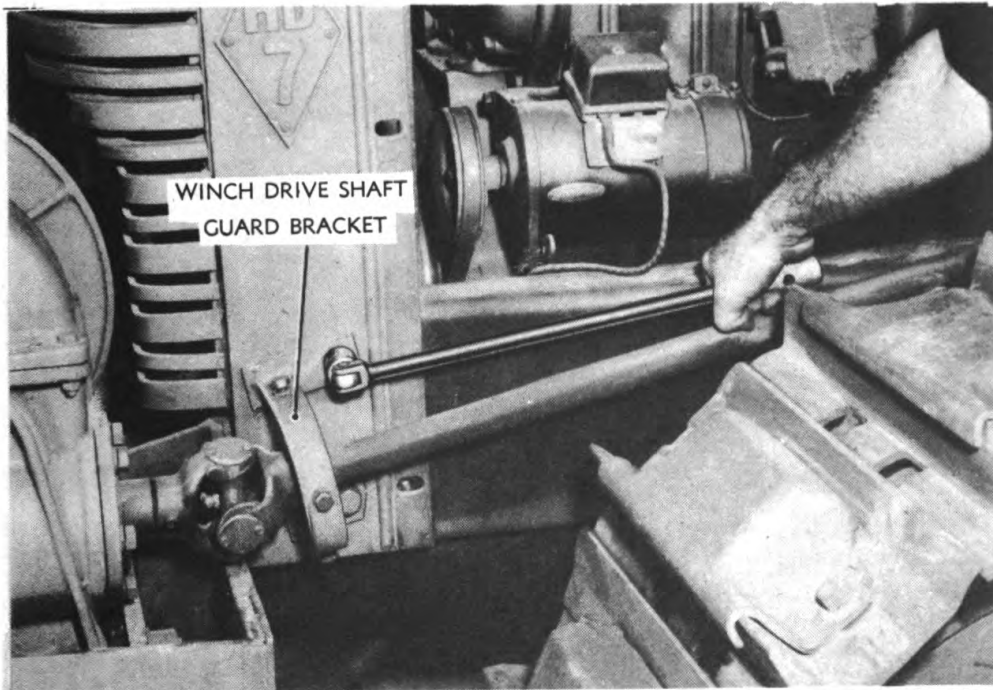
\* Corrections not within the scope of operating organization. Notify ordnance personnel.

# ENGINE



RA PD 56460

**Figure 35—Removing Winch Drive Shaft Guard**



RA PD 56461

**Figure 36—Removing Cap Screws from Winch Drive Shaft Guard Bracket**

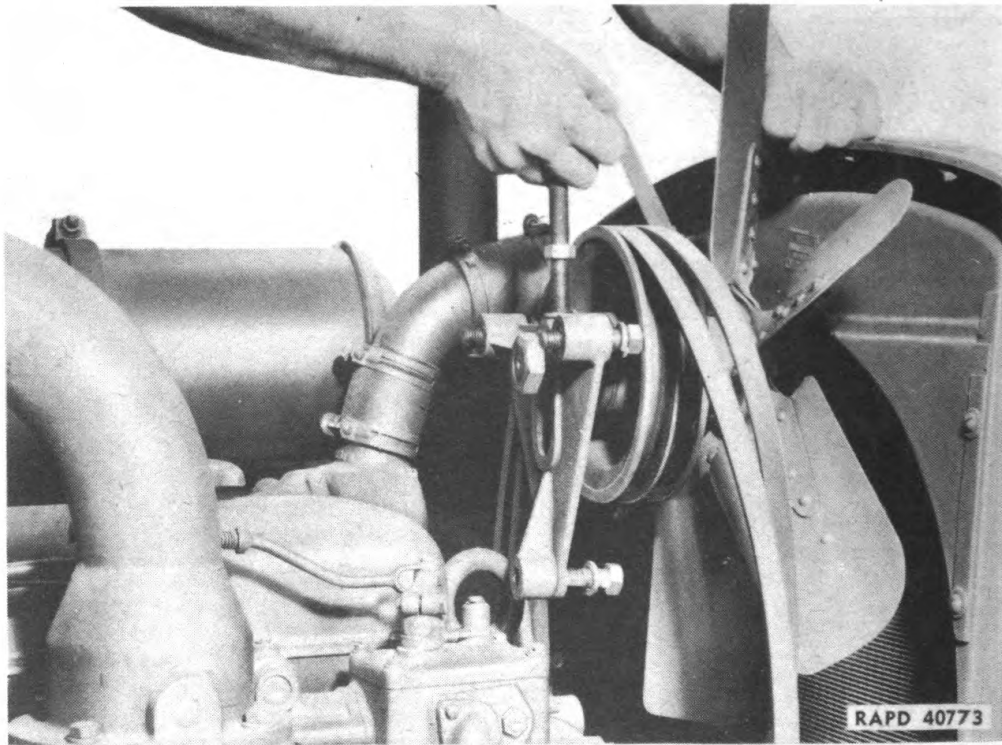
**MEDIUM TRACTOR M1**

- (5) **DISCONNECT INLET AND OUTLET WATER CONNECTIONS.**  
**SCREWDRIVER**, 6-in.                      **WRENCH**, socket, 1/2-in.  
**WRENCH**, 7/8-in.

Loosen top hose clamps and slide hose onto radiator inlet pipe (screwdriver). Remove 4 cap screws from engine support bottom cover (fig. 92) (7/8-in. wrench). Remove cover. Remove 2 cap screws from lower radiator connection at oil cooler inlet (1/2-in. wrench).

- (6) **REMOVE FAN ASSEMBLY.**  
**WRENCH**, 3/4-in.

Remove 3 cap screws holding fan assembly to balance weight cover. Remove fan belts from lower pulley, tilt radiator forward, and lift out fan assembly and belts (fig. 37).



**Figure 37—Removing Fan Assembly**

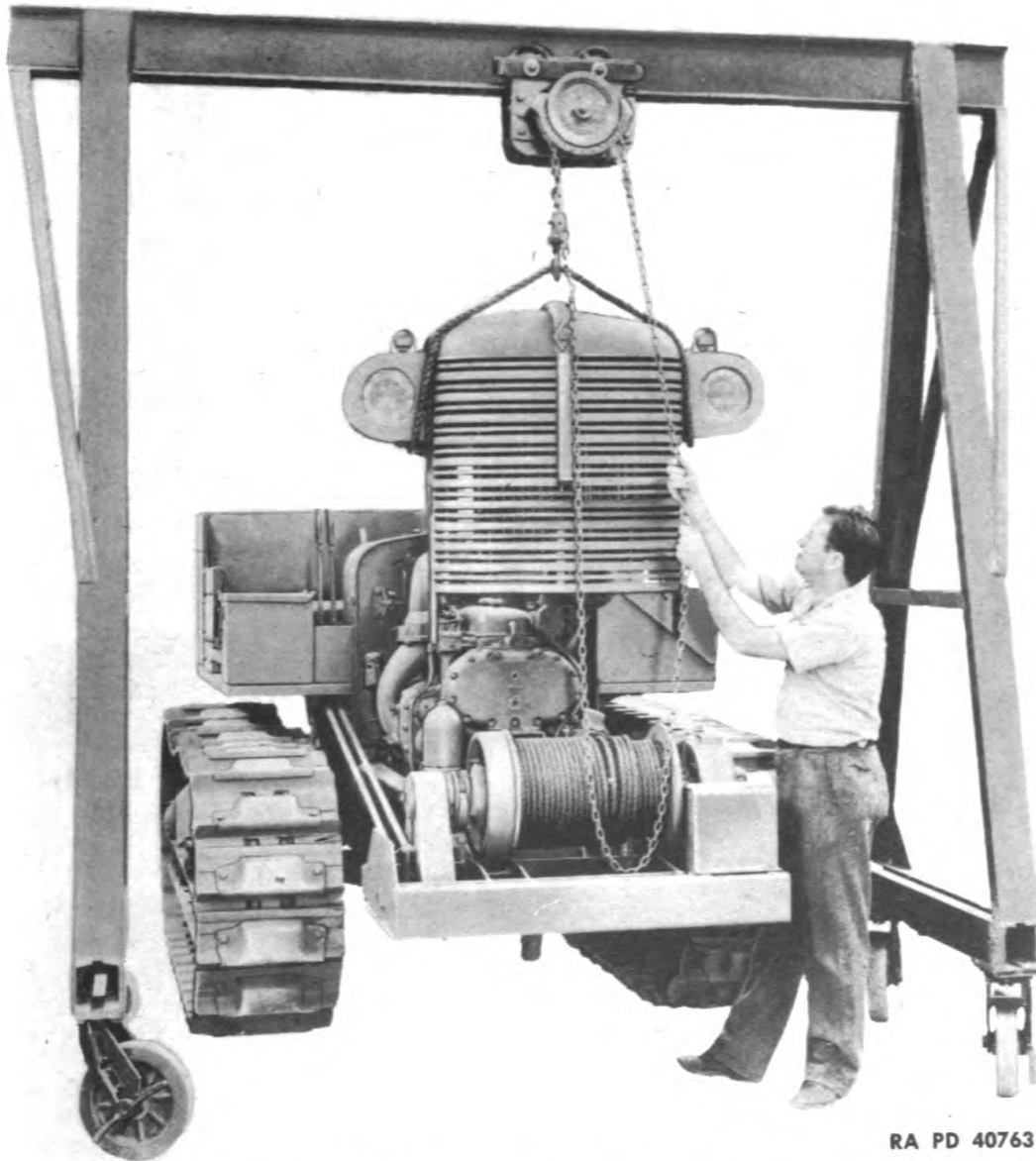
- (7) **DISCONNECT SHUTTER CONTROL AND HEADLIGHT WIRES.**  
**PLIERS**

Remove pin from shutter control rod. Disconnect headlight wires at connector found near generator.

- (8) **REMOVE RADIATOR ASSEMBLY.**  
**HOIST**, chain                                      **ROPE**

Remove the 2 cap screws previously loosened holding radiator to engine support, place rope around radiator assembly under headlights, hook rope into chain hoist, and lift off radiator assembly (fig. 38).

**ENGINE**



RA PD 40763

**Figure 38—Lifting Out Radiator Assembly**

- (9) **DISCONNECT MASTER CLUTCH CONTROL.**  
**PLIERS**

Engage master clutch. Remove pin holding clutch control rod to master clutch lever.

- (10) **DISCONNECT OIL PRESSURE GAGE LINE.**  
**WRENCH**, open-end,  $\frac{7}{8}$ -in.

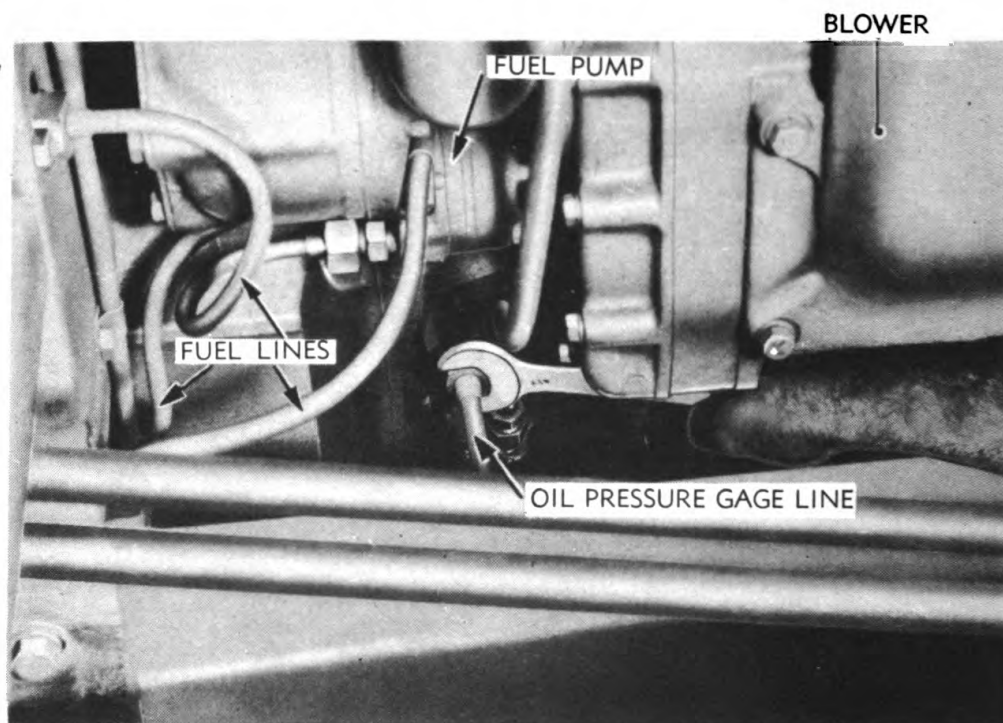
Disconnect oil pressure gage line from engine beneath blower (fig. 39).

- (11) **DISCONNECT FUEL LINES.**  
**WRENCH**, open-end,  $\frac{7}{8}$ -in. (2)

Disconnect outlet fuel line from fuel pump to second fuel filter. Dis-

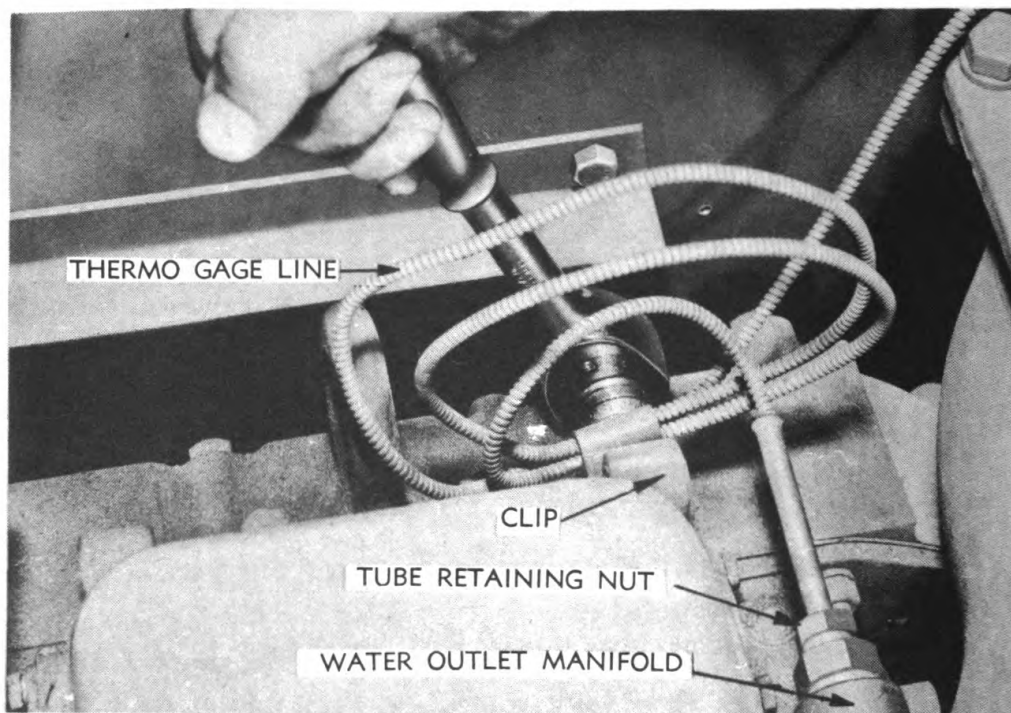


MEDIUM TRACTOR M1



RA PD 56462

Figure 39—Disconnecting Lubricating Oil Pressure Gage Line



RA PD 56463

Figure 40—Removing Cap Screw from Clip on Thermo Gage Line

**ENGINE**

connect inlet fuel line to fuel pump (figs. 66 and 61). Disconnect fuel line from top of second stage fuel filter to third stage fuel filter. Disconnect fuel oil pressure gage line at top of third stage filter. Disconnect fuel return line at fitting underneath right side of cowl.

**(12) DISCONNECT THERMO GAGE TUBE AND LINE.****WRENCH,  $\frac{5}{8}$ -in.****WRENCH, open-end,  $1\frac{1}{16}$ -in.**

Remove thermo gage tube from rear of water manifold and remove clip holding flexible line to engine rear lifter bracket (fig. 40). Replace cap screw in bracket after clip is removed.

**(13) DISCONNECT ENGINE CONTROLS AND WIRES (figs. 41 and 42).****PLIERS****WRENCH,  $\frac{3}{4}$ -in.****SCREWDRIVER, 6-in.**

Remove pin from starter pedal at starting motor switch (pliers). Disconnect throttle rod and front shut-off rod at throttle shaft by removing pins (pliers). Disconnect battery cable at battery and starting motor switch ( $\frac{3}{4}$ -in. wrench). Disconnect ammeter wire at voltage control unit (screwdriver).

**(14) DISCONNECT AIR HEATER (fig. 42).****WRENCH,  $\frac{3}{8}$ -in.****WRENCH,  $\frac{9}{16}$ -in. (2)****WRENCH,  $\frac{1}{2}$ -in.**

Disconnect air heater fuel line at check valve on heater cover (two  $\frac{9}{16}$ -in. wrenches). Remove clip from cylinder block end plate, holding line to engine by removing nut from bolt ( $\frac{9}{16}$ -in. wrench). Remove 2 cap screws from heater cover ( $\frac{1}{2}$ -in. wrench), remove cover, and disconnect coil wire ( $\frac{3}{8}$ -in. wrench).

**(15) DISCONNECT CLUTCH RELEASE BEARING GREASE TUBE.****WRENCH,  $1\frac{5}{16}$ -in.**

Remove nut from grease tube to master clutch release bearing and push tube and fitting into master clutch compartment (fig. 44).

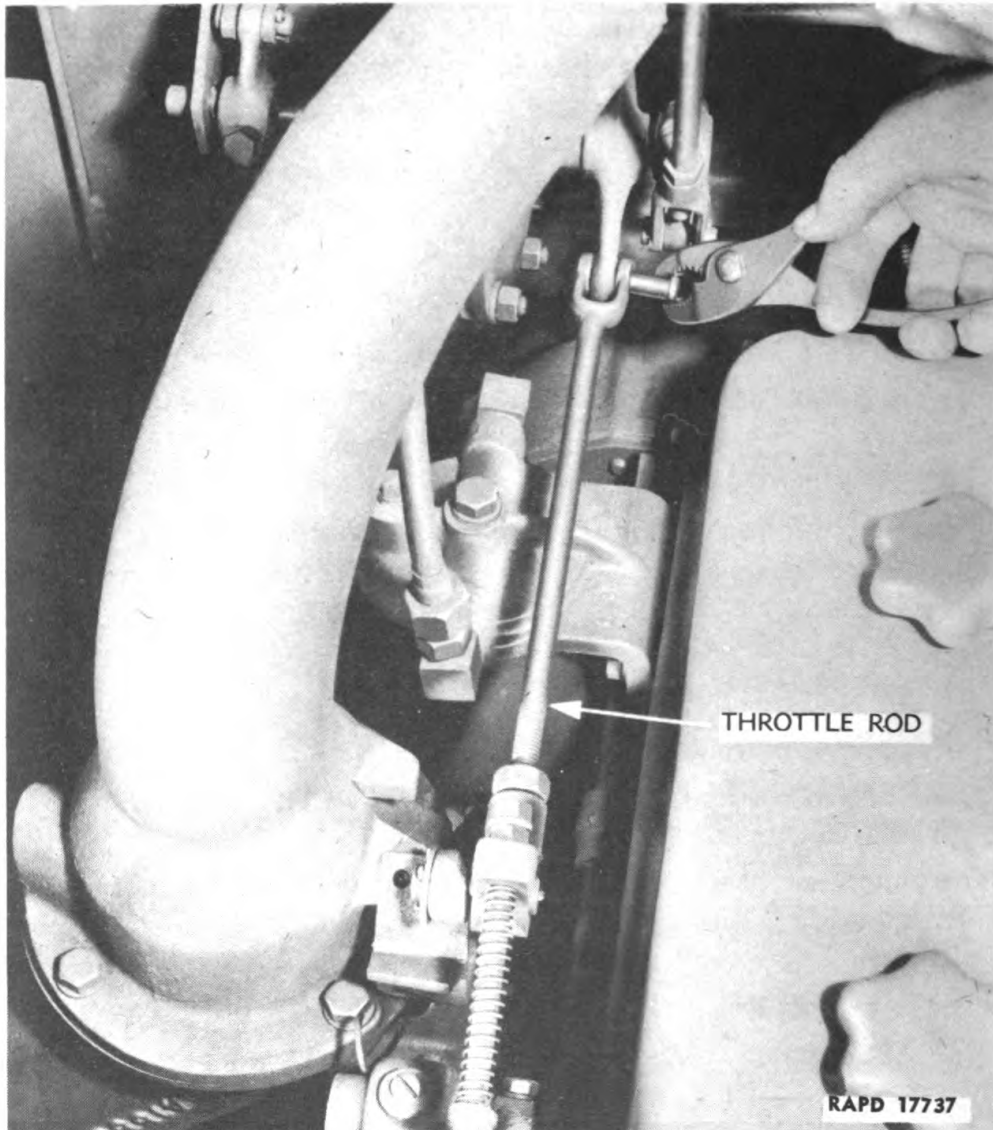
**(16) DISCONNECT AIR INTAKE HOSE (See fig. 31 for location).****SCREWDRIVER, 8-in.**

Loosen hose clamps and push hose back onto air intake elbow.

**(17) REMOVE BOLTS FROM FRONT ENGINE SUPPORT.****WRENCH,  $\frac{7}{8}$ -in.****WRENCH,  $1\frac{5}{16}$ -in.**

Remove 2 bolts at outer ends of front engine support (fig. 43). **CAUTION:** There are shims between the lower side of engine support arms and brackets. Save these shims so they may be used again when engine is installed back in tractor.

## MEDIUM TRACTOR M1



**Figure 41 – Disconnecting Throttle Rod**

**(18) REMOVE GOVERNOR BREATHER TUBE.**

**SCREWDRIVER, 8-in.**

Remove 2 screws from governor breather tube and lift tube from clip on oil cooler housing (fig. 85).

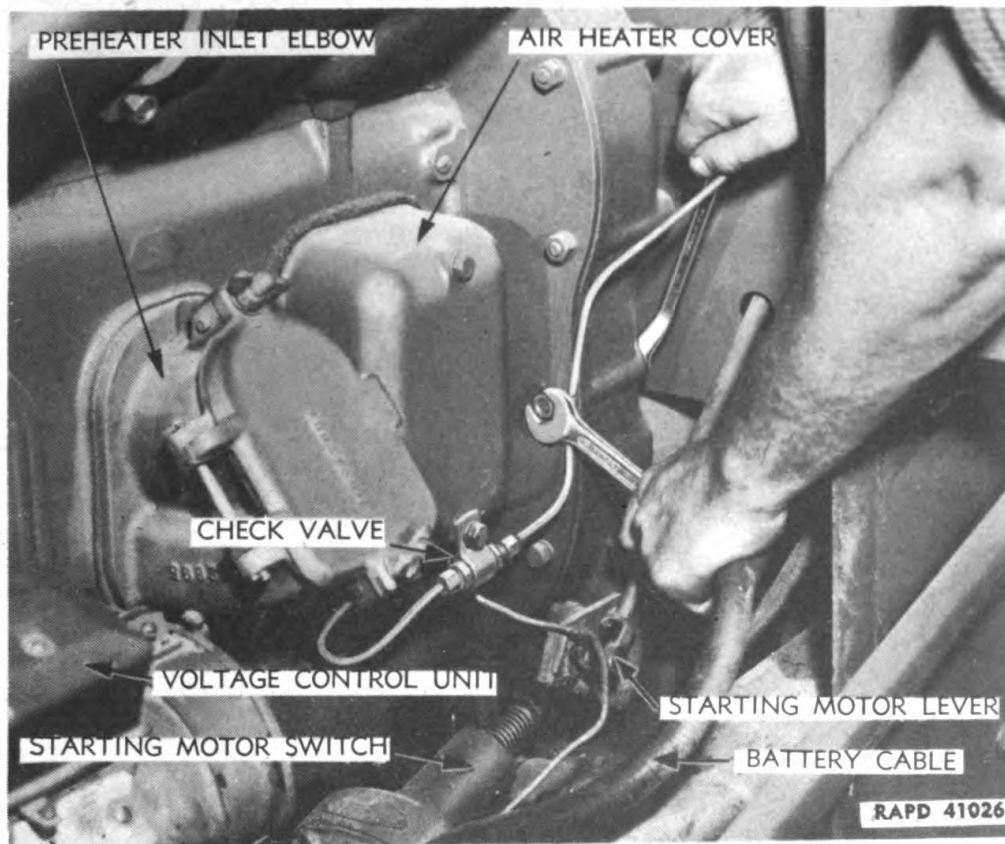
**(19) REMOVE CAP SCREWS FROM FLYWHEEL HOUSING.**

**WRENCH,  $\frac{9}{16}$ -in.**

**WRENCH,  $\frac{3}{4}$ -in.**

Remove the 10 cap screws holding flywheel housing to engine spacer ( $\frac{9}{16}$ -in. wrench) (fig. 44). **NOTE:** Four of these cap screws will be removed by reaching into the master clutch housing through 2 inspection holes in top of engine spacer (fig. 115). Remove clutch cover plates by removing 4 cap screws from covers and lift off covers. Also remove 2 cap screws from master clutch cover and remove cover ( $\frac{3}{4}$ -in. wrench).

## ENGINE



**Figure 42—Removing Air Heater Fuel Line Clip**

**(20) REMOVE ENGINE.**

**HOIST, chain  
ROPE**

**WRENCH,  $\frac{9}{16}$ -in.**

Attach chain hoist to lifter bracket eyes of engine at both ends of cylinder head (fig. 31). Raise motor just enough to slide it ahead. Reach between flywheel housing and engine spacer and remove 12 cap screws holding master clutch to flywheel ( $\frac{9}{16}$ -in. wrench). Push clutch assembly back on shaft. Lift engine assembly from tractor (fig. 45).

**e. General Inspection of Removed Engine.** Before installing engine back into tractor, wash dirt and grease from the engine support and master clutch compartment. At the same time, inspect the engine support assembly, engine spacer and master clutch compartment and assemblies contained in them, and if any repair work is necessary on them, do it before engine is installed. Check engine spacer and engine support bolts to see that they are tight and that none are missing. Check bolts holding winch assembly to engine support to see if they are tight. Repair or replace any damaged wires or fuel lines.

MEDIUM TRACTOR M1

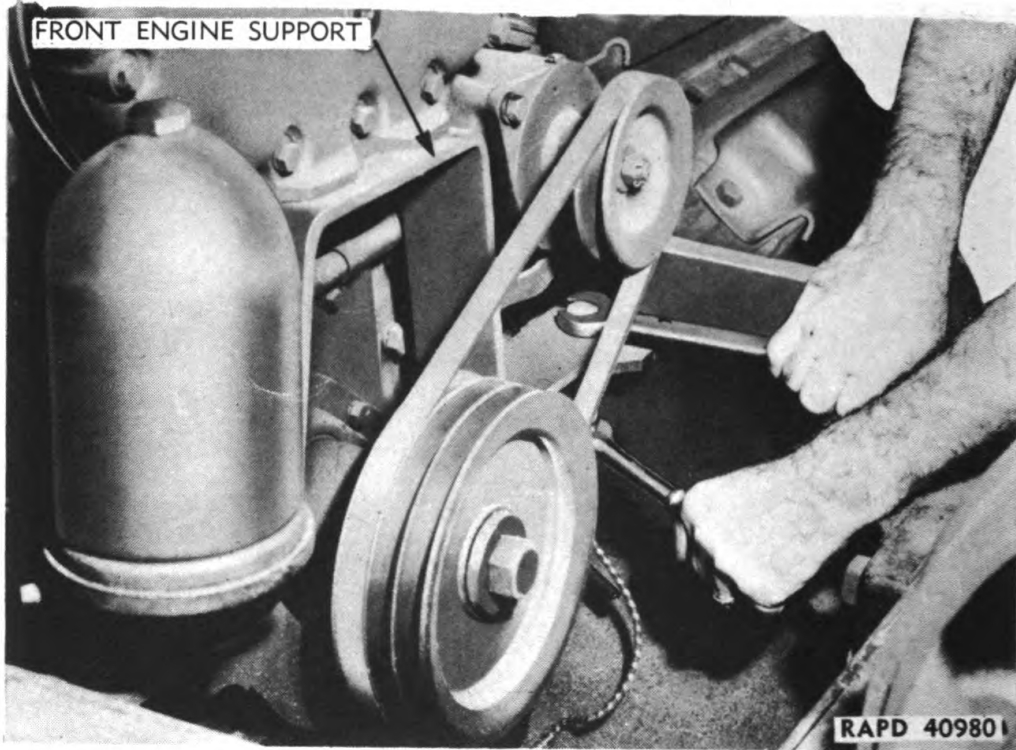
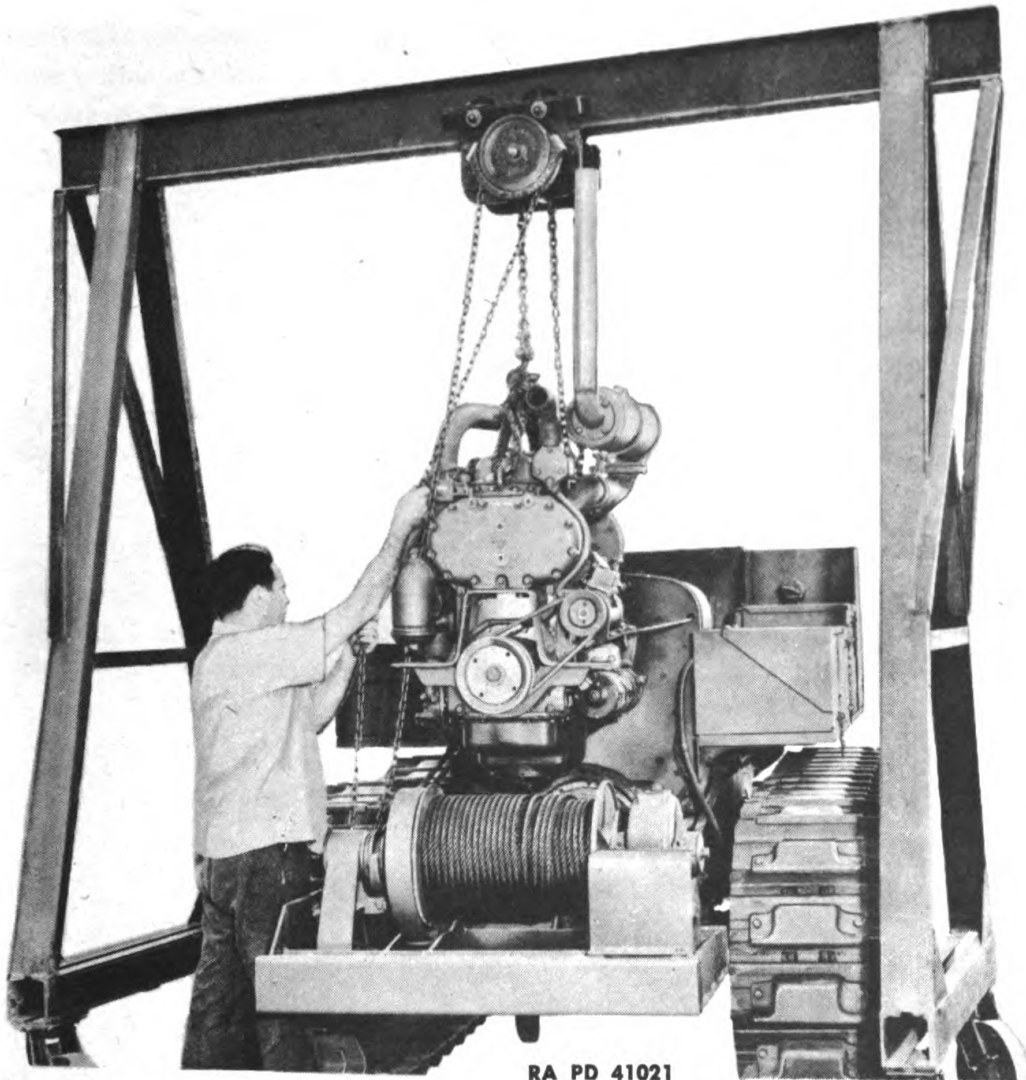


Figure 43—Removing Bolts from Front Engine Support



Figure 44—Removing Cap Screw Holding Engine to Spacer

**ENGINE**



RA PD 41021

**Figure 45—Removing Engine from Tractor**

**f. Installation of Engine in Tractor.**

- |                               |                                      |
|-------------------------------|--------------------------------------|
| <b>GAGE</b> , injector timing | <b>WRENCH</b> , 3/4-in. (2)          |
| <b>HOIST</b> , chain          | <b>WRENCH</b> , 7/8-in. (2)          |
| <b>PLIERS</b>                 | <b>WRENCH</b> , 1 5/16-in.           |
| <b>PLIERS</b> , battery       | <b>WRENCH</b> , 1-in.                |
| <b>ROPE</b>                   | <b>WRENCH</b> , engine cranking      |
| <b>SCREWDRIVER</b> , 6-in.    | <b>WRENCH</b> , open-end, 5/16-in.   |
| <b>SCREWDRIVER</b> , 8-in.    | <b>WRENCH</b> , open-end, 1/2-in.    |
| <b>SHELLAC</b>                | <b>WRENCH</b> , open-end, 9/16-in.   |
| <b>WRENCH</b> , 3/8-in.       | (2)                                  |
| <b>WRENCH</b> , 7/16-in.      | <b>WRENCH</b> , open-end, 1 1/16-in. |
| <b>WRENCH</b> , 1/2-in.       | <b>WRENCH</b> , socket, 1/2-in.      |
| <b>WRENCH</b> , 9/16-in. (2)  | <b>WRENCH</b> , socket, 9/16-in.     |
| <b>WRENCH</b> , 5/8-in.       |                                      |

**MEDIUM TRACTOR M1**

(1) **INSTALL MASTER CLUTCH ON CLUTCH SHAFT.** (fig. 46). Place master clutch assembly on clutch shaft, taking care to see that slots on the throw-out yoke fit in place on sliding blocks on release yoke and that the sliding blocks are placed on the release yoke so that flanges are toward the bearing. Next install driven plate assembly on clutch shaft with the oil slinger on driven plate assembly toward front of tractor.

(2) **LOWER ENGINE INTO POSITION** (fig. 45).

**HOIST**, chain

**WRENCH**, socket,  $\frac{9}{16}$ -in.

**ROPE**

Using chain hoist and rope, lower engine evenly into engine support and push engine back, making sure that end of clutch shaft engages pilot bearing in flywheel. Then install the 10 cap screws with lock washers holding engine to spacer assembly ( $\frac{9}{16}$ -in. wrench).

(3) **INSTALL SHIMS UNDER FRONT ENGINE SUPPORT.**

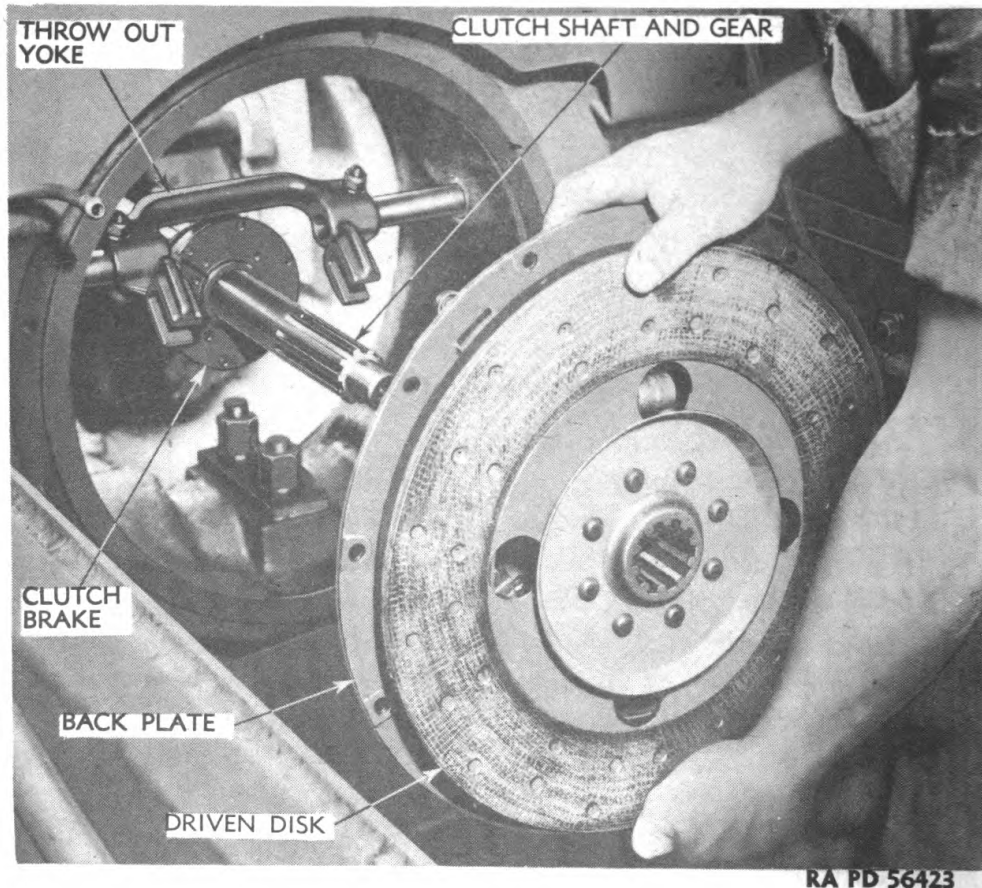
**HOIST**, chain

**WRENCH**,  $\frac{7}{8}$ -in.

**ROPE**

**WRENCH**,  $1\frac{5}{16}$ -in.

Crowd as many shims as possible without raising front of engine be-



RA PD 56423

**Figure 46—Installation of Master Clutch on Clutch Shaft**

**ENGINE**

tween front engine support and engine support bracket. Then raise front of engine and add one more shim to each side. Install the 2 bolts with lock washers holding front engine support and shims to engine support bracket.

**(4) CONNECT CLUTCH ASSEMBLY TO FLYWHEEL.**

• **WRENCH**, engine cranking                      **WRENCH**, socket,  $\frac{9}{16}$ -in.

Working through master clutch inspection, cover holes in transmission above clutch, slide master clutch assembly against flywheel, lining up holes in master clutch backplate with holes in flywheel, and install the 12 cap screws with lock washers holding master clutch to flywheel ( $\frac{9}{16}$ -in. wrench). **NOTE:** The engine will have to be turned while installing these cap screws with engine cranking wrench.

**(5) CONNECT MASTER CLUTCH CONTROL ROD.**

**WRENCH**,  $\frac{3}{4}$ -in.                                      **WRENCH**,  $1\frac{5}{16}$ -in.

Install the yoke pin and cotter pin holding master clutch control rod to sublever on left side of transmission case. Adjust master clutch and clutch brake as outlined in section 17. Insert clutch throw-out bearing grease tube through hole in transmission case (fig. 44), and install lock nut ( $1\frac{5}{16}$ -in. wrench).

**(6) INSTALL INSPECTION COVERS.**

**WRENCH**,  $\frac{3}{4}$ -in.

Install master clutch cover using 4 cap screws and lock washers holding cover to transmission case and install the 2 cover plates with 4 cap screws holding each cover plate to spacer assembly (fig. 115).

**(7) CONNECT OIL GAGE LINE.**

**WRENCH**, open-end,  $\frac{7}{8}$ -in.

Connect oil pressure gage line to fitting in cylinder block beneath blower (fig. 36).

**(8) CONNECT FUEL LINES (figs. 61 and 66).**

**WRENCH**, open-end,  $\frac{7}{8}$ -in. (2)

Connect inlet fuel line to fuel pump. Install and connect outlet fuel line to fuel pump and to lower coupling on second stage filter. Install and connect outlet fuel line at top of second stage filter to third stage fuel filter on right side of engine. Connect the return fuel line to fitting underneath right side of cowl. Connect fuel oil pressure gage line to top of third stage filter.

**(9) CONNECT FUEL AND AIR SHUT-OFF ROD.**

**PLIERS**

Connect fuel and air shut-off rod at long shut-off lever at rear of engine with yoke pin and cotter pin (fig. 41).



**MEDIUM TRACTOR M1****(10) CONNECT THROTTLE ROD.****PLIERS**

Connect throttle control rod to lever to short shut-off lever at rear of engine with yoke pin and cotter pin (fig. 41).

**(11) CONNECT AIR INTAKE HOSE.****SCREWDRIVER, 8-in.**

Slide hose on air intake elbow onto air intake tube and tighten hose clamps.

**(12) CONNECT THERMO GAGE LINE.****WRENCH,  $\frac{5}{8}$ -in.****WRENCH, open-end,  $1\frac{1}{16}$ -in.**

Install thermo gage clip under cap screw holding rear engine lifter bracket on left side of engine (fig. 40). Insert the tube in the fitting in water manifold and tighten the tube nut.

**(13) INSTALL AIR HEATER COVER.****WRENCH,  $\frac{3}{8}$ -in.****WRENCH,  $\frac{1}{2}$ -in.****WRENCH,  $\frac{7}{16}$ -in.****WRENCH, open-end,  $\frac{9}{16}$ -in.****(2)**

Connect air heater coil wire to coil ( $\frac{3}{8}$ -in. wrench) and install air heater cover with 2 cap screws with lock washers ( $\frac{1}{2}$ -in. wrench). Connect the air heater fuel check valve clip to air heater cover with the lower cap screw. Connect air heater fuel line to check valve (two  $\frac{9}{16}$ -in. wrenches). Attach clip on fuel line to lower left bolt on rear cylinder block end plate and install  $\frac{3}{8}$ -inch nut and lock washer on bolt ( $\frac{9}{16}$ -in. wrench).

**(14) CONNECT AMMETER WIRE AND STARTER CABLE.****WRENCH,  $\frac{3}{4}$ -in.**

Connect ammeter wire and battery cable to starting motor switch post.

**(15) CONNECT AMMETER WIRE TO VOLTAGE CONTROL UNIT.****SCREWDRIVER, 6-in.**

Connect remaining ammeter wire to voltage control on top of generator.

**(16) CONNECT STARTING MOTOR.****PLIERS**

Install starter rod over pin on starting motor switch lever and install cotter pin.

**(17) CONNECT CABLE FROM STARTING MOTOR TO BATTERY.****PLIERS, battery**

Place cable terminal on battery terminal and tighten clamp bolt and nut.

**ENGINE****(18) INSTALL RADIATOR ASSEMBLY INTO PLACE.****HOIST**, chain**ROPE**

Using a chain hoist, lower radiator assembly into position, at the same time guiding radiator shutter control rod into place through left side of radiator shell and case (fig. 38). Install the 2 (1 on each side) cap screws with lock washers in the lower front corner of radiator shell, but do not tighten these cap screws. Tilt radiator forward as far as possible, place belts in pulley grooves, and lower fan assembly into position (fig. 37). Install 3 cap screws with lock washers securing fan assembly to balance weight cover, and tilt radiator back into an upright position.

**(19) INSTALL WINCH DRIVE SHAFT GUARD BRACKET.****WRENCH**,  $\frac{7}{8}$ -in.

Install winch drive shaft guard bracket over winch drive shaft, and install the 2 cap screws, holding winch bracket to radiator shell and radiator shell to engine support (fig. 36).

**(20) CONNECT SHUTTER ROD AND LIGHT WIRES.****PLIERS****WRENCH**,  $\frac{7}{8}$ -in.

Install the remaining 2 cap screws on right side of radiator, holding radiator shell to engine support ( $\frac{7}{8}$ -in. wrench), and install pin, holding radiator shutter control rod to shutter lever on left top side of radiator (pliers) (fig. 47). Connect the 2 headlight blackout light wires to their sockets underneath generator. Tighten all cap screws and bolts ( $\frac{7}{8}$ -in. wrench).

**(21) CONNECT INLET AND OUTLET HOSES (see fig. 31 for location).****SCREWDRIVER**, 8-in.**WRENCH**, socket,  $\frac{1}{2}$ -in.

Tighten the 2 hose clamp screws holding radiator outlet hose at lower water connection and radiator connection (screwdriver). Shellac gasket to lower water connection and install the 2 cap screws and lock washers holding lower water connection to oil cooler ( $\frac{1}{2}$ -in. wrench). Shellac radiator inlet elbow to the water manifold outlet. Tighten hose clamp connections (screwdriver). **NOTE:** The lower water hose connection may be installed best through opening of engine support bottom cover, if this cover is not already in place.

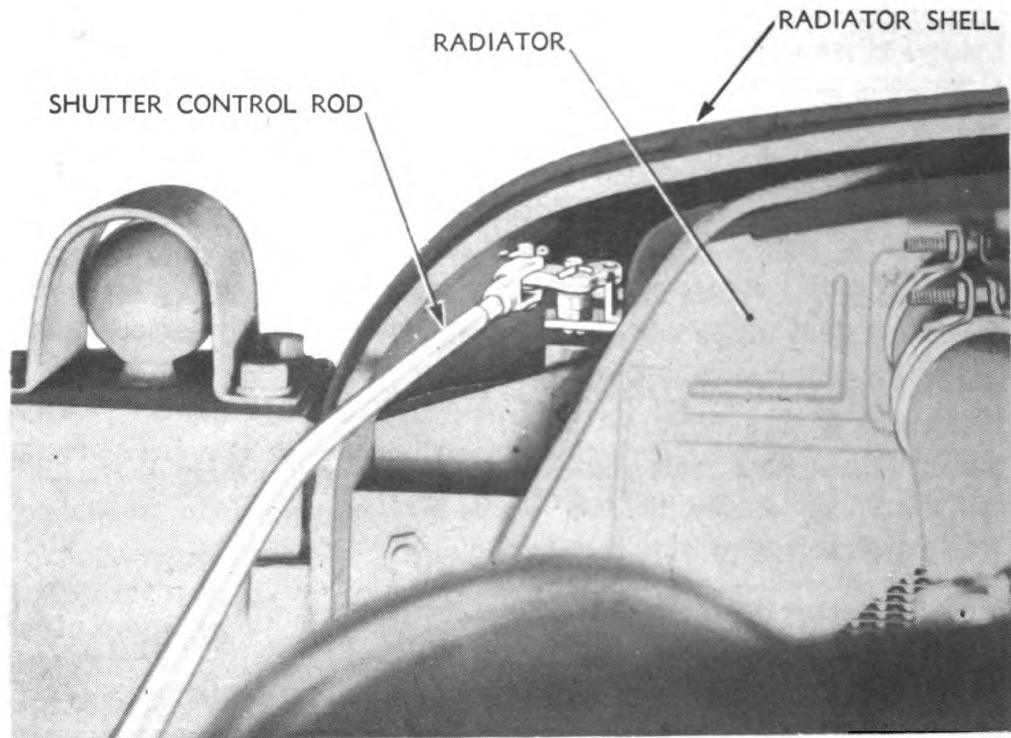
**(22) INSTALL ENGINE SUPPORT BOTTOM COVER.****WRENCH**,  $\frac{7}{8}$ -in.

Check to see that crankcase drain plug is tight. Install cover and secure with 4 cap screws and lock washers holding engine support bottom cover to engine support (fig. 97).

**(23) INSTALL FRONT FENDERS.****WRENCH**,  $\frac{3}{4}$ -in. (2)

Install the 3 bolts with lock washers and 2 caps screws with lock

**MEDIUM TRACTOR M1**



RA PD 17215

**Figure 47—Shutter Control Rod Connection at Radiator**

washers holding left front fender. Install 1 bolt with lock washer and 3 cap screws with lock washers holding right front fender. **NOTE:** The top rear bolt holding left front fender to rear fender also holds the starting motor-to-battery cable clip.

**(24) INSTALL WINCH DRIVE SHAFT GUARD.**

**WRENCH,  $\frac{9}{16}$ -in. (2)**

**WRENCH,  $\frac{3}{4}$ -in. (2)**

Install the 3 cap screws with lock washers holding front end of guard to bracket ( $\frac{9}{16}$ -in. wrench), 2 bolts with lock washers holding guard to left rear fender (2  $\frac{9}{16}$ -in. wrenches), and 1 bolt with lock washer on top rear hole (2  $\frac{3}{4}$ -in. wrenches) (fig. 35).

**(25) FILL RADIATOR.** Close drain cocks. Fill radiator with clean water or cooling solution. Remove pipe plug from side of thermostat housing while filling radiator until water runs out of holes. Replace plug and finish filling radiator.

**(26) FILL CRANKCASE.** Fill crankcase with 11 quarts of recommended engine lubricating oil. See lubrication chart.

## ENGINE

### (27) EQUALIZE INJECTORS.

GAGE, injector timing

WRENCH, open-end, 1/2-in.

WRENCH, open-end, 5/16-in.

Injectors must be equalized at this time. Remove rocker arm cover, if it has been installed, and follow procedure outlined under injector equalizing in paragraph 66.

(28) **START ENGINE.** Check all wires, fuel line, and controls to be sure they are all connected and tight, open valve under fuel tank, and start engine. It is advisable to fill the second and third stage fuel filters to save cranking the engine with starting motor until fuel pump fills these filters. After engine starts, check all fuel, oil, and water connections, and fuel and oil filters for leaks. Observe fuel and oil pressure gages to see that they are registering the correct pressures. Install rocker arm cover and tighten cover bolts.

### (29) INSTALL HOOD.

WRENCH, 9/16-in.

Lower hood over exhaust pipe and into position on cowl and radiator shell. Tighten the 4 hold-down bolts at each corner of hood. **NOTE:** The bolt holding the left rear corner of hood is located inside the battery box.

## 57. ROCKER ARM ASSEMBLY.

a. **General.** There are 3 rocker arms for each cylinder. The 2 outer arms operate the exhaust valves and the center rocker arm operates the injector. Each rocker arm assembly operates on a separate shaft supported by 2 brackets. A special 1/2-inch hollow cap screw holds each bracket to the cylinder head. The removal of these 2 cap screws permits the brackets to be removed from the shaft and the shaft removed from the rocker arms. The rocker arms may then be laid back, giving access to the injector and valve assemblies. The rocker arm assemblies may be replaced by the using arm personnel if they are broken or worn.

### b. Removal of Rocker Arm Assembly.

WRENCH, open-end, 7/16-in.

WRENCH, open-end, 9/16-in.

(2)

WRENCH, socket, 3/4-in.

WRENCH, open-end, 1/2-in.

(1) **REMOVE HOOD.** Refer to paragraph 66 d (1) and figures 70 and 71.

(2) **REMOVE ROCKER ARM COVER.** Unscrew the 2 hand screws holding rocker arm cover to cylinder head and lift off cover.

### (3) LOOSEN PUSH ROD LOCK NUTS.

WRENCH, open-end, 1/2-in.

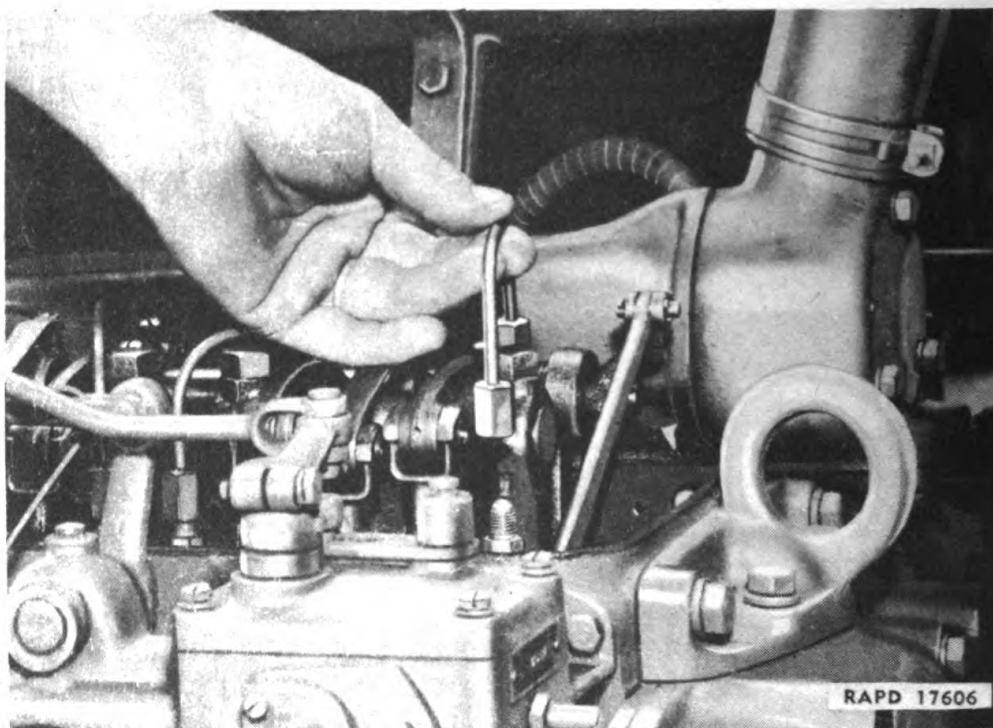
Loosen nuts underneath clevis on push rods (see fig. 45 for location).

**MEDIUM TRACTOR M1**

**(4) REMOVE INJECTOR FUEL LINES.**

**WRENCH**, open-end, 1/2-in.

Remove the fuel line connectors at both ends of lines and remove lines (fig. 48). Place shipping caps on fittings from which lines were removed.



**Figure 48—Injector Fuel Line Removed**

**(5) REMOVE ROCKER ARM BRACKETS.**

**WRENCH**, socket, 3/4-in.

Remove the 2 cap screws holding the rocker arm assembly to cylinder head and remove brackets (fig. 49).

**(6) REMOVE SHAFT.** Remove shaft by sliding it out of rocker arms and brackets.

**(7) REMOVE ROCKER ARM ASSEMBLIES.** Unscrew clevises from push rods and remove rocker arms.

**c. Installation.**

**GAGE**, feeler

**GAGE**, injector timing

**SCREWDRIVER**

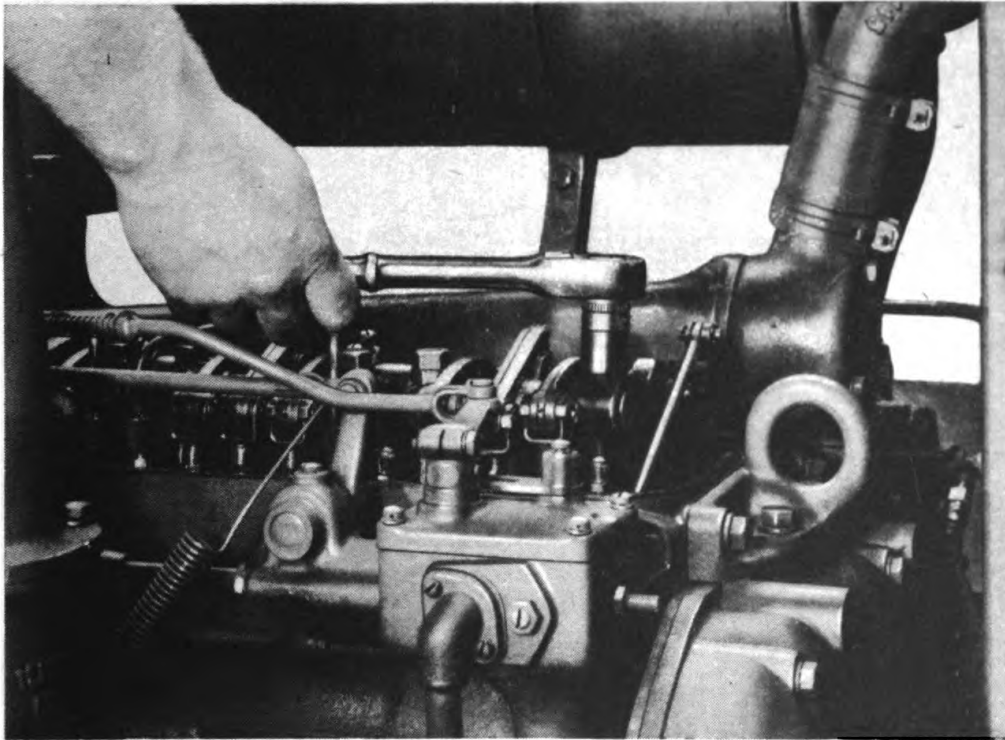
**WRENCH**, open-end, 5/16-in.

**WRENCH**, open-end, 1/2-in.

**WRENCH**, socket, 3/4-in.

**(1) INSTALL ROCKER ARMS ON PUSH RODS.** Screw the push rods

## ENGINE



RA PD 17619

**Figure 49—Removing Cap Screws from Rocker Shaft Brackets**

into the rocker arm clevis so that the end of the rod is flush with the top of the threaded part of the clevis (fig. 50). NOTE: This is very important because of the small clearance between the valve head and the top of the piston when the piston is at the top of its stroke. It is possible for the piston to strike the head of the valve, resulting in considerable damage, if rocker arm is not screwed down far enough. The injector rocker arm has a hardened ball stud and ball seat which form a universal joint.

(2) **SLIDE SHAFT THROUGH ROCKER ARMS.** If the original shaft is used, turn the side having the greatest evidence of wear up.

(3) **INSTALL ROCKER ARM BRACKETS.**

WRENCH, socket,  $\frac{3}{4}$ -in.

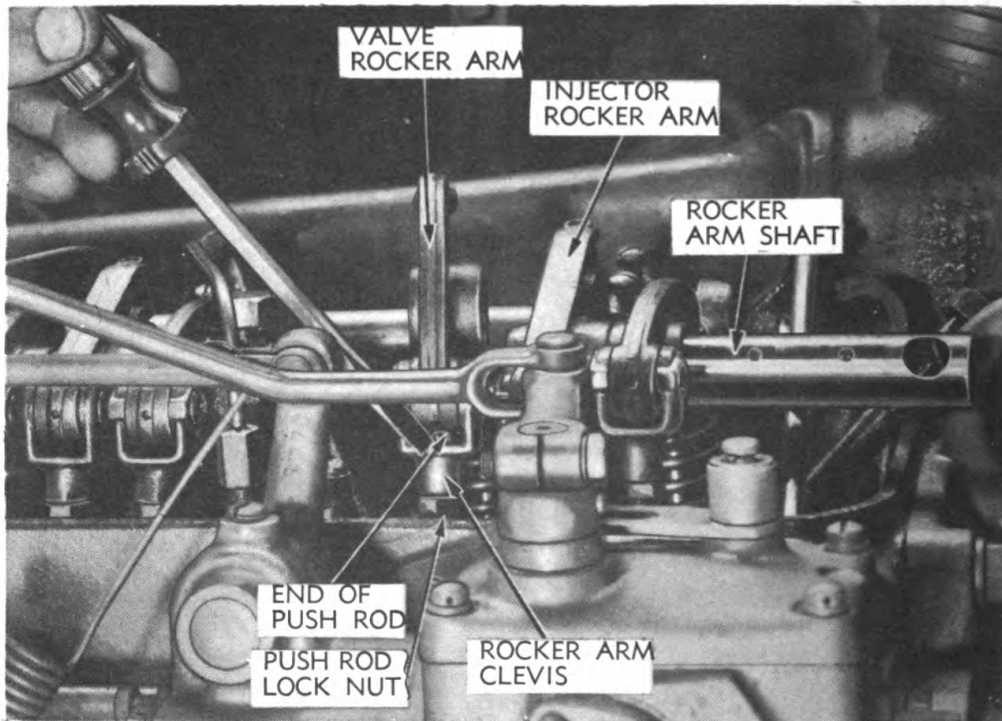
Place the brackets on the shaft, smooth side towards rocker arms, and draw the long cap screws down firmly. As the brackets are tightened down, hold the brackets together allowing only slight clearance between the rocker arms and brackets. A total of 0.003- to 0.006-inch clearance is sufficient.

(4) **INSTALL THE INJECTOR FUEL LINES.**

WRENCH, open-end,  $\frac{1}{2}$ -in.

Remove the shipping caps and install the fuel lines.

MEDIUM TRACTOR M1



RA PD 56464

**Figure 50—Installing Rocker Arm**

(5) **ADJUST VALVE CLEARANCE, TIME AND EQUALIZE INJECTOR.** See paragraph 58 for valve clearance adjustment and paragraph 66 for injector timing and equalizing.

**58. VALVE CLEARANCE.**

**a. General.** Correct valve clearance is important because of high compression pressure developed in a Diesel engine. Too little clearance causes a loss of compression, "missing," and eventual burning of the valves and valve seats. Too much clearance results in noisy engine operation. The correct valve clearance is 0.010-inch at operating temperature. The valve clearance is adjusted by turning the push rod in the push rod clevis, which changes the length of the rod. Turn the push rod to the left to decrease valve lash clearance (lengthen rod), and to the right to increase clearance (shorten rod). Follow the steps outlined below to set the valve clearance correctly.

**b. Adjustment.**

GAGE, feeler

WRENCH, open-end, 1/2-in.

WRENCH, open-end, 5/16-in.

(1) **ROTATE ENGINE TO "OPEN VALVE" POSITION.** Rotate the

## ENGINE

engine with the starting motor until the injector plunger is fully depressed (injector rocker arm down).

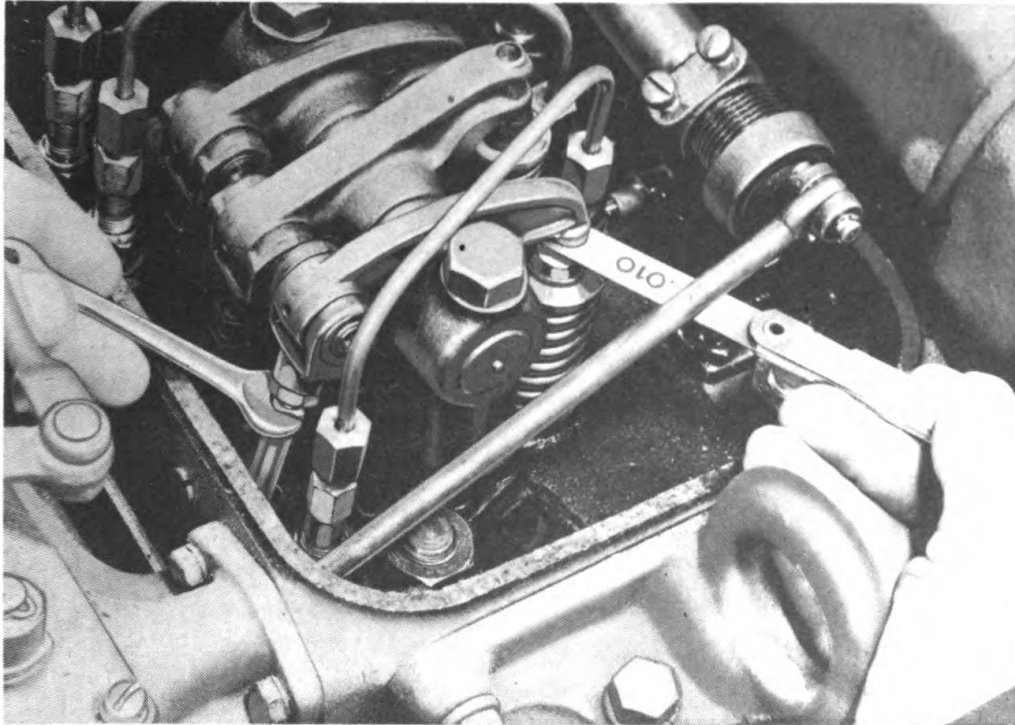
(2) **ADJUST CLEARANCE BETWEEN ROCKER ARM AND PUSH ROD.**

**GAGE**, feeler

**WRENCH**, open-end, 1/2-in.

**WRENCH**, open-end, 1/4-in.

Use the 0.010-inch feeler gage and adjust each push rod until the gage will just pass between the valve stem and the rocker arm (fig. 51).



RA PD 17491

**Figure 51—Valve Clearance Adjustment**

(3) **TIGHTEN LOCK NUT.**

**WRENCH**, open-end, 1/4-in.

**WRENCH**, open-end, 1/2-in.

Hold push rod and tighten lock nut. Check again to see if 0.010-inch feeler gage can be inserted between the valve stem and rocker arm. A slight drag should be felt on feeler gage.

(4) Repeat above steps for each cylinder.

## 59. GOVERNOR.

**a. Description.** The governor is of the mechanical, fly ball, or fly-weight type. Its purpose is to control engine idling speed and to limit maximum engine speed under the variable load requirements.

**b.** Many governors are adjusted unnecessarily because of failure to realize that while irregularities in engine performance may result from



**MEDIUM TRACTOR M1**

faulty governors, they more often are due to other causes. A governor when correctly adjusted will seldom require attention; therefore, unwarranted tampering with the governor is most vigorously discouraged.

c. The using arm personnel should not attempt any adjustment or replacement of the governor. All other possible causes of irregular engine performance should be eliminated first, and if the governor is still suspected as the cause, report it to the next higher authority.

**60. EXHAUST MANIFOLD AND MUFFLER.**

a. **Description** (fig. 32). The exhaust manifold is in one section and is held to the cylinder head by 4  $\frac{7}{16}$ -inch studs, nuts, and special washers. The muffler is bolted to the manifold with 4  $\frac{1}{2}$ -inch cap screws and lock washers and supported at front end by a support strap from the exhaust manifold.

**b. Trouble Shooting.****(1) LOUD EXHAUST.**

Probable Cause	Probable Remedy
Gasket blown.	Replace gasket.
Holes in muffler.	Replace muffler.
Break in manifold.	Replace manifold.

**c. Removal.**

WRENCH, open-end, $\frac{9}{16}$ -in.	WRENCH, socket, $\frac{3}{4}$ -in., with extension
WRENCH, socket, $\frac{9}{16}$ -in.	
WRENCH, socket, $\frac{5}{8}$ -in.	

**(1) REMOVE MUFFLER CLAMP.**

WRENCH, open-end, $\frac{9}{16}$ -in.	WRENCH, socket, $\frac{9}{16}$ -in.
Remove the 4 bolts from clamp around muffler.	

**(2) REMOVE MUFFLER.**

WRENCH, socket, $\frac{9}{16}$ -in.	WRENCH, socket, $\frac{3}{4}$ -in.
Remove the 2 cap screws holding muffler to front support (fig. 52), 4 cap screws holding stack elbow to muffler, and the 4 cap screws holding muffler and elbow to manifold (fig. 53), and remove muffler.	

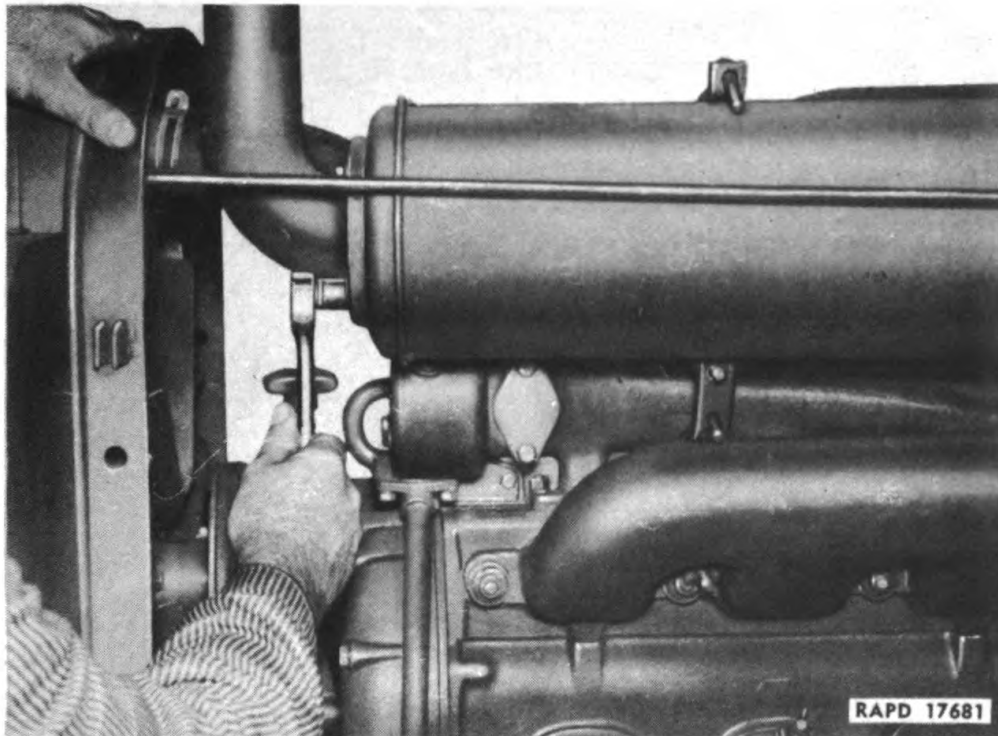
**(3) REMOVE MANIFOLD.**

WRENCH, socket, $\frac{5}{8}$ -in., with extension
Loosen the nuts on stud bolts holding manifold to cylinder head and lift manifold off the studs (fig. 54).

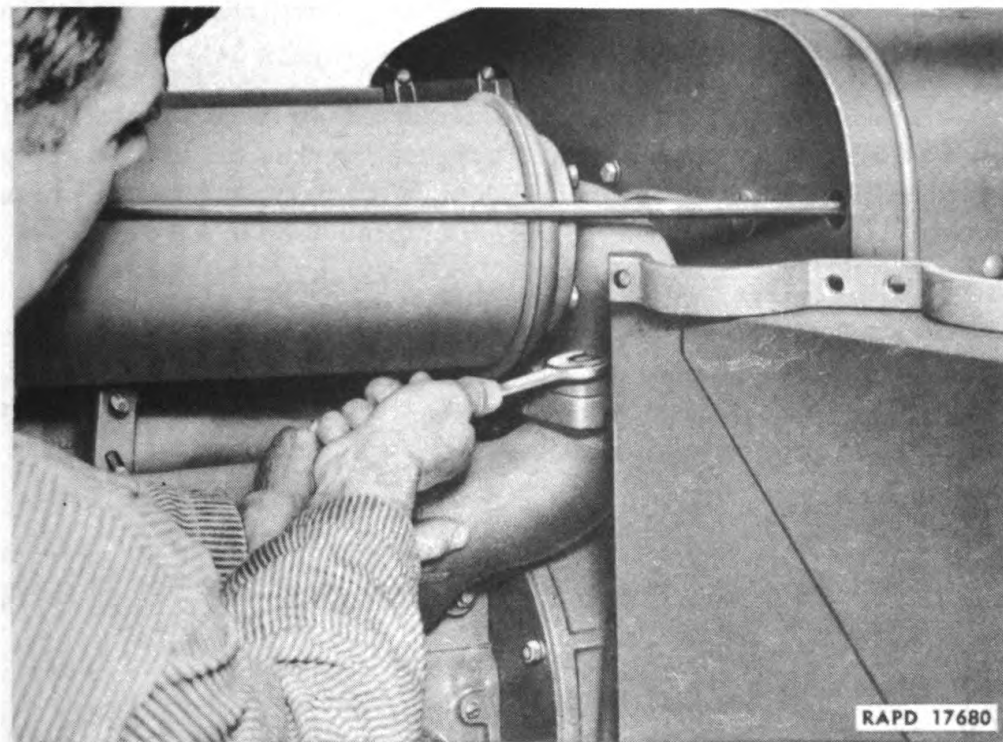
**d. Installation.**

WRENCH, open-end, $\frac{9}{16}$ -in.	WRENCH, socket, $\frac{3}{4}$ -in., with extension
WRENCH, socket, $\frac{9}{16}$ -in.	
WRENCH, socket, $\frac{5}{8}$ -in.	

ENGINE

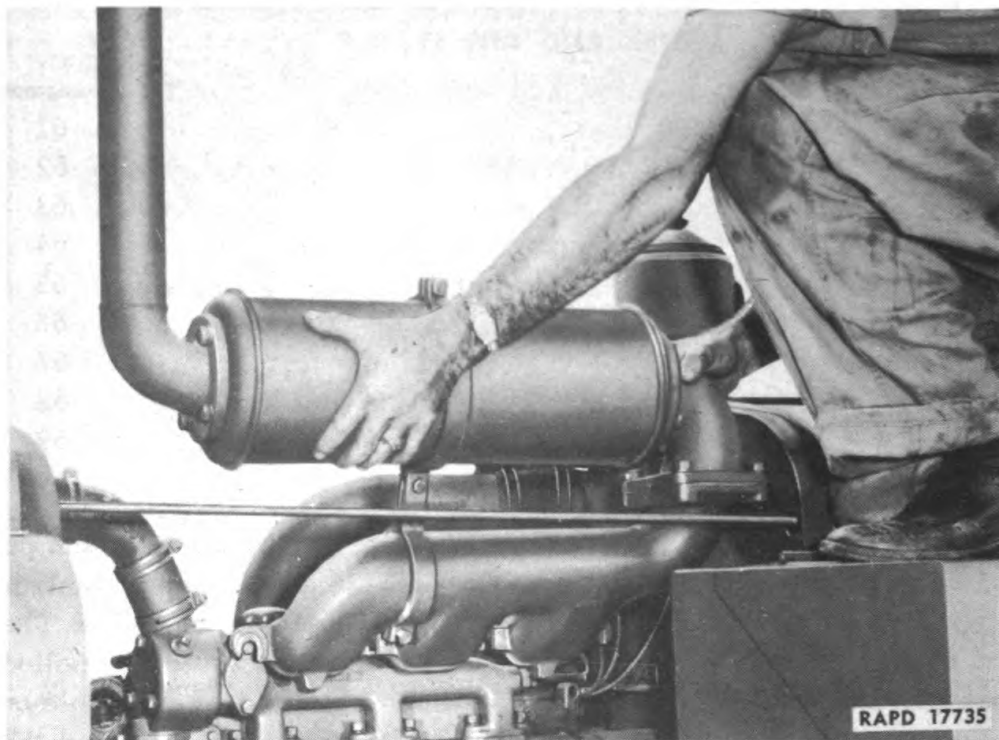


**Figure 52—Removing Cap Screws from Muffler**



**Figure 53—Removing Cap Screws from Muffler Elbow**

## MEDIUM TRACTOR M1



**Figure 54—Removing Exhaust Manifold and Muffler as One Unit**

**(1) INSTALL MANIFOLD.**

**WRENCH**, socket,  $\frac{5}{8}$ -in.

Clean all old gaskets off manifold and head. Remove the nuts and washers from stud bolts in head and place new gaskets on studs. Shellac or grease is unnecessary. Place manifold on studs and tighten all nuts evenly.

**(2) INSTALL MUFFLER.**

**WRENCH**, socket,  $\frac{9}{16}$ -in.

**WRENCH**, socket,  $\frac{3}{4}$ -in., with extension

Install the 4 cap screws with lock washers through muffler elbow and into manifold (fig. 53).

**(3) INSTALL MUFFLER CLAMP.**

**WRENCH**, open-end,  $\frac{9}{16}$ -in.

**WRENCH**, socket,  $\frac{9}{16}$ -in.

Place clamp around muffler body, install bolts, lock washers and nuts, and tighten.

**(4) INSTALL EXHAUST OUTLET PIPE.**

**WRENCH**, socket,  $\frac{9}{16}$ -in.

Install 4 cap screws with lock washers holding exhaust outlet pipe to front of muffler.

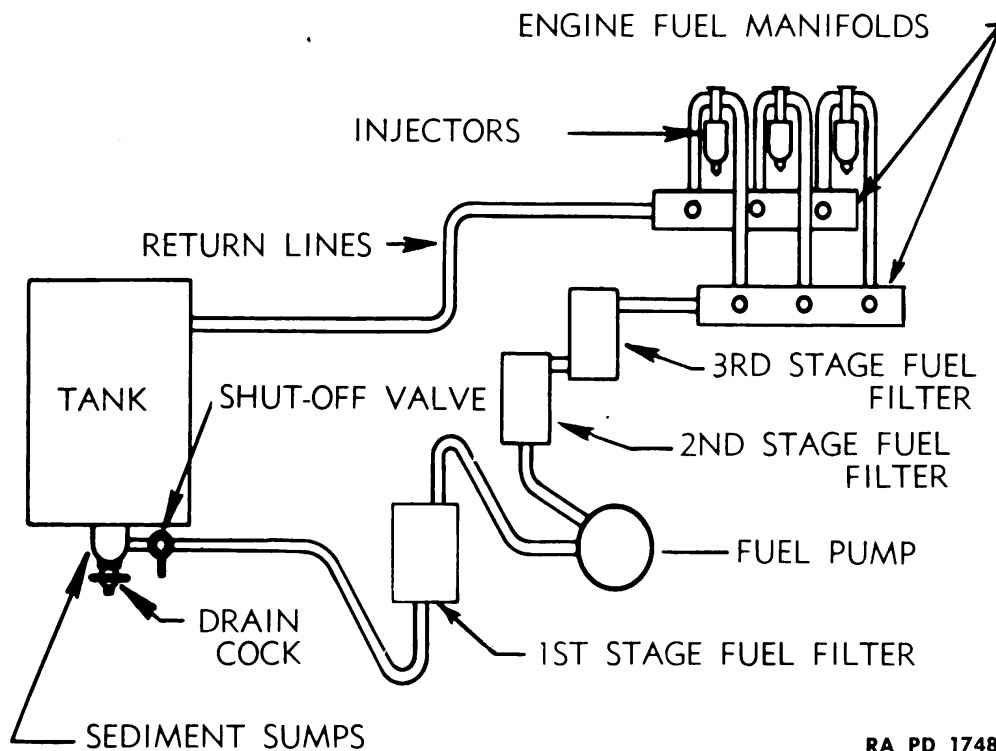
Section XII

FUEL AND AIR SYSTEM

	Paragraph
General .....	61
Fuel supply tank .....	62
Sediment sumps .....	63
Fuel filters .....	64
Fuel pump .....	65
Injectors .....	66
Fuel lines and connections .....	67
Precleaner .....	68
Air cleaner .....	69

61. GENERAL (fig. 55).

a. The fuel system consists of a fuel supply tank, sediment sumps, fuel pump, fuel filters, and injectors. The 120-gallon supply tank is equipped with sediment sumps, drains, and a fuel shut-off valve. The first stage, or primary filter assembly, is mounted on a bracket bolted to the right rear fender under seat. There are also two other filters: the second stage fuel filter, fastened on the back side of cowl, and the third stage fuel filter, bolted to the engine. The fuel pump is bolted to the rear of the blower and is driven by the lower blower rotor shaft.



RA PD 17485

Figure 55—Fuel System Diagram

**MEDIUM TRACTOR M1**

b. The fuel is drawn from the bottom of the fuel tank and through the first stage filter by the fuel pump. The fuel is then forced, under about 25 pounds pressure, through the second and third stage fuel filters to the lower fuel manifold on the side of the cylinder head. From this manifold the fuel flows, under pressure, to the injectors through a porous bronze filter located in the injector. The surplus fuel leaves the injector, through a similar porous bronze filter, and returns through the return or upper fuel manifold and fuel return line to the fuel tank. This continual circulation of fuel oil helps to cool the injectors, warms up the fuel, and eliminates air pockets in the fuel system.

**62. FUEL SUPPLY TANK.**

a. **Description.** The fuel tank is located at the rear of the tractor and has a capacity of 120 U. S. standard gallons. Care should be taken when filling the tank with fuel that all hoses, funnels, or containers used are *clean* to prevent dirt from entering and clogging the fuel lines and filters.

b. Two sediment sumps on the bottom of the tank (fig. 56) are provided to allow the operator to drain out, with a minimum waste of fuel, the dirt and water which settles to the bottom. Dirt and water will settle out of the fuel into these sumps and can be drained out. Drain cocks on these sumps should be opened daily, preferably after the tractor has stood for an hour or more, or overnight. In freezing weather, it is doubly important to drain the water from the sediment sumps and filters to prevent freezing and damage due to freezing.

c. **Maintenance.** The tank should be drained and flushed out periodically with clean fuel oil whenever an accumulation of rust or dirt is evident. To do this, the tractor should be on level ground. Remove the 2 sediment sumps from the tank and pour about 10 gallons of clean fuel oil into the tank and let it drain out, flushing the dirt and rust with it. If a pressure fuel hose is available, flushing may be done by inserting the hose through the holes in the bottom of the tank where the sediment sumps were removed. Use new gaskets and shellac both sides of gasket when installing the sediment sumps back on the tank.

**63. SEDIMENT SUMPS (fig. 56).**

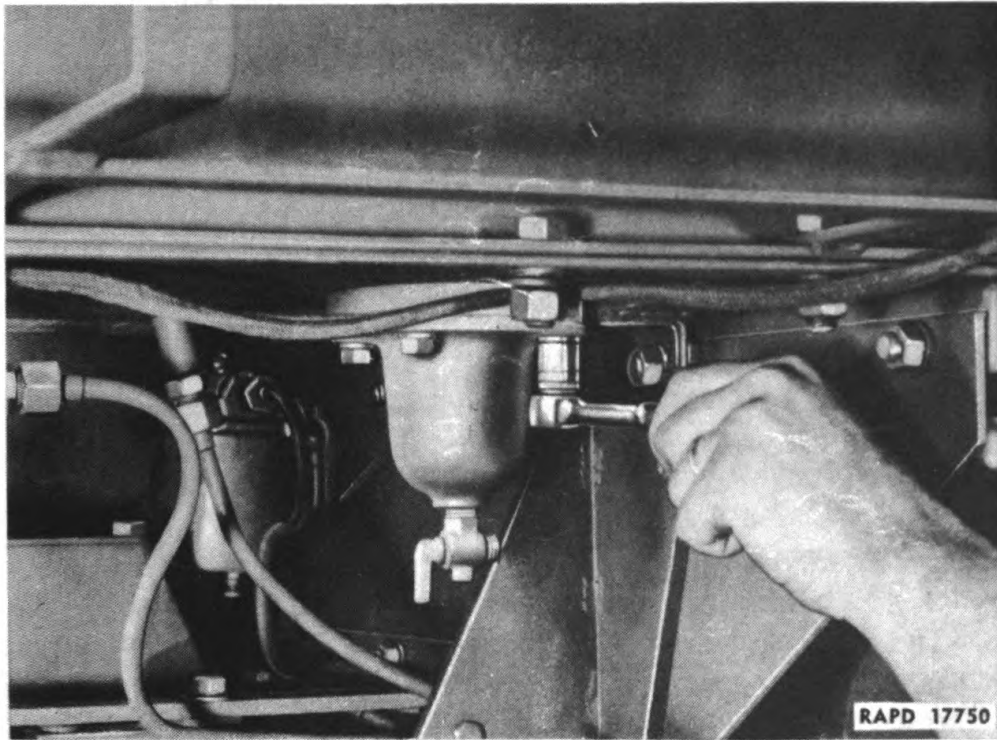
a. The purpose of the sediment sumps has been explained in the previous paragraph.

**b. Removal.**

CONTAINERS, fuel

WRENCH, socket,  $\frac{9}{16}$ -in., with extension(1) **DRAIN TANK.** Drain fuel from tank into clean containers.

## FUEL AND AIR SYSTEM



**Figure 56—Removing Sediment Sumps**

(2) **REMOVE SUMPS.** Remove 3 cap screws and lock washers from each and remove the sediment sumps.

(3) **CLEAN OFF OLD GASKETS.** Clean old gaskets off fuel tank before installing new sediment sumps.

### c. Installation.

**SHELLAC**

**WRENCH**, socket,  $\frac{9}{16}$ -in., with extension

(1) **INSTALL SUMPS.** Shellac both sides of gaskets, place one on each sump and secure sumps with cap screws and lock washers.

## 64. FUEL FILTERS.

a. **General.** The circulation of fuel oil through the injectors in this engine helps keep the injectors cool. The fuel pump circulates approximately 25 gallons of fuel per hour through the injection system. If this quantity is allowed to decrease and get too low, there is a possibility of serious damage to the injectors because of overheating. As the fuel filters begin to plug up, the quantity of fuel circulating through the injectors

**MEDIUM TRACTOR M1**

becomes less. It may be reduced to the point where the injectors are becoming dangerously overheated, even though this flow may be sufficient to keep the engine operating normally. Therefore, proper performance of the engine does *not* necessarily mean that enough fuel is being circulated. For this reason the fuel filtering system should be checked and the filter elements replaced, if necessary, at the first indication of any deviation from normal fuel oil pressure. All fuel filters are of the replaceable element type. A good indication as to about how often it will be necessary to replace filter elements will be given by the length of time the first two or three elements used operate satisfactorily. That is, if the filters plug up on an average of every 400 hours for the first two or three times, the fuel filters should be changed, as an item of routine service, every 400 hours of operation thereafter, without waiting for a drop in fuel pressure. The length of time that the fuel filter elements will operate, of course, depends upon the type and kind of fuel oil being used and also on how clean the fuel oil is kept. In accordance with the above paragraphs, change the filter elements in the fuel filters after a reasonable number of hours of operation, even though they are not completely plugged up, in order to safeguard the injection system.

**b. Maintenance.**

(1) Normal fuel pressure is from 20 to 30 pounds on the gage at operating engine speed. *Do not operate* when the fuel pressure is not within this range. When pressure drops to below 20, proceed as follows:

(a) Drain sediment sump under fuel tank of all water and sediment.

(b) Remove first stage fuel filter element and test fuel line from the tank to this filter to be absolutely sure that it is free and open. If necessary, replace the first stage filter element with a new one. When installing it, make certain that the filter can gasket is in its proper place to prevent leakage. When starting engine after replacing this filter element, it may be necessary to open drain at bottom of filter to allow air to escape before fuel will start to circulate through fuel system.

(c) Start engine and check to see whether fuel oil pressure comes up to normal. If not, stop the engine and replace element in second stage fuel filter. Check fuel lines for obstructions and leaks and again start engine to determine whether fuel oil pressure comes up to normal.

(d) If fuel oil pressure is still below normal, replace element in third stage fuel filter. If all fuel line connections are tight, eliminating all possibility of air leaks, and pressure still does not come up to normal after above procedure, the fuel pump will have to be removed for repair or rebuilding and a new pump installed.

## FUEL AND AIR SYSTEM

(2) If the fuel pressure is within the normal range and the operation of engine indicates that insufficient fuel is being supplied to the injectors, proceed as follows to locate the trouble:

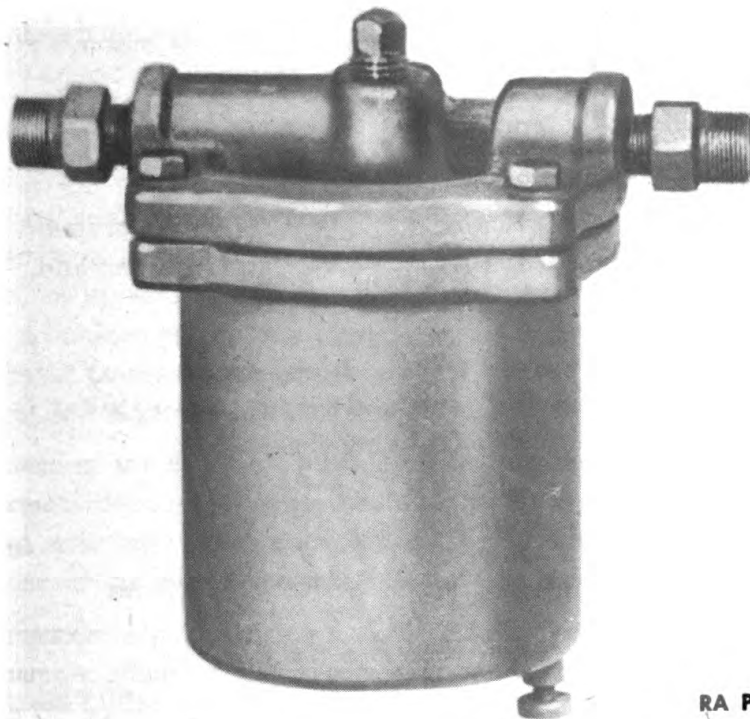
(a) Check for obstructions in fuel lines and fuel manifold carrying fuel to the injectors. Also see that return fuel manifold and return fuel line to tank are not restricted in any way. To check the return flow, remove fuel tank cover and look into tank. When the engine is running at high idling speed, there should be an ample flow of fuel into the tank from the return line.

(b) If no restriction is found in any part of fuel system as outlined in paragraph (1), it is likely that the porous bronze filters in the injectors are plugged and the injectors will have to be removed.

(c) Replace, time, and equalize the injectors, and adjust exhaust valve clearance (pars. 66 d, 66 e, 66 f, 66 g, and 58 b).

### c. First Stage Filter Assembly.

(1) **DESCRIPTION** (fig. 57). The first stage fuel filter assembly consists of a bracket and filter bolted to the right rear fender. A fuel line from the supply tank leads to this assembly and another leads from the assembly to the fuel pump. A cotton wound filtering element is used in this filter.



RA PD 40779

**Figure 57—First Stage Fuel Filter Assembly**



**MEDIUM TRACTOR M1**

**(2) REMOVAL.**

WRENCH, open-end,  $\frac{7}{16}$ -in.

WRENCH, open-end,  $\frac{3}{4}$ -in.

WRENCH, open-end,  $\frac{9}{16}$ -in.

WRENCH, open-end,  $\frac{7}{8}$ -in.

**(a) Disconnect Fuel Lines.**

WRENCH, open-end,  $\frac{3}{4}$ -in.

WRENCH, open-end,  $\frac{7}{8}$ -in.

Close fuel shut-off valve at tank and disconnect the fuel lines from both inlet and outlet side of filter assembly.

**(b) Remove Assembly from Tractor.**

WRENCH, open-end,  $\frac{9}{16}$ -in.

Remove the 2 cap screws holding bracket to plate on fender and remove assembly.

**(c) Remove Cup from Filter.**

WRENCH, open-end,  $\frac{7}{16}$ -in.

Remove the 4 cap screws holding filter cup to clamp ring and remove filter cup. Lift element from cup (fig. 58).

**(3) MAINTENANCE.** Remove the dirty or clogged element and clean cup thoroughly with clean fuel oil. Replace old element with new one. **NOTE:** Do not attempt to clean dirty or clogged element. It is not necessary to remove the entire assembly to replace filter element. The element can be changed by merely removing the filter cup from the filter clamp ring of the assembly, leaving balance of assembly installed (fig. 59).

**(4) INSTALLATION.**

WRENCH, open-end,  $\frac{7}{16}$ -in.

WRENCH, open-end,  $\frac{3}{4}$ -in.

WRENCH, open-end,  $\frac{9}{16}$ -in.

WRENCH, open-end,  $\frac{7}{8}$ -in.

**(a) Install Element and Cup.**

WRENCH, open-end,  $\frac{7}{16}$ -in.

Place clean element in filter cup and secure cup to filter head with 4 cap screws and lock washers. Use new gasket.

**(b) Install Assembly on Tractor.**

WRENCH, open-end,  $\frac{9}{16}$ -in.

Secure assembly to plate on fender with 2 cap screws.

**(c) Connect Fuel Lines to Filter Assembly.**

WRENCH, open-end,  $\frac{3}{4}$ -in.

WRENCH, open-end,  $\frac{7}{8}$ -in.

Connect the fuel lines to each end fitting of filter assembly; open fuel shut-off valve under fuel supply tank, start engine, and inspect for leaks.

FUEL AND AIR SYSTEM

RA PD 17268

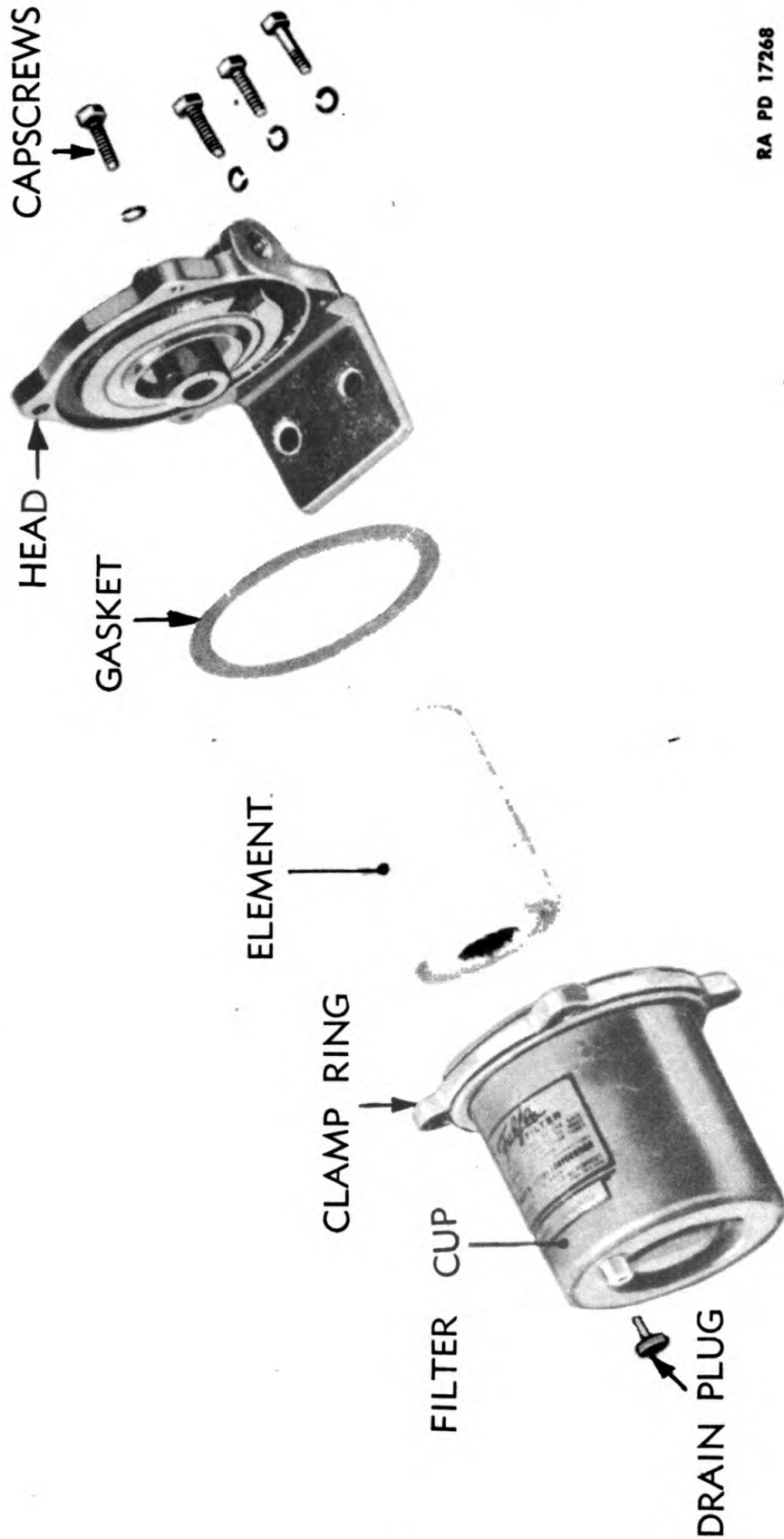
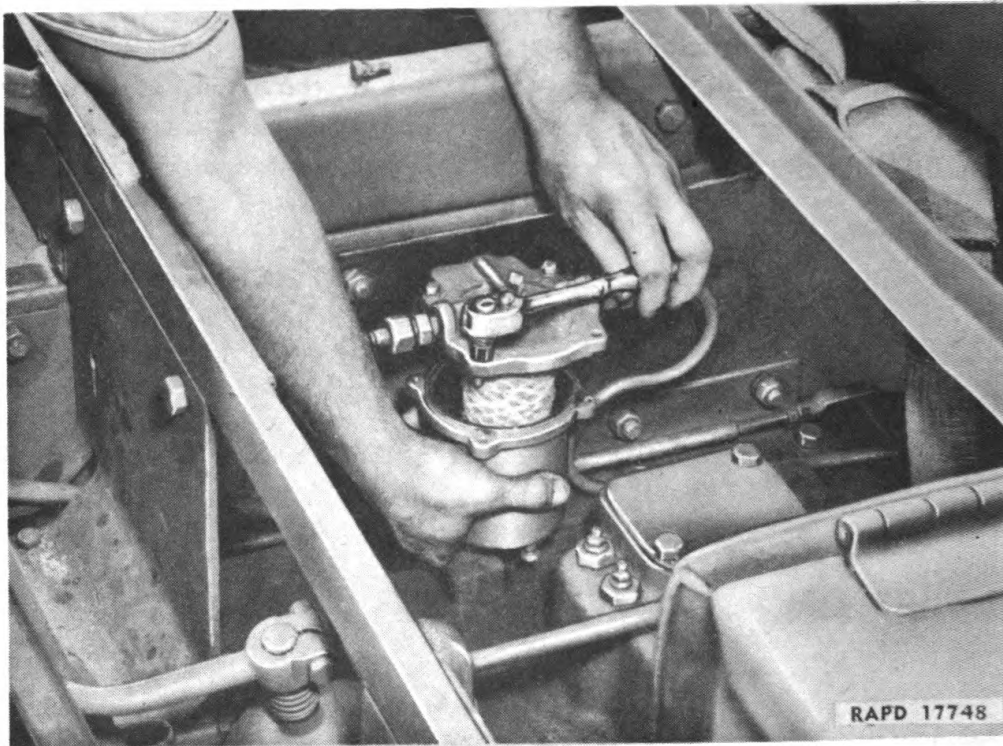
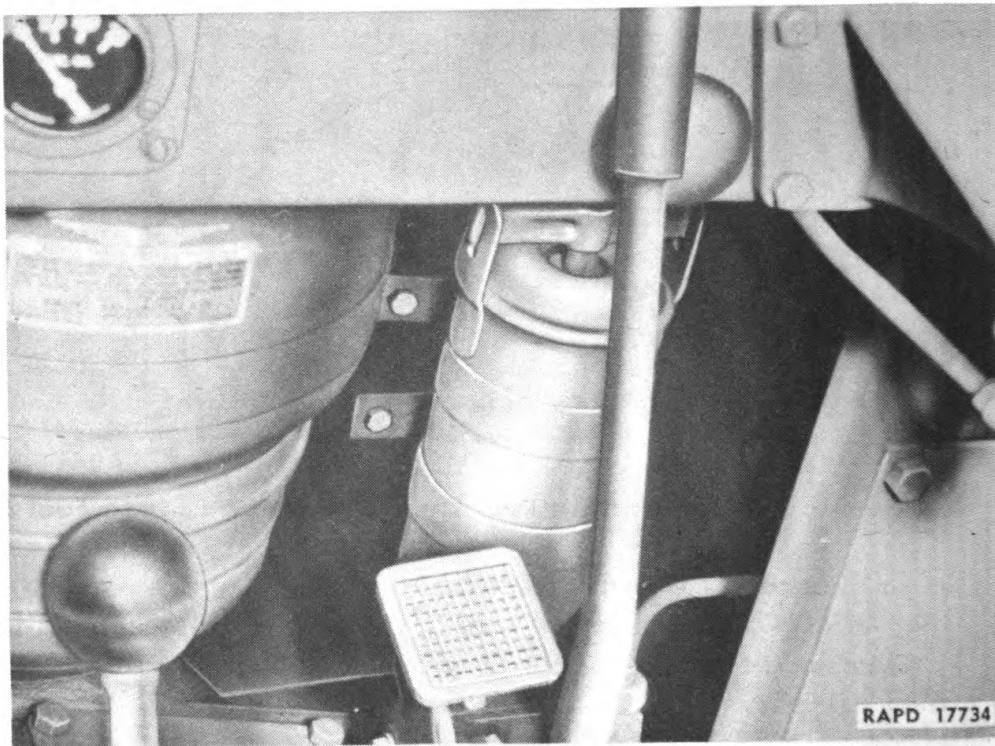


Figure 58 — First Stage Fuel Filter Disassembled

**MEDIUM TRACTOR M1**



**Figure 59—Removing First Stage Fuel Filter Cup**



**Figure 60—Second Stage Fuel Filter**

## FUEL AND AIR SYSTEM

### d. Second Stage Fuel Filter.

(1) **DESCRIPTION** (fig. 60). This filter is located back of the cowl and held in 2 mounting bands bolted to the cowl. It is connected to the fuel pump on the inlet side and to the third stage fuel filter on the outlet side. A cotton wound filtering element is used in this filter.

### (2) **REMOVAL.**

**WRENCH**, open-end,  $\frac{9}{16}$ -in.

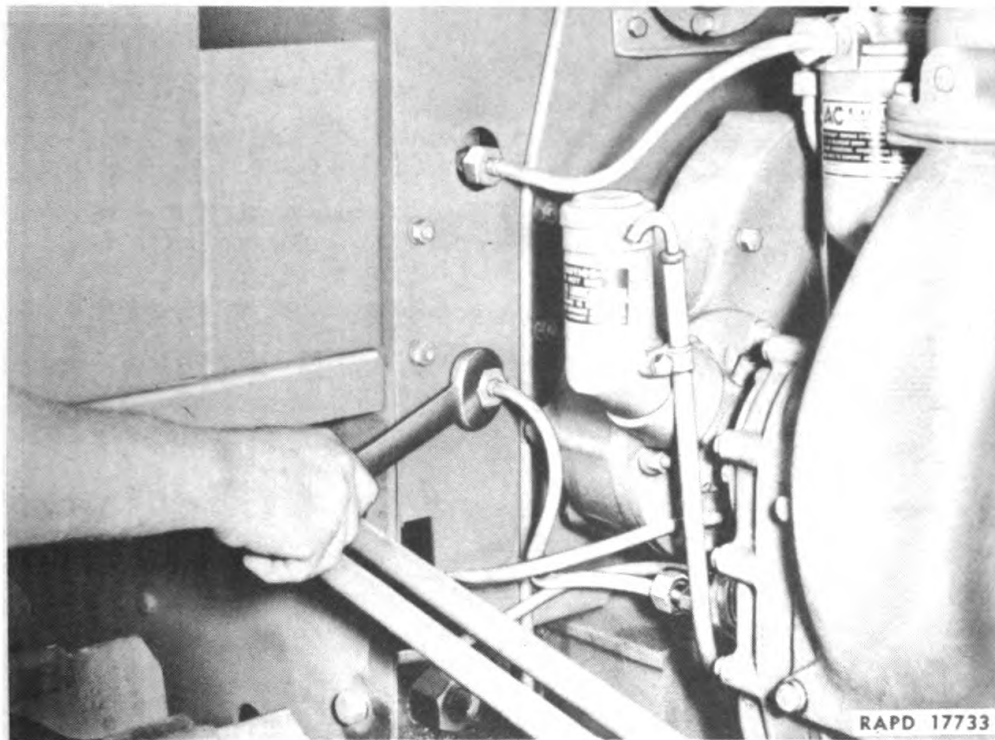
**WRENCH**, socket,  $\frac{9}{16}$ -in.

**WRENCH**, open-end,  $\frac{7}{8}$ -in.

### (a) *Disconnect Fuel Lines.*

**WRENCH**, open-end,  $\frac{7}{8}$ -in.

Disconnect both inlet and outlet fuel lines from filter head fittings (fig. 61).



**Figure 61—Disconnecting Fuel Line from Second Stage Fuel Filter**

### (b) *Remove Filter from Cowl.*

**WRENCH**, open-end,  $\frac{9}{16}$ -in.

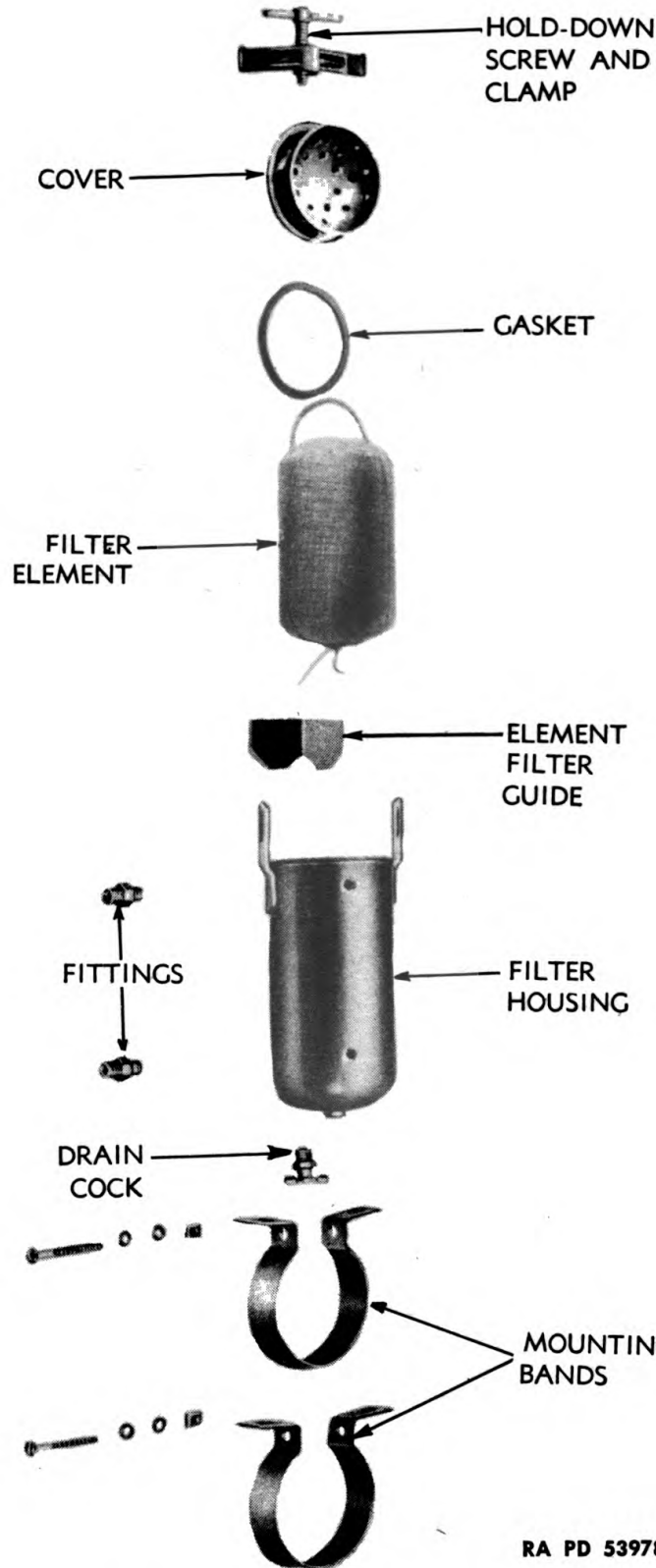
**WRENCH**, socket,  $\frac{9}{16}$ -in.

Remove the 4 bolts holding filter mounting bands to cowl and remove filter assembly.

### (3) **DISASSEMBLY** (fig. 62).

**WRENCH**, open-end,  $\frac{1}{2}$ -in.

MEDIUM TRACTOR M1



RA PD 53978

**Figure 62—Second Stage Fuel Filter Disassembled**

**FUEL AND AIR SYSTEM****(a) Remove Mounting Bands.**

WRENCH, open-end, 1/2-in.

Remove the bolts through mounting bands and slide bands off filter body.

**(b) Remove Filter Element.** Loosen and remove cover hold-down screw, clamp, and cover. Lift out filter element.

**(4) MAINTENANCE.** Wash filter case out with clean fuel oil before installing new element. See that drain cock is not clogged. This drain cock should be opened every day to drain sediment and water out of filter. **NOTE:** To replace element only, the filter assembly should be left installed on the tractor and only the hold-down clamp and cover removed.

**(5) REASSEMBLY.**

WRENCH, open-end, 1/2-in.

**(a) Install Element in Filter and Secure Cover.** Place new filter element in body. Install new gasket between body and cover and tighten cover with hold-down clamp and screw.

**(b) Install Mounting Bands on Filter.** Place bands on filter and install bolts through bands, leaving nuts loose.

**(c) Installation.**

WRENCH, open-end, 1/2-in.

WRENCH, open-end, 7/8-in.

WRENCH, open-end, 9/16-in.

WRENCH, socket, 9/16-in.

**(1) INSTALL FILTER ASSEMBLY ON COWL.** Install bolts through mounting bands and cowl, and start nuts. Tighten mounting band bolts and filter holding bolts.

**(2) CONNECT FUEL LINES.**

WRENCH, open-end, 7/8-in.

Connect inlet (lower) fuel line, fill the filter with fuel (this will save cranking engine with starter to pump fuel to fill filter), and connect outlet (upper) fuel line.

**(3) CHECK FOR LEAKS.** Start engine and check for leaks.

**e. Third Stage Fuel Filter.**

**(1) GENERAL.** The fuel leaving the second stage fuel filter passes into and through the third stage fuel filter to the intake fuel manifold on the cylinder head. The third stage fuel filter also is of the replaceable element type (fig. 63).

MEDIUM TRACTOR M1

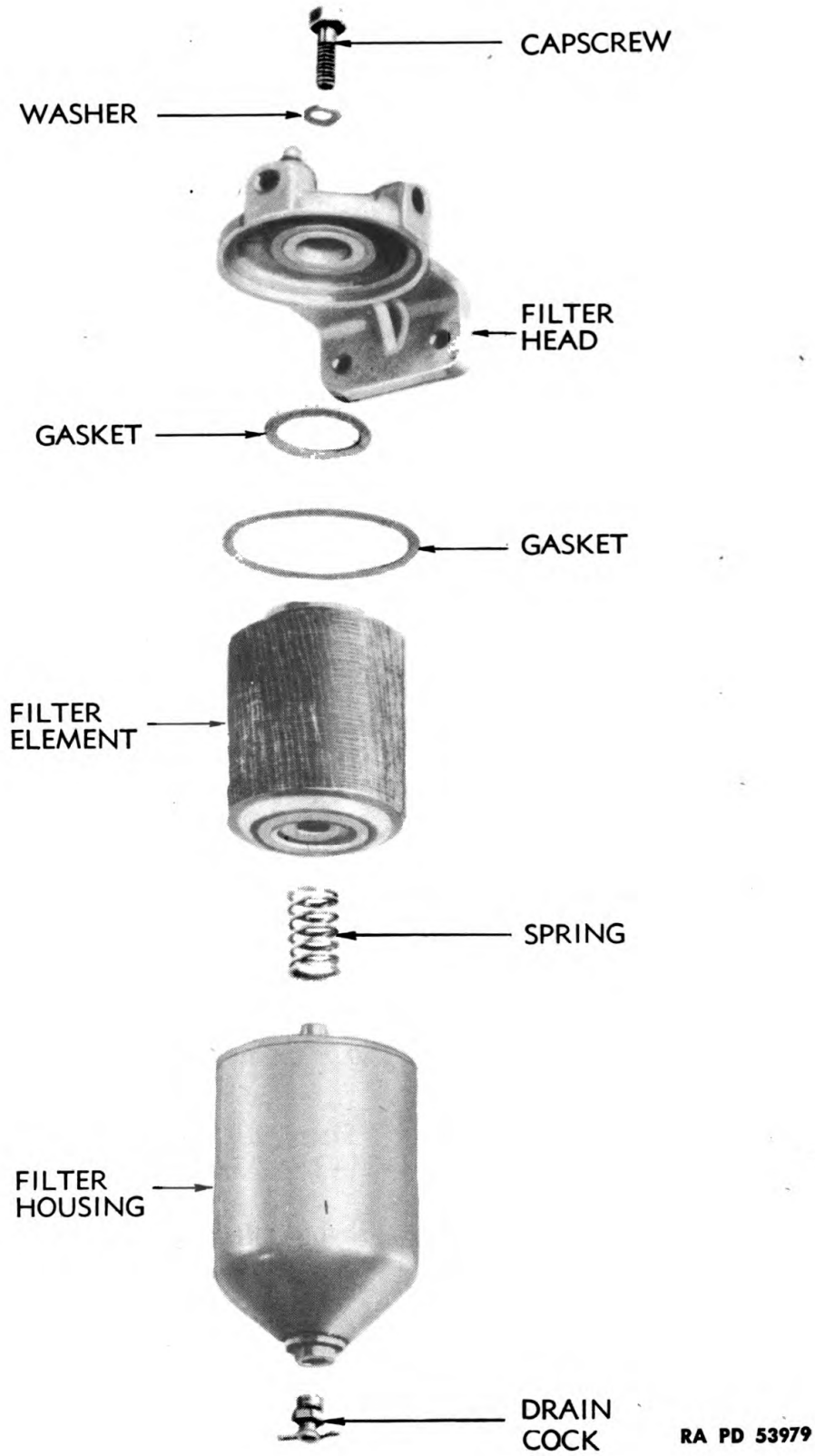


Figure 63—Third Stage Fuel Filter Disassembled

### FUEL AND AIR SYSTEM

(2) **REMOVAL.**

WRENCH, open-end,  $\frac{7}{8}$ -in.

WRENCH, socket,  $\frac{5}{8}$ -in.

WRENCH, socket,  $\frac{9}{16}$ -in.

(a) *Disconnect Fuel Lines.*

WRENCH, open-end,  $\frac{7}{8}$ -in.

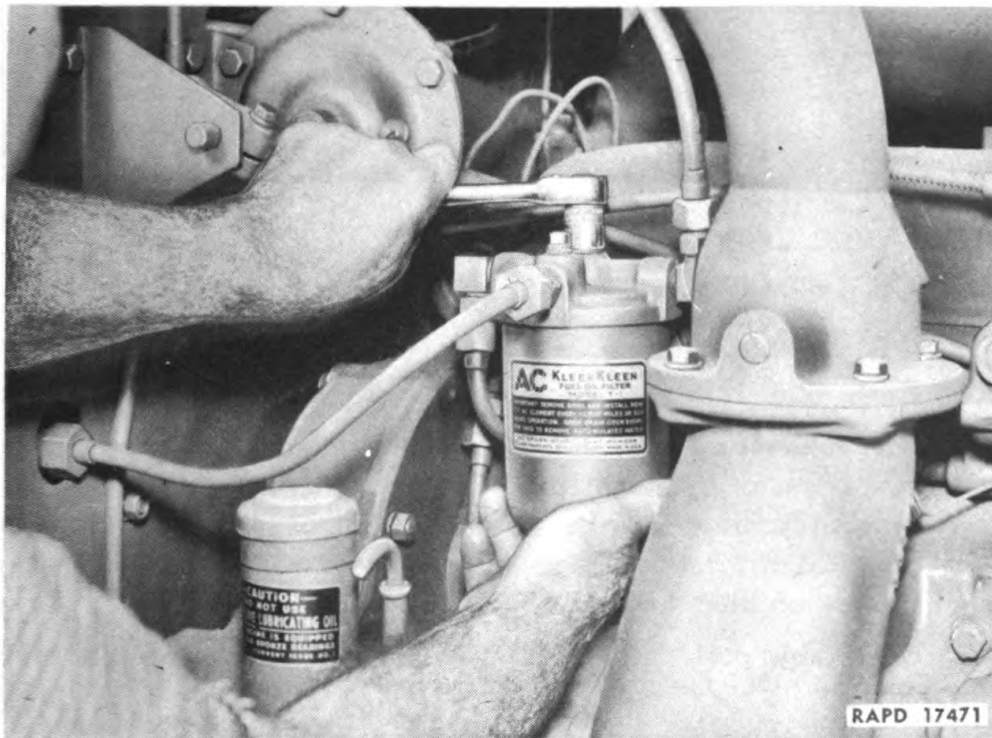
Disconnect the fuel lines from the fittings on the filter head (fig. 64).

(b) *Drain Fuel from Filter.* Drain filter by opening drain cock at bottom of filter.

(c) *Remove Filter Case* (fig. 64).

WRENCH, socket,  $\frac{5}{8}$ -in.

Remove retaining cap screw holding filter case to filter head and remove filter case.



**Figure 64—Removing Third Stage Fuel Filter Case**

(d) *Remove Filter Head.*

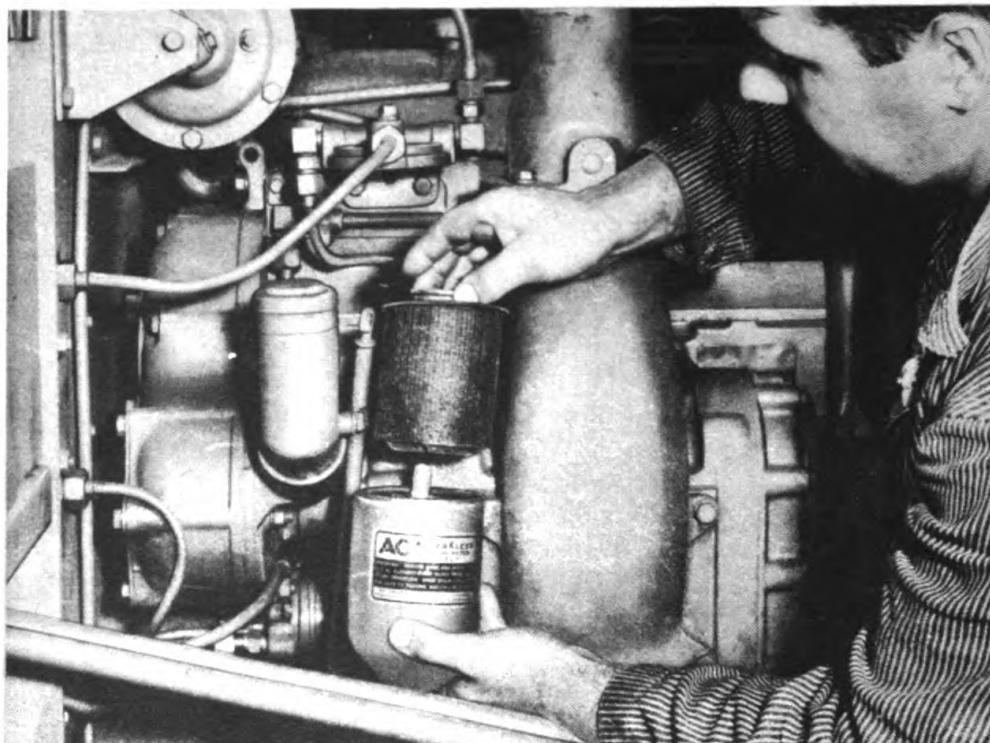
WRENCH, socket,  $\frac{9}{16}$ -in.

Remove 2 cap screws holding head to cylinder head and lift off filter head.

(e) *Remove Filter Element.* Lift out element and spring from filter case.



## MEDIUM TRACTOR M1



RA PD 17731

**Figure 65—Removing Third Stage Fuel Filter Element**

**(3) MAINTENANCE.**

(a) Clean filter case with clean fuel oil after removing the element.

(b) The element may be replaced without removing the filter assembly from the tractor by removing the retaining screw which will allow the case to drop down and be removed (figs. 64 and 65). Use new gasket supplied with each new element. Fill case with fuel oil before installing case on filter head.

(c) Open drain cock daily to drain sediment and water from filter.

**(4) INSTALLATION.**

WRENCH, open-end,  $\frac{3}{4}$ -in.

WRENCH, socket,  $\frac{9}{16}$ -in.

WRENCH, open-end,  $\frac{7}{8}$ -in.

WRENCH, socket,  $\frac{5}{8}$ -in.

**(a) Install Filter Head.**

WRENCH, socket,  $\frac{9}{16}$ -in.

Secure filter head to cylinder head with 2 cap screws.

(b) **Install Element in Case.** Install the spring and new cartridge in the case with the end marked "TOP" up, and fill the case with fuel. **NOTE:** Two interchangeable types of filter cartridges are supplied for use in the third stage fuel filter. One is a cotton wound type similar to

**FUEL AND AIR SYSTEM**

the filter elements used in the filters located under the seat. A steel washer is supplied with each of these cartridges, and when this type filter element is used, the washer should be placed on the hollow stud inside the filter cup before the gasket and filter are installed.

*(c) Install Case.*

WRENCH, socket,  $\frac{5}{8}$ -in.

Install new gaskets in filter head and on top of element; install retaining screw and draw case up to head (fig. 65).

*(d) Connect Fuel Lines.*

WRENCH, open-end,  $\frac{7}{8}$ -in.

Connect the fuel inlet and outlet lines to the filter head fitting.

**65. FUEL PUMP.**

**a. Description.** The fuel pump is a positive displacement, vane-type pump. It is bolted to the rear end cover of the blower and is driven by the lower blower rotor shaft. A U-shaped steel stamping forms a part of the drive assembly and provides a safety release if the pump should lock for any cause.

**b. Removal.**

PUMP, special fuel

WRENCH, open-end,  $\frac{7}{8}$ -in.

WRENCH, box,  $\frac{9}{16}$ -in.

WRENCH, water pump

**(1) CLOSE FUEL SHUT-OFF.**

**(2) DISCONNECT FUEL LINES FROM PUMP.**

WRENCH, open-end,  $\frac{7}{8}$ -in.

WRENCH, open-end,  $\frac{3}{4}$ -in.

Disconnect inlet and outlet lines from pump fittings (fig. 66). **CAUTION:** Make sure the union does not come out before the nut to prevent twisting fuel line.

**(3) REMOVE FUEL PUMP FROM BLOWER.**

WRENCH, box,  $\frac{9}{16}$ -in.

WRENCH, fuel pump

Remove the 3 cap screws holding fuel pump to blower. Use the special wrench to remove the cap screw nearest the cylinder block (fig. 67). Remove the fuel pump assembly and drive coupling fork as a unit (fig. 68).

**c. Maintenance.** No maintenance will be attempted by the using arm personnel.

**d. Installation.**

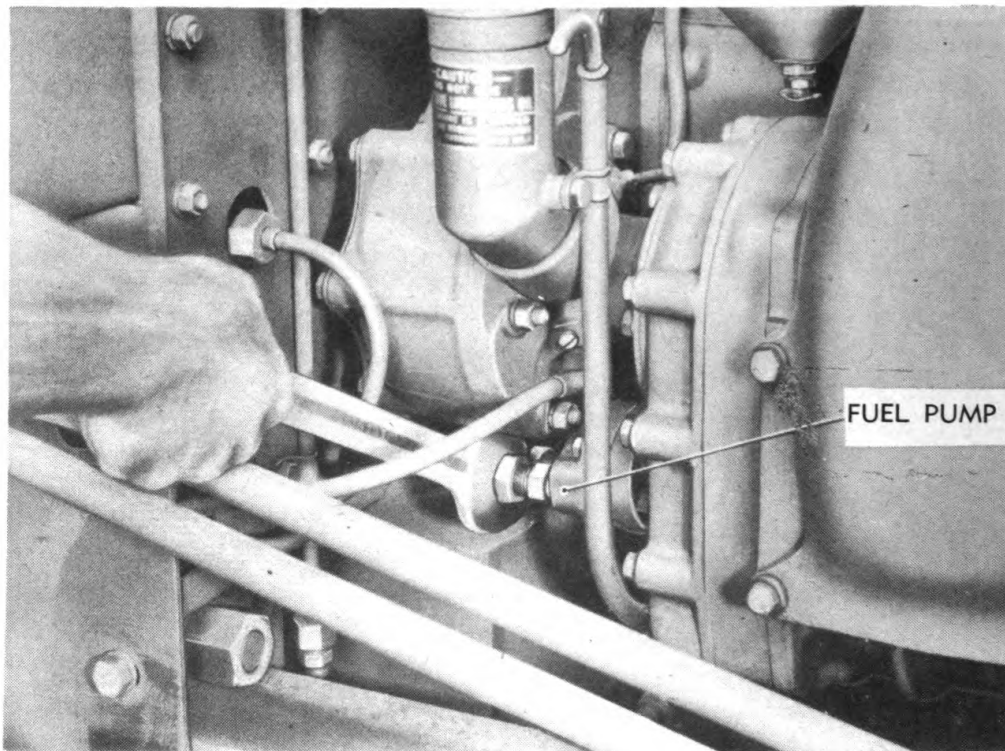
WRENCH, box,  $\frac{1}{2}$ -in.

WRENCH, special fuel pump

WRENCH, open-end,  $\frac{7}{8}$  in.

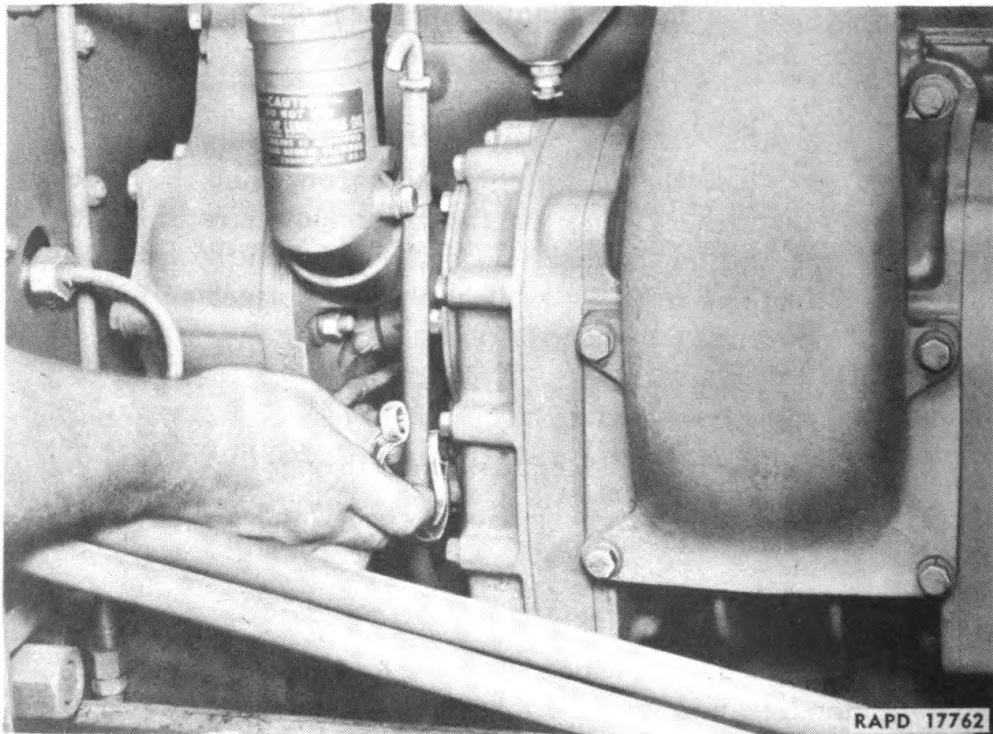
Digitized by Google

MEDIUM TRACTOR M1



RA PD 56467

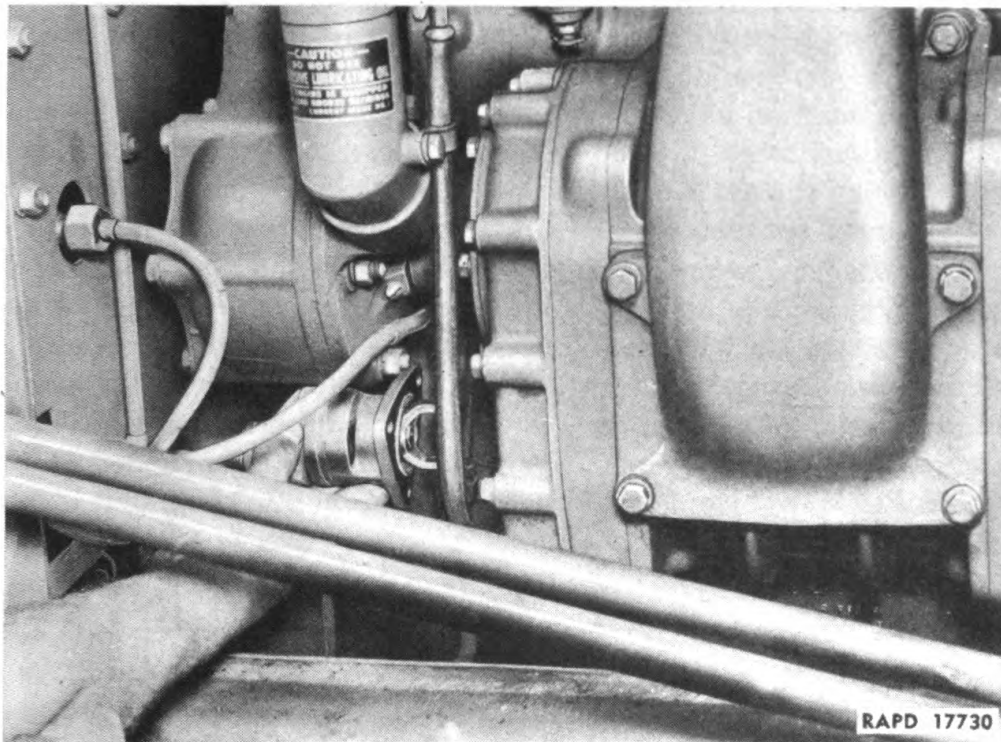
**Figure 66—Disconnecting Fuel Lines from Fuel Pump**



RAPD 17762

**Figure 67—Removing Cap Screws from Fuel Pump with Special Wrench**

FUEL AND AIR SYSTEM



**Figure 68—Removing Fuel Pump**

(1) **INSTALL COUPLING FORK ON PUMP.** Put drive coupling fork (arms out) on the squared outer end of the pump shaft. Use a new paper gasket on the pump support flange.

(2) **INSTALL PUMP.**

**WRENCH**, box, 1/2-in.

**WRENCH**, special fuel pump

Install pump assembly on the blower end housing, engaging the drive fork in the slots of the driving plate on the lower blower rotor shaft. **NOTE:** The "IN" marking on the pump body should be on the cylinder block side, and the fuel line from the fuel supply tank connected to the fitting on the "IN" side of the pump body.

(3) **CONNECT FUEL LINES TO PUMP.**

**WRENCH**, open-end, 7/8 in.

Connect inlet and outlet fuel lines to fuel pump fittings.

(4) **TEST FOR OPERATION.** Start engine and check for leaks and fuel pressure.

## 66. INJECTORS.

a. **General.** To secure combustion, a small quantity of accurately metered, finely atomized fuel must be mixed, near the end of the compression stroke, with the charge of air which has been forced into the cylinder by the blower. This is accomplished by an injector which is a

**MEDIUM TRACTOR M1**

high pressure fuel injection device. There is one injector for each cylinder. The injectors in this 2-cycle engine are called "unit injectors" because they are a combination injection pump and injection nozzle or valve. The function of an injection pump is threefold: to meter out the exact amount of fuel to be supplied to each cylinder, to put that fuel under a pressure high enough to assure proper atomization or breaking up of the fuel for rapid ignition when it is released into the highly heated air of the cylinder, and to time its injection at exactly the right point in the operating cycle. The function of an injection valve is to see that no fuel is admitted to the cylinder until it is at a high enough pressure to atomize properly for quick ignition, and that injection stops as soon as the pressure drops below the lowest permissible injection pressure. These functions are combined in the unit injector for each cylinder of this engine. For convenience, this combined pump and injector unit is here referred to as the injector.

b. The injectors (fig. 69) are mounted in the cylinder head with their spray tips projecting slightly below the head into the combustion chambers. A clamp, bolted to the cylinder head, holds the injector in place in a water-cooled copper tube in the head. A dowel pin in the injector body registers with a hole in the cylinder head for accurately locating the injector assembly. A taper seat on the lower end of the injector, when seated in the copper tube in the cylinder head, forms a seal against the pressure of the compression in the cylinder.

c. **Operation.** Each injector is operated by a push rod and rocker arm in the same manner as the exhaust valves. As the piston nears the top of its compression stroke, the rocker arm forces the injector plunger down. The fuel is forced by the plunger into the combustion chamber through 6 holes in the injector spray tip. These holes, only 0.006 inch in diameter, distribute the fuel and break it into a very fine spray. A faulty injector will usually result in a loss of power, uneven operation of the engine, or a black exhaust smoke. Injectors can be cut-out in much the same manner as shorting out spark plugs on a gasoline engine. With hood and rocker arm cover removed and engine running at about  $\frac{1}{3}$  throttle, cut-out one injector at a time by pushing down on the injector plunger follower with a stick of wood about  $\frac{1}{2}$  inch square (damage may be done if a screwdriver is used). The one that seems to have no effect on the operation of the engine when cut-out will be the faulty injector. It should be removed and a new or rebuilt injector installed.

d. **Removal.**

TOOL, injector remover

WRENCH, open-end,  $\frac{1}{2}$ -in.

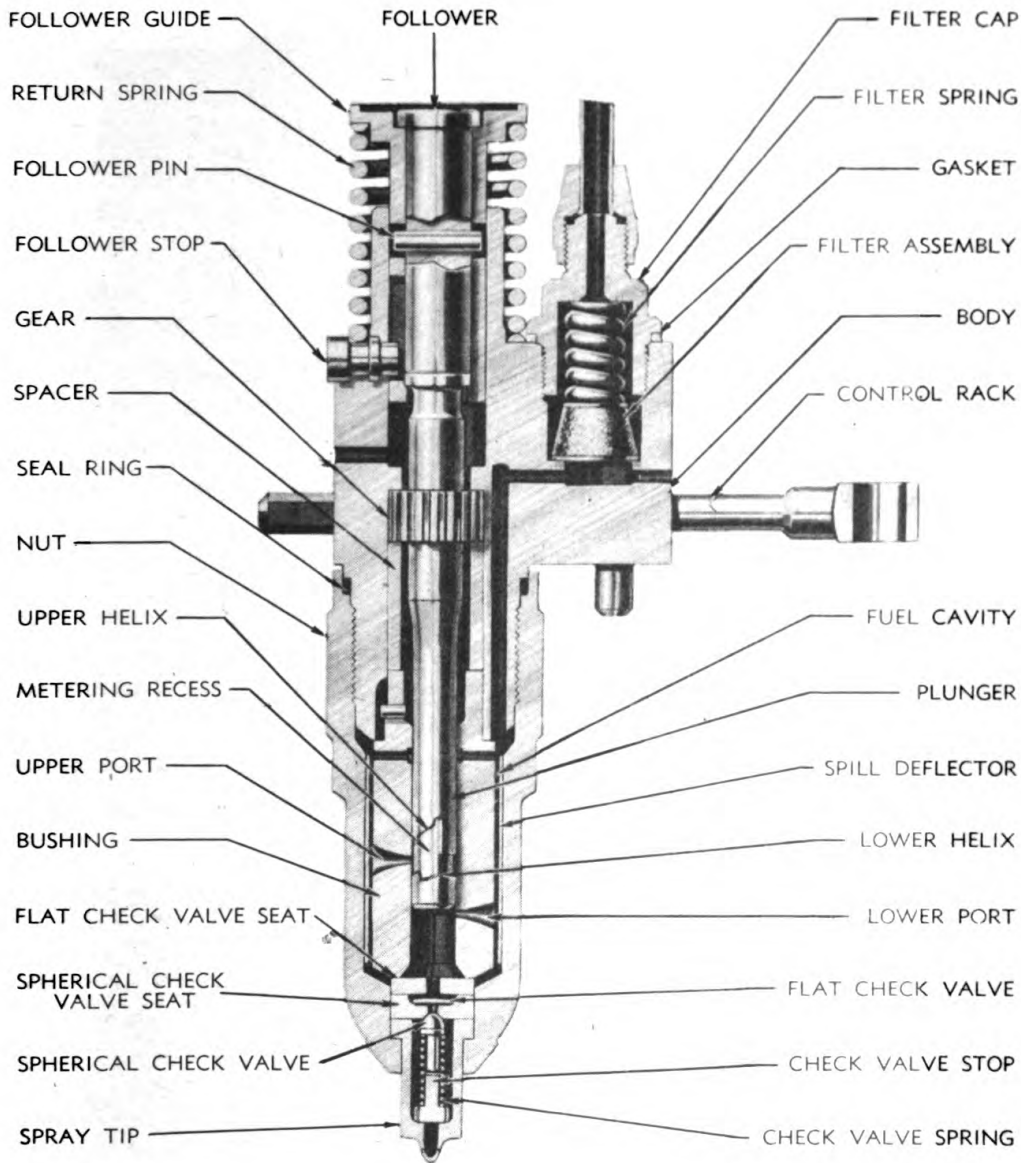
WRENCH, open-end,  $1\frac{1}{8}$ -in.

(2)

WRENCH, socket,  $\frac{9}{16}$ -in.

WRENCH, socket,  $\frac{3}{4}$ -in.

**FUEL AND AIR SYSTEM**



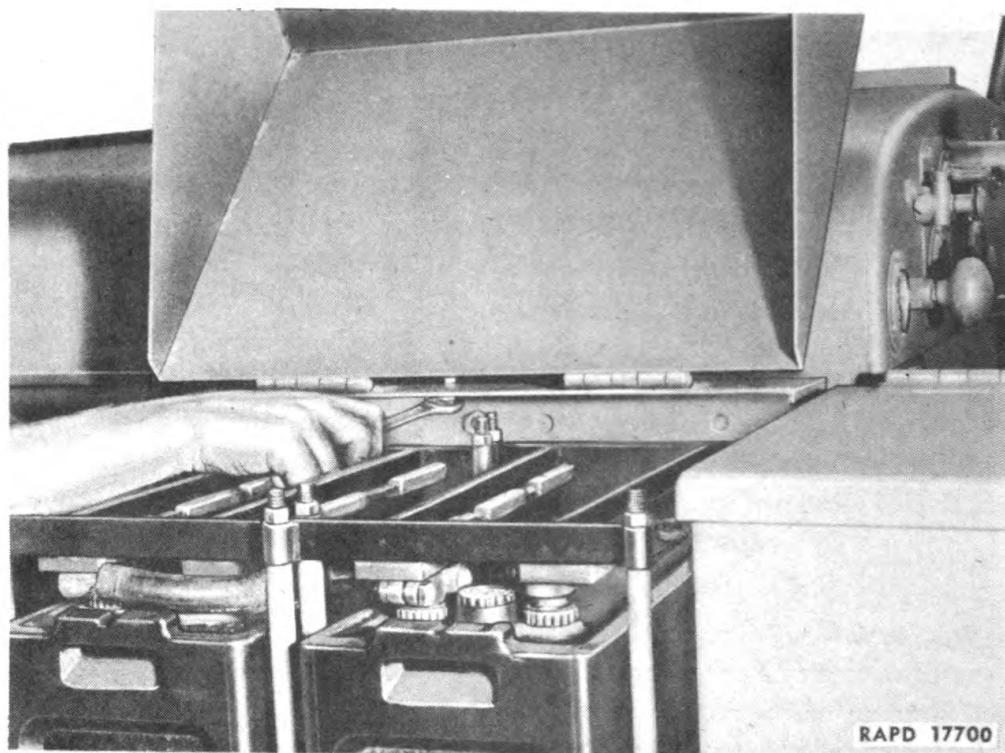
RA PD 17255

**Figure 69—Cross Section of Injector**

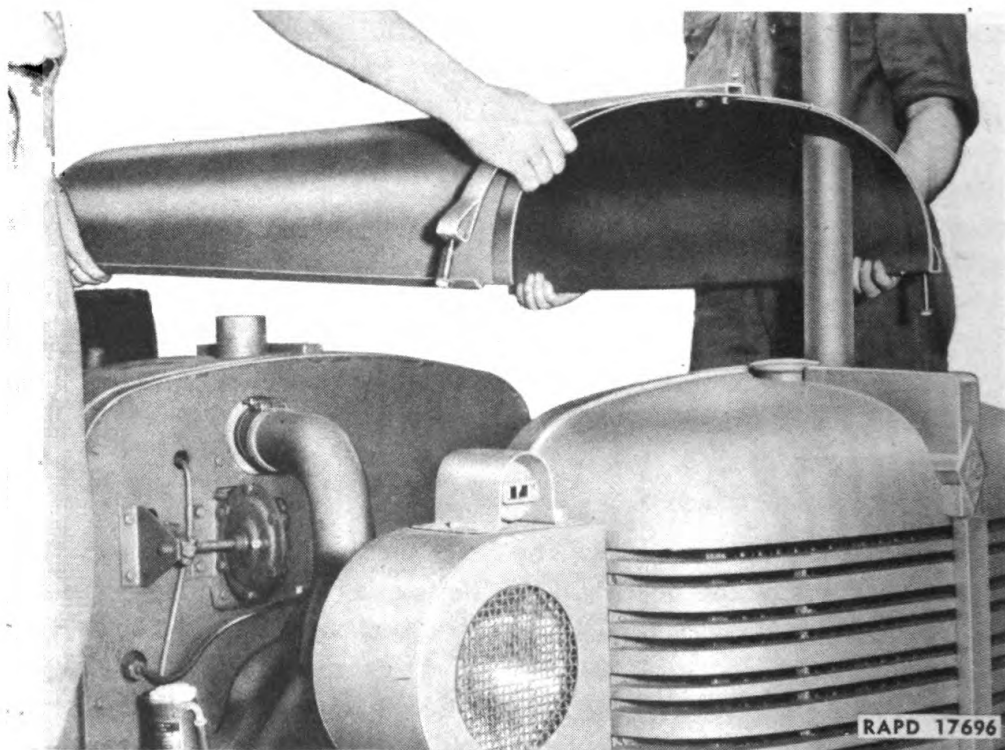
**(1) REMOVE HOOD.** Loosen the bolts on the hood hold-down straps at three corners of the hood and pry bolts out of slot. Remove nut from hood bolt inside battery box, and remove the hood (figs. 70 and 71).

**(2) REMOVE ROCKER ARM COVER.** Clean the rocker arm cover thoroughly, and remove the cover by loosening the 2 hand screws that hold it to the cylinder head.

MEDIUM TRACTOR M1



**Figure 70—Removing Nut from Hood Bolt Inside Battery Box**



**Figure 71—Removing Hood**

## FUEL AND AIR SYSTEM

### (3) REMOVE FUEL LINES.

WRENCH, open-end, 1/2-in.

Disconnect the fuel lines of the injector to be removed and place shipping caps on the fuel fittings to prevent dirt from entering the fuel system (fig. 48).

### (4) REMOVE ROCKER ARM BRACKETS.

WRENCH, socket, 3/4-in.

With a 3/4-inch wrench, remove the 2 hollow cap screws that hold the rocker arm assembly to the head and slide the brackets off the rocker arm shaft (fig. 49).

(5) REMOVE ROCKER ARM SHAFT. Slide shaft from the rocker arms before laying the assembly back out of the way. This should be done to avoid bending the push rods.

### (6) REMOVE INJECTOR CLAMP.

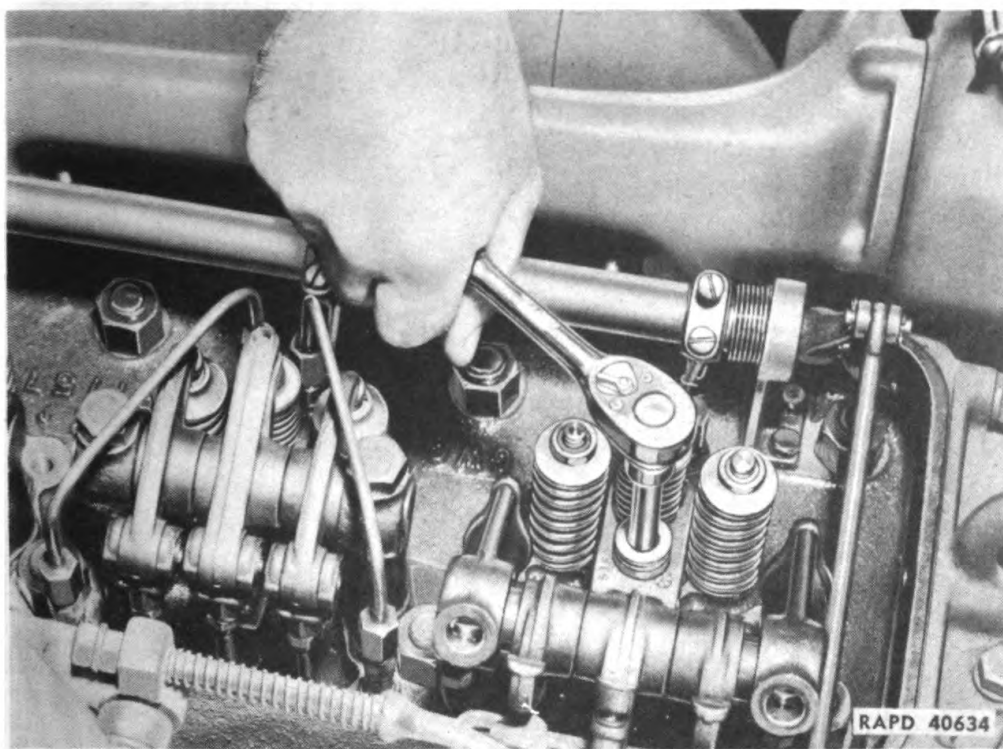
WRENCH, socket, 9/16-in.

Remove nut holding injector clamp and lift off clamp washer and clamp (figs. 72 and 73).

### (7) REMOVE INJECTOR.

TOOL, injector remover

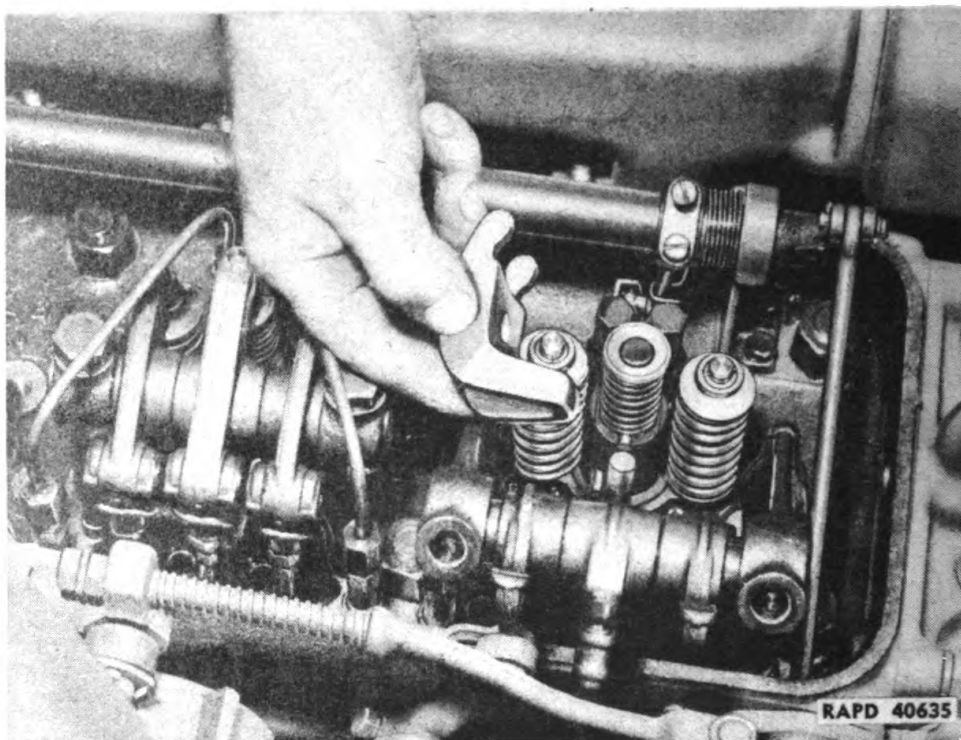
Place square end of injector remover tool under shoulder of injector body and pry injector from its seat; at the same time disengage the control rack linkage (figs. 74 and 75).



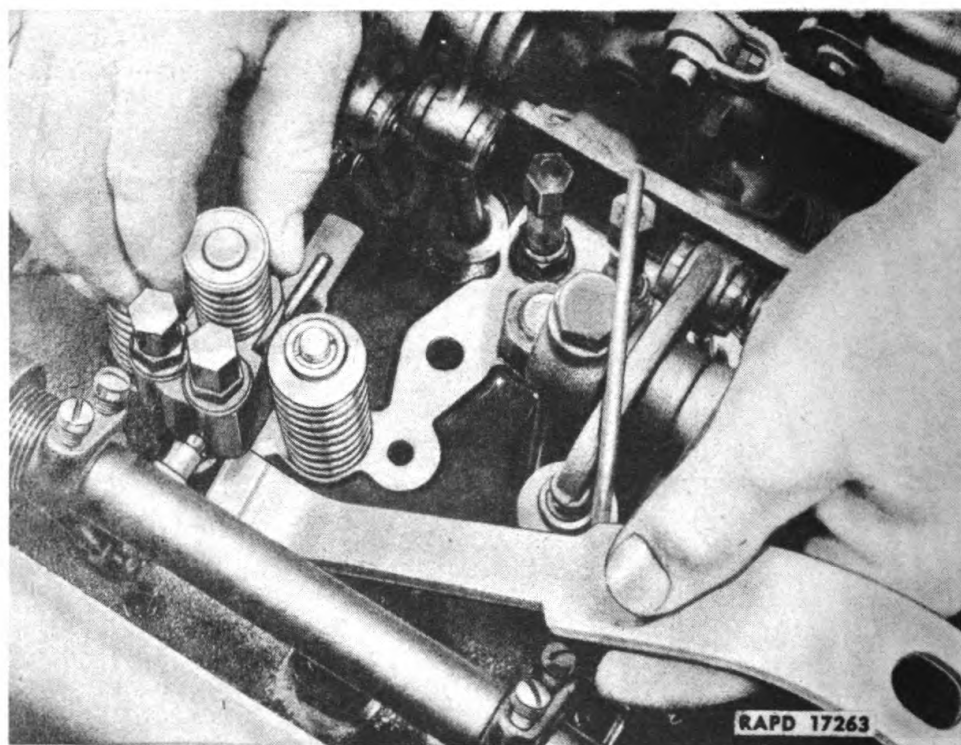
**Figure 72—Removing Injector Clamp Nut**



**MEDIUM TRACTOR M1**

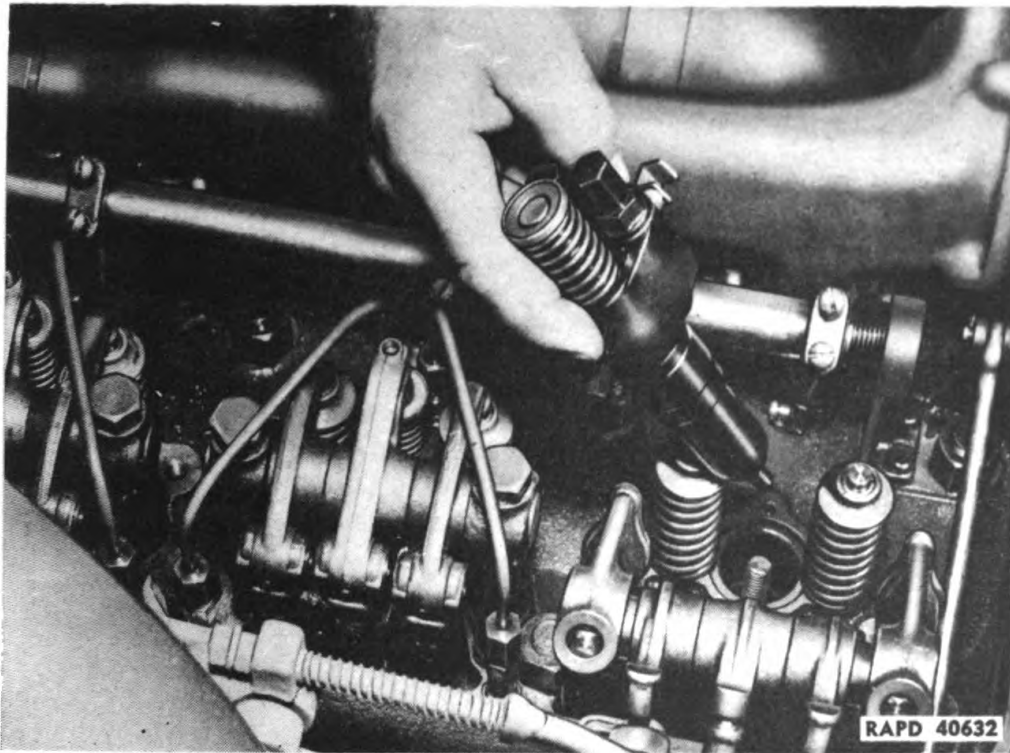


**Figure 73—Lifting Out Injector Clamp**



**Figure 74—Injector Removal**

**FUEL AND AIR SYSTEM**



**Figure 75—Injector Removed**

**e. Installation.**

**WRENCH**, open-end, 1/2-in.

**WRENCH**, socket, 3/4-in.

**WRENCH**, socket, 9/16-in.

(1) **PLACE THE INJECTOR IN THE INJECTOR TUBE.** A dowel, provided on the injector body, registers with a hole in the cylinder head so that the injector can be located in only one position in the head. Engage the control rack with the control lever at the same time.

(2) **INSTALL THE INJECTOR CLAMP.**

**WRENCH**, socket, 9/16-in.

Place clamp on the injector body, centering the side arms of the clamp as well as possible in the machined recesses in the injector body. Drop the special washer over the stud with rounded side down. Put nut on stud and draw down clamp firmly, using wrench with 8-inch handle (figs. 72 and 73).

(3) **INSTALL ROCKER ARM SHAFT AND BRACKETS.**

**WRENCH**, socket, 3/4-in.

Slide shaft through rocker arms and place a bracket on each end of shaft, with the smooth side of brackets toward rocker arms. Install cap screws and draw brackets down firmly, at the same time holding rocker arm brackets loosely against rocker arms, allowing about 0.006-inch clearance.

**MEDIUM TRACTOR M1**

**(4) CONNECT FUEL LINES.**

**WRENCH**, open-end, 1/2-in.

Remove the shipping caps from fuel fittings in head and on injectors and connect fuel lines. After engine has been started, check for leaks before installing rocker arm cover. **NOTE:** The injector must be timed and equalized and the valve clearance adjusted (par. 58) before the rocker arm cover and hood are installed.

**f. Injector Timing** (figs. 76 and 78). The timing of an injector consists of properly locating the top of the injector plunger follower in relation to the injector body when it is at the top of its stroke. This distance is 1.484 inches and a special tool called a timing gage (in the injector service kit) is used to make the proper adjustment. After installation of an injector, or if the rocker arm assembly has been worked upon, the injector must always be timed and equalized before the engine is operated. The following procedure should be used to time the injectors.

**GAGE**, timing

**WRENCH**, open-end, 5/16-in.

**SCREWDRIVER**, small

**WRENCH**, open-end, 1/2-in.

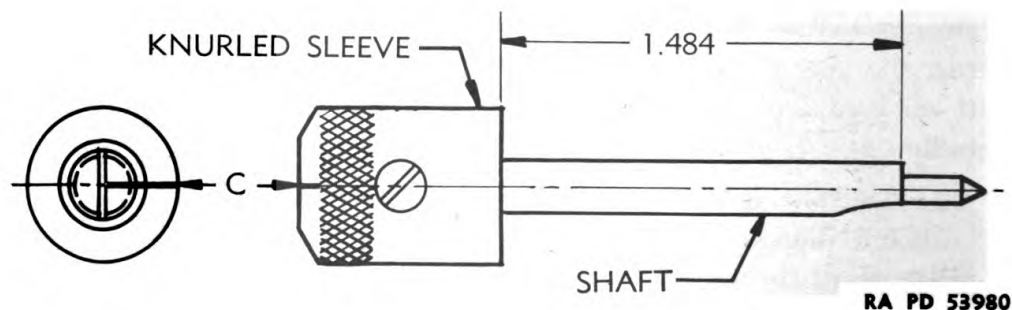
**(1) PULL FUEL SHUT-OFF TO "OFF" POSITION.** Do not allow the engine to start. Crank engine with the starting motor until the exhaust valves of the cylinder on which the injector is to be timed are fully opened. When the rocker arms have depressed the exhaust valves, the injector may be timed.

**(2) SET TIMING GAGE IN POSITION** (fig. 77).

**GAGE**, timing

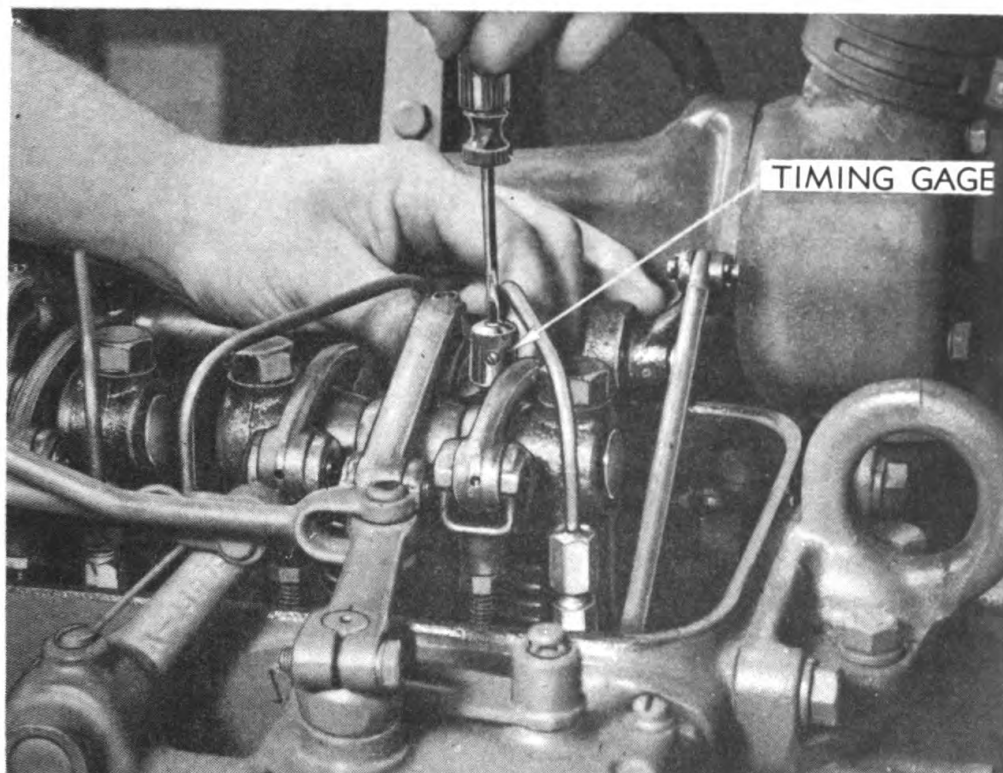
**SCREWDRIVER**, small

Place the timing gage in the timing hole in the injector body. The knurled head or sleeve should be turned to the left as far as possible. Hold the gage vertical with a firm downward pressure on a small screwdriver engaged in the slot in the top of the timing gage shaft. Make certain that the shoulder at the lower end of the timing gage shaft rests



**Figure 76—Injector Timing Gage**

FUEL AND AIR SYSTEM



RA PD 56386

**Figure 77—Injector Timing**

squarely on the injector body and is not resting on the copper gasket under the fuel line fitting in the injector.

**(3) CHECK PRESENT SETTING.**

**GAGE, timing**

Rotate the knurled sleeve to the right until the lower shoulder of the sleeve rests squarely on the edge of the follower guide. If the top of the shaft and the sleeve are not flush and the marks "C" on the sleeve and shaft are not in line, the push rod must be lengthened or shortened to obtain the proper adjustment.

**(4) ADJUST PUSH ROD (fig. 78).**

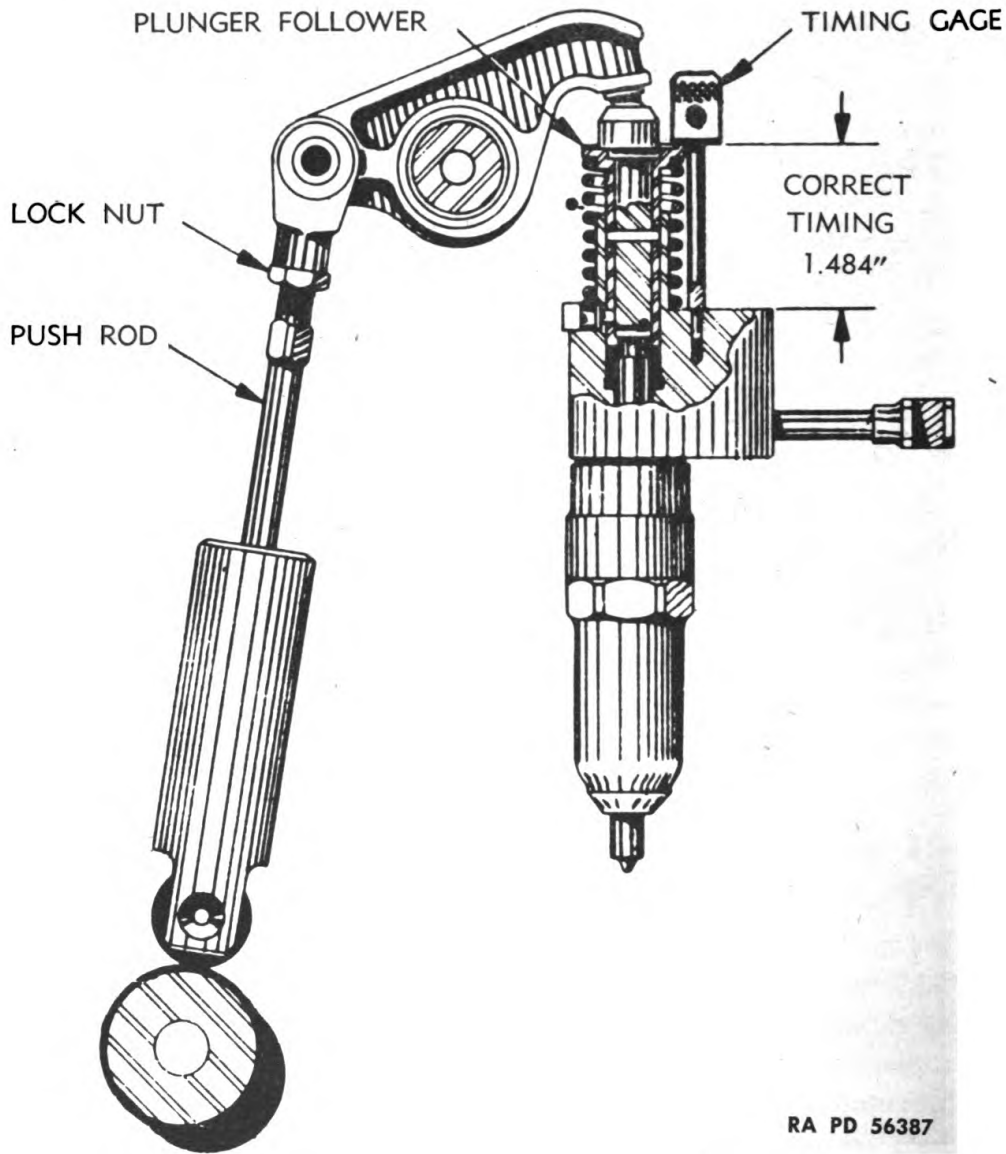
**WRENCH, open-end,  $\frac{5}{16}$ -in.**

**WRENCH, open-end,  $\frac{1}{2}$ -in.**

Loosen the lock nut on the push rod. Adjust the rocker arm by turning the push rod to the right to shorten it, which will allow the injector plunger follower to come up. Turning the push rod to the left will lengthen the push rod and will push the plunger follower guide down. When the timing marks line up, with a small allowance for a slight change which occurs when the lock nut is tightened, the sleeve should also be flush with the top of the timing shaft. Tighten the lock nut on the push rod. The timing marks should now be exactly in line.

**MEDIUM TRACTOR M1**

If they are not in line, change the adjustment slightly until the marks line up when the lock nut is tight.



**Figure 78—Correct Timing of Injector**

**g. Injector Equalizing.** This operation consists of properly adjusting all injector control racks to obtain an equal fuel injection from each injector. Accurate timing of the injectors is essential before they are equalized. The injector must be timed and equalized every time any part of the engine is worked on which might affect the position of the injector or rocker arm assembly. Equalizing is accomplished by the following procedure:

**PLIERS**

**SCREWDRIVER**

### FUEL AND AIR SYSTEM

(1) **PUSH FUEL SHUT-OFF FORWARD (OPEN).** Push fuel shut-off all the way forward and pull throttle back (open) as far as possible.

(2) **LOOSEN ADJUSTING SCREWS.**

#### SCREWDRIVER

Loosen all adjusting screws on the control rack levers and be sure the levers are free on the control tube and that the control tube rotates freely in the bearings.

(3) **DISCONNECT GOVERNOR CONTROL LINK.**

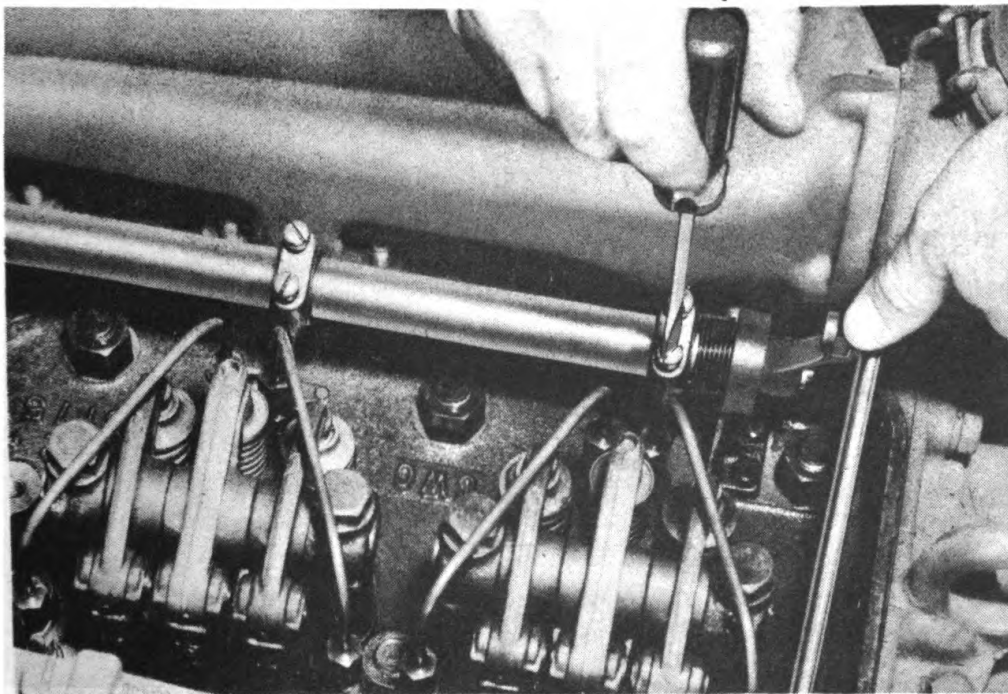
#### PLIERS

Remove link pin from governor control link and control tube lever. All injector control racks should move freely and the injector control tube assembly should return to the "NO INJECTION" position when the governor control link is disconnected.

(4) **ADJUST FOR CONTROL RACK AND GEAR CLEARANCE.**

#### SCREWDRIVER

Hold the throttle lever on the top of the governor in full load position and turn the lower adjusting screw for No. 1 injector in until the hole for the pin in the control tube lever is  $\frac{1}{84}$  inch out of line with the hole in the governor control link (figs. 79 and 80). Turn the upper adjusting screw down and tighten both screws lightly so that the  $\frac{1}{84}$ -inch spacing is maintained.



RA PD 17664

**Figure 79—No. 1 Control Rack Adjustment**

MEDIUM TRACTOR M1

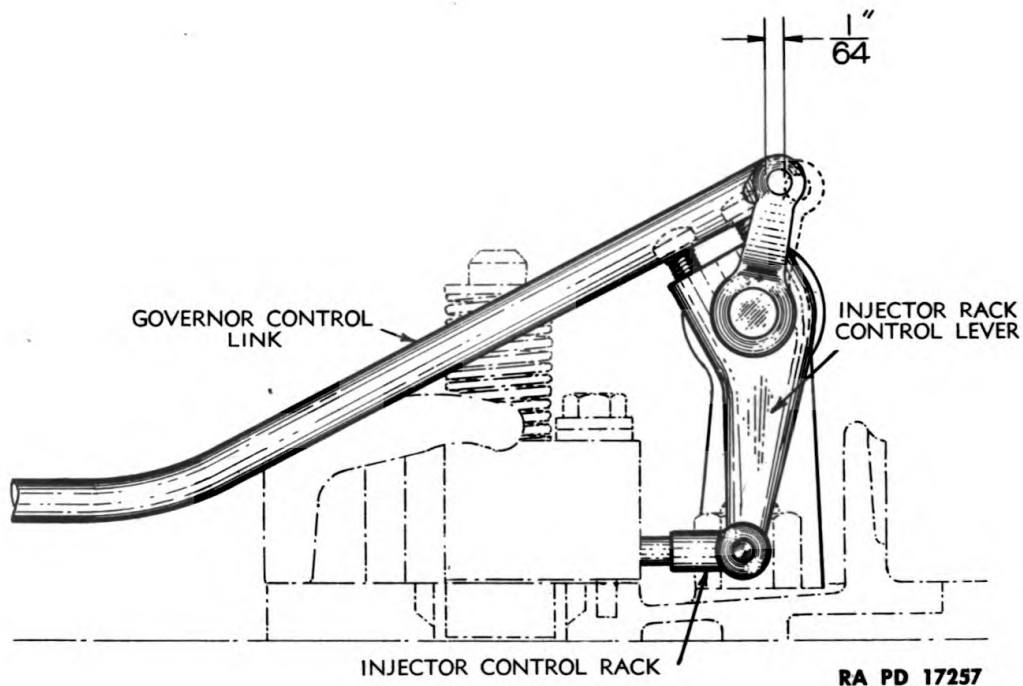


Figure 80—Clearance for Control Rack and Gear

(5) **ADJUST REMAINING RACK CONTROL LEVERS.** Hold No. 1 rack control lever against No. 1 injector control rack in its "IN" position and adjust the remaining rack control levers until the lugs on all rack control levers just contact the inner faces of the slots in the injector control racks. **CAUTION:** The adjusting screws will be damaged if drawn too tightly. If they are just screwed down firmly, they will not loosen.

(6) **CONNECT GOVERNOR CONTROL LINK.**

**PLIERS**

Install link pin in governor control link and control tube lever, and secure with cotter pin. Install rocker arm cover, start engine, and test for proper operation.

(7) **INSTALL HOOD.**

**WRENCH**, open-end,  $\frac{9}{16}$ -in.

Place hood in position and secure with bolts and nuts.

**67. FUEL LINES AND CONNECTIONS.**

a. The fuel lines and connections should be inspected regularly and any damaged or defective parts removed for repair or replaced with new ones. The fuel lines are steel tubing, and it is important to avoid bending them. All clips that hold the fuel lines to the tractor transmission case and to the engine should be tight. Practically all the fuel

## FUEL AND AIR SYSTEM

line connections have connector nuts requiring a  $\frac{7}{8}$ -inch open-end wrench. Any time a fuel connection is broken, the engine should be started after the line is connected again and inspection made for leakage of fuel or loss of fuel pressure due to air being drawn into the fuel system through a defective or loose connection.

b. It is important that the clips holding fuel lines to parts of the tractor be installed again in the proper places when lines are replaced. These clips prevent breakage of lines from vibration. Always use a wrench, not pliers, when connecting or disconnecting fuel lines.

### 68. PRECLEANER.

a. **Description.** The United precleaner, model C-11215, is of the cyclone type. Approximately 85 percent of the dirt entering with air is removed by it before the air reaches the oil bath air cleaner. A glass inspection port makes it easy for the operator to observe the quantity of dirt and dust in the dirt compartment, and enables him to determine readily when it should be emptied from the precleaner. If precleaner becomes damaged, it should be immediately replaced.

#### b. Removal.

**WRENCH**, open-end,  $\frac{7}{16}$ -in. (2)

Loosen clamp bolt at base of precleaner and lift off precleaner assembly (fig. 81).

c. **Maintenance.** The precleaner should be emptied daily, or oftener,



Figure 81—Removing Air Precleaner



**MEDIUM TRACTOR M1**

if necessary. In any case, it should be emptied before dirt is level with top of glass. To empty precleaner, proceed as follows:

- (1) Remove wing nut assembly from the top of precleaner and remove bowl.
- (2) Shake dust from dirt compartment.
- (3) Wipe gasket and reassemble. Replace rubber gasket if present one is not in good condition.
- (4) Tighten wing nut with fingers. **CAUTION:** Do not use a wrench.

**d. Installation.**

**WRENCH**, open-end,  $\frac{7}{16}$ -in. (2)

Place precleaner assembly in position over pipe, pushing it down as far as possible, and tighten clamp bolt.

**69. AIR CLEANER.**

**a. Description.** A United oil bath air cleaner, model CT 85 9665, is used on this tractor and is mounted under the tractor cowl. An oil cup with baffle plate is suspended at the lower end of the air cleaner and is filled to a specified level with engine oil (sec. IV). As the air is drawn through the cleaner, a portion of this oil is whipped up into screen mats in the main body of the cleaner. The dust in the air collects on these oily screen mats as the air is drawn through them and, as a result, only clean air reaches the engine. The oil dripping back into the cup from the screen mats carries the dirt with it and deposits it in the cup. The cup must be removed periodically and cleaned to remove this dirt. A broken hose, loose clamps, or a leak of any kind between the air cleaner and the blower will defeat the purpose of the cleaner; therefore, care should be taken to see that all connections are tight.

**b. Maintenance.** The cleaner must be checked after the day's operation. Remove the oil cup and check the amount and condition of the filtering oil. Swab out the air inlet pipe in the air cleaner to remove any dust accumulation on the sides of the passage. Improper care of the air cleaner will result in abnormal wear on blower, rings, pistons and cylinder liners. The air cleaner should be serviced as follows:

- (1) Swing bail assembly from under cup and remove cup (fig. 82).
- (2) Remove baffle ring and baffle (fig. 83).
- (3) Empty oil and dirt, thoroughly clean cup, baffle, and baffle ring.
- (4) Replace baffle and baffle ring, and fill cup to the oil level line at top of cone with OIL, engine, SAE 30, when temperature is above 32 F, and OIL, engine, SAE 10, when temperature is below 32 F (sec. IV). **CAUTION:** Do not use a Diesel engine oil in the air cleaner as oils of this type are likely to foam and reduce the efficiency of the air cleaner.
- (5) Replace cup on cleaner assembly and snap bail assembly into place under the cup.

FUEL AND AIR SYSTEM

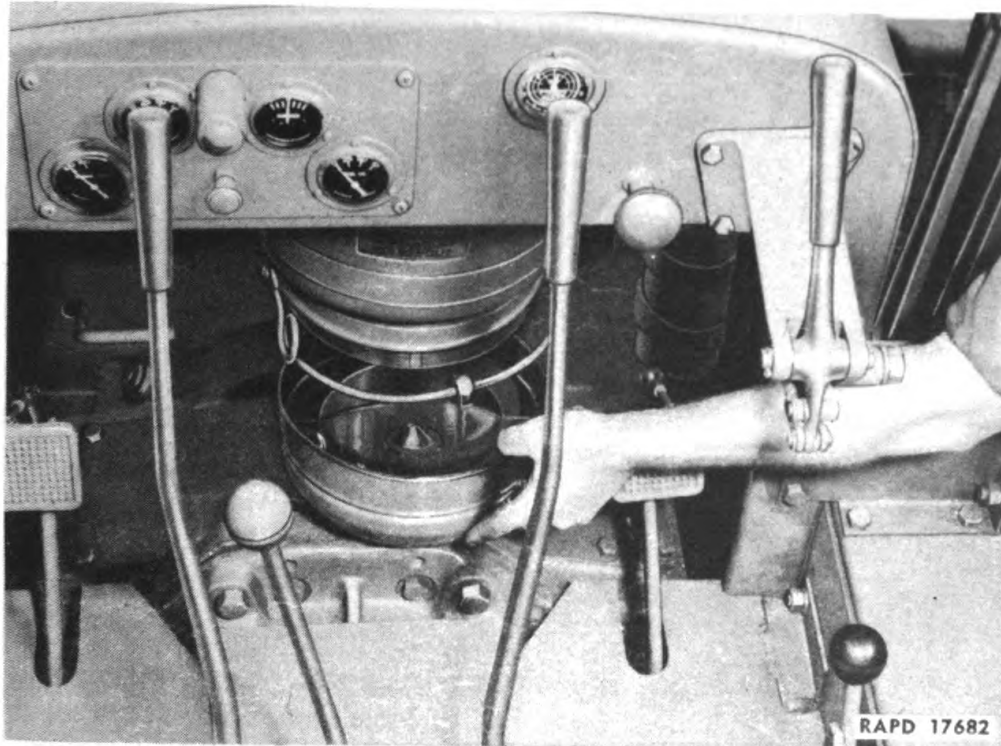


Figure 82—Removing Air Cleaner Cup

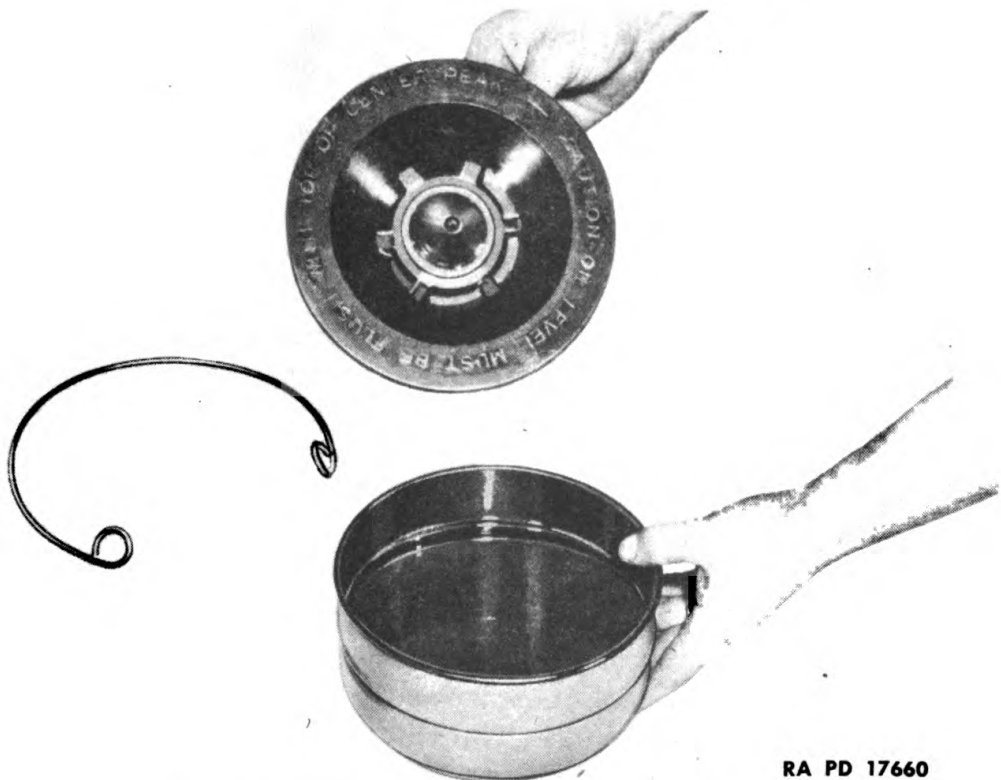


Figure 83—Removing Baffle and Baffle Ring

MEDIUM TRACTOR M1

Section XIII

COOLING SYSTEM

	Paragraph
Description .....	70
Water pump .....	71
Water manifold .....	72
Radiator .....	73
Thermostat .....	74
Hoses and pipes .....	75
Fan assembly .....	76

**70. DESCRIPTION.**

a. Cooling of the engine is accomplished by means of water circulated through the cylinder block and cylinder head by a centrifugal pump mounted on the front end of the blower and driven by the lower blower rotor shaft. This pump delivers the heated water to the top of the radiator core. A cooling fan is provided which draws air through the radiator core, thus dissipating the heat and lowering the water temperature while it passes from the top to the bottom of the radiator.

b. The cooling system has two drain points (fig. 28), and both of these should be opened when the cooling system is drained or the unit is stored. One drain cock is in the bottom of the water pump housing, and the other is in the bottom of the elbow connecting the radiator to the lubricating oil cooler assembly. **CAUTION:** When refilling cooling system, remove the 1/4-inch pipe plug in the thermostat housing (see fig. 29 for location of pipe plug). This will permit air to escape from the head and block. As soon as water runs out of the hole freely, the plug should be replaced and the system filled to its specified capacity, 5 3/4 gallons.

**71. WATER PUMP.**

a. **Description.** The water pump is mounted on the forward end of the blower housing (fig. 86). It is driven by the lower blower rotor shaft through a jaw-type coupling. This coupling fits on the shaft with a light press fit. If the pump becomes frozen or otherwise bound, the coupling will turn on the shaft and will thus prevent damage to the pump itself.

**COOLING SYSTEM**

**b. Trouble Shooting.**

Probable Cause	Probable Remedy
<b>(1) OVERHEATING.</b>	
Pump drive shaft coupling turning on shaft.	Replace coupling.
Impeller turning on shaft.	Replace pump.
<b>(2) NOISY PUMP.</b>	
Bearing defective.	Replace pump.
Impeller defective.	Replace pump.
<b>(3) LOSS OF WATER.</b>	
Water pump seal faulty.	Replace pump.

**c. Removal.**

PUMP, water, and	WRENCH, open-end, 3/4-in.
WRENCH, fuel pump	WRENCH, socket, 3/4-in.
SCREWDRIVER	WRENCH, water pump drain
WRENCH, open-end, 1/2-in.	

**(1) DRAIN COOLING SYSTEM.**

WRENCH, water pump drain

Open both water pump and radiator drain cocks. If antifreeze solution is in cooling system, drain into clean containers to save for refilling radiator.

**(2) REMOVE RIGHT FRONT FENDER.**

WRENCH, open-end, 3/4-in.      WRENCH, socket, 3/4-in.

Remove 3 cap screws and bolt holding fender, and remove fender (fig. 84).

**(3) REMOVE BREATHER TUBE.**

SCREWDRIVER

Remove 2 screws holding top of tube to governor housing and lift tube out of clip at bottom (fig. 85).

**(4) DISCONNECT HOSE.**

SCREWDRIVER

Loosen hose clamp on hose connection between water pump and oil cooler.

**(5) DISCONNECT PUMP OUTLET PACKING FLANGE.**

WRENCH, open-end, 1/2-in.

Remove the 2 cap screws holding pump outlet packing flange to cylinder block (figs. 86 and 87).

**(6) REMOVE PUMP ASSEMBLY.**

PUMP, water and fuel      WRENCH, fuel pump

Remove the 3 cap screws holding water pump to front end of blower and remove pump assembly and coupling (fig. 87).

MEDIUM TRACTOR M1

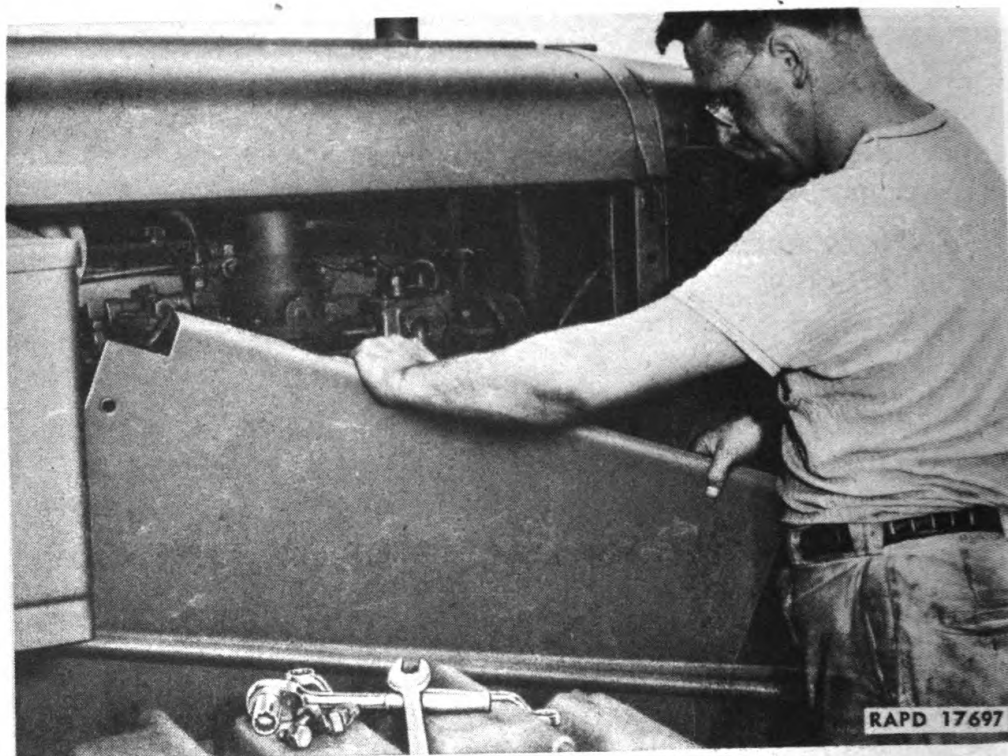


Figure 84—Removing Right Front Fender

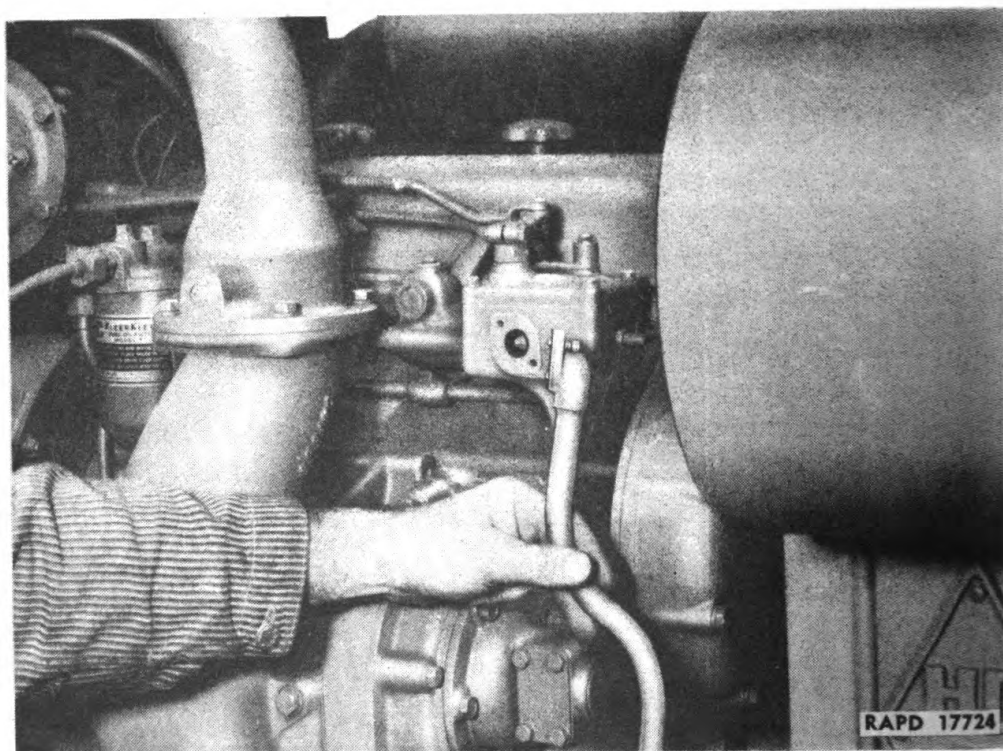
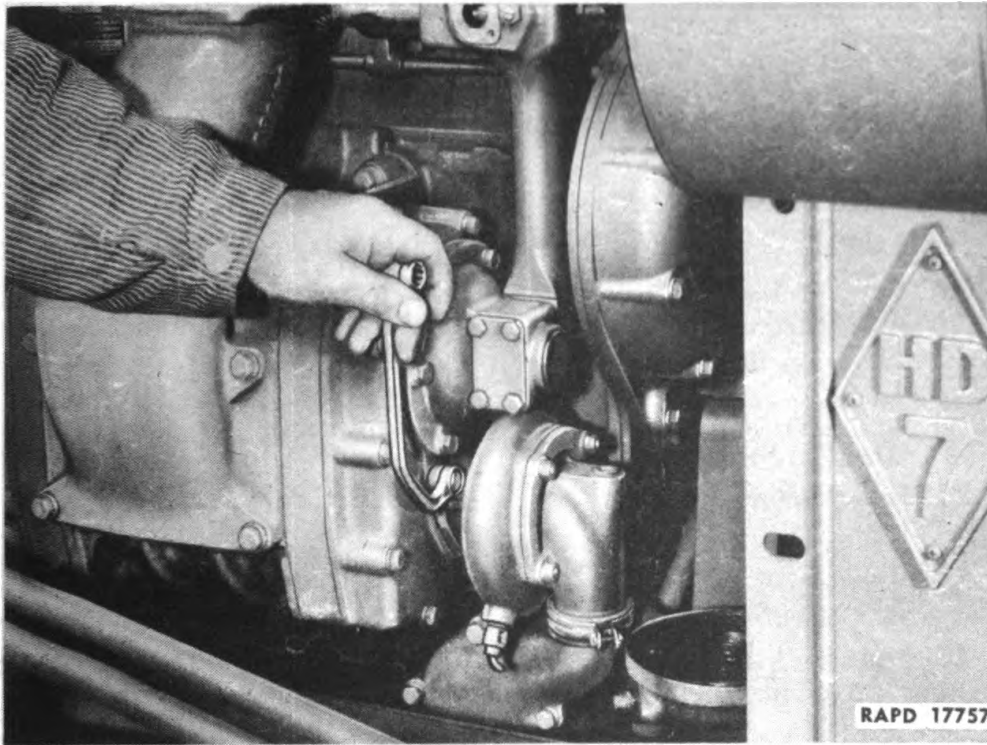
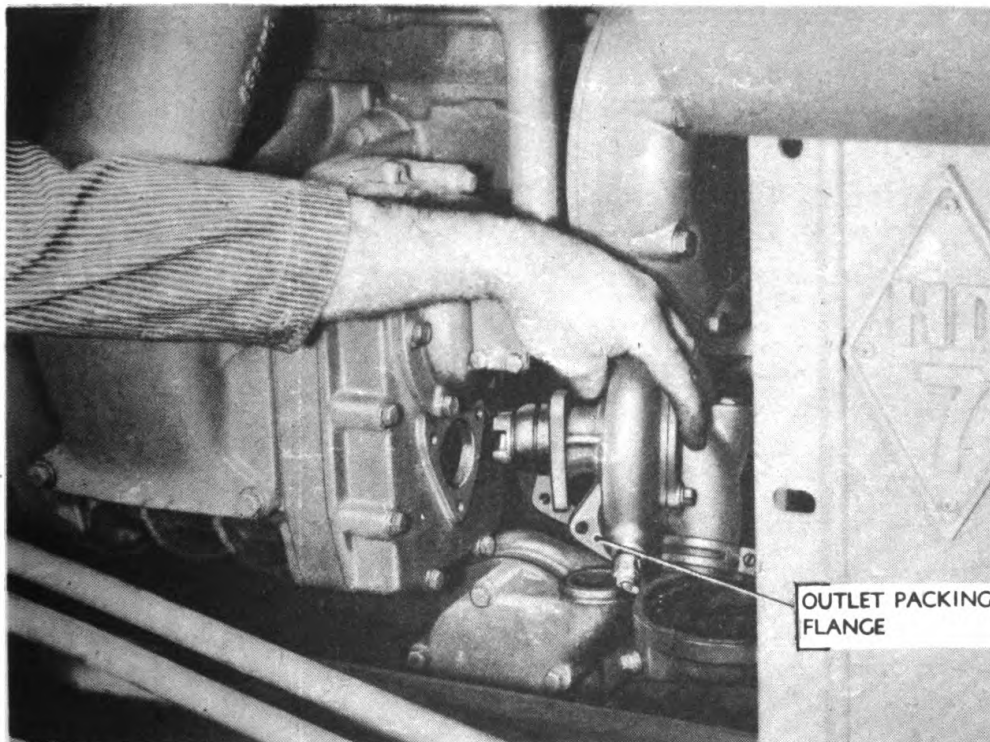


Figure 85—Removing Breather Tube

**COOLING SYSTEM**



**Figure 86—Removing Cap Screws from Water Pump**



RA PD 56468

**Figure 87—Removing Water Pump**

**MEDIUM TRACTOR M1**

**d. Installation.**

**PUMP, water and fuel**

**SCREWDRIVER**

**WRENCH, fuel pump**

**WRENCH, open-end,  $\frac{9}{16}$ -in.**

**WRENCH, open-end,  $\frac{3}{4}$ -in.**

**WRENCH, socket,  $\frac{1}{2}$ -in., with extension**

**WRENCH, socket,  $\frac{3}{4}$ -in.**

**WRENCH, water pump drain**

(1) **INSTALL NEW COUPLING ON PUMP SHAFT.** Place coupling on pump shaft with jaws pointing towards blower. See that packing flange and packing ring are in position on the discharge pipe and that the hose connection from the pump to the oil cooler is in place. Use new gasket, if necessary.

(2) **INSTALL PUMP ASSEMBLY.**

**PUMP, water and fuel**

**WRENCH, fuel pump**

**WRENCH, open-end,  $\frac{9}{16}$ -in.**

Install the pump assembly on the front end cover of the blower and secure assembly with 3 cap screws, taking care that the driving jaws of the coupling engage the driving assembly on the blower rotor shaft. Tighten hose connection.

(3) **CONNECT PUMP OUTLET PACKING FLANGE.**

**WRENCH, socket,  $\frac{1}{2}$ -in., with extension**

Secure outlet packing flange to cylinder block with 2 cap screws.

(4) **INSTALL BREATHER TUBE.**

**SCREWDRIVER**

Insert lower end of tube through clip on oil cooler and secure upper end of tube to governor housing with screws.

(5) **INSTALL FRONT FENDER.**

**WRENCH, open-end,  $\frac{3}{4}$ -in.**

**WRENCH, socket,  $\frac{3}{4}$ -in.**

Install fender and secure with the 3 cap screws, 1 bolt and lock washers.

(6) **FILL COOLING SYSTEM.**

**WRENCH, water pump drain**

Close drain cocks and fill cooling system. Start engine and check for leaks. **NOTE:** As the water pump ball bearing is the shielded type and filled with lubricant when assembled, no further lubrication is necessary.

**72. WATER MANIFOLD.**

**a. Description.** The water manifold is bolted to the left side of the cylinder head and discharges the cooling water back into the radiator. The thermostat is located in a special housing bolted to the front end of the manifold and is used to change the flow of water from the radiator to the bypass tube, which carries the water into the oil cooler, the water pump, and finally into the engine.

### COOLING SYSTEM

#### b. Water Manifold Removal.

SCREWDRIVER

WRENCH, open-end,  $1\frac{1}{16}$ -in.

WRENCH, open-end,  $\frac{9}{16}$ -in.

WRENCH, socket,  $\frac{1}{2}$ -in.

(1) DRAIN COOLING SYSTEM. See paragraph 71 c (1).

(2) REMOVE HOOD. See paragraph 66 d (1).

(3) DISCONNECT HOSE FROM THERMOSTAT HOUSING.

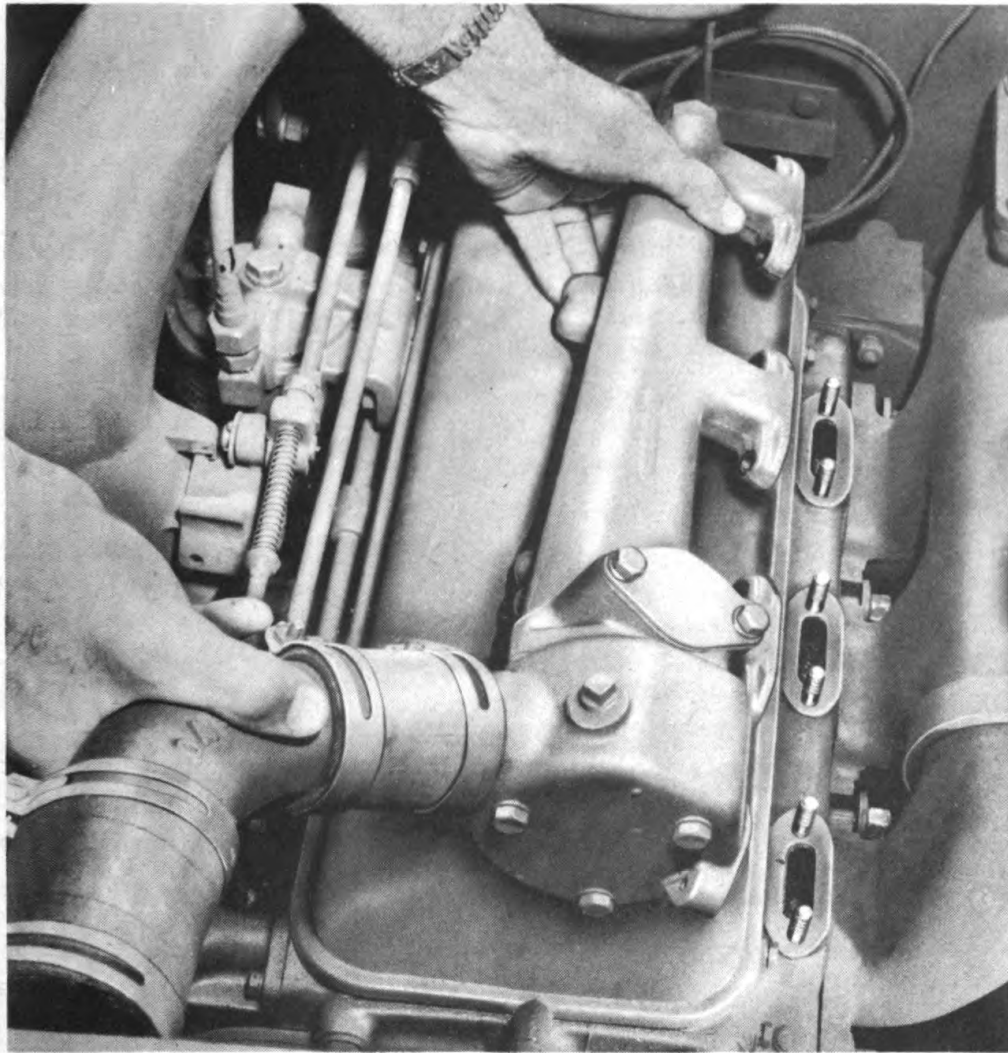
SCREWDRIVER

Loosen clamp on hose at thermostat housing.

(4) REMOVE THERMOSTAT HOUSING.

WRENCH, socket,  $\frac{1}{2}$ -in.

Remove 3 cap screws from the thermostat housing and disconnect water bypass tube from thermostat (fig. 89).



RA PD 17747

**Figure 88—Removing Water Manifold**



**MEDIUM TRACTOR M1**

(5) REMOVE THERMO GAGE TUBE.

WRENCH, open-end,  $1\frac{1}{16}$ -in.

Remove tube of thermo gage from rear of manifold.

(6) REMOVE MANIFOLD. Remove the 6 nuts and lock washers from stud bolts holding manifold to head and lift off manifold (fig. 88).

c. Installation.

GREASE, chassis

SCREWDRIVER

SHELLAC

WRENCH, open-end,  $\frac{9}{16}$ -in.

WRENCH, open-end,  $1\frac{1}{16}$ -in.

WRENCH, socket,  $\frac{1}{2}$ -in.

(1) INSTALL GASKETS ON MANIFOLD.

SHELLAC

Scrape all old gaskets off head and manifold and shellac new gaskets to manifold. Coat other side of gaskets with chassis grease.

(2) INSTALL MANIFOLD ON HEAD.

WRENCH, open-end,  $\frac{9}{16}$ -in.

Place the manifold on the head and tighten all the stud nuts evenly.

(3) INSTALL THERMO GAGE TUBE.

WRENCH, open-end,  $1\frac{1}{16}$ -in.

Install the thermo gage and tube in the rear end of the manifold.

(4) INSTALL THERMOSTAT AND HOUSING.

WRENCH, socket,  $\frac{1}{2}$ -in.

Install the thermostat and housing and connect the water bypass tube to the thermostat housing (fig. 89).

(5) FILL COOLING SYSTEM. Close drain cocks and fill the cooling system. Start the engine and inspect for leaks.

(6) INSTALL HOOD.

WRENCH, open-end,  $\frac{9}{16}$ -in.

Place hood in position and secure with bolts and nuts.

**73. RADIATOR.**

a. **Description.** After the engine has reached operating temperature, the thermostat opens and allows the water to circulate through the radiator. The fan draws air through the radiator core and cools the hot water coming from the engine. The radiator core is bolted inside a shell and protected by the grill in front.

b. **Trouble Shooting.**

(1) OVERHEATING.

Probable Cause	Probable Remedy
Lack of water.	Fill radiator.
Radiator clogged.	Clean and flush.
Dirt, trash, or insects in radiator air passages.	Blow out with compressed air.
Stopped hoses.	Replace hoses.

## COOLING SYSTEM

### (2) LOSS OF WATER.

Leaks in radiator core.	*Repair or replace.
Radiator clogged so that water builds up in top tank and is lost through overflow.	Clean and flush.

**c. Maintenance.** The cooling system should be flushed out periodically to remove accumulated loose rust or foreign material. This may be done with clean water or, if necessary, with a cleaning solvent which is not injurious to steel, cast iron, or copper. Follow directions for flushing as given below.

(1) For flushing with clean water, proceed as follows:

(a) Drain the cooling system and disconnect the water bypass tube at the thermostat housing (fig. 89).

(b) Remove the thermostat (par. 74).

(c) After the thermostat has been removed, bolt housing back to the water outlet manifold, and reconnect the water bypass tube.

(d) System may now be flushed. Fill the cooling system, start the engine, then open both drain cocks and, using a hose, keep the radiator filled as the water runs through the system and drains out.

(e) When all the rust, etc., has been flushed from the system, stop the engine, install the thermostat, close the drains, and refill the system.

(2) If a solvent solution is used to clean the cooling system, a different procedure should be followed:

(a) Drain the cooling system.

(b) Close the drains and fill the system with cleaning solution.

(c) Start the engine and run it for about an hour, regulating the radiator shutter to hold the engine temperature at 190 F.

(d) Drain the solution, flush radiator thoroughly, and refill.

(3) If trash or foreign material has gathered at the top of the tubes in the radiator core, back-flushing of the radiator is necessary.

(a) Drain the cooling system and remove radiator cap.

(b) Disconnect the hose from the elbow in which the main drain cock is located.

(c) Insert a water hose inside this hose, and stuff a cloth around it if an adapter is not available for connection.

(d) Let water run slowly into radiator through hose until water runs out the top of radiator; then increase the water pressure.

(e) Run water through the radiator in this way long enough to force the obstructions off the top of the tubes and out the radiator filler pipe.

(f) Reconnect the lower hose and refill the cooling system.

\* Corrections not within the scope of operating organization.

**MEDIUM TRACTOR M1**

**d. Removal.**

BAR, pry	WRENCH, $\frac{9}{16}$ -in. (2)
HOIST, chain	WRENCH, $\frac{3}{4}$ -in. (2)
PLIERS	WRENCH, $\frac{7}{8}$ -in.
ROPE,	WRENCH, socket, $\frac{1}{2}$ -in.
SCREWDRIVER, 8-in.	

(1) REMOVE RADIATOR ASSEMBLY. Proceed as explained in steps (1) through (8), paragraph 56 d.

**e. Installation.**

HOIST, chain	WRENCH, $\frac{9}{16}$ -in. (2)
PLIERS	WRENCH, $\frac{3}{4}$ -in. (2)
ROPE	WRENCH, $\frac{7}{8}$ -in.
SCREWDRIVER, 8-in.	WRENCH, socket, $\frac{1}{2}$ -in.

(1) INSTALL RADIATOR ASSEMBLY. Proceed as explained in steps (18) through (25) paragraph 56 f.

**74. THERMOSTAT.**

**a. Description.** The thermostat is a bellows type and is located at the front end of the water manifold. It is designed to keep the operating temperature of the cooling fluid at 170 F. There is a  $\frac{1}{4}$ -inch pipe plug in the thermostat housing which must be removed whenever the cooling system is being refilled in order to prevent air locks in the cylinder head and block.

**b. Trouble Shooting.**

(1) ENGINE OVERHEATING.

Probable Cause	Probable Remedy
Thermostat not opening.	Replace thermostat.

(2) ENGINE TEMPERATURE TOO LOW.

Thermostat defective and remaining open.	Replace thermostat.
Thermostat gasket defective.	Install new gasket.

**c. Removal.**

SCREWDRIVER	WRENCH, socket, $\frac{1}{2}$ -in., with 6-in. extension.
WRENCH, open-end, $\frac{1}{2}$ -in.	
WRENCH, open-end, $\frac{9}{16}$ -in.	

(1) DRAIN COOLING SYSTEM. See paragraph 71 c (1).

(2) REMOVE HOOD. See paragraph 66 d (1).

(3) DISCONNECT RADIATOR HOSE.

SCREWDRIVER

Loosen clamp on hose connection.

### COOLING SYSTEM

**(4) DISCONNECT BYPASS TUBE.**

WRENCH, socket, 1/2-in., with  
6-in. extension.

Remove 2 cap screws holding the bypass tube to the thermostat housing.

**(5) REMOVE THERMOSTAT HOUSING.**

WRENCH, socket, 1/2-in.

Remove the 3 cap screws holding the thermostat housing to the water manifold; remove the housing and lift out the thermostat.

**d. Installation.**

SHELLAC

WRENCH, open-end, 9/16-in.

SCREWDRIVER

WRENCH, socket, 1/2-in., with

WRENCH, open-end, 1/2-in.

6-in. extension.

**(1) INSTALL THERMOSTAT.** Place new gasket over the thermostat and place thermostat in housing, taking care to keep gasket in place.

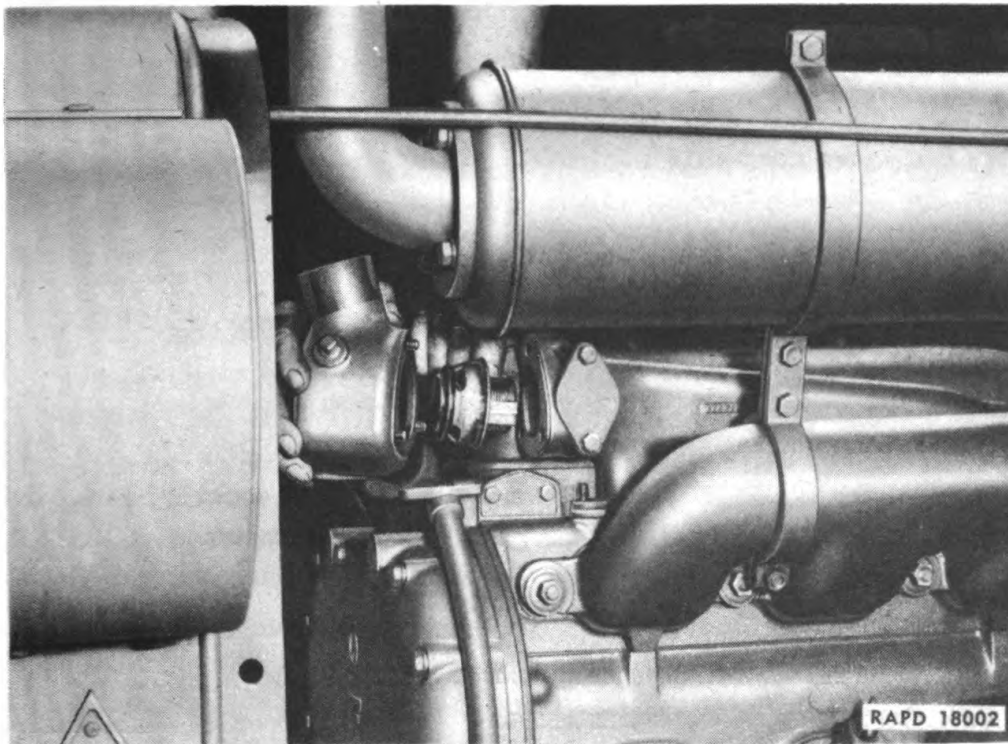
**(2) INSTALL GASKET ON HOUSING.**

SHELLAC

Shellac new gasket to thermostat housing and coat other side of gasket with chassis grease.

**(3) INSTALL ASSEMBLY TO CYLINDER HEAD.**

WRENCH, socket, 1/2-in.



**Figure 89—Installing Thermostat Assembly**

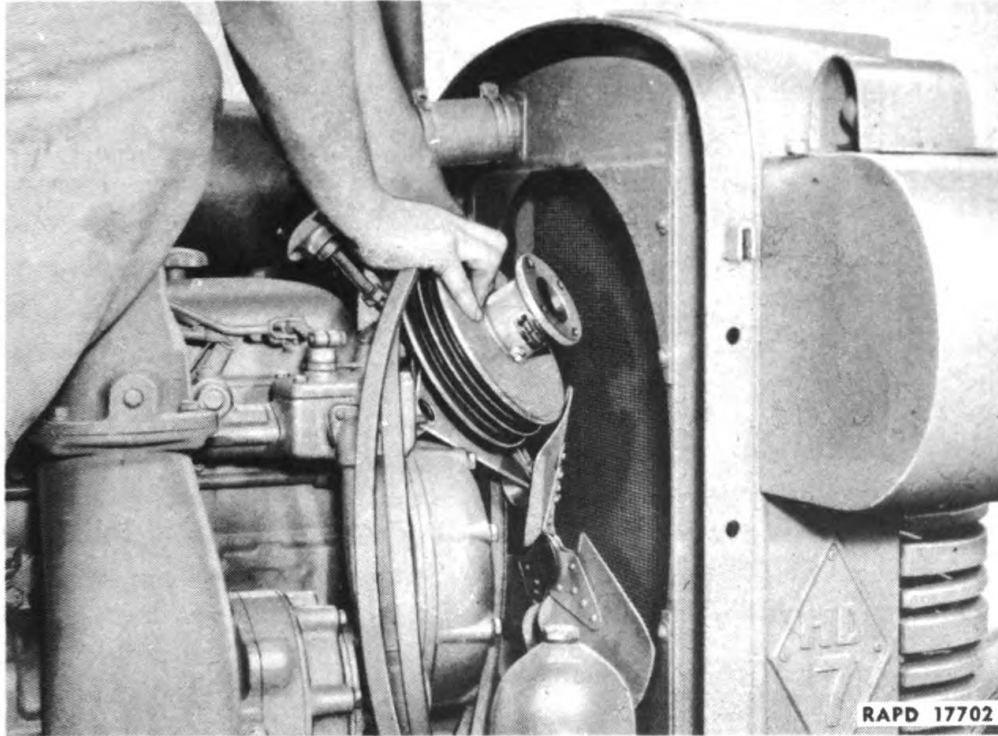


## COOLING SYSTEM

### (2) REMOVE BRACKET AND PULLEY.

WRENCH, socket,  $\frac{3}{4}$ -in.

Remove 3 cap screws and lock washers holding bracket to engine, remove belts from crankshaft pulley, and lift out bracket, pulley, and belts (fig. 85). Then remove fan blade assembly.



**Figure 90—Removing Fan Pulley and Bracket**

#### d. Installation.

WRENCH, socket,  $\frac{1}{2}$ -in.

WRENCH, socket,  $\frac{3}{4}$ -in.

### (1) INSTALL PULLEY AND BRACKET ASSEMBLY.

WRENCH, socket,  $\frac{3}{4}$ -in.

Lay fan blade assembly in against bottom of radiator. Place belts in grooves of fan pulley, lower assembly into place in front of engine, and place lower ends of belts in grooves of crankshaft pulley. Then raise bracket and pulley and install the 3 cap screws holding bracket to balance weight cover of engine.

### (2) INSTALL FAN BLADE ASSEMBLY.

WRENCH, socket,  $\frac{1}{2}$ -in.

Lift fan blade assembly from where it lies at bottom of radiator and install it on pulley with the 4 cap screws.

**MEDIUM TRACTOR M1**

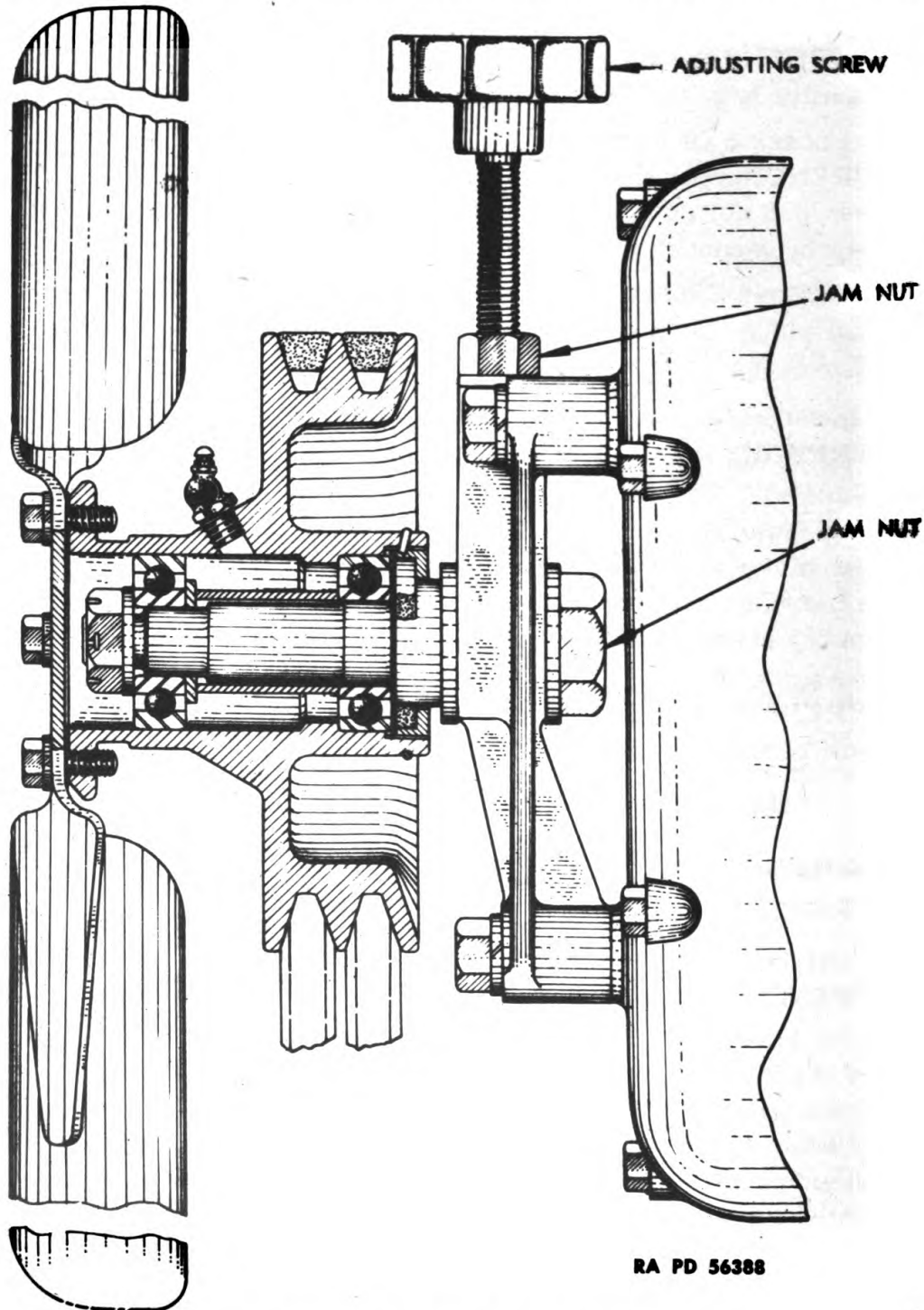
(3) **ADJUST BELTS.** See following step e.

e. **Fan Belt Adjustment** (fig. 91).

**WRENCH, fan**

**WRENCH, open-end, 3/4-in.**

With jam nuts on adjusting screw and fan spindle loosened, turn adjusting screw clockwise to tighten belts. Belts are correctly adjusted



RA PD 56388

**Figure 91—Fan Belt Adjustment**

**COOLING SYSTEM**

when one side of belts can be pressed towards the other side about 1 inch at a point halfway between the pulleys. Tighten adjusting screw jam nut and fan spindle jam nut.

**f. Fan Belt Removal.**

**WRENCH, fan**

**WRENCH, open-end, 3/4-in.**

**(1) LOOSEN JAM NUT ON FAN SPINDLE.**

**WRENCH, fan**

Loosen the large nut in back of bracket on end of fan spindle.

**(2) LOOSEN FAN BELTS.**

**WRENCH, open-end, 3/4-in.**

Loosen jam nut on adjusting screw and turn screw counterclockwise to loosen belts enough to remove them from belt pulley grooves.

**(3) REMOVE BELTS.** Remove one belt at a time. After removing belt from fan pulley, remove belt from lower crankshaft pulley and work belt off over fan. Remove second belt in same manner.

**g. Installation.**

**WRENCH, fan**

**WRENCH, open-end, 3/4-in.**

**(1) INSTALL BELTS.** Work belts over fan. Place first belt in rear groove of lower crankshaft pulley first; then work belt onto fan pulley into rear groove. It may be necessary to turn fan by turning motor with engine cranking wrench to run belt onto fan pulley. Install second belt in front pulley grooves in same manner.

**(2) ADJUST BELTS.**

**WRENCH, open-end, 3/4-in.**

Adjust belts as described under paragraph e, above.



MEDIUM TRACTOR M1

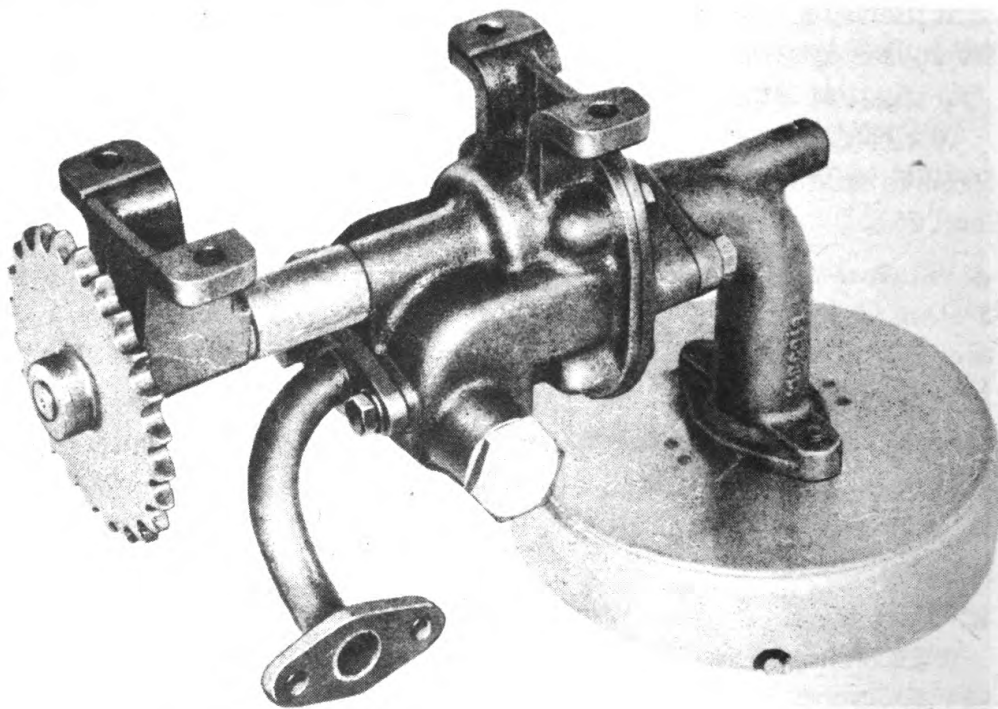
Section XIV

LUBRICATION SYSTEM

	Paragraph
General .....	77
Oil pump .....	78
Oil filter .....	79
Oil cooler .....	80

77. GENERAL.

a. The lubrication system for the engine consists of the oil pump, oil filter, and oil cooler. As explained in paragraph 26, the engine block and head contain drilled passages to deliver oil, under pressure, to most of the moving parts of the engine after passing through the filter and cooler. The oil, in returning to sump, flows through other parts and bearings to lubricate them. Diesel engine lubricating oil is used in the engine, engine oil (not Diesel) in other compartments of the tractor itself, chassis grease in all pressure gun fittings, and transmission oil in the winch and power take-off housings.



RA PD 17247

Figure 92—Lubricating Oil Pump Assembly

## LUBRICATION SYSTEM

### 78. OIL PUMP.

a. **Description** (fig. 92). The oil pump is a conventional gear type pump mounted to one of the engine main bearing caps and driven by the crankshaft through a chain and sprockets.

b. **Maintenance.** No provision is made on the pump for increasing or decreasing oil pressure. If pressure is not within normal range of from 25 to 35 pounds at operating engine speed and temperature, stop the engine immediately and report to higher authority. The using arms will not attempt any maintenance on oil pump.

### 79. OIL FILTER.

a. **Description** (fig. 93). The oil filter located on the front of engine, is of the full flow type and consists of 2 metal elements inside a housing. The bracket supporting the oil filter is cast with the adapter between the oil cooler and engine block.

b. A sudden drop in oil pressure would indicate that this filter is plugged, possibly from sludge or dirt. Remove the filter and clean elements and base if this occurs.

c. **Removal.**

WRENCH, socket, 1 1/8-in.

WRENCH, square socket, 1/4-in.

(1) **REMOVE FILTER DRAIN PLUG.**

WRENCH, square socket, 1/4-in.

Remove plug at base of filter and allow oil to drain from filter.

(2) **REMOVE OIL FILTER STUD.**

WRENCH, socket, 1 1/8-in.

Remove stud and gasket and lift off filter housing and element (figs. 94 and 95).

d. **Maintenance.** The metal elements in the filter should be removed and cleaned each time engine crankcase is drained and at any time between oil changes that low oil pressure may be due to clogged filter.

(1) Wash the elements in clean fuel oil with a soft brush. Do not scrape with a sharp instrument or use a wire brush as damage may result.

(2) Wash all parts thoroughly, and dry them. Clean inside of filter base. Make sure gasket in base of filter is in good condition when filter is put back on tractor.

e. **Installation.**

WRENCH, socket, 1 1/8-in.

WRENCH, square socket, 1/4-in.

(1) **EXAMINE FILTER HOUSING GASKET.** Make sure that this gasket in base of filter is in good condition. If not, replace it.

(2) **SET ELEMENTS IN PLACE.** Assemble screens, one inside the other, and set them in filter base.

MEDIUM TRACTOR M1

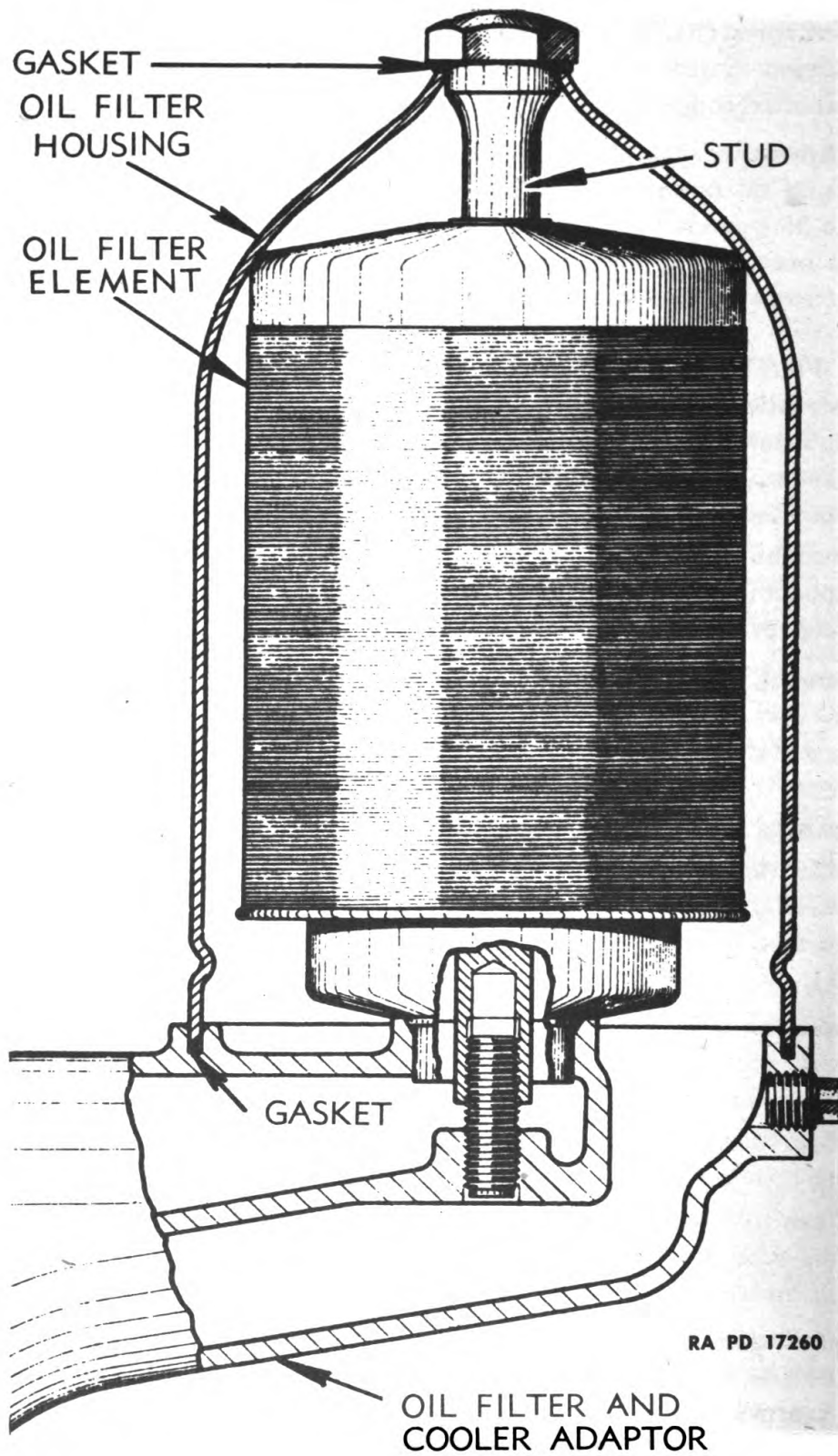
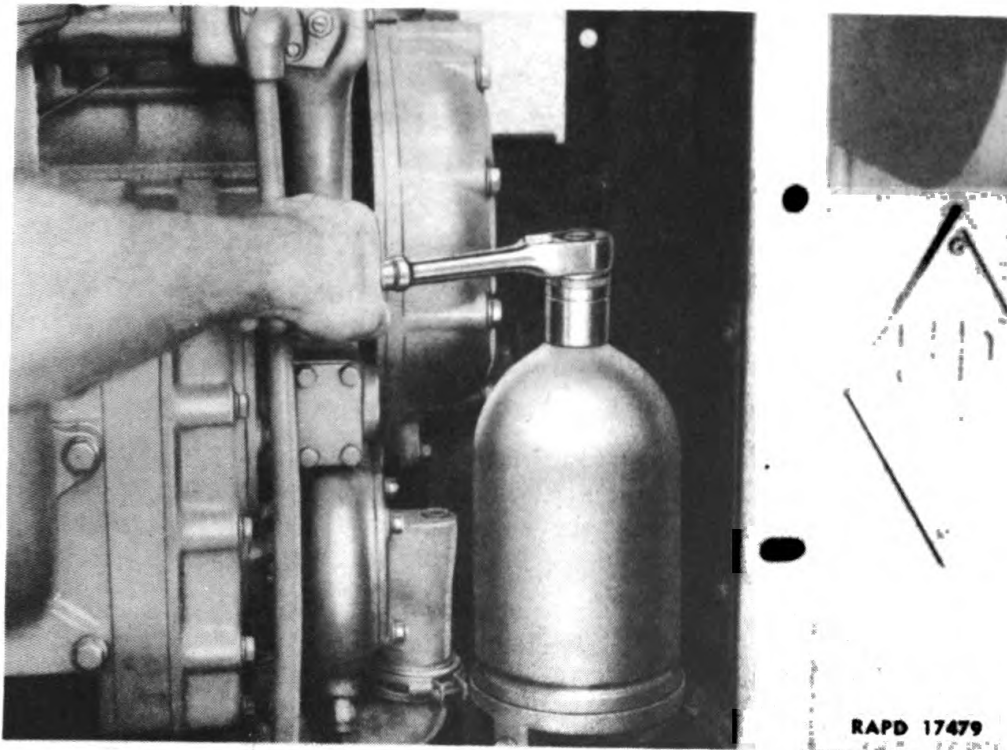
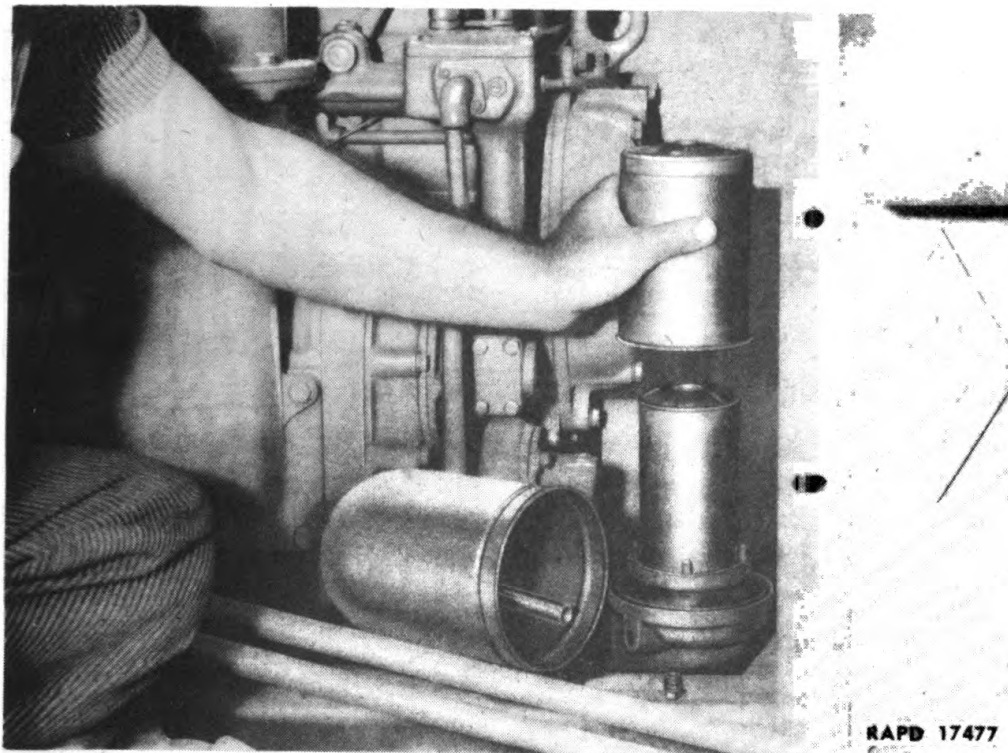


Figure 93—Cutaway View of Lubricating Oil Filter

LUBRICATION SYSTEM



**Figure 94—Removing Lubricating Oil Filter Stud**



**Figure 95—Removing Lubricating Oil Filter Element**

**MEDIUM TRACTOR M1**

**(3) INSTALL HOUSING AND DRAIN PLUG.**

**WRENCH**, socket, 1 1/8-in.

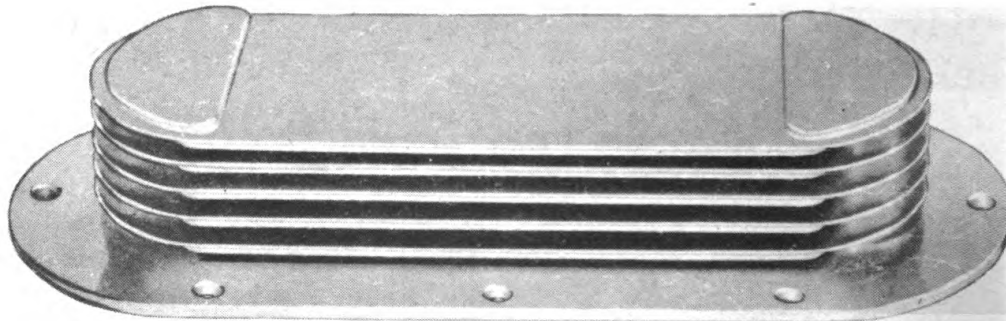
**WRENCH**, square socket, 1/4-in.

Place housing over elements, making sure that bottom of housing enters groove in base. Install stud and gasket and tighten with 9-inch handle for wrench. Install filter drain plug.

**(4) START ENGINE AND INSPECT FOR LEAKS.**

**80. OIL COOLER.**

a. **Description (fig. 96).** The oil cooler assembly consists of a housing inside of which is a metal element somewhat similar to the core of a radiator. Water from the radiator circulates around the element in the cooler and lubricating oil circulates through the element. The oil cooler plates are lined with small fins which dissipate heat from the oil inside the element to cooling water surrounding the element inside the cooler housing.



RA PD 17261

**Figure 96—Lubricating Oil Cooler Element**

b. If proper lubricating oil maintenance procedure is followed, the cooler will function efficiently for an indefinite period. However, when oil is allowed to become laden with impurities, these impurities will deposit in the cooler; consequently causing clogging and inefficiency. To effectively clean the cooler, it is necessary to remove cooler element and circulate a special solvent through cooler element for some time by use of a force pump.

**c. Removal.**

**WRENCH**, open-end, 1/2-in.

**WRENCH**, socket, 3/4-in.

**WRENCH**, open-end, 3/4-in.

**WRENCH**, socket, 1 1/8-in.

**WRENCH**, socket, 9/16-in., with extension

**WRENCH**, square socket, 1/4-in.

### LUBRICATION SYSTEM

**(1) REMOVE RIGHT FRONT FENDER.**

**WRENCH**, open-end,  $\frac{3}{4}$ -in.      **WRENCH**, socket,  $\frac{3}{4}$ -in.  
Remove 3 cap screws and 1 bolt holding fender and lift it off (fig. 84).

**(2) DRAIN COOLING SYSTEM AND OIL FILTER.**

**WRENCH**, square socket,  $\frac{1}{4}$ -in.  
Drain cooling system and drain oil from filter by removing drain plug in filter base.

**(3) REMOVE OIL FILTER.**

**WRENCH**, socket,  $1\frac{1}{8}$ -in.  
Remove filter housing stud and lift off housing, element, and gasket.

**(4) DISCONNECT WATER BYPASS TUBE.**

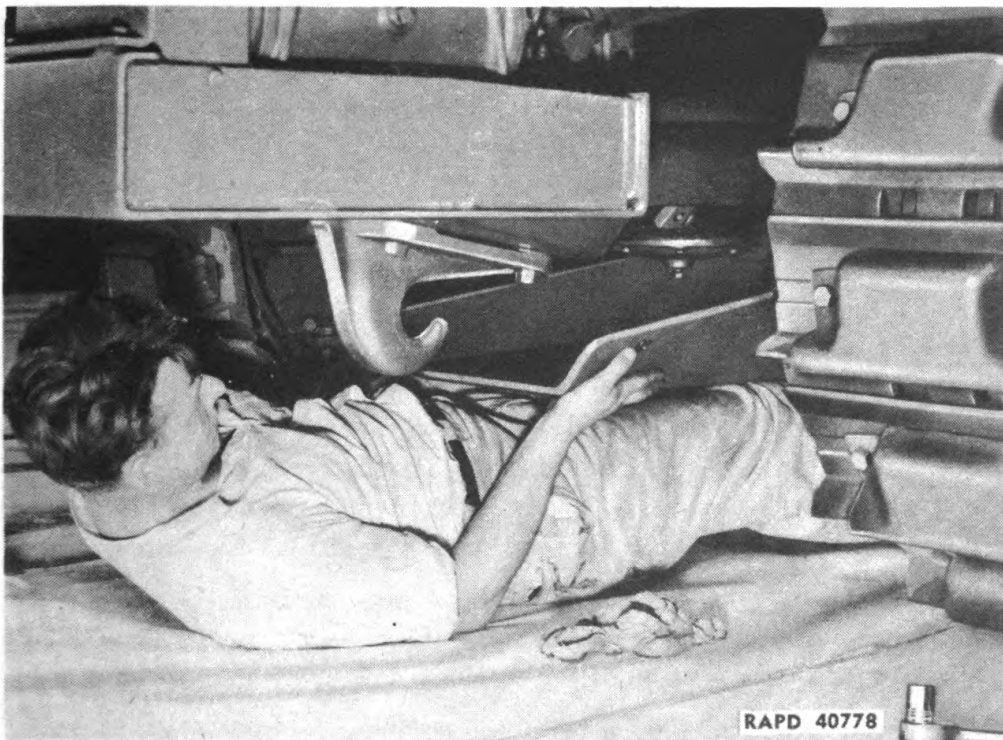
**WRENCH**, socket,  $\frac{1}{2}$ -in.  
Remove cap screw holding water bypass tube clip to cooler housing.

**(5) REMOVE ENGINE SUPPORT BOTTOM COVER.**

**WRENCH**, socket,  $\frac{7}{8}$ -in.  
Remove the 4 cap screws holding cover to engine support and remove cover (fig. 97).

**(6) DISCONNECT HOSES.**

**SCREWDRIVER**      **WRENCH**, socket,  $\frac{1}{2}$ -in., with short extension



**Figure 97—Removing Engine Support Bottom Cover**

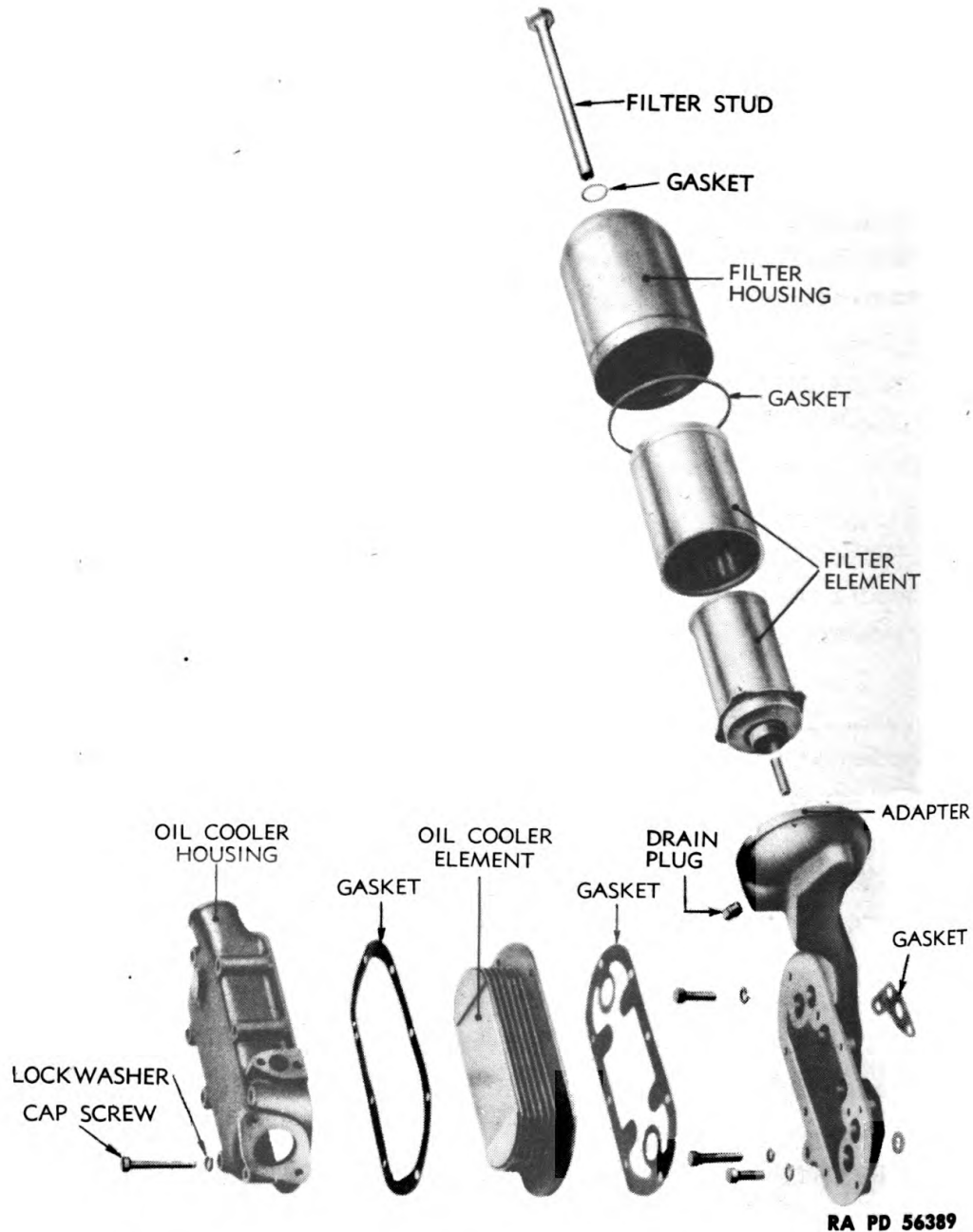
**MEDIUM TRACTOR M1**

Loosen clamp on hose connecting water pump and oil cooler. Slip hose connection between water pump and cooler down onto cooler pipe. Remove 2 cap screws from lower water connection.

**(7) REMOVE COOLER HOUSING.**

WRENCH, socket,  $\frac{9}{16}$ -in., with short extension

Remove the 8 cap screws and lock washers holding cooler housing to oil filter and cooler adapter and remove housing, element, and gaskets.



**Figure 98—Lubricating Oil Filter and Cooler Disassembled**

**LUBRICATION SYSTEM****d. Installation (fig. 98).****SCREWDRIVER****WRENCH, socket, 3/4-in.****SHELLAC****WRENCH, socket, 7/8-in.****WRENCH, open-end, 1/2-in.****WRENCH, socket, 1 1/8-in.****WRENCH, open-end, 3/4-in.****WRENCH, square socket,****WRENCH, socket, 1/2-in.****1/4-in.****WRENCH, socket, 9/16-in., with  
extension****(1) SHELLAC COOLER GASKETS.****SHELLAC**

Clean cooler element housing and adapter surfaces and shellac both sides of cooler gasket.

**(2) INSTALL ELEMENT AND HOUSING.****WRENCH, socket, 9/16-in., with extension**

Place new element in housing and stick gasket to housing. Install assembly to engine with cap screws and lock washers.

**(3) INSTALL HOSES.****SCREWDRIVER****WRENCH, socket, 1/2-in.**

Connect hose at inlet of cooler and tighten clamp. Install cap screws in lower water connection and tighten, using a new gasket, if necessary.

**(4) INSTALL ENGINE SUPPORT BOTTOM COVER.****WRENCH, socket, 7/8-in.**

Install cover on engine support and secure with the 4 cap screws and lock washers (fig. 97).

**(5) CONNECT WATER BYPASS TUBE.****SHELLAC****WRENCH, open-end, 1/2-in.**

Shellac both sides of a new gasket and install gasket and water bypass tube to cooler.

**(6) INSTALL CAP SCREW HOLDING GOVERNOR BREATHER PIPE CLIP.****WRENCH, socket, 9/16-in.**

Secure breather pipe clip with cap screw.

**(7) INSTALL OIL FILTER AND PLUG.****WRENCH, socket, 1 1/8-in.****WRENCH, square socket,  
1/4-in.**

Install filter and drain plug in filter base.

**(8) INSTALL FENDER.****WRENCH, open-end, 3/4-in.****WRENCH, socket, 3/4-in.**

Install fender and secure with cap screws, bolt, and lock washers.

**(9) START ENGINE AND INSPECT FOR LEAKS.** Fill system with water, start engine, and inspect all connections for leaks.



**MEDIUM TRACTOR M1**

**Section XV**

**ELECTRICAL SYSTEM AND EQUIPMENT**

	Paragraph
Description .....	81
Batteries .....	82
Generator .....	83
Generator voltage control unit .....	84
Starting motor .....	85
Ammeter .....	86
Hour meter .....	87
Air heater .....	88
Light switch .....	89
Panel light .....	90
Service lights .....	91
Wiring .....	92

**81. DESCRIPTION.**

a. A 12-volt electrical system is used on the tractor. Two 6-volt batteries are connected in series. The capacity of the generator is sufficient to keep the batteries fully charged under normal operating conditions.

**82. BATTERIES.**

a. **Description.** The batteries are located in front box on left top fender. The positive cable is grounded to the engine support. The batteries supplied with the tractor are of two kinds and may be equipped with a "no-over-flo" device. This is a lead washer in each vent well which is designed to prevent overflowing.

**b. Trouble Shooting.**

**(1) DISCHARGED BATTERY.**

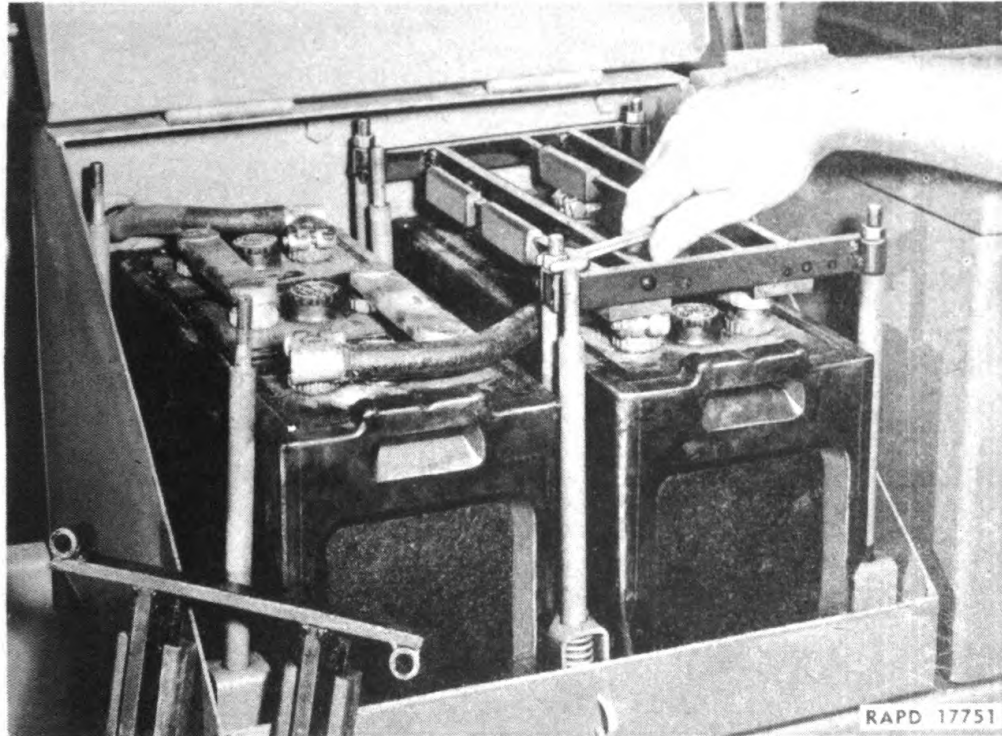
Probable Cause	Probable Remedy
Short circuits.	Locate and correct shorts.
Connections loose.	Tighten connections.
Connections dirty or corroded.	Clean connections.
Voltage control unit out of order.	Replace.
Generator not charging.	Check generator and voltage control unit.

**(2) BATTERY OVERHEATING.**

Voltage control unit out of order.	Replace.
High charging rate.	Check voltage control unit.

**ELECTRICAL SYSTEM AND EQUIPMENT****c. Removal.****SCREWDRIVER****WRENCH, socket,  $\frac{9}{16}$ -in.****WRENCH, open-end,  $\frac{9}{16}$ -in.****(1) REMOVE HOLD-DOWN ASSEMBLY.****WRENCH, socket,  $\frac{9}{16}$ -in.**

Remove hold-down assembly by removing nuts from the long cap screws which extend through equalizers (fig. 99).



**Figure 99—Removing Battery Hold-Down Assembly**

**(2) REMOVE CABLES FROM BATTERY TERMINALS.****WRENCH, open-end,  $\frac{9}{16}$ -in.**

Loosen bolts in clamps around battery terminals; spread clamps with screwdriver and lift them off battery terminals (fig. 100). **NOTE:** When necessary to tighten or loosen the clamped connections at the battery terminals, use a wrench of the proper size. Care must be taken that the wrench does not come in contact with any other metal parts of the battery or tractor. When removing terminals, remove grounded or positive terminal first, and when replacing terminals, replace grounded terminal last.

**(3) REMOVE BATTERIES.** Lift batteries out of box. Keep batteries right side up, and in handling be careful to keep batteries from touching clothes, as acid may drop on clothes. This acid will destroy any fabric it touches.

MEDIUM TRACTOR M1



Figure 100—Removing Battery Cable

d. Maintenance.

(1) **SPECIFIC GRAVITY.** Specific gravity readings of each battery should be taken periodically. Use a hydrometer and test each cell separately. If readings are below 1.240, the battery is not receiving sufficient charge. (In zero weather there is danger of freezing if readings are below 1.175; a battery with a specific gravity reading of 1.225 will freeze at 35 degrees below zero F.) If water must be added oftener than every 2 weeks, the electrical system should be adjusted to decrease the charging rate. Otherwise the battery life will be shortened by overcharging.

(2) The electrolyte temperature affects the hydrometer reading. For each 30 F that the electrolyte is above 77 F, add 10 points to the hydrometer reading to get the true specific gravity. For each 30 F that the electrolyte is below 77 F, subtract 10 points from hydrometer reading to get true specific gravity. The above correction is tabulated in the following table for several electrolyte temperatures.

Electrolyte Temperature	Correction to Obtain True Specific Gravity
+122 F	Add 15 points
+107 F	Add 10 points
+ 92 F	Add 5 points
+ 77 F	No correction
+ 62 F	Subtract 5 points

**ELECTRICAL SYSTEM AND EQUIPMENT**

Electrolyte Temperature	Obtain True Specific Gravity Correction to
+ 47 F	Subtract 10 points
+ 32 F	Subtract 15 points
+ 17 F	Subtract 20 points
+ 2 F	Subtract 25 points
- 13 F	Subtract 30 points
- 43 F	Subtract 40 points

Hydrometer reading: 1.250

Example: Electrolyte temperature: 17 F

True specific gravity: 1.250 minus 20 points = 1.230

(a) When taking hydrometer readings on batteries equipped with "no-over-flo," it will be necessary to return all electrolyte withdrawn from battery for purpose of reading by depressing the lead washer. CAUTION: This washer should be depressed only when returning electrolyte to cell and not when filling with water.

**(3) ADDING WATER.**

(a) If water is added in freezing temperature and battery is not charged to mix water with electrolyte, the water will remain on top and freeze. In a cold climate, water should be added when the battery is in a room warm enough so that the battery can be sufficiently charged to thoroughly mix the water with electrolyte before the water can freeze.

(b) Distilled water or rain water may be used.

(c) Do not overfill, as subsequent electrolyte expansion may cause flooding and damage. The proper filling height is approximately 3/8 inch above top of separators.

(d) The battery may be equipped with a lead washer in each vent well which is designed to prevent overfilling. Therefore, add water only until it begins to rise into the vent plug well. Draw off any excess in order to obtain proper level when vent caps are in place.

(4) VENT PLUGS. Always keep vent plugs in place except when filling or taking gravity readings. Vent plugs must be in place while charging. Be sure hole in vent plug is open.

(5) KEEP BATTERIES CLEAN AND DRY. If wet or dirty, wash with baking soda solution or ammonia, then with clear water. Be sure vent plugs are tight before washing.

(6) TERMINALS. Keep terminals tight and clean. If corroded, disconnect and clean (wash as in (5) above). Apply a thin coat of COMPOUND, rust-preventive, light (not cup grease) to terminal and battery posts before replacing terminal.

(7) IDLE BATTERIES. An idle battery requires a charge every month or two or at sufficient intervals to keep the gravity above 1.240.

(8) Temperatures at which electrolyte will freeze with various specific gravities are as follows.

**MEDIUM TRACTOR M1**

True Specific Gravity	Freezing Temperatures
1.270	-96 F
1.255	-60 F
1.210	-31 F
1.185	- 8 F
1.150	+ 5 F
1.100	+18 F

(9) The battery is in a hard rubber container. When working around the battery, remember that all its exposed metal parts are "alive" and that no metal, tool, or wire should be laid across the terminals, as a spark or short circuit will result. Sparks and lighted matches or exposed flames should be avoided near the battery.

**e. Installation.**

**WRENCH**, open-end,  $\frac{9}{16}$ -in.

**WRENCH**, socket,  $\frac{9}{16}$ -in.,  
with extension

(1) **CLEAN ALL CABLES AND CABLE TERMINALS.** Scrape off all dirt or corrosion. Coat cable and battery terminals with **COMPOUND**, rust-preventive, light.

(2) **INSTALL BATTERIES.**

**WRENCH**, open-end,  $\frac{9}{16}$ -in.

Place batteries in box with negative post of front battery and positive post of rear battery towards cowl of tractor. Place large cable, extending through box from starter switch, on negative post of one battery, positive or ground cable on positive post of the other battery (fig. 100). Connect the two batteries with the connector cable.

(3) **INSTALL HOLD-DOWN ASSEMBLY.**

**WRENCH**, socket,  $\frac{9}{16}$ -in., with extension

The hold-down device used for securing the batteries in the tractors is designed to give the battery the maximum protection against mechanical shaking and vibration. It holds the battery by downward pressure on top of the cell connectors and terminals instead of holding down on the rubber case. Care should be exercised in tightening the hold-down to guard against too much pressure being applied; also that the rubber lining of the hold-down bears on both the inter-cell connector (lead strips between cells) and terminal connectors. In replacing hold-down, check to see that cable connectors to batteries are tight, that the ungrounded terminals are clear of any metal part of the hold-down and that the cables are not subject to rubbing which will wear off the insulation.

**83. GENERATOR.**

**a. Description.** The Delco-Remy generator, model 1105377, is a  $5\frac{1}{16}$ -inch 2-pole, third-brush, sealed-type unit, with ball bearings in each

**ELECTRICAL SYSTEM AND EQUIPMENT**

end to support the armature. It is used in connection with a Delco-Remy step-voltage control unit, model 5886. The purpose of the generator is to furnish electrical energy for ignition, lights, etc., when the vehicle is in operation and to keep the battery charged. Energy drained from the battery is replaced by the generator. The generator is driven by a V-belt from a pulley on the engine crankshaft.

**b. Operation.** Proper operation of the electrical system depends largely on a well charged battery. The battery will be able to supply enough current to meet the needs of the system only if the generator is serviced regularly and checked at frequent intervals to determine if any adjustments or repairs are necessary. These adjustments or repairs will not be made by the using arms. Minor adjustments may be made without removing generator from tractor. The charging rate of the generator is set at from 4 to 8 amperes when the tractor leaves the factory. This should be sufficient to keep the battery fully charged under ordinary operating conditions. The step-voltage control unit serves to prevent overcharging of the battery.

**c. Lubrication.** The 2 hinge cap oilers should be supplied with 8 to 10 drops of light engine oil after every 100 hours of operation. Do not oil excessively. *Never oil commutator.*

**d. Trouble Shooting.**

**(1) NOISY GENERATOR.**

Probable Cause	Probable Remedy
Loose mounting.	Tighten mounting bolts.
Loose pulley.	Tighten pulley.
Worn bearings.	*Replace bearings.
Dry bearings.	Lubricate.

**(2) EXCESSIVE GENERATOR OUTPUT.**

Generator field grounded.	Locate external ground.
Voltage control unit out of adjustment.	*Adjust.
Voltage control unit defective.	Replace voltage control unit.

**(3) NO GENERATOR OUTPUT.**

Burned commutator bars.	*Recut commutator.
Worn brushes.	*Replace brushes.
Sticking brushes.	Clean brushes.
Open or short circuit in field or armature.	Replace unit.
Loose belt.	Adjust for 1-inch slack.

**(4) LOW GENERATOR OUTPUT AND LOW BATTERY.**

Low brush tension.	*Adjust or replace brush springs.
Brushes sticking.	Clean brushes.

\* Corrections not within scope of operating organization. See next higher authority.

**MEDIUM TRACTOR M1**

Probable Cause	Probable Remedy
Rough, dirty, or greasy commutator bars.	Clean commutator bars.
High mica on commutator.	*Undercut mica.
Loose belt.	Adjust to 1-inch slack.

**e. Quick Checks to Determine if Units Are Operating Normally.**

(1) A fully charged battery and a low charging rate indicates normal operation.

(2) With a fully charged battery and a high-charging rate, it is necessary to determine whether or not the step-voltage control has operated to insert its resistance into the generator field circuit. This can be determined by removing the voltage control cover and checking to see if the voltage control points are open. If they are not, open them by depressing, by hand, the arm on which the movable point is mounted. If the output now falls off, the voltage control must be readjusted. If the output does not drop off with the points held open, disconnect the lead from the voltage control "F" terminal. If the output remains high, it indicates a grounded field in the generator. If it drops off, it indicates a grounded field circuit in the voltage control unit.

(3) It must be remembered that even after the step-voltage control has operated and inserted its resistance into the generator field circuit, it may still be possible for the generator to overcharge the battery. Under these conditions, it is desirable to reduce the generator output.

(4) With a low battery and a low or no charging rate, momentarily ground the voltage control "F" terminal. This should normally cause the output to increase. If it does not, the generator will probably require repair, since it is apparently incapable of producing specified output. If the output does come up, check the voltage control, since it is apparently not grounding the generator field circuit in a normal manner to permit increased output as the battery drops to a low state of charge. This may be caused by the voltage control points not making contact, due to oxidation or improper adjustment. Loose connections, defective wiring, or other causes of excessive resistance in the charging circuit will cause the voltage control to operate and reduce the generator output even though the battery is still in a low state of charge.

**f. Removal.**

- |                           |                         |
|---------------------------|-------------------------|
| SCREWDRIVER               | WRENCH, socket, 5/8-in. |
| WRENCH, open-end, 1/2-in. | WRENCH, socket, 3/4-in. |
| WRENCH, open-end, 3/4-in. |                         |

**(1) REMOVE FRONT FENDER.**

- |                           |                         |
|---------------------------|-------------------------|
| WRENCH, open-end, 3/4-in. | WRENCH, socket, 3/4-in. |
|---------------------------|-------------------------|

Remove 3 bolts and 2 cap screws which secure and remove fender.

\* Corrections not within scope of operating organization. See next higher authority.

**ELECTRICAL SYSTEM AND EQUIPMENT**

**(2) REMOVE WIRES.**

**SCREWDRIVER**

Remove screw to disconnect wire from generator voltage control unit to ammeter.

**(3) REMOVE ADJUSTING SCREW.**

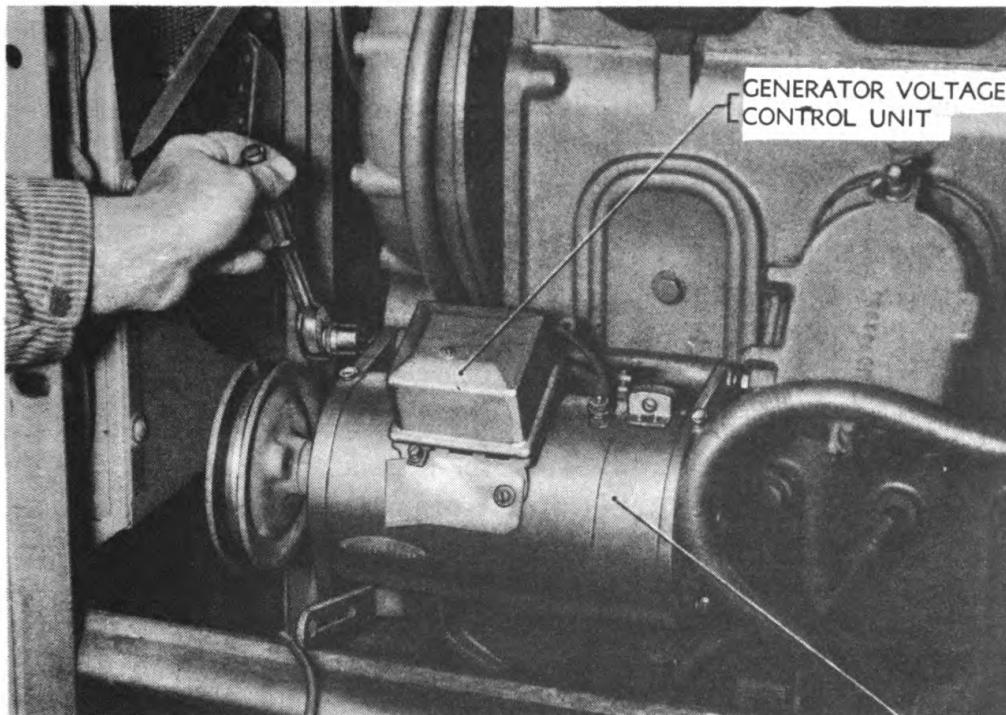
**WRENCH**, open-end, 1/2-in.

Remove cap screw in adjusting link.

**(4) REMOVE GENERATOR.**

**WRENCH**, socket, 5/8-in.

Remove the 2 cap screws holding generator to generator bracket and lift generator out of belt (figs. 96 and 97). Generator and voltage control unit can be taken out as one unit.



**GENERATOR**

RA PD 56469

**Figure 101—Removing Cap Screws Holding Generator**

**g. Installation.**

**SCREWDRIVER**

**WRENCH**, open-end, 1/2-in.

**WRENCH**, open-end, 3/4-in.

**WRENCH**, socket, 5/8-in., with extension

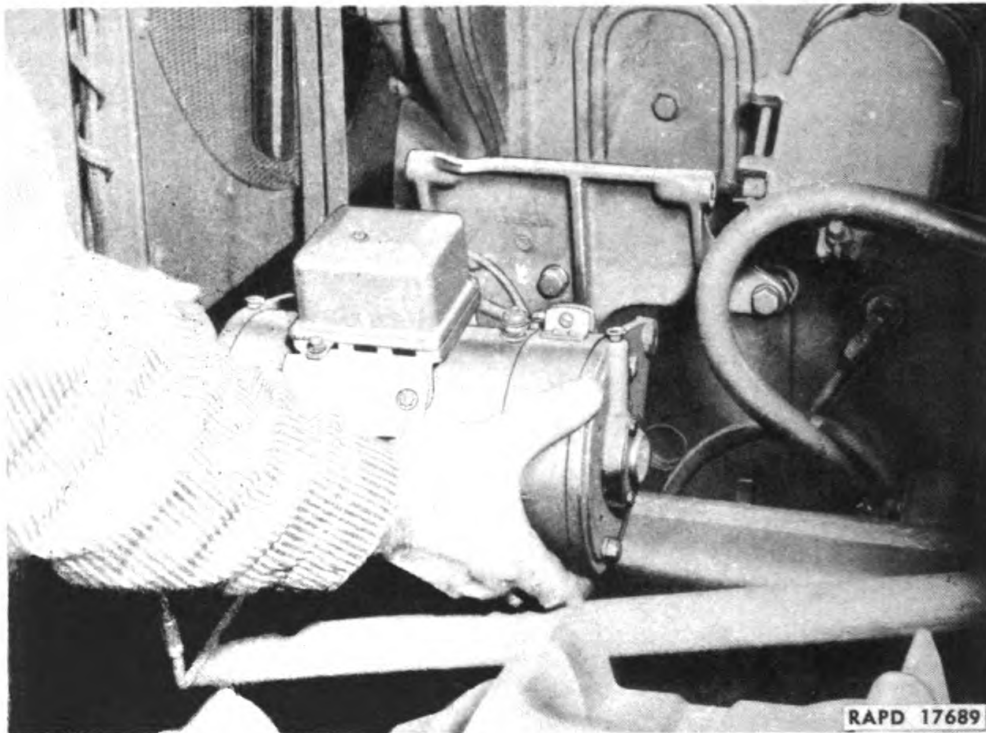
**WRENCH**, socket, 3/4-in.

**(1) INSTALL GENERATOR ON BRACKET.**

**WRENCH**, socket, 5/8-in., with extension



## MEDIUM TRACTOR M1



**Figure 102—Removing Generator**

Hold generator in place and install cap screws in generator bracket (fig. 101).

**(2) CONNECT WIRE.**

**SCREWDRIVER**

Connect wire from ammeter to generator voltage control unit.

**(3) INSTALL AND ADJUST BELT IN PULLEY.**

**WRENCH, open-end, 1/2-in.**

Swing generator up and place drive belt in generator pulley. Install cap screw through washer and adjusting link into generator. Adjust belt to have from 3/4- to 1-inch slack measured halfway between pulleys. After the generator or control unit is reinstalled on the engine, or at any time after leads have been disconnected and then reconnected, a jumper lead should be connected momentarily between the battery and generator terminals of the voltage control unit *before starting the engine*. This allows a momentary surge of current from the battery to the generator which correctly polarizes the generator with respect to the battery it is to charge.

**(4) INSTALL FENDER.**

**WRENCH, open-end, 3/4-in.**

**WRENCH, socket, 3/4-in.**

Install fender and secure with the 3 bolts and 2 cap screws.

## ELECTRICAL SYSTEM AND EQUIPMENT

### h. Generator Belt Removal.

BAR, small pry

WRENCH, open-end, 3/4-in.

WRENCH, fan

WRENCH, socket, 3/4-in.

WRENCH, open-end, 1/2-in.

#### (1) REMOVE FRONT FENDER.

WRENCH, open-end, 3/4-in.

WRENCH, socket, 3/4-in.

Remove 3 bolts and 2 cap screws which secure fender and lift it off.

#### (2) LOOSEN GENERATOR BELT.

WRENCH, open-end, 1/2-in.

Loosen belt by loosening adjusting cap screw in adjusting link and force generator to hinge down.

#### (3) REMOVE FAN BELTS.

WRENCH, fan

WRENCH, open-end, 3/4-in.

Remove fan belts as outlined in paragraph 76 f. Generator belt may now be removed from pulleys.

### i. Generator Belt Installation.

BAR, small pry

WRENCH, open-end, 3/4-in.

WRENCH, fan

WRENCH, socket, 3/4-in.

WRENCH, open-end, 1/2-in.

(1) **INSTALL BELTS.** Place generator belt in inside groove of engine crankshaft pulley and on generator drive pulley.

#### (2) ADJUST GENERATOR BELT.

BAR, small pry

WRENCH, open-end, 1/2-in.

Tighten belt by prying up on generator. Adjust belt to have from 3/4- to 1-inch slack measured halfway between pulleys. Tighten adjusting cap screw.

#### (3) INSTALL FAN BELTS.

WRENCH, fan

WRENCH, open-end, 3/4-in.

Install and adjust fan belts as outlined in paragraph 76 g.

#### (4) INSTALL FENDER.

WRENCH, open-end, 3/4-in.

WRENCH, socket, 3/4-in.

Install fender and secure with 3 bolts and 2 cap screws.

## 84. GENERATOR VOLTAGE CONTROL UNIT.

**a. Description.** This assembly, mounted on the generator, consists of a voltage regulating mechanism and a cut-out relay, both mounted on the same metal base and under the same cover. This unit operates to decrease the maximum generator output when the battery approaches full charge. No adjustments of the generator voltage control unit should be attempted by the operating organization beyond those outlined in paragraph 83.

**MEDIUM TRACTOR M1**

**b. Removal.**

**SCREWDRIVER**

**(1) DISCONNECT WIRES.**

**SCREWDRIVER**

Remove the screws holding the 3 wires to the control unit terminals.

**(2) REMOVE CONTROL UNIT.**

**SCREWDRIVER**

Remove 4 screws holding regulator to generator, and lift off voltage control unit.

**c. Installation.**

**SCREWDRIVER**

**(1) INSTALL VOLTAGE CONTROL UNIT.**

**WRENCH, open-end,  $\frac{7}{16}$ -in.**

Set control unit in place on generator and install the 4 holding screws.

**(2) CONNECT WIRES.**

**SCREWDRIVER**

Connect the 3 wires to the control unit terminals with the 3 screws.

**85. STARTING MOTOR.**

**a. Description.** This is a Delco-Remy model 1108714, heavy duty, 12-volt unit, with a Dyer drive operated by a shift lever on the motor.

**b. Lubrication.** The hinge cap oilers should be supplied with a few drops of light engine oil after every 200 hours of operation.

**c. Trouble Shooting.**

**(1) SLOW STARTING MOTOR SPEED.**

<b>Probable Cause</b>	<b>Probable Remedy</b>
Loose connections.	Tighten connections.
Dirty connections.	Clean connections.
Worn brushes.	*Replace brushes.
Dirty armature.	Clean armature.
Armature rubbing field coils.	*Replace bearings.
Low battery voltage.	Check generator and voltage control unit.

**(2) INOPERATIVE STARTING MOTOR.**

Battery down.	*Charge battery.
Poor connections.	Clean and tighten connections.
Burned commutator bars.	*Recut commutator.
Open or short circuits in field or armature.	Replace unit.
Defective starter switch.	Inspect contacts.

\* Corrections not within scope of operating organization. See next higher authority.

**ELECTRICAL SYSTEM AND EQUIPMENT**

**d. Maintenance.** If the starting motor does not develop rated torque, and cranks the engine slowly or not at all, check the battery, battery terminals and connections, and battery cables. Corroded, frayed, or broken cables should be replaced, and loose or dirty connections corrected. The starting motor switch should be checked for burned contacts and the switch contacts cleaned or replaced if necessary. Starting motor failure or faulty operation, if caused by other than loose and corroded terminals or minor adjustments, will not be corrected by the using arm personnel.

**e. Removal.****PLIERS**WRENCH, open-end,  $\frac{3}{4}$ -in.WRENCH, open-end,  $1\frac{5}{16}$ -in.WRENCH, socket,  $\frac{3}{4}$ -in.WRENCH, socket,  $\frac{7}{8}$ -in., with long extension**(1) REMOVE FRONT FENDER.**WRENCH, open-end,  $\frac{3}{4}$ -in.WRENCH, socket,  $\frac{3}{4}$ -in.

Remove 3 bolts and 2 cap screws which secure fender and remove fender.

**(2) DISCONNECT BATTERY CABLE.**WRENCH, socket,  $\frac{3}{4}$ -in.

Disconnect battery cable from starting motor. Tape the end of cable to prevent it from touching metal and causing a short circuit. Remove other wires on same post.

**(3) DISCONNECT STARTING MOTOR ROD.****PLIERS**

Remove cotter pin and slide starting motor rod from pin on starting motor lever.

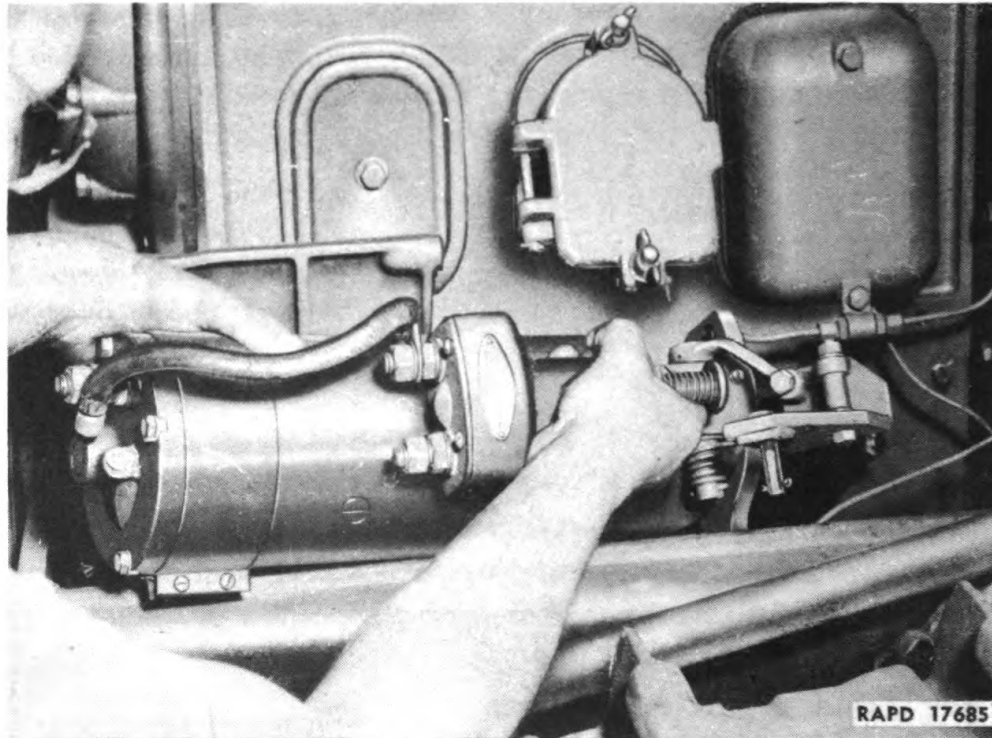
**(4) REMOVE STARTING MOTOR.**WRENCH, open-end,  $1\frac{5}{16}$ -in.WRENCH, socket,  $\frac{7}{8}$ -in., with long extension

Remove the 2 cap screws and bolt holding starting motor to flywheel housing. Jar the starting motor loose and lift it from tractor (fig. 103).

**f. Installation.****PLIERS**WRENCH, open-end,  $\frac{3}{4}$ -in.WRENCH, open-end,  $\frac{9}{16}$ -in.WRENCH, open-end,  $1\frac{5}{16}$ -in.WRENCH, socket,  $\frac{7}{8}$ -in., with long extension**(1) INSTALL STARTING MOTOR.**WRENCH, open-end,  $1\frac{5}{16}$ -in.WRENCH, socket,  $\frac{7}{8}$ -in., with long extension

Clean off mounting flange of starting motor and flywheel housing, set starting motor in housing and secure with cap screws and bolt.

MEDIUM TRACTOR M1



**Figure 103—Removing Starting Motor**

**(2) CONNECT STARTING MOTOR ROD.**

**PLIERS**

**WRENCH, open-end,  $\frac{9}{16}$ -in.**

Connect starting motor rod on shift lever with pin. Adjust cap screw on shift lever as follows. Screw the adjusting cap screw in toward the lever so that the switch contacts do not touch when the lever is pushed all the way forward. Place the shifter lever in full forward position (the starting motor pinion will be against the stop). Back the cap screw out so that the switch contacts close. Pull the starting motor shift lever back and turn the adjusting screw out an additional two turns. Lock the nut.

**(3) CONNECT BATTERY CABLE.**

**WRENCH, socket,  $\frac{3}{4}$ -in.**

Connect battery cable and ammeter wire to starting motor switch post. Put on washer and nut and tighten.

**(4) INSTALL FENDER.**

**WRENCH, open-end,  $\frac{3}{4}$ -in.**

**WRENCH, socket,  $\frac{3}{4}$ -in.**

Place fender in position and secure with bolts, cap screws, and lock washer.

**86. AMMETER.**

**a. Description.** The ammeter needle registers on the dial the amount of current being delivered to the battery when the engine and generator

## ELECTRICAL SYSTEM AND EQUIPMENT

are running, or discharged from the battery when the engine is not running. If generator operation is normal, the needle swings towards the plus (+) side of the scale. When engine is not running, current used by electrical equipment discharges the battery and the needle swings towards the minus (—) side of the scale.

**b. Maintenance.** When the ammeter registers too high a charging rate (over 8 amperes charge on plus side of scale) with the engine running at normal speed, generator and voltage control unit should be checked and adjusted (see par. 85 d). If it registers zero with the engine running at normal and no electrical equipment turned on, it indicates one of the following:

- (1) Batteries are fully charged; no correction necessary.
- (2) Generator is not working; generator burned out or inoperative.
- (3) Voltage control is inoperative; check for causes (par. 83).
- (4) A wire may be loose or broken; inspect wiring.
- (5) Ammeter may be faulty; replace ammeter.

**c. Removal.**

SCREWDRIVER, Phillips  
head

WRENCH, open-end,  $\frac{3}{8}$ -in.

(1) REMOVE AMMETER FROM DASH PANEL.

SCREWDRIVER, Phillips head

Remove the 3 Phillips head screws holding ammeter in panel and remove ammeter from panel.

(2) REMOVE WIRES.

WRENCH, open-end,  $\frac{3}{8}$ -in.

Remove the 5 wires from 2 terminals on back of ammeter by removing the nuts and washers from terminals. Tag the wires so they may be reinstalled on the correct terminals of the new ammeter.

**d. Installation.**

SCREWDRIVER, Phillips  
head

WRENCH, open-end,  $\frac{3}{8}$ -in.

(1) CONNECT WIRES.

WRENCH, open-end,  $\frac{3}{8}$ -in.

Connect wires to new ammeter, placing the 2 wires on left-hand terminal and 3 wires on right-hand terminal. Tighten nuts.

(2) INSTALL AMMETER.

SCREWDRIVER, Phillips head

Set ammeter in panel and install the three Phillips head screws.

(3) TEST AMMETER. Start engine and see that all electrical equipment operates properly.

## MEDIUM TRACTOR M1

## 87. HOUR METER.

a. **Description.** The engine hour meter is located on the dash to the right of the instrument panel and registers the total number of hours that the engine has operated. A pressure switch connected to the oil pressure gage is operated by pressure of the oil to the gage when engine is started. One wire from the pressure switch is connected to the hour meter and the other to the ammeter. A ground wire from the hour meter is connected to the temperature gage. Paragraph 23 gives instructions on how to read the hour meter.

b. **Maintenance.** If the hour meter becomes inoperative, it may be due to either a faulty pressure switch or to the meter itself. Check for broken wires and loose connections before replacing either. Do not attempt any repair of either the switch or hour meter. Check the pressure switch first by removing the 2 wires from the terminals of the switch and connecting the two ends. If the hour meter begins to operate immediately, the pressure switch should be replaced. If it does not, the hour meter should be replaced.

c. **Removal.**

PLIERS

WRENCH, open-end,  $\frac{9}{16}$ -in.SCREWDRIVER, Phillips  
head(1) **REMOVE PANEL FROM DASH.**

SCREWDRIVER, Phillips head

Remove the 4 Phillips head screws holding panel to dash and pull panel out of dash carefully (fig. 104).

(2) **DISCONNECT WIRES.**

SCREWDRIVER

Disconnect the wire leading from the hour meter to the temperature gage. Remove the wire seal and cover from the pressure switch and disconnect the wire leading from the pressure switch to the hour meter.

(3) **REMOVE HOUR METER.**

SCREWDRIVER, Phillips head

Remove the 3 Phillips head screws holding hour meter to dash and remove hour meter.

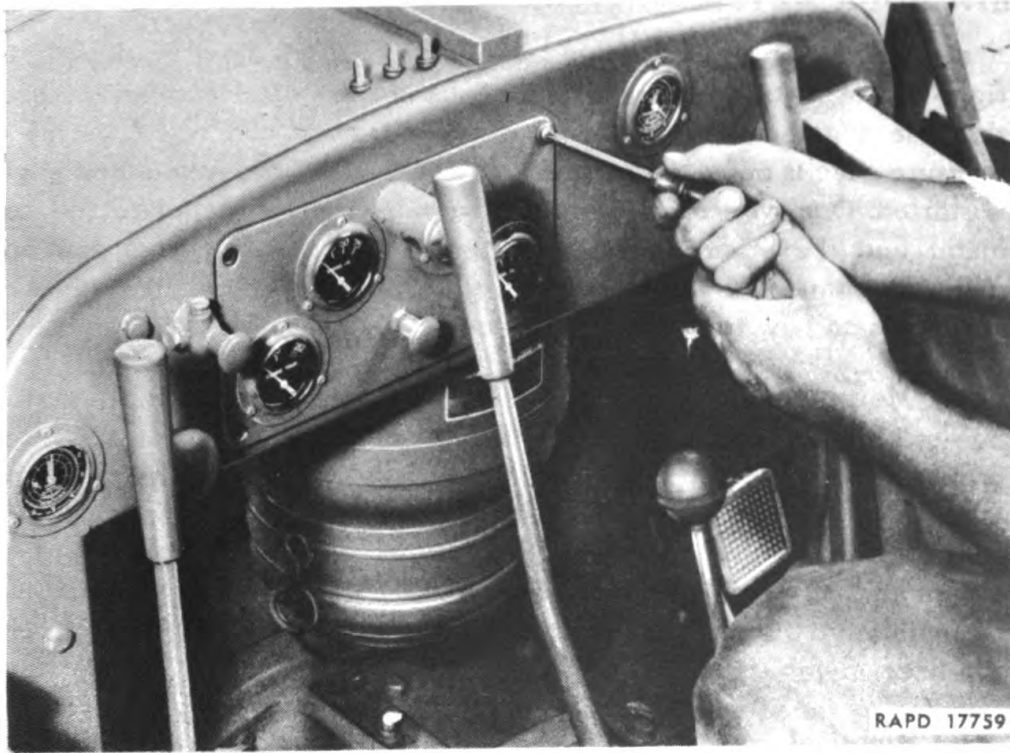
(4) **REMOVE PRESSURE SWITCH.**

PLIERS

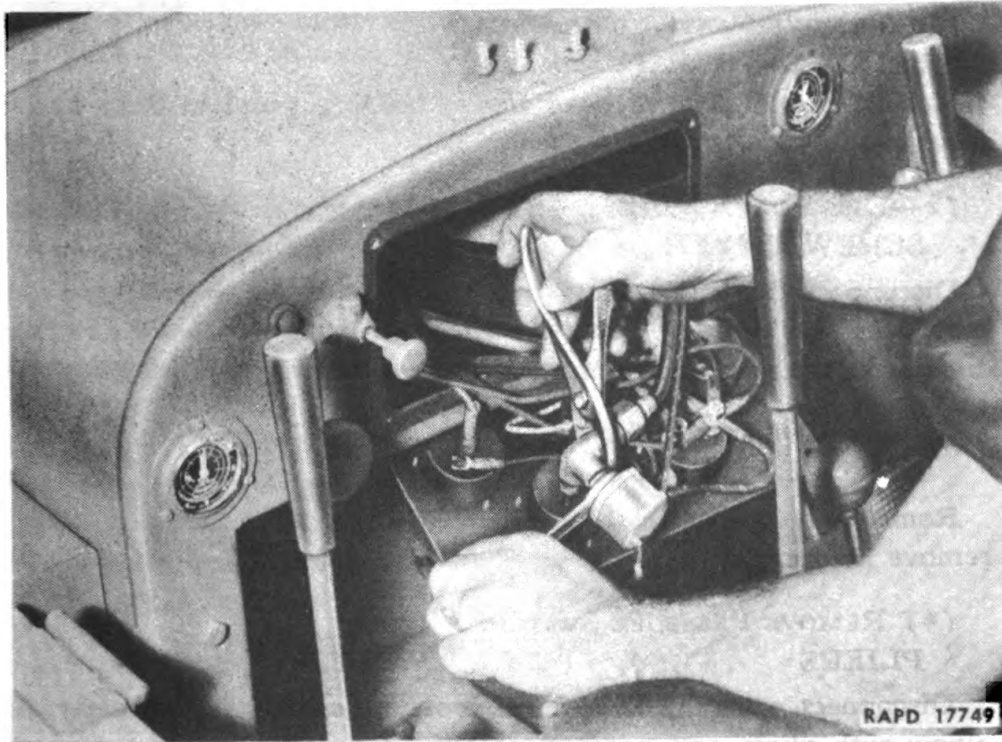
WRENCH, open-end,  $\frac{9}{16}$ -in.

Disconnect wire leading from pressure switch to ammeter. Hold elbow with pliers, and unscrew pressure switch from side outlet elbow (fig. 105).

**ELECTRICAL SYSTEM AND EQUIPMENT**



**Figure 104—Removing Screws from Instrument Panel**



**Figure 105—Removing Hour Meter Pressure Switch**



**MEDIUM TRACTOR M1**

**d. Installation.**

**PERMATEX or WHITE  
LEAD  
PLIERS**

**SCREWDRIVER, Phillips  
head  
WRENCH, open-end,  $\frac{9}{16}$ -in.**

- (1) INSTALL PRESSURE SWITCH.  
WRENCH, open-end,  $\frac{9}{16}$ -in.**

Coat threads of pressure switch with permatex or white lead and screw into side outlet elbow tightly.

- (2) INSTALL HOUR METER.  
SCREWDRIVER, Phillips head**

Place hour meter in hole in dash and secure with the 3 Phillips head screws.

- (3) CONNECT WIRES.  
SCREWDRIVER**

Connect short wire on hour meter to one terminal of pressure switch. Connect long wire to temperature gage. Connect the wire from the ammeter to the other terminal of pressure switch. Install cover on switch and install seal wire.

- (4) INSTALL INSTRUMENT PANEL.  
SCREWDRIVER, Phillips head**

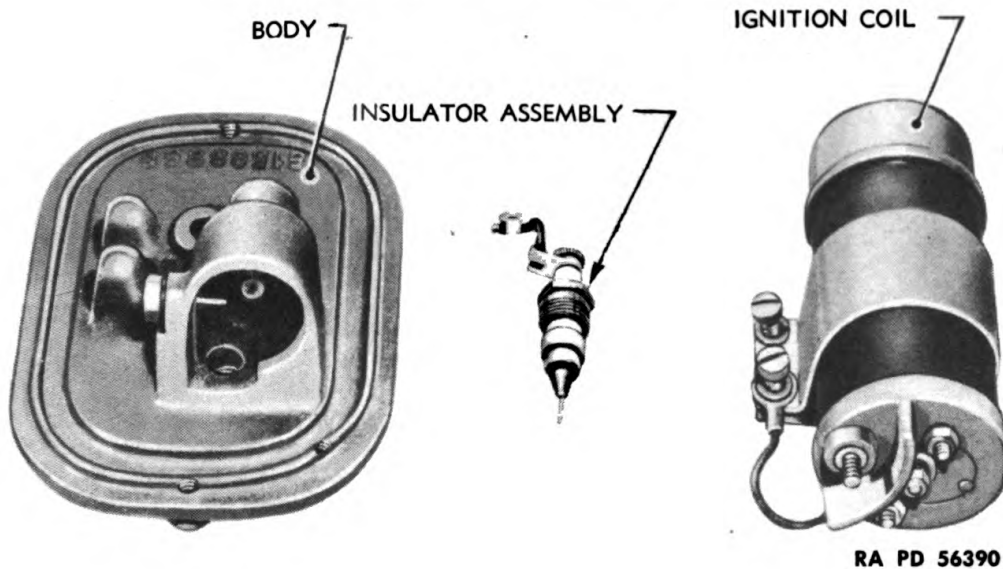
Place panel back in dash and secure with the 4 Phillips head screws.

- (5) TEST FOR OPERATION.** Start engine and watch small hand at top left of dial of hour meter. As soon as oil pressure rises to 5 pounds, this hand should start to rotate.

**88. AIR HEATER.**

**a. Description** (fig. 106). The air heater is essentially a small, pressure oil burner with electric ignition. The burner proper is mounted in the engine air box and obtains the necessary air for combustion from the blower. The flame heated air is discharged directly into the engine cylinders. The air heater consists of 2 assemblies; one unit comprises the pressure pump mounted on the dash, and the other unit consists of a burner nozzle, filter, ignition coil, and ignition points. It is designed to replace one of the hand hole cover plates nearest the center of the engine. The hand pump on the dash supplies fuel under pressure to the burner unit where it is ignited as it is sprayed through the nozzle. A button switch on dash is used when air heater is to be operated. For operation of the air heater, refer to paragraph 11.

**b. Maintenance.** The vibrator in the air heater should buzz when the button switch is depressed. If no buzz can be heard, it is an indication that no current is being supplied to the coil or the vibrator points

**ELECTRICAL SYSTEM AND EQUIPMENT****Figure 106—Air Heater Parts**

are stuck or burned. A unit that fails to arc at the electrodes may often be made to operate by cleaning and drying the electrodes.

**c. Removal of Air Heater Burner Unit.**

WRENCH, open-end,  $\frac{3}{8}$ -in.

WRENCH, open-end,  $\frac{7}{16}$ -in.

WRENCH, socket,  $\frac{1}{2}$ -in.

**(1) DISCONNECT FUEL LINE.**

WRENCH, open-end,  $\frac{7}{16}$ -in.

Disconnect fuel line at rear of check valve.

**(2) REMOVE COVER.**

WRENCH, socket,  $\frac{1}{2}$ -in.

Remove the 2 cap screws holding cover to unit and remove cover.

**(3) DISCONNECT WIRE FROM COIL.**

WRENCH, open-end,  $\frac{3}{8}$ -in.

Disconnect the wire leading from air heater switch to coil.

**(4) REMOVE AIR HEATER BODY.**

WRENCH, socket,  $\frac{9}{16}$ -in., with extension

Remove the special cap screw holding burner unit and remove air heater body (fig. 107).

**d. Installation of Air Heater Burner Unit.**

WRENCH, open-end,  $\frac{3}{8}$ -in.

WRENCH, open-end,  $\frac{7}{16}$ -in.

WRENCH, socket  $\frac{1}{2}$ -in.

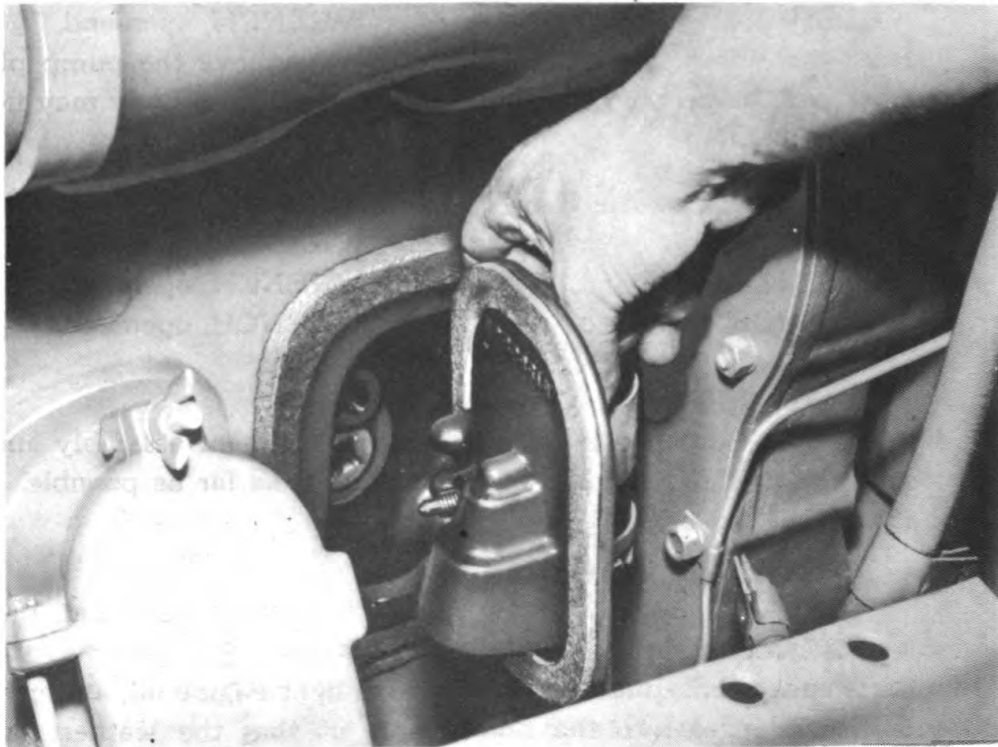
WRENCH, socket,  $\frac{9}{16}$ -in., with extension

**(1) INSTALL UNIT.**

WRENCH, socket,  $\frac{9}{16}$ -in., with extension

Clean off all old gaskets and use new ones. Install unit in place with the special cap screw.

MEDIUM TRACTOR M1



RA PD 17743

**Figure 107—Removing Air Heater Burner Unit**

(2) **CONNECT WIRE TO COIL.**

**WRENCH**, open-end,  $\frac{3}{8}$ -in.

Connect wire from coil to air heater switch.

(3) **INSTALL COVER.**

**WRENCH**, socket,  $\frac{1}{2}$ -in.

Use a new felt gasket, if necessary, and bolt cover in place with the 2 cap screws. Install lower cap screw through clip holding fuel line check valve.

(4) **CONNECT FUEL LINE.**

**WRENCH**, open-end,  $\frac{7}{16}$ -in.

Connect the fuel line to rear of check valve.

**e. Removal of Air Heater Pump Assembly (fig. 11).**

**PLIERS**

**WRENCH**, open-end,  $\frac{7}{16}$ -in.

**WRENCH**, open-end,  $\frac{9}{16}$ -in.

**WRENCH**, open-end,  $\frac{5}{8}$ -in.

**WRENCH**, open-end,  $\frac{7}{8}$ -in.

**WRENCH**, open-end,  $1\frac{5}{16}$ -in.

(1) **CLOSE FUEL SHUT-OFF VALVE AT TANK.**

(2) **DISCONNECT FUEL LINES.**

**WRENCH**, open-end,  $\frac{7}{16}$ -in.

**WRENCH**, open-end,  $\frac{9}{16}$ -in.

**WRENCH**, open-end,  $\frac{5}{8}$ -in.

**WRENCH**, open-end,  $\frac{7}{8}$ -in.

Disconnect both intake and discharge lines from pump.

**ELECTRICAL SYSTEM AND EQUIPMENT****(3) REMOVE PUMP PLUNGER AND PUMP BODY.****PLIERS****WRENCH**, open-end,  $\frac{7}{8}$ -in.

Hold the pump to keep it from turning, remove the pump plunger nut and pull pump plunger from pump body. Pump body may now be pushed out of dash.

**f. Installation of Air Heater Pump Assembly.****PLIERS****WRENCH**, open-end,  $\frac{5}{8}$ -in.**WRENCH**, open-end,  $\frac{7}{16}$ -in.**WRENCH**, open-end,  $\frac{7}{8}$ -in.**WRENCH**, open-end,  $\frac{9}{16}$ -in.**WRENCH**, open-end,  $1\frac{5}{16}$ -in.**(1) INSTALL PUMP BODY.****WRENCH**, open-end,  $\frac{7}{8}$ -in.

Remove the pump plunger nut from replacement assembly and pull plunger out. Screw jam nut back on threads as far as possible. Place the threaded end through dash from inside.

**(2) INSTALL PLUNGER.****PLIERS****WRENCH**, open-end,  $1\frac{5}{16}$ -in.**WRENCH**, open-end,  $\frac{7}{8}$ -in.

Soften the pump plunger leathers with light engine oil, and carefully enter the plunger into the pump body so that the leathers are not damaged. Tighten the pump plunger nut; then tighten jam nut against inside of dash.

**(3) CONNECT FUEL LINES.****WRENCH**, open-end,  $\frac{7}{16}$ -in.**WRENCH**, open-end,  $\frac{5}{8}$ -in.**WRENCH**, open-end,  $\frac{9}{16}$ -in.**WRENCH**, open-end,  $\frac{7}{8}$ -in.

Connect intake and discharge fuel lines; open the fuel shut-off valve and operate the pump a few times to make sure it operates properly and does not leak.

**g. Removal of Air Heater Switch (fig. 11).****PLIERS****SCREWDRIVER****(1) REMOVE SWITCH FROM DASH.****PLIERS**

Hold the switch body to keep it from turning; remove the round knurled lock nut that is tight against dash, and remove switch from dash.

**(2) REMOVE WIRES.****SCREWDRIVER**

Disconnect the wires from the switch by removing the 2 screws holding them.

**h. Installation of Air Heater Switch.****PLIERS****WRENCH**, open-end,  $\frac{3}{4}$ -in.**SCREWDRIVER**

**MEDIUM TRACTOR M1****(1) INSTALL WIRES ON SWITCH.****SCREWDRIVER**

Connect the 2 wires to the switch with the 2 screws

**(2) INSTALL SWITCH.****PLIERS****WRENCH, open-end, 3/4-in.**

Insert the threaded end of switch through hole in dash with button towards operator, and tighten in place with the knurled nut. Tighten jam nut.

**89. LIGHT SWITCH.**

**a. Description.** The light switch is of the push-pull type with a spring stop to control its three positions. It may be pulled out to the first position (blackout lights) without depressing the latch button. For the other two positions (service lights and service stop light), the latch button must be depressed to pull switch out.

**b. Removal.****PLIERS****WRENCH, open-end 1/2-in.****SCREWDRIVER****WRENCH, open-end, 3/4-in.****SCREWDRIVER, 1/8-in.****(1) REMOVE SWITCH KNOB.****PLIERS****SCREWDRIVER, 1/8-in.**

Loosen set screw in knob and unscrew knob from shaft.

**(2) REMOVE BLACKOUT CONTROL ASSEMBLY.****WRENCH, open-end, 1/2-in.**

Remove lock screw from side of blackout control assembly, depress button and pull control assembly from dash.

**(3) REMOVE SWITCH.****WRENCH, open-end, 3/4-in.**

Remove switch mounting nut and pull light switch assembly from dash.

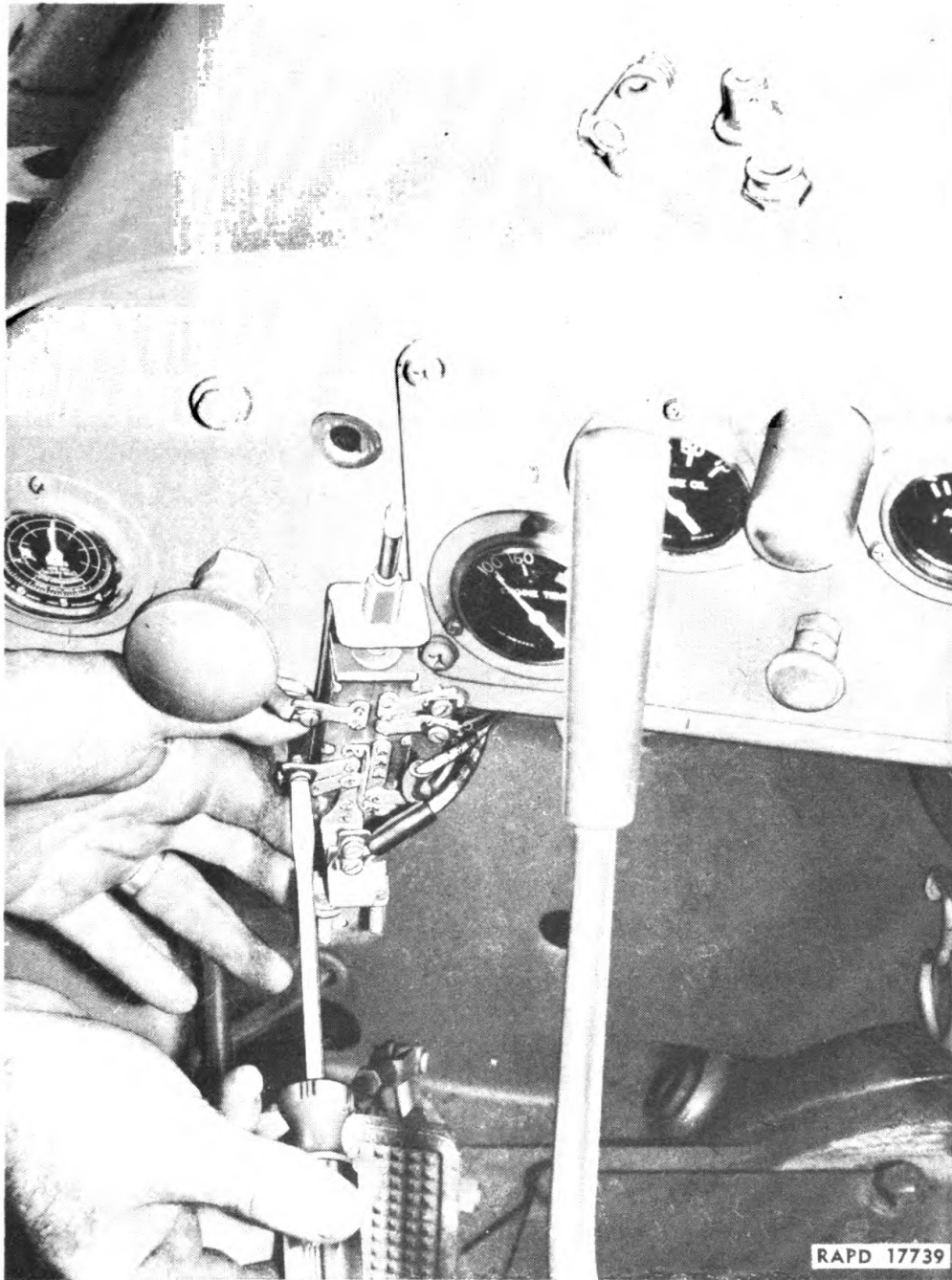
**(4) REMOVE WIRES.****SCREWDRIVER**

Remove wires by removing the screws from terminals on switch (fig. 108). Tag wires for identification.

**c. Installation.****PLIERS****WRENCH, open-end, 1/2-in.****SCREWDRIVER****WRENCH, open-end, 3/4-in.****SCREWDRIVER, 1/8-in.****(1) CONNECT WIRES TO SWITCH.****SCREWDRIVER**

Place wires on terminals according to tags on wires or refer to wiring agram (fig. 114).

**ELECTRICAL SYSTEM AND EQUIPMENT**



**Figure 108—Removing Light Switch**

**(2) INSTALL SWITCH IN DASH.**

**WRENCH**, open-end,  $\frac{3}{4}$ -in.

**Insert shaft of switch through dash with shaft towards operator. Install mounting nut and lock washer and tighten.**

**Notches on shaft should be to the left.**

**MEDIUM TRACTOR M1**

**(3) INSTALL BLACKOUT CONTROL ASSEMBLY.**

**WRENCH**, open-end, 1/2-in.

Slip blackout control assembly on shaft, holding latch button down. (Latch button should point up.) Hold assembly against dash, place lock washer on lock screw, install and tighten.

**(4) INSTALL LOCK SCREW KNOB.**

**PLIERS**

**SCREWDRIVER**, 1/8-in.

Screw knob tight on shaft and tighten set screw.

**90. PANEL LIGHT.**

**a. General.** The panel light is similar to those ordinarily used on cars and trucks. It is mounted on the instrument panel in the dash and is controlled by a separate push-pull type switch. The panel light contains a No. 63 3C 6-8V bulb which throws sufficient light on the operating instruments to make them easily read during night operation. The main light switch must be pulled out before panel light will turn on.

**b. Removal of Panel Light.**

**SCREWDRIVER**

**(1) REMOVE SHIELD.**

**SCREWDRIVER**

Remove the 2 screws holding shield to bracket and pull off shield. Glass inside of shield will come off with shield.

**(2) REMOVE LAMP.** Push in slightly on lamp and turn it to the left. Lamp can now be pulled out of socket.

**c. Installation of Panel Light.**

**SCREWDRIVER**

**(1) INSTALL LAMP.** Insert lamp in socket with lamp turned so that the 2 points on lamp coincide with the 2 slots in socket. Push bulb in far enough so that the 2 points may be turned to the right into locking notches.

**(2) INSTALL SHIELD.**

**SCREWDRIVER**

Be sure rubber ring is in place. Push shield on around bracket and install the 2 holding screws.

**91. SERVICE LIGHTS.**

**a. Description.** The lighting system is 12-volt throughout with the exception of the panel light. Headlights are mounted one on each side of radiator and are protected with guards. Small blackout lamps are mounted to top of headlight guards. Rear lights are combined stop and taillights and blackout lights. Lights are controlled by main light switch (par. 89).

## ELECTRICAL SYSTEM AND EQUIPMENT

### b. Removal of Headlight and Lamp.

SCREWDRIVER

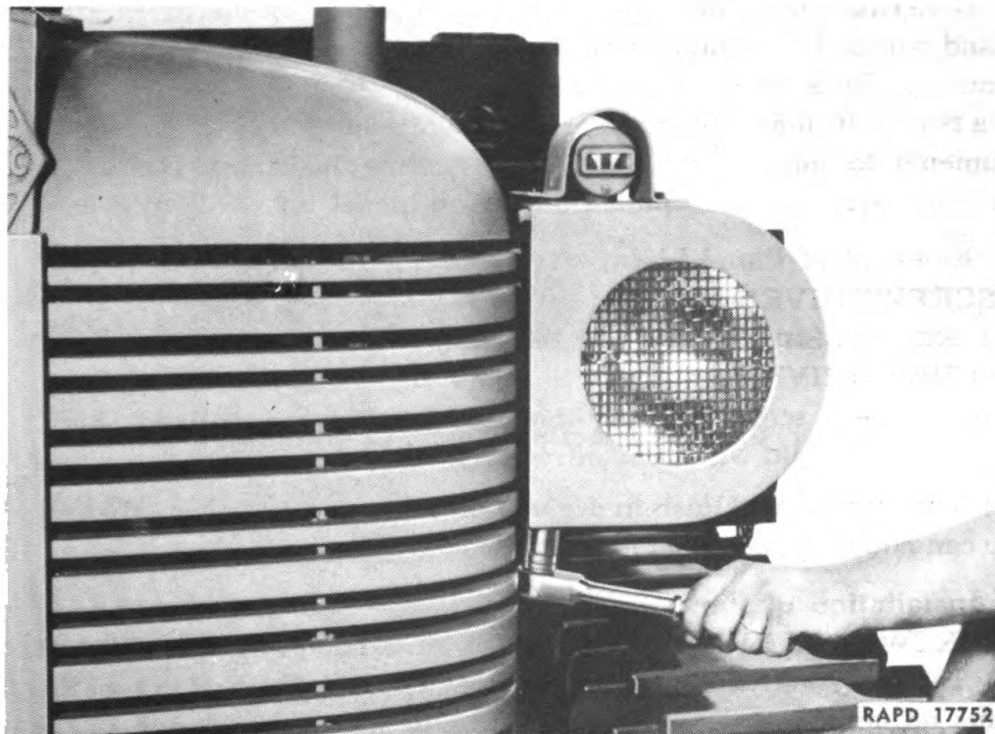
WRENCH, socket,  $\frac{3}{4}$ -in.

WRENCH, socket,  $\frac{9}{16}$ -in.

#### (1) REMOVE GUARD.

WRENCH, socket,  $\frac{3}{4}$ -in.

Remove guard by removing 4 cap screws holding guard to brackets on radiator shell (fig. 109). Blackout lights are fastened to guard. Pull wire to blackout light from socket as guard is removed (fig. 110).



**Figure 109—Removing Headlight Guard**

#### (2) REMOVE HEADLIGHT.

WRENCH, socket,  $\frac{9}{16}$ -in.

Unscrew retaining nut and remove wire from bottom of headlight. Remove 2 cap screws holding light to radiator shell and remove headlight.

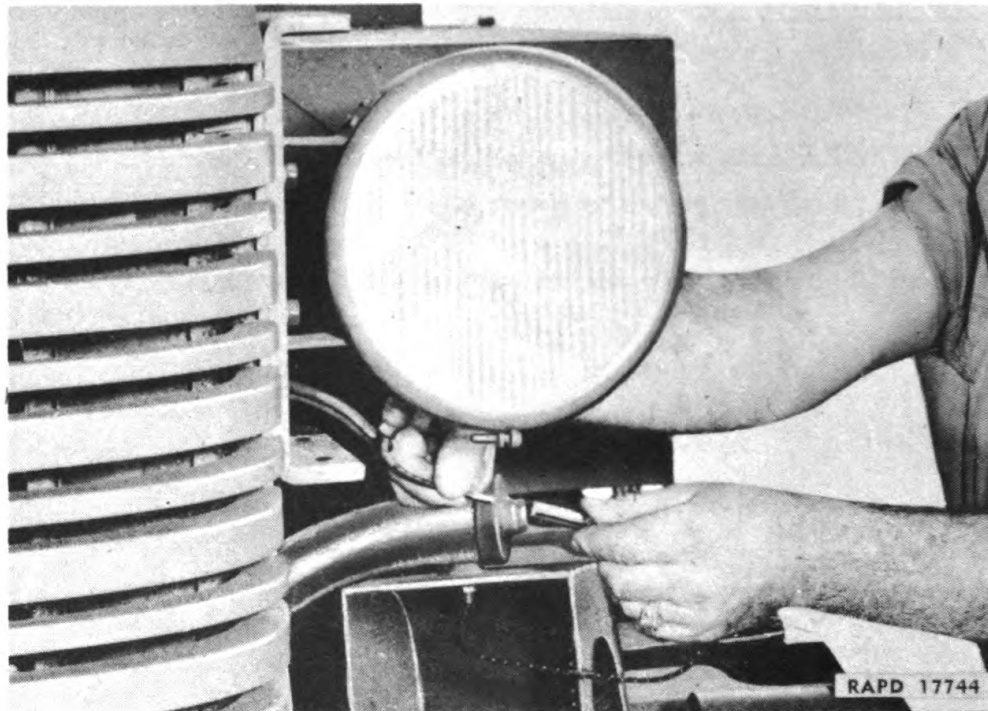
#### (3) REMOVE LAMP.

SCREWDRIVER

Loosen screw in clamp around lens and remove clamp moulding assembly and lens. Push in on lamp, turn lamp to left and pull out lamp. NOTE: Omit second step if only lamp is to be removed.



MEDIUM TRACTOR M1



**Figure 110—Disconnecting Blackout Headlight Wire**

**c. Installation of Headlight and Lamp.**

**SCREWDRIVER**  
**WRENCH, socket,  $\frac{9}{16}$ -in.**

**WRENCH, socket,  $\frac{3}{4}$ -in.**

(1) **INSTALL LAMP.** Insert a 12-volt, 32 candlepower lamp in socket. Push lamp in and turn it to right into locking notches.

(2) **INSTALL LENS.**

**SCREWDRIVER**

With lens in clamp moulding assembly, work clamp onto headlight and tighten screw in clamp.

(3) **INSTALL HEADLIGHT.**

**WRENCH, socket,  $\frac{9}{16}$ -in.**

Hold headlight against radiator shell and install cap screws (fig. 109). Connect headlight wire by inserting plug on end of wires in socket of headlight and screw retaining nut on socket.

(4) **INSTALL GUARD.**

**WRENCH, socket,  $\frac{3}{4}$ -in.**

Hold guard close to headlight and plug blackout light wire into connector (fig. 110). Place guard over headlight and on the brackets on radiator shell and secure with cap screws.

**ELECTRICAL SYSTEM AND EQUIPMENT****d. Removal of Blackout Light and Lamp.****SCREWDRIVER****WRENCH**, socket,  $\frac{9}{16}$ -in.**WRENCH**, open-end,  $\frac{1}{2}$ -in.**WRENCH**, socket,  $\frac{3}{4}$ -in.**WRENCH**, open-end,  $\frac{9}{16}$ -in.**(1) REMOVE HEADLIGHT GUARD.****WRENCH**, socket,  $\frac{3}{4}$ -in.

Remove 4 cap screws holding guard to brackets on radiator shell and remove guard. Pull blackout light wire from connector as guard is removed.

**(2) REMOVE BLACKOUT LIGHT GUARD FROM HEADLIGHT GUARD.****WRENCH**, open-end,  $\frac{9}{16}$ -in.**WRENCH**, socket,  $\frac{9}{16}$ -in.

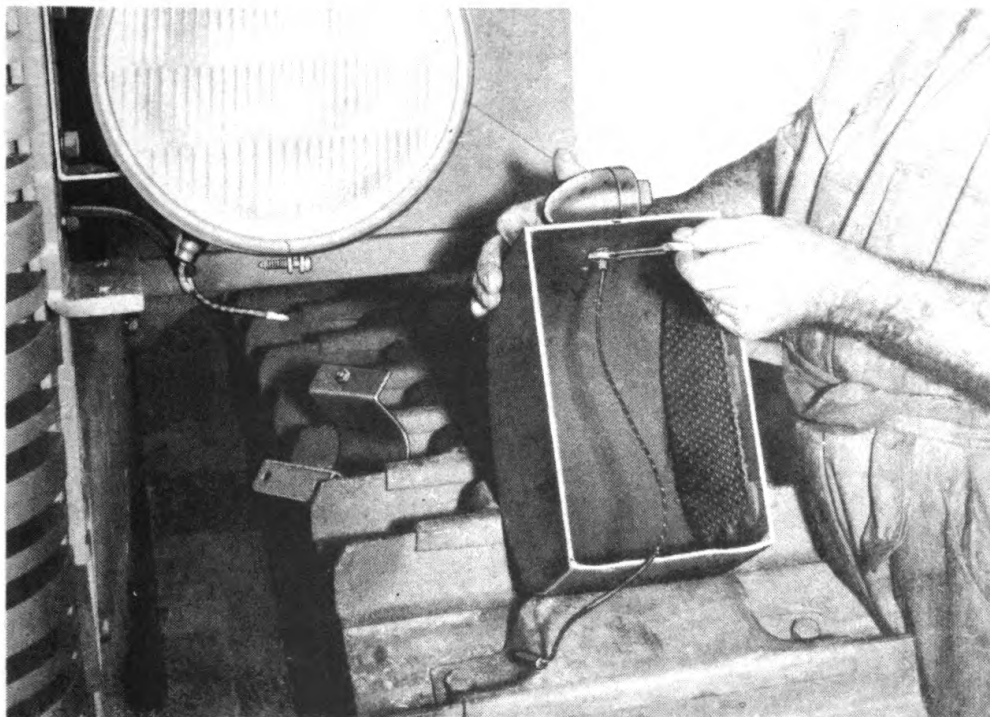
Remove outside bolt which secures blackout light guard to headlight guard and remove blackout light guard.

**(3) REMOVE BLACKOUT LIGHT.****WRENCH**, open-end,  $\frac{1}{2}$ -in.

Remove nut holding blackout light on headlight guard and slip it off over wire (fig. 111). Remove blackout light from guard.

**(4) REMOVE LAMP.****SCREWDRIVER**

Remove screw holding lens. Remove lens, push lamp in and turn



RA PD 17763

**Figure 111—Removing Blackout Headlight**

**MEDIUM TRACTOR M1**

it to left out of locking notches and pull lamp out of socket. **NOTE:** For removal of lamp only, this is the only step necessary.

**e. Installation of Blackout Light and Lamp.**

- |  |  |
|--|--|
| <b>SCREWDRIVER</b>                                     | <b>WRENCH, socket, <math>\frac{9}{16}</math>-in.</b> |
| <b>WRENCH, open-end, <math>\frac{1}{2}</math>-in.</b>  | <b>WRENCH, socket, <math>\frac{3}{4}</math>-in.</b>  |
| <b>WRENCH, open-end, <math>\frac{9}{16}</math>-in.</b> |  |

(1) **INSTALL LAMP.** Insert lamp in socket of light. Push lamp in far enough to engage in locking notches and turn lamp to the right.

(2) **INSTALL LENS.**

**SCREWDRIVER**

Place lens on light and secure with screw.

(3) **INSTALL LIGHT.**

**WRENCH, open-end,  $\frac{1}{2}$ -in.**

Insert wire and threaded part of light assembly through hole in headlight guard, install nut, and tighten (fig. 111).

(4) **INSTALL GUARD.**

**WRENCH, open-end,  $\frac{9}{16}$ -in.      WRENCH, socket,  $\frac{9}{16}$ -in.**

Place blackout light guard on headlight guard and install outside bolt.

(5) **INSTALL ASSEMBLY ON TRACTOR.**

**WRENCH, socket,  $\frac{3}{4}$ -in.**

Insert blackout light wire into connector and bolt headlight assembly to tractor.

**f. Removal of Taillight Assembly.**

- |   |  |
|---|--|
| <b>SCREWDRIVER</b>                                    | <b>WRENCH, open-end, <math>\frac{9}{16}</math>-in.</b> |
| <b>WRENCH, open-end, <math>\frac{1}{2}</math>-in.</b> | <b>WRENCH, socket, <math>\frac{9}{16}</math>-in.</b>   |

(1) **DISCONNECT WIRES.** Slip rubber boots back off connections at rear of lamp, turn the plugs and pull them from their sockets.

(2) **REMOVE TAILLIGHT.**

**WRENCH, open-end,  $\frac{1}{2}$ -in.**

Remove the 2 nuts holding lamp to guard bracket and remove taillight from bracket.

(3) **REMOVE BRACKET.**

**WRENCH, open-end,  $\frac{9}{16}$ -in.      WRENCH, socket,  $\frac{9}{16}$ -in.**

Remove 4 bolts holding taillight guard to rear street plate box and remove guard. **NOTE:** Replacement of taillight assembly only requires first two steps.

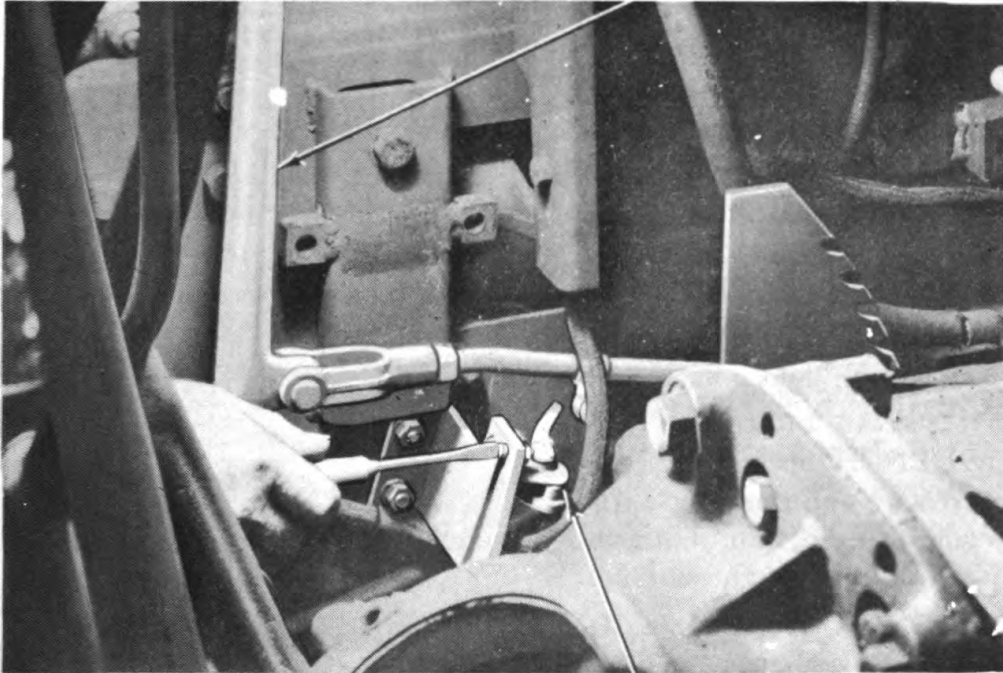
(4) **REMOVE INDIVIDUAL LAMP UNITS.**

**SCREWDRIVER**

Remove 2 screws holding rim of taillight, remove rim and pull lamp units from sockets (fig. 112) **NOTE:** To replace either lamp units it is necessary to perform this step only.

**ELECTRICAL SYSTEM AND EQUIPMENT**

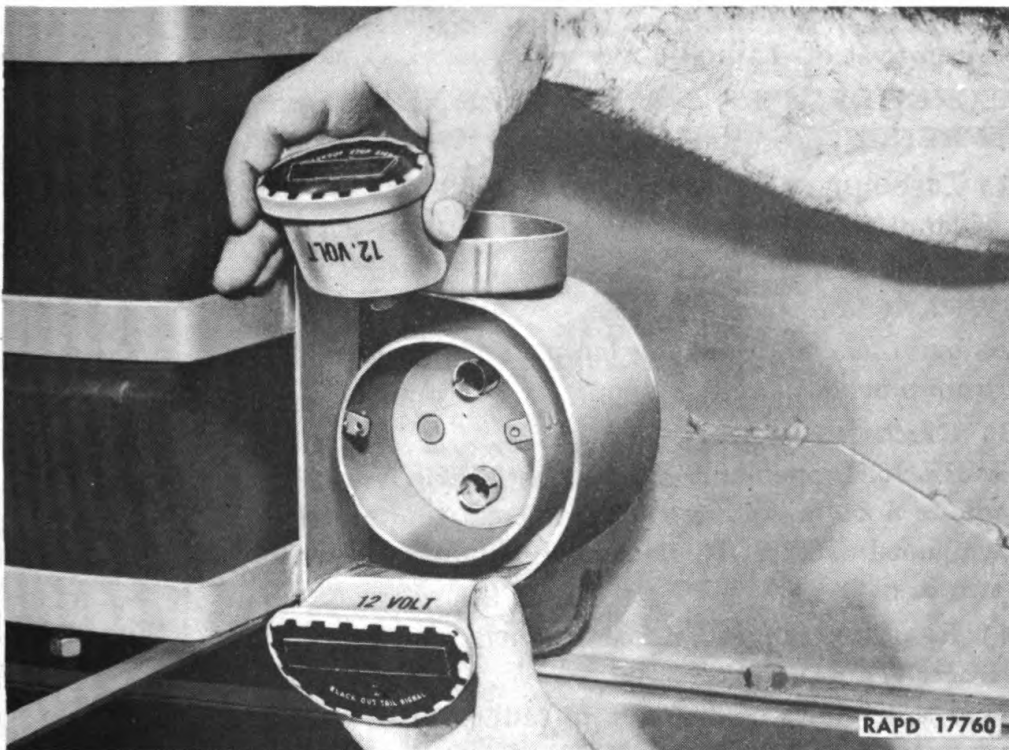
**MASTER CLUTCH LEVER**



**STOP LIGHT SWITCH**

RA PD 41414

**Figure 112—Removing Stop Light Switch**



**Figure 113—Removing Lamp Units from Taillight**

**MEDIUM TRACTOR M1**

**g. Installation of Taillight Assembly.**

**SCREWDRIVER**

**WRENCH**, open-end,  $\frac{9}{16}$ -in.

**WRENCH**, open-end,  $\frac{1}{2}$ -in.

**WRENCH**, socket,  $\frac{9}{16}$ -in.

**(1) INSTALL LAMP UNITS.**

**SCREWDRIVER**

Insert lamp units in their respective sockets, install taillight rim and secure with screws.

**(2) INSTALL TAILLIGHT IN GUARD.**

**WRENCH**, open-end,  $\frac{1}{2}$ -in.

Insert bolts at rear of taillight through holes in guard and install and tighten holding nuts.

**(3) FASTEN ASSEMBLY TO BOX.**

**WRENCH**, open-end,  $\frac{9}{16}$ -in.

**WRENCH**, socket,  $\frac{9}{16}$ -in.

Place assembly in position against end of street plate box, install holding bolts and tighten them.

**(4) CONNECT WIRES.** Insert plugs on ends of wires in sockets. Push them in far enough so that plugs can be turned to engage in locking notches. **NOTE:** The plug with 2 wires should be installed in upper socket of left lamp. Slip rubber boots over connections.

**h. Stop Light Switch** (fig. 112). This is a lever type switch bolted to rear fender underneath floor plate and is operated by the master clutch lever. When clutch lever is pushed forward to release the clutch, the lower end of the lever actuates stop light switch lever and stop light is lighted.

**(1) REMOVAL.**

**SCREWDRIVER**

**WRENCH**, socket,  $\frac{9}{16}$ -in.

**WRENCH**, open-end,  $\frac{9}{16}$ -in.

**WRENCH**, socket,  $\frac{3}{4}$ -in.

**WRENCH**, open-end,  $\frac{3}{4}$ -in.

**(a) Remove Floor Plate Sections.**

**WRENCH**, open-end,  $\frac{9}{16}$ -in.

**WRENCH**, socket,  $\frac{9}{16}$ -in.

**WRENCH**, socket,  $\frac{3}{4}$ -in.

Remove 4 cap screws holding master clutch cover and remove clutch cover. Remove 2 cap screws and 3 bolts holding left floor plate to rear fender and bracket on seat frame and lift out floor plate, over master clutch lever.

**(b) Remove Switch.**

**SCREWDRIVER**

**WRENCH**, socket,  $\frac{9}{16}$ -in.

**WRENCH**, open-end,  $\frac{9}{16}$ -in.

Remove the 2 bolts holding switch to left rear fender and lift switch up. Turn switch over and remove the 2 screws holding wires to switch.

## ELECTRICAL SYSTEM AND EQUIPMENT

### (2) INSTALLATION.

SCREWDRIVER  
WRENCH, open-end,  $\frac{9}{16}$ -in.  
WRENCH, open-end,  $\frac{3}{4}$ -in.

WRENCH, socket,  $\frac{9}{16}$ -in.  
WRENCH, socket,  $\frac{3}{4}$ -in.

#### (a) *Connect Wires to Switch and Install Switch.*

SCREWDRIVER  
WRENCH, open-end,  $\frac{9}{16}$ -in.

WRENCH, socket,  $\frac{9}{16}$ -in.

Connect the 2 wires to the switch terminals. Secure switch to left rear fender of tractor at side of master clutch lever with 2 bolts. Have master clutch engaged.

#### (b) *Install Floor Plate and Clutch Cover.*

WRENCH, open-end,  $\frac{3}{4}$ -in.      WRENCH, socket,  $\frac{3}{4}$ -in.

Engage clutch lever in slot in left floor plate and lower floor plate into position. Place clutch cover in position, start all bolts and cap screws in both sections and tighten.

## 92. WIRING (fig. 114).

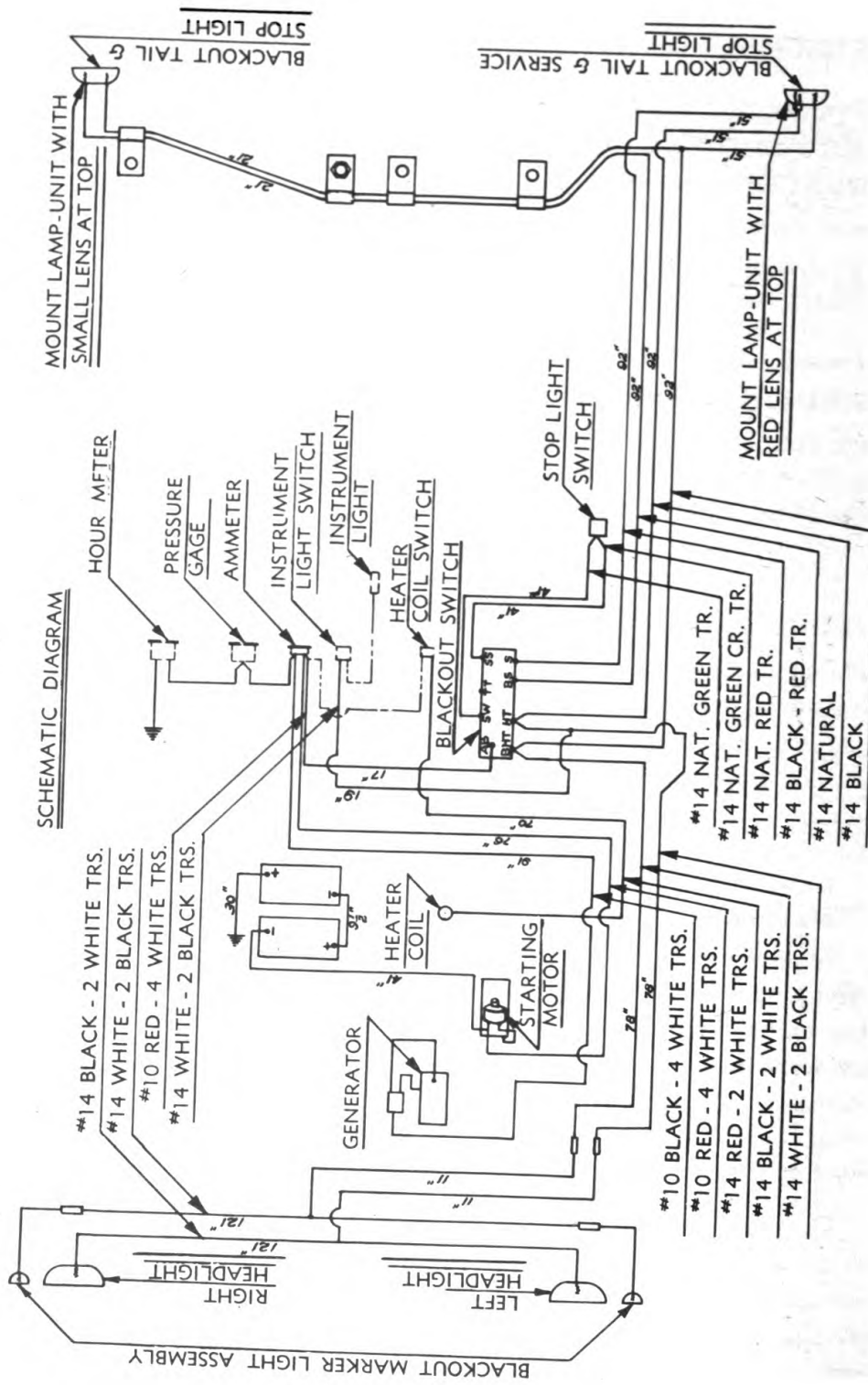
a. The schematic diagram of the wiring of the tractor shown in the figure below shows the length of the wires and their distinguishing colors. After a tractor has been in use for a certain length of time, it may be necessary when replacing a wire or wires to strip the loom of a harness of wires back a little ways to expose the wires and determine their coloring. The entire system can be rewired from this diagram.

### b. Maintenance.

(1) Replacement of wires is seldom necessary unless the wires are destroyed by fire or like causes. A broken wire can be repaired easily by stripping about an inch of insulation off the two broken ends, twisting the two ends together and wrapping the spliced section with adhesive or friction tape. Any portions of the wire that have the insulation rubbed off through rubbing on some part of tractor should be wrapped with tape to prevent short circuits.

(2) There are no fuses in the wiring system of the tractor. A thermal cut-out unit on the main light switch automatically shuts off current from circuit in which a short circuit occurs. After the short circuit is located, the wire shorted may be pulled from the closest connector between it and switch and only that part of the electrical system will be inoperative. Operation can continue then if time or facilities for repair are lacking. However, the cause of shortening should be remedied as soon as possible so entire system will be in operating condition.

MEDIUM TRACTOR M1



RA PD 56466

Figure 114—Schematic Wiring Diagram

Section XVI

**NONELECTRICAL INSTRUMENTS**

	Paragraph
Lubricating oil pressure gage .....	93
Fuel pressure gage .....	94
Temperature gage .....	95
Mile meter .....	96

**93. LUBRICATING OIL PRESSURE GAGE (fig. 11).**

**a. Description.** The lubricating oil pressure gage is located in the instrument panel. A dial facing the operator registers the pressure of the lubricating oil delivered to the engine. At engine operating speed and temperature, the oil pressure should be between 25 and 35 pounds. If pressure falls below 25 pounds (at full throttle), the cause should be immediately determined (par. 79).

**b. Removal.**

**PLIERS** **WRENCH**, open-end,  $\frac{9}{16}$ -in.

**SCREWDRIVER**, Phillips head

**(1) REMOVE INSTRUMENT PANEL.**

**SCREWDRIVER**, Phillips head

Remove the 4 Phillips head screws holding panel to dash and pull panel back carefully until fittings at rear of oil pressure gage can be reached.

**(2) REMOVE GAGE.**

**PLIERS** **WRENCH**, open-end,  $\frac{9}{16}$ -in.

**SCREWDRIVER**, Phillips head

Remove the 3 Phillips head screws holding gage in panel. Hold pipe elbow with pliers and unscrew oil pressure gage from elbow with  $\frac{9}{16}$ -inch wrench.

**c. Installation.**

**PERMATEX** or **LEAD**, white **SCREWDRIVER**, Phillips

**PLIERS** head

**WRENCH**, open-end,  $\frac{9}{16}$ -in.

**(1) INSTALL GAGE IN PIPE ELBOW.**

**PERMATEX** or **LEAD**, white **WRENCH**, open-end,  $\frac{9}{16}$ -in.

**PLIERS**

Coat threads of gage with permatex or white lead and screw into pipe elbow. Tighten, using pliers to hold elbow and the wrench to turn gage. Turn so that the gage dial is in correct position and the hour meter pressure switch stands up.



**MEDIUM TRACTOR M1**

**(2) INSTALL GAGE IN PANEL.**

**SCREWDRIVER**, Phillips head

Secure gage to panel with the 3 Phillips head screws.

**(3) INSTALL PANEL IN DASH.**

**SCREWDRIVER**

Work panel back into dash and secure with the 4 Phillips head screws. Start engine and check operation of oil pressure gage.

**94. FUEL PRESSURE GAGE.**

**a. Description.** The fuel pressure gage is similar to the oil pressure gage. The dial registers the fuel pressure to the injectors. A fuel line from a point between the third stage fuel filter and the intake manifold leads to the gage.

**b. Maintenance.** Normal fuel pressure is from 20 to 35 pounds and may be even higher than 35 pounds. In the event high fuel pressure is experienced, remove fuel tank filler cap and, with engine running at full throttle, observe if a full stream of fuel is returning into tank. If not, there may be clogged filters in the system or injectors, or the restricted fitting at rear end of return fuel manifold may be clogged. If there is a good stream of fuel returning into tank, no correction is necessary and the high fuel pressure will cause no damage. Refer to section XII.

**c. Removal.**

**SCREWDRIVER**, Phillips head

**WRENCH**, open-end,  $\frac{7}{8}$ -in.

**WRENCH**, open-end,  $\frac{9}{16}$ -in.

**WRENCH**, open-end,  $\frac{5}{8}$ -in.

**(1) REMOVE INSTRUMENT PANEL FROM DASH.**

**SCREWDRIVER**, Phillips head

Remove the 4 Phillips head screws holding panel to dash and pull panel out of dash far enough to reach fuel lines with wrenches.

**(2) DISCONNECT FUEL LINES.**

**WRENCH**, open-end,  $\frac{5}{8}$ -in.

**WRENCH**, open-end,  $\frac{7}{8}$ -in.

Disconnect fuel line, holding coupling with  $\frac{5}{8}$ -inch wrench and turning nut off with  $\frac{7}{8}$ -inch wrench.

**(3) REMOVE RESTRICTION UNIT.**

**WRENCH**, open-end,  $\frac{9}{16}$ -in.

Unscrew restriction unit out of elbow.

**(4) REMOVE GAGE.**

**SCREWDRIVER**, Phillips head

Remove the 3 Phillips head screws holding gage in panel and remove gage. Remove elbow from gage.

## NONELECTRICAL INSTRUMENTS

### d. Installation.

PERMATEX  
SCREWDRIVER, Phillips head

WRENCH, open-end,  $\frac{9}{16}$ -in.  
WRENCH, open-end,  $\frac{5}{8}$ -in.  
WRENCH, open-end,  $\frac{7}{8}$ -in.

#### (1) INSTALL ELBOW ON GAGE.

PERMATEX or LEAD, white      PLIERS

Coat threads of elbow with permatex or white lead and screw elbow into gage.

#### (2) INSTALL GAGE IN INSTRUMENT PANEL.

SCREWDRIVER, Phillips head

Set gage in place in panel and secure with 3 Phillips head screws.

#### (3) INSTALL RESTRICTION UNIT.

PERMATEX or LEAD, white      WRENCH, open-end,  $\frac{9}{16}$ -in.

Coat threads of unit with permatex or white lead and screw into elbow. Restriction unit and elbow should point towards the right.

#### (4) CONNECT FUEL LINE.

WRENCH, open-end,  $\frac{5}{8}$ -in.      WRENCH, open-end,  $\frac{7}{8}$ -in.

Screw connector into restriction unit and then connect fuel line with nut on end of line.

#### (5) INSTALL PANEL IN DASH.

SCREWDRIVER, Phillips head

Work wires and lines back through panel opening and install Phillips head screws in panel and dash.

## 95. TEMPERATURE GAGE.

**a. Description.** The temperature gage assembly consists of a thermal tube, cable, and dial gage. The dial registers the temperature of the water in the engine. It is actuated by the tube which is mounted in the rear of the water manifold.

### b. Removal.

SCREWDRIVER, Phillips head

WRENCH, open-end,  $\frac{9}{16}$ -in.  
WRENCH, open-end,  $1\frac{1}{16}$ -in.

(1) **DRAIN COOLING SYSTEM.** Open drain cock in lower connector elbow and drain out enough water to bring level below water manifold.

#### (2) REMOVE CLIP AND CAP SCREW.

WRENCH, open-end,  $\frac{9}{16}$ -in.

Remove cap screw from balance weight housing holding clip and pipe.

#### (3) REMOVE THERMAL TUBE.

WRENCH, open-end,  $1\frac{1}{16}$ -in.

Unscrew fitting which holds thermal tube to rear of water manifold.

**MEDIUM TRACTOR M1**

**(4) REMOVE TEMPERATURE GAGE ASSEMBLY.**

**SCREWDRIVER, Phillips head**

Remove 3 Phillips head screws holding gage in panel and remove gage, cable, and thermal tube out through cowl and dash as an assembly.

**c. Installation.**

**SCREWDRIVER, Phillips head**

**WRENCH, open-end,  $\frac{9}{16}$ -in.  
WRENCH, open-end,  $1\frac{1}{16}$ -in.**

**(1) INSTALL GAGE IN PANEL.**

**SCREWDRIVER, Phillips head**

Insert end of cable through temperature gage hole in dash panel; then through hole in cowl. Place gage in panel and install the 3 Phillips head screws.

**(2) INSTALL THERMAL TUBE.**

**WRENCH, open-end,  $1\frac{1}{16}$ -in.**

Insert tube into hole in rear of water manifold; screw in and tighten retaining nut.

**(3) INSTALL CLIP AND CAP SCREW.**

**WRENCH, open-end,  $\frac{9}{16}$ -in.**

Place clip around cable, cap screw through clip and into side hole in balance weight cover, and tighten.

**96. MILE METER (fig. 11).**

**a. General.** The mile meter (odometer) is driven by a flexible shaft inside a housing extending from the back of the meter into the transmission case to a gear on the front end of the lower transmission shaft.

**b. Maintenance.**

**PLIERS**

If the mile meter becomes inoperative, make the following check. With pliers, disconnect the cable from the bottom of the meter by unscrewing the retainer nut holding the shaft housing to the meter. Put the tractor in motion and observe if the shaft turns inside its retainer. If it does, the mile meter should be replaced. If it does not, the shaft is broken or the gears at the lower end of shaft are stripped. In this case, the drive assembly will have to be replaced. Replacement of meter can be done by the using arms, but not replacement of the drive assembly.

**c. Removal of Meter.**

**PLIERS**

**SCREWDRIVER, Phillips head**

**NONELECTRICAL INSTRUMENTS****(1) DISCONNECT CABLE.****PLIERS**

Loosen retainer nut holding end of housing to bottom of meter with pliers and unscrew it from meter. Pull cable and housing from meter.

**(2) REMOVE METER FROM DASH.****SCREWDRIVER, Phillips head**

Remove the 4 Phillips head screws holding meter to dash and pull meter from dash.

**d. Installation.****PLIERS****SCREWDRIVER, Phillips  
head****(1) INSTALL METER IN DASH.****SCREWDRIVER, Phillips head**

Place meter in hole in dash and install 3 Phillips head screws through flange of meter and into dash.

**(2) CONNECT DRIVE CABLE AND HOUSING.****PLIERS**

The end of drive cable is square and fits into a square socket in meter drive. Insert the cable in meter, hold up cable housing and screw retainer nut on meter. Tighten nut lightly with pliers.

MEDIUM TRACTOR M1

Section XVII

MASTER CLUTCH

	Paragraph
Description .....	97
Trouble shooting .....	98
Clutch adjustment .....	99
Master clutch brake assembly .....	100

97. DESCRIPTION.

a. The master clutch is an overcenter cam engaging type. A driven disk, with friction lining on both sides, is riveted to a splined hub carried on the master clutch shaft. All other parts of the clutch except the release mechanism and clutch brake are bolted to the engine flywheel.

b. **Operation.** To engage the clutch, the pressure plate is forced forward against the driven disk by means of the control lever and linkage. This tightly clamps the clutch driven disk between the pressure plate and flywheel, thus transmitting power from flywheel to the driven disk, which carries it to the transmission. As the control lever is pulled all the way back, the overcenter actuating lever assemblies snap in to hold the clutch engaged until pressure on the control lever snaps them out to release the clutch. A flexible grease tube extends from outside the clutch housing to the release bearing for lubrication of the bearing and sleeve.

98. TROUBLE SHOOTING.

a. Slipping.

Probable Cause	Probable Remedy
Improper adjustment.	Adjust clutch.
Oily facings.	Wash out clutch. Inspect rear main bearing seal and wick in crankshaft for excess oil loss. *Replace drive disk assembly, if necessary.
Worn or glazed facings.	*Replace drive disk assembly.
Warped pressure plate.	*Machine face or replace.

b. Clutch Does Not Engage.

Facing torn off.	*Install new drive disk assembly.
Release bearing failure.	*Install new bearing.
Adjusting lock worked loose.	Adjust clutch and inspect locking lug.
Actuating lever assemblies worn.	Replace assemblies.

\* Corrections not within the scope of operating organization. See next higher authority.

**MASTER CLUTCH**

**c. Clutch Hard to Operate.**

Probable Cause	Probable Remedy
Warped pressure plate.	*Machine face or replace.
Throwout bearing or clutch sleeve dry.	Lubricate the bearing, which also lubricates the sleeve and shaft.
Linkage worn.	Install new parts and lubricate with engine oil.
Linkage binding.	Clean and lubricate.
Lining torn off.	*Replace drive disk assembly.

**d. Clutch Disengages When in Operation.**

Actuating lever rollers worn.	*Replace lever assemblies.
Sleeve bushings worn.	*Replace release assembly.

**e. Noise, Rattles, or Squeaks.**

Pilot bearing failure.	*Replace bearing, and if caused by lack of lubrication, replace wick in crankshaft.
Release bearing failure.	*Replace bearing and inspect grease tube for breaks.
Worn clutch shaft splines.	*Replace clutch shaft.

**f. Clutch Will Not Disengage.**

Clutch adjustment too tight.	Loosen adjustment.
Pilot bearing failure (bearing "seized").	*Replace bearing and inspect wick in crankshaft.
Linkage dry or binding.	Free linkage and lubricate.

**99. CLUTCH ADJUSTMENT.**

**a. Engagement of the master clutch when in proper adjustment requires a pull of from 50 to 55 pounds on the control lever when engine is idling, or from 60 to 65 pounds when engine is stopped. It should engage with a snap and lever will lock into position with an overcenter action. When this action is not present or when the pull required on the lever to engage clutch drops to around 30 pounds, it indicates that the clutch should be adjusted before slippage occurs. These figures assume that there is no binding in any of the linkage. If the linkage is binding in any place, those parts or joints should be freed and lubricated before attempting to obtain the correct adjustment. Do not adjust the clutch too tightly, as that would result in faster wear on the linkage and make operation harder. Proceed as follows:**

**b. Adjustment.**

**BAR, small pry**

**WRENCH, socket, 3/4-in.**

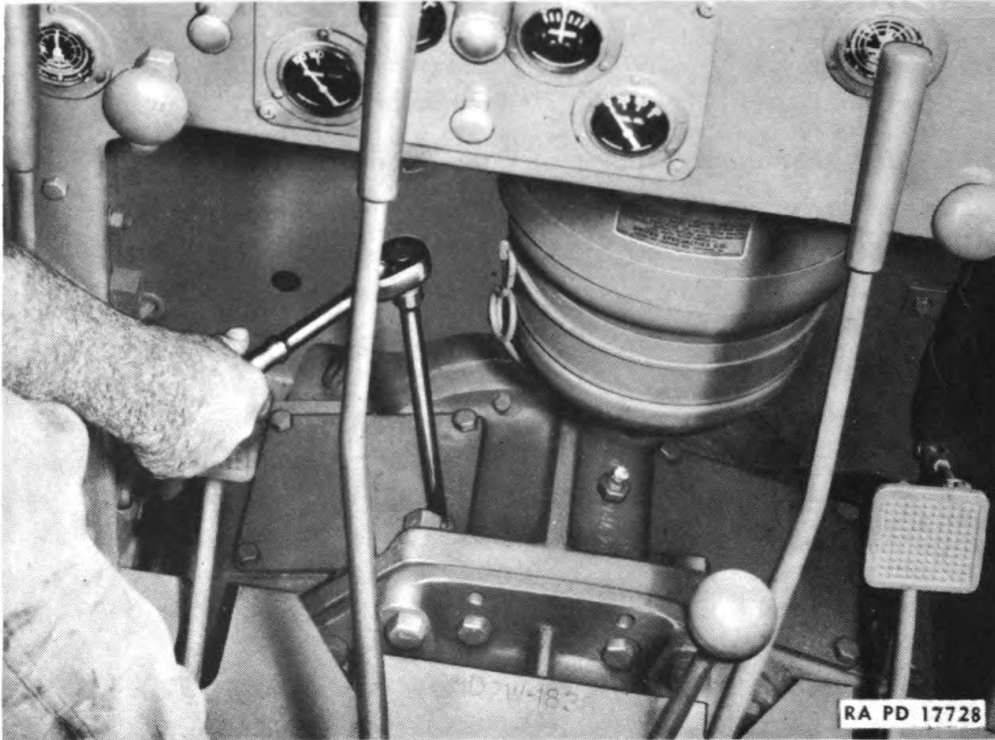
\* Corrections not within the scope of operating organization. See next higher authority.

**MEDIUM TRACTOR M1**

**(1) REMOVE COVER PLATES.**

**WRENCH**, socket,  $\frac{3}{4}$ -in.

Remove clutch cover plates by removing 4 cap screws holding each cover to engine spacer (fig. 115).



**Figure 115—Removing Clutch Cover Plates**

**(2) TURN CLUTCH TO ADJUSTING POSITION.** Disengage clutch and revolve the clutch until the adjusting lock is located near the inspection hole (fig. 116).

**(3) DISENGAGE ADJUSTING LOCK.** Hinge adjusting lock back out of slot in back plate.

**(4) TURN ADJUSTING RING.**

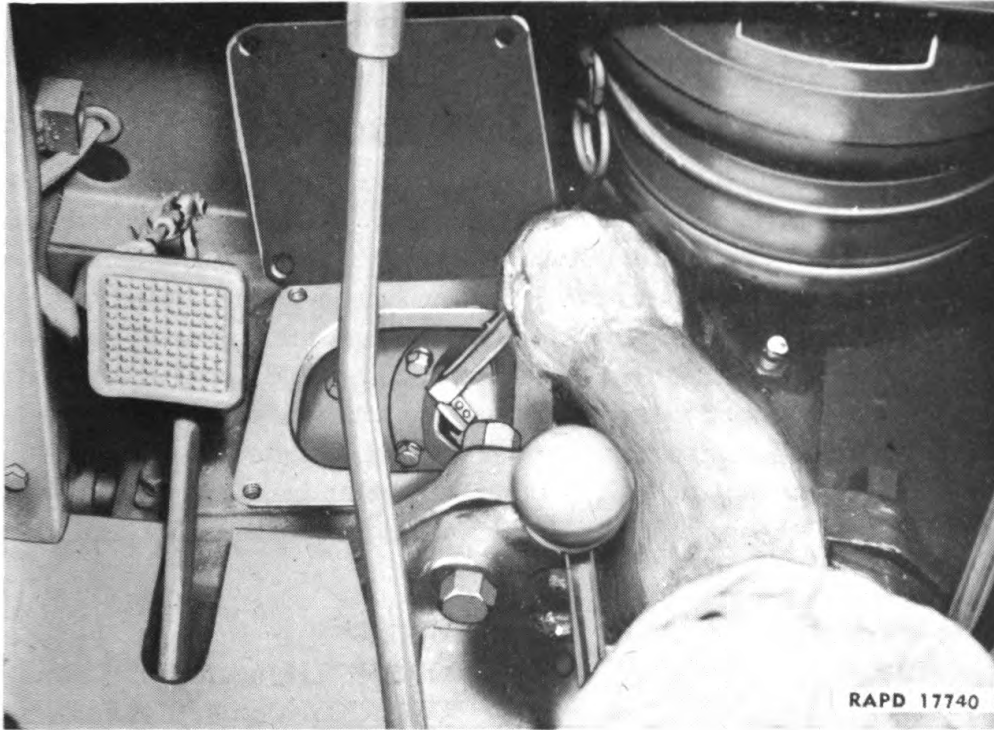
**BAR**, small pry

Pry on the notches in adjusting ring to turn ring (fig. 116). To tighten clutch, turn adjusting ring clockwise; to loosen it, turn the ring counter-clockwise. Turn ring in desired direction a notch at a time and test pull required on lever to engage clutch until desired pull is obtained.

**(5) LOCK RING IN PLACE.**

**WRENCH**, socket,  $\frac{3}{4}$ -in.

Engage adjusting lock in notch in back plate and install inspection covers.

**MASTER CLUTCH****Figure 116—Adjusting Master Clutch****(6) INSTALL INSPECTION COVER.**

**WRENCH**, socket,  $\frac{3}{4}$ -in.

Place cover in position and secure with 4 cap screws.

**c. Washing Master Clutch.** If master clutch slips due to over-lubrication of release bearing or oil leaking from engine or transmission into clutch compartment, washing of the clutch and compartment will be necessary. Proceed as follows:

- (1) Place  $\frac{1}{2}$ -inch pipe plug in drain hole at left rear of clutch housing.
- (2) Remove inspection hole cover and pour about 3 gallons of fuel oil or SOLVENT, dry-cleaning, into clutch compartment.
- (3) With gear shift lever in neutral position and clutch engaged, start engine. Run engine for 5 minutes without disengaging clutch; then drain dirty fuel oil or solvent out by removing pipe plug.
- (4) Again place pipe plug in drain hole. Pour about 3 gallons of fuel oil or cleaning fluid into clutch compartment and operate engine as before. Disengage and engage master clutch several times while engine is running; then stop engine and drain fuel oil or solvent from compartment.
- (5) Lubricate throw-out bearing thoroughly.
- (6) Lubricate clutch mechanism and linkage by splashing about a quart of engine oil against back of clutch assembly and over release



**MEDIUM TRACTOR M1**

assembly linkage. Allow oil to drain from clutch compartment. **NOTE:** This must be done with clutch engaged. If clutch linkage becomes dry and binds, or is hard to operate, it may be lubricated in this manner.

**100. MASTER CLUTCH BRAKE ASSEMBLY.**

**a. Description.** The master clutch brake assembly is a two-piece casting which is bolted around the clutch shaft. The brake is faced on the flanged side with brake lining. When the master clutch lever is pushed forward, the clutch release bearing carrier is forced back against the clutch brake assembly, which stops the transmission gears and permits easy shifting. The throw-out mechanism should contact the brake before operator's hand can come in contact with the dash when pushing lever ahead to disengage clutch and engage clutch brake. The brake does not require adjusting very often, but should at least be adjusted before clutch lever can hit dash. This can be done at a time when covers are removed to adjust master clutch.

**b. Clutch Brake Adjustment (figs. 117 and 46).**

**PLIERS**

**RULER or SCALE**

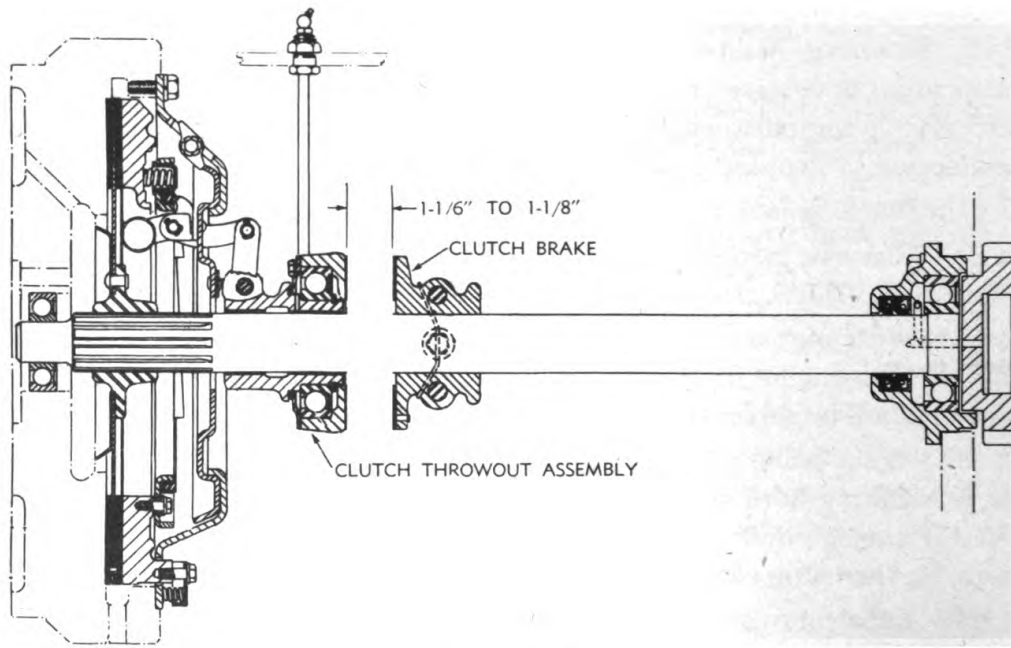
**WRENCH, open-end,  $\frac{9}{16}$ -in.**

**WRENCH, socket,  $\frac{3}{4}$ -in.**

**(1) REMOVE LOCKING WIRE.**

**PLIERS**

Cut wire running through head of lock screw and around the clutch shaft and remove wire.



RA PD 41418

**Figure 117—Clutch Brake Adjustment**

## MASTER CLUTCH

### (2) LOOSEN BOLTS.

WRENCH, open-end,  $\frac{9}{16}$ -in.      WRENCH, socket,  $\frac{3}{4}$ -in.

Loosen lock screw. Loosen bolts that clamp the 2 halves of clutch brake to clutch shaft.

### (3) ADJUST CLEARANCE.

RULER or SCALE

Engage master clutch. Move brake assembly ahead on shaft until space between clutch throw-out assembly and brake measures  $1\frac{1}{16}$  to  $1\frac{1}{8}$  inches.

### (4) TIGHTEN BOLTS AND INSTALL LOCK WIRE.

PLIERS

WRENCH, socket,  $\frac{3}{4}$ -in.

WRENCH, open-end,  $\frac{9}{16}$ -in.

Tighten bolts clamping brake assembly to shaft. Then tighten lock screw and install lock wire through head of lock screw and around shaft.

MEDIUM TRACTOR M1

Section XVIII

STEERING CLUTCHES

	Paragraph
Description and operation .....	101
Trouble shooting .....	102
Steering clutch adjustment .....	103
Washing and lubrication .....	104

101. DESCRIPTION AND OPERATION.

a. The steering clutches are of the multiple disk type with 11 friction disks and 11 steel disks in each clutch assembly. Power is transmitted through these clutches from the bevel gear shaft to the final drive pinion shafts. The steering clutches are released by means of the two levers directly in front of operator (fig. 10). When either clutch is released, the bevel gear shaft turns without driving or supplying power to the final drive pinion shaft on that side.

102. TROUBLE SHOOTING.

a. Steering Clutch Slipping.

Probable Cause	Probable Remedy
Improper adjustment.	Adjust clutches.
Friction disks worn out.	*Rebuild clutches.
Loss of spring tension.	*Replace springs.
Grease in clutch.	Wash clutches.

b. Clutch Will Not Disengage.

Improper adjustment.	Adjust clutches.
Throw-out bearing failure.	*Replace bearings.
Lower end of throw-out fork out of equalizer in bottom of steering clutch compartment.	*Install fork in equalizer.

103. STEERING CLUTCH ADJUSTMENT (fig. 117).

a. Check Steering Clutch Levers.

(1) Check each clutch lever for adjustment separately. Perform the following steps to check if steering clutch needs adjustment.

(a) Place one end of a ruler or scale against the dash so it projects horizontally past the top of the steering clutch lever.

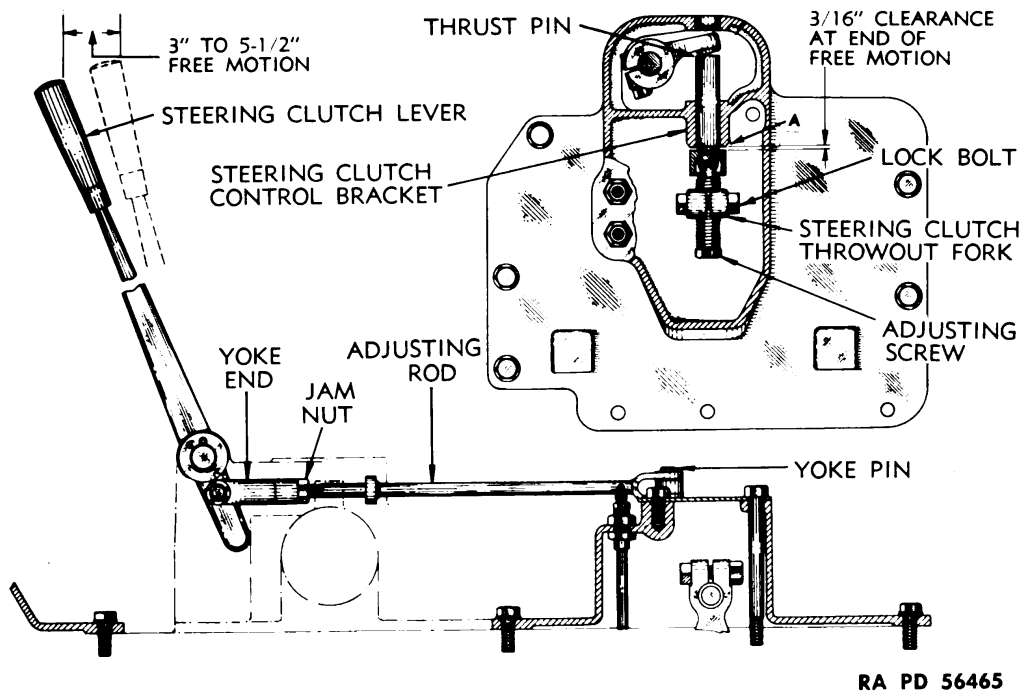
(b) Push the lever forward as far as it will go; at this point the bottom end of the lever strikes a stop on the gear shifter housing and prevents it from going too far forward.

\* Corrections not within the scope of operating organization. See next higher authority.

### STEERING CLUTCHES

(c) Pull the lever back until the lost motion is taken up. This can easily be felt by a definite increase in the pull required to release the clutch.

(d) Observe the measurement of the distance between the dash and the top of the lever when it is in its forward position, and also the distance when the lever is pulled back to the position where the lost motion is all taken up. The free motion, or difference between these two measurements, should not be less than 3 inches and not more than 5½ inches. As the steering clutches wear, the free motion of the levers becomes less. If the free motion of the lever is less than 3 inches, it is an indication that adjustment is necessary.



**Figure 118—Steering Clutch Adjustments**

#### b. Check Thrust Pin.

(1) Remove the steering clutch inspection cover, using a ¾-inch socket wrench to remove the holding cap screws.

(2) (fig. 118). With steering clutch lever ahead as far as it will go, the shoulder of thrust pin should contact boss on steering clutch control bracket at "A." When steering clutch lever is pulled back to end of its free travel where disengagement of clutch begins, top of throw-out fork and thrust pin should move out and there should be ⅜-inch clearance at "A" between shoulder of thrust pin and boss on steering clutch control bracket. If thrust pin shoulder does not move back against boss on bracket when lever is ahead against stop, the following adjustment must be made.

**MEDIUM TRACTOR M1**

**c. Adjustment (figs. 118, 119, 120).**

**PLIERS**

**WRENCH, open-end, 3/4-in.**

**SCALE**

**(2)**

**(1) ADJUST ROD.**

**PLIERS**

**WRENCH, open-end, 3/4-in.**

Loosen jam nut on adjusting rod and remove yoke pin. Turn adjusting rod out of yoke end (counterclockwise) 1/2 turn and replace pin. Test to see if shoulder of thrust pin contacts boss on bracket. Turn rod out of yoke end more if necessary until it does. Check now to see if thrust pin moves out as soon as lever is pulled back. There should be no free travel of lever before thrust pin begins to move out. If there is, the adjusting rod should be screwed into yoke end (clockwise) until free lever travel is eliminated.

**(2) ADJUST FREE MOTION OF THRUST PIN AND TOP OF THROW-OUT FORK.**

**SCALE**

**WRENCH, open-end, 3/4-in.**

**(2)**

Pull steering clutch lever back to end of its free travel where pressure is felt and disengagement of clutch begins. Hold lever in that position and check clearance at "A." If it is less than 3/16 inch, loosen lock bolt (fig. 119) and turn adjusting screw out (counterclockwise) (fig. 120) until 3/16-inch clearance is obtained. If it is more than 3/16-inch, turn adjusting screw in. Tighten lock bolt. Top of steering clutch lever should now have approximately 5-inch free travel before disengagement of clutch begins. Be sure jam nut on adjusting rod is tightened and cotter pin is in yoke pin before installing inspection covers. **NOTE:** This adjustment is very important, and it should be done carefully. If there is no clearance at this point, it is possible for the clutch throw-out bearings to ride against the shifter plate even though the steering clutch levers are adjusted as specified.

**104. WASHING AND LUBRICATION.**

**a. Washing Clutches.** If grease or oil accumulates in steering clutch compartments from closed drains and leaks or overlubrication of throw-out bearings, slipping of the clutches will result. Open drains and wash clutches and compartments as follows.

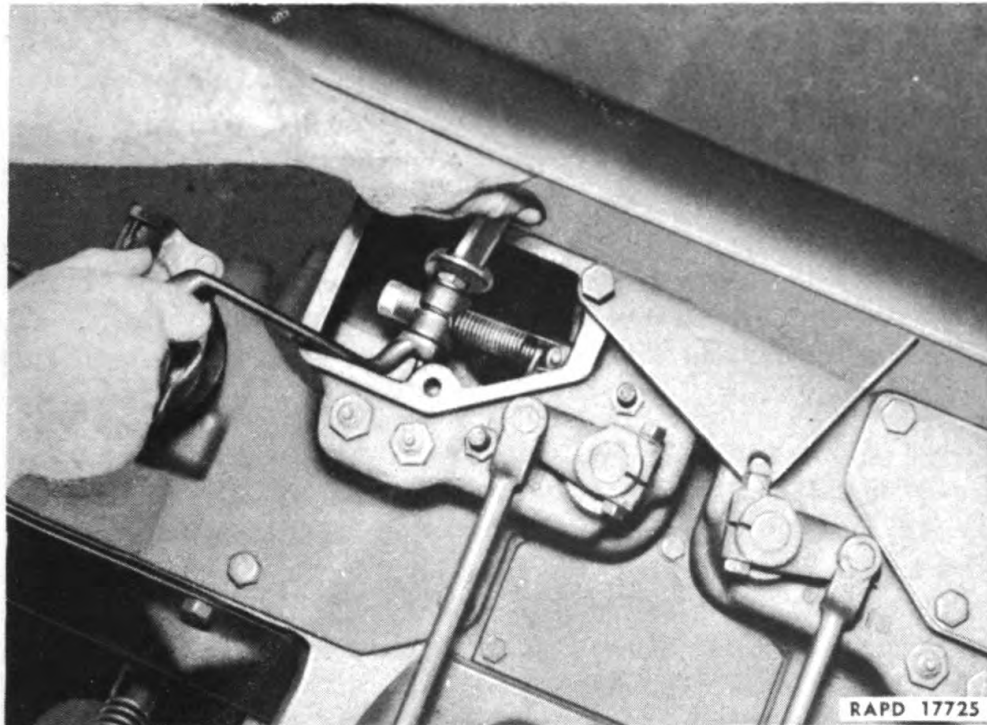
(1) Use pressure gun and fill throw-out bearings with grease (fig. 21).

(2) Install pipe plugs in drain holes.

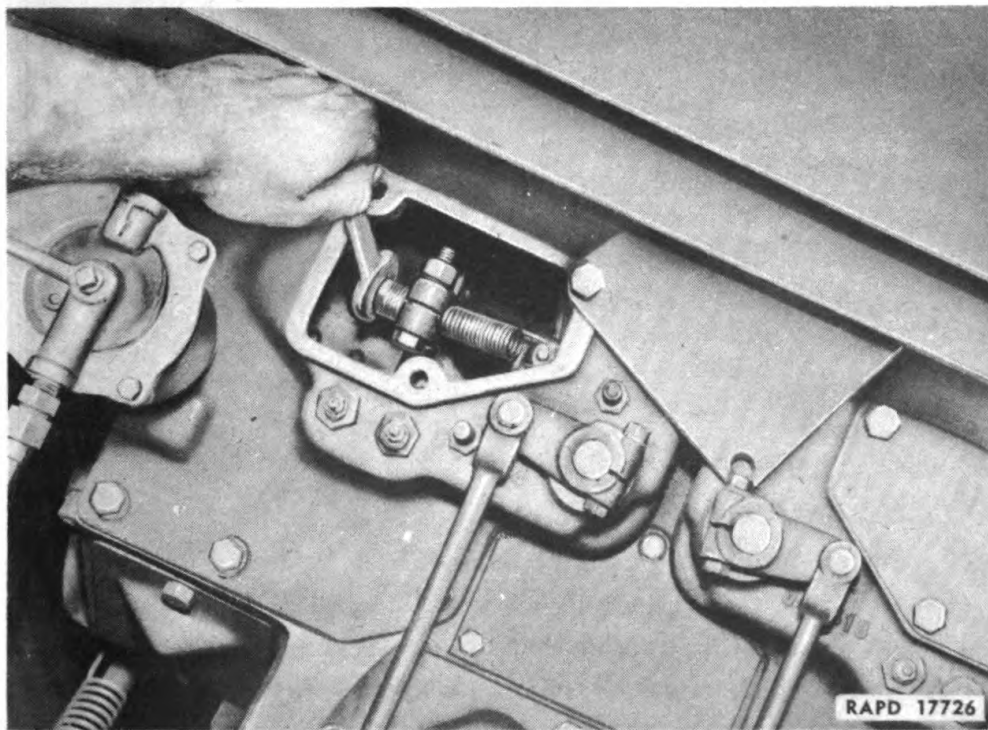
(3) Remove steering clutch inspection covers and pour 5 gallons of fuel oil or SOLVENT, dry-cleaning, into each compartment.

(4) Start engine and run tractor backward and forward for several minutes without releasing either steering clutch. Stop tractor and drain compartments.

STEERING CLUTCHES



**Figure 119—Loosening Steering Clutch Adjusting Screw Lock Bolt**



**Figure 120—Adjusting Steering Clutch**

**MEDIUM TRACTOR M1**

(5) Install drain plugs again and pour same amount of fuel oil or SOLVENT, dry-cleaning, into each compartment. Operate tractor with no load for five minutes, releasing both steering clutches as often as possible. Drain compartments.

(6) The steering clutch throw-out bearings and mechanisms should be lubricated after the steering clutches are washed out, as all lubricant will have been washed out. Since it is possible that some fuel oil might drain from the steering clutch compartments into the final drive gear cases during the process of washing, the final drive gear cases should be drained, flushed, and refilled with new oil after the steering clutches are washed.

**b. Lubrication.** The bell crank pivot pins (see tractor lubrication chart, fig. 21) are provided with pressure gun grease fittings and should be lubricated after day's operation. Flexible grease tubes from the bearings on the throw-out forks extend through the top of the transmission case, and these bearings should be lubricated every 10 hours through the fittings on these tubes. Do not use other than a hand gun for lubricating these points, as overlubrication may get grease on the steering clutch disks.

Section XIX

STEERING CLUTCH BRAKES

	Paragraph
Description .....	105
Brake adjustment .....	106

105. DESCRIPTION.

a. The brake system (fig. 121) on the tractor consists of lined bands which encircle the brake drums and are operated by the 2 foot pedals. The brakes are used in conjunction with the steering clutch levers for making short turns. Lever locks are provided to hold the brakes in applied or locked position for parking purposes.

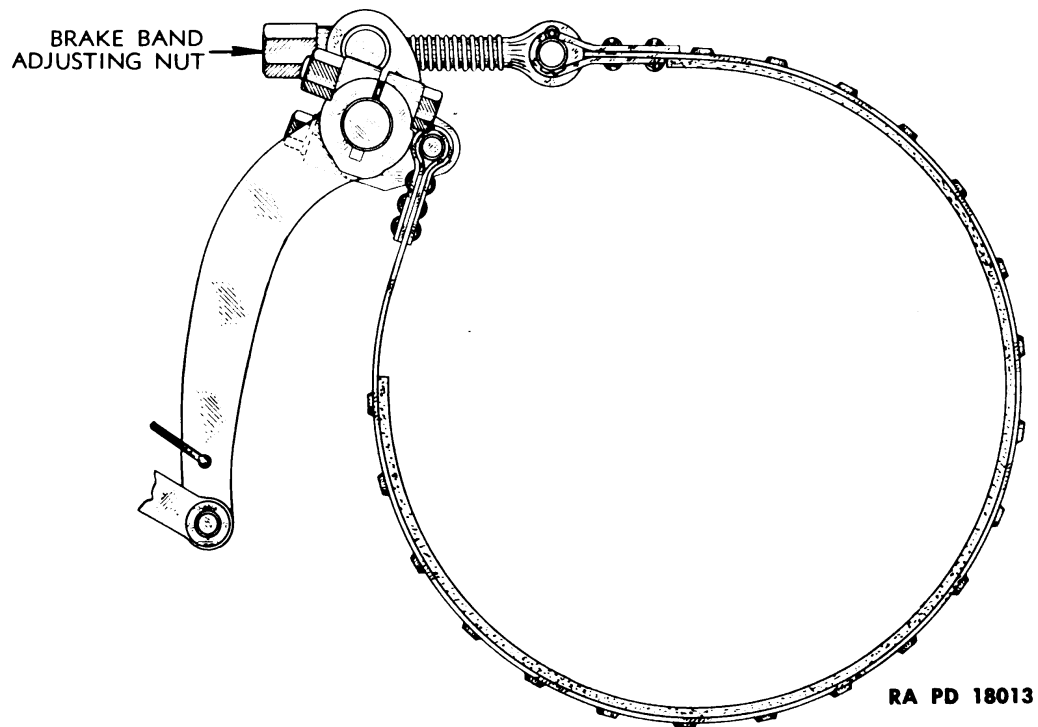


Figure 121—Brake Assembly

106. BRAKE ADJUSTMENT.

a. The brake bands are one-piece bands installed with the two ends of the band towards the top and front of the brake and steering clutch compartment. A bell crank arrangement actuated by the rod from the foot pedals compresses the brake around the drum. Only one adjustment is necessary for tightening brakes.



**MEDIUM TRACTOR M1**

**b. Procedure for Adjustment.**

**WRENCH**, deep socket,  
 $1\frac{5}{16}$ -in.

**WRENCH**, socket,  $\frac{3}{4}$ -in.

**WRENCH**, open-end,  $\frac{3}{4}$ -in.

**(1) REMOVE MASTER CLUTCH COVER.**

**WRENCH**, open-end,  $\frac{3}{4}$ -in.

Remove the 4 cap screws holding cover to transmission housing and floor plates and remove cover.

**(2) REMOVE FLOOR PLATES.**

**WRENCH**, open-end,  $\frac{3}{4}$ -in.

**WRENCH**, socket,  $\frac{3}{4}$ -in.

Remove 2 cap screws and 3 bolts holding each floor plate to seat frame and rear fenders and remove floor plates.

**(3) REMOVE BRAKE HOLE COVERS.**

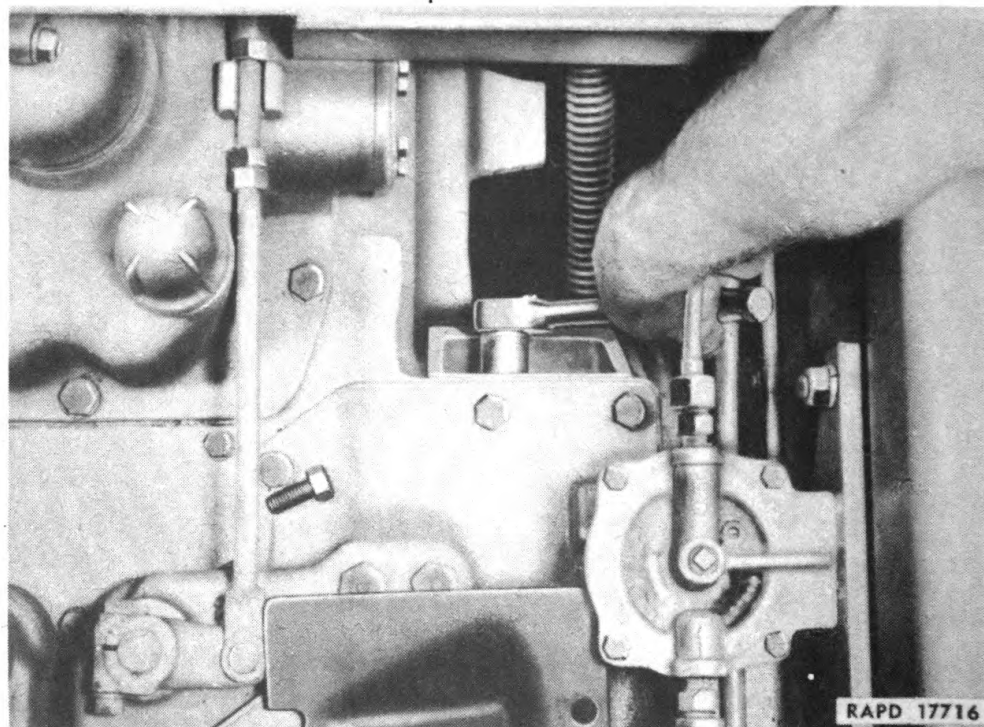
**WRENCH**, open-end,  $\frac{3}{4}$ -in.

Remove 2 cap screws from each cover and lift out covers.

**(4) ADJUST BRAKE BANDS.**

**WRENCH**, deep socket,  $1\frac{5}{16}$ -in.

Tighten the brake bands by turning the brake band adjusting nut in a clockwise direction (fig. 122). The brake bands are in correct adjustment when pawl on pedal lever lacks 1 inch of striking master clutch



**Figure 122—Adjusting Brakes**

### STEERING CLUTCH BRAKES

inspection covers on engine spacer when pedals are depressed as far as possible to apply brakes. **NOTE:** The tractor should be in motion when making this test. The rear of the adjusting nut is formed with a circular notch which fits over the bell crank to hold nut from coming loose while tractor is in operation. Therefore it should be turned  $\frac{1}{2}$  turn at a time while adjusting brakes so the notch will again be in proper position. It is desirable to maintain the maximum free travel of pedal travel to insure as much clearance as possible between brake bands and drums, which in turn results in less heat and longer wear on brake linings.

**(5) INSTALL COVERS AND FLOOR PLATES.**

**WRENCH**, open-end,  $\frac{3}{4}$ -in.      **WRENCH**, socket,  $\frac{3}{4}$ -in.

Install brake hole covers, floor plates, and master clutch cover.

**c. Washing Brakes.** If grease or oil get on the brake linings and brakes fail to hold, the oil may be washed from linings and compartments by the same method as used in washing steering clutches (par. 104 except that step (5) will be omitted).

MEDIUM TRACTOR M1

Section XX

FINAL DRIVES

	Paragraph
Description .....	107
Lubrication .....	108
Rear axle bearing adjustment .....	109

**107. DESCRIPTION.**

a. The large final drive gear is pressed on a splined hub and is driven by a small final drive pinion and shaft. The hub rotates on tapered roller bearings on the rear axle, and the drive sprocket is bolted to a flange on the hub. Two seal assemblies in each final drive assembly guard against the entrance of dirt and water and prevent oil from escaping. Each oil seal assembly consists of two finely machined steel rings, one turning with sprocket and one held stationary. A spring arrangement holds the 2 seal rings tightly against each other so that dirt or oil cannot pass between them, thus forming a seal.

**108. LUBRICATION.**

a. LUBRICANT, gear, universal, SAE 90, is used to lubricate the final drive assembly, and the oil level should be maintained level with the final drive filler plug. Inspection should be made after each day's operation to see if oil is at this level. The final drive cases should be drained and refilled with new oil after every 200 hours of operation. The magnetic drain plug is designed to catch small metal particles that might chip off or wear off during operation. This plug should be cleaned off and magnetism tested each time final drive gear cases are drained.

**109. REAR AXLE BEARING ADJUSTMENT.**

a. The rear axle bearings should be adjusted periodically. Adjustment procedure is as follows.

WRENCH, hexagon,  $\frac{3}{8}$ -in.

WRENCH, socket,  $\frac{7}{8}$ -in.

WRENCH, open-end,  $\frac{7}{8}$ -in.

WRENCH, socket,  $1\frac{5}{16}$ -in.

WRENCH, open-end, 2 $\frac{1}{2}$ -in.

(1) REMOVE END COVER.

WRENCH, socket,  $\frac{7}{8}$ -in.

Remove 3 cap screws and take off end cover from rear axle bracket.

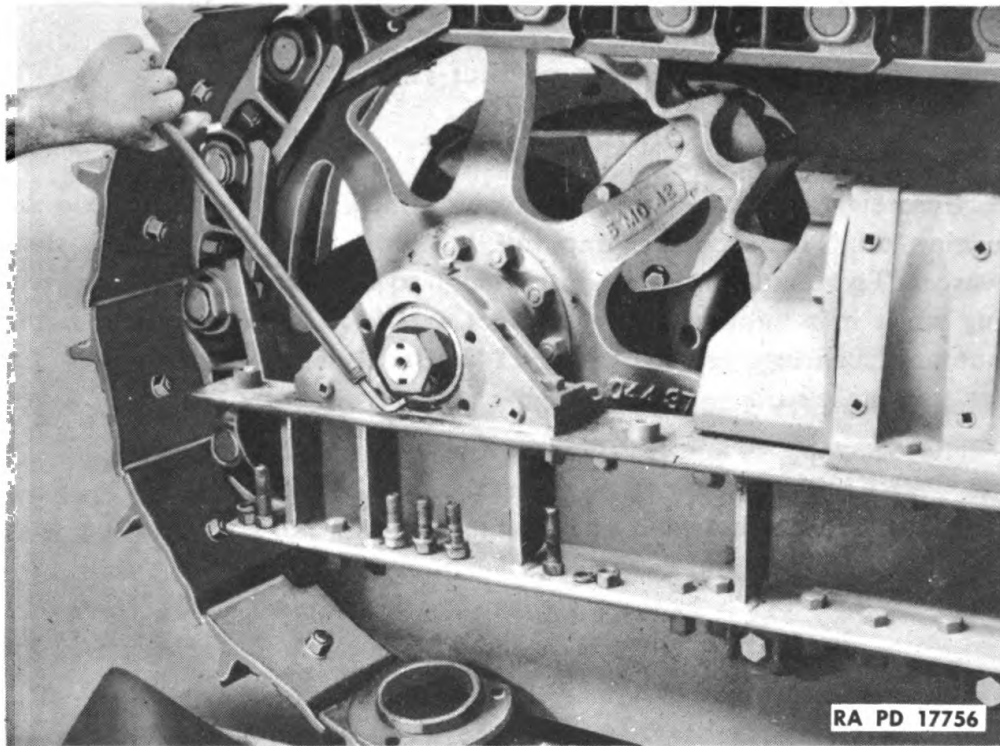
(2) REMOVE SPROCKET GUARD.

WRENCH, open-end,  $\frac{7}{8}$ -in.

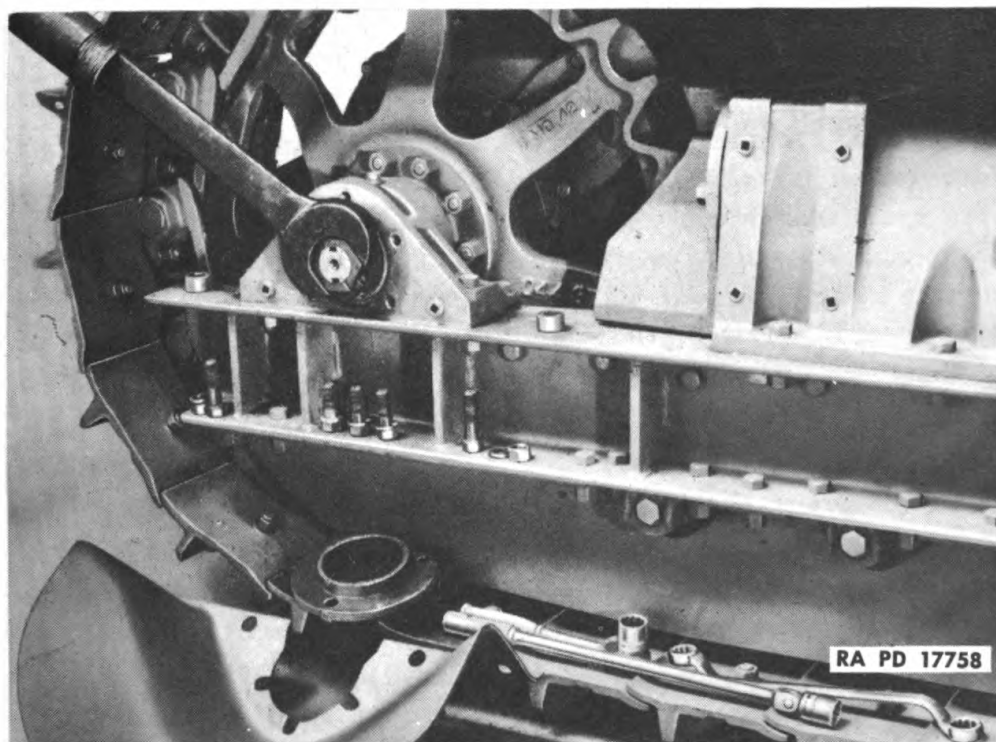
WRENCH, socket,  $1\frac{5}{16}$ -in.

Remove 2 bolts holding sprocket guard to truck frame and remove sprocket guard.

**FINAL DRIVES**



**Figure 123—Loosening Clamp Screw on Rear Axle Nut**



**Figure 124—Adjusting Rear Axle Bearings**

**MEDIUM TRACTOR M1**

**(3) LOOSEN CLAMP SCREW.**

**WRENCH**, hex.,  $\frac{3}{8}$ -in.

Loosen clamp screw in rear axle nut (fig. 123).

**(4) ADJUST BEARINGS.**

**WRENCH**, open-end,  $2\frac{1}{2}$ -in.

Unscrew rear axle clamp nut about 1 inch. Oil threads on axle with engine oil. Then screw clamp nut back on until nut touches thrust washer. Tighten clamp screw just enough to keep clamp nut from spreading while it is tightened. Use a 4-foot extension on wrench and tighten nut until bearings are tight (fig. 124). Back off the clamp nut  $\frac{1}{6}$  turn for bearing clearance, and tighten clamp screw.

**(5) INSTALL SPROCKET GUARD AND END COVER.**

**WRENCH**, open-end,  $\frac{7}{8}$ -in.

**WRENCH**, socket,  $\frac{15}{16}$ -in.

Install spacers between guard and truck frame when putting guard on tractor. Install end cover last.

Section XXI

TRACKS AND TRUCK FRAME ASSEMBLY

	Paragraph
Description .....	110
Track release mechanism .....	111
Truck wheels .....	112
Track support rollers .....	113
Pintles .....	114

**110. DESCRIPTION.**

a. The track assembly includes track rails, shoes, and street plates. The pins and bushings in the track rails are of hardened steel and are pressed into the side bars of the tracks. The master pin is a little longer than the other pins and has a special bushing. When necessary to remove track assembly, this pin is ordinarily removed to split the tracks. The 18-inch track shoes are bolted to rails with special hardened bolts and street plates are bolted to the shoes.

b. The truck frame assembly includes the truck frame, track release mechanism, front idlers, truck wheels, and track support rollers. The truck wheels, five on each side, carry the weight of the tractor, except when crossing obstacles, when part of the weight of the tractor may be supported on the front idlers and sprockets.

**111. TRACK RELEASE MECHANISM.**

a. **Description.** The track release mechanism contains a bell crank and coil spring assembly which allows front idlers to move back to loosen track and prevent severe strain or breakage if rocks, tree limbs, or other objects should be caught in the track. The idler brackets are free to slide on truck frame. Shims are provided between each side of front idler brackets and track release yoke for track alinement purposes. Adjustment of tracks is made with an adjusting screw in track release yoke.

**b. Track Adjustment.**

WRENCH, open-end, 7/8-in.

WRENCH, socket, 15/16-in.

WRENCH, socket, 3/4-in.

WRENCH, track, adjusting

(1) **LOOSEN CLAMP BOLTS.**

WRENCH, open-end, 7/8-in.

WRENCH, socket, 15/16-in.

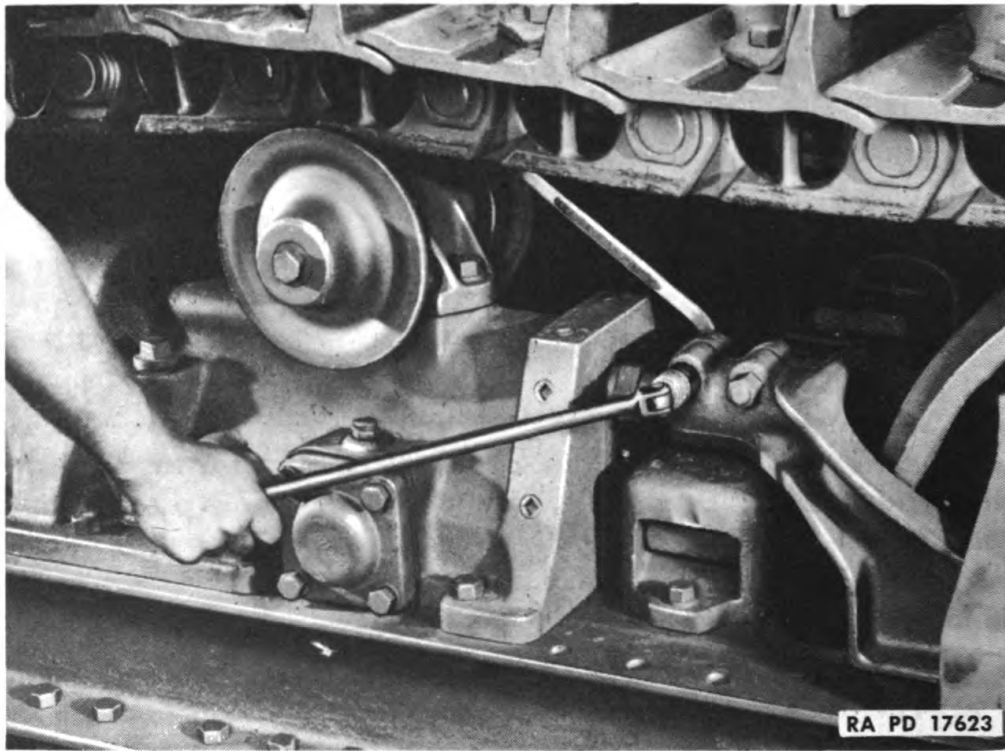
Loosen the nuts on clamp bolts in track release yoke (fig. 118).

(2) **ADJUST TRACKS (fig. 126).**

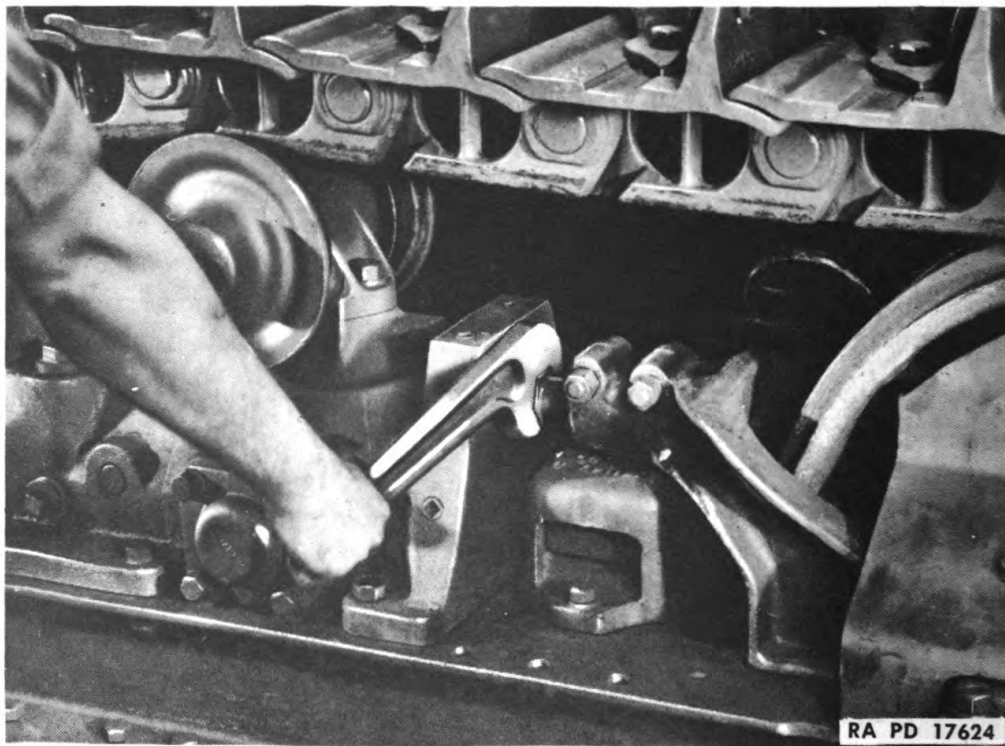
WRENCH, track, adjusting

Turn the adjusting screw out of the yoke to force the front idler ahead and tighten the track. Turn it into the yoke to allow the idler to move

**MEDIUM TRACTOR M1**



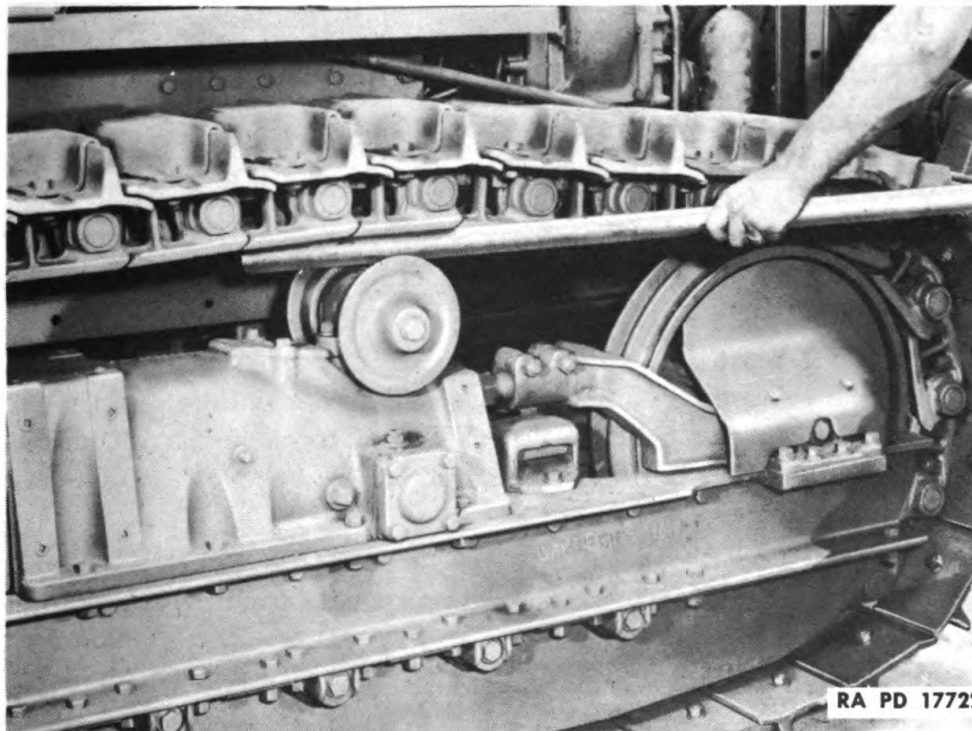
**Figure 125—Loosening Clamp Bolts in Track Release Yoke**



**Figure 126—Adjusting Track**

**TRACKS AND TRUCK FRAME ASSEMBLY**

back and loosen the track. Track is properly adjusted when it can be lifted about 2 inches off support roller with bar (fig. 127). Drive tractor back and forth a few times after making adjustment. This gives idlers a chance to move out if brackets are binding on truck frame. Then check adjustment again with bar. If driving the tractor back and forth makes no change in track tension, tighten the clamp bolts in track release yoke.



**Figure 127—Testing Track Adjustment**

(3) **CHECK TRACK ALINEMENT.** Observe if inside of track rail is rubbing on either flange of front idler. If it is, the idler should be alined. Some of the shims between front idler brackets and track release yoke should be removed from side on which rail is rubbing and added to side on which rail is not wearing until idler is in alinement and there is clearance between each flange and inside of rail.

(4) **ALINE FRONT IDLER.**

**WRENCH**, socket,  $\frac{3}{4}$ -in.

Remove 2 cap screws from each guard and lift off idler guard. Remove 2 cap screws from each idler bracket holding track release yoke to brackets. Change correct amount of shims from one side to the other to aline front idler. Install cap screws in idler bracket and install idler guard.



**MEDIUM TRACTOR M1**

**112. TRUCK WHEELS.**

**a. Description.** The truck wheels are equipped with tapered roller bearings and positive oil seals. The positive oil seals prevent dirt or water from entering wheels and oil from leaking out. The seal assemblies consist of finely machined steel rings, one held stationary and one turning with wheel, held tightly against each other with synthetic rubber seal boots so that oil or dirt cannot pass between them. Three truck wheels on each side have flanges on outside only; two have double flanges.

**b. Removal.**

**BLOCKS**, wood, 8- x 8-in. (2)      **WRENCH**, socket,  $1\frac{5}{16}$ -in.  
**WRENCH**, open-end,  $\frac{7}{8}$ -in.      **WRENCH**, track, adjusting

**(1) LOOSEN TRACKS.**

**WRENCH**, open-end,  $\frac{7}{8}$ -in.      **WRENCH**, track, adjusting  
**WRENCH**, socket,  $1\frac{5}{16}$ -in.

Loosen clamp bolts holding track adjusting screw. Turn screw into track release yoke until track sags (figs. 125 and 126).

**(2) DRIVE TRACTOR UP ON BLOCKS.**

**BLOCKS**, wood, 8- x 8-in. (2)

Drive tractor forward on first block so that block will be slightly back of front idler. Then back tractor onto second block and track will sag to ground (fig. 128). Set brakes on tractor.

**(3) REMOVE TRUCK WHEEL GUARD.**

**WRENCH**, open-end,  $\frac{7}{8}$ -in.      **WRENCH**, socket,  $1\frac{5}{16}$ -in.

Remove the 9 nuts from bolts holding outside truck wheel guard to truck frame and remove guard.

**(4) REMOVE TRUCK WHEEL ASSEMBLY.**

**WRENCH**, open-end,  $\frac{7}{8}$ -in.      **WRENCH**, socket,  $1\frac{5}{16}$ -in.

Remove 4 bolts holding truck wheel brackets to truck frame. Tap brackets with hammer or pry down with small bar. Truck wheel assembly will drop down out of frame and can be removed (fig. 128). **NOTE:** In some cases it may be necessary to loosen bolts holding inside truck wheel guard.

**c. Installation.**

**WRENCH**, open-end,  $\frac{7}{8}$ -in.      **WRENCH**, track, adjusting  
**WRENCH**, socket,  $1\frac{5}{16}$ -in.

**(1) INSTALL TRUCK WHEEL ASSEMBLY IN FRAME.**

**WRENCH**, open-end,  $\frac{7}{8}$ -in.      **WRENCH**, socket,  $1\frac{5}{16}$ -in.

Place truck wheel in position, inserting inside end of truck wheel through slot in inside truck wheel guard. Hold brackets against frame and install bolts through frame and brackets. **NOTE:** End of truck wheel with plug should be outside. Counting from front of frame, truck wheels 1, 3 and 5 are single flanged; 2 and 4 are double flanged.

TRACKS AND TRUCK FRAME ASSEMBLY

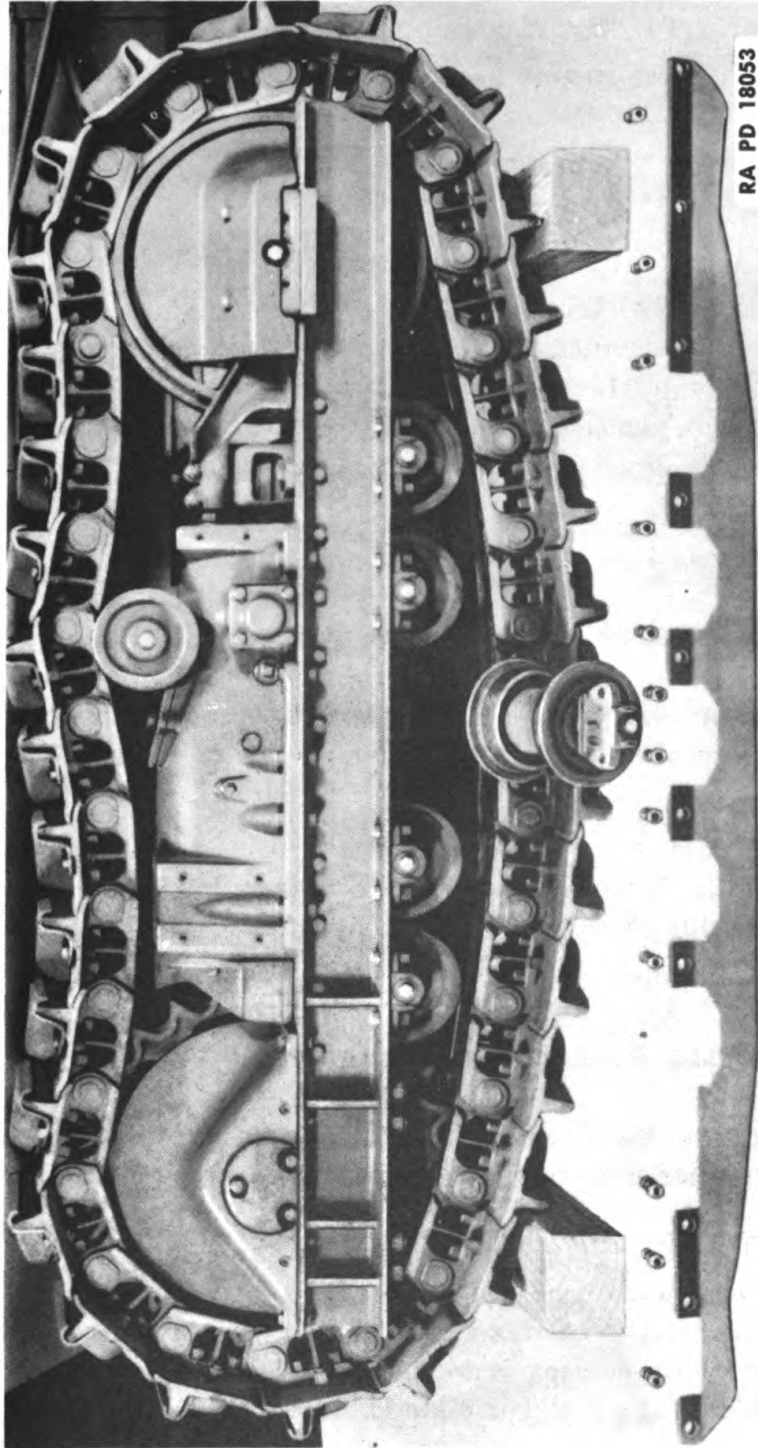


Figure 128—Truck Wheel Removed

**MEDIUM TRACTOR M1**

**(2) INSTALL TRUCK WHEEL GUARD.**

**WRENCH**, open-end,  $\frac{7}{8}$ -in.      **WRENCH**, socket,  $1\frac{5}{16}$ -in.  
Place guard in position and install bolts.

**(3) DRIVE TRACTOR OFF BLOCKS AND ADJUST TRACKS.**

**WRENCH**, open-end,  $\frac{7}{8}$ -in.      **WRENCH**, track, adjusting  
**WRENCH**, socket,  $1\frac{5}{16}$ -in.

Drive tractor off blocks onto floor, and adjust tracks as explained in paragraph 111 h.

**113. TRACK SUPPORT ROLLERS.**

**a. Description.** The track support rollers and the truck wheels are of similar construction. They are single flange rollers supported on brackets on top of the track release housings. Instead of having 2 brackets on the ends of the shaft like the truck wheels, the track support roller has one bracket in the center which is bolted to the support bracket.

**b. Removal.**

**JACK**      **WRENCH**, socket,  $\frac{7}{8}$ -in.

**(1) RAISE TRACK.**

**JACK**  
Set jack on track release housing and jack track up off support roller far enough to allow removal of roller.

**(2) REMOVE ROLLER.**

**WRENCH**, socket,  $\frac{7}{8}$ -in.  
Remove the 2 cap screws and lock washers holding roller to support bracket and lift off roller assembly (fig. 129).

**c. Installation.**

**JACK**      **WRENCH**, socket,  $\frac{7}{8}$ -in.

**(1) INSTALL ROLLER ASSEMBLY.**

**JACK**  
With jack on track release housing holding center of track up, install roller in position and install cap screws and lock washers. Remove jack.

**114. PINTLES.**

**a. Description.**

**(1)** This tractor carries two standard design pintles at the rear. The lower pintle housing is welded to a drawbar which is bolted to a drawbar plate. The drawbar plate is bolted to the rear of the transmission case.

**(2)** The upper pintle is secured to a plate which is bolted to the rear of the transmission case and braced by steel tubing. The tubing is bolted at the bottom to the lower pintle drawbar plate.

TRACKS AND TRUCK FRAME ASSEMBLY

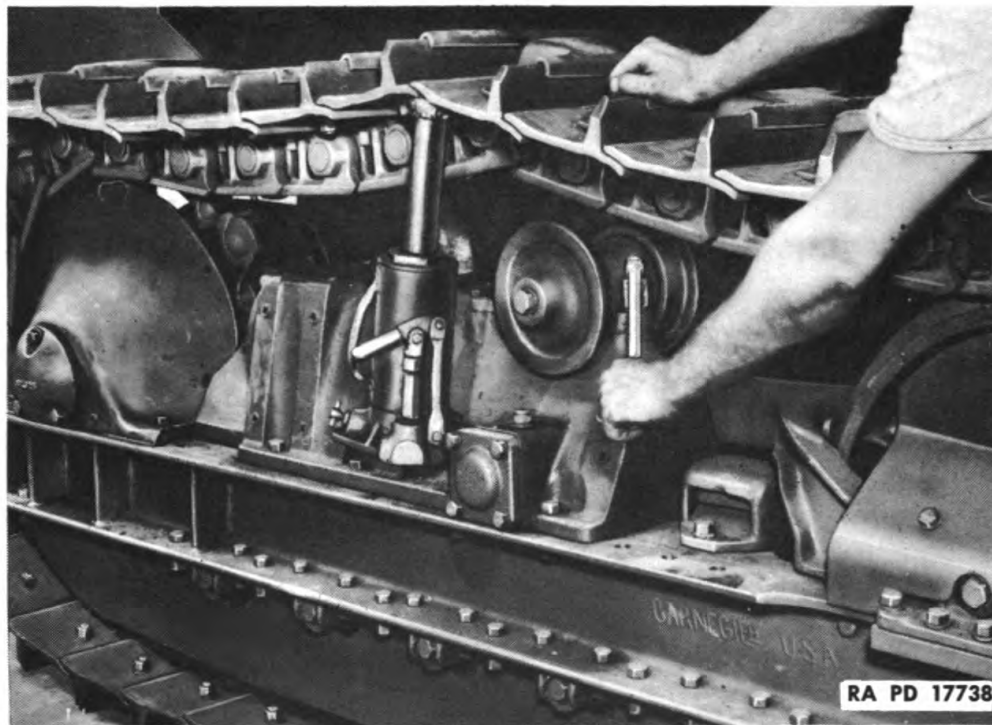


Figure 129—Removing Track Support Roller

**b. Removal of Pintle Drawbar Assembly.**

BAR, 3-ft

CHISEL,  $\frac{3}{4}$ -in.

HAMMER, 2-lb

PUNCH, small

WRENCH,  $1\frac{7}{16}$ -in.

WRENCH, open-end, 2 $\frac{1}{2}$ -in.

WRENCH, socket,  $1\frac{5}{16}$ -in.

**(1) REMOVE PINTLE FROM DRAWBAR.**

BAR, 3-ft

HAMMER, 2-lb

PUNCH, small

WRENCH, open-end, 2 $\frac{1}{2}$ -in.

Remove cotter pin from nut (hammer and punch). Hold nut with 2 $\frac{1}{2}$ -inch wrench and with bar through pintle hook, turn shaft out of nut. Remove washer and pull pintle from drawbar.

**(2) REMOVE DRAWBAR.**

CHISEL,  $\frac{3}{4}$ -in.

HAMMER, 2-lb

WRENCH,  $1\frac{7}{16}$ -in.

WRENCH, socket,  $1\frac{5}{16}$ -in.

Remove cotter pins from 2 bolts holding drawbar to drawbar plate (pliers). Remove the bolts ( $1\frac{5}{16}$ - and  $1\frac{7}{16}$ -in. wrenches). Straighten screw locks on cap screws holding drawbar stirrup at front end of drawbar to bottom of transmission case (hammer and chisel). Remove the 4 cap screws from stirrup ( $1\frac{5}{16}$ -in. wrench). Remove drawbar and stirrup from tractor. Remove front drawbar pin to separate drawbar and stirrup.

**MEDIUM TRACTOR M1**

**c. Installation of Pintle and Drawbar Assembly.**

- |   |  |
|---|--|
| <b>BAR, 3-ft</b>                            | <b>WRENCH, 1<math>\frac{7}{16}</math>-in.</b>          |
| <b>CHISEL, <math>\frac{3}{4}</math>-in.</b> | <b>WRENCH, open-end, 2<math>\frac{1}{2}</math>-in.</b> |
| <b>HAMMER, 2-lb</b>                         | <b>WRENCH, socket, 1<math>\frac{5}{16}</math>-in.</b>  |
| <b>PLIERS</b>                               |  |

**(1) INSTALL DRAWBAR.**

- |   |  |
|---|--|
| <b>CHISEL, <math>\frac{3}{4}</math>-in.</b> | <b>WRENCH, 1<math>\frac{7}{16}</math>-in.</b>          |
| <b>HAMMER, 2-lb</b>                         | <b>WRENCH, socket, 1<math>\frac{5}{16}</math>-in.</b>  |
| <b>PLIERS</b>                               | <b>WRENCH, open-end, 2<math>\frac{1}{2}</math>-in.</b> |

Insert front end of drawbar into stirrup and insert front drawbar pin. Place drawbar in position on drawbar plate. Using new screw locks, secure stirrup on front end of drawbar to bottom of transmission case with 4 cap screws (1 $\frac{5}{16}$ -in. wrench). Bend screw locks around cap screw heads (hammer and chisel). Install 2 cap screws with lock washers in rear end of drawbar and drawbar plate (1 $\frac{5}{16}$ - and 1 $\frac{7}{16}$ -in. wrenches). Install cotter pins through bolts (pliers).

**(2) INSTALL PINTLE.**

- |                  |  |
|------------------|--|
| <b>BAR, 3-ft</b> | <b>WRENCH, open-end, 2<math>\frac{1}{2}</math>-in.</b> |
| <b>PLIERS</b>    |  |

Insert shaft into drawbar. Place washer on shaft and start nut. Hold nut with 2 $\frac{1}{2}$ -inch wrench and turn shaft into nut with bar through pintle hook. Install cotter pin through nut and shaft (pliers).

**d. Removal of Pintle and Bracket Assembly.**

- |  |  |
|--|--|
| <b>BAR, 3-ft</b>                                 | <b>WRENCH, 1<math>\frac{1}{8}</math>-in.</b>           |
| <b>HAMMER, 2-lb</b>                              | <b>WRENCH, open-end, 2<math>\frac{1}{2}</math>-in.</b> |
| <b>PLIERS</b>                                    | <b>WRENCH, socket, 1<math>\frac{5}{16}</math>-in.,</b> |
| <b>PUNCH, small</b>                              | <b>with long extension</b>                             |
| <b>WRENCH, <math>\frac{9}{16}</math>-in. (2)</b> |  |

**(1) REMOVE WINCH DRIVE SHAFT SPROCKET GUARD.**

- WRENCH,  $\frac{9}{16}$ -in.**

Remove 4 bolts holding guard to pintle bracket and top fender.

**(2) REMOVE PINTLE.**

- |                     |  |
|---------------------|--|
| <b>BAR, 3-ft</b>    | <b>PUNCH, small</b>                                    |
| <b>HAMMER, 2-lb</b> | <b>WRENCH, open-end, 2<math>\frac{1}{2}</math>-in.</b> |

Remove cotter pin from pintle nut (hammer and punch). Hold nut with 2 $\frac{1}{2}$ -inch wrench, insert bar through pintle hook and turn shaft out of nut. Remove washer and pull pintle from bracket.

**(3) DISCONNECT WINCH DRIVE CHAIN.**

- |                     |  |
|---------------------|--|
| <b>HAMMER, 2-lb</b> | <b>PLIERS</b>  |
| <b>PUNCH, small</b> | <b>WRENCH, open-end, 2<math>\frac{1}{2}</math>-in.</b> |

Remove cotter pins from both pins of one chain link (pliers). Hold 2 $\frac{1}{2}$ -inch wrench back of chain and drive this link out of chain (hammer and punch). Remove chain from sprockets.

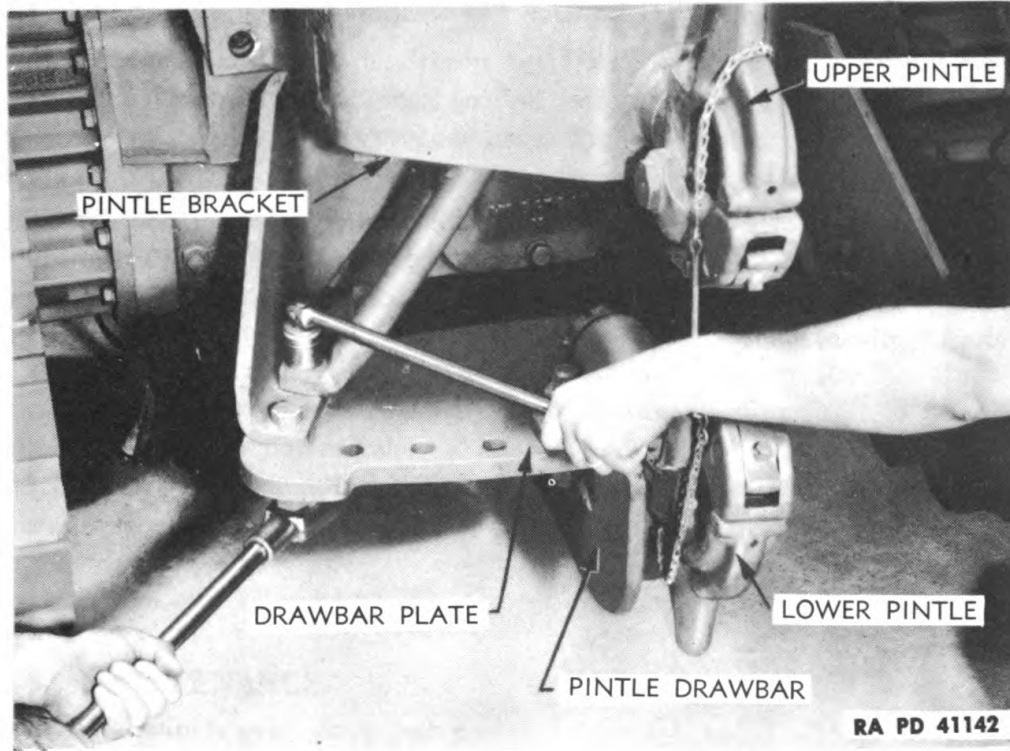
**TRACKS AND TRUCK FRAME ASSEMBLY**

**(4) REMOVE BRACKET.**

**WRENCH, 1 1/8-in.**

**WRENCH, socket, 1 5/16-in.,  
with long extension**

Remove 2 cap screws holding lower bracket arms to drawbar plate and brace (1 1/8- and 1 5/16-in. wrenches) (fig. 130). Remove 4 cap screws holding bracket to rear of transmission case (1 5/16-in. wrench) and lift off bracket.



**Figure 130—Removing Pintle Bracket**

**e. Installation of Pintle and Bracket Assembly.**

**BAR, 3-ft**

**WRENCH, open-end, 2 1/2-in.**

**PLIERS**

**WRENCH, socket, 1 5/16-in.,**

**WRENCH, 9/16-in. (2)**

**with long extension**

**WRENCH, 1 1/8-in.**

**(1) INSTALL PINTLE BRACKET.**

**WRENCH, 1 1/8-in.**

**WRENCH, socket, 1 5/16-in.,  
with long extension**

Install pintle bracket in place. Install the 4 cap screws with lock washers holding pintle bracket to transmission case (1 5/16-in. wrench), and 2 bolts and high nuts holding pintle bracket to drawbar plate (1 1/8- and 1 5/16-in. wrenches).

**MEDIUM TRACTOR M1**

**(2) INSTALL WINCH DRIVE CHAIN.**

**PLIERS**

Install drive chain over sprockets. Install connecting link in chain and place keeper on link pins. Secure with 2 cotter pins in link pins (pliers).

**(3) INSTALL DRIVE CHAIN GUARD.**

**WRENCH,  $\frac{9}{16}$ -in. (2)**

Install sprocket guard with 2 bolts with flat washers and lock washers in pintle bracket, and 2 bolts with flat washers and lock washers in left top fender (2  $\frac{9}{16}$ -in. wrenches).

**(4) INSTALL PINTLE.**

**BAR, 3-ft**

**WRENCH, open-end, 2½-in.**

**PLIERS**

Insert shaft of pintle in bracket. Place washer on shaft and start nut. Hold nut with 2½-inch wrench and turn shaft into nut and tighten with bar inserted through pintle. Install cotter pin through nut and shaft (pliers).

Section XXII

WINCH AND POWER TAKE-OFF

	Paragraph
Description .....	115
Maintenance .....	116

115. DESCRIPTION.

a. **Winch.** The winch, with 300 feet of 3/4-inch cable, is mounted on front of tractor and is driven by the power take-off on rear of tractor. Drive shafts, supported in ball bearings on side of tractor, run from rear of tractor to winch gear case. The drum is driven by a worm and gear through a jaw clutch. This gear reduction makes possible the maximum pull on cable. The jaw clutch is engaged and disengaged by a control lever on right fender. The winch drum brake used for controlling drum is operated by a lever on right fender of tractor. There is also an automatic brake assembly on winch worm shaft.

b. **Power Take-Off.** The power take-off is driven by the top transmission shaft. A splined coupling connects transmission shaft to power take-off shaft. The power take-off is of the reversible type and can turn winch drum for unwinding cable from drum as well as for winding cable on drum. The shifter shaft is operated by a control lever ahead of operator's seat for putting power take-off in winding, unwinding, or neutral position.

116. MAINTENANCE.

a. The winch gear case and power take-off housing should be kept filled with lubricant to level of the oil level plugs (sec. IV, lubrication). Drum bearings and winch drive shaft bearings and universals should be lubricated after every day's operation of the winch. The breather cap on top of power take-off housing should be washed periodically in clean fuel oil.

b. Winch drum brake and automatic winch worm shaft safety brake should be kept in adjustment. The winch drum brake will require very little adjustment. If adjustment is required, the brake may be tightened or loosened by shortening or lengthening the control rod running back to the control lever on the fender. If automatic winch worm shaft safety brake fails to hold load when winch is stopped, adjust as follows.

c. **Adjustment of Winch Worm Safety Brake.**

- |                            |                            |
|----------------------------|----------------------------|
| PLIERS                     | WRENCH, open-end, 9/16-in. |
| WRENCH, open-end, 7/16-in. | WRENCH, socket, 3/4-in.    |
| (2)                        | WRENCH, socket, 9/16-in.   |

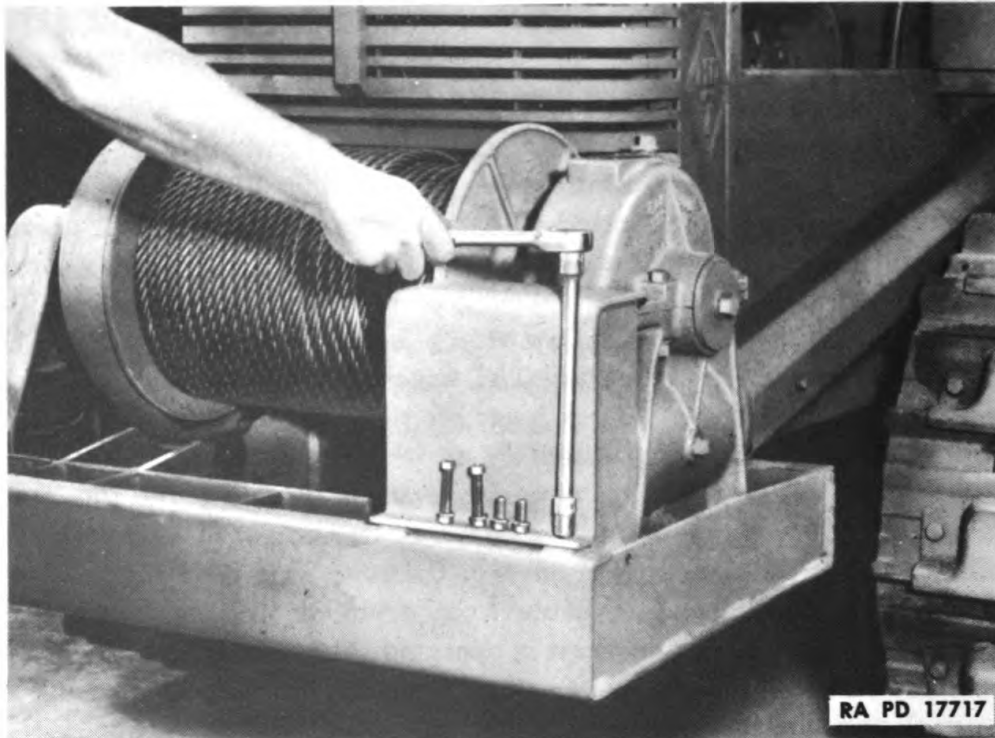


**MEDIUM TRACTOR M1**

**(1) REMOVE WINCH WORM BRAKE GUARD.**

**WRENCH**, open-end,  $\frac{9}{16}$ -in.      **WRENCH**, socket,  $\frac{9}{16}$ -in.

Remove 4 cap screws and 2 bolts which secure guard (fig. 131) and lift off guard.



**Figure 131—Removing Winch Worm Brake Guard**

**(2) REMOVE COVER FROM GEAR CASE.**

**PLIERS**

Remove 2 wing nuts and remove top half of cover (fig. 132).

**(3) ADJUST BRAKE (fig. 133).**

**WRENCH**, open-end,  $\frac{7}{16}$ -in. (2)

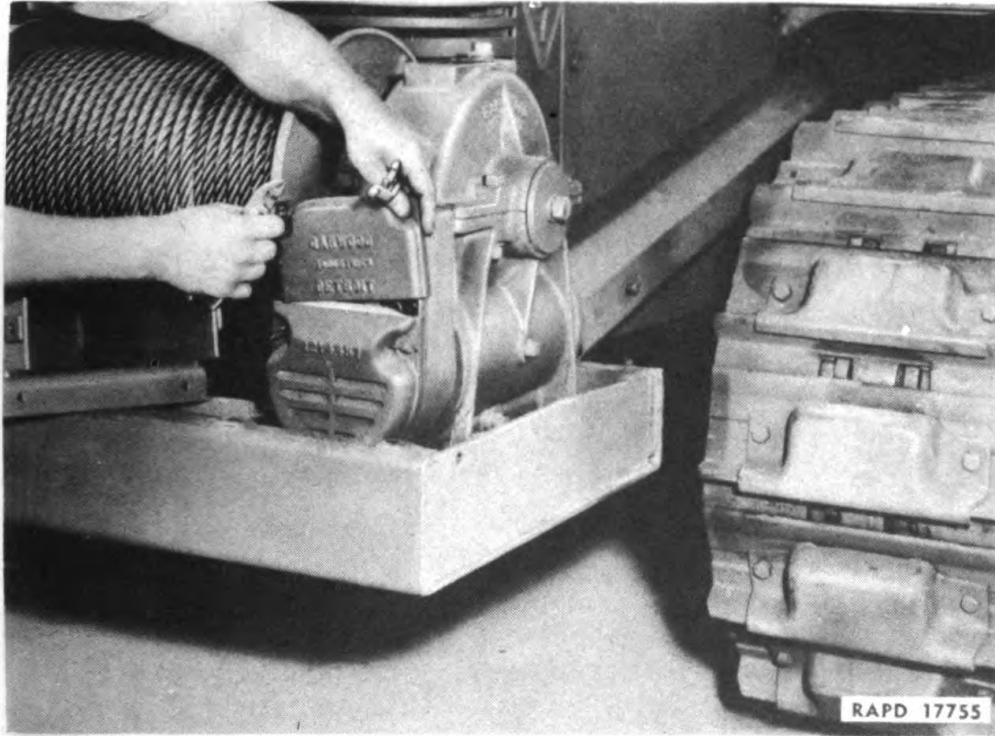
Tighten nut "A" on brake spring  $\frac{1}{2}$  turn, tighten lock nut and test brake. Tighten another  $\frac{1}{2}$  turn if brake still fails to hold load when winch is stopped. **CAUTION:** Do not tighten more than necessary, as brake will run hot and lining of brake band will wear excessively as a result. A clearance of  $\frac{1}{16}$  inch should be maintained between nut and shoulder at point "B." This clearance can be adjusted with the two nuts "C."

**d. Removal of Cable.**

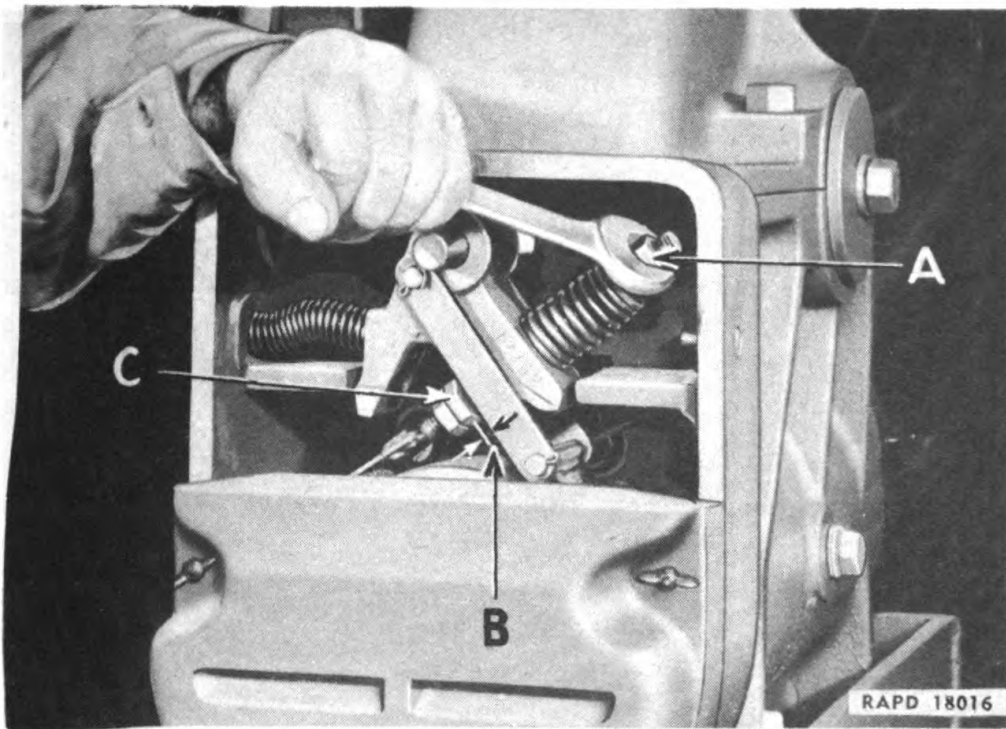
**WRENCH**, socket,  $\frac{3}{4}$ -in.

**(1) UNREEL CABLE FROM DRUM.** Unreel balance of cable if any is remaining on drum.

**WINCH AND POWER TAKE-OFF**



**Figure 132—Removing Winch Worm Brake Cover**



**Figure 133—Adjusting Winch Worm Brake**

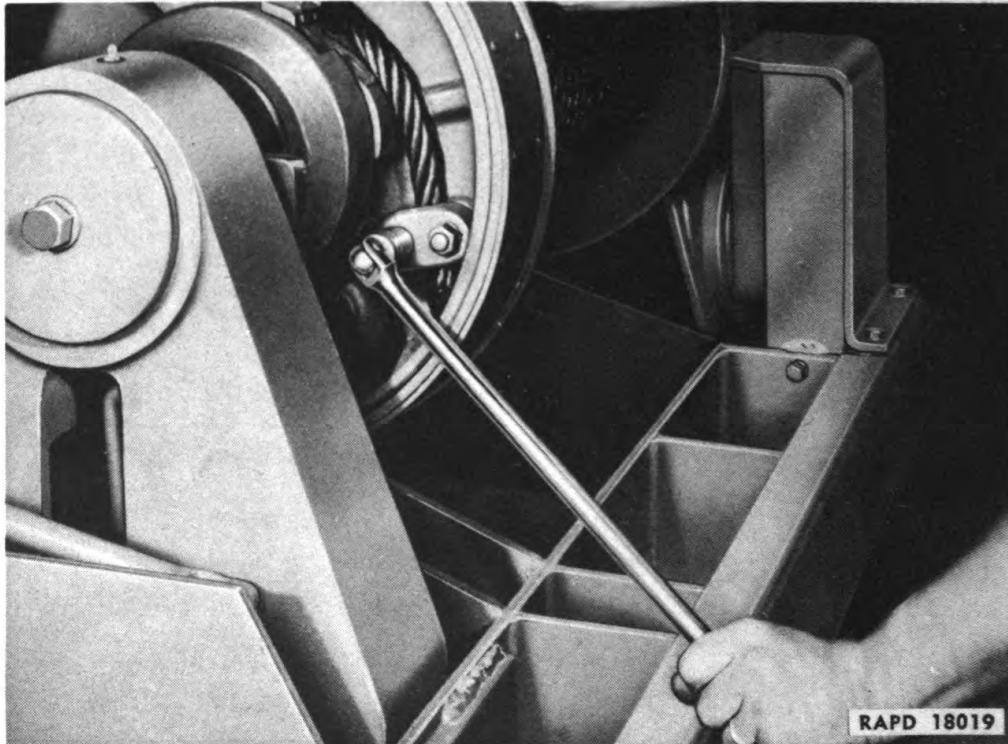
test  
inch  
fe

**MEDIUM TRACTOR M1**

**(2) REMOVE CLAMPS.**

**WRENCH, socket,  $\frac{3}{4}$ -in.**

Remove the 2 nuts and clamp from end of cable and pull end of cable out through hole in flange of drum (fig. 134).



**Figure 134—Removing Cable Clamp**

**e. Installation of Cable.**

**WRENCH, socket,  $\frac{3}{4}$ -in.**

**(1) INSTALL CABLE.** Start end of cable underneath drum, and around the drum to the hole in flange of drum. Pull about 8 inches of cable through hole.

**(2) INSTALL CLAMP.**

**WRENCH, socket,  $\frac{3}{4}$ -in.**

Place clamp over cable, install the clamp nuts, and tighten, having about 2 inches of cable extending through clamp (fig. 134).

**(3) WIND CABLE ON DRUM.** Start engine and wind cable on drum. Keep cable taut while winding and lay each coil tightly against the one before it.

Section XXIII

COLD WEATHER LUBRICATION AND SERVICE

	Paragraph
General .....	117
Fuels for low temperature .....	118
Preparation and lubrication for continuous operation below 0 F .....	119
Protection of cooling system .....	120
Mechanical condition of vehicles .....	121
Cold weather accessories .....	122

**117. GENERAL.**

a. Operation of automotive equipment at sub-zero temperatures presents problems that demand special precautions and careful extra servicing if poor performance and possible total functional failure is to be avoided.

b. Extreme care must be exercised whenever a vehicle or parts are moved from a warm place into sub-zero temperatures as any moisture on surfaces will freeze there.

**118. FUELS FOR LOW TEMPERATURE.**

a. Many fuels suitable for Diesel engines operated in warm weather contain waxes that congeal at temperatures below 0 F. Congealed wax clogs fuel strainers and prevents fuel flow to the pump. Fuels for sub-zero operation are free from these materials. Therefore, Diesel fuel (U. S. Army Specification 2-102) will be used at low temperatures.

b. If emergency demands procurement of commercial fuel extreme care will be taken, if practicable, to see that the cloud point is 10 degrees lower than the lowest atmospheric temperature anticipated. Otherwise the fuel will not flow to the injectors in quantities sufficient for engine operation.

c. Water in Diesel fuel will freeze and stop fuel flow in the fuel pump. The following precautions should be taken to avoid formation of ice:

(1) Keep tank full as possible. The more fuel there is in the tank the less volume of air from which moisture can be condensed.

(2) Be sure that all containers are thoroughly clean, dry, and free from rust before storing fuel in them.

(3) If possible, after filling or moving a container, allow the fuel to settle 16 hours before filling vehicle tank with it.

(4) Keep all closures on containers tight to prevent snow, frost, or other foreign matter entering.

**MEDIUM TRACTOR M1**

**119. PREPARATION AND LUBRICATION FOR CONTINUOUS OPERATION BELOW 0 F.**

a. Lubrication of this vehicle at temperatures above 0 F is covered in section IV. The instructions contained in this section are to be followed only when temperatures below 0 F prevail.

b. Sub-zero temperatures affect both metals and lubricants. Therefore, special attention must be given to lubrication and servicing of equipment when such temperatures are encountered.

c. Shrouds and heaters are supplied and no oil dilution is necessary. For short shut down periods vehicle should be parked in a sheltered spot out of the wind if possible. If no shelter is available it will be helpful to park so that the vehicle is not facing the wind. For long periods of shut down as in bivouac, park vehicle in as sheltered a place as possible.

d. Starting in sub-zero weather is described in paragraph 12.

e. **Transmission and Gear Cases.** LUBRICANT, gear, universal, SAE 80, shall be used for temperatures above -20 F. Below -20 F LUBRICANT, gear, universal, SAE 80, diluted with the Diesel fuel in the proportion of 1 part fuel to 6 parts of lubricant shall be used.

f. Other lubrication points as track support rollers, are lubricated with LUBRICANT, gear, universal, above 0 F, no special attention is required.

(1) **UNIVERSAL AND SLIP JOINTS.** Lubricate with GREASE, general purpose, No. 00.

(2) **STEERING CLUTCH AND CLUTCH THROW-OUT BEARING.** Lubricate with GREASE, general purpose, No. 00. Under conditions of 0 F and below it may be necessary to service these bearings more frequently than for normal operation.

(3) All other places requiring GREASE, general purpose, shall be lubricated with OIL, engine, SAE 30. CAUTION: When temperatures below 0 F are no longer anticipated the above bearings must be lubricated immediately with GREASE, general purpose, proper seasonal grade.

**120. PROTECTION OF COOLING SYSTEM.**

a. **ETHYLENE GLYCOL** (Prestone) is prescribed for use as an antifreeze solution in vehicle radiators. If ethylene glycol is not available, other materials may be used. The following table gives three permissible materials and the quantity required to protect the cooling system of this vehicle.

**COLD WEATHER LUBRICATION AND SERVICE**

Freezing Point	Pints, ETHYLENE GLYCOL (Prestone)	*Pints, G.P.A., Radiator Glycerine	Pints Denatured Alcohol
10 F	19½	29	24½
0 F	24½	34	29
-10 F	29	34	34
-20 F	34	39	39
-30 F	39	49	49
-40 F	44	—	53½
-50 F	44	—	58½
-60 F	49	—	63½
-70 F	49	—	—

\*G.P.A. denotes Glycerine Producers Association.

b. Do not use alcohol if the other materials are available for the temperatures indicated. Denatured alcohol boils at 173 F. CAUTION: Do not mix antifreeze solutions.

c. The following precautions should be taken before installing the antifreeze solution.

(1) Thoroughly flush the cooling system. The radiator and the cylinder block should be flushed out separately in order not to transfer any residue from one unit to the other.

(2) Check the system for leaks; tighten the hose connections and replace, if necessary.

(3) Check thermostats.

(4) Use radiator covers to accelerate and maintain normal engine operating temperatures. These covers may be improvised locally.

(5) Check the fan belt for adjustment or weakness. Replace the belt if necessary. Do not use rubber fan belts at temperatures below -20 F. Use leather, fiber, or synthetic rubber fan belts.

**121. MECHANICAL CONDITION OF VEHICLES.**

**a. Electrical System.**

(1) **WIRING.** Check and clean all connections, especially the battery terminals. Care should be taken that no short circuits are present.

(2) **BATTERIES.**

(a) The efficiency of batteries decreases sharply with decreasing temperatures and becomes practically nil at -40 F. Do not try to start the engine with the battery when it has been chilled to temperatures below -30 F. See that the battery is always fully charged with the hydrometer reading between 1.275 and 1.300. A fully charged battery will not freeze at temperatures likely to be encountered even in arctic climates, but a fully discharged battery will freeze and rupture at 5 F.

## MEDIUM TRACTOR M1

(b) Do not add water to batteries when they have been exposed to sub-zero temperatures unless the battery is to be charged immediately afterward. If water is added and the battery is not put on charge, the layer of water will stay at the top and freeze before it gets a chance to mix with the acid.

(3) **LIGHTS.** Inspect the lights carefully. Check for short circuits and presence of moisture around sockets.

### b. Engine.

(1) Keep engine in the best mechanical condition.

(2) Inspect the fuel pump and ejectors frequently for wear.

(3) Water pump should have been serviced prior to the advent of cold weather.

(4) It is necessary to bypass the full flow engine oil filter.

(5) Only in extreme emergencies below 30 F may the fuel filters be removed if the flow of fuel to the filter is reduced to a point where engine operation is impaired.

(6) Remove and wash air cleaner screens in SOLVENT, dry-cleaning, and replace.

### c. Chassis.

(1) Brake bands, particularly on new vehicles, have a tendency to bind when they are very cold. Always have a blowtorch handy to warm these parts if they bind prior to moving or attempting to move the vehicle. Parking the vehicle with the brake released will eliminate most of the binding. Precaution must be taken under these circumstances to block the tracks or otherwise prevent movement of the vehicle.

(2) Inspect the vehicle frequently. The shock resistance of metals or resistance against breaking is greatly reduced at extremely low temperatures. Operation of vehicles on hard frozen ground causes strain and jolting which may result in screws breaking or nuts jarring loose.

(3) Disconnect mile meter (odometer) cable at drive end when operating vehicle at temperatures of -30 F and below. Cables often fail to work properly at these temperatures and sometimes break due to the excessive drag caused by cold oil.

## 122. COLD WEATHER ACCESSORIES.

a. Some cold weather accessories are included in the cold starting equipment supplied with the vehicle. Items listed below may be used to supplement this equipment for starting and operating at temperatures as low as -40 F.

(1) Insulated battery box with hot water coil in bottom.

**COLD WEATHER LUBRICATION AND SERVICE**

- (2) Auxiliary battery warming gasoline burning heater.
- (3) Insulated battery box with hot air ducts in each compartment.
- (4) Foot warmer heater or cab heater.
- (5) Shroud for engine compartment on entire vehicle.
- (6) Under chassis heater.
- (7) Radiator shutters and louver guards.
- (8) Special engine cooling thermostat.
- (9) Engine coolant heater.
- (10) Straps and hold-downs for cold weather equipment.
- (11) Special fuel pump.



**MEDIUM TRACTOR M1**

**Section XXIV**  
**STORAGE AND SHIPMENT**

	Paragraph
General .....	123
Limited storage .....	124
Placing vehicles in dead storage .....	125
Removing vehicles from dead storage .....	126
Preparation for shipment .....	127
Crating .....	128
Loading .....	129

**123. GENERAL.**

a. **Selection of Storage Site.** All motor vehicles not in use will be stored in covered or closed buildings whenever practicable. If exterior storage is necessary, the best available surface will be selected, taking into consideration, firmness, smoothness and drainage of terrain. Except when a tactical situation requires concealment, parking under low hanging limbs of trees will be avoided.

b. **Preparation for Storage.** Before being stored the vehicle and its equipment will be thoroughly cleaned, lubricated and inspected (secs. IV, V, and VI). When practicable the vehicles will be promptly repaired and placed in good operating condition. If repairs can not be made prior to placing of vehicles in storage, a tag will be attached to the steering lever specifying the repairs needed, and a written report of these items will be made to the officer in charge of the vehicles.

c. **Spacing of Vehicles in Park.** Sufficient space should be allowed between vehicles to provide accessibility for the routine inspections and servicing prescribed. Excessive spacing will be avoided in order to conserve space.

d. **Severe Conditions.** Special precautions should be taken for such severe conditions as: extreme temperatures, rapid change of temperature, humid or arid climate, dust, salty spray, corrosive vapors from nearby industrial plants, or other harmful conditions.

**124. LIMITED STORAGE.**

a. **Definition.** Vehicles in limited storage are those temporarily out of service for less than 30 days, or vehicles that must be ready for operation on call.

b. **Preparation for Limited Storage.**

(1) **BATTERIES.**

(a) Batteries that show signs of corrosion will be removed and cleaned

## STORAGE AND SHIPMENT

as follows: After plugging the vents in the cells, the battery case will be cleaned with a solution of SODA ASH or baking soda and water to neutralize the acid. The concentration of soda ash will be  $\frac{8}{8}$  ounces per gallon of water; if baking soda is used, the concentration will be 1 pound per gallon of water. After this treatment the case should be flushed with cold water. Do not use hot water or steam. Remove plugs from the vents after cleaning. Terminals and cable ends will be thoroughly cleaned with neutralizing solution and scraped clean with suitable tool or wire brush.

(b) Terminals of all batteries will be coated with COMPOUND, rust-preventive, light. Hydrometer readings of each cell will also be taken. Distilled water or its nearest equivalent will be added to cover the plates, but not in excess of  $\frac{3}{8}$  inch above separators. If hydrometer readings are 1.225 or less, the battery will be charged.

(c) If sub-zero temperatures are anticipated a higher state of charge, suitable for the anticipated temperature will be maintained.

(2) COOLING SYSTEM. If freezing temperature is normally expected during the storage period, the coolant will be tested with an antifreeze hydrometer and the proper quantity of antifreeze will be added to afford protection from freezing at the lowest temperature anticipated during the storage period (par. 120). The cooling system will be inspected for leaks.

(3) ROAD TESTS. The preparation for storage will include a road test of at least 5 miles after the battery and cooling system service to check on general condition of the vehicle. Any defects discovered will be corrected or noted as specified in paragraph 123 b.

(4) ENGINE. The engine will be prepared for storage as follows.

(a) Check the engine oil and replenish, if necessary. Use the recommended grade for temperatures anticipated during storage period (sec. IV or XXIII).

(b) Drain fuel tank.

(c) Prepare a mixture of 20 percent OIL, lubricating, preservative, medium, and 80 percent Diesel fuel. Prepare enough of this mixture to operate the vehicle for 15 minutes. Pour mixture into fuel tank and run the engine at fast idling speed for 15 minutes.

(d) Drain the fuel system.

(5) BRAKES. Brakes will be released and the tracks chocked. Air tank will be thoroughly drained by fully opening drain cock. When no water shows in air stream, close drain cock tightly.

(6) EXTERIOR.

(a) Rust appearing on any part of the vehicle before storage will be

**MEDIUM TRACTOR M1**

removed with sandpaper. Painted surfaces will be repainted wherever necessary to protect the metal.

(b) Exposed polished metal surfaces susceptible to rust will be coated with OIL, lubricating, preservative, medium.

(c) Winch, cables, and chains will be coated with OIL, lubricating, preservative, medium.

(d) Equipment such as pioneer and truck tools, street plates, and fire extinguishers will remain in place in the vehicle.

(7) AIR COMPRESSOR. Check oil level, replenish if necessary. Use the recommended grade for temperatures anticipated during storage period.

**c. Inspections in Limited Storage.**

(1) Vehicles in limited storage will be inspected weekly with the following as a minimum.

(a) Repeat the battery service described in b (1) above. If water is added when freezing weather is anticipated, recharge the battery with a portable charger or remove the battery for charging. Do not attempt to charge the battery by running the engine.

(2) Vehicles in "on call" limited storage for more than 30 days will receive the following service at monthly intervals, in addition to the weekly inspection.

(a) Remove the oil filler cap, fill fuel tank, and start the engine. Observe the oil pressure gage. If no pressure is registered, shut off the engine and report this fact to the officer in charge. If oil pressure is registered, allow the engine to idle. When the radiator temperature reaches 180 F (if necessary cover the radiator to obtain this temperature) advance the throttle to a fast idling speed, not to exceed 800 revolutions per minute, and allow the engine to continue running at this speed and temperature for 30 minutes. After shutting off the engine install the oil filler cap. CAUTION: If the cooling system contains a volatile antifreeze, the amount of liquid will be checked every 5 minutes and more added, if necessary.

(b) Repeat the cooling system service outlined in b (2) above.

(c) Repeat the engine service outlined in b (4) above.

(d) Repeat to the extent required, the exterior service outlined in b (6) above.

**d. Inspection When Removed From Limited Storage.** Upon removal from storage any item noted by a tag attached to the steering lever as still needing repair (par. 123 b) will be repaired and the vehicle will be given a complete monthly maintenance inspection, plus any repairs which this inspection shows necessary.

**STORAGE AND SHIPMENT****125. PLACING VEHICLES IN DEAD STORAGE.**

a. **Definition.** Vehicles in dead storage are those that will not be required for service over an indefinite period exceeding 30 days.

b. **Engine.**

(1) **CRANKCASE.** The crankcase will be drained while the engine is still warm. The oil will be drained from the engine by removing drain plugs from the crankcase. The oil screen will be removed, cleaned, and reinstalled in the engine. Drain plugs will then be reinstalled in the engine. Fill crankcase with  $\frac{1}{2}$  charge of OIL, lubricating, preservative, medium. Run engine for 15 minutes at approximately 1,000 revolutions per minute. Leave preservative in crankcase.

(2) **FUEL SYSTEM.** The fuel tank will be drained and the fuel system purged with a mixture prepared as shown below, a quantity of which will remain in the system when the engine is shut down for storage. Proceed as follows:

(a) Prepare a mixture of 20 percent OIL, lubricating, preservative medium, and 80 percent Diesel fuel.

(b) Drain and clean fuel filters and fuel tanks.

(c) Place approximately 2 gallons of the fuel oil mixture in tanks and run engine at normal speed until the 2 gallons of fuel oil mixture are nearly exhausted. Leave the remaining oil in the fuel system.

(3) **CYLINDERS.**

(a) The cylinder wall, piston heads, and valves will be treated with OIL, lubricating, preservative, medium.

(b) *Remove Injectors.* The engine will be cranked by hand until each piston is placed on bottom center and the inside of that cylinder will be sprayed through injector opening in head with approximately  $\frac{1}{8}$  pint (2-oz) of OIL, lubricating, preservative, medium. Following the above, the crankshaft will be rotated by hand at least two complete revolutions and the cylinder space above each piston will be resprayed with approximately  $\frac{1}{16}$  pint (1-oz) of the OIL, lubricating, preservative, medium. Do not rotate the crankshaft after this treatment.

(c) *Injector.* The injectors will be removed and cleaned while the valves and cylinders are being treated with the Preservative. Clean injectors in SOLVENT, dry-cleaning. Dry thoroughly and dip in preservative. After the corrosion preventive treatment is completed, coat the injector holes with the preservative and install the injectors in the engine. Care must be taken not to damage the injectors. Diesel engine injectors will remain in the engine during shipping and storage.

**MEDIUM TRACTOR M1**

c. **Valves and Rocker Arms.** Remove rocker arm cover and thoroughly clean interior of cover, rocker arms, and control rack. Spray with OIL, lubricating, preservative, medium, while the crankshaft is being rotated, so that the entire surface of the rocker arms, control rack and the protruding ends of the valve stems will be coated thoroughly. Spray the interior of the cover and replace.

d. **Cooling System.** Drain and flush cooling system, including both radiator and engine block ( par. 73). Compressed air, if available, will be blown into the outlet passages forcing the moisture down and out of the inlet passage.

e. **Openings.** All coolant passage openings, fuel and oil lines, open connections, or other openings will be coated with preservative. Threaded openings will be coated with preservative. Plug all openings. If tapered plugs are used, they will be so constructed that they cannot be accidentally pushed or driven completely into the openings. If plugs are not available, tubes, or pipes and most other openings can be sealed satisfactorily by covering with a small piece of oiled or waxed paper. Gather the ends of the paper around the tube and tie with cord. The air pre-cleaners can be sealed by covering with a paper bag and tying a cord around the intake stack.

**f. Exterior.**

(1) The exterior of the engine will be thoroughly cleaned and dried. Material used for cleaning must not have a harmful effect on the exterior of the engine. A coating of COMPOUND, rust-preventive, light, will be applied to all unpainted steel parts. Rust appearing on any parts before storage will be removed with sandpaper, and the metal either painted or lightly coated with rust-preventive compound.

(2) Care must be taken to remove rust-preventive compound from exposed rubber and painted parts.

**g. Battery.**

(1) Remove the battery from the vehicle and service as outlined in paragraph 124 b (1).

(2) Place the battery in active stock. Never allow batteries in stock to become discharged below a hydrometer reading of 1.225. This will be a proper precaution against freezing in all but the most severe weather, when a specific gravity of 1.250 will be maintained.

**h. Air Compressors.** Drain lubricating oil at the same time oil in engine crankcase is drained. Replace drain plug and fill with ½ charge of OIL, lubricating, preservative, medium. Run engine for 15 minutes at approximately 1,000 revolutions per minute. Leave preservative in compressor.

## STORAGE AND SHIPMENT

**i. Vehicle.** Rust appearing on any part before storage will be removed with sandpaper. Painted surfaces will be repainted and unpainted surfaces will be lightly coated with COMPOUND, rust-preventive, light.

**j. Equipment.**

(1) Release all brakes and chock the tracks.

(2) Depress clutch pedal and place small block of wood between clutch control lever and under side of floor board to hold the clutch out of engagement. The blocks must not be larger than necessary to make sure the clutch faces are separated.

(3) When vehicles are stored in any open location, remove such equipment as pioneer tools, street plates, chains and fire extinguisher. Store them separately. When vehicles are stored in closed or locked buildings, such equipment may remain in place in the vehicles.

**k. Inspections.**

(1) A tag will be attached to the steering lever on which will be recorded the date of all inspections, the initials of the inspectors, and their findings.

(2) Monthly inspections will be made to determine:

(a) Existence and condition of all equipment removed and stored separately.

(b) That parts and equipment have not been removed without proper authority.

(c) If the protection measures are effectively preventing deterioration so that corrective measures can be immediately instituted.

**l. Periodic Treatment of Engine and Vehicle.** At the expiration of each 3-month period, the following treatment should be repeated:

(1) **CYLINDERS.** See b (3) above.

(2) **VALVES.** See c above.

(3) **EXTERNAL METAL PARTS.** See f above.

(4) **VEHICLE.** See i above.

**m. Unfavorable Climatic Conditions.** For storage in unfavorable climatic conditions, such as might occur in tropical climates, or near sea water, it may be necessary to use an additional precaution to prevent corrosion and rust. If the foregoing treatment is inadequate, the engines and vehicles will be retreated at intervals of 1 month instead of every 3 months.

## 126. REMOVING VEHICLES FROM DEAD STORAGE.

**a. Cooling System.** When vehicles are removed from dead storage, the cooling system will be flushed to remove loose sediment (par. 73 c).

### MEDIUM TRACTOR M1

New hoses will be installed at this time if required. The cooling system will then be filled with water. If the temperature is below freezing, the required amount of antifreeze to afford adequate protection at the lowest anticipated temperature will be added.

**b. Cylinders.** Excessive preservative oil above the pistons will be removed with hand pump, if available, otherwise remove injectors and turn the engine over by hand to force out the excess oil.

**c. Valves.** Rotate the crankshaft through three or four revolutions by hand and observe the proper operation of valve mechanism. Also observe that excessive preservative oil or other material is not present in the cylinder to cause damage due to hydrostatic obstruction when the engine is turned over. Any valve found to be sticking will have the stem generously lubricated with penetrating oil or with a 50-50 mixture of kerosene and light lubricating oil, such as OIL, engine, SAE 10. Continue to turn the engine over by hand until all evidence of sticking valves has been eliminated. If this treatment does not free the valves, necessary mechanical repairs to free them must be made before the engine is placed in service.

**d. Fuel Tank.** Tank will be filled.

**e. Battery.** Install a fully charged battery.

**f. Lubrication.** The remainder of vehicle will be thoroughly lubricated before being placed in service (sec. IV). Gear cases will be drained, flushed, and refilled to proper level with the correct lubricant according to seasonal requirements.

**g. Crankcase.** Drain old oil and flush the crankcase using  $\frac{1}{2}$  the normal quantity of oil.

**h. Inspection.** A thorough inspection will be made of the vehicle at this time. Any repairs which have been ordered at the time the vehicle was placed in storage, and have not already been performed, must be accomplished at this time. The following special considerations will be observed in accomplishing this inspection.

#### (1) BRAKES.

(a) *General.* It is necessary that the connections of the mechanical linkage have complete freedom of action. In other words, there must not be any parts which may be restricted in their action due to drying out, corrosion, or rusting of movable joints. All clevises, pins, and movable joints should be free and lubricated carefully. Return springs should be checked for their full action and useful life. Movement of brake actuating mechanism will be checked to insure free action. Adjust brakes as outlined in paragraph 106.

## STORAGE AND SHIPMENT

(2) **SPROCKET HUB BEARING.** When the period of dead storage has extended over several months, consideration will be given to cleaning and repacking sprocket hub bearings, and replacing all oil seals. This will be done by ordnance personnel.

(3) **LIGHTS.** Light reflectors will be cleaned and polished, when necessary. Check for loose or damaged gaskets.

(4) **OIL FILTERS.** The oil filter element will be replaced in all vehicles which have formerly been in service.

i. **Starting Engine.** If practical, vehicle which is removed from dead storage will, after the proper preparation for service, be towed with high gear engaged until the engine starts. See if the engine runs smoothly. Shut off engine and drain flushing oil while the engine is still warm. Fill the crankcase with the specified grade and quantity of lubricating oil.

### 127. PREPARATION FOR SHIPMENT.

a. After tractor has been used and before it can be crated and shipped, it must be thoroughly cleaned and inspected. Wash all dirt and grease from vehicle. Make an inspection of entire vehicle for broken parts and tighten all loose bolts. Replace worn bolts that cannot be tightened. Repair or replace broken or missing parts so that tractor will be ready for operation when it reaches destination. Check tools and equipment against the equipment list for tractor.

b. If tractor is to be shipped by rail, nothing on tractor need be removed. If shipment is to be by boat, the tractor must be crated. Crating requires the removal of the precleaner and extension tube, exhaust tail pipe, pintles, pack carrier, and rear lamps. The cooling system must be drained and battery cables disconnected from battery terminals.

### 128. CRATING.

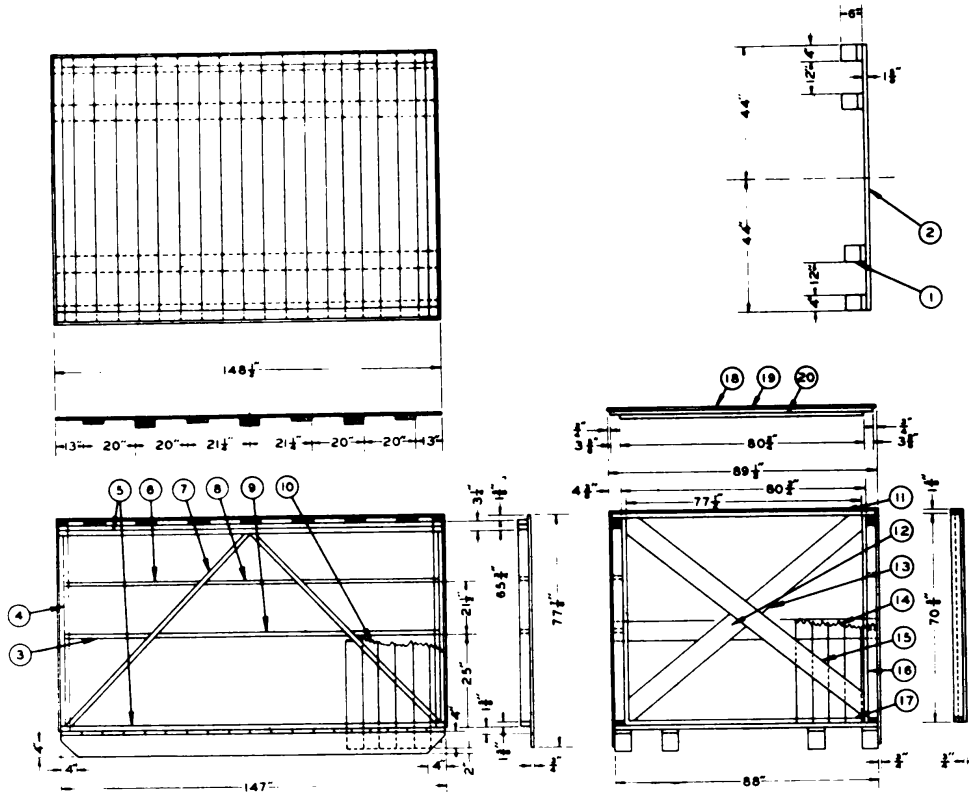
a. **Crates.** Figure 135 contains specifications and list of material needed for building crates for this tractor in the event the original crates have been destroyed and new ones have to be made. Drawings show construction of crate and how each section is braced.

b. **Crating Tractor** (figs. 136 and 137).

(1) Drive tractor up onto floor of crate so that there is equal clearance on both ends and both sides of floor. Using 4 triangular shaped blocks, nail one block at each end of each of the tracks (using two



MEDIUM TRACTOR M1



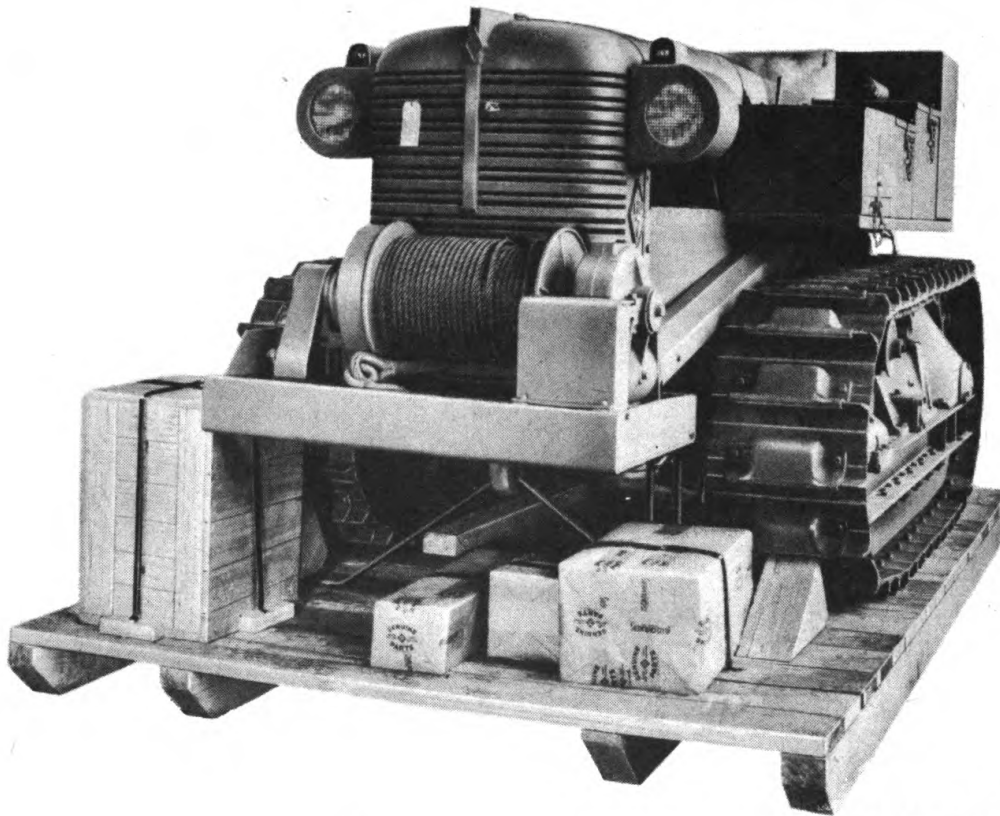
Total Material Required Board Feet	Group	Item No.	No. Req.	Name	Stock Size	Material	Board Feet	
4" x 6" x 13' OAK 104'	Base	1	4	Skids	4 x 6 x 147	Red Oak	100'	
2" x 8" Y.P. 341'		2	20	Flooring	2 x 8 x 88	Y.P.	196'	
2" x 4" Y.P. 149'			120	Nails	#20		4#	
2" x 2" Y.P. 5'	Sides 2 Req'd	3	4	Brace	2 x 4 x 26 1/2	Y.P.	6'	
1" x 6" T.G. Y.P. 387'		4	4	Columns	2 x 4 x 65 3/4	Y.P.	15'	
#8 NAILS 6 3/4#		5	6	Headers	2 x 4 x 147	Y.P.	49'	
#16 NAILS 3 1/2#		6	4	Brace	2 x 4 x 49 1/4	Y.P.	11'	
#20 NAILS 4#		7	4	"A" Brace	2 x 4 x 97 1/4	Y.P.	22'	
		8	2	Brace	2 x 4 x 44	Y.P.	5'	
		9	2	Brace	2 x 4 x 89 5/8	Y.P.	10'	
		10	54	Planking T.G.	1 x 6 x 77 7/8	Y.P.	182'	
<b>Amt. Tot. Mat'l. for Blocking</b>				432	Nails	#8		3#
				92	Nails	#16		2#
12 6 x 8 x 18 Blocks	End	11	2	Header	2 x 4 x 88	Y.P.	10'	
6 3 x 5 x 48 Blocks		12	2	Brace	2 x 8 x 50 1/4	Y.P.	12'	
2 Bandiron 1 1/4 x 42 1/2 Ea		13	2	Brace	2 x 8 x 47 1/4	Y.P.	11'	
1 Mach. Bolt 1/2-13 x 20"		14	33	Planking T.G.	1 x 6 x 73 3/8	Y.P.	102'	
24 #60 NAILS 3#		15	2	Brace	2 x 8 x 103 3/8	Y.P.	23'	
120 #40 NAILS 7#		16	4	Stud	2 x 4 x 70 3/8	Y.P.	16'	
232 #8 NAILS 1-2, 3#		17	2	Header	2 x 2 x 77 1/2	Y.P.	5'	
40 #16 NAILS 1#								
<b>Weight</b>			264	Nails	#8		2#	
			48	Nails	#16		1#	
Net 16,300#	Top	18	16 1/2	Planking T.G.	1 x 6 x 148 1/2	Y.P.	103'	
Tare 2,280#		19	7	Brace	2 x 8 x 88	Y.P.	69'	
Gross 18,580#		20	3	Brace	2 x 8 x 80 1/4	Y.P.	30'	
			24	Nails	#16		1/2#	
			238	Nails	#8		1 3/4#	
<b>Overall Dimensions</b>								
Height 80 3/8"	Width 89 1/2"	Length 148 1/2"						
Cubic Ft. 628.7								

Note: All Yellow Pine #2 Common.

RA PD 17252

Figure 135—Shipping Crate Specifications

## STORAGE AND SHIPMENT



RA PD 17783

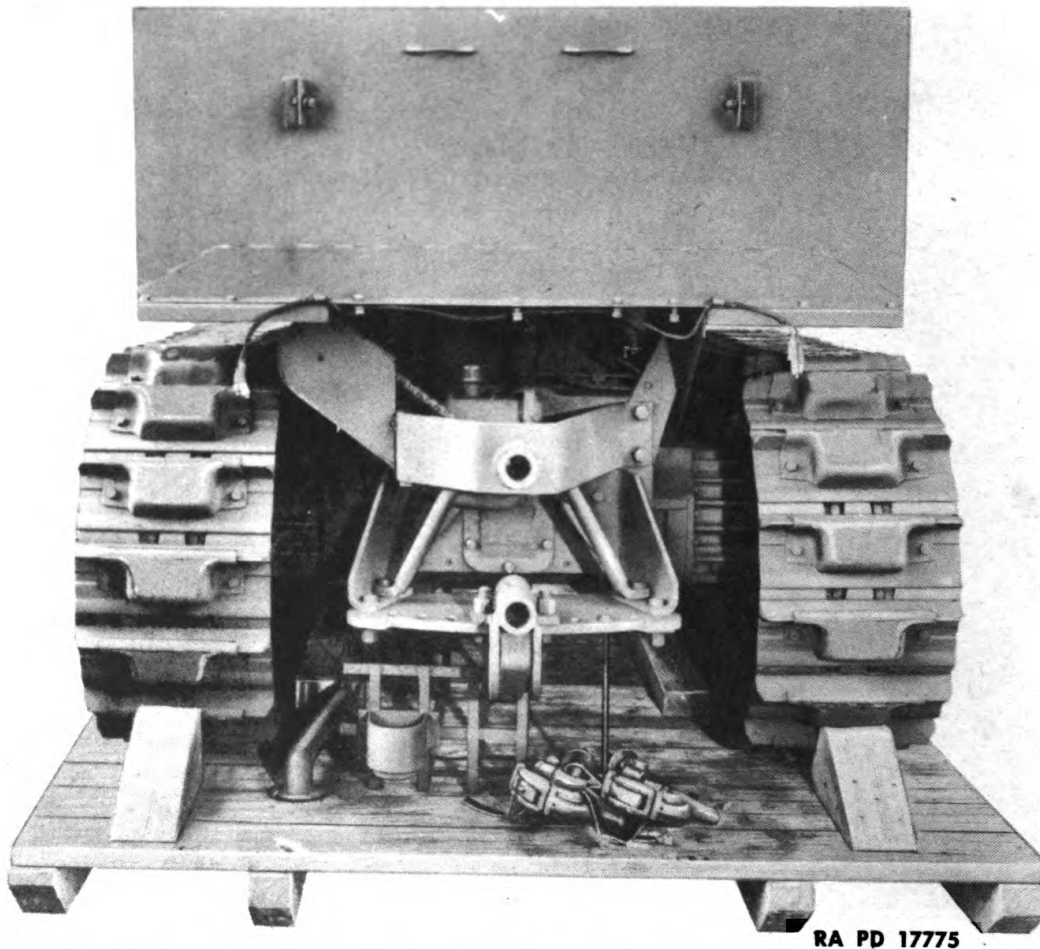
**Figure 136—Front View of Tractor Blocked to Crate Floor**

60-penny and seven 40-penny nails in each block). Drive these chocking blocks tightly against tracks before nailing them down. Nail a block 4-feet long, 4-inches high, and 5-inches wide to floor against inside of each track with six 40-penny nails. These blocks will hold tractor from shifting in crate. Place banding iron over front pull hook and nail ends to crate floor. Bore a  $\frac{1}{2}$ -inch hole in crate floor and install a long  $\frac{1}{2}$ -inch bolt through a hole in drawbar plate and through the hole bored in floor. The banding iron in front and bolt in rear are to keep tractor from bouncing on spring.

(2) Fasten pintles, pack carrier and rear lamps and exhaust tail pipe to floor of crate with nails and banding iron. Place lubricating equipment, precleaner, and tools in suitable boxes and fasten boxes to floor with blocks around boxes and banding iron to hold them to floor.

(3) Disconnect battery cables, put gear shift lever in lowest forward or reverse position, and set tractor brakes. Then nail sides and ends of crate to crate floor and install top of crate.

**MEDIUM TRACTOR M1**

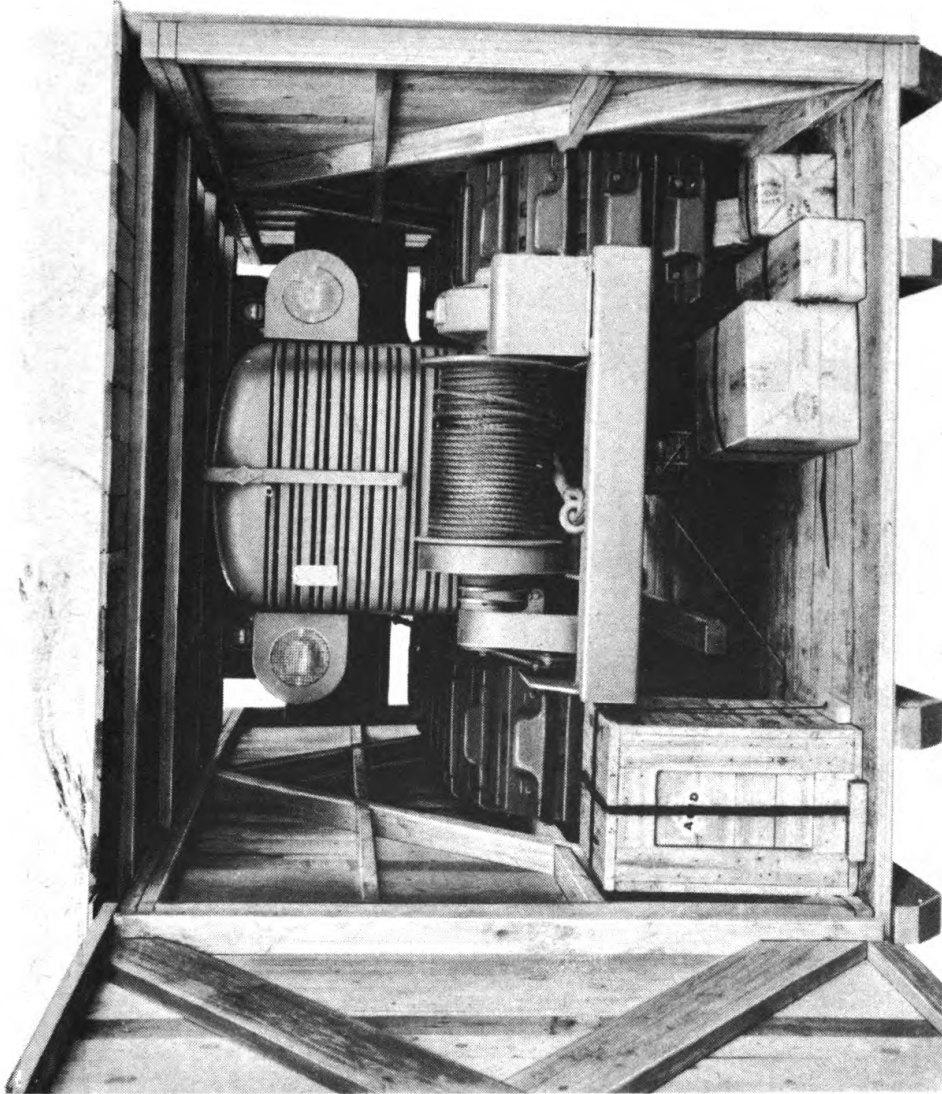


**Figure 137—Rear View of Tractor Blocked to Crate Floor**

**129. LOADING.**

a. If tractor is to be shipped by rail, it may be crated and hoisted on flat car. If this is done, the crate should have blocks nailed to floor of flat car on all four sides. Nail blocks well with 40-penny nails. If it is shipped uncrated, it should be fastened to floor of flat car or box car the same as it is fastened to crate floor, with the exception that the accessories will be left on tractor. Tools and equipment not carried in tool boxes should be put in one large box and box fastened to floor of car. If a flat car is used, the box should be covered with waterproof paper.

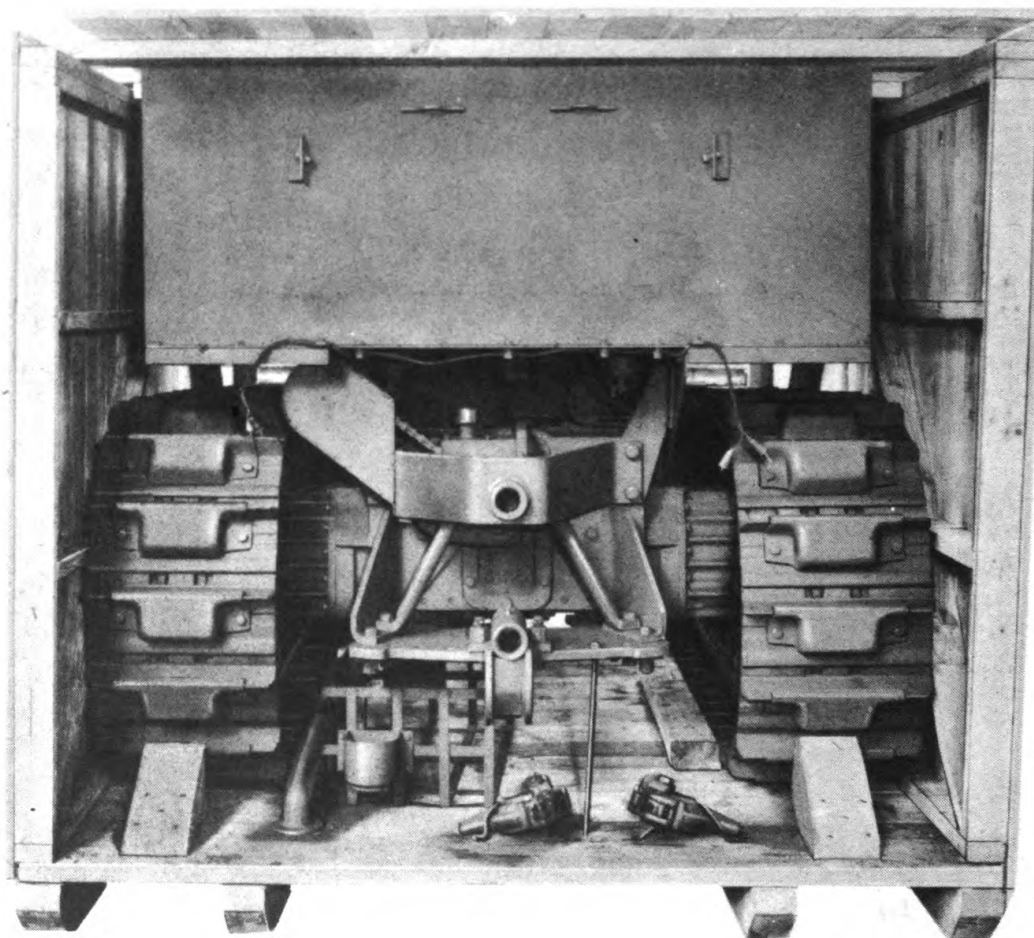
STORAGE AND SHIPMENT



RA PD 17770

**Figure 138—Front View of Tractor in Crate**

**MEDIUM TRACTOR M1**



**RA PD 17802**

**Figure 139—Rear View of Tractor in Crate**

**Section XXV**

**REFERENCES**

	Paragraph
Standard nomenclature lists . . . . .	130
Explanatory publications . . . . .	131
Training films and film strips . . . . .	132

**130. STANDARD NOMENCLATURE LISTS.**

- a. Cleaning and preserving and lubricating materials, recoil fluids, special oils, and miscellaneous related items . . . . . SNL K-1
  - b. Tractor, heavy, M1, w/winch (Allis-Chalmers HD-10W) (Diesel) . . . . . SNL G-98
  - c. Tractor, medium, M1 (Allis-Chalmers HD-7W) . . . . . SNL G-125
- Current Standard Nomenclature Lists are as tabulated here.
- An up-to-date list of SNL's is maintained as the "Ordnance Publications for Supply Index" . . . . . OPSI

**131. EXPLANATORY PUBLICATIONS.**

- a. **Automotive Materiel.**
- b. Cleaning, preserving, lubricating, and welding materials and similar items issued by the Ordnance Department . . . . . TM 9-850
- Military motor vehicles . . . . . AR 850-15
- Motor transport . . . . . FM 25-10
- Tractor, medium, M1 (Allis-Chalmers HD-7W) (winch, Gar Wood) (with engine) . . . . . TM 9-1870B
- Tractor, medium, M1 (Allis-Chalmers HD-7W) (winch, Gar Wood) (without engine) . . . . . TM 9-1870A
- c. **Inspection and Maintenance.**
- Echelon system of maintenance . . . . . TM 10-525
- Fire prevention, safety precautions, accidents . . . . . TM 10-360
- Motor transport inspections . . . . . TM 10-545
- d. **Miscellaneous.**
- Automotive electricity . . . . . TM 10-580
- Diesel engines and fuels . . . . . TM 10-575
- Electrical fundamentals . . . . . TM 1-455
- List of publications for training, including training films and film strips . . . . . FM 21-6
- The internal combustion engine . . . . . TM 10-570

**MEDIUM TRACTOR M1**

**e. Shipment and Storage.**

- Rules governing the loading of mechanized and motorized army equipment, also major caliber guns for the United States Army and Navy, on open top equipment—Association of American Railroads . . . . .
- Storage of motor vehicle equipment . . . . . AR 850-18

**132. TRAINING FILMS AND FILM STRIPS.**

**a. Diesels.**

- Diesel engines . . . . . TF 9-159
- Diesel engine and fuels . . . . . FS 10-37
- Engine of the Diesel tractor . . . . . TF 9-171
- Power train of the Diesel tractor . . . . . TF 9-172
- The electrical system of the Diesel tractor . . . . . TF 9-169
- The fuel system of the Diesel tractor . . . . . TF 9-170
- The track and suspension system of the Diesel tractor . . . . . TF 9-173

**b. Inspection and Maintenance.**

- First echelon of maintenance . . . . . FS 10-53
- Inspection of motor vehicles . . . . . FS 10-58
- Second echelon of maintenance . . . . . FS 10-54
- The motor vehicle driver—first echelon maintenance . . . . . TF 11-558

**c. Lubrication . . . . . FS 10-39**

INDEX

A	Page No.	Page No.
Accessories, cold weather	214-215	
Accessory drive, ratio of to crank- shaft speed	66	
Adjustments		
fan belt	134-135	
injector control racks	116-118	
master clutch	181-184	
master clutch brake assembly	184-185	
rear axle bearings	194-196	
steering clutch brakes	191-193	
washing	193	
steering clutches	186-188	
track release mechanism	197	
valve clearance	86-87	
winch worm safety brake	207-208	
Air cleaner	120-121	
Air compressors, storage treatment	220	
Air heater		
burner unit		
installation	161-162	
removal	161	
description	160	
maintenance	160-161	
operation (temperature 40 F to 0 F)	20-21	
pump assembly		
installation	163	
removal	162-163	
switch		
installation	163-164	
removal	163	
Air system (See Fuel and air system)		
Ammeter		
description	156-157	
maintenance	157	
removal and installation	157	
Antifreeze solution	18, 212-213	
Assignment record	47	
Automotive materiel, special pre- cautions for	53	
<b>B</b>		
Batteries		
care of in cold weather	213-214	
description	144	
installation	148	
maintenance	146-148	
preparation of for use	18	
removal	145	
storage treatment	220, 222	
trouble shooting	144	
Blackout light and lamp (See under Service lights)		
Brakes, tractor, maintenance	56	
<b>C</b>		
Cable, attaching of to load	27	
Camouflage, paint as	49	
preserving	50	
Capacity, oil		
crankcase	65	
data	16	
Care and preservation	47	
equipment	59	
transmission	26	
Chassis, care of in cold weather	214	
Chemicals, liquid, removal of	51-52	
Cleaning:		
gas exposed materiel	50	
vehicle	47	
Climatic conditions, unfavorable, storage treatment of vehicle in	221	
Cold weather lubrication and service		
cold weather accessories	214-215	
cooling system, protection of	212-213	
fuels for low temperature	211	
general discussion of	211	
mechanical condition of vehicle		
chassis	214	
electrical system	213-214	
engine	214	
preparation and lubrication for continuous operation below 0 F	212	
Compression stroke, piston	60	
Controls (See Operating instruc- tions and controls)		
Cooling system		
maintenance	55	
protection of	212-213	
storage treatment	220, 221-222	
Crankcase		
capacity	65	
storage treatment	219, 222	
Crankshaft speed, ratio of accessory drive to	66	
Crating the vehicle	223-225	
Cylinders, storage treatment	219	
<b>D</b>		
Data		
capacities (oil)	16	
dimensions	13	



MEDIUM TRACTOR M1

D—Cont'd	Page No.		Page No.
Data—Cont'd		lubricating oil pressure	175
engine	63-66	mile meter	178
direction of rotation	65-66	temperature	177
ratio of accessory drive to		general	8
crankshaft speed	66	lubrication system	136
general	12	oil cooler	140
performance of vehicle	14-15	oil filter	137
power take-off	16	oil pump	137
steering	15	master clutch	180
tracks	15	master clutch brake assembly	184
winch	16	meters	
Dead storage (See under Storage		hour	29
and shipment)		mile	30
Decontamination of gas exposed		seat	8
materiel	51-52	steering	8
Definitions of:		steering clutch brakes	191
dead storage	219	steering clutches	186
maintenance operation names	54	tractor and engine numbers	8-9
Description		tracks and truck frame assembly	
cooling system	122	general	197
fan assembly	132	pintles	202
radiator	128	track release mechanism	197
thermostat	130	track support rollers	202
water manifold	126	truck wheels	200
water pump	122	transmission	24
electrical system and equipment	144	winch	8
air heater	160	winch and power take-off	207
ammeter	156-157	Detonating engine, cause and	
batteries	144	remedy	67-68
generator	148-149	Dimensions, data on	13
generator voltage control unit	153	Direction of rotation	65-66
hour meter	158	Downhill, steering vehicle	26
light switch	164	Drawbar pull, maximum	9
panel light	166		
service lights	166	<b>E</b>	
starting motor	154	Electrical system and equipment	144-174
engine	8, 60-61	air heater	160-164
exhaust manifold and muffler	88	ammeter	156-157
governor	87	batteries	144-148
equipment	8	care of in cold weather	213-214
final drives	194	description	144
fuel and air system		generator	148-153
air cleaner	120	generator voltage control unit	153-154
fuel filters	93-94	hour meter	158-160
first stage filter assembly	95	light switch	164-166
second stage fuel filter	99	maintenance	55
third stage fuel filter	101	panel light	166
fuel pump	105	service lights	166-173
fuel supply tank	92	starting motor	154-156
injectors	107-108	wiring	173-174
precleaner	119	(For detailed information see	
gage		under above names)	
fuel pressure	176		

## INDEX

<b>E—Cont'd</b>	<b>Page No.</b>	<b>Page No.</b>	
<b>Engine</b>		<b>50-hours of operation, inspection</b>	
care of in cold weather . . . . .	214	after . . . . .	42
data on . . . . .	15	<b>Final drives (assembly)</b>	
description . . . . .	8, 60-61	description . . . . .	194
exhaust manifold and muffler . . . . .	88-90	lubrication . . . . .	194
governor		maintenance . . . . .	56
caution in adjusting . . . . .	87-88	rear axle bearing adjustment . . . . .	194-196
description . . . . .	87	<b>Firing order . . . . .</b>	63
installation of in vehicle . . . . .	77-83	<b>First stage filter assembly . . . . .</b>	95-97
maintenance . . . . .	54	<b>Fittings, lubrication, illustrations . . . . .</b>	36-39
removal of from vehicle . . . . .	68-76	<b>Front of engine . . . . .</b>	64
inspection of removed engine . . . . .	75	<b>Fuel and air system . . . . .</b>	91-121
rocker arm assembly		air cleaner . . . . .	120-121
installation . . . . .	84-86	fuel filters (See Fuel filter(s) )	
operation . . . . .	83	fuel lines and connections . . . . .	118-119
removal . . . . .	83-84	fuel supply tank . . . . .	92
starting instructions . . . . .	18-23	general discussion of . . . . .	91-92
after vehicle removed from		injectors (See Injectors, fuel)	
storage . . . . .	223	maintenance . . . . .	55
temperature below 0 F . . . . .	21-23	precleaner . . . . .	119-120
temperature 40 F to 0 F . . . . .	20-21	sediment sumps . . . . .	92-93
temperature normal . . . . .	18-20	<b>Fuel filter(s)</b>	
stopping . . . . .	23	description and operation . . . . .	93-94
storage treatment . . . . .	219	first stage assembly . . . . .	95-97
trouble shooting . . . . .	66-68	maintenance . . . . .	94-95
valve clearance . . . . .	86-87	second stage . . . . .	99-100
<b>Engine number . . . . .</b>	<b>9</b>	third stage . . . . .	101-105
<b>Engine oil, use of . . . . .</b>	<b>17-18</b>	<b>Fuel injectors (See Injectors, fuel)</b>	
<b>Engine preheater, operation (tem-</b>		<b>Fuel lines and connections . . . . .</b>	<b>118-119</b>
perature below 0 F) . . . . .	<b>21-23</b>	<b>Fuel, passage of . . . . .</b>	<b>92</b>
<b>Equalizing fuel injectors . . . . .</b>	<b>116-118</b>	<b>Fuel pressure gage (See under Gage)</b>	
<b>Equipment on vehicle, list of . . . . .</b>	<b>8</b>	<b>Fuel pump</b>	
(See also Electrical system and		description . . . . .	105
equipment)		installation . . . . .	105-107
<b>Ethylene glycol . . . . .</b>	<b>212-213</b>	removal . . . . .	105
<b>Exhaust, cause and remedy</b>		<b>Fuel supply tank . . . . .</b>	<b>92</b>
loud . . . . .	88	<b>Fuel system, storage treatment . . . . .</b>	<b>219</b>
smoke from . . . . .	67	<b>Fuel tank, storage treatment . . . . .</b>	<b>222</b>
<b>Exhaust manifold and muffler</b>		<b>Fuels for low temperature . . . . .</b>	<b>211</b>
description . . . . .	88		
installation . . . . .	88-90	<b>G</b>	
removal . . . . .	88	<b>Gage</b>	
trouble shooting . . . . .	88	fuel pressure	
		description . . . . .	176
		installation . . . . .	177
		maintenance . . . . .	176
		removal . . . . .	176
		lubricating oil pressure	
		description . . . . .	175
		installation . . . . .	175-176
		removal . . . . .	175
		maintenance . . . . .	55

**F****Fan assembly****belt**

  adjustment . . . . . 134-135

  installation and removal . . . . . 135

  description . . . . . 132

  installation . . . . . 133-134

  trouble shooting . . . . . 132

## MEDIUM TRACTOR M1

G—Cont'd	Page No.	I	Page No.
Gage—Cont'd		Injectors, fuel	
mile meter		combustion .....	107-108
description .....	30	equalizing .....	116-118
how to read .....	30	installation .....	113-114
installation .....	179	operation .....	108
maintenance .....	178	removal .....	108-112
operation .....	178	storage treatment .....	219
removal .....	178-179	timing .....	114-115
temperature		Inspection	
description .....	177	after	
installation .....	178	50 hours of operation .....	42
removal .....	177-178	100 hours of operation .....	45
Gas, materiel affected by .....	51-53	operation .....	41
automotive materiel, special		in deep mud .....	45
precautions for .....	53	in deep snow .....	45
cleaning .....	51	in sandy terrain .....	45
decontamination .....	51-52	in water .....	46
protective measures .....	51	during operation .....	41
Gear shift lever, use of .....	24	general .....	40
Generator		new vehicle .....	17
belt removal and installation .....	153	prestarting .....	40-41
description .....	148-149	removed engine .....	75
installation .....	151-152		
lubrication .....	149	<b>K</b>	
operation .....	149	Knocks in engine, cause and	
quick checks to determine if units		remedy .....	67-68
are operating normally .....	150		
removal .....	150-151	<b>L</b>	
Generator voltage control unit		Light switch	
description .....	153	description .....	164
installation and removal .....	154	installation .....	164-166
Governor		location and operation .....	28
caution in adjusting .....	87-88	removal .....	164
description .....	87	Lighting system (See also Service	
Grease fittings, cleaning .....	47	lights)	
Guide, lubrication .....	31, 32, 34	light switches .....	28
notes for .....	33	purpose of .....	28
<b>H</b>		Limited storage (See under Storage	
Headlight and lamp (See under Serv-		and shipment)	
ice lights)		Liquid chemicals, removal of ...	51-52
Horsepower, maximum drawbar ...	9	Load	
Hoses and pipes, inspection .....	132	attaching cable to .....	27
Hot engine, cause and remedy .....	66	pulling .....	27-28
Hour meter		Loading the vehicle .....	226
description .....	2, 158	"Log Book," use of .....	47
how to read .....	29-30	Lubricating devices, painting .....	50
installation .....	160	Lubricating oil pressure gage (See	
maintenance .....	158	under Gage)	
removal .....	158	Lubricaton (See also Lubrication	
Hydrometer, use of in reading elec-		systems)	
trolyte temperatures .....	146-147	cold weather (See Cold weather	
		lubrication and service)	
		final drives .....	194
		general information on .....	31
		generator .....	149

INDEX

<b>L—Cont'd</b>	<b>Page No.</b>		<b>Page No.</b>
Lubrication—Cont'd		radiator .....	129
guide .....	31, 32, 34	steering clutch .....	56
new vehicle for use .....	17-18	tractor brakes .....	56
ordnance maintenance personnel		tracks and truck frame assembly	56
duties .....	31	winch and power take-off (See	
reports and records .....	39	<i>under Winch and power take-off</i> )	
steering clutches .....	190	Master clutch	
supplementary illustrations	35-38, 39	adjustment .....	181-184
Lubrication system		washing .....	183-184
general discussion of .....	136	description .....	180
maintenance .....	55	mount .....	56
oil cooler		trouble shooting .....	180-181
description .....	140	use of .....	23-24
installation .....	143	Master clutch brake assembly	
removal .....	140-142	adjustment .....	184-185
oil filter		description .....	184
description .....	137	Masteriel affected by gas (See Gas,	
installation .....	137-140	materiel affected by)	
maintenance .....	137	Maximum drawbar horsepower .....	12
removal .....	137	Maximum drawbar pull .....	12
oil pump .....	137	Metal surfaces, painting .....	49
		Mile meter (See <i>under Gage</i> )	
		Motor (See Starting motor)	
		Motor Book, use of .....	47
		Mud, operating vehicle in .....	26
		inspection after .....	45
		Muffler (See Exhaust manifold and	
		muffler)	
		<b>N</b>	
		Nonelectrical instruments (See	
		Gage)	
		Number	
		engine .....	9
		serial, of vehicle .....	8-9
		<b>O</b>	
		Odometer (See mile meter <i>under</i>	
		Gage)	
		Oil capacities, data .....	16
		Oil cooler (See <i>under Lubrication</i>	
		system)	
		Oil cups, cleaning .....	47
		Oil filter (See <i>under Lubrication</i>	
		system)	
		Oil pump .....	137
		100 hours of operation, inspection	
		after .....	45
		Operating instructions and controls	17-30
		engine	
		starting (See starting instruc-	
		tions <i>under Engine</i> )	
		stopping .....	23

**M**

Maintenance	
cooling system .....	55
definitions of operation	
names .....	54
electrical system and equipment	55
air heater .....	160-161
ammeter .....	157
batteries .....	146-148
hour meter .....	158
starting motor .....	155
wiring .....	173
engine .....	54
final drive assembly .....	56
fuel and air system .....	55
air cleaner .....	120
fuel filters .....	94-95
first stage filter assembly	96
second stage fuel filter	101
third stage fuel filter	104
fuel lines and connections	118-119
fuel supply tank .....	92
precleaner .....	119-120
gages .....	55
fuel pressure .....	176
lubricating system .....	55
master clutch .....	56
mile meter .....	178
miscellaneous duties .....	56
oil filter and oil pump .....	137
preventive (See Inspection)	

MEDIUM TRACTOR M1

O—Cont'd	Page No.	Page No.
Operating instructions and controls—		Plugs, removal and installation when
Cont'd		operating in mud or water . . . . . 27
hour meter . . . . . 29-30		Power, loss of in engine . . . . . 67
inspection of new tractor . . . . . 17		Power stroke, piston . . . . . 60
lighting system . . . . . 28		Power take-off
master clutch, use of . . . . . 23		data on . . . . . 16
mile meter . . . . . 30		(See also Winch and power
operating		take-off)
in mud or water . . . . . 26-27		Precleaner
new vehicle . . . . . 18		description . . . . . 119
packing the vehicle . . . . . 28		installation . . . . . 120
preparing for use		maintenance . . . . . 119-120
new batteries . . . . . 48		removal . . . . . 119
new tractor . . . . . 17-18		Preheater, engine, operation (tem-
steering		perature below 0 F) . . . . . 21-23
clutch brakes . . . . . 26		Prestarting inspection . . . . . 40-41
downhill . . . . . 26		Prestone, use of . . . . . 212-213
transmission . . . . . 24-26		Preventive maintenance (See In-
winch and controls, use of . . . . . 27-28		spection)
Operation (See also Operating in-		<b>R</b>
structions and controls)		Radiator
engine		description . . . . . 128
air heater (temperature 40 F to		installation and removal . . . . . 130
0 F) . . . . . 20-21		maintenance . . . . . 129
fuel filters . . . . . 93-94		trouble shooting . . . . . 128-129
generator . . . . . 149		Ratio of accessory drive to crank-
inspections during, after, and in		shaft speed . . . . . 66
various conditions (See under		Rear axle bearings, adjustment . 194-196
Inspection)		Rear of engine . . . . . 65
lubrication for below 0 F . . . . . 212		Records
master clutch . . . . . 180		lubrication . . . . . 39
new vehicle . . . . . 18		tools and equipment . . . . . 59
steering clutches . . . . . 186		vehicle, use of . . . . . 47
Over-all dimensions . . . . . 13		Rocker arm assembly
<b>P</b>		installation . . . . . 84-86
Paint(-ing)		operation . . . . . 83
as camouflage . . . . . 49		removal . . . . . 83-84
preserving . . . . . 50		storage treatment . . . . . 220
general information on . . . . . 48		Rotation, direction of . . . . . 65-66
lubricating devices . . . . . 50		Repair, definition of . . . . . 54
metal surfaces . . . . . 49		Replace, definition of . . . . . 54
preparing for . . . . . 48-49		<b>S</b>
removing . . . . . 50		Sandy terrain, inspection of vehicle
Panel light . . . . . 166		after operation in . . . . . 45
operation . . . . . 28		Seat, description . . . . . 8
Parking the vehicle . . . . . 28		Second stage fuel filter . . . . . 99-100
Performance of vehicle, data on . . 14-15		Sediment sumps
Pintles (See under Tracks and truck		installation . . . . . 93
frame assembly)		removal . . . . . 92-93
Pipes . . . . . 132		
Piston power stroke . . . . . 60		

INDEX

<b>S—Cont'd</b>	<b>Page No.</b>		<b>Page No.</b>
Serial number of vehicle	8-9	Stoplight switch (See under Service lights)	
Service, definition of	54	Stopping the engine	23
Service lights		Storage and shipment	
blackout light and lamp		crating	223-225
installation	170	dead storage	
removal	169-170	placing vehicles in	
description	166	air compressors	220
headlight and lamp		battery	220
installation	168	cooling system	220
removal	167	definition	219
stoplight switch		engine	219
installation	173	equipment	221
removal	172	exterior	220
taillight assembly		inspections	221
installation	172	openings	220
removal	170	periodic treatment	221
Shipment (See Storage and shipment)		rust removal	221
Shipping weight of vehicle	12	unfavorable climatic conditions	221
Smoke from exhaust, cause and remedy	67	valves and rocker arms	220
Snow, inspection of vehicle after operation in	45	removing vehicles from	
Starting (See starting instructions under Engine)		battery	222
Starting motor		cooling system	221-222
description	154	crankcase	222
installation	155-156	cylinders	222
lubrication	154	fuel tank	222
maintenance	155	inspection	222-223
removal	155	lubrication	222
trouble shooting	154	starting engine	223
Steering		valves	222
data	15	general discussion of	216
downhill	26	limited storage	216-218
operation	8, 26	inspection when removed from	218
Steering clutch brakes		inspections in	218
adjustment	191-193	loading	226
washing	193	shipment, preparation for	223
description	191	Sumps, sediment (See Sediment sumps)	
operation	26		
Steering clutches		<b>T</b>	
adjustment	186-188	Tabulated data (See Data)	
lever, checking	186-187	Taillight assembly (See under Service lights)	
thrust pin, checking	187	Temperature(s)	
description and operation	186	fuels for low	211
lubrication	190	gage (See under Gage)	
maintenance	56	electrolyte, table	146-147
operation	8	freezing	148
trouble shooting	186	operation of engine in various (See starting instructions under Engine)	
washing	188-190		

MEDIUM TRACTOR M1

T—Cont'd	Page No.		Page No.
Thermostat		master clutch	180-181
description	130	steering clutches	186
installation	131-132	Truck wheels (See under Tracks and	
removal	130-131	truck frame assembly)	
trouble shooting	130		
Third stage fuel filter	101-105		
Timing fuel injector	114-116	<b>V</b>	
Tools and equipment		Valve clearance	
care of	47, 59	adjustment	86-87
standard equipment furnished with		general discussion of	86
vehicle	57-59	Valves, storage treatment	220, 222
Track release mechanism (See under		Vibration, excessive, of engine	66
Tracks and truck frame assembly)			
Track support rollers	202	<b>W</b>	
Tracks and truck frame assembly		Washing:	
data	15	master clutch	183-184
description	197	steering clutch brakes	193
maintenance	56	steering clutches	188-190
pintles		Water manifold	
description	202	description	126
pintle and bracket assembly		installation	128
installation	205-206	removal	127-128
removal	204-205	Water, operating vehicle in	26-27
pintle drawbar assembly		inspection after	46
installation	204	Water pump	
removal	203	description	122
track release mechanism		installation	126
adjustment	197-199	removal	123-125
description	197	trouble shooting	123
track support rollers	202	Weight, shipping, of vehicle	9
truck wheels		Wheels, truck (See truck wheels	
description	200	under Tracks and truck frame	
installation	200-202	assembly)	
removal	200	Winch and controls, use of	
Tractor brakes, maintenance	56	to attach cable to load	27
Transmission		to pull load	27-28
care of	26	winch hand brake	28
description	24	Winch and power take-off	
gear shift lever, use of	24	data	16
power delivered from	8	description	8, 207
Trouble shooting		maintenance	207-210
cooling system		cable	
fan assembly	132	installation	210
radiator	128-129	removal	208-210
thermostat	130	winch worm safety brake ad-	
water pump	123	justment	207-208
electrical system and equipment		Winch hand brake	28
batteries	144	Wiring	
generator	149-150	maintenance	173
starting motor	154	replacing	173
engine	66-68	schematic diagram	174
exhaust manifold and muffler	88		

[ A.G. 062.11 (10-29-42)  
O.O. 461/26695 O.O. (12-3-42) ]

BY ORDER OF THE SECRETARY OF WAR:

G. C. MARSHALL,  
*Chief of Staff.*

OFFICIAL:

J. A. ULIO,  
*Major General,*  
*The Adjutant General.*

DISTRIBUTION: R 9(2); IBn 9(1); IC 9(4)

(For explanation of symbols, see FM 21-6)



