

6.VAU.3.CH.4,1/621

REGISTERED

5 MEI 1955

16KL BBV

TM 9-1765A

K3-27

WAR DEPARTMENT

TECHNICAL MANUAL



ORDNANCE MAINTENANCE

AXLES, PROPELLER SHAFTS AND WHEELS  
FOR BOMB SERVICE TRUCK M6 (CHEVROLET)

DECEMBER 15, 1942

BIBL. DML  
Geregistreerd

# ORDNANCE MAINTENANCE AXLES, PROPELLER SHAFTS AND WHEELS FOR BOMB SERVICE TRUCK M6 (CHEVROLET)

Prepared under the direction of  
the Chief of Ordnance

(with the cooperation of the Chevrolet Motor Division, General Motors Corporation)

## CONTENTS

	Paragraphs	Pages
CHAPTER 1: Introduction	1- 3	3
CHAPTER 2: Front axle repair operations	4-30	4-57
SECTION I: Front axle	4- 7	4- 8
II: Trouble shooting	8- 9	9-10
III: Front axle repairs that can be per- formed without removing unit from vehicle	10-19	11-29
IV: Removal of front axle from vehicle	20-21	30-32
V: Disassembly of front axle	22-23	33-34
VI: Cleaning, inspecting, repairing or replacing of front axle component parts	24-26	35-47
VII: Assembling front axle	27-28	48-51
VIII: Installation of front axle assembly in vehicle	29	52-55
IX: Front axle fits and tolerances	30	56-57
CHAPTER 3: Rear axle repair operations	31-50	58- 94
SECTION I: Rear axle	31-34	58-60
II: Rear axle trouble shooting	35	61
III: Rear axle repairs that can be per- formed without removing unit from vehicle	36-39	62-69
IV: Removal of rear axle from vehicle	40-41	70-72
V: Disassembly of rear axle	42-43	73-74
VI: Cleaning, inspecting, repairing or replacing of rear axle component parts	44-46	75-86
VII: Assembling rear axle	47-48	87-92
VIII: Installation of rear axle assembly in vehicle	49	93
IX: Rear axle fits and tolerances	50	94

**ORDNANCE MAINTENANCE—AXLES, PROPELLER SHAFTS AND WHEELS FOR BOMB SERVICE TRUCK M6 (CHEVROLET)**

	Paragraphs	Pages
CHAPTER 4: Propeller shafts and universal joints	51-66	95-107
SECTION I: Introduction	51-55	95-98
II: Trouble shooting	56	99
III: Removal of propeller shafts and universal joints	57-58	100-101
IV: Disassembly of universal joints	59-60	102-103
V: Cleaning and inspection of propeller shafts and universal joints	61-62	104
VI: Reassembly of universal joints	63-64	105-106
VII: Installation of propeller shafts and universal joints	65-66	107
CHAPTER 5: Wheels, wheel bearings, tires	67-79	108-121
SECTION I: Introduction	67-70	108-109
II: Trouble shooting	71	110
III: Wheels	72-73	111-112
IV: Wheel bearings	74-77	113-119
V: Tires	78-79	120-121
CHAPTER 6: References	80-81	122
INDEX		123-126

## Chapter 1

### INTRODUCTION

	Paragraph
Scope .....	1
Arrangement of manual .....	2
Importance of good repairs .....	3

#### 1. SCOPE.

a. This manual is published for the information of ordnance maintenance personnel. It contains detailed instructions for inspection, disassembly, assembly, maintenance and repair of the Bomb Service Truck M6 (Chevrolet), supplementary to those in the field and technical manuals prepared for the using arms. Additional descriptive matter and illustrations are included to aid in providing a complete working knowledge of the materiel.

#### 2. ARRANGEMENT OF MANUAL.

a. The chapters of this manual cover the maintenance operations of the following main assemblies: front axle, rear axle, propeller shafts and universal joints, wheels, wheel bearings, tires. Each chapter is broken into sections which cover the removal of the assembly, disassembly, inspection, repairing and reassembling of the main assembly. The section index covers the paragraphs of the various operations within the section.

#### 3. IMPORTANCE OF GOOD REPAIRS.

a. It is important that the mechanic repairing the vehicle use every precautionary measure possible to make sure that the repairs he is performing are of a high quality. This is important when dealing with army units, as much confusion and delay can result from "break-downs" on the road. Success is dependent upon fresh troops, ammunition, and supplies arriving at their destination on time. A systematic and careful check should be made as the various repair operations are being performed in order to prevent failures occurring again after repairs are performed.

**ORDNANCE MAINTENANCE—AXLES, PROPELLER SHAFTS AND  
WHEELS FOR BOMB SERVICE TRUCK M6 (CHEVROLET)**

**Chapter 2**

**FRONT AXLE REPAIR OPERATIONS**

**Section I**

**FRONT AXLE**

	Paragraph
Description .....	4
Data .....	5
Reference to second echelon .....	6
Echelon break-down of maintenance and repair .....	7

**4. DESCRIPTION.**

a. A differential carrier assembly is mounted on the inside of the banjo housing in the same manner as in the rear axle, except that the pinion shaft points toward the rear instead of the front and the pinion is above the center line of the housing, while on the rear axle it is below the center line.

b. The differential carrier assembly in the front axle is identically the same as the assembly in the rear axle and its parts are interchangeable with the carrier assembly on the rear axle.

c. The differential housing cover is interchangeable with the one on the rear axle. The cover has two filler plug holes in it but it can be installed only in the correct position.

**5. DATA.**

**a. Differential.**

Housing type .....	Banjo
Drive .....	Through the springs (Hotchkiss)
Drive type .....	Hypoid
Gear ratio .....	6.67 to 1
Differential bearing .....	Hyatt A-11820-Z
Inner pinion bearing .....	Hyatt U-1306-TAM
Outer pinion bearing .....	New Departure H-5310-A

**b. Wheel Bearing.**

Cone and roller assembly (inner) .....	Timken 33275
Cup (inner) .....	Timken 33472
Cone and roller assembly (outer) .....	Timken 399-A
Cup (outer) .....	Timken 394-A

FRONT AXLE

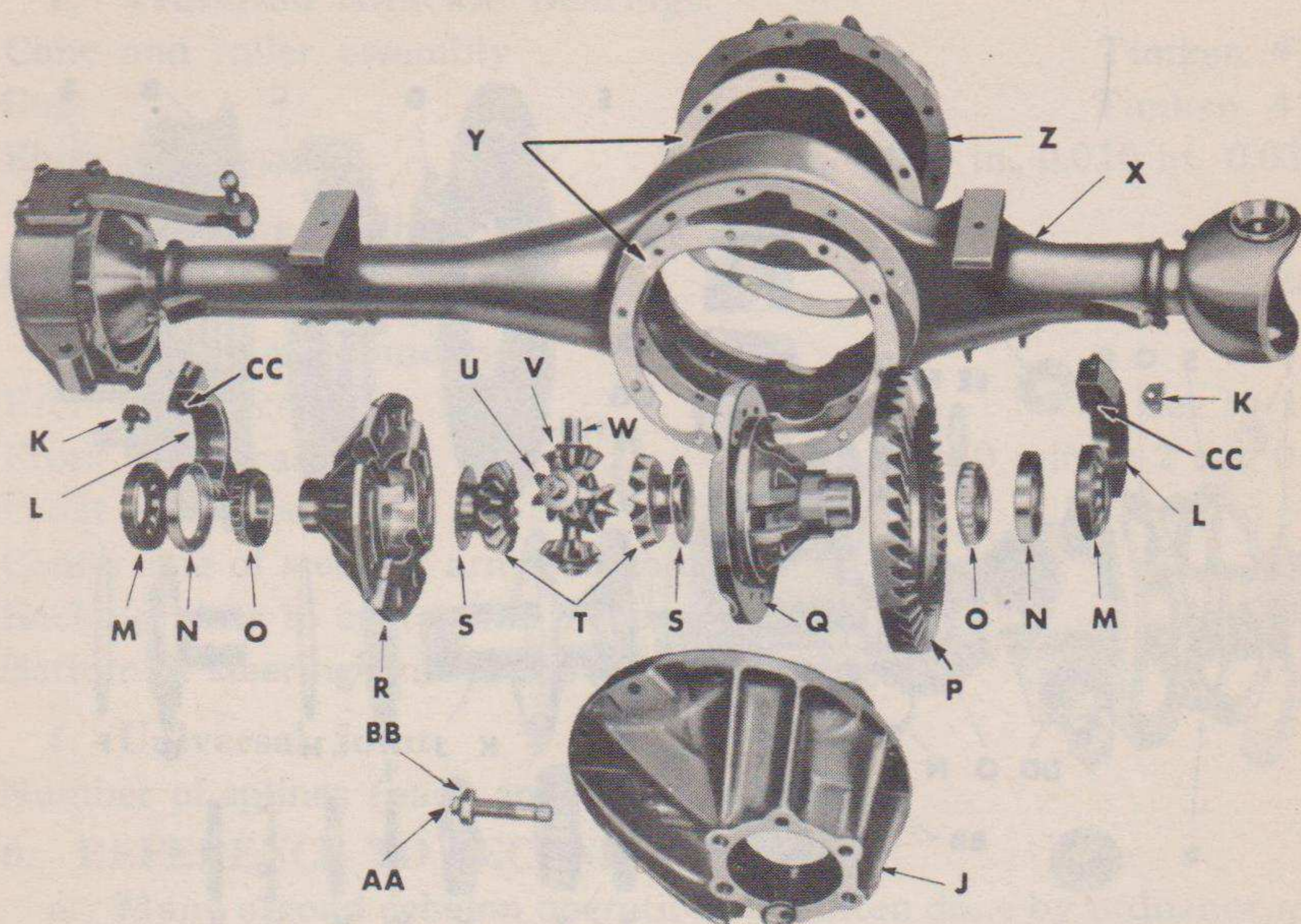

- A—PROPELLER SHAFT PINION FLANGE NUT
- B—PROPELLER SHAFT PINION FLANGE WASHER
- C—PROPELLER SHAFT PINION FLANGE
- D—PINION OIL SEAL AND BEARING RETAINER
- E—PINION BEARING RETAINER PACKING
- F—PROPELLER SHAFT PINION FLANGE OIL SEAL ASSEMBLY
- G—DOUBLE ROW BALL BEARING (N.D.)
- H—HYPOID DRIVE PINION
- I—ROLLER BEARING ASSEMBLY
- J—DIFFERENTIAL CARRIER
- K—DIFFERENTIAL ADJUSTING NUT LOCK
- L—DIFFERENTIAL CARRIER BEARING CAP
- M—DIFFERENTIAL ADJUSTING NUT
- N—DIFFERENTIAL BEARING CUP
- O—DIFFERENTIAL BEARING CONE AND ROLLER ASSEMBLY

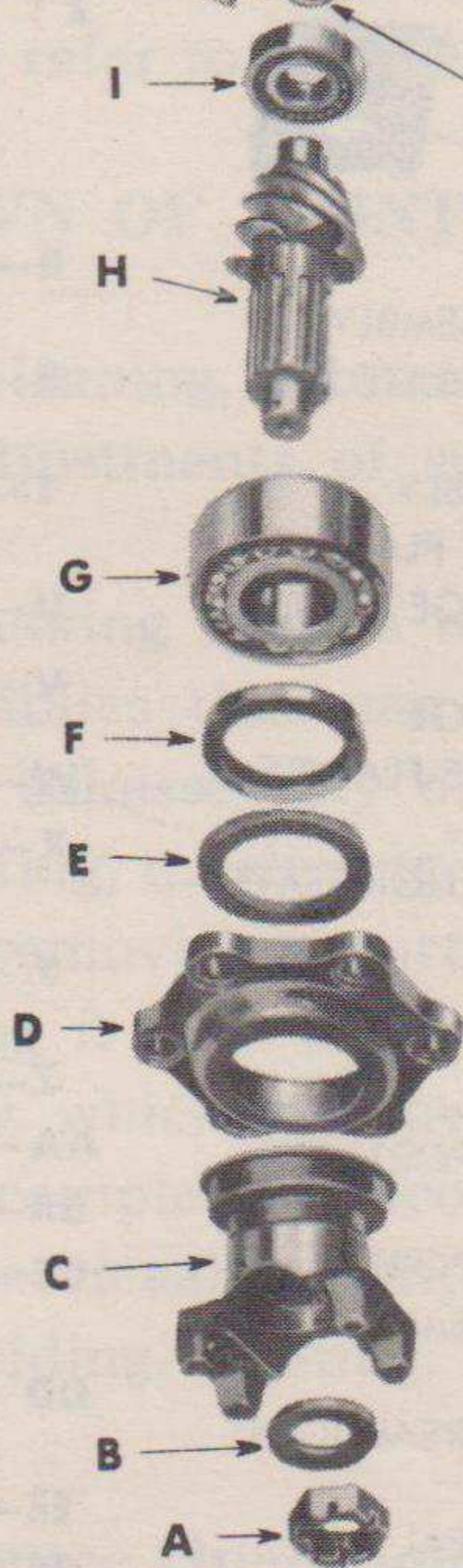

- P—HYPOID DRIVE GEAR
- Q—DIFFERENTIAL CASE
- R—DIFFERENTIAL CASE COVER
- S—DIFFERENTIAL SIDE GEAR THRUST WASHER
- T—DIFFERENTIAL SIDE GEAR
- U—DIFFERENTIAL PINION
- V—DIFFERENTIAL PINION THRUST WASHER
- W—DIFFERENTIAL PINION SPIDER
- X—HOUSING ASSEMBLY
- Y—DIFFERENTIAL CARRIER GASKET
- Z—AXLE HOUSING COVER
- AA—HYPOID DRIVE GEAR THRUST PAD AND SCREW ASSEMBLY
- BB—CHECK NUT
- CC—DIFFERENTIAL CARRIER BEARING CAP DOWEL
- DD—ROLLER BEARING LOCK

RA PD 55800

Figure 1—Front Axle and Differential

ORDNANCE MAINTENANCE—AXLES, PROPELLER SHAFTS AND WHEELS FOR BOMB SERVICE TRUCK M6 (CHEVROLET)

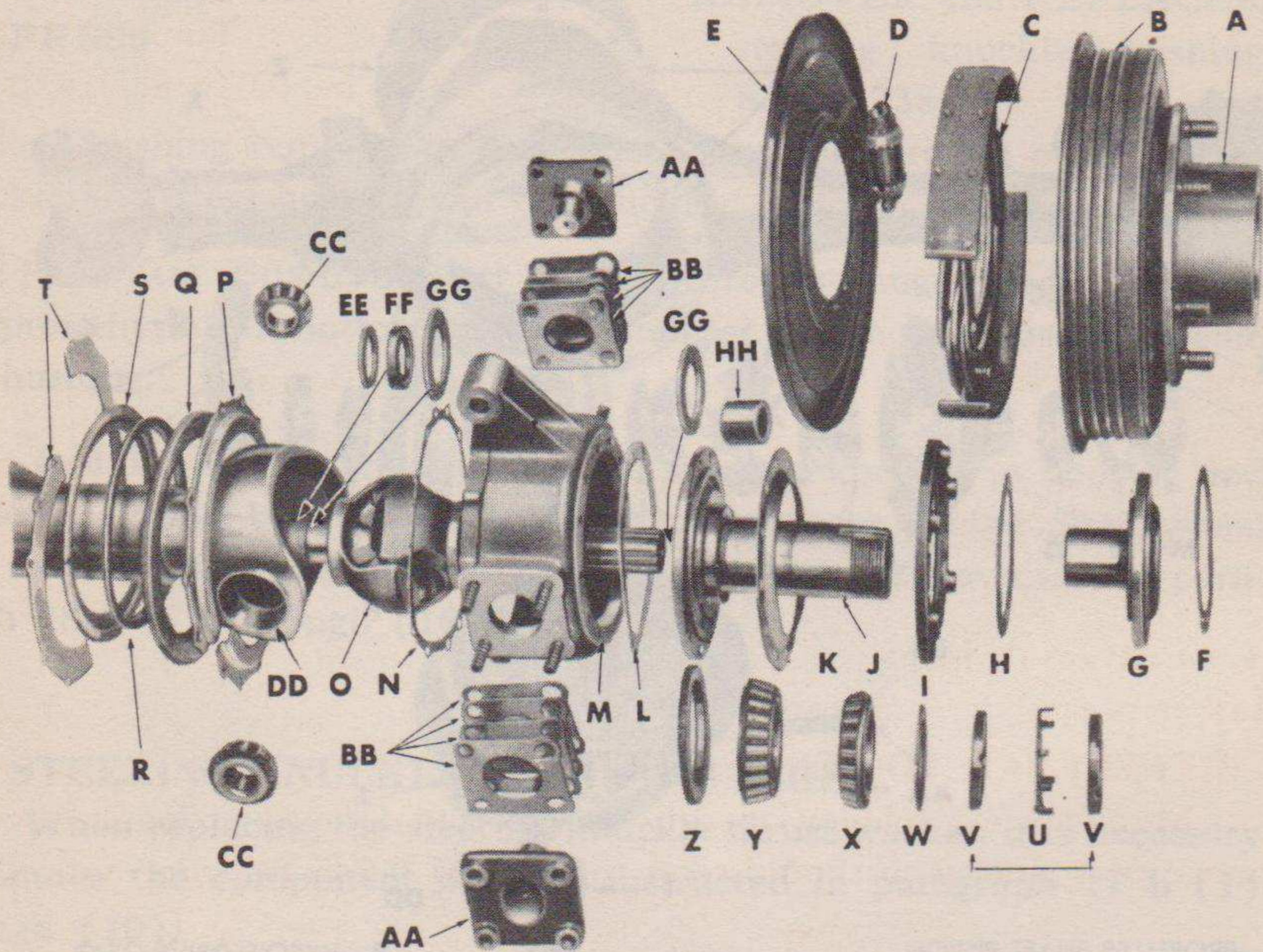

- A—FRONT WHEEL HUB
- B—FRONT BRAKE DRUM ASSEMBLY
- C—FRONT BRAKE ANCHOR PLATE AND SHOE ASSEMBLY
- D—WHEEL CYLINDER ASSEMBLY
- E—FRONT BRAKE BACKING PLATE
- F—FRONT AXLE DRIVE FLANGE BOLT LOCK
- G—FRONT AXLE DRIVE FLANGE
- H—FRONT WHEEL HUB DRIVE FLANGE GASKET
- I—FRONT BRAKE SHOE ANCHOR PLATE SPACER
- J—STEERING KNUCKLE
- K—FRONT WHEEL HUB INNER OIL DEFLECTOR
- L—STEERING KNUCKLE SUPPORT GASKET
- M—STEERING KNUCKLE SUPPORT
- N—HOUSING OUTER END SEAL RETAINER GASKET
- O—AXLE SHAFT AND UNIVERSAL JOINT ASSEMBLY
- P—HOUSING OUTER END SEAL RETAINER
- Q—HOUSING OUTER END SEAL
- R—HOUSING OUTER END SEAL (SPRING LOADED)
- S—OIL SEAL RETAINER
- T—HOUSING OUTER END SEAL INNER RETAINER
- U—FRONT WHEEL HUB NUT LOCK
- V—FRONT WHEEL HUB BEARING ADJUSTING NUT
- W—FRONT WHEEL HUB NUT WASHER
- X—WHEEL BEARING CONE AND ROLLER ASSEMBLY (OUTER)
- Y—WHEEL BEARING CONE AND ROLLER ASSEMBLY (INNER)
- Z—FRONT WHEEL BEARING OIL SEAL
- AA—FRONT AXLE TRUNNION
- BB—STEERING KNUCKLE BEARING SHIM
- CC—STEERING KNUCKLE TRUNNION BEARING CONE AND ROLLER ASS'Y
- DD—STEERING KNUCKLE TRUNNION BEARING CUP
- EE—AXLE SHAFT OIL SEAL
- FF—AXLE SHAFT OIL SEAL SHIM
- GG—THRUST WASHER
- HH—STEERING KNUCKLE BUSHING

RA BD 55801

Figure 2—Front Wheel Hub and Steering Knuckle Parts

**FRONT AXLE**

**c. Trunnion Knuckle Bearings.**

Cone and roller assembly .....	Timken 41125
Cup .....	Timken 41286
Shim thickness .....	0.002 in., 0.005 in., 0.010 in., 0.030 in.

**d. Turning Radius Stop Screw.**

Maximum angle of inner wheel .....	28 deg + 1 deg - 0 deg
------------------------------------	------------------------

**e. Steering Geometry.**

Front wheel camber .....	1/2 deg to 1 deg
Front wheel caster .....	1 deg 30 min to 2 deg 0 min
Front wheel toe-in .....	0 in. to 1/8 in.
Center line of steering arm ball to center line of spring .....	4 1/2 in.
Backing plate to center line of tie rod bolt .....	3 19/64 in.
Bottom of steering arm to top of axle housing .....	1 3/4 in.

**f. Universal Joint.**

Number of splines (each end) .....	10
------------------------------------	----

**6. REFERENCE TO SECOND ECHELON.**

a. Many second echelon operations are often done by ordnance maintenance personnel who should refer to the TM 9-765 for information.

**7. ECHELON BREAK-DOWN OF MAINTENANCE AND REPAIR.**

**a. Definitions.**

(1) **SERVICE.** Consists of cleaning, lubricating, tightening bolts and nuts, and making external adjustments of subassemblies or assemblies and controls.

(2) **REPAIR.** Consists of making repairs to, or replacement of such parts, subassemblies or assemblies that can be accomplished without completely disassembling the subassembly or assemblies and does not require heavy welding or riveting, machining, fitting, and/or alining.

(3) **REPLACE.** Consists of removing a part, subassembly or assembly from the vehicle and replacing it with a new, reconditioned or rebuilt part, subassembly or assembly, whichever the case may be.

(4) **REBUILD.** Consists of completely reconditioning and placing in serviceable condition any unserviceable part, subassembly or assembly of motor vehicle including welding, riveting, machining, fitting, alining, assembling and testing.

**b. Allocation of Maintenance Operations.**

	Echelons 2nd, 3rd, 4th
Front axle assembly—replace .....	x
Front axle assembly—minor repairs .....	x
Front axle assembly—rebuild .....	x



**ORDNANCE MAINTENANCE—AXLES, PROPELLER SHAFTS AND  
WHEELS FOR BOMB SERVICE TRUCK M6 (CHEVROLET)**

	Echelons		
	2nd,	3rd,	4th
Drive flange—replace .....	X		
Front hub—replace .....	X		
Wheel bearings—adjust or replace .....	X		
Retracting springs—replace .....	X		
Anchor plate—replace .....	X		
Brake flange plate—replace .....	X		
Brake shoes—replace .....	X		
Brake shoes—reline .....			X
Wheel cylinders—replace .....	X		
Wheel cylinders—repair .....		X	
Steering knuckle—replace .....	X		
Steering knuckle—repair or rebush .....		X	
Axle shaft—replace .....	X		
Axle shaft—repair .....			X
Trunnion knuckle bearings—replace .....		X	
Steering knuckle support—replace .....		X	
Tie rod bushing—replace .....		X	
Outer end seal—replace .....	X		
Third member—replace .....	X		
Third member—rebuild .....			X
Universal joint—replace .....	X		
Universal joint—repair .....			X
Turning radius stop screw—adjust .....			X
Caster—adjust .....			X
Camber—adjust .....			X
Toe-in—adjust .....	X		

Section II

TROUBLE SHOOTING

General .....	Paragraph 8
Trouble shooting .....	9

8. GENERAL.

a. In checking the front axle, practically all troubles can be located through a good visual inspection and a thorough road test of the vehicle. In some cases it may be necessary to raise the front end of the vehicle with a suitable jack. This will take the load off the front axle and make it easier to inspect the wheel bearings, tie rod, etc. In cases of misalignment of the front end, it will be necessary to check the caster, camber and steering geometry with front end alinement equipment.

9. TROUBLE SHOOTING.

a. Hard Steering.

Probable Cause	Probable Remedy
Lack of lubrication.	Lubricate tie rod ends, steering gear and steering connecting rod.
Steering gear out of adjustment.	Adjust steering gear (TM 9-765, par. 161).
Improper toe-in.	Adjust toe-in at end of tie rod (par. 29 c (11)).
Low tire pressure.	Inflate tires to 55 pounds.
Bent frame.	Straighten and aline frame.
Incorrect front end alinement.	Aline front end.
Unevenly worn or cupped tires.	Aline front end.
Spring leaf or leaves broken.	Repair springs.
Spring center bolt broken and spring shifted on axle.	Replace spring center bolt and line up spring with axle.
Bent axle housing.	Replace or straighten axle housing (par. 29 c (12)).

b. Lubricant Leaks.

Leak at steering knuckle support.	Replace housing outer end seal and gasket (par. 28 b (5)).
Leaks at differential cover.	Replace cover gasket (par. 48 b (6)).
Leak between third member and banjo housing.	Replace gasket (par. 28 b (2)).

## ORDNANCE MAINTENANCE—AXLES, PROPELLER SHAFTS AND WHEELS FOR BOMB SERVICE TRUCK M6 (CHEVROLET)

### c. Shimmy and Wandering.

#### Probable Cause

Tie rod bushings loose or worn.  
 Steering knuckle bearings worn or out of adjustment.  
 Incorrect front end alinement.  
 Improper tire inflation.  
 Loose or worn wheel bearings.  
 Steering gear out of adjustment.  
 Spring center bolt broken and spring out of alinement with axle.  
 Bent axle housing.

#### Probable Remedy

Replace bushings (par. 17).  
 Adjust or replace bearings (par. 12).  
 Aline front end.  
 Inflate tires to 55 pounds.  
 Adjust or replace front wheel bearings (pars. 75 and 76).  
 Adjust steering gear (TM 9-765).  
 Replace spring center bolt and aline spring with front axle.  
 Replace or straighten axle housing (par. 29 c (12)).

### d. Differential.

Noisy gears or bearings.

Replace worn gears and/or bearings.

Section III

**FRONT AXLE REPAIRS THAT CAN BE PERFORMED WITHOUT REMOVING UNIT FROM VEHICLE**

	Paragraph
Introduction .....	10
Differential carrier assembly .....	11
Steering knuckle support and bearings .....	12
Housing outer end seal .....	13
Steering arm bushing .....	14
Axle shaft .....	15
Axle shaft oil seal .....	16
Steering knuckle .....	17
Steering knuckle thrust washer .....	18
Tie rod .....	19

**10. INTRODUCTION.**

a. **General.** Many times repairs can be made to the front axle without removing the complete unit from the vehicle. The following paragraphs cover these repairs to the various parts and subassemblies of the front axle.

b. **Cleaning and Inspection of the Component Parts.** The cleaning, inspection and repairing of the component parts must be done with extreme care and cleanliness. All parts must be cleaned thoroughly. Dry with clean rags and with pressure from an air blow gun. **CAUTION:** Do not allow ball bearings to be spun by the air stream, as the air pressure is liable to imbed small particles of dirt in the race and damage the bearings. As the parts are disassembled, they should be put into a cleansing tank with SOLVENT, dry-cleaning, and permitted to soak. Do not allow rubber or leather parts to soak, as this cleaning solution will deteriorate the rubber and leather. All leather and rubber parts will be cleaned with alcohol.

**11. DIFFERENTIAL CARRIER ASSEMBLY.**

a. **Equipment.**

CHISEL	STAND, jack (2), or suitable blocks
CLAMP, wheel cylinder, KM-J718C	WRENCH, 3/4-in.
HAMMER, 1-lb	WRENCH, open-end, 7/16-in.
JACK, 41-J-73-5	WRENCH, socket, 9/16-in.
PAN, drain	WRENCH, socket, 5/8-in.
PLIERS, brake spring, KM-KMO-142	WRENCH, wheel bearing nut, KM-J1663
PLIERS, large	WRENCH, wheel nut
SCREWDRIVER, large	

**ORDNANCE MAINTENANCE—AXLES, PROPELLER SHAFTS AND  
WHEELS FOR BOMB SERVICE TRUCK M6 (CHEVROLET)**

**b. Removal Procedure.**

**(1) LOOSEN WHEELS.**

**WRENCH**, wheel nut

Place vehicle on level ground and apply parking brake. Loosen the six pairs of wheel stud nuts on both front wheels two turns.

**(2) RAISE FRONT OF VEHICLE.**

**JACK**, 41-J-73-5

**STAND**, jack (2), or suitable  
blocks

Raise front of vehicle until the wheels clear the ground and support axle housing on jack stands or suitable blocks.

**(3) REMOVE WHEELS.**

**WRENCH**, wheel nut

Remove the six pairs of wheel stud nuts that were previously loosened on each side and remove the wheels.

**(4) REMOVE DRIVE FLANGE.**

**CHISEL**

**WRENCH**,  $\frac{3}{4}$ -in.

**HAMMER**, 1-lb

Bend tangs away from bolt heads and remove the eight bolts and locks on each side. Install two bolts in the tapped holes of flange, screw them in alternately, and the flanges will come out.

**(5) REMOVE HUB (fig. 3).**

**PLIERS**, large

**WRENCH**, wheel bearing nut,  
KM-J1663

Raise the tangs which lock the outer bearing lock nut and remove the nut, using bearing nut wrench. Then remove the inner lock nut, spacer washer, outer bearing cone and roller assembly, and pull off wheel hub.

**(6) INSTALL WHEEL CYLINDER CLAMP (fig. 4).**

**CLAMP**, wheel cylinder, KM-J718C

Install wheel cylinder clamp to keep the wheel cylinder pistons in place and prevent leakage of brake fluid.

**(7) REMOVE RETRACTING SPRING.**

**PLIERS**, brake spring, KM-KMO-142

Remove the brake shoe retracting spring.

**(8) REMOVE ANCHOR PLATE.**

**WRENCH**, socket,  $\frac{5}{8}$ -in.

Remove the six cap screws that attach the brake shoe anchor plate to the steering knuckle. Remove the anchor plate.

**FRONT AXLE REPAIRS THAT CAN BE PERFORMED WITHOUT  
REMOVING UNIT FROM VEHICLE**

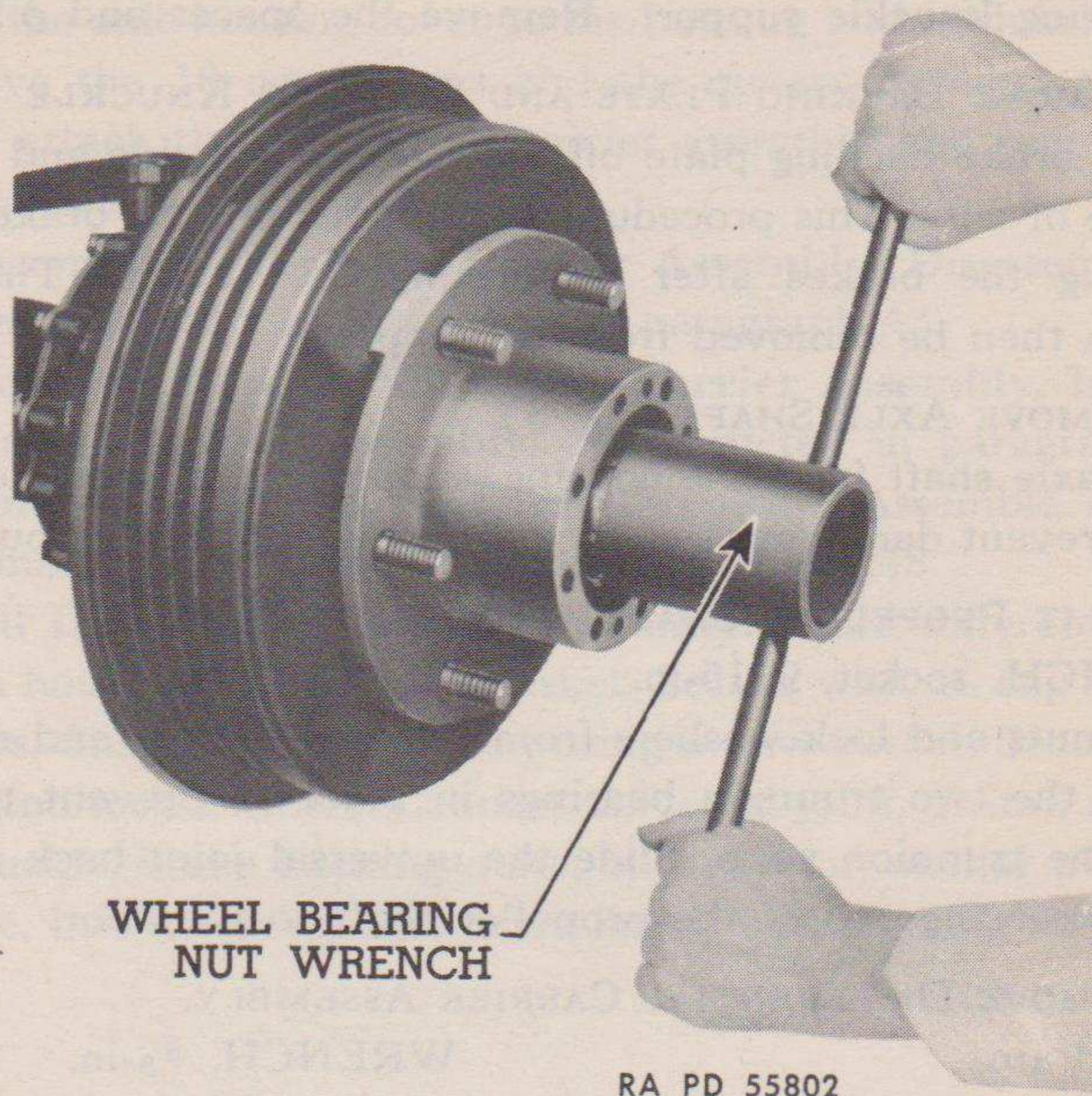

**WHEEL BEARING  
NUT WRENCH**

RA PD 55802

**Figure 3—Hub Removal**

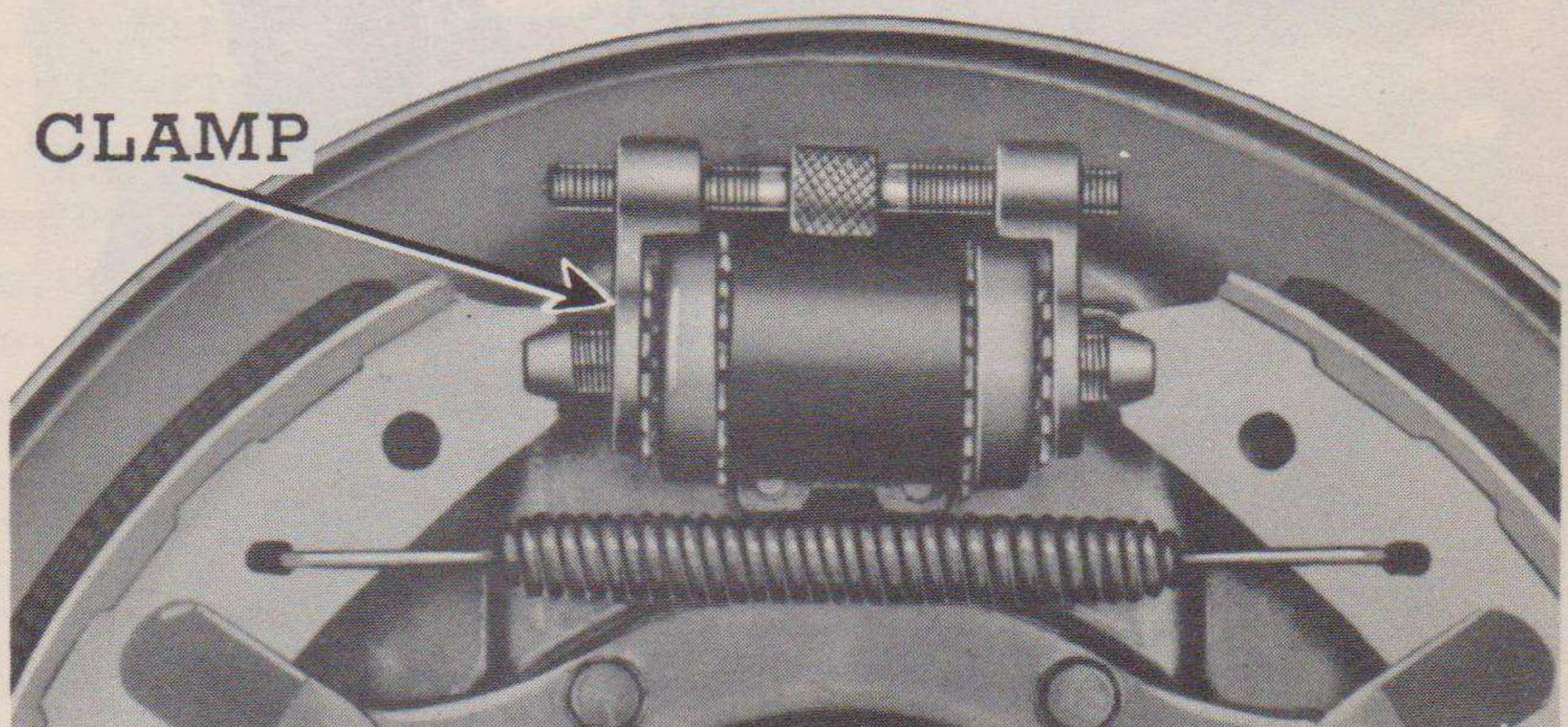

**CLAMP**

RA PD 32214

**Figure 4—Brake Wheel Cylinder Clamp**

(9) REMOVE ANCHOR PLATE SPACER.

WRENCH, socket,  $\frac{5}{8}$ -in.

Remove the twelve cap screws that attach the brake shoe anchor

## ORDNANCE MAINTENANCE—AXLES, PROPELLER SHAFTS AND WHEELS FOR BOMB SERVICE TRUCK M6 (CHEVROLET)

plate spacer, inner oil deflector, brake backing plate and steering knuckle to the steering knuckle support. Remove the spacer and oil deflector.

### (10) REMOVE BACKING PLATE AND STEERING KNUCKLE (fig. 2).

Slide the brake backing plate off the steering knuckle and support it with a piece of wire. This procedure saves removing the brake line hose and bleeding the brakes after performing the repairs. The steering knuckle can then be removed from its support.

### (11) REMOVE AXLE SHAFT (fig. 5).

Pull the axle shaft from the housing, supporting it throughout its full length, to prevent damaging the oil seal in the end of the housing.

### (12) SPLIT PROPELLER SHAFT UNIVERSAL JOINT.

WRENCH, socket, 9/16-in.

Remove nuts and lock washers from the two U-bolts and remove U-bolts. Tape the two trunnion bearings in place to prevent them from falling off the trunnion yoke. Slide the universal joint back on its slip joint and lower the end of the propeller shaft to the floor.

### (13) REMOVE DIFFERENTIAL CARRIER ASSEMBLY.

PAN, drain

WRENCH,  $\frac{5}{8}$ -in.

BRAKE BACKING PLATE

AXLE SHAFT

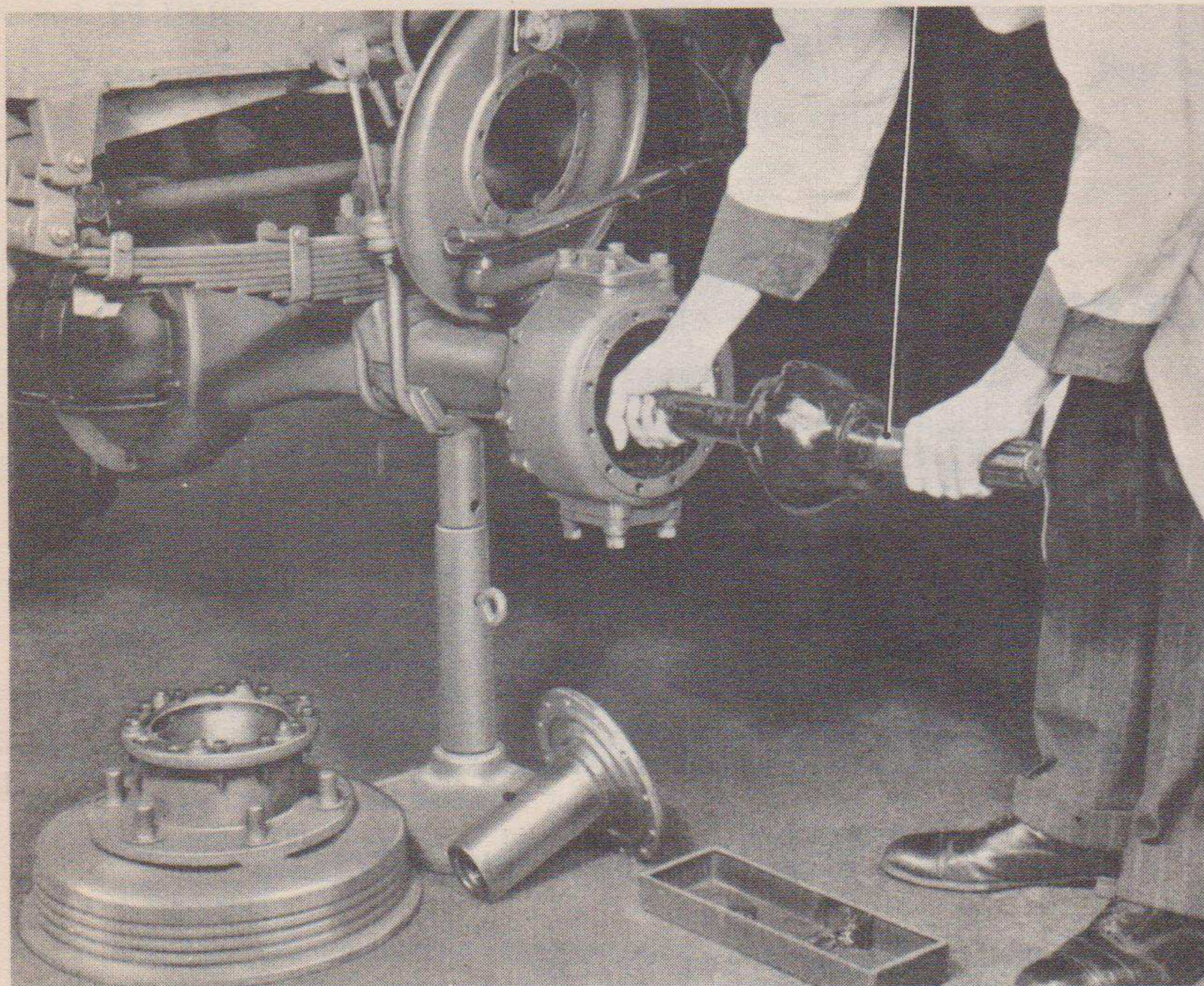

RA PD 55803

Figure 5—Front Axle Shaft Removal

**ORDNANCE MAINTENANCE—AXLES, PROPELLER SHAFTS AND WHEELS FOR BOMB SERVICE TRUCK M6 (CHEVROLET)**

such cases, it is not necessary to remove the steering knuckle support. Instructions covering this operation are contained in paragraph 12 a (1) and (9).

**14. STEERING ARM BUSHING.**

**a. Equipment.**

DRIVER, bushing, KM-J1665  
 HAMMER, 1-lb  
 JACK, floor  
 PLIERS

REAMER, KM-KMO-347  
 STAND, jack, or suitable block  
 WRENCH, 1<sup>5</sup>/<sub>16</sub>-in.  
 WRENCH, wheel nut

**b. Procedure.**

**(1) REMOVE WHEEL.**

JACK, floor  
 STAND, jack, or suitable block

WRENCH, wheel, nut

Raise front of vehicle, place one end of axle on jack stand or suitable block and then remove wheel.

**(2) DISCONNECT TIE ROD.**

DRIFT, brass  
 PLIERS

WRENCH, 1<sup>5</sup>/<sub>16</sub>-in.

Remove cotter pin from tie rod bolt and remove bolt nut. Tap out tie rod bolt and pull tie rod away from steering knuckle arm.

**(3) REMOVE BUSHING (fig. 11).**

DRIVER, bushing, KM-J1665

HAMMER, 1-lb

The steering arm bushing may be removed by driving out the worn bushing, using bushing driver.

**(4) INSTALL BUSHING.**

DRIVER, bushing, KM-J1665

HAMMER, 1-lb

Install new bushing in place, using bushing driver.

**(5) REAM BUSHING.**

REAMER, KM-KMO-347

Ream bushing to proper size, using special bushing reamer.

**(6) CONNECT TIE ROD.**

HAMMER, 1-lb  
 PLIERS

WRENCH, 1<sup>5</sup>/<sub>16</sub>-in.

Place tie rod end over steering arm and install tie rod bolt and nut. Tighten nut snug and back it off one-third to one-half turn and install new cotter key.



**ORDNANCE MAINTENANCE—AXLES, PROPELLER SHAFTS AND  
WHEELS FOR BOMB SERVICE TRUCK M6 (CHEVROLET)**

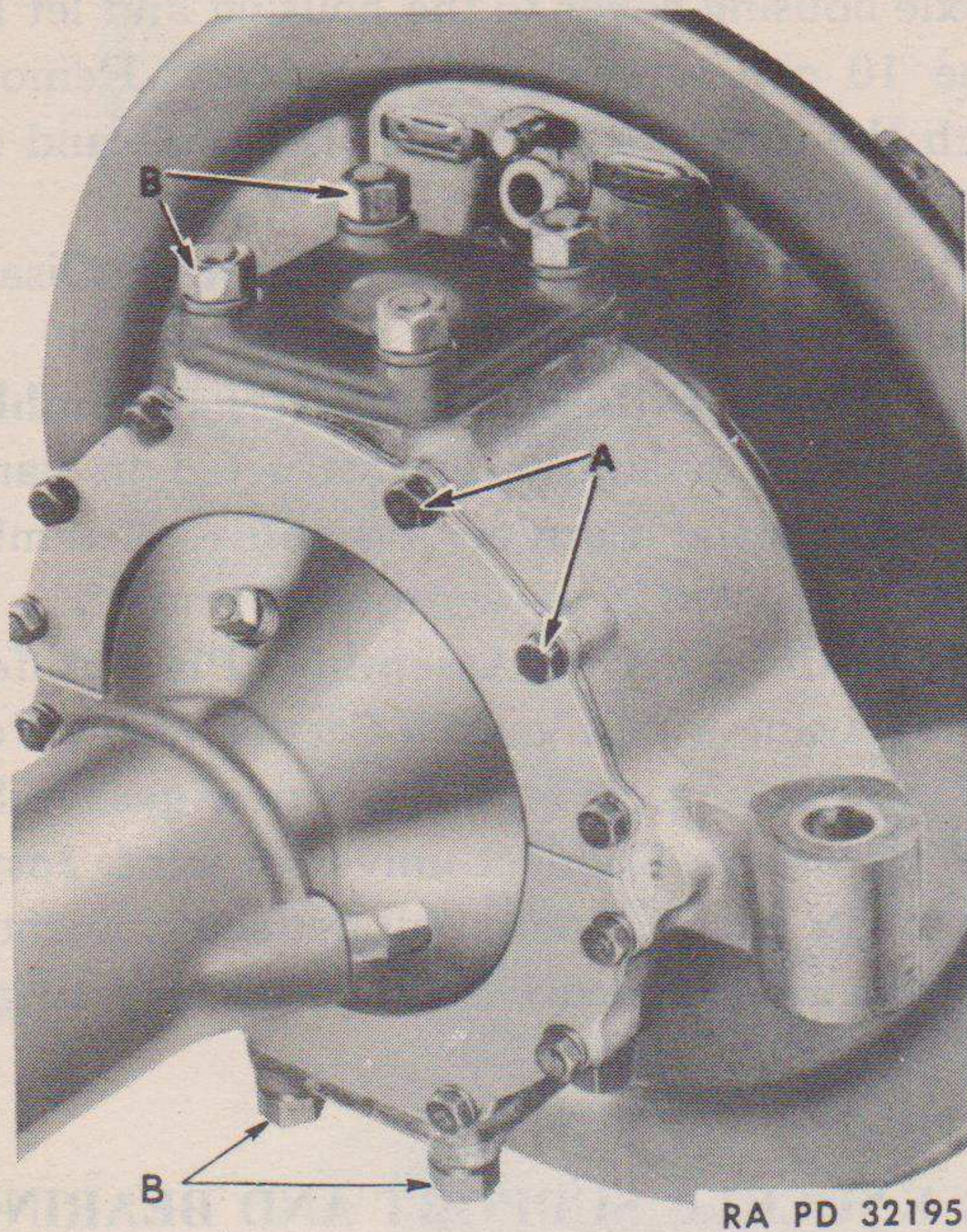

**Figure 6—Outer End Seal Construction**

Inspect the spherical ball on axle end for scores; any scratches on the ball should be smoothed up with sandpaper.

**(4) REMOVE BEARING CUPS (fig. 7).**

DRIVER, bearing cup,  
KM-J1660-2

HAMMER, 1-lb

Drive out the upper bearing cup and oil retainer, using bearing cup driver KM-J1660-2, through the lower bearing cup. After the upper bearing cup and oil retainer have been removed, the lower bearing cup may be driven out from the top, using the same driver.

**(5) INSTALL RETAINERS AND CUPS (fig. 8).**

DRIVER, bearing cup,  
KM-J1660-2

HAMMER, 1-lb.

Install a new oil retainer in the axle end (top side), then install the bearing cup, using bearing cup driver KM-J1660-2. Install the bearing cup in the lower side of the axle end, using the same special tool.

**(6) INSTALL SPRING-LOADED SEAL.** Install spring-loaded seal over end of axle housing.

**FRONT AXLE REPAIRS THAT CAN BE PERFORMED WITHOUT REMOVING UNIT FROM VEHICLE**



**Figure 7—Removing Steering Knuckle Bearing Cup**

**(7) INSTALL TRUNNIONS.  
WRENCH,  $\frac{3}{4}$ -in.**

Hand pack bearings with **GREASE**, general purpose, No. 2. Install the roller bearings in the axle end and then slip the steering knuckle support over the axle end. Install one each of the following thickness shims over the studs for the front axle trunnions: 0.002-inch, 0.005-inch, 0.010-inch, 0.030-inch. Install the trunnions, lock washers and nuts; then tighten the nuts securely.

**(8) STEERING KNUCKLE ADJUSTMENT (fig. 9).  
SCALE, KM-J1670**

Adjustment of the trunnion bearings is accomplished by adding or removing shims until the load necessary to turn the steering knuckle support is 35 inch pounds plus or minus 5 inch pounds after start of rotation. To check this load, hook the end of the checking scale KM-J1670 in the tie rod bolt bushing in the steering knuckle support. The load necessary to keep the steering knuckle support in motion at this point is  $4\frac{1}{2}$  to 6 pounds. **NOTE:** It is most important that the same thickness of shims be used between the trunnions and steering knuckle support top and bottom.

ORDNANCE MAINTENANCE—AXLES, PROPELLER SHAFTS AND  
WHEELS FOR BOMB SERVICE TRUCK M6 (CHEVROLET)

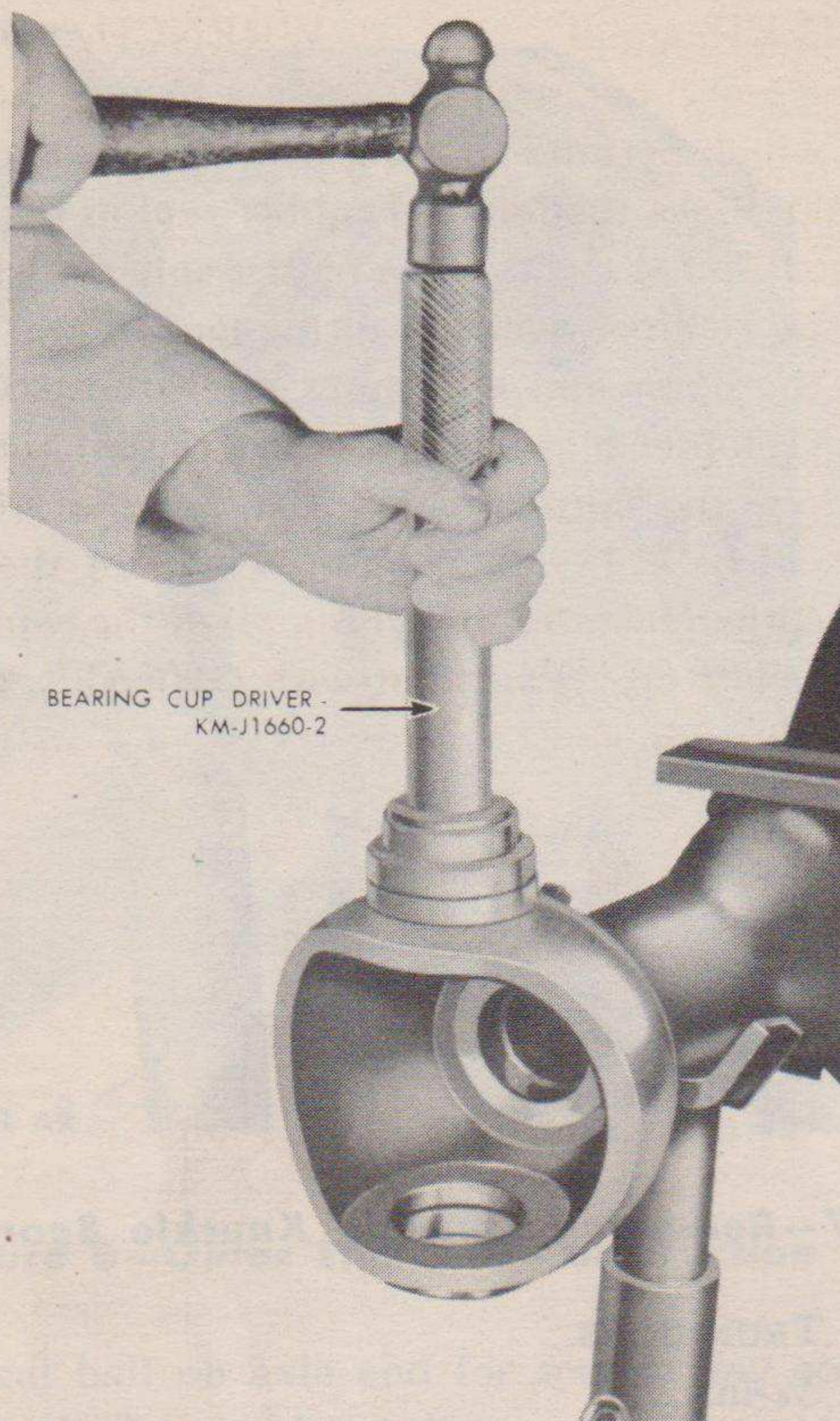

RA PD 55805

**Figure 8—Installing Steering Knuckle Bearing Cup**

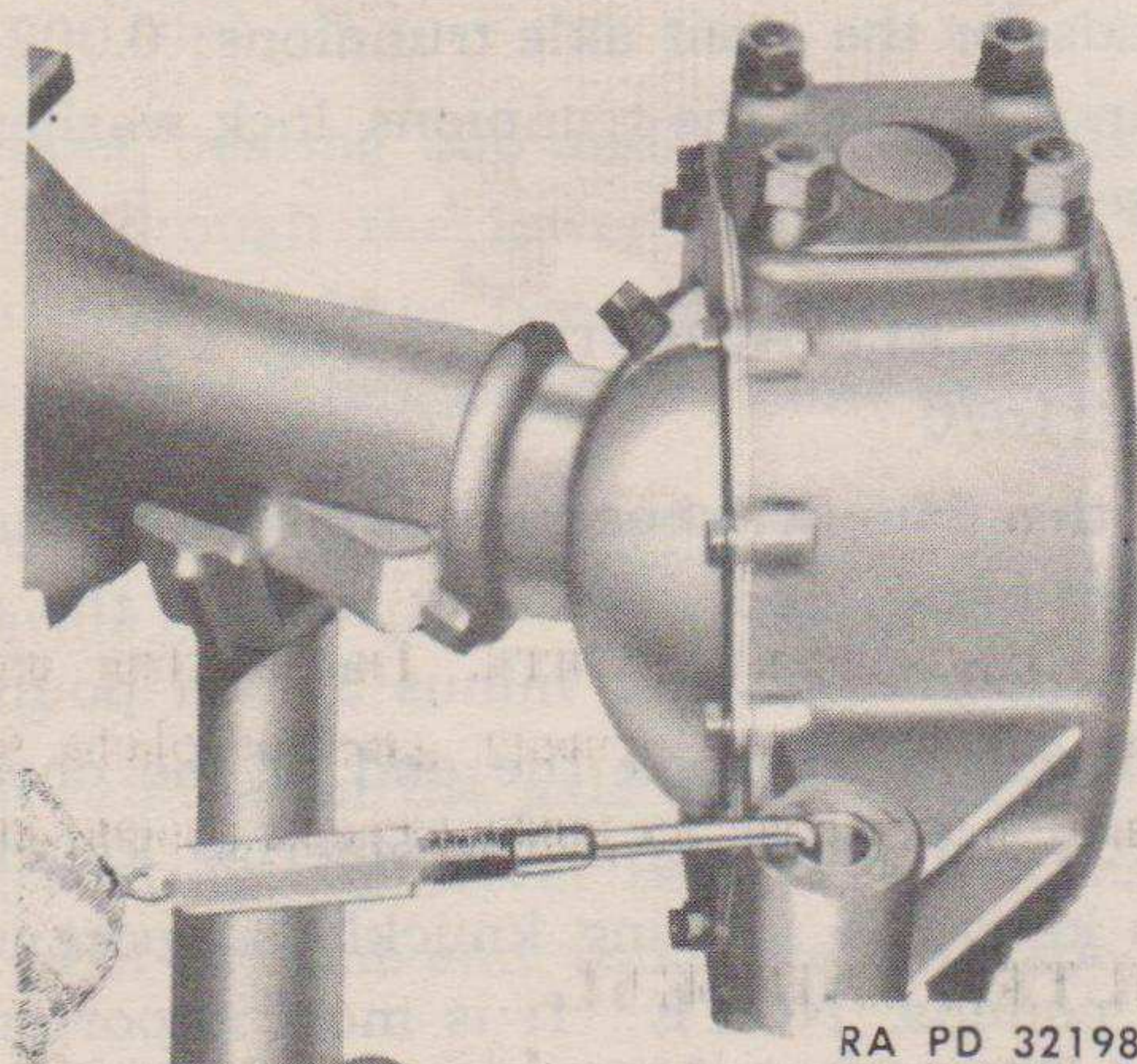

RA PD 32198

**Figure 9—Checking Load on Steering Knuckle Bearings**

## FRONT AXLE REPAIRS THAT CAN BE PERFORMED WITHOUT REMOVING UNIT FROM VEHICLE

(9) INSTALL SEALS, GASKETS AND RETAINER (fig. 10).

SCREWDRIVER, small

WRENCH, 1/2-in.

Install the outer seal inner retainer, using a new gasket. The diagonal cut in the gasket, which permits slipping it over the axle housing, should be placed at the top. Place the felt and rubber seal in the retainer so that the taper of the seal fits the curvature of the spherical ball on the axle end. Place the metal retainer over the spring-loaded seal and then install the lower half of the outer end seal inner retainer plate. Start two cap screws through the retainer plate to hold it in position, then, using a small screwdriver, position the spring-loaded seal so that it fits uniformly around the spherical ball. Install the upper half of the outer end seal inner retainer plate, then install and tighten all of the retainer cap screws. Lubricate the axle shaft universal joint with GREASE, general purpose, No. 1, then install the axle shaft.

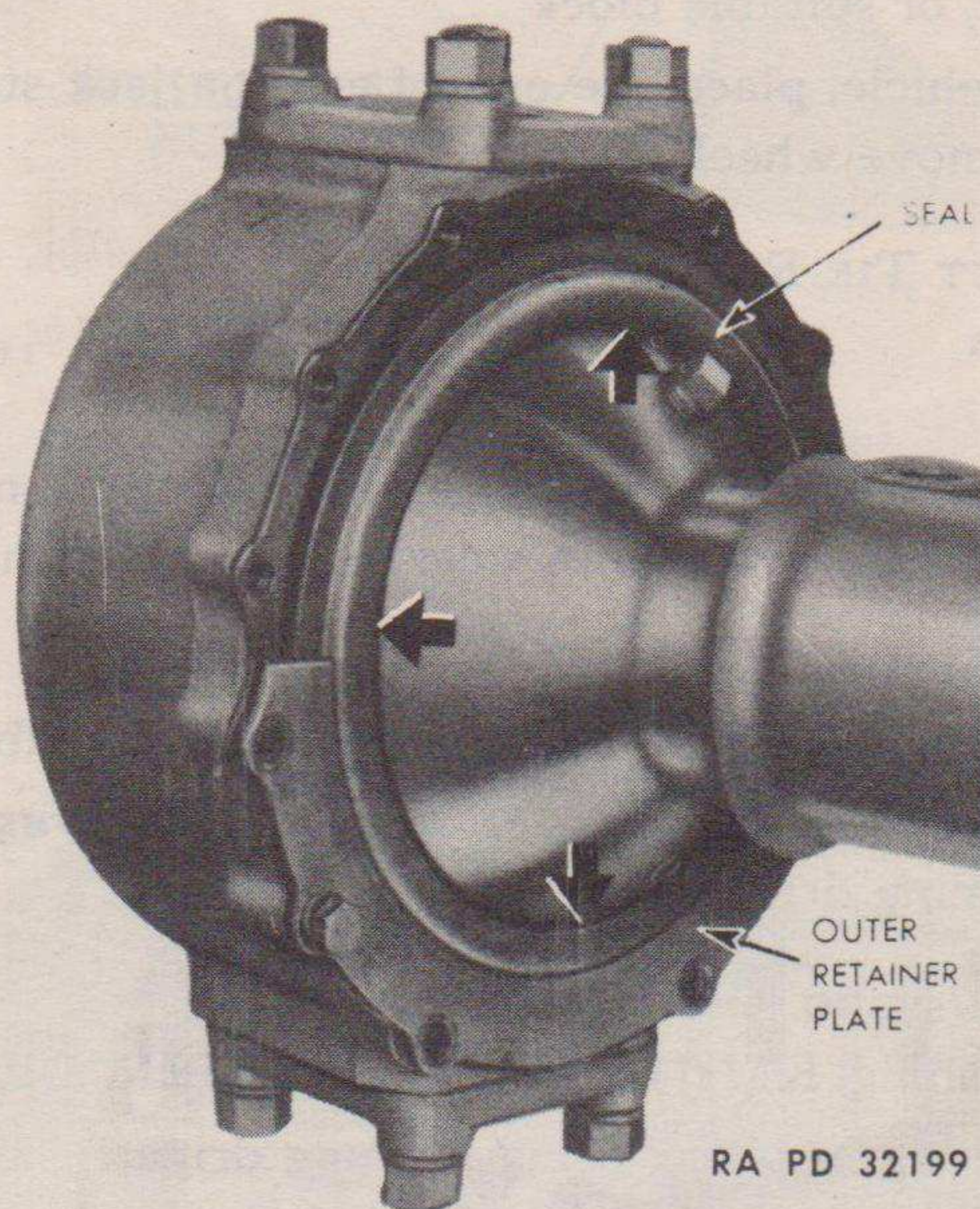

RA PD 32199

**Figure 10—Installing Outer End Seal**

(10) ASSEMBLE COMPONENT PARTS. Install the steering knuckle, brake backing plate, oil deflector, spacer, anchor plate, wheel hub, driving flange and wheel, according to instructions given in paragraph 28.

### 13. HOUSING OUTER END SEAL.

a. There may be times when it would be necessary to replace the felt and rubber outer end seal without replacing the spring-loaded seal. In

**ORDNANCE MAINTENANCE—AXLES, PROPELLER SHAFTS AND WHEELS FOR BOMB SERVICE TRUCK M6 (CHEVROLET)**

such cases, it is not necessary to remove the steering knuckle support. Instructions covering this operation are contained in paragraph 12 a (1) and (9).

**14. STEERING ARM BUSHING.**

**a. Equipment.**

DRIVER, bushing, KM-J1665  
 HAMMER, 1-lb  
 JACK, floor  
 PLIERS

REAMER, KM-KMO-347  
 STAND, jack, or suitable block  
 WRENCH, 1<sup>5</sup>/<sub>16</sub>-in.  
 WRENCH, wheel nut

**b. Procedure.**

**(1) REMOVE WHEEL.**

JACK, floor  
 STAND, jack, or suitable block

WRENCH, wheel, nut

Raise front of vehicle, place one end of axle on jack stand or suitable block and then remove wheel.

**(2) DISCONNECT TIE ROD.**

DRIFT, brass  
 PLIERS

WRENCH, 1<sup>5</sup>/<sub>16</sub>-in.

Remove cotter pin from tie rod bolt and remove bolt nut. Tap out tie rod bolt and pull tie rod away from steering knuckle arm.

**(3) REMOVE BUSHING (fig. 11).**

DRIVER, bushing, KM-J1665

HAMMER, 1-lb

The steering arm bushing may be removed by driving out the worn bushing, using bushing driver.

**(4) INSTALL BUSHING.**

DRIVER, bushing, KM-J1665

HAMMER, 1-lb

Install new bushing in place, using bushing driver.

**(5) REAM BUSHING.**

REAMER, KM-KMO-347

Ream bushing to proper size, using special bushing reamer.

**(6) CONNECT TIE ROD.**

HAMMER, 1-lb  
 PLIERS

WRENCH, 1<sup>5</sup>/<sub>16</sub>-in.

Place tie rod end over steering arm and install tie rod bolt and nut. Tighten nut snug and back it off one-third to one-half turn and install new cotter key.

## FRONT AXLE REPAIRS THAT CAN BE PERFORMED WITHOUT REMOVING UNIT FROM VEHICLE

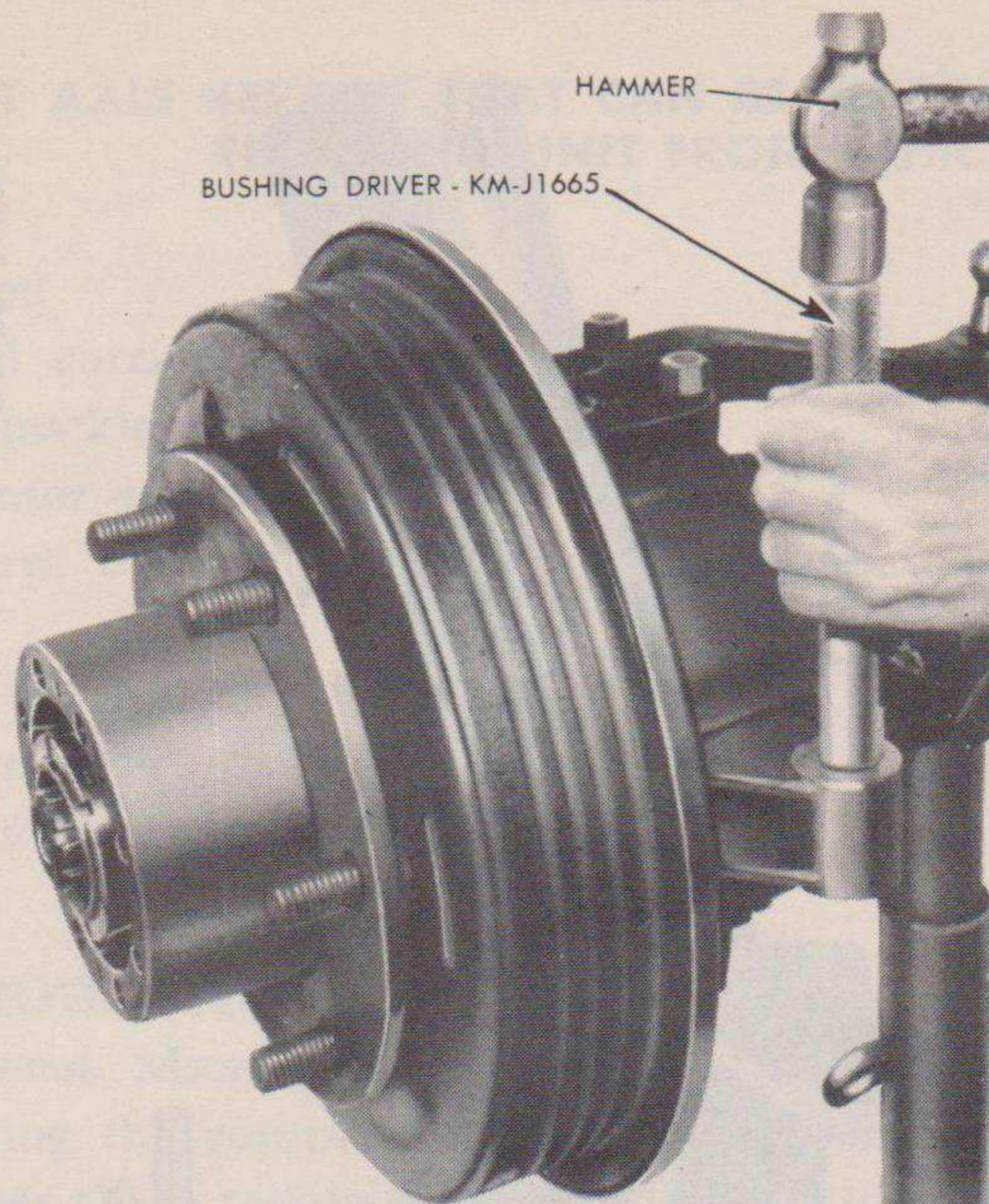

RA PD 55806

**Figure 11—Removing Steering Knuckle Arm Bushing**

(7) CHECK TOE-IN. Toe-in should be from zero inch to one-eighth inch. If necessary to adjust toe-in, refer to instructions in paragraph 19 b (2).

### 15. AXLE SHAFT.

#### a. Removal Procedure.

(1) REMOVE AXLE SHAFT. Remove the front wheel drive flange, wheel hub and steering knuckle according to instructions given in paragraph 11. Then pull the axle shaft out of the housing. NOTE: The axle shafts are of different lengths, therefore, they are not interchangeable.

#### b. Axle Shaft Universal Joint.

(1) DISASSEMBLE AXLE SHAFT UNIVERSAL JOINT (figs. 12 and 13).

HAMMER, 1-lb

PUNCH, drift, small

MICROMETER

PUNCH, prick

PAN, washing

Mark each yoke and all four driving balls as they must be reassembled in the same relationship. Wash the axle shaft and universal joint thoroughly in SOLVENT, dry-cleaning. Using a drift punch and hammer, drive out the retainer pin which locks the center ball pin. Bounce the

ORDNANCE MAINTENANCE—AXLES, PROPELLER SHAFTS AND  
WHEELS FOR BOMB SERVICE TRUCK M6 (CHEVROLET)

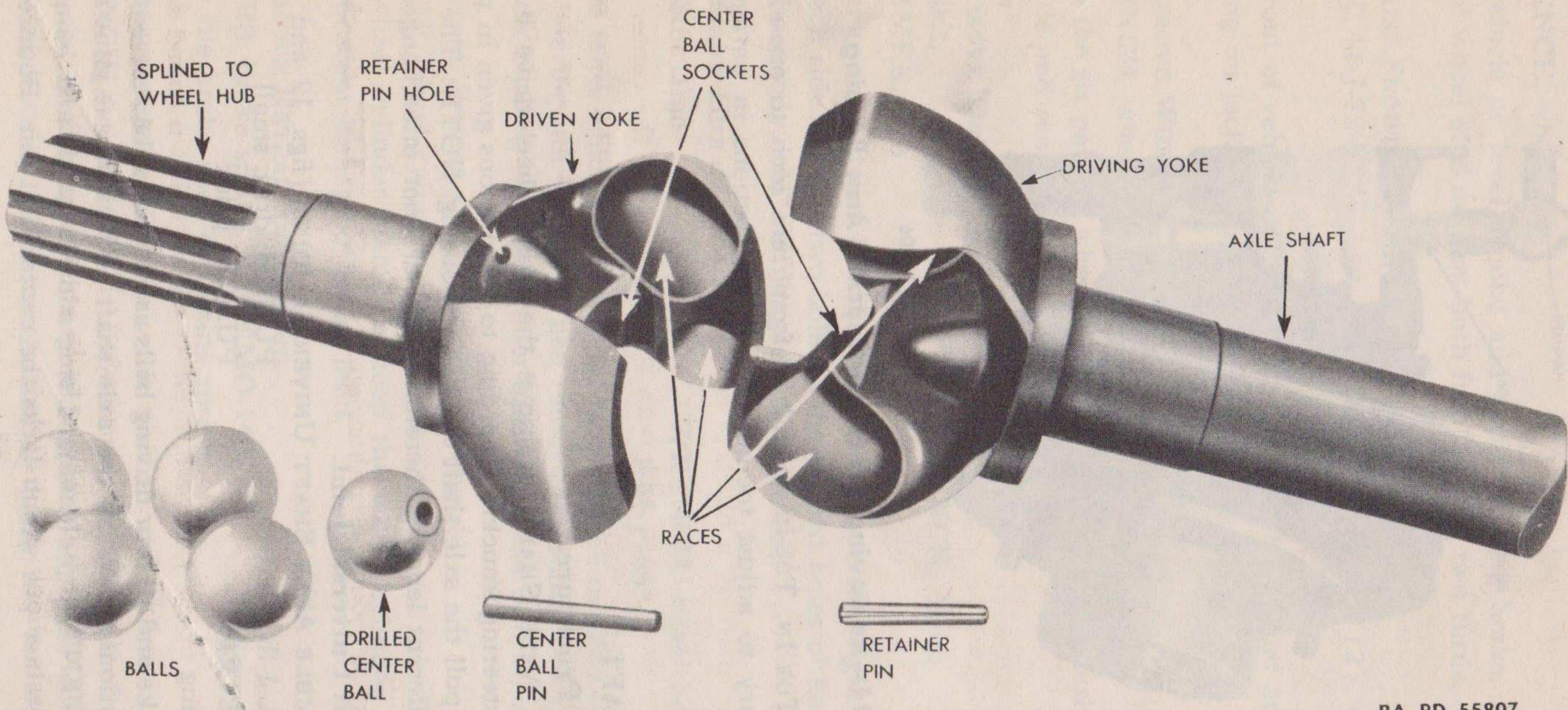

22

RA PD 55807

Figure 12—Axle Shaft Universal Joint Disassembled

## FRONT AXLE REPAIRS THAT CAN BE PERFORMED WITHOUT REMOVING UNIT FROM VEHICLE

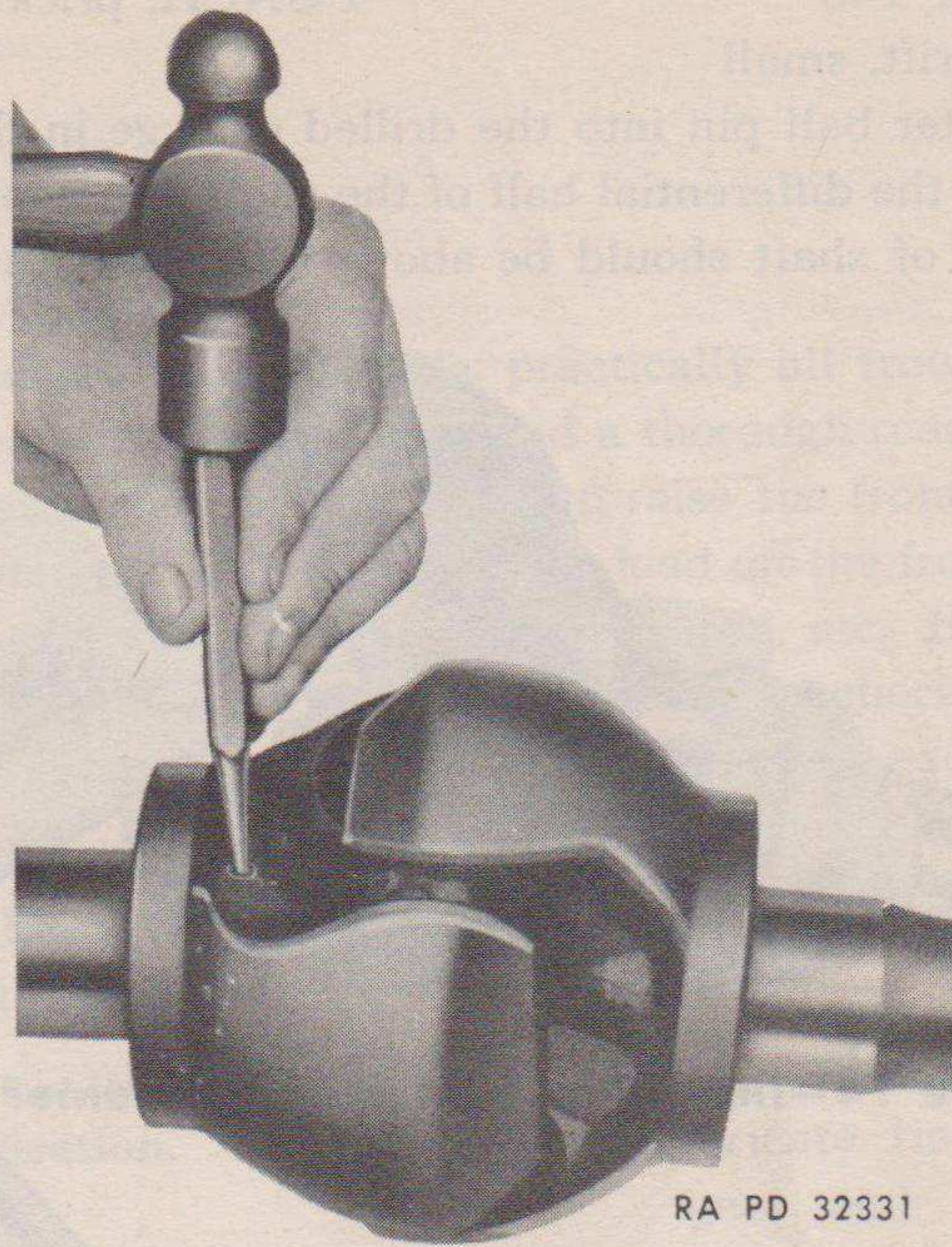

RA PD 32331

**Figure 13—Driving Out Retainer Pin**

wheel end of the shaft on a block of wood to cause the center ball pin to move into the drilled passage in the wheel end of the shaft. Pull the two halves of the joint apart, and, with the fingers, turn the center ball until the grooves in the ball line up with one of the races, then swing the joint to an angle to permit one of the driving balls to pass through the groove in the center ball. The remaining three driving balls and center ball will then drop out.

### (2) CLEANING.

PAN, washing

Wash the universal joint parts thoroughly with SOLVENT, dry-cleaning.

### (3) INSPECTION.

MICROMETER

Inspect the parts of the joint and, if either of the yokes is found damaged or if any of the four driving balls show scratches, or flat spots, the installation of a new joint is recommended. If the center ball pin or center ball, or any of the four driving balls show scratches, grooves, or flat spots, new parts should be installed.



**ORDNANCE MAINTENANCE—AXLES, PROPELLER SHAFTS AND WHEELS FOR BOMB SERVICE TRUCK M6 (CHEVROLET)**

(4) ASSEMBLE AXLE SHAFT UNIVERSAL JOINT (figs. 14 and 15).

HAMMER, 1-lb

PUNCH, prick

PUNCH, drift, small

Drop the center ball pin into the drilled passage in the wheel end of the shaft. Place the differential half of the shaft in a bench vise. **NOTE:** Ground portion of shaft should be above vise jaws. Install center ball

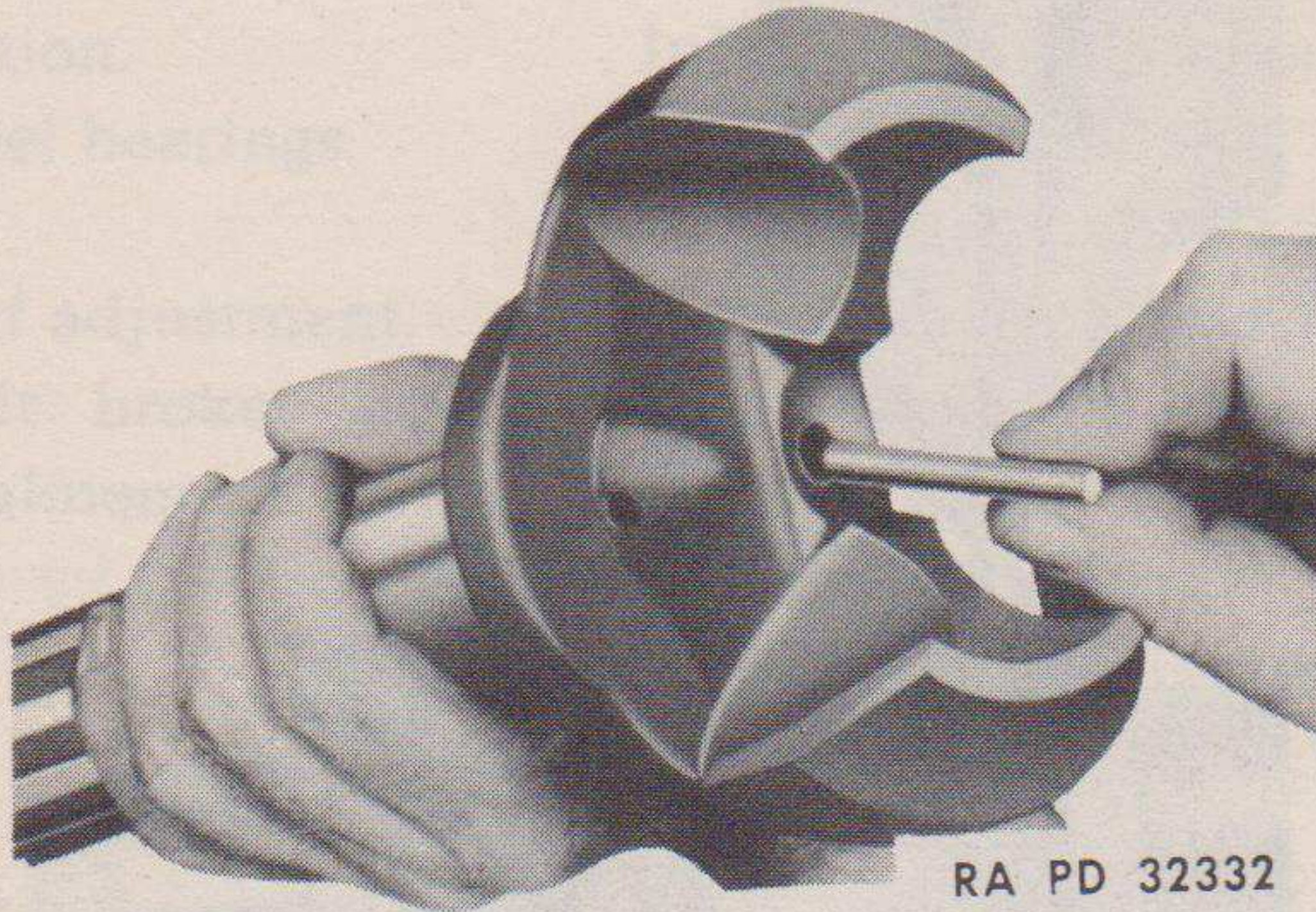

**Figure 14—Installing Center Ball Retainer Pin**

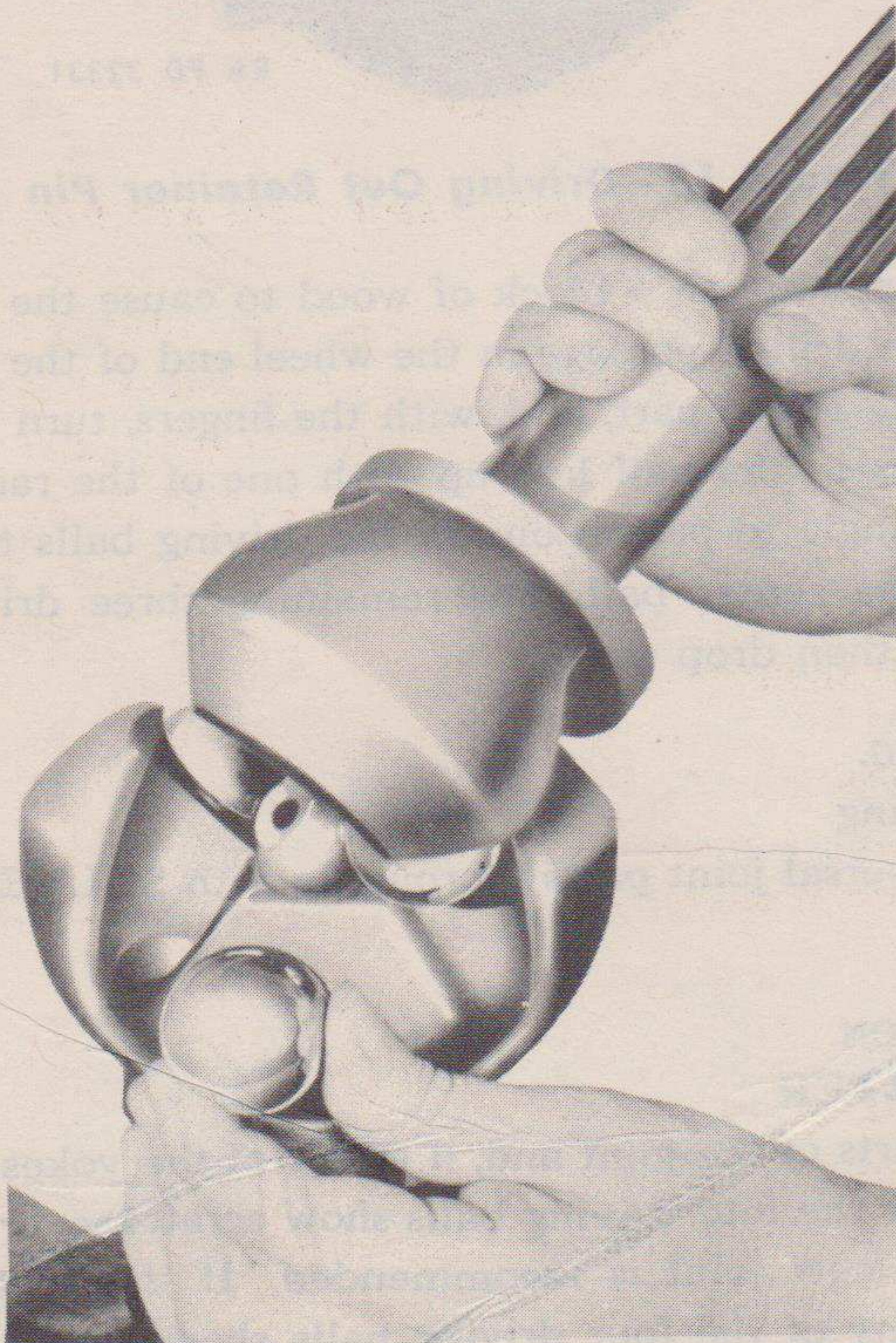

**Figure 15—Installing Universal Joint Balls**

## FRONT AXLE REPAIRS THAT CAN BE PERFORMED WITHOUT REMOVING UNIT FROM VEHICLE

(one with groove and hole drilled in it) in its socket in the shaft, hole, and groove, facing operator. Place the wheel end of joint on the center ball. Then slip three driving balls into the races. Turn center ball until the groove in it lines up with the race for the remaining ball. The joint should now be tipped to extreme angle to slip the fourth driving ball into the race. Then straighten up the wheel end of shaft. Reach in with fingers and turn the center ball until the center ball pin drops in hole in ball. Install the retainer pin and prick-punch both ends to securely lock it in place. Use a new retainer pin if available. This universal joint is designed to have a limited amount of end play after being installed in the axle. This end play is controlled by two bronze thrust washers, one in the end of the housing and the other in the knuckle support.

(5) **INSTALL AXLE SHAFT.** Pack the universal joint with **GREASE**, general purpose, seasonal grade. Push the axle shaft into the housing and rotate the shaft slightly until it slips into the splines in the differential side gear. When installing the axle shaft, care must be taken not to damage the axle shaft oil seal. The universal joint should be supported from below while bearing down on the end of the shaft to enter it in the differential side gear. Lubricate the shaft where it contacts the bushing and thrust washer in the steering knuckle. Install the steering knuckle, using a new gasket; then install the brake assembly, wheel hub and drive flange according to instructions in paragraph 28 b (8) through (13). **CAUTION:** If a vehicle is to be left standing out of doors for a period of time, a coating of grease should be applied to the exposed portion of the spherical shell surrounding the universal joint to prevent rusting. This machined surface cannot be painted because it moves against the oil seal when the wheels are turned in steering. It will be kept well lubricated automatically when the vehicle is in operation, but if it becomes rusty due to being stored in the open, the rusty surface would rapidly wear the oil seal and allow lubricant to be lost from the universal joint.

### 16. AXLE SHAFT OIL SEAL.

a. **Procedure.** To replace the axle shaft oil seals, it is necessary to remove the component parts as instructed in paragraph 11 b (1) through (11). After removing the axle shaft, proceed as follows:

(1) **REMOVE AXLE SHAFT OIL SEAL** (fig. 16).

CHISEL, cold

PULLER, oil seal, KM-J943

HAMMER, 1-lb

Insert oil seal puller through the opening in the end of housing and in behind the seal. Place a wedge, such as a cold chisel, between the puller tangs to keep the tangs forced out into place behind the seal and tap the center of the puller to remove the oil seal (fig. 16).

**ORDNANCE MAINTENANCE—AXLES, PROPELLER SHAFTS AND  
WHEELS FOR BOMB SERVICE TRUCK M6 (CHEVROLET)**

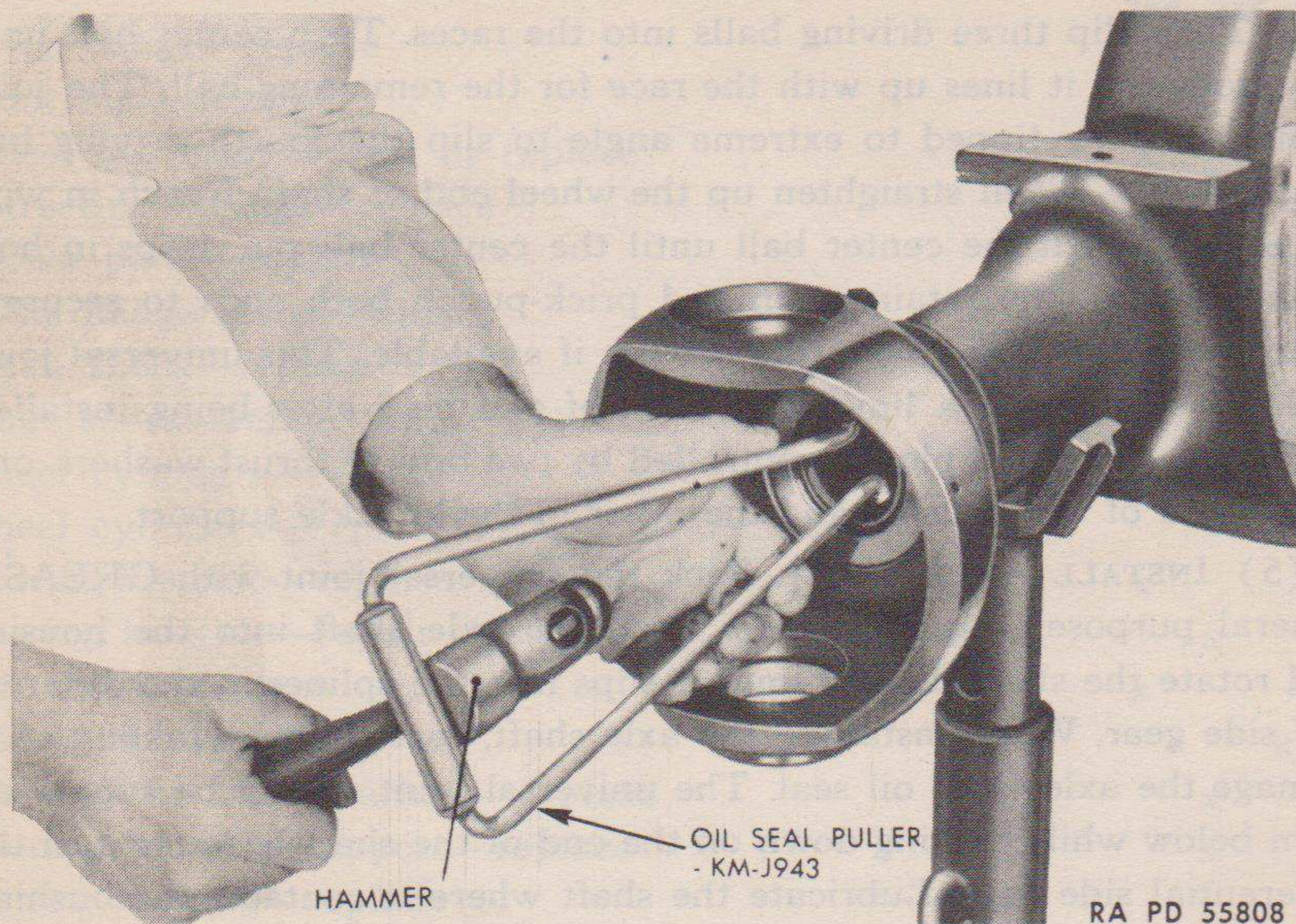

**Figure 16—Removing Axle Shaft Oil Seal**

(2) **INSTALL AXLE SHAFT OIL SEAL** (fig. 17).

**DRIVER**, oil seal, KM-J1661      **HAMMER**, 1-lb

Before a new seal is installed, it should be soaked in engine oil to make the leather pliable and also to prevent burning the leather before the regular axle lubricant can reach it. Place the new seal on seal driver with the free end of the leather toward the end of the tool and drive the seal in place in the end of the housing. Then install the oil seal retainer with the open side of the retainer toward the seal. The retainer should be driven in until its outer surface is flush with the end of the housing bore (inside the thrust washer).

(3) **REASSEMBLE COMPONENT PARTS.** Install the axle shaft, steering knuckle, brake backing plate, oil deflector, spacer, anchor plate, wheel hub, driving flange and wheels according to instructions given in paragraph 28 b (6) through (15).

**17. STEERING KNUCKLE** (fig. 18).

a. To replace the steering knuckle or bushing, it is necessary to remove the component parts, as instructed in paragraph 11 (1) through (10). After removing the brake backing plate, remove steering knuckle from housing.

**FRONT AXLE REPAIRS THAT CAN BE PERFORMED WITHOUT REMOVING UNIT FROM VEHICLE**

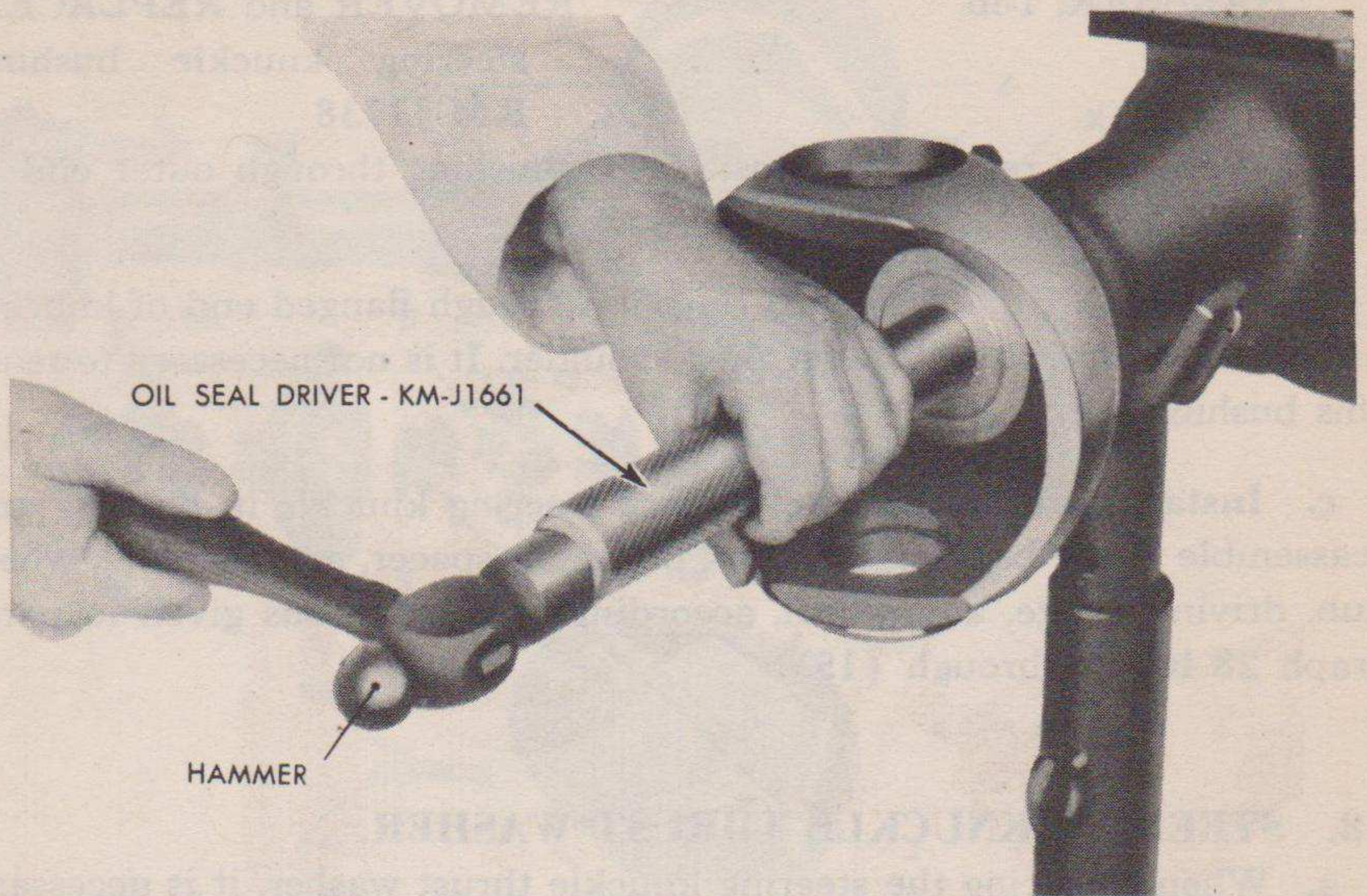

RA PD 55809

**Figure 17—Installing Axle Shaft Oil Seal**

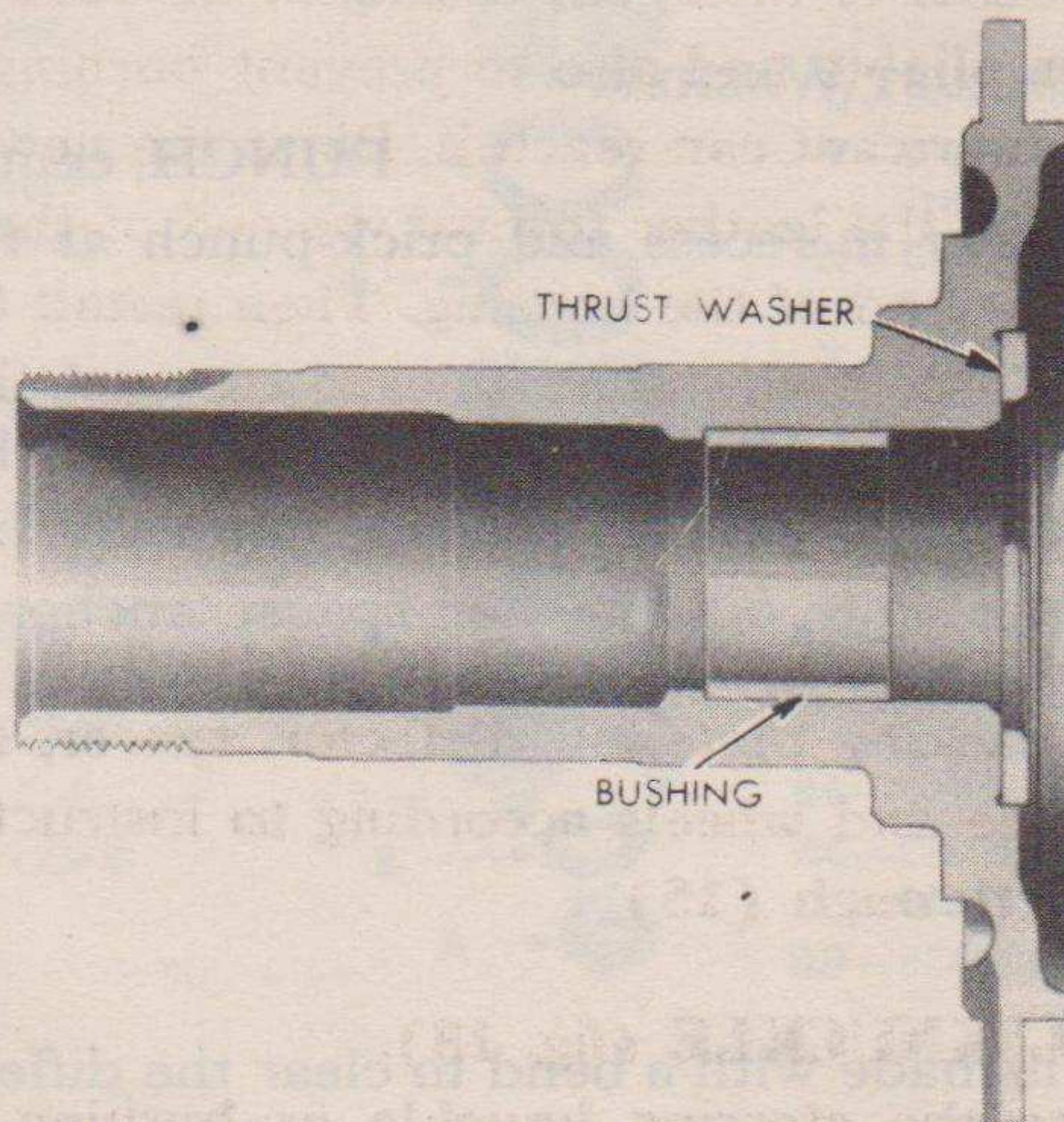

RA PD 32336

**Figure 18—Cross Section of Steering Knuckle**

**ORDNANCE MAINTENANCE—AXLES, PROPELLER SHAFTS AND WHEELS FOR BOMB SERVICE TRUCK M6 (CHEVROLET)**

**b. Steering Knuckle Repairs.**

**(1) REMOVE BUSHING.**

HAMMER, 1-lb  
PRESS

REMOVER and REPLACER,  
steering knuckle bushing,  
KM-J1738

Place bushing remover in position on bushing through outer end of knuckle and press bushing out of knuckle.

**(2) INSTALL BUSHING.** Start bushing through flanged end of knuckle and press in until it bottoms against shoulder. It is not necessary to ream this bushing.

**c. Install Component Parts.** Place steering knuckle in housing and reassemble brake backing plate, oil deflector, spacer, anchor plate, wheel hub, driving flange, and wheel, according to instructions given in paragraph 28 b (7) through (15).

**18. STEERING KNUCKLE THRUST WASHER.**

**a.** When replacing the steering knuckle thrust washer, it is necessary to remove the component parts as instructed in paragraph 11 b (1) through (10).

**b. Thrust Washer Replacement.**

**(1) REMOVE THRUST WASHER.**

CHISEL, cold, small

HAMMER, 1-lb

Remove center punch marks with chisel and pry out thrust washer.

**(2) INSTALL THRUST WASHER.**

HAMMER, 1-lb

PUNCH, center

Place thrust washer in recess and prick-punch at three equal points around its outer edge.

**c. Install Component Parts.** Place axle shaft in housing and reassemble seals, retainers, gasket, steering knuckle support, steering knuckle, brake flange plate, oil deflector, spacer, anchor plate, wheel hub, driving flange and wheel according to instructions given in paragraph 28 b (5) through (15).

**19. TIE ROD.**

**a.** The tie rod is made with a bend to clear the differential. The right end is threaded with a coarse thread to screw into the right tie rod end. The left end is threaded with a fine thread for making toe-in adjustment. A keyway is milled in the rod to position it for clearance.

## FRONT AXLE REPAIRS THAT CAN BE PERFORMED WITHOUT REMOVING UNIT FROM VEHICLE

### b. Replacement.

#### (1) REMOVE TIE ROD.

PLIERS

WRENCH,  $1\frac{5}{16}$ -in.

WRENCH,  $\frac{3}{4}$ -in.

Remove cotter pin from each steering arm bolt and remove bolt nut and bolt. Lower tie rod assembly. Remove tie rod end clamp bolts and nut and unscrew ends.

#### (2) INSTALL TIE ROD AND ADJUST TOE-IN.

GAGE, toe-in

(a) When installing the tie rod, it should be screwed into the right tie rod end until there is a minimum of one-eighth inch clearance between the lower rib on the left side of the differential and of the tie rod, when the wheels are turned for a full left turn. After checking the above clearance, the left tie rod end should be adjusted to provide zero-inch to one-eighth inch toe-in. Lock the tie rod by placing the circular lock in the keyway of the rod and inserting one of the tie rod end clamp bolts through it. Then tighten the two tie rod end clamp bolt nuts on each end. Install tie rod assembly on steering knuckle arms by inserting bolts and securing with nuts. The nuts should be pulled down snug and then backed off one-third to one-half turn and locked with cotter pins.

(b) Adjust toe-in as described in TM 9-765. If difficulty is experienced in securing proper toe-in, it may be necessary to disconnect the tie rod from the right steering arm and screw the end either on or off the tie rod one turn. Then screw the left tie rod end on or off the rod to secure proper toe-in. The reason for this operation is the fact that a coarse thread is used on the right side while a fine thread is used on the left side. Since any change in toe-in involves a complete turn of the tie rod end, working with the two tie rod ends, one having a coarse thread and the other a fine thread, closer toe-in adjustment is obtainable.

**ORDNANCE MAINTENANCE—AXLES, PROPELLER SHAFTS AND WHEELS FOR BOMB SERVICE TRUCK M6 (CHEVROLET)**

**Section IV**

**REMOVAL OF FRONT AXLE FROM VEHICLE**

	Paragraph
Preliminary procedure .....	20
Removal of front axle assembly .....	21

**20. PRELIMINARY PROCEDURE.**

a. In preparing to replace the front axle as a unit, it is important that the truck be placed on a solid foundation, preferably a concrete floor. After raising the front end of the truck, the frame should be supported on solid jack stands or suitable blocking. The front axle unit should be supported on a floor jack while removing it from the truck. This will facilitate ease in handling the unit while removing it.

**21. REMOVAL OF FRONT AXLE ASSEMBLY.**

a. **Equipment.** The equipment needed for repair operations in this section is listed below. Equipment needed for each operation is listed at the start of each paragraph covering the operation.

- |                                      |                                       |
|--------------------------------------|---------------------------------------|
| JACK, floor, 41-J-73-5               | WRENCH, $\frac{9}{16}$ -in.           |
| PLIERS                               | WRENCH, $\frac{5}{8}$ -in.            |
| SCREWDRIVER, large                   | WRENCH, $\frac{15}{16}$ -in.          |
| STANDS, jack (2), or suitable blocks | WRENCH, open-end, $\frac{7}{16}$ -in. |
|                                      | WRENCH, wheel nut                     |

**b. Procedure.**

**(1) LOOSEN WHEELS.**

WRENCH, wheel nut.

Loosen the six pairs of wheel nuts two turns.

**(2) RAISE FRONT OF VEHICLE.**

JACK, floor, 41-J-73-5	STANDS, jack, (2), or suitable blocks
------------------------	---------------------------------------

Raise front of vehicle and support frame on suitable jack stands or blocks. Use floor jack to support axle assembly.

**(3) SLIT PROPELLER SHAFT. UNIVERSAL JOINT.**

WRENCH,  $\frac{9}{16}$ -in.

Remove the four nuts and lock washers from the two U-bolts and remove U-bolts. Tape the two trunnion bearings in place to prevent them from falling off the trunnion yoke. Slide the universal joint back on its slip joint and lower the end of the propeller shaft to the floor.

**REMOVAL OF FRONT AXLE FROM VEHICLE****(4) DISCONNECT STEERING CONNECTING ROD (DRAG LINK).****PLIERS****SCREWDRIVER, large**

Remove cotter pin and unscrew end plug. Then remove safety plug, tension spring and ball seat. Lift steering connecting rod (drag link) off the steering knuckle arm ball.

**(5) DISCONNECT BRAKE HOSES.****PLIERS****WRENCH, open-end,  $\frac{7}{16}$ -in.**

Unscrew brake pipe to brake hose coupling nut, remove hose from mounting clip on each side.

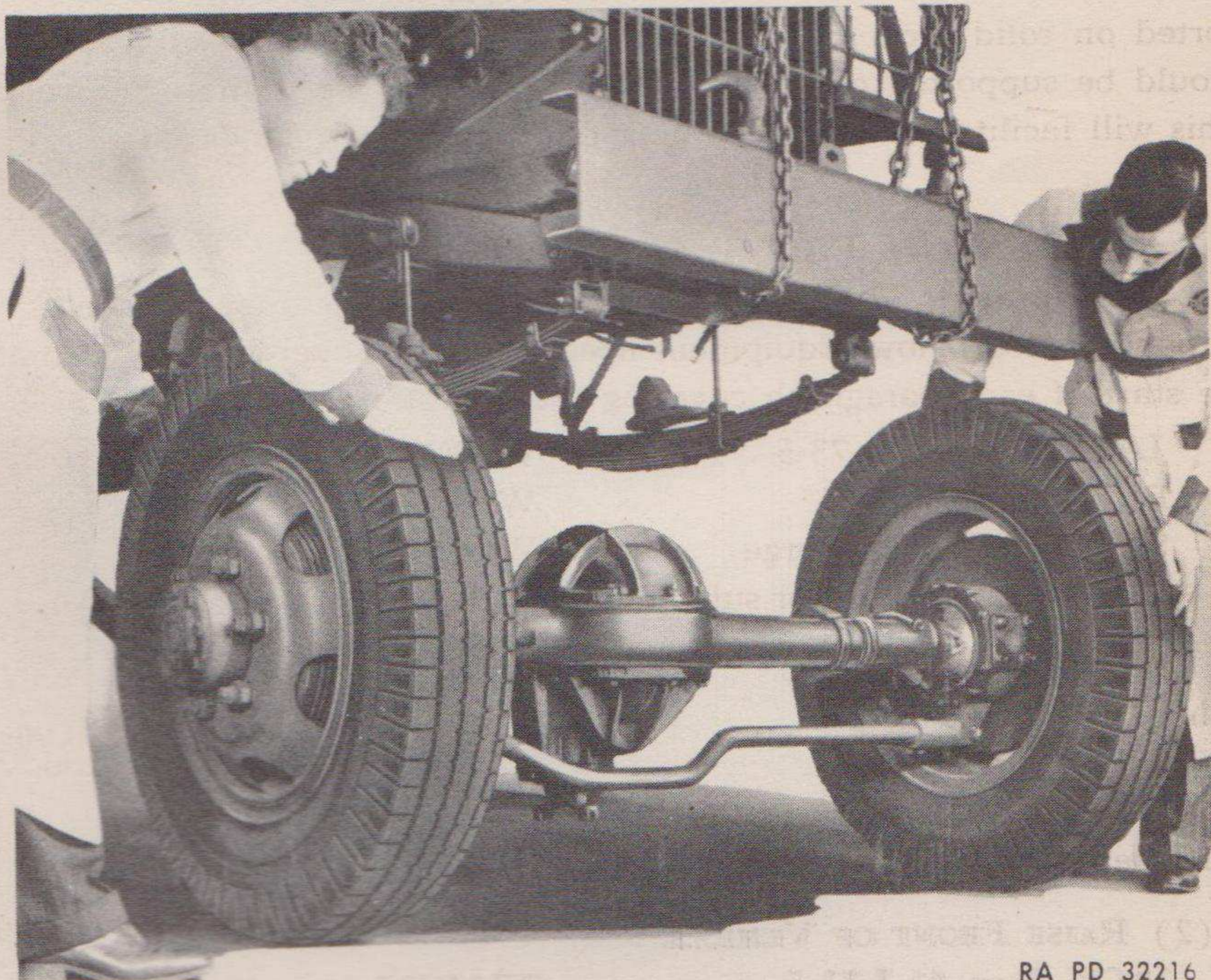

RA PD 32216

**Figure 19—Front Axle Assembly Removal****(6) DISCONNECT SHOCK ABSORBER LINKS.****WRENCH,  $\frac{5}{8}$ -in.**

Remove nut from bottom of shock absorber connecting link and remove link from bracket on each side.

**(7) REMOVE FRONT SPRING U-BOLTS.****HAMMER, 1-lb****WRENCH,  $\frac{15}{16}$ -in.**



**ORDNANCE MAINTENANCE—AXLES, PROPELLER SHAFTS AND  
WHEELS FOR BOMB SERVICE TRUCK M6 (CHEVROLET)**

Remove the four nuts from the two front spring U-bolts on each side and remove the U-bolts and bumper retainer.

(8) REMOVING FRONT AXLE ASSEMBLY (fig. 19).

BLOCKS

WRENCH, wheel nut

Lower supporting jack carefully and roll the entire front axle assembly out from under car. Block up axle, remove the six pairs of wheel nuts from each wheel and remove the wheels.

**Section V**

**DISASSEMBLY OF FRONT AXLE**

	Paragraph
Preliminary procedure .....	22
Front axle disassembly .....	23

**22. PRELIMINARY PROCEDURE.**

a. Before disassembling the front axle assembly, it should be cleaned thoroughly so that it can be inspected for external damage, cracks, etc. As the parts are disassembled, they should be put in a cleansing tank with solution so that they can soak. This will make them easier to clean. Do not let rubber or leather parts soak in the cleaning solution, as this will deteriorate the rubber and leather.

**23. FRONT AXLE DISASSEMBLY (fig. 1).**

a. **Equipment.** The equipment needed for repair operations in this section is listed below. Equipment needed for each operation is listed at the start of each paragraph covering the operation.

- |   |  |
|---|--|
| BRUSH, cleaning                         | SOLVENT, dry-cleaning                  |
| CHISEL, cold                            | STAND, rear axle                       |
| CLAMPS, wheel cylinder,<br>KM-J718C (2) | TANK, parts cleaning (large)           |
| CLOTH, cleaning                         | TANK, parts cleaning (small)           |
| GUN, air blow                           | WISE, bench                            |
| HAMMER, 1-lb                            | WRENCH, 1/2-in.                        |
| HAMMER, soft                            | WRENCH, 9/16-in.                       |
| HANDLE, socket, 24-in.                  | WRENCH, 5/8-in.                        |
| HANDLE, speed socket                    | WRENCH, 3/4-in.                        |
| PAN, drain                              | WRENCH, 1 5/16-in.                     |
| PLIERS                                  | WRENCH, socket, 1 5/8-in.              |
| PLIERS, brake spring, KM-<br>KMO-142    | WRENCH, wheel bearing nut,<br>KM-J1633 |

**b. Procedure.**

**(1) REMOVE TIE ROD.**

- |              |                    |
|--------------|--------------------|
| HAMMER, 1-lb | WRENCH, 1 5/16-in. |
| PLIERS       |                    |

Remove cotter pins from the bolts which secure each end of the tie rod to the steering knuckle arms and remove the nuts and tie rod bolts. Lift off tie rod assembly.

**(2) REMOVE DRIVE FLANGES.**

- |              |                 |
|--------------|-----------------|
| CHISEL, cold | WRENCH, 3/4-in. |
| HAMMER, 1-lb |                 |

## ORDNANCE MAINTENANCE—AXLES, PROPELLER SHAFTS AND WHEELS FOR BOMB SERVICE TRUCK M6 (CHEVROLET)

Bend tangs away from bolt heads and remove the eight bolts and locks on each side. Install two bolts in the tapped holes of flanges, screw them in alternately and the flanges will come out.

### (3) REMOVE HUBS.

CHISEL, cold

HAMMER, 1-lb

WRENCH, wheel bearing nut,  
KM-J1633

Raise tangs on bearing nut lock and remove lock nut, lock, adjusting nut, washer and outer bearing cone and roller assembly on each side. Then pull off hub assemblies.

### (4) REMOVE AXLE SHAFTS.

CLAMP, wheel cylinder, KM-  
J718C (2)

PLIERS, brake spring, KM-  
KMO-142

WRENCH, socket,  $\frac{5}{8}$ -in.

Install wheel cylinder clamp and remove brake shoe retracting spring. Then remove the 6 cap screws from the brake anchor plate and remove anchor plate. Remove the 12 cap screws from the anchor plate spacer and remove the anchor plate spacer, oil deflector, brake backing plate, steering knuckle and axle shaft on each side of vehicle. NOTE: Slide the brake backing plate off the steering knuckle and support it with a piece of wire. This saves removing the brake hose and bleeding the brakes later.

### (5) REMOVE STEERING KNUCKLE SUPPORT.

WRENCH,  $\frac{1}{2}$ -in.

WRENCH,  $\frac{3}{4}$ -in.

Remove the 12 cap screws that attach the inner retainer to the support on each side and remove the inner retainer, oil seal retainer, outer end seal and outer end seal retainer. Remove the 4 nuts from the upper and lower trunnion on each side and remove the lock washers, trunnions and shims. Reach inside the knuckle support and remove the lower steering knuckle trunnion bearing cone and roller assemblies. Slide support off end of housing and remove the spring-loaded seals.

### (6) REMOVE DIFFERENTIAL CARRIER ASSEMBLY.

PAN, drain

WRENCH,  $\frac{5}{8}$ -in.

Set drain pan under banjo housing and remove the 10 cap screws that attach the housing cover and remove cover, draining the oil in the pan. Then remove the 10 cap screws that attach the differential carrier assembly to the housing and remove the assembly.

### (7) DISASSEMBLE DIFFERENTIAL CARRIER ASSEMBLY.

The disassembling and assembling of the differential carrier assembly is covered in paragraphs 43, 47 and 48.

**Section VI**

**CLEANING, INSPECTING, REPAIRING OR REPLACING OF  
FRONT AXLE COMPONENT PARTS**

	Paragraph
Introduction .....	24
Component parts, inspection and disassembling .....	25
Component parts, repairing and assembling .....	26

**24. INTRODUCTION.**

a. **General.** The cleaning, inspection and repairing of front axle component parts must be done with extreme care and cleanliness. All parts must be thoroughly cleaned, both inside and outside, and then dried with clean cloths and air pressure from an air blow gun. **CAUTION:** Do not allow ball bearings to be spun by the air stream. Spinning the bearings with air pressure is liable to embed small particles in the race and damage the bearings. Worn and damaged parts that are removed from subassemblies should be placed to one side to keep them separated from the parts that are to be used again.

b. **Equipment.** The equipment needed to remove and replace parts from subassemblies will be listed at the start of each paragraph covering the operation.

**25. COMPONENT PARTS, INSPECTION AND DISASSEMBLING.**

a. **Differential Carrier Assembly.** The differential carrier assembly in the front axle is the same as the carrier assembly in the rear axle. Instructions for cleaning, inspection and repairing are the same and are given in paragraphs 45 and 46.

**b. Axle Housing.**

**(1) STEERING KNUCKLE TRUNNION BEARING CUPS.**

(a) *Inspection.* Inspect the trunnion bearing cups for ridges, scores, cracks or other damage. If they are damaged, they should be replaced.

(b) *Remove Steering Knuckle Trunnion Bearing Cups* (fig. 7).

**DRIVER,** bearing cup,  
KM-J1660-2

**HAMMER,** 1-lb

Drive out the upper cups and oil retainer from the inside.

Then drive out the lower cups from the inside in the same manner.

**(2) AXLE SHAFT OIL SEAL.**

(a) *Inspection.* Inspect the axle shaft oil seals for damage or wear. If they are damaged or worn, they should be replaced as follows:

## ORDNANCE MAINTENANCE—AXLES, PROPELLER SHAFTS AND WHEELS FOR BOMB SERVICE TRUCK M6 (CHEVROLET)

(b) *Remove Axle Shaft Oil Seals* (fig. 16).

CHISEL, cold

PULLER, oil seal, KM-J943

HAMMER, 1-lb

Insert oil seal puller through the opening in the end of housing and in behind the seal. Place a wedge, such as a cold chisel, between the puller tangs to keep the tangs forced out into place behind the seal and tap the center of the puller (fig. 16) to remove the oil seal.

(3) **THRUST WASHERS.**

(a) *Inspection.* Inspect the thrust washers for ridges or excessive wear, and if damaged or worn, they should be replaced.

(b) *Remove Thrust Washers.*

CHISEL, cold, small

HAMMER, 1-lb

Remove center punch marks with chisel and pry out thrust washer.

(4) **AXLE HOUSING.**

(a) *Inspection.* Inspect the axle housing for cracks or other damage and if damaged, it should be replaced.

c. **Axle Shaft.**

(1) **GENERAL.** Any damage to the front axle shafts, except center ball or center ball pin necessitates replacing the complete shaft. Inspect the ground surfaces on the shafts, the thrust washer contact surfaces, the splines and the ball races for ridges, scores or other damage, and if damaged, replace the axle shaft assembly.

(2) **INSPECTION.** Inspect the balls for wear or scoring. If the center ball is damaged, the ball should be replaced. Damage to the driving balls necessitates replacement of the complete shaft.

(3) **REMOVE RETAINER PIN.**

HAMMER, 1-lb

PUNCH, drift, 1/8-in.

Drive out the retainer pin (fig. 13).

(4) **RELEASE CENTER BALL PIN.**

BLOCK, wood

Bounce the wheel end of the shaft on a block of wood to cause the center ball pin to move into the drilled passage in the wheel end of the shaft.

(5) **REMOVE BALLS.**

CRAYON

WISE, bench

Mark the yokes and the four driving balls as they must be assembled in exactly the same relative position. Set the axle shaft in a bench vise with the wheel end of the shaft down. **NOTE:** Do not clamp the vise on

## CLEANING, INSPECTING, REPAIRING OR REPLACING OF FRONT AXLE COMPONENT PARTS

the ground surface of the shaft. Swing the top half of the shaft to one side and turn the center ball until the groove lines up with one of the driving balls so that the driving ball will pass through the groove. Swing top half of the shaft further to permit the drive ball to pass through the groove and out of the joint. The remaining balls will then drop out.

### d. Steering Knuckle Support.

#### (1) TIE ROD BOLT-BUSHING.

(a) *Inspection.* Inspect the bushings for wear or other damage, and if worn or damaged, they should be replaced.

#### (b) *Remove Bushing* (fig. 11).

DRIVER, bushing, KM-J1665      HAMMER, 1-lb

Drive out bushing with special driver.

#### (2) STUDS.

(a) Inspect the eight studs on each support to see that they are not broken and that the threads are not stripped. Damaged studs should be replaced.

#### (b) *Remove Stripped Studs.*

REMOVER, stud      WRENCH, Stillson, 8-in.

Attach Stillson wrench or stud remover and unscrew stud from support.

#### (c) *Remove Broken Studs.*

BIT, drill, 1/4-in.      HAMMER, 1-lb  
DRILL, electric, small      PUNCH, center  
EASYOUT      WRENCH, to fit easyout

Prick-punch center of broken stud and drill hole deep enough to receive easyout. Start easyout and turn in counterclockwise direction until the broken stud is removed from the support.

### e. Trunnions.

(1) *INSPECTION.* Inspect the trunnions for scored or damaged surfaces where they contact the bearings. Also inspect the ball on the end of the knuckle arm for wear or damage. Replace any damaged trunnions or arm.

### f. Steering Knuckle.

(1) *INSPECTION.* Inspect the bushing and thrust washer in each knuckle for wear or other damage. If worn or damaged, replace them.

#### (2) REMOVE STEERING KNUCKLE BUSHING.

HAMMER, 1-lb      REMOVER and REPLACER,  
PRESS, bench      steering knuckle bushing,  
KM-J 1738

## ORDNANCE MAINTENANCE—AXLES, PROPELLER SHAFTS AND WHEELS FOR BOMB SERVICE TRUCK M6 (CHEVROLET)

Place bushing remover in position on bushing through outer end of knuckle and press bushing out of knuckle.

### (3) REMOVE THRUST WASHER.

CHISEL, cold, small

HAMMER, 1-lb

Remove center punch marks with chisel and pry out thrust washer.

### g. Brake Backing Plate.

(1) INSPECTION. Inspect the brake backing plate for damage. If damaged, replace it.

### (2) REMOVE WHEEL CYLINDER.

WRENCH, 1/2-in.

Remove the two cap screws that attach the wheel cylinder to the backing plate and remove the wheel cylinder.

### h. Wheel Cylinders.

(1) GENERAL. It is not necessary to remove the wheel cylinders from the backing plates to inspect or repair them. It will be necessary, however, to disassemble the wheel cylinder to inspect it.

(2) DISASSEMBLE WHEEL CYLINDER (fig. 20). Remove wheel cylinder clamp. Remove the end covers with the adjusting screws and remove pistons, rubber cups and spring. Inspect rubber cups for swelling or other damage. Inspect pistons and piston fit in housing. This clearance should be 0.002 inch to 0.005 inch. Inspect end covers and adjusting screws for wear or other damage. Replace any damaged parts.

### i. Brake Shoe Attaching Parts.

(1) INSPECTION. Inspect the brake shoe attaching parts for excessive looseness or binding at the pivot pins. If the pivot pins bind, lubricate them with a thin film of GREASE, graphite, light. If any of the attaching parts are worn or damaged, replace them.

### (2) REMOVE BRAKE SHOE ATTACHING PARTS.

PLIERS

SCREWDRIVER

Pry edge of the lower pin lock over the pin and pull off pin lock. Then remove the pins and locks from the brake shoes in the same manner. Pry off pin spring lock at center of link and remove spring and shoe pin.

### j. Brake Shoes.

(1) INSPECTION. Inspect brake linings to see that they are not oil soaked or worn down to the rivet heads. If lining is oil soaked, worn or damaged, it should be replaced.

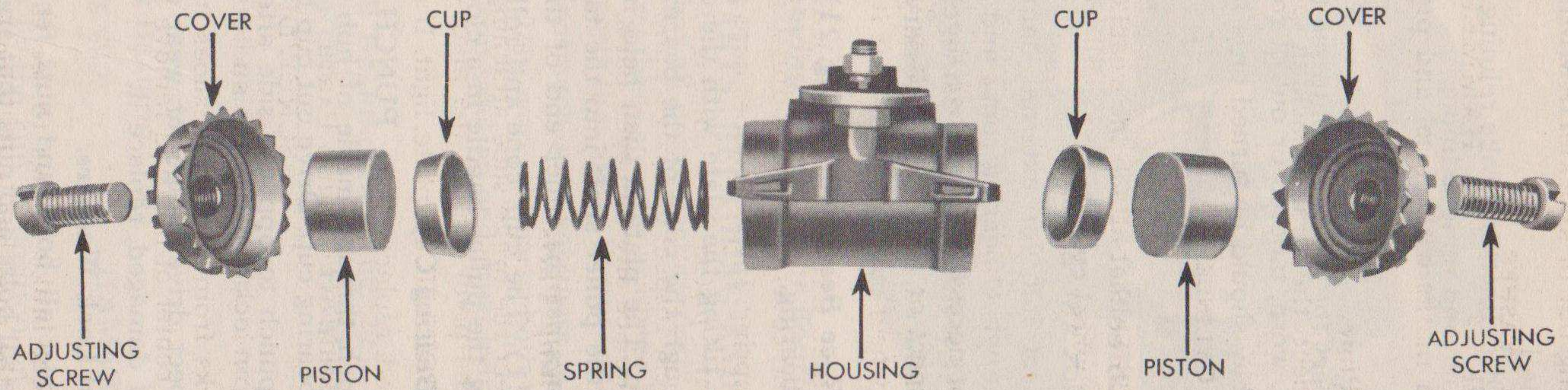

RA PD 32337

Figure 20—Wheel Cylinder Disassembled



**ORDNANCE MAINTENANCE—AXLES, PROPELLER SHAFTS AND  
WHEELS FOR BOMB SERVICE TRUCK M6 (CHEVROLET)**

**(2) REMOVE LINING.**

DELINER, brake

HAMMER, 1-lb

CHISEL, cold, small

Punch out rivets with deliner on brake relining machine or cut them with a chisel and hammer and remove lining.

**k. Hub Assembly.****(1) BRAKE DRUM.**

*(a) Inspection.* Inspect the brake drum to see that the lining contact surfaces are not scored, worn, tapered or out of round. If the drums are damaged in any way, they should be turned on a lathe or be replaced.

*(b) Remove Drums.*

HAMMER, 1-lb

Drive out the six hub bolts.

**(2) WHEEL BEARINGS AND SEAL.**

*(a) Inspection.* Inspect hub for external damage or stripped stud threads. Also inspect the wheel bearing cones and cups for wear, scoring or other damage. Inspect seal for wear or damage. Replace all damaged parts. If hub is to be replaced, it will be necessary to remove the wheel bearing parts.

*(b) Remove Inner Race Bearing Cups (fig. 21).*

PULLER, inner bearing,

KM-J918G

Install the puller by tilting the plate with the chain attached so that it may be slipped through the cone of the bearing and then raised up behind the bearing cup. The plate is then held in this position by the chain while threading the puller shaft into the tapped hole. The puller body is then located against the inner end of the hub and the puller handle installed (fig. 21). The cup, cone and roller assembly, and seal are removed by turning the puller handle in a clockwise direction.

*(c) Remove Outer Bearing Cup.*

HAMMER, 1-lb

PUNCH, drift, long

Insert long drift punch through inside of hub and engage it against the back of the outer bearing cup. Drive out cup by tapping punch with hammer and moving punch to opposite side after each hammer blow.

**l. Drive Flange.**

*(a) Inspection.* Inspect drive flange for wear or other damage, particularly the splines. If damaged, replace it.

**m. Bolts, Nuts and Lock Washers.**

*(a) Inspection.* Inspect all bolts and nuts for stripped threads and other damage. Replace all bolts and nuts that are damaged and replace all broken or damaged lock washers.

## CLEANING, INSPECTING, REPAIRING OR REPLACING OF FRONT AXLE COMPONENT PARTS

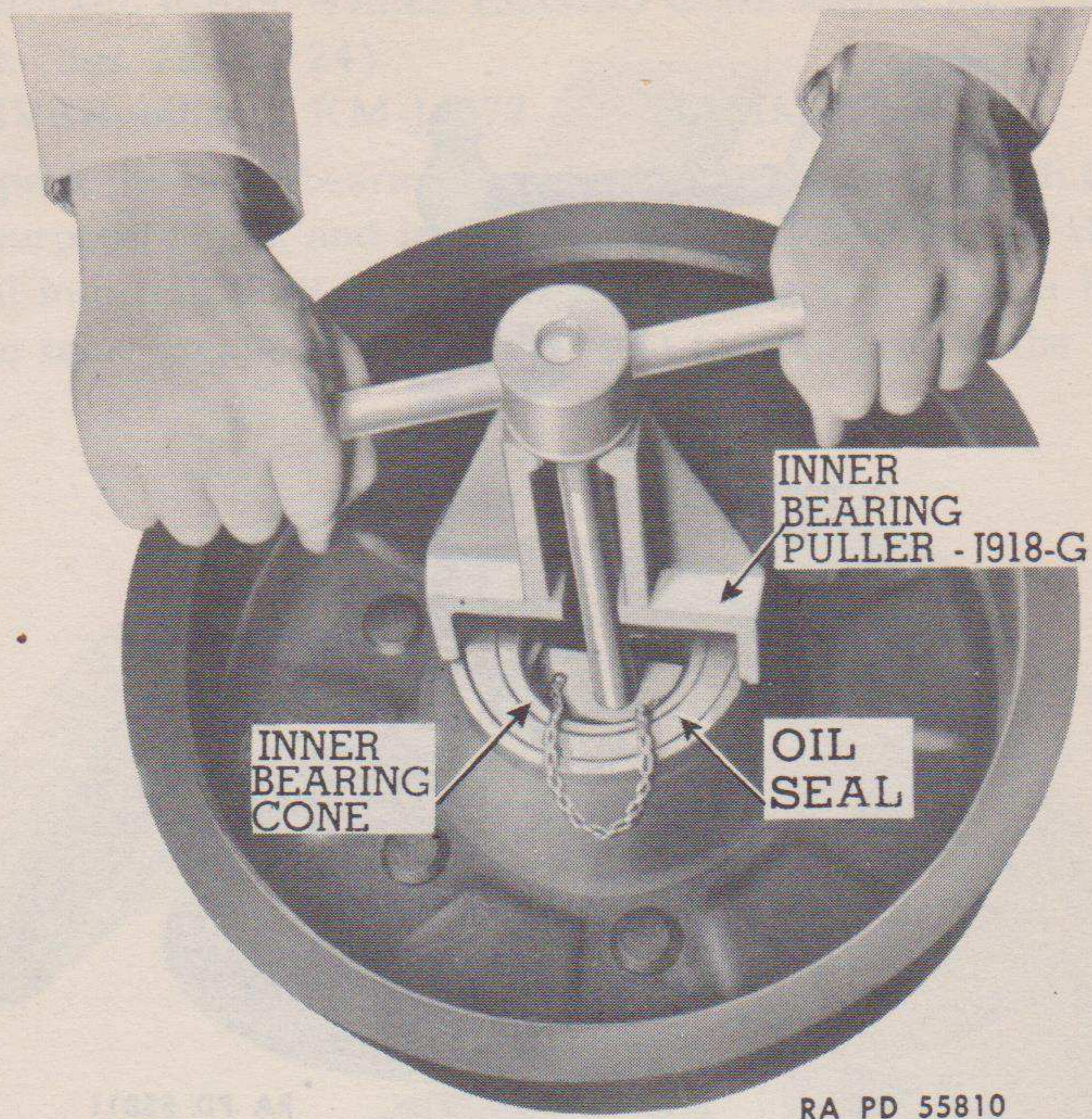

**Figure 21—Removing Wheel Inner Bearing and Oil Seal**

### 26. COMPONENT PARTS, REPAIRING AND ASSEMBLING.

a. It is presumed that all unsatisfactory parts were replaced and the new parts of the subassemblies are now ready to be assembled. It is also presumed that all the parts that are to be put in the assembly have been thoroughly cleaned. Inasmuch as cleanliness is one of the most important parts of satisfactory work, all parts, both old and new, should be rinsed thoroughly in clean solution and dried before they are assembled.

#### b. Hub Assembly.

(1) INSTALL OUTER BEARING CUP (fig. 22).

DRIVER, bearing cup,

KM-J1660-3

HAMMER, 1-lb

Place the wide side of the cup in position on hub and drive in cup until it bottoms.

(2) INSTALL INNER BEARING CUPS.

DRIVER, bearing cup,

KM-J1660-3

HAMMER, 1-lb

Place the wide side of the cup in position on hub and drive in cup until it bottoms.

**ORDNANCE MAINTENANCE—AXLES, PROPELLER SHAFTS AND  
WHEELS FOR BOMB SERVICE TRUCK M6 (CHEVROLET)**

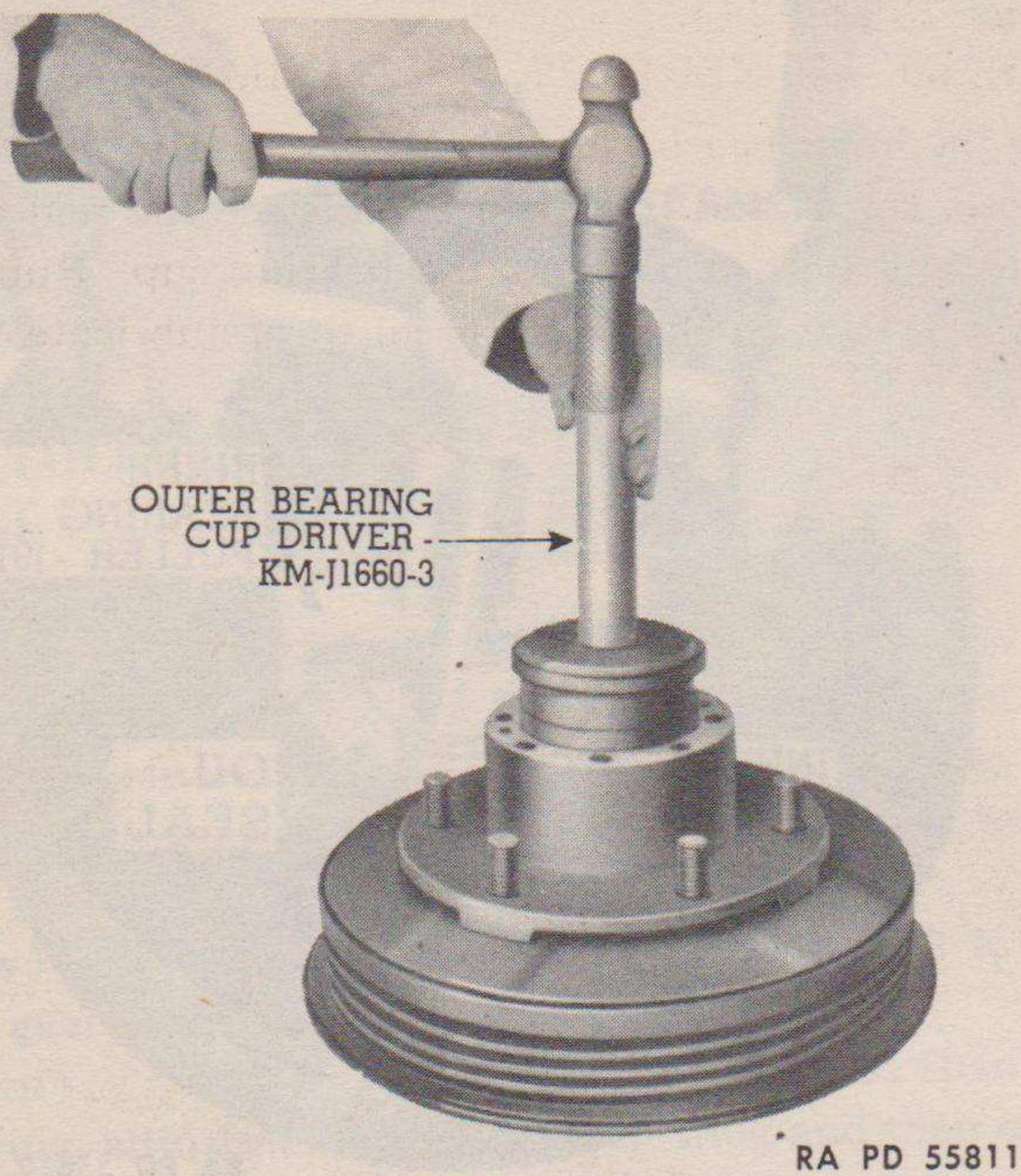

**Figure 22—Replacing Outer Bearing Cup**

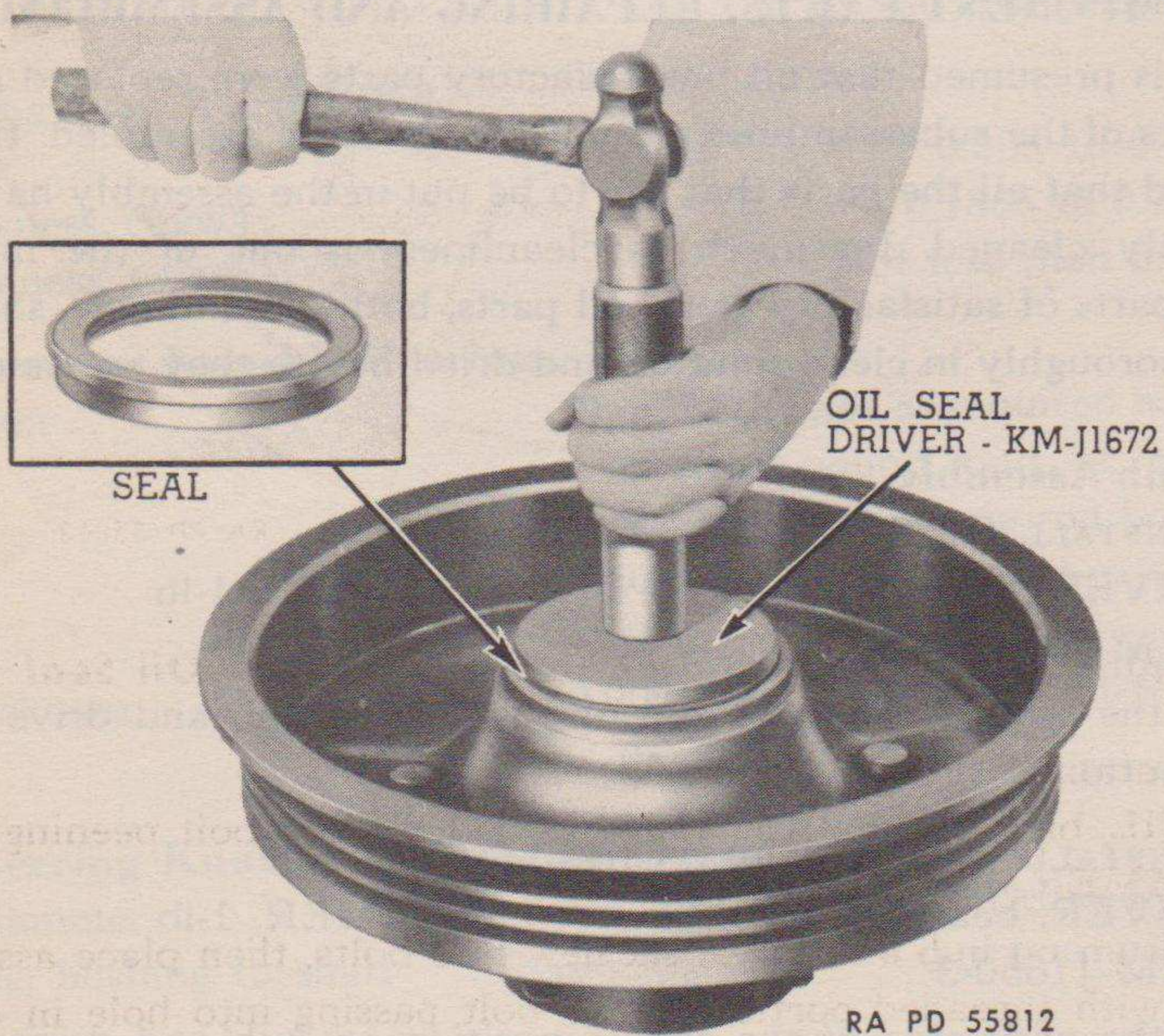

**Figure 23—Installing Inner Oil Seal**

## CLEANING, INSPECTING, REPAIRING OR REPLACING OF FRONT AXLE COMPONENT PARTS

(3) INSTALL INNER WHEEL BEARING CONE AND ROLLER ASSEMBLY AND SEAL (figs. 23 and 24).

DRIVER, oil seal, KM-J1672      HAMMER, 1-lb

Hand pack the inner bearing cone and roller assembly with GREASE, general purpose, No. 2, and install in cup. Place the seal on driver and drive seal into hub until it contacts the bearing cup. Rub a light coating of the same grease on the leather seal to prelubricate the leather.

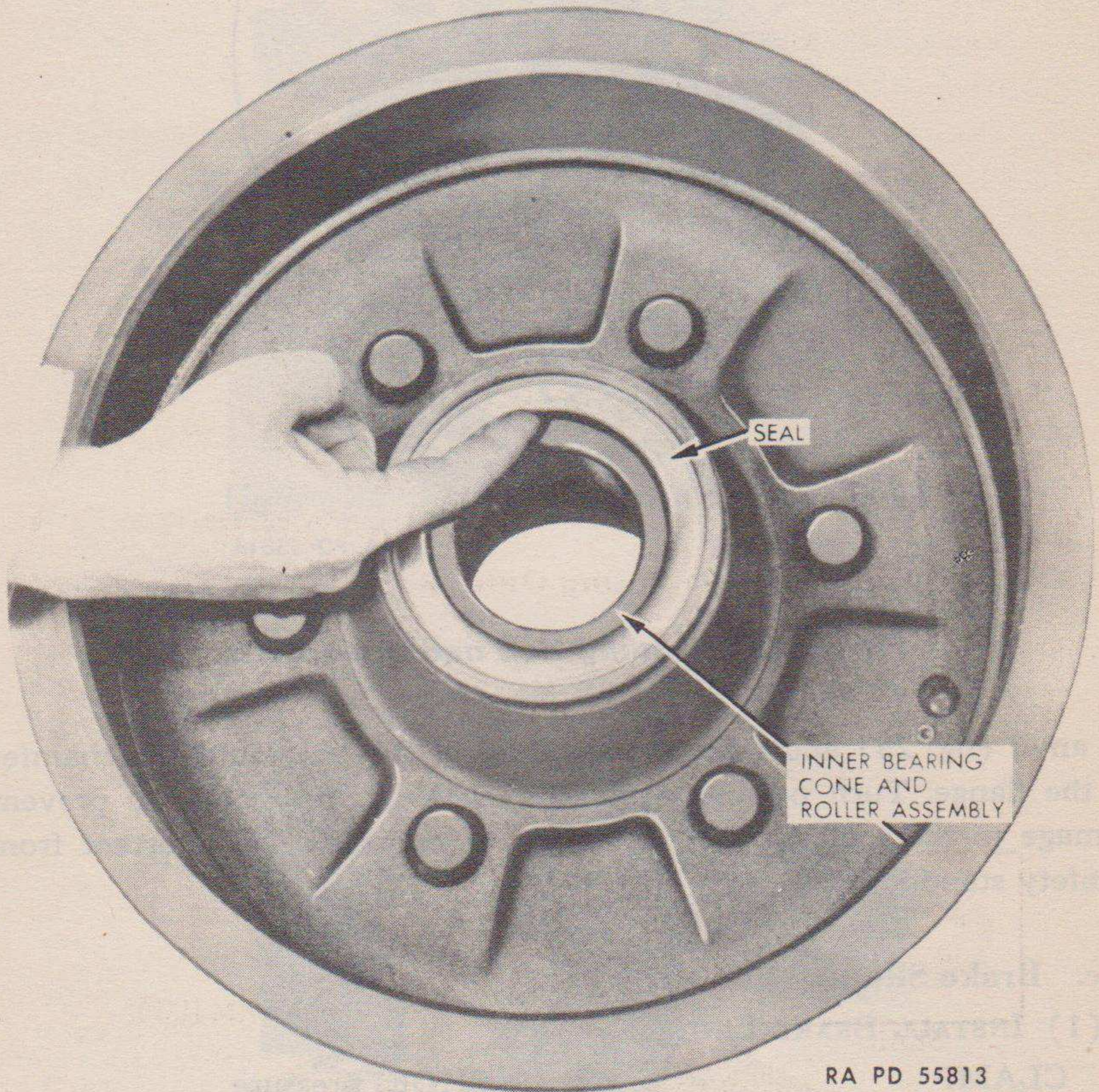

RA PD 55813

**Figure 24—Prelubricating Front Wheel Inner Oil Seal**

(4) INSTALL BRAKE DRUMS (fig. 25).

ANVIL, brake drum, KM-J554      TOOL, hub bolt peening  
HAMMER, 1-lb

Place drum on hub and insert six new hub bolts, then place assembly on anvil, with threaded portion of the bolt passing into hole in one of the supports. Drive each bolt into place solidly. Place the hub assembly

## ORDNANCE MAINTENANCE—AXLES, PROPELLER SHAFTS AND WHEELS FOR BOMB SERVICE TRUCK M6 (CHEVROLET)

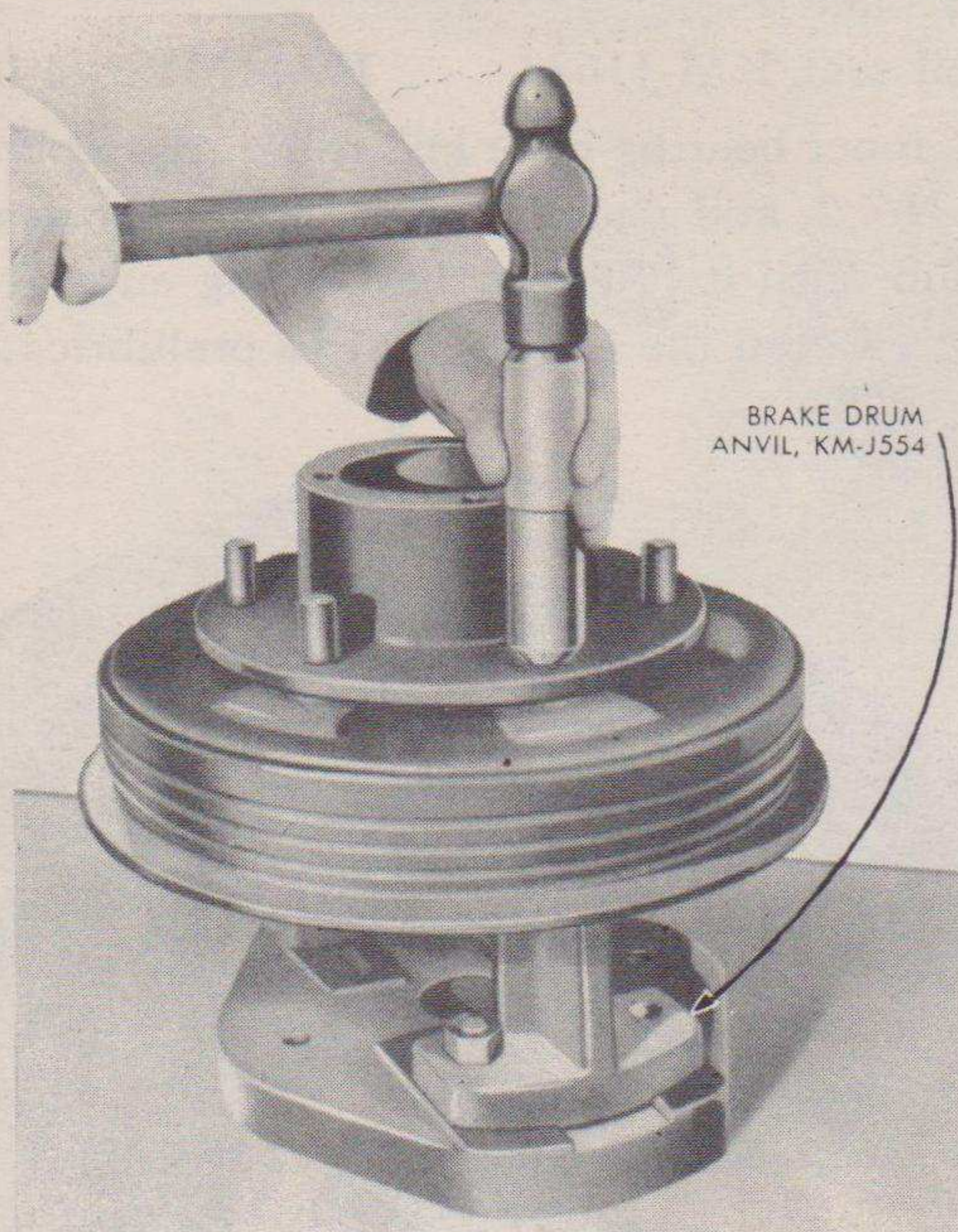

RA PD 55814

**Figure 25—Peening Hub and Drum Bolts**

on anvil (fig. 25) and peen the shoulder of the bolts into the chamfer of the flange. Turn peening tool after each hammer blow to prevent damage to the tool. **NOTE:** The peening operation is important from a safety standpoint.

### c. Brake Shoes.

#### (1) INSTALL BRAKE LINING.

CLAMP

SHOE, pressure

MACHINE, relining

(a) Place lining in position on shoe and install one rivet on each side near center of shoe. Install pressure shoe and clamp assembly (fig. 26). Install two rivets in each end of lining (fig. 27). Remove pressure shoe and install remaining rivets.

(b) If pressure shoe and clamp are not available, use following alternative method: After placing the rivets near center of shoe, work out toward each end of the brake shoe in applying rivets. (This will eliminate any chance of lining not fitting snugly against the shoe.)

**CLEANING, INSPECTING, REPAIRING OR REPLACING OF  
FRONT AXLE COMPONENT PARTS**

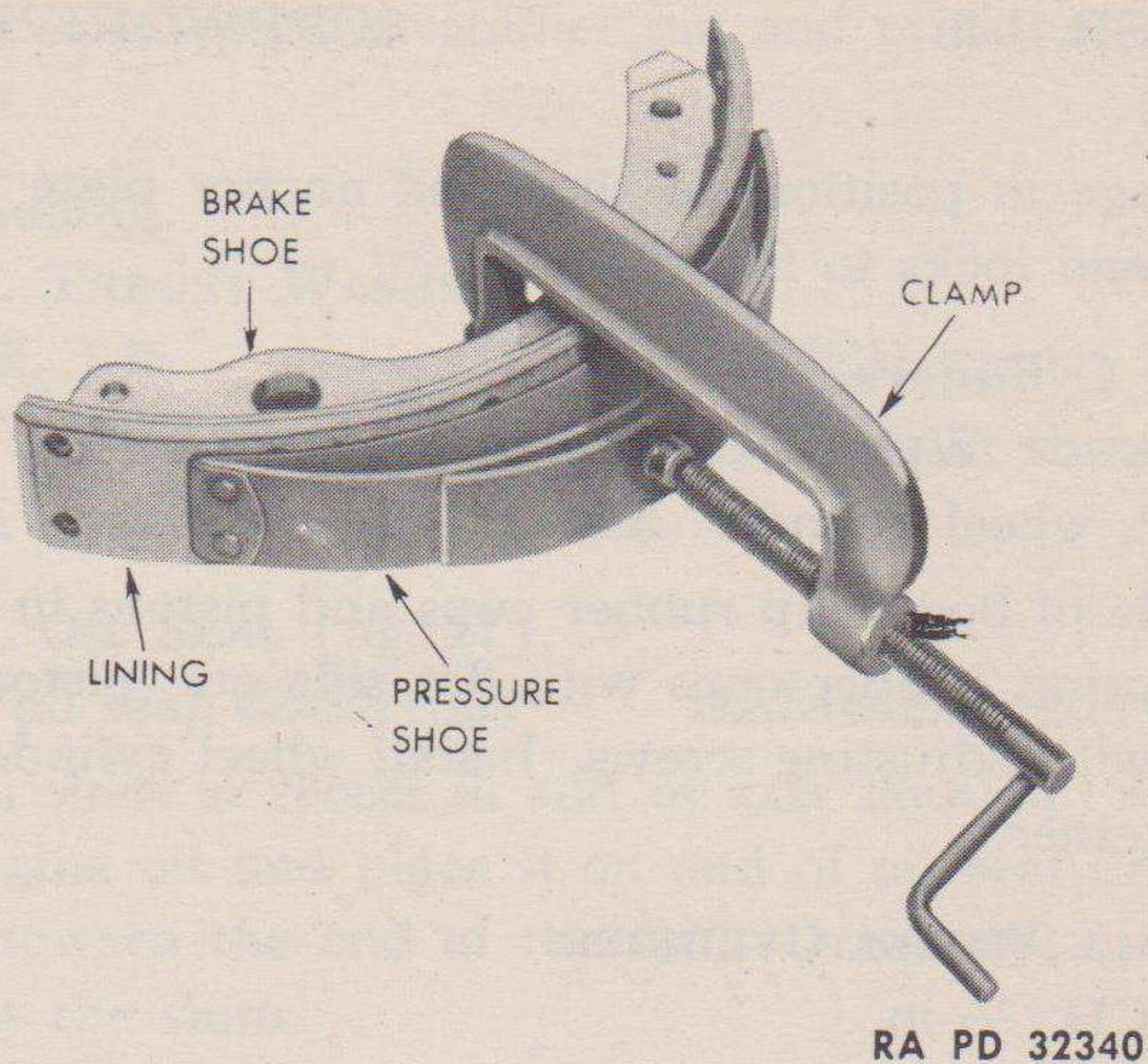

**Figure 26—Installing Brake Lining Clamp**

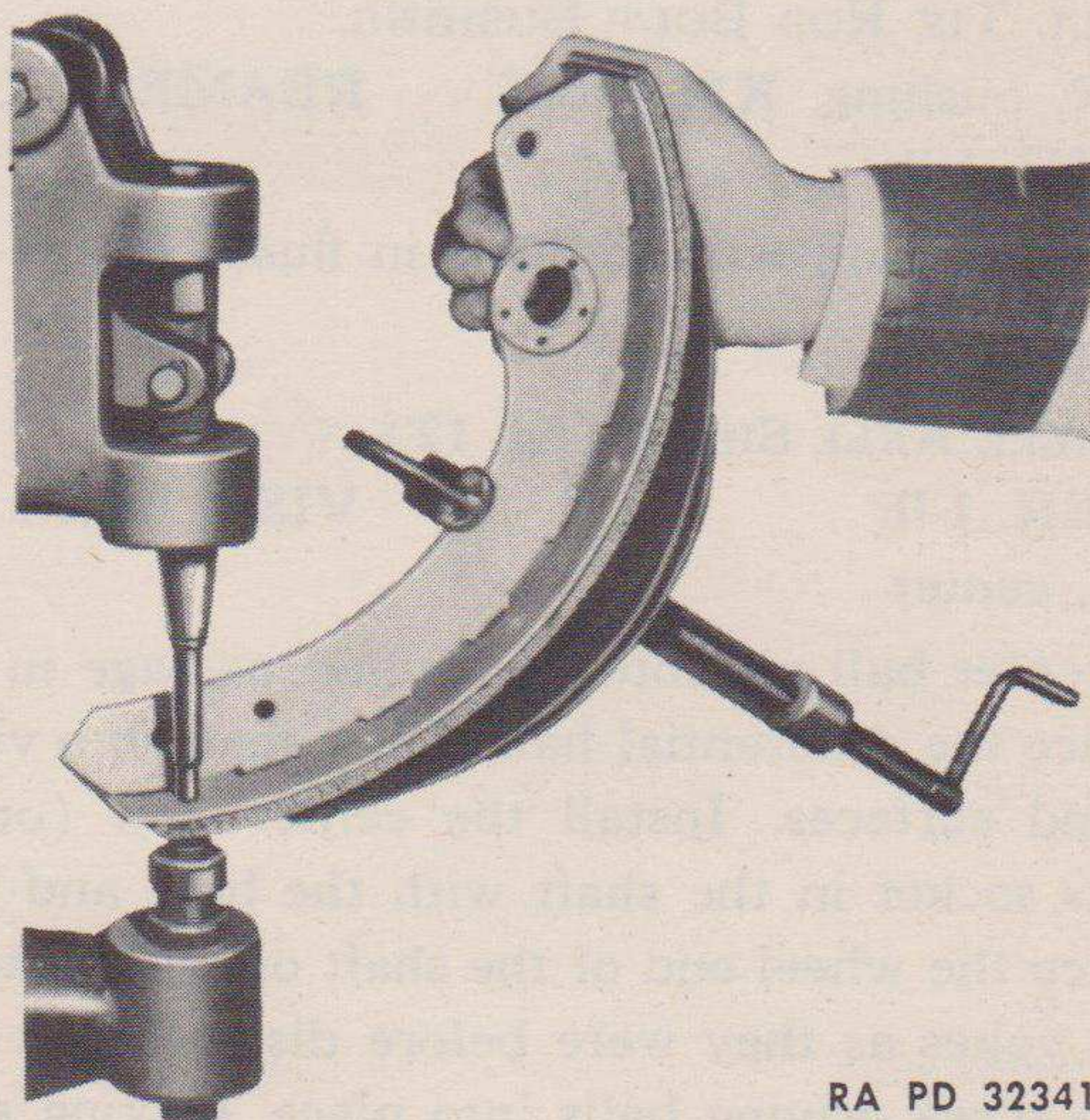

**Figure 27—Riveting Brake Lining to Shoe**

## ORDNANCE MAINTENANCE—AXLES, PROPELLER SHAFTS AND WHEELS FOR BOMB SERVICE TRUCK M6 (CHEVROLET)

### d. Brake Shoe Attaching Parts.

#### (1) ASSEMBLE LINKAGE.

HAMMER, 1-lb

SCREWDRIVER

PLIERS

Place linkage in position on shoe and anchor plate and install pins and locks. Bend locks to fit over pins.

### e. Wheel Cylinders.

#### (1) ASSEMBLE WHEEL CYLINDER.

CLAMP, wheel cylinder, KM-J718C

Wipe inside of body, dip rubber cups and pistons in new brake fluid and install spring, rubber cups with flat side out, pistons with flat side in, and caps with adjusting screws. Install wheel cylinder clamp to hold assembly together.

#### (2) INSTALL WHEEL CYLINDER.

WRENCH, 1/2-in.

Place wheel cylinder in position on backing plate and install the two cap screws. Tighten the cap screws securely.

### f. Steering Knuckle Support.

#### (1) INSTALL STUDS.

WRENCH, stud

Start stud in support and tighten securely.

#### (2) INSTALL TIE ROD BOLT BUSHING.

DRIVER, bushing, KM-J1665      REAMER, KM-KMO-347

HAMMER, 1-lb

Start bushing in support and drive in flush. Ream bushing.

### g. Axle Shaft.

#### (1) ASSEMBLE AXLE SHAFT (fig. 12).

HAMMER, 1-lb

WISE, bench

PUNCH, center

Drop the center ball pin into the drilled passage in the wheel end of the shaft. Place the differential half of the shaft in a vise. Do not clamp vise on ground surfaces. Install the center ball (one with hole and groove) in its socket in the shaft with the hole and groove facing the operator. Place the wheel end of the shaft on the center ball, being sure to match the yokes as they were before disassembly. Tip wheel end of shaft and slip three driving balls into place, making sure that they are installed in the same relative positions from which they were removed. Tip top half of joint back and slip the last driving ball in place. At the same time, turn the center ball so that the groove lines up to permit the

## CLEANING, INSPECTING, REPAIRING OR REPLACING OF FRONT AXLE COMPONENT PARTS

driving ball to slide through the groove. Then straighten up the joints and turn the center ball so that the center pin will drop into the hole in the center ball. Install a new retainer pin and prick-punch the ends to lock it in place.

### **h. Axle Housing.**

#### **(1) INSTALL THRUST WASHER.**

**HAMMER, 1-lb**

**PUNCH, center**

Place thrust washer in recess and prick-punch at three equal points around its outer edge.

#### **(2) INSTALL OIL SEAL (fig. 17).**

**DRIVER, oil seal, KM-J1661**

**HAMMER, 1-lb**

Place oil seal shim in recess in end of axle housing. Soak a new oil seal in light engine oil and place it on end of oil seal driver with free end of leather toward the end of the tool. Drive seal in place until it bottoms against the shim.

#### **(3) INSTALL TRUNNION BEARING CUPS (fig. 8).**

**DRIVER, bearing cup,**

**HAMMER, 1-lb**

**KM-J1660-2**

Place a new oil retainer in the upper bearing cup opening. Place trunnion bearing cup in position and drive it in place, making sure that the oil retainer stays in its proper position. Drive lower cup in until it bottoms.



**ORDNANCE MAINTENANCE—AXLES, PROPELLER SHAFTS AND  
WHEELS FOR BOMB SERVICE TRUCK M6 (CHEVROLET)**

**Section VII**

**ASSEMBLING FRONT AXLE**

	Paragraph
Preliminary procedure .....	27
Assembling front axle .....	28

**27. PRELIMINARY PROCEDURE.**

a. See that all parts of the front axle assembly have been cleaned and inspected and that all damaged parts have been replaced. Before assembling the unit, each part should be cleaned again and inspected to make sure all parts that are assembled meet the required specifications. It is important that the tools, equipment and the workman's hands be clean before starting to assemble the parts.

**28. ASSEMBLING FRONT AXLE.**

a. **Equipment.** The equipment needed for repair operations in this section is listed below. Equipment needed for each operation is listed at the start of each paragraph covering the operation.

- |                                     |  |
|-------------------------------------|--|
| CHISEL, cold                        | WRENCH, 1/2-in.                        |
| HAMMER, 1-lb                        | WRENCH, 5/8-in.                        |
| HANDLE, 12-in.                      | WRENCH, 3/4-in.                        |
| PLIERS                              | WRENCH, socket, 9/16-in.               |
| PLIERS, brake spring,<br>KM-KMO-142 | WRENCH, wheel bearing nut,<br>KM-J1663 |
| SCALE, checking, KM-J1670           | WRENCH, wheel nut                      |
| SCREWDRIVER                         |  |

**b. Procedure.**

(1) **ASSEMBLE DIFFERENTIAL CARRIER ASSEMBLY.** Assemble the differential carrier assembly, as instructed in paragraphs 48 b(1) through (6).

(2) **INSTALL SPRING-LOADED SEAL.** Slip a spring-loaded seal over each end of the housing.

(3) **INSTALL STEERING KNUCKLE SUPPORTS.** Pack the four steering knuckle trunnion bearings with **GREASE**, general purpose, No. 2, and install one of the bearings in each of the two top trunnion bearing cups. Slip the steering knuckle supports over the ends of the housing and insert the two lower bearings in place.

(4) **INSTALL TRUNNIONS.**

WRENCH, 3/4-in.

Install one of each of the following thickness shims, 0.002-inch, 0.005-inch, 0.010-inch, and 0.030-inch, on the top and bottom of each support

## ASSEMBLING FRONT AXLE

and install the upper and lower trunnions, lock washers and nuts. Tighten the 16 nuts securely. Be sure to install the trunnion with the steering arm on the top of the left-hand end of the housing. **NOTE:** The adjustment of these bearings is accomplished by adding or removing shims until the load necessary to turn the steering knuckle support is 4½ to 6 pounds on the checking scale. It is important that the same total thickness of shims be used at top and bottom.

### (5) INSTALL RETAINERS AND SEALS (fig. 10).

SCREWDRIVER

WRENCH, ½-in.

Place new retainer gasket in position on inner side of support, then the outer end seal retainer; then place the felt and rubber seal in position so that the taper of the seal fits the curvature of the spherical ball. Place spring-loaded seal against the felt and rubber seal and then place the oil seal retainer and the upper half of the retainer in position and start two cap screws and lock washers (fig. 10). Using a screwdriver, position the spring-loaded seal so that it fits uniformly around the spherical ball. Install the lower half of the retainer and all the remaining cap screws and lock washers and tighten them securely.

(6) **INSTALL AXLE SHAFTS.** Pack axle shaft universal joints with **GREASE**, general purpose, seasonal grade, and rub a thin layer of grease on the surfaces that contact the bushing and thrust washer. **CAUTION:** When inserting the axle shaft, care must be taken not to damage the axle shaft oil seal. The universal joint should be supported from below when sliding the shaft into the differential side gears.

(7) **INSTALL STEERING KNUCKLES.** Place new gasket in position on each support and place steering knuckles in position over axle shafts with keyway at the top.

(8) **INSTALL BRAKE BACKING PLATE, OIL DEFLECTOR AND ANCHOR PLATE SPACER.**

WRENCH, socket, 5/8-in.

Place each brake backing plate and oil deflector in position on the steering knuckle with the wheel cylinder at the top. Then place the anchor plate spacer in position so that two bosses are spaced equally with reference to the wheel cylinder and install the 12 cap screws and tighten them securely.

(9) **INSTALL ANCHOR PLATES.**

WRENCH, socket, 5/8-in.

Place anchor plate, with brake shoes attached, in position, and install the six cap screws on each side and tighten them securely.

## ORDNANCE MAINTENANCE—AXLES, PROPELLER SHAFTS AND WHEELS FOR BOMB SERVICE TRUCK M6 (CHEVROLET)

### (10) INSTALL BRAKE SHOE RETRACTING SPRINGS.

PLIERS, brake spring,  
KM-KMO-142

Hook one end of spring in second hole of right-hand brake shoe and stretch spring to fit in second hole of left-hand shoe on each side. Then remove wheel cylinder clamps.

### (11) INSTALL HUBS AND BEARINGS.

CHISEL, cold	WRENCH, wheel bearing nut,
HAMMER, 1-lb	KM-J1663
HANDLE, 12-in.	

Distribute one pint of GREASE, general purpose, No. 2, in the hub between the bearings and hand pack the outer bearing with the same grease. Place hub assembly in position on the steering knuckle and install the outer bearing, washer and adjusting nut. Using the bearing adjusting wrench, tighten the adjusting nut snugly, wrench tight, then back the nut off a distance equal to that between two adjacent flange bolt holes which is equal to 45 degrees, or  $\frac{1}{8}$  turn of the nut. Align nearest slot in nut with short tang on a hub nut locking washer.

### (12) INSTALL WHEEL BEARING LOCK NUT.

CHISEL, cold	WRENCH, wheel bearing nut,
HAMMER, 1-lb	KM-J1663

Place lock in position over each adjusting nut and bend tang down in slot of nut. Install locking nut and tighten nut securely. Bend one of the tangs to fit in slot of lock nut.

### (13) INSTALL DRIVE FLANGE (fig. 28).

CHISEL, cold	WRENCH, $\frac{3}{4}$ -in.
HAMMER, 1-lb	

Place a new drive flange gasket over each drive flange and install the flanges, making sure to line up the holes in the flanges with those in the gaskets. Install the eight bolts on each side through the shaft bolt lock and flange, and tighten them securely. Bend down the tangs on the lock against the bolt heads.

### (14) INSTALL TIE ROD.

PLIERS	WRENCH, $1\frac{5}{16}$ -in.
--------	------------------------------

Place tie rod in position and install a tie rod bolt in each end. Then install the nuts, pull the nuts down snug and then back them off one-third to one-half turn and lock each nut with a new cotter pin.

ASSEMBLING FRONT AXLE

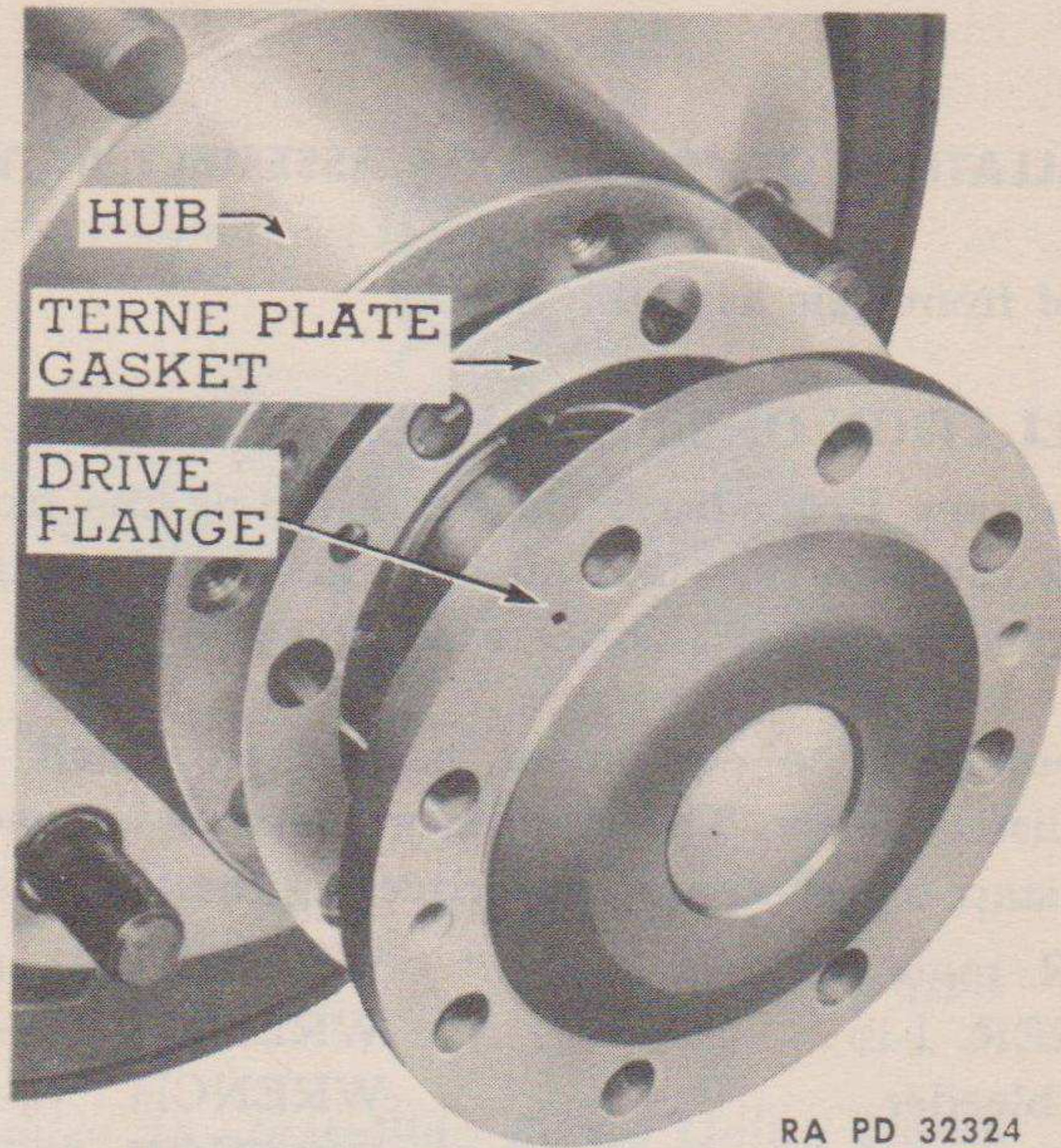

RA PD 32324

**Figure 28—Hub Drive Flange and Gasket**

(15) **INSTALL WHEELS.**

**BLOCKS**

**WRENCH, wheel nut**

Set axle assembly on blocks on floor and install wheels on studs and secure with six pairs of stud nuts.



**INSTALLATION OF FRONT AXLE ASSEMBLY IN VEHICLE**

**(5) INSTALL STEERING CONNECTING ROD.**

**SCREWDRIVER**

Install half of ball seat. Place rod over ball and install other half of ball seat spring, safety plug and end plug. Tighten end plug securely and lock in place with new cotter key.

**(6) CONNECT PROPELLER SHAFT UNIVERSAL JOINT.**

**HAMMER, 1-lb**

**WRENCH,  $\frac{9}{16}$ -in.**

Remove tape from universal joint bearing caps and place yokes in matching position. Install the two U-bolts, lockwashers and nuts. Tighten nuts securely. Lubricate the grease fitting with **GREASE**, general purpose, seasonal grade.

**(7) REMOVE JACK STANDS.**

Raise front of vehicle and remove jack stands, lower vehicle and remove floor jack.

**(8) TIGHTEN WHEEL STUD NUTS.**

**WRENCH, wheel nut**

Tighten the six pairs of wheel stud nuts on each wheel securely.

**(9) BLEED BRAKE SYSTEM (figs. 29 and 30).**

**FILLER, master cylinder**

**WRENCH,  $\frac{5}{16}$ -in.**

**HOSE, bleeder**

**WRENCH,  $\frac{3}{8}$ -in.**

**JAR, bleeder**

**WRENCH,  $\frac{7}{8}$ -in.**

Clean dirt away from around master cylinder filler plug. Remove plug and install adapter and master cylinder filler. Open automatic valve in the filler. Remove bleeder valve screw from the hydraulic adapter on the Hydrovac cylinder and insert the bleeder hose. Place other end of hose in bleeder jar with about one inch of clean brake fluid. Keep end of hose below surface of fluid. Open bleeder valve one-half to three-fourths turn. Depress foot pedal slowly and allow it to return slowly. Continue this pumping action of the pedal until all air bubbles disappear in the jar while pumping. When the air bubbles cease, close the bleeder valve, unscrew hose and install bleeder screw. Repeat the bleeding operation at two bleeder valves on the slave cylinder. Repeat the bleeding operation on all four wheel cylinders starting with the left rear wheel, then the left front wheel bleed at check valve again; then the right rear wheel and then the right front wheel. Be sure to follow the above sequence when bleeding brakes and keep the master cylinder at least half full during the operation. Remove filler and install filler cap.

**(10) LUBRICATE AXLE ASSEMBLY.**

**WRENCH,  $\frac{3}{4}$ -in.**

Rub a small amount of grease on both spherical balls. Remove differ-

ORDNANCE MAINTENANCE—AXLES, PROPELLER SHAFTS AND  
WHEELS FOR BOMB SERVICE TRUCK M6 (CHEVROLET)

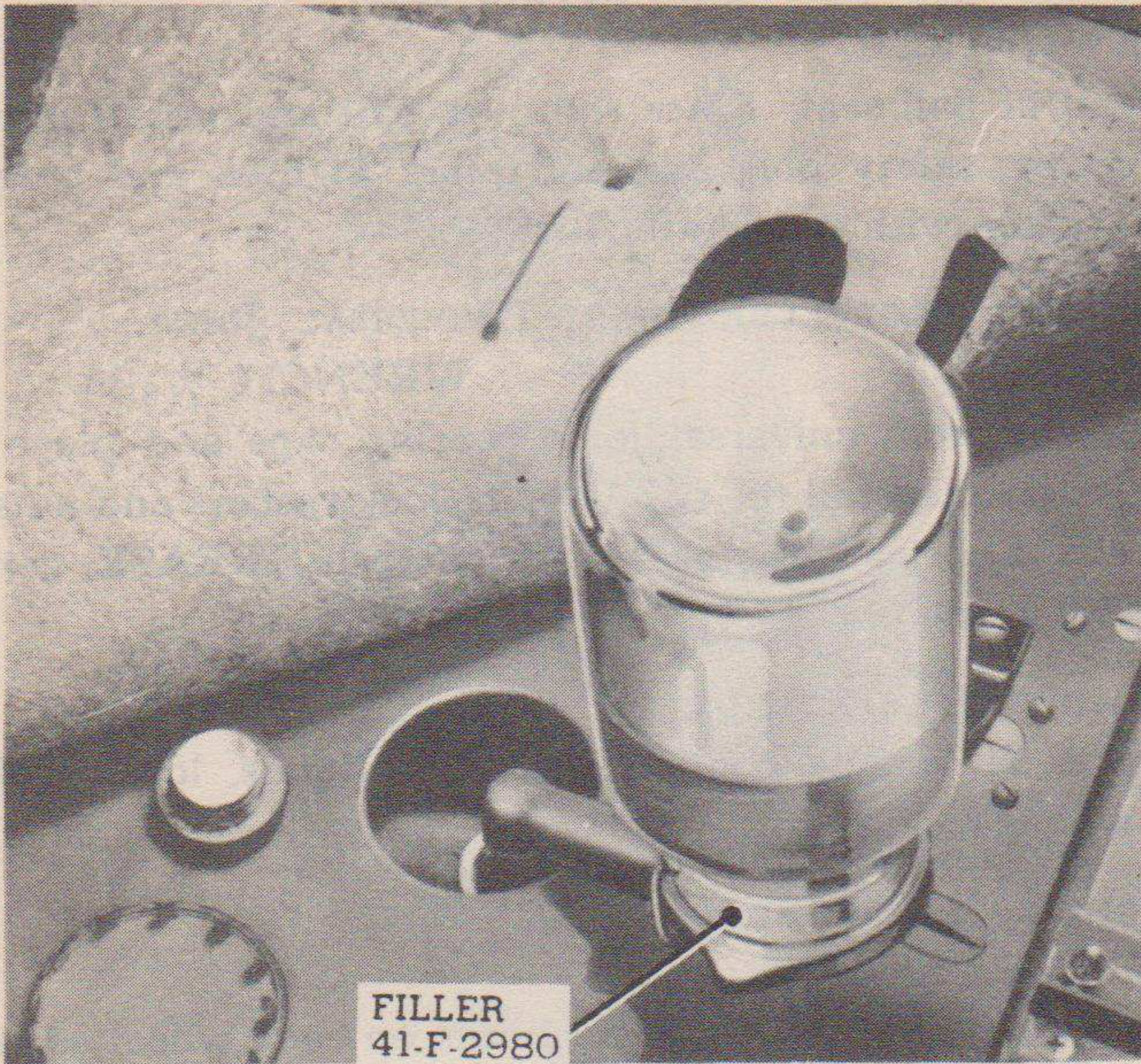

RA PD 32229

*Figure 29—Master Cylinder Filler*

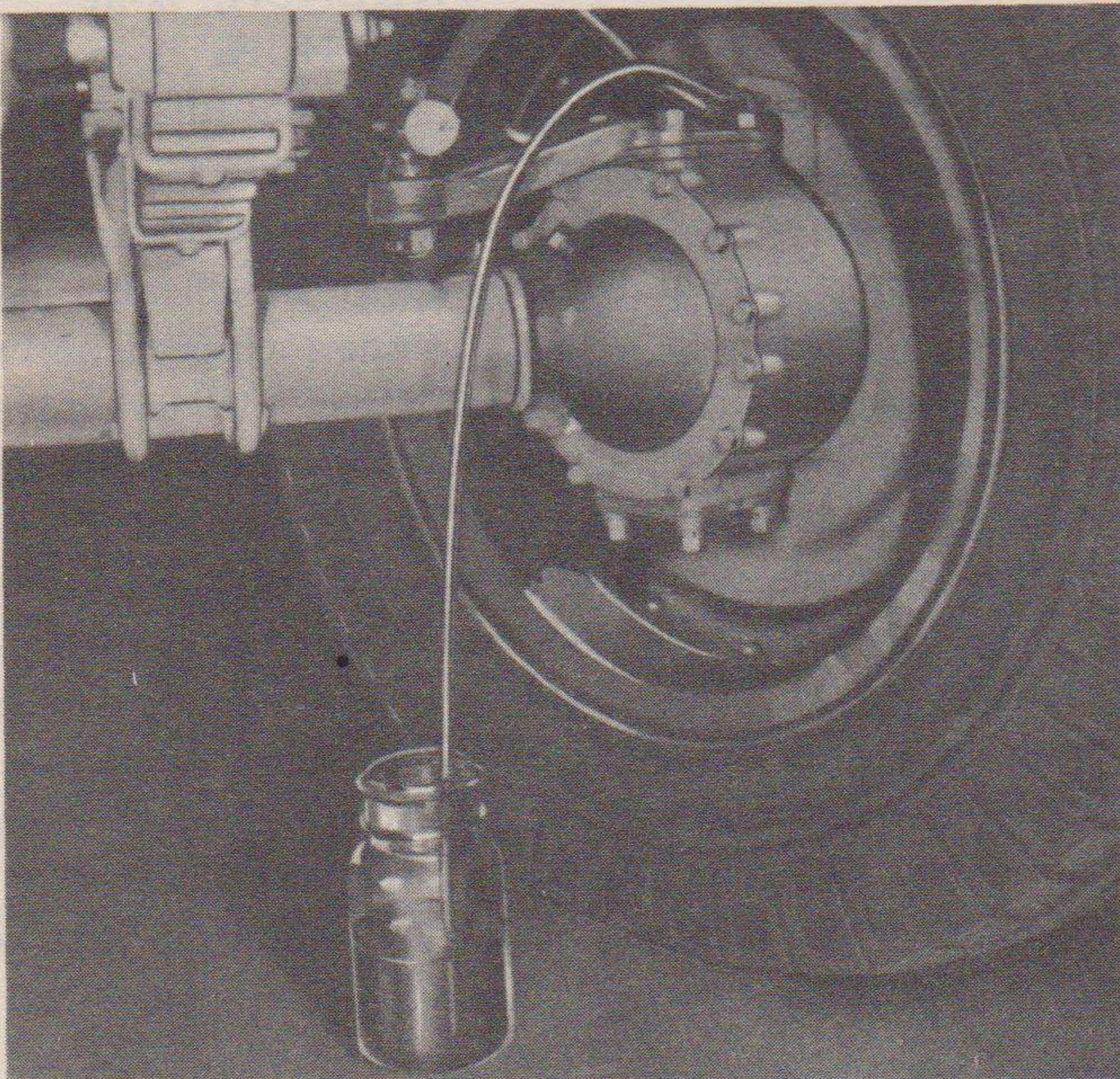

RA PD 32230

*Figure 30—Bleeding Brakes*

## INSTALLATION OF FRONT AXLE ASSEMBLY IN VEHICLE

ential filler plug and insert 13½ pints of GREASE, general purpose, No. 2.

### (11) ADJUST TOE-IN.

(a) *General.* The tie rod is made with a bend to clear the differential. The right end is threaded with a coarse thread to screw into the right tie rod end. The left end is threaded with a fine thread for making toe-in adjustment. A keyway is milled in it to position the rod for proper clearance.

#### (b) *Procedure.*

WRENCH, ¾-in.

WRENCH, 1<sup>5</sup>/<sub>16</sub>-in.

See paragraph 19 b (2).

### (12) NEW BANJO HOUSING.

(a) *General.* If a new banjo housing has been installed, it will be necessary to adjust the turning radius stop screws.

#### (b) *Procedure.*

OUTFIT, welding

WRENCH, ½-in.

Place the front wheels on turning radius plates and turn left wheel in 28 degrees and set left-hand adjusting screw so that it contacts the steering knuckle support. Turn right wheel in 28 degrees and adjust right adjusting screw so that it contacts the steering knuckle. Spot-weld or braze the adjusting screws so that they cannot turn.

### (13) ROAD TEST VEHICLE.

Road test vehicle to check the operation of the front differential and steering.



**ORDNANCE MAINTENANCE—AXLES, PROPELLER SHAFTS AND WHEELS FOR BOMB SERVICE TRUCK M6 (CHEVROLET)**

**Section IX**

**FRONT AXLE FITS AND TOLERANCES**

	Paragraph
Fits and tolerances .....	30

**30. FITS AND TOLERANCES.**

**a. Differential.**

Ring gear to pinion backlash .....	0.005 to 0.007 in.
Ring gear run-out .....	Not over 0.001 in.
Ring gear case run-out .....	Not over 0.002 in.
Clearance between spider and pinion .....	0.004 to 0.008 in.
Clearance between side gear and case .....	0.002 to 0.006 in.
Differential side gear thrust washer thickness (new) .....	0.058 to 0.062 in.
Differential side gear thrust washer thickness (worn) .....	Not less than 0.048 in.
Differential bearing adjustment .....	Tighten snug and then one or two notches more.
Outer pinion bearing adjustment .....	Bearing must turn with no perceptible end play. Tighten nut to 180 to 280 ft-lb torque.

**b. Ring Gear Thrust Pad.**

Clearance .....	0.005 to 0.007 in.
Pad thickness (new) .....	0.1865 to 0.1885 in.
Pad thickness (worn) .....	Not less than 0.125 in.

**c. Trunnion Knuckle Bearings.**

Adjustment .....	Shim both ends as required to obtain 4½-to-6-pound pull at steering knuckle support tie rod bolt hole, with equal shims on top and bottom.
Shim thickness .....	0.002 in., 0.005 in., 0.010 in., 0.030 in.

**d. Steering Knuckle Bushing.**

Inside diameter .....	1.7025 to 1.7045 in.
Clearance, bushing to shaft .....	0.015 to 0.0175 in.

**e. Turning Radius Stop Screw.**

Maximum angle of inner wheel .....	28 deg plus 1 deg minus 0 deg
------------------------------------	-------------------------------

## FRONT AXLE FITS AND TOLERANCES

**f. Tie Rod Yoke.**

Bushing, inside diameter .....	0.7495 to 0.7505 in.
Clearance, bolt to bushing .....	0.0005 to 0.00025 in.

**g. Steering Geometry.**

Front wheel camber .....	1/2 deg to 1 deg
Front wheel caster .....	1 deg minus to 2 deg minus
Front wheel toe-in .....	0 to 1/8 in.
Center line of steering arm to center line of spring .....	4 1/8 in.
Backing plate to center line of tie rod bolt .....	3 19/64 in.
Bottom of steering arms to top of axle housing .....	1 3/4 in.

**h. Universal Joint.**

Front axle shaft and universal joint Diameter at splines (outer end) .....	1.6435 to 1.6445 in.
Front axle shaft and universal joint Diameter at splines (inner end) .....	1.6305 to 1.6385 in.
Front axle shaft and universal joint Diameter at bushing contacts .....	1.6865 to 1.6875 in.
Thrust washer thickness (new) .....	0.155 to 0.157 in.

SGV TD

**ORDNANCE MAINTENANCE—AXLES, PROPELLER SHAFTS AND  
WHEELS FOR BOMB SERVICE TRUCK M6 (CHEVROLET)**

**CHAPTER 3**

**REAR AXLE REPAIR OPERATIONS**

**Section I**

**REAR AXLE**

	Paragraph
Description .....	31
Data .....	32
Reference to second echelon .....	33
Echelon break-down .....	34

**31. DESCRIPTION.**

a. The rear axle assembly in this vehicle is similar in construction to the front axle, the difference being in the banjo housing and axle shafts, which are straight and in a fixed position. The brake assembly is larger than the front brake assembly.

b. The differential carrier and/or parts are interchangeable with the front axle (fig. 31).

**32. DATA.**

**a. General.**

Housing .....	Banjo
Drive .....	Through the springs

**b. Differential.**

Gear ratio .....	6.67 to 1
Drive type .....	Hypoid
Differential bearing .....	Hyatt KA-11820Z
Pinion bearings:	
Inner .....	Hyatt U-1306-TAM
Outer .....	New departure H-5310-A

**c. Wheel Bearings.**

Inner assembly .....	Hyatt KD-12051-Z
Outer assembly .....	Hyatt KB-11786-Y

**d. Propeller Shafts.**

Number used .....	3
Shaft diameter .....	3 in.

REAR AXLE

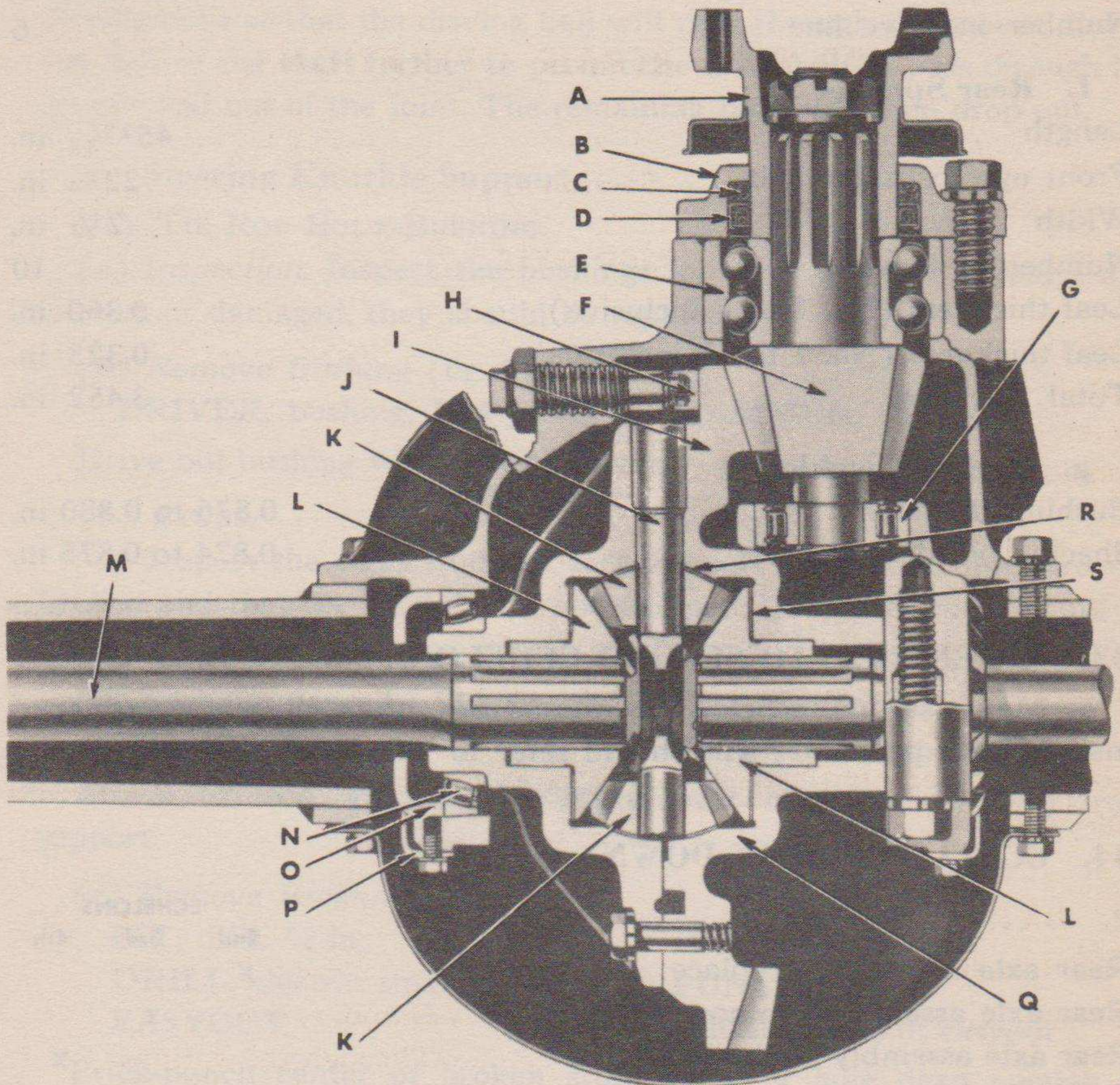

- A — PROPELLER SHAFT PINION FLANGE AND DEFLECTOR
- B — PINION OIL SEAL AND BEARING RETAINER
- C — BEARING RETAINER PACKING
- D — PINION FLANGE OIL SEAL ASS'Y
- E — DOUBLE-ROW PINION BEARING
- F — PINION GEAR
- G — STRADDLE MOUNT PINION BEARING

- H — RING GEAR THRUST PAD
- I — RING GEAR
- J — DIFFERENTIAL SPIDER
- K — DIFFERENTIAL PINION (SPIDER) GEAR
- L — DIFFERENTIAL SIDE GEAR
- M — AXLE SHAFT
- N — DIFFERENTIAL BEARING

- O — DIFFERENTIAL BEARING ADJUSTING NUT
- P — ADJUSTING NUT LOCK
- Q — DIFFERENTIAL CASE
- R — DIFFERENTIAL SPIDER THRUST WASHER
- S — DIFFERENTIAL SIDE GEAR THRUST WASHER

RA PD 55815

Figure 31—Rear Axle Differential and Pinion Assembly

**ORDNANCE MAINTENANCE—AXLES, PROPELLER SHAFTS AND WHEELS FOR BOMB SERVICE TRUCK M6 (CHEVROLET)**

**e. Universal Joints.**

Type .....	Needle bearing
Number in drive line .....	6

**f. Rear Springs.**

Length .....	45 <sup>19</sup> / <sub>32</sub> in.
Front eye to center bolt .....	22 <sup>1</sup> / <sub>4</sub> in.
Width .....	2 <sup>1</sup> / <sub>2</sub> in.
Number of leaves .....	10
Leaf thickness (No. 1 to 6 inclusive) .....	0.360 in.
Leaf thickness (No. 7 to 10 inclusive) .....	0.323 in.
Total thickness .....	3.452 in.

**g. Spring Shackles.**

Bushing diameter .....	0.876 to 0.880 in.
Shackle pin diameter .....	0.874 to 0.875 in.

**33. REFERENCE TO SECOND ECHELON.**

a. Many second echelon operations are often done by ordnance maintenance personnel who should refer to TM 9-765 for information.

**34. ECHELON BREAK-DOWN**

	ECHELONS		
	2nd	3rd	4th
Rear axle assembly—replace .....	X		
Rear axle assembly—minor repairs .....		X	
Rear axle assembly—rebuild .....			X
Drive flange—replace .....	X		
Rear hub—replace .....	X		
Wheel bearings—adjust or replace .....	X		
Retracting springs—replace .....	X		
Anchor plate—replace .....	X		
Brake flange plate—replace .....	X		
Brake shoes—replace .....	X		
Brake shoes—reline .....			X
Wheel cylinders—replace .....	X		
Wheel cylinders—repair .....		X	
Wheel cylinders—rebuild .....			X
Axle shaft—replace .....	X		
Differential carrier—replace .....	X		
Differential carrier—rebuild .....			X
Universal joint—replace .....	X		
Universal joint—repair .....			X

Section II

REAR AXLE TROUBLE SHOOTING

Trouble shooting .....	Paragraph 35
------------------------	-----------------

**35. TROUBLE SHOOTING.**

**a. Axle Noisy on Drive.**

Probable Cause	Probable Remedy
Ring gear and pinion adjustment too tight.	Readjust ring gear and pinion (par. 48 b (6)).
Rear side of double row pinion bearing rough.	Replace bearing and readjust ring gear and pinion (pars. 43 and 48).

**b. Axle Noisy on Coast.**

Excessive lash between ring gear and pinion.	Readjust ring gear and pinion (par. 48 b (6)).
Front row of double row bearing rough.	Replace bearing and readjust ring gear and pinion (pars. 43 and 48).
End play in double row bearing.	Replace bearing and readjust ring gear and pinion (pars. 43 and 48).

**c. Axle Noisy on Both Drive and Coast.**

Pinion too deep in ring gear.	Double row bearing installed backward. Reverse bearings.
Ring gear and pinion adjustment too tight.	Readjust ring gear and pinion (par. 48 b (6)).
Worn or damaged pinion or differential bearings.	Replace damaged bearing or bearings (pars. 43 and 48).
Loose or worn wheel bearings.	Adjust or replace bearings (ch. 4, sec. IV).

**d. Excessive Backlash.**

Axle shaft flange loose.	Replace terneplate gasket and tighten bolts and lock (par. 75 c (9)).
--------------------------	---

**ORDNANCE MAINTENANCE—AXLES, PROPELLER SHAFTS AND WHEELS FOR BOMB SERVICE TRUCK M6 (CHEVROLET)**

**Section III**

**REAR AXLE REPAIRS THAT CAN BE PERFORMED WITHOUT REMOVING UNIT FROM VEHICLE**

	Paragraph
Introduction .....	36
Differential carrier assembly .....	37
Axle shaft and gasket .....	38
Wheel bearing oil seal and slinger .....	39

**36. INTRODUCTION.**

a. **General.** Many times repairs can be made to the rear axle without removing the complete unit from the vehicle. The following paragraphs cover the repairs to the subassemblies and various parts of the rear axle.

b. **Cleaning and Inspection of the Component Parts.** The cleaning, inspection and repairing of the component parts must be done with extreme care and cleanliness. All parts must be cleaned thoroughly. Dry with clean rags and with pressure from an air blow gun. **CAUTION:** Do not allow ball bearings to be spun by the air stream as the air pressure is liable to embed small particles in the race and damage the bearings. As the parts are disassembled, they should be put into a cleansing tank with **SOLVENT**, dry-cleaning, and permitted to soak.

**37. DIFFERENTIAL CARRIER ASSEMBLY.**

a. **Equipment.**

- |                      |                              |
|----------------------|------------------------------|
| BRUSH, cleaning      | SCREWDRIVER, large           |
| CHISEL, cold         | TANK, parts cleaning (large) |
| HAMMER, 1-lb         | WISE, bench                  |
| HANDLE, speed socket | WRENCH, 9/16-in.             |
| PAN, drain           | WRENCH, socket, 5/8-in.      |
| PLIERS, large        | WRENCH, 5/8-in.              |

b. **Removal Procedure.** Place vehicle on level ground and block front wheels.

(1) **REMOVE AXLE SHAFT** (fig. 32).

- |              |                 |
|--------------|-----------------|
| CHISEL, cold | WRENCH, 5/8-in. |
| HAMMER, 1-lb |                 |

With a cold chisel and hammer, bend the lugs of the shaft bolt lock away from the bolt heads. Remove the eight 7/16-inch bolts and lock plate. Install two 7/16-inch bolts in the threaded holes provided in the

REAR AXLE REPAIRS THAT CAN BE PERFORMED WITHOUT  
REMOVING UNIT FROM VEHICLE

TM 9-1765A  
37

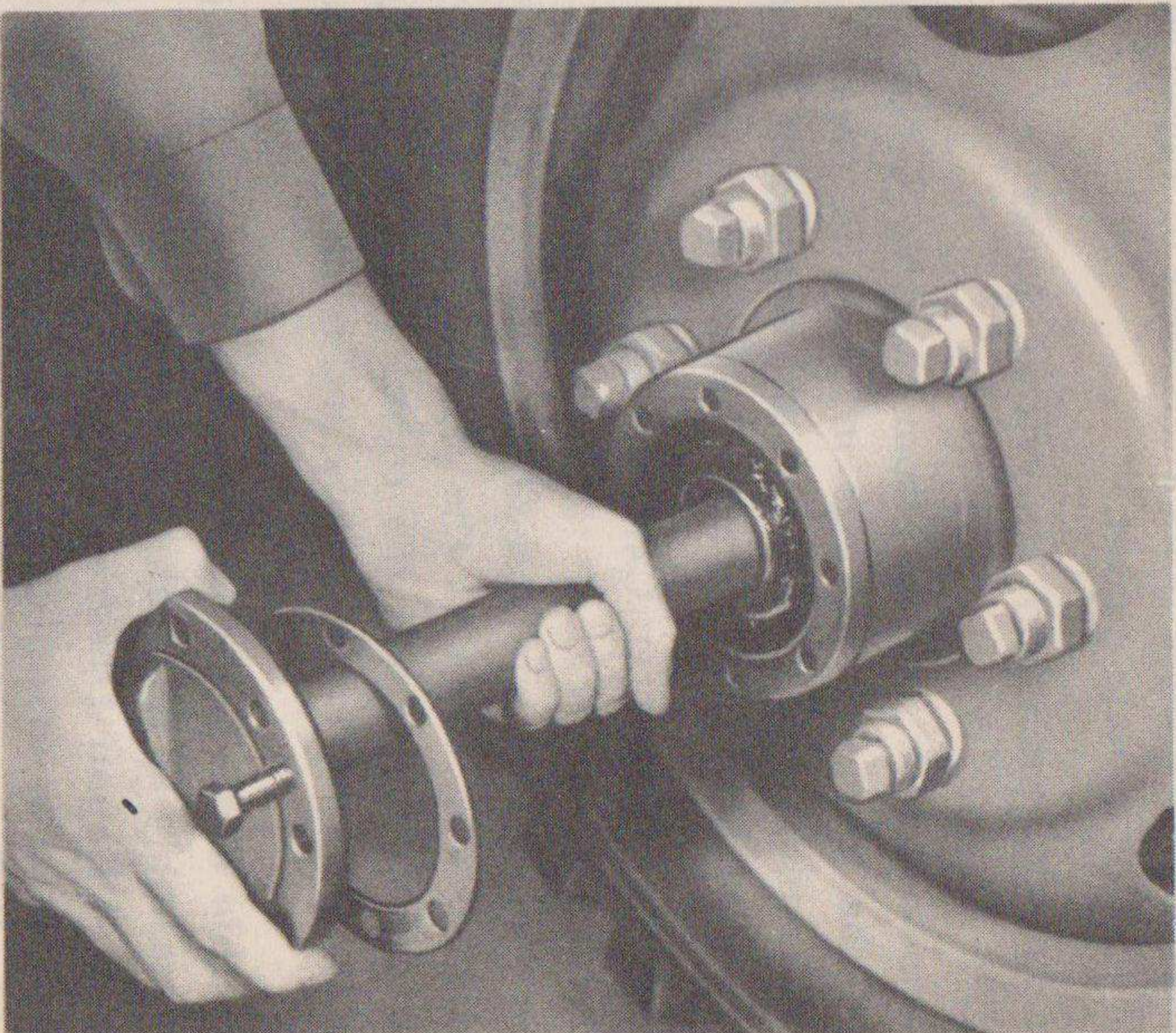

RA PD 32531

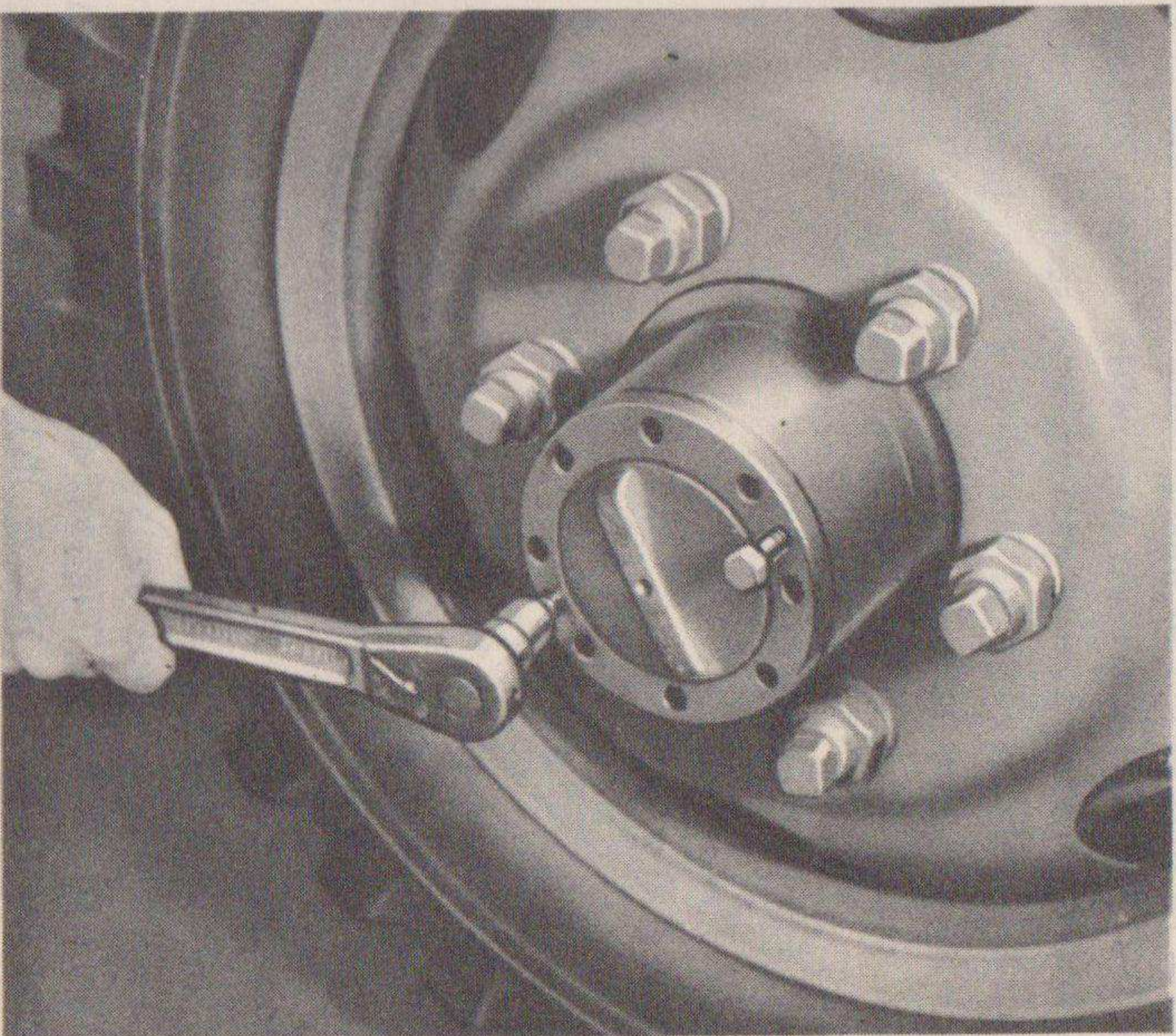

Figure 32—Rear Axle Shaft Removal



## ORDNANCE MAINTENANCE—AXLES, PROPELLER SHAFTS AND WHEELS FOR BOMB SERVICE TRUCK M6 (CHEVROLET)

axle shaft flange and turn these bolts alternately to loosen shaft. Remove the axle shaft and terneplate gasket.

### (2) SPLIT PROPELLER SHAFT UNIVERSAL JOINT.

WRENCH,  $\frac{9}{16}$ -in.

Remove nuts and lock washers from the two U-bolts and remove U-bolts. Tape the trunnion bearings in place to prevent them from falling off the trunnion yoke. Slide the universal joint back on its slip joint and lower the end of the propeller shaft to the floor.

### (3) REMOVE DIFFERENTIAL CARRIER ASSEMBLY.

PAN, drain

WRENCH,  $\frac{5}{8}$ -in.

Place a pan under the axle assembly and loosen the 10 bolts that attach the axle housing cover to the housing and let lubricant drain. Then remove the 10 bolts and the cover. Remove the 10 bolts that attach the differential carrier assembly and remove the assembly from axle housing.

c. **Disassemble Differential Carrier Assembly.** Disassemble differential carrier assembly as instructed in paragraph 43.

d. **Inspect and Repair Differential Carrier Assembly.** Inspect and repair differential carrier assembly as instructed in paragraph 45.

e. **Assemble Differential Carrier Assembly.** Assemble differential carrier assembly as instructed in paragraphs 47 and 48.

f. **Install Differential Carrier Assembly.** Place differential carrier assembly in housing, using a new gasket, and secure assembly with cap screws and lock washers. Install housing cover, using a new gasket, secure cones with 10 cap screws and lock washers. Connect propeller shaft universal joint. Install axle shafts, steering knuckle, and brake.

## 38. AXLE SHAFT AND GASKET.

### a. Removal Procedure.

#### (1) REMOVE AXLE SHAFT.

CHISEL, cold

WRENCH,  $\frac{5}{8}$ -in.

HAMMER, 1-lb

Bend tangs away from bolt heads and remove the eight bolts and the lock. Install two of the bolts in the tapped holes in the flange of the axle shaft. Screw them in alternately to loosen shafts and pull shafts out.

(2) **INSTALL AXLE SHAFT.** Place a new terneplate axle shaft flange gasket on the axle shaft and push the shaft into the housing. Use a new shaft bolt lock at the axle shaft bolts and insert the eight bolts through the lock end axle shaft flange. Tighten them alternately and make sure they are pulled up tight (95-100 ft lb). Then bend the tangs of the lock plate against the heads of the bolts.

## REAR AXLE REPAIRS THAT CAN BE PERFORMED WITHOUT REMOVING UNIT FROM VEHICLE

### 39. WHEEL BEARING OIL SEAL AND SLINGER.

a. When replacing wheel bearing oil seal or slinger, it is necessary to remove the component parts as instructed in the previous paragraphs and remove the hub and drum assembly.

#### b. Equipment.

CHISEL, cold	REPLACER, oil slinger,
DRIFT, small diameter	KM-J973
DRIVER, oil seal, KM-J872-2	STAND, jack (1) or suitable
HAMMER, 1-lb	block
JACK, 41-J-73-5	WRENCH, socket, 5/8-in.
PRESS, arbor	WRENCH, wheel nut
PUNCH, center	WRENCH, wheel bearing nut

#### c. Procedure.

##### (1) LOOSEN WHEEL.

WRENCH, wheel nut

Place vehicle on level ground and apply parking brake. Loosen the six pairs of wheel stud nuts on rear wheel two turns.

##### (2) RAISE REAR OF VEHICLE.

JACK, 41-J-73-5	STAND, jack (1) or suitable
	block

Block front wheels, raise rear of vehicle until the wheels clear the ground and support axle housing on jack stand or suitable block.

##### (3) REMOVE WHEEL.

WRENCH, wheel nut

Remove the six pairs of wheel stud nuts that were previously loosened and remove the wheel.

##### (4) REMOVE AXLE SHAFT (fig. 32).

CHISEL, cold	WRENCH, 5/8-in.
HAMMER, 1-lb	

With a cold chisel and hammer, bend the lugs of the shaft bolt lock away from the bolt heads. Remove the eight 7/16-inch bolts and lock plate. Install two 7/16-inch bolts in the threaded holes provided in the axle shaft flange. Turn these bolts alternately to loosen the axle shaft and remove the axle shaft and terneplate gasket.

##### (5) REMOVE HUB AND DRUM ASSEMBLY.

CHISEL, cold	WRENCH, bearing nut
HAMMER, 1-lb	

Raise the lip of the special hub nut lock from the notch in the lock nut. Remove lock nut with the bearing nut wrench and remove the lock, inner adjusting nut, and thrust washer. Remove the hub and drum assembly. Install brake wheel cylinder clamp on wheel cylinder to pre-

**ORDNANCE MAINTENANCE—AXLES, PROPELLER SHAFTS AND  
WHEELS FOR BOMB SERVICE TRUCK M6 (CHEVROLET)**

vent brake fluid from leaking should the brake pedal be accidentally depressed.

**(6) REMOVE OIL SEAL.****CHISEL**

Using a chisel, remove the oil seal from the hub and also chisel off the punch marks.

**(7) INSTALL OIL SEAL (fig. 24).****DRIVER, oil seal, KM-J872-2****PRESS, arbor****HAMMER, 1-lb**

Prelubricate the inner oil seal with **GREASE**, general purpose, No. 2, and install the oil seal, using the seal driving tool, with an arbor press. Lock the seal in place by prick-punching at three equally spaced places. The wheel bearing lock nut incorporates a leather seal which bears against the inner surface of the axle shaft flange. This seal should be inspected and if any damage is indicated, the seal should be replaced (fig. 33).

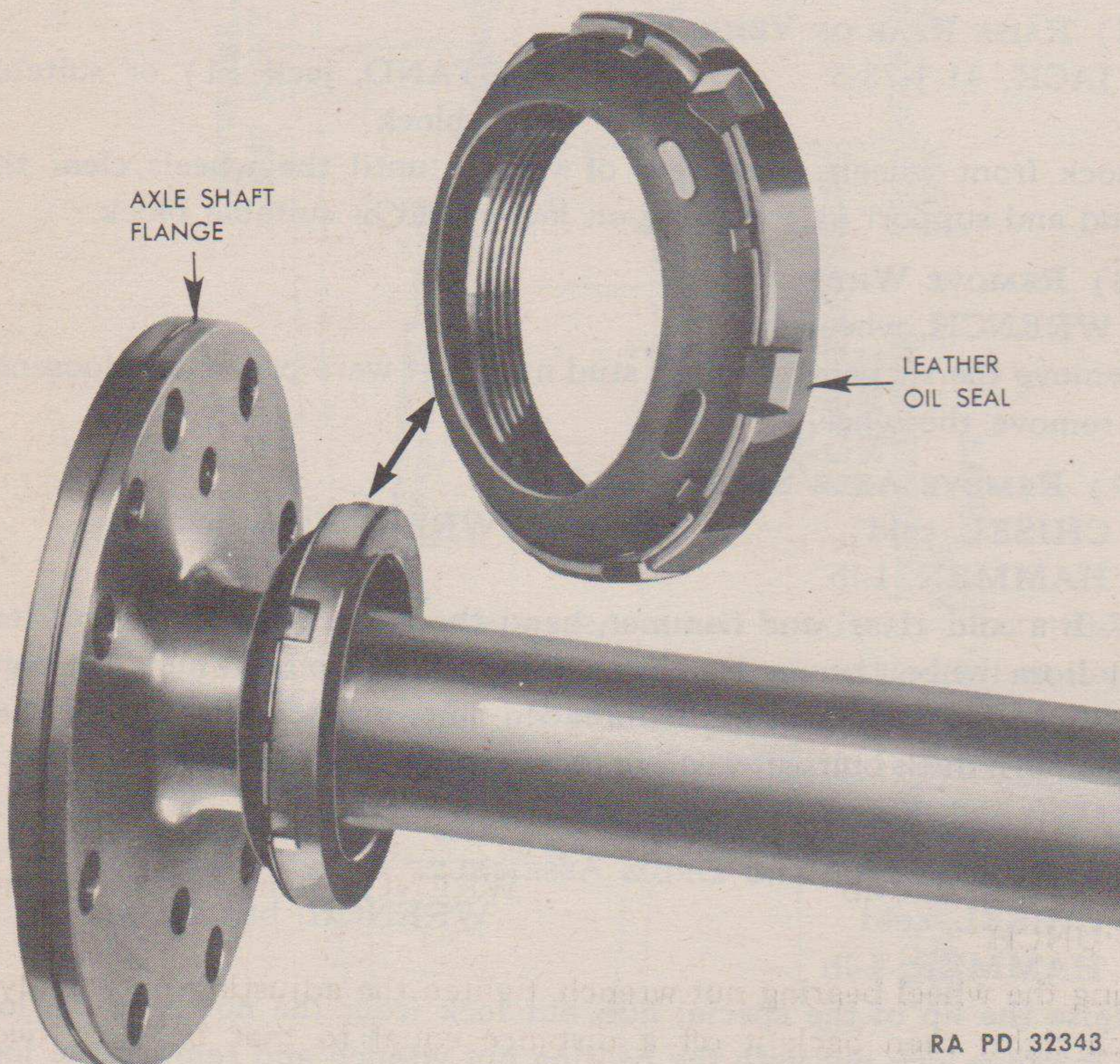

RA PD 32343

**Figure 33—Outer Bearing Oil Seal**

**REAR AXLE REPAIRS THAT CAN BE PERFORMED WITHOUT REMOVING UNIT FROM VEHICLE**

(8) REPLACE OIL SLINGER (fig. 34).

REPLACER, oil slinger,  
KM-J973

The location of the oil slinger requires that it be driven on the rear axle housing. If for any reason the oil slinger is removed, it must be replaced with a new one. A special tool is necessary for this purpose because the slinger must be located with relation to the bearings. The oil slinger replacer is designed so it will pilot on the housing and drive the slinger into proper position to mate with the oil slinger in the wheel hub.

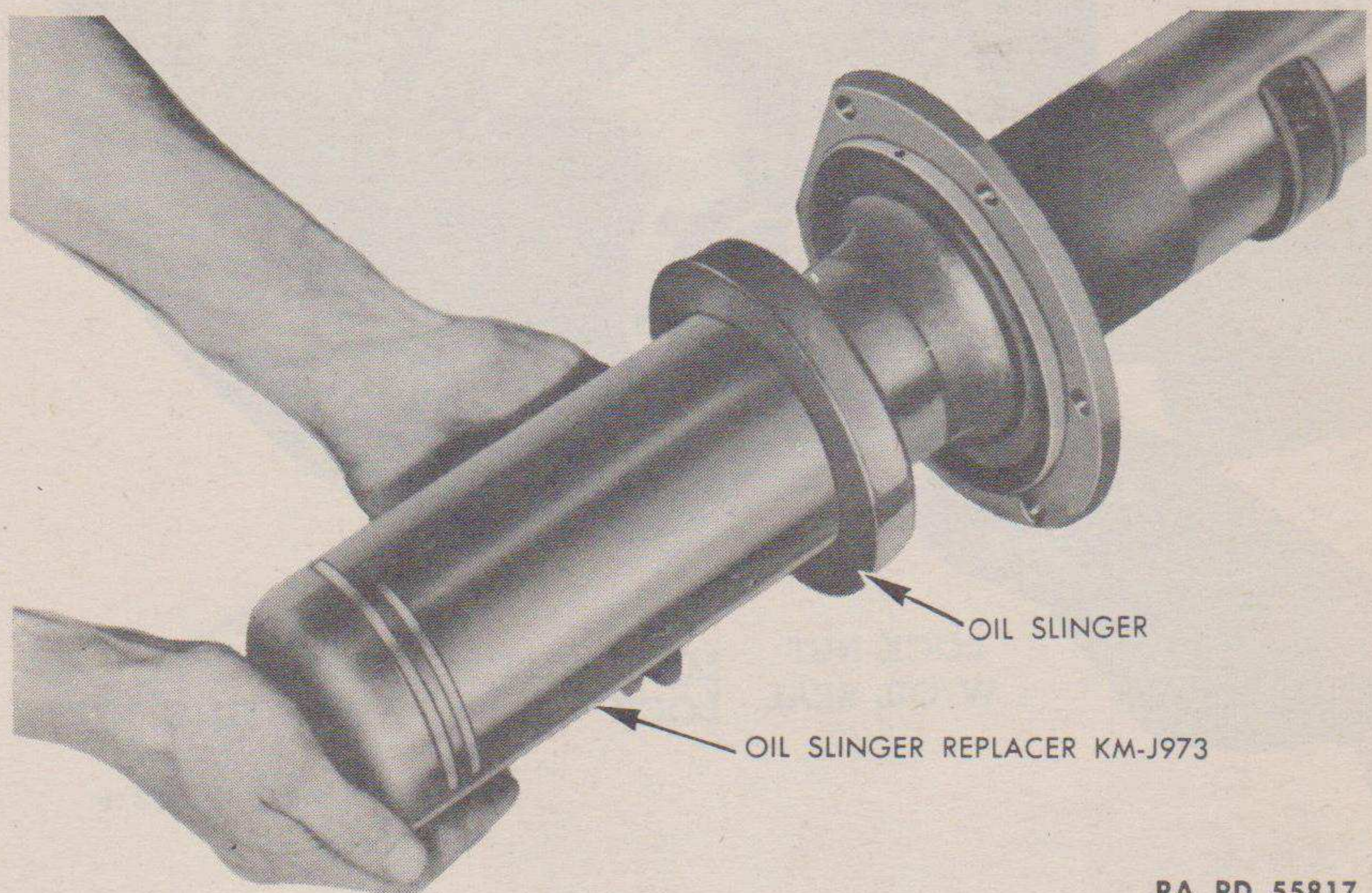

RA PD 55817

**Figure 34—Replacing Oil Slinger**

(9) INSTALL HUB AND DRUM ASSEMBLY.

Install the wheel hub and drum assembly. Then install the outer bearing cone and roller assembly, turning the hub to properly line up the bearings. Install the thrust washer and adjusting nut.

(10) ADJUST WHEEL BEARINGS (fig. 35).

HAMMER, 1-lb

WRENCH, wheel bearing nut

PUNCH

Using the wheel bearing nut wrench, tighten the adjusting nut snugly, wrench tight; then back it off a distance equal to that between two adjacent axle flange bolt holes which is equivalent to 45 degrees, or one-eighth of a turn of the nut. Turn the wheel hub by hand to make

**ORDNANCE MAINTENANCE—AXLES, PROPELLER SHAFTS AND  
WHEELS FOR BOMB SERVICE TRUCK M6 (CHEVROLET)**

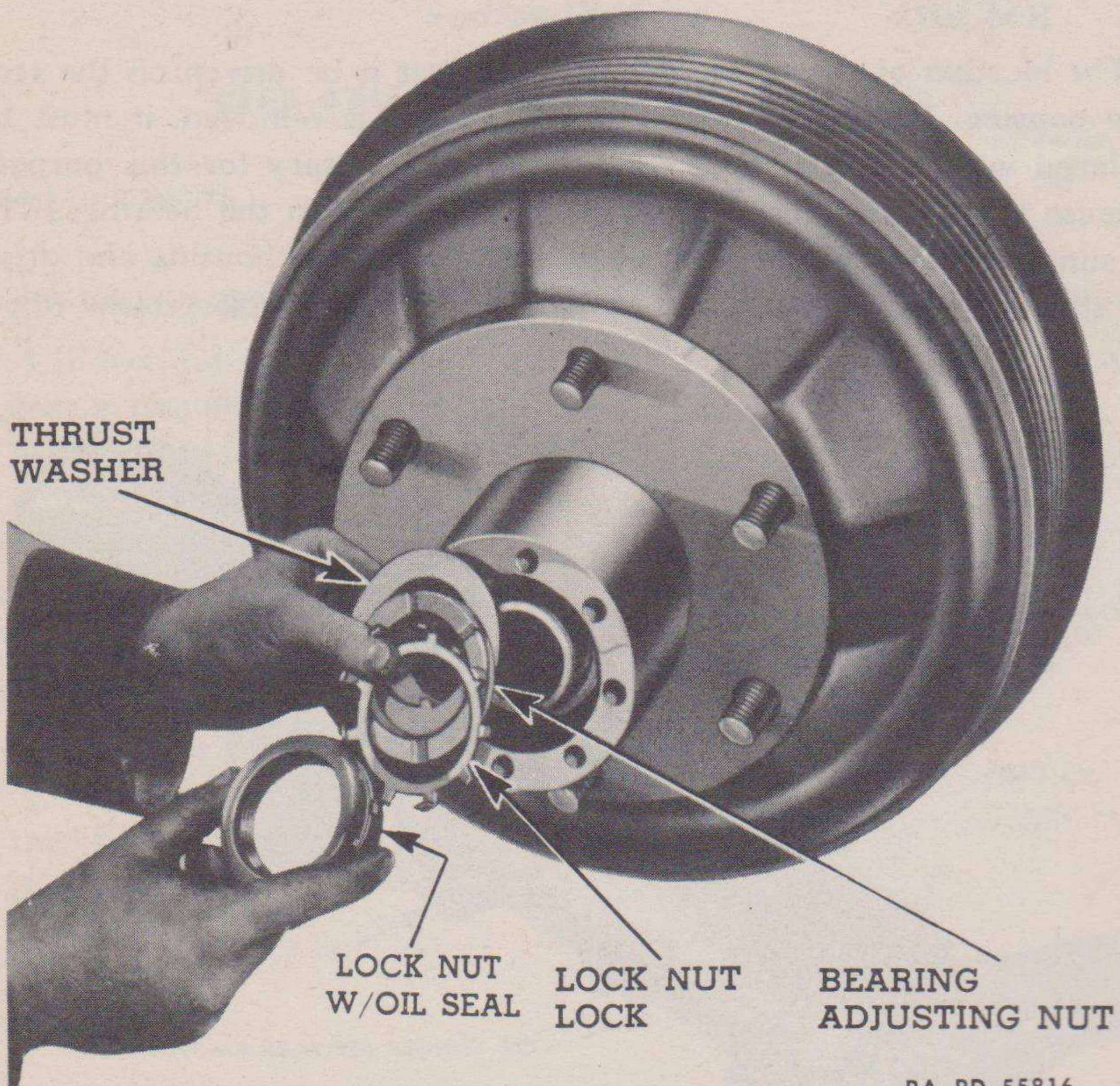

RA PD 55816

**Figure 35—Installing Wheel Bearing Adjusting Nut Parts**

sure the hub turns freely. Install the adjusting nut lock and check the alinement of the tangs with the slots in the nut. Rotate the hub by hand, grasping the hub at the wheel bolts to see that the bearings are properly seated and that the hub turns freely. Bend the tang on the lock into the notch of the adjusting nut. Install the outer lock nut and pull up tight to prevent any loosening of the adjusting nut. Bend the tang of the lock into the notch of the lock nut.

**(11) INSTALL AXLE SHAFT.**

**DRIFT**, small diameter

**WRENCH**, socket,  $\frac{5}{8}$ -in.

**HAMMER**, 1-lb

Install a new terneplate gasket and the axle shaft. Install the lock

**REAR AXLE REPAIRS THAT CAN BE PERFORMED WITHOUT  
REMOVING UNIT FROM VEHICLE**

plate. Install the eight axle shaft bolts and tighten securely (95-100 ft-lb). Then bend tangs on shaft bolt lock.

**(12) INSTALL WHEELS.**

**WRENCH**, wheel nut

Place wheel on studs and secure assembly with six pairs of nuts. Remove jack stand, lower vehicle to floor and remove jack.

**ORDNANCE MAINTENANCE—AXLES, PROPELLER SHAFTS AND WHEELS FOR BOMB SERVICE TRUCK M6 (CHEVROLET)**

**Section IV**

**REMOVAL OF REAR AXLE FROM VEHICLE**

	Paragraph
Preliminary procedure .....	40
Removal of rear axle assembly .....	41

**40. PRELIMINARY PROCEDURE.**

a. In preparing to replace the rear axle as a unit, it is important that the vehicle be placed on a solid foundation, preferably a concrete floor. After raising the rear end of the vehicle, the frame should be supported on solid jack stands or suitable blocking.

**41. REMOVAL OF REAR AXLE ASSEMBLY.**

a. **Equipment.** The equipment needed for repair operations in this section is listed below. Equipment needed for each operation is listed at the start of each paragraph covering the operation.

- |                                    |                              |
|------------------------------------|------------------------------|
| HAMMER, 1-lb                       | WRENCH, wheel nut            |
| JACK, 41-J-73-5                    | WRENCH, $\frac{9}{16}$ -in.  |
| PLIERS                             | WRENCH, $\frac{5}{8}$ -in.   |
| SCREWDRIVER                        | WRENCH, $1\frac{3}{16}$ -in. |
| STAND, jack (2) or suitable blocks | WRENCH, $1\frac{5}{16}$ -in. |

**b. Procedure.**

**(1) LOOSEN WHEELS.**

WRENCH, wheel nut

Loosen the six pairs of nuts on each rear wheel two turns.

**(2) RAISE REAR OF VEHICLE.**

JACK, 41-J-73-5

STAND, jack, (2) or suitable blocks

Raise rear of vehicle and support frame on suitable jack stands or blocks. Use floor jack to support axle assembly.

**(3) SPLIT PROPELLER SHAFT UNIVERSAL JOINT (fig. 36).**

WRENCH,  $\frac{9}{16}$ -in.

Remove the four nuts and lock washers from the two U-bolts and remove the U-bolts. Tape the two trunnion bearings in place to prevent them from falling off the trunnion yoke. Slide the universal joint back on its slip joint and lower the end of the propeller shaft to the floor.

## REMOVAL OF REAR AXLE FROM VEHICLE

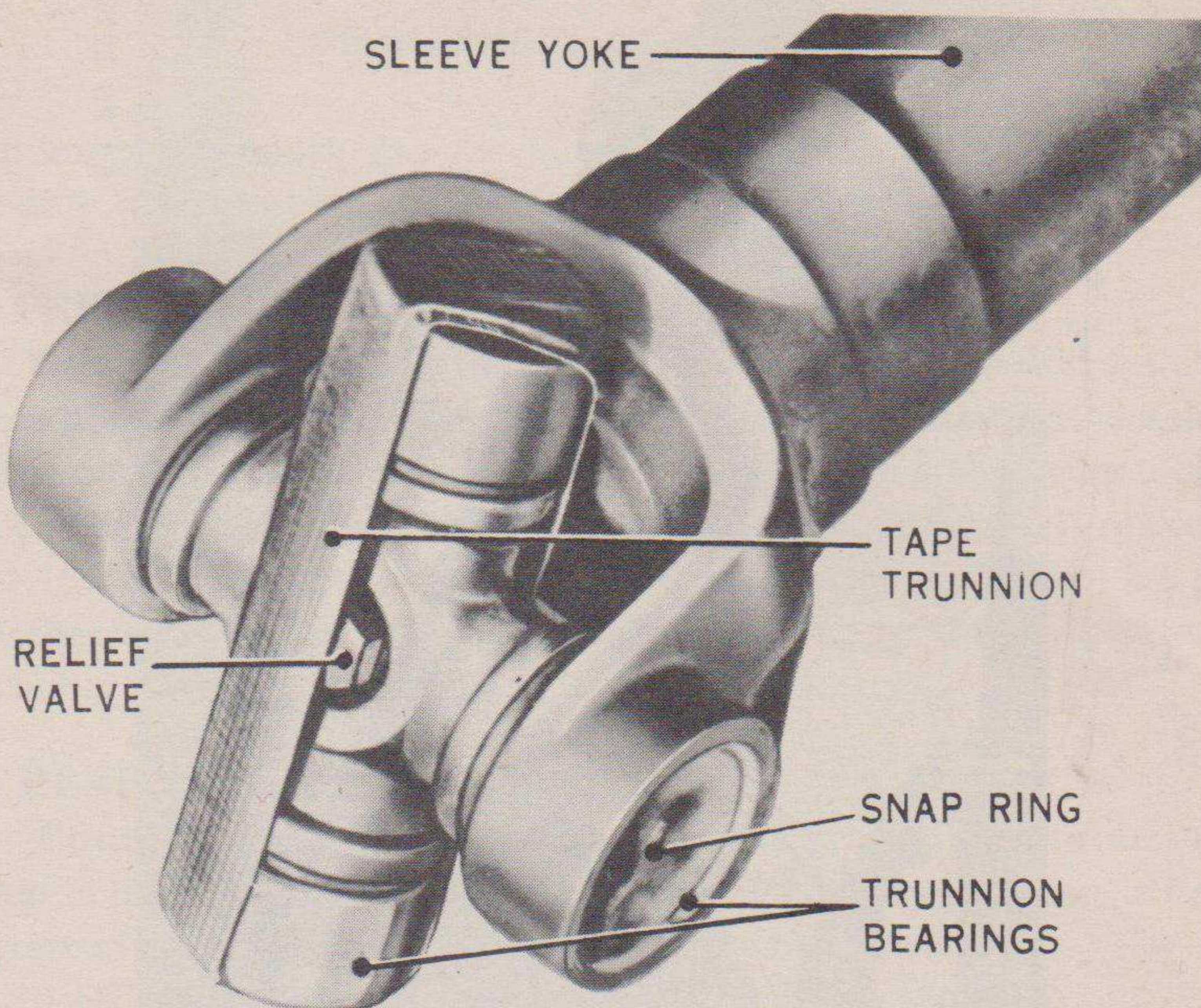

RA PD 55818

**Figure 36—Trunnion Bearings Held in Place with Tape**

**(4) DISCONNECT SHOCK ABSORBER LINK.**

**WRENCH,  $1\frac{3}{16}$ -in.**

Remove the nut and lock washer from bottom of link and remove link from anchor plate.

**(5) DISCONNECT BRAKE LINES.**

**WRENCH,  $\frac{5}{8}$ -in.**

Remove bolts from connectors at rear of wheel cylinder.

**(6) REMOVE REAR SPRING U-BOLTS.**

**HAMMER, 1-lb**

**WRENCH,  $1\frac{5}{16}$ -in.**

Remove the four nuts and lock washers from the two U-bolts on each side. Remove the U-bolts and anchor plates.

**(7) REMOVE REAR AXLE ASSEMBLY (fig. 37).**

Lower the supporting jack carefully and roll the rear axle assembly out from under the vehicle.



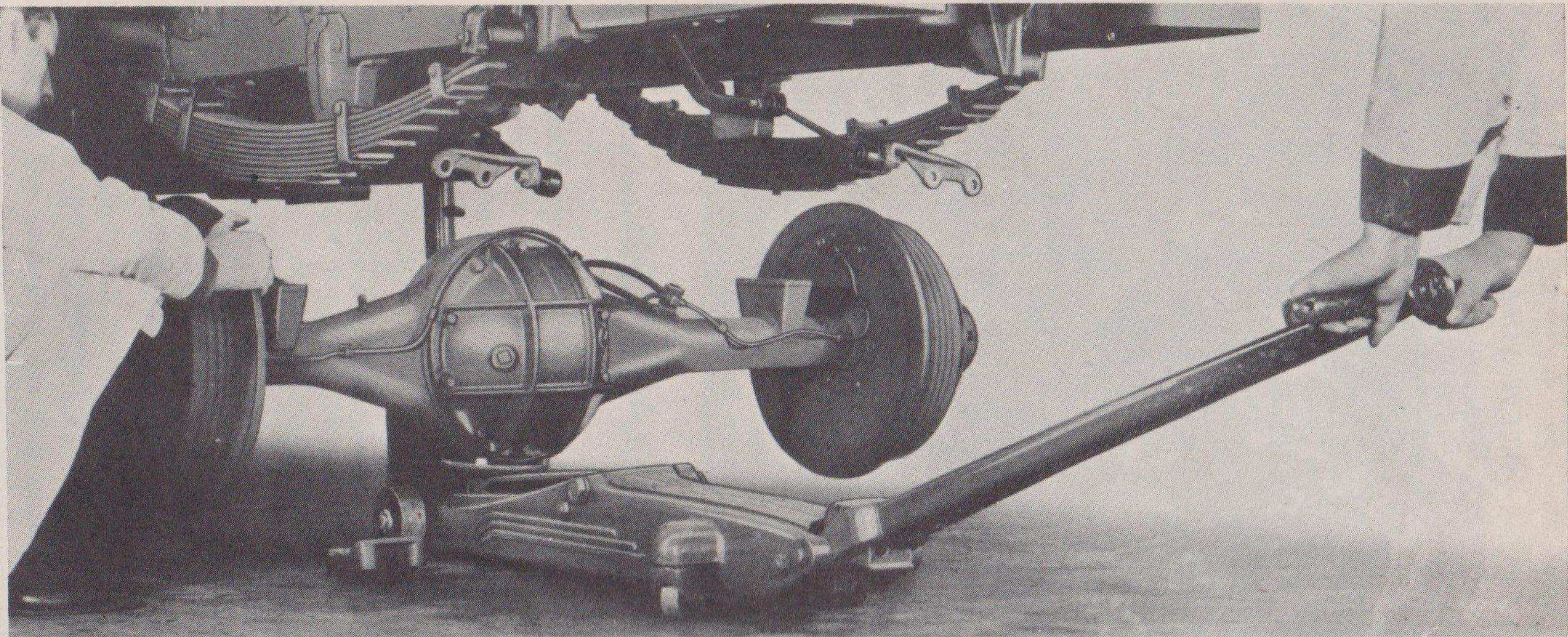

RA PD 32218

**Figure 37—Rear Axle Assembly Removal**

**Section V**

**DISASSEMBLY OF REAR AXLE**

	Paragraph
Preliminary procedure .....	42
Rear axle disassembly .....	43

**42. PRELIMINARY PROCEDURE.**

a. Before disassembling the rear axle assembly, it should be cleaned thoroughly so that it can be inspected for external damage, cracks, etc. As the parts are disassembled, they should be put in a cleansing tank with SOLVENT, dry-cleaning, so that they can soak, which will make them easier to clean. Rubber will be cleaned with alcohol. Do not let rubber or leather soak in the SOLVENT, dry-cleaning, as this will deteriorate the rubber and leather.

**43. REAR AXLE DISASSEMBLY.**

a. **Equipment.** The equipment needed for repair operations in this section is listed below. Equipment needed for each operation is listed at the start of each paragraph covering the operation.

- |                        |                              |
|------------------------|------------------------------|
| BLOCKS                 | STAND, rear axle             |
| BRUSH, cleaning        | TANK, parts cleaning (large) |
| CHISEL, cold           | TANK, parts cleaning (small) |
| CLAMPS, wheel cylinder | WISE, bench                  |
| KM-J18C (2)            | WRENCH, 3/8-in.              |
| CLOTH, cleaning        | WRENCH, 1/2-in.              |
| GUN, air blow          | WRENCH, 3/4-in.              |
| HAMMER, 1-lb           | WRENCH, 7/8-in.              |
| HANDLE, socket, 24-in. | WRENCH, 1-in.                |
| HANDLE, speed socket   | WRENCH, 1 1/4-in.            |
| PAN, drain             | WRENCH, socket, 5/8-in.      |
| PLIERS, combination    | WRENCH, socket, 1 5/8-in.    |
| PLIERS, brake spring   | KM-J870                      |
| KM-KMO-142             | WRENCH, wheel nut            |
| SOLUTION, cleaning     | WRENCH, wheel bearing nut    |

**b. Procedure.**

**(1) REMOVE WHEELS.**

- |        |                   |
|--------|-------------------|
| BLOCKS | WRENCH, wheel nut |
|--------|-------------------|

Place assembly on blocks and remove the six pairs of nuts on each wheel and remove wheels.

**(2) PLACE ASSEMBLY IN HOLDING FIXTURE.**

- |                  |
|------------------|
| STAND, rear axle |
|------------------|

Place rear axle assembly on rear axle stand and tighten clamps securely.

**ORDNANCE MAINTENANCE—AXLES, PROPELLER SHAFTS AND WHEELS FOR BOMB SERVICE TRUCK M6 (CHEVROLET)**

**(3) REMOVE AXLE SHAFTS (fig. 32).**

CHISEL, cold

WRENCH, socket,  $\frac{5}{8}$ -in.

HAMMER, 1-lb

Bend tangs away from bolt heads and remove the eight bolts and lock from each shaft. Install two of the bolts in the tapped holes in the flange of the axle shaft and screw them in alternately to loosen the shafts. Pull out shafts.

**(4) REMOVE HUB ASSEMBLY.**

CHISEL, cold

WRENCH, wheel bearing nut

HAMMER, 1-lb

KM-J870

Raise the lip of the special hub nut lock from the notch in the lock nut. Remove the lock nut, lock inner adjusting nut and washer. Pull hub assembly off end of housing.

**(5) REMOVE DIFFERENTIAL CARRIER ASSEMBLY.**

PAN, drain

WRENCH, socket,  $\frac{5}{8}$ -in.

Set drain pan under banjo housing and remove the 10 cap screws that attach the housing cover and remove cover, allowing oil to drain into pan. Then remove the 10 cap screws that attach the differential carrier assembly to the housing and remove the assembly.

**(6) DISASSEMBLE DIFFERENTIAL CARRIER ASSEMBLY.**

HANDLE, socket, 24-in.

WRENCH,  $\frac{3}{4}$ -in.

PLIERS, combination

WRENCH,  $\frac{7}{8}$ -in.

SCREWDRIVER

WRENCH, 1-in.

WRENCH,  $\frac{3}{8}$ -in.

WRENCH, 1 $\frac{1}{4}$ -in.

WRENCH,  $\frac{1}{2}$ -in.

WRENCH, open-end, 1 $\frac{5}{8}$ -in.

Set differential carrier assembly in vise and remove thrust pad adjusting screw and nut. Remove the six cap screws that attach the pinion bearing retainer to the carrier and remove the pinion shaft. Remove the cap screw on each differential bearing cap that attaches the adjusting nut lock and remove the locks. Remove the two cap screws which secure each bearing cap and remove the caps, adjusting nuts, bearing cups and differential case with hypoid drive (ring) gear. Remove the 12 cap screws which attach the hypoid drive (ring) gear to the case and separate the two halves. Remove the spider, differential pinions and differential side gears. Clamp the propeller shaft pinion flange in a vise and remove the cotter pin and nut from the end of the drive pinion shaft; remove flange and retainer from the drive pinion shaft.

Section VI

**CLEANING, INSPECTING, REPAIRING OR REPLACING OF  
REAR AXLE COMPONENT PARTS**

	Paragraph
Introduction .....	44
Component parts, inspection and disassembly .....	45
Component parts, repairing and assembling .....	46

**44. INTRODUCTION.**

a. **General.** The cleaning, inspection and repairing of rear axle component parts must be done with extreme care and cleanliness. All parts must be thoroughly cleaned, both inside and outside. Then dry with clean cloth and with pressure from an air blow gun. **CAUTION:** Do not allow ball bearings to be spun by the air stream. Spinning the bearings with air pressure is liable to embed small particles in the race and damage the bearings. Worn and damaged parts that are removed from subassemblies should be placed to one side to keep them separated from the parts that are to be used again.

b. **Equipment.** The equipment needed to remove and replace parts from subassemblies will be listed at the start of each paragraph covering the operation.

**45. COMPONENT PARTS, INSPECTION AND DISASSEMBLY.**

a. **Differential Case.**

(1) **INSPECTION.** Inspect the thrust surfaces in the case halves for wear or score marks. Check the fit of the side gear hubs in the case. Inspect the thrust washers for wear or other damage. Check the fit of the spider and spider gears. Worn or damaged parts should be replaced. **NOTE:** If any of the six differential gears are damaged, all six gears should be replaced. Inspect the bearing cone and roller assemblies and cups for wear, scores or roughness, and replace damaged bearings.

(2) **DISASSEMBLY.**

(a) *Remove Differential Bearing Cone and Roller Assemblies (fig. 38).*

**PULLER, bearing, KM-TR278R**

Assemble puller to the case with the two fingers of the puller in the notches of the case. This allows the fingers to pull in against the inner race, preventing damage to the bearings. Tighten clamp screw and turn handle in clockwise direction to remove bearing cone and roller assembly.

ORDNANCE MAINTENANCE—AXLES, PROPELLER SHAFTS AND  
WHEELS FOR BOMB SERVICE TRUCK M6 (CHEVROLET)

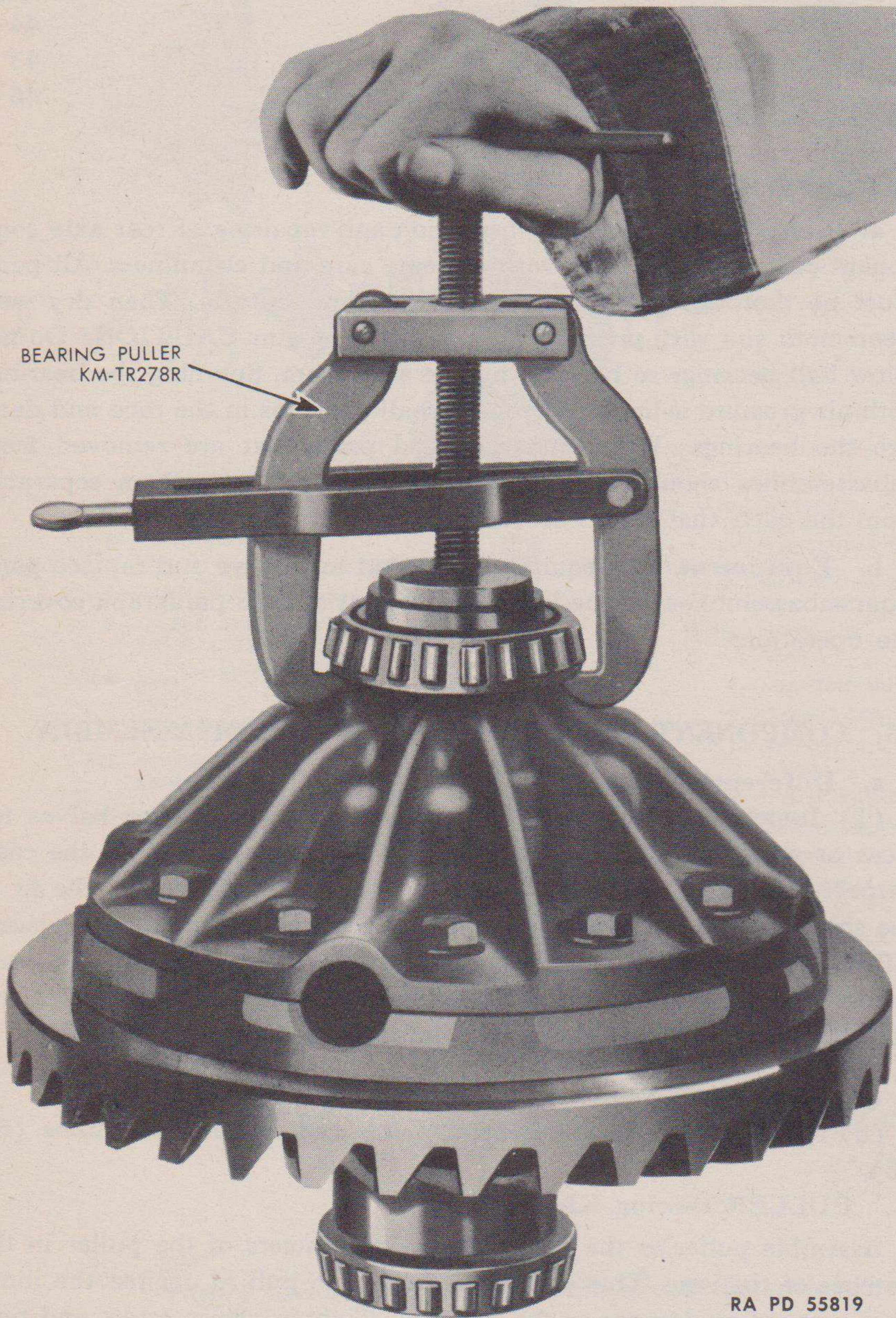

Figure 38—Differential Bearing Puller

## CLEANING, INSPECTING, REPAIRING OR REPLACING OF REAR AXLE COMPONENT PARTS

### b. Pinion Assembly.

(1) **INSPECTION.** Put a few drops of light engine oil on the straddle mounted bearing and the double row bearing. Turn bearings slowly by hand and check for roughness or other damage. Replace damaged bearings.

### (2) **DISASSEMBLY.**

#### (a) *Remove Straddle Mounted Bearing.*

PLATE, press, KM-J1453

PRESS

PLIERS, combination

SCREWDRIVER

Remove lock ring and place press plates behind bearing with raised position of plates against the inner race. Press shaft out of bearing (fig. 39).

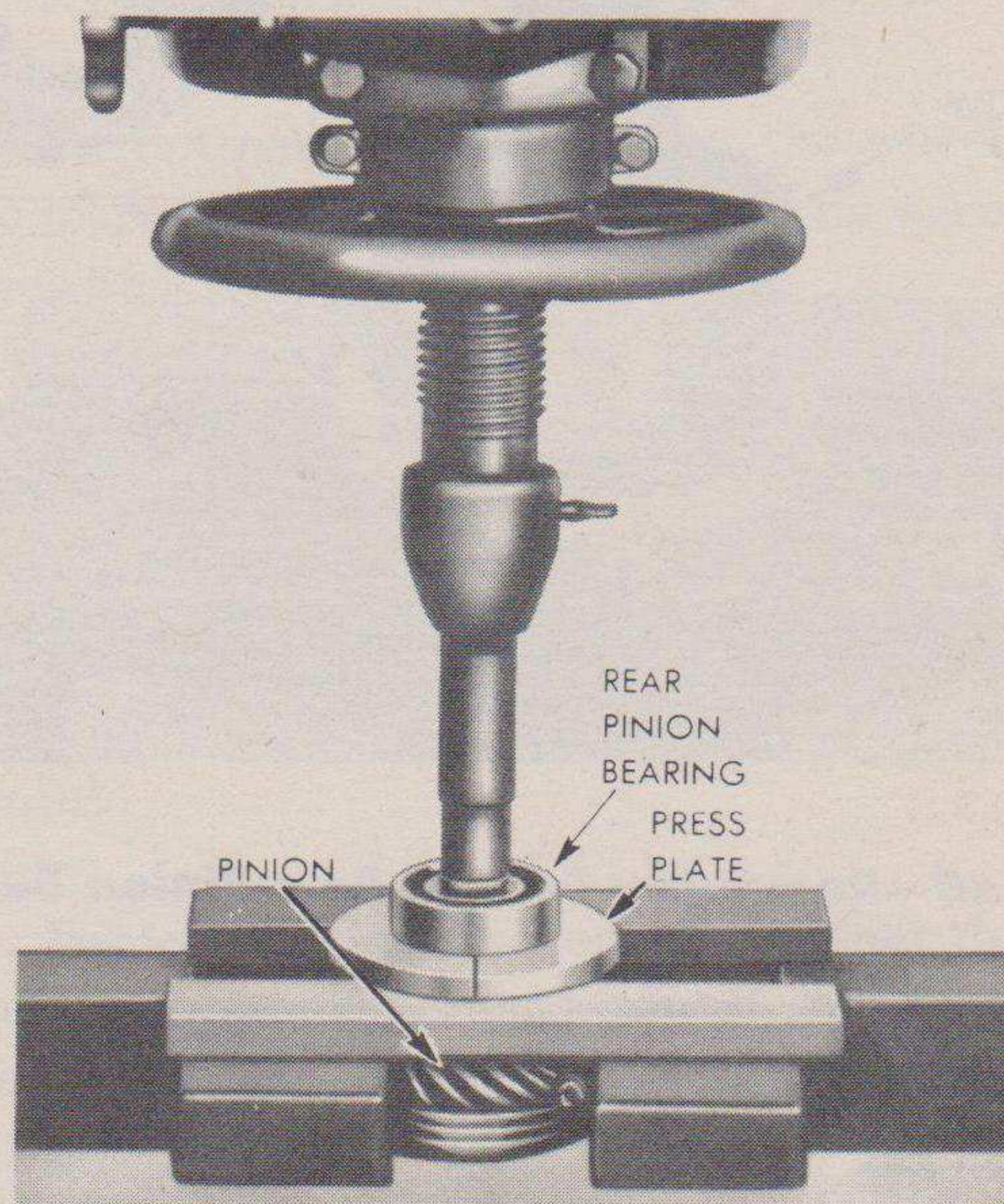

RA PD 32346

**Figure 39 – Removing Straddle-Mounted Pinion Bearing**

#### (b) *Remove Double Row Bearing.*

PLATE, press, KM-J1439

PRESS

Place press plate over pinion shaft and pinion. Press shaft out of bearing (fig. 40).

### c. Pinion Bearing Retainer.

(1) **INSPECTION.** Check the oil seal and felt packing, and replace damaged parts.

**ORDNANCE MAINTENANCE—AXLES, PROPELLER SHAFTS AND  
WHEELS FOR BOMB SERVICE TRUCK M6 (CHEVROLET)**

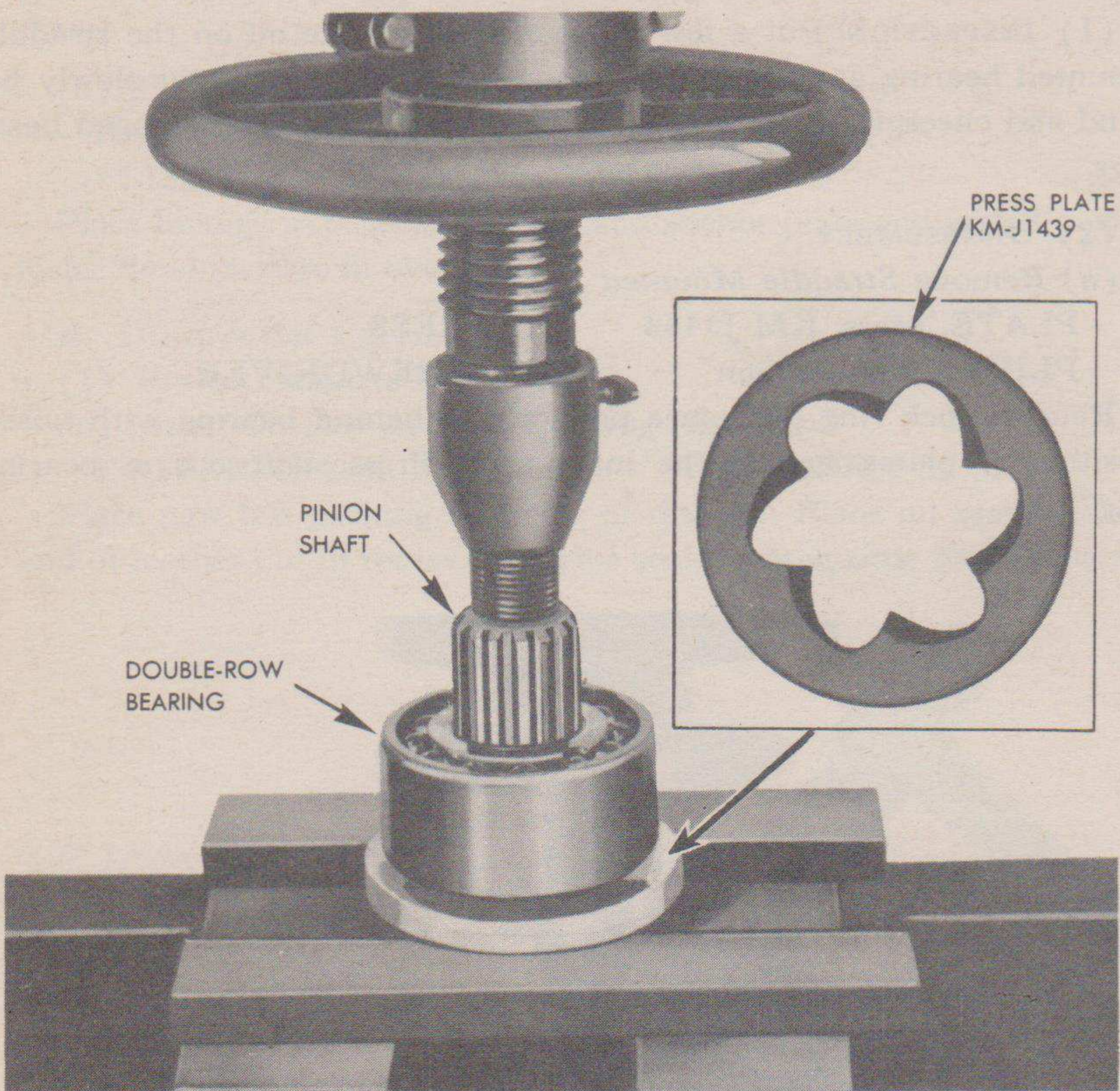

RA PD. 55820

**Figure 40—Removing Double Row Pinion Bearing**

**(2) DISASSEMBLY.**

*(a) Remove Oil Seal and Felt Packing.*

**SCREWDRIVER**

Pry out oil seal and felt packing.

**d. Axle Housing and Brake Parts.**

**(1) INSPECTION.** Inspect the housing for cracks or other damage. Inspect the brake linkage, brake lining and brake backing plate for wear or other damage. Replace any damaged parts.

**(2) DISASSEMBLY.**

*(a) Remove Brake Shoes.*

**CLAMP, wheel cylinder,  
KM-5718C (2)**

**PLIERS, brake spring,  
KM-KMO-142**

**PLIERS, combination  
SCREWDRIVER**

## CLEANING, INSPECTING, REPAIRING OR REPLACING OF REAR AXLE COMPONENT PARTS

Install wheel cylinder clamps and remove retracting spring. Pry edge of pivot pin lock over end of pivot pins at lower end of shoes and remove the locks and pins. Remove the two locks and pins from the opposite end of the links in the same manner. Pry off spring locks at center of links and remove springs and pins. Remove the links and shoes.

### (b) Remove Brake Lining.

CHISEL, small, cold, or Deli-      HAMMER  
ner, brake

Remove rivets that attach lining to shoe and pull off lining.

### (c) Remove Brake Backing Plate.

WRENCH, 1/2-in.      WRENCH, 5/8-in.

Remove the six cap screws and nuts that attach the backing plate to the housing and remove the backing plate. Remove the two cap screws that attach the wheel cylinder to the backing plate and lift off cylinder.

### e. Wheel Cylinder.

(1) GENERAL. It is not necessary to remove the wheel cylinders from the flange plate to inspect or repair them. It will be necessary, however, to disassemble the wheel cylinder to inspect it.

#### (a) Disassemble Wheel Cylinder.

Remove wheel cylinder clamp, end covers with adjusting screws, pistons, rubber cups and spring. Inspect rubber cups for swelling or other damage. Inspect pistons and piston fit in housing. This clearance should be 0.002 to 0.005 inch. Inspect end covers and adjusting screws for wear or other damage. Replace any damaged parts.

### f. Hub Assembly.

#### (1) BRAKE DRUM.

(a) *Inspection.* Inspect the brake drum to see that the lining contact surfaces are not scored, worn, tapered or out of round. If the drums are damaged in any way, they should be turned on lathe or replaced.

#### (b) Remove Drums.

HAMMER, 1-lb

Drive out the six hub bolts and separate drum from hub.

### g. Wheel Bearings and Seal.

(1) INSPECTION. Inspect hub for external damage or stripped stud threads. Also inspect the wheel bearing cones and cups for wear, scoring or other damage. Inspect seal for wear or damage. Replace all damaged parts. If hub is to be replaced, it will be necessary to remove the wheel bearing parts.

#### (2) DISASSEMBLY.

#### (a) Remove Inner Bearing Cup (fig. 21).

PULLER, KM-J918G.



**ORDNANCE MAINTENANCE—AXLES, PROPELLER SHAFTS AND WHEELS FOR BOMB SERVICE TRUCK M6 (CHEVROLET)**

Install the puller by tilting the plate with the chain attached so that it may be slipped through the cone of the bearing and then raised up behind the cup. The plate is then held in this position by the chain while threading the puller shaft into the tapped hole. The puller body is then located against the inner end of the hub and the puller handle installed (fig. 21). The cup, cone and roller assembly, and seal are removed by turning the puller handle in a clockwise direction.

(b) *Remove Outer Bearing Cup* (fig. 41).

DRIFT, long	HAMMER, 1-lb
DRIVER, outer bearing cup, KM-J872-1	PLIERS

From inside the hub, tap the outer bearing with drift to relieve the tension at the snap ring on the inside of the hub, then remove the snap ring. Turn hub over and drive out the cup.

**h. Axle Shaft.** Inspect the axle for damage to the splines, twisted shaft or any other damage. Replace the shaft if it is damaged.

**i. Bolts and Nuts.** Inspect all bolts and nuts for stripped threads or other damage. Replace any bolts or nuts that are damaged.

**46. COMPONENT PARTS, REPAIRING AND ASSEMBLING.**

**a. Hub Assembly.**

(1) **INSTALL OUTER BEARING CUP.**

DRIVER, outer bearing cup, KM-J872-1	PLIERS PRESS
---	-----------------

Install snap ring in place in the groove. Place cup in position on outer end of hub with wide side of cup down and press cup in until it bottoms against the snap ring.

(2) **INSTALL INNER BEARING CUP.**

DRIVER, inner bearing cup, KM-J872-4	PRESS
---	-------

Place inner bearing cup in position on inner end of hub with wide side of cup down and press cup in until it bottoms against the shoulder. Hand pack the bearing with GREASE, general purpose, No. 2. Place bearing in cup.

(3) **INSTALL SEAL.**

DRIVER, oil seal, KM-J872-2	PRESS
HAMMER, 1-lb	

Place new seal in position on hub and press it in until it bottoms against the race.

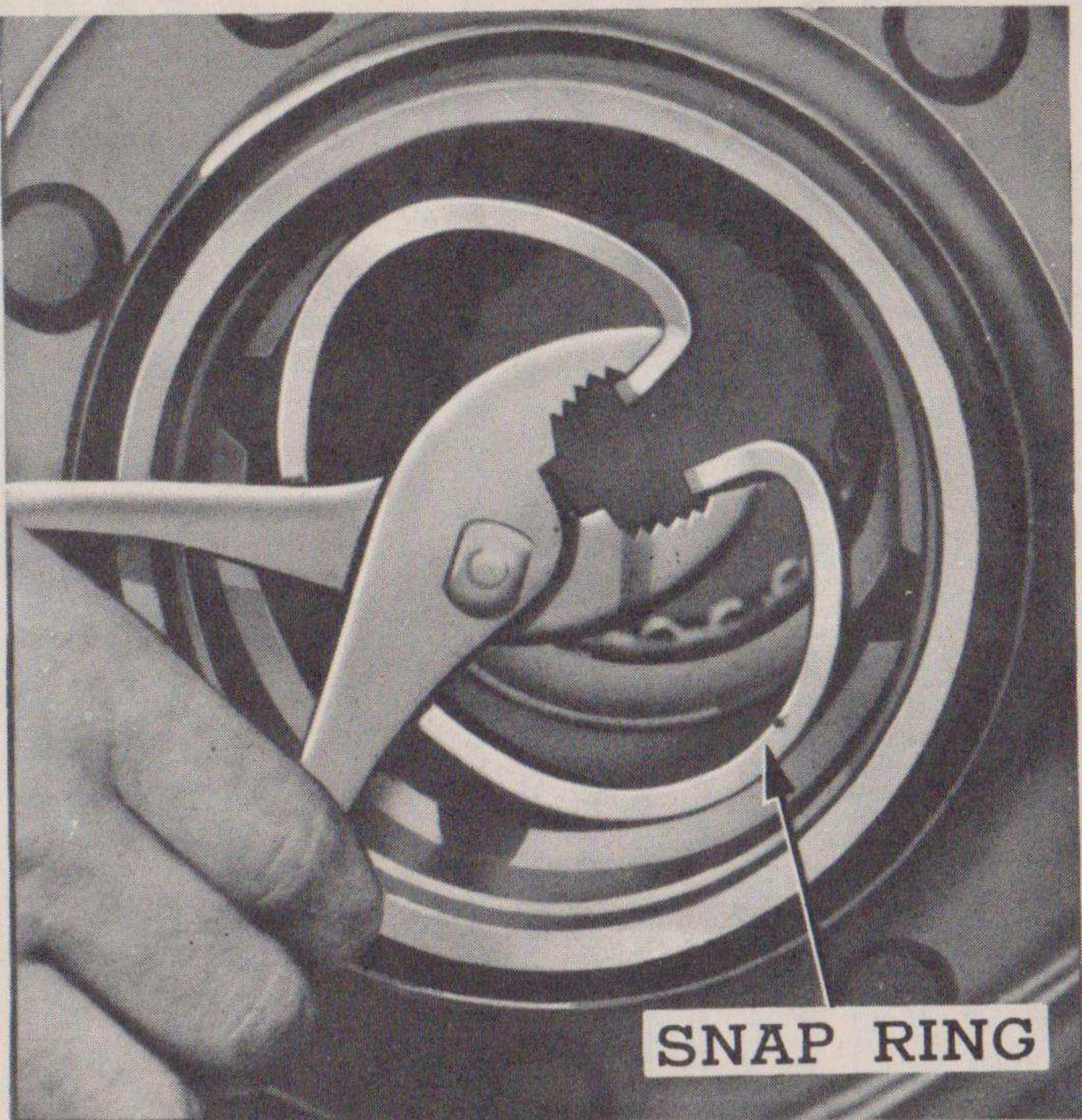

RA PD 32328

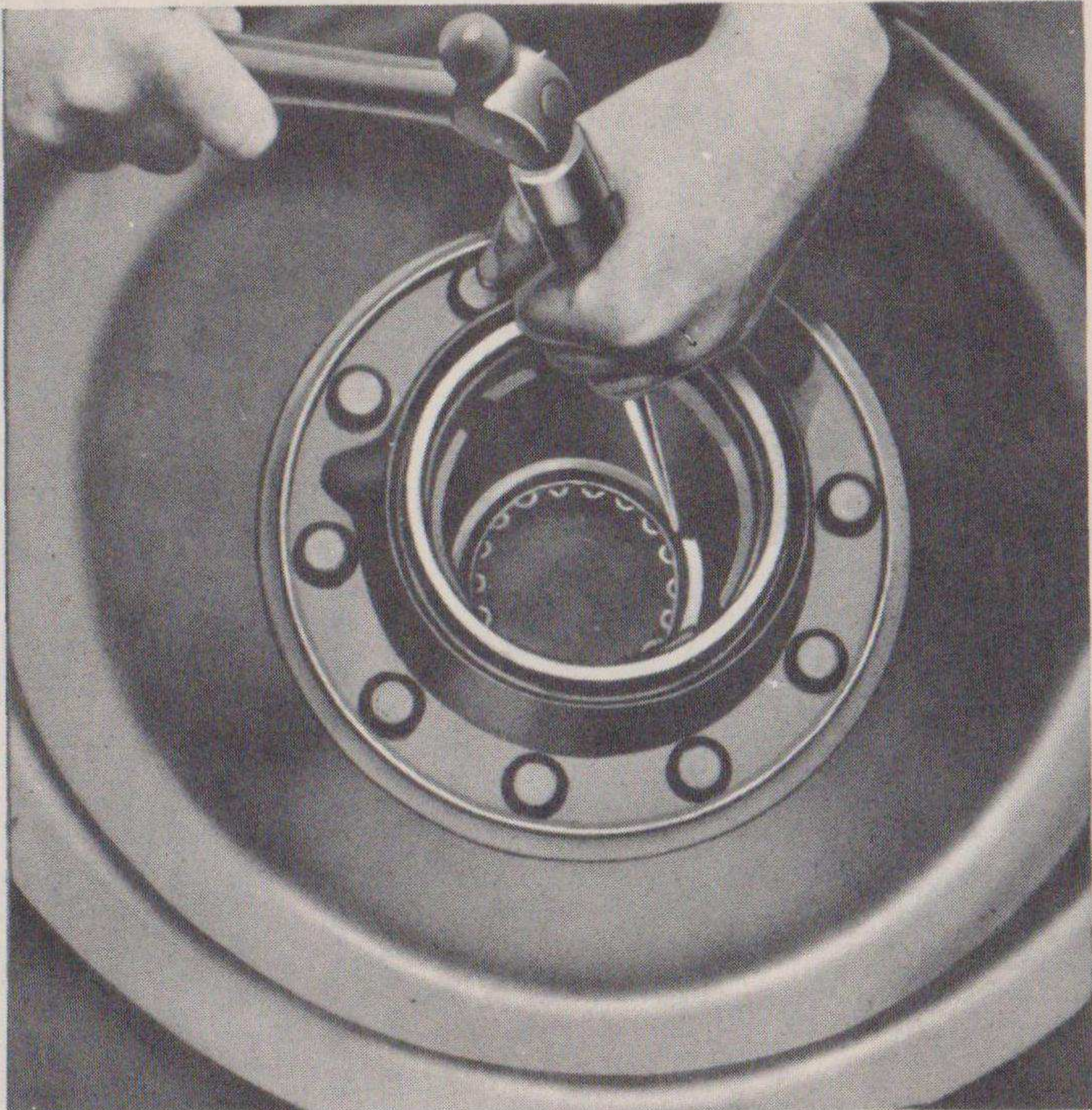

Figure 41—Removing Outer Bearing Snap Ring

## ORDNANCE MAINTENANCE—AXLES, PROPELLER SHAFTS AND WHEELS FOR BOMB SERVICE TRUCK M6 (CHEVROLET)

### (4) INSTALL BRAKE DRUM (fig. 42).

ANVIL, brake drum, KM-J554      TOOL, hub bolt peening  
HAMMER, 1-lb

Place drum on hub. Shellac both sides of a new gasket and place on drum with small hole in line with the oil relief hole in the drum. Place oil deflector on gasket with channel in deflector in line with small hole in gasket. Insert six new hub bolts; then place assembly on anvil with the threaded portion of the bolt passing into the hole in one of the supports. Drive each bolt into place solidly. Place the hub assembly on anvil (fig. 42) and peen the shoulder of the bolt into the chamfer of the flange. Turn peening tool after each hammer blow to prevent damage to the tool. **NOTE:** The peening operation is important from a safety standpoint.

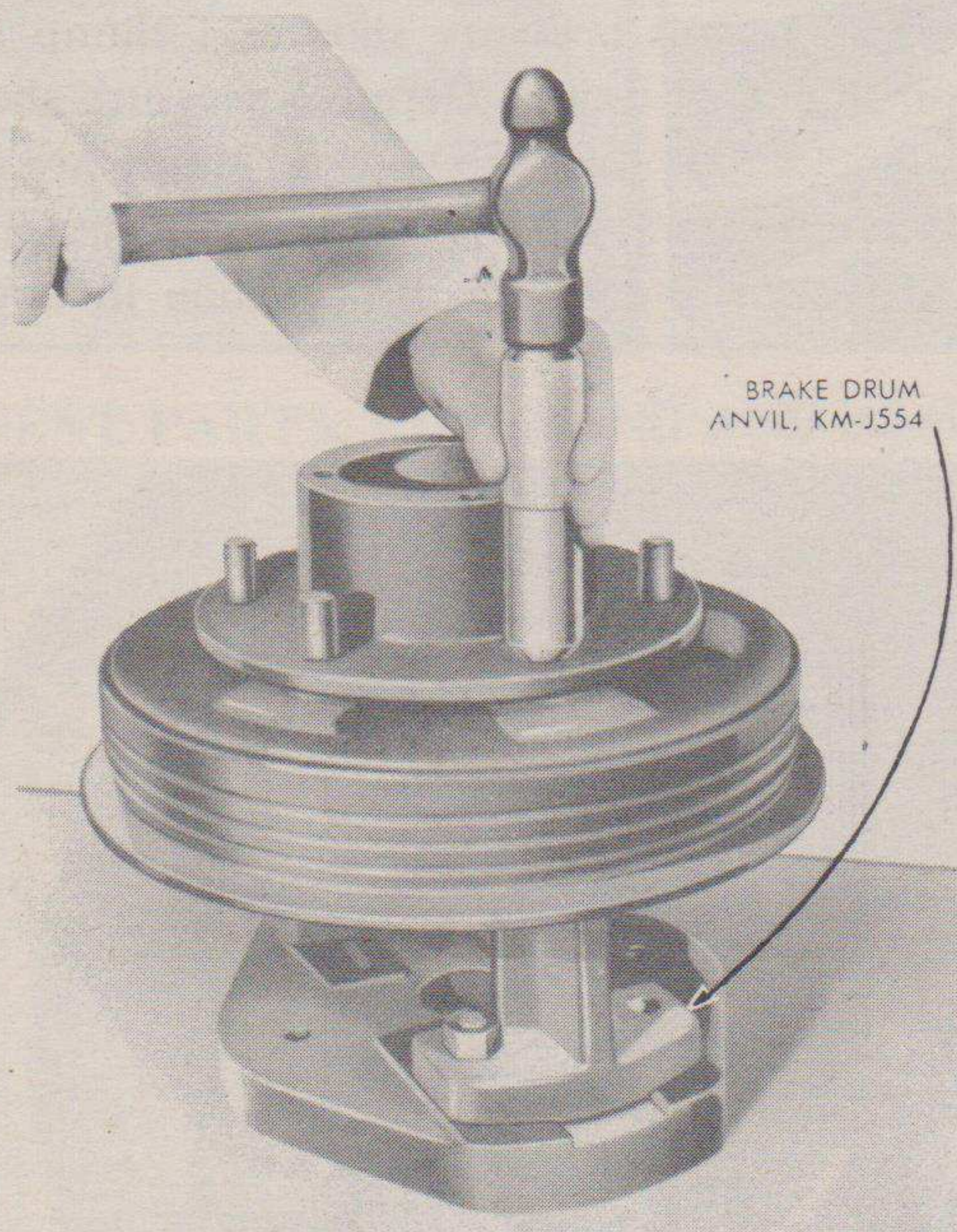

**Figure 42—Installing Brake Drum**

### b. Wheel Cylinders (fig. 20).

#### (1) ASSEMBLE WHEEL CYLINDER.

CLAMP, wheel cylinder, KM-J718C.

Wipe inside of housing, dip rubber cups and pistons in new brake fluid and install spring, rubber cups, with flat side out, pistons with flat

### CLEANING, INSPECTING, REPAIRING OR REPLACING OF REAR AXLE COMPONENT PARTS

side in, and caps with adjusting screws. Install wheel cylinder clamp to hold assembly together.

#### (2) INSTALL WHEEL CYLINDER.

WRENCH, 1/2-in.

Place wheel cylinder in position on brake backing plate and install the two holding cap screws. Tighten cap screws securely.

#### c. Housing and Brake Parts.

#### (1) INSTALL BRAKE BACKING PLATE.

WRENCH, 5/8-in.

Place backing plate in position and install the six cap screws, nuts and lock washers. Tighten securely.

#### (2) INSTALL BRAKE LININGS (fig. 27).

Place lining in position on brake shoe and install one rivet on each side near center of shoe. Install pressure shoe and clamp (fig. 27) and install two rivets at each end of lining. Remove pressure shoe and install the remaining rivets. **NOTE:** If pressure shoe and clamp are not available, use following alternative method. After placing the rivets near center of shoe, work out toward each end of the brake shoe in applying rivets.



RA PD 55821

**Figure 43—Installing Oil Seal**

**ORDNANCE MAINTENANCE—AXLES, PROPELLER SHAFTS AND WHEELS FOR BOMB SERVICE TRUCK M6 (CHEVROLET)**

(This will eliminate any chance of lining not fitting snugly against the shoe.)

**(3) INSTALL BRAKE SHOES.**

**HAMMER, 1-lb**

**SCREWDRIVER**

**PLIERS**

Place linkage in position on shoe and anchor plate and install pins and locks. Bend locks to fit over pins.

**d. Differential Carrier.**

**(1) PINION BEARING RETAINER.**

*(a) Install Oil Seal and Felt Packing (fig. 43).*

**DRIVER, oil seal, KM-J1658**

**HAMMER, 1-lb**

Place new felt packing in recess of retainer. Place oil seal with open end of leather out in recess and drive seal down against the felt packing.

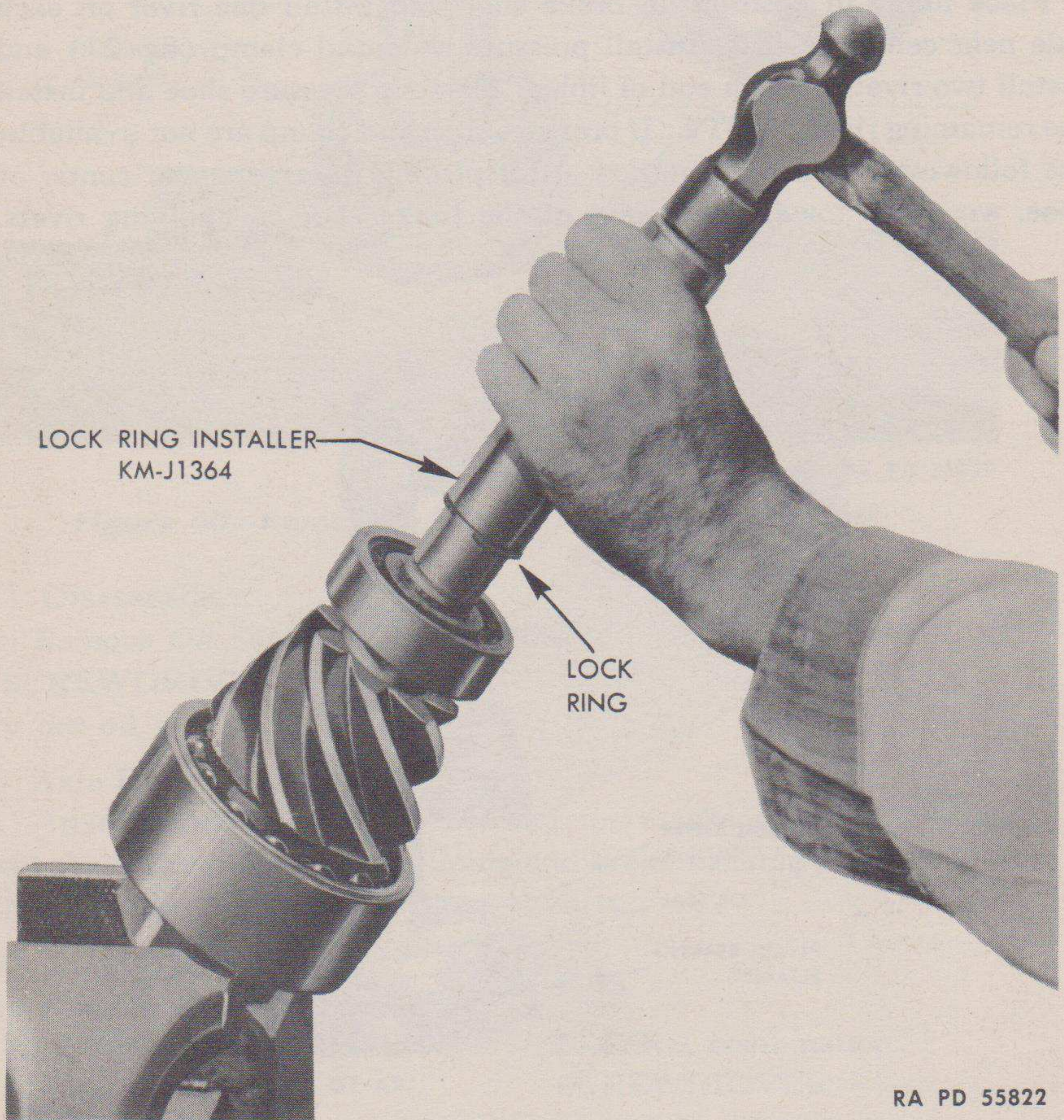

RA PD 55822

**Figure 44—Installing Lock Ring**

**CLEANING, INSPECTING, REPAIRING OR REPLACING OF  
REAR AXLE COMPONENT PARTS**

**(2) PINION ASSEMBLY.**

*(a) Install Double Row Bearing.*

**PRESS**, arbor

Place bearing on shaft with extended portion of inner race toward the gear. Press shaft into bearing until the gear bottoms against the inner race.

*(b) Install Straddle Mounted Bearing.*

**HAMMER**, 1-15

**PRESS**

**INSTALLER**, lock ring, KM-

**J1364**

Place bearing on shaft with chamfered side of inner race toward the pinion. Press the bearing on shaft until it bottoms against the gear. Start a new lock ring over end of shaft and drive in place with the special lock ring installer (fig. 44).

**(3) DIFFERENTIAL CASE.**

*(a) Install Differential Bearing Cone and Roller Assemblies.*

**DRIVER**, bearing, KM-J1488

**HAMMER**, 1-1b

Place cone and roller assemblies in position on case with wide side of cone down. Drive cone and roller assemblies in place until they bottom on the case.

ORDNANCE MAINTENANCE—AXLES, PROPELLER SHAFTS AND WHEELS FOR BOMB SERVICE TRUCK M6 (CHEVROLET)

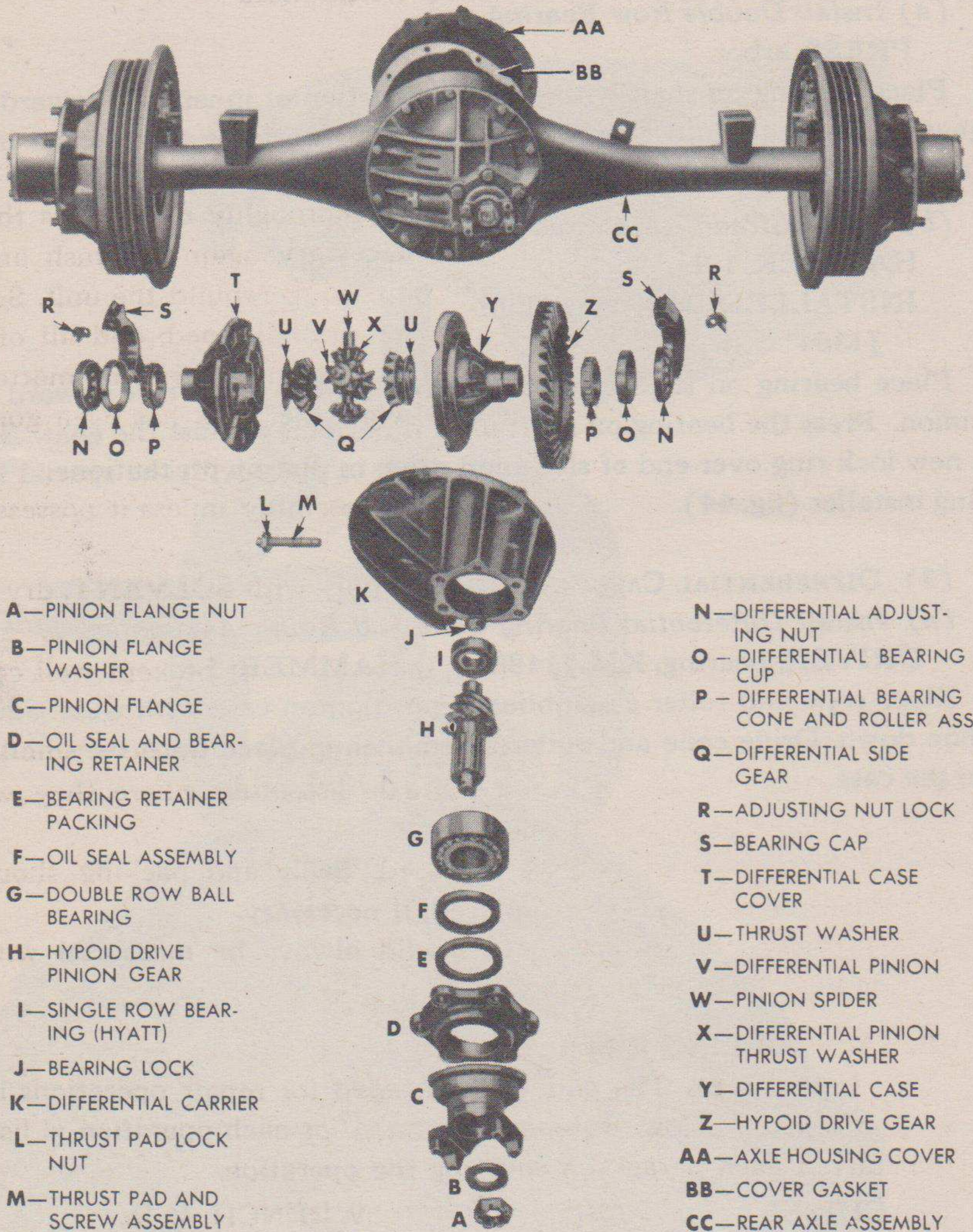

- A—PINION FLANGE NUT
- B—PINION FLANGE WASHER
- C—PINION FLANGE
- D—OIL SEAL AND BEARING RETAINER
- E—BEARING RETAINER PACKING
- F—OIL SEAL ASSEMBLY
- G—DOUBLE ROW BALL BEARING
- H—HYPOID DRIVE PINION GEAR
- I—SINGLE ROW BEARING (HYATT)
- J—BEARING LOCK
- K—DIFFERENTIAL CARRIER
- L—THRUST PAD LOCK NUT
- M—THRUST PAD AND SCREW ASSEMBLY

- N—DIFFERENTIAL ADJUSTING NUT
- O—DIFFERENTIAL BEARING CUP
- P—DIFFERENTIAL BEARING CONE AND ROLLER ASS'Y
- Q—DIFFERENTIAL SIDE GEAR
- R—ADJUSTING NUT LOCK
- S—BEARING CAP
- T—DIFFERENTIAL CASE COVER
- U—THRUST WASHER
- V—DIFFERENTIAL PINION
- W—PINION SPIDER
- X—DIFFERENTIAL PINION THRUST WASHER
- Y—DIFFERENTIAL CASE
- Z—HYPOID DRIVE GEAR
- AA—AXLE HOUSING COVER
- BB—COVER GASKET
- CC—REAR AXLE ASSEMBLY

RA PD 55823

Figure 45—Layout of Rear Axle and Differential Parts

Section VII

ASSEMBLING REAR AXLE

	Paragraph
Preliminary procedure .....	47
Assembling rear axle .....	48

**47. PRELIMINARY PROCEDURE.**

a. Although the various parts were thoroughly cleaned as the rear axle was being disassembled, it is necessary again to wash and dry thoroughly all of the parts that will be used to rebuild the unit. Some of these parts may have been repaired or reconditioned, and all of them have been exposed to dust, dirt and to foreign material or matter that may have fallen on or near the axle while the work has been going on.

b. **Precautions.** Observe the following list of precautions:

(1) No part should be used for final assembly unless it possesses the required specifications.

(2) All parts must be washed thoroughly with SOLVENT, dry-cleaning, before they are assembled.

(3) As the assembling proceeds, the work must be kept well covered to protect it from dust, dirt, etc.

(4) Precaution must be taken that nuts, bolts, washers, small tools, sockets, etc., do not fall inside the axle assembly where they will do damage if not removed at once.

(5) All gaskets should be replaced. Seals and packing should be inspected for condition and replaced, if necessary.

(6) Backlash between gears should always be measured with the mating gear teeth clean and dry.

**48. ASSEMBLING REAR AXLE.**

a. **Equipment.** The equipment needed for repair operations in this section is listed below. Equipment needed for each operation is listed at the start of each paragraph covering the operation.

- |                        |                         |
|------------------------|-------------------------|
| CHISEL                 | WRENCH, 3/8-in.         |
| DRIFT, small diameter  | WRENCH, 1/2-in.         |
| GAGE, dial             | WRENCH, 7/8-in.         |
| HAMMER, 1-lb           | WRENCH, 1-in.           |
| HANDLE, socket, 24-in. | WRENCH, 1 1/4-in.       |
| PUNCH                  | WRENCH, 1 5/8-in.       |
| PLIERS, brake spring,  | WRENCH, socket, 5/8-in. |
| 41-P-1579              | WRENCH, torque          |
| SCREWDRIVER            |                         |
| WRENCH, adjusting,     |                         |
| KM-J972                |                         |



## ORDNANCE MAINTENANCE—AXLES, PROPELLER SHAFTS AND WHEELS FOR BOMB SERVICE TRUCK M6 (CHEVROLET)

### b. Procedure.

#### (1) ASSEMBLE DIFFERENTIAL.

SCREWDRIVER

WRENCH, socket,  $\frac{5}{8}$ -in.

Insert two guide pins in hypoid ring gear (fig. 46) and set ring gear in position on differential case. The guide pins can be made from two differential and ring gear screws, 3652253. Their ends should be slightly tapered and screwdriver slots cut so they may be easily removed. Install the thrust washers, differential side gears, spider and differential pinions in the case. Place cover and case together. **NOTE:** Be sure to line up marks on the two halves of the case (fig. 47). Install 10 cap screws and lock washers through case into gear, tightening them evenly one turn at a time until they are tight. Remove the two guide pins and install the two remaining cap screws and lock washers. Tighten all cap screws.

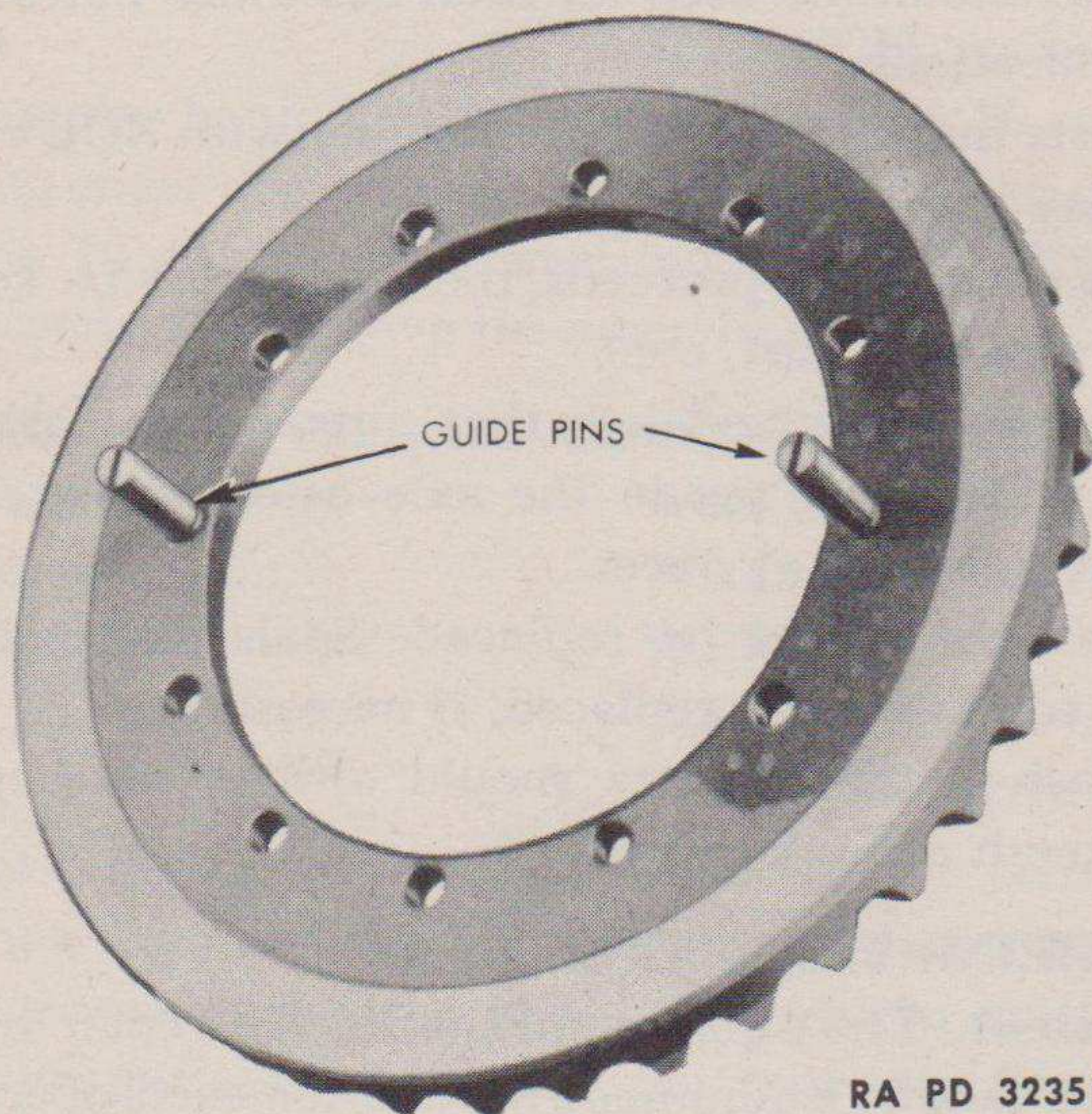

RA PD 32351

**Figure 46—Ring Gear Guide Pins**

#### (2) ASSEMBLE PINION SHAFT PARTS.

WRENCH, torque

Assemble the bearing retainer, propeller shaft pinion flange, washer and nut on the pinion shaft. Use torque wrench and tighten nut to 160 to 280 foot-pounds. Lock cotter pin in place.

#### (3) INSTALL PINION SHAFT.

WRENCH, socket,  $\frac{5}{8}$ -in.

Install pinion shaft assembly in differential carrier, using new gasket, and secure with six cap screws and lock washers.

**ASSEMBLING REAR AXLE**

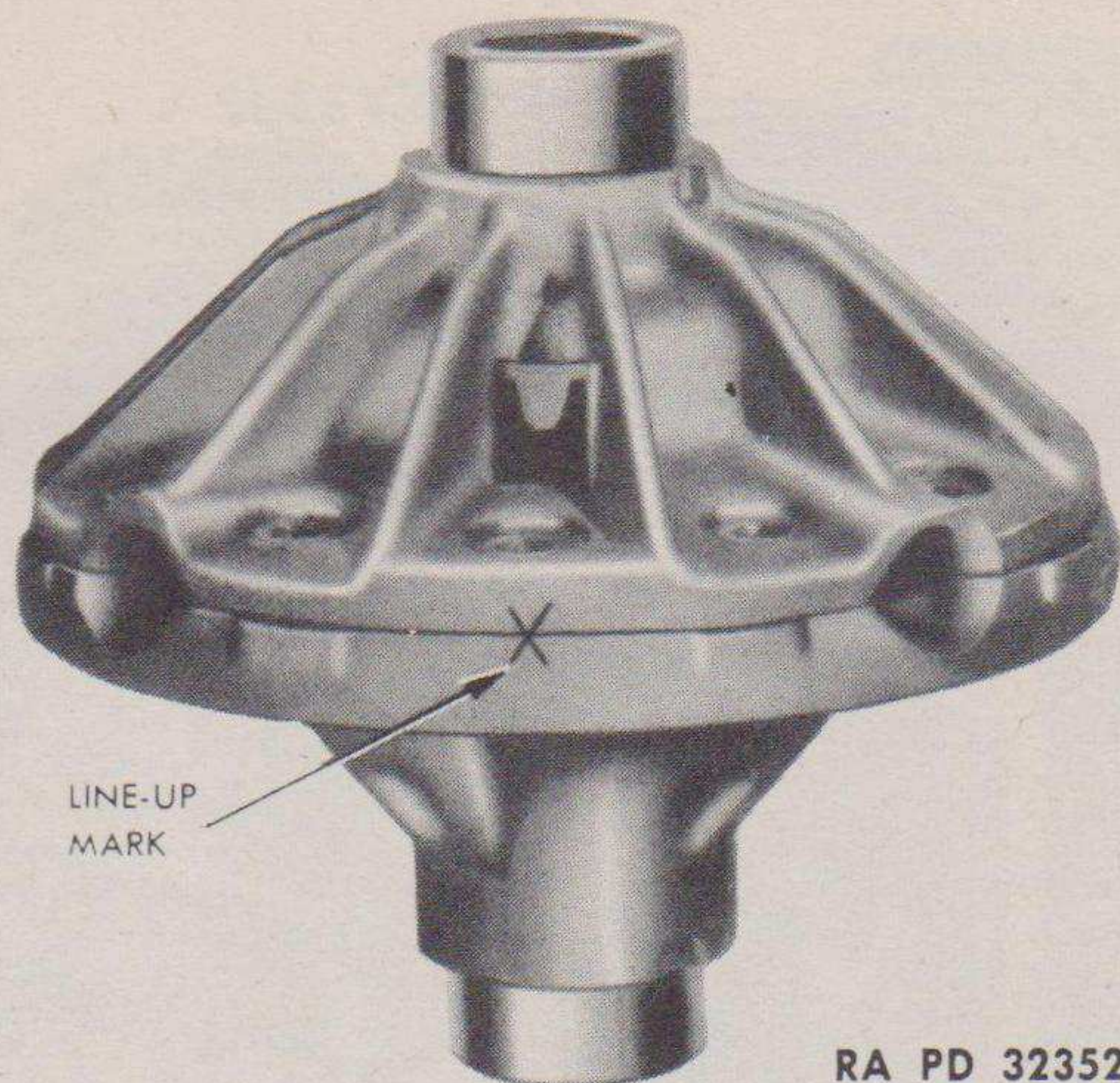

RA PD 32352

**Figure 47—Differential Case Line-Up Mark**

**(4) INSTALL DIFFERENTIAL ASSEMBLY IN CARRIER.**

Place differential case assembly in place in the differential carrier with outer bearing races in place on the bearings.

**(5) INSTALL BEARING CAPS.**

**WRENCH, 1-in.**

Install the bearing caps and lock washers. Be sure that the marks on the caps line up with the marks on the carrier. Draw the cap screws down until the lock washers just flatten out.

**(6) ADJUST RING GEAR AND PINION (fig. 48).**

**GAGE, dial**

**WRENCH, 1/2-in.**

**WRENCH, 1-in.**

**WRENCH, 1 1/4-in.**

**WRENCH, adjusting,**

**KM-J972**

**WRENCH, open-end, 1 5/8-in.**

**WRENCH, socket, 5/8-in.**

Screw the adjusting nuts into the carrier, making sure that they turn freely. Tighten them snugly to straighten up the bearing outer races. Back off the right-hand adjusting nut and tighten the left-hand adjusting nut to a point where all lash between the ring gear and pinion is removed. Use KM-J972 adjusting wrench. Back off the left-hand adjusting nut approximately two notches and to a locking position. Tighten right-hand adjusting nut to a solid position; then back it off until it is free of bearing. Tighten it again until all play in bearing is removed and then one to two notches more to a locking position in order to preload the bearings. Mount dial indicator and clamp on differential carrier and

ORDNANCE MAINTENANCE—AXLES, PROPELLER SHAFTS AND  
WHEELS FOR BOMB SERVICE TRUCK M6 (CHEVROLET)

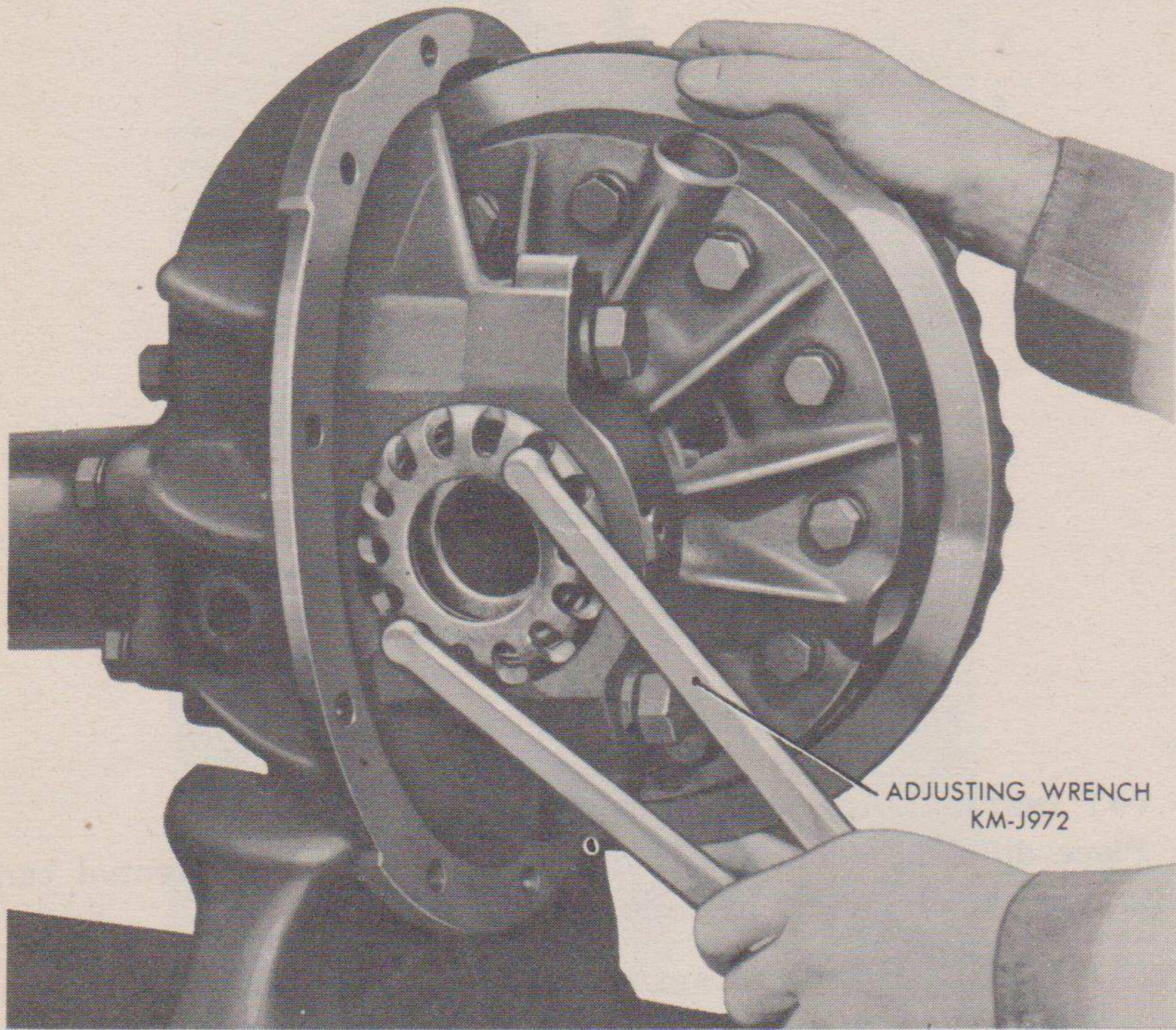

ADJUSTING WRENCH  
KM-J972

RA PD 55824

**Figure 48—Adjusting Ring Gear and Pinion Backlash**

check the ring gear and pinion backlash (fig. 49). This should be from 0.005 to 0.008 inch. If it is more than 0.008 inch, loosen the right-hand adjusting nut one notch and tighten the left-hand adjusting nut one notch. If it is less than 0.005 inch, loosen the left-hand adjusting nut one notch and tighten the right-hand nut one notch. Tighten down the cap screws and recheck the ring gear and pinion backlash. Assemble the adjusting nut locks. Install the drive gear thrust pad adjusting screw and lock nut and adjust as follows: Tighten the adjusting screw until the bronze tip lightly engages the back of the ring gear. Back off the adjusting screw one-twelfth of a turn and tighten the lock nut, making sure that the screw does not turn during the locking process (fig. 50). This will provide 0.005 to 0.007 inch clearance. Clean out the banjo housing and cover and install the differential carrier in the banjo housing, using a new gasket. Install all cap screws and lock washers loosely and tighten opposite cap screws until all are secure. Install housing cover, using new gasket, and secure with 10 cap screws and lock washers.

## ASSEMBLING REAR AXLE

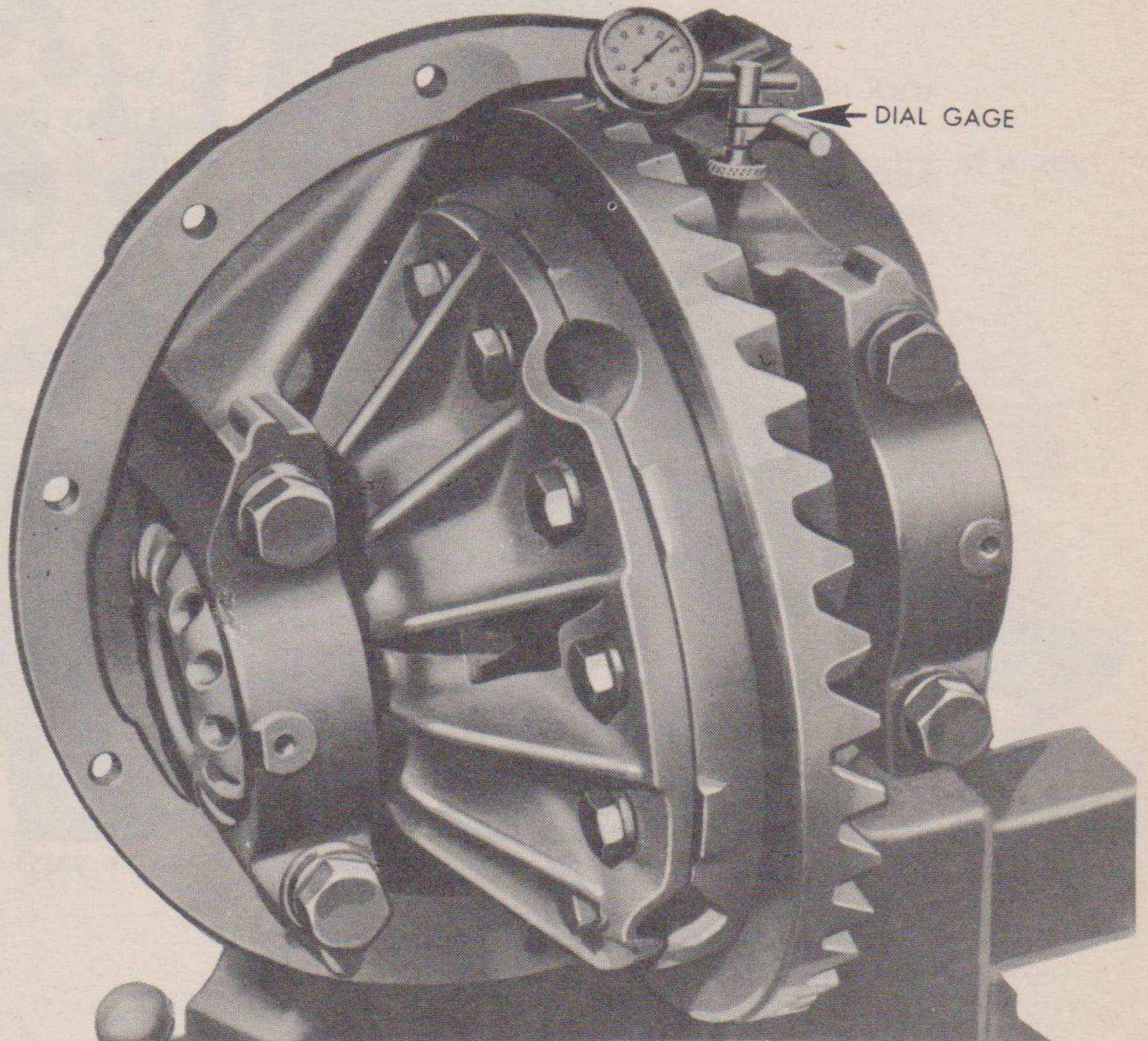

RA PD 55825

**Figure 49—Checking Ring Gear and Pinion Backlash**

**(7) INSTALL AXLE SHAFTS.**

**DRIFT**, small diameter

**HAMMER**, 1-lb

**WRENCH**, socket,  $\frac{5}{8}$ -in.

Install new terneplate gasket on the axle shaft and push the shaft into place, turning it slightly to pick up the splines in the differential side gears. Install new lock plate and cap screws and tighten them alternately. Bend the tangs on the lock plate against the head of the cap screws. **NOTE:** If the hubs have been removed, install them and adjust the bearings according to instructions in paragraph 75 c (7) and (8).

**(8) LUBRICATE AXLE ASSEMBLY.**

Fill the axle housing with 14 pints of **LUBRICANT**, gear, universal, seasonal grade.

ORDNANCE MAINTENANCE—AXLES, PROPELLER SHAFTS AND  
WHEELS FOR BOMB SERVICE TRUCK M6 (CHEVROLET)

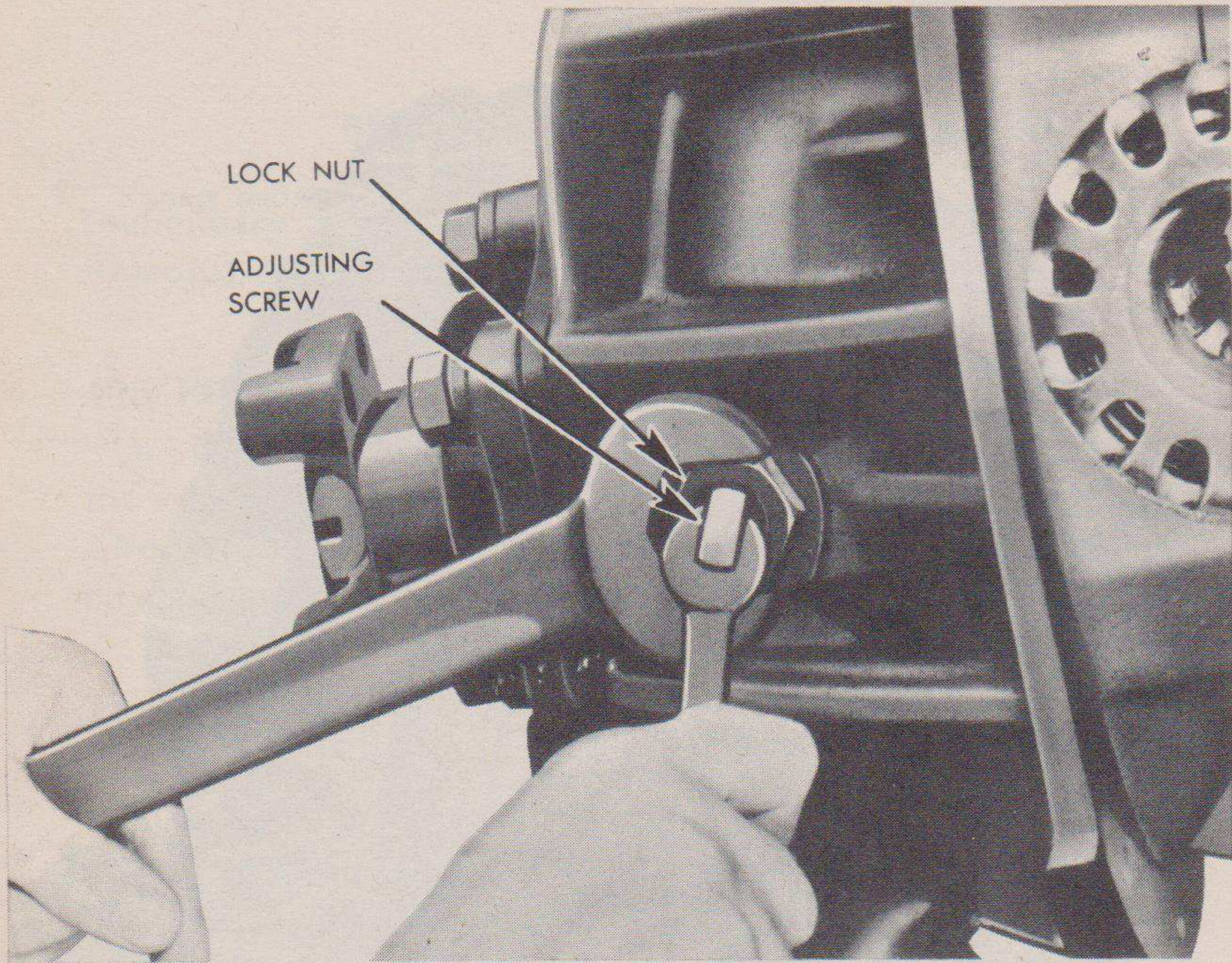

RA PD 32355

**Figure 50—Adjusting Thrust Pad**

**Section VIII**

**INSTALLATION OF REAR AXLE ASSEMBLY IN VEHICLE**

Installation of rear axle in vehicle .....	Paragraph 49
--	-----------------

**49. INSTALLATION OF REAR AXLE IN VEHICLE.**

a. **Preliminary Procedure.** Set rear axle assembly on stands and install wheels and nuts. Then support assembly on floor jack and remove stands. Roll the assembly into position under the vehicle and raise to correct position under springs.

b. **Equipment.**

- |                                     |                    |
|-------------------------------------|--------------------|
| JACK, 41-J-73-5                     | WRENCH, 5/8-in.    |
| PLIERS                              | WRENCH, 1 3/16-in. |
| STAND, jack, (2) or suitable blocks | WRENCH, 1 5/16-in. |
| WRENCH, 9/16-in.                    | WRENCH, wheel nut  |

(1) **INSTALL U-BOLTS.**

WRENCH, 1 5/16-in.

Install spring U-bolts and anchor plates and secure with nuts and lock washers.

(2) **CONNECT SHOCK ABSORBER LINKS.**

WRENCH, 1 3/16-in.

Secure each shock absorber connecting link to anchor plate with nut and lock washer.

(3) **ASSEMBLE UNIVERSAL JOINT.**

WRENCH, 9/16-in.

Slide universal joint to the rear on its slip joint. Remove tape from universal joint bearing caps and place yokes in matching position. Install two U-bolts and secure with lock washers and nuts. Lubricate through grease fitting, with GREASE, general purpose, seasonal grade.

(4) **CONNECT BRAKE LINES.**

WRENCH, 5/8-in.

Connect brake lines and bleed brakes as instructed in paragraph 29(9).

(5) **TIGHTEN WHEEL NUTS.**

WRENCH, wheel nut.

Raise rear of vehicle, remove jack stand and then lower vehicle to floor. Tighten all rear wheel stud nuts.

**ORDNANCE MAINTENANCE—AXLES, PROPELLER SHAFTS AND WHEELS FOR BOMB SERVICE TRUCK M6 (CHEVROLET)**

**Section IX**

**REAR AXLE FITS AND TOLERANCES**

Fits and tolerances .....	Paragraph 50
---------------------------	-----------------

**50. FITS AND TOLERANCES.**

**a. Differential.**

Ring gear to pinion backlash .....	0.005 to 0.008 in.
Ring gear run-out .....	0.001 in.
Case run-out .....	0.002 in.
Clearance between spider and pinion .....	0.004 to 0.008 in.
Clearance between side gear and case .....	0.002 to 0.006 in.
Side gear thrust washer—thickness—(new) .....	0.058 to 0.062 in.
Side gear thrust washer—limits—(worn) .....	0.048 in.

**b. Ring Gear Thrust Pad.**

Clearance pad to gear .....	0.005 to 0.007 in.
Pad thickness—limits (new) .....	0.1865 to 0.1885 in.
Pad thickness—Limits (worn) .....	0.125 in.

**CHAPTER 4**

**PROPELLER SHAFTS AND UNIVERSAL JOINTS**

**Section I**

**INTRODUCTION**

	Paragraph
Description—propeller shafts .....	51
Description—universal joints .....	52
Data .....	53
Reference to TM 9-765 .....	54
Echelon break-down of maintenance .....	55

**51. DESCRIPTION—PROPELLER SHAFTS.**

a. Three tubular propeller shafts are used on the bomb service truck. One shaft provides the drive from the transmission to the transfer case, one from the transfer case to the rear axle and the third from the transfer case to the front axle. The propeller shafts from the transfer case to the front and rear axles are dimensionally the same and are therefore interchangeable.

b. Each of these three shafts has a splined end welded into one end of the shaft. This provides a means of installing a slip joint. The other end of the shaft has a universal joint yoke welded into it. These three shafts, when fitted with the permanent and slip type universal joints, make up the drive shaft assemblies.

**52. DESCRIPTION—UNIVERSAL JOINTS.**

a. The six universal joints are of the needle bearing type (fig. 52). The trunnion has drilled passages to the trunnion pins, and a central lubrication fitting on each yoke provides lubricant to all four trunnion bearings. A special adapter is furnished with the tool kit, which should be placed on the lubrication gun for lubricating these joints. On the yoke, opposite the lubrication fitting, a relief valve is used to prevent over-lubrication and damage to the cork trunnion bearing seals. Each of the three slip joints is fitted with a lubrication fitting on the splined yoke to provide sufficient lubricant to assure free movement of the slip joint on the spline. A plug is staked in the joint end of the splined sleeve yoke to retain the lubricant and keep dirt out of the splines. A small hole is drilled in the plug to relieve trapped air. A cork washer and dust cap is used at the other end of the splined yoke to retain the lubricant and prevent dirt from entering at this point (fig. 53).



ORDNANCE MAINTENANCE—AXLES, PROPELLER SHAFTS AND WHEELS FOR BOMB SERVICE TRUCK M6 (CHEVROLET)

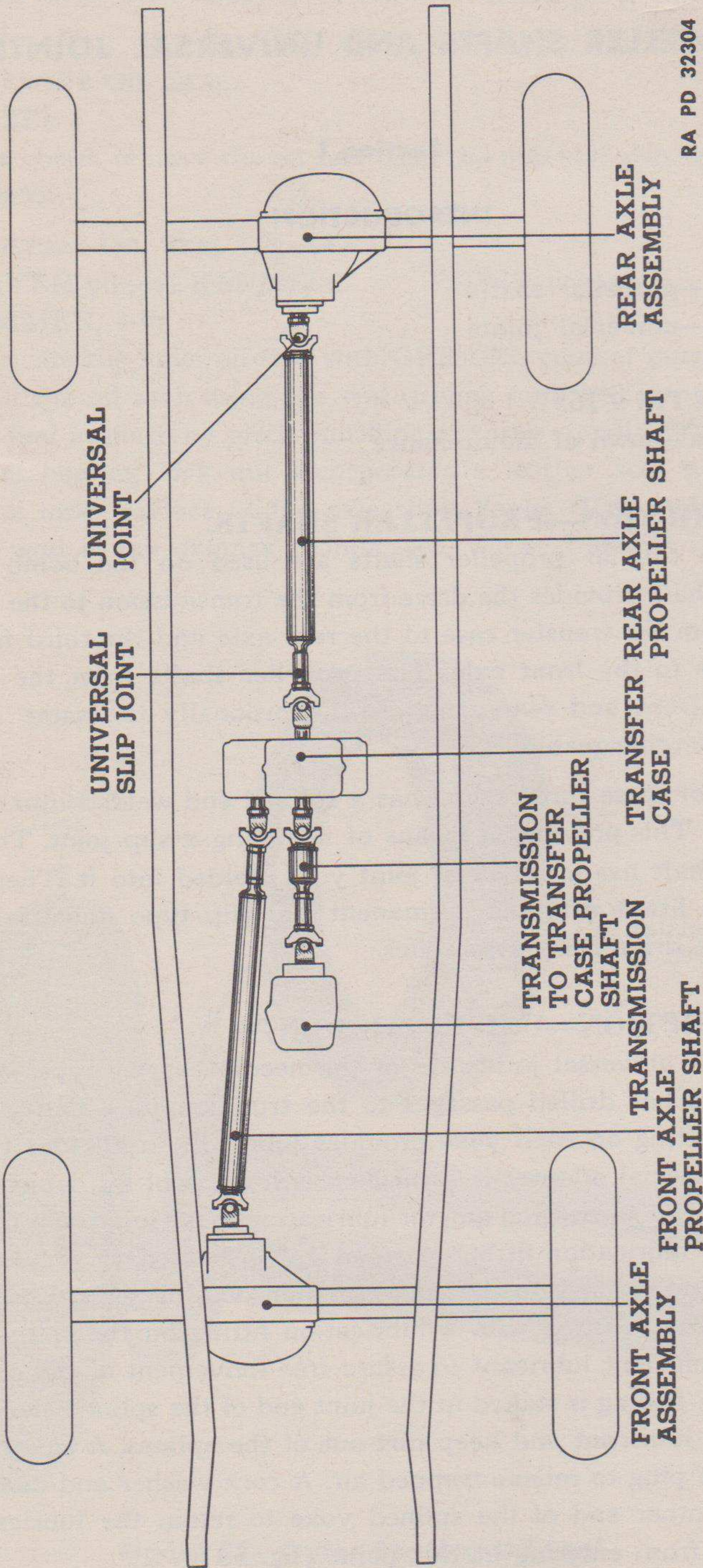

Figure 51—Propeller Shaft Drive Line