

AD706691

INTERIM DEVELOPMENT REPORT

FOR

AN/PPS-() ULTRA RELIABLE RADAR

CONTRACT N00039-70-C-3502

RCA

Reproduced by the
CLEARINGHOUSE
for Federal Scientific & Technical
Information Springfield Va. 22151

DDC
REPRODUCED
MAY 5 1970
C

This document has been approved
for public release and sale; its
distribution is unlimited.

7 April 1970

102

NOTICE TO USERS

Portions of this document have been judged by the Clearinghouse to be of poor reproduction quality and not fully legible. However, in an effort to make as much information as possible available to the public, the Clearinghouse sells this document with the understanding that if the user is not satisfied, the document may be returned for refund.

If you return this document, please include this notice together with the IBM order card (label) to:

Clearinghouse
Attn: 152.12
Springfield, Va. 22151

INTERIM DEVELOPMENT REPORT
FOR
AN/PPS-() ULTRA RELIABLE RADAR

THIS REPORT COVERS THE PERIOD FROM 3/3/70 TO 3/31/70

PREPARED BY

RCA CORPORATION
DEFENSE ELECTRONIC PRODUCTS
MISSILE AND SURFACE RADAR DIVISION
MOORESTOWN, NEW JERSEY 08057

PREPARED FOR

DEPARTMENT OF THE NAVY
NAVAL ELECTRONIC SYSTEMS COMMAND
WASHINGTON, D. C. 20360

CONTRACT: NO0039-70-C-3502

6 April 1970

ABSTRACT

This report covers the fifth month of design and development activity during Phase II of the AN/PPS-() Ultra Reliable Radar Program. Results of studies performed on the scanner concept and receiver packaging are presented. Design and layout work to accomplish transmitter tuning at organizational maintenance level is discussed and general program progress in all other radar and reliability areas is covered.

PART I

PURPOSE

This program covers the study, design, construction, test, analysis and inspection of a complete and operative, highly reliable, relatively failure-free version of the pulsed doppler surveillance AN/PPS-6 radar set. The radar set is intended to be a lightweight, miniaturized, X-Band, pulsed doppler combat surveillance radar. The basic purpose of this program is to develop a highly reliable radar set considering the overall cost of ownership when development, production and maintenance costs are taken into account while keeping the same general performance, form-factor and weight as the AN/PPS-6 radar.

The basic program definition was completed under Phase I and reported in the Final Report of Contract N00039-68-C-3610. The current contract, N00039-70-C-3502, consists of Phases II and III with Phase II covering the design, development and production of twenty (20) units and Phase III covering the six month reliability test program.

General Factual Data

1. The following is a listing of personnel contributing significantly to the program during the period from 15 February 1970 to 15 March 1970.

<u>Name</u>	<u>Hours</u>	<u>Name</u>	<u>Hours</u>
W. Alexander	28	A. Mastrogiovanni	32
L. Andros	172	R. Ottinger	160
R. Araskewitz	200	M. Paglee	16
C. Babiowski	23	F. Palmer	192
R. Bell	75	A. Petrilla	188
J. Bouvier	120	G. Punis	180
M. Breese	54	D. Sackett	189
H. Brelsford	4	P. Schick	27
W. Carter	78	E. Schwartz	16
J. Ferrara	190	M. Schwartz	42
J. Frattura	184	A. Schwartzmann	144
H. Harmon	129	R. Shultz	156
W. Harton	150	R. St John	19
D. Keys	30	W. Wells	127
R. Killion	107	Z. White	28
B. Knell	132	W. Wilkinson	23
		O. Woodward	51

Detail Factual Data

During the month of March, major program effort was devoted to completion of the investigative work reported last month, the continuation of detailed design engineering work, and reliability planning and monitoring. In addition to this effort, a technical status review meeting, attended by NAVALEX and DCAS technical representatives, was held at RCA, Moorestown, New Jersey.

The investigative effort discussed in the February report was generally completed and summary results were presented and discussed in the Technical Review of March 10-11. The basic technical content of the Technical Review Meeting is included in Part III of this report. Where necessary, a more complete report on each item will be available at future technical reviews and included as attachments to future monthly reports.

Information describing engineering activities in each major design area is presented in the following paragraphs.

1. Antenna

The basic configuration and pattern response are described in Section 4 of Attachment I. Measurements of gain, pattern characteristics and VSWR have been carried out, using five different types of dielectric sheet materials, each printed with the same array configuration. Duplicate antennas are also being tested as a check on repeatability of performance. An evaluation of the data is being performed to determine optimum material to satisfy both electrical and mechanical requirements. Work is also continuing on the antenna packaging design to insure environmental compatibility, including atmospheric pressure changes due to transport requirements.

2. Scanner

Experiments with a stepping motor breadboard and an RCA 4019 radar showed that clutter modulation was not sufficient to effect target detection performance as had been anticipated. However, during these tests, the scanner was observed to exhibit non-linear performance. This occurred under conditions such as tripod system resonance, reverse or aiding torque on the motor (such as would occur from bearing seal friction) and wind load on the radar. The angular displacement per pulse changes from the normal value, and has the effect of shifting the antenna sector coverage. This condition would have to be corrected by additional design effort if the stepping motor scanner design concept was to be implemented.

The reliability evaluation of the stepping motor and DC brush motor concepts was completed and resulted in some interesting considerations. Results of the reliability evaluation are presented in the following table:

	DC Brush Motor (6 RPM Rated Speed)	Stepping Motor
Expected Motor Life		
Brushes	10 to 100 years (10^8 Rev)	Not Applicable
Bearings	>>10 years	>>10 years
Expected Failure Rate		
Motor Coils	$1.8/10^6$ Hours	$1.2/10^6$ Hours
Gears & Bearings	Negligible	Negligible
Control Circuitry	$3.8/10^6$ Hours	$1.8/10^6$ Hours
Total Failure Rate	$5.6/10^6$ Hours	$3.0/10^6$ Hours

The allotted failure rate for the scanner is 13 failures/10⁶ hours and it can be seen from the above table that although the stepping motor is more reliable, the scanner with the DC brush motor has a reliability factor which is more than adequate. The main reason that such high reliability is possible with a brush motor is that this specific motor develops its rated output torque at very low speed (6 RPM) and because of this, the manufacture claims brush life up to 10⁸ revolutions of the motor.

The other interesting considerations which came out during the reliability evaluation were effects on cost, weight and battery power consumption.

Costs came out about equal for both approaches although it is felt that the additional design effort required to correct the non-linear stepping characteristic represents an unknown cost at the present time.

The reliability analysis performed on the gears showed that the stepping motor drive gears would be about 0.6 pound heavier than the DC brush motor drive gears for equally negligible failure characteristics. Since motor weight and other parts are about equal, this would represent 0.6 pound more weight for the stepping motor scanner.

The estimated battery power requirements for the DC brush motor scanner is 1.0 watt, whereas the stepping motor scanner will require between 3 and 5 watts.

Taking all of the foregoing into account, with particular emphasis on the fact that the reliability of the DC brush motor is more than adequate (less than 1/2 the scanner failure rate allotment), it was decided to continue with the design of the DC brush motor as the drive mechanism for the scanner. Effort is proceeding accordingly.

3. Tripod

Improved versions of the AN/PPS-6 Tripod by Lockheed Electronics and General Instruments are being evaluated for use on this program. Quotation requests have been issued to both suppliers which include certain desirable design changes intended to contribute to reliability in the field. Quotations are expected during the next month, at which time an evaluation will be performed to determine the tripod to be procured for use during the radar reliability test and the tripod destructive test program.

4. Radar Control and Signal Processor:

Significant progress has been made in the areas of the radar case layout, development of procurement specifications for major sub-assemblies, and design and development of signal processing and control circuitry.

As a result of the Technical Review on March 10-11, a change in the concept of the radar case layout has been initiated to allow transmitter tuning at the organizational maintenance level. Prior to this time, in order to keep the case size and weight down, the concept for transmitter tuning was to disassemble the case, remove the transmitter sub-assembly and perform the tuning on a service bench. With the new case layout, the transmitter tuning can be performed at the organizational level with a spectrum analyzer and a frequency counter, but without disassembly of the transmitter or case. To accomplish this, a sealed access panel or equivalent will be provided in the case to allow access to the transmitter tuning devices. In addition, it was necessary to reposition the transmitters and receivers within the case. This will increase the depth of the radar case by about one inch and increase the weight of the radar by about 1.5 pounds.

Procurement specifications for the range encoder and range control input assembly have been completed for review and approval prior to sourcing.

Design and development work was continued on the analog and digital signal processor circuits, DC converter and controls. Digital integrated circuits were selected and ordered for use in the breadboards and prototype equipments. Testing of the 6 MHz digital clock was completed and a design review was held on the preliminary Control Unit concept.

5. Receiver

The change to a more simplified redundancy switching configuration, which was discussed in last month's report, had the desirable effect of reducing the cost of the receiver purchase order by \$3299. The reason for this was the elimination of the latching circulators within the original receiver package. Because of the latching circulators and the desire to conserve size and weight, original receiver package was configured with two receiver channels in one receiver hermetically sealed case.

Elimination of the latching circulators eliminated the need for a single package receiver system and an investigation was conducted to examine the effect on "Cost of Ownership" if the receiver packaging were changed to a "single receiver per package" configuration. The basis of the investigation was supporting 112 radars in the field for ten years. The investigation showed that "Cost of Ownership" is not a significant factor in deciding between a 1/1 or 2/1 receiver package. This is largely due to the high reliability of the receiver. The additional cost of the 1/1 package decreases, passes through zero, and becomes a savings as the receiver failure rate is increased from 5 to 10 per 10^6 hours. Other factors considered in change to the 1/1 package were:

- (a) Slight increase in weight of about 1 1/2 ozs.
- (b) Slight increase in size
- (c) Increased engineering cost of about \$8K
- (d) Schedule delay of receiver deliveries
- (e) Both packages have same reliability

The controlling factor was the "Cost of Ownership" and the decision was made to retain the original 2/1 receiver package configuration.

Detailed progress being made by Sperry Microwave Electronics, Division of Sperry Rand Corporation, is included in their Monthly Status Report for March 1970, which is included with this report as Attachment III.

6. Transmitter

Transmitter tuning at organizational level, which was a subject of discussion during the March 10-11 Technical Review Meeting at Moorestown, is discussed in the section on Radar Control and Signal Processor since the major impact of this change was on radar case layout.

Detailed progress on the Transmitter is covered in Attachment IV.

7. Reliability

The Reliability Flow Chart, included as Attachment II, serves to illustrate the primary functions of the AN/PPS-() Ultra Reliable Program as they relate to reliability. These charts also show the participation of the Project Management Organization, Engineering, Materials, Management, and Manufacturing and Quality Control. Triangular symbols on the chart indicate points at which a check is made on the achievement of goals throughout the program.

Various functions illustrated on this chart may be described in more detail in procedures or memos as the need is established. The charts will also be modified as required throughout the program and a report of the reason for and the nature of any changes will be prepared for file.

When test data is recorded, a file of all such test results will be maintained for each assembly and system to aid in the evaluation of any anomalies that may develop. Test discrepancy reports will be utilized throughout all phases of system testing, including qualification testing, acceptance testing, burn-in, and reliability testing.

These charts must be used in conjunction with the program schedules to determine the phasing of the various functions. At future reviews, the extent of progress along the flow chart will be illustrated.

A continuing effort is being expended to locate and identify failure free parts for application on the AN/PPS-() UR Program. One technique being used is to apply derating factors to special parts to achieve the reliability. Another is to apply parts which operate on simple reliable principles. The need for a rotary type selector switch has led to application of both techniques. Consideration is being given to the use of an instrumentation type rotary switch with solid precision metal contacts and multi-leaved wiper arms. These switches are normally rated up to 10A at 120VAC. When used to switch low level logic signals, the switch life expectation increases to 4×10^6 operations, which is considerably in excess of the reliability requirement. Another type of

RCA DEFENSE ELECTRONIC PRODUCTS
PROJECT PERFORMANCE AND SCHEDULE CHART
- AN/PPS-() ULTRA RELIABLE RADAR

CONTRACT NO.: NO0039-70-C-3502 DATE: 6 April 1970

	N	D	J	F	M	A	M	J	J	A	S	O	N	D	J	F	M	A	
	1	2	3	4	5	6	7	8	9	10	11	12	13	14	15	16	17	18	
SYSTEM STUDY																			
RELIABILITY CRITERIA																			
RECEIVER CONTRACT PLACED																			
TRANSMITTER CONTRACT PLACED																			
DESIGN AND DEVELOPMENT																			
MANUFACTURING																			
SYSTEM/ACCEPTANCE TESTS																			
RELIABILITY TEST PLAN																			
FINAL ENGINEERING REPORT																			
DRAWINGS/MICROFILM																			

SYSTEM STUDY

RELIABILITY CRITERIA

RECEIVER CONTRACT PLACED

TRANSMITTER CONTRACT PLACED

DESIGN AND DEVELOPMENT

MANUFACTURING

SYSTEM/ACCEPTANCE TESTS

RELIABILITY TEST PLAN

FINAL ENGINEERING REPORT

DRAWINGS/MICROFILM

LEGEND:

WORK COMPLETED ▲ EVENT SCHEDULED
 PROJECTED OPERATION ▲ EVENT COMPLETED

switch being considered is the hermetically sealed reed switch which is actuated by a permanent magnetic field. Vendor information indicates that up to 10^8 operations can be expected before first failure to open or close and 2×10^8 operations before five failures in 100,000 consecutive operations.

The parts selection effort on general circuit parts has been largely on the selection of specific semiconductor devices and low volume electrical devices. This has consisted generally of consulting with design engineers and vendors for the selection of parts that provide an optimum combination of electrical performance, reliability and availability. The effort on the semiconductor devices is directed at selecting parts with the highest level of performance and reliable circuit integration that can be acquired in a reasonable procurement cycle. A reasonable procurement cycle has been defined as one estimated as 12 weeks or less after receipt of order by the Vendor. It has also been assumed that integrated circuits procured from responsible Vendors, to the basic requirements of Class B of MIL-STD-883, have essentially the same failure rate as their basic discrete active JANTX type counterpart. Accordingly, about 95% of the semiconductor devices have been selected. The primary objective of this effort now is on the selection and preparation of procurement drawings for the selected parts.

The low volume electrical devices consist of transformers, delay lines, switches, and potentiometers. Effort on these items has primarily been one of finding versions of these parts that have failure rates that are fairly well substantiated and sufficiently low enough for the system requirements. The overall aim being that of writing procurement documents around these versions with a listing of the basis for the low failure rate. Results from this effort show clearly that the only basis for reliability in parts of this type is in the overall performance of the manufacturer on parts of the same general category.

CONCLUSIONS

The design and development effort is proceeding in all areas. The scanner design concept has been finalized. The transmitter tuning concept has been revised to allow transmitter tuning at the organizational maintenance level. The reliability plan has been broadened to show check and balance control over the entire program.

Part II

Program for Next Interval

During the next reporting interval, the design and development effort will continue with more emphasis being put on planning for release, procurement and manufacturing. Reliability planning and monitoring will also continue with updating of the basic plan as required.

Part III

Attachments

- I - AN/PPS-() Ultra Reliable Radar Customer Review Material.
Dated 10-11 March 1970
- II - AN/PPS-() Ultra Reliable Radar - Reliability Flow Chart.
Dated 25 March 1970.
- III - Monthly Status Report for Receiver Subsystem of AN/PPS-() Ultra Reliable Radar, Dated March 1970. Prepared by Sperry Rand Corp., Clearwater, Florida.
- IV - Development and Fabrication of Transmitter Subsystems for AN/PPS-() Ultra Reliable Radar - Monthly Progress Report No. 1, Dated 13 March 1970, Prepared by RCA Electronics Components Division, Harrison, New Jersey

ATTACHMENT I

10-11 March 1970

AN/PPS-() ULTRA RELIABLE RADAR
ATTENDEES OF CUSTOMER REVIEW

<u>NAME</u>	<u>ORGANIZATION-TECH. REP.</u>	<u>TELEPHONE</u>	<u>EXTENSION</u>
L. ANDROS	RCA-PMO	(609) 963-8000	2479
R. BELL	RCA-TRIPOD	(609) 963-8000	2395
M. BREISE	RCA-ADV. MICROWAVES	(609) 963-8000	2417
L. A. CAPLAN	RCA-PRODUCT ASSURANCE	(609) 963-8000	3659
D. R. CECIL	RCA-PMO ADMIN.	(609) 963-8000	3647
J. D. FRATTURA	RCA-PMO	(609) 963-8000	2254
H. D. HARMON	RCA-ENG. RELIABILITY	(609) 963-8000	3768
W. L. HENDRY	RCA-PMO	(609) 963-8000	4371
E. HOLMES	RCA-EQUIP. REPAIR PMS.	(609) 963-8000	3496
() R. E. KILLION	RCA-ENG. RELIABILITY	(609) 963-8000	4428
B. KNELL	RCA-RADAR PACKAGING	(609) 963-8000	3293
A. MASTRO	RCA-QUAL TESTS	(609) 963-8000	2298
R. W. OTTINGER	RCA-SYSTEMS ENG.	(609) 963-8000	2984
F. I. PALMER	RCA-TACTICAL EQUIPMENT	(609) 963-8000	4266
D. A. PILEGGI	RCA-CONTRACT ADMIN.	(609) 963-8000	3092
D. A. PLUMMER	DCAS-OPC. OF ENGG.	(609) 966-3344	284
P. R. RAY	RCA-SYSTEMS DEVELOPMENT	(609) 963-8000	4242
C. R. ROERDOMP	DCAS-QAE	(609) 963-8000	3548
D. SACKETT	RCA-SCANNER	(609) 963-8000	3838
J. SCHAFER	DCAS-QUALITY ASSURANCE	(609) 963-8000	2333
P. J. SCHICK	RCA-SYSTEMS ENG.	(609) 963-8000	2984
R. S. SHULTZ	RCA-RELIABILITY	(609) 963-8000	2555
M. SCHWARTZ	RCA-RAD. EQ. ENGG.	(609) 963-8000	2641
A. SCHWARZMANN	RCA-ADV. MICROWAVES	(609) 963-8000	2929
J. SPIEGEL	RCA-MARKETING	(609) 963-8000	3010
W. STENDER	NAVELEX (0542)	(202) 696-6531	22-66728
R. STJOHN	RCA-DESIGN	(609) 963-8000	3022
E. WEINBERG	RCA-MARKETING	(609) 963-8000	3231
Z. L. WHITE	RCA-ANTENNA ME	(609) 963-8000	2570
J. M. WOODWARD	RCA-ANTENNA	(609) 963-8000	3870

CUSTOMER REVIEW
AN/PPS-() ULTRA RELIABLE RADAR

AGENDA

TUESDAY, 10 MARCH 1970

INTRODUCTION
RELIABILITY CONTROL PLAN

J. FRATTURA
R. KILLION

HARDWARE CONFIGURATION

SYSTEM DESCRIPTION
TRANSMITTER
RECEIVER
ANTENNA
SIGNAL PROCESSOR
RADAR CONTROL
TRIPOD
SCANNER

R. OTTINGER
A. SCHWARTZMANN
A. SCHWARTZMANN
O. WOODWARD
F. PALMER
F. PALMER
R. BELL
D. SACKETT

RADAR PACKAGING

B. KNELL

QUALIFICATION TESTS

A. MASTRO

EQUIPMENT REPAIR PARTS

E. HOLMES

PHASE III DISCUSSIONS

WEDNESDAY, 11 MARCH 1970

ITEMS OF INTERPRETATION/CLARIFICATION

CUSTOMER REVIEW
MATERIAL

AN/PPS-() ULTRA RELIABLE RADAR

10-11 MARCH 1970

TABLE OF CONTENTS

SECTION 1 - SYSTEM

SYSTEM BLOCK DIAGRAM	1-1
SYSTEM FEATURES	1-2
MODES OF OPERATION	1-3
SEARCH MODE COVERAGE	1-4
WAVEFORMS	1-5
EQUIPMENT PERFORMANCE CHARACTERISTICS	1-6
TRANSMIT/RECEIVE-PATHS/LOSSES	1-7
S/N CALCULATION CHART, MODE 3	1-8
S/N COMPARISON WITH PPS-6, ALL MODES	1-9

SECTION 2 - TRANSMITTER

SUMMARY SPECIFICATION	2-1
BLOCK DIAGRAM	2-2
SPURIOUS OUTPUTS	2-3
STABILITY TEST CIRCUIT	2-4
OUTLINE DRAWING	2-5
TUNING TEST SET-UP	2-6

SECTION 3 - RECEIVER

SUMMARY SPECIFICATION	3-1
BLOCK DIAGRAM	3-2
NOISE FIGURE TEST	3-3
RECEIVER ASSEMBLY	3-4

SECTION 4 - ANTENNA

CHARACTERISTICS	4-1
GAIN VS. APERTURE SIZE	4-2
H-PLANE PATTERN	4-3
E-PLANE PATTERN	4-4

TABLE OF CONTENTS

(CONTINUED)

SECTION 5 - SIGNAL PROCESSOR

FUNCTIONAL BLOCK DIAGRAM	5-1
TIMING DIAGRAM - MODE 1	5-2
TIMING DIAGRAM - MODE 2	5-3
TIMING DIAGRAM - MODE 3	5-4
DC-DC CONVERTER BLOCK DIAGRAM	5-5

SECTION 6 - RADAR CONTROL

RADAR CONTROLS	6-1
----------------	-----

SECTION 7 - TRIPOD

TASK DEFINITION	7-1
DESIGN CONSIDERATIONS	7-2

SECTION 8 - SCANNER

DESIGN INVESTIGATIONS	8-1
BLOCK DIAGRAM-STEPPER MOTOR	8-2
BLOCK DIAGRAM-DC BRUSH MOTOR	8-3

SECTION 9 - RADAR PACKAGING

BETA LIGHT ILLUMINATION	9-1
WEIGHT AND POWER SUMMARY	9-2
GENERAL LAYOUT	9-3
MODULE MOUNTING AND ANTENNA SEAL	9-4

SECTION 10 - QUALIFICATION TESTS

ENVIRONMENTAL TESTS	10-1
TRIPOD DESTRUCTIVE TESTS	10-2

"A" CHANNEL

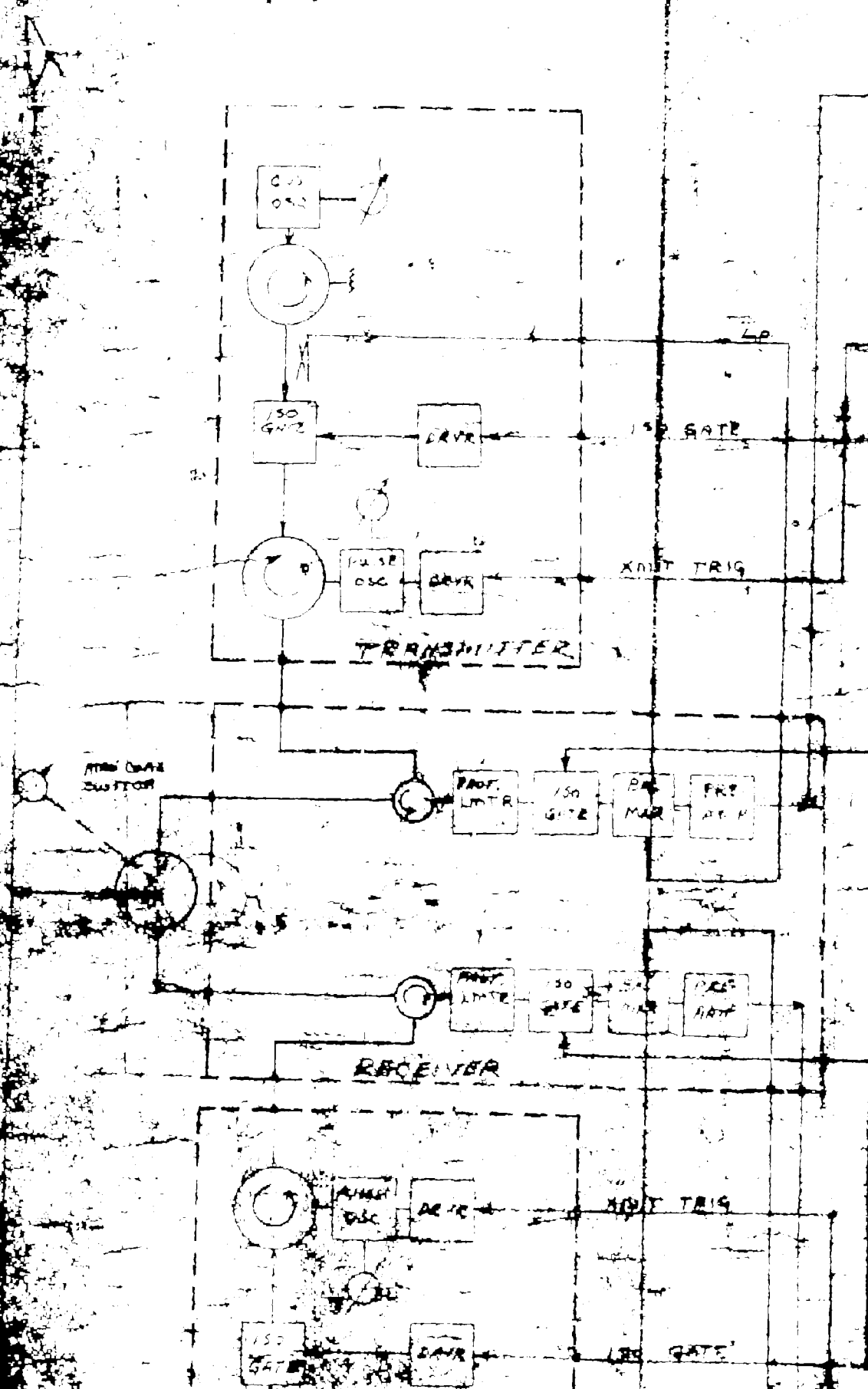

B

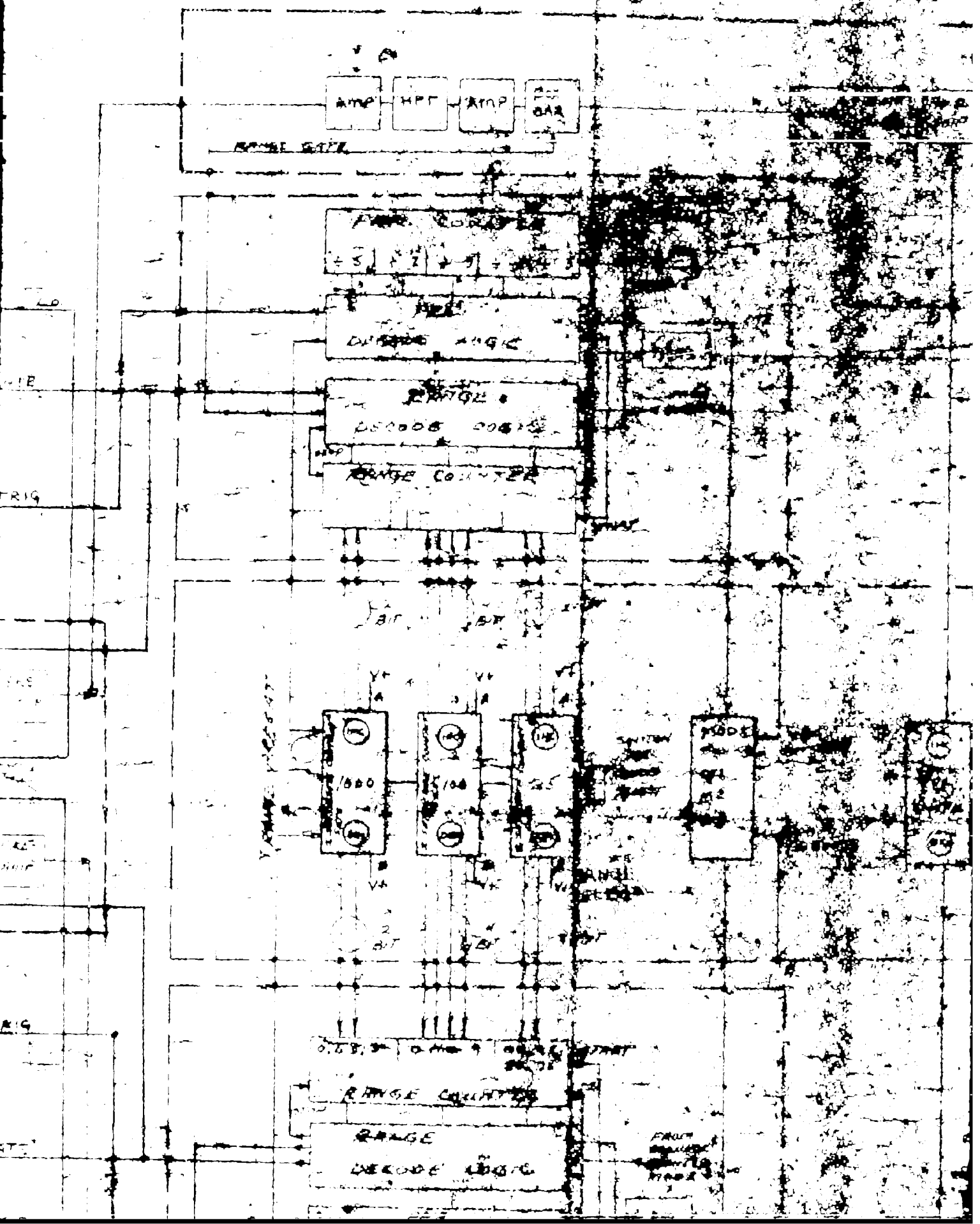

C

HI REL ANALYSIS SYSTEM BLOCK



H1 REL AN/PPS - () SYSTEM BLOCK DIAGRAM

4/7/72

D

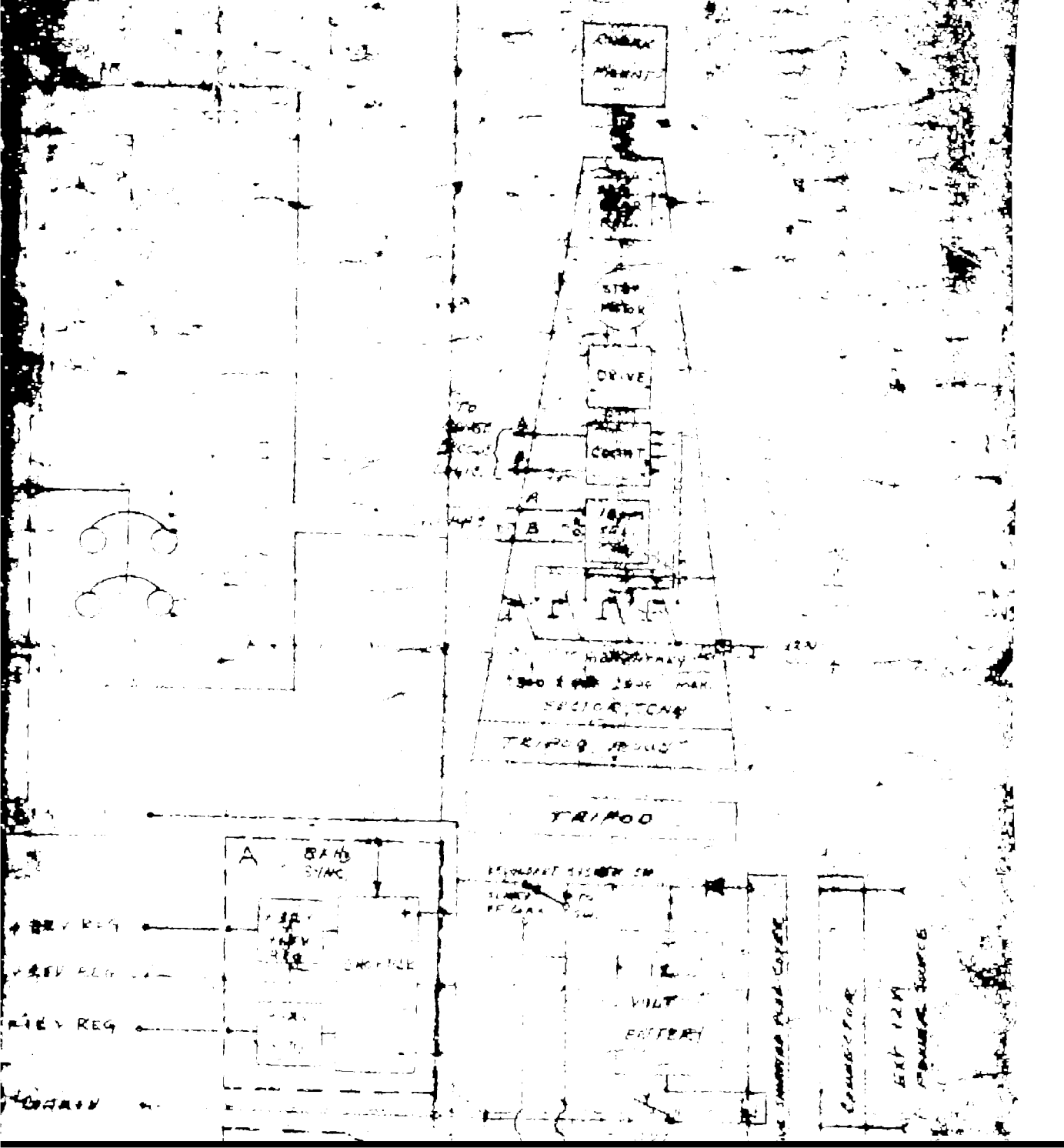

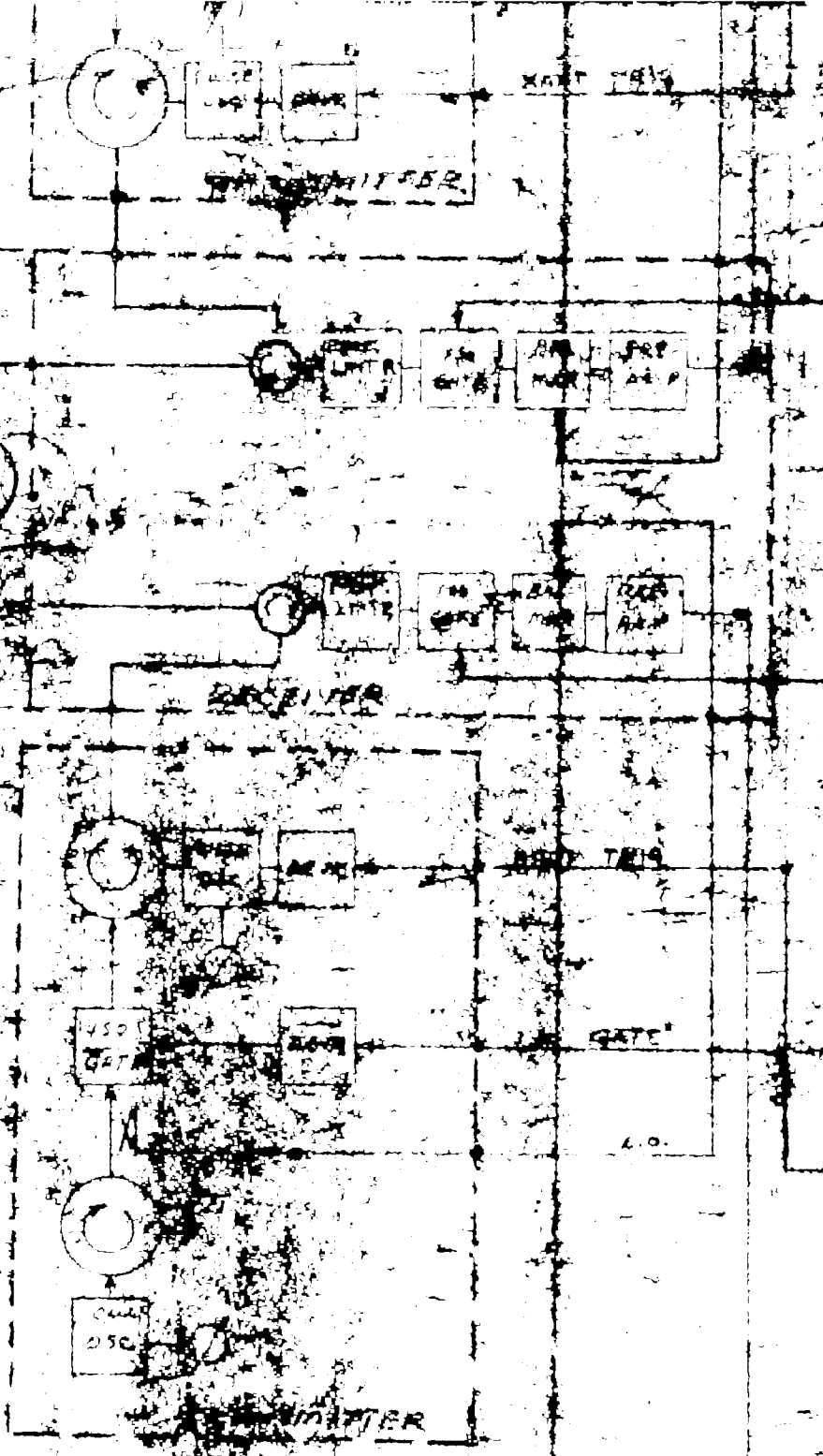

"B" CHANNEL

E

AT

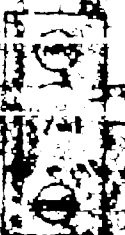

BT

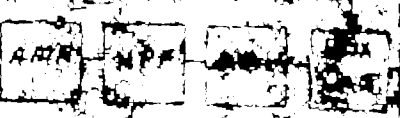
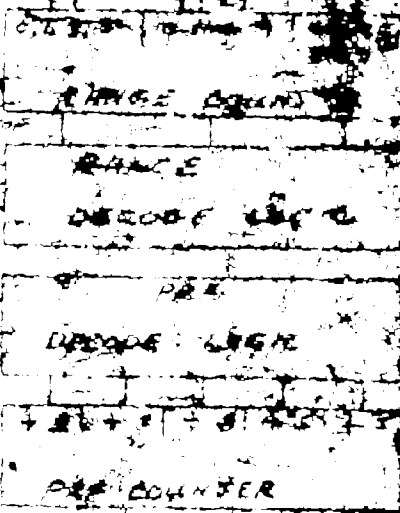

F

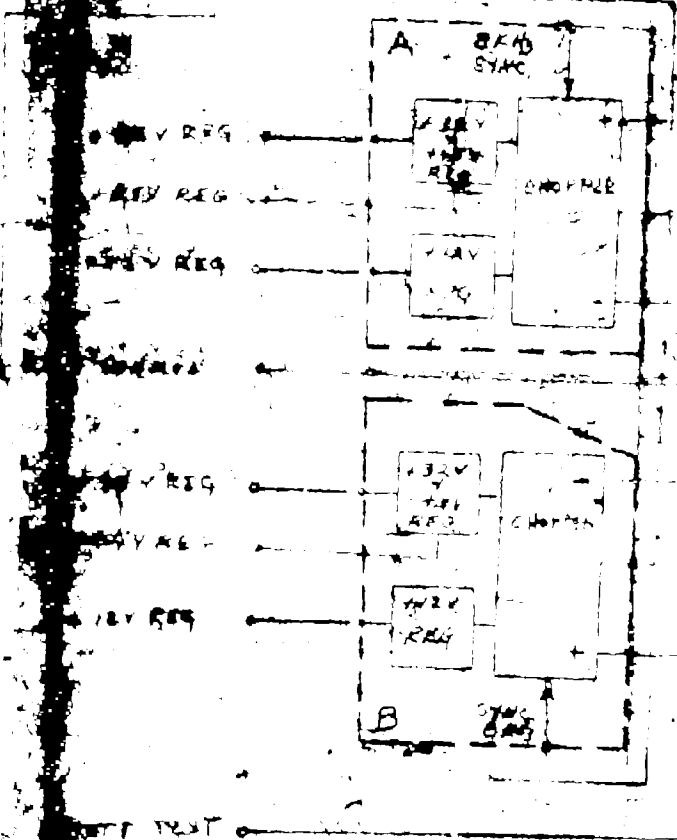
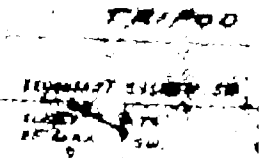
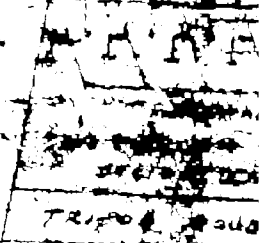
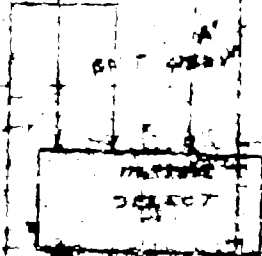

NOTE: REQUIREMENT FOR CONNECTION DIAGRAM ABOVE IS PER SUBSYSTEM APPROVAL

G



NOTE: REDUNDANT FOR CONNECTION SCHEMATIC
 ABOVE IS ONE SUGGESTED APPROACH

H

SYSTEM FEATURES

- DESIGN BASED ON
 - ALL SOLID STATE DESIGN
 - INJECTION LOCKED GUNN OSCILLATOR TRANSMITTER
 - MICROWAVE INTEGRATED CIRCUIT RECEIVER
 - PRINTED CIRCUIT DIPOLE ARRAY ANTENNA
 - TOTAL REDUNDANCY - TWO SEPARATE RADAR SYSTEMS
 - HOMODYNE PROCESSING CONCEPT
 - HIGH RELIABILITY SHAFT ENCODER RANGE READOUT
 - COMPACT SIZE FOR OPTIONAL CHEST OPERATION
- { RELIABILITY
COST OF OWNERSHIP
PERFORMANCE

MODES OF OPERATION

MODE 1
600 METER RANGE SEARCH

600 METER RANGE DEPTH SCAN
600 METERS BEYOND SELECTED RANGE
AZIMUTH SCAN: +300, +450 OR +600 MILS

MODE 2
300 METER RANGE SEARCH

300 METER RANGE DEPTH SCAN
300 METERS BEYOND SELECTED RANGE
AZIMUTH SCAN: +300, +450, OR +600 MILS

MODE 3
FINE RANGING

50 METERS RANGE RESOLUTION

RANGE GATE AND RANGE INDICATOR CAN BE MOVED TO ANY RANGE FROM
50 METERS TO 3000 METERS IN 25 METER STEPS.

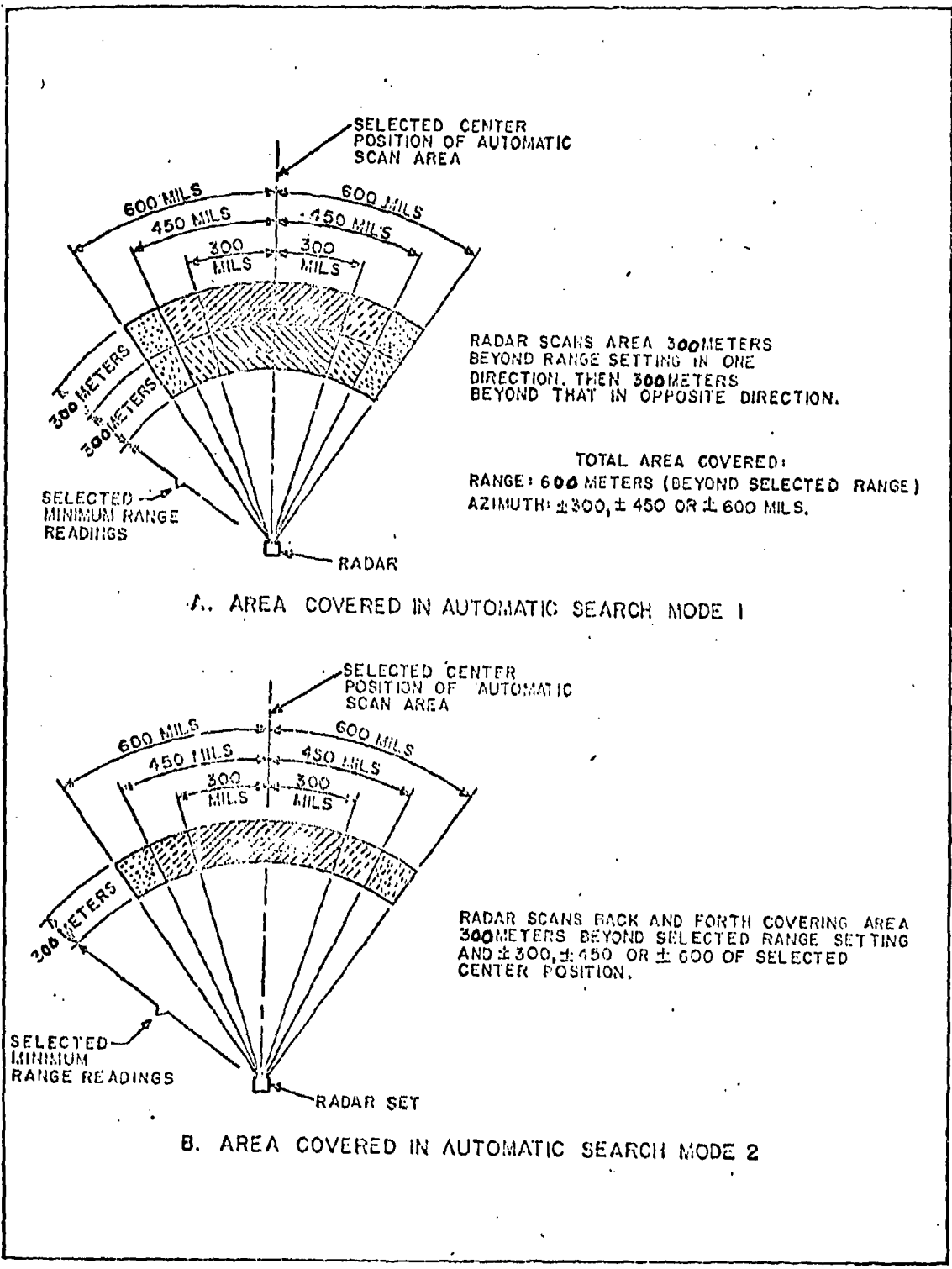

SELECTED CENTER POSITION OF AUTOMATIC SCAN AREA

600 MILS

450 MILS

300 MILS

300 MILS

300 METERS

300 METERS

SELECTED MINIMUM RANGE READINGS

RADAR

RADAR SCANS AREA 300 METERS BEYOND RANGE SETTING IN ONE DIRECTION, THEN 300 METERS BEYOND THAT IN OPPOSITE DIRECTION.

TOTAL AREA COVERED:
 RANGE: 600 METERS (BEYOND SELECTED RANGE)
 AZIMUTH: ± 300 , ± 450 OR ± 600 MILS.

A. AREA COVERED IN AUTOMATIC SEARCH MODE 1

SELECTED CENTER POSITION OF AUTOMATIC SCAN AREA

600 MILS

450 MILS

300 MILS

300 MILS

200 METERS

SELECTED MINIMUM RANGE READINGS

RADAR SET

RADAR SCANS BACK AND FORTH COVERING AREA 300 METERS BEYOND SELECTED RANGE SETTING AND ± 300 , ± 450 OR ± 600 OF SELECTED CENTER POSITION.

B. AREA COVERED IN AUTOMATIC SEARCH MODE 2

AN/PPS-()

WAVEFORMS

SEARCH WAVEFORM
MODES 1 AND 2

PEAK PWR = 3 W
PRF = 8 KHz
PW = 2.0 USEC

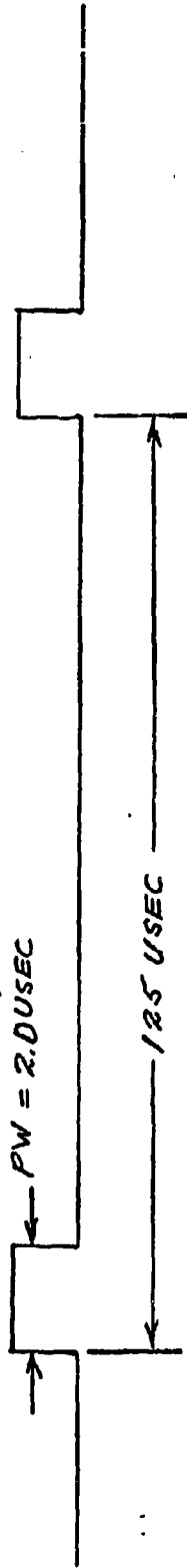

FINE RANGING WAVEFORM
MODE 3

PEAK PWR = 3 W
PRF = 40 KHz
PW = 0.3 USEC

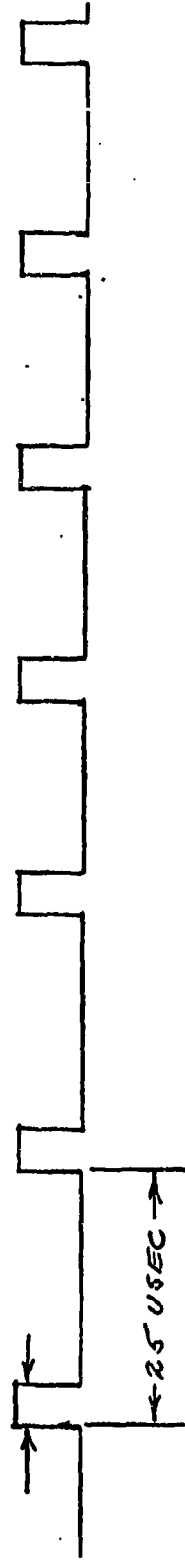

EQUIPMENT PERFORMANCE CHARACTERISTICS

ITEM

VALUE

FREQUENCY

9.0 to 9.5 MC
TUNEABLE AT 4TH ECHELON DEPOT

WAVEFORM

SEARCH MODE 1 & 2	FINE RANGING MODE 3
----------------------	------------------------

PRF

8 KHz

40 KHz

PULSE WIDTH

2.0 USEC

0.3 USEC

PEAK POWER

3.0 WATTS

3.0 WATTS

AVERAGE POWER

48.0 MW

36.0 MW

RANGE GATE

50 METERS

50 METERS

DETECTION RANGE

0.5 SQUARE METER TARGET

50 - 1500 METERS

10.0 SQUARE METER TARGET

50 - 3000 METERS

RESOLUTION

RANGE

50 METERS

AZIMUTH

155 MILS

ACCURACY (STANDARD DEVIATION)

RANGE

25 METERS

AZIMUTH

18 MILS

ELEVATION

18 MILS

POWER CONSUMPTION

15.74 WATTS

SIZE

12.8" X 12.8" X 5 1/2"

WEIGHT (WITHOUT BATTERY)

11.7 LB

WEIGHT (WITH BATTERY)

19.7 LB

RECEIVER

N.F.

10.5 db

ANTENNA

PRINTED CIRCUIT DIPOLE ARRAY

GAIN

27 db

BEAMWIDTH

6°

SIDELOBES

-12 db

POLARIZATION

VERTICAL

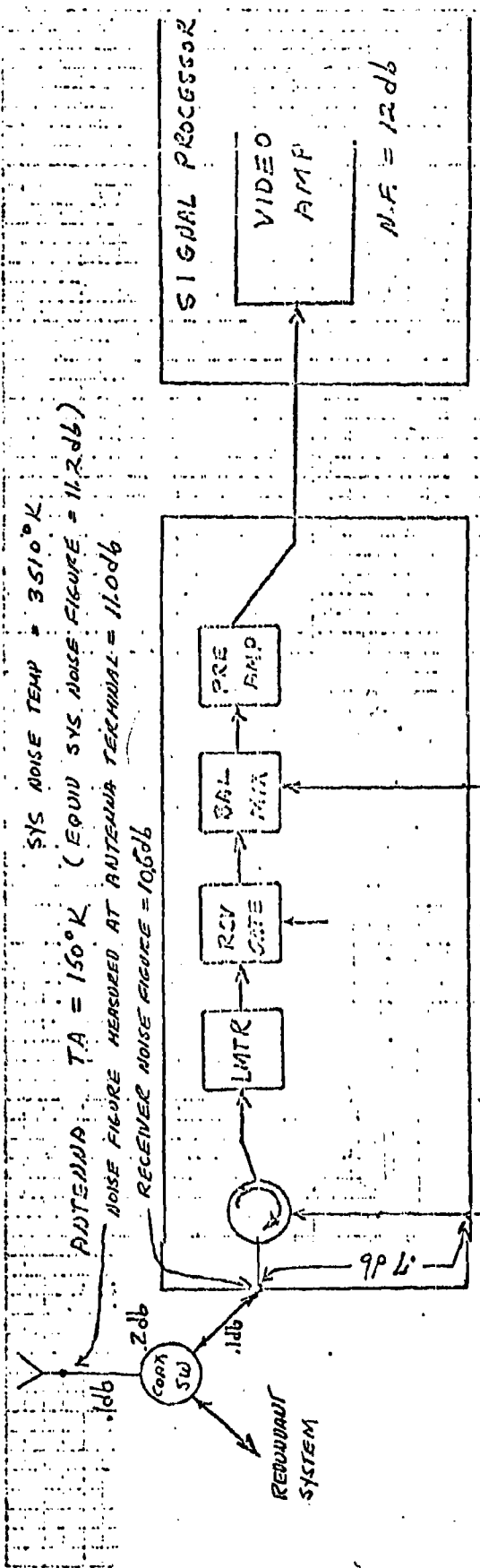

ANTENNA TA = 150°K (EQUIV SYS NOISE FIGURE = 11.2db)
 SYS NOISE TEMP = 3510°K
 NOISE FIGURE MEASURED AT ANTENNA TERMINAL = 11.0db
 RECEIVER NOISE FIGURE = 10.5db
 TRANSMIT 1.2 db
 RECEIVE 0.0 db (ASSUMED IN N.F.)
 ANTENNA MISMATCH 0.2 db
 INT EFF. 1.0 db
 TOTAL LOSSES 2.4 db
 * RECEIVER NOISE FIGURE (SIG PROC N.F. = 6db) 10.5 db
 RECEIVER NOISE FIGURE (SIG PROC N.F. = 12db) 10.6 db
 EFFECTIVE SYS. NOISE FIGURE (TA = 150°K) = 11.2 db
 (SYSTEM NOISE TEMPERATURE TS = 3510°K)

NOT REPRODUCIBLE

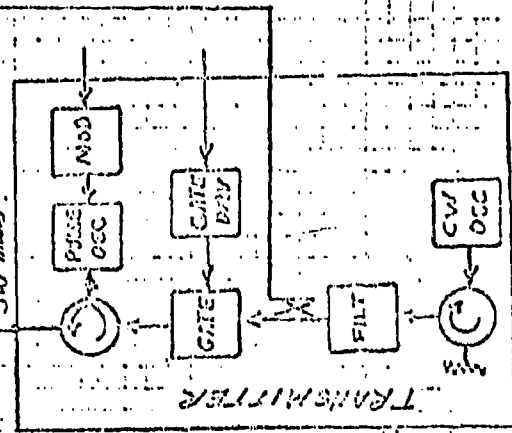

TS ABOVE BASED ON INCLUDING ANTENNA FEED LOSSES
 IN ANTENNA GAIN
 TRANSMIT/RECEIVE - PATHS/LOSSES

$$S/N = \frac{P_T G^2 \lambda^2 \sigma}{(4\pi R)^3 R^2 L} \cdot \frac{1}{KTB \Delta F}$$

	AN/PPS-()	AN/PPS-6
TRANSMIT PEAK POWER	3 W	-
ANTENNA GAIN	4.5	20.0
WAVELENGTH	54.0	49.0
CROSS-SECTION	.0325 M	29.6
MAXIMUM RANGE	10.0	10.0
KT	3000 M	139.2
BAUDWIDTH	-204	204.0
LOSSES	6 MC	67.8
NOISE FIGURE (SYS)	2.4 db	3.0
(4T) ³	11.2 db	10.0
	(12.54) ³	33.0
TOTAL	272.8	283.2
	SINGLE PULSE S/N = -10.4 db	SINGLE PULSE S/N = +0.4 db
	INTEGRATION GAIN = 40 KHZ/50HZ = 800 = 29 db	INTEGRATION GAIN = 2KHZ/50HZ = 40 = 16 db
	S/N _I = +18.6 db	S/N _I = +16.4 db

AN/PPS-() LOSSES

TRANSMIT LOSSES = 1.2 db

RECEIVE LOSSES = 0.0 db (INCLUDED IN SYSTEM N.F.)

FILTER MISMATCH LOSSES = 0db (6 MC BANDWIDTH INCLUDES THESE)

ANTENNA MISMATCH LOSSES = 0.2 db

INTEGRATION EFFICIENCY LOSS = 1.0 db

TOTAL LOSSES = 2.4 db

RCA INTEGRATED S/N IS 2.2 db > PPS-6 (MODE 3)

Sensitivity Comparison of AN/PPS-6 and RCA AN/PPS-() UR

Unit	Target Range (meters)	Target Cross Sect (m ²)	S/N Ratio in dB	
			Mode 3	Mode 1 & 2
PPS-6	1500	0.5	15.4	7.0
RCA	1500	0.5	17.6	10.6
PPS-6	3000	10	16.4	8.0
RCA	3000	10	18.6	11.6

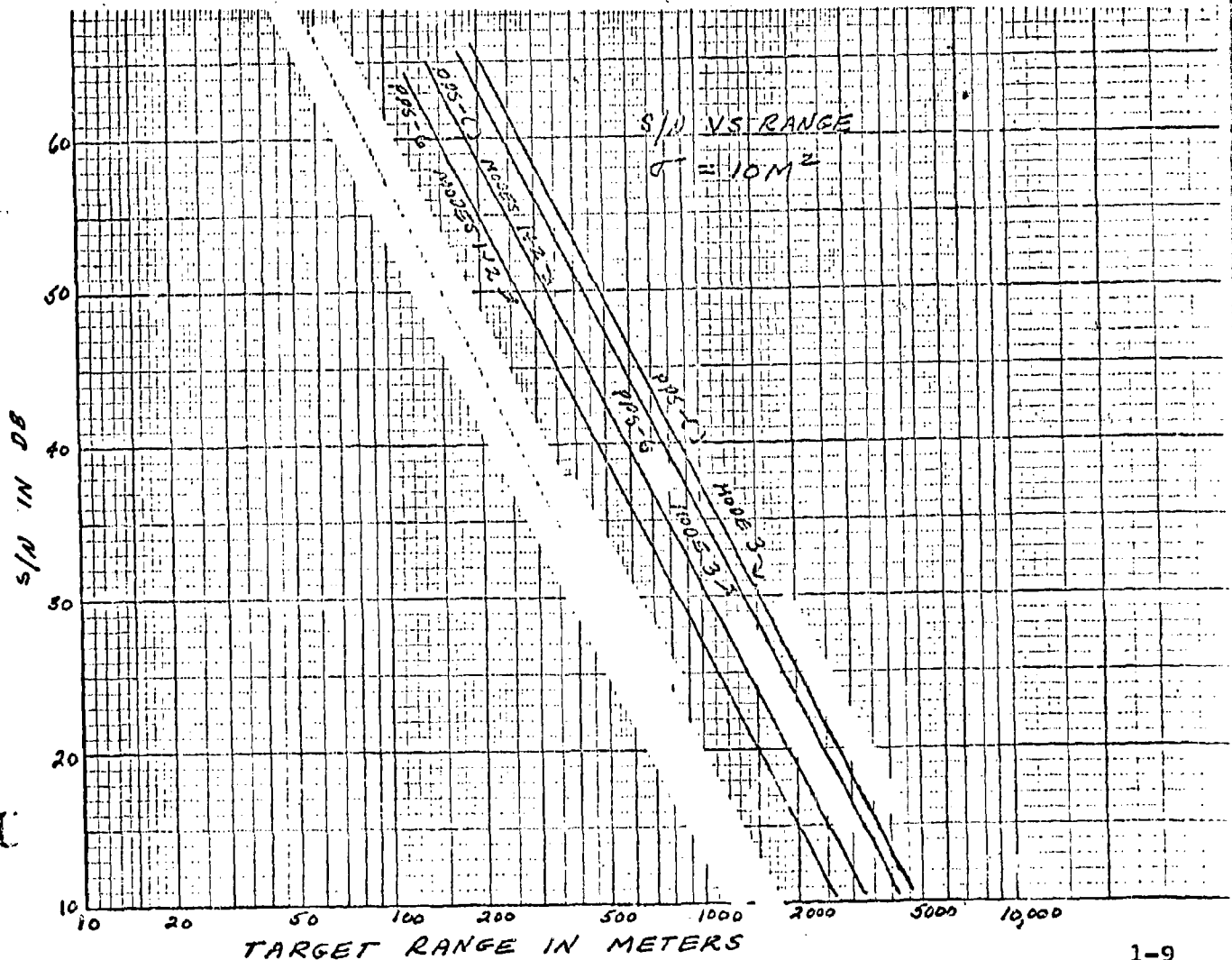

TRANSMITTER

SUMMARY SPECIFICATION

- FREQUENCY 9.0 - 9.5 GHz
TUNEABLE AT
4TH ECHELON

- PULSE REP. RATE
 - SEARCH 8 KHz
 - FINE RANGING 40 KHz

- PULSE WIDTH
 - SEARCH 2.1 μ S
 - FINE RANGING 0.3 μ S

- PBAK POWER OUT 3.0 W

- L.O. POWER OUT 5.0 mW

- D.C. INPUT POWER 6.0 W

- RELIABILITY PRED. 50,000 HRS MTBF

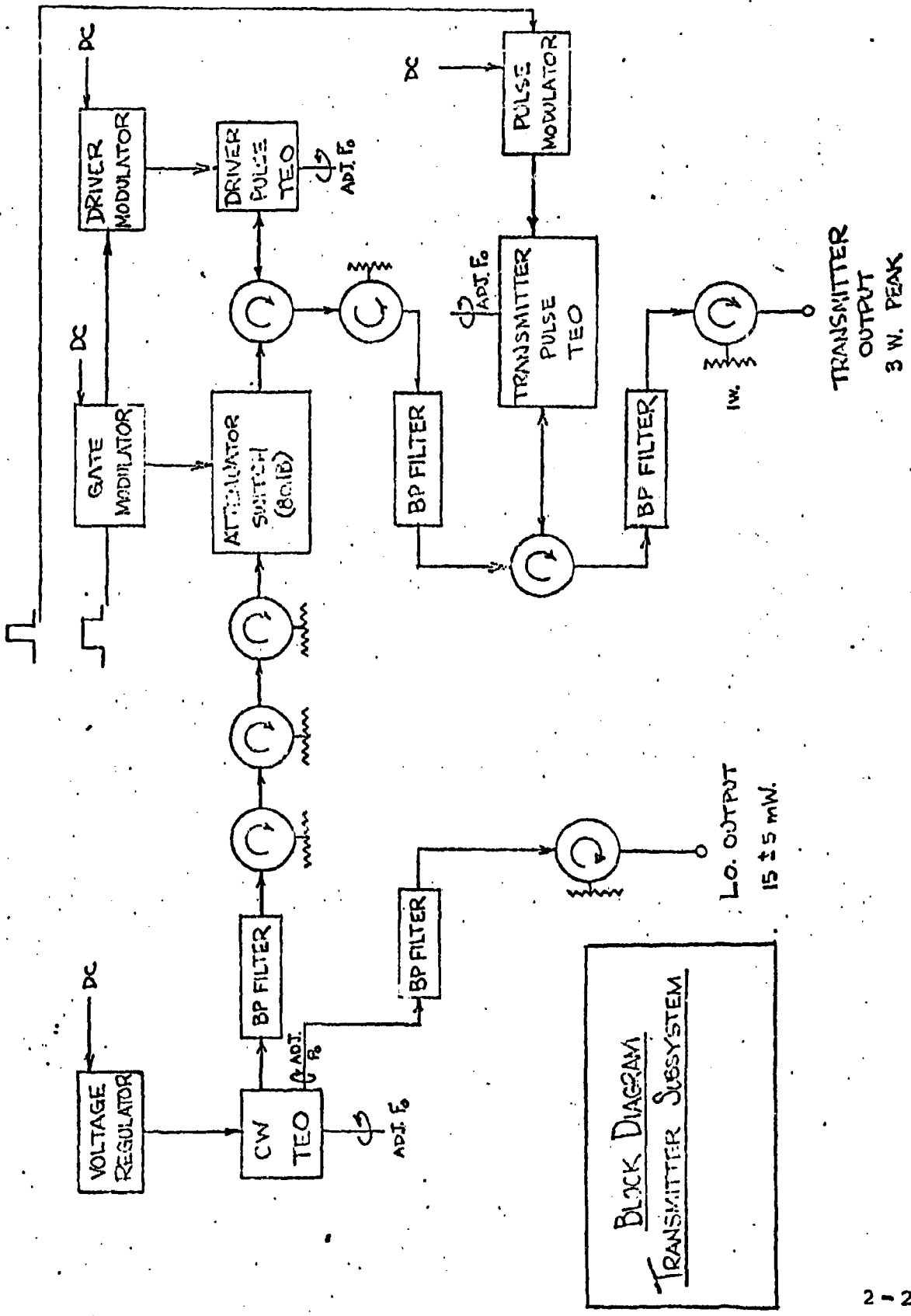

SPURIOUS OUTPUTS

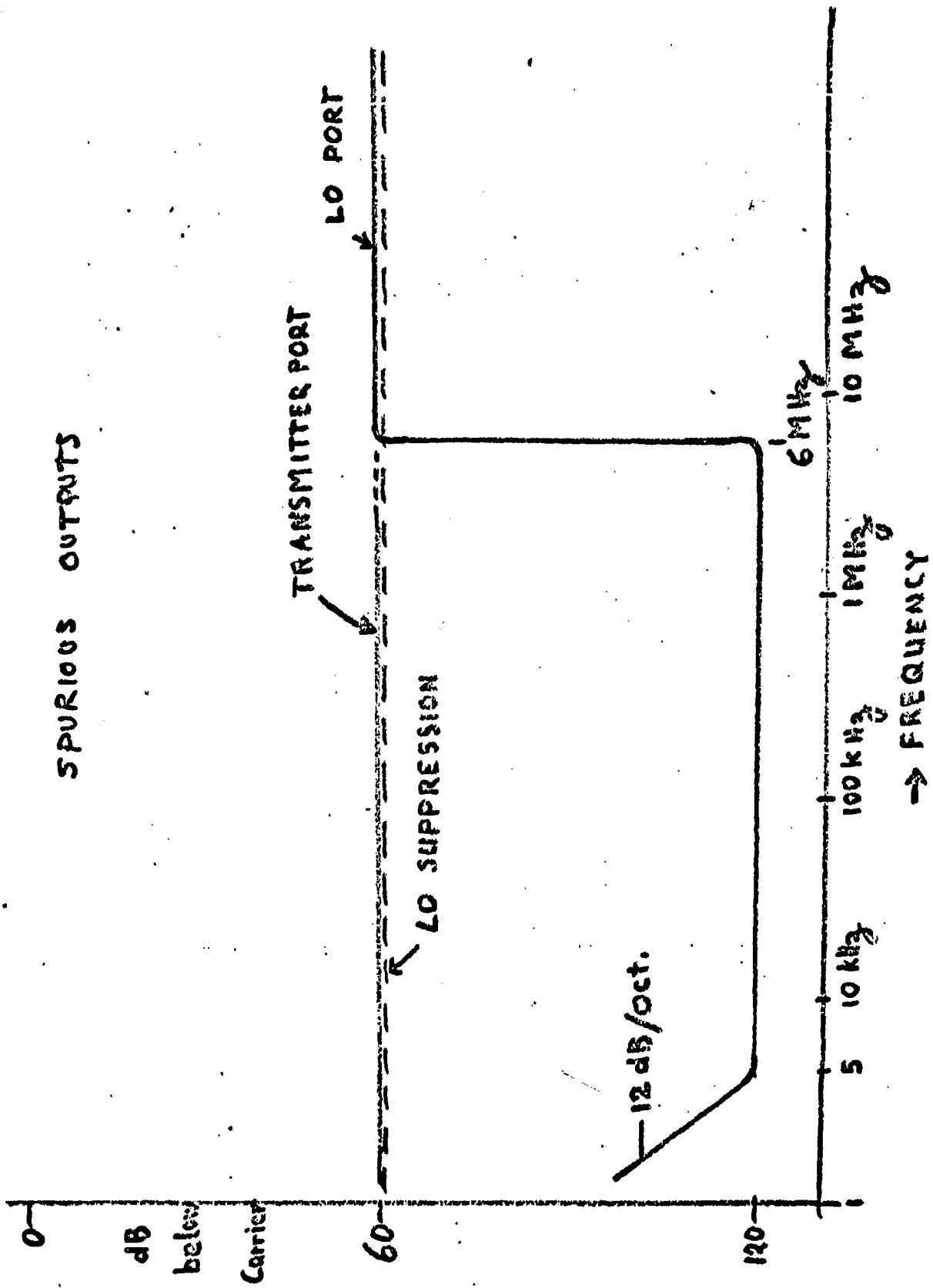

STABILITY TEST CIRCUIT

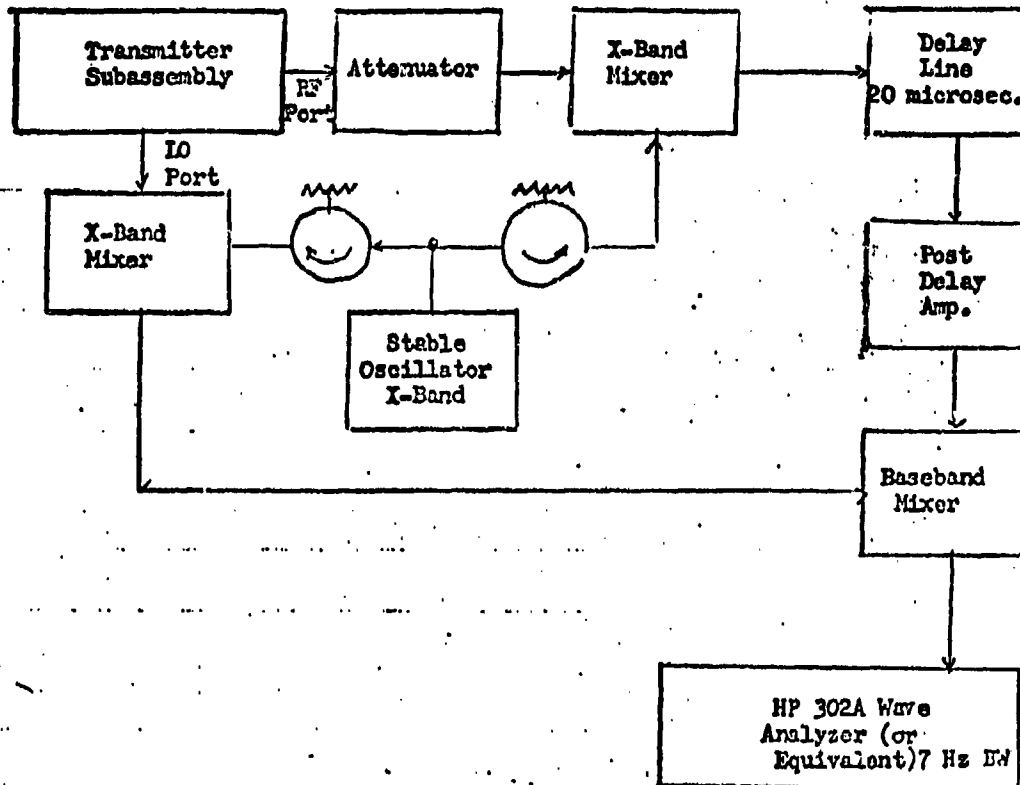

NOTE: Alternative circuit with delay in I.O. channel also acceptable.

ALL COMPONENTS WITHIN TEST FREQUENCY RANGE SHALL BE AT LEAST 60 DB BELOW THE RESPECTIVE SPECTRAL LINE

MODE 1 38 KHz to 39.93 KHz

MODE 2 6 KHz to 7.78 KHz

TRANSMITTER OUTLINE DRAWING

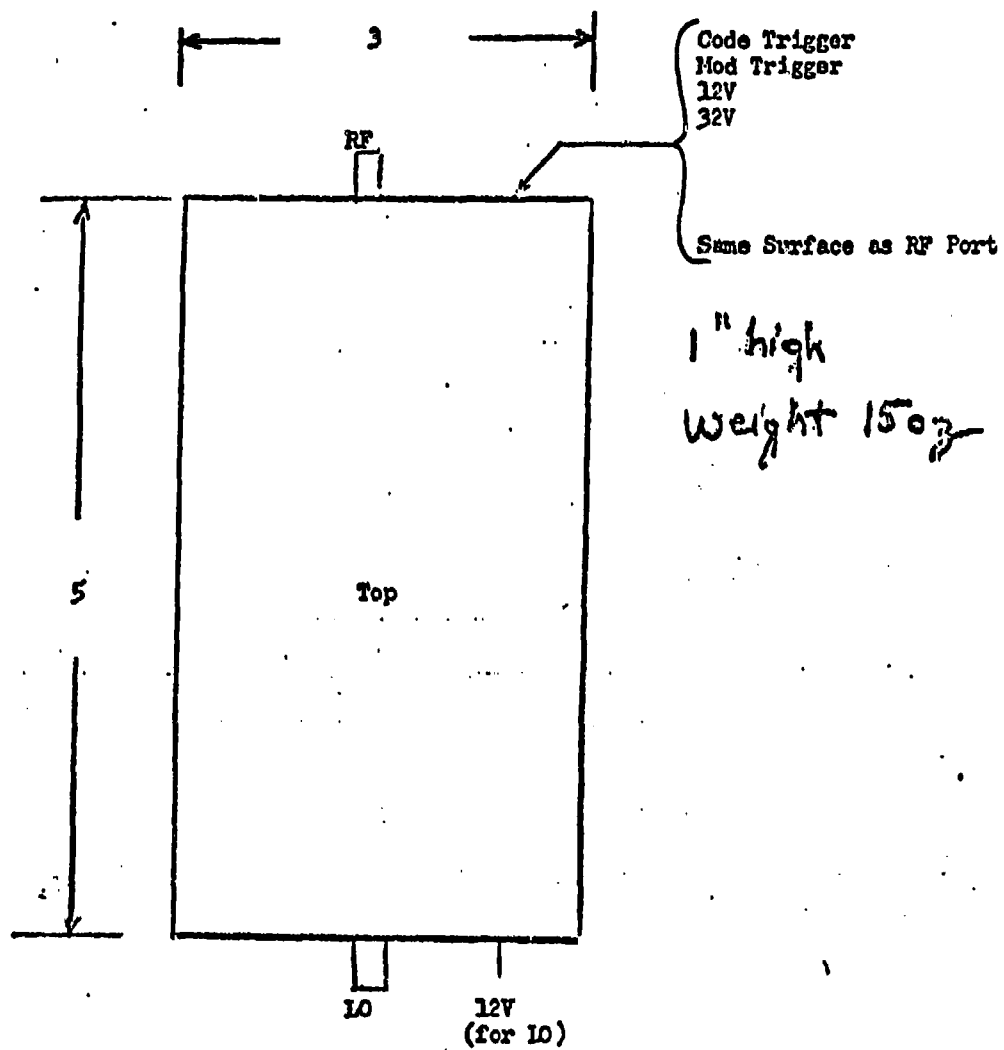

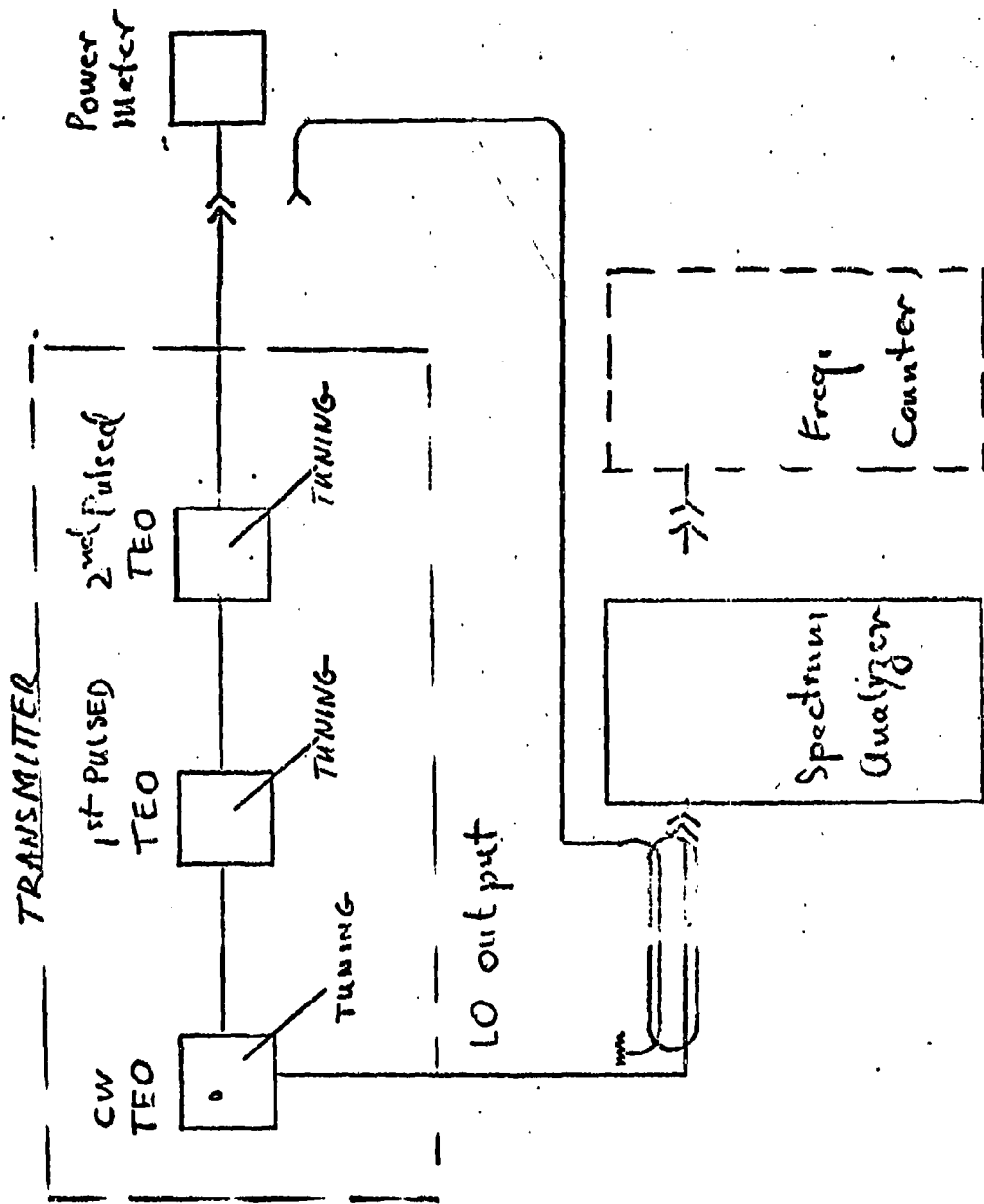

Tuning TEST SET-UP

RECEIVER SUMMARY SPECIFICATION

- R.F. FREQUENCY B.W. 9.0-9.5 GHz
- NOISE FIGURE (SSB) 10.5 dB
- I.F. FREQ. 0 Hz
- BASE BAND 2 KHz - 4.4 MHz
- RANGE GATE ISOLATION 55 dB
- L.O. TO ANT. ISOLATION
(RANGE GATE OPEN) 32 dB
- L.O. POWER 5 mW
- RELIABILITY PRED. 100,000 HRS. MTBF

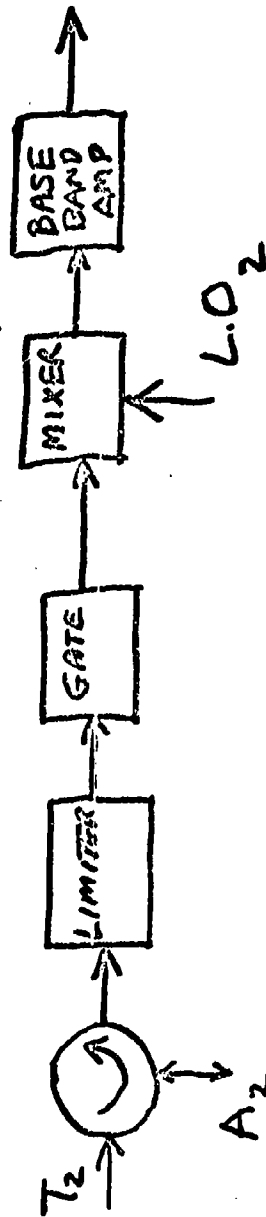
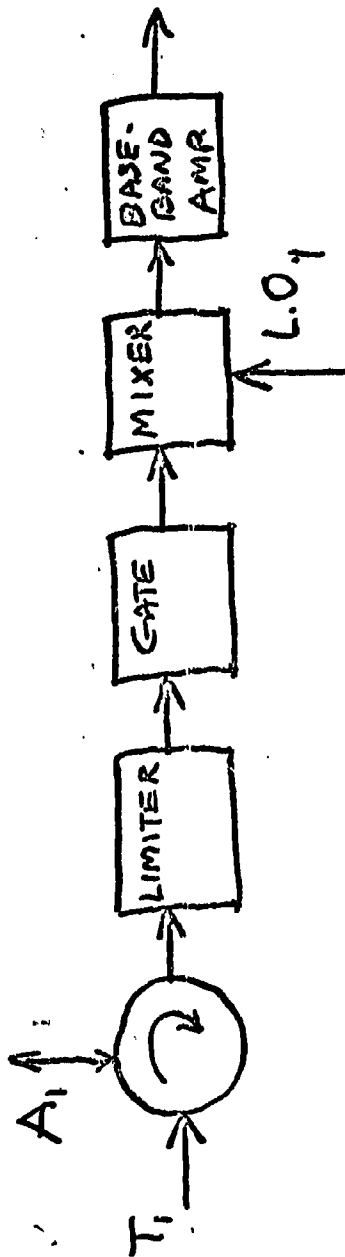

DUAL RECEIVER
BLOCK DIAGRAM

RECEIVER UNDER TEST

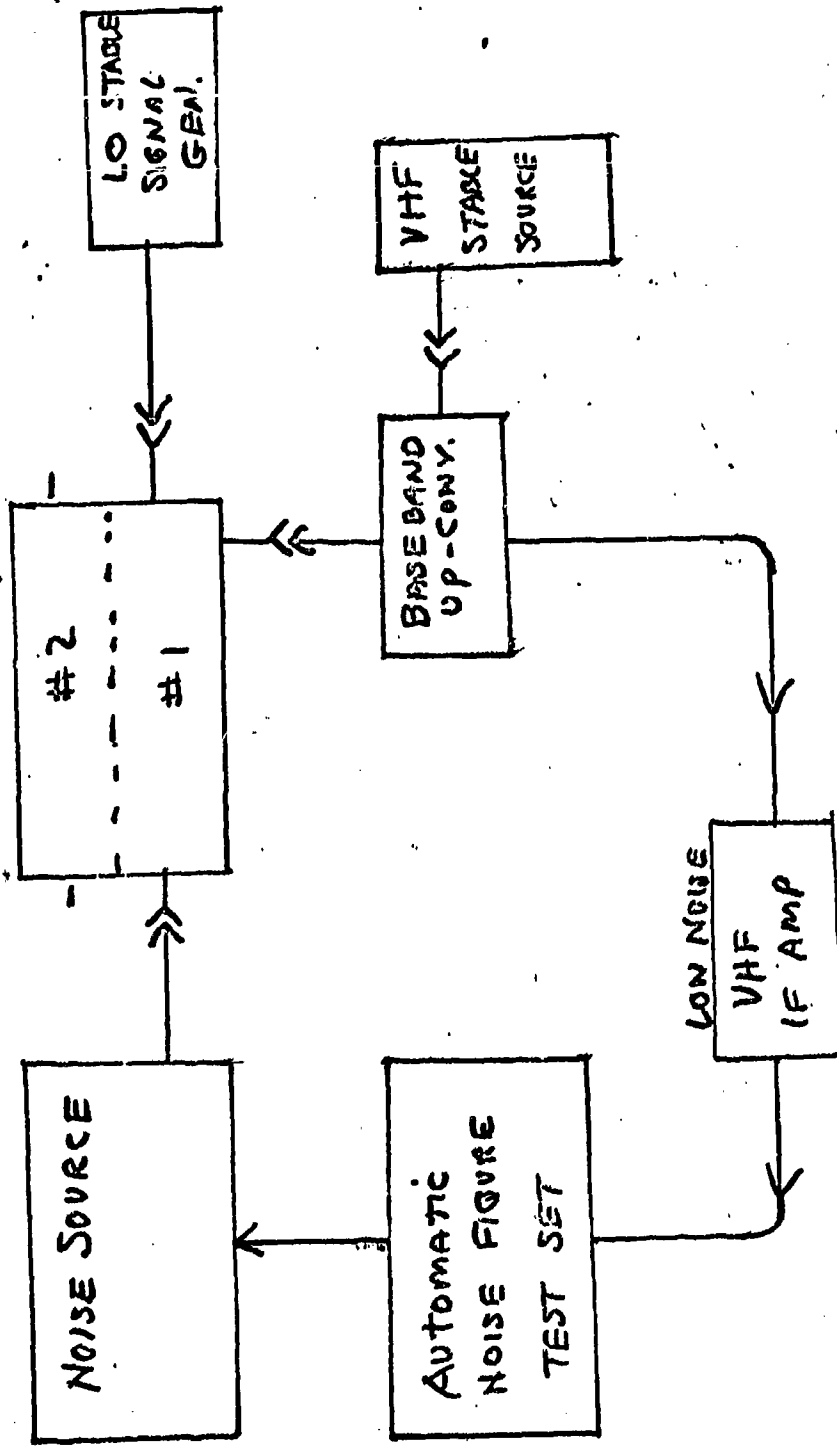

N.F. TEST SET-UP

Sealed Upper Compartment

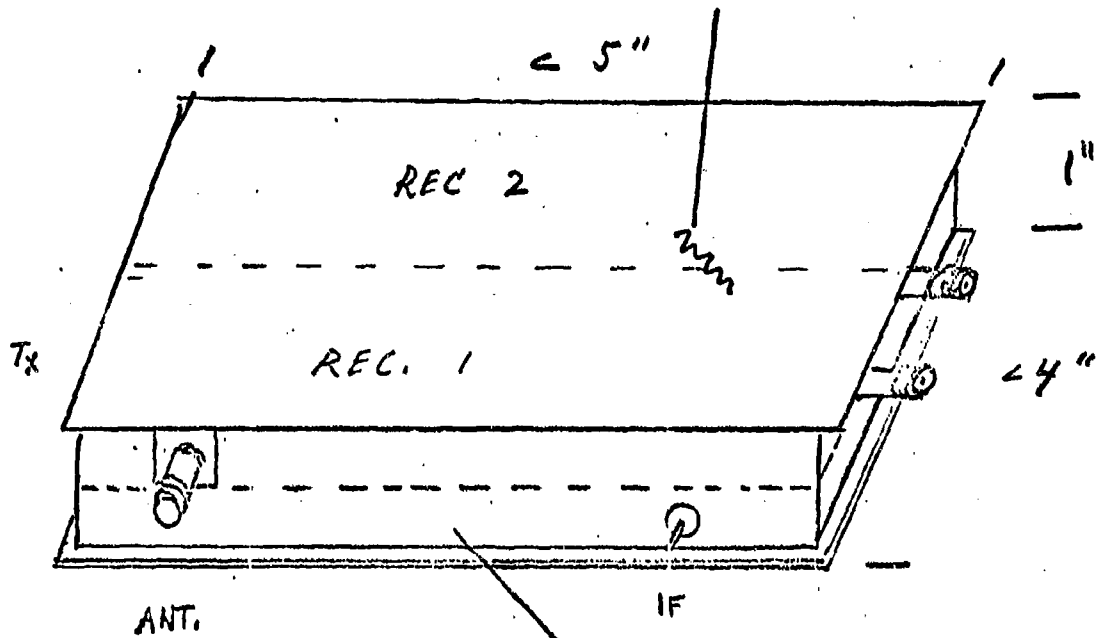

Lower Compartment
Contains IF PRE-AMP
AND GATE DRIVERS
(not sealed)

RECEIVER ASSEMBLY

ANTENNA

Description:

This antenna consists of a broadside array of fan dipoles and corporate feed network printed on a single dielectric sheet. One-half of the balanced feed line and one-half of each dipole radiator are printed on each side of the sheet. The array consisted of 256 dipoles fed through a corporate network. A tapered-type balun, also printed on the single sheet, is used to convert the unbalanced coaxial input to the balanced input to the network. The printed-circuit sheet is foam-supported over a ground plane to achieve a unidirectional beam. The measured data shows that the presence of the feed network in the same plane as the radiators does not cause material pattern deterioration.

Size: 12-3/8" x 12-3/8" x 5/8"

Weight: Approx. 1-1/2 lbs.

Gain: 27 db min. over band of 9.0 to 9.5 GHz

VSWR: 1.5:1 (50-ohm line)

Efficiency: 45%

Gain vs Aperture Size

$N = 256$ dipoles

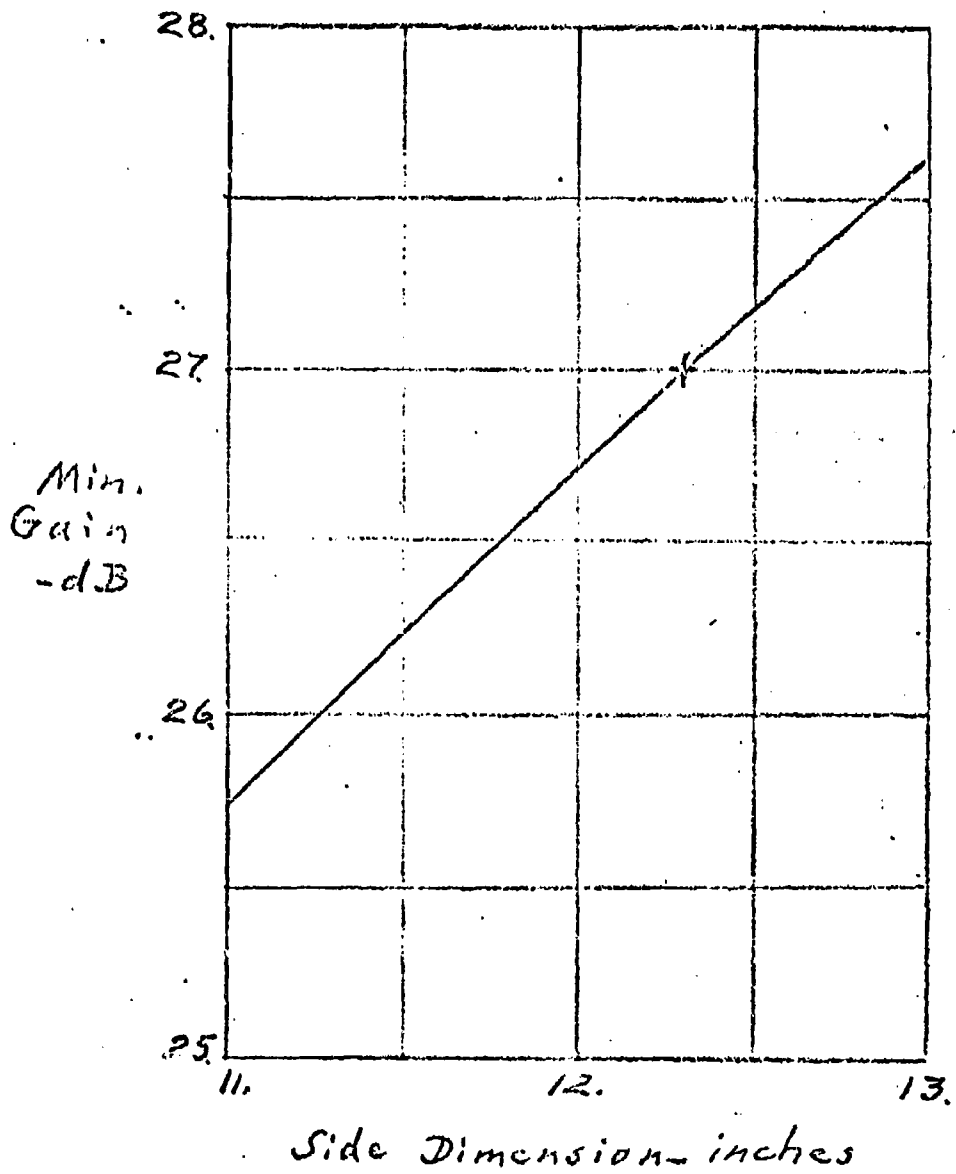

EXPERIMENTAL PATTERN

$f = 9250 \text{ MHz}$
H-plane

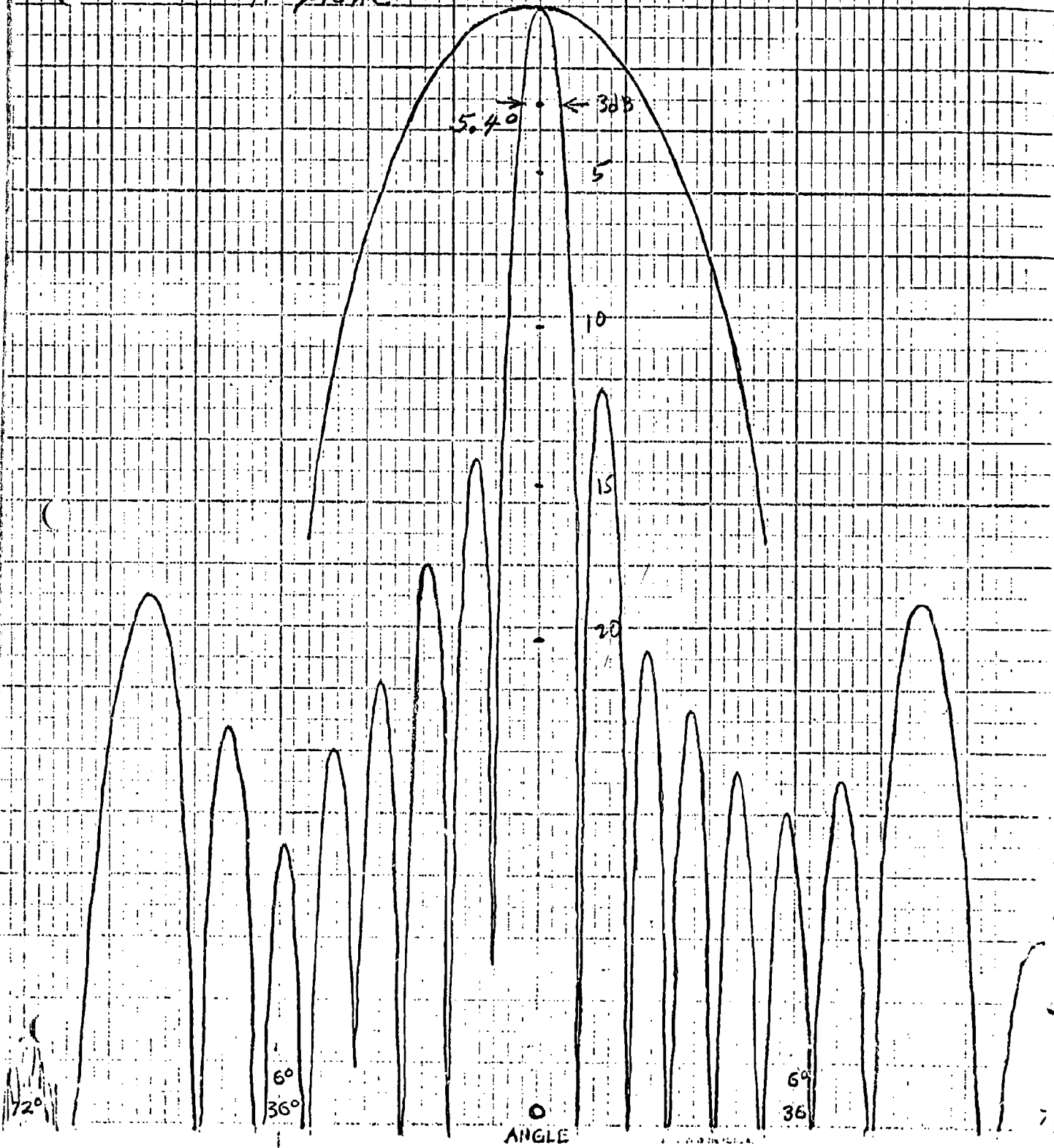

Experimental Pattern

$f = 9.250 \text{ MHz}$

E-plane

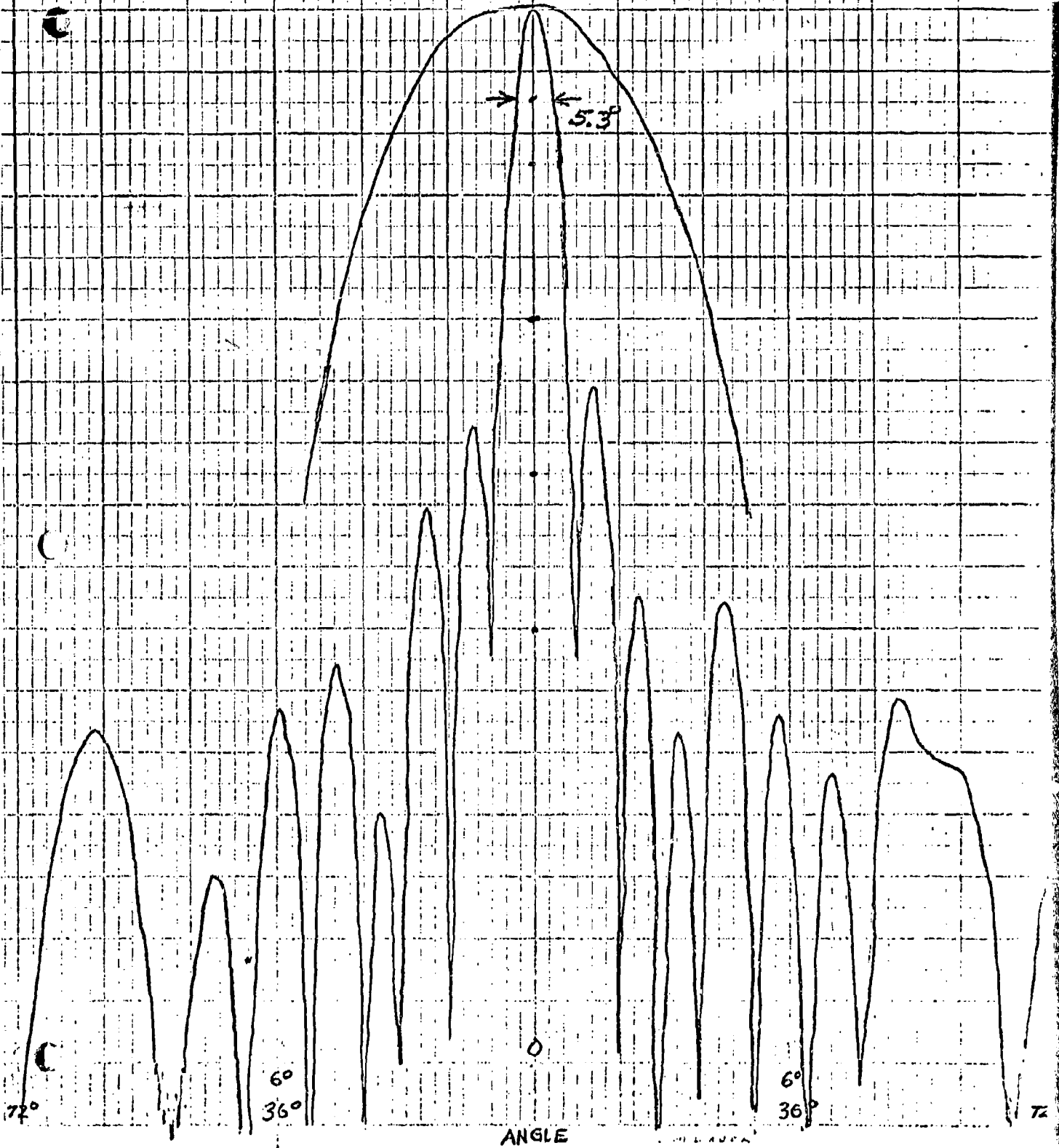

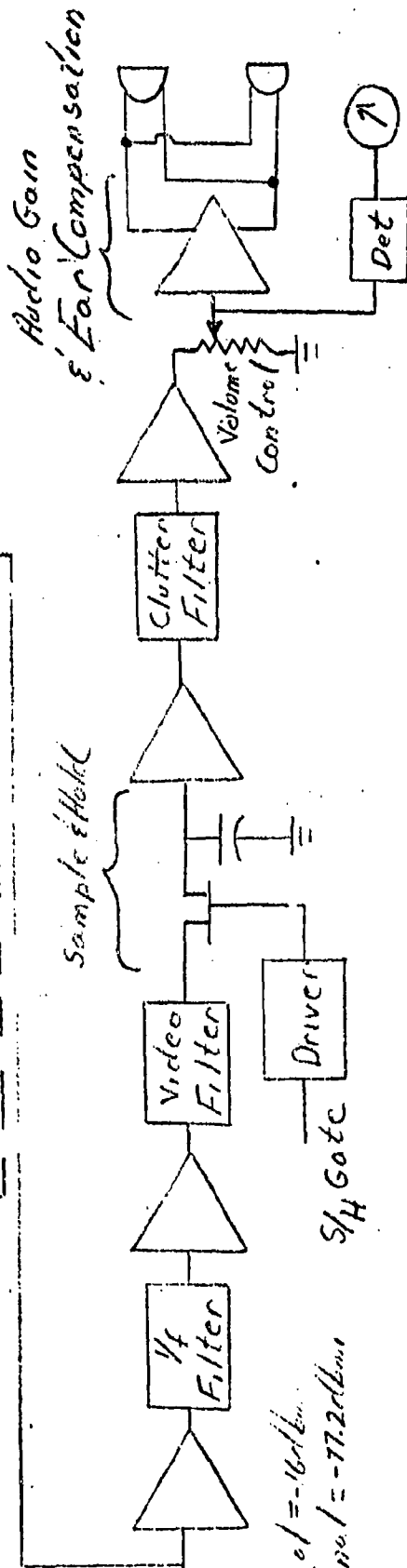
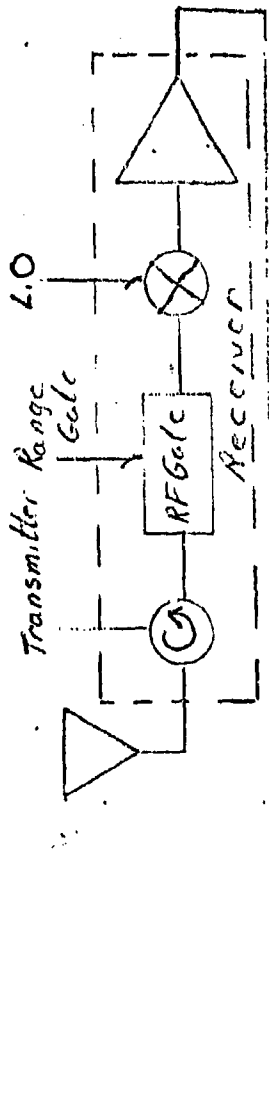

Max Signal = -16dBm
Min Signal = -77.2dBm

54 Gate

Det

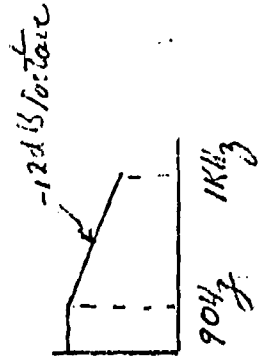
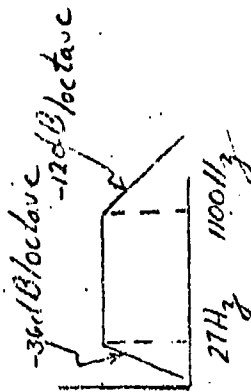
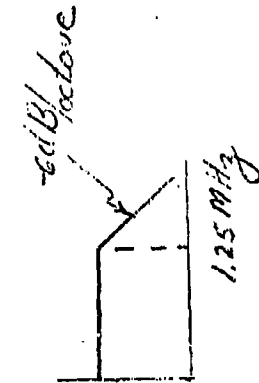
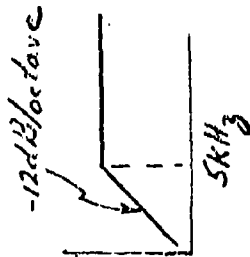

NOT REPRODUCIBLE

Signal Processor Analog
Functional Block Diagram

F101

Signal Processor
Timing Diagram - Mode 1

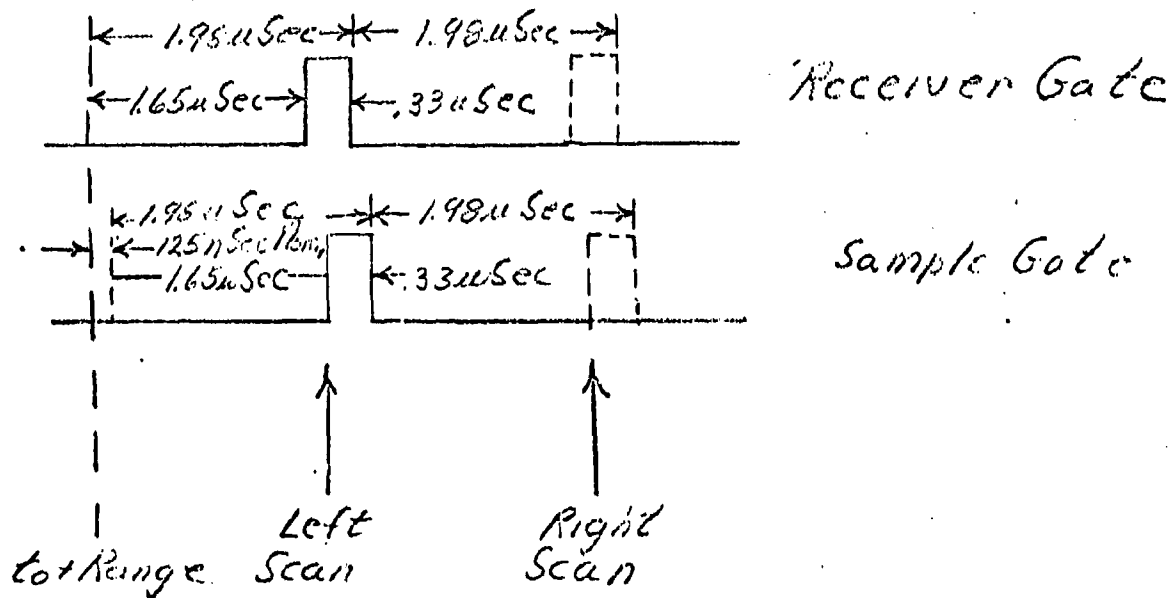
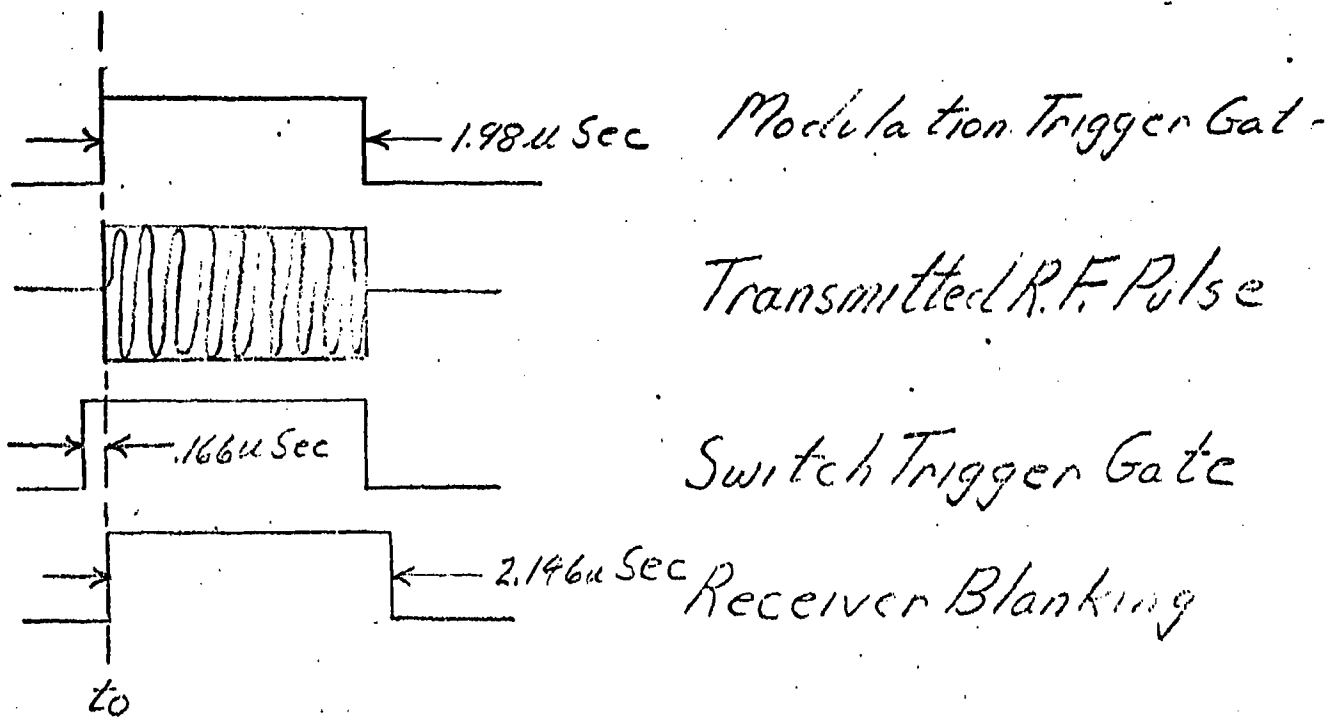

Signal Processor Timing Diagram - Mode 2

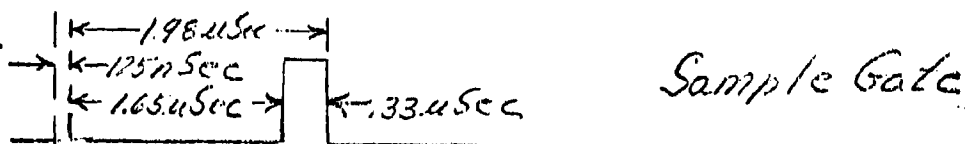
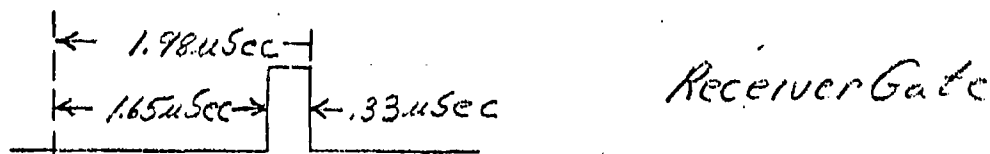
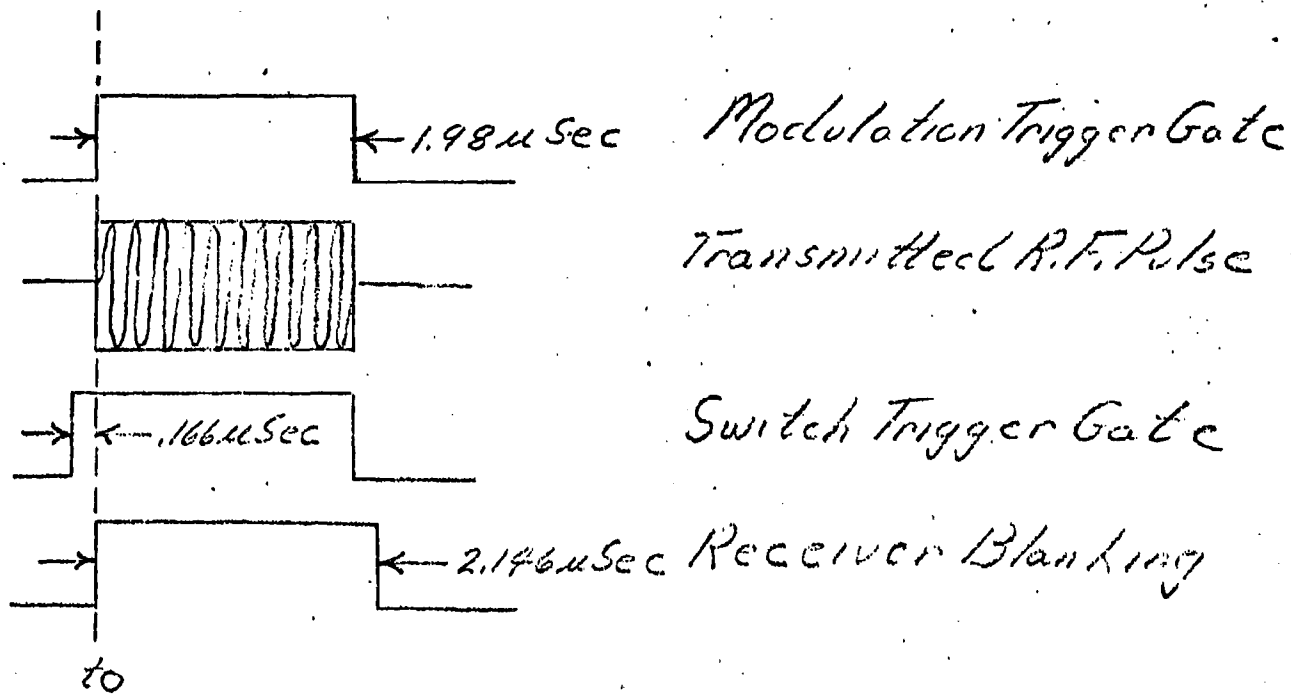

to Range

left & Right Scan

Signal Processor
Timing Diagram - Mode 3 (Fine Ranging)

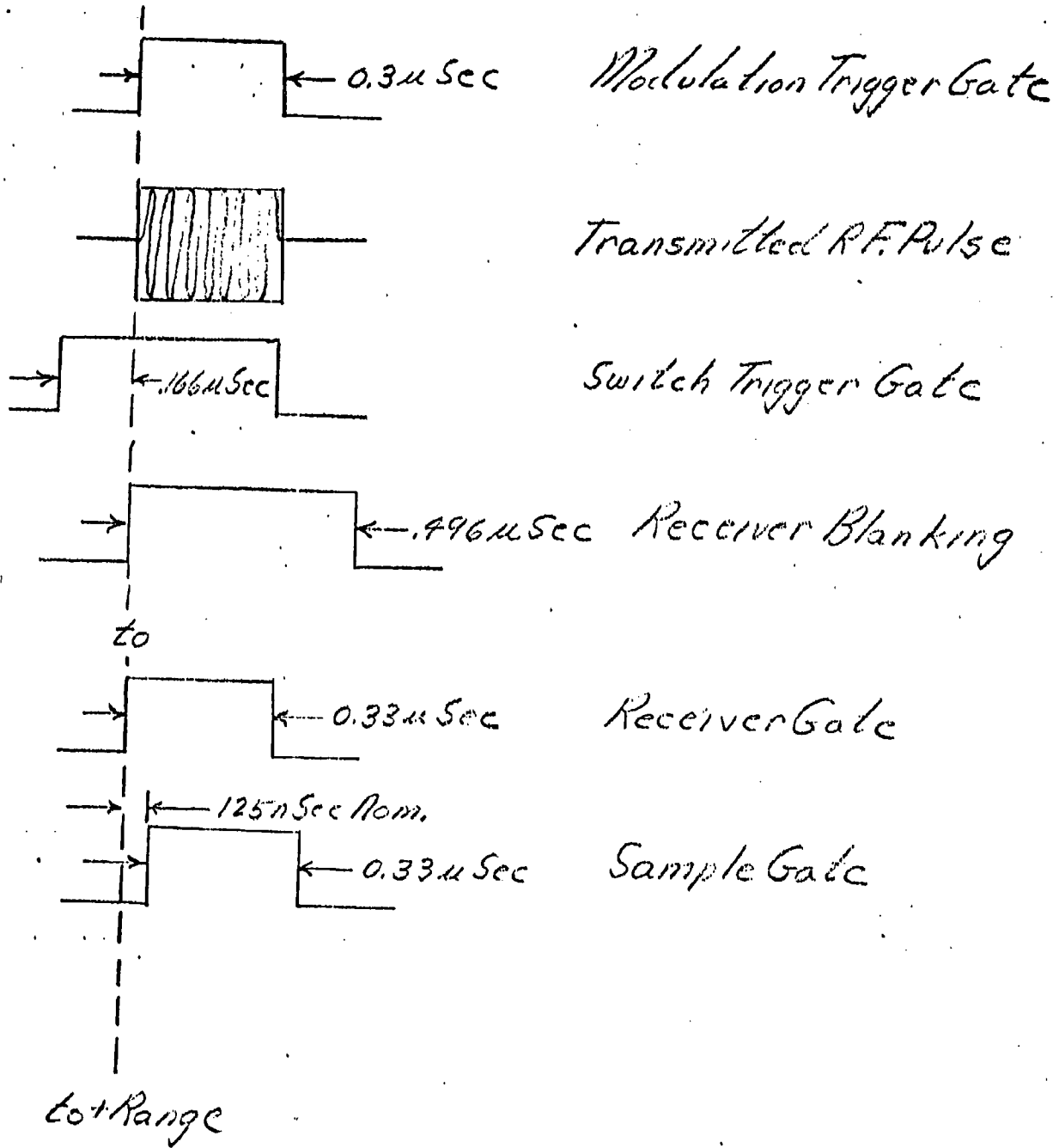

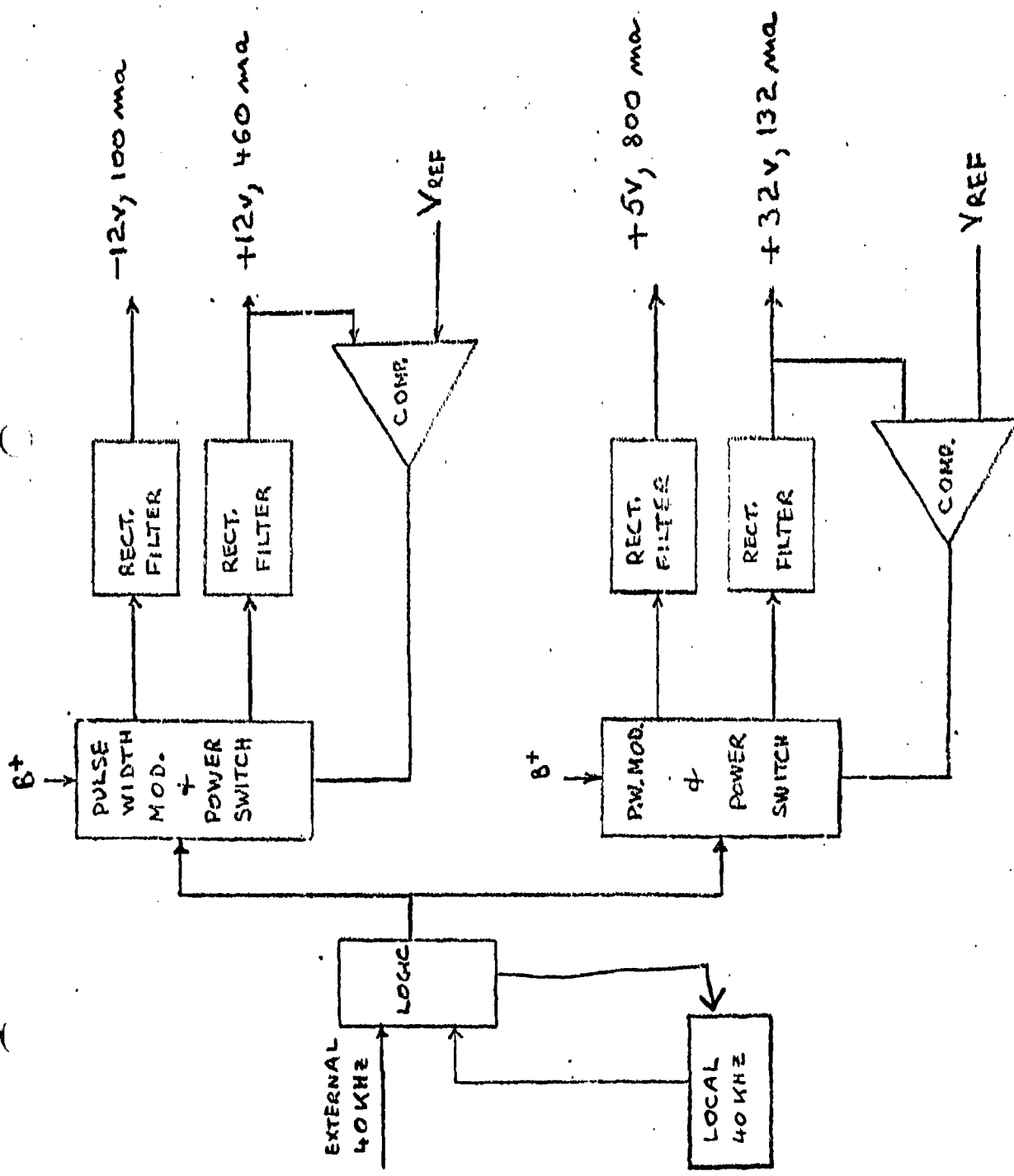

DC-DC CONVERTER BLOCK DIAGRAM

F1P3

Radar Controls

Range Switch

Shaft Encoder & Mechanical Counter
Range Reading - 50 to 3175 Meter in
25 Meter Steps

Mode Switch

Rotary Shaft - 3 positions

Volume Control

Conductive Plastic Potentiometer

Meter

1 1/2 inches

Graduation full, 1/2, 1/4, 1/8 scale Graduation
3/4 scale Green area for Voltage
check

Meter Switch

Rotary Shaft - 12 positions

OFF, Battery, Channel A & B - 4 Voltages,
and operability check

Dimmer Switch

Potentiometer

ON-OFF SWITCH

on-off C.B.

T R I P O D

- DESIGN INVESTIGATIONS
- PROCUREMENT OF TWENTY-FIVE UNITS
- TEST PROGRAM FOR FIVE UNITS
- DELIVER TWENTY UNITS FOR RADAR SUPPORT DURING PHASE II AND PHASE III
- FAILURE ANALYSIS AND REPORT OF TEST PROGRAM FOR FIVE UNITS

TRIPOD

AN/PPS-6 DESIGNS UNDER CURRENT CONSIDERATION

LOCKHEED ELECTRONICS A	LOCKHEED ELECTRONICS B	GENERAL INSTRUMENTS
ALUMINUM ALLOY	ALUMINUM ALLOY	ALUMINUM ALLOY
REDESIGNED WYE	REDESIGNED WYE	STANDARD WYE
SQUARE UPPER LEG	ROUND TUBE-SAME	ROUND TUBE-SAME
TWIST LOCK	REDESIGNED CLAMP	REDESIGNED CLAMP
REDESIGNED OUTER LEG FITTING	REDESIGNED OUTER LEG FITTING	STANDARD OUTER LEG FITTING
DELETE FEED TUBE	DELETE FEED TUBE	DELETE FEED TUBE
REDESIGNED LEVEL CLAMP	REDESIGNED LEVEL CLAMP	STANDARD LEVEL CLAMP

SCANNER

I. PHASE I STUDY

- A. PROPOSED USE OF STEPPER MOTOR FOR SCANNER DRIVE

II. INITIAL DESIGN INVESTIGATION

- A. DISCOVERY OF POSSIBLE CLUTTER MODULATION
- B. ANALYSIS INTO DIFFERENT STEPPING RATES
- C. POSSIBLE PERFORMANCE RISK WITH STEPPER
- D. DECISION TO PROCEED WITH D.C. BRUSH MOTOR DESIGN BASED ON ADEQUATE RELIABILITY
- E. BUILT BREADBOARD WITH STEPPING MOTOR
- F. RESULTS OF BREADBOARD EXPERIMENT

III. PRESENT EFFORTS

- A. DESIGNING D.C. BRUSH MOTOR CIRCUITRY FOR FURTHER RELIABILITY ANALYSIS
- B. PERFORMING GEAR ANALYSIS OF STEPPER SYSTEM
- C. OBTAINING MORE VENDOR DATA FOR RELIABILITY UPDATE FOR BOTH SYSTEMS
- D. PERFORMING RELIABILITY EVALUATION OF TOTAL SYSTEM OF TWO DRIVES
- E. PROCEEDING WITH D.C. BRUSH MOTOR DESIGN AND LAYOUT UNLESS RELIABILITY EVALUATION WARRANTS A CHANGE

DS3670-1

STEPPER MOTOR

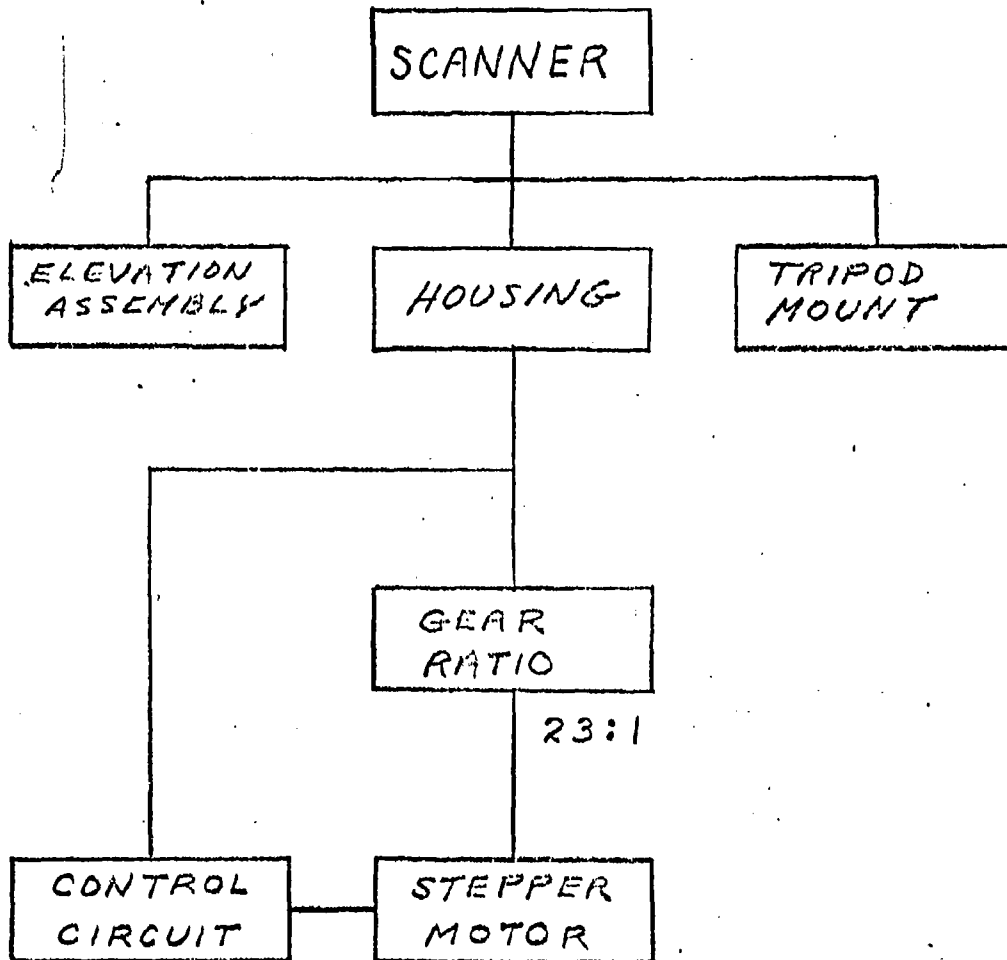

PULSE GENERATOR 10 STEPS/SEC
SCAN WIDTH CONTROL
SCAN SELECT BUTTONS

DC BRUSH MOTOR

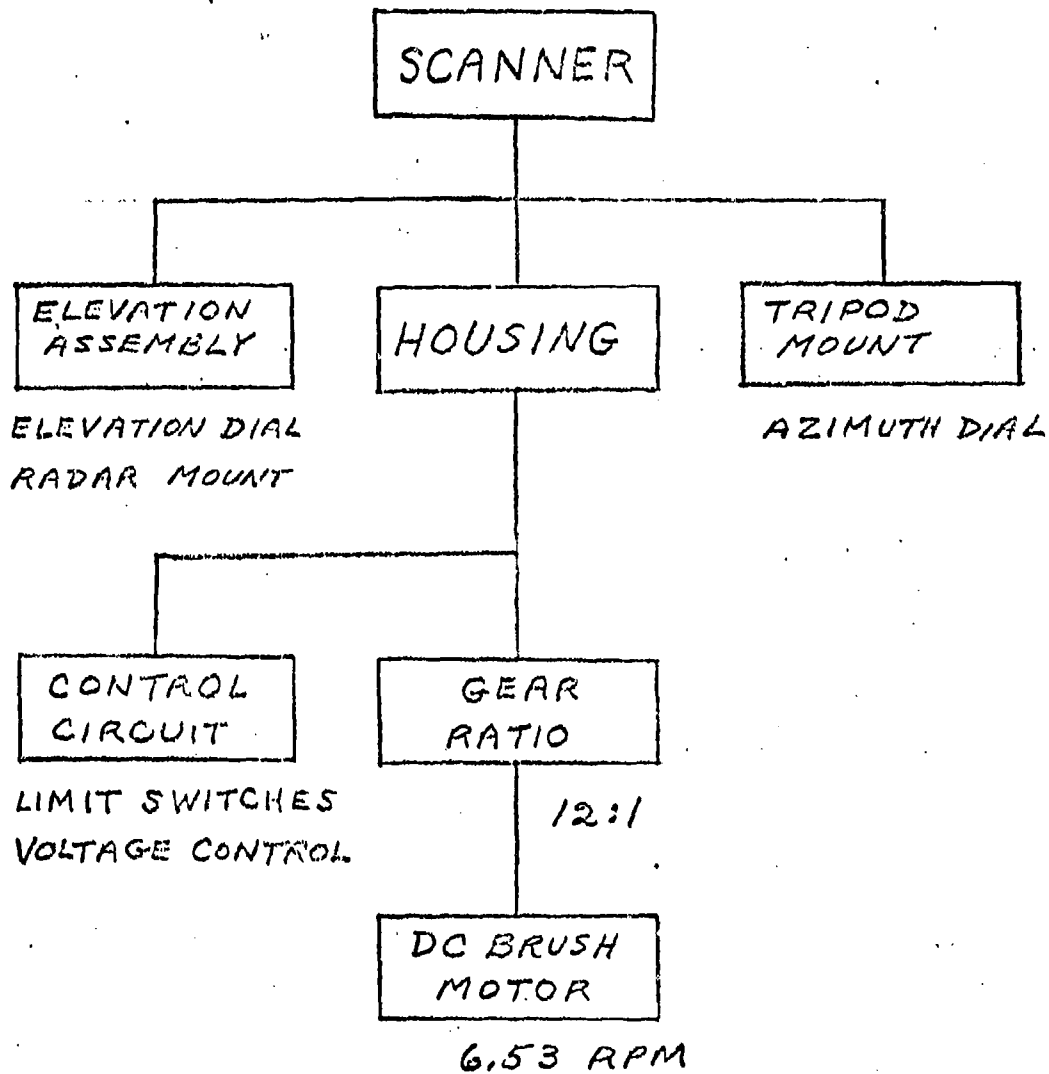

BETA LIGHT ILLUMINATION

PROBLEMS RELATIVE TO USE

- 1) Need for AEC license.
- 2) Special facilities for service.
- 3) Accountability & AEC Compliance Inspections
- 4) Radiation Hazard Marking on Equipment.
- 5) Strict Isotope Inventory.
- 6) Radiological Test Equipment.

WEIGHT & POWER SUMMARY

<u>UNIT</u>	<u>WEIGHT (lbs.)</u>	<u>POWER (Watts)</u>
XTR'S	1.88	6.00
RCVR'S	2.81	0.22
SIG. PROC'S	0.25	3.20
PWR CONV'S	0.63	3.52
ANTENNA	1.25	—
CASE	3.50	—
RANGE INPUT	0.31	—
CONT., CONN., ETC.	1.07	—
<hr/>		
RADAR	11.70	12.94
BATTERY	8.00	—
TRIPOD, SCANNER, HEADSET	10.50	2.80**
<hr/>		
TOTAL	30.20 lbs.	15.74 watts

* BASED ON PPS-6 WEIGHT

** BASED ON STEPPER MOTOR, DECREASES
IF LINEAR MOTOR.

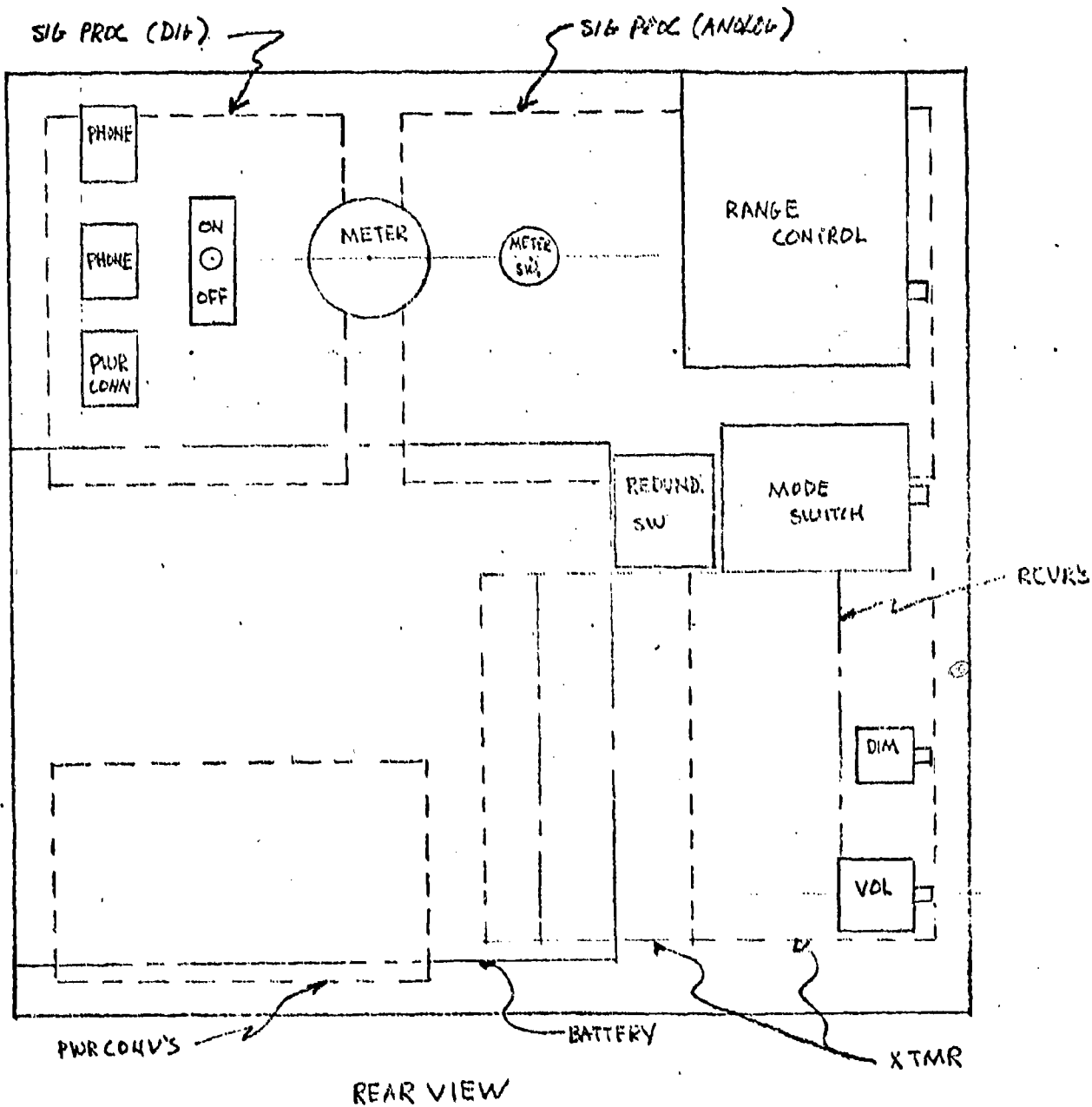

PPS-C) GENERAL LAYOUT

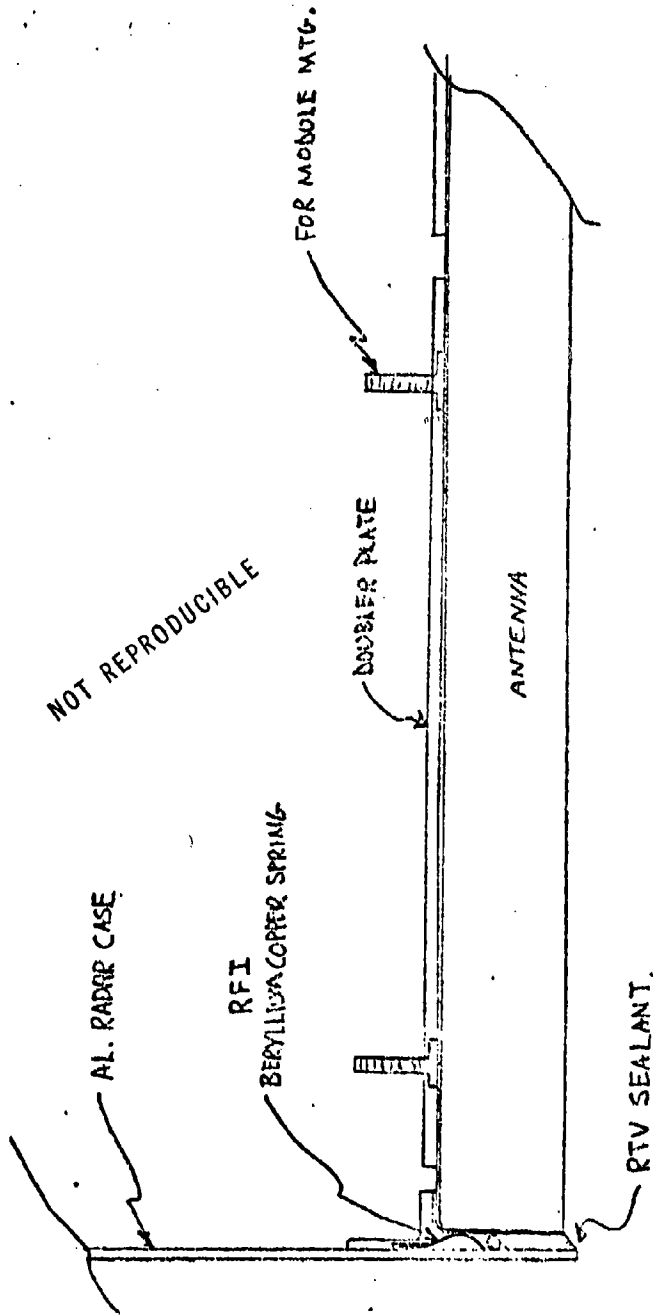

MOBILE MOUNTING & ANTENNA SEAL

AN/PPS-C ENVIRONMENTAL TESTS. PHASE II

ENV TEST	CONTROL SPECIFICATION	PROPOSED RANGE/LIMIT
1. R.F.I	MIL-STD-449C	150°F ± 5°F (CHAMBER) 77°F ± 10°F (CHAMBER) 40 TO 60% RH
2. ENCLOSURE (CONDITIONING)	SHIPS R-5271 PARA. 4.2.7 a	* 65°F ± 10°F (WATER TEST) * 77°F ± 10°F (CHAMBER) 2 INCHES/HR (RAIN)
(a) RAIN	PARA 4.2.4 b	20 MILES/HR WIND SOURCE ± 5 MI/HR. EACH SIDE FOR 1 HOUR. POTATE UNIT 9.0 (4 Sides)
(c) WIND & RAIN	PARA. 4.2.4. c	-62°C ± 0° - 5°C +25°C ± 2°C +75°C ± 5°C
(d) WIND & RAIN	PARA 4.2.4. d, e	-54°C ± 0° - 5°C +25°C ± 2°C +65°C ± 2°C
3. TEMPERATURE (NON-OPERATING)	MIL-E-16400 PARA 4.5.8.1	
4. TEMPERATURE (OPERATING)	MIL-E-16400 PARA. 4.5.8.2.1 CLASS II	
	* INCREASE OF TOLERANCE	

NOT REPRODUCIBLE

AM/PPS-(C) ENVIRONMENTAL TESTS PHASE II

ENV TEST	CONTRAL SPECIFICATION	PROPOSED RANGE/LIMIT
5. HUMIDITY		
(a) CONDITIONING	CLASS I (4.5.9)	+40°C ±10-0°C
(b) REFERENCE Measurements	Para. 4.5.9.1	+35°C ±2°C
	Para. 4.5.9.2	50% RH ±5%
(c) TEMPERATURE Cycling.	Para. 4.5.9.3	+60°C ±5°C (APPROX 16 HRS)
		+50°C ±5°C (APPROX 5 HRS)
		TRANSITION TIME 3 HOURS.
(d) MEASUREMENTS DURING Cycling (EVERY 24 HRS @ +60°C ±5°C)	Para 4.5.9.4	95% RH ±5%
		AT +60°C ±5°C
		RH @ 95% ±5%
(e) MEAS. AFTER TEMP Cycling (AFTER 3 COMPLETE TEMP. HUMIDITY CYCLES).	Para. 4.5.9.5	30°C ±5°C
(f) TESTS AS REQUIRED	Para. 4.5.9.5.1	50% RH ±5%
		25°C ±5°C
		50% RH ±5%
		(12 TO 24 HRS)
(g) HUMIDITY CYCLE (VARY RH AS INDICATED DURING 3 HR TEST @ +50°C ±5°C).	Para 4.5.9.6	+50°C ±5°C (8 HRS)
		50% RH ±5% FOR 2 HRS.
		95% RH ±5% FOR 1 HRS.
		40% RH ±5% FOR 2 HRS.

NOT REPRODUCIBLE

AN/PPS-C) ENVIRONMENTAL TESTS PHASE II

ENV TEST	CONTROL SPECIFICATION	PROPOSED RANGE / LIMIT
6. SHOCK BOUNCE	SHIPS R-5271 PARA. 4.2.8 PARA. 3.3.19	5 TO 10 PLEVEL USING A FILTER OF 5 TO 100 HZ BANDWIDTH
7. VIBRATION	SHIPS R-5271 PARA 4.2.9 PARA 3.3.20	34 TO 500 HZ. (.010 DOUBLE AMPL) 7 TO 33 HZ (1.69) $Q \leq 2$
8. SIMULATED ALTITUDE	SHIPS R-5271 PARA 3.2.12	20,000 FT ALTITUDE FOR 20 HRS.

NOT REPRODUCIBLE

AN (PPS-C) TRIPOD DESTRUCTIVE TESTS:

PROPOSED TEST	PROPOSED CONDITIONS	NUMBER OF UNITS.
1. SHOCK (CONCRETE FLOOR)	(a) FREE FALL DROP TEST FROM HEIGHTS OF 24 IN, 36 IN & 48 IN AT TEMPERATURES OF 25°C, 0°C, -30°C & -54°C (b) TRIPOD TO BE TESTED AT ABOVE TEMPERATURES FROM THE FOLLOWING POSITIONS FEET DOWN TOP DOWN FLAT 45° / 45° \	2
2. SHOCK (CONCRETE FLOOR)	(a) FREE FALL DROP TEST FROM HEIGHT OF 50 INCHES INITIALLY AND INCREMENTAL HEIGHTS OF 5 INCHES. POSITIONS SAME AS THOSE IN 1 b.	1
3. VIBRATION	(a) VIBRATION TEST AS PER MIL-STD 810.3; METHOD 514, PROCEDURE I, CYCLE AW. (b) BOUNCE TEST PER MIL-STD 810.8, METHOD 514, PROCEDURE I PART 2.	1

NOT REPRODUCIBLE

AN/PP3C TRIPOD D. DESTRUCTIVE TESTS

PROPOSED TEST	PROPOSED CONDITIONS	NUMBER OF UNITS
C. HUMAN ELEMENT TESTS.	(a) POSITION TRIPOD ON DIRT FLOOR AND WALK ON, STEP ON, & JUMP ON.	1
	(b) SAME AS (a) BUT ON CONCRETE FLOOR.	

AN/PPS - () ULTI RELIABILITY

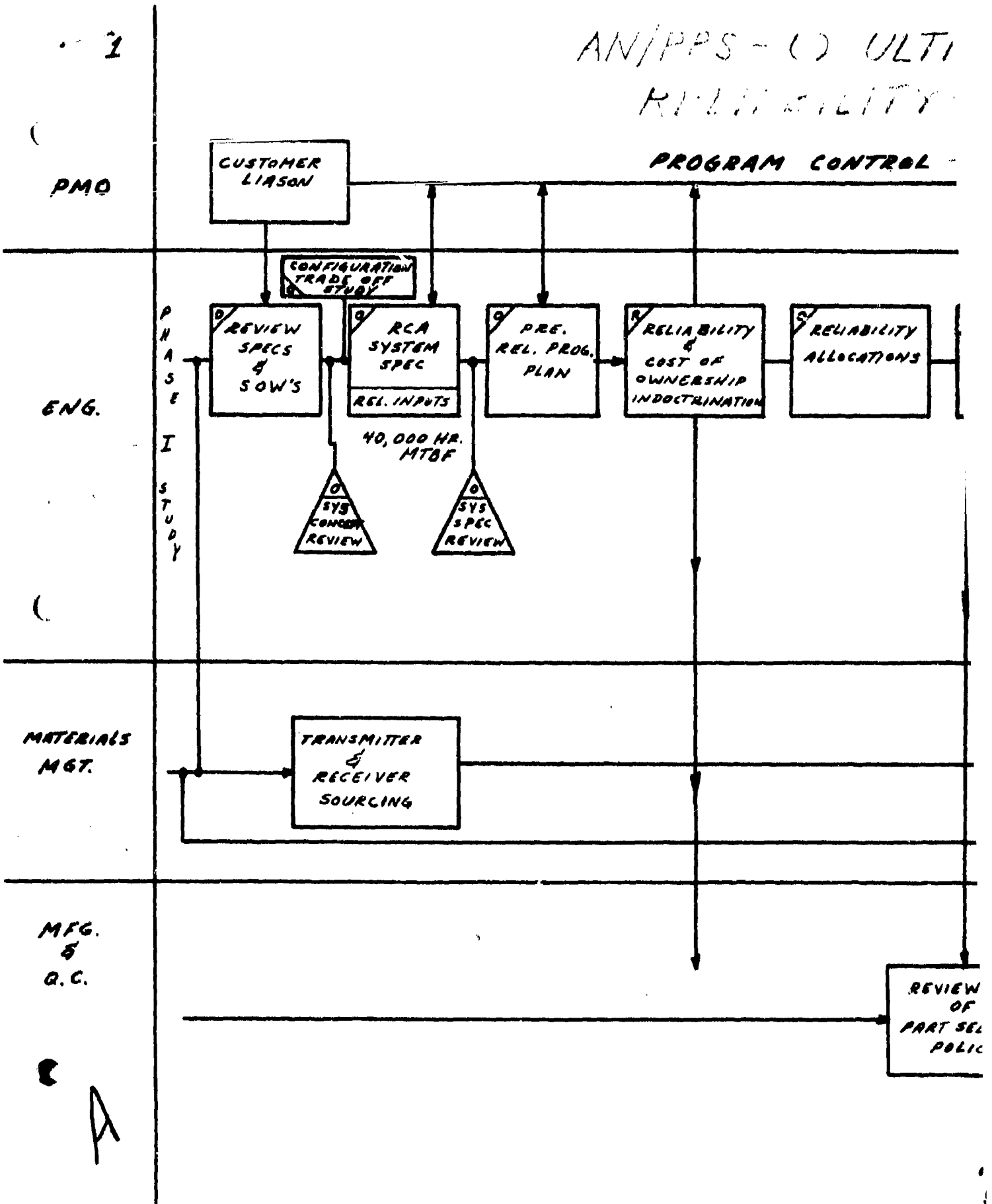

A

TRA RELIABLE RATING FLOW CHART

O - ONE TIME
R - REPETITIVE
C - CONTINUOUS

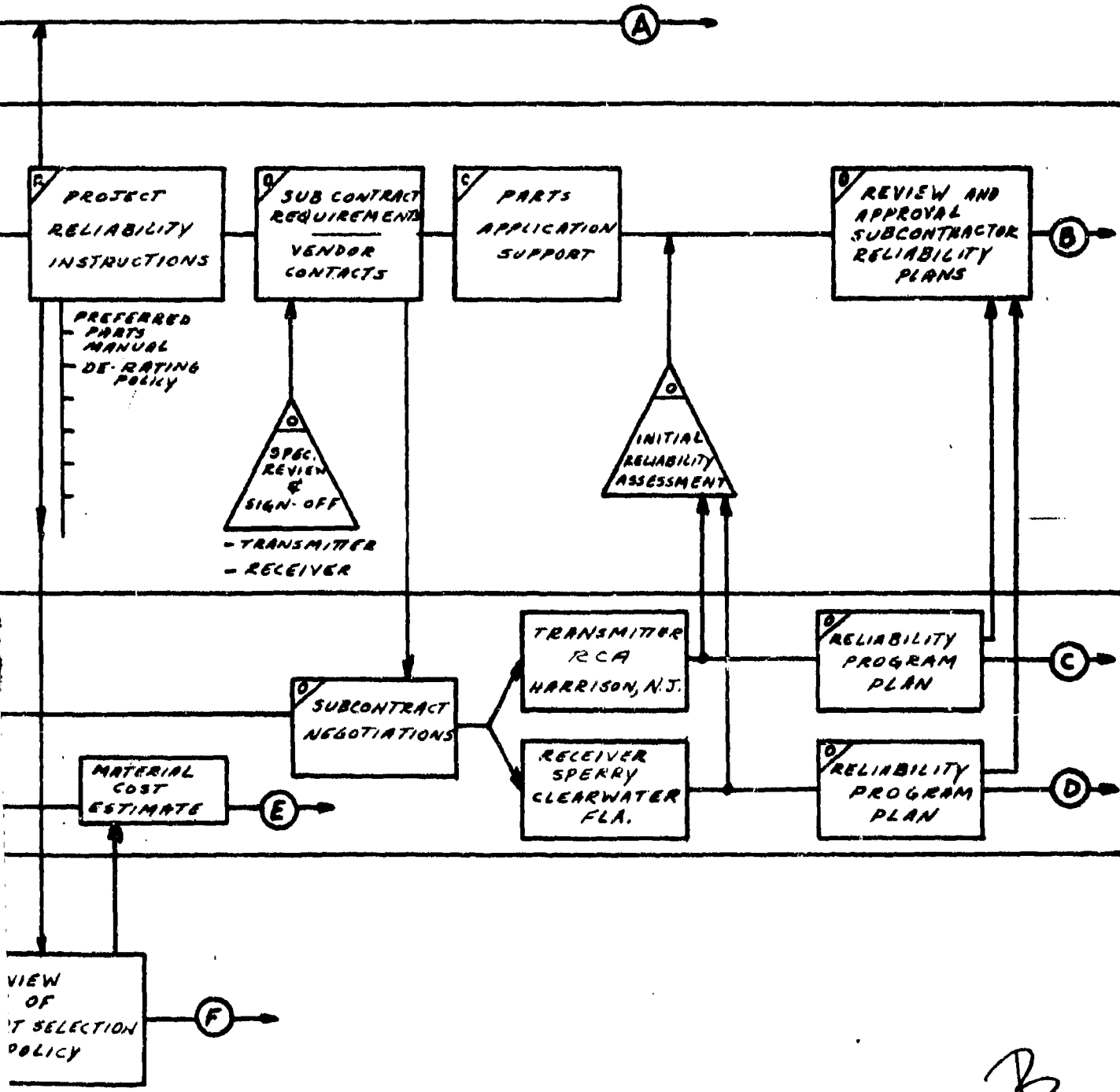

B

ATTACHMENT III

MONTHLY STATUS REPORT

RECEIVER SUBSYSTEM

of

AN/PPS-() ULTRA RELIABLE RADAR

Submitted to:

RCA
Defense Electronic Products
MISSILE & SURFACE RADAR DIVISION
Moorestown, New Jersey

March 1970

SPERRY MICROWAVE ELECTRONICS DIVISION
SPERRY RAND CORPORATION
CLEARWATER, FLORIDA

SJ228-6359-2

Copy No. _____

1. INTRODUCTION

This monthly letter is provided to report program status in accordance with RCA, P.O. J2640A-9001-014. The information contained herein covers the period of 2/23/70 through 3/23/70 and includes the status of the Reliability and Development programs.

2. PROGRAM PLANNING AND SCHEDULE

A meeting was held at Sperry on 2/27/70 for the purpose of discussing specification changes. The following personnel were present:

RCA

L. Andros
M. Breese
T. Feeney
H. Harmon
A. Schwartzman

SPERRY RAND

J. Black
J. Brown
D. Musgrave
B. Savage
D. Scott

The attached Program Schedule has been revised to reflect a two-week slippage caused by the elimination of the Redundancy Switch and the associated specification changes.

3. MECHANICAL DESIGN

General - Preliminary mechanical design has begun. Layouts are in progress to determine substrate and P/C Board sizes and to establish the unit outline.

Housing - The choice of housing material is now between #304 and #430 Stainless steels. Testing of materials and methods of sealing and soldering will determine which steel is best for this application. It has been established that unit size and weight

will be within specification limits.

Materials for the cover seal are being investigated. A test housing has been designed to aid in the final selection of materials and methods. The housing will comprise a sealed cavity with a sample substrate, connector, and feedthru. The lower cavity may be sealed as well, should we wish to test two methods of sealing.

The test unit will be subjected to a complete environmental test; (1) leak test, (2) sinusoidal vibration, (3) shock, (4) thermal cycling, (5) final leak test. The vibration fixture has been designed.

4. GATE/LIMITER

A computer-aided study of the gate with three stagger-tuned diodes shows that the required 60 dB isolation can be achieved over the frequency band, but by too small a margin to accommodate variations in diode parameters, manufacturing tolerances, temperature effects, etc. Therefore, it has been decided to use four diodes in the gate. The insertion loss will be increased by a few tenths of a dB, but should still be within that loss assumed for the gate in the noise figure calculations. Preliminary diode measurements, both low frequency and r f, indicate that the quality of the diodes is close to that assumed for the model used in the computer study. However, the diode capacitance appears to be significantly different from the value

quoted by the manufacturer. This discrepancy is expected to be resolved shortly.

A model of the limiter circuit was also programmed and run on the computer. The circuit appears adequate in all respects.

Complete gate and limiter circuits will be tested early in the next period.

5. CIRCULATOR

The work during this period was shifted from the latching circulator to the fixed junction after the former was deleted. The circulator is ready for temperature testing and finalizing the matching design.

6. MIXER

Development of a mixer hybrid with good performance has been completed. The IF filter has been developed and is being used in impedance measurements on the mixer diodes. These measurements will be used to determine the matching required. Upon completion of the matching design, the mixer will be fabricated and tested.

It is Sperry's understanding that the L.O. ports can be moved from the end of the housing to the sides. This is being considered, but no decision has been reached at present.

7. VIDEO AMPLIFIER

Several video circuit configurations have been evaluated

utilizing available low noise transistors. These configurations have included common base and common emitter input stages in which the collector currents have been optimized for best trade-off between low noise and gain. Various methods of feedback to control input impedance and gain characteristics with minimum degradation of noise figure have been considered. The adjustment of load impedance offered to the first stage has been the best method to date of controlling response characteristics across the band with the gain determined by dividing the output down. Feedback is a more desirable way of controlling gain and response characteristics but degradation of noise figure has been prohibitive.

A lower noise transistor has been ordered for first stage evaluation.

"Ball park" noise figures of 2 dB have been obtained to date.

Another problem associated with the video amplifier has been the method of quickly and accurately determining noise figure.

A temperature limited diode such as the Sylvania 5722 is an excellent noise source for frequencies between 10 MHz and 300 MHz. Within these frequencies, the constant of proportionality between available power and current is easily calculated.

$$\text{Noise factor, } F = \frac{e}{2kT} IR = 20 IR$$

Where: e = Charge of electron (1.60×10^{-19} coulomb)
k = Boltzmann's constant (1.6×10^{-20})
T = degrees Kelvin
I = diode current
R = effective source resistance

However, below 10 MHz the temperature limited noise diode cannot be relied on to be accurate owing to a possible increase of 1/f noise and a falling off of shot noise. Measurements using this method along with single frequency measurements are useful for rapid comparative measurements during development.

A more accurate method using an AIL Hot-Cold Body Standard Noise Generator is being considered to obtain noise figure measurements. This noise generator uses two resistive elements, one immersed in liquid nitrogen (77.3°K) and the other mounted in a temperature-controlled oven (373.2°K). A variable attenuator is used in the setup to obtain a y factor (in dB). The y factor is converted to a power ratio to obtain noise factor (F) which may then be converted to dB using the standard power ratio relation:

$$\text{Noise figure} = 10 \log F.$$

This method may be used to calibrate noise generators.

Development will continue on the video amplifier to improve noise figure.

8. GATE DRIVER

The following change to RCA Specification 8998827, Rev. B has been agreed to by RCA and Sperry:

Paragraph 3.5.4.3 - Gate Pulse
"1" level - (energized)
0.0 to 0.4 volts
25 nsecs (max.) rise and fall times
"0" level: 5.0 volts

In addition, SMED has agreed to include a 1K series resistor between the gate pulse input and the 5 volt B+ line and an 82 μ fd

capacitor (High Rel. 137D Sprague) between the 5 volt line and ground.

9. RELIABILITY

The program tasks described in the Reliability program plan have begun and are proceeding on schedule. Activity in each for this reporting period is discussed below:

9.1 Reliability Model and Apportionment

For the purposes of reliability analysis, each channel of the receiver module can be considered a series configuration. That is to say that every component in the channel must function in order for that channel to operate successfully. The failure rates, therefore, are additive from the component to the active element and finally to the subsystem level. Apportionment of the subsystem MTBF requirement to the individual components is now in progress. This is influenced, in part, by state-of-the-art capabilities which are being explored with suppliers. An initial MTBF prediction will be included in the next monthly status report.

9.2 Design Reviews

The two major items discussed in the internal design reviews held during this period were the basic component layout and the materials for case and seal.

The basic layout of the electronic circuitry was reviewed with three possible approaches considered.

- A. Use of two separate P.C. boards, each with one video amplifier and one gate driver.
- B. Use of two separate P.C. boards, one with two video amplifiers and one with two gate drivers.
- C. Use of one single P.C. board containing all four circuits.

Electrical test of transients and ground placement is required before the final configuration can be selected. Whichever method is selected will include separate B+, grounds, and trigger inputs to maintain complete redundancy.

Two housing materials, stainless #304 and stainless #430, together with both wire and powder forms of 50 - 50 Indium Tin Solder are being tested in all possible combinations. In addition, aluminum-loaded and silver-loaded epoxies are being evaluated. All samples will be subjected to pull tests to determine the integrity of the seal.

9.3 Other Reliability Program Tasks

Failure mode studies have begun and the other tasks shown in the program schedule are in progress. A preliminary reliability prediction will be included in next month's report.

ENGINEERING PROJECT - MILESTONE PLANNING CHART
 A.O. 6350
 DESCRIPTION PSS-1 Receiver Subsystem
 PROGRAM MANAGEMENT E. Savage

LEGEND

- ▽ SCHEDULED MILESTONE
- COMPLETED MILESTONE
- ▽ SCHED EXTENSION
- ACTIVITY
- INTERRELATED ACTIVITIES

REVISION	DATE	APPROVAL
2/27/70		
3/5/70		
3/12/70		

3/3/70 Revised

	February	March	April	May	June	July	August	September	October	November	December	January
Planning	▽											
Reliability												
Proc. Plan			▽									
Mixer & IO			▽									
Mixer-Dev.			▽									
Gate-Lim. Dev.			▽									
Redundancy		Deleted										
Switch Dev.			▽									
Gate Driv.			▽									
Dev.			▽									
Video			▽									
Exp. Dev.			▽									
System Integ.			▽									
Prototype Hardware			▽									
Parts Fab.			▽									
Prototype Assembly			▽									
Electrical Test			▽									
Delivery			▽									
Prod. Hardware			▽									
Fab. & Purchase			▽									
Parts Screening			▽									
ing Prod.			▽									
Assembly Electrical Test												
Assy Screening Test												
Selected Final Electrical Test												
Delivery												

ATTACHMENT IV

DEVELOPMENT AND FABRICATION
OF TRANSMITTER SUBSYSTEMS FOR
THE AN/PPS-() ULTRA RELIABLE RADAR

IDT-J26-40A-98-C2-Q16

Monthly Progress Report No. 1

March 13, 1970

For

RCA Missile & Surface Radar
Moorestown, New Jersey

RCA Electronic Components
Harrison, New Jersey

CONTENTS

	Page
1.0 GENERAL	1
2.0 SUMMARY	1
3.0 TRANSMITTER SUBSYSTEM	2
3.1 Overall Subsystem Design	2
3.2 Subsystem Component Design	2
3.2.1 TEO Diodes	2
3.2.1.1 CW Diodes	3
3.2.1.2 High Power Pulse Diodes	4
3.2.1.3 Low Power Pulse Diodes	4
3.2.2 Oscillator Cavities	4
3.2.3 Ferrite Components	5
3.2.4 Diode Switch	5
3.2.5 Low Pass Filters	7
3.2.6 Modulators/Regulator	7
3.3 Subsystem Package Design	7
4.0 RELIABILITY	8
5.0 MILESTONE CHART	9

1.0 GENERAL

This is the initial monthly status report issued on the RCA-MDOD program to develop and fabricate Transmitter Subsystems for the RCA M&SR AN/PPS-() Ultra Reliable Radar. The report covers work performed on IDT-J26-40A-98-C2-Q16 for the period from February 13, 1970 to March 13, 1970.

The Transmitter Subsystem is a solid state module consisting of gallium arsenide transferred electron oscillators and other microwave components which supplies both the pulsed transmitter output and the local oscillator power for the Ultra Reliable Radar. Injection locking techniques are employed to maintain frequency coherence between the two outputs. During the program, RCA MDOD intends to develop the TEO diodes and other components of the subsystem, build a prototype model for system evaluation, and, pending approval, fabricate and deliver 40 modules for extended life test and reliability evaluation. The design and fabrication will be done in accordance with the procedures and guidelines established by the concurrent Reliability Program. An estimated MTBF of 50,000 hours is the reliability objective of the program.

2.0 SUMMARY

During the first month of the program, most of the engineering effort has been directed toward determining the basic subsystem design, establishing requirements for the various components, and starting the design work on the diodes and the ferrite components. Additional engineering effort has been expended in analyzing and responding to several change proposals from M&SR including a detailed trade-off analysis between the two and three stage approaches and several specification changes defining pulse timing and input power division.

3.0 TRANSMITTER SUBSYSTEM

3.1 Overall Subsystem Design

A three-stage injection locked transferred electron oscillator (TEO) approach has been selected for the subsystem. Although this will require more components than the simpler two-stage approach, less CW locking-power is needed resulting in a lower DC battery drain for the system. The three-stage subsystem will require 6 watts of input power; the two-stage approach would require at least 12 watts.

A block diagram of the proposed system is attached. It differs in some respects with the diagram discussed prior to the program, changes having been made to permit more efficient packaging of the components.

To provide further system design information, a preliminary room temperature DC and RF power flow diagram has been prepared and is attached.

3.2 Subsystem Component Design

3.2.1 TEO Diodes

So that as much parallel effort as practical may be directed to the major development area of the program, the transferred electron diodes, the development work has been divided between the Microwave Solid State Technology Center (MSSTC) in Harrison and the Microwave Applied Research Laboratory (MAR) in Princeton. Responsibility for the design and fabrication of CW TEO diodes has been assigned to the MSSTC. The high power pulse TEO diode work will be done by MAR. A decision, based on the early results of these assignments, will be made as to the responsibility for the low power pulse diode work.

3.2.1.1 CW TEO Diodes

An evaluation of material from existing wafers is being made to determine whether or not available material can be used to supply the needs for the CW and/or low power pulse diodes. A total of 70 diodes from 10 different wafers have been made and have been submitted to test. All diodes were formed with the same area of the active region (49 square mils) and mounted with the epi-side on the heat sink. This area is larger than required for the CW diodes, but is a convenient size for material analysis.

Diodes from two of the wafers have been tested and perform as follows:

<u>Wafer No.</u>	<u>Diode No.</u>	$\frac{V_D}{V}$	$\frac{I_D}{mA}$	$\frac{P_O}{mW}$	$\frac{f_o}{GHz}$
HP-4B	12	9.6	375	50	10.8
HB-4B	14	8.0	340	38	9.2
HB-4B	15	8.0	375	30	12.35
HB-18A	01	10.0	550	77	10.4
HB-18A	02	10.0	560	66	10.4
HB-18A	10	7.57	580	52	10.5
HB-18A	16	9.0	450	50	8.7

The material selected from both of the wafers prefers to operate above 10 GHz, however, both materials have yielded one diode which gives significant CW power at lower frequencies.

The performance of the diodes from the remaining 8 wafers will be obtained and evaluated before deciding on any further investigation of HB-4B and HB-18A.

3.2.1.2 High Power Pulse TEO Diodes

The program for the fabrication of the high power pulsed transferred electron oscillators for the Transmitter Subsystem was started on February 20, 1970. Special capital equipment for the program, a high power pulser and a package welder, has been requested.

The organization of this phase of the program has been completed. We have developed a formal process schedule and documentation procedures in order to record all the data obtained during processing. This scheme has been specially designed with device reliability in view. The process schedule has been made available for program and reliability review.

Work on the growth of n⁺-n-n⁺ GaAs wafers for this program has been initiated. We expect to have a wafer by March 21, 1970. We have started processing a chip from an existing wafer in order to try out our formal device fabrication procedure. By the end of the next reporting period, we expect to have devices fabricated from a wafer grown specifically for this program.

3.2.1.3 Low Power Pulse Diode

Material from both the CW and high power pulse diode programs will be evaluated for the low power pulse diode. After performance and reliability evaluation, the better material will be selected.

3.2.2 Oscillator Cavities

The oscillator cavities have not yet been designed. It is intended that the CW TEO will use a waveguide cavity to obtain a relatively high Q to enhance locking directivity and minimize FM noise. It is desirable that the locked pulse oscillators have a lower external Q for the widest possible locking range, and coaxial cavities will be used.

Cavities of both types have been built for X-band oscillators and the required designs will be based on these existing devices.

3.2.3 Ferrite Components

Eight microstrip ferrite circulators will be included in the subsystem six with terminations so as to function as isolators. The design is based on the work of Dr. B. Hershonov of the David Sarnoff Research Laboratories. A computer program developed by MDOD engineering has been used to establish the basic design parameters.

A circulator disc of approximately 0.200" diameter and quarter-wave transformer sections will be etched on a metallized garnet substrate. Full band isolation of greater than 20 dB with approximately 0.3 dB loss is predicted for each section. In two cases, three circulator sections will be fabricated on a common substrate. The remaining L.O. and R.F. output isolators will be on separate substrates and built with one-watt terminations.

Orders have been placed for a quantity of single circulator elements, which can be interconnected to evaluate the operation with several different load configurations.

3.2.4 Diode Switch

The purpose of the diode switch is to suppress the CW locking power which would be present at the RF (transmitter) output during the interpulse period. Approximately 75 dB isolation is required to meet the -60 dBm specification. A complicating factor which restricts the design approach is the necessity of having the switch in the "on" state when the voltage is applied. The

most commonly used arrangement, direct shunt diodes, would require that current be supplied during 98% of the time rather than the 2% maximum duty cycle.

Three preliminary circuit configurations have been analyzed using a standard transmission line computer program: (1) three diodes in series, (2) a series-shunt-series TEE, and (3) three diodes in shunt spaced approximately a quarter wavelength from the main transmission line to effectively reverse the "on-off" states. The results indicate that the best figure of merit (Isolation/Insertion loss) will be obtained from the last mentioned configuration, however, the series arrangement will have superior bandwidth and allow for more efficient use of the switching power. Some DC power economy could be obtained if a lower voltage supply were made available.

Diodes suitable for microstrip mounting have been ordered and network analyzer measurements will be performed to obtain more accurate data for the computations.

An important system consideration which has been discussed with M&SR is the predicted interaction of the diode switch and the CW oscillator frequency. Since the switch will present a different load to the oscillator in each of the two states, some frequency shift will occur. The isolation provided between the switch and the oscillator will reduce this to a predicted shift of from 0 to 200 kHz depending on phasing. Since the system is coherent, it has been stated by M&SR that this effect will not present a problem to the operation of the system.

3.2.5 Low Pass Filters

Work has begun on selecting the type of filter which will be used in the subsystem. Since it is imperative for injection locking that harmonic signals are completely rejected, special attention is being given to a design which will consider the effects of signal radiation around the filter.

The system layout has been arranged to provide a filter directly at the output of each oscillator rather than in the main signal flow path. This should make separate oscillator testing more meaningful since the harmonic loading will not be substantially altered after integration into the subsystem.

3.2.6 Modulators/Regulator

The only work to date on the modulators and regulator has been to begin a survey of transistors suitable for the application. Types which are consistent with the goals of the reliability program will be used. Some further information on the TEO diode characteristics will be required before detailed design can be initiated.

3.3 Subsystem Package Design

A preliminary outline drawing of the Transmitter Subsystem has been informally released for M&SR guidance. This outline was based on a component layout which will permit the ferrite circulators and diode switch to be separate from the oscillators, filters, and modulators to make hermetic sealing of the ferrite components more practical.

A basic 1" x 3" x 5" outline is proposed as per the specification with the addition of a 3/32" mounting flange extending approximately 3/8" on each end where the input and output connectors are mounted. Tuning access to one 1" x 5" wall will be necessary to adjust the frequency of each of the three TEO cavities.

4.0 RELIABILITY

The MDOD Quality Assurance and Reliability activity has established the preliminary work plan covering the major reliability requirements of the program. This has been reported in detail in the "Reliability Program Plan" transmitted to M&SR in accordance with the governing specification PPSS-2.

The first attention of the Q&RA personnel has been to the TEO diode fabrication areas. Processing flow charts are being developed so that pertinent inspection and test control points can be established.

The basic reliability philosophy of this program will emphasize inspections, tests, and screening processes as a means of establishing reliability on a limited number of units in contrast to the wholly statistical approach more pertinent to mass produced components.

5.0 MILESTONE CHART

Next Monthly Status Report	April 13, 1970
Reliability Program Plan	March 13, 1970 Complete
Design Review Data Package	May 6, 1970
Design Review at MDOD	May 13, 1970
Configuration Drawings	May 13, 1970
Preliminary Acceptance Test Procedure	May 13, 1970
Prototype Units	June 29, 1970
Reliability Design Review	June 29, 1970
Design Approval - M&SR	August 13, 1970
Final Acceptance Test Procedure	September 1, 1970
Transmitter Subsystem Deliveries (Including Inspection and Test Reports)	
2	October 13, 1970
10	November 13, 1970
13	December 14, 1970
15	January 13, 1971
Reliability Report	February 15, 1971
Handbook Data	March 15, 1971

BLOCK DIAGRAM TRANSMITTER SUB-SYSTEM FOR URR-PPS-()

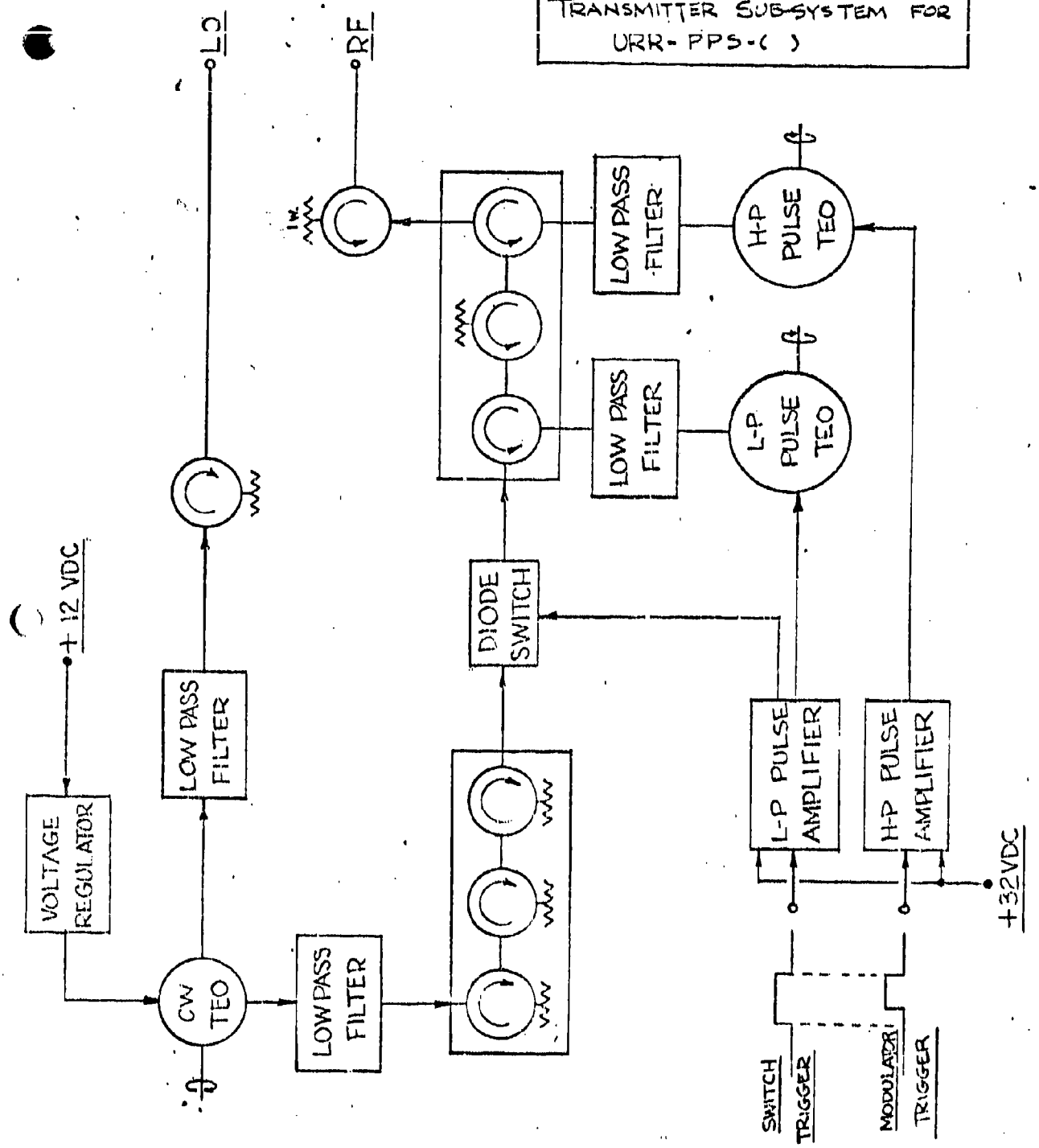

THESE DRAWINGS AND SPECIFICATIONS ARE THE PROPERTY OF RADIO CORPORATION OF AMERICA, AND SHALL NOT BE REPRODUCED OR COPIED OR USED AS THE BASIS FOR THE MANUFACTURE OR SALE OF APPARATUS OR DEVICES WITHOUT PERMISSION.

CODE IDENT NO.	SIZE	NUMBER
49671	A	303/359
SCALE	WEIGHT	SHEET 1 OF 1

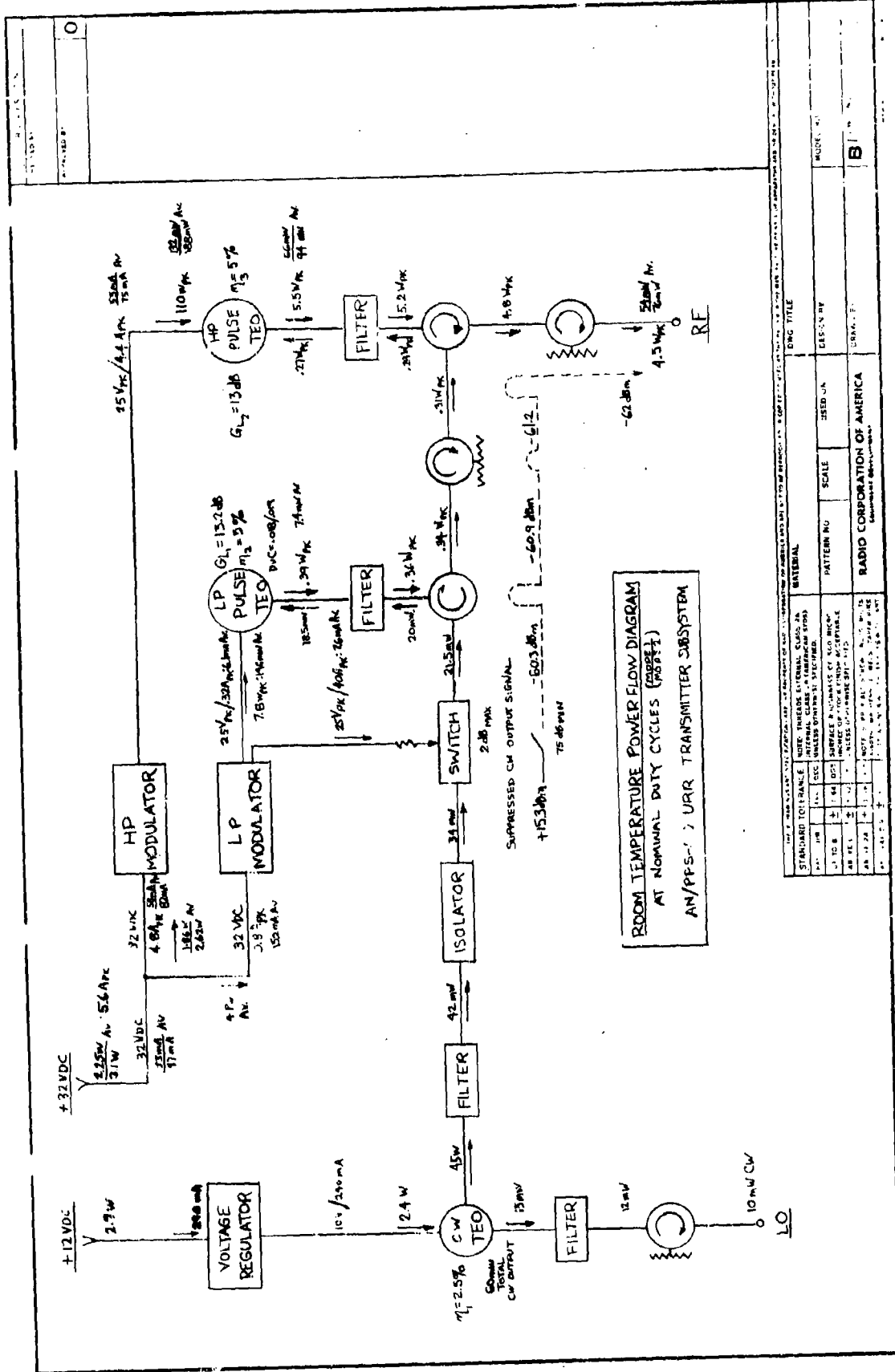

STANDARD TOLERANCE		MATERIAL		ENG TITLE	
UNLESS OTHERWISE SPECIFIED	ALL DIMENSIONS ARE TO BE TAKEN TO THE CENTER OF MASS UNLESS OTHERWISE SPECIFIED	UNLESS OTHERWISE SPECIFIED	ALL MATERIALS ARE TO BE OF THE HIGHEST QUALITY AVAILABLE	UNLESS OTHERWISE SPECIFIED	ALL DIMENSIONS ARE TO BE IN INCHES AND DECIMALS THEREOF
UNLESS OTHERWISE SPECIFIED	ALL DIMENSIONS ARE TO BE TAKEN TO THE CENTER OF MASS UNLESS OTHERWISE SPECIFIED	UNLESS OTHERWISE SPECIFIED	ALL MATERIALS ARE TO BE OF THE HIGHEST QUALITY AVAILABLE	UNLESS OTHERWISE SPECIFIED	ALL DIMENSIONS ARE TO BE IN INCHES AND DECIMALS THEREOF
UNLESS OTHERWISE SPECIFIED	ALL DIMENSIONS ARE TO BE TAKEN TO THE CENTER OF MASS UNLESS OTHERWISE SPECIFIED	UNLESS OTHERWISE SPECIFIED	ALL MATERIALS ARE TO BE OF THE HIGHEST QUALITY AVAILABLE	UNLESS OTHERWISE SPECIFIED	ALL DIMENSIONS ARE TO BE IN INCHES AND DECIMALS THEREOF
UNLESS OTHERWISE SPECIFIED	ALL DIMENSIONS ARE TO BE TAKEN TO THE CENTER OF MASS UNLESS OTHERWISE SPECIFIED	UNLESS OTHERWISE SPECIFIED	ALL MATERIALS ARE TO BE OF THE HIGHEST QUALITY AVAILABLE	UNLESS OTHERWISE SPECIFIED	ALL DIMENSIONS ARE TO BE IN INCHES AND DECIMALS THEREOF
UNLESS OTHERWISE SPECIFIED	ALL DIMENSIONS ARE TO BE TAKEN TO THE CENTER OF MASS UNLESS OTHERWISE SPECIFIED	UNLESS OTHERWISE SPECIFIED	ALL MATERIALS ARE TO BE OF THE HIGHEST QUALITY AVAILABLE	UNLESS OTHERWISE SPECIFIED	ALL DIMENSIONS ARE TO BE IN INCHES AND DECIMALS THEREOF

REVISED BY	
DATE	

DESIGN BY	
SCALE	
PATTERN NO.	
USED ON	
DATE	
REVISION	
BY	
DATE	
REVISION	
BY	
DATE	

AN/PPS- () ULTRA RELIABILITY

PROGRAM CONTROL

CUSTOMER
LIASON

PMO

CONFIGURATION
TRADE OFF
STUDY

REVIEW
SPECS
&
SOW'S

RCA
SYSTEM
SPEC
REL. INPUTS

PRE.
REL. PROG.
PLAN

RELIABILITY
&
COST OF
OWNERSHIP
INDOCTRINATION

RELIABILITY
ALLOCATIONS

RELIABILITY
POLICY

PHASE
I
STUDY

ENG.

40,000 HR.
MTBF

SYS
CONCEPT
REVIEW

SYS
SPEC
REVIEW

MATERIALS
MGT.

TRANSMITTER
&
RECEIVER
SOURCING

MFG.
&
Q.C.

REVIEW
OF
PART SELECTION
POLICY

C
A

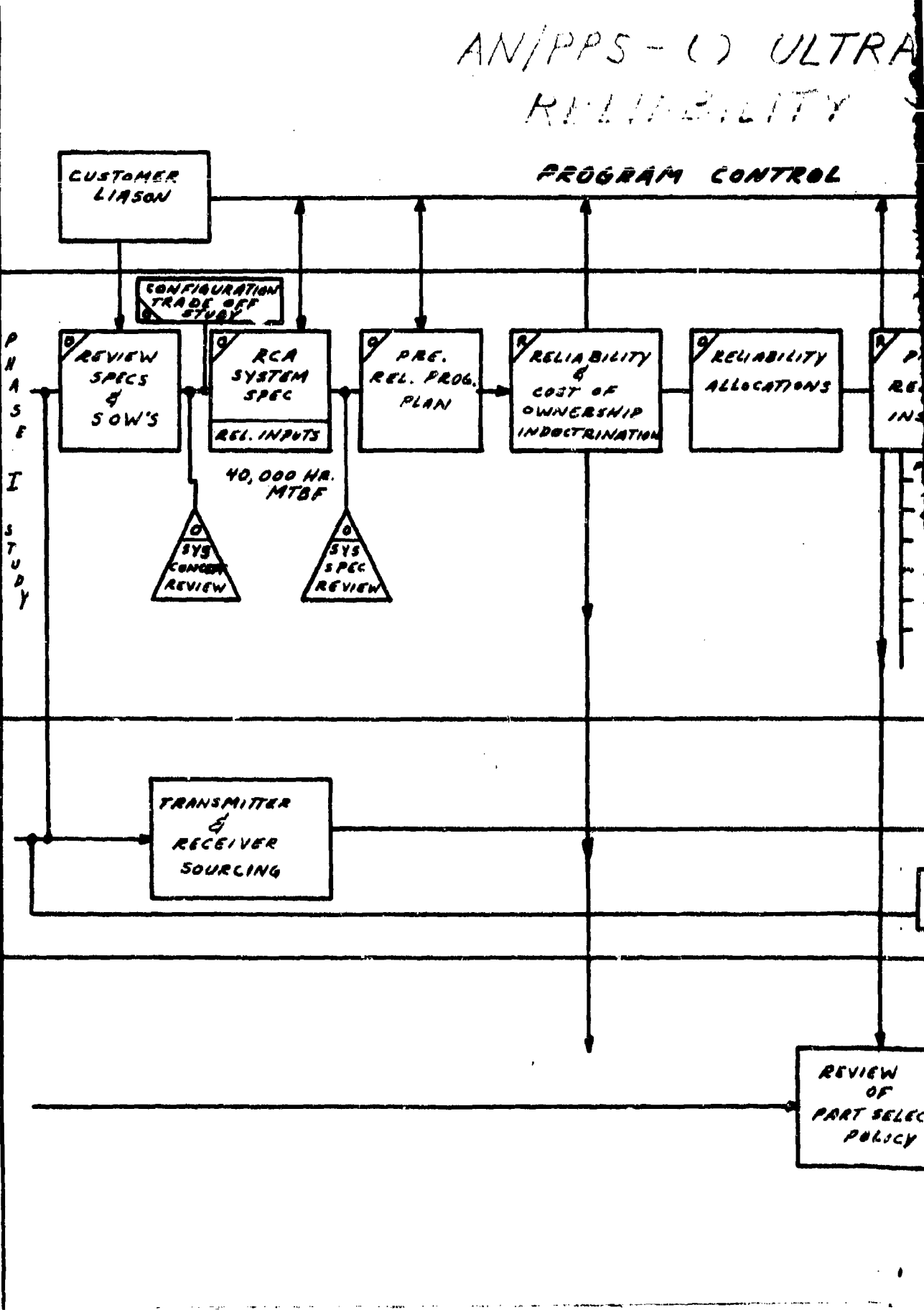

ULTRA RELIABLE RADAR FLOW CHART

O - ONE TIME
R - REPETITIVE
C - CONTINUOUS

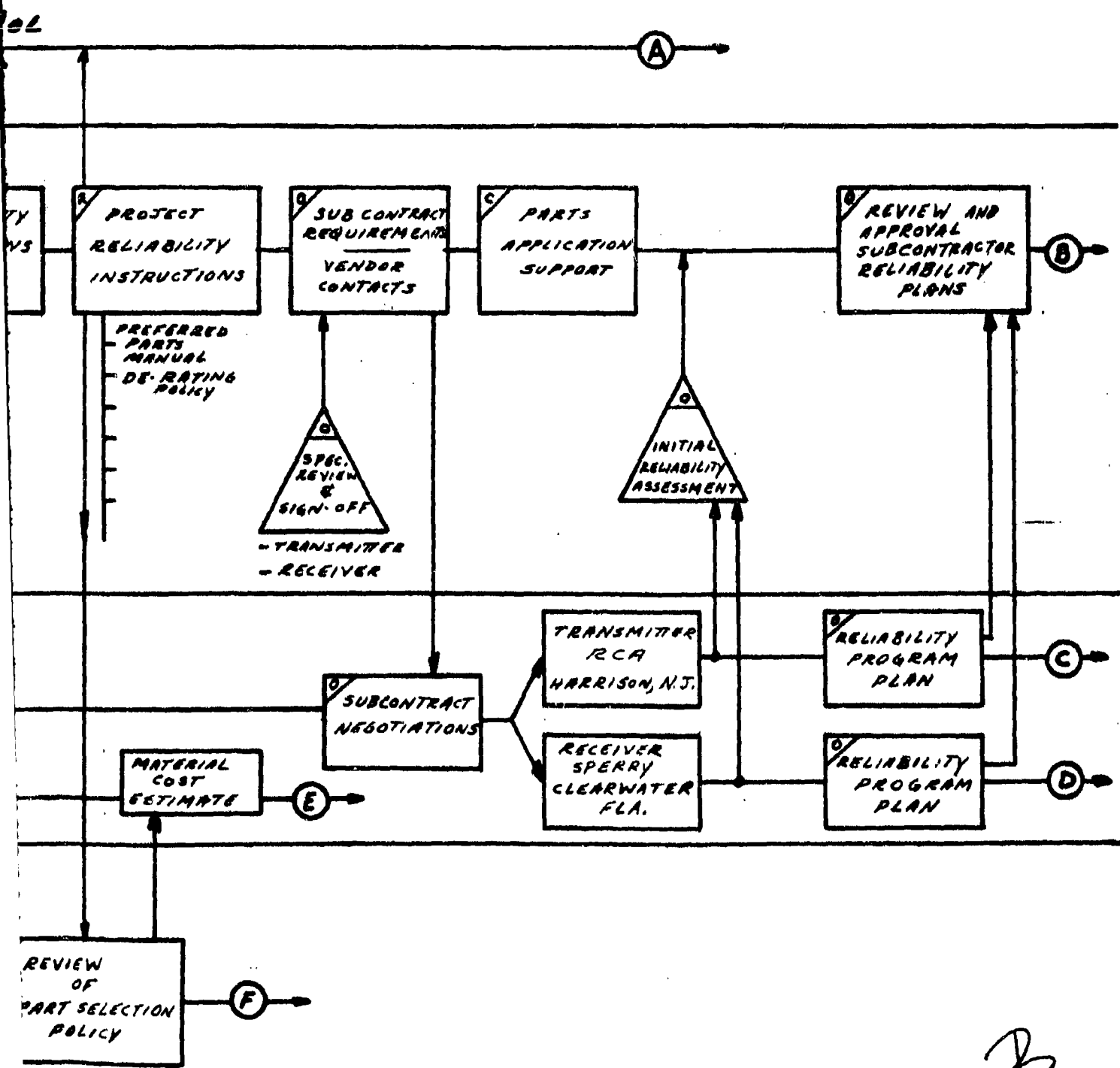

B

2

TMO → (A)

ENG.

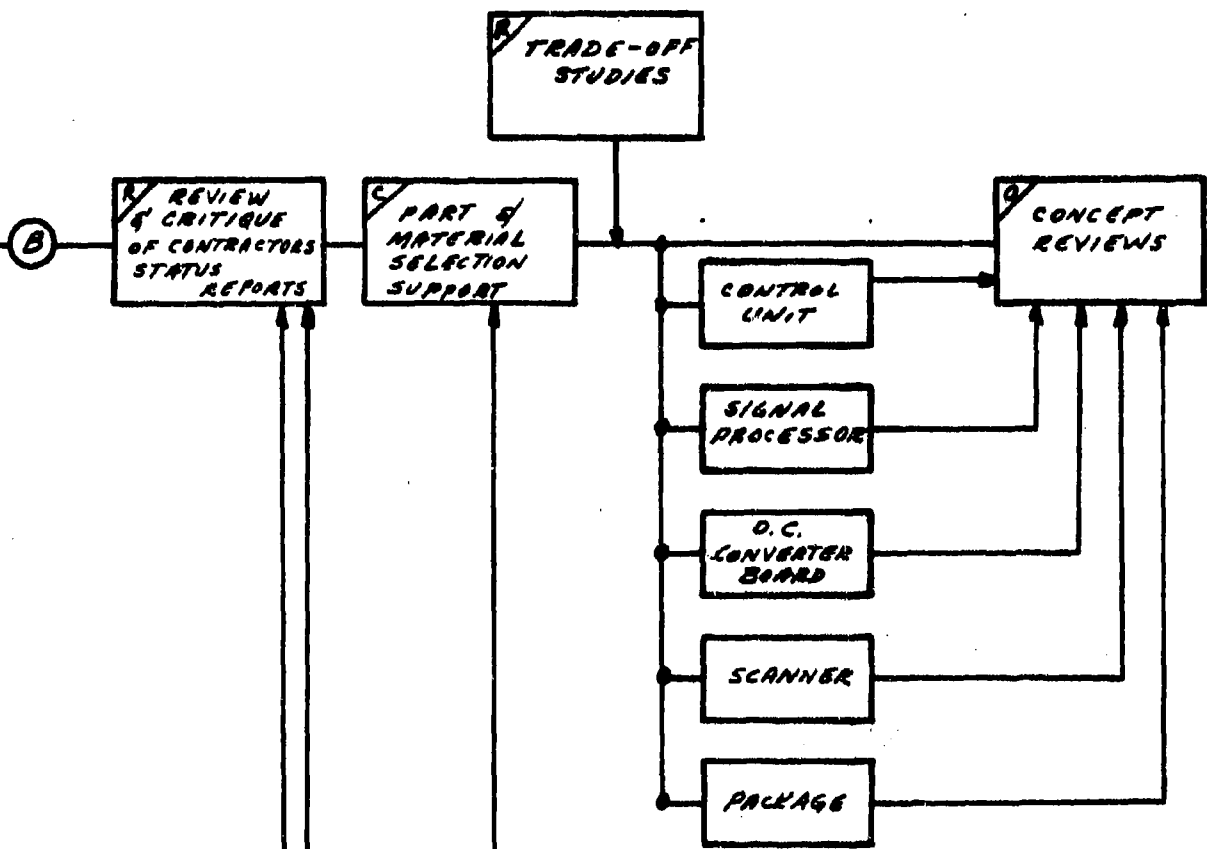

MATERIALS MGT.

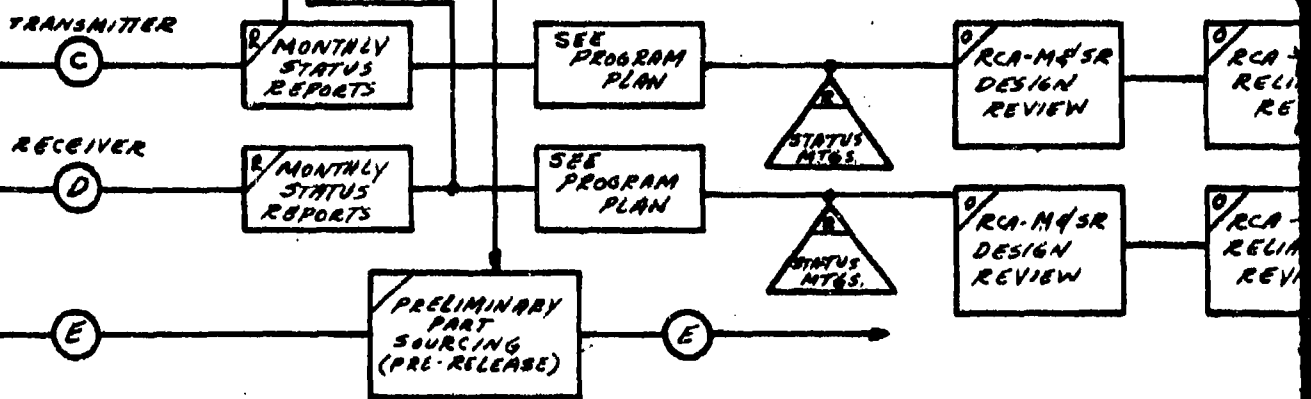

MFG. & Q.C.

→ (F)

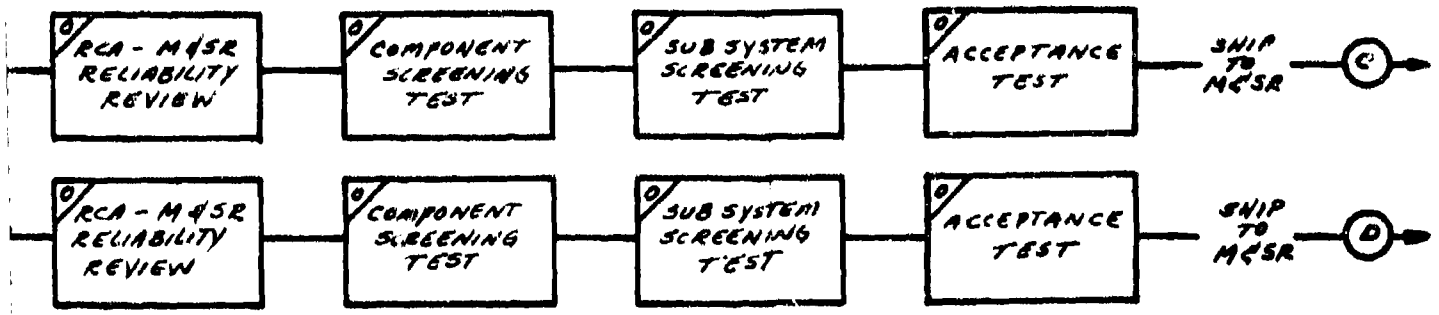
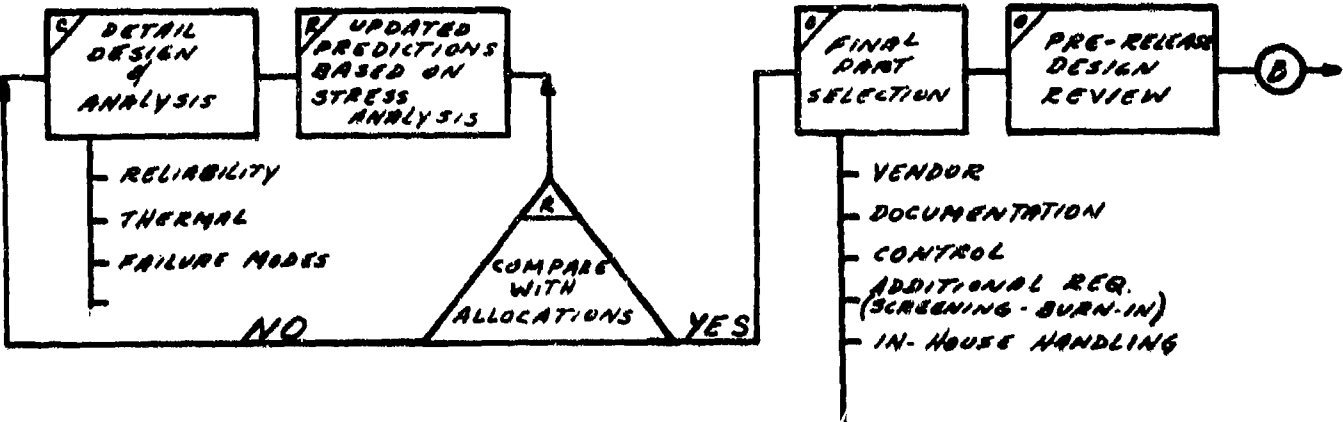

FIG. 2
3/26/70

B

3

PMO

ENG.

RISK ASSESSMENT ANALYSIS

PRELIMINARY P/L DATA SHEET DEM 2325R1

CONFIGURATION MGT.

FINAL RELEASE & UPDATING DEM 2423 DEM 2424

FINAL PREDICTION

REVIEW & SIGN-OFF

EN REVIEW & SIGN-OFF

AUTOMATED OUTPUTS

REVIEW & SIGN-OFF DEM 2423 DEM 2424

COMP WITH ALLOCATE

SPECIAL PROCESS, TEST, OR ASSEMBLY INSTRUCTIONS

MANUAL OUTPUTS

MATERIALS MGT.

MATERIAL ORDERING

NON BULK ORDERING

MANUAL

REQUISITIONS

BULK ORDERING

AUTO. PRO.

5AM CARDS

MFG. & Q.C.

F

METHODS ENG.

A

PMO

ENG

MATERIALS
MGT.

MFG.
&
Q.C.

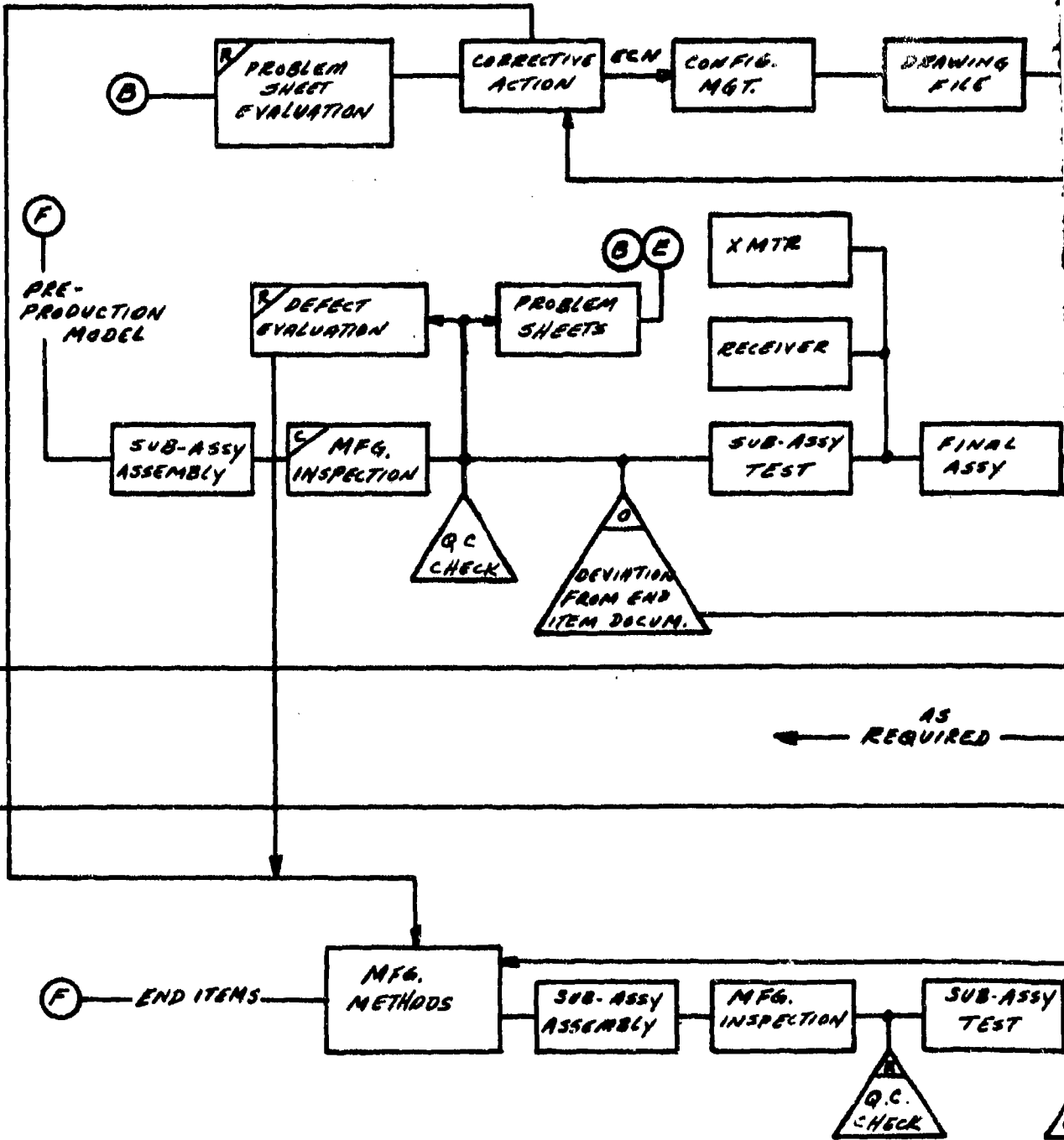

A

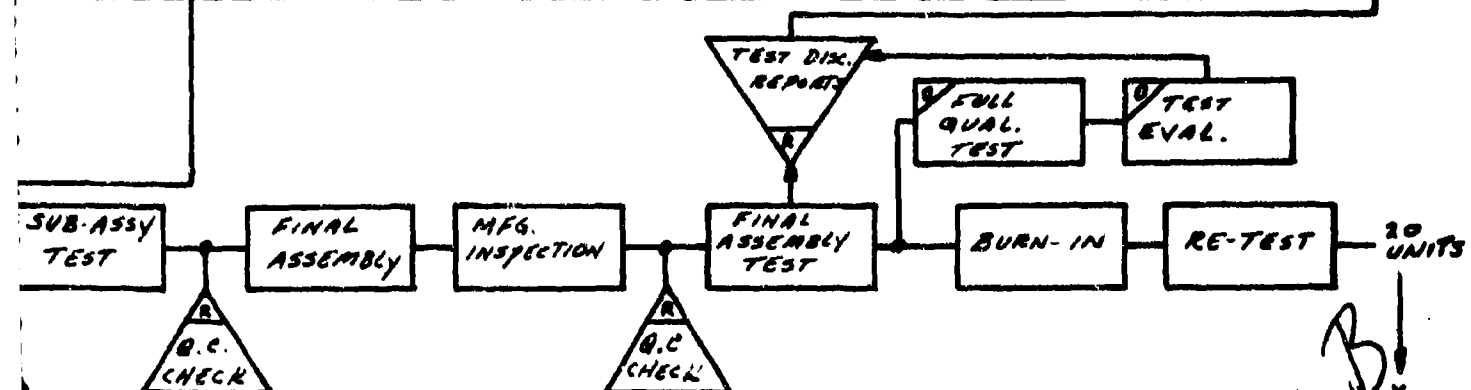
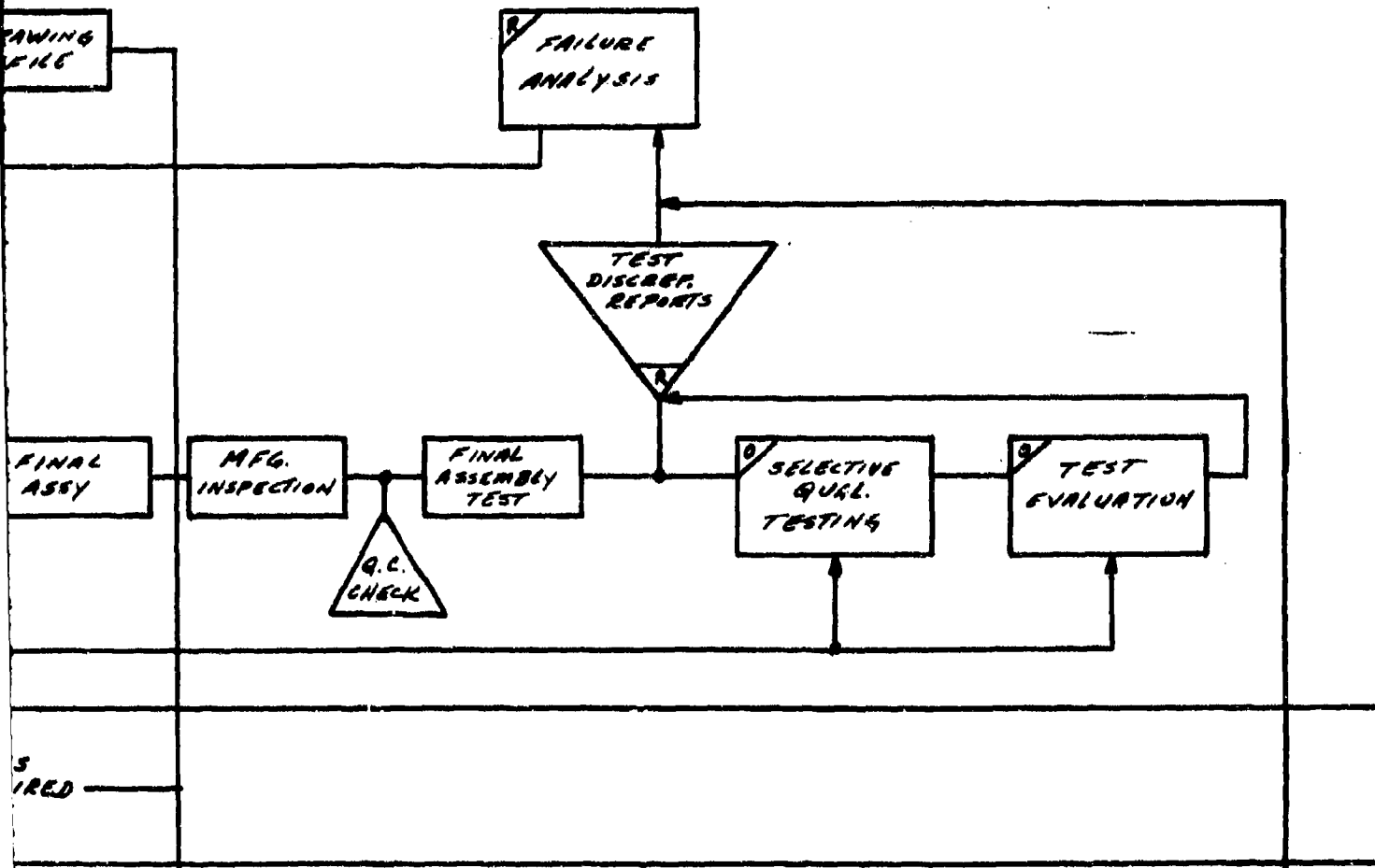
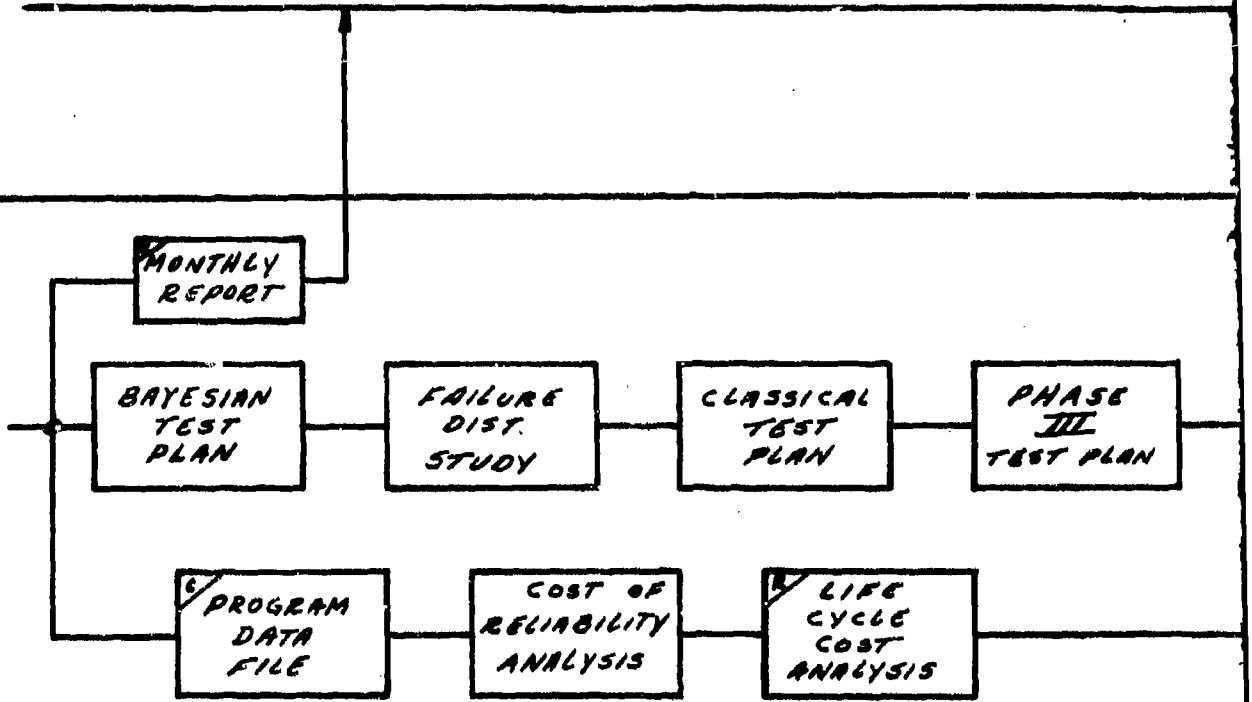

FIG - 4
 3/26/70
 B ↓ x

5

PMO

ENG.



MATERIALS
MGT.

MFG.
&
Q.C.

A

CUSTOMER

PHASE III

AN

C
PHASE
III
TEST

D
FINAL
REPORT

20
PPSE]

INSPECT

PACK
&
SHIP

PHASE 5
3/20/73

B

