

TM 11-6660-218-12

TECHNICAL MANUAL

OPERATOR'S AND ORGANIZATIONAL MAINTENANCE MANUAL

**METEOROLOGICAL STATION,
MANUAL AN/TMQ-4**

(NSN 6660-00-537-9195)

This copy is a reprint which includes current pages from Changes 2 through 8.

HEADQUARTERS, DEPARTMENT OF THE ARMY
25 MAY 1967

CHANGE }
 No. 8 }

HEADQUARTERS
 DEPARTMENT OF THE ARMY
 WASHINGTON, DC, 2 July 1981

Operator's and Organizational Maintenance Manual
 METEOROLOGICAL STATION, MANUAL AN/TMQ4
 (NSN 6660-00-537-9195)

TM 11-6660-218-12, 25 May 1967, is changed as follows:

1. A vertical bar appears opposite new or changed material.
2. Remove and insert pages as indicated in the page list below:

Remove pages	<i>Insert pagea</i>
<i>i</i> _____	<i>i</i> _____
1-1 through 1-12 _____	1-1 through 1-12
1-21 through 1-37/1-38 blank _____	1-21 through 1-40
2-1 through 2-8 _____	2-1 through 2-8
3-1 through 3-6 _____	3-1 through 3-6
3-9 through 3-16 _____	3-9 through 3-15
6-1 and 6-2 _____	6-1/(6-2 Blank)
A-1 and A-2 _____	A-1 and A-2
I-1 through I-3 _____	I-1 through I-2

3. File this change sheet in front of the manual for reference purposes.

By Order of the Secretary of the Army:

Official:

ROBERT M. JOYCE
Brigadier General, United States Army
The Adjutant General

E. C. MEYER
General, United States Army
Chief of Staff

Distribution:

To be distributed in accordance with DA Form 12-25C requirements for Meteorology.

WARNING

Should any corroded, pitted, scarred, or broken ML-304A/TM, ML-305A/TM, or ML-587/TM canisters be found, perform the following:

- a. Extinguish any source of spark or flame.
- b. Fill a large bucket minimum 5 gallon container with water.
- c. Puncture the knockout holes in the canister.
- d. Put *one* canister at a time in the bucket in an open uncovered area away from all source of spark flame, or ventilation intakes.
- e. Allow 3045 minutes for hydrogen generation. Remove canister from bucket and dispose of through normal channels *after* hydrogen cycle has stopped

TECHNICAL MANUAL }
 No. 11-6660-218-12 }

HEADQUARTERS
 DEPARTMENT OF THE ARMY
 WASHINGTON, DC, 25 May 1967

Operator's and Organizational Maintenance Manual
METEOROLOGICAL STATION MANUAL AN/TMQ-4
(NSN 6660-00-537-9195)

	Paragraphs	Page
CHAPTER 1. INTRODUCTION		
Section I. General	1-1—1-3	1-1
II. Description and data	1-4-1-14	1-3
CHAPTER 2. INSTALLATION	2-1-2-5	2-1
3. OPERATING INSTRUCTIONS		
Section I. Preliminary operating procedures and observation of equipment	3-1-3-3	3-1
II. Meteorological data techniques	3-4-3-10	3-11
CHAPTER 4. OPERATOR'S MAINTENANCE	4-1-4-10	4-1
5. ORGANIZATIONAL MAINTENANCE		
Section I. Organizational maintenance instructions	5-1—5-10	5-1
II. Troubleshooting and repair procedures	5-11—5-15	5-4
III. Functioning of equipment	5-16-5-19	5-7
CHAPTER 6. SHIPMENT AND LIMITED STORAGE	6-1-6-2	6-1
APPENDIX A. REFERENCES		A-1
B. BASIC ISSUE ITEMS LIST (BIIL) AND ITEMS TROOP INSTALLED OR AUTHORIZED LIST (ITIAL)		
Section I. Introduction		B-1
II. Basic Issue items list		B-2
III. Items troop installed or authorized list (not applicable)		
APPENDIX C. MAINTENANCE ALLOCATION		C-1
INDEX		1-1

* This manual supersedes so much of TM 11-6660-218-15, 6 April 1961, as pertains to instruction for the operation and maintenance of the equipment including C 2, 18 September 1963, C 3,3 January 1966.

CHAPTER 1

INTRODUCTION

Section I. GENERAL

1-1. Scope

a. This manual describes Meteorological Station, Manual AN/TMQ-4, and covers its installation, operation, and maintenance. It includes operation, cleaning and inspection of equipment, and replacement of parts.

b. The basic issue items list is contained in appendix B, and the maintenance allocation chart is contained in appendix C.

c. Official nomenclature followed by (*) is used to indicate all models of equipment items covered in this manual. Thus, Barometer ML-102-(*) represents Barometers ML-102-B, ML-102-D, ML-102-E, ML-102-F, and ML-102-G; Reel RL-39(*) represents Reels RL-39, RL-39-A, and RP 39-B; Radiosonde Set AN/AMTA (*) represents Radiosonde Sets AN/AMT-4A, AN/AMT-4B, AN/AMT-4C, AN/AMT-4D, and AN/AMT-4E; Radiosonde Recorder AN/TMQ-5 (*) represents Radiosonde Recorders AN/TMQ-5A, AN/TMQ-5B, and AN/TMQ-5C; Rawin Set AN/GMD-1(*) represents Rawin Sets AN/GMD-1A and AN/GMD-1B.

1-2. Indexes of Publications

Refer to the latest issue of DA PAM 3104 to determine whether there are new editions, changes, additional publications or modification work orders pertaining to the equipment.

1-3. Maintenance Forms, Records, and Reports

a. *Report of Maintenance and Unsatisfactory Equipment.* Department of the Army forms and procedures used for equipment maintenance will be those prescribed by TM 38-750, The Army Maintenance Management System.

b. *Report of Item and Packaging Discrepancies.* Fill out and forward SF 364 (Report of Discrepancy (ROD)) as prescribed in AR 735-11-2/DLAR 4140.55/NAVMATINST 4355.73/AFR 400-54/MCO 4430.3E.

c. *Discrepancy in Shipment Report (DISREP) (SF 361).* Fill out and forward Discrepancy in

Shipment Report (DISREP) (SF 361) as prescribed in AR 55-38/NAVSUPINST 4610.33B/AFR 75-18/MCO P4610.19C and DLAR 4500.15.

1-3.1. Reporting Errors and Recommending Improvements

You can help improve this manual. If you find any mistakes or if you know of a way to improve the procedures, please let us know. Mail your letter, DA Form 2028 (Recommended Changes to Publications and Blank Forms), or DA Form 2028-2 located in back of this manual direct to Commander, US Army Communications and Electronics Materiel Readiness Command, ATTN: DRSEL-ME-MQ, Fort Monmouth, NJ 07703. In either case, a reply will be furnished direct to you.

1-3.2. Reporting Equipment Improvement Recommendations (EIR)

If your AN/TMQ4 needs improvement, let us know. Send us an EIR. You, the user, are the only one who can tell us what you don't like about your equipment. Let us know why you don't like the design. Tell us why a procedure is hard to perform. Put it on an SF 368 (Quality Deficiency Report). Mail it to Commander, US Army Communications and Electronics Materiel Readiness Command, ATTN: DRSELME-MQ, Fort Monmouth, NJ 07703. We'll send you a reply.

1-3.3. Administrative Storage

Administrative storage of equipment issued to and used by Army activities will have preventive maintenance performed in accordance with the PMCS charts before storing. When removing the equipment from administrative storage the PMCS should be performed to assure operational readiness.

1-3.4. Destruction of Army Electronics Materiel

Destruction of Army electronics materiel to prevent enemy use shall be in accordance with TM 750-244-2.



Figure 1-1. Meteorological Station, Manual AN/TMIQ-4, using visual means of collecting meteorological data.

Section II. DESCRIPTION AND DATA

1-4. Purpose and Use

a. Purpose. Meteorological Station, Manual AN/TMQ-4 is a transportable meteorological equipment set. It includes equipment for making and evaluating pilot balloon observations; for making surface observations of temperature, relative humidity, dewpoint, vapor pressure, atmospheric pressure, and wind direction and velocity; and for determining ballistic winds, density, and temperature.

b. Use. The equipment is used by field artillery units to make visual (fig. 1-1), and electronic (fig. 1-2) observations of the atmosphere, and to perform sound ranging techniques. The information obtained by these observations is used to make corrections for atmospheric effects on the trajectory of artillery projectiles, and to locate positions of enemy fire.

1-5. Technical Characteristics

a. Anemometer.

Note. Anemometer ML-497/PM is similar to ML-433A/PM. Information in this manual applies to both units, unless otherwise specified.

ML-433A/PM:

Velometer ----- 0 to 8 ± 1.5 knots. 0 through 40 ± 2.0 knots.

Wind vane and
compass --__ ---0-360° $\pm 11.25^\circ$.

Mounting ----- Handle.

ML-497/PM:

Velometer - - - - - 0 to 8 ± 1.5 , 0 to 40 ± 2.0 mph.

Wind vane and
compass - - - - - 0-360° $\pm 11.25^\circ$.

Mounting - - - - - Handle.

b. Barometer ML-102-().*

Type ----- Aneroid, portable, precision.

Inches of mercury

range ----- 22-31.5 (ML-102-B,-E,-F).

Millibar range ----- 745-1,085 (ML-102-B,-E,-F).

745-1,065 (ML-102-D,-G).

Graduation intervals:

Inch scale ----- 0.02 from 22 to 31, numbered each 0.1 inch (ML-102-B,-E,-F),

Millibar scale ----- 1 millibar, numbered each 5 millibars (ML-102-B, -E, -F).

0.5 millibar, numbered each 10 millibars (ML-102-D, -G).

Reading position -- Vertical (models B, E, and F). Horizontal (models D and G).

c. Battery Pack BA-259/AM.

Voltage ----- 1.5- and 6-volt A-supply, 115-volt B-supply.

Operating life ----- 2 to 4 hours.

Type ----- Water activated.

d. Calcium Hydride Charges ML-304A/TM, ML-305A/TM, and ML-587/TM.

ML-304A/TM ----- Generates enough hydrogen to inflate a 30-gram balloon to produce a free lift of 155 grams minimum.

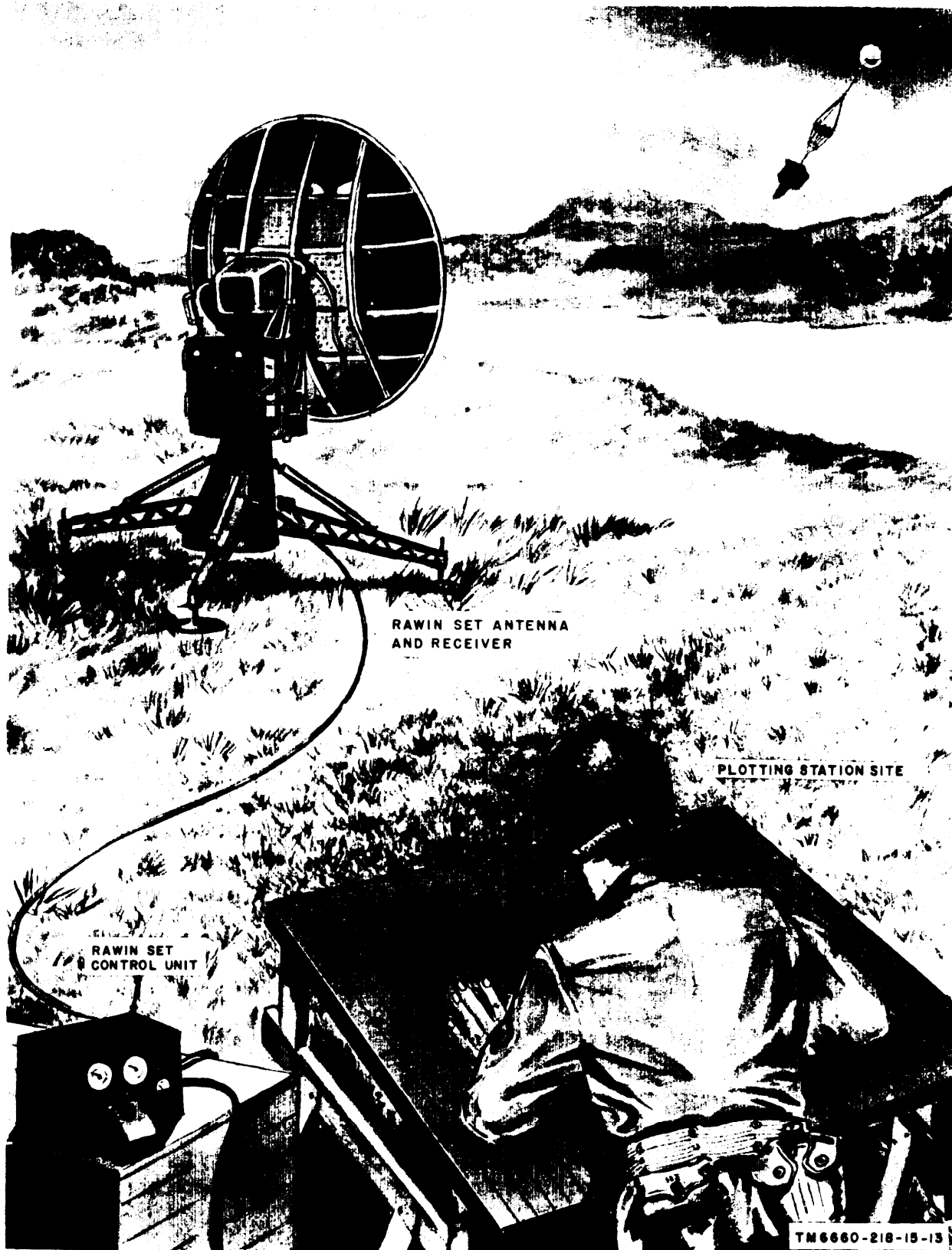

Figure 1-2. Electronic observation of upper atmosphere.

- ML-305A/TM Generates enough hydrogen to inflate a 100-gram balloon to produces free lift of 650 grams minimum.
 ML-587/TM. Generates enough hydrogen from calcium hydride to produce a total lift of 1,360 grams.
- e. Head and Chest Set H-164/U.*
 Impedance. 900 ohms.
 operating power. Sound powered.
 Operating range. Approximately 3 miles.
- f. Hydrogen Generator Set AN/TMQ-3.*
 Hose ML-81
 Material Heavy gum tubing.
 Dimensions 1/8-inch inside diameter. 3/4-inch outside diameter. S-10 feet long.
- Hydrogen Generator
 ML-303/TM :
 Chemical charge. Calcium hydride.
 Type One-shot.
- Manifold ML-344/TMQ-3:
 Number of input tubes. 4.
 Number of output tubes. 1.
- g. Lighting Unit ML-608/AM*
 Power source 6-volt dc, water-actiaaed Battery BA-253/U.
 Bulb base Bayonet.
- h. Nozzle ML-196.*
 Material Steel.
 Weighing off range 1,500 to 3,700 grams in 100-gram steps.
 Separate weights. 100, 200, 400, 500, and 1,000 grams.
- i. Parachute ML-132.*
 Material Paper.
 Size 6 feet in diameter.
- j. Parachute ML-609/U*
 Material Paper.
 Size 16 1/4 inches in diameter.
- k. Plotting Board ML-122.*
 Type. Portable.
 Material Plywood with phenolic surface.
 Inscriptions. 3 horizontal lines, 25 vertical lines, and a degree azimuth scale consisting of 360 circle marked in 1/5 divisions.
- 1. Psychrometer ML-224.*
 Type General observation.
 Thermal element Mercury.
 Temperature range:
 General. -37° C to +46° C.
 Tropical. 12° C to +63 C.
 Tropical 1° intervals with every tenth degree numbered.
- Accuracy :
 Below -18 C ±0.4° C.
 From -18 to 0° C ±0.3° C.
 Above 0° C ±0.2° C.
- Mounting. Metal frame.
 Method of ventilation. Hand sling.
- m. Radiosonde Set AN/AMT--4(*).*
 Meteorological measurements:
 Atmospheric pressure. 5 to 1,060 millibars ±4.
 Temperature +60 C to -90 C ± 1
 Relative humidity. 15 to 100 percent ±10.
 Distance range:
 Altitude 100,000 feet maximum.
 Horizontal 125 miles maximum.
 Power source Battery Pack BA-259/AM.
 Output power 3 watts (approximate).
- n. Reel RL -39-(*)*.
 (capacity 1/2 mile of Wire W - 130-A, or its equivalent.

TM 11-6660-218-12

o. Reel, Launching ML-367/AM.

Material _____ Aluminum.
Length of cord _____ 60 feet.

p. Regulator, Pressure, Compressed Gas ML-528/GM.

Material _____ Brass.
Gage, high pressure _____ Indicates high pressure from 0 to 3,000-pounds per square inch.
Gage, low pressure _____ Indicates pressure from 0 to 50 pounds per square inch.
Valve _____ Diaphragm-type reducing.
Fittings _____ For attachment to a gas cylinder valve.

q. Meter, Volume, Hydrogen-Helium, ML-605/U.

Rate of gas delivery:
Helium _____ 400 cubic feet per hour minimum.
Hydrogen _____ 600 cubic feet per hour minimum.
Method of metering gas delivery _____ Gas volume indicator at 60° F and 1013 milibars of pressure. Temperature-compressed bimetal element corrects for temperature changes between +140° F and -40° F.

r. Shroud, Balloon ML-424.

Material _____ Cotton duck.
Size _____ 61/4 feet.

s. Slide Rule ML-59.

Type _____ Mannheim.
Material _____ Wood/Metal.
Indicator _____ Frameless glass.

t. Telephone Set TA-312/PT.

Transmission frequency range - 300 to 3,200 cycles per second.
Altitude limit _____ -10,000 feet.
Temperature limits _____ -40° F to +131° F.
Power source:
Local battery _____ 2 batteries (BA-30) located within the battery compartment of the telephone.
Common battery _____ Battery supplied by switchboard.
Transmission range using
Wire WD-TT - _____ Wet 14 miles, dry 22 miles.

u. Balloon Launcher ML-594/U.

Operating ranges:
Wind _____ 0-50 mph/w rain or dust.
Temperature _____ -40 to +140° F.
Ice cover on equipment surface 1/16-inch maximum thickness.
Altitude _____ Sea level to 10,000 feet.

v. Theodolites, Double Center ML-474/GM.

Tracking telescope:
Magnification _____ 19 to 24 power.
Field of view _____ 1.7° to 2.1°.
Optical system _____ Right angle, using prism.
Finder telescope:
Magnification _____ 3.75 to 5 power'.
Field of view _____ 10 Degrees (Approximate).
Optical system _____ Right angle, using mirror.
Azimuth scale:
Range _____ -360°.
Marking degrees _____ 0.1°.
Elevation scale:
Range _____ 240°.
Marking degrees _____ 0.1°.
Power source _____ 2 Batteries BA-30.

w. Timer, Stop FM-103.

Type _____ Mechanical.
Range _____ 1/2 second to 0 minute.
Fast hand _____ -1 revolution every 1 minute.
Slow hand _____ 1 revolution every 60 minutes.

The magnification of the tracking telescope and the finder telescope is a fixed characteristic within the limits indicated.

x. Tropical Thermometer.

Temperature range +5° to +150° F.
 Graduation intervals _____ Each 10 numbered every 10".
 Readability _____ ±0.5
 Accuracy _____ ±0.5°.
 Thermal liquid ----- Mercury.

y. Balloons.

Nomenclature	Type	Color	Rate of rise (feet/meters) ¹	Bursting altitude (feet/meters) ¹	Volume cu. ft. ^{b,c}	Free lift (grams) ¹
Balloon ML-50-A	Pilot	White	600/183	30,000/9145	6	132
Balloon ML-51-A	Pilot	Black	600/183	30,000/9145	6	132
Balloon ML-64-A	Pilot	Red	600/183	30,000/9145	6	132
Balloon ML-159-A	Pilot	White	900/302	45,000/13715	24	575
Balloon ML-160-A	Pilot	Black	900/302	45,000/13715	24	576
Balloon ML-161-A	Pilot	Red	900/302	45,000/13715	24	575
Balloon ML-537/UM	Sounding	Clear	1000/305	100,000/30479	126	1600
Balloon ML-635	Sounding	Clear	1312/400	35,000/10668	85	1100

^a Figures are approximate.

^b Volumes listed are for balloons at normal inflation, at approximately 70° F.

^c Varies slightly with type of gas used (Hydrogen or Helium).

1-6. Chart of Weights and Measures

The dimensions and weights for components of Meteorological Station, Manual AN/TMQ4 are listed in the chart below:

Component	Dimensions (in.)			Weight	
	Height	Depth	Length	Lb	Grams
Anemometer ML-433A/PM	7"	1 3/8	3 1/2		
Balloon ML-50-A					30
Balloon ML-51-A					30
Balloon ML-64-A					30
Balloon ML-159-A					100
Balloon ML-160-A					100
Balloon ML-161-A					100
Balloon ML-537-UM					1,000
■ Balloon ML-635			40		150
Barometer ML-102 ()	37/8	6 1/8	6 1/4	4 1/2	
■ Balloon Launcher ML-594/U with transit case	93/4	48	66"	140.4	
Balloon Nozzle ML-3731 GM			5		575
Battery Pack BA-259/AM	23/8	4	45/8		500
Calcium Hydride Charges					
ML-304A/TM	2	33/4 (dia)		1/8	
ML-305A/TM	6 1/4	33/4 (dia)		11/2	
ML-587/TM	10	33/4 (dia)		13/4	
■ Case, Meter CY-4917/U	36	36	36	35	
Case, Theodolite CY-787/U	17	143/4	113/4	19	
Coupling ML-49				0.3	
Hammer HM-3				2	
Head and Chest Set H-164/U				2.6	
Hydrogen Generator ML-303/TM	19	5 1/8		1.6	
Manifold ML-3341 TMQ-3	11	11	11	2.3	
Hose ML-81			6		
Jack JK-54		7/8 (dia)	2 1/4	0.1	
■ Lighting Unit ML-608/AM					85
Nozzle ML-196				7	
Oil, Lubricating				1/4	
Parachute ML-132		72 (dia)			100
■ Parachute ML-609/U		16 1/2 (dia)			
Plotting Board ML-122	7/8	36	42		
Psychrometer ML-224		15/16	11 15/16		

TM 11-6660-218-12

Component	Dimensions (in.)			Weight	
	Height	Depth	Length	Lb	Grams
Reel RL-39-(*)	7 1/4	7 1/2	13 1/2	7	100
Reel, Launching ML-367/AM				6	
Regulator, Pressure, Compressed Gas ML-528/GM					
Scale ML-577	0.035	7 3/4	10 1/2		
Scale, Plotting ML-573/UM		2 3/4	11 1/3		
Scale ML-126A			26 1/16		
Slide Rule ML-59			20	1.6	
Straightedge ML-357/GM		1 1/4	12		
Telephone Set TA-312/PT	4	7	11	9 1/2	
Theodolite, Double Center ML-474/GM		2 3/4	16 1/3		
Timer, Stop FM-103	7 3/4	2 3/4	6	11/3	
Tool Equipment TE-33	8	1 3/4	3		
Tripod, Surveying MT-1309/GM	60				
Meter, Volume, Hydrogen-Helium ML-606/U	19	10	10	22	

1-7. Common Names

Common names which have been assigned to the nomenclature items are listed below.

Nomenclature	Common name
Meteorological Station, Manual AN/TMQ-4	Met station.
Anemometer ML-433A/PM or ML-497/PM	Anemometer.
Balloon Nozzle ML-373/GM	Pilot balloon nozzle.
Barometer ML-102-(*)	Barometer.
Battery Pack BA-259/AM	Battery check.
Bracket Assembly, Antibuoyance	Bracket assembly.
Calcium Hydride Charges ML-304A/TM; ML-305A/TM, and ML-587/TM	Calcium hydride charges.
Case, Theodolite CY-787/U	Theodolite set case.
Head and Chest Set H-164/U	Head and chest set.
Hydrogen Generator Set AN/TMQ-3	Hydrogen generator set.
Hose ML-81	Hose.
Hydrogen Generator ML-303/TM	Hydrogen generator.
Manifold ML-344/TMQ-3	Manifold.
Jack JK-54	Jack.
Parachute ML-132	Radiosonde parachute.
Parachute ML-609/U	Lighting unit parachute.
Plotting Board ML-122	Plotting board.
Psychrometer ML-224	Psychrometer.
Lighting Unit ML-608/U	Lighting unit.
Nozzle ML-196	Sounding balloon nozzle.
Coupling ML-49	Coupling.
Radiosonde Set AN/AMT-4	Radiosonde set.
Reel RL-39-(*)	Reel.
Reel, Launching ML-367/AM	Launching reel.
Regulator, Pressure, Compressed Gas ML-528/GM	Gas regulator.
Rule ML-126-A	Rule.
Shroud, Balloon ML-424/U	Balloon shroud.
Slide Rule ML-59	Slide rule.
Telephone Set TA-312/PT	Telephone.
Theodolite, Double Center ML-474/GM	Theodolite set.
Timer, Stop FM-103	Timer.
Tripod, Surveying MT-1309/GM	Tripod.
Wire WD-1/TT	Wire.
Balloon ML-50-A, Balloon ML-51-A, or Balloon ML-64-A	30-gram pilot balloon.
Balloon ML-159-A, Balloon ML-160-A, or Balloon ML-161-A	100-gram pilot balloon.
Balloon ML-537/UM, or Balloon ML-635/UM	Sounding balloon.
Scale ML-577/UM	Pilot balloon scale.
Scale, Plotting ML-573/UM	Zone height scale.
Balloon Launcher ML-594/U	Launcher.
Meter, Volume, Hydrogen-Helium ML-605/U	Gas meter.
MT-1355/TMQ-5	Radiosonde Recorder Support

1-8. Description of Meteorological Station, Manual AN/TMQ-4

a. Meteorological Station, Manual AN/TMQ 4 consists of surface observation equipment (fig. 1-3), wind plotting equipment (fig. 1-4), communication equipment (fig. 1-5), balloon inflation equipment (fig. 1-6), balloon equipment and accessories (fig. 1-7), and miscellaneous minor components that are required to obtain weather and ballistic data and to assemble the equipment.

b. After assembly in the field, the met. station is divided in two sites: the balloon launching site (fig. 1-1) and the plotting station site (figs. 1-1 and 1-2). The equipments located at each site are used in a system that allows the operator to perform visual observations in the collection of meteorological data. The met. station can also be used in a system in conjunction with Rawin Set AN/GM1 1(*) (rawin set) and Radiosonde Recorder AN/TMQ 5(*) (radiosonde recorder) for electronic observation in the collection of meteorological data,

Detailed descriptions of system application are given in paragraph 1-12 and 3-5.

1-9. Description of Major Components

a. *Anemometer (fig. 1-8)*. The anemometer consists of a wind vane with a removable (cover, a

velometer, a compass, and a detachable handle (not shown). The velometer, on which the wind vane is mounted, has a knurled range selector knob on one side with an adjustable vent and a screened aperture on the other side. A two-range windspeed scale on the front of the velometer is graduated in knots.

b. *Barometer.*

(1) *ML 102 E* (fig. 1-9). This barometer consists of a metal case (not shown) and a frame. The case is shock mounted in the metal frame. A plastic window in the case is held in place by a snapping. A slotted screw on the bottom side of the case enables the instrument to be adjusted without the case being opened. A metal ring is provided at the top of the frame for hanging the barometer. The back of the case of Barometer ML 102 E has a metal rim which holds a nomograph and temperature correction chart in place. The dials on the three instruments are identical; each contains a pointer, two millibar scales, an inch of mercury scale, and a mirror ring.

(2) *ML 102-D* (fig. 1-10). This barometer has wooden cases with metal reinforcements at the outside corners. A metal hanger set flush with the back of the case is used for hanging the barometer. The lid (not shown) is

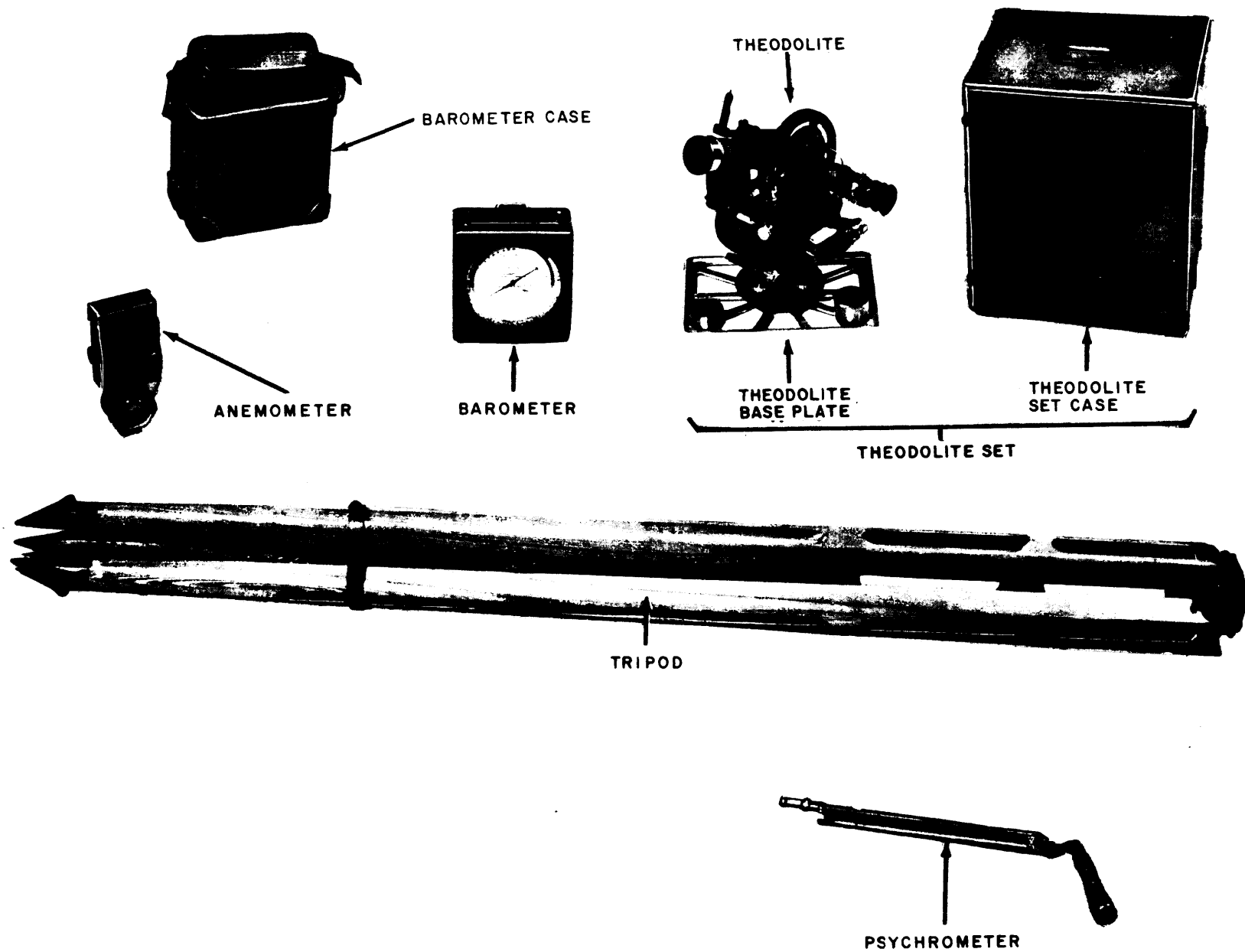

■ *Figure 1-3. Surface observation equipment.*

fastened to the case by separable hinges and a fastener. A temperature correction and conversion chart is located on the inside of the lid of the case. A plastic window protects the dial. The pointer of the barometer is adjusted through an opening in the dial. This opening is protected by a plug when adjustments are not being made. The dial of the barometer contains two millibar scales and a mirroring.

c. *Hydrogen Generator Set.* The hydrogen generator set (fig. 1-6) consists of four generator bodies mounted on a common manifold, two spare generator bodies, a packing case, hoses,

and a punch. The manifold consists of a steel tube welded to a square, sheet-iron plate. The plate has four holes for mounting four Hydrogen Generators ML-303/TM, which are coupled together to permit the generation of hydrogen at four times the rate of a single Hydrogen Generator ML-303/TM.

d. *Head and Chest Set.* The head and chest set (fig. 1-11) consists of a lightweight chest-type transmitter assembly and a single headset. A 10-foot, rubber-covered cord leads from the connection block on the chest plate to terminating Plug PL-A7.

(1) *Headset.* The headset consists of a single receiver with a sponge rubber

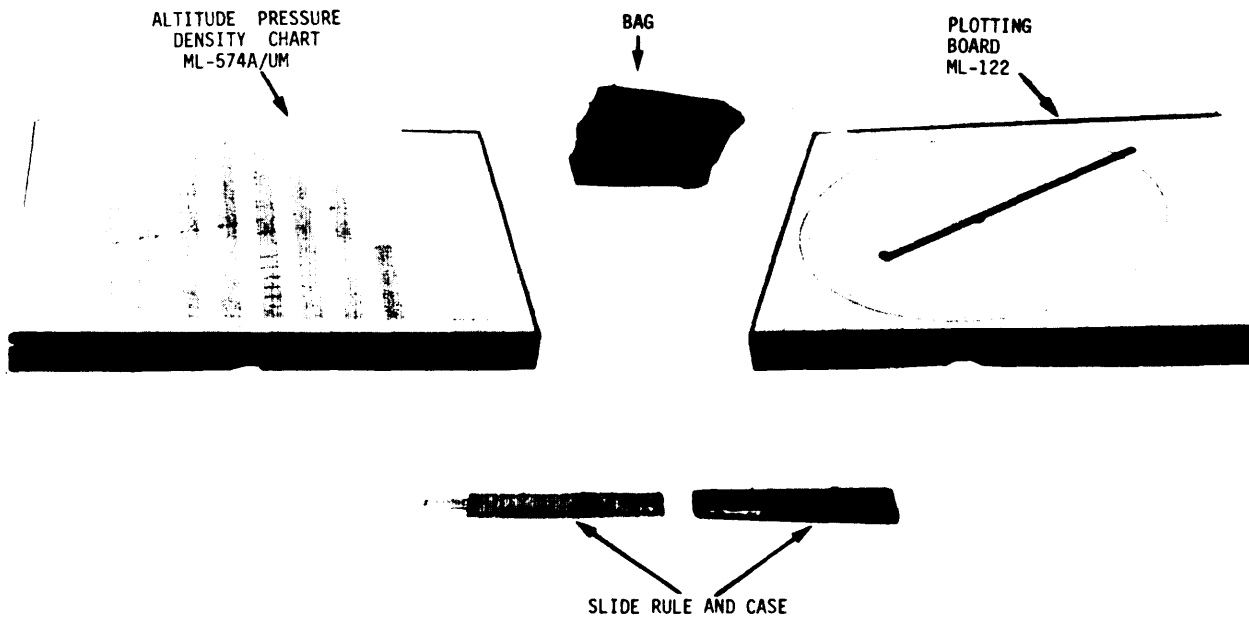

EL7UF003

Figure 1-4. Wind plotting equipment (less timer and DA Forms)

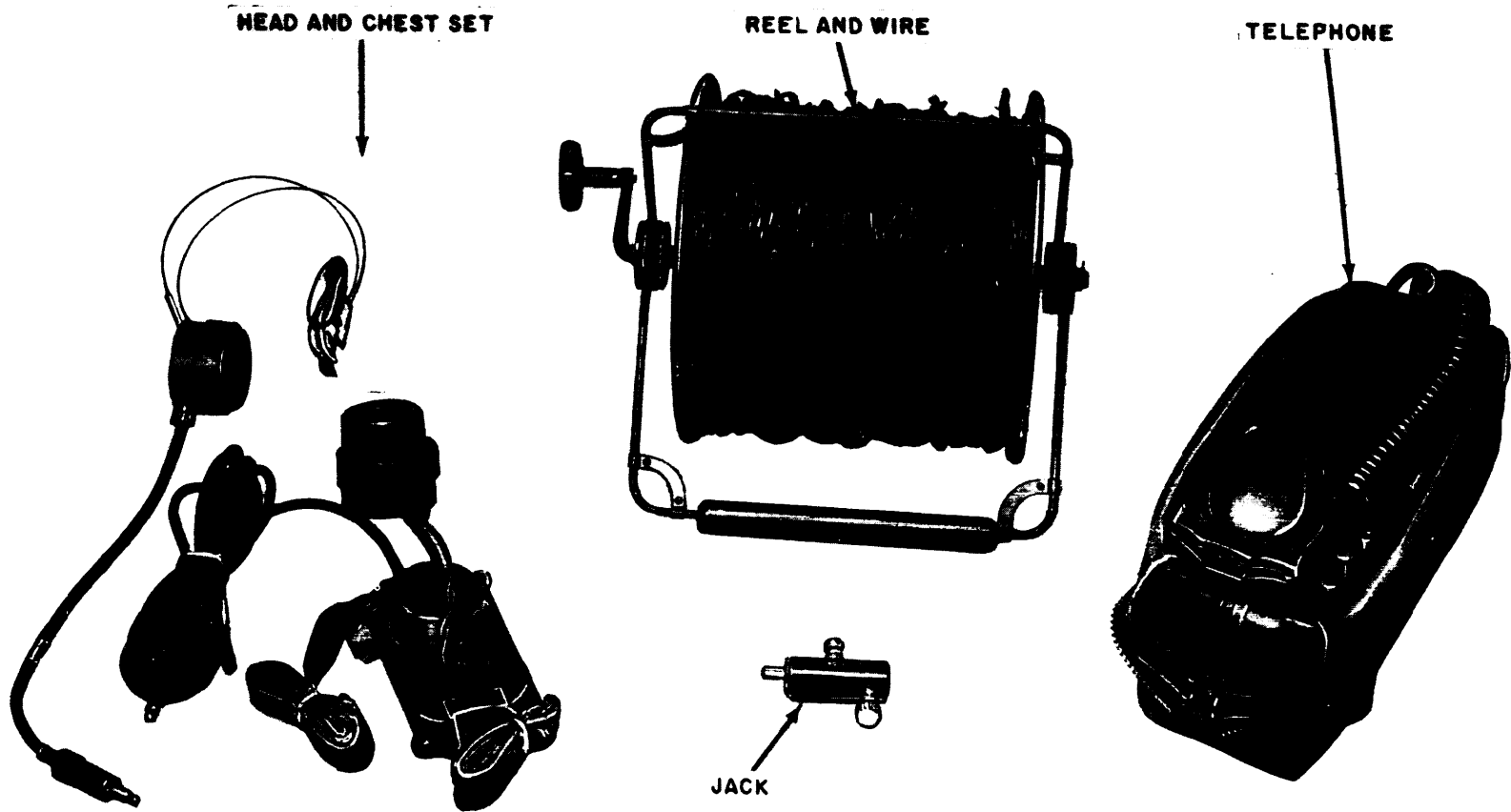

TM6660-218-15-3

Figure 1-5. Communication equipment.

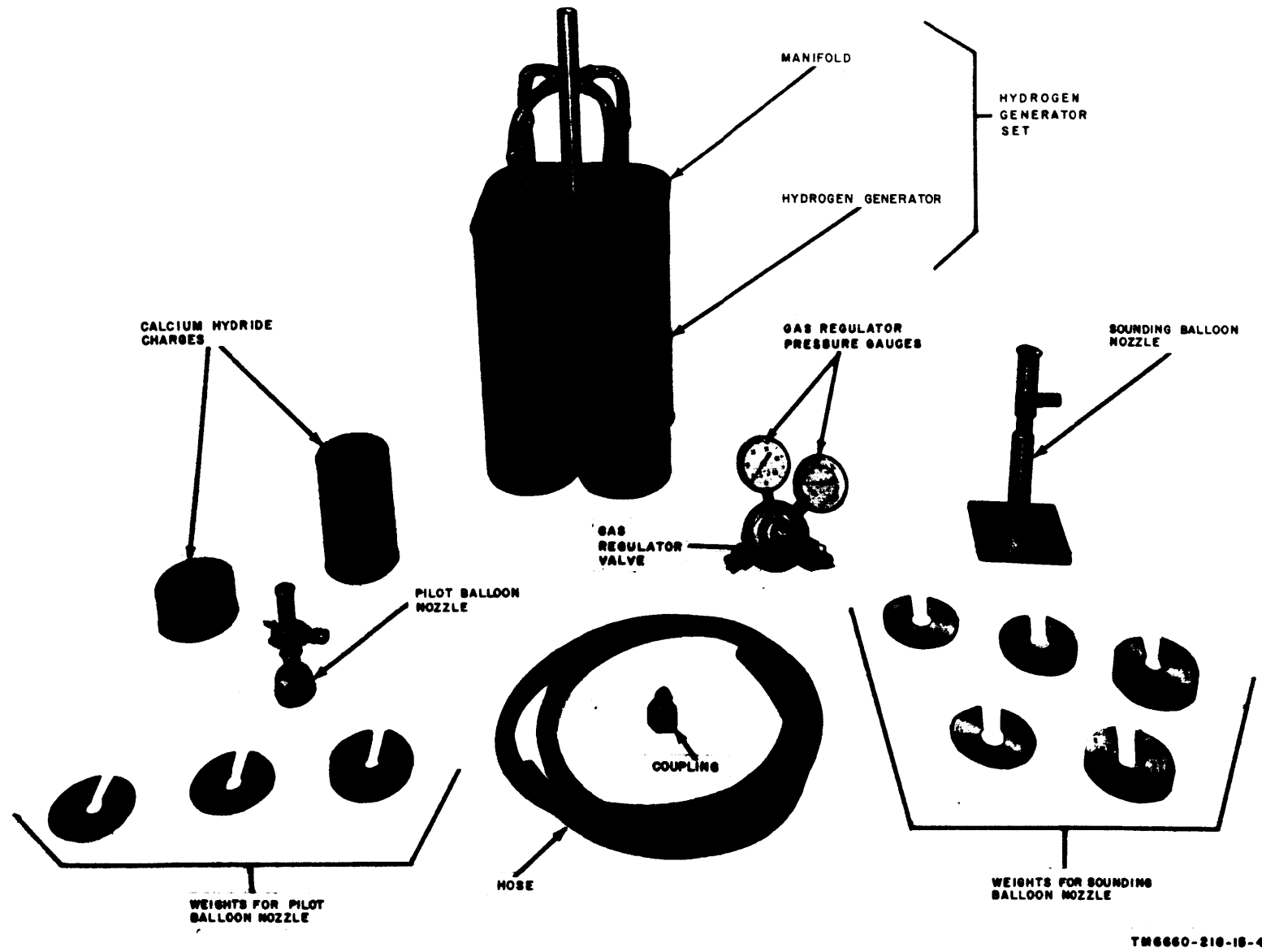
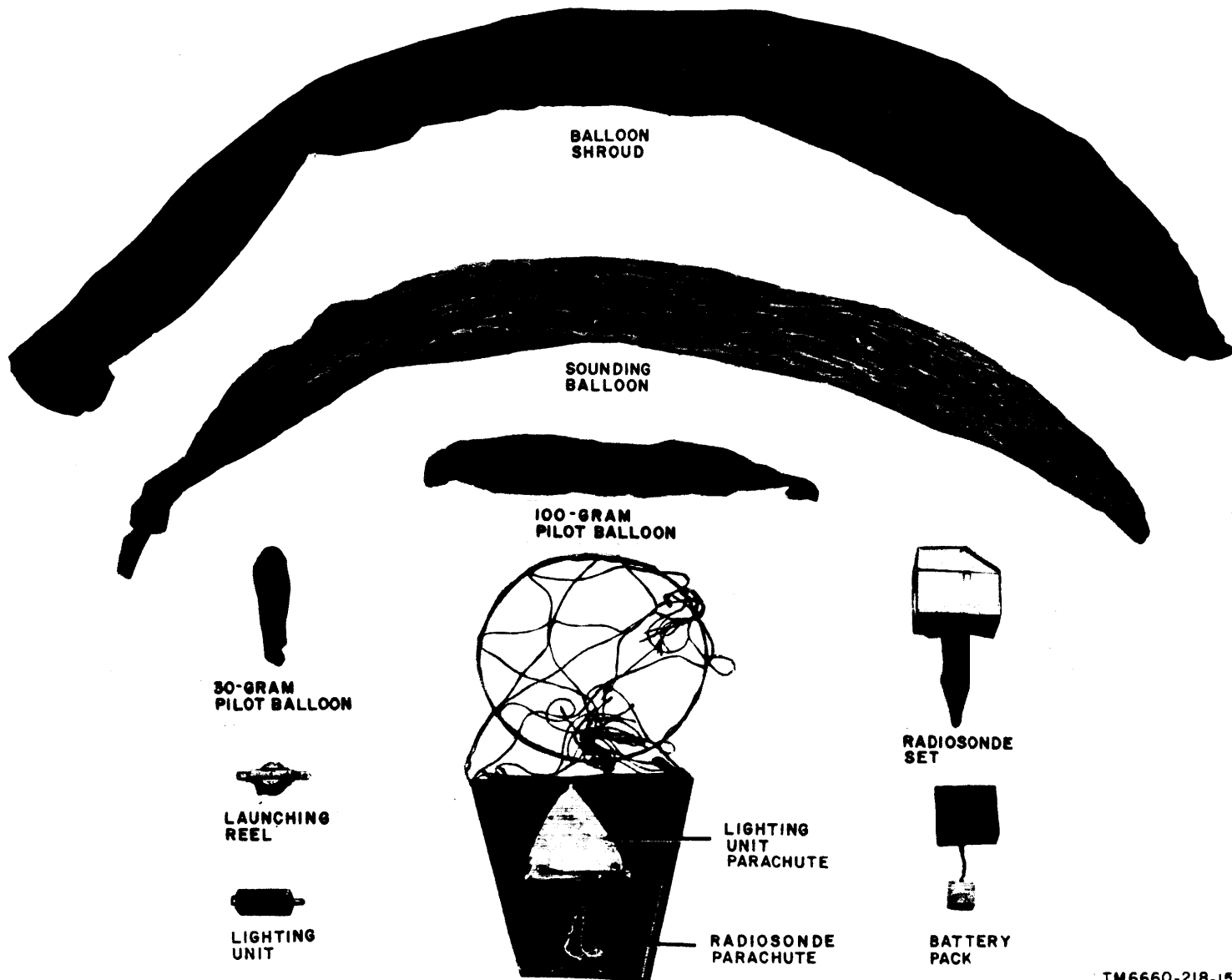

Figure 1-6. Balloon inflation equipment (less bracket assembly and water can).

TM6660-218-18-4



TM6660-218-15-5

Figure 1-7. Balloon equipment and accessories.

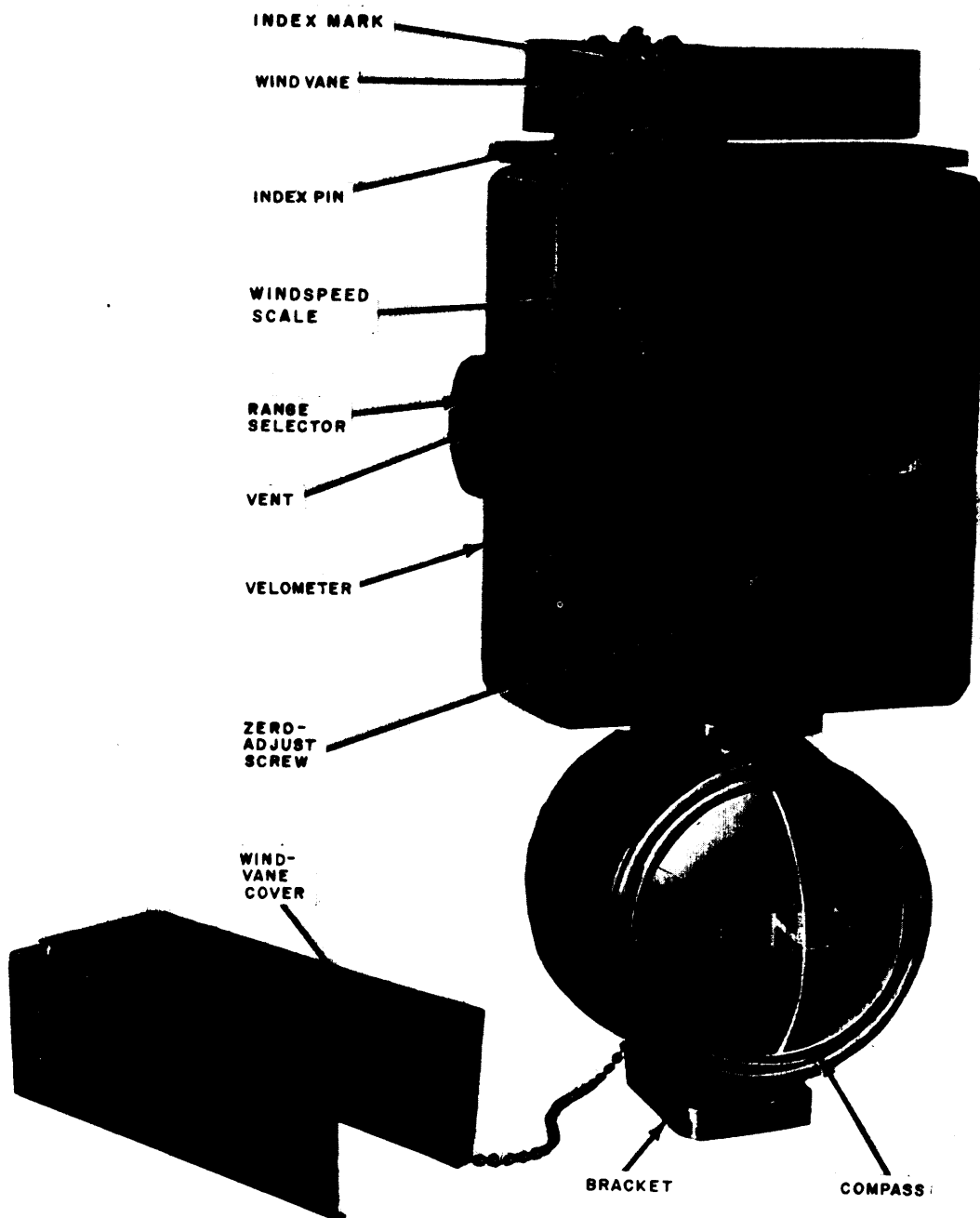

TM6660-218-15-8

Figure 1-8. Anemometer.

earpiece mounted on a flexible wire headband. The receiver cord terminates in a receiver cord plug which

fits into a rubber-covered jack on a short cord which leads to the chest plate connection block.

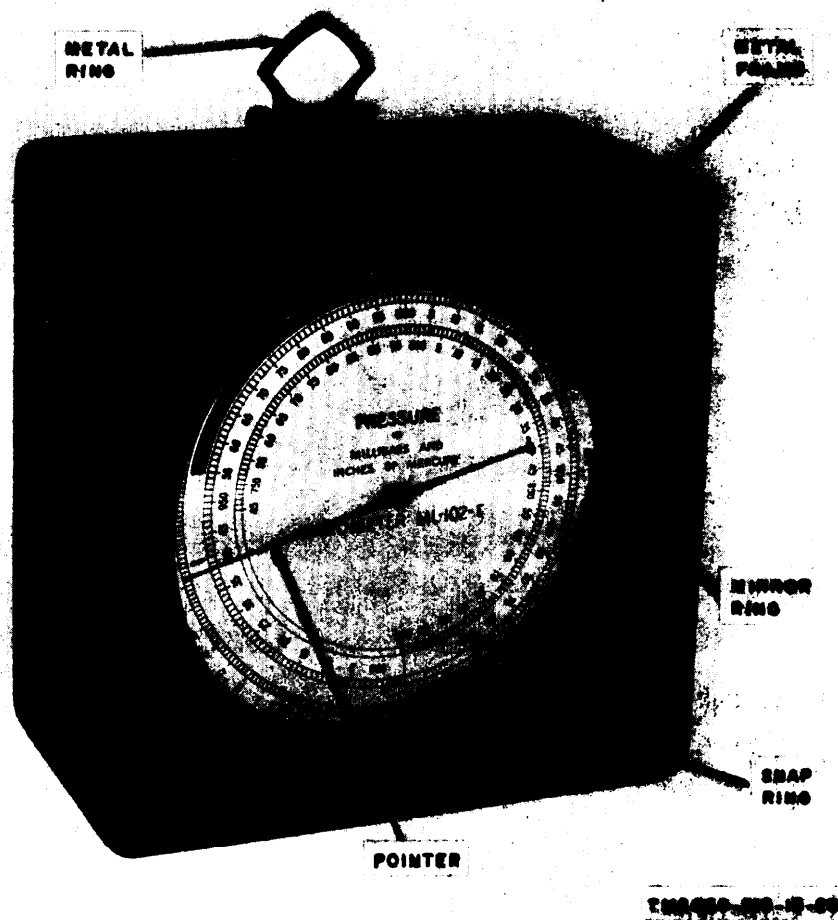
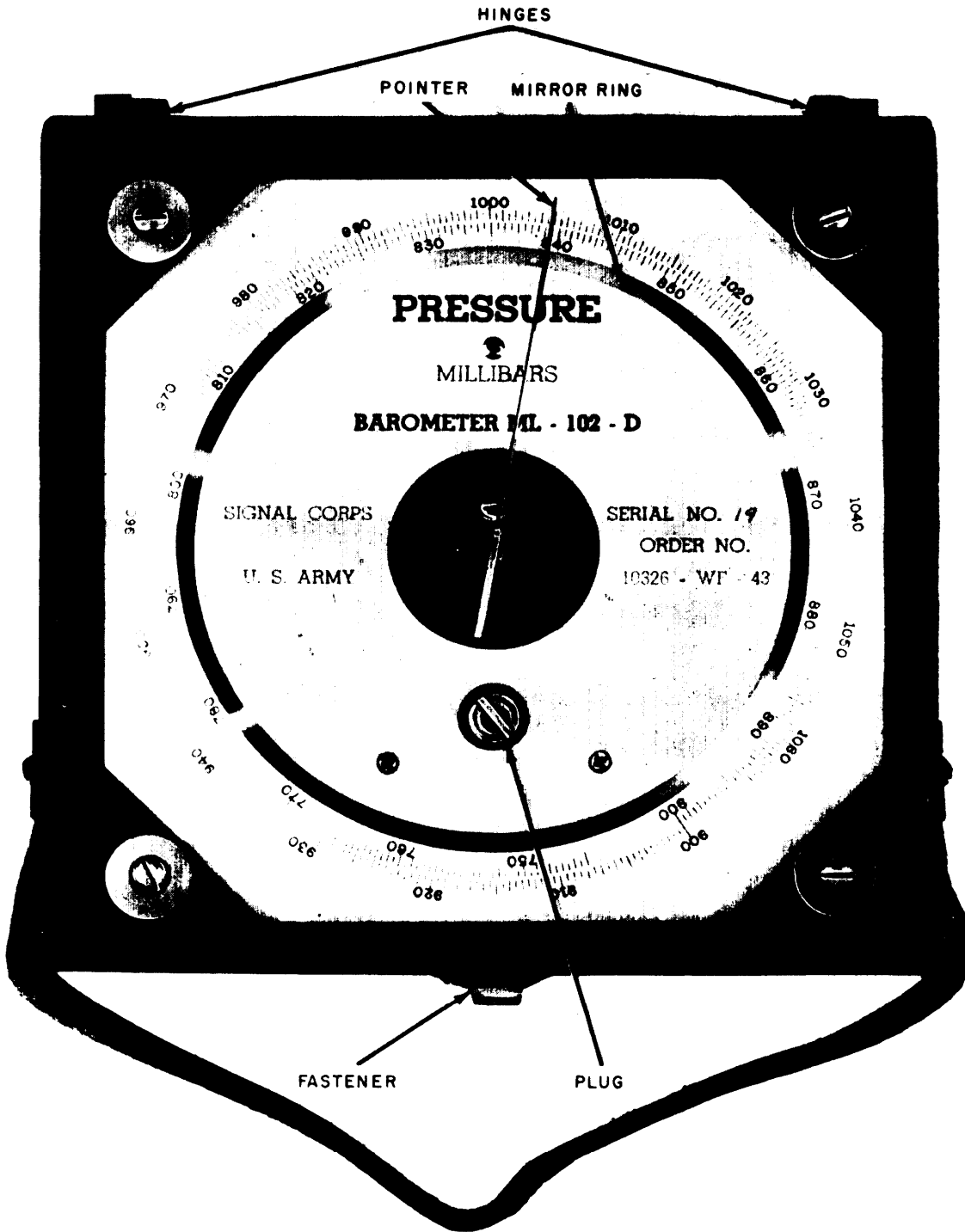

Figure 1-9. Barometer ML-102-E.

- (2) *Chest set.* The chest set consists of a transmitter assembly and a connection block mounted on a flat metal chest plate. The transmitter assembly is mounted on the end of a curved metal arm. The arm is attached to the chest plate by a swivel flange, and may be adjusted to any desired position by loosening a knurled thumbscrew at the base of the swivel flange.
- e. *Psychrometer (fig. 1-12).*
- (1) *General.* The psychrometer consists of two 9-inch, mercury-in-glass thermometers of the same type (general or tropical) mounted on a metal

frame which is attached by means of a small chain to a wooden handle. The thermometers are graduated in degrees Celsius from -37 to $+46$. One thermometer (wet bulb) is covered by a small cotton wick to hold water and is mounted about $1\frac{1}{2}$ inches lower than the dry bulb thermometer. Each thermometer is held firmly in place on the frame with metal rings which encircle the top and bottom of each glass tube.

- (2) *Scale graduations.* The thermometer scales are etched on the glass stem, and graduations are in whole degrees centigrade with numbered



TM6660-218-15-7

Figure 1-10. Barometer ML-102-D.

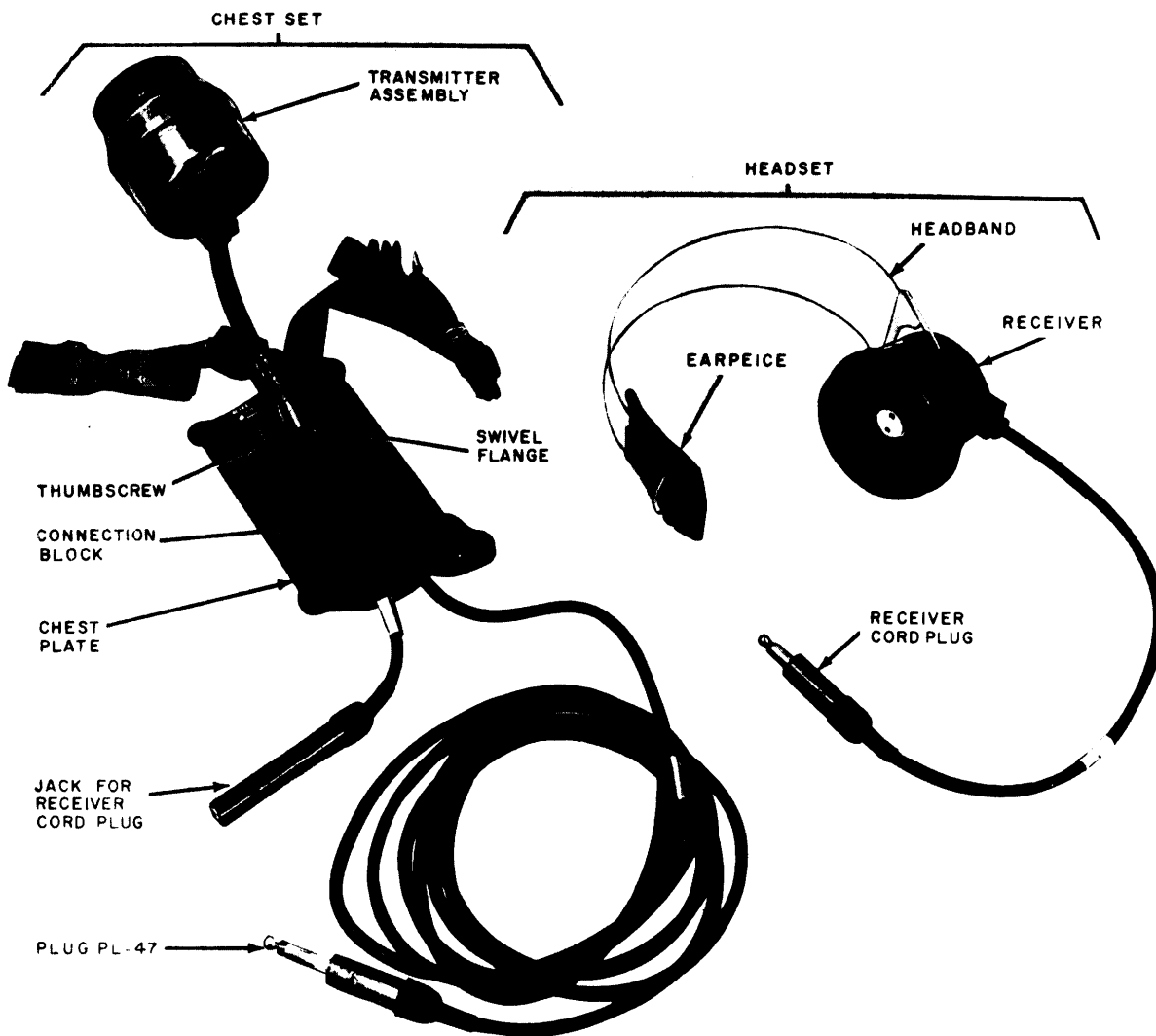

TM6660-218-15-27

Figure 1-11. Head and chest set.

graduations for each multiple of 10°. Each 5° and 10° interval is marked by a longer line.

f. Plotting Board and Rule.

(1) *Plotting board (fig. 1-13)*. The plotting board consists of two sheets of plastic separated by a plywood filler; all three are cemented together. Metal strips are used to bind and protect the edges of the laminated board. The top sheet consists of a white,

opaque, plastic chart with horizontal and vertical lines and a degree-azimuth scale printed in black. A retractable pin at the center of the degree-azimuth scale acts as a pivot for the rule. The retractable pin can be raised or lowered by the retractable pin adjustment located under the plotting board.

(2) *Rule (fig. 1-14)*. The rule is made of vinyl plastic and is 231/16 inches long,

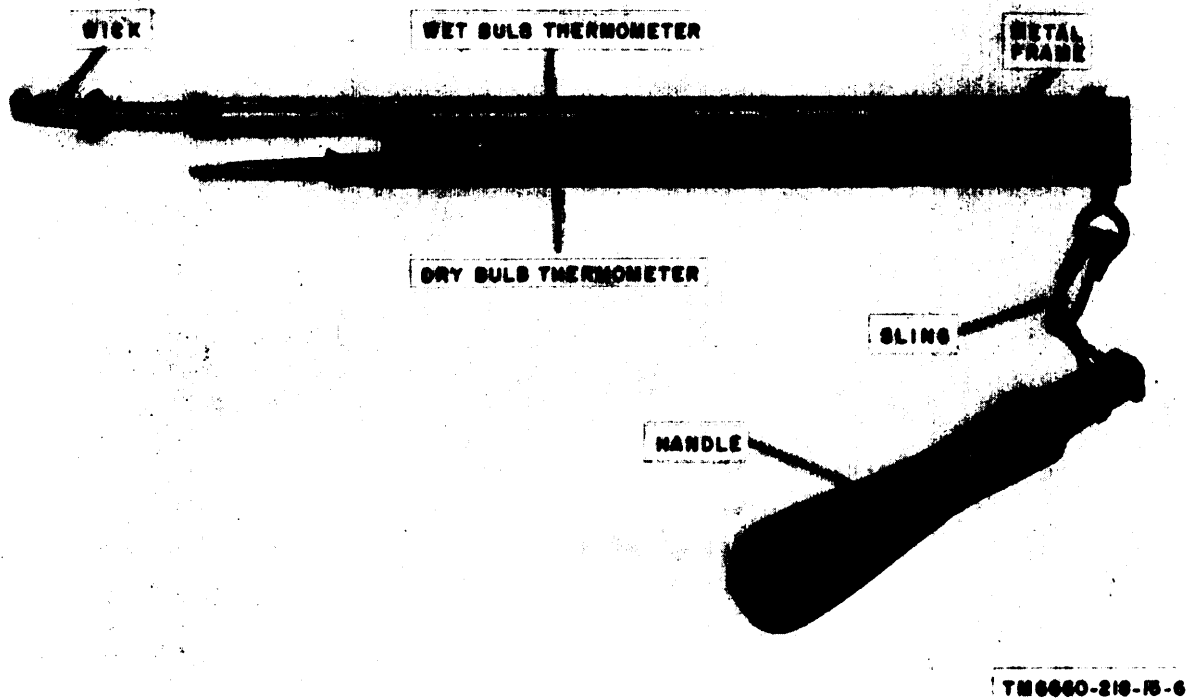

Figure 1-12 Psychrometer.

13/8 inches wide, and V8 inch thick. Two pivot holes are provided for use with balloon horizontal distance scales. The pivot hole located on the upper side is used with the 1,700-yard scale. The pivot hole located on the lower side of the rule is used with the 1,100-yard scale.

Note. Rule ML-126A, when used in the metric system, has a scale of 1 inch to 750 meters.

g. *Radiosonde Set (fig. 1-15).* The radiosonde set consists of a modulator and a transmitter.

- (1) *Transmitter.* The transmitter is inclosed in a plastic tube. One end of the tube is pointed and the other is closed by a removable cover. The leads used to connect the transmitter and the modulator are brought out

to either one or two plugs, depending on the model of the radiosonde set.

- (2) *Modulator.* The modulator is assembled in a white plastic container. The top of the modulator can be opened to permit access to the sensor element. A door on the bottom of the modulator covers the battery compartment. A clip is provided to secure the transmitter to the modulator. In some models of the radiosonde set, this clip is replaced by a mounting recess in the modulator door.

h. *Telephone (fig. 1-16).* The telephone consists of Handset H-60/PT, a panel and housing assembly, and Telephone Set Case CY-1277/PT. Telephone Set Case CY-1277/PT is equipped with a carrying strap and loops used to mount the telephone on a vertical support. The panel and housing assembly con-

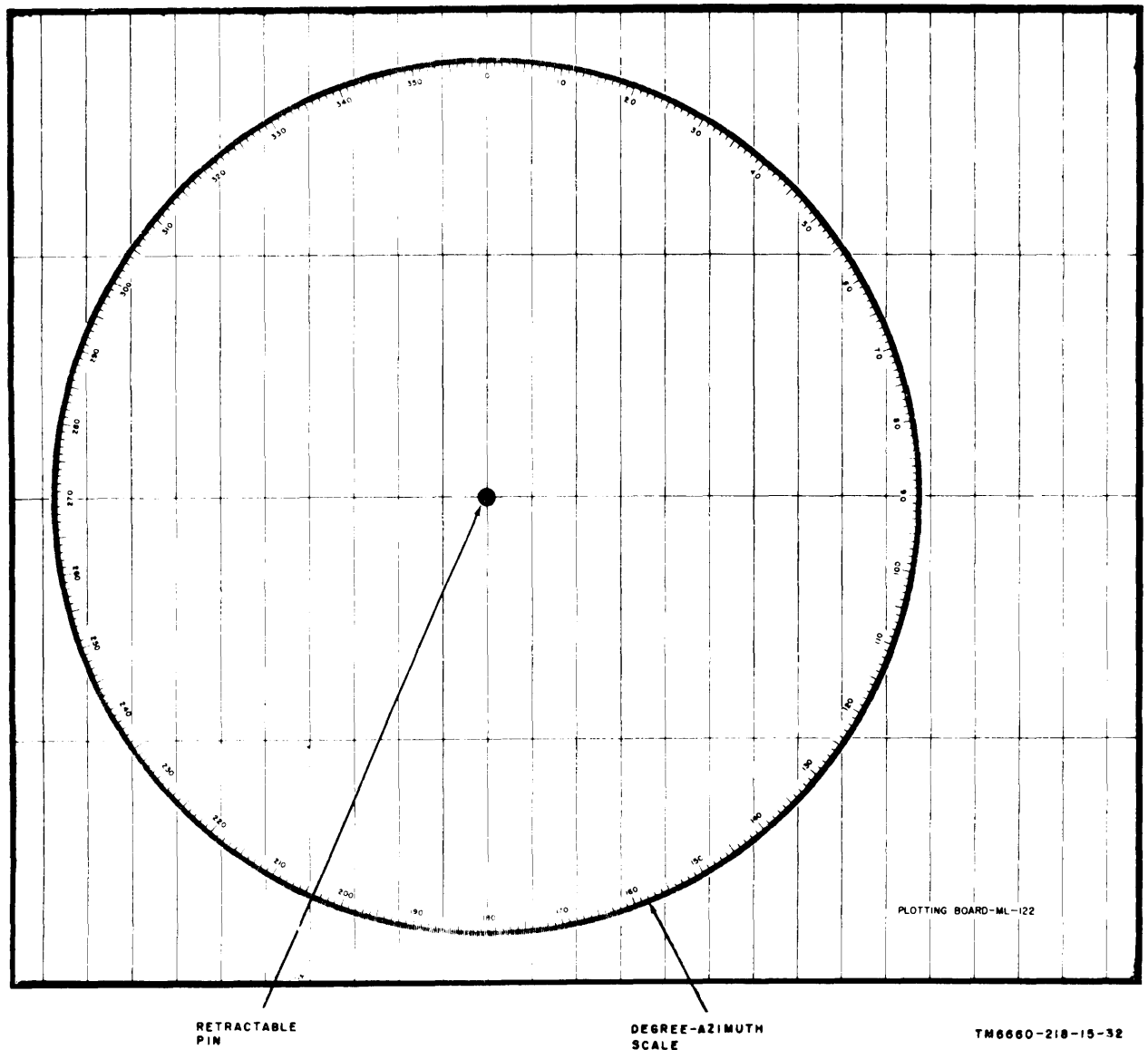

Figure 1-13. Plotting board.

tains all the controls and connections used during the operation of the telephone. Handset H-60/PT contains a receiver and a transmitter section; the receiver section is shaped so that it will fit under a standard field helmet. A bracket is located on the panel and housing assembly to hold Handset H-60/PT when it is not in use.

i. *Theodolite Set* The theodolite set consists of the theodolite, the theodolite base plate, and the theodolite set case (fig. 1-3).

- (1) The theodolite (fig. 1-17) consists of a dual telescope (finder and tracking), an azimuth and elevation mounting, and a leveling assembly. The azimuth and elevation mounting contains a compass, a battery compartment, levels, elevation and azimuth tracking controls, and an azimuth-scale cover. The leveling assembly contains the controls for leveling the theodolite during orientation

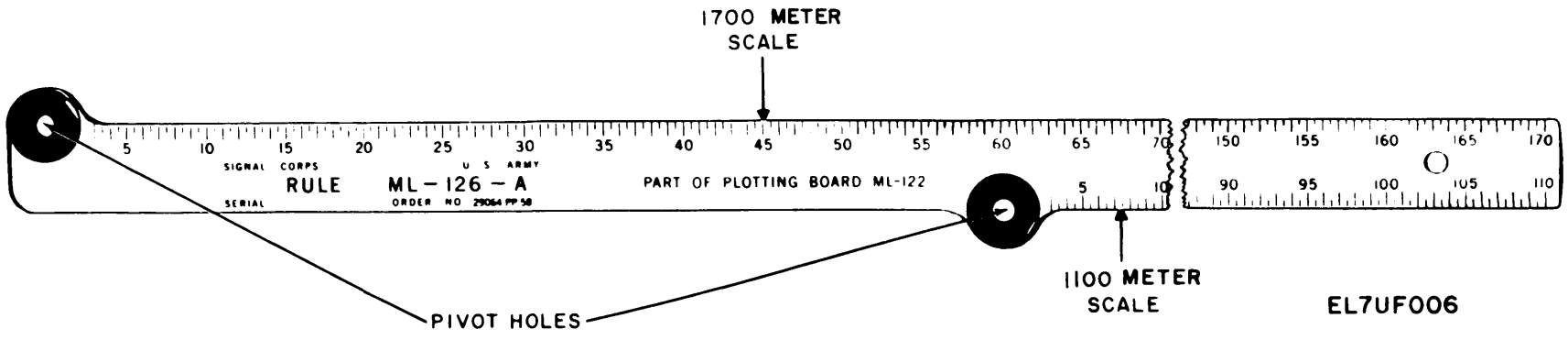
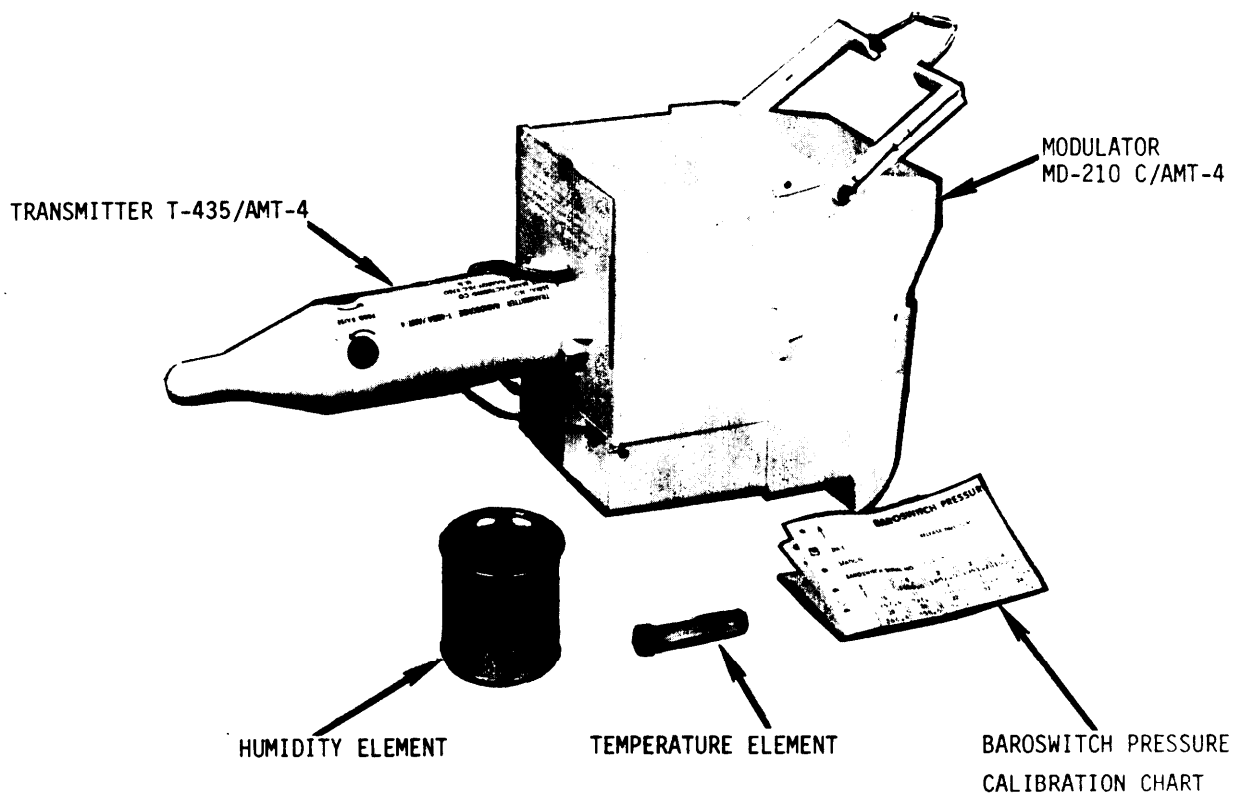

Figure 1-14. Rule.



EL7UF004

Figure 1-15. Radiosonde Set AN/AMT-4E.

(TM 11-6675-200-10). A lens cap protects the tracking telescope when it is not in use.

(2) The theodolite baseplate (fig. 1-3) contains a threaded mount for securing the

theodolite. Two wooden blocks on the theodolite base plate holds tools and a lens hood.

(3) The wooden theodolite set case has a hinged door and an interior rack to hold spare batteries.

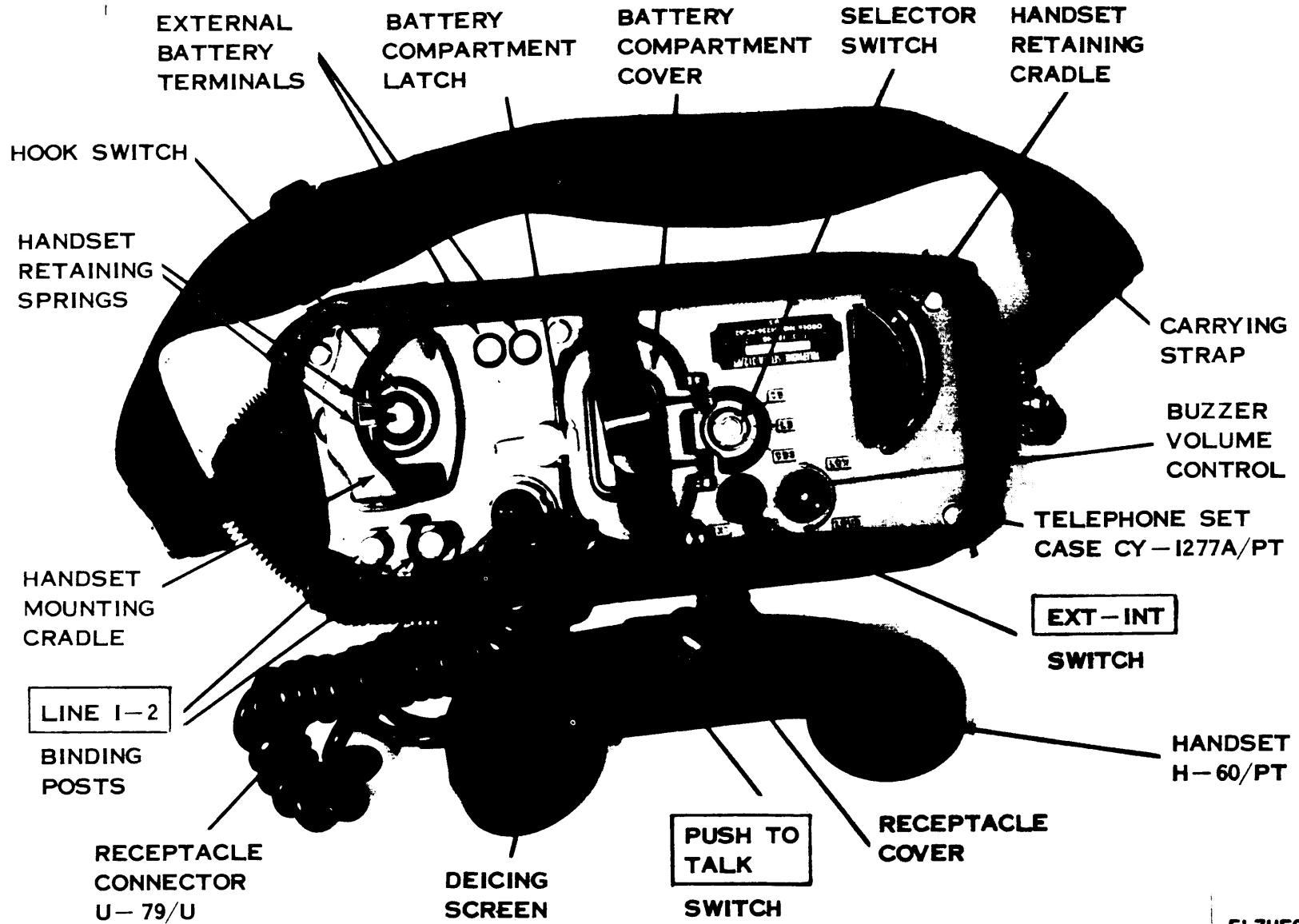

EL7UF005

■ Figure 1-16. Telephone Set TA-512/PT.

j. *Thermometers*. (Fig. 1-18). Thermometers are self-indicating, mercury-in-glass type. The thermometer scales are etched in black on the glass stem, and graduations are in whole degrees centigrade with graduations numbered for each multiple of 10 degrees. Each 5° and 10° interval is marked by a longer line. Refer to paragraph 1-9e (1) for mounting of spare thermometer tubes on metal frame. Thermometer tubes when mounted on a metal frame will then constitute Psychrometer ML224.

k. *Balloon launcher* (fig. 1-19). The balloon launcher is a portable inflation device and launching platform designed to secure and protect meteorological balloons during inflation and launching. The launcher is 3 feet high, 6 feet wide, and 11 feet long when assembled. The launcher consists of a canopy support, attached to a four-section tubular metal frame. Three pairs of legs, with self-adjusting skids, are fitted to each pair of legs. An anchoring assembly is attached at five

points on the main frame. A tubular windbreak assembly and a flexible canopy, extending the entire length of the frame, protect the balloon from weather during inflation and launch.

l. *Timer* (fig. 1-20). The timer has a 5-inch dial with white, luminescent markings and luminous second and minute hands. A plastic case, 73/4 inches high, 6 inches wide, and 23/4 inches deep, houses the unit. Operating and adjustment controls are located at the top and rear of the timer. A cover plate protects the speed regulator in the rear of the timer.

m. *Gas Meter*. The gas meter is designed to measure the volume of gas, in cubic feet, required for obtaining the proper lift for meteorological balloons. This meter is used when gas cylinders, containing either hydrogen or helium, are used to inflate balloons. The gas meter can deliver helium gas at a minimum rate of 420 cubic feet per hour and hydrogen gas at a minimum rate of 600 cubic feet per hour.

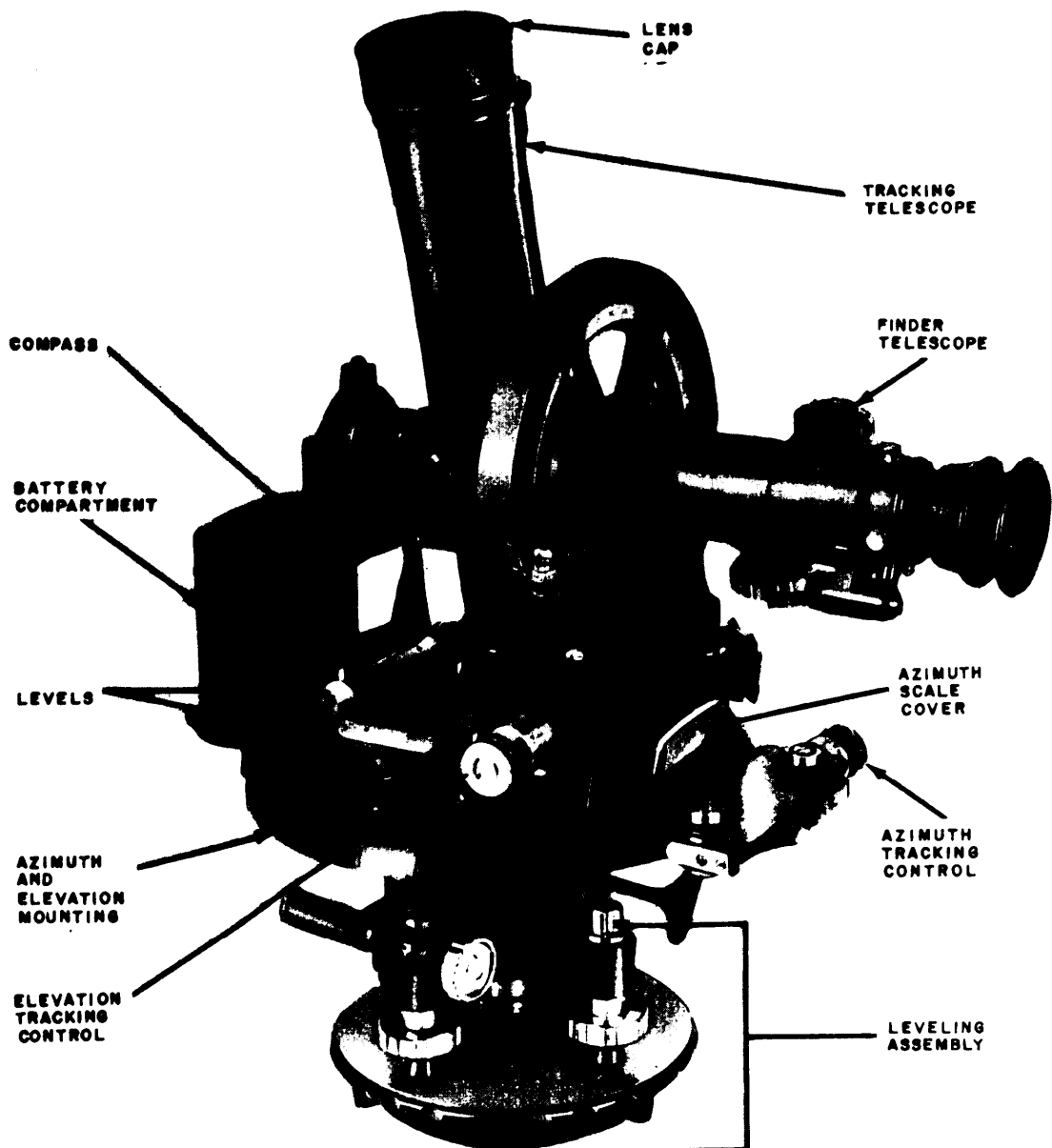

TM 6660-218-15-9

Figure 1-17. Theodolite.

1-10. Description of Minor Components

a. *Altitude Pressure-Density Chart* (fig. 1-4). This chart is made up of brown vertical lines graduated in degrees centigrade (°C), brown constant pressure lines sloped slightly upward from

left to right, short brown vertical lines or hatching, and blue lines of constant density which curve downward from left to right. The altitude pressure-density chart is used to graphically determine upper air density and temperature from figures obtained during an electronic observation.

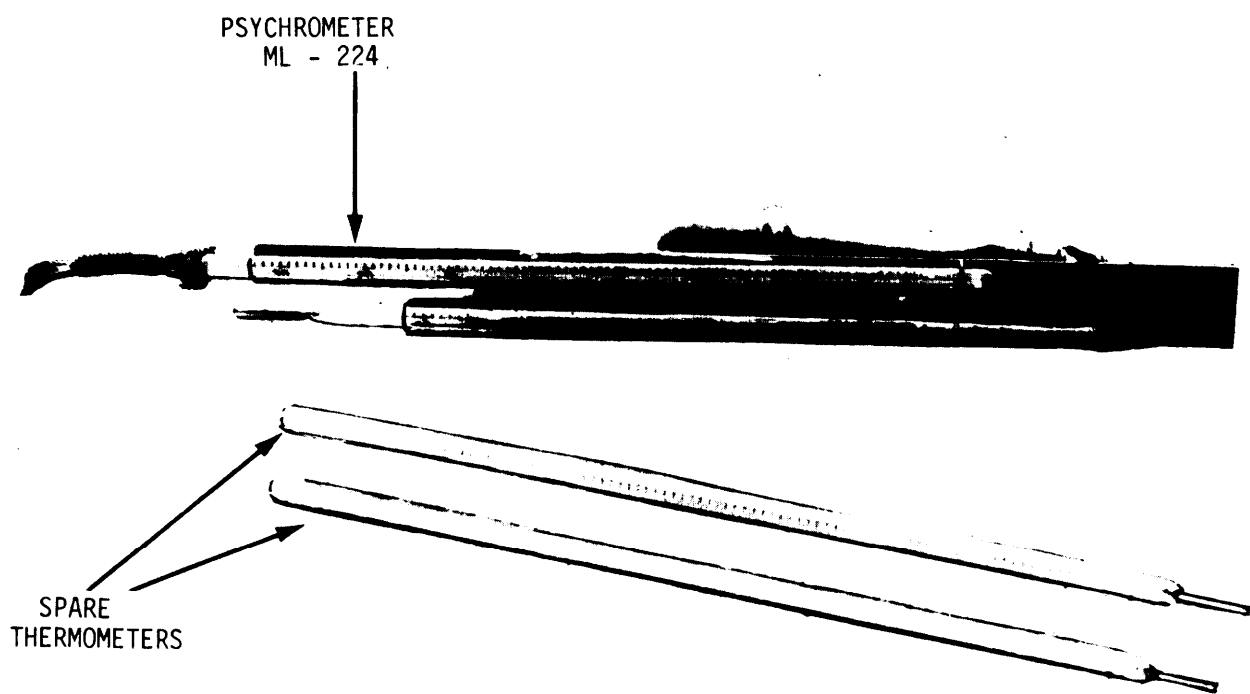

EL7UF013

Figure 1-18. Thermometer and psychrometer ML-224.

1-28
Change 8

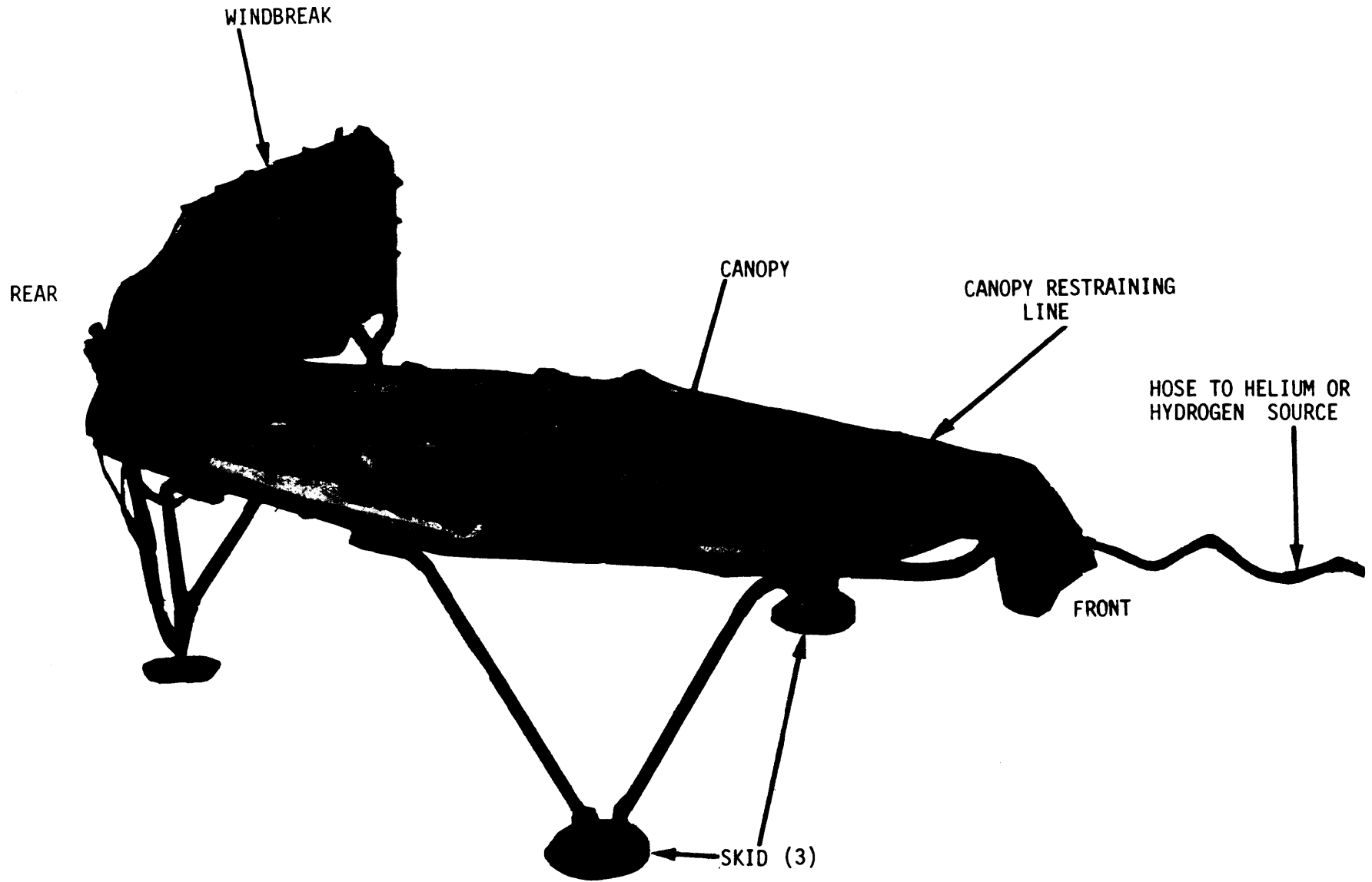

EL7UF007

■ Figure 1-19. Balloon inflation and launching device ML-594/U.

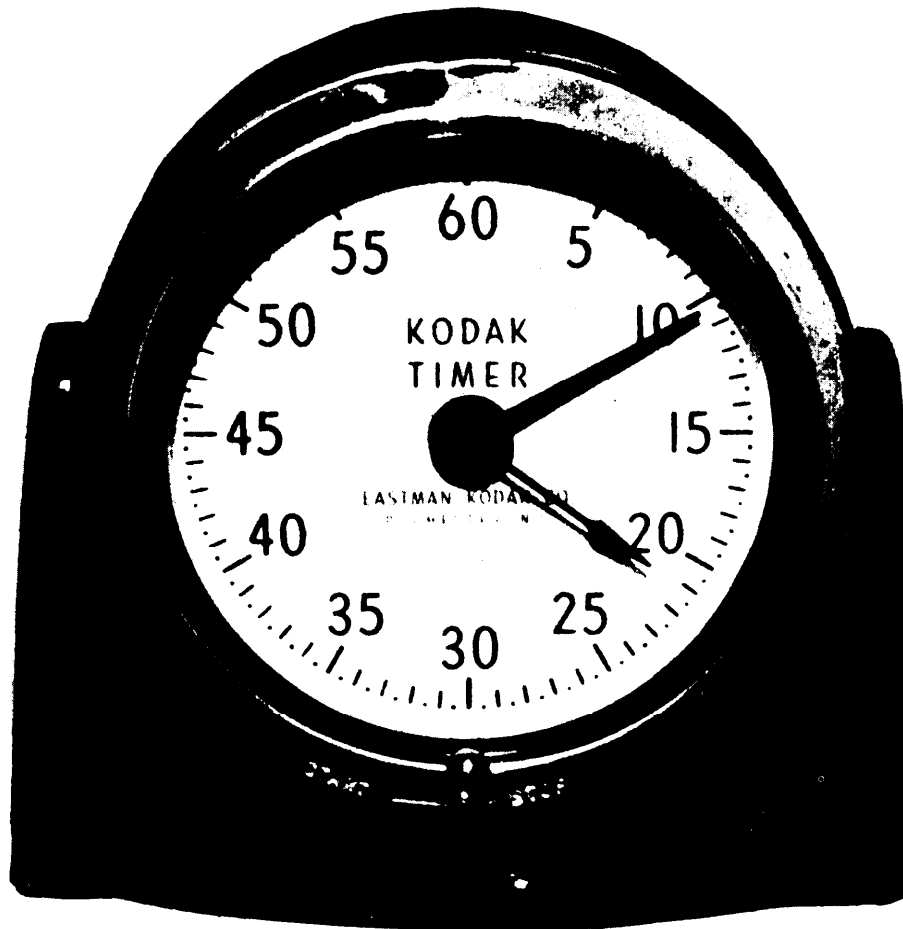

Figure 1-20. Timer.

b. Bag. The bag is constructed of canvas and is approximately 35 inches long, 1 inch high, and 30 inches deep. It is used to carry the plotting board, and has a canvas strap and handle (not shown) to facilitate handling by the met. station personnel.

c. *Balloons (fig. 1-7).*

(1) *30-gram pilot balloons.* The 30-gram pilot balloons are approximately 24 inches in diameter after inflation. The neck of the balloons is about 2 inches long and 1 inch in diameter. The 30-gram pilot balloons include Balloons ML-50-A (white), ML 51-A (black), and ML-64-A (red).

(2) *100-gram pilot balloons.* The 100-gram pilot balloons are approximately 36 inches in diameter after inflation. The neck of the balloons is about $1\frac{7}{8}$ inches long and 1 inch in diameter. The 100-gram pilot balloons include Balloons ML-159-A (white), ML-160-A (black), and ML-161-A (red).

(3) *Sounding balloon.* The sounding balloons are approximately 6 feet in diameter after inflation. They are not colored because their visibility in the sky is not important. The neck of the balloons is about $4\frac{1}{2}$ inches long and 1 inch in di-

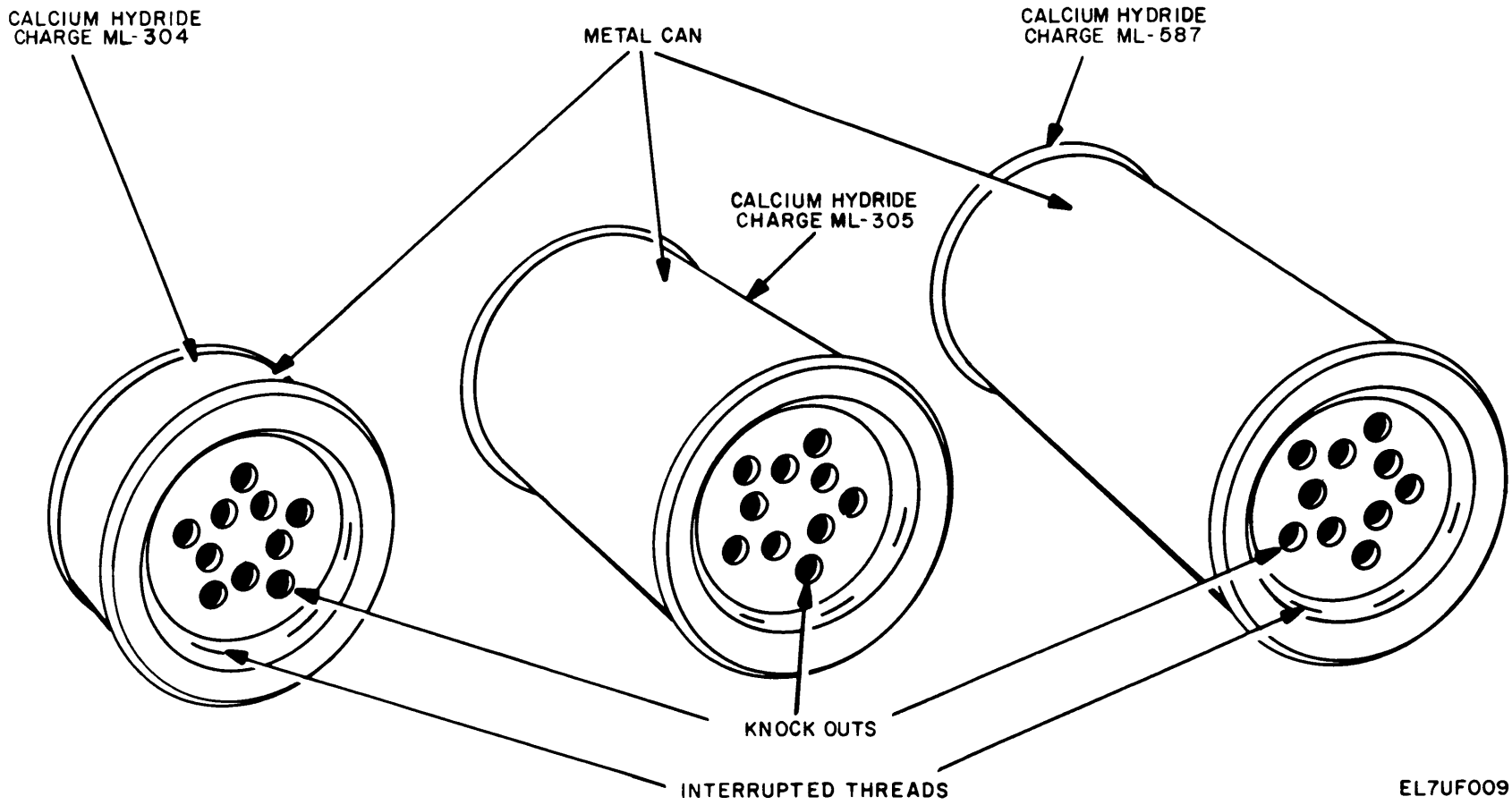

EL7UF009

Figure 1-21. Calcium hydride charges.

- ameter. The sounding balloons include Balloons ML-537/UM and ML-635/UM.
- d. *Battery Pack (fig. 1-7)*. The battery pack is a dunk-type (water activated) battery which supplies 115 volts, 6 volts, and 1.5 volts direct current for the radiosonde set.

NOTE

The average time for the battery to reach full power is 20 minutes. The life of the battery is about 4 hours.

WARNING

Should any corroded, pitted, scarred, or broken ML-304A/TM, ML-305A/TM, or ML-587/TM canisters be found, follow all steps as shown on the warning page to render the canisters safe.

- e. *Calcium Hydride Charge (fig. 1-21)*.
- (1) Calcium Hydride Charge ML-304A/TM is an airtight metal can that contains approximately 6 ounces of 90-percent pure calcium hydride. The can is 33/4 inches in diameter and 2 inches high. The top of the can is recessed and is provided with interrupted threads for attaching the charge to the bottom of the hydrogen generator. On the top of the can there are a number of knockouts which can be removed to allow water to enter the can.

The ML-304A/TM produces 6 cubic feet of Hydrogen.

- (2) Calcium Hydride Charge ML305A/TM is the same as Calcium Hydride Charge ML-304/TM ((1) above), except that it contains approximately 11/2 pounds of 90-percent pure calcium hydride and is 63/4 inches high. The ML-305A/TM produces 24 cubic feet of Hydrogen.
- (3) Calcium Hydride Charge ML-587/TM is the same as Calcium Hydride Charge ML-305A/TM, except that it contains approximately 21/2 pounds of 90-percent pure calcium hydride and is 10 inches high. The ML587/TM produces 42 cubic feet of Hydrogen.

f. *Water Can*. The water can used with the met. station is a standard, galvanized steel, 31-gallon container (fig. 3-1). It has a diameter of 20 1/2 inches and is 26 1/2 inches high. Two handles are on the sides, and a galvanized steel lid (not shown) covers the top of the water can when it is not in use.

g. *Bracket Assembly (fig. 1-22)*. The bracket assembly consists of a steel bar with a clamp and adjustable hanger brackets. The clamp is located at the center of the bar for attachment to the manifold (fig. 3-1) of a hydrogen generator set. The adjustable hanger brackets allow the bracket

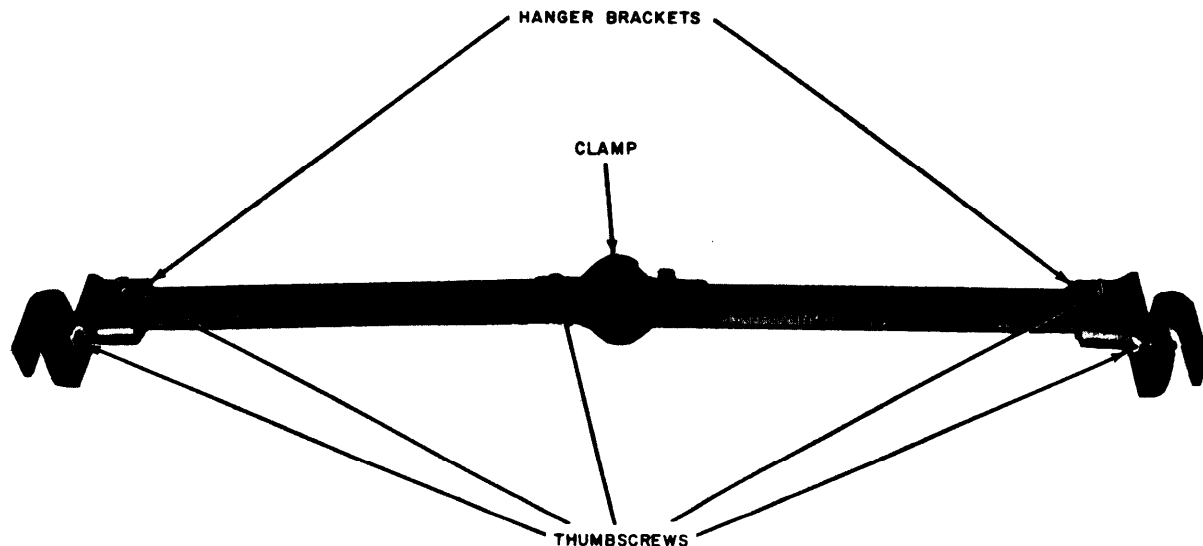

TM6660-218-15-41

Figure 1-22. Bracket assembly.

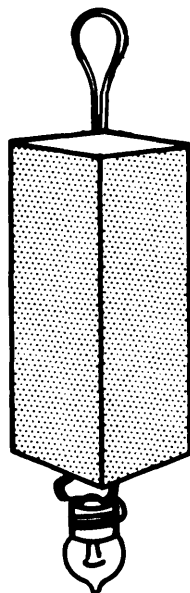

EL7UFO10

Figure 1-23. Lighting unit MI-608/AM.

assembly to be fitted on various size water cans. The thumb-screws (fig. 1-22) secure the clamp and hanger brackets during operation.

h. Coupling (fig. 1-6). This fitting has a 1A inch, left-hand thread at one end for connection to a gas regulator or standard gas cylinder. The other end of the fitting has a nipple to allow it to be inserted in a hose.

i. Lighting Unit (fig. 1-23). The lighting unit is a 2.6-3.8 VDC water immersion activated battery. It furnishes 30 minutes of light at temperatures from + 800 F to — 30° F. The lighting unit is attached to a pilot or sounding balloon when the balloons are launched at night.

j. Sounding Balloon Nozzle (fig. 1-24). The sounding balloon nozzle provides connection between the gas regulator and sounding balloon. It is used to weigh off a sounding balloon to the proper free lift. The sounding balloon nozzle consists of a horizontal tapered inlet and an upright outlet over which a balloon nozzle can be stretched. A flat base holds up to five weights.

k. Parachutes (fig. 1-7). The radiosonde and lighting unit parachutes are made of paper and are used to prevent injury to persons or property from falling radiosonde sets or lighting units.

l. Reel (fig. 1-25). The reel is a lightweight portable unit designed to be carried by one man. It consists of Spool DR-8, a reel handle assembly, an axle and crank, and adjustable straps. Mounted

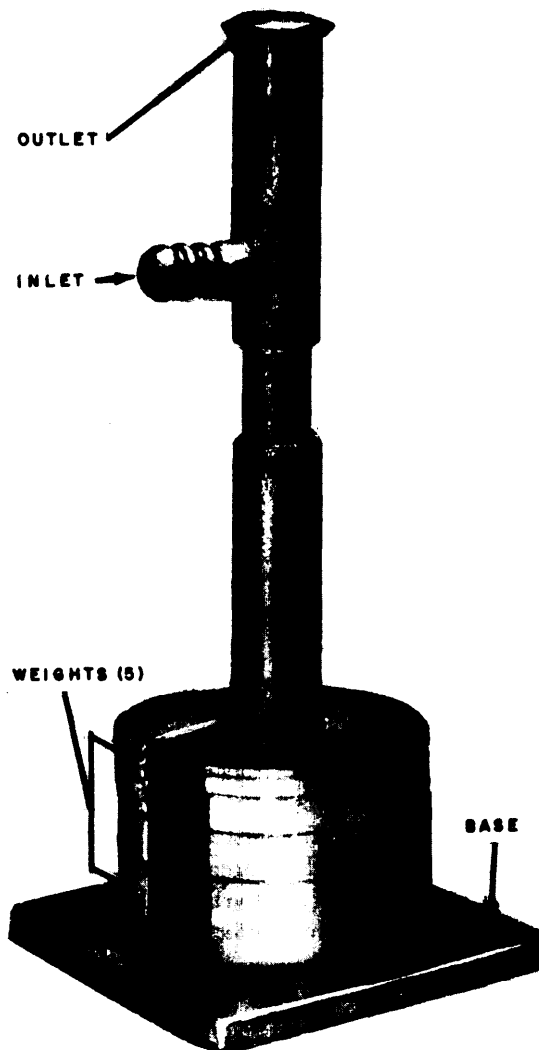

TM6660-218-15-40

Figure 1-24. Sounding balloon nozzle.

on one side of Spool DR-8 is a terminal board fitted with two brass hexnut terminals. A hole in the spool, just below the terminal board, permits the reel end of the wire to be connected to the hexnut terminals. The reel handle assembly has U-shaped steel rods, with a loop formed at each end, to encircle a reel handle bearing. Two bearings support the axle and Spool DR-8 and rotate freely when the wire is played out or when the crank is used to rewind the wire. A crank, which consists of a lever arm and a cast iron knob, is attached to one end of the axle. The straps are made of cotton webbing and adjusted by metal buckles.

m. Launching Reel (fig. 1-26). The launching

reel consists of a frame, a reel, a 60-foot cord, and a governor. One end of the cord is attached to the reel. The eyelet in the frame is used to connect the launching reel to a pilot or sounding balloon. The launching reel is used as an aid in launching balloons when winds exceed 15 miles per hour.

n. Pilot Balloon Nozzle (fig. 1-28). The pilot balloon nozzle provides connection between the hydrogen generator equipment and pilot balloons during inflation; it is also used to weigh off the balloon to its proper free lift after inflation. It has a hose connection, a large injector for connection to 30-gram pilot balloons, and a small injector for connection to 100-gram pilot balloons. It weighs 132 grams and has three auxiliary weights of 50, 70, and 443 grams. A handle controls the flow of gas through the nozzle to the balloon.

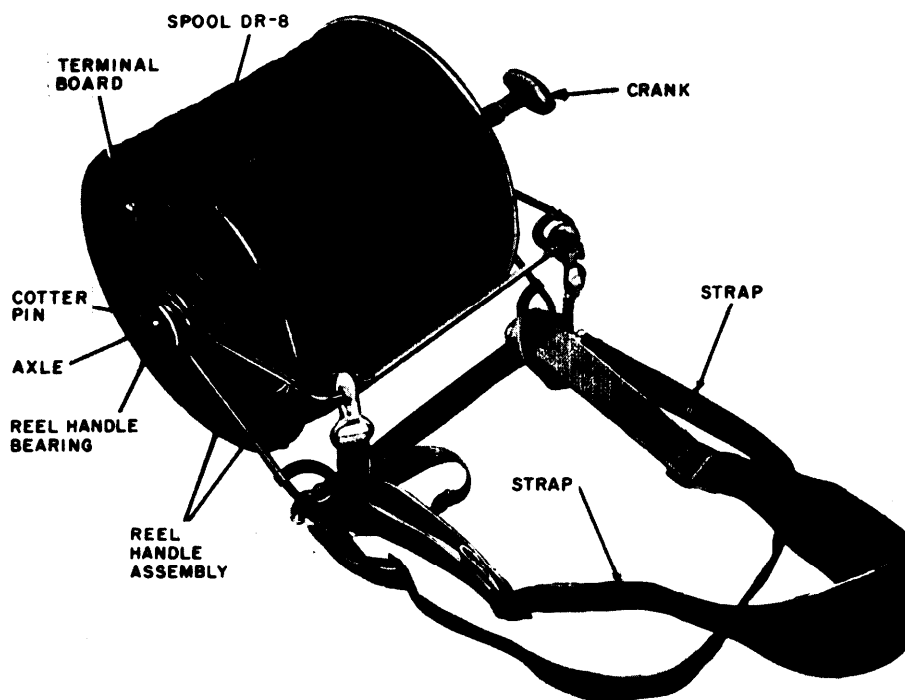

TM6660-218-15-34

Figure 1-25. Reel,

p. Jack (fig. 2-4). The jack is a two-way extension jack enclosed in a phenolic shell through which two external binding posts protrude. It provides a connection between the wire in the reel (fig. 2-4) and the head and chest set.

g. Gas Regulator (fig. 1-29). The gas regulator is made of brass and consists of a nipple connector, a standard thread connector, a regulator valve, and two pressure gages. The right-hand gage has a scale from 0 to 3,000 pounds per square inch and indicates supply gas cylinder pressure. The left-

o. Scales.

- (1) Scale ML-577\UM (fig. 3-3) is a clear plastic, rectangular protractor, with a center reference mark and a North-South reference line. The pilot balloon scale has divisions to measure the wind direction to the nearest 10 roils when it is used with Plotting Board ML-122.
- (2) Scale, Plotting ML-573/UM (fig. 1-27) is made of clear plastic, in a rectangular flat shape, with two scales on the outside edges, one in meters and the other in feet, for height measurements. Three scales are available in the middle, to measure the zone height thickness of the standard artillery zones when used with Chart ML-574A/UM.

hand gage has a scale from 0 to 50 pounds per square inch and indicates gas release pressure.

r. Balloon Shroud (fig. 1-7). The balloon shroud is made of cotton duck and has a spherical diameter of 61A feet. Four handles (not shown) facilitate handling when the shroud is being used to launch a balloon.

s. Tripod (fig. 1-30). The tripod consists of three wooden legs and a threaded mount. A leather strap holds the legs together when the tripod is transported. The threaded mount is protected by a protector cap when the tripod is not in use.

1-11. Additional Equipment Required

a. The equipment listed below is not supplied with the met. station but is required when the met. station is used for electronic observation of upper winds:

- (1) Radiosonde Recorder AN/TMQ-5 (*).
- (2) Rawin Set AN/GMD-1(*).

(3) Radiosonde Baseline Check Set AN/GMM-1.

(4) Power Unit PU-620.

b. A cylinder of helium gas can be used (when available) for inflation of the pilot and sounding balloons in place of the hydrogen generator set.

c. (Deleted).

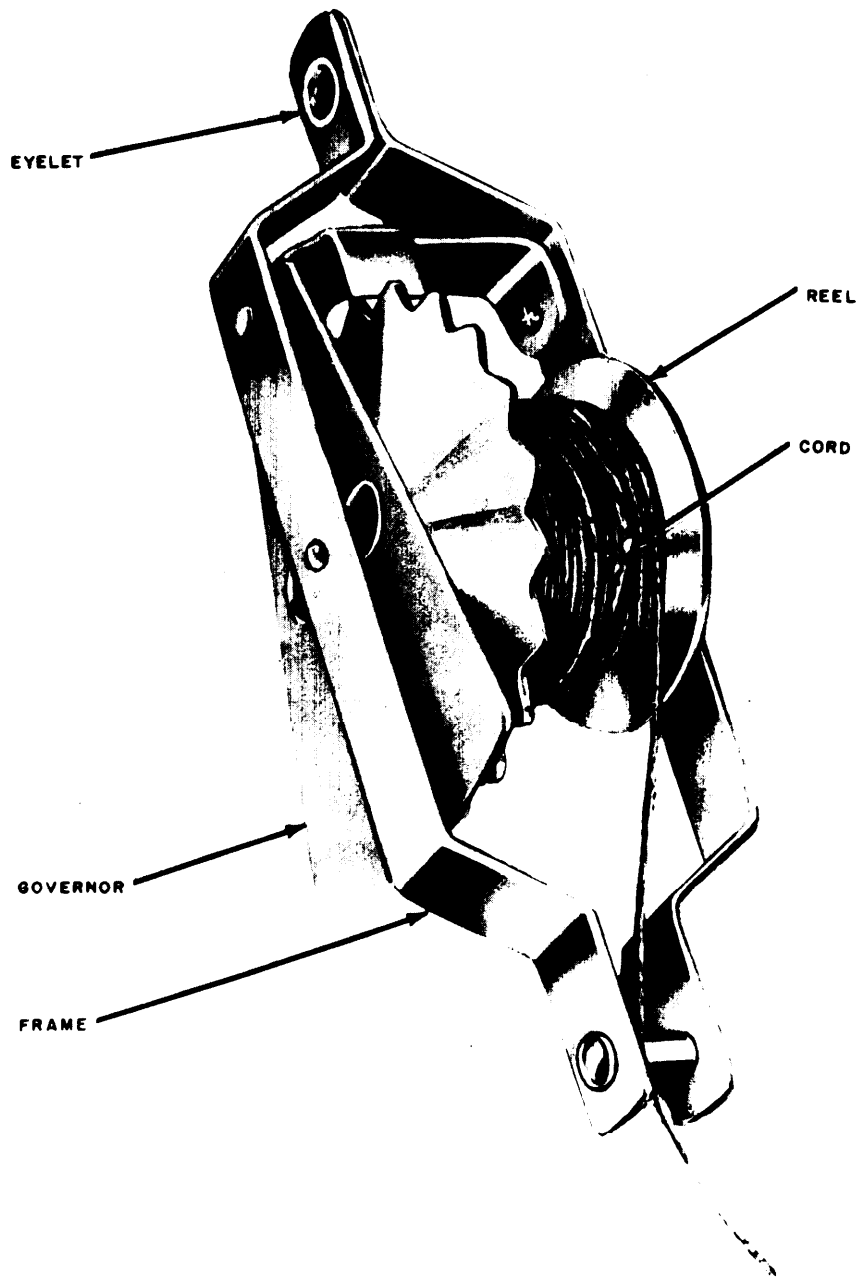

EL7UF011

Figure 1-26. Launching reel.

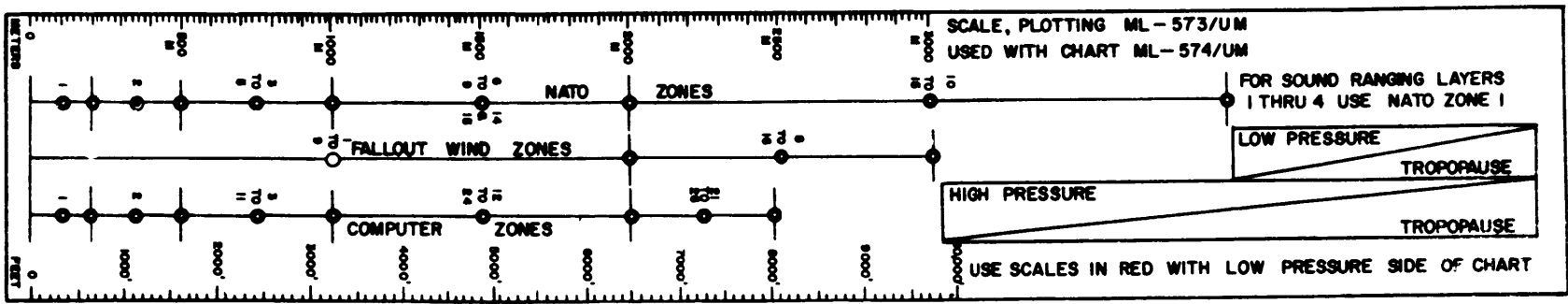

TM 6660-218-15-44

Figure 1-27. Zone height scale ML-573.

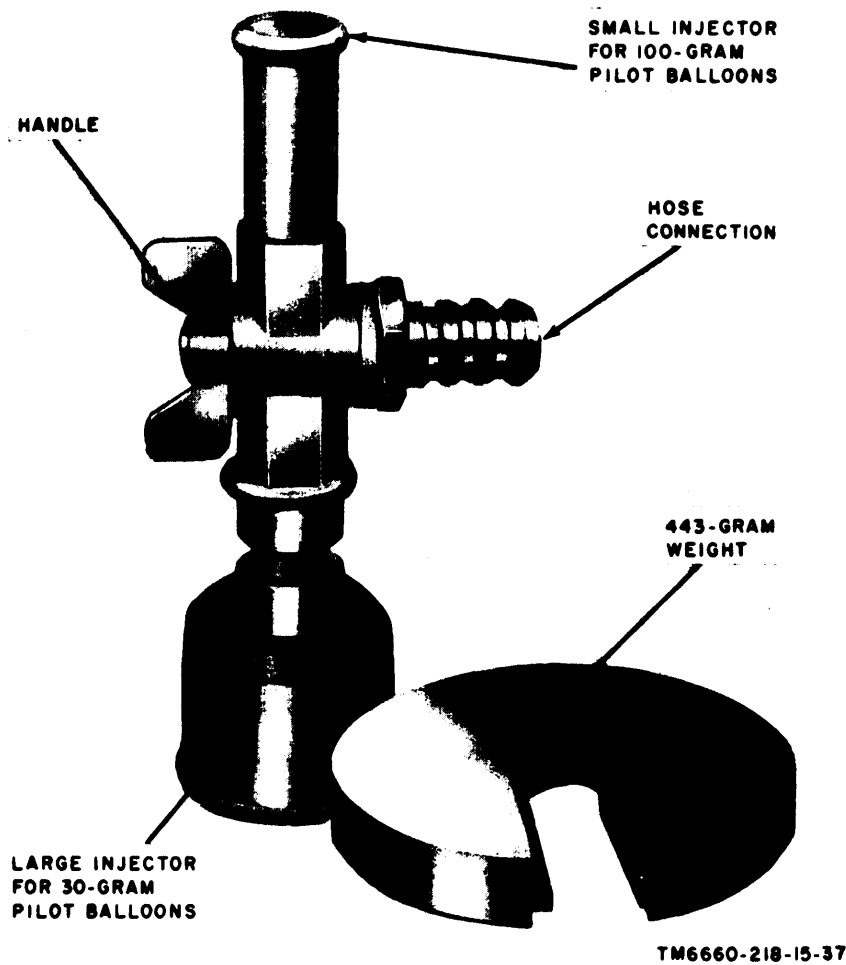

Figure 1-28, Pilot balloon nozzle.

1-12. System Application

When visual observations are performed at the met. station, the theodolite (fig. 1-3), the inflation device (fig. 1-19), the balloon inflation equipment (fig. 1-6), and the balloon equipment and accessories are kept in the area called the balloon launching site (fig. 1-1). The anemometer (fig. 1-8), the barometer (fig. 1-9 and 1-10), the psychrometer (fig. 1-12), the telephone (fig. 1-16), the timer (fig. 1-20), and the wind plotting equipment (fig. 1-4) are kept in an area called the plot-

ting station site (fig. 1-1). During electronic observations (fig. 1-2) a rawin set is located in an area convenient for operation and a rawin set control and radiosonde recorder (not shown) are added to the plotting station site. If the location of enemy fire is desired, sound-ranging techniques are obtained through basic visual or electronic observations. System techniques employed at the met. station for the collection of the various types of meteorological data are given below:

a. *Visual Observation of Upper Winds.* A 30-

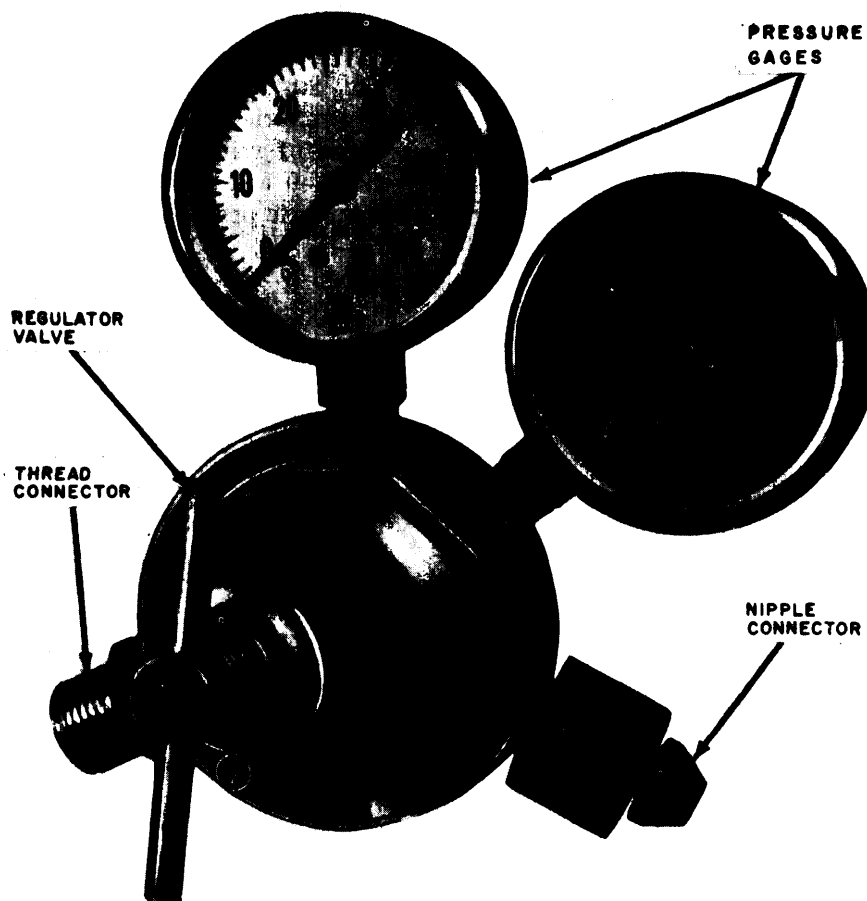

TM 6660-218-15-38

Figure 1-29. Gas regulator.

or 100-gram pilot balloon is inflated in the inflation device and launched from the balloon launching site. Visual observations of the balloon are made with the theodolite to obtain azimuth and elevation readings. If the observations are made at night, a lighting unit is attached to the balloon. As the readings are obtained, they are relayed to the plotting station through the head and chest set. The readings are plotted on the plotting board and converted to windspeed and wind direction data through the use of various charts and forms supplied with the met. station.

b. Electronic Observation of Upper Winds (fig.

1-2). A sounding balloon is inflated in the inflation device and launched from the balloon launching site after a radiosonde set and a radiosonde parachute have been attached to it. As the radiosonde set is lifted aloft by the balloon, signals emitted from it are received by the rawin set and graphically recorded on the radiosonde recorder. The signals are converted to information regarding relative humidity, temperature, and atmospheric pressure of upper level air. The rawin set antenna, by tracking (following) the radiosonde set, provides the rawin set control unit with azimuth and elevation information, which is con-

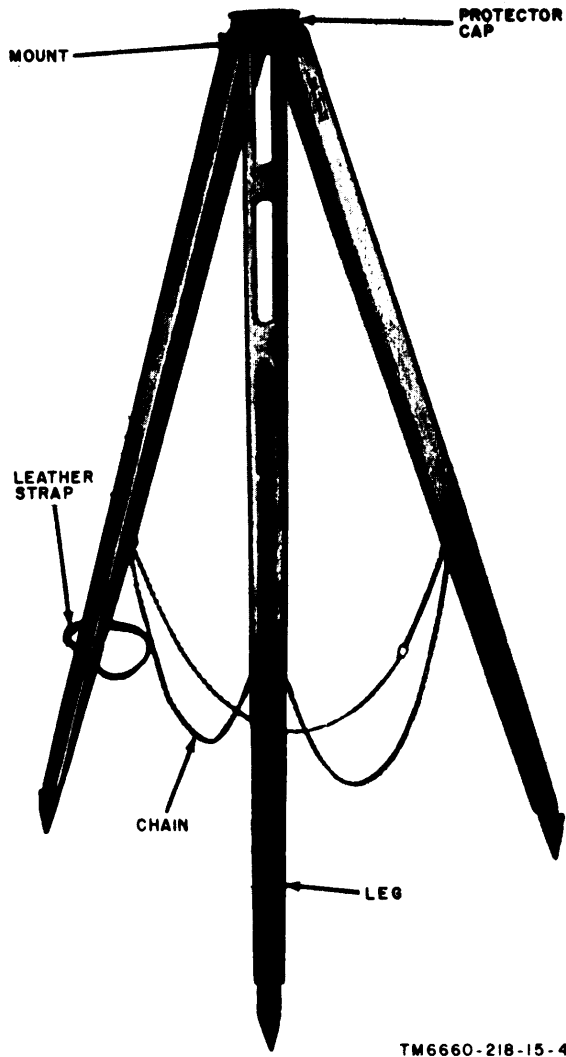

TM6660-218-15-44

Figure I-30. Tripod.

verted to windspeed and direction in a manner similar to that when the balloon was observed visually (a above).

c. *Surface Atmospheric Pressure.* Surface atmospheric pressure is obtained through observation of readings obtained from the barometer (fig. 1-9 and 1-10). The barometer indicates atmospheric pressure directly in millibars (ML102-B, -D, -E, -F, and -G) and inches of mercury (ML-102-B, -E, -F).

d. *Surface Wind Direction and Speed.* Surface wind direction and speed are obtained through the observation of indications on the anemometer (fig. 1-8). The velometer on the anemometer gives indications of windspeed in knots and the compass indicates direction of the wind.

e. *Surface Temperature.* Temperatures are obtained through the use of the general and/or tropical thermometers (fig. 1-18).

f. *Surface Relative Humidity.* Data required for the computation of surface relative humidity is obtained through the indications provided by the psychrometer (fig. 1-12).

1-13. Items Comprising an Operable Meteorological Station, Manual AN/TMQ4

NSN	QTY	Nomenclature, part No., and mfg code	Fig. No.
		The part number is followed by the applicable 5-digit Federal supply code for manufacturers (FSCM) identified in SB 708-42 and used to identify manufacturer, distributor, or Government agency, etc.	
6660-00-537-9195		Meteorological Station, Manual AN/TMQA consisting of:	1-1, 1-2
DA Form 4469	400	Winds Computation Form	
DA Form 4197	200	Radiosonde Data Sheet Form	
DA Form 4450	200	Ballistic Density and Temperature Form	
DA Form 4884	200	Weather Data for Sound Ranging Form	
DA Form 3959	200	Pressure-Time Chart	
DA Form 4524	200	Ballistic Density and Surface Data Form	
DA Form 3675	400	Ballistic Meteorological Message	
DA Form 3676	400	Fallout Metro Message	
DA Form 3677	400	Computer Metro Message	
DA Form 3583	200	Meteorology Data for Artillery-Air Weather Service Exchange	
6660-00-663-8090	1	Anemometer ML-433A/PM: SC-DL-106434:80063	1-8

NSN	QTY	Nomenclature, part No., and mfg code	Fig. No.
6660-00-663-8158	50	Balloon ML-50A	1-7
6660-00-526-6041	50	Balloon ML-51-A	1-7
6660-00-663-8159	50	Balloon ML-64-A	1-7
6660-00-663-8154	50	Balloon ML-159-A	1-7
6660-00-663-8155	50	Balloon ML-160-A (Black)	1-7
6660-00-151-7772	50	Balloon ML-161-A (Red)	1-7
6660-00-999-2663	1	Balloon Inflation and Launching Device ML-594/U	1-19
6660-00-809-5114	72	Balloon, Meteorological ML-537A/UM	1-7
6660-00-936-8927	144	Balloon, Meteorological ML-635/AM	
6660-00-238-3044	1	Balloon Nozzle ML-373/GM	1-28
6660-00-526-5907	1	Balloon Nozzle ML-462/UM	
7510-00-243-3437	1	Bands, Rubber: #18 box 402	
6660-00-223-5073	1	Barometer ML-102B.D, E, F, G	1-9,1-10
6135-00-635-6370	192	Battery Pack BA-259/AM	1-7
6660-00-513-0090	1	Bracket Assembly, Anti-Buoyancy:SC-DL87779; 80063	1-22
6660-00-408-4559	168	Calcium Hydride Charge ML-304A/TM	1-21
6660-00-408-4560	244	Calcium Hydride Charge ML-305()/TM	1-21
6660-00-999-0743	264	Calcium Hydride Charge ML-587(/)/TM	1-21
7240-00-160-0440	1	Can, Ash and Garbage Feb Spec RR-C-82 as modified by Reply #6	3-1
6660-00-944-4574	200	Chart ML-574/UM ;SC-DL-441916, 80063	
5999-00-248-5814	4	Clamp; 90190,9491	
7520-00-281-5918	2	Clipboard: 9 in. w x 12 1/2 in. lg, 81348, LLL-F-336, Type B	1-6
4730-00-408-4628	1	Coupling ML-49: SC-DL-87873; 80063	
5965-00-577-6172	2	Head and Chest Set H-164/U	1-11
3655-00-408-4683	1	Hydrogen Generator Set AN/TMQ-3	1-6
5935-00-199-2455	2	Jack JK-54: SC-D-7626; 80063	1-5
6660-00-839-4927	120	Lighting Unit ML608/AM	
6660-00-999-2661	1	Meter Hydrogen-Helium ML-605/U	
4730-00-831-4011	1	Nipple, Pipe: SC-B-36246; 80063	1-29
6660-00-663-7924	1	Nozzle ML-196	1-24
6660-00-408-4718	192	Parachute ML-132 :SC-DL-21356; 80063	1-7
6660-00-924-2011	96	Parachute ML-609/AM: SC-DL-21357, 80063	1-7
6660-00-663-4748	2	Plotting Board ML-122'	1-4
6660-00-640-9162	2	Psychrometer ML-224 (Tropical Range) ^b	1-12
6660-00-223-5084	2	Psychrometer ML-224 (General Range) ^b	1-12
6660-00-542-1964	192	Radiosonde Set AN/AMT-4A, B, C, D, E ^c	1-15
3895-00-498-8343	1	Reel RL-39A, B	1-25
6660-00-408-4696	96	Reel, Radiosonde Launching ML-367/AM: SC-D-20451; 80063	1-26
6685-00-408-4766	1	Regulator, Pressure, Compressed Gas ML-528/GM: (Formerly Hydrogen Regulator ML-193)	1-29
6660-00-606-5835	4	Scale, Ballistic Winds ML-577/UM: SC-D-76382; 80063	3-3
6660-00-606-5834	2	Scale, Conversion, Pressure-Temperature Altitude ML-573/IJM: SC-D-76286; 80063	1-27
6660-00-356-6196	1	Shroud, Balloon ML-424/D	
7520-00-868-4734	2	Slide Rule GG-S-466 Type 1, Style A Class 2	1-4
6675-00-250-0503	2	Straight Edge ML-357/GM :SC-DL-30775; 80063	
6660-00-513-0109	2	Strap, Ground Assembly: SC-DL-88263; 80063	2-5
6660-00-392-9737	2	Support, Radiosonde Recorder MT-1355/TMQ-5	
5805-00-543-0012	1	Telephone TA-312/PT	
6660-00-526-5069	1	Theodolite, Double Center, ML-474A/GM: SC-DL-531781; 80063	1-17
6660-00-515-4817	2	Thermometer, Tropical Range	1-18
6685-00-533-5971	8	Thermometer, General Range	1-18
6645-00-583-0066	1	Timer Stop FM-103-1	1-20
6675-00-222-2505	1	Tripod, Surveying MT-1309/GM	

TM 11-6660-218-12

NSN	QTY	Nomenclature, part No., and mfg code	Fig. No.
6146-00-226-8812	2	Wide WD-1/TT: 1320 ft wound on spool; DR.-8-A	1-15
5180-00-408-1859	1	Tool Equipment TE33	
5120-00-449-8083	1	Wrench TL-112	

^c Replaceable Scale, ML-126A (NSN 6675-00-515-5212)

^b Replaceable Wicks, Cotton Woven (NSN 9390-00-264-6158)

^f Replaceable Temperature Element ML-419/AMT-4 (NSN 6660-00-663-8168) or (NSN 6676-00-616-6312)

1-14. Expendable Consumable Supplies and Material

Table 1-1 lists the supplies and material required for operation of the AN/TMQ-4.

Table 1-1. Expendable Consumable Supplies and Material

The supplies and material listed in this table are required for operation of this equipment and are authorized to be requisitioned by SB 700-50. The NSN for the applicable unit of issue required can be found in appropriate supply catalogs. The FSCM is used as an element in item identification to designate manufacturer or distributor or Government agency, etc., and is identified in SB 708-41/42.

Item	Description.	Ref. No. and FSCM	FSC
1	Envelope: Kraft Print; 8 1/2 x 11%		7530
2	Eraser, Pencil	3335-20	7510
3	Oil lubricating: FED Spec VV-L-820 oz Bottle		9150
4	Oil lubricating 4 oz container		9150
5	Pencil TM-140: No. 2		9150
6	Tape, Scotch: 1" w x 72 yard roll UU-T-101	81348	7510
7	Twine RP-15 (NSN 4020-00-231-5878)		4020
8	Pencil, Drawing: Black lead 3H; 70389, 3800		7510
9	Sharpener, Pencil: General writing; GG-S-236	81348	7520

CHAPTER 2 INSTALLATION

2-1. Unpacking

a. Packaging Data When packaged for shipment, the components of the met. station are placed in corrugated cartons and are packed in wooden boxes. An exploded view of components packaged for shipment is shown in figures 2-1, 2-2, and 2-3. Box numbers, dimensions, and contents are shown in para .2-2 .

b. Removing Contents.

- (1) Place the wooden packing cases that contain the components of the met. station close to the balloon launching site since most of the components are used at that location.
- (2) Cut and fold back the metal straps.
- (3) Remove the nails with a nailpuller. Remove the wooden covers from the packing cases and expose the corrugated cartons. Do not attempt to pry off the wooden covers; the equipment may become damaged.
- (4) Open the corrugated cartons and expose the components wrapped in individual corrugated cartons.
- (5) Open the individual corrugated cartons and remove the components.
- (6) Move the anemometer, the barometer, the psychrometer, thermometers, the telephone, the timer, the plotting board, scales, charts, and forms to the plotting station site.

2-2. Checking Unpacked Equipment

a. Check the unpacked equipment for any loss or damage that may have occurred during shipment. If the equipment has been damaged or is incomplete, refer to procedures given in paragraph 1-3 for disposition of the equipment.

b. Check the equipment against the packing

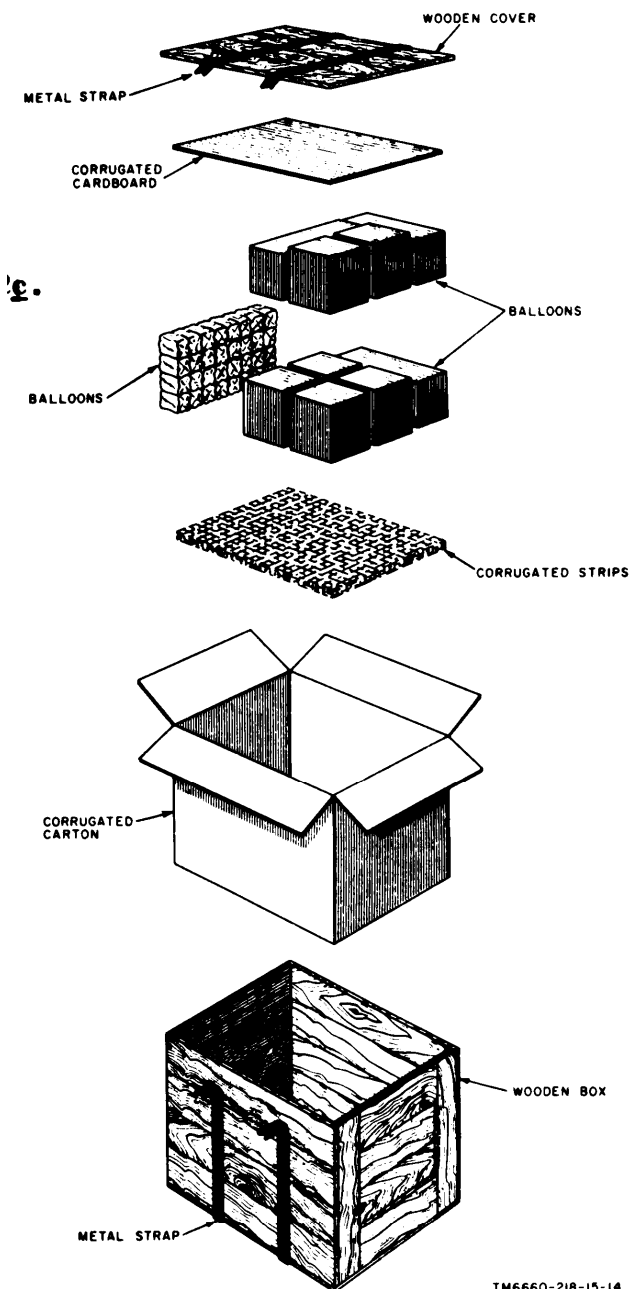

TM6660-218-15-14

Figure 2-1. Typical packaging diagram, balloon equipment.

TM 11-6660-218-12

list. When no packing list accompanies the equipment, weights and measures given in paragraph 1-6 and/or the packaging data given in c below, may be used as a general

check to indicate the equipment that probably has been packed.

c. The packaging data for Meteorological Station, Manual AN/TMQ4 is listed below.

Box No.	Dimensions (in.)			volume (Cu ft)	Contents of box
	Height	Width	Depth		
1 and 2 of 124 -----	16	34	10	2.9	Hydrogen Generator Set AN/TMQ-3 Pencil sharpener Bracket assembly, antibuoyance Scale, Plotting ML-A68/U
3 of 124 -----	34	24	24	11.2	
4 of 124 -----	24	27	27	10	Water can Pencil erasers Pencils scotch tape Rubberbands Clipboards Envelopes FM 6-15 FM 6-16 Bag Theodolite ML-474/GM
6 of 124 -----	7	65 1/2	8 1/2	2.2	Case, Theodolite CY-787/U Hammer HM-3 Ground rods Tripod, Surveying MT-1309/GM
6 and 7 of 124 -----	20	41	27	13	Parachute ML-132
8, 9, and 10 of 124 -----	22	31 1/2	28 1/2	11.2	Balloon ML-537/UM
11 of 124 -----	17	26	17	43	Balloon ML-50-A Balloon ML-51-A Balloon ML64-A Balloon ML159-A Balloon ML160-A Balloon ML-161-A
12 of 124 -----	16	43	33 1/2	12.6	Reel RL-39-(*) Twine RP-15 Telephone Set TA-312/PT Head and Chest Set (H164/U) Jack JK-54 Wire WD-1/TT Plotting Board ML-122 Regulator, Pressure, Compressed Gas, ML-528/GM Rule ML-126-A Barometer ML-102-B, -D, -E, -F, or -G
13 of 124 -----	14	36	29	12.2	Coupling ML-49 Wrench TL-112 Tool Equipment TE-33 Clamp Timer, Stop FM-103 Balloon Nozzle ML-373/GM Lighting Unit ML- 608/AM Parachute ML-430/U Scale, Plotting ML-573/UM Strap, ground assembly Chart ML-574A/UM

Box No.	Dimensions (in.)			Volume (cu ft)	Contents of box
	Height	Width	Depth		
14 and 15 of 124 -----	24	34	24	11.2	Nozzle ML-196 Straightedge, ML-357/ GM Thermometer, general Psychrometer ML-224 Slide Rule ML-59 Clock and watch oil Lubricating oil Pipe nipple Balloon ML-635/UM Balloon Inflation and Launching Device ML-594/U Calcium Hydride Charge ML-304A/TM Calcium Hydride Charge ML-305A/TM Calcium Hydride Charge ML-587 Radiosonde Set AN/AMT-4(*) Battery Pack BA-259/AM
16 of 124 -----	9	48	66	24.1	
17 of 124 -----	21 1/2	27 1/2	18 1/2	6.2	
18 thru 97 of 124 -----	8	23	17	1.8	
98 thru 106 of 124 --	28	18	22	8.6	
107 thru 124 of 124	29	26	22	9.6	
	13%	15	21	2.4	

2-3. Siting

The met. station should be centrally located with respect to the organization it services. It should be at or near the mean altitude of the using unit and, if possible, not over 600 feet above the mean altitude. The balloon launching site (fig. 1-1) must be in a clear area, preferably with no obstructions above 30 elevation when the rawin set is being used (fig. 1-2), and 6° elevation when the theodolite is being used. A source of water should be available for the operation of the hydrogen generator set and the area should have good drainage for the disposal of water and waste chemicals. The plotting station site (fig. 1-1 and 1-2) can be located at a distance from the balloon launching site, depending on situations that prevail. If visual balloon observations are to be made, the plotting station can be out of sight of the balloon launching site, because the operator of the theodolite will transmit all information back to the plotting station through the head and chest set. If electronic observations are to be made with the rawin set, it will be necessary to locate the rawin set no farther than 30 meters from the balloon launching site, and the plotting station site no farther than 62 meters from the rawin set. If possible, select the plotting station site so that it affords some cover.

2-4. Tools Required

The following tools are required for the installation of the met. station:

- a. Tool Equipment TE-33.
- b. Wrench TL-112.
- c. Hammer HM-3.

2-5. Installation Instructions

After the balloon launching and plotting station sites have been selected, install the equipment as follows :

- a. *Installation of Equipment at Balloon Launching Site.*
 - (1) When electronic observations are to be made, position the rawin set as described in paragraph 2-3 and place the Power Unit PU-620 so that the noise of the generator will not interfere with the work personnel. The length of the power cord (46 meters) limits the distance.
 - (2) Place Radiosonde Baseline Check Set AN/GMM-1 so it is shielded from the direct or reflected rays of the sun. Make sure that no obstacles or metallic objects block the transmitted signal between the baseline check set and the rawin set main assembly.
 - (3) Select an area of operation so that the location and altitude of the station can be established on a large scale map. Establish a line of direction to true North; use the compass on the theodolite and the area declination or by a survey.

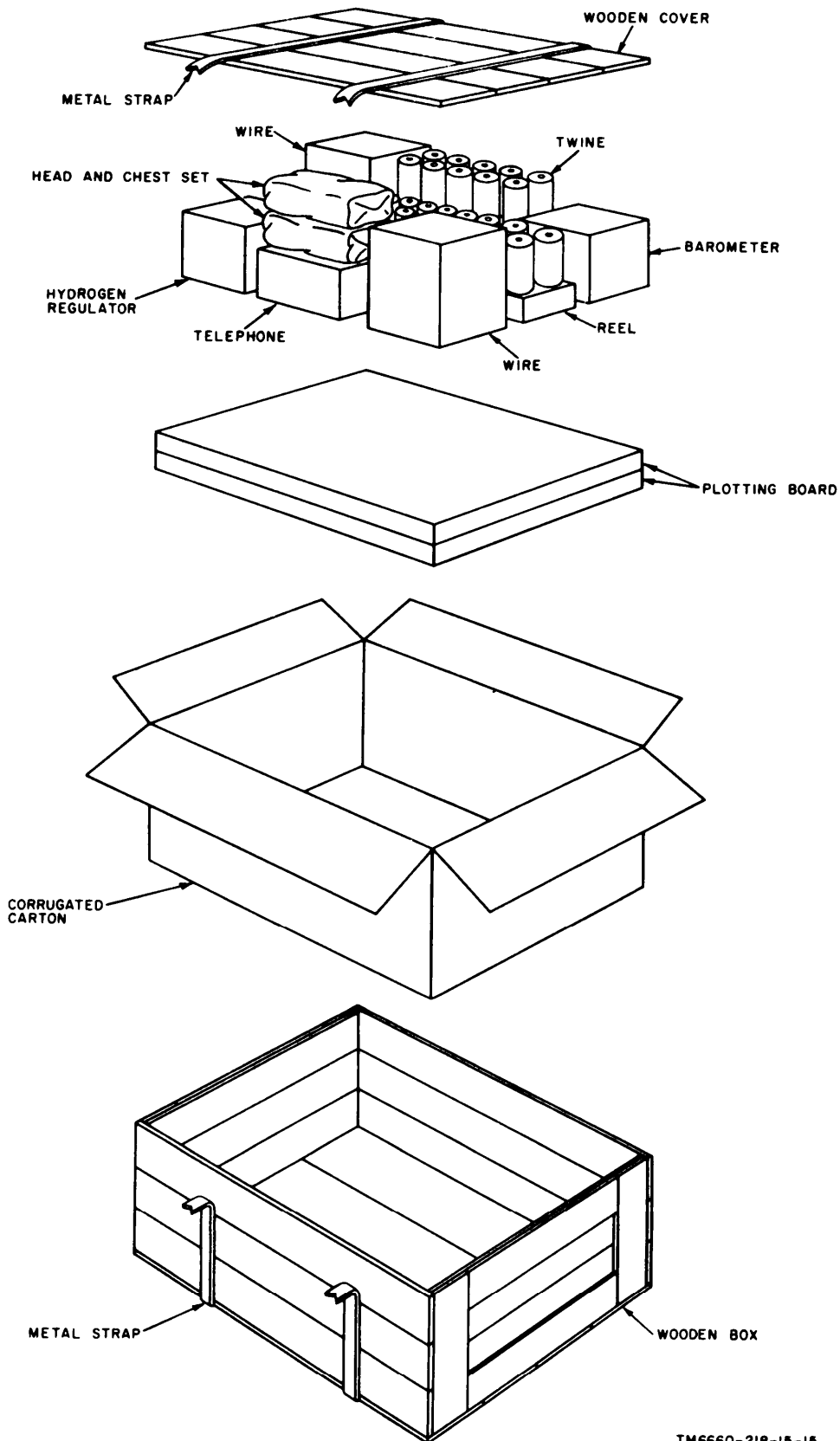

TM6660-218-15-15

Figure 2-2. Typical packaging diagram, communication, surface observation, and balloon inflation equipments.

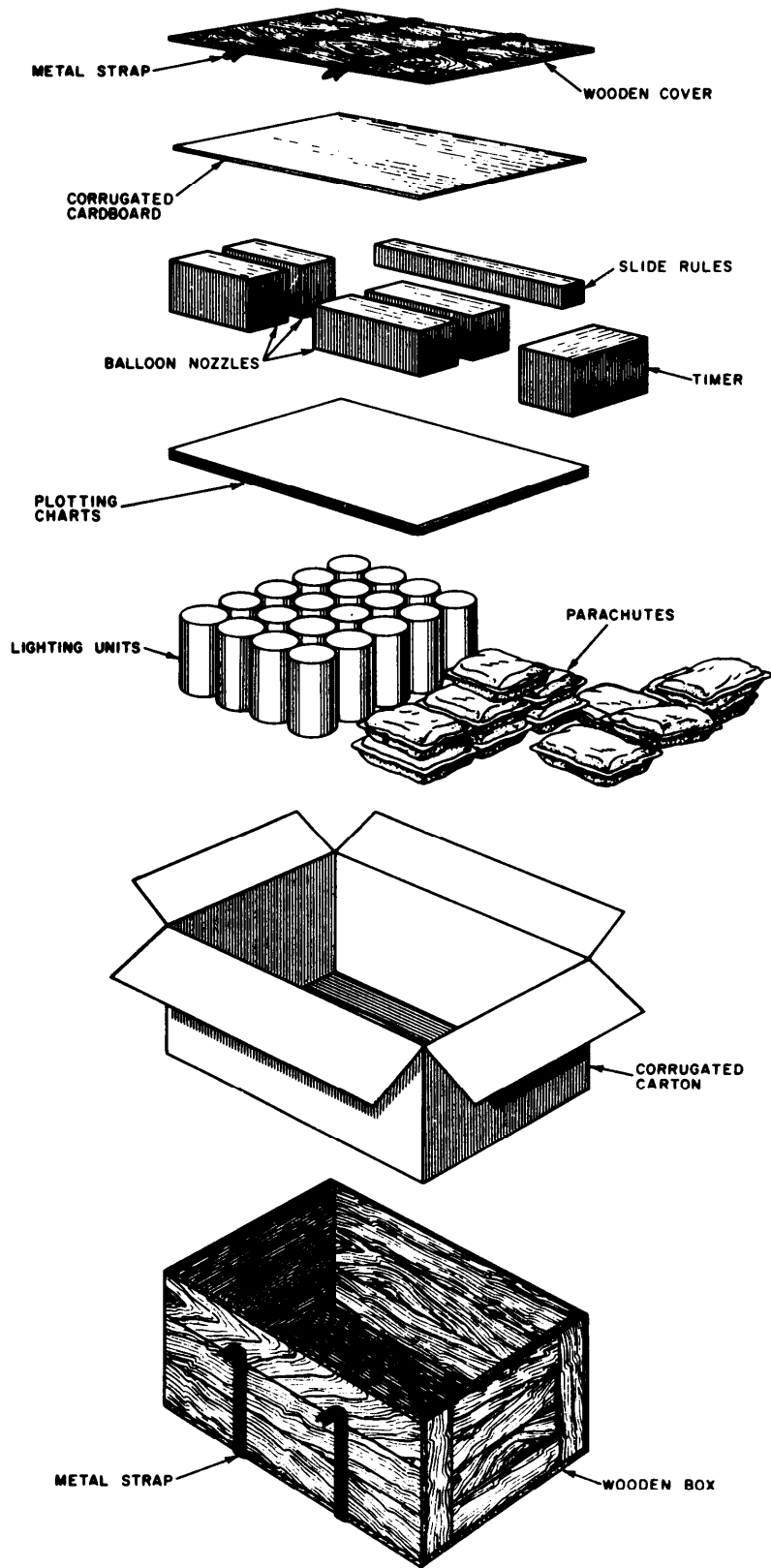

Figure 2-3. Typical packaging diagram, balloon-launching, balloon-inflation, and wind plotting equipments.

- (4) Position the inflation device downwind from the rawin set main assembly. The opening of the inflation device should be downwind to facilitate the release of the sounding balloon.
- (5) When visual observations are to be made, select an area as described in paragraph 2-3; select balloons to be used and prepare for a balloon release (para 3-2) ; erect the tripod and mount; orient and operate the theodolite as described in TM 11-6675-200-10.
- (6) When visual observations are taken for low level winds in support of free rockets, install the theodolite as follows:
 - (a) *Orient the theodolite so that the zero direction* of the theodolite is in the direction of fire and not in the direction of true North.
 - (b) *Locate theodolite upwind* at approximately 50 meters.
 - (c) *Orient the theodolite by using* the panoramic telescope, orientation angle, or the compass method. Detailed procedures for support are outlined in the artillery manuals for the individual free rockets launching procedure.

b. Installation of Equipment at Plotting Station.

- (1) Remove the anemometer from the case and attach the handle for surface wind evaluation.
- (2) Remove the barometer from its case and place it in a shaded area near the location picked for the plotting board (fig. 1-1).
- (3) Place the plotting board on a flat surface, or on a stand if one is available. Place the rule on the plotting board so that the retractable pin is inserted in the pivot hole on the side of the rule to be used. The side of the rule to be used depends on wind conditions. Use the 1,100-yard scale for low winds, and the 1,700-yard scale for high winds.

Caution

Do not tie the wire to the theodolite tripod.

- (4) Set up the telephone in a location convenient to the operator of the plotting board (fig. 1-1). Install batteries in the battery compartment (fig. 1-16) and connect telephone wires to the wire terminals; tie the wires to some fixed object near the terminal.
- (5) When electronic observations are to be taken, install the radiosonde recorder (not shown) in a location convenient to the operator of the plotting board, Connect the radiosonde recorder as indicated in TM 11-6660-204-10.
- (6) Store all Department of the Army forms, charts, and scales in a sheltered area or case until they are needed.

c. Installation of Communications Between Sites. When theodolites are used to visually observe upper winds, head and chest sets must be installed as follows to provide communication between the theodolite operator and the operator at the plotting section:

- (1) Place the reel at the plotting station and unreel the wire from the reel to the theodolite operator; connect the jack for the plug to the head and chest set (fig. 1-11) worn by the theodolite operator.
- (2) At the plotting station, connect the short end of the wire (fig. 2-4) to the terminal board on Spool DR-8.
- (3) Connect the jack for the plug to the head and chest set worn by the operator at the plotting station.

d. Installation of Inflation Equipment.

- (1) After the inflation device has been erected, prepare the area with the proper grounding procedures for use with hydrogen cylinders or generators.
- (2) Drive two brass rods, spaced 6 meters

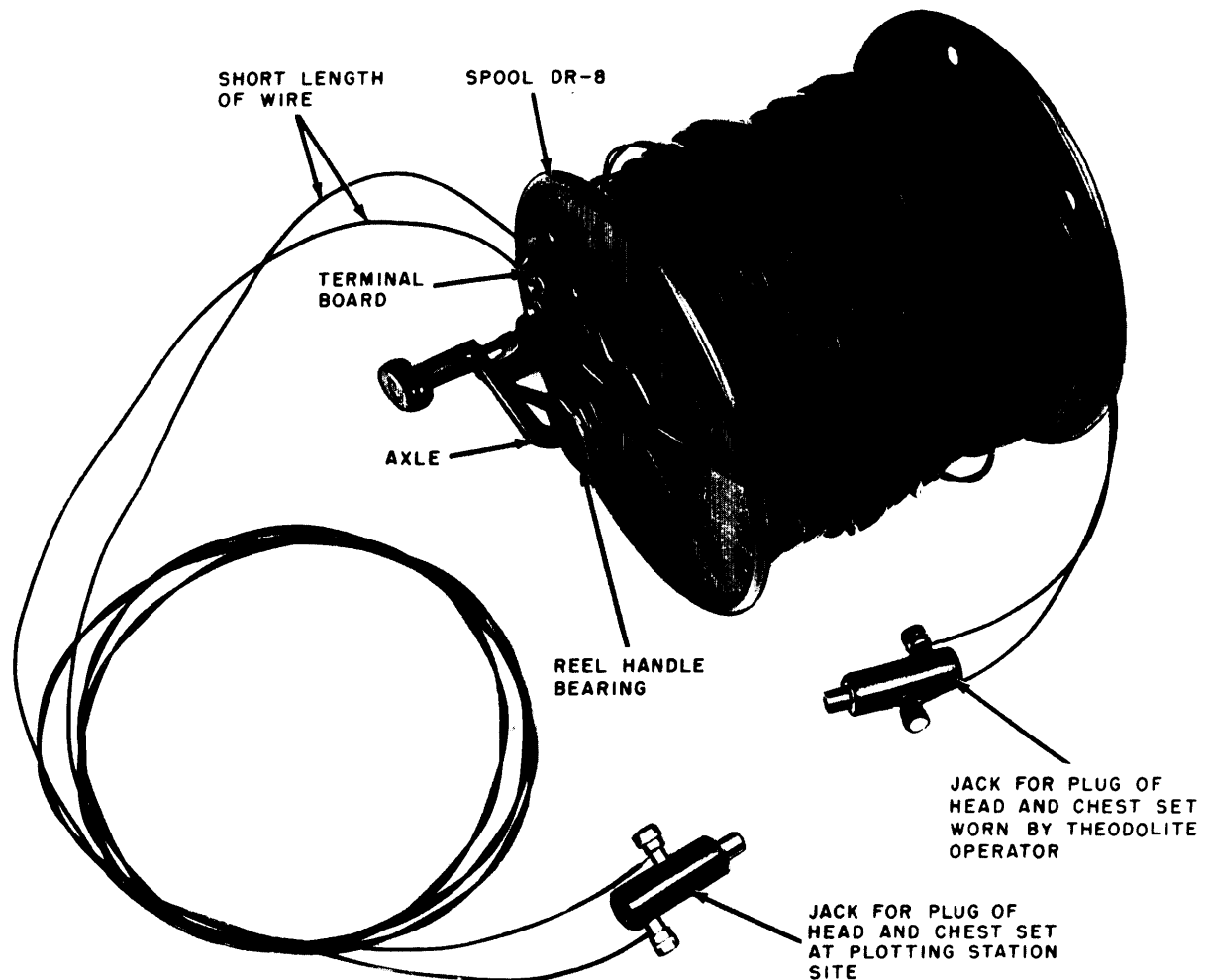

TM6660-218-15-23

Figure 2-4. Reel and jack hookup for communications.

apart, into the ground to a depth of 1 meter.

- (3) Measure the resistance with an ohm-meter between the two rods. The resistance should be less than 1,000 ohms; if the resistance is more add as many rods as needed at 1.5-meter intervals

until the resistance measures less than 1,000 ohms.

- (4) Connect the grounding stakes to the water can with straps or wire. Personnel actually handling the balloon should be grounded by a strap for discharge of a static buildup (figs. 2-5 ① and 2-5 ②).
- (5) Deleted.

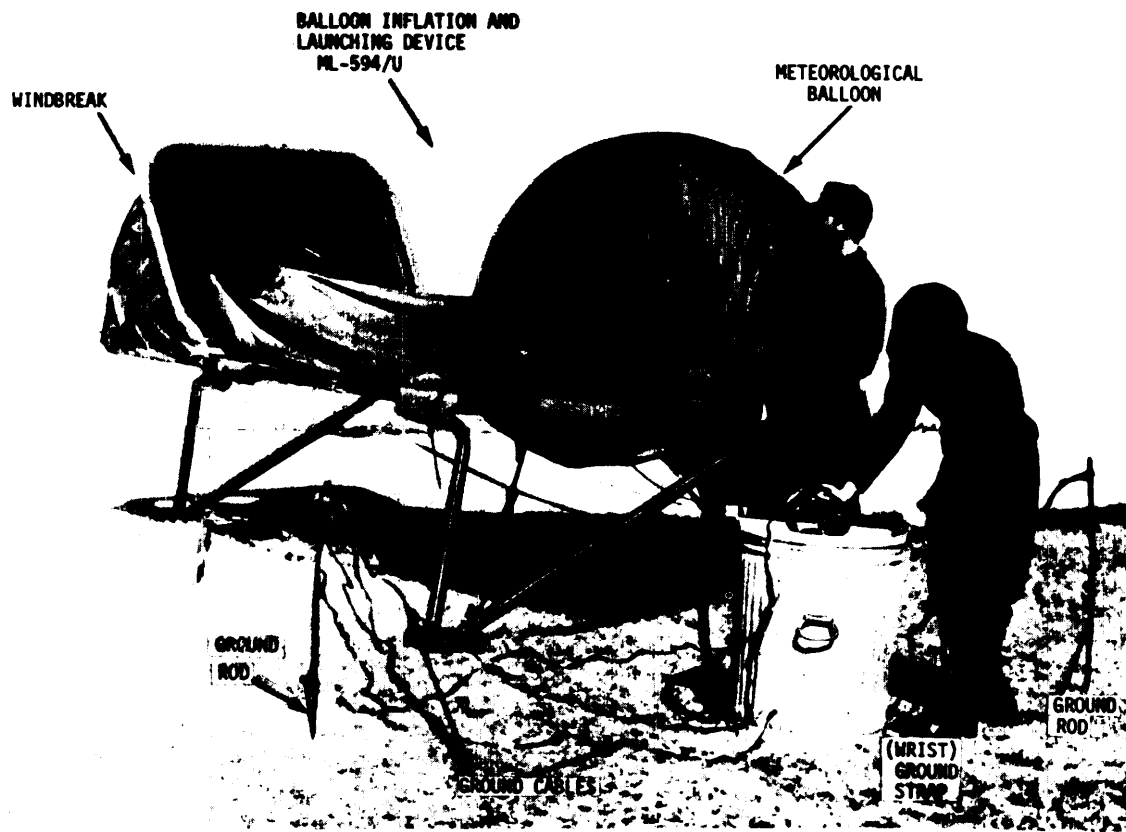

EL7UF012

Figure 2-5 ①. Grounding of Hydrogen generating equipment. (Part 1 of 2).

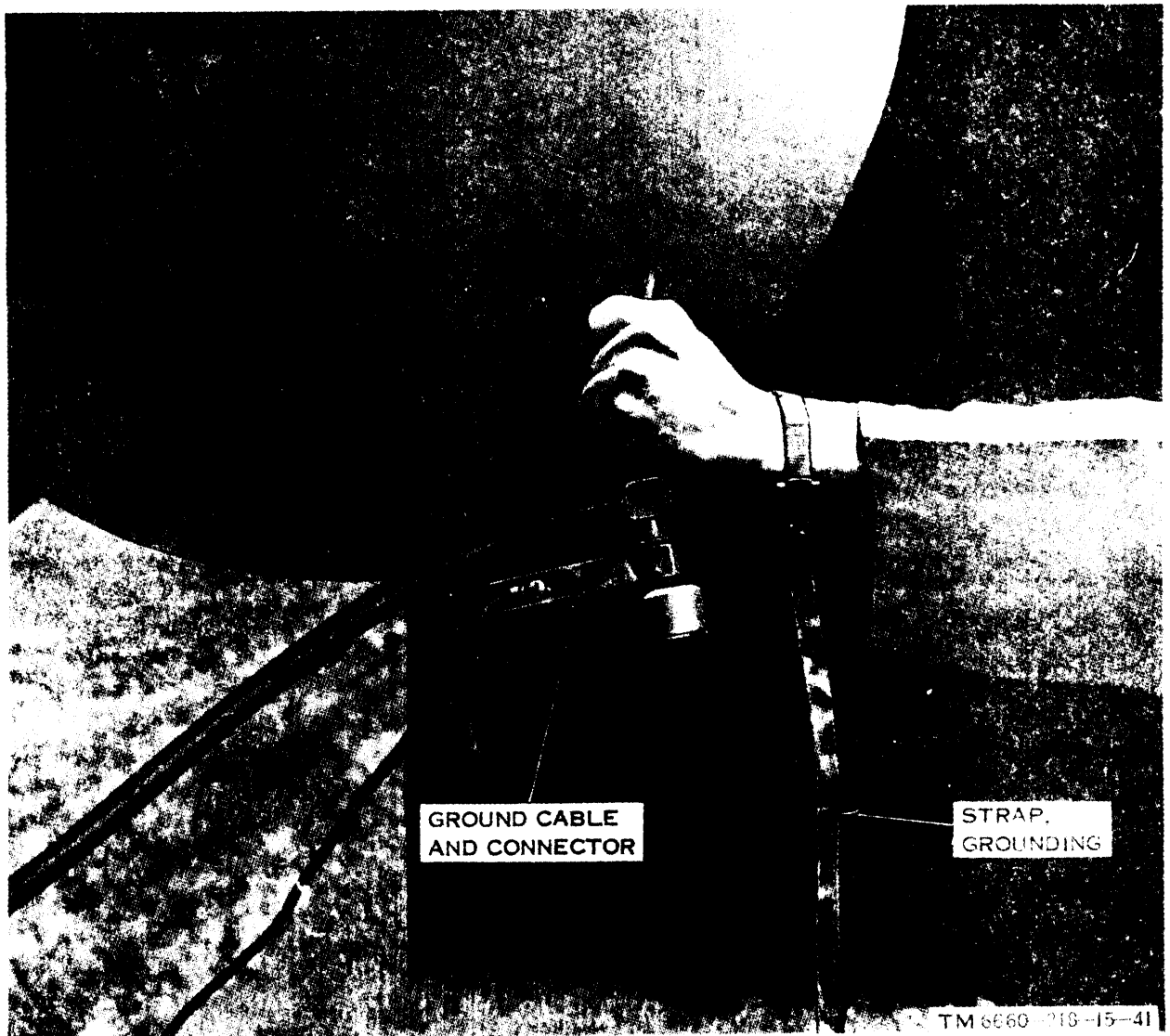

Figure 2-5②. Grounding of hydrogen generating equipment (part 2 of 2).

CHAPTER 3 OPERATING INSTRUCTIONS

Section I. PRELIMINARY OPERATING PROCEDURES AND OBSERVATION OF EQUIPMENT FUNCTIONS

3-1. Controls and Indicators

a. Anemometer (fig. 1-8).

Control or indicator	Function
Range selector _____	Determines the size of the vent exposed to the wind when windspeed is measured.
Index mark _____	
Zero-adjust screw _____	When set in line with the index pin, indicates that the front of the anemometer is perpendicular to the direction of the wind-flow.
Windspeed scale _____	
	Sets pointer of dial to zero. Indicates windspeed from 0 to 40 knots per hour (ML-433A/PM), or 0 to 40 mph (ML-497/PM).

b. Barometer (figs. 1-9 and 1-10).

Control or indicator	Function
Slotted screw (ML-102-B, -E or -F only). Dial (fig. 1-9 and 1-10) _	Dial calibration. Indicates atmospheric pressure in millibars (ML-102-B, -D, -E, -F, or -G) and inches of mercury (ML-102-B, -E, or -F).

c. Plotting Board. The only control on the plotting board is the retractable pin adjustment, which allows the retractable pin to be raised and lowered when needed.

d. Radiosonde Set. Refer to TM 11-6660-228-10 for information concerning the controls of the radiosonde set.

e. Telephone. Refer to TM 11-5805-201-12 for information concerning the controls on Telephone Set TA-312/PT.

f. Theodolite Set. Refer to TM 11-6675-200-10 for information concerning the controls and indicators on the theodolite set.

g. Timer (fig. 1-20).

Controls and indicators	Function
Start-stop pushbutton _____	Starts and stops the movement of the second and minute hands.
Return to zero pushbutton.	Returns the second hand to zero.
Spring winding knob _____	Winds the mainspring of the timer.
Speed regulator cover-plate.	Controls the accuracy of the timer.
Dial _____	Records elapsed time since the timer was started in minutes (minute hand) and seconds (second hand).

3-2. Preliminary Operating Procedures

a. Balloon Launching Site (Visual Observation).

- (1) Perform preliminary procedures (leveling and orienting) on the theodolite set. Refer to TM 11-6675-200-10 for detailed instructions.
- (2) Select the proper pilot balloon for use in the visual observation; use the following criteria:
 - (a) Uncolored pilot balloons are used when the sky is clear or lightly obscured due to fog, haze, or

smoke. This pilot balloon may also be used when only a few clouds, which are not increasing, are present.

- (b) Black pilot balloons stand out most clearly in an overcast sky condition of clouds or a dense haze aloft. Regardless of other sky conditions, a black pilot balloon will give the best results in the early morning (at sunrise) or in the evening (at sunset).
 - (c) Red pilot balloons are used primarily when the sky is partly cloudy with a blue or cloudy background. This pilot balloon may also be used when sky conditions are indefinite or changeable.
- (3) Prepare the pilot balloons for inflation. If the pilot balloon is more than 1 year old, conditioning may be required to prevent premature bursting.
 - (4) If the pilot balloon is to be released at night, AR 385-70 and AFR 55-73 require the use of Lighting Unit ML-608 and Parachute ML-609. The balloon train is prepared as follows:
 - (a) Inflate the pilot balloon.
 - (b) Unfold the lighting unit parachute; check the paper for rips, holes, or tangles in the shroud lines, and tie the cord attached to the lighting unit parachute to the pilot balloon neck.
 - (c) Prepare the lighting unit in accordance with instructions on the can.
 - (d) Tie one end of a 5-foot cord to the battery tabs, and the other end of the cord to the bottom of the lighting unit parachute shroud lines.

b. Balloon Launching Site (Electronic Observations) .

- (1) Perform the preoperational checks on the rawin set as indicated in TM 11-6660-206-12.
- (2) Obtain current temperatures from the wet and dry bulb thermometers at the plotting station site. These will be used when adjusting and performing the baseline check of the radiosonde set.

Caution

Be careful to handle the sensing elements by the edges (humidity) or lead wires (temperature) when installing these units in the modulator. Reject broken,

chipped, scratched, or finger-printed elements.

- (3) The assembly of the radiosonde set should be scheduled in accordance with the required time of release. A time interval of 20 minutes is allowed for the activation of the battery and production of full power. After activation, the battery is connected to the plug provided on the Radiosonde Baseline Check Set AN/GMM-1.

c. Baseline Check Procedures.

- (1) After the radiosonde unit is visually inspected for material defects, prepare the radiosonde set for a baseline check.
- (2) Turn the power switch of Radiosonde Baseline Check Set AN/GMM-1 to ON. The fan, the heater, and light switches will operate but the heater will not operate unless the fan is on. Allow the baseline check set to stabilize for at least 20 minutes.
- (3) Place the test leads of the radiosonde set into the baseline check set terminal strip, and set the selector switch of the baseline check set control unit to REF.

d. Baseline Check Using Radiosonde Recorder AN/TMQ-5().*

- (1) With the baseline check set selector switch set to REF, adjust the printing circuit with the Control Panel C-834/TMQ-5 REC ADJ control knob to print at 95.0 recorder divisions on the Frequency-Recorder Time graph.
- (2) Place the baseline check set selector switch at TEMP for approximately 15 seconds, then at HUM for approximately 15 seconds.
- (3) With the Control Panel C-834/TMQ-5 selector switch set to SIG, mark, with a pencil, the respective traces, *T* for temperature, *H* for humidity on the Frequency-Recorder Time graph.
- (4) Place the baseline check set control switch at AUTO, the Control Panel C-834/TMQ-5 selector switch at SIG, and proceed with the baseline check until requirements are met as given in the standard operating procedures.
- (5) When procedures given in (4) above have been completed, Control Recorder C-577/GMD-1 records control switch is set to

STANDBY. Read the psychrometer in the baseline check set; first the wet bulb temperature reading, then the dry bulb temperature.

Note. The radiosonde set is left in the baseline check set until the validity of the baseline is determined.

- (6) Verify the temperature readings with the temperature and relative humidity traces from the Frequency-Recorder Time graph; use Computer CP-223C/UM and the following criteria:
 - (a) The 25° centigrade value must fall between 66.5 and 68.9 ordinates when Thermistor ML-419/AMT-4 is used, and the relative humidity must be between 20 and 70 %. If the temperature or humidity traces do not fall within the prescribed criteria, install a new temperature or humidity element, or both, and prepare for a new baseline check.
 - (b) When the baseline check is valid, the radiosonde set is removed from the baseline check set. The baseline selector switch is placed at TEMP and the power, the fan, the heater, and light switches are turned to OFF.

e. Preparation of Pressure Time Chart DA Form 8959.

- (1) Enter the following information in the appropriate spaces on the form:
 - (a) Station location.
 - (b) Flight number.
 - (c) Release time.
 - (d) Baroswitch serial number.
 - (e) Computer.
 - (f) Checker.
- (2) The contact number which corresponds to the surface pressure is entered in the bottom box of the left column, and the surface pressure is entered in the center column.
- (3) In the left column, cross out the numbered reference contacts lower than the contact which represents the surface pressure.
- (4) The pressure for each reference contact number in the left column is read from the radiosonde pressure calibration chart to the nearest whole millibar and entered in the center column.

- (5) Record, in the right column, the time each reference is reached from the control recorder tape as it becomes available during the flight.

f. Preparation of Radiosonde Data Form DA Form 4197.

- (1) Enter the following information in the appropriate space on the form:
 - (a) Station location.
 - (b) Flight number.
 - (c) Release time.
 - (d) Baroswitch serial number.
 - (e) Computer.
 - (f) Checker.
- (2) The baseline check observations are entered in the spaces opposite the words *BASELINE CHECK DATA*, columns 1 through 6.
- (3) The surface observational release is entered in the spaces opposite the words *RELEASE DATA*, columns 1 through 6.
- (4) Values for pressure, temperatures, and humidity aloft are entered as the data is evaluated.

g. Selection of a Sounding Balloon.

- (1) The bursting altitude of a sounding balloon depends on conditioning, inflation procedure, and the type of balloon.
- (2) High altitude sounding balloons weigh 1,000 to 1,200 grams and burst near an altitude of 32,000 meters.
- (3) Fast rising sounding balloons rise to altitudes of 32,000 meters at a rate of approximately 500 meters per minute.
- (4) Sounding balloons, at night, will normally burst at lower altitudes. Bursting altitudes are with respect to sea level.
- (5) Conditioning of sounding balloons before inflation is necessary to assure maximum bursting altitude.
- (6) Sounding balloons in storage and exposed to relatively low temperatures lose elasticity. Neoprene sounding balloons used without conditioning will result in premature burst.

Note

Balloons less than 1 year old need no conditioning. Exposure to room temperature (21° C) for 24 hours is all that is required.

- (7) To insure maximum bursting altitude, all sounding balloons will be conditioned as described in paragraph 3-2.

(8) A sounding balloon may be inflated immediately after conditioning.

h. Inflation of Sounding Balloons Using Nozzle ML-196.

- (1) Nozzle ML-196 weighs 1,500 grams and is issued with weights (100, 200, 400, 500, and 1,000 grams).
- (2) Shake out the sounding balloon to remove the powder inside; then roll up the sounding balloon to expel all the air. Attach the neck of the sounding balloon to the sounding balloon nozzle with a short piece of twine.
- (3) The weights required (in addition to the sounding balloon nozzle) to balance the desired total lift are placed on the sound-

ing balloon nozzle (see charts given in (4) and (6) (a) and (b) below).

(4) The chart given below is used as a guide to determine the amount of free lift required for sounding balloons during fair weather. The chart also specifies calcium hydride charges normally used to produce that free lift when Hydrogen Generator Set AN/TMQ-3 is used for inflation.

WARNING

Should any corroded, pitted, scarred, or broken ML-304A/TM, ML-305A/TM, or ML-387/TM canisters be found, follow all steps as shown on the warning page to render the canisters safe.

Inflation of sounding balloons

Balloon type	Use	Free lift (grams)	Number of charges using AN/TMQ-3				
			ML-305A		ML-304A	ML-587/U	
ML-537/UM	Day	1,600	5	and	1	or	3
ML-537/UM	Night	1,900	6	and	1	or	4
ML-635/UM	Day	1,100	3	and	2	or	2
ML-635/UM	Night	1,300	4	and	1	or	0

(5) Determine the required nozzle lift, which is defined as the total weight in grams, to be balanced by the inflated sounding balloon to assure the desired ascension rate.

(6) The chart (a) below) lists the weights of the usual sounding balloon attachments used in the balloon train. The chart (b) below) indicates the additional weights necessary to compensate for adverse weather conditions.

(a) Weight of sounding balloon attachments are as follows:

Attachment	Weight (grams)
Radiosonde Set AN/AMT-4(*), with battery.	1,200
Radiosondc Set AN/AMT-12, with battery.	
Lighting Unit ML-608	15
Parachute ML-132	150
Reel, Launching ML-367/AM	100

(b) Additional weights for foul weather are as follows:

Weather	Weight (grams)
Precipitation of light intensity (all balloon types).	200
Heavy precipitation and/or icing (all balloon types).	400
Average zonal winds exceeding 60 knots (spherical-type balloons).	600 to 1,200

Example: An example of the computation of the nozzle lift required for a typical day-time radiosonde flight using Balloon ML-537/UM is as follows:

Required free lift from (a) above	1,600 grams
Weight (radioisnde set and parachute) from (b) above	1,350 grams
Nozzle lift required (highest 100 grams)	<u>3,000 grams</u>

(7) Using the example given above, enough weight must be attached to Nozzle ML-196 so that the total weight of the sounding balloon nozzle and the weights is equal to the weight of the sounding balloon and attachments, plus the free lift

required (nozzle lift). The computation of weights required to obtain this lift is as follows::

Nozzle lift required	3,000 grams
Minus weight of nozzle.	<u>1,500 grams</u>
Additional weight required	1,500 grams

- (8) When the Hydrogen Generator Set AN/TMQ-3 is used to inflate the sounding balloon, attach charges as listed in the

chart given in (4) above and proceed as follows :

- (a) Prepare the inflation area by grounding the hydrogen generator set and personnel as described in paragraph 2-5d.
- (b) Clamp the bracket assembly to the outlet tube of the hydrogen generator set (fig. 3-1), and mount the bracket assembly on the water can.
- (c) Generate hydrogen until charges are

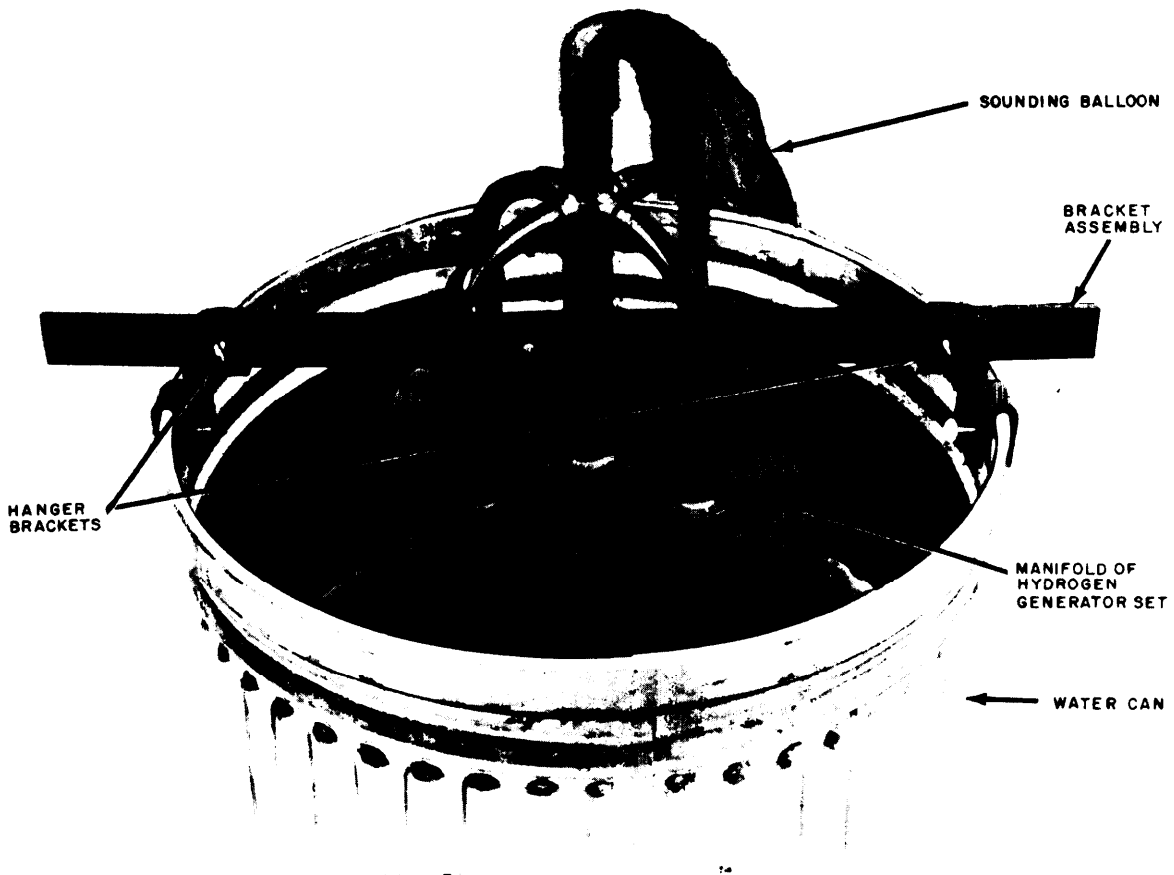

TM 6660-218-15-46

Figure 3-1. Hydrogen generator set and bracket assembly mounted in water can.

- expended; then remove the hydrogen generator set from the water can.
- (d) Remove the sounding balloon from the hydrogen generator set and weight of the sounding balloon to the desired free lift, as described in the chart given in (4) above.
 - (9) After the inflation is complete, tie the

balloon neck with twine and place it outside the inflation area.

i. Preparation for Inflating Sounding Balloons with Gas Cylinders.

- (1) Move the gas cylinder to the place where the sounding balloon is to be inflated several hours before inflation. The gas inside the sounding balloon must be at

TM 11-6660-218-12

the same temperature as the air in which the sounding balloon is weighed off. Keep the gas cylinder out of the sun at all times. Safety procedures for handling commercial gas cylinders are listed in AR 700-8120-1.

- (2) Remove the valve protection cap from the gas cylinder.

WARNING

If gas does not flow when the cylinder valve is opened, IMMEDIATELY close the cylinder valve and replace the valve protection cap. Apply a red tag to the valve protec-

tion cap and mark the tag with the following notice:

WARNING !

This gas cylinder has a faulty cylinder valve and is at full pressure. Return the gas cylinder to supply for necessary action.

- (3) Quickly open and close the cylinder valve to expel any dirt in the valve outlet and check to see that the cylinder valve is functioning properly.
- (4) Attach one end of Hose ML-81 to the gas regulator that will be used with the gas cylinder. Use a hose clamp to fasten the ML-81 securely. Screw the gas regulator to the cylinder valve and tighten it with a wrench.

Note. The gas cylinder and gas regulator have left-hand threads.

j. Inflation of Sounding Balloon with Gas Cylinder.

- (1) Attach the free end of Hose ML-81 to Nozzle ML-196, which is then secured to the sounding balloon. The other end of the ML-81 is attached to the gas regulator.

Warning: If the gas pressure is not indicated on the high-pressure gage as soon as the cylinder valve is opened, immediately close the valve and remove the gas regulator. Replace the valve protection cap. Apply a red tag to the valve protection cap and mark the tag with the following notice:

WARNING !

This gas cylinder has a faulty cylinder valve. Gas, under pressure, still remains in the tank. Return the gas cylinder to supply for necessary action.

- (2) Slowly open the cylinder valve on the gas cylinder.

Warning: Failure to open the valve slowly may cause Hose M1A1 to blow off the gas regulator, cause possible injury to personnel, and release gas into the inflation area.

- (3) slowly open the regulator valve on the gas regulator.
- (4) Inflate the sounding balloon slowly to avoid overinflation.
- (5) When the sounding balloon just lifts the sounding balloon nozzle with the required weights from the supporting surface (para 3-2h), close the cylinder valve and the valve on the regulator if a regulator is used.
- (6) Remove the hose from the sounding balloon nozzle and allow the sounding balloon to float in the air. If it rises, release some of the gas until the sounding balloon floats motionless. If the sounding balloon sinks, connect the hose to the sounding balloon nozzle and add more gas. When the sounding balloon remains motionless in the air, it has the required lift.
- (7) Place the fingers of one hand firmly around the neck of the sounding balloon and the sounding balloon nozzle. With the other hand, lift the upper part of the neck and twist it completely once or twice. Grasp the twisted part with the fingers and remove the twine. Remove the sounding balloon from the sounding balloon nozzle.
- (8) Tie the sounding balloon neck securely with twine.

k. Preparation of balloon Train.

- (1) Tie the sounding balloon line of the radiosonde parachute to the ring in the top of the radiosonde set.
- (2) If the sounding balloon is to be launched in winds less than 15 miles per hour, tie one end of a 60-foot length of a 100-pound, test nylon cord, or 16-ply cord to the top of the radiosonde parachute. The other end is attached to the sounding balloon after the sounding balloon is inflated.
- (3) If the sounding balloon is to be launched in winds which exceed 15 miles per hour, use Reel, Launching

ML-367/AM (fig. 1-26). Connect the launching reel as follows:

- (a) Unwind about 5 feet of cord from the launching reel. Double the unwound cord and tie the end securely to form a loop.
- (b) Wind 1½ feet of the doubled cord back on the launching reel.
- (c) Place the unwound cord under the spacer and securely tie the cord end to the top of the radiosonde parachute.
- (d) Tie one end of a doubled short length of 16-ply cord to the eyelet in the opposite end of the frame. Use this cord for tying the launching reel to the sounding balloon after inflation.

I. Inflation of Sounding Balloon with Balloon Launcher.

(1) Assemble the balloon launcher as described in TM 11-6660-238-15.

(2) Place the balloon in the canopy, position the train line, and insert the inflation nozzle through the canopy and on to the neck of the balloon.

(3) Connect the gas meter and the gas cylinder to the balloon nozzle as described in TM 11-6660-238-15, and prepare the balloon for inflation.

(4) Tie and seal the balloon and launcher as described in TM 11-6660-238-15.

3-3. Surface, Visual, and Electronic Observation Procedures

The procedures given below will be used to make weather observations during normal operating conditions. Record all readings in each step. These readings will be used to fill out the appropriate DA forms.

a. Atmospheric Pressure. Read the atmospheric pressure from Barometer ML-102(*) (figs. 1-9 and 1-10), to the nearest tenth of a millibar, after tapping the barometer slightly to see that the pointer is in equilibrium. View the pointer with the eye directly above the pointer.

b. Surrounding Temperature. To determine the surrounding temperature, read the appropriate thermometer. Use the void weather thermometer in arctic regions at all times, and in temperate zones during winter months. Use the tropical thermometer in tropical regions at all times, and in temperate

zones during the spring, the summer, and the fall months.

c. Wet and Dry Bulb Reading, from Psychrometer ML-224.

- (1) After checking to assure that the wick of the wet bulb thermometer is wet, whirl the psychrometer; hold it to the front of the body at waist height for 15 seconds and read the thermometers.
- (2) Repeat the above process until the wet bulb indications change less than 1° between readings.
- (3) Repeat the process at 5-second intervals until the minimum wet bulb indication is reached.
- (4) Record the lowest wet bulb indication and the dry bulb indication to the nearest 0.1 Centigrade.
- (5) When operating at temperatures below freezing, the wick is wetted 10 to 15 minutes before use so that the heat of fusion of ice is dissipated before the readings are made.
- (6) Note the readings from the wet and dry bulb thermometers and record the information on the proper DA forms.

d. Surface Wind Direction and Windspeed.

- (1) Hold the anemometer in an upright, level position. Keep the instrument away from magnetic material because such material will cause a false compass indication.
- (2) Turn the anemometer slowly back and forth until the index mark on the wind vane is in alignment with the index pin.
- (3) Read the compass. The compass card marking directly in line with the index line on the compass is the indicated wind direction.

Note. Wind direction is indicated in relation to magnetic North and must be corrected for local magnetic declination to obtain wind direction in relation to true North. The correction in magnetic degrees for the magnetic declination at a particular station will be supplied by the commanding officer.

- (4) Record wind direction in tens of degrees *front true North*. and convert the compass readings to an azimuth reading in hundreds of mils (fig. 3-2). Enter this data on the proper DA forms.

- (5) Set the index mark on the anemometer range selector knob at the appropriate (estimated) windspeed range (0 to 8 or 0 to 40).
- (6) Without moving the anemometer from the position in which it was held to determine wind direction ((2) above), read the windspeed from the velometer scale. Be sure to view the velometer pointer directly from the front to avoid an erroneous reading. If the pointer fluctuates considerably, read the high and low points and average the two readings. Note the windspeed in whole knots (MP433A/PM), or miles per hour (mph) (ML-497/PM) (rounded to the nearest whole number).
- (7) Correct the observed windspeed-reading for the effects of varying air density; use the windspeed correction factor chart furnished with the anemometer. Instructions for using the chart are printed on the chart.
- (8) Record the correct windspeed to the nearest whole knot, or mph.

e. *Upper Air Wind Direction and Windspeed (Visual Observation)*. Three observers are required for this operation; one observer releases the balloon, the second observer operates the theodolite set (after the pilot balloon is released, this operator will assist the theodolite set observer), and the third observer is located at the plotting section and indicates when the theodolite set readings should be taken. He also records the readings on DA Form 4469.

- (1) The plotting section gives the order to release the pilot balloon. When possible, the pilot balloon should be released approximately 100 meters downwind from the theodolite; this will reduce the tracking error and increase the accuracy of low-level winds.
- (2) When the order is given to launch the pilot balloon, the plotting section presses the start pushbutton of the timer (fig. 1-20).
- (3) The theodolite observer tracks the pilot balloon with the open sights and the tracking controls disengaged. The first elevation and azimuth angles are read to the nearest whole degree; then the operator changes to the telescopic sights, aligns the sights on the pilot balloon, and engages the tracking controls. The pilot balloon is tracked, using the tracking controls for the remainder of the flight.
- (4) When the time recorder commands WARNING, the observer adjusts the tracking controls with the crosshairs centered on the pilot balloon. At the command READ, he ceases tracking and reports to the plotting section the elevation and azimuth angle of the balloon to the nearest 0.10.
- (5) The theodolite set operator at the plotting section enters the readings on DA Form 4469.
- (6) Five seconds before each reading, the plotting section will warn the theodolite set operator to make an exact

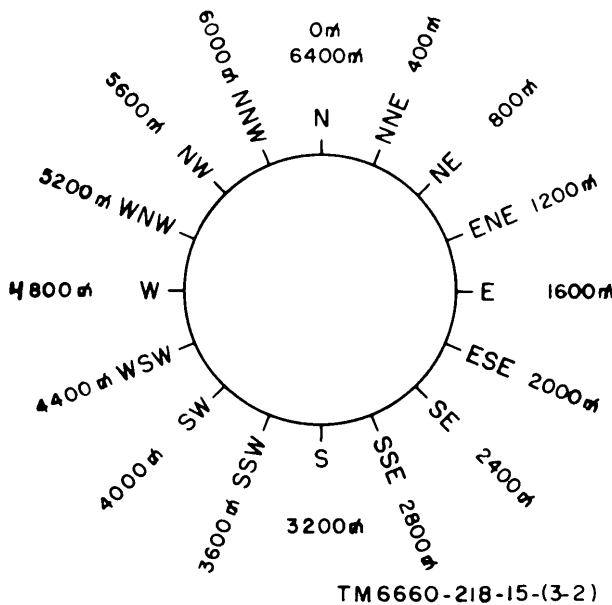

Figure 3-2. Mils scale conversion.

sighting on the pilot balloon, and at the end of the warning period (5 seconds) the operator will read the elevation and azimuth angles, as described in (4) above.

- (7) Continue the procedure given in (1) through (6) above until the mission is completed, or the pilot balloon disappears.
- (8) Use DA Form 3675 for the transfer of ballistic data to a Ballistic MET Message.

f. Release of Sounding Balloons (Electronic Observations). Two methods are used to release sounding balloons; mechanically with Balloon Launcher ML-594/U, as described in TM 11-6660-238-15, or manually with one or two observers. The proper procedure for release of the sounding balloon manually varies with the wind conditions at the time of release. One observer is required for release of spherical-type balloon (ML537/UM) in calm or very light winds. The release procedures for sounding balloons are as follows :

- (1) Release the spherical-type sounding balloon (ML-537/UM) in calm winds, with one observer, as follows:
 - (a) With one hand, hold the sounding balloon by the cord attached to the sounding balloon neck and gradually pay out the cord until the radiosonde set is reached. With the other hand, hold the bottom of the radiosonde set case.
 - (b) Lift the radiosonde set and allow the sounding balloon to carry it aloft.
- (2) Reel, Launching ML-367/UM is used when the sounding balloon is to be released by one observer. Release the spherical-type sounding balloon (ML-537/UM) in light winds, with one observer, as follows:
 - (a) Hold the launching reel with one hand and the radiosonde set with the other hand.
 - (b) Release the launching reel and permit the sounding balloon to rise without restraint. Observer should keep directly beneath the balloon as it drifts until the sounding balloon lifts the radiosonde set from the hand.
- (3) Release the spherical-type sounding balloon (ML-537/UM) in light to moderate winds, with two observers, when a

launching reel is not available, as follows :

- (a) Observer No. 1 holds the sounding balloon neck. Observer No. 2 holds the radiosonde set upright, by the bottom of the case, and assumes a position the full length of the cord, downwind from the sounding balloon.
 - (b) Observer No. 1 releases the sounding balloon at a given signal.
 - (c) As the sounding balloon ascends, observer No. 2 maintains a position beneath the drifting sounding balloon, and holds the radiosonde set until it is lifted from the hands by the rising balloon.
- (4) Release the spherical-type sounding balloon (ML-537/UM) during high surface winds, with two observers, by using a running release as follows:
- (a) Shorten the train line by using a launching reel.
 - (b) Observer No. 2 carries the radiosonde set downwind until the train is taut, while observer No. 1 carries the balloon upwind.
 - (c) At a signal to release, observer No. 2 runs with the sounding balloon until the train line is taut, and then releases the radiosonde set.
- (5) Deleted.

g. Plotting Section for Upper Air Wind Direction and Speed Electronic Observation).

- (1) Track and sounding balloon with the rawin set as indicated in TM 11-6660-206-12
- (2) Obtain the information from the rawin set control recorder printed chart (azimuth and elevation readings) and extract the data for the required computations on the forms given below.
 - (a) DA Form 4197 for computation of radiosonde data.
 - (b) DA Form 4450 for computation of ballistic temperatures and densities for all types of meteorological messages.
 - (c) DA Form 4469 for computation of zone windspeeds and directions.
 - (d) DA Form 3959 for evaluation of pressure versus time.
 - (e) Chart ML-574A/UM for the determination of mean zone densities and temperature from radiosonde data.

h. Upper Air Pressure, Temperature, and Relative Humidity (Electronic Observation). The observer on Radiosonde Recorder AN/TMQ-5(*)

evaluates the data received by the radiosonde recorder for pressure, temperature, and relative humidity and records the data on DA Form 4197.

Section II. METEOROLOGICAL DATA TECHNIQUES

3-4. Use of Visual Observation Data

a. Ballistic air densities and temperature can be determined from surface observations of pressure, temperature, and wet bulb depression when the station height is above sea level and the time of sunrise and sunset are known.

- (1) The surface data initially recorded on DA Form 4524 are used to determine ballistic density for each line of the message.
- (2) The station pressure is recorded to the nearest millibar.
- (3) The temperatures from both the wet bulb and the dry bulb are measured to the nearest 0.1° Celsius with Psychrometer ML-224.
- (4) The altitude of the station is determined to the nearest 10 meters above sea level.

b. Ballistic temperature is determined by the surface observation and entered on each line of the message. Express this value to the nearest 0.1 percent of International Civil Aviation Organization (ICAO) standard. The temperature change with height will be made in accordance with the ICAO atmosphere lapse rate. The virtual temperature is determined in percent of ICAO standard and recorded on DA Form 4524 in degrees Celcius.

c. Ballistic density is determined by the use of departure tables and entries made in blocks (8), (9) and (10) of DA Form 4524.

d. Departure from mean surface density is evaluated from artillery tables and blocks (11) and (12) of DA Form 4524.

e. Departure from mean ballistic density is determined to the nearest 0.1 percent for each line number required and entered in block (14) of DA Form 4524.

f. Percentage of standard ballistic density is entered to the nearest 0.1 percent for each line in block (15) of DA Form 4524.

g. Determine the zone wind direction and speed by using the information given in columns 1, 2, and 3 of DA Form 4469. The zone windspeeds and directions are plotted as follows:

- (1) Compute the horizontal distance in meters; use the artillery tables and the

elevation angles from each zone. When the pilot balloon is released from an offset point, more than 50 meters from the observing station, enter the data on the zone wind plotting board (fig. 3-3).

- (2) Enter the horizontal distance readings in column 4 of DA Form 4469.
- (3) Plotting Board ML-122 is oriented by placing NORTH directly away from the plotter. Rule ML-126-A is then placed so that the edge which is in line with the pivot hole passes over the appropriate azimuth on the plotting board (fig. 3-4) for the zone indicated.
- (4) Mark the pilot balloon position on the plotting board with a small capital *T* opposite the horizontal distance. The top of the *T* is placed along the edge of the rule, and the stem of the *T* is placed at the desired horizontal distance. Each point plotted is identified by the zone number at which the angular data was read. If the plot is made at other than the normal scale, the factor by which the distance is expanded or reduced is shown after the zone number by writing a multiplication or division sign and the factor used.
- (5) The direction and windspeed at the surface level is determined with the hand anemometer. Convert the azimuth reading of the compass reading to the nearest 100 roils, as described in paragraph 3-3d. Read the windspeed directly from the anemometer to the nearest whole knot and enter this data in columns 7 and 8 of DA Form 4469.
- (6) The zone wind directions for zone No. 1 and higher are read directly from the plots; use Scale ML-557/UM. A line is drawn from the zone entered over and beyond the next point; then, the direction is read on Scale ML-577/UM. The center of the pilot balloon scale is placed over the point of origin, or the plotted point where the pilot balloon entered the zone being considered.
- (7) Scale ML577/UM is oriented with NORTH on the plotting board by align-

ing the vertical lines of the pilot balloon scale with those on the plotting board. The wind direction is read and recorded to the nearest 10 mils. This procedure is used for each succeeding plot.

- (8) Scale ML-577/UM is constructed so that the black azimuth can be read directly. When an offset release point is used, the wind direction for zone No. 1 must be

determined from the offset release point as it is the point of origin.

- (9) Continue to move the pilot balloon scale from plot to plot until the wind direction for all points has been determined and entered in column 7 of DA Form 4469.
- (10) Windspeed is determined by measuring the horizontal travel in each zone, in meters, with Rule MP126-A. This is

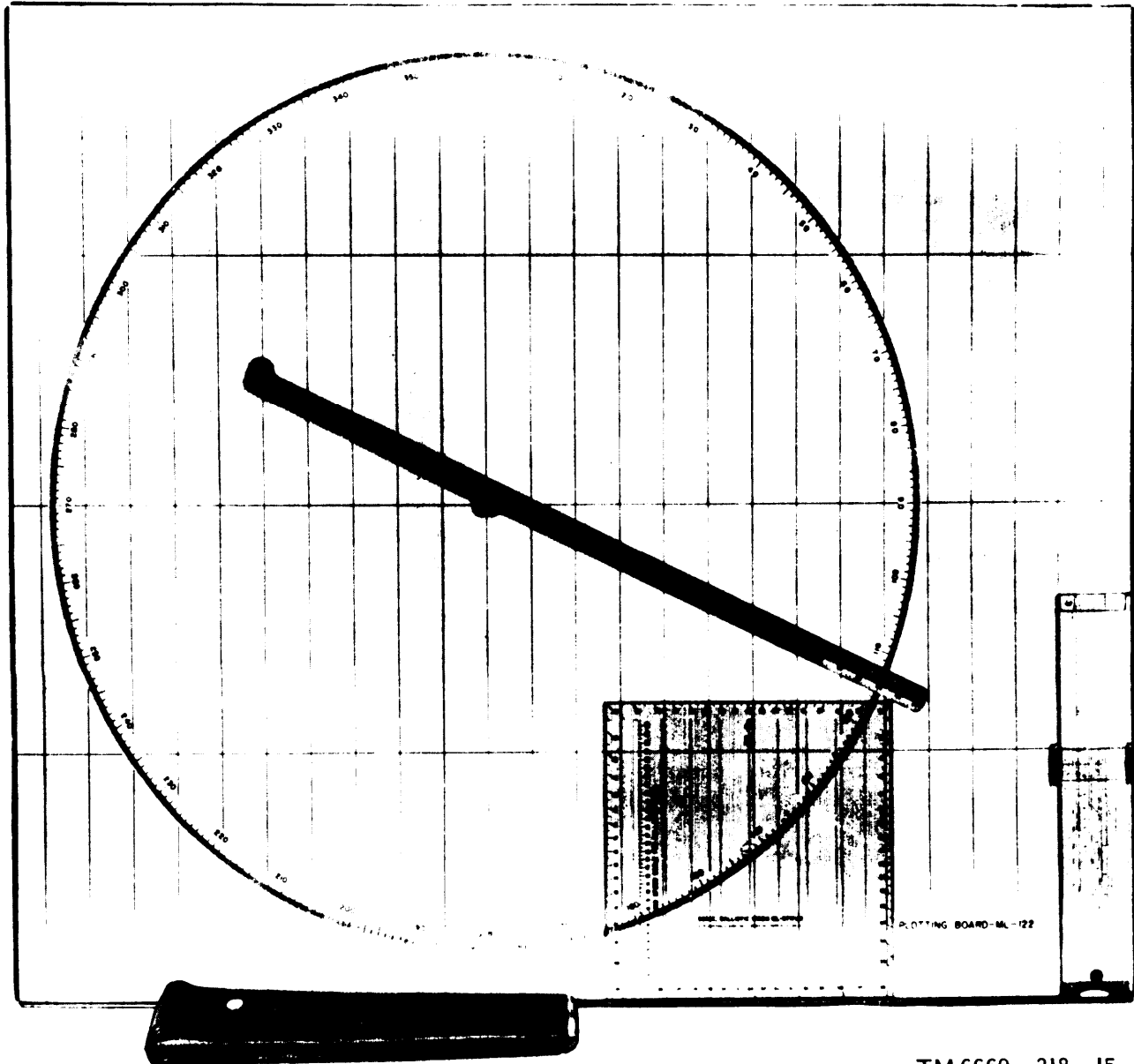

TM 6660 - 218 - 15 - 43

Figure 3-3. Zone wind plotting board.

done between plotted points, as determined in procedures given in (7), (8),

and (9) above, and entered in column 5 on DA Form 4469. ■

- (11) The time in zone is determined from the fixed standards given in column 6 of DA Form 4469.
- (12) Compute the zone windspeed by using Slide Rule ML-59 and the formula $D/T \times 0.0324 = S$; where D is the horizontal

travel in meters, T is the time in zone in minutes and tenths, and S is the zone windspeed in knots. The values of the windspeed are entered in columns 8 of DA Form 4469.

h. Ballistic wind determination for line 0 and

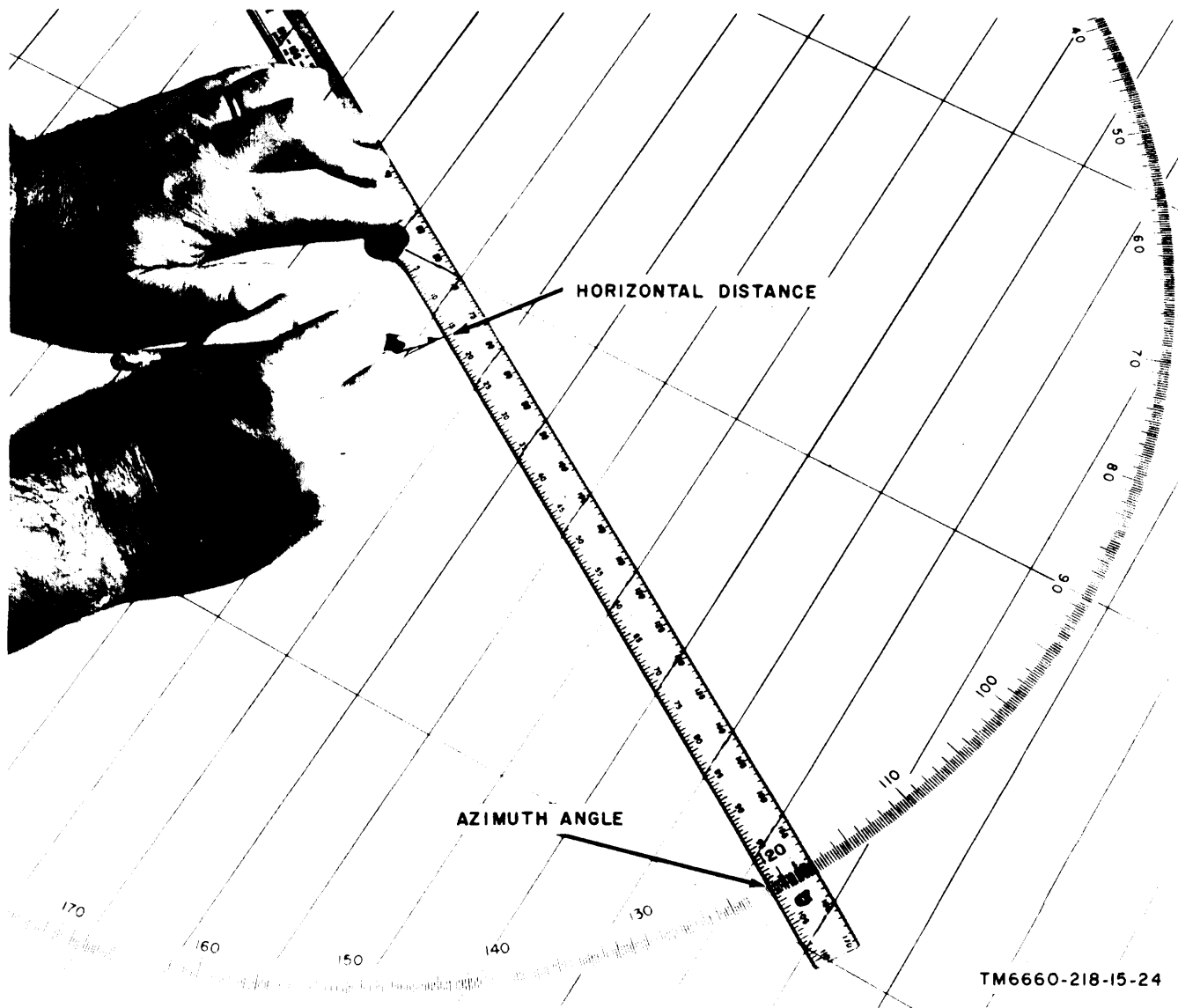

Figure 3-4. Plotting azimuth angle and horizontal distance.

line 1 are the same as the surface and the zone 1 winds. Zone wind data recorded in columns 7 and 8 are entered for ballistic wind data in columns 9 and 10 of DA Form 4469. The value of the ballistic wind for any given line is determined by considering the zone winds of all zones from the surface to the standard height of that line. To obtain the ballistic wind for any line above line 1, a plot is made of the weighted wind effect of each zone which contributes to the ballistic value for that

line of the message. These plots take the form of vectors. The sum of the zone winds vectors is the ballistic wind.

- (1) Orient Plotting Board ML-122 with the spaced parallel lines running from the top to the bottom of the plotting board. The top of the plotting board represents North.
- (2) Select origin points for the lines to be

plotted at the intersections of the horizontal and vertical lines.

- (3) If the wind is from the west, select an origin at an intersection near the left edge of the plotting board. If the wind is from the east, move to the right for the origin so plots will not fall off the plotting board.
- (4) Center Scale ML-577/UM over the origins for lines 1 through 15.
- (5) Determine zone-weighted windspeeds with the artillery tables, and plot the weighted values with Scale ML-577~UM and procedures given in 9h (1) through (12) above.
- (6) Complete the ballistic wind plot and measure the ballistic wind direction and speed. Record the data in columns 9 and 10 of DA Form 4469.

3-5. Use of Electronic Observation Data

a. *The radiosonde data sheet* is completed when the information obtained from the radiosonde recorder is entered on DA Form 4197.

b. *Ballistic temperature* for a 15-line ballistic metro message is determined by use of the information obtained from DA Form 4197 and Chart ML-574A/UM. The altitude pressure density is measured with the zone height scale, which is graduated in meters and indicates the thickness of the standard artillery zones.

- (1) Plot the significant data from DA Form 4197 for each significant level on Chart ML-574A/UM successive legs for a 15-line message.
- (2) Compute ballistic temperature, using Chart MG574A/UM with the artillery tables, and enter the data on DA Form 4450.
- (3) Report ballistic temperatures as percents of standards, and enter a check in the type of message being prepared.
- (4) Complete ballistic temperatures for lines 1 through 15 and enter the sum of the ballistic values on DA Form 4450.

c. *Ballistic densities* for all meteorological messages are computed and entered on DA Form 4450. The densities are read from Chart ML-574A/UM and recorded on this form.

- (1) Enter the surface density in column 1, after checking the block marked DENSITY GM/M3, to indicate the form is being used to compute density.

- (2) Enter the densities for the remaining zones, obtained from Chart ML-574A/UM, in column 1 opposite the appropriate zone number on DA Form 4450.
- (3) After the required weighted densities have been determined and recorded, obtain the ballistic density values for each line by adding the weighted densities of each columns 1 through 15.
- (4) Record these sums in the appropriate space under the line number.

d. Zone wind data using Rawin Set AN/GMD-1 (*) requires the plotting of a pressure time curve to establish the time at which the radiosonde set reached the standard heights. Rawin DA Form 4469 is then completed as follows:

- (1) The pressure at the top of each zone, from Chart ML-574A/UM, is entered in column 2.
- (2) Time value, from the pressure time curve, is entered in column 3, opposite each zone number.
- (3) The angular data from the control recorder tape is entered in columns 4 and 5.
- (4) Horizontal data, which corresponds to the elevation angle for each standard height, is determined from artillery tables and entered in column 6.
- (5) Zone winds are plotted; use the procedures described in paragraph 3-4g.
- (6) After the zone wind plot has been made, enter the distance traveled in each zone in column 7.
- (7) Compute the time in zone and enter the data in column 8.
- (8) Measure the wind direction in each zone; use Scale ML-577/UM, and enter zone wind directions to the nearest 10 roils in column 9.
- (9) Compute the zone windspeed in knots and enter the data in column 10.
- (10) Enter the surface wind measurement; use the hand velometer and enter the data in columns 11 and 12.

3-6. Sound-Ranging procedures

The standard meteorological conditions for sound-ranging computations are based on a height of 200 meters above the surface level, with a zero windspeed, at 100 Centigrade. Speed of sound under these conditions is 337.6 meters per second.

a. *Effective temperature* for sound ranging is determined from measurements of temperature and relative humidity.

b. *Effective wind data* for sound ranging is determined from the angular position of the sounding balloon at designated time intervals with the weighted values for the layers of the atmosphere required.

c. *Sound-ranging data* is recorded and evaluated on DA Form 6-48.

3-7. Composition of Radar Flights

a. Some artillery and air defense radars are capable of determining the data required for computation of zone winds; however, they should not be requested to do so when the data can be obtained by other means.

b. Radar is used to determine zone winds by tracking a balloon-borne radar reflector. The height of the radar is observed, and as the pilot balloon reaches each zone limit, the values of time, horizontal range, and azimuth are read and recorded.

c. A zone wind plot is constructed, and the zone and ballistic winds are determined as in the operation procedures (para 3-3).

3-8. Preparing Meteorological Messages

The information for meteorological data, prepared by the artillery metro system, will be forwarded by radio or teletypewriter using current artillery message center procedures. Data for transmission will be entered on Computer Message DA Form 3677 or Ballistic MET Message DA Form 3675.

a. *Artillery metro sections* can produce the following types of messages and data:

- (1) Ballistic messages, types 2 and 3.
- (2) Computer messages.
- (3) Fallout messages.
- (4) Sound-ranging messages.
- (5) Data for transmission to Air Weather Service.
- (6) Low level winds for rockets.

3-9. Standard Artillery Computer Meteorological Message

The complete standard artillery computer meteorological message consists of a number of groups in symbolic form, containing an introduction and 27 computer lines. It is not necessary to include all lines in every message, only those lines from the Meteorological Datum Plane (MDP) to the computer lines required by the artillery units initiating the request.

a. The normal standard artillery computer meteorological message contains four groups, in symbolic form, METCMQ LaLaLaLoLoLo YYG_oG_oG_o hhhP_dP_dP_d. Refer to c below for an explanation of the symbolic code for the first communication line in the computer message. When it is not necessary to send the second group for hemispheric latitude or longitude location, a series of XXXXXX will replace the second group.

b. The body of the message contains meteorological information for use with meteorological computers. The message is printed in pairs of eight-figure groups, example: Z_nZ_ndddFFF TTTTPPPP etc. . . . called lines.

(1) Each line, except for 00, contains means direction and windspeed values including mean virtual temperature values for a specific zone layer in the atmosphere also included is the barometric pressure at the midheight of the zone.

(2) Line number 00 contains the actual values for the Meteorological Datum Plane.

(3) Refer to table B for the zone number code and the designated upper and lower standard height limits for each zone.

c. Symbolic codes and explanations are given below.

Symbolic code	Definition
METCMQ	Meteorological message.
MET	Artillery computer.
CM	Code for octant of globe (table A).
Q	
LaLaLaLoLoLo	Latitude of the center of the area given in tens, units, and tenths of a degree.
LaLaLa	
LoLoLo	Longitude of the center of the area given in tens, units and tenths of a degree. The hundreds digit is omitted for longitude of 100 to 180 .
XXXXXXX	Group sent in place of LaLaLaLoLoLo for location of an area in code (Q 9).
YYG _o G _o G _o	Day of month the validity of the message commences.
YY	
G _o G _o G _o	Time (GMT) of the commencement of the valid period given in tens, units, and tenths of an hour, using the 24-hour clock from 000 to 239.

Symbolic code	Definition
G	Duration, in hours, of the valid period from 1 8: code figure 9 indicates 12 hours.
hhhP _d P _d P _d hhh	Height of the Meteorological Datum Plane above mean sea level in decimeters. This plane is the horizontal surface where the zone heights of the meteorological elements are measured on land, the Meteorological Datum Plane is normally located at the height of the station above Mean Sea Level. At sea the Meteorological Datum Plane is normally at mean sea level.
P _d P _d P _d	Pressure at the Meteorological Datum Plane in hundreds, tens, and units, of millibars. When the pressure is 1,000 millibars or more, the thousandths digit is omitted.
Z _n Z _n dddFFF Z _n Z _n	Zone number corresponding to a line number in the message. Refer to table B.
ddd	Direction from which the mean vector wind is blowing, measured clockwise from geographic north and expressed in thousands, hundreds, and tens of roils. Encoded from 001 to 640, as 000 when windspeed is zero. For zone No. 00, the value of the wind direction is measured at the Meteorological Datum Plane.
FFF	Speed of the mean vector wind for the zone, expressed in hundreds, tens, and units of knots. For zone No. 00, the value will be windspeed measured at the Meteorological Datum Plane.
TTTTPPPP TTTT	Mean virtual temperature for the zone given in hundreds, tens, and tenths of a degree Kelvin. For zone No. 00, the value will be the temperature measured at the Meteorological Datum Plane.
PPPP	Air pressure in the middle of the zone given in thousands, hundreds, tens, and units of mini bars. For zone No. 00, the value will be the pressure measured at the meteorological Datum Plane.

Table A Code for Octant of Globe

Code figure	Greenwich longitude	Hemisphere
0	0 to 90 W	Northern
1	90 to 180 W	
2	180 to 90 E	
3	90 to 0 E	
4	Not used	
5	0 to 90 W	Southern
6	90 to 180 W	
7	180 to 90 E	
8	90 to 0 E	
9	Used when the area of applicability is not indicated by latitude and longitude.	

Table B. Zone Number Code.

All heights in the zone number code are above the Meteorological Datum Plane. Zone No. 00 indicates zero height above the Meteorological Datum Plane. Zone No. 4, as an example, refers to a zone extending from 100 to 1,500 meters with midpoint occurring at 1,250 meters above the Meteorological Datum Plane.

Table E. Zone Number Code

Z _n Z _n	Zone number code	
	Height above MDP of midpoint of zone (meters)	Height above MDP from base to top of zone (meters)
00	0	0
01	100	0 to 200
02	350	200 to 500
03	750	500 to 1000
04	1250	1000 to 1500
05	1750	1500 to 2000
06	2250	2000 to 2500
07	2750	2500 to 3000
08	3250	3000 to 3500
09	3750	3500 to 4000
10	4250	4000 to 4500
11	4750	4500 to 5000
12	5500	5000 to 6000
13	6500	6000 to 7000
14	7500	7000 to 8000
15	8500	8000 to 9000
16	9500	9000 to 10000
17	10500	10000 to 11000
18	11500	11000 to 12000
19	12500	12000 to 13000
20	13500	13000 to 14000
21	14500	14000 to 15000
22	15500	15000 to 16000
23	16500	16000 to 17000
24	17500	17000 to 18000
25	18500	18000 to 19000
26	19500	19000 to 20000

3-10. Standard Artillery Computer Meteorological Message

The message given below is a typical complete computer meteorological message consisting of an introductory line with 1 letter group, 3 number groups, and 27 computer lines. The introductory group and three lines of the computer message are decoded and explained in detail.

METCMO	512018	070952	013972
00310004	29770972	01290013	29560961
02306014	29040933	03357014	28340890
04396007	28090837	05502008	28040787
0645015	27801742	07475013	27440696
08520013	27050653	09582018	26730613
10575017	26430575	11566016	26100538
12571015	25620487	13588009	25000427
14611011	24270372	15354012	23570323

16395016	22980278	17384014	22320240
18379028	21950206	19394021	21340175
20423017	20800149	21625016	20480126
22003019	20330107	23634025	20490091
24074023	20660077	25106026	20950066
26156029	21180056		

a. Introduction.

(1) Station Identification.

METCMO MET Meteorological message.
CM Computer.
O Octant 0 Northern Hemisphere, 0 to 90 West

(2) Latitude and longitude location.

512018 512 Latitude of center of area is 51.2° N.
018 Longitude of the center of the area is 01.8° W.

(3) Time and validity.

070952 07 Period of validity commences on the 7thth day of the month.
095 Start of the period of validity is at 09.5 hours; for example, 0930 hours GMT.
2 Valid period lasts for 2 hours; for example, until 1130 GMT.

(4) Station height and pressure.

013972 013 Height of the MDP above mean sea level is 13 decameters.
972 Pressure at the MDP is 972 millibars.

b. Body of Message (Eight Groups Per Line).

(1) Line 0

00310004 00 Zone number 00 denoting 0 meters above the MDP.
310 Wind direction at the MDP is 3,100 mils.
004 Windspeed at the MDP is 4 knots.
29770972 2977 Virtual air temperature at MDP is 297.7° K.
0972 Air pressure at MDP is 972 millibars.

(2) Line 1

01290013 01 Zone No. 01, with upper limits 200 meters above MDP.
290 Mean wind direction in zone 1 is 2,900 mils.
013 Mean windspeed in zone 1 is 13 knots.
29560961 2956 Mean virtual temperature for zone 1 is 295.6° K.
0961 Air pressure at midheight of zone 1; for example, 100 meters is 961 millibars.

(3) Line 2

02306014 02 Zone No. 2, with upper limits 500 meters above MDP.
306 Mean wind direction in zone 2 is 3,060 mils.
014 Mean windspeed is 14 knots.
29040933 2904 Mean virtual temperature for zone 2 is 290.4° K.
0933 Air pressure at midheight of zone 2; for example, 350 meters is 933 millibars.

Continue to decode the remaining 24 lines in the body of the message in the same manner shown above.

CHAPTER 4

OPERATOR'S MAINTENANCE

4-1. Scope of Operator's Maintenance

The maintenance duties assigned to the operator of Meteorological Station, Manual AN/TMQ-4 are listed below together with a reference to paragraphs covering the specific maintenance function.

- a. Operator's daily preventive maintenance checks and services (para 4-5).
- b. Operator's weekly preventive maintenance checks and services (para 4-6).
- c. Operator's quarterly preventive maintenance checks and services (para 4-7).
- d. Cleaning (para 4-8).

4-2. Tools and Materials Required for Operator's Maintenance

- a. *Tools.* Only Tool Equipment TE-33 is required for maintenance.
- b. *Materials.*
 - (1) Cleaning Compound (Federal stock No. 7930-395-9542) .
 - (2) Cleaning cloth.
 - (3) Fine sandpaper (supplied in Tool Equipment TE-33).
 - (4) Lens tissue. (Federal stock No. 6640-393-2090).
 - (5) Lubricating Oil, Instrument (OAI) (Federal stock No. 9150-257-5449).
 - (6) Lubricating Oil, General Purpose, (FED VV-L-800) (Federal stock No. 9150-273-2389) .
 - (7) Lubricating Oil, Watch (MIL-3918) (Federal stock No. 9150-252-6382).
 - (8) Cleaning brush (supplied in Tool Equipment TE-33).

4-3. Operator's Preventive Maintenance

Operator's preventive maintenance is the

systematic care, servicing, and inspection of equipment to prevent the occurrence of trouble, reduce downtime, and assure that the equipment is serviceable.

a. *Systematic Care.* The procedures given in paragraphs 4-5 through 4-8 cover routine systematic care and cleaning essential to proper upkeep and operation of the equipment.

b. *Preventive Maintenance Checks and Services.* The preventive maintenance checks and services charts (para 4-5, 4-6, and 4-7) describe functions to be performed at specific intervals. These checks and services are to maintain Army equipment in a combat serviceable condition; that is, in good general (physical) condition and in good operating condition. To assist operators in maintaining combat serviceability, the charts indicate what to check, how to check, and the normal conditions; the *References* column lists additional information. If the difficulty cannot be remedied by the operator, a higher category of maintenance of repair is required. Records and reports of these checks and services must be made in accordance with the requirements set forth in TM 38-750.

4-4. Operator's Preventive Maintenance Checks and Services Periods

Preventive maintenance checks and services of the met. station are required on a daily, weekly, and quarterly basis.

a. Paragraph 4-5 specifies checks and services that must be accomplished daily and under the following conditions:

- (1) When the equipment is initially installed.

TM 11-6660-218-12

- (2) When the equipment is reinstalled after removal for any reason.
- (3) At least once each week if the equipment is maintained in standby condition.

b. Paragraph 4–6 specifies checks and services that must be performed *once* each week.

These checks and services are in addition to the daily checks and services.

c. Paragraph 4–7 specifies checks and services that must be performed on a quarterly basis. These checks and services are in addition to the daily and weekly checks and services.

4-5. Operator's Daily Preventive Maintenance Checks and Services Chart

Sequence No.	Item to be inspected	Procedure	References
1	Exterior and interior surfaces	a. Inspect the theodolite set (fig. 1–17) for accumulation of dust and dirt. Clean and lubricate the theodolite set as required. b. Inspect the remainder of the equipment for dust, dirt, grease, and fungus.	a. TM 11–6675–200–10. b. Para 4–8.
2	Thermometers . . . - - . . .	Inspect thermometers (fig. 1–3) for cracks and separated mercury columns. Replace thermometer if defective.	
3	Gas regulator, timer, anemometer, and barometer.	a. Inspect dial windows for cracks or breaks. b. Inspect for bent or broken needles. c. Inspect the compass on the anemometer (fig. 1–8) for signs of oil leakage.	

4-6. Operator's Weekly Preventive Maintenance Checks and Services Chart

Sequence No.	Item to be inspected	Procedure	References
1	Batteries in theodolite set and telephone.	a. Inspect the batteries in the theodolite set (fig. 1–3) for signs of leaking or swelling. Replace defective batteries. b. Inspect the batteries in the telephone (fig. 1–5) for signs of leaking or swelling. Replace defective batteries.	a. TM 11–6675–200–10. b. TM 11-337.
2	Calcium hydride charges --	Inspect calcium hydride charges (fig. 1–21) for signs of leaking or swelling. Replace defective charges.	
3	Rule, slide rule, plotting boards _.	Inspect the rule and the slide rule (fig. 1–4), and the plotting boards (fig. 1-13) for cracks, breaks, and worn printing. Replace defective items.	

4-7. Operator’s Quarterly Preventive Maintenance Checks and Services Chart

Sequence No.	Item to be inspected	Procedure	References
1	Lubrication _____	a. Lubricate the reel (fig. 1-25); place a few drops of oil (OAI) in the oilcups on each reel handle bearing and in the oilhole on the crank. b. Clean and lubricate the theodolite (fig. 1-17) .	a. None. b. TM 11-6675-200-10.
2	Hydrogen generator _____	Inspect the hydrogen generator (fig. 1-6) for signs of damage. Replace unit if damaged.	
3	Water can _____	Inspect the water can (fig. 3-1) for signs of leaks and damage. Replace defective water can.	
4	Sounding balloon and pilot balloon nozzles.	Inspect nozzles (fig. 1-24 and 1-28) for signs of damage. Replace defective nozzle.	
5	Hoses _____	Inspect the hose (fig. 1-6) for cuts and cracks. Replace defective hose.	
6	Knobs, switches, and indicators _____	While making the operating checks (items 8 through 12), check to see that the mechanical action of each knob, switch, and indicator is smooth and free of external or internal binding.	
7	Head and chest set _____	a. Install the head and chest sets. The axle of the reel (fig. 2-4) should rotate freely.	
8	Timer _____	b. Establish two-way communication between the sites. Undistorted audio should be heard in both headsets. a. Wind the timer (fig. 1-20) ; use the spring winding knob. b. Return the second and minute hands to the zero (60) position by pressing the return to zero pushbutton. c. Press the start-stop pushbutton and simultaneously start a timing source of known accuracy. d. Allow the timer to operate for several minutes. The time indicated on the timer should agree with that of the timing source. If the time is either slow or fast, remove the speed regulator cover plate and move the speed regulator (not shown) in the proper direction. e. Repeat the procedures in <i>b</i> , <i>c</i> , and <i>d</i> above until the timer agrees with the timing source.	
9	Barometer _____	a. Tap the barometer (fig. 1-9) lightly to see that the pointer is free and in equilibrium.	

Sequence	Item to be inspected	Procedure	Reference
No		<ul style="list-style-type: none"> b. Compare the barometer indication with the indication of a barometer of known accuracy. If the barometer indication is incorrect, adjust the barometer. 	TM 11-427.
10	Anemometer -----	<ul style="list-style-type: none"> u. Hold the anemometer (fig. 1-8) in a vertical position and cover the vent. The pointer (not shown) on the anemometer should be positioned at 0. If the pointer is not positioned at 0, turn the zero-adjust screw until the pointer is positioned at 0. b. Uncover the vent and set the range selector to the estimated wind-speed range (0 through 8 or 0 through 40). c. Turn the anemometer slowly back and forth in the wind until the index mark is aligned with the index pin. The pointer of the anemometer should deflect upscale and the compass should indicate the wind direction. 	
11	Theodolite set -----	Operate the theodolite set in accordance with the instructions given in TM 11-6675-200-10.	
12	Telephone -----	Operate the telephone in accordance with the instructions given in TM 11-337.	

4-8. Cleaning

Inspect the exterior and interior surfaces of the inflation tent, the barometer, and telephone cases, and the exterior surfaces of the remainder of the equipment. The surfaces should be clean and free of dust, dirt, grease, and fungus.

a. Remove the dust and loose dirt from the inflation tent and the barometer and telephone cases with a brush. Remove the dust and loose dirt from the remainder of the equipment with a clean, soft cloth.

Warning: Cleaning compound is flammable and its fumes are toxic. Provide adequate ventilation. *Do not* use near a flame.

b. Remove grease, fungus, and ground-in dirt from the equipment; use a cloth dampened (not wet) with the cleaning compound.

c. Remove dust or dirt from plugs and jacks with a brush.

Caution: Do not press on the meter faces when cleaning, the meter may be damaged.

d. Clean the scales, rules, front panel, meters, and control knobs; use a soft, clean cloth. If the dirt is difficult to remove, dampen the cloth with water; mild soap may be used.

4-9. Lubrication

a. Lubricate the theodolite set as described in TM 11-6675-200-10.

b. Lubricate the reel (fig. 1-25); place a few drops of lubricating oil (OAI) in the oilcups of each bearing on the reel unit handles and in the oilhole on the crank handle.

c. Lubricate the launching reel (fig. 1-26); place a few drops of lubricating oil (OAI) on the axle of the unit.

4-10. Troubleshooting

a. Operator's troubleshooting is limited to inspection and replacement of components for surface observation, inflation, and plotting equipments. If the inspection reveals a deficiency which cannot be corrected at the operator's category, additional maintenance

must be performed by a higher category of maintenance personnel.

b. Troubleshooting procedures for the telephone, barometer, head and chest set, hydrogen generator, theodolite, and plotting equipments will be found in the applicable manual covering the equipment (appx A).

CHAPTER 5

ORGANIZATIONAL MAINTENANCE

Section 1. ORGANIZATIONAL MAINTENANCE INSTRUCTIONS

5-1. Scope of Organizational Maintenance

The maintenance duties assigned to the organizational repairman of Meteorological Station, Manual AN/TMQ-4 are listed below together with a reference to the paragraph covering the specific maintenance function.

- a. Organizational weekly preventive maintenance checks and services (para 5-5).
- b. Organizational monthly preventive maintenance checks and services (para 5-7).
- c. Organizational quarterly preventive maintenance checks and services (para 5-9).
- d. Touchup painting (para 5-10).

5-2. Tools and Materials Required for Organizational Maintenance

- a. *Tools.*
 - (1) Tool Equipment TE-33.
 - (2) Wrench TL-112.
 - (3) Hammer HM-3.
- b. *Materials.*
 - (1) Cleaning cloth.
 - (2) Fine sandpaper (supplied in Tool Equipment TE-33).
 - (3) Touchup paint.

5-3. Organizational Preventive Maintenance

a. Organizational preventive maintenance is the systematic care, inspection, and servicing of equipment to maintain it in serviceable condition, prevent breakdowns, and assure maximum operational capability. Preventive

maintenance is the responsibility of all categories concerned with the equipment and includes the inspection, testing, and repair or replacement of parts, subassemblies, or units that inspection and tests indicate would probably fail before the next scheduled periodic service. Preventive maintenance checks and services of the met. station at the organizational maintenance category are made at weekly, monthly, and quarterly intervals unless otherwise directed by the commanding officer.

b. Maintenance forms and records to be used and maintained on the equipment are specified in TM 38-750.

5-4. Organizational Preventive Maintenance Checks and Services Periods

Preventive maintenance checks and services of the met. station at the organizational category are required on a weekly, monthly, and quarterly basis.

a. Paragraph 5-5 specifies preventive maintenance checks and services that must be accomplished weekly.

b. Paragraphs 5-6 and 5-7 specify preventive maintenance checks and services that must be accomplished each month in addition to the weekly organizational preventive maintenance checks and services.

c. Paragraphs 5-8 and 5-9 specify preventive maintenance checks and services that must be accomplished each quarter in addition to the weekly and monthly organizational preventive maintenance checks and services.

5-5. Organizational Weekly Preventive Maintenance Checks and Services Chart

Sequence No.	Item to be reported	Procedure	References.
1	Gas cylinders, gas regulator.	a. Inspect cylinders for worn threads or valves. Tag and return for supply action. b. Inspect regulator for broken meter glass or dial indications. Check regulator valves for pressure indication. Replace defective items.	Para 3-2 i, f, and j.
2	Wire and cables	Inspect the wire and cables on reels for cuts, tears, and fraying.	Fig. 1-25
3	Canvas items	Inspect windbreaker and canvas covering for cuts, tears, and fraying. Replace defective items.	Para 1-9k.
4	Gas meter	a. Check all hoses and ice shields. Change if defective, b. Check operation and spare parts for general condition and method of storage. All shortages must be ordered on valid requisitions.	TM 11-6660-245-15, para 3-3 and appendix B.
5	Gaskets	Inspect the gaskets on the anemometer and telephone for moisture, oil saturation, and brittle, broken, cracked, loose, pinched, or missing sections.	Figs. 1-16 and 1-8.
6	Mountings	Check to see that all bolts, screws, nuts, and washers are correctly positioned and properly tightened. Check for cracked, bent, or broken brackets. Tighten loose bolts, screw's, or nuts. Replace missing hardware as needed.	None,

5-6. Organizational Monthly Maintenance

Perform the maintenance functions indicated in the organizational monthly preventive maintenance checks and services chart (para 5-7) once each month. A month is defined as approximately 30 calendar days of 8-hour-per-day operation. If the equipment is operated 16 hours a day, the monthly preventive maintenance checks and services

should be performed at 15-day intervals. Adjustment of the maintenance interval must be made to compensate for any unusual operating condition. Equipment maintained in a standby (ready for immediate operation) condition must have monthly preventive maintenance checks and services performed on it. Equipment in limited storage (requires service before operation) does not require monthly preventive maintenance.

5-7. Organizational Monthly Preventive Maintenance Checks and Services Chart

Sequence No.	Item to be inspected	Procedure	References
1	Battery compartment on telephone	Open the battery compartment on the telephone (fig. 1-16) and inspect the interior for evidence of water leakage, condensation, and corrosion. Use a clean, soft cloth to remove moisture. Remove corrosion with fine sandpaper, and paint surfaces intended to be painted with touchup paint.	Para 5-10.
2	Battery compartment on theodolite set.	Open the battery compartment on the theodolite set (fig. 1-17) and inspect the interior for evidence of water leakage, condensation, and corrosion. Use a clean, soft cloth to remove moisture. Remove corrosion with fine sandpaper, and paint surfaces intended to be painted with touchup paint.	Para 5-10.

5-8. Organizational Quarterly Maintenance

Quarterly organizational preventive maintenance checks and services (para 5-9) on the met. station are required. Periodic weekly and monthly services constitute a part of the

quarterly preventive maintenance checks and services and must be performed concurrently. All deficiencies or shortcomings will be recorded in accordance with the requirements of TM 38-750.

5-9. Organizational Quarterly Preventive Maintenance Checks and Services Chart

Sequence No.	Item to be inspected	Procedure	References
1	Completeness -----	Check to see that the equipment is complete (appx A).	Para 5-10.
2	Installation -----	Check to see that the equipment is properly installed (para 2-5).	
3	Preservation -----	Check all surfaces for rust and corrosion. Remove rust and corrosion and paint bare spots intended to be painted.	
4	Publications -----	Check to see that all publications are complete, serviceable, and current.	DA Pam 310-4.
5	Modifications -----	Check DA Pam 310-4 to determine if new applicable MWO'S have been published. All URGENT MWO's must be applied immediately. ALL NORMAL MWO'S must be scheduled.	TM 38-750 and DA Pam 310-4.
6	Spare parts -----	Check all spare parts (operator and organizational) for general condition and method of storage. There should be no evidence of overstock, and all shortages must be on valid requisitions.	Appx B.

5-10. Touchup Painting

Remove the rust and corrosion from metal surfaces by lightly sanding them with fine sandpaper. Brush two thin coats of paint on

the bare metal to protect it from further corrosion. Refer to the applicable cleaning and refinishing practices specified in TM 9-213 and TB SIG 364.

Section II. TROUBLESHOOTING AND REPAIR PROCEDURES

5-11. General

Troubleshooting and repair of Meteorological Station, Manual AN/TMQ4 is based on the operational checks contained in the preventive maintenance checks and the services charts. Detailed troubleshooting and repair procedures for the telephone, barometer, head

and chest set, hydrogen generator set, and theodolite set will be found in the applicable manual covering the equipment (appx A). Perform the checks and corrective measures indicated in the troubleshooting chart for the anemometer, the cold weather and tropical thermometers, and the timer, as described in paragraph 5-12.

5-12. Troubleshooting Charts

a. Anemometer.

Trouble symptom	Probable trouble	Checks and corrective measures
Air bubbles in compass Erratic movement of velometer pointer.	Defective gasket Wind vane touching wall of air passage.	Replace gasket (para 5-15). Disassemble and repair in accordance with procedures given in paragraphs 5-14 and 5-15.
Wind vane unbalanced	Distortion of vane	Check and repair or replace in accordance with procedures given in paragraph 5-15.

b. Cold Weather and Tropical Thermometers.

Trouble symptom	Probable trouble	Checks and corrective measures
Indications on identical thermometers do not agree.	Break in thermometric fluid	Tap stem of thermometer against palm of hand. Immerse bulb of thermometer into crushed solid carbon dioxide (CO ₂ , dry ice).
Graduation markings not legible	Paint has worn off	Replace thermometer.

c. Timer. If the timer operates erratically, the spring motor is defective. Replace the timer.

5-13. Organizational Repairs and Adjustments
(fig. 5-1)

Instructions for the repair of the anemometer and the psychrometer are given in paragraphs 5-14, 5-15, and 5-16. Tools and materials required are listed in paragraph 5-2.

5-14. Anemometer ML-433A/PM

a. General. Disassembly procedures for the anemometer are given below. The velometer requires special equipment for calibration, and the compass is a factory-sealed assembly. If either of these is defective, the anemometer must be replaced as a unit.

b. Disassembly of Anemometer.

- (1) Unscrew handle H213 from bracket A207.
- (2) Slide off cover assembly A201, and remove self-tapping screw H211.

- Cover A202 is connected to bracket A207 by riveted chain H201.
- (3) Loosen hexagonal nut H203 and jewel bearing 0201, and lift out vane assembly 0202.
 - (4) Remove hexagonal nut H212 from the rear of the bracket, and lift out magnetic compass 1201. Do not attempt to disassemble the compass; replace it as a unit.
 - (5) Remove four machine screws H205, and lift off mounting plate A203. The two flat washers H206 on each machine screw H205 will fall free.
 - (6) Remove three machine screws H208, lockwashers H207, hexagonal nut H209, and lower jewel bearing 0205 from mounting plate A205. Removal of machine screws H208 will free supporting post A204.
 - (7) Disassemble vane assembly 0202 by removing three machine screws H204 to release shaft 0204 from wind vane 0203.

c. *Inspection.*

- (1) Check jewel bearings for chips or cracks.
- (2) Check pivots for scratches or burrs.
- (3) Check metal parts for bends, dents, or other damage.

d. *Cleaning.*

Warning: Cleaning compound is flammable and its fumes are toxic. Do not use near a flame; provide adequate ventilation.

- (1) Clean bearing points, pivots, and jewel bearings with cleaning compound.
- (2) Brush clean all remaining parts.
- (3) Dry all parts with a clean, lint-free cloth.

e. *Replacement of Parts.* Replace all damaged or defective parts. For reassembly, replace the parts in the reverse order in which they were disassembled.

5-15. Anemometer ML-497/PM (fig. 5-2)

- a. *Removal of Compass I1.* Remove hexagonal

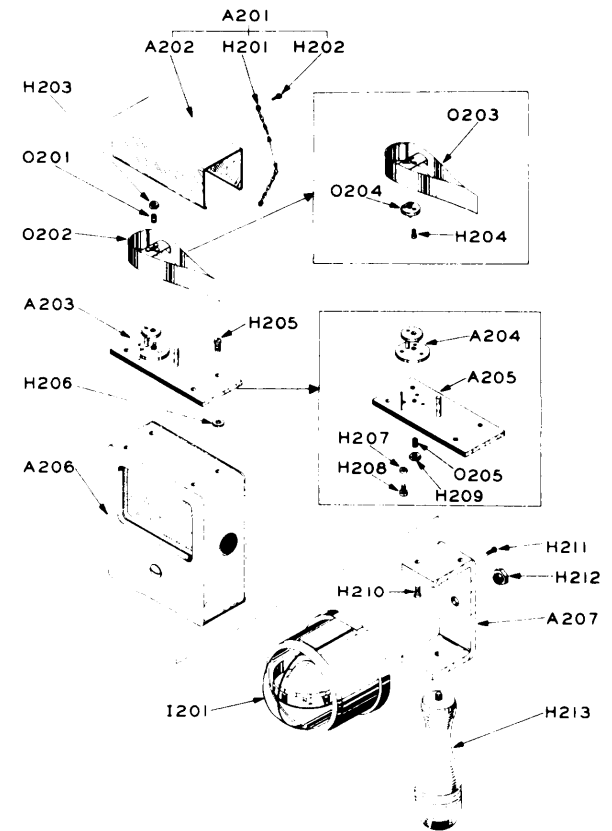

TM6660-218-15-19

A201	Cover assembly	H207	Lockwasher
A202	Cover	H208	Machine screw
A203	Mounting plate	H209	Hexagonal nut
A204	Supporting post	H210	Machine screw
A205	Mounting plate	H211	Self-tapping screw
A206	Velometer	H212	Hexagonal nut
A207	Bracket	H213	Handle
H201	Chain	1201	Magnetic compass
H202	Rivet	0201	Jewel bearing
H203	Hexagonal nut	0202	Vane assembly
H204	Machine screw	0203	Wind vane
H205	Machine screw	0204	Shaft
H206	Flat washer	0205	Jewel bearing

Figure 5-1. Anemometer ML-433A/PM, exploded view.

nut H93 that holds the compass to bracket A2 and pull the compass away from the bracket. Unscrew the handle (not shown) from bracket A2. To detach bracket A2 from velometer housing 099, remove the flathead screw (1).

b. *Disassembly of Wind Vane.*

- (1) Slide wind vane cover A3 off mounting plate A4.

- (2) Remove four flathead screws H99 that secure mounting plate A4 to velometer housing 099. Do not lose four flat washers H98 that are used as spacers between mounting plate A4 and velometer housing 099.
- (3) Remove two flathead screws H97 and lift wind vane support A8 from mounting plate A4.

c. Reassembly of Wind Vane.

- (1) Assemble bearing plate A5, bearing 02, wind vane 08, and wind vane support A8. Secure with two roundhead screws H96 and the hexagonal nut (2).
- (2) Place the assembled items ((1) above) on mounting plate A4, and secure with two flathead screws H97.
- (3) Place the assembled items ((2) above) on velometer housing 099. Be sure to use four flat washers H98 as spacers between mounting plate A4 and velometer housing 099. Secure the assembled items to velometer housing 099 with four flathead screws H99.
- (4) Slide wind vane cover A3 over mounting plate A4.

d. Disassembly of Velometer M1.

Caution: Do not disassemble the velometer in a drafty location.

- (1) Unscrew and remove range-selector knob A99; do not lose the washer (3) that is under the knob.
- (2) Remove four Phillips-head screws H95 from the corners of backplate A97.
- (3) Gently pry backplate A97 from velometer housing 099; be careful not to damage gasket A98.
- (4) Remove Phillips-head screws H94 that secure the velometer mechanism to backplate A97.

e. Repair of Velometer Mechanism (fig. 5-3).

Remove dust by brushing the velometer mechanism carefully with a clean camel's-hair

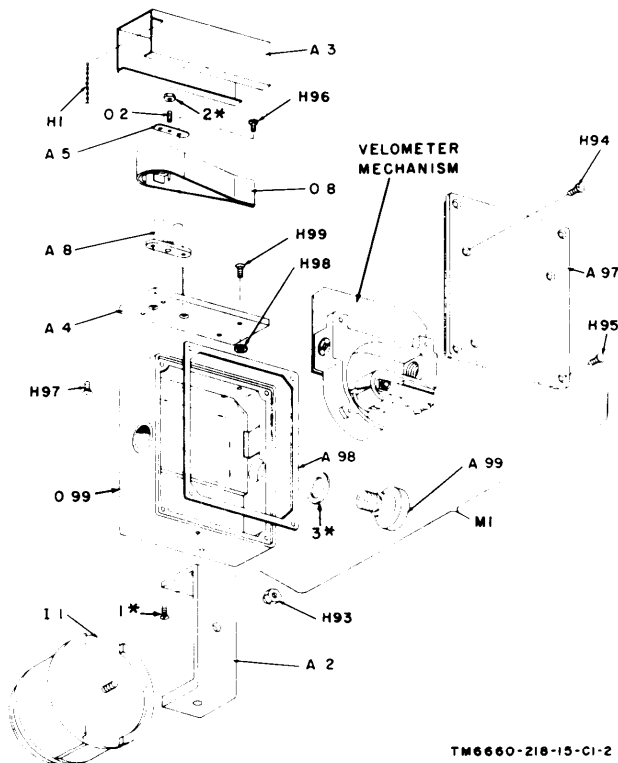

TM 6660-218-15-C1-2

A2 Bracket	H96 Roundhead screw
A3 Wind vane cover	H97 Flathead screw
A4 Mounting plate	H98 Flat washer
A5 Bearing plate	H99 Flathead screw
A8 Wind vane support	11 Compass
A97 Backplate	M1 Velometer
A98 Gasket	O2 Bearing
A99 Range-selector knob	O8 Wind vane
H1 Chain	O99 Velometer housing
H93 Hexagonal nut	*1 Flathead screw
H94 Phillips-head screw	*2 Hexagonal nut
H95 Phillips-head screw	*3 Washer

*Arbitrary number added for identification purpose.

Figure 5-2. Anemometer, exploded view.

brush. If the vane, as it moves, touches the wall, loosen screws A and B that mount the bracket to the velometer mechanism and reposition the vane so that it moves freely. Loosening screw A will allow the bracket to pivot in a horizontal plane; loosening screw B will allow the bracket to pivot in a vertical plane. Retighten the screws.

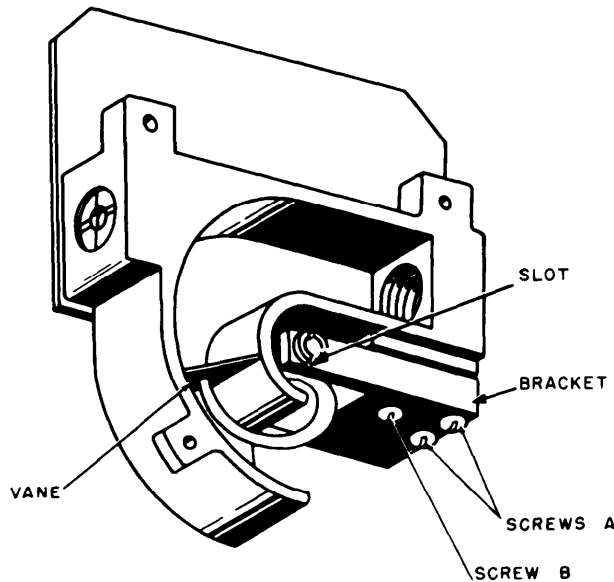

Figure 5-3. Velometer mechanism.

f. Reassembly of Velometer M1.

- (1) Mount the velometer mechanism (fig. 5-2) on backplate A97 and secure it with Phillips-head screws H94.
- (2) Assemble backplane A97, gasket A98, and velometer housing 099. Secure with four Phillips-head screws H95.

Note. Be sure that the tab of the zero-adjust screw (fig. 1-8) rests in the slot of the bracket (fig. 5-3) on the velometer mechanism.

- (3) Place the washer (3) on the shaft of range-selector knob A99 (fig. 5-2), slide range-selector knob A99 into the side of velometer housing 099 and screw it into the velometer mechanism.

Section III. FUNCTIONING OF EQUIPMENT

5-16. General

Each of the units in Meteorological Station, Manual AN/TMQ-4 is designed to operate independently of any other unit. The readings from each of the units are used together to obtain the necessary meteorological data. The detailed analysis for the majority of the components of the met. station will be found in the applicable technical manual (appx A). The general functions of the anemometer, the psychrometer, and the timer are given in paragraphs 5-17, 5-18, and 5-19.

5-17. Anemometer (fig. 1-8)

The anemometer consists of a wind vane, a compass, and a velometer, which provide facilities for determination of windspeed and direction.

a. *Wind Vane.* The wind vane is an airfoil pivoted on a shaft on top of the velometer case. As a current of air strikes the wind

vane, the wind vane rotates to the position in which it offers minimum resistance to the air. In this position, the tail of the wind vane is parallel to the path of the air passing over it. By turning the velometer case until the index pin is aligned with the index line, the anemometer is placed parallel to the air currents, and the vent is fully exposed to them.

b. *Compass.* The compass consists of a card, bent into a circular form and mounted on a rounded support, which is balanced on a pivot. Two magnetic needles, suspended on the underside of the card support, are always aligned with magnetic north when the anemometer is held in an upright position. The card rotates freely in an oil medium, and compass points are marked on the outer surface. An index mark on the glass compass cover (not shown) is aligned with a marking on the card to give a reading of wind direction.

c. *Velometer.* Wind velocity is determined

by the velometer at the same time that wind direction is observed from the compass. The velometer is in an inclosed case with a vent at one side and an aperture at the other side. The vent may be set for either of two wind-speed ranges. Between the vent and the aperture is a wind guide through which the air passes when a reading is to be taken. A wind vane extends into an opening in the guide. This wind vane is attached to a pointer which moves over a scale calibrated in knots (ML-433A/PM), or mph (ML-497A/PM). As the wind blows through the wind guide, the wind vane is deflected in accordance with the wind velocity, which is indicated by the position of the pointer on the scale. Deflection of the vane is controlled by a calibrated spring linked to the pointer.

5-18. Psychrometer

a. The cooling effect due to the evaporation of moisture from the wick (fig. 1-12)

lowers the temperature of the wet bulb thermometer. At any particular dry bulb temperature, the wet bulb depression increases as the humidity increases, because moisture can be evaporated from the wick at a greater rate when the air contains less moisture.

b. When constructing the psychrometer, the wet bulb is placed lower on the frame than the dry bulb to saturate the wick more easily and to prevent the moisture from the wet bulb from affecting the dry bulb.

5-19. Timer

The timer is a mechanical timing device used in timing readings of the theodolite set settings during visual balloon observations. The clock is constructed so that the second hand will make a complete revolution in 1 minute, while the minute hand will make a complete circumference of the dial in 1 hour. The timer is kept running by a mechanical spring which must be wound at intervals.

CHAPTER 6

SHIPMENT AND LIMITED STORAGE

6-1. Disassembly*a. Balloon-Launching Site.*

- (1) Remove the theodolite (fig. 1-17) from the tripod (fig. 1-30) and place it in the theodolite case.
- (2) Disconnect the head and chest set from the jack.
- (3) Disassemble the inflation device; reverse the instructions given on the front cover of the inflation device.
- (4) Remove all ground stakes from the area.
- (5) If a rawin set was used, disassemble it as indicated in TM 6660-20612.

b. Plotting Station Site.

- (1) Unscrew the anemometer (fig. 1-3) from the handle.
- (2) Place the barometer (fig. 1-9 and 1-10) into its case.
- (3) Remove the rule (fig. 1A) from the plotting board.
- (4) Remove the telephone wire from the terminals of the telephone (fig. 1-16) and close the telephone case. Remove the batteries from the battery compartment.

- (5) Disconnect the head and chest set from the jack.

- (6) Disconnect the radiosonde recorder or the receptor from the rawin set (if electronic observations were used).

c. Between Sites.

- (1) At the plotting station, disconnect the short piece of wire from the terminal board on the side of the reel. Disconnect the jack from the other end of the short piece of wire.
- (2) At the balloon launching site, disconnect the jack from wire connected between the balloon-launching site and the plotting station site.
- (3) Wind the wire back onto the reel.

6-2. Repacking

The exact procedure for repacking the equipment used in the met. station, for shipment or limited storage, depends on the packing material available and on the conditions under which the equipment is to be stored or shipped. If materials are available, repack the equipment in the reverse order of the procedures given in paragraph 2-1.

APPENDIX A

REFERENCES

DA PAM 310-4	Index of Technical Publications: Technical Manuals, Technical Bulletins, Supply Manuals (Types 7, 8, and 9), Supply Bulletins, Lubrication Orders, Modification Work Orders, and Supply Catalogs and Supply Manuals (Excluding Types 7,8, and 9).
FM 6-15	Field Artillery Meteorology.
FM 6-16	Tables for Artillery Meteorology.
SB 11-617	Disposition of Recovered and Rejected Radiosondes.
SB 88-100	Preservation, Packaging, Packing and Marking Materials, Supplies and Equipment Used by the Army.
TM 11-427	Barometers ML-102-B, ML102-D, ML102-E, ML-102-F, MP102-G and ML-316/TM.
TM 11-2419	Hydrogen Generator ML303/TM and Hydrogen Generator Set AN/TMQ-3 (Including Repair Parts and Special Tool Lists).
TM 11-2442	Plotting Board ML122.
TM 11-5806-201-12	Operator's and Organizational Maintenance Manual (Including Repair Parts and Special Tool Lists): Telephone Set, TA-312/PT (NSN 5805-00-543-0012) .
TM 11-5965-224-14P	Operator's, Organizational, Direct Support and General Support Maintenance Repair Parts and Special Tools Lists (Including Depot Maintenance Repair Parts and Special Tools Lists) : Handsets H-60/PT (NSN 596600-669-9145) and H-165/U (NSN 5966-00-643-1837).
TM 11-5965-242-20P	Organizational Maintenance Repair Parts and Special Tools List: Headset-Chest Sets, Electrical H-164/U and H-164A/U NSN 596600-677-6172.
TM 11-6660-204-10	Operator's Manual: Radiosonde Recorders AN/TMQ-S, AN/TMQ-6A, AN/TMQ-SB, and AN/TMQ-6C.
TM 11-6660-205-14P	Operator's, Organizational, Direct Support, and General Support Maintenance Repair Parts and Special Tools Lists (Including Depot Maintenance Repair Parts and Special Tools Lists) : Anemometers ML-433/PM (NSN 6660-00-663-8090) and ML-433A/PM (NSN 6660-00-663-8090).
TM 11-6660-218-25P	Organizational, Field and Depot Maintenance Repair Parts and Special Tools Lists for Meteorological Station, Manual AN/TMQ-4.
TM 11-6660-219-12	Operator's and Organizational Maintenance Manual (Including Repair Parts and Special Tools Lists) : Radiosonde Baseline Check Sets AN/GMM-1 and AN/GMM-1A (NSN 6660-00-527-8392).
TM 11-6660-220-10	Operator's Manual: Radiosonde Sets AN/AMT-12 and AN/AMT-12A.
TM 11-6660-228-10	Operator's Manual: Radiosonde Set AN/AMT-4D (NSN 6660-00-54-1964).

TM 11-6660-218-12

- TM 11-6660-238-15 Organizational, DS, GS, and Depot Maintenance Manual: Balloon Inflation and Launching Device ML-594/U.
- TM 11-6660-246-15 Operator's, Organizational, DS, GS, and Depot Maintenance Manual: Meter, Volume, Hydrogen-Helium ML-605/U.
- TM 11-6676-200-10 Operator's Manual: Theodolites ML-47-C through ML-47-R, ML-247 and ML-247A and Double Center Theodolites ML-474/GM and ML-474A/GM.
- TM 11-6675-200-20 Organizational Maintenance Manual (Including Repair Parts and Special Tools Lists) : Theodolites ML-47-C through ML-47-R, ML-247 and ML-247-A, and Double Center Theodolites ML-474/GM and GM-474A/GM.
- TM 33-750 The Army Maintenance Management System (TAMMS).
- TM 43-0139 Painting Instructions for Field Use.
- TM 750-244-2 Procedures for Destruction of Electronics Materiel to Prevent Enemy Use (Electronics Command).

APPENDIX B

BASIC ISSUE ITEMS LIST (BIIL) AND ITEMS TROOP INSTALLED OR AUTHORIZED LIST (ITIAL)

Section I. INTRODUCTION

B-1. Scope

This appendix lists only basic issue items required by the crew/operator for installation, operation, and maintenance of Meteorological Station, Manual AN/TMQ-4.

B-2. General

This Basic Issue Items and Items Troop Installed or Authorized List is divided into the following sections:

a. Basic Issue Items List-Section II. A list, in alphabetical sequence, of items which are furnished with, and which must be turned in with the end item.

b. Items Troop Installed or Authorized List - Section III. Not applicable.

B-3. Explanation of Columns

The following provides an explanation of columns found in the tabular listings:

a. Illustration. This column is divided as follows:

(1) *Figure Number.* Indicates the figure number of the illustration in which the item is shown.

(2) *Item number.* Not applicable.

b. Federal Stock Number. Indicates the Federal stock number assigned to the item and will be used

for requisitioning purposes.

c. Part Number. Indicates the primary number used by the manufacturer (individual, company, firm, corporation, or Government activity), which controls the design and characteristics of the item by means of its engineering drawings, specifications standards, and inspection requirements, to identify an item or range of items.

d. Federal Supply Code for Manufacturer (FSCM). The FSCM is a 5-digit numeric code used to identify the manufacturer, distributor, or Government agency, etc., and is identified in SB 708-42.

e. Description. Indicates the Federal item name and a minimum description required to identify the item.

f. Unit of Measure (U/M). Indicates the standard of basic quantity of the listed item as used in performing the actual maintenance function. This measure is expressed by a two-character alphabetical abbreviation, (e.g., ea, in., pr, etc. When the unit of measure differs from the unit of issue, the lowest unit of issue that will satisfy the required units of measure will be requisitioned.

g. Quantity Furnished with Equipment (Basic Issue Items Only). Indicates the quantity of the basic issue item furnished with the equipment.

Section II. BASIC ISSUE ITEMS LIST

(1) Illustration		(2) Federal stack number	(3) Part number	(4) FSCM	(5) Description	(6) Unit of meas	(7) Qty furn with equip
(A) Fig. No.	(B) Item No.						
1-4		6660-663-4629	SC-DL-87824	80063	CASE, CY-1397/PM ANEMOMETER	EA	1
1-3		6660-664-6536	SC-DL-88273	80063	CASE, PLOTTING BOARD	EA	1
1-3		6660-663-4630			CASE, CY-1059/UM BAROMETER	EA	1
1-3		6660-498-9772	SC-B-9073	80063	CASE CY-787/UM THEODOLITE	EA	1
2-5		5975-240-3864	K8479221P5	24446	GROUND ROD	EA	2
		5120-224-4128			HAMMER HM-3	EA	1

APPENDIX C MAINTENANCE ALLOCATION

Section I. INTRODUCTION

C-1. General

This appendix provides a summary of the maintenance operations covered in the equipment literature for Meteorological Station AN/TMQ-4. It authorizes categories of maintenance for specific maintenance functions on repairable items and components and the tools and equipment required to perform each function. This appendix may be used as an aid in planning maintenance operations.

C-2. Explanation of Format for Maintenance Allocation Chart

- a. *Group Number.* Not used.
- b. *Component Assembly Nomenclature.* This column lists the item names of component units, assemblies, subassemblies, and modules on which maintenance is authorized
- c. *Maintenance Function.* This column indicates the maintenance category at which performance of the specific maintenance function is authorized. Authorization to perform a function at any category also includes authorization to perform that function at higher categories. The codes used represent the various maintenance categories as follows:

Code	Maintenance category
c	Operator/Crew
o	Organizational Maintenance
F	Direct Support Maintenance
H	General Support Maintenance
D	Depot Maintenance

d. *Tools and Equipment.* The numbers appearing in this column refer to specific tools and equipment which are identified by these numbers in Section III.

e. *Remarks.* Self explanatory.

C-3. Explanation of Format for Tool and Test Equipment Requirements

The columns in the tool and test equipment requirements chart are as follows:

- a. *Tools and Equipment.* The numbers in this column coincide with the numbers used in the tools and equipment column of the tool for the maintenance function.
- b. *Maintenance Category.* The codes in this column indicate the maintenance category normally allocated the facility.
- c. *Nomenclature.* This column lists tools, test, and maintenance equipment required to perform the maintenance functions.
- d. *Federal Stock Number.* This column lists the Federal stock number.
- e. *Tool Number.* Not used.

SECTION II. MAINTENANCE ALLOCATION CHART

MAINTENANCE ALLOCATION CHART															
GROUP NUMBER	COMPONENT ASSEMBLY NOMENCLATURE	MAINTENANCE FUNCTIONS										TOOLS AND EQUIPMENT	REMARKS		
		INSPECT	TEST	SERVICE	ADJUST	ALIGN	CALIBRATE	INSTALL	REPLACE	REPAIR	OVERHAUL			REBUILD	
	METEOROLOGICAL STATION AN/TMQ-4	C		C							C	C			See individual item listing for specific details
	ANEMOMETER ML-433/PM AND ANEMOMETER ML-497/PM	#		#	#						#	#			See TM 11-6660-205-15P And See TM 11-6660-233-15P
	BAROMETER ML-102	#	#	#			#				#		#		See TM 11-6685-202-12P
	HEADSET-CHEST SET H-164/U	#	#	#							#				See TM 11-334
	HYDROGEN GENERATOR AN/TMQ-3										#	#	#		See TM 11-2413
	NOZZLE ML-196				C						C				Clean complete nozzle
	NOZZLE METEOROLOGICAL BALOON INFLATION ML-373/GM	C			C									5	Clean exterior
					O									5	Clean all parts and lubricate
															Replace parts
	NOZZLE METEOROLOGICAL BALOON INFLATION ML-462/UM	C			C									5	Clean exterior
					O									5	Clean all parts and lubricate
															Replace parts

ANSEL-MR Form 6031 (Supersedes edition of 1 Feb 64, which is obsolete) 1 Jun 64 AN/TMQ-4

830-PH 97-66

MAINTENANCE ALLOCATION CHART														
GROUP NUMBER	COMPONENT ASSEMBLY NOMENCLATURE	MAINTENANCE FUNCTIONS										TOOLS AND EQUIPMENT	REMARKS	
		INSPECT	TEST	SERVICE	ADJUST	ALIGN	CALIBRATE	INSTALL	REPLACE	REPAIR	OVERHAUL			REBUILD
	AN/TMQ-4 (continued)													
	PLOTTING BOARD	C		C					C					Clean Board or rule
	PSYCHROMETER ML-224	C		C						O			5	Visual; thermometer mercury continuity Clean Replace all parts
	RADIOSONDE SET AN/AMT-4A	C	C	C	C								1,3	Visual Frequency test; baseline check Clean contacts Frequency pressure switch
	REELING MACHINE RL-39			C						O			5	Clean; lubricate Replace parts
	REGULATOR, PRESSURE ML-528/GM (Was ML-193)	C		C				C						Visual Clean exterior To gas cylinder
	TELEPHONE SET TA-312/PT	#	#	#	#				#	#	#			See TM 11-5805-201-12

ANSI Std Form 1 Jan 64

6031 (Supersedes edition of 1 Feb 64, which is obsolete)

AN/TMQ-4

EBO-PH 97-66

MAINTENANCE ALLOCATION CHART															
GROUP NUMBER	COMPONENT ASSEMBLY NOMENCLATURE	MAINTENANCE FUNCTIONS									TOOLS AND EQUIPMENT	REMARKS			
		INSPECT	TEST	SERVICE	ADJUST	ALIGN	CALIBRATE	INSTALL	REPLACE	REPAIR			OVERHAUL	REBUILD	
	AN/TM-4 (continued)														
	TENT, M-1957	C		C							O			5 4	Visual Clean Replace parts Repair canvas and frame
	THEODOLITE ML-474	#	#		#					#	#		#		See TM 11-6675-200-20
	TIMER, STOP FM-103		O	C										2	Clean Check time Complete unit
	TRIPOD SURVEYING MT-1309/GM				C			O				F		4	Clean Replace parts
	#Indicates that maintenance guidance will be found in documents referenced in remarks column.														

AMSEL-48 Form 1 Jan 64

6031 (Supersedes edition of 1 Feb 63, which is obsolete)

AN/TM-4

ESC-PH 97-64

SECTION III. TOOL AND TEST EQUIPMENT REQUIREMENTS

TOOL AND TEST EQUIPMENT REQUIREMENTS				
TOOLS AND EQUIPMENT	MAINTENANCE CATEGORY	NOMENCLATURE	FEDERAL STOCK NUMBER	TOOL NUMBER
		AN/TMQ-4 (continued)		
1	C	RADIOSONDE BASELINE CHECK SET AN/GMM-1	6660-527-8392	
2	O	STOP WATCH	6645-679-8216	
3	C	TEST SET, RADIO TS-538/U	6625-243-5174	
4	F,H,D	TOOL KIT TK-88	5180-893-1389	
5	O	TOOL KIT TK-115	5180-856-1578	

ANSI-ASR Form 6013 (Supersedes edition of 1 Jan 65, which is obsolete)
1 Jan 66

AN/TMQ-4

EOC-FM 95-66

INDEX

	Paragraph	Page		Paragraph	Page
Additional equipment required -----	1-11	1-30	Head and chest set-----	1-5e	1-5
■ Administrative storage -----	1-3.3	1-1	Hydrogen generator charges	1-5d	1-3
Anemometer ML433A/PM:			Hydrogen Generator Set		
Cleaning -----	5-14d	5-5	AN/TMQ-3 -----	1-5f	1-5
Disassembly -----	5-14b	5-4	Lighting Unit ML-608/AM ----	1-5g	1-5
General -----	5-16	5-7	Nozzle ML-196 -----	1-5h	1-5
Replacement, parts -----	5-14e	5-5	Parachute ML-132 -----	1-5i	1-5
Anemometer ML-A97/PM -----	5-15	6-5	Parachute ML-609/U -----	1-5j	1-5
Compass removal -----	5-15a	6-5	Plotting Board ML-122 -----	1-5k	1-5
General: -----	5-16	6-7	Psychrometer ML-224 -----	1-5l	1-5
Velometer: -----			Radiosonde Set AN/AMT-4(*)	1-5m	1-5
Disassembly -----	5-15d	6-6	Reel RL-39-(*) -----	1-5n	1-5
Reassembly -----	5-15f	6-7	Reel Launching ML-367/AM ----	1-5o	1-6
Repair -----	5-15e	6-6	Regulator, Pressure Compressed		
Wind vane -----	5-15b	5-5	Gas ML-528/GM -----	1-5p	1-6
Disassembly -----	5-15b	5-5	Slide Rule ML-59 -----	1-5r	1-6
Reassembly -----	5-15c	5-6	Telephone TA-312/PT -----	1-5s	1-6
Balloons:			Theodolite, Double Center		
■ Conditioning -----	3-2a(3)	3-2	ML-474/GM, -----	1-5u	1-6
Inflation:			Timer, Stop FM-103 -----	1-5w	1-7
Guides -----	3-2h	3-4	Tropical thermometer -----	1-5x	1-7
Equipment -----	2-5d	2-6	Description, minor components -----	1-10	1-24
Preparation -----	3-2i	3-6	Altitude pressure density chart	1-10a	1-24
Sounding balloon, nozzle	3-2h	3-4	Bag -----	1-10b	1-26
Sounding balloons, gas cylinder	3-2j	3-7	Balloons -----	1-10c	1-26
Release procedures -----	3-2	3-1	Balloon shroud -----	1-10r	1-30
Selection -----	3-2	3-1	Battery pack -----	1-10d	1-27
■ Technical characteristics -----		1-7	Bracket assembly -----	1-10g	1-27
Train preparation -----	1-5y	3-7	Calcium hydride charge -----	1-10e	1-27
Chart, weights, and measures -----	1-6	1-7	Coupling -----	1-10h	1-28
Checking unpacked equipment -----	2-2	2-1	Gas regulator -----	1-10q	1-30
Cleaning -----	4-8	4-4	Jack -----	1-10p	1-30
Common names -----	1-7	1-8	Launching reel -----	1-10m	1-29
Computation, radar flights -----	3-7	3-16	Lighting unit -----	1-10i	1-28
Controls and indicators -----	3-1	3-1	Parachutes -----	1-10k	1-28
Anemometer -----	3-1a	3-1	Pilot balloon nozzle -----	1-10n	1-29
Barometer -----	3-1b	3-1	Reel -----	1-10l	1-28
Timer -----	3-1q	3-1	Scales -----	1-10o	1-29
Description, major components:			Sounding balloon nozzle -----	1-10j	1-28
■ Anemometers -----	1-9a	1-10	Tripod -----	1-10s	1-30
Balloon launcher -----	1-9k	1-23	Water can -----	1-10f	1-27
Barometers -----	1-9b	1-10	Destruction of Army Electronics		
Head and chest set -----	1-9d	1-11	Material -----	1-3.4	1-1
Hydrogen generator set -----	1-9c	1-11	Functioning equipment:		
Plotting board and rule -----	1-9f	1-19	Anemometer -----	6-17	5-7
Psychrometer -----	1-9e	1-17	Destruction -----	1-3.4	1-1
Radiosonde set -----	1-9g	1-20	General -----	6-16	5-7
Telephone -----	1-9h	1-20	Psychrometer -----	5-18	6-8
Theodolite set -----	1-9i	1-21	Timer -----	5-19	6-8
■ Timer -----	1-9L	1-23	Index, publications -----	1-2	1-1
Description, Meteorological Station,			Installation:		
Manual AN/TMQ-4 -----	1-8	1-10	Checking unpacked equipment ----	2-2	2-1
Purpose and use -----	1-4	1-3	Communication between sites ----	2-5c	2-6
Technical characteristics:			Equipment, balloon launching site	2-5a	2-3
Anemometers -----	1-5a	1-3	Equipment, plotting station -----	2-5b	2-6
Balloons -----	1-5y	1-3	General -----	2-5	2-3
Barometers -----	1-5b	1-3	Inflation equipment - -----	2-5d	2-3
Battery Pack BA-259/AM -----	1-5c	1-3	Site selection -----		2-3
			Tools required -----		2-3
			Unpacking -----	2-1	2-1
			Lubrication -----	4-9	4-4
			Maintenance Forms, Records, and		
			Reports -----	1-3	1-1

	Paragraph	Page		Paragraph	Page
Methods, destruction	1-34	1-1	Reporting errors and recommending improvements	1-3.1	1-1
Operator maintenance:			Scope	1-1	1-1
Materials and tools required	4-2	4-1	Shipment and limited storage:		
Preventive maintenance	4-3	4-1	Disassembly	6-1	6-1
Preventive maintenance checks and services periods	4-4	4-1	Repacking	6-2	6-1
Preventive maintenance checks and services:			Siting	2-3	2-3
Daily	4-5		Sound-ranging procedure	3-6	3-16
Quarterly	4-7	4-3	Effective temperature	3-6a	3-16
Weekly	4-6	4-2	Effective wind data	3-6b	3-16
scope	4-1	4-1	Sound ranging data	3-6c	3-16
Troubleshooting	4-10	4-5	Surface, visual, and electronic observation Procedures:		
Organizational maintenance:			Air temperature	3-3b	3-8
Preventive maintenance	5-3	5-1	Atmospheric pressure	3-3a	3-8
Preventive maintenance checks and services:			Plotting upper air wind direction and speed, electronic	3-3g	3-11
Monthly	5-6,5-7	5-2,5-3	Release, sounding balloons, electronically	3-3f	3-10
Quarterly	5-8,5-9	5-3	Surface wind direction and speed	3-3d	3-8
Weekly	5-5	5-2	Upper air pressure, temperature, and relative humidity, electronic	3-3h	3-11
Preventive maintenance checks and services periods	5-4	5-1	Upper air wind direction and speed, visual	3-3e	3-9
Repairs and adjustments	5-13	5-4	Wet and dry bulb readings		
Scope	5-1	5-1	Psychrometer	3-3c	3-8
Tools and materials required	5-2	5-1	System application	1-12	1-33
Troubleshooting	5-11	5-4	Technical characteristics	1-5	1-3
Preliminary observations, equipment functions:			Timer	5-19	5-8
Anemometer	3-1a	3-1	Tools required, installation	2-4	2-3
Barometer	3-1b	3-1	Tools required, operator's maintenance	4-2	4-1
Controls and indicators	3-1	3-1	Touchup painting	5-10	5-4
Plotting board	3-1c	3-1	Troubleshooting and general repair	5-11	5-4
Radiosonde set	3-1d	3-1	Unpacking	2-1	2-1
Telephone	3-1e	3-1	Use, electronic observation data	3-5	3-15
Theodolite set	3-1f	3-1	Ballistic densities	3-5c	3-15
Timer	3-1g	3-1	Ballistic temperature	3-6b	3-15
Preliminary operating procedures:			Radiosonde data sheet	3-5a	3-15
Balloon launching site, electronic observation	3-2b	3-2	Zone wind data	3-5d	3-15
Balloon launching site, visual observation	3-3a	3-1	Use, visual observation data	3-4	3-11
Baseline check procedure	3-2c	3-3	Ballistic air densities and temperature	3-4a	3-11
Baseline check, Radiosonde Recorder AN/TMQ-5(*)	3-2d	3-3	Ballistic density	3-4c	3-12
Preparation:			Ballistic temperature	3-4b	3-11
Balloon train	3-2k	3-7	Departure, mean surface density	3-4d	2-12
Pressure time chart	3-2e	3-3	Determination, ballistic wind direction	3-4h	3-13
Radiosonde data form DA Form 4197	3-2f	3-4	Determination, zone wind direction and speed	3-4g	3-12
Preparation meteorological messages	3-8	3-16	Percentage, standard ballistic density	3-4f	3-12
Repacking, shipment or limited storage	6-2	6-1	Weights and measures chart	1-6	1-1
Repairs and adjustments:					
Anemometir ML-433A/PM	5-14	5-4			
Anemometer ML-497/PM	5-15	6-6			
Reporting Equipment Improvement Recommendations (EIR)	1-3.2	1-1			

By Order of the Secretary of the Army:

HAROLD K. JOHNSON,
General, United States Army,
Chief of Staff.

Official:

KENNETH G. WICKHAM,
Major General, United States Army,
The Adjutant General.

Distribution:

Active Army:

USASA (2)
 CNGB (1)
 CC-E (7)
 Dir of Trans (1)
 CofEngrs (1)
 TSG (1)
 CofSpts (1)
 USAARENBD (2)
 USACDCEA (1)
 USACDCCBRA (1)
 USACDCCEA (1)
 USACDCCEA:
 Ft Huachuca (1)
 USACDCOA (1)
 USACDCQMA (1)
 USACDCTA (1)
 USACDCADA (1)
 USACDCARMA (1)
 USACDCAVNA (1)
 USACDCARTYA (1)
 USACDCSWA (1)
 USAMC (5)
 ARADCOM (5)
 ARADCOM Rgn (2)
 USCONARC (5)
 OS Maj Comd (4)
 USA Panama (5)
 LOGCOMD (2)
 USAMICOM (4)
 USASTRATCOM (4)
 USAESC (70)
 MDW (1)
 Armies (2)
 Corps (2)
 USAC (3)
 Svc Colleges (2)
 USASCS (75)
 USASESCS (5)
 USAADS (2)
 USAAMS (40)
 USAARMS (2)
 USAIS (2)
 USAES (2)
 USATC Armor (2)
 USATC Engr (2)

USATC Inf (2)
 USASTC (2)
 USACDCEC (10)
 Army Pic Cen (2)
 WRAMC (1)
 Gen Dep (2)
 Sig Sec Gen Dep (5)
 Sig Dep (12)
 A Dep (2) except
 LEAD (14)
 SAAD (30)
 TOAD (14)
 LEAD (7)
 SHAD (3)
 NAAD (5)
 SVAD (5)
 CHAD (3)
 ATAD (10)
 Instls (2) except
 Ft Hancock (4)
 Ft Gordon (10)
 Ft Huachuca (10)
 Ft Carson (25)
 Ft Knox (12)
 WSMR (5)
 Sig FLDMS (2)
 AMS (1)
 USAERDAA (2)
 USAERDAW (13)
 USACRREL (2)
 Units org under fol TOE:
 (2 copies each)
 6-100
 6-101
 6-185
 6-186
 6-200
 6-201
 6-300
 6-385
 6-386
 6-525
 6-526
 6-565
 6-575

TM 11-6660-218-12

6-576
6-577
6-700
6-701
7
7-100
11-57
11-97
11-98

11-117
11-127
11-155
11-157
11-158
11-500 (AA-AC)
11-587
11-592
11-597

NG: State AG (8).

USAR: None.

For explanation of abbreviations used, see AB 320-50.

★U.S. GOVERNMENT PRINTING OFFICE : 1989 O - 242-451 (1656)

AGO 8829A

RECOMMENDED CHANGES TO EQUIPMENT TECHNICAL PUBLICATIONS

SOMETHING WRONG

WITH THIS PUBLICATION?



THEN . . . JOT DOWN THE DOPE ABOUT IT ON THIS FORM, FOLD IT, AND DROP IT IN THE MAIL!

FROM: (PRINT YOUR UNIT'S COMPLETE ADDRESS)

DATE SENT

PUBLICATION NUMBER

PUBLICATION DATE

PUBLICATION TITLE

BE EXACT . . . PIN-POINT WHERE IT IS

IN THIS SPACE TELL WHAT IS WRONG AND WHAT SHOULD BE DONE ABOUT IT:

PAGE NO.

PARA-GRAPH

FIGURE NO.

TABLE NO.

PRINTED NAME, GRADE OR TITLE, AND TELEPHONE NUMBER

SIGN HERE

THE METRIC SYSTEM AND EQUIVALENTS

WEIGHT MEASURE

1 Centimeter = 10 Millimeters = 0.01 Meters = 0.3937 Inches
 1 Meter = 100 Centimeters = 1000 Millimeters = 39.37 Inches
 1 Kilometer = 1000 Meters = 0.621 Miles

WEIGHTS

1 Gram = 0.001 Kilograms = 1000 Milligrams = 0.035 Ounces
 1 Kilogram = 1000 Grams = 2.2 lb.
 1 Metric Ton = 1000 Kilograms = 1 Megagram = 1.1 Short Tons

LIQUID MEASURE

1 Milliliter = 0.001 Liters = 0.0338 Fluid Ounces
 1 Liter = 1000 Milliliters = 33.82 Fluid Ounces

SQUARE MEASURE

1 Sq. Centimeter = 100 Sq. Millimeters = 0.155 Sq. Inches
 1 Sq. Meter = 10,000 Sq. Centimeters = 10.76 Sq. Feet
 1 Sq. Kilometer = 1,000,000 Sq. Meters = 0.386 Sq. Miles

CUBIC MEASURE

1 Cu. Centimeter = 1000 Cu. Millimeters = 0.06 Cu. Inches
 1 Cu. Meter = 1,000,000 Cu. Centimeters = 35.31 Cu. Feet

TEMPERATURE

$5/9(^{\circ}\text{F} - 32) = ^{\circ}\text{C}$
 212° Fahrenheit is equivalent to 100° Celsius
 90° Fahrenheit is equivalent to 32.2° Celsius
 32° Fahrenheit is equivalent to 0° Celsius
 $9/5^{\circ}\text{C} + 32 = ^{\circ}\text{F}$

APPROXIMATE CONVERSION FACTORS

TO CHANGE	TO	MULTIPLY BY
Inches	Centimeters	2.540
Feet	Meters	0.305
Yards	Meters	0.914
Miles	Kilometers	1.609
Square Inches	Square Centimeters	6.451
Square Feet	Square Meters	0.093
Square Yards	Square Meters	0.836
Square Miles	Square Kilometers	2.590
Acres	Square Hectometers	0.405
Cubic Feet	Cubic Meters	0.028
Cubic Yards	Cubic Meters	0.765
Fluid Ounces	Milliliters	29.573
its	Liters	0.473
arts	Liters	0.946
allons	Liters	3.785
Ounces	Grams	28.349
Pounds	Kilograms	0.454
Short Tons	Metric Tons	0.907
Pound-Feet	Newton-Meters	1.356
Pounds per Square Inch	Kilopascals	6.895
Miles per Gallon	Kilometers per Liter	0.425
Miles per Hour	Kilometers per Hour	1.609

TO CHANGE	TO	MULTIPLY BY
Centimeters	Inches	0.394
Meters	Feet	3.280
Meters	Yards	1.094
Kilometers	Miles	0.621
Square Centimeters	Square Inches	0.155
Square Meters	Square Feet	10.764
Square Meters	Square Yards	1.196
Square Kilometers	Square Miles	0.386
Square Hectometers	Acres	2.471
Cubic Meters	Cubic Feet	35.315
Cubic Meters	Cubic Yards	1.308
Milliliters	Fluid Ounces	0.034
Liters	Pints	2.113
Liters	Quarts	1.057
ers	Gallons	0.264
ms	Ounces	0.035
ograms	Pounds	2.205
Metric Tons	Short Tons	1.102
Newton-Meters	Pounds-Feet	0.738
Kilopascals	Pounds per Square Inch	0.145
ometers per Liter	Miles per Gallon	2.354
ometers per Hour	Miles per Hour	0.621



PIN: 017636-008