

1/4 bld 4113
12
TM
1943

TM 9-1756A

WAR DEPARTMENT TECHNICAL MANUAL

U.S.A.

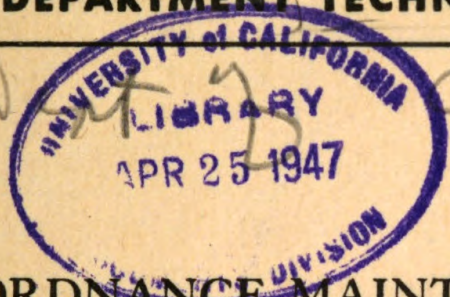

Army

ORDNANCE MAINTENANCE

Ordnance Engine Model RD-1820 (Caterpillar)

WAR DEPARTMENT

9 DECEMBER 1943

WAR DEPARTMENT TECHNICAL MANUAL

TM 9-1756A

ORDNANCE MAINTENANCE

Ordnance Engine
Model RD-1820 (Caterpillar)



WAR DEPARTMENT
9 DECEMBER 1943

WAR DEPARTMENT
Washington 25, D. C., 9 December 1943

TM 9-1756A, Ordnance Maintenance, Ordnance Engine Model RD-1820 (Caterpillar), is published for the information and guidance of all concerned.

[A.G. 300.7 (12 Nov 43)
O.O.M. 461/(TM 9) Rar. Ars. (12-9-43) (9 Dec 43)]

BY ORDER OF THE SECRETARY OF WAR:

G. C. MARSHALL,
Chief of Staff.

OFFICIAL:
J. A. ULIO,
Major General,
The Adjutant General.

DISTRIBUTION: X

(For explanation of symbols, see FM 21-6.)

U113

CONTENTS

TM 9:1756A
1943
★

	Paragraphs	Pages
CHAPTER 1. INTRODUCTION	1- 2	4- 7
CHAPTER 2. ORDNANCE ENGINE MODEL RD-1820	3-24	8- 97
SECTION I. Description and data	3- 4	8- 11
SECTION II. Disassembly of component into subassemblies	5- 6	11- 24
SECTION III. Disassembly, cleaning, inspection, repair, and assembly of subassemblies	7-19	24- 72
SECTION IV. Assembly	20-21	72- 87
SECTION V. Fits and tolerances	22-24	88- 97
CHAPTER 3. FUEL SYSTEM	25-46	98-111
SECTION I. Description	25	98
SECTION II. Fuel transfer pump	26-30	98-101
SECTION III. Secondary fuel filter and priming pump	31-34	102-104
SECTION IV. Fuel injection pump, lines, valves, and precombustion chamber	35-38	104-105
SECTION V. Governor and controls	39-46	105-111
CHAPTER 4. LUBRICATION SYSTEM	47-54	112-117
SECTION I. Description	47	112
SECTION II. Oil pump and lines	48-51	112-115
SECTION III. Lubricating oil filters	52-54	115-117
CHAPTER 5. ENGINE ELECTRICAL SYSTEM	55-70	118-127
SECTION I. Description	55	118
SECTION II. Cranking motors	56-61	118-123
SECTION III. Air heater	62-67	123-125
SECTION IV. Indicator and wiring, vibrator coil and magnetic valve	68-70	125-127
CHAPTER 6. SPECIAL TOOLS	71	128-131
REFERENCES		132-133
INDEX		134-139

CHAPTER 1

INTRODUCTION

	Paragraph
Scope	1
Maintenance allocation	2

1. SCOPE.

a. The instructions contained in this manual are for the information and guidance of personnel charged with the maintenance and repair of Ordnance Engine Model RD-1820. These instructions are supplementary to field and technical manuals prepared for the using arm. This manual does not contain information which is intended primarily for the using arm, since such information is available to ordnance maintenance personnel in 100-series TM's or FM's. For using arm information particularly applicable to this engine, see TM 9-756, Medium Tank M4A6.

b. This manual contains a description of and procedure for disassembly, inspection, repair, and assembly, of the engine and accessories.

2. MAINTENANCE ALLOCATION.

a. **Scope.** The scope of maintenance and repair by the crew and other units of the using arms is determined by the availability of suitable tools, availability of necessary parts, capabilities of the mechanics, time available and the tactical situation. No exact system of procedure can be prescribed which will be uniformly applicable to all types of vehicles.

b. **Allocation of Maintenance.** Indicated below are the maintenance duties for which, under normal circumstances, tools and parts have been provided for the using arm and ordnance maintenance personnel. Certain replacements and repairs are the responsibility of ordnance maintenance personnel, but may be performed by using arm personnel when circumstances permit or require, within the discretion of the commander concerned. Echelons and words as used in this list of maintenance allocations are defined as follows:

- | | |
|--|---|
| FIRST AND
SECOND ECHELON:
Table III
AR 850-15 | Operating organization driver, operator or crew, companies and detachments, battalions, squadrons, regiments, and separate companies and detachments (first and second echelons, respectively). |
| THIRD ECHELON:
Table III
AR 850-15 | Technical light and medium maintenance units, including Post and Port Shops. |
| FOURTH ECHELON:
Table III
AR 850-15 | Technical heavy maintenance and field depot units including designated post and service command shops. |

INTRODUCTION

FIFTH ECHELON: Table III AR 850-15	Technical base Units.
SERVICE: (Including preventive maintenance) par. 24 a (2) and (3) in part AR 850-15	Checking and replenishing fuel, oil, grease, water and anti-freeze, air, and battery liquid; checking and tightening nuts and bolts; cleaning.
REPLACE: Par. 24 a (5) AR 850-15	To remove an unserviceable part, assembly, or subassembly from a vehicle and replace it with a serviceable one.
REPAIR: Par. 24 a (6) in part AR 850-15	To restore to a serviceable condition, such parts, assemblies or subassemblies as can be accomplished without completely disassembling the assembly or subassembly, and where heavy riveting, or precision machining, fitting, balancing, or alining is not required.
REBUILD: Par. 24 a (6) AR 850-15	Consists of stripping and completely reconditioning and replacing in serviceable condition any vehicle or unserviceable part, subassembly, or assembly of the vehicle, including welding, riveting, machining, fitting, alining, balancing, assembling, and testing.
RECLAMATION: AR 850-15 Par. 4 (c) in part CIR. 75, dated 16 March '43	Salvage of serviceable or economically repairable units and parts removed from vehicles, and their return to stock. This includes the process which recovers and/or reclaims unusable articles or component parts thereof and places them in a serviceable condition.

NOTES:

- (1) Operations allocated will normally be performed in the echelon indicated by "X."
- (2) Operations allocated to the third echelon as indicated by "E" may be performed by these units in emergencies only.
- (3) Operations allocated to the fourth echelon by "E" are normally fifth echelon operations. They will not be performed by the fourth echelon, unless the unit is expressly authorized to do so by the chief of the service concerned.
- (4) Consult technical bulletins of the 2830 series for detailed information relative to reclamation procedure.

ORDNANCE MAINTENANCE — ORDNANCE ENGINE MODEL RD-1820 (CATERPILLAR)

ENGINE, RADIAL, ORDNANCE, MODEL RD-1820	ECHELONS			
	2nd	3rd	4th	5th
Breather assemblies — replace	X			
Breather assemblies — repair		X		
Case, transfer — replace		X		
Case, transfer — repair		E	X	
Case, transfer — rebuild			E	X
Chamber, precombustion — replace		X		
Clutch assembly — replace		X		
Clutch assembly — repair			X	
Clutch assembly — rebuild			E	X
Cooler, engine oil — replace or repair		X		
Cooler, engine oil — rebuild			E	X
Cowl, air deflector — replace		X		
Cowl, air deflector — repair			X	
Cylinder assembly — replace		E	E	X
Cylinder assembly — repair		E	X	
Cylinder assembly — rebuild			E	X
Director, air — replace		X		
Director, air — repair			X	
* Engine assembly — replace	*	X		
Engine assembly — repair		X		
Engine assembly — rebuild			E	X
Fan assembly — replace		X		
Fan assembly — repair or rebuild			E	X
Filter, fuel (auxiliary) — replace	X			
Filter, fuel (auxiliary) — repair		X		
Filter, engine oil — replace		X		
Filter, engine oil — repair			X	
Flywheel and hub assembly — replace		X		
Flywheel and hub assembly — repair			X	
Flywheel and hub assembly — rebuild			E	X
Governor assembly — service and/or replace		X		
Governor assembly — rebuild			E	X
Heater and manifold, air, supercharger — replace	X			

*The second echelon is authorized to remove and reinstall items marked by an asterisk. However, when it is necessary to replace an item marked by an asterisk with a new or rebuilt part, subassembly or unit assembly, the assembly marked by an asterisk may be removed from the vehicle by the second echelon *only after authority has been obtained from a higher echelon of maintenance.*

INTRODUCTION

Engine, Radial, Ordnance, Model RD-1820 (Cont'd)	ECHELONS			
	2nd	3rd	4th	5th
Heater and manifold, air, supercharger — repair		X		
Heater and manifold, air, supercharger — rebuild			X	
Manifold, exhaust and intake — replace		X		
Manifold, exhaust and intake — rebuild			X	
Meter, hour — replace	X			
Meter, hour — repair		X		
Motor assembly, starting — replace	X			
Motor assembly, starting — repair		X		
Motor assembly, starting — rebuild			X	
Mounts, engine (front and rear) — replace		X		
Pistons and rings — replace		E	E	X
Pump assembly, fuel injection — replace	X			
Pump assembly, fuel transfer — replace	X			
Pump assembly, fuel transfer — repair		X		
Pump assembly, fuel transfer — rebuild			E	X
Pump assembly, oil pressure and scavenger — replace	X			
Pump assembly, oil pressure and scavenger — repair		X		
Pump assembly, oil pressure and scavenger — rebuild			E	X
Rocker assembly, valve — replace		X		
Rocker assembly, valve — repair			X	
Rocker assembly, valve — rebuild			E	X
Rod assembly, control, fuel pump to governor — re- place		X		
Rod assembly, control, fuel pump to governor — re- pair			X	
Rod, valve push — replace		X		
Seals, oil supercharger (ring type) — replace		X		
Strainer, oil — service and/or replace	X			
Strainer, oil — repair		X		
Supercharger assembly — replace		X		
Supercharger assembly — repair		E	X	
Supercharger assembly — rebuild			E	X
Valve assembly, fuel injection — replace		X		

CHAPTER 2

ORDNANCE ENGINE MODEL RD-1820

Section I

DESCRIPTION AND DATA

Description and operation	Paragraph 3
Data	4

3. DESCRIPTION AND OPERATION.

a. **General.** The RD-1820 Ordnance Engine is a single-row, 9-cylinder, air-cooled, radial engine operating on a 4-stroke cycle. It uses fuels ranging from Diesel fuel to low octane gasoline. Engine rotation is clockwise when viewed from the rear or accessory end.

b. **Power Unit.** The nine cylinders are attached radially to a cylindrical, two-piece crankcase. The crankshaft, which is carried by three antifriction bearings, has one crankpin which carries the master connecting rod. The eight articulated rods attach, by means of knuckle pins, to a circular web on the master rod. The aluminum pistons are cooled by a jet of oil directed against their under sides.

c. **Cooling System.** The engine is cooled by air drawn through the engine compartment by a fan attached to the flywheel. Air passes through the lubricating oil cooler and over the fins of the cylinders and precombustion chambers.

d. **Supercharger.** The supercharger and accessory drive gears are located at the rear of the engine. The supercharger consists of a gear driven impeller and a diffuser plate.

e. **Power Train.** Power is transmitted from the crankshaft through a flywheel clutch to the transfer case. The transfer case lowers the line of drive from the crankshaft to the propeller shaft.

4. DATA.

Model	RD-1820
Type	Single-row, air-cooled, radial
Number of cylinders	9
Bore and stroke	6.125 in. x 6.875 in.
Piston displacement	1,823 cu in.
Compression ratio	15.5 to 1
Supercharger ratio	10 to 1
Governor speed (full load)	2,000 rpm

ORDNANCE ENGINE MODEL RD-1820

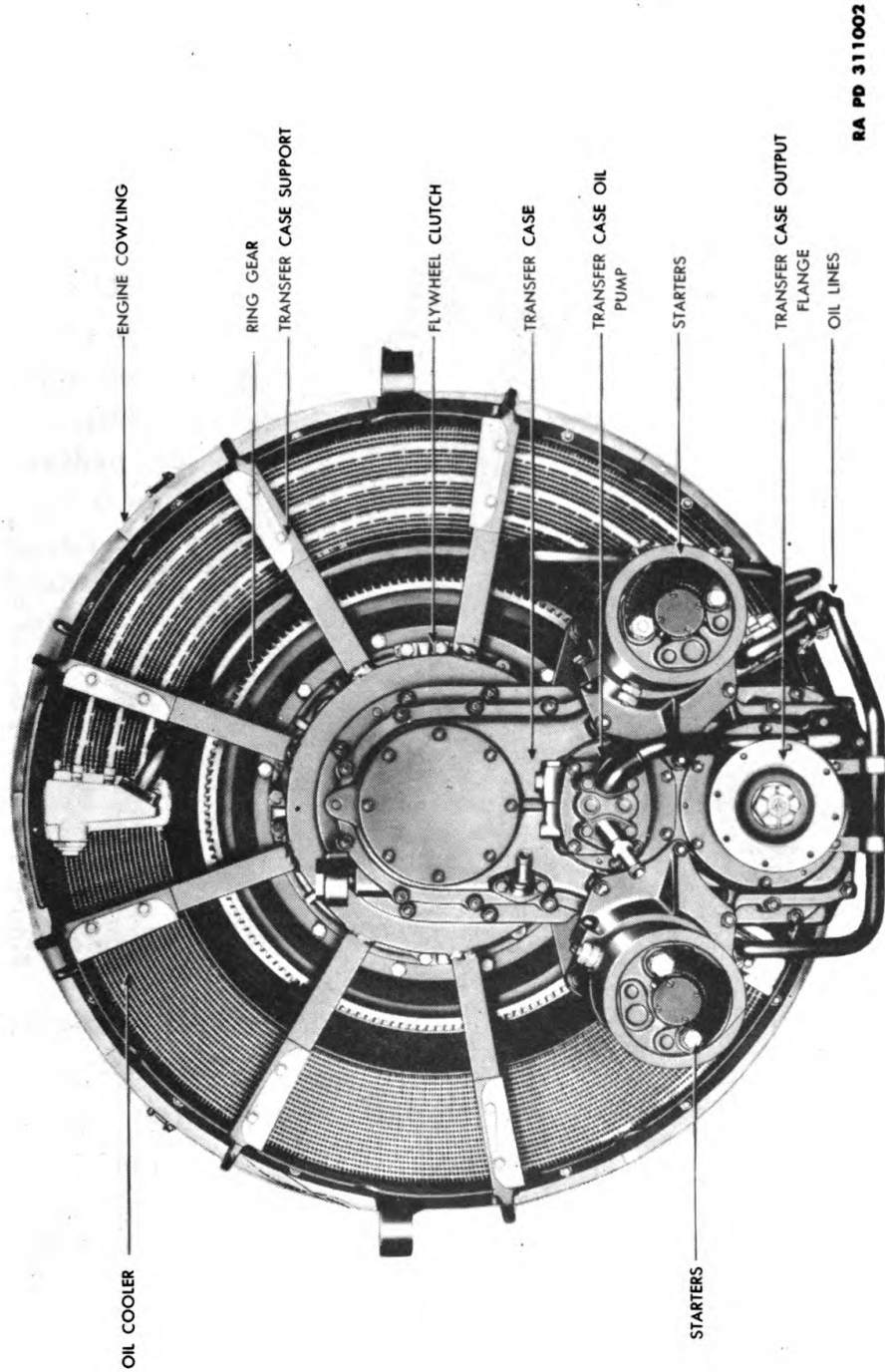
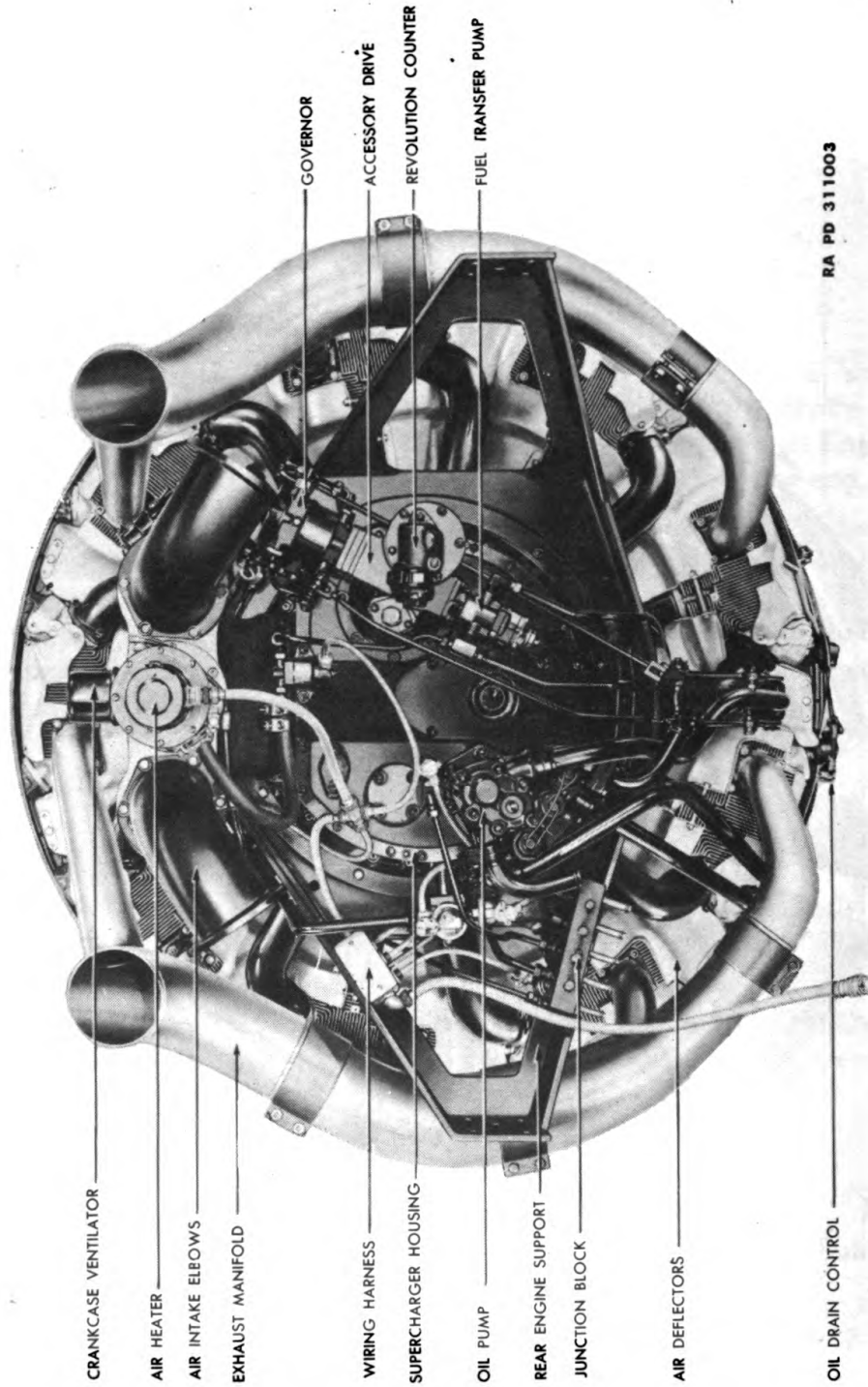

Figure 1 — Front View of Engine

ORDNANCE MAINTENANCE — ORDNANCE ENGINE MODEL RD-1820 (CATERPILLAR)



RA PD 311003

Figure 2 — Rear View of Engine

ORDNANCE ENGINE MODEL RD-1820

Low idle speed	650 rpm
Rated brake horsepower, standard conditions (with all accessories)	450 at 2,000 rpm
Torque at engine crankshaft:	
At maximum horsepower	1,180 lb-ft
Maximum at 1,200 rpm when engine is lugged down	1,470 lb-ft
Torque at drive shaft:	
At maximum horsepower (drive shaft rpm 3,000)	746 lb-ft
Maximum at 1,200 rpm engine speed (drive shaft rpm 1,800) when engine is lugged down	931 lb-ft
Rotation of crankshaft (viewed from rear)	Clockwise
Firing order	1-3-5-7-9-2-4-6-8
Piston speed at 2,000 rpm	2,292 fpm
Crankshaft spline size	SAE No. 40
Overall diameter of engine	55 in.
Overall length of engine (includes starters and air inlet elbows)	70.16 in.
Weight of engine proper (excluding air cleaners, fuel filter and oil filter)	3,900
Serial number location	Plate on supercharge rear cover

CHAPTER 2 – cont'd

Section II

DISASSEMBLY OF COMPONENT INTO SUBASSEMBLIES

	Paragraph
Preliminary instructions	5
Disassembly instructions	6

5. PRELIMINARY INSTRUCTIONS.

a. Mount Engine on Stand.

(1) **GENERAL PREPARATION.** With the engine suspended in the lifting sling (fig. 3), remove the drain plug from the oil sump, and drain the accumulated oil. Remove exhaust manifolds, air heater manifold, air heater, air inlet elbows, oil line connecting oil cooler to oil pump and oil line connecting sump to oil pump. (Refer to pertinent 100-series manual for instructions.)

(2) **MOUNT ENGINE.** Install engine on a rotating engine stand.

b. Remove Accessories. Remove the oil pump, fuel transfer pump, primary oil filter and starting motors. (Refer to TM 9-756 or other pertinent 100-series (using arm) manual for instructions.) Remove

ORDNANCE MAINTENANCE — ORDNANCE ENGINE MODEL RD-1820 (CATERPILLAR)

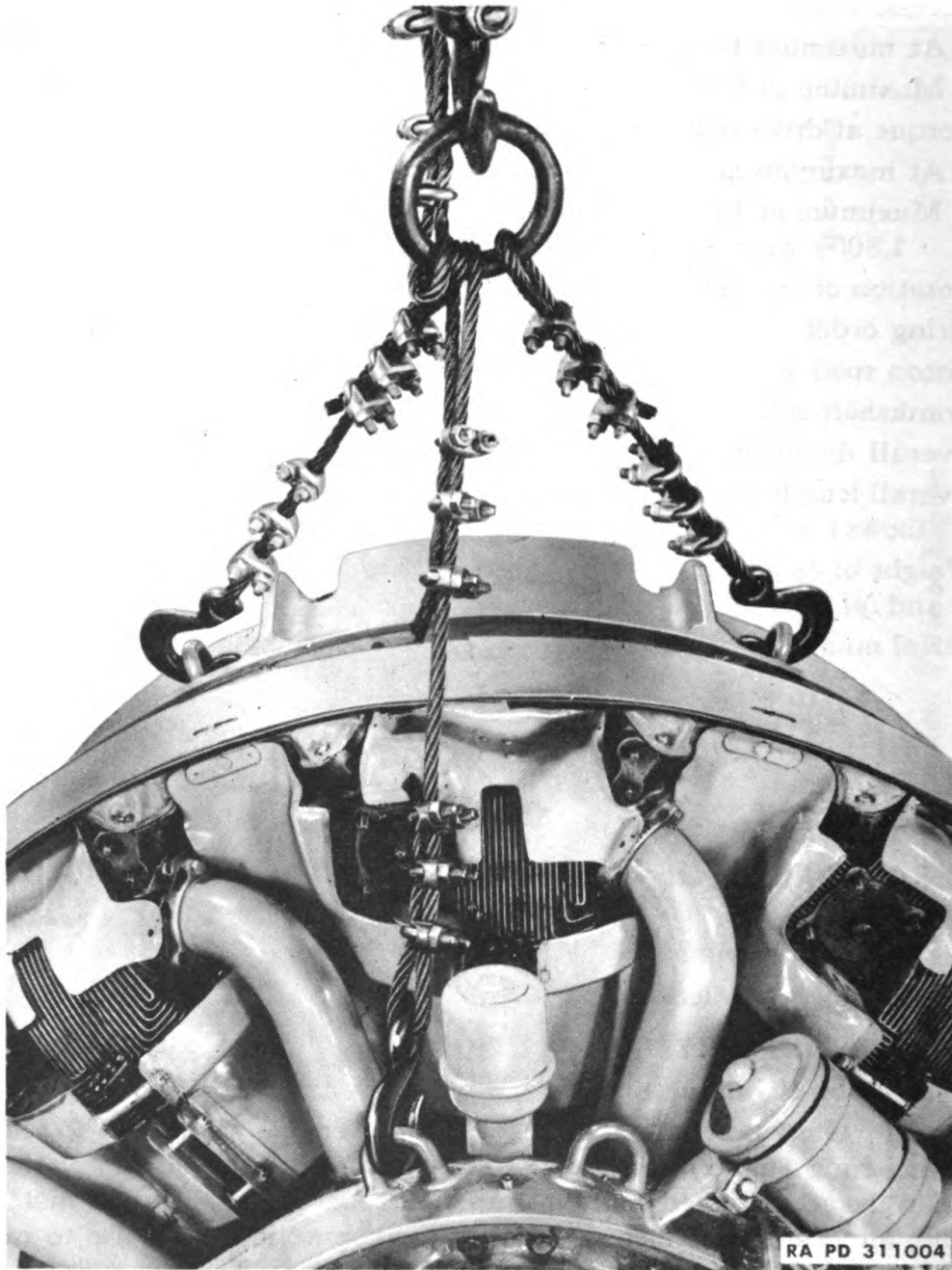

Figure 3 — Engine Lifting Sling 5A2228

ORDNANCE ENGINE MODEL RD-1820

governor (par. 40). Remove indicator and wiring harness, vibrator coil and magnetic valve (par. 68). Remove governor oil filter (par 54).

c. **Clean Exterior of Engine.** With engine cowling removed, inspect component for fuel leaks and oil leaks. Examine for loose or missing bolts, nuts, plugs, hose clamps, and conduit coupling nuts. Cover all openings carefully while cleaning. Use dry-cleaning solvent or steam to remove grease and dirt. Clean the cylinder heads, barrels, and oil cooler, thoroughly. Do not use wire brush, sharp instrument or wooden scraper in cleaning oil cooler. When component is very dirty, remove transfer case support and front engine support, so that cylinder barrels are more accessible for cleaning. (Refer to par. 6 for disassembly.) The cranking motors are not to be cleaned with liquids. Dry compressed air is used to blow out dirt and dust.

6. DISASSEMBLY INSTRUCTIONS.

a. Remove transfer case (fig. 4). Remove oil cooler inlet tube. Remove transfer case input gear bearing cage cover from the transfer case and remove cotter pin and nut from clutch spindle shaft which is exposed when cover is removed. Remove nuts securing transfer case to support, and lift transfer case from support using two lifting eyes (5A2317) on cranking motor bracket studs.

b. **Remove Clutch Controls and Oil Cooler** (fig. 5). Remove elastic stop nuts and bolts which hold transfer case support assembly to engine front support. Remove clutch release arm pin retaining cap-screws and withdraw the pins far enough to free the clutch yoke assembly. Using lifting eyes (5A2317) on the transfer case mounting studs, lift transfer case support and oil cooler as a unit. Lift off the clutch control assembly.

c. **Remove Flywheel Clutch and Fan.** Remove cap screws holding ring gear and clutch cover assembly to flywheel, and lift off cover assembly and ring gear (fig. 6). Remove clutch spindle assembly (fig. 6). Remove intermediate pressure plate and driven plates (fig. 7). Loosen flywheel retaining nut, using wrench (5A2303) (fig. 8). Install lifting eyes (5A2318) in flywheel flange, and lift flywheel and fan assembly from engine (fig. 9). Remove front engine support using lifting eyes (5A2318) in tappet holes (fig. 10).

d. **Remove Fuel Injection Pumps, Valves and Precombustion Chambers** (fig. 11). Fuel injection pumps are located adjacent to each cylinder and are mounted on the crankcase front section. Remove the fuel injection line, and place protector caps (5A79) over the pump and valve openings and plugs (5A1442) in each end of the lines. Remove the hollow head cap screws which hold pump to housing. Lift pump straight up. While holding precombustion chamber with wrench

ORDNANCE MAINTENANCE — ORDNANCE ENGINE MODEL RD-1820 (CATERPILLAR)

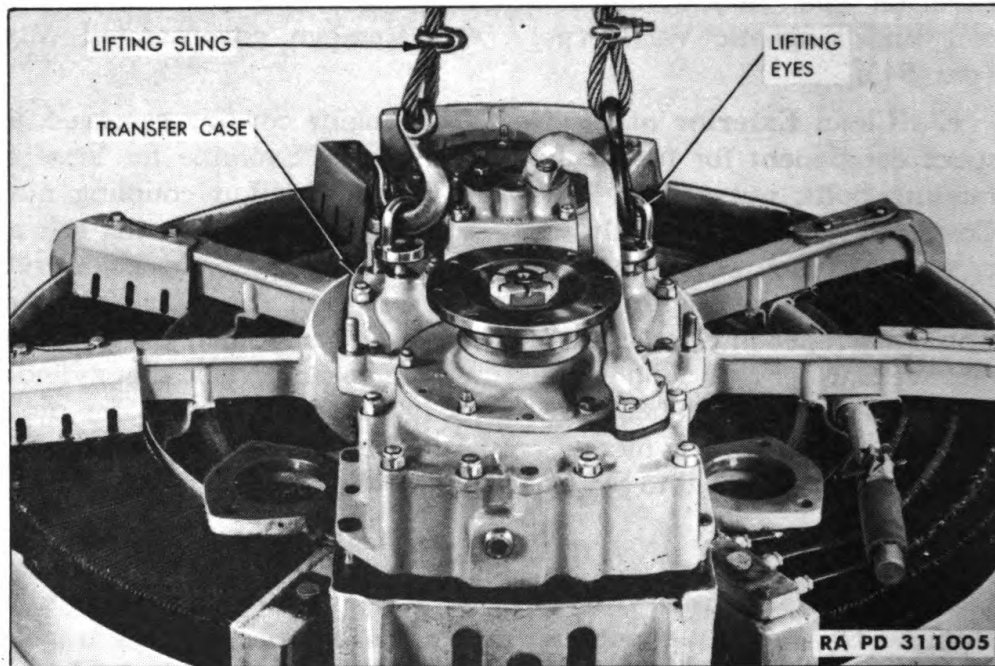

Figure 4 — Removing Transfer Case, Using Sling 5A2228 and Eyes 5A2317

(5A1943), remove the fuel injection valve using wrench (5A2167) (fig. 12). If it is necessary to remove precombustion chamber for replacement, use wrench (5A1937) (fig. 13).

e. Remove Intake Pipes (fig. 14). Loosen the packing nut at the crankcase end of all intake pipes using lug wrench (5A2287). Remove three capscrews at cylinder end of intake pipes. Withdraw the intake pipes from the supercharger front housing.

f. Remove Air Deflectors. Remove lock wire and fillister head screw which attaches each cylinder head air deflector at intake port. Remove lock wire and two fillister head screws at top of each deflector. Remove cylinder head air deflector. Remove nuts from through-bolts which secure intercylinder air deflector clamps. Remove clamps, bolts, and spacers. Remove nuts, plates, and grommets, from studs which attach deflectors to rocker box cover extensions. Remove intercylinder air deflectors from the rear. These instructions apply to all intercylinder air deflectors except the one located at sump section. To remove this cylinder air deflector, remove nut, plate and grommet which secure deflector to rocker box cover extensions. Remove cap screws which attach deflector to arms of sump. Withdraw deflector to the rear.

g. Remove Oil Sump (fig. 11). Remove magnetic drain plug from bottom of sump. Drain oil from sump. Remove screened strainer by unscrewing plug at front of sump. Remove nuts and washers which

ORDNANCE ENGINE MODEL RD-1820

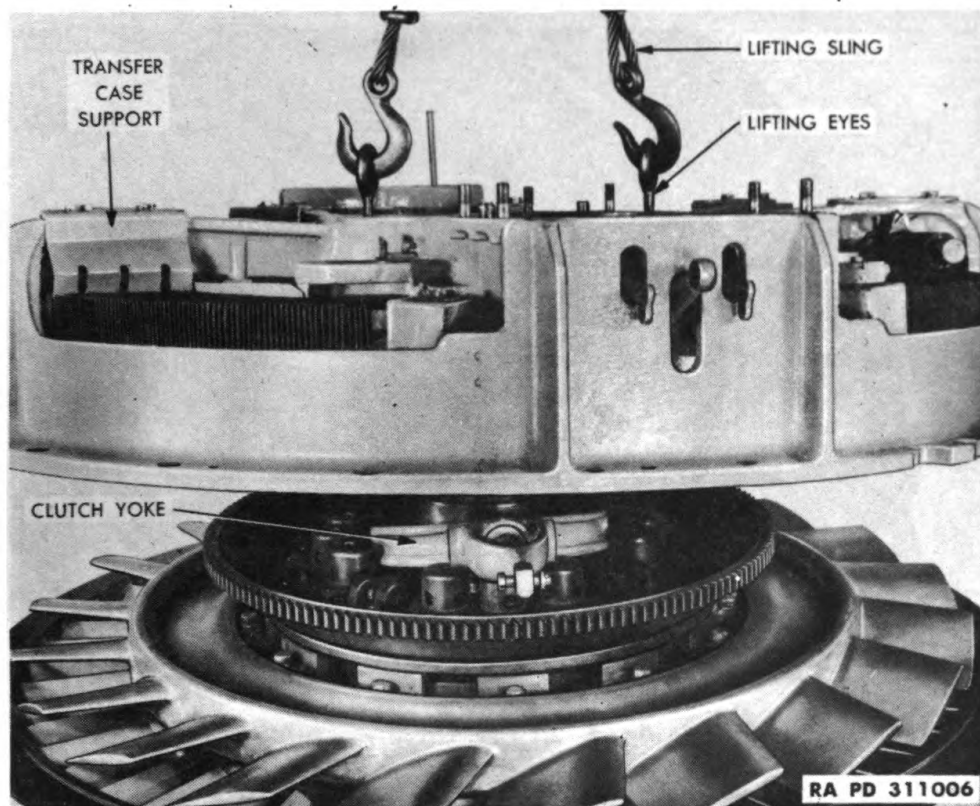

Figure 5 — Removing Transfer Case Support, Using Sling 5A2228 and Eyes 5A2318

secure front sump attaching flange to crankcase front section and nuts and washers which attach each arm of sump to supercharger front housing. Remove sump.

h. Remove Piston Cooling Tubes (fig. 11). Remove tubes leading from piston cooling oil manifold to piston cooling nozzles by loosening nuts securing tubes in position. Remove oil tube leading from primary oil filter to inlet fitting of filter. This tube passes between No. 9 and No. 1 cylinders. Remove nuts attaching piston cooling manifold to crankcase front section and lift piston cooling manifold from engine.

i. Remove Cylinder Oil Drain Mechanism. Remove nuts and lock washers from rocker box cover studs on two bottom rocker box covers. Lift drain mechanism from engine.

j. Remove Rocker Arms and Push Rods. Remove cotter pin from the rocker arm hub bolt nut in each rocker box. Remove rocker arm hub bolt nut. Turn crankshaft until valve is contacting its seat and a clearance exists between rocker arm roller and valve stem. Push out rocker

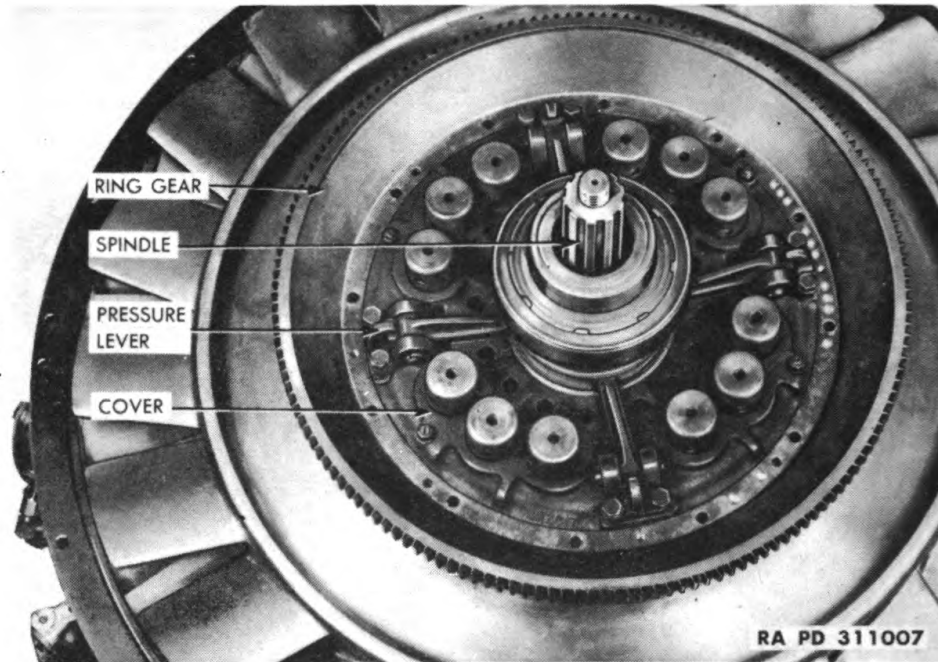

Figure 6 — Clutch Cover and Spindle

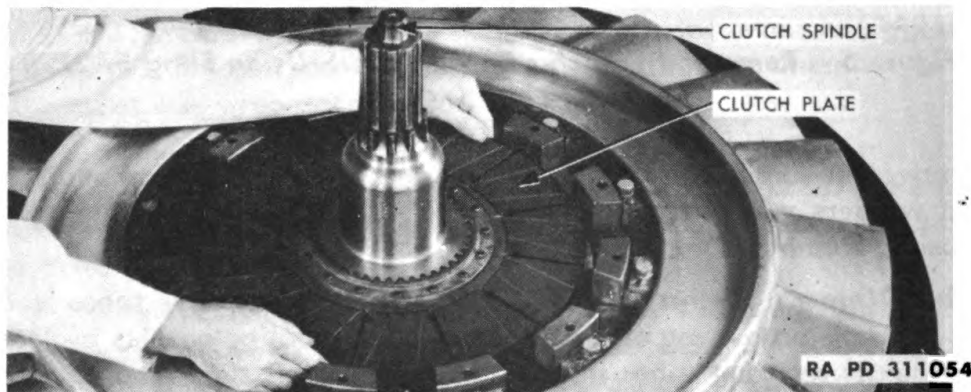

Figure 7 — Removing Clutch Plates

arm hub bolt being careful not to damage threads on end of bolt. Remove rubber seals and two spherical seat washers. Lift rocker arm and push rod out of rocker box. Remove clamping screw and valve clearance adjusting screw from rocker arms. **CAUTION:** *The valve clearance adjusting screw must be removed socket end first. A flange on the outside diameter of the screw at the socket end will not permit removal of the screw slotted end first.* Press rocker arm bearing out of each rocker arm.

ORDNANCE ENGINE MODEL RD-1820



Figure 8 — Loosening Flywheel Retaining Nut, Using Wrench 5A2303

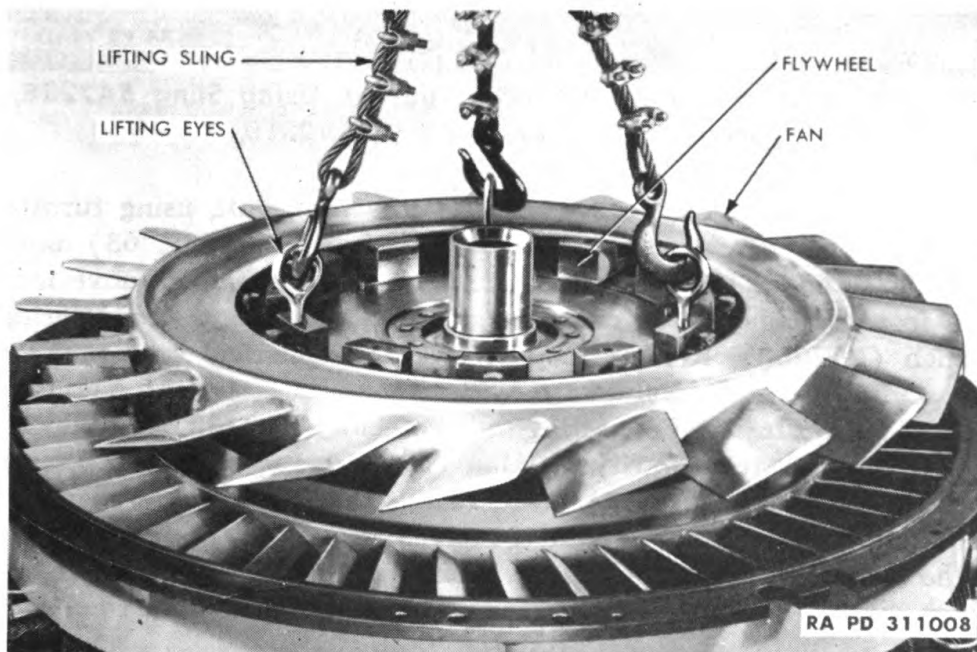

Figure 9 — Removing Fan and Flywheel, Using Sling 5A2228 and Eyes 5A2318

k. **Remove Push Rod Housings** (fig. 11). Loosen clamps at each end of each push rod housing. Slide housing radially inward toward crankcase front section. Lift rocker box end of push rod housing up and remove housing by pulling outward away from engine. Remove hoses and clamps. Remove loose fitting valve tappet ball sockets and springs from all of the valve tappets. Turn crankshaft, if necessary, to push sockets within reach.

l. **Remove Pistons and Cylinders.** Begin removal of cylinders with either No. 2 or No. 9 cylinder continuing in such a direction that

ORDNANCE MAINTENANCE — ORDNANCE ENGINE MODEL RD-1820 (CATERPILLAR)

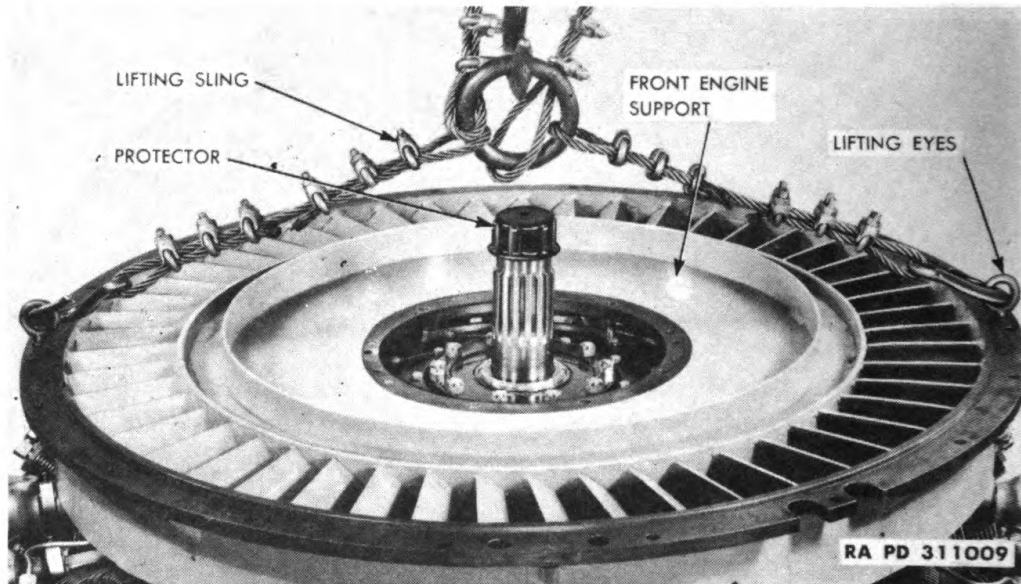

Figure 10 — Removing Front Engine Support, Using Sling 5A2228, Protector 5A2342, and Eyes 5A2318

No. 1 cylinder will be removed last. Turn crankshaft, using turning tool (5A2165) installed on propeller shaft splines (fig. 63) until piston in cylinder being removed is at top dead center. Remove lock wire from cylinder hold-down cap screws. Loosen cap screws, using wrench (5A2268). Remove cap screws and spherical seat washers from cylinder flange. Remove cylinder by pulling straight out until clear of piston. Install a connecting rod protector (5A2159) on cylinder pad, attaching it temporarily with two cap screws to prevent rod from striking crankcase (fig. 17). **CAUTION:** *Cylinder hold-down cap screws must be kept sorted so that each cap screw will be reassembled in the same hole from which it was removed.* Remove piston pin retainer (fig. 15) from side of piston at which piston pin is to be removed. Remove piston pin and lift off piston.

m. Remove Crankcase Front Section. Remove valve tappet retaining cap screws. Install puller (5A2282) over ridge on valve tappet guide and pull guide from crankcase (fig. 16). Remove tappets. Loosen thrust nut on the crankshaft with wrench (5A2297) and remove nut. Remove cap screws attaching crankcase front section to crankcase main section. Remove crankcase front section using lifting eyes (5A2317) (fig. 17). Remove spacer, ring assembly, and cam driving gear.

n. Remove Crankcase Main Front Section. Remove cotter pins and nuts which hold two crankcase sections together, using wrench (5A2306) (fig. 18). Lift crankcase main front section over crankshaft (fig. 19).

ORDNANCE ENGINE MODEL RD-1820

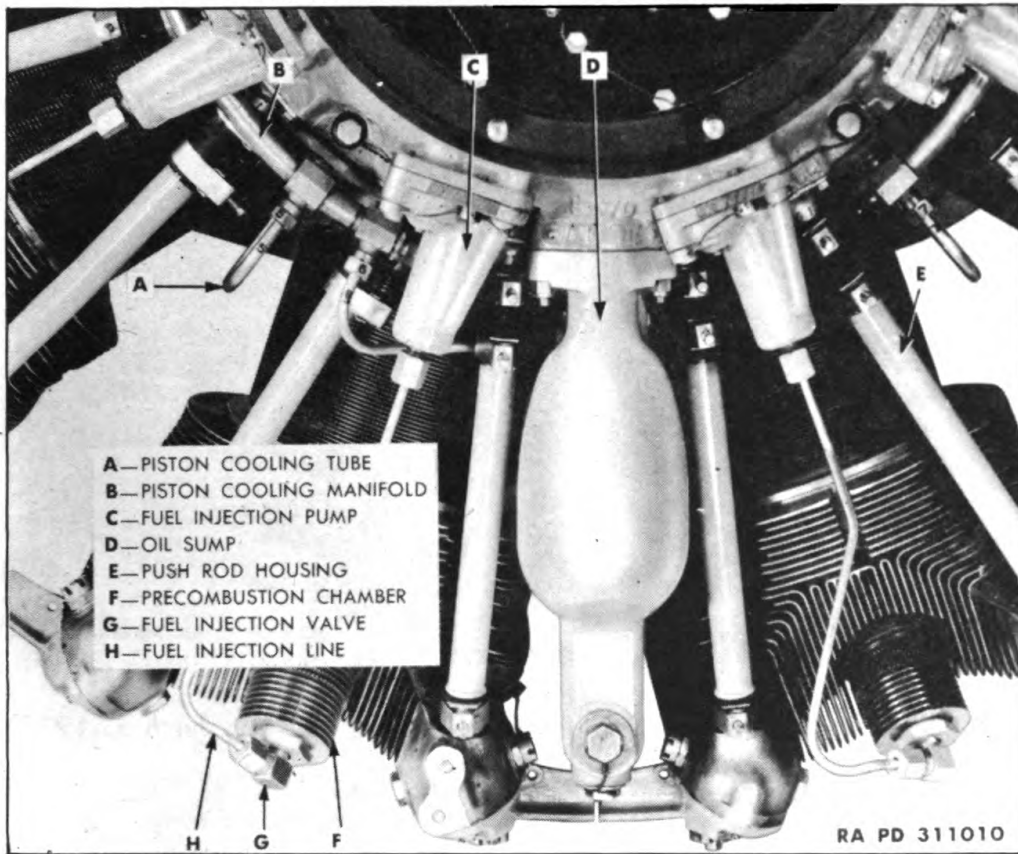

Figure 11 — Engine with Front Support Removed

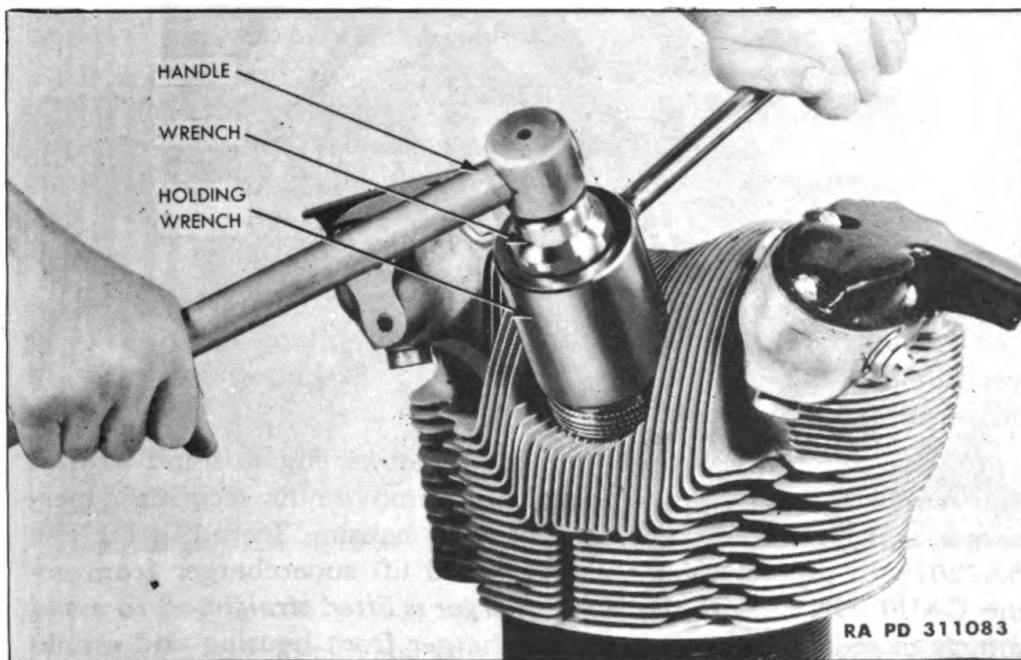

Figure 12 — Removing Fuel Injection Valve, Using Wrenches 5A1943 and 5A2167

ORDNANCE MAINTENANCE — ORDNANCE ENGINE MODEL RD-1820 (CATERPILLAR)

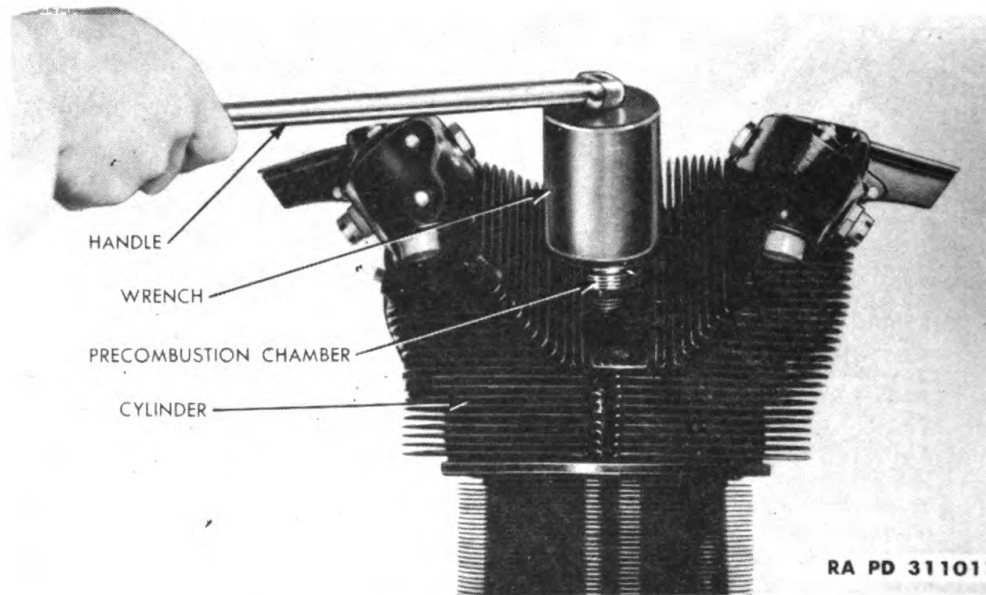

Figure 13 — Removing Precombustion Chamber, Using Wrench 5A1937

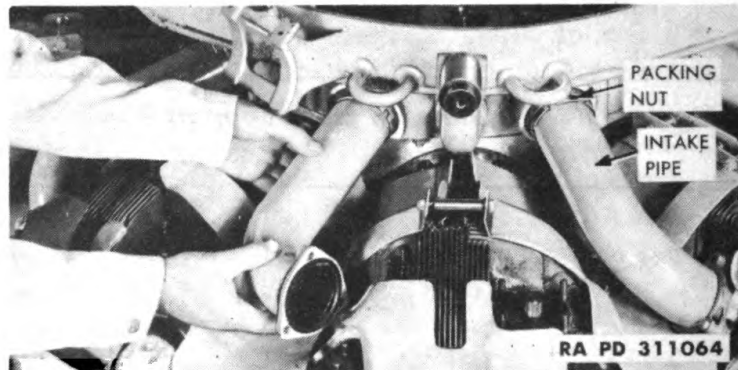

Figure 14 — Removing Intake Pipe

o. **Remove Crankshaft** (fig. 20). Install lifting eye (5A2265) over threads at end of crankshaft, and lift crankshaft and connecting rod assembly out of crankcase main rear section.

p. **Remove Supercharger** (fig. 21). Rotate engine stand so that supercharger is in the upward position. Remove nuts securing supercharger rear housing to supercharger front housing. Install lifting eye (5A2207) to supercharger rear cover and lift supercharger from engine. **CAUTION:** *Insure that supercharger is lifted straight off to avoid damage of seal rings.* Remove supercharger front housing and crankcase rear main section by removing bolts that secure front supercharger housing to rear engine support.

ORDNANCE ENGINE MODEL RD-1820

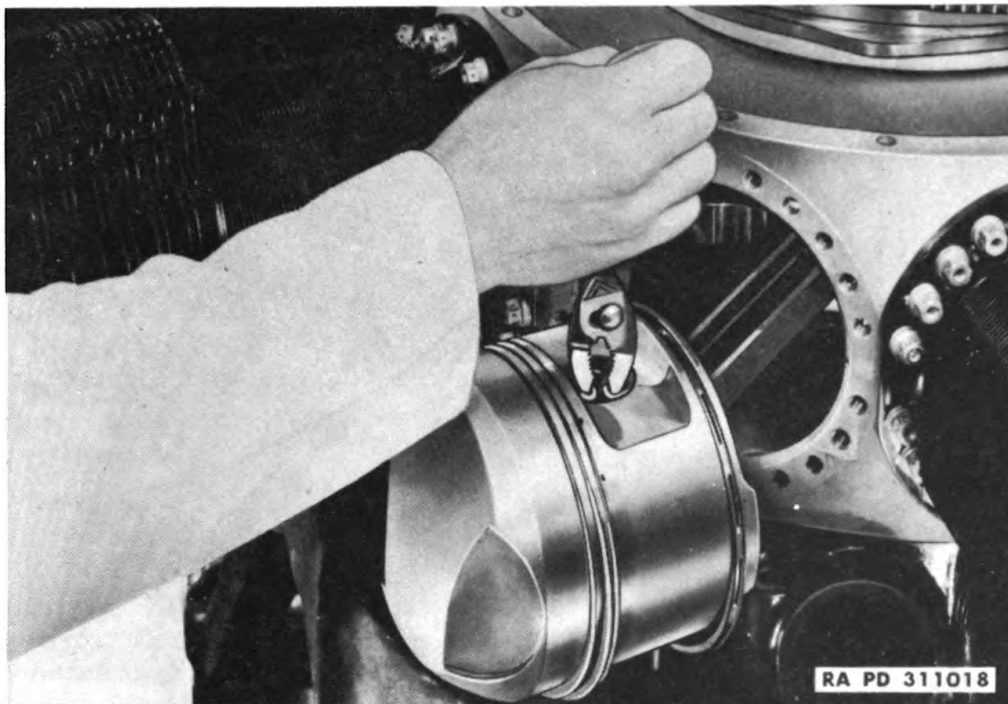

Figure 15—Removing Piston Pin Retainer

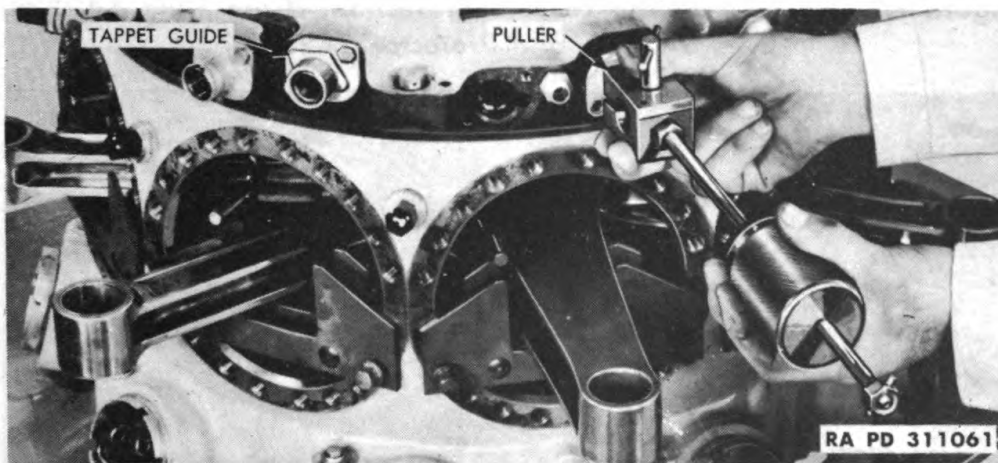

Figure 16 — Removing Valve Tappet Guide, Using Puller 5A2282

ORDNANCE MAINTENANCE — ORDNANCE ENGINE MODEL RD-1820 (CATERPILLAR)

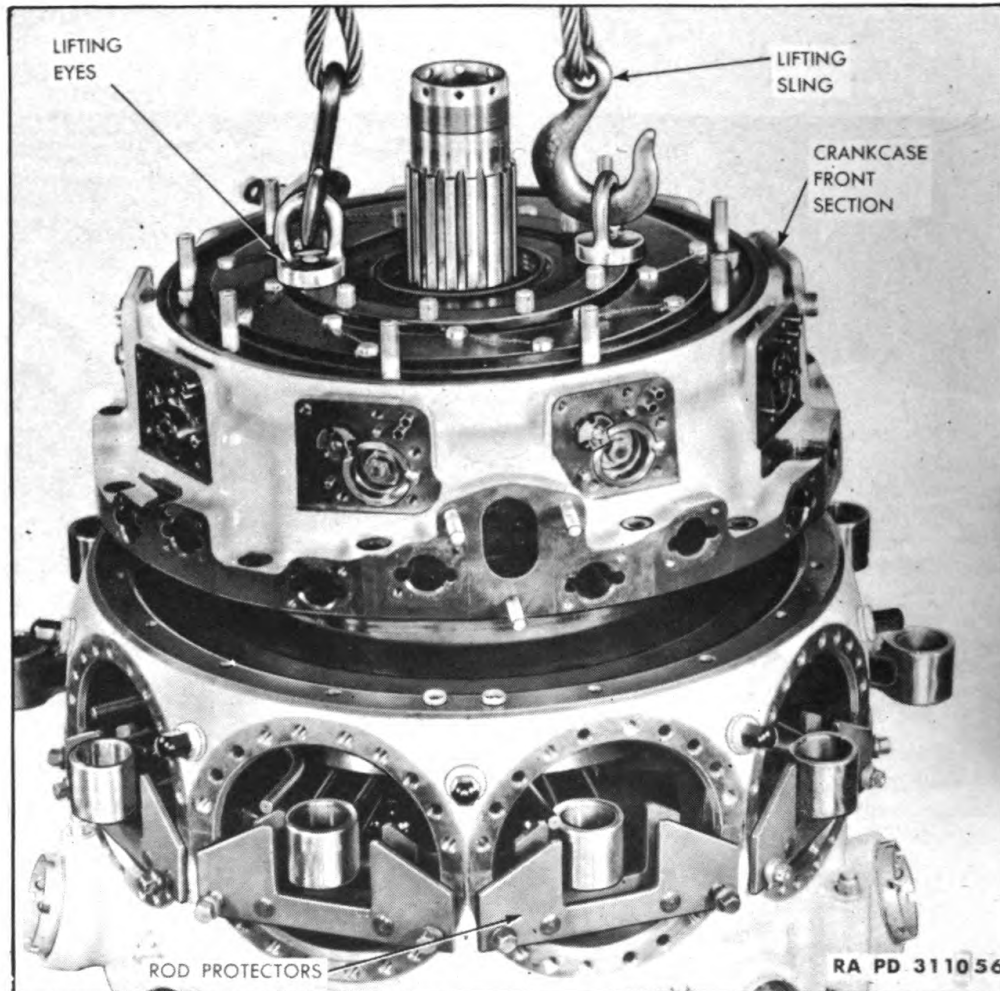

Figure 17 — Removing Crankcase Front Section, Using Sling 5A2228, Eyes 5A2317, and Protector 5A2159

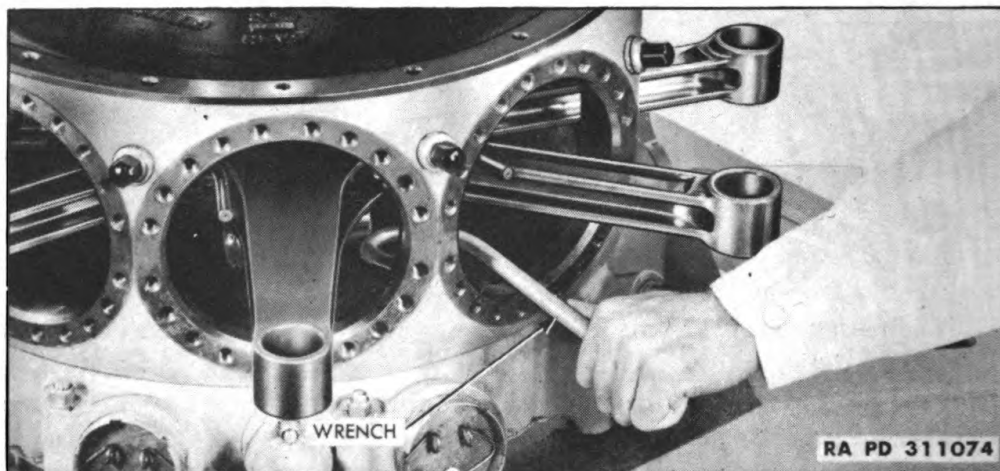

Figure 18 — Removing Crankcase Main Section Nuts, Using Wrench 5A2306

ORDNANCE ENGINE MODEL RD-1820

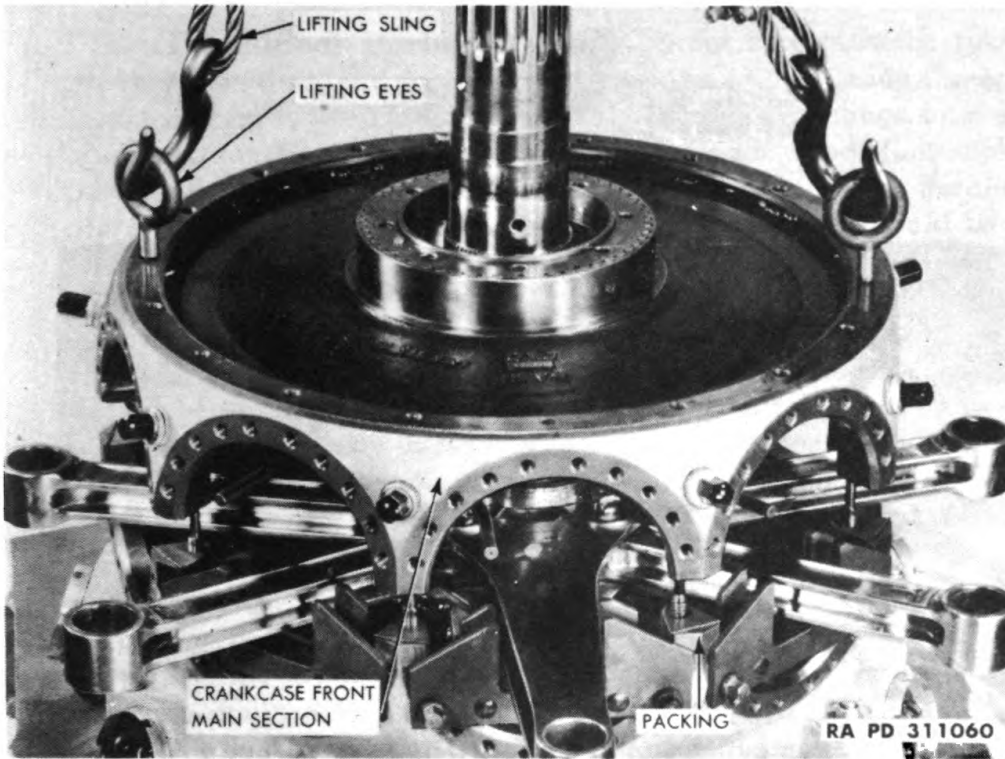

Figure 19 — Removing Crankcase Main Front Section, Using Sling 5A2228 and Eyes 5A2318

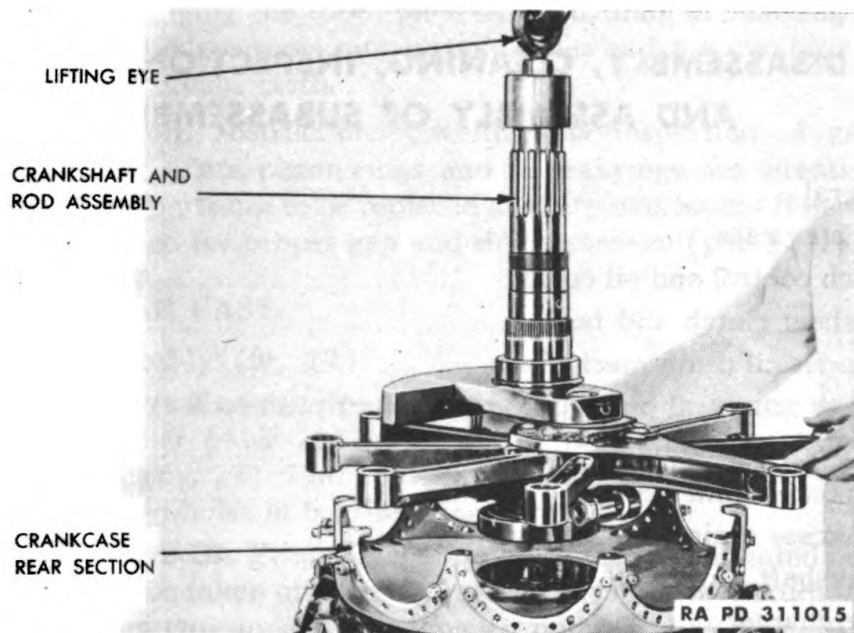

Figure 20 — Removing Crankshaft, Using Lifting Eye 5A2265

ORDNANCE MAINTENANCE — ORDNANCE ENGINE MODEL RD-1820 (CATERPILLAR)

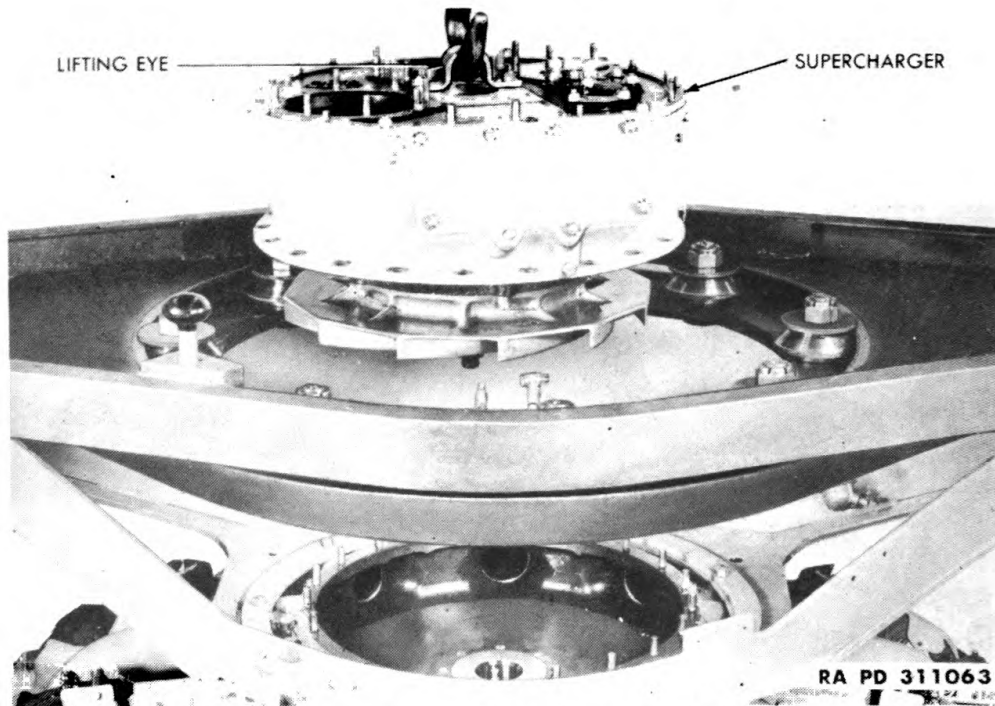

Figure 21 — Removing Supercharger, Using Lifting Eye 5A2207

CHAPTER 2 — cont'd

Section III

**DISASSEMBLY, CLEANING, INSPECTION, REPAIR,
AND ASSEMBLY OF SUBASSEMBLIES**

	Paragraph
General	7
Transfer case	8
Clutch control and oil cooler.....	9
Flywheel clutch and fan.....	10
Cylinder oil drain mechanism.....	11
Rocker arms and push rod housings and push rods.....	12
Pistons and cylinders.....	13
Crankcase front section	14
Crankcase main front section.....	15
Crankshaft	16
Supercharger	17
Crankcase main rear section	18
Miscellaneous items	19

ORDNANCE ENGINE MODEL RD-1820

7. GENERAL.

a. **Precautions During Assembly.** Great care must be taken to prevent dirt, dust, and foreign material, from falling inside the engine. It is necessary to keep all precombustion chamber openings, intake pipe openings, intake and exhaust ports of cylinder head, fuel injection pumps, lines and valves covered until respective part is installed in place. Before being assembled in the engine, all parts should be thoroughly clean and free from grit or dust. Wipe them with cloth free from lint. Never use cotton waste or tattered rags. The engine will operate for a short period before the oil pump will furnish the regular supply of oil. Coat all bearing surfaces with a good supply of engine lubricating oil before assembling. Nuts and drive fit parts should likewise be oiled. Apply oil freely to pistons and rings just prior to their assembly in the engine. Use a torque indicating wrench in tightening threaded parts during assembly. Tightening torque values are listed. (Refer to par. 24.)

b. **Repair.** Use crocus cloth and suitable lubricant to polish out light scratches, roughness, and chafing, from finished surfaces of engine parts. Specific instances where this is not to be done are given in text. Remove small nicks, burs and scores and smooth slightly galled and pitted areas from finished surfaces of engine parts by light stoning. After stoning clean parts with crocus cloth and suitable lubricant. Specific instances where stoning is not advisable are given in text. It is permissible to stone gear teeth to remove slight pitting or galling. Care must be exercised not to stone to a degree which will result in appreciably changing the tooth form. After drilling or reaming holes, break all sharp edges remaining around holes and remove burs using a fine stone or crocus cloth.

c. **Inspection.** Instructions covering the inspection of gaskets, packing, hose, circllets, piston rings, and oil seal rings, are intentionally omitted. These parts are to be replaced at every overhaul. All new rings are to be checked for proper gap and side clearance (par. 22).

8. TRANSFER CASE.

a. **Disassembly** (fig. 22).

(1) **REMOVE FLANGE.** Remove driving flange retaining nut. Pull flange with puller (41-P-2911), being careful not to damage thrower behind flange (fig. 23). Pull bearing cage from cover, using two cap screws in tapped holes in bearing cage flange.

(2) **REMOVE OIL PUMP.** The oil pump assembly mounted on idler gear cover can be taken off after removing nuts from four studs around cover and from two upper studs through pump body. Disassemble oil pump by removing two nuts securing pump body and cover assembly. Remove pump body, oil pump cover assembly, and oil pump idler

ORDNANCE MAINTENANCE — ORDNANCE ENGINE MODEL RD-1820 (CATERPILLAR)

- I—CHECK VALVE SPRING
- J—PUMP IDLER GEAR
- K—PUMP DRIVE GEAR
- L—PUMP DRIVE SHAFT
- M—PUMP BODY COVER
- N—FLANGE
- O—OUTPUT GEAR FRONT BEARING CAGE
- P—OUTPUT GEAR
- Q—IDLER GEAR
- R—OUTPUT GEAR REAR BEARING CAGE

- A—CASE
- B—REAR BEARINGS
- C—INPUT GEAR
- D—FRONT BEARINGS
- E—COVER
- F—INPUT GEAR FRONT BEARING CAGE
- G—PUMP BODY
- H—CHECK VALVE PLUNGER

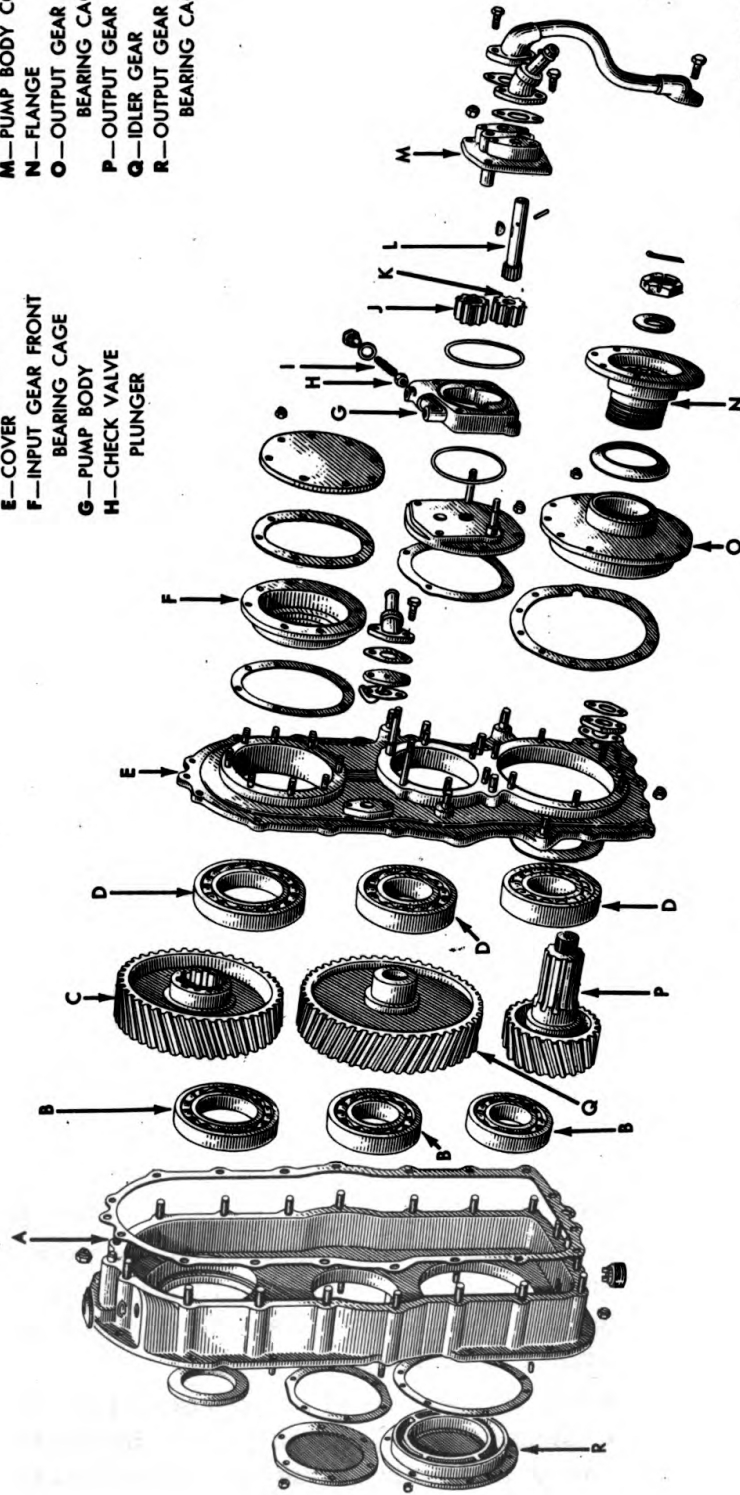

RA PD 311046

Figure 22 — Transfer Case Disassembled

ORDNANCE ENGINE MODEL RD-1820

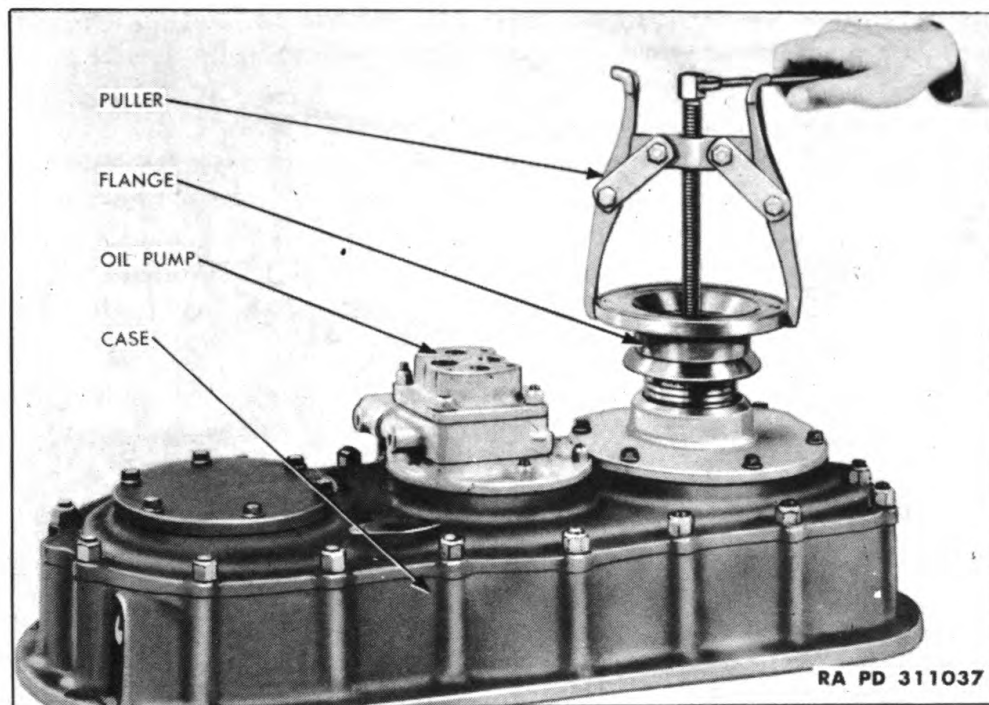

Figure 23 — Removing Transfer Case Flange, Using Puller 41-P-2911

gear. Remove pump drive shaft from cover assembly by pressing pin that locks drive gear to shaft, and slide gear off key and shaft. Remove oil pressure relief plunger by taking out retainer plug and spring.

(3) **REMOVE GEARS, BEARINGS, AND CAPS.** Remove bearing cage at upper input gear, using two cap screws in tapped holes in cage flange. Remove transfer case cover from transfer case. Remove oil thrower from output shaft. Pull bearing from output gear, using puller (41-D-2905-60) (fig. 24). Pull bearings from input gear and idler gear, using puller (41-P-2911) (fig. 25).

b. Cleaning. Wash all parts in dry-cleaning solvent. Clean ball bearings by dipping them in a container of dry-cleaning solvent. The container must be free from metal chips and dirt. Rotate bearing while immersed in dry-cleaning solution until all trace of lubricant is removed. Hold both races against spinning, and blow bearing dry with compressed air. Direct the air squarely at side of face of bearing, that is, so nozzle is parallel with bearing bore. Never allow bearing to spin while drying with compressed air. To do so may cause scratching or scoring by any abrasive material which may not have been washed out. If bearing is very dirty, rinse it a second time in dry-cleaning solvent and blow dry. Oil bearing immediately with clean engine oil to prevent corrosion of highly polished surfaces. Rotate bearing so as to dis-

ORDNANCE MAINTENANCE — ORDNANCE ENGINE MODEL RD-1820 (CATERPILLAR)

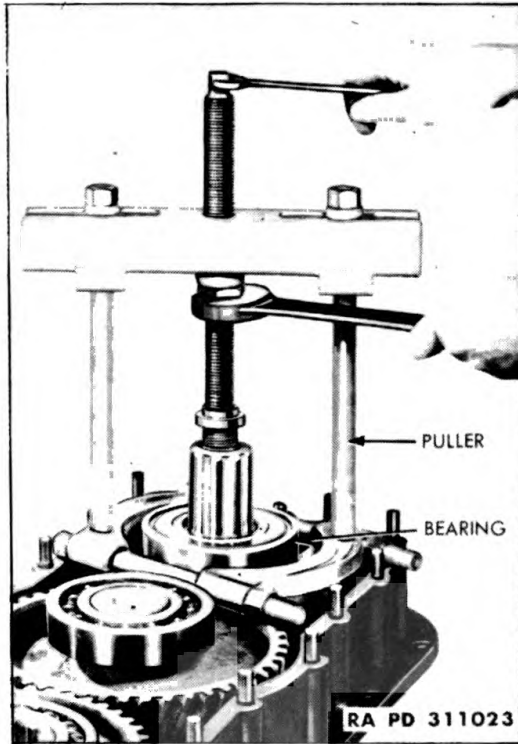

Figure 24 — Removing Transfer Case Output Gear Bearing, Using Puller 41-D-2905-60

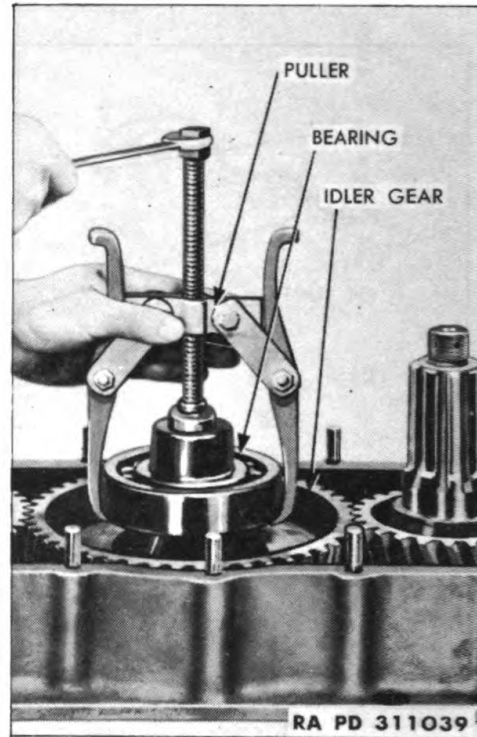

Figure 25 — Removing Transfer Case Idler Gear Bearing, Using Puller 41-P-2911

tribute lubricant to all surfaces. Wrap each cleaned bearing in oiled paper if it is not to be used immediately.

c. Inspection.

(1) **BEARINGS.** The inspection of a ball bearing is best performed if the bearing is washed, dried, and dipped in light oil (subpar. b, above). The condition of bearing is best determined by the surface condition of balls and races and the looseness of its races. Check for pits caused by corrosion. Check for discoloration of balls, races, and retainers as this is evidence of overheating. Bearings that have been over-heated must be discarded. Bearings which are heavily pitted or corroded must be discarded. Spinning a bearing while holding it in the hands is not an accurate check of its running qualities, although this will indicate presence of dirt or foreign matter. Bearings in this condition are to be rewashed, lubricated, and again checked. Check fits of outer race in retainer and inner race on shaft (par. 22).

(2) **GEARS.** Gears showing excessive wear or damage are to be discarded; shafts showing excessive wear at the splines (par. 22) are also to be discarded.

(3) **STUDS.** Bent studs or studs with damaged threads must be replaced.

ORDNANCE ENGINE MODEL RD-1820

(4) **CASE AND COVERS.** Examine transfer case and covers for cracks, tightness of dowels, and studs and roughness of finished surfaces. Check all pilot diameters of bearing cages to determine fit (par. 22).

(5) **OIL PUMP.** Check oil pump gears for pitting, galling, scoring and wear of teeth and gear faces. Inspect oil pump drive gear shaft for cracks and scoring; excessive wear of spline necessitates discarding shaft. Check relief valve for freedom and spring for proper tension. Check bushings of oil pump drive shaft. If found to be worn more than prescribed limits, bushings must be replaced (par. 22).

d. **Repair.** Using a suitable drift, drive out bushing of oil pump drive shaft. Press in new bushings and ream to proper running fit on shaft (par. 22). All parts worn beyond prescribed limits must be replaced.

e. **Assembly.**

(1) **ASSEMBLE GEARS AND BEARINGS.** Heat bearings to 300° F. and install on respective gears. Place transfer case on work bench and install gasket and lower gear rear bearing cage over studs in rear of transfer case. Place transfer case output gear into cage. Install rear bearing idler gear cover, and place intermediate drive gear into position in case with internal spline in gear towards front of case. Install input gear in top cage of transfer case with counterbore and extending through rear of case. Place oil slinger over bearing on output gear. Position cover over studs, dowels, and idler gear bearing in case. Install nuts and tighten driving cover into position. Install gasket and bearing cage into bore of cover at lower output shaft. Install elastic stop nuts and tighten. Press outer dirt thrower onto hub of output shaft flange, and press output shaft flange onto spline of output gear. Install flange retaining washer and nut. Tighten nut and lock with cotter pin. Install gasket and bearing cage into transfer case cover at top bore. Press oil seal into transfer case on opposite side of gear with leather seal lip towards inside of case.

(2) **ASSEMBLE OIL PUMP.** Place oil pump drive shaft through idler gear bearing cover. Install key in slot in shaft and position oil pump over key so as to line up hole in shaft and hole in one side of oil pump drive gear. Drill $\frac{1}{8}$ -inch hole through gear and shaft. Drive oil pump idler gear lock pin into hole, and peen over end of hole in gear to retain pin. Install rubber seals in each side of oil pump body, and position body over studs and dowel in oil pump base. Place oil pump idler gear in oil pump body, and position oil pump cover into idler gear and over drive gear shaft. Install elastic stop nuts. Install gasket and oil pump assembly onto transfer case at idler gear, mating splines of oil pump drive shaft with internal splines of transfer case idler gear. Install elastic stop nuts and tighten. Install check valve plunger, spring, gasket, and plug in bore of oil pump body. Tighten plug securely.

ORDNANCE MAINTENANCE — ORDNANCE ENGINE MODEL RD-1820 (CATERPILLAR)

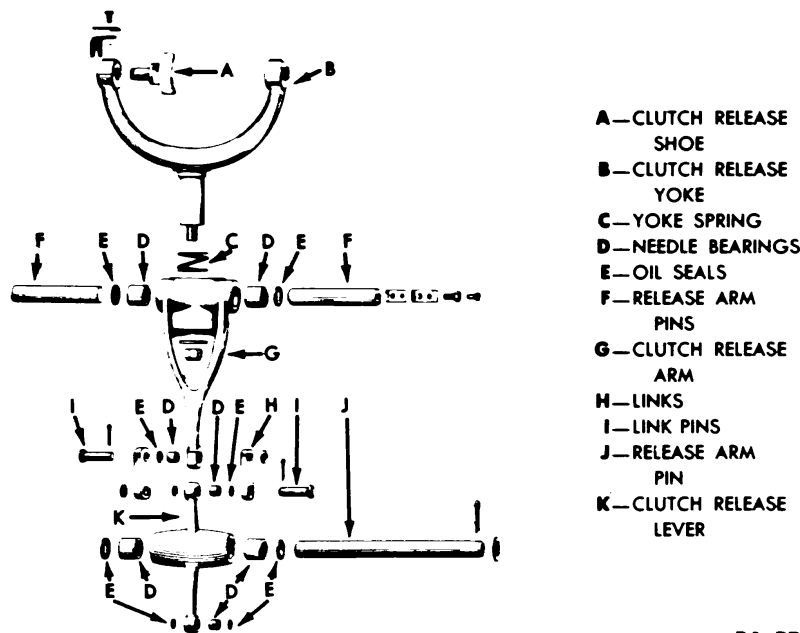

- A—CLUTCH RELEASE SHOE
- B—CLUTCH RELEASE YOKE
- C—YOKE SPRING
- D—NEEDLE BEARINGS
- E—OIL SEALS
- F—RELEASE ARM PINS
- G—CLUTCH RELEASE ARM
- H—LINKS
- I—LINK PINS
- J—RELEASE ARM PIN
- K—CLUTCH RELEASE LEVER

RA PD 311052

Figure 26 — Clutch Control Disassembled

(3) **INSTALL OIL LINES.** Install gasket and oil suction tube assembly from base of transfer case to inlet of oil pump. Tighten cap screws and lock wire. Install gasket and oil outlet assembly at outlet of transfer case oil pump with nipple pointing towards left viewed from cover side of transfer case. Secure in place with cap screws and lock wire. Install gasket and oil distributing pipe assembly in opening in transfer case cover above oil pump. Install gasket and oil inlet assembly over distributing pipe. Position oil inlet assembly with nipple pointing towards the right. Secure in place with cap screws and lock wire. Screw breather adapter into top of transfer case and install gasket and breather tube pipe assembly, securing in place with cap screws and lock wire.

9. CLUTCH CONTROL AND OIL COOLER.

a. Oil Cooler (fig. 1).

(1) **DISASSEMBLY.** Disconnect oil outlet pipe from cooler. Remove cap screws holding oil cooler to transfer case support and lift out oil cooler. **CAUTION:** *Handle carefully and do not twist cooler.*

(2) **CLEANING.** Refer to paragraph 5 a.

(3) **INSPECTION.** Inspect oil cooler for cracked, broken or damaged tubes. Inspect bypass tubes for mutilations causing possible restrictions. Test cooler by filling with oil and applying 200 pounds air pressure.

ORDNANCE ENGINE MODEL RD-1820

(4) **REPAIR.** Leaks in tanks, bypass tubes or cooling tubes are repaired by soldering.

(5) **ASSEMBLY.** Place transfer case support on work bench and install oil cooler outlet tube on interior of support, holding in position with rubber bushings, clips, and cap screws. Tighten cap screws and lock wire. Install air intake baffle on interior of support, securing in place with cap screws and lock wire. Install oil cooler assembly into transfer case support. Install gasket and oil outlet pipe at top tank of oil cooler. Secure in place with cap screws and lock wire. Secure oil cooler in place with cap screws and lock wire.

h. Clutch Controls (fig. 26).

(1) **DISASSEMBLY.** Remove clutch release yoke nut and withdraw yoke from release arm. Remove link pins and cotter pins.

(2) **CLEANING.** Clean all parts of the controls, using dry-cleaning solvent.

(3) **INSPECTOR.** Inspect condition of needle bearings in arm and lever of clutch controls. If needle bearings are badly worn or some needles are missing, the bearings must be replaced.

(4) **REPAIR.** Press out needle bearings, using a suitable drift. Press in new bushings just deep enough to allow for installation of grease seals (approximately $\frac{1}{8}$ inch below the surface).

(5) **ASSEMBLY.** Position spring over clutch control yoke. Lubricate bearing surface with graphite grease. Place yoke into bore in clutch release arm, securing in place with washer and elastic stop nut. Insure that yoke is free to move in arm. Position clutch release shoes in holes in clutch control yoke. Place shoe retainer spring in groove provided in shoe. Secure spring in position with sheet metal lock and cap screw. Tighten cap screw and bend up lock. Insure that shoes are free to move. Assemble clutch control lever with two bushings and seals in inner bore and bushing and seals in bores at ends of lever as prescribed above for clutch release arm. Pack bearing with grease. Position lever in transfer case support. Insert clutch release lever pin through transfer case support and clutch release lever. Retain pin with washers and cotter pins at each end. Locate arm and yoke assembly in position in transfer case support so that recess in arm is facing transfer case support. Connect assembly to clutch release lever with links and pins. Install washers and cotter pins. Install throttle control levers at inside of transfer case support. Assemble levers with bearings, and seal in bores, and place in position inside of transfer case support. Install lever retaining pin and secure with nut and cotter pin.

ORDNANCE MAINTENANCE — ORDNANCE ENGINE MODEL RD-1820 (CATERPILLAR)

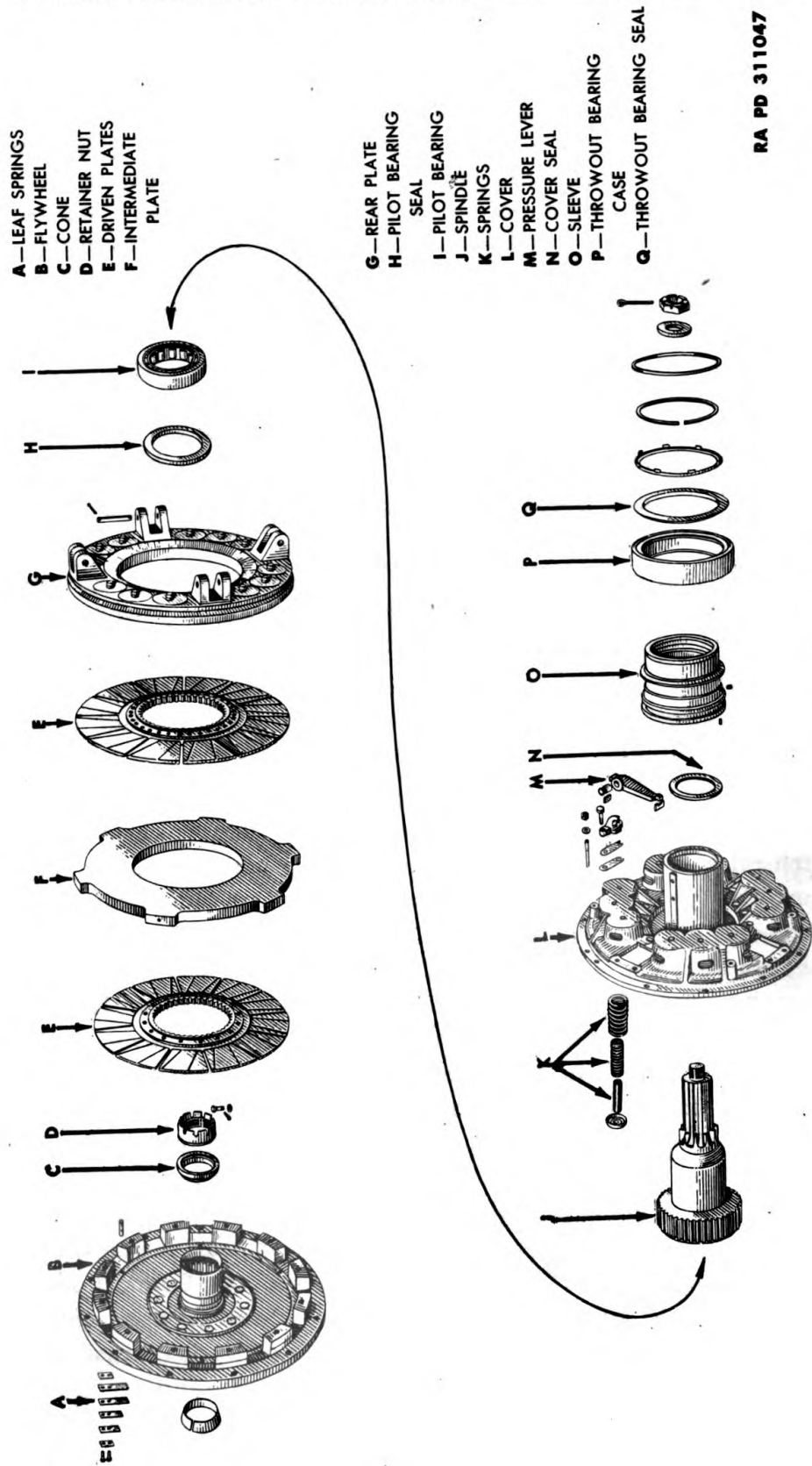

RA PD 311047

Figure 27 — Clutch Disassembled

ORDNANCE ENGINE MODEL RD-1820

10. FLYWHEEL CLUTCH AND FAN.

a. Disassembly (fig. 27).

(1) REMOVE CLUTCH SPINDLE. Pull oil seal from inner bore of clutch spindle. Push out bearing by pushing through wood dowels with $\frac{1}{4}$ -inch rods.

(2) REMOVE CLUTCH RELEASE SLEEVE. Bend up tabs on retainer lock ring, and remove lock ring retaining snap ring. Remove seal and case retaining snap ring, and lift off inner throwout bearing seal. Remove throwout bearing case assembly.

b. Cleaning. Wash parts in dry-cleaning solvent, making certain all trace of grease and dust is removed from parts. Clean all ball and needle bearings as outlined in paragraph 8 b.

c. Inspection.

(1) CLUTCH COVER ASSEMBLY. Inspect pressure plate and intermediate plate for cracks. Examine for signs of burning and scoring. Plates must be flat within 0.010. Check clutch cover for cracks. Check tension of springs (par. 23).

(2) FLYWHEEL AND FAN. Inspect fan for cracks. Inspect flywheel hub splines for mutilation. If splines show excessive wear, replace flywheel (par. 22). Inspect clutch friction surface of flywheel for burning and scoring.

(3) CLUTCH DRIVEN PLATES. Inspect friction facings of clutch driven plates for wear and deep scores. Minimum permissible thickness of clutch driven plate is $\frac{3}{16}$ inch.

(4) BEARINGS. Check fit of bearing outer race in retainer and inner race on shaft (par. 22). Inspect bearing (par. 8 c (1)).

d. Repair.

(1) FLYWHEEL, INTERMEDIATE PRESSURE PLATE, AND REAR PRESSURE PLATE. If condition of clutch friction surfaces necessitates refacing, a maximum of 0.010 inch may be removed from each surface. Thoroughly clean surfaces after machining operation, and coat surface with oil to prevent rusting if clutch is not to be assembled immediately.

(2) CLUTCH COVER ASSEMBLY. The clutch cover assembly need not to be disassembled unless replacement of parts are necessary. If necessary, disassemble as follows:

(a) *Disassemble Clutch Cover.* Install spring compressor stud assemblies (5A2155) in tapped hole in center spring retainer in clutch cover and tighten nut, compressing springs until release sleeve is free from clutch cover face (fig. 28). Remove pressure lever pins, pressure levers, and struts. Remove clutch release lever brackets, adjusting shims, and wear-in shims. Remove spring compressor studs assemblies and lift clutch cover from rear pressure plate.

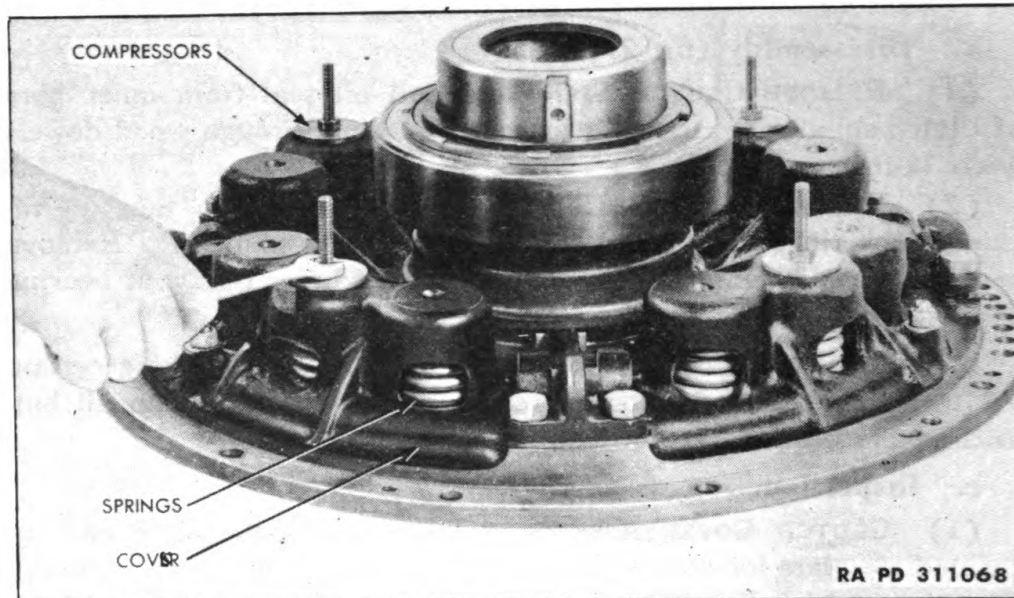

Figure 28 — Compressing Clutch Springs, Using Compressor 5A2155

(b) *Assemble Clutch Cover.* Install clutch throwout sleeve key in slot in clutch cover. Lock in place with rivets, peening rivets over in counterbore in key. Peened rivet head must not project above top face of key. Place clutch rear pressure plate on work bench with friction face down. Place spring seats on each of the pilot bosses on rear pressure plate and place inner, intermediate, and outer springs on spring seat. Position clutch cover over springs and lugs on rear pressure plate. Install spring compressor stud assemblies (5A2155) into tapped hole in center retainer spring in clutch cover, and tighten nuts to compress springs (fig. 28). Place adjusting shim, wear-in shim, and clutch release bracket, into position on clutch mounting pads. Secure in place with body fit cap screws (do not lock wire). Pack bearing in clutch throwout bearing case assembly with special lubricating grease. This is done by removing a plug in clutch release sleeve, installing a fitting and applying grease with a gun. Reinstall plug. Install case assembly onto clutch sleeve with thrust face of case towards shoulder of sleeve. Position inner seal over sleeve so that large diameter is towards the outside. Install ring retainer over inner seal and snap ring in groove of clutch sleeve. Position lock ring evenly around snap ring and bend over tabs on ring retainer. Make certain that thrust face of bearing is on anti-lock side of clutch sleeve assembly. Install clutch sleeve assembly onto hub of clutch cover with thrust face of bearing toward clutch cover. Position clutch release lever inner struts into groove in clutch sleeve, and position clutch release outer struts into groove in clutch release brackets. Place clutch release lever with needle bearings installed over struts, and secure

ORDNANCE ENGINE MODEL RD-1820

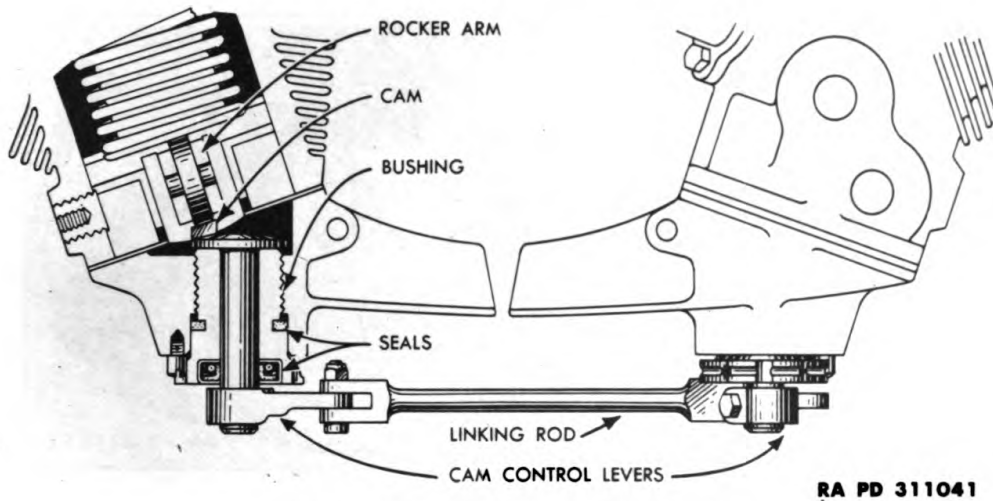

Figure 29 — Oil Drain Mechanism

in place with pin through lugs on clutch rear pressure plate. Lock pin in place with cotter pins at each end.

(c) *Adjust Clutch Cover Assembly.* This adjustment is made when new clutch plates have been installed. Adjust spring compressor stud assembly (5A2155) until 0.38 inch distance is obtained between rear pressure plate face and mounting face of clutch cover. Remove or add adjusting shims under clutch release bracket until 4.15-inch distance is obtained between thrust face of clutch sleeve and face of clutch cover at outer diameter of hub. Tighten bracket cap screws and lock wire.

e. **Assembly.**

- (1) **CLUTCH RELEASE SLEEVE.** Refer to paragraph 9 d (2) (c).
- (2) **CLUTCH SPINDLE.** Press bearing into spindle, using suitable drift. Pack bearing with ball and roller bearing grease. Drive oil seal into spindle bore.

11. CYLINDER OIL DRAIN MECHANISM.

a. **Disassembly** (fig. 29). Disconnect rocker box covers by removing link joining two levers of oil drain mechanism. Loosen cap screws holding lever on cam and lift levers from cam. Remove screw which locks bushing to cover and screw bushing assembly from rocker box cover. Remove key and lift bushing assembly from cam.

b. **Cleaning.** Wash all parts in dry-cleaning solvent.

c. **Inspection.** Inspect oil seal and rubber oil seal ring for mutilation.

d. **Repair.** If inspection warrants a new oil seal, press out old oil seal, and install new seal, using a suitable drift.

e. **Assembly.** Refer to paragraph 21 h.

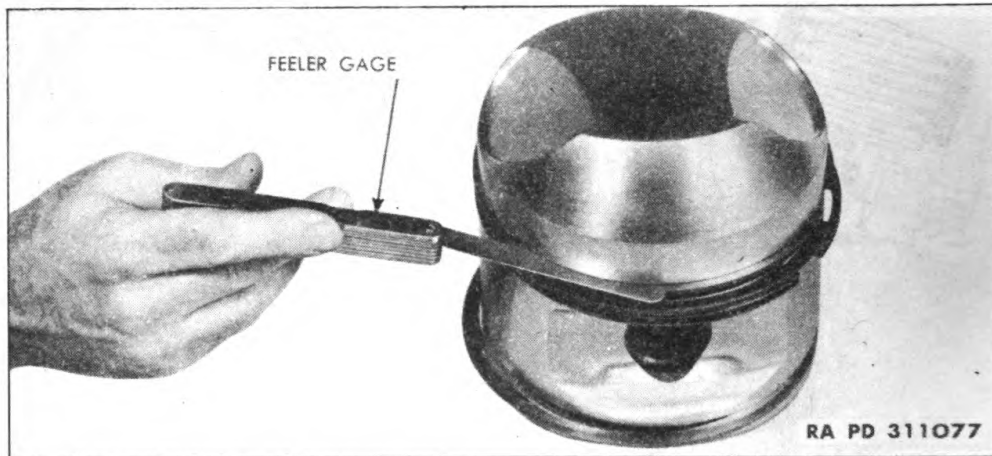

Figure 30 — Checking Piston Ring Side Clearance

12. ROCKER ARMS AND PUSH ROD HOUSINGS AND PUSH RODS.

a. Rocker Arms (fig. 31).

(1) **CLEANING.** Refer to paragraph 8 b.

(2) **INSPECTION.** Inspect rocker arms for cracks. Inspect rocker arm rollers for flat spots on outside diameter, chipped edges, cracks, and pitting. Check end clearance of roller and roller hub in yoke of rocker arm (par. 22). Inspect pin for tightness in arm. Inspect bearing (par. 8 c (1)). Make certain oil passages are clean.

(3) **REPAIR.** To remove a rocker arm roller hub or pin that requires replacement, grind one end of pin flush with face of fork, being careful not to mar or remove any metal from fork. Partially drill out portion of pin which has been peened into the hole chamfer. Drive out pin, using suitable punch. Install new rocker arm roller and hub in fork in rocker arm. Drive in pin and upset it with a heavy blow on each side to assure tight fit. Peen over ends of pin. Press out rocker arm bearing, using suitable drift. Install rocker arm bearing by first beating rocker arm in an oil bath at a temperature of 250° F. Chill bearing in dry ice and alcohol. Press bearing into rocker arm.

b. Push Rods and Push Rod Housings (fig. 11).

(1) **CLEANING.** Wash all parts clean in dry-cleaning solvent.

(2) **INSPECTION.** Inspect push rods for cracks, bending, and cleanliness of oil passage. Inspect ball ends for cracks, looseness in rods, and excessive wear. Inspect push rod housings for cracks and dents. Inspect for indications for push rod interference.

(3) **REPAIR.** Slightly bent push rods may be straightened by tapping to proper shape with a light rawhide hammer. Check balls for tightness and tubes for cracks after straightening. Do not attempt

ORDNANCE ENGINE MODEL RD-1820



**Figure 31 —
Removing Rocker Arm**

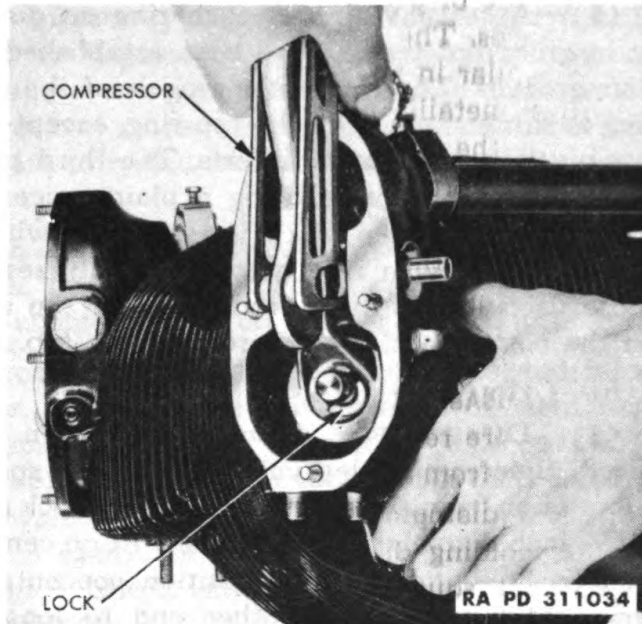

**Figure 32 — Compressing Valve Springs,
Using Compressor 5A2155**

to remove push rod ball ends. Remove dents from push rod housings by tapping them out with housing placed on a properly fitting mandrel.

13. PISTONS AND CYLINDERS.

a. Pistons.

(1) **DISASSEMBLY.** Lift rings from piston grooves.

(2) **CLEANING.** Remove hard carbon deposits by polishing surface with crocus cloth and suitable lubricant. Wash pistons in dry-cleaning solvent.

(3) **INSPECTION.** Inspect pistons for cracks and scoring. Check piston skirt wear. Check ring groove wear, using standard ring and feeler gage (fig. 30). Check piston pin hole wear (par. 22). Piston rings are always replaced at overhaul. Discard old rings without inspection.

(4) **REPAIR.** Place a new piston ring in the cylinder, pressing it down about half way into bore so that ring will be square with cylinder wall. Measure and refer to paragraph 22 for proper gap. If gap is less than that prescribed, remove ring and file with a fine cut file until correct gap is obtained. When correct gap has been obtained for each ring, roll the new ring around its particular groove in piston. The ring should roll freely. Remove any raised metal resulting from nicks that prevent ring from rolling freely. Measure the clearance between the ring and groove with a feeler gage (fig. 30).

ORDNANCE MAINTENANCE — ORDNANCE ENGINE MODEL RD-1820 (CATERPILLAR)

(5) **ASSEMBLY.** Install each ring on piston as soon as gap and fit in groove of piston have been established. Six rings are placed in four grooves. The top piston ring is of the plated type. The second ring is similar in size to the top ring, except that it is not plated and has black metallic oxide inserts. The third piston ring groove carries two rings, the top ring being a plain spacer and the bottom ring a tapered oil spreader which is assembled with the contacting surface down. The bottom ring groove also utilizes two rings, the same as those used in the third groove except the spacer ring is assembled on the bottom and the tapered ring on top.

b. Cylinders.

(1) **DISASSEMBLY.** Place cylinder on a suitable disassembly block. Before removing valves and valve springs, remove carbon accumulation from around valve locks and lock grooves. Place one end on a 1¼-inch diameter tubular fiber drift on center of valve spring upper washer, holding drift in a position concentric with valve stem and strike drift squarely on other end to loosen accumulated carbon. These precautions are necessary in order that valve spring upper washer will not be cocked when struck, as this may cause serious nicking of the valve stem by the bottom edge of washer. Install valve spring compressor (5A2286) in place, and insert rod attached to tool through rocker-arm hub bolt hole in rocker box (fig. 32). Compress springs and remove split locks. Remove compressor and lift out valve spring upper washer, valve springs, and lower washers. Before lifting cylinder off holding block, remove any nicks or burrs from valve stems by polishing. A nick or bur on valve stem may scratch or score valve guide upon removal of valve. Remove cylinder from block while holding valve stems to prevent them from falling out of guides. Lay cylinder on its side, and remove valves.

(2) **CLEANING.** Wash all parts in dry-cleaning solvent. Hard carbon deposits are removed by polishing the surface with crocus cloth and a suitable lubricant. Wash parts carefully to remove foreign matter. Dry parts after cleaning with compressed air.

(3) INSPECTION.

(a) *Cylinder Heads.* Visually inspect all cylinder heads internally and externally for cracks. If a cracked head is found, the cylinder assembly must be replaced. Cracked or broken fins may be reworked by profiling to depth of crack provided crack does not extend into dome of cylinder head, and total amount of fin metal removed does not exceed 14 square inches per cylinder. Inspect exhaust and intake valve guides for tightness in head, backing out, cracks and scratching or scoring of inside diameter. Check inner end of exhaust valve guide and adjacent part of valve guide boss in exhaust port for burning and pocketing. Inspect exhaust and intake valve seat inserts for pitting, burning and concentricity with valve guides. Regrind valve seat inserts which are pitted or burned.

ORDNANCE ENGINE MODEL RD-1820

(b) *Cylinder Barrels.* Inspect cylinder barrels for bent, cracked, and broken, skirts and fins. Replace any cylinder with a bent or cracked skirt, or with fins broken at root. Inspect inside diameter of cylinder barrel for corrosion, scores, wear and out-of-roundness. (par. 22). The cylinders are provided with a choke bore at the head end of barrel.

(c) *Precombustion Chamber.* Inspect precombustion chamber for tightness in cylinder head. Examine for cracked or broken fins. Replace any precombustion chambers with cracked or broken fins.

(d) *Valves.* Inspect rocker arm bushing bores for size and measure rocker arm bolt (par. 22). Examine valve head, face, stem, and tip for fitting, scores and burning. Check fit of valve in guide (par 22). **CAUTION:** *Exhaust valves are filled with sodium which is inflammable in the presence of water. Care should be exercised in disposing of exhaust valves to insure against fire and possible personal injury. Do not try to cut valve open.* Check valve springs for proper tension (par. 23).

(4) REPAIR.

(a) *Profiling Cylinder Head Fins.* Rework cracked or broken cylinder head fins by profiling to depth of crack, provided the crack does not extend into dome of cylinder head. Remove sharp corners of reworked fins. Exercise care not to scratch adjacent fins.

(b) *Honing Cylinder Barrels.* Cylinder barrel bores which are corroded or slightly scored or worn may be reconditioned by honing, provided the maximum permissible clearance between the cylinder and piston is not exceeded by this operation (par. 22).

(c) *Intake Pipe Flange and Air Deflector Cap Screw Bushings.* To replace cap screw bushings, drill out old bushing and remove remaining thin shell. Select bushing that will enter head about three threads when cold. Heat head to 300°F. for 20 minutes. Install new bushing.

(d) *Rocker Bolt Bushing.* To replace bushing, remove old bushing using puller (5A2276). Heat cylinder head to 250° F. and press new bushing into place using puller (5A2276). Line ream bushings using reamer (5A2280). Face ends of bushings using cutter and bar (5A2279), nut (5A2278) and plate (5A2277) (par. 22).

(e) *Refacing Exhaust and Intake Valve Seats.* Reface valve seats whenever they are pitted or not concentric with valve guides. An exhaust valve guide which is pitted to such an extent that it cannot be fitted for further use by grinding, must be replaced with a new part. When valve seat is not concentric with its valve guide within 0.0075 inch, the cylinder must be replaced. Grind valve seat to obtain 100 per cent blued surface and a minimum concentricity of 0.003 inches with valve guide bore.

ORDNANCE MAINTENANCE — ORDNANCE ENGINE MODEL RD-1820 (CATERPILLAR)

(f) *Valve Guides.* If valve guides do not require replacement, clean bores with crocus cloth and suitable lubricant. To replace valve guides, drill out old guide so that a thin shell remains in cylinder head. Break out this shell, being careful not to damage bore of cylinder head. If bore of cylinder head has not been damaged, a standard valve guide may be installed. If oversize guide must be used, ream to obtain proper fit between valve guide and cylinder head. Press in new guide after heating cylinder assembly to 300°F. for one hour. Valve guide flange must bottom within 0.001 inches of head. Ream newly installed valves to obtain proper fit, with valve stems (Refer to par. 22). Clean bores with crocus cloth. Reface valve seats after installation of new guides.

(g) *Valves.* Stone burs or nicks from valve spring washers and from retainer locks. Reface pitted or warped valve faces, removing no more metal than is necessary to true up face. Remove carbon and discoloration by polishing with crocus cloth and gasoline. Do not attempt to remove more than 0.005 inch of metal from diameter of exhaust valve. Grind faces of exhaust valves to an angle of 43° 30' to 43° 45'. If a valve does not seat properly upon testing, it is permissible to lightly lap valve and seat.

(5) **ASSEMBLY.** Lubricate valve stems with engine oil. Place both valves in cylinder. Install lower valve spring washers around each valve guide. Place inner, intermediate, and outer valve springs, in place on lower washers and the upper valve spring retainer washer on top of springs. Compress valve springs, using valve spring compressor (5A2286) and install valve locks (fig. 32).

14. CRANKCASE FRONT SECTION.**a. Disassembly (fig.17).**

(1) **FUEL PUMP CAM.** Remove cap screws that retain fuel cam thrust washer to cam bearing support. Lift out fuel pump cam. Remove fuel injection pump rack by removing nuts from thrust bearing retainer flange on front of crankcase front section and withdraw bolts. Remove two cam bearing support cap screws. Remove support and fuel injection pump rack.

(2) **THRUST BEARING.** With thrust bearing retainer and cam bearing support removed, press thrust bearing from crankcase front section. Remove fuel valve lifter retaining screws from fuel injection pump pad on crankcase front section. Lift out fuel valve lifter.

(3) **FUEL PUMP CONTROL.** Remove cap screws holding body and sleeve to crankcase, and lift off governor fuel pump control which is located between No. 1 and No. 2 cylinders. Loosen cap screws that lock fuel pump control dogs (fig. 64) to pump control shaft. These

ORDNANCE ENGINE MODEL RD-1820

dogs are located at each of the fuel pump pads. Lift out shafts from inside of crankcase. Remove plate cover over fuel annulus by removing retaining cap screws.

(4) **VALVE TAPPET.** To disassemble valve tappets, remove valve tappet circket from each assembly. Push floating pin out of slotted end of tappet, and remove bushing and roller. Since valve tappets and guides are matched assemblies, care must be taken when these parts are disassembled to insure that they do not become mismatched.

b. **Cleaning.** Wash all parts, using dry-cleaning solvent. Clean bearing (par. 8 b).

c. **Inspection.**

(1) **THRUST BEARING.** Inspect thrust bearing balls and races, using a magnifying glass for pits and galled or worn spots. Inspect retainer for wear and cracks (par. 8 c). Check fit on crankshaft and in crankcase flange (par. 22).

(2) **CRANKCASE FRONT SECTION.** Inspect crankcase front section for cracks. Be certain all oil and fuel passages are clean and free from obstructions. Inspect dowels and ferrules in fuel injection pump mounting pads for cracks and tightness.

(3) **VALVE TAPPETS AND GUIDES.** Check valve tappets and guides for cracks and scoring. Examine oil passages for cleanliness. Check spring for tension. Check fits of tappet ball socket and tappet, guide and tappet, guide and crankcase front section, roller bushing and roller, tappet bushing and tappet, tappet roller and tappet, roller pin and guide, roller pin, bushing, valve tappet, valve tappet roller, and valve guide (par. 22).

(4) **FUEL CAM.** Inspect cam for cracks. Inspect cam lobes for pitting, galling, scoring, and for wear or flat spots on the tappet roller contact areas. Inspect internal gear teeth for pitting, chipping and wear. Flat spots and cracks on cam are causes for rejection. Pitted or galled cams and worn or chipped gears should be discarded. Check fit between cam bushing and support (par. 22).

(5) **FUEL PUMP CONTROL.** Check fuel pump control face gear for pitting, galling, scratching and roughness on inside diameter and faces. Inspect teeth for pitting, chipping, and wear ridges. Examine individual control gear teeth for the same conditions. Check control gear for bearing wear (par. 22).

(6) **FUEL VALVE LIFTERS.** Inspect fuel tappet rollers for flat spots on outside diameter, chipped edges, cracks and pitting. Flat spots, chipped edges, cracks or pitting, warrants replacement of lifter assembly.



Figure 33 — Installing Fuel Pump Sleeve, Using Driver 5A2171

d. Repair.

(1) **THRUST NUT.** Fit new oil seal rings in thrust nut, insuring that proper ring side clearance and gap are obtained (par. 22).

(2) **VALVE TAPPETS AND VALVE TAPPET GUIDES.** Valve tappets and guides which are scored or scratched to such an extent that they may not be smoothed up by light polishing should be replaced with new parts. After polishing reinspect parts for size (par. 14 b).

(3) **FUEL PUMP CONTROL.**

(a) **Governor Fuel Pump Control.** Disassemble governor fuel pump control as follows: Remove lever arm by driving out tapered pin which holds lever to control gear shaft. Lift lever over key and shaft. Pull shaft through bearings in control housing and remove. Remove pump control adjusting plate retaining capscrews and lift off plate. Remove capscrews from underside of governor fuel pump control body and lift off fuel pump control cover. Pull out needle bearing in control sleeve. Assemble governor fuel pump control as follows: Press needle bearing into governor fuel pump control sleeve until it bottoms in bore of sleeve. Install governor fuel pump control sleeve on pad between fuel injection pump pads Nos. 1 and 2. Place gasket on control pad, install sleeve, place another gasket on top face of control sleeve and install governor fuel pump control body. Secure these parts to crankcase front section with cap screws. Lock wire cap screws. Insert governor fuel pump control shaft gear through sleeve and body. Install ball bearing on shaft and secure in place with cirlet positioned in groove above bearing. Place gasket on body and install governor fuel pump control cover, securing in place with cap screws from under side of body. Lock wire cap screws and drive oil seal over shaft in cover. Locate adjusting eccentric in cover, and position stop plate on cover over eccentric and locating dowel pin. Secure with screws and lock washers. Assemble governor fuel pump control lever by driving governor fuel pump control rod bushing into lever. Install governor fuel pump control lever by inserting key

ORDNANCE ENGINE MODEL RD-1820

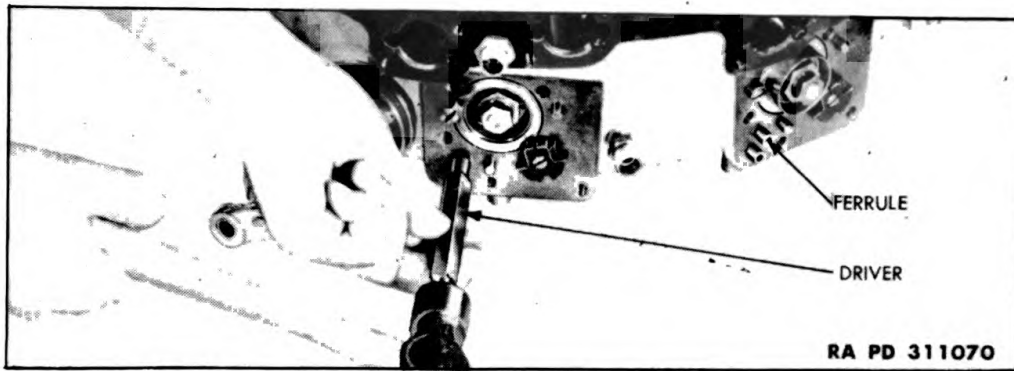

Figure 34 – Installing Crankcase Ferrule, Using Driver 5A2161

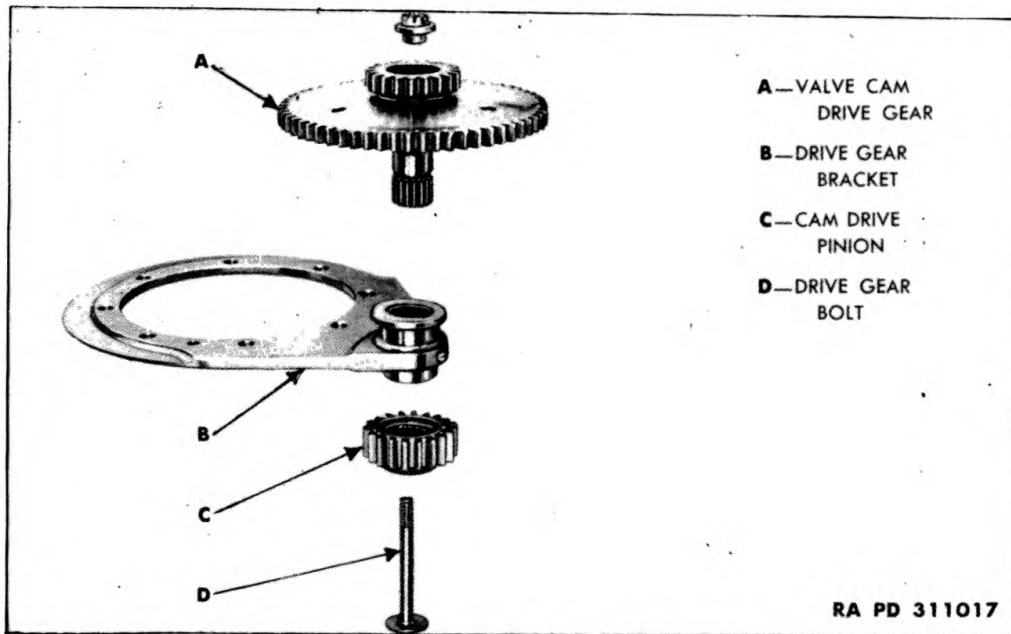

Figure 35 – Cam Drive Gears Disassembled

in groove in shaft and placing lever on shaft over key. Drill and taper ream hole through lever and shaft. Drive locking pin into position in taper reamed hole through lever and shaft, staking metal over large end of pin.

(b) *Fuel Pump Control.* If replacement of fuel pump control sleeves is found necessary, drive sleeves from crankcase front section using a suitable fiber drift. Install new control sleeves using driver (5A2171) (fig. 33). The sleeves will bottom on shoulder when installed to proper depth.

(4) **CRANKCASE FRONT SECTION.** New ferrules may be installed in fuel pump pads of crankcase front section with driver (5A2161) (fig. 34).

ORDNANCE MAINTENANCE — ORDNANCE ENGINE MODEL RD-1820 (CATERPILLAR)

e. Assembly.

(1) **INSTALL FUEL MANIFOLD COVER.** Install fuel manifold cover and gasket on crankcase front section and secure with bolts. Lock wire bolts in pairs. Make certain fuel manifold is free from foreign matter before installing cover.

(2) **INSTALL FUEL PUMP CONTROL GEARS.** Install fuel pump control gears into fuel pump control gear sleeves from inside of crankcase front section. Place fuel pump control dog on shaft end of gear with the raised portion of dog toward fuel pump pad of crankcase. Lock dog in place with screw by lining up hole in dog with groove in gear shaft. The screw holding dog in place need not be tightened securely as the dog must be adjusted upon final engine assembly.

(3) **INSTALL LIFTER ASSEMBLIES.** Install fuel pump lifter assemblies into bores in fuel pump pads of crankcase front sections. Secure in place with screws.

(4) **INSTALL FACE GEARS.** Place fuel pump control face gear into position over 10 fuel pump control gears. Locate fuel pump cam and face gear support on inside face of crankcase front section. Lock support into position with two capscrews and locks. Tighten screws and bend up locks. Install fuel pump cam on support with internal gear visible. Secure in place with fuel cam thrust washer and cap screw. Tighten cap screws and lock wire in pairs.

(5) **INSTALL CRANKSHAFT BEARINGS.** Install crankshaft thrust bearing and spacer ring assembly into bore of cam support flange. Do not damage rings. Lubricate with engine oil. Install crankshaft front ball bearing into bore in crankcase front section, and place oil slinger on bearing. Install crankcase front section flange, adding oil seal ring to piloting bore and lowering flange onto crankcase front section. Install nuts and lock wire in pairs.

15. CRANKCASE MAIN FRONT SECTION.

a. Disassembly. Remove screws which attach cam drive gear bracket to the crankcase main front section. Remove bracket cam drive gear and pinion assembly (fig. 35). Remove cam drive gear bracket spacer and splined cam bearing ring spacer. Lift off cam. Do not remove cam bearing ring unless replacement of this part is found necessary. Remove cotter pin, nut bolt, cam drive gear, and pinion. Remove crankshaft front main bearing outer race from inner bore of crankcase main front section. Remove piston cooling jets using wrench (5A2184).

b. Cleaning. Wash all parts in dry-cleaning solvent and dry in air blast.

ORDNANCE ENGINE MODEL RD-1820

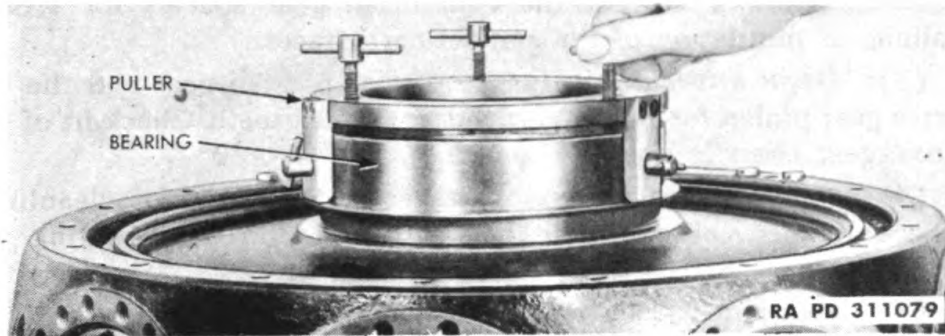

Figure 36 — Removing Cam Bearing, Using Puller 5A2305

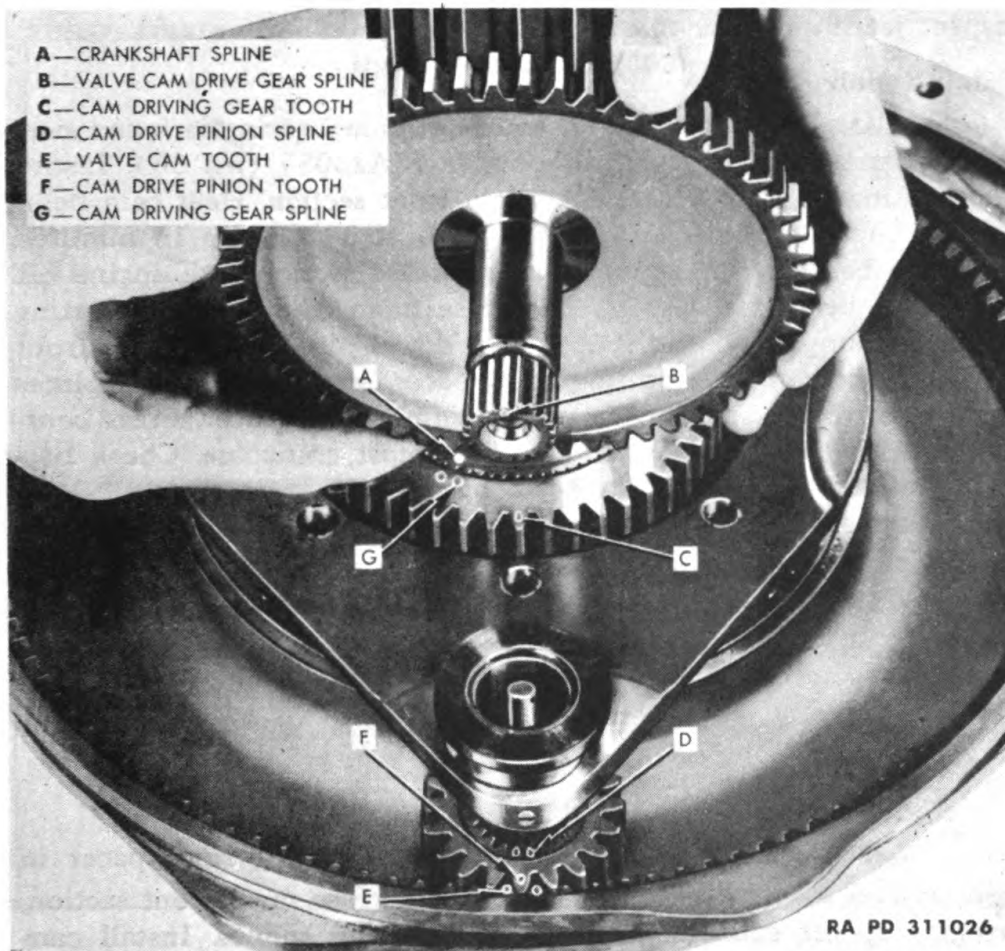

Figure 37 — Timing Marks

c. Inspection.

(1) **CAM.** Inspect cam for cracks. Inspect cam lobes for pitting, wear, and flat spots. Examine internal gear teeth on the cam for pitting, chipping, and wear ridges.

ORDNANCE MAINTENANCE — ORDNANCE ENGINE MODEL RD-1820 (CATERPILLAR)

(2) **SPACERS.** Inspect the cam drive gear spacers for scoring, galling, or mutilation of the contacting surfaces.

(3) **GEAR AND PINION.** Inspect the cam drive gear and the cam drive gear pinion for pitted, chipped, or broken teeth. Check fit of cam drive gear shaft in bushing (par. 22).

(4) **CAM FIT.** Inspect oil passages and grooves for cleanliness. Check diametrical clearance between cam and cam bearing ring (par. 22).

(5) **BEARING FITS.** Check front main bearing location for galling and scoring. Check fit of bearing in crankcase (par. 22).

(6) **PISTON COOLING JETS.** Inspect piston cooling jets for cracks or signs of mutilation. All cracked or mutilated jets are to be replaced. Inspect jet interior for cleanliness.

d. **Repair.**

(1) **CAM BEARING.** If replacement of cam bearing is found necessary, remove old bearing with puller (5A2305) (fig. 36). Install cam bearing ring onto crankcase main front section. Heat cam bearing ring in an oil bath at a temperature of 300°F. for 15 minutes. Coat cam bearing ring support on crankcase section with engine oil. Place cam bearing spacer on crankcase main front section locating $\frac{5}{16}$ inch diameter hole in spacer over dowel pins in crankcase front section. Place cam bearing ring over spacer, engaging bearing splines correctly with the splines on outside diameter of spacer. Press bearing down so that flange bears tightly against crankcase. Check bottoming of bearing ring on crankcase by attempting to insert a 0.0015 feeler gage between these parts. Remove spacer after bearing ring has cooled.

(2) **CAM DRIVE GEAR BRACKET.** To replace cam drive gear bracket bushing, machine out old bushing and press in new bushing. Machine new bushing to obtain proper fit with cam drive gear (par. 22).

(3) **PISTON COOLING JETS.** Remove all scratches using crocus cloth and suitable lubricant.

e. **Assembly (fig. 37).**

(1) **INSTALL SPACER AND CAM.** Install bearing ring spacer in position over locating dowel pin in the crankcase main front section, engaging spacer splines with cam bearing ring splines. Install cam on bearing ring after lubricating thoroughly.

(2) **INSTALL PINION AND GEAR.** Install and stake oil passage plug in cam drive gear bracket. Lubricate cam drive gear shaft and cam drive gear support bushing and insert shaft in bushing. Install cam drive gear pinion on splined end of shaft, engaging the two marked splines on the pinion with the single marked spline on the shaft. Install cam drive gear, pinion bolt, nut, and cotter pin.

ORDNANCE ENGINE MODEL RD-1820

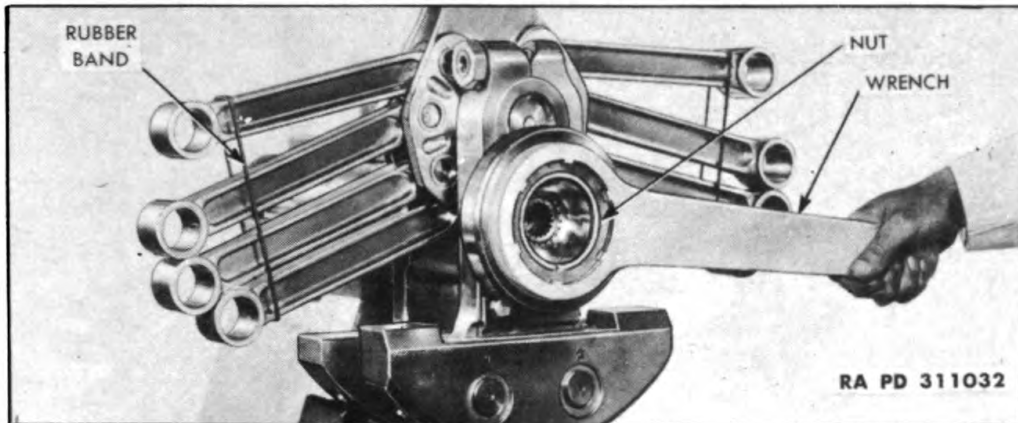

Figure 38 — Removing Crankshaft Rear Bearing Nut, Using Wrench 5A2303

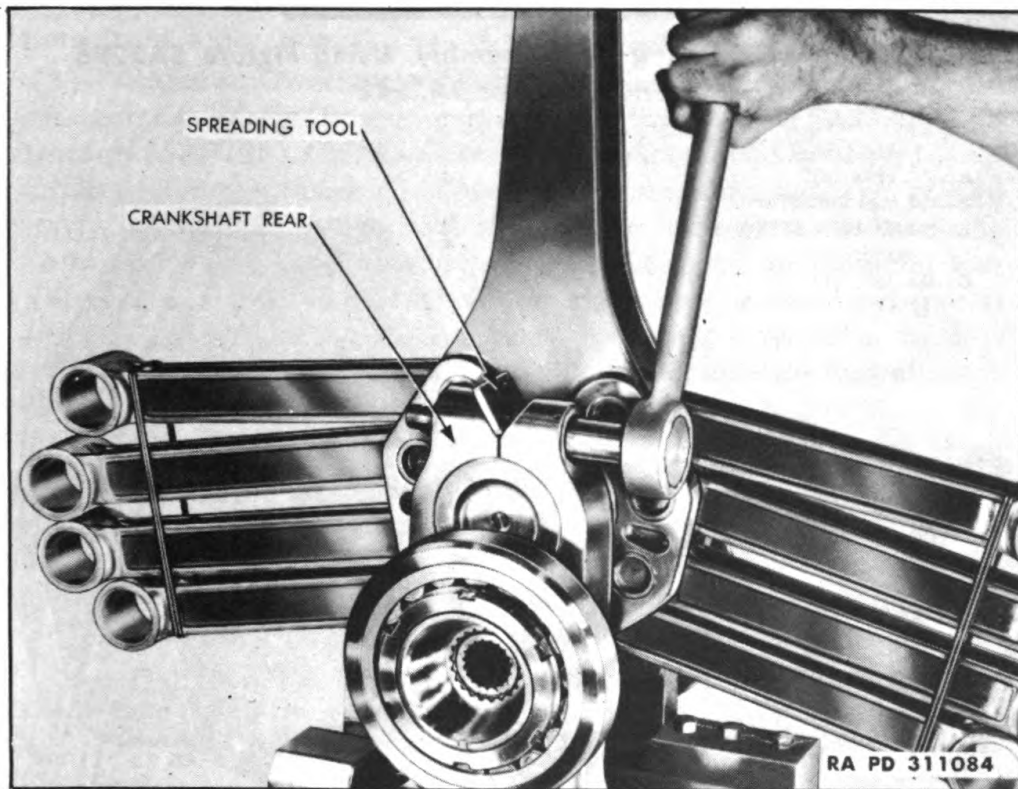

Figure 39 — Removing Crankshaft Rear, Using Spreading Tool 5A2300 and 5A2301

(3) **INSTALL GEAR BRACKET.** Rotate cam so the two marked internal teeth are in line with the vertical centerline of the crankcase front section. Install cam drive gear bracket spacer and cam drive

ORDNANCE MAINTENANCE — ORDNANCE ENGINE MODEL RD-1820 (CATERPILLAR)

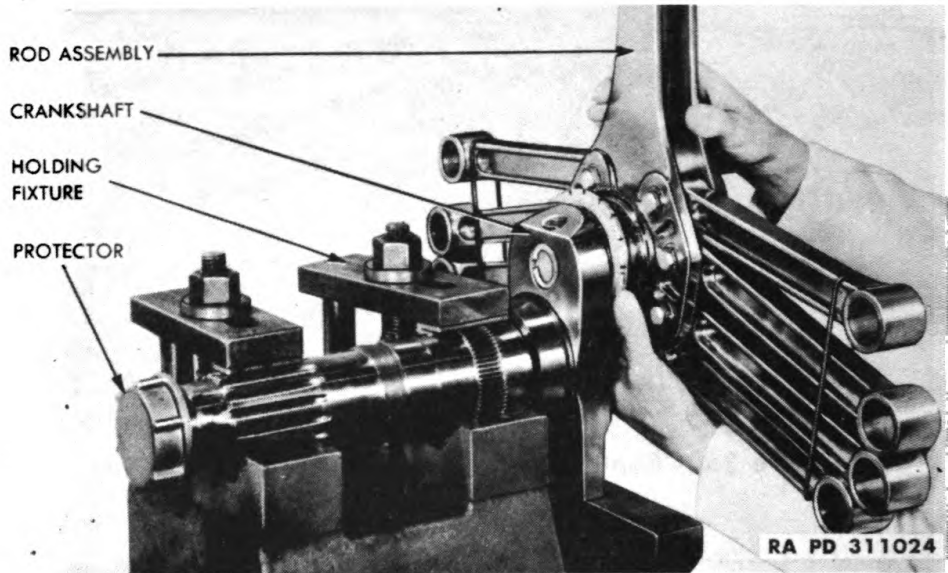

Figure 40 — Removing Rod Assembly, Using Fixture 5A2296 and Protector 5A2342

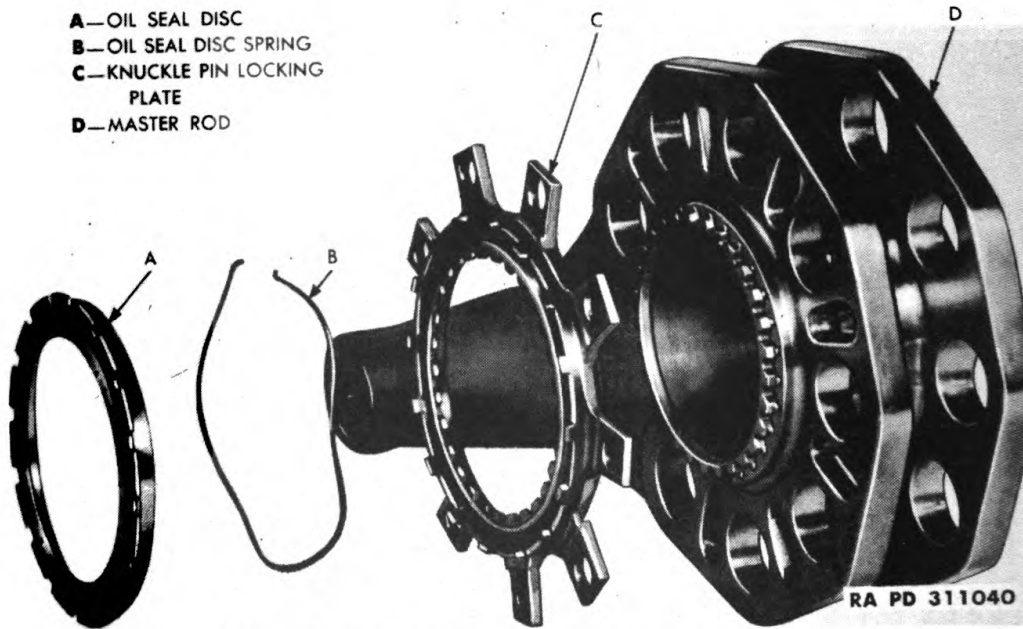

Figure 41 — Master Rod and Seal Assembly

gear bracket over splined cam bearing ring spacer, locating these parts correctly over dowel pin in main section. Time cam and cam drive pinion by engaging two marked cam teeth and single marked pinion tooth. Secure cam drive gear bracket to crankcase main front section with eight retaining screws. Tighten screws and lock wire in pairs.

ORDNANCE ENGINE MODEL RD-1820

(4) **INSTALL PISTON COOLING TUBES.** Install piston cooling tubes in openings in spherical surface of front crankcase main section. Rotate piston cooling nozzles with gaskets so that semicircular groove in piston cooling tube is adjacent to semi-circular groove in the hole in crankcase main front section. Insert locating pin into groove. Install copper gasket, retaining nut, and locking nut, using wrench (5A2184).

16. CRANKSHAFT.

a. Disassembly.

(1) **MOUNT IN FIXTURE.** Install crankshaft in assembly and disassembly fixture (5A2296) with counterweights in downward position. Tighten two clamps on fixture to hold crankshaft firmly in fixture (fig. 40).

(2) **REMOVE REAR MAIN BEARING.** Remove crankshaft rear main bearing nut lock screw and locking tab. Remove nut using lug wrench (5A2303) (fig. 38). Remove rear main bearing, outer race, and rollers from inner race.

(3) **REMOVE CRANKSHAFT REAR.** Remove cotter pin from crankshaft rear cap screw. Loosen cap screw with wrench (5A2339) and extension (5A2295) (fig. 45). Remove cap screw and washer. Install crankshaft rear spreader (5A2300) plug in unthreaded end of cap screw hole and install plate in slot of plug so that plate contacts side of clamp joint (fig. 39). Tighten screw (5A2301) in threaded end of cap screw hole to force plate against side of clamp joint and spread crankshaft rear. Do not spread crankshaft rear any more than is necessary to permit removal of this part. Remove crankshaft rear and spreading tools.

(4) **REMOVE COUNTERWEIGHT.** Remove nuts, bolts and stops which lock crankshaft rear counterweights. Line up bushings in crankshaft rear with counterweight bushings, and remove counterweight pins. Remove crankshaft rear from counterweights. Remove floating steel bushings from crankshaft rear. Do not remove bronze bushings from counterweight unless replacement of these parts is necessary.

(5) **REMOVE BEARING RACES.** Remove front main bearing inner race, using puller (5A2298) and adapter (5A2288). Remove rear main bearing inner race, using puller (5A2299) and adapter (5A2289).

(6) **DISASSEMBLE MASTER AND ARTICULATED RODS.** Remove master rod end seal spacer. Check rear end of crankpin to insure that no nicks or burrs are present to scratch or score master rod bearing upon removal of master rod and articulated rod assembly. Remove any nicks or burrs by stoning and polishing. Grasp two groups of articulated rods, one on each side of the master rod and remove master rod and articulated rod assembly from crankpin (fig. 40). Remove end seal disk and spring (fig. 40).

ORDNANCE MAINTENANCE — ORDNANCE ENGINE MODEL RD-1820 (CATERPILLAR)

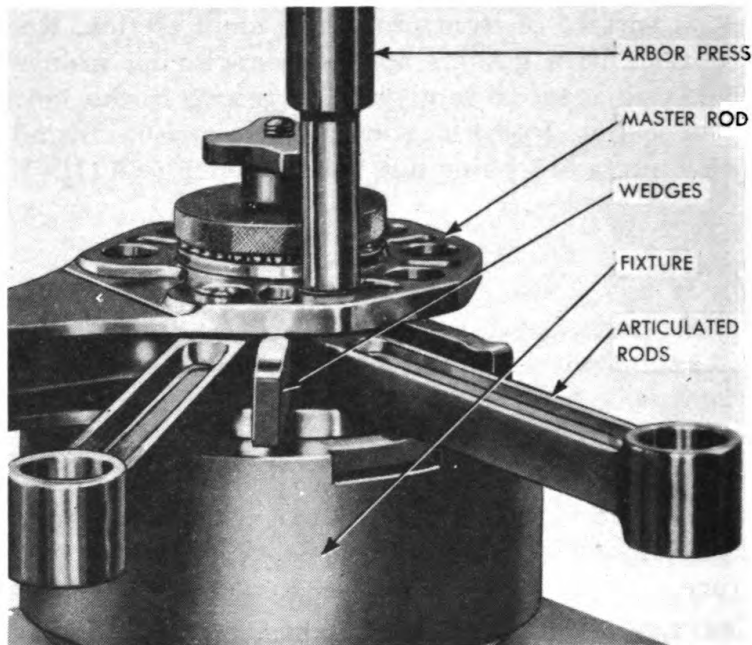

RA PD 311016

Figure 42 — Removing Knuckle Pins, Using Wedges 5A2309 and Fixture 5A2308

(7) **REMOVE KNUCKLE PIN LOCKING PLATE.** Place master rod and articulated assembly on a bench, rear end down. Bend down knuckle pin lock screw tabs and remove lock screws and tabs. Lift off knuckle pin locking plate (fig. 41).

(8) **REMOVE KNUCKLE PINS.** Place knuckle pin assembly and disassembly fixture (5A2308) on an arbor press table (fig. 42). Locate knuckle pin to be removed over a hole in fixture. Insert two wedges (5A2309) between flanges of master rod, one on each side of articulated rod to be removed, to prevent possible damage to master rod flanges when pressing out knuckle pin. Press out knuckle pin, using removing plug under arbor, fitting step of plug in step of knuckle pin. Remove knuckle pin and articulated rod. Remove all knuckle pins and articulated rods in same manner, each time moving wedges to respective articulated rod.

b. Cleaning. Wash all parts thoroughly in dry-cleaning solvent. Clean bearings (par. 8 b).

c. Inspection.

(1) **CRANKSHAFT FRONT AND REAR MAIN BEARINGS.** Check fit of the bearing on shaft and in crankcase (par. 22). Inspect rollers and races, using a magnifying glass, for cracks and pitted or galled surfaces. Examine retaining surfaces for cracks and wear (par. 8 c (11)).

(2) **CRANKSHAFT FRONT.** Inspect crankshaft front for cracks.

ORDNANCE ENGINE MODEL RD-1820

Carefully inspect all surfaces for scratches, nicks and scores. Examine crankpin for burning, scratching, scoring, burring and picking-up, especially at crankpin oil hole and fillet at front end of crankpin. Inspect for an out-of-round condition at both front and rear of crankpin with a micrometer. Examine clamping surface at rear of crankpin for scratches, burrs, chafing and evidence of turning of crankshaft rear on crankpin. Inspect rear face of front crankshaft cheek adjacent to crankpin fillet for scratching, scuffing, and roughness. The surface must be glossy, nearly mirror-like, and perfectly smooth to the touch. Check front main bearing journal for scratching and scoring. Check fit of bearing on journal (par. 22). Check splines for pitting, burring, scoring, galling and wear. Make certain oil passages are clean and that crankpin oil tube in interior of crankpin is tight in shaft. Inspect front counterweight for cracks, nicks, scratches and scores. Check rivets for tightness and evidence of cracking or splitting.

(3) **CRANKSHAFT REAR.** Inspect for cracks, scratches, nicks, and scores. Examine inside diameter of crankpin hole for scratches, burs, and chafing. Inspect front face of crankshaft rear adjacent to crankpin hole for scratching, scuffing, and roughness. The surface must be glossy, nearly mirror-like, and perfectly smooth to the touch. Check rear main bearing journal for scratching and scoring. Check fit of bearing on rear main bearing journal (par. 22). Inspect splines for pitting, burring, scoring, and wear. Examine accessory drive coupling for cracks, pitting, burring, scoring, and wear of internal and external splines. Inspect bronze bushings for pitting, chafing, scoring, picking up, wear on ends and inside diameter, and for tightness. Examine floating steel bushings for cracks, pitting, chafing, scoring, picking-up, wear on ends, and both inside and outside diameter. Check fit of floating bushings in bronze bushings with a feeler gage (par. 22). Examine rear counterweight for cracks, nicks, scratches, and scores. Inspect rear counterweight bushings for tightness in counterweight, pitting, chafing, scoring, picking-up and wear on ends and inside diameter. Inspect rear counterweight pins for cracks, scratches, pitting, scuffing, pounding and wear.

(4) **MASTER ROD.** Examine for cracks, scratches, nicks, and burs. The rear face of master rod must not be scratched, scuffed or rough. The surface should be glossy, mirror-like and perfectly smooth to the touch. All oil passages must be clean and free from obstructions. Examine piston pin bushing in master rod for cracks, burs, scratches, galling, wear and tightness in rod. Check fit of piston pin in bushing (par. 22). Inspect master rod bearing for cracks, scoring, over-heating, flaking or bearing material, fatigue cracks, foreign material in bearing and high spots in bearing inside diameter. Replace master rods which show any of above conditions. If no more

ORDNANCE MAINTENANCE — ORDNANCE ENGINE MODEL RD-1820 (CATERPILLAR)

than a few very light scratches are found and none of other conditions exist, the bearing is usable. Over-heating is indicated by a red orange color, possibly streaked with lead from bearing lining. Fatigue cracks are short, irregular cracks that run parallel to bearing bore. Small gas holes in bearing are permissible. Check bearing for tightness in rod, condition of splines at front end, and fit of crankpin in bearing (par. 22). Inspect knuckle pin locking plate for cracks, burs, condition of spline, bending of lugs, and cleanliness of oil passages. Inspect knuckle pin lock screws for cracks, condition of threads, and cleanliness of oil holes. Check master rod end seal disk and spacer for cracks, mutilation, wear, burs, scores, and flaking of plating or bearing material. Inspect end seal spring for proper tension (par. 23).

(5) **ARTICULATED RODS.** Inspect articulated rods for cracks, scratches, nicks, burs and bending. *Do not use nor attempt to straighten a bent rod.* Check piston pin bushing and knuckle pin bushing in each rod for cracks, burs, scratches, galling, wear and tightness in rod. Split type bushings are used and the split must not be mistaken for a crack. Check alinement of piston pin bushing bore and knuckle pin bushing bore. Check rods for twist. Check fit of piston pins and knuckle pins in their respective rods (par. 22).

d. **Repair.**(1) **CRANKSHAFT FRONT.**

(a) *Polish Crankpin.* Remove scratches or high spots from outside diameter of crankpin by light stoning. Remove burred, scratched or galled areas from clamping surface at end of crankpin. Polish with crocus cloth and light oil after stoning.

(b) *Polish Crank Cheeks.* Polish rear face of front crank cheek adjacent to crankpin fillet to obtain a mirror-like finish. This highly polished surface must be maintained to prevent mutilation and wear of master rod oil seal disk.

(2) **CRANKSHAFT REAR.**

(a) *Polish Front Face.* Polish front face of crankshaft rear adjacent to crankpin hole to obtain a mirror-like finish.

(b) *Clean Oil Passages.* Press bearing from crankshaft rear just far enough to clear oil passages in the crankcheek rear extension. It is advisable to leave bushing bearing partly in crankcheek extension in order to preserve proper alinement of oil passages. Clean lubrication holes thoroughly. Press bushing back into place using collar (5A2294).

(c) *Replace Rear Bearings.* If replacement of crankshaft rear bushing bearings is found necessary, press out old bearing using suitable drift and collar (5A2294). Remove burs from bearing hole. Check size of parts to insure their proper fit (par. 22). Press in new bearing using suitable drift, base (5A2292) and collar (5A2294).

ORDNANCE ENGINE MODEL RD-1820

Machine bushing to size by referring to par. 22 and measuring mating part. If replacement of rear counterweight bushing is found to be necessary, press out old bushing using a suitable drift. Install new bushing using stop (5A2302) and base (5A2292).

(d) *Replace Counterweight Bushings.* If replacement of crankshaft rear counterweight bushing is found necessary, press out old bushing using a suitable drift. Install crankshaft rear counterweight bushing by applying a thin coating of light graphite grease to bushing. Insert stop (5A2302) into slot of counterweight. Tighten two wedges into seats provided in stop so that side of stop is contacting side of counterweight in which new bushing is to be installed. Place counterweight on base (5A2292) on an arbor press table and press in bushing until bottomed on stop.

e. Assembly.

(1) **ASSEMBLE CRANKSHAFT FRONT.** Coat crankpin front plug with graphited grease and install in crankpin. Insure that hole in plug is alined with tapped hole in crankshaft. Install tab lock and crankpin front plug locking cap screw. Tighten cap screw and bend up tab lock. Install crankshaft front into assembly and disassembly fixture (5A2296) with the counterweight in downward position. Tighten two clamps to hold crankshaft firmly in fixture.

(2) **ASSEMBLE CRANKSHAFT REAR.** Before assembling rear counterweight to crankshaft rear, coat inside diameter of counterweight bushings and floating crankshaft rear bushings thoroughly with graphited grease. Install rear end bushings in bronze bearings of crankshaft rear. Install rear counterweight on crankshaft, so that rear crankshaft cheek extends into slot of counterweight. **CAUTION:** *Insure that the end of the counterweight which is marked "REAR" is facing toward rear of crankshaft.* Thoroughly coat counterweight pins with graphited grease. Hold counterweight in position and install pins. Install rear counterweight stop plate on rear face of crankshaft rear, and secure with two bolts and nuts. Tighten nuts and secure with cotter pins.

(3) **ASSEMBLY OF MASTER ROD AND ARTICULATED RODS.**

(a) *Lubricate Knuckle Pins and Bushings.* Before assembling articulated rods to master rod, coat holes in master rod with graphited grease and coat knuckle pin bushings in articulated rods with clean engine oil. Articulated rods and knuckle pins are marked with number of cylinder in which they were originally installed. These parts must be installed in their original position. If new parts are used, identify them for proper position.

(b) *Locate Knuckle Pins in Master Rod.* The knuckle pins must be assembled in master rod so that step in small end of each knuckle pin will mate with squared end of lugs in knuckle pin locking plate.

ORDNANCE MAINTENANCE — ORDNANCE ENGINE MODEL RD-1820 (CATERPILLAR)

To do this, install knuckle pin locking plate temporarily on front of master rod, engaging splines on inside diameter of locking plate with splines of master rod bearing flange. Install knuckle pins using fixture (5A2308). Install one articulated rod and its knuckle pin in the proper position in master rod by hand. Place a metal rule approximately $\frac{5}{8}$ inch wide over squared end of lug on locking plate so that end of rule contacts end of knuckle pin. Turn knuckle pin until side of step in end of knuckle pin is flat against rule when rule is flat against end of lug on locking plate. Tap knuckle pin in master rod with a fibre mallet just far enough so that pin is tight in rod. Repeat this procedure for each of the other knuckle pins and articulated rods. When all of knuckle pins have been installed in this manner, remove knuckle pin locking plate.

(c) *Install Knuckle Pins.* Place master and articulated rod and knuckle pin assembly on fixture (5A2308) on an arbor press table, with the stepped end of the knuckle pins down. Insert two wedges (5A2309) between flanges of master rod on each side of one articulated rod (fig. 42). Press knuckle pin into master rod until front face of pin bottoms on fixture. Insure that knuckle pin being pressed in is not over hole in base. Installing plug (5A2341) is used under arbor for this pressing-in operation. When locating pin bottoms in fixture, small end of knuckle pin will be within required limits of "flush to 0.002 inch above flush" with front face of master rod front flange. Press in all knuckle pins in this manner. Do not under any circumstances drive knuckle pins in or out of master rod using a drift and a hammer.

(d) *Install Locking Plate.* Install knuckle pin locking plate in position on front end of master rod, engaging splines on inside diameter of locking plate with splines of master rod bearing flange. Check to insure that squared ends of lugs on locking plate mate with flat side of step of knuckle pins. Install new tab locks and knuckle pin locking capscrews. Tighten lock screws and bend up tab locks.

(e) *Install Master Rod Seal* (fig. 41). Place master rod end seal spring in position in master rod end seal disk, and place disk and spring in position in locking plate, engaging lugs of disk with those of locking plate (fig. 41).

(4) ASSEMBLE MASTER ROD ASSEMBLY TO CRANKSHAFT.

(a) *Install Master Rod Assembly.* Wash crankpin with dry-cleaning solvent, dry in air blast, and lubricate freely with clean engine oil. Lubricate inside diameter of master rod bearing with clean engine oil. Hold master rod in a vertical position and group four articulated rods on either side of master rod together, holding each group of rods together with a heavy rubber band (fig. 38). Install master and articulated rod and end seal assembly on crankpin (fig. 40)

ORDNANCE ENGINE MODEL RD-1820

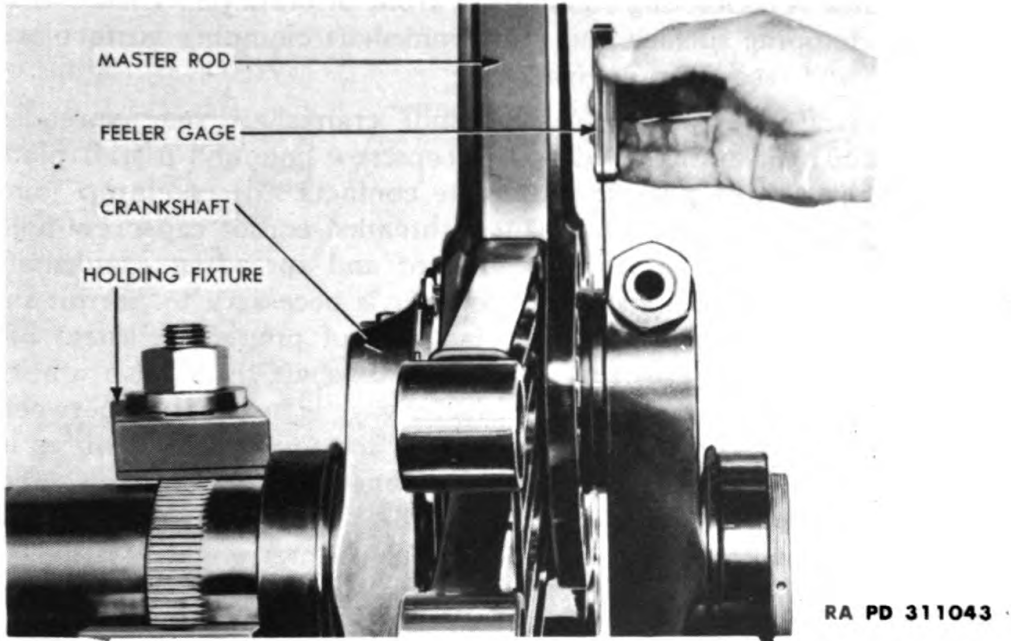

Figure 43 – Checking Master Rod Side Clearance, Using Holding Fixture 5A2296

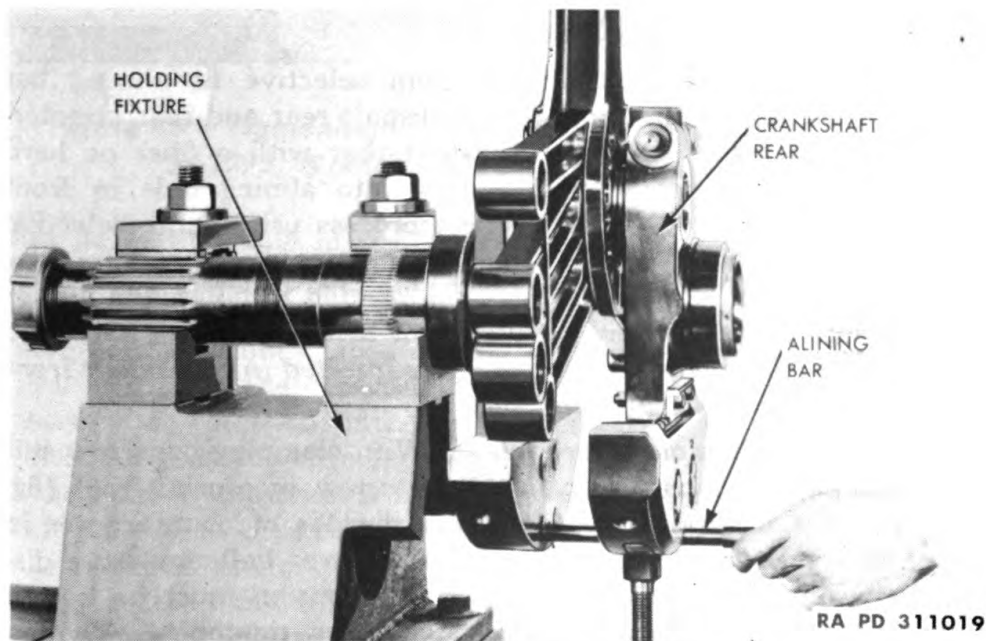

Figure 44 – Checking Crankshaft Alinement, Using Fixture 5A2296 and Alining Bar 5A2290

with crankshaft front end clamped in crankshaft, and disassembly fixture. Install spacer over rear end of master rod hub. Push master and articulated rod and end seal assembly forward on crankpin until

ORDNANCE MAINTENANCE — ORDNANCE ENGINE MODEL RD-1820 (CATERPILLAR)

end seal disk is contacting shoulder at front of crankpin. Insure that crankpin clamping surface and rear crankshaft clamping surface are clean, dry and free from engine oil.

(b) *Install Crankshaft Rear.* Install crankshaft rear spreader plug (5A2301) in unthreaded end of capscrew hole and install plate (5A2300) in slot of plug so that plate contacts side of clamp joint (fig. 39). Tighten screw (5A2301) in threaded end of capscrew hole forcing plate against side of clamp joint and spreading crankshaft rear. Do not spread crankshaft more than is necessary to permit installation on crankpin. Insert a feeler gage of proper thickness between master rod, end seal spacer, and crankshaft rear. Push crankshaft rear forward on crankpin until feeler gage is held firmly between the two parts, thus insuring that proper master rod movement is obtained (fig. 43). Turn crankshaft rear on crankpin until the smallest of selective fit alining bars (5A2290) may be inserted through holes in crankshaft front and rear counterweights (fig. 44). Remove installing tools. Lubricate threaded portion of clamping capscrew hole in crankshaft rear with graphited grease and install chamfered washer and clamping capscrew finger tight. **CAUTION:** *Insure that none of lubricant is deposited on crankpin clamping surface, since this will seriously impair the clamping action of crankshaft rear. If this condition is encountered, disassemble parts, clean thoroughly, and reassemble as previously outlined.*

(c) *Aline Crankshaft.* Insert medium selective fit alining bar (5A2337) into the alining holes of crankshaft rear and rear counterweight (fig. 44). Tap side of crankshaft rear with a fiber or hard rubber mallet until bar will slip easily into alining hole in front counterweight. Remove bar and repeat process using large selective fit bar (5A2338). The position of best alining may be determined by the ease with which alining bar may be inserted in holes. Binding of bar upon insertion indicates misalignment of parts. **CAUTION:** *Do not tap crankshaft rear when alining bar is inserted in crankshaft front counterweight, as this may bend bar.*

(d) *Tighten Clamping Cap Screws.* With clamping capscrew still finger tight in crankshaft rear install capscrew measuring tool (fig. 45). The balls of tool contact chamfered sides of counterbores in ends of screw. Using a micrometer installed over balls, measure distance between outer ends of balls. This dimension must be known in order to determine capscrew stretch after tightening. Tighten knurled head bolt of holding fixture underneath crankshaft rear counterweight to support crankshaft during following operations. Tighten lock nut on bolt to lock bolt in proper position. Tighten crankshaft rear clamping capscrew (fig. 45) using wrench (5A2339) and extension (5A2295) until proper capscrew stretch is obtained. At the same time aline cotter pin hole in threaded end of capscrew

ORDNANCE ENGINE MODEL RD-1820

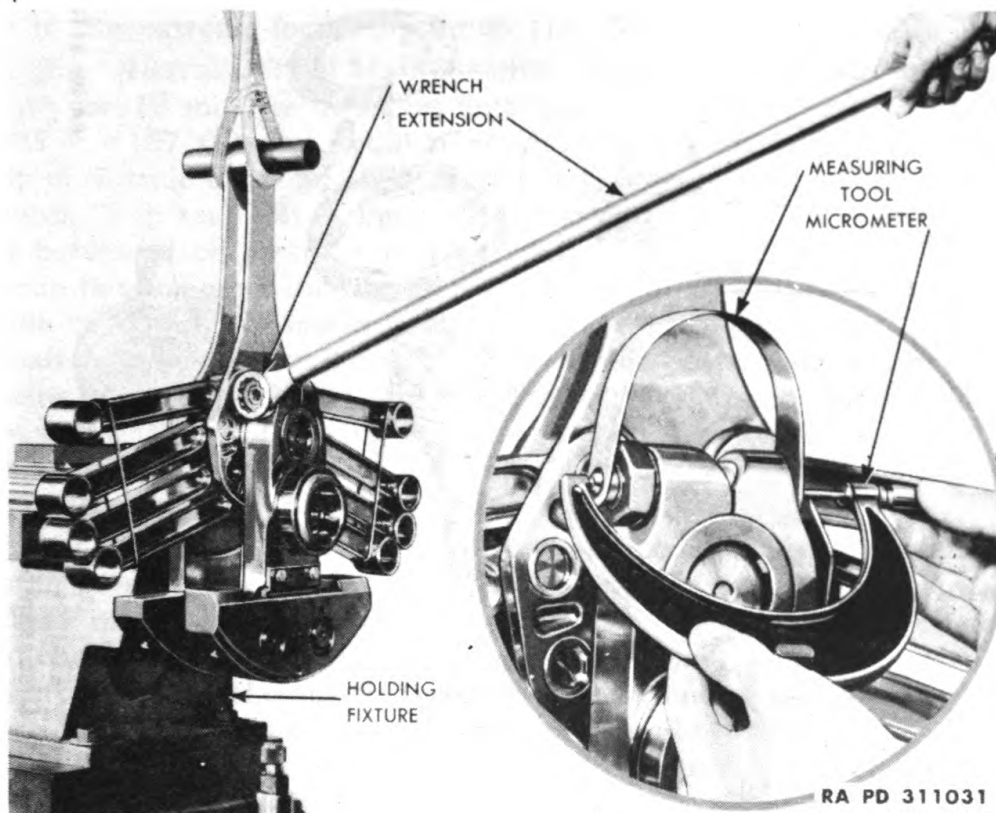
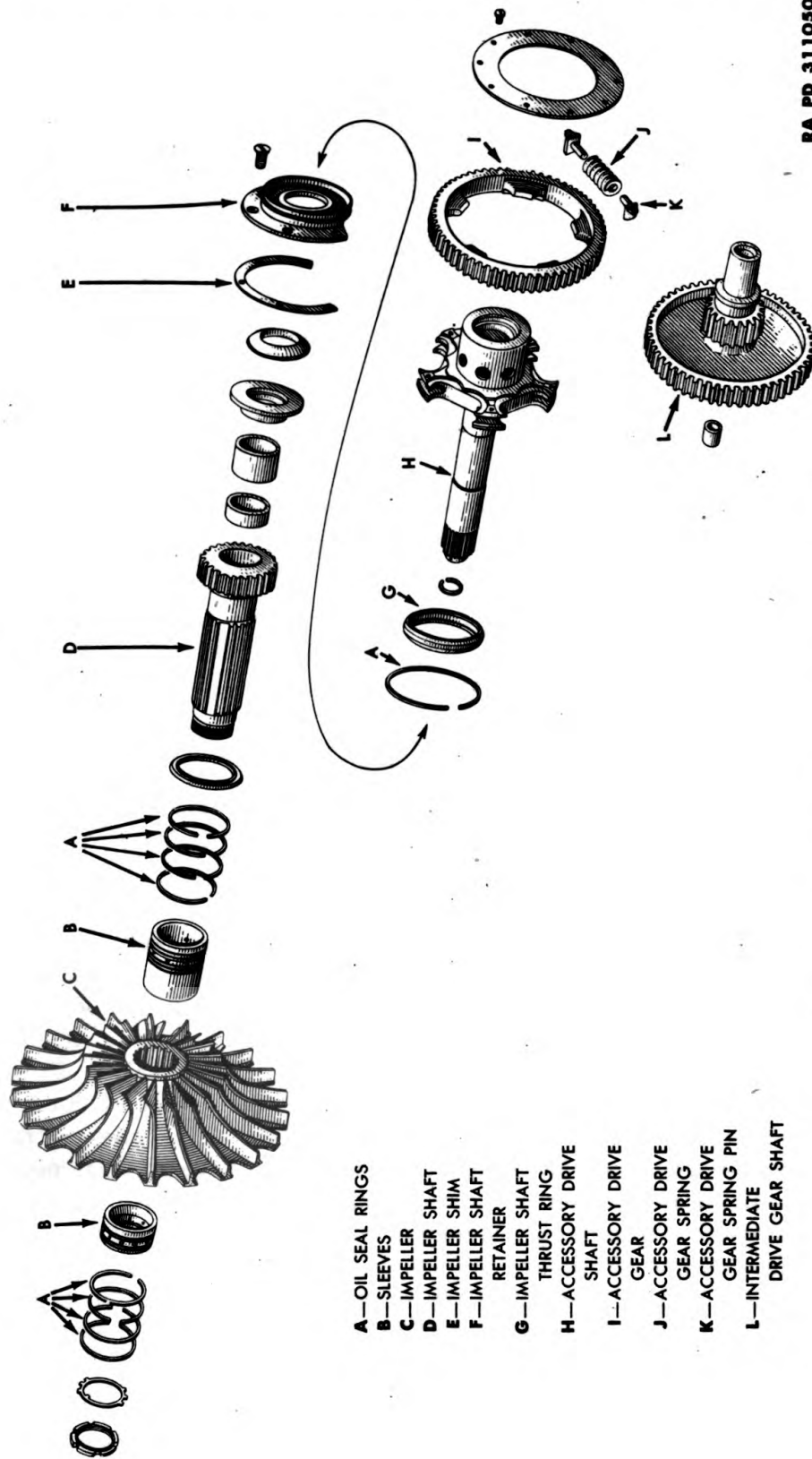

Figure 45 — Tightening Crankcheck Cap Screw, Using Extension 5A2295, Wrench 5A2339, and Fixture 5A2296

with its mating hole in crankshaft rear. Reinstall stretch measuring tool over capscrew, and again measure distance between outer ends of balls. The capscrew stretch is the difference between the two micrometer readings. Insure that stretch is within proper limits (par. 22). Lock the capscrew by inserting cotter pin from inside of capscrew at threaded end, allowing cotterpin to protrude through crankshaft rear approximately $\frac{3}{8}$ inch. Bend down legs of cotterpin. If the hole in capscrew is not alined with its mating hole in crankshaft rear when capscrew is tightened to proper stretch, it is permissible to drill a new cotterpin hole in end of capscrew. Insure that new hole is located a minimum distance of $\frac{1}{4}$ inch, measured at root of the cap screw thread, from any adjacent hole. It is also permissible to grind either face of chamfered cap screw washer in order to locate an undrilled portion of cap screw under cotter pin hole in crankshaft rear. If this is done, break all sharp edges to a $\frac{1}{16}$ -radius after grinding.

(e) *Check Master Rod Movement.* Recheck master rod end movement by inserting a feeler gage between master rod and seal spacer

ORDNANCE MAINTENANCE — ORDNANCE ENGINE MODEL RD-1820 (CATERPILLAR)



RA PD 311050

- A—OIL SEAL RINGS
- B—SLEEVES
- C—IMPELLER
- D—IMPELLER SHAFT
- E—IMPELLER SHIM
- F—IMPELLER SHAFT RETAINER
- G—IMPELLER SHAFT THRUST RING
- H—ACCESSORY DRIVE SHAFT
- I—ACCESSORY DRIVE GEAR
- J—ACCESSORY DRIVE GEAR SPRING
- K—ACCESSORY DRIVE GEAR SPRING PIN
- L—INTERMEDIATE DRIVE GEAR SHAFT

Figure 46 — Supercharger Disassembled

ORDNANCE ENGINE MODEL RD-1820

and crankshaft rear, when master rod and articulated rod assembly is in the extreme forward position (fig. 43).

(5) **INSTALL REAR MAIN BEARING.** Heat rear main bearing inner race for 10 minutes in an oil bath maintained at a temperature of 225°F. (107°C.), and install on crankshaft rear extension. Insure that lip of outside diameter of inner race is facing toward crankshaft rear cheek. Tap rear end of inner race after installation to insure that it is bottomed on shoulder of crankshaft rear. Install crankshaft rear main bearing outer race, retainer and rollers on inner race. Insure that side of outer race marked "Propeller End" is facing toward crankshaft rear cheek. Install crankshaft rear main bearing nut and tighten, using wrench (5A2303) (fig. 38), lining up one of the tapped holes in nut with one of the drilled holes in crankshaft rear extension. Install a new tab lock and rear main bearing nut locking capscrew. Tighten lock screw and bend up tab lock.

(6) **CHECK CRANKSHAFT RUNOUT.** Remove crankshaft assembly from assembly and disassembly fixture and install on two alignment check rollers. While turning crankshaft on rollers, use a dial indicator to check runout at front and rear flywheel flange journals of crankshaft (par. 22). If crankshaft runout is above limit, it will be necessary to reassemble crankshaft to obtain proper alignment. Check clearance between shank of master rod and front surface of rear counterweight or counterweight pins, whichever is closer to rod. When making this check, hold master rod in extreme rear position on crankpin, with end seal spacer contacting crankshaft rear. The minimum permissible clearance in this location is 0.038 inch.

(7) **INSTALL FRONT MAIN BEARING.** Heat the inner race of crankshaft front main bearing in an oil bath at 225°F. for ten minutes. Install race on crankshaft, tapping race lightly with a fiber drift while cooling to insure a tight fit against shoulder of crankshaft.

17. SUPERCHARGER.

a. Disassembly (fig. 46).

(1) **REMOVE ACCESSORY DRIVE.** Remove accessory drive housing attaching nuts, and lift assembly from rear cover (fig. 2). Remove revolution counter assembly and drive shaft, but do not disassemble unless unit is inoperative. Lift out bushing assembly, shaft and plug assembly. Do not remove plug from shaft. Lift off bearing assembly from rear cover using puller capscrews in tapped holes. Remove gear retaining nut. Lift off gear and withdraw shaft from bearing.

(2) **REMOVE SUPERCHARGER REAR HOUSING COVER.** Remove elastic stop nuts and three puller hole plugs from rear cover. Make certain primary oil filter is removed. Insert three long cap screws in puller holes. Screw down cap screws evenly to remove rear cover. Lift off

ORDNANCE MAINTENANCE — ORDNANCE ENGINE MODEL RD-1820 (CATERPILLAR)

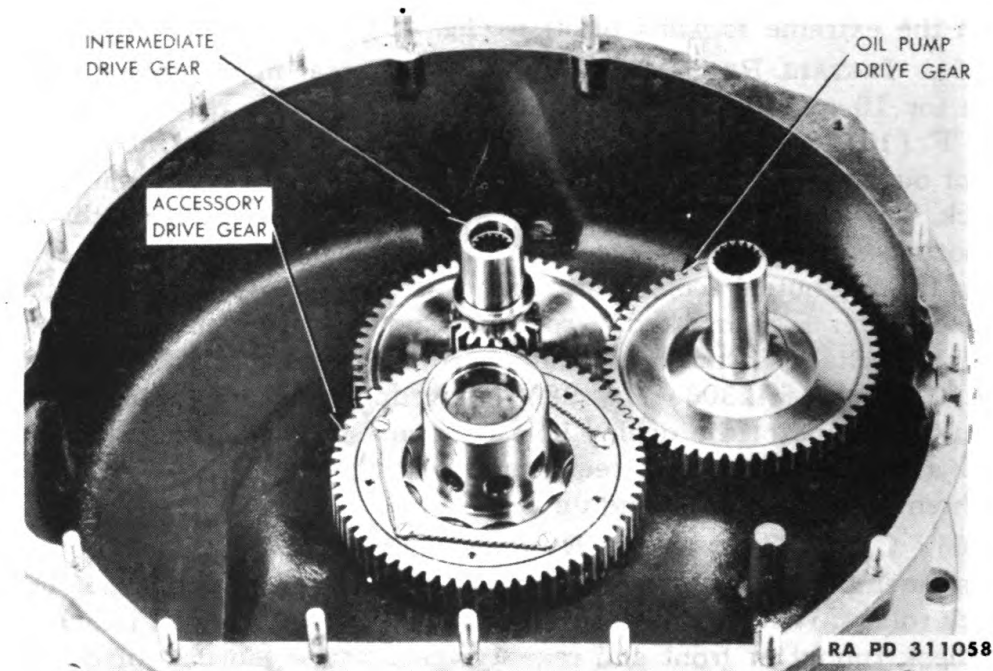

Figure 47 — Accessory Drive Gears

rear cover and remove puller cap screws. Lift oil pump drive gear (fig. 47) from supercharger rear housing.

(3) **REMOVE IMPELLER DRIVE.** Lift out accessory drive shaft, making certain shaft splines do not scratch or score impeller shaft bushings. Remove bronze thrust ring from recess in impeller shaft retainer. Remove five screws which attach accessory drive gear rear plate to shaft and remove plate. While disassembling springs and retaining pins from shaft, wrap a heavy cloth tightly around accessory drive gear and rear end of shaft, so that when the springs are driven out of shaft they will not be free to fly. Stand the shaft on a disassembly bench, rear end down, and drive out springs and retaining pins with a mallet. Remove cloth from shaft. Remove gear by turning approximately 30 degrees to disengage internal lugs on gear from mating ears on shaft. Remove the five flat head screws which secure impeller shaft retainer to rear housing. Remove retainer, ring, shims, spherical thrust ring, and steel washer.

(4) **REMOVE IMPELLER AND IMPELLER SHAFT.** Place strips of light cardboard between impeller vanes and diffuser plate to protect these parts during the following operations. Bend tab of impeller nut lock out of slot of nut. Install impeller holding fixture (5A2170) on supercharger rear housing (fig. 48). With impeller locked firmly, remove impeller nut using lug wrench (5A2264). Remove impeller nut lock and impeller shaft front oil sleeve and rings. Remove oil seal

ORDNANCE ENGINE MODEL RD-1820

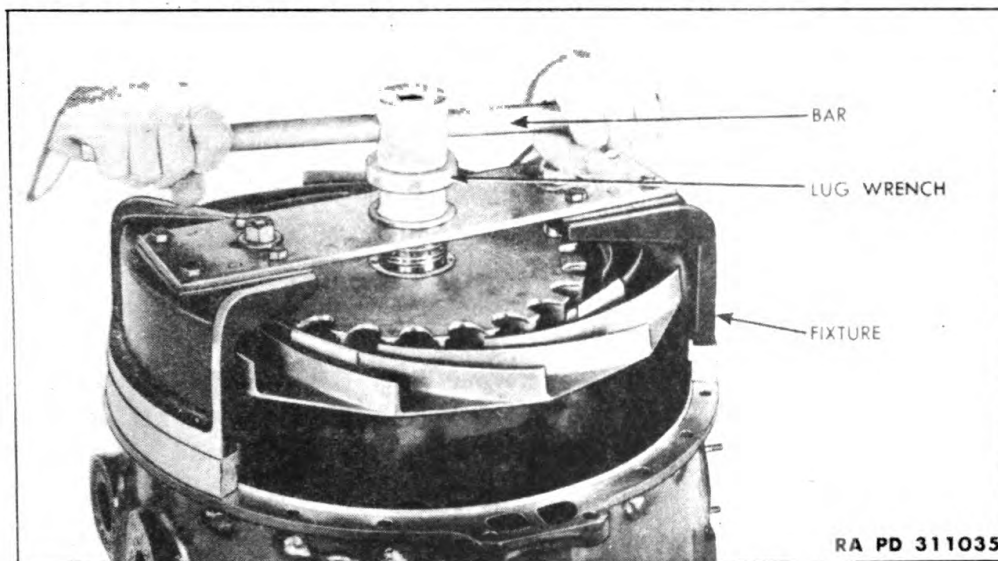

Figure 48 – Removing Impeller Nut, Using Fixture 5A2170 and Wrench 5A2264

from sleeve and discard rings. Remove impeller locking tool. Remove impeller from shaft using puller (5A2263) (fig. 48). Remove impeller shaft from rear housing (fig. 50). Remove impeller shaft rear oil sleeve and rings and bronze washer from impeller shaft (fig. 50). Do not remove diffuser plate from supercharger rear housing unless inspection indicates that its replacement is necessary.

b. Cleaning. Wash all parts thoroughly in dry-cleaning solvent.

c. Inspection.

(1) **SUPERCHARGER FRONT HOUSING.** Inspect supercharger front housing for cracks, nicks and chafing, particularly at parting surfaces. Inspect rear side of web for roughness and depressions caused by chafing of diffuser plate vanes. Inspect impeller shaft bearing support for cracks, smoothness of contacting surfaces and its inside diameter for roughness or wear.

(2) **SUPERCHARGER REAR HOUSING.** Inspect for cracks, galling and chafing, particularly at the parting surfaces and at locations of bolt holes and studs. Inspect finished surfaces for scratches and nicks. Make certain oil passages are clean and free from obstruction. Check rear impeller shaft sleeve for tightness in rear housing and for roughness and wear on inside diameter. Inspect flange at rear end of this sleeve for scoring, galling and wear. Inspect impeller drive gear front bushing for tightness in rear housing and for scratches, burs and wear. Check fit of impeller drive gear front journal in bushing (par. 22).

(3) **DIFFUSER PLATE.** Inspect diffuser plate for cracks. Examine vanes for nicks, burs and mutilation on its edges.

ORDNANCE MAINTENANCE — ORDNANCE ENGINE MODEL RD-1820 (CATERPILLAR)

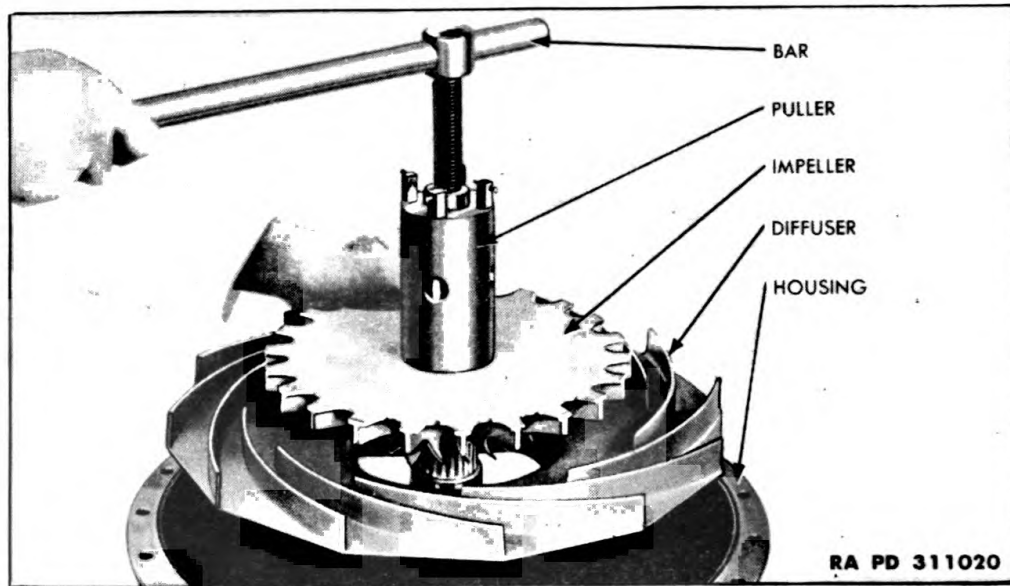

Figure 49 — Removing Impeller, Using Puller 5A2263

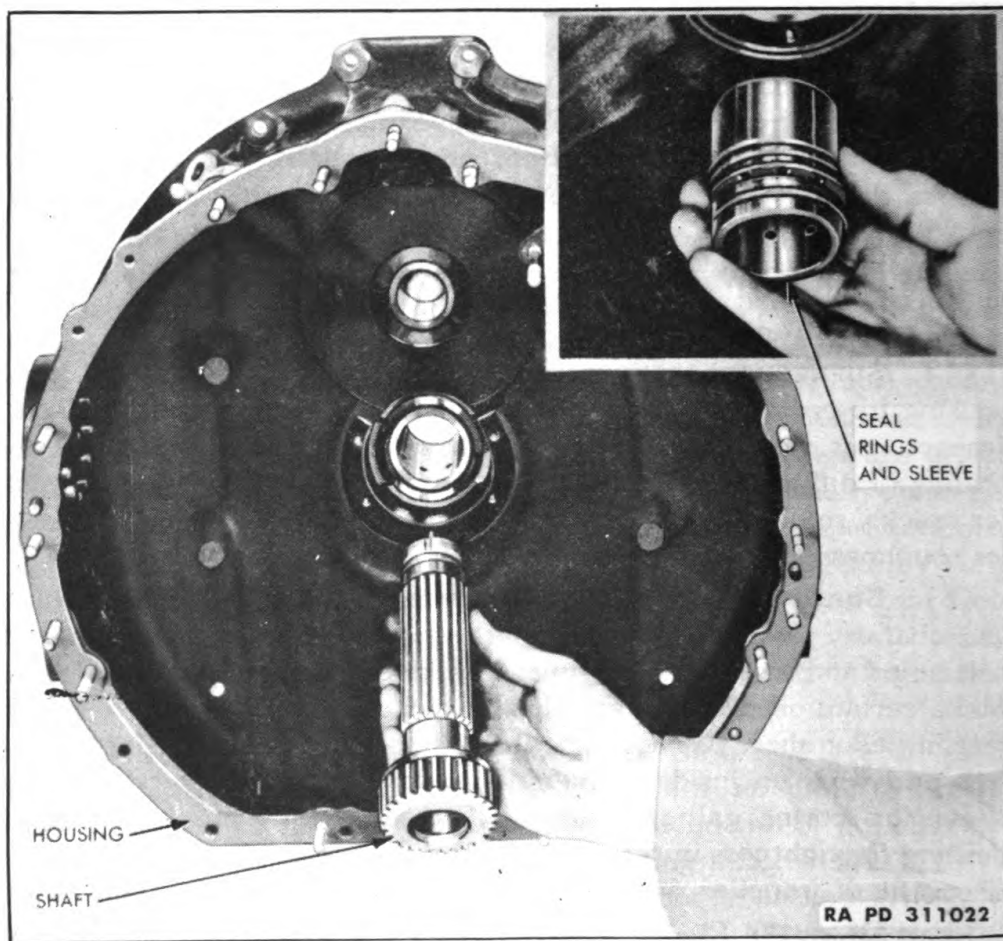

Figure 50 — Impeller Drive Shaft and Seal

ORDNANCE ENGINE MODEL RD-1820

(4) **SUPERCHARGER REAR HOUSING COVER.** Inspect cover for cracks, galling, and chafing at finished surfaces, bolt holes and studs. Inspect oil passages for cleanliness. Examine bushings for tightness in cover, scratches, burs, and wear. Check fit of shafts in bushings (par. 22). Make certain accessory drive shaft bushing has one slot located directly opposite oil passage from oil filter recess. Replace bushing, if necessary, to secure this alinement.

(5) **IMPELLER.** Inspect impeller for cracks in hub and blades. Examine blades for scratches, burs, roughness, and evidence of rubbing against diffuser plate. Inspect impeller splines for burs, pitting, galling, picking-up and wear. The impeller should slide on shaft approximately half way by hand. *An impeller which slides on shaft all the way by hand should not be used.*

(6) **Impeller Shaft.** Inspect impeller shaft and integral gear for cracks, particularly at threads, splines, and gear teeth. Check splines and gear teeth for pitting, burring, chipping, galling and wear. Examine impeller shaft front and rear bushings for burs, scratches, galling, wear and tightness in shaft. Check fit of accessory drive shaft in bushings (par. 22). Inspect impeller shaft front and rear oil sleeves for cracks, burring, and galling. Inspect ring grooves for wear and for chipped, burred and broken lands (par. 22). Inspect impeller shaft gear bronze washer and thrust ring steel washer for cracks, scratches, burring and scoring. Check spline condition of steel washer. Check spherical thrust ring for cracks, nicks, burs, and scores. Inspect shaft retainer for cracks, chipping, burring and wear of ring groove.

(7) **IMPELLER DRIVE GEAR AND PINION.** Inspect for cracks, pitted, burred, chipped and worn teeth; and for burred, scratched, scored and worn journals.

(8) **ACCESSORY DRIVE.** Inspect housing for cracks, nicks and chafing. Check fits of shafts in mating bushings (par. 22). Inspect gears for cracks, pitted, burred, and worn teeth.

d. Repair.

(1) **OIL SEAL RINGS.** Fit new oil seal rings in impeller shaft front and rear oil sleeves, insuring that proper ring side clearance and gap are obtained (Refer to par. 22).

(2) **IMPELLER SHAFT THRUST RING.** If the bronze spherical impeller shaft thrust ring and spherical counterbore in impeller shaft retainer are scratched, burred or scored, lap the mating spherical surfaces of these parts.

(3) **DIFFUSER PLATE.**

(a) **Remove.** If replacement of diffuser plate is found to be necessary, remove attaching nuts and lift off plate.

(b) **Install.** The installation necessitates a pinch fit between diffuser plate and supercharger front housing. The fit is controlled by

ORDNANCE MAINTENANCE — ORDNANCE ENGINE MODEL RD-1820 (CATERPILLAR)

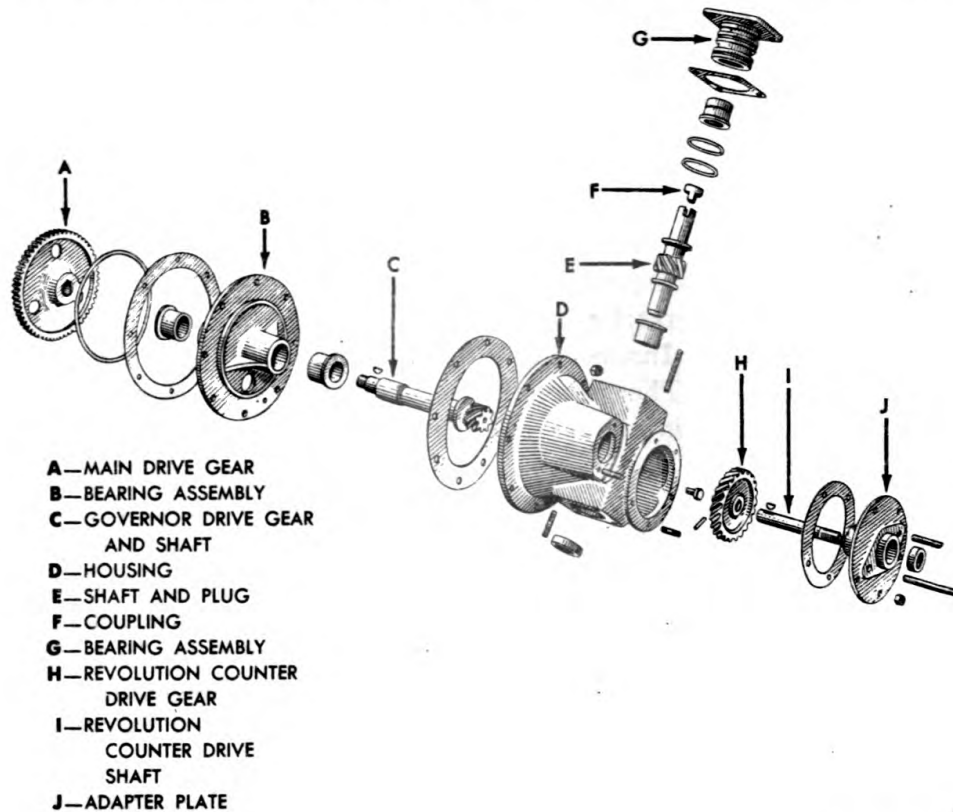

RA PD 311048

Figure 51 — Accessory Drive Disassembled

installing a shim or shims between diffuser plate and supercharger rear housing. It is not necessary to check this pinch fit at overhaul of an engine in which the original diffuser plate and supercharger front and rear housings are used, since proper fit is obtained at initial assembly of engine. If a new diffuser plate or front or rear supercharger housing is used, adjustment must be made as follows: Place diffuser plate in position on supercharger rear housing. Insert and tighten diffuser plate nuts but do not lockwire at this time. Place supercharger rear housing in position on front housing parting flange without a gasket. Make certain that vanes of diffuser plate are resting on supercharger front housing. Measure clearance between parting surfaces of supercharger front and rear housings, using two feeler gages on diametrically opposite sides of housings. Measure thickness of gasket used between supercharger front and rear housings using a micrometer and subtract .001 inch from this measurement to allow for compressibility of gasket. Subtract figure thus obtained from measured clearance between supercharger front and rear housings. This final figure is the pinch fit which will be obtained between diffuser vanes and supercharger front housing when nuts attaching supercharger front housing to rear housing are tightened. Refer to

ORDNANCE ENGINE MODEL RD-1820

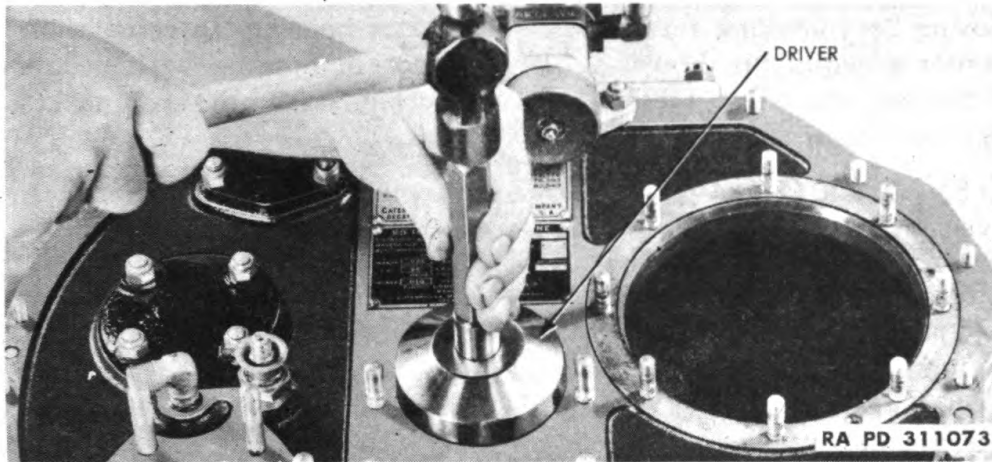

**Figure 52 – Installing Supercharger Rear Cover Core Plug,
Using Driver 5A2157**

paragraph 22 for proper fit. If figure obtained above representing this pinch fit is less than minimum figure given in paragraph 22, it will be necessary to install one or two diffuser plate shims, as required, to obtain proper fit. Lift supercharger rear housing from front housing, and remove diffuser plate nuts and diffuser plate. Install shim or shims, if necessary, on diffuser plate parting surface and assemble diffuser plate to supercharger rear housing. Tighten diffuser plate attaching nuts and lock wire securely.

(4) **ACCESSORY DRIVE** (fig. 51).

(a) *Bearing Assembly.* To replace bushing in bearing assembly, pull or machine out old bushings. Press in new bushings and line ream to proper size (par. 22). Machine faces of bushings, taking off an equal thickness of face, to obtain a dimension of 5.093 to 5.090 inches between bushing faces. Check end play of shaft upon assembly (par. 22).

(b) *Housing Assembly.* To replace bushing in accessory housing, press out old bushing and press in new one. Ream bushing to obtain proper fit with mating part (par. 22). Machine face of bushing to obtain a depth of 3.976 to 3.973 inches from face of bushing to face of housing where bushing assembly seats. Check end play of shaft upon assembly (par. 22).

(c) *Bushing Assembly.* To replace bushing, press out old one and press in new one. Ream bushing to obtain proper fit with mating part (par. 22). Machine face of bushing to obtain 1.941 to 1.939 inches between face of bushing and seating surface of retaining bushing. Check end play of shaft upon assembly (par. 22).

ORDNANCE MAINTENANCE — ORDNANCE ENGINE MODEL RD-1820 (CATERPILLAR)

(d) *Revolution Counter.* The revolution counter is to be disassembled only when it is inoperative. Remove counter assembly from housing by removing retainer nut at side of housing. In reinstalling counter assembly in housing, line up pilot in housing with groove in counter assembly. Install retainer, spring assembly, and gasket. Tighten retainer securely.

(5) **REAR COVER.** If the large core plug is removed from rear cover, install a new plug using driver (5A2157) (fig. 52).

e. Assembly.

(1) **INSTALL IMPELLER AND IMPELLER SHAFT INTO REAR SUPERCHARGER HOUSING.** Install bronze washer on impeller shaft splines so that chamfered side of internal diameter of washer is against gear. Install impeller shaft rear oil seal, with rings, on shaft so that oil seal rings are nearest gear (fig. 50). Place impeller shaft in position in supercharger rear housing, taking care that oil seal rings are not damaged. Place impeller shaft spherical thrust ring on rear end of shaft, and install laminated steel shim and impeller shaft retainer on supercharger rear housing (fig. 53). Tighten five flat head screws into tapped holes in rear housing to secure retainer to housing. Do not stake screws at this time. Check impeller shaft end movement by inserting a feeler gage between spherical thrust ring and rear end of impeller shaft (fig. 54) (par. 22). If impeller shaft and movement is not within specified limits, add or subtract laminations from shim used under impeller shaft retainer and repeat this check. Remove impeller shaft retainer attaching screws and retainer, install impeller intermediate gear shaft (fig. 47) in its bushing in rear housing, and reinstall retainer and attaching screws. Stake attaching screws into retainer after tightening.

(2) **INSTALL IMPELLER.** Press impeller on impeller shaft as far as possible by hand. Complete installation of impeller as follows using puller (5A2263) and adapter (5A2310) (fig. 55). Tighten four screws passing through body of installing tool into tapped holes of impeller. Install adapter on end of rod which passes through impeller shaft so that pilot on adapter is centered in spherical thrust ring. Lock adapter in place with locking pin. The adapter tool should be seating on impeller shaft retainer, and locking pin should be seating in semi-circular groove in adapter. Press impeller on shaft by turning screw until impeller hub is bottomed on rear impeller shaft oil sleeve. Remove installing tools. Measure clearance between impeller blades and diffuser plate when impeller is in extreme rear position. Obtain this measurement, using a feeler gage, checking at several points around impeller circumference (fig. 56) (par. 22). If this clearance is too small, remove impeller, impeller shaft retainer, and impeller shaft. Grind required amount from bronze washer which is installed ahead

ORDNANCE ENGINE MODEL RD-1820

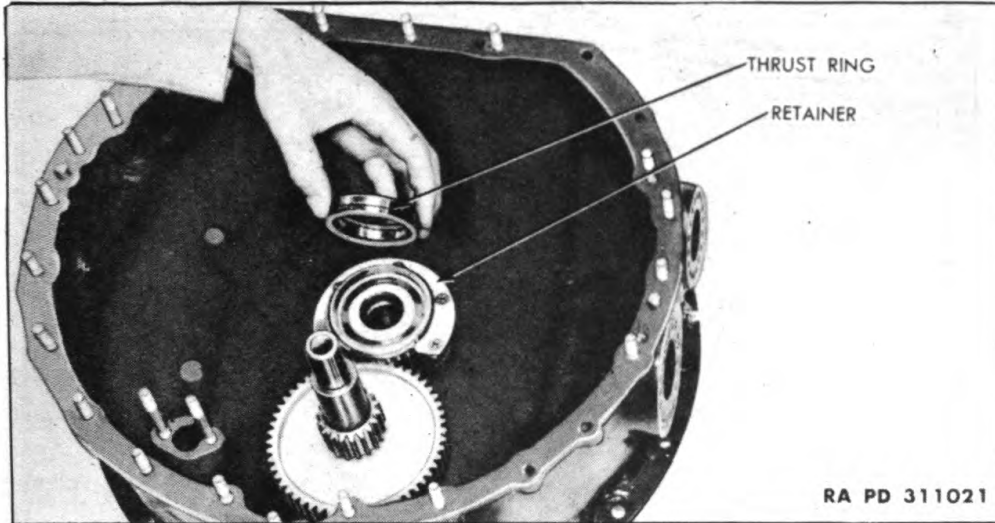

Figure 53 – Impeller Drive Shaft Thrust Ring

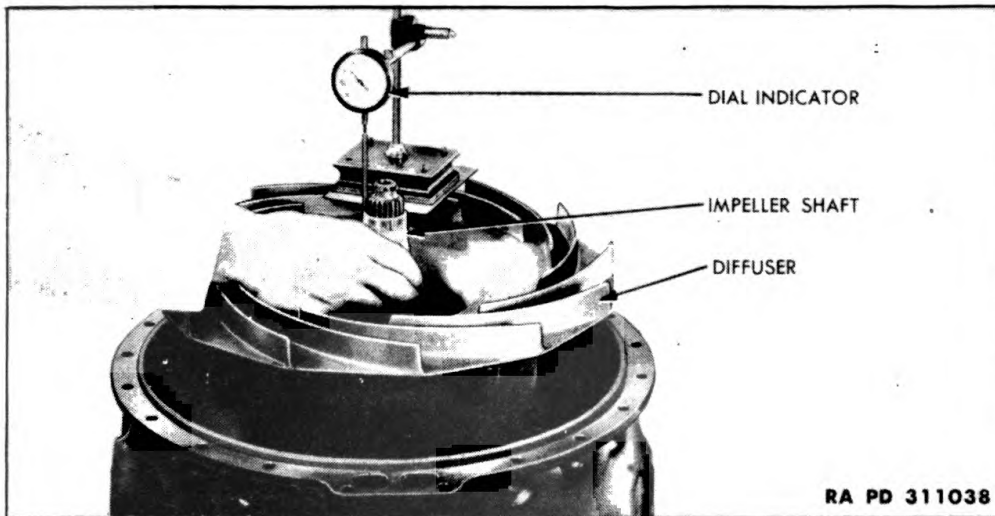

Figure 54 – Checking Impeller Shaft End Clearance

of impeller shaft gear. If clearance is too large, remove impeller shaft retainer, and impeller shaft and install a thicker bronze washer, grinding in same manner as above to obtain proper clearance. In either case, recheck end movement of impeller shaft in same manner as previously described before pressing on impeller. Changing the width of bronze impeller shaft gear washer may change impeller shaft end movement so that it is not within proper limits. Install front impeller shaft oil sleeve, with rings, on impeller shaft, so that oil seal rings are nearest threaded end of shaft. Install impeller nut lock and impeller front nut. Lock impeller, using holding fixture

ORDNANCE MAINTENANCE — ORDNANCE ENGINE MODEL RD-1820 (CATERPILLAR)

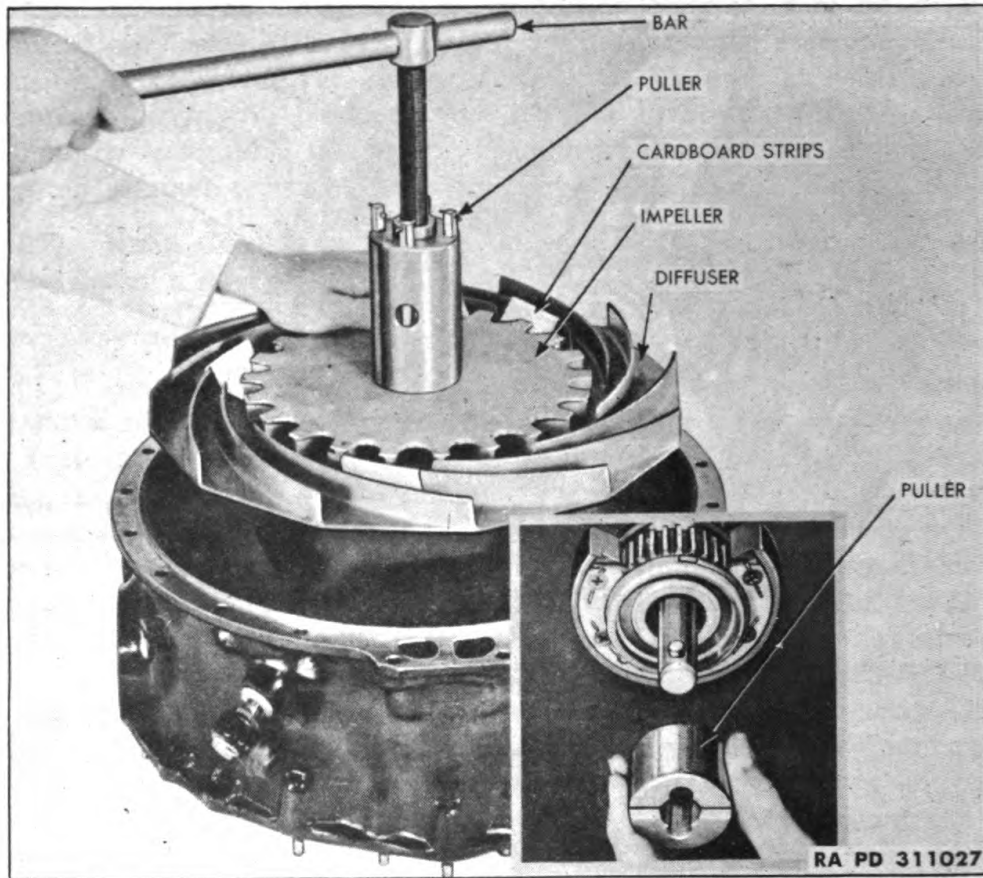

Figure 55 — Installing Impeller, Using Puller 5A2263 and Adapter 5A2310

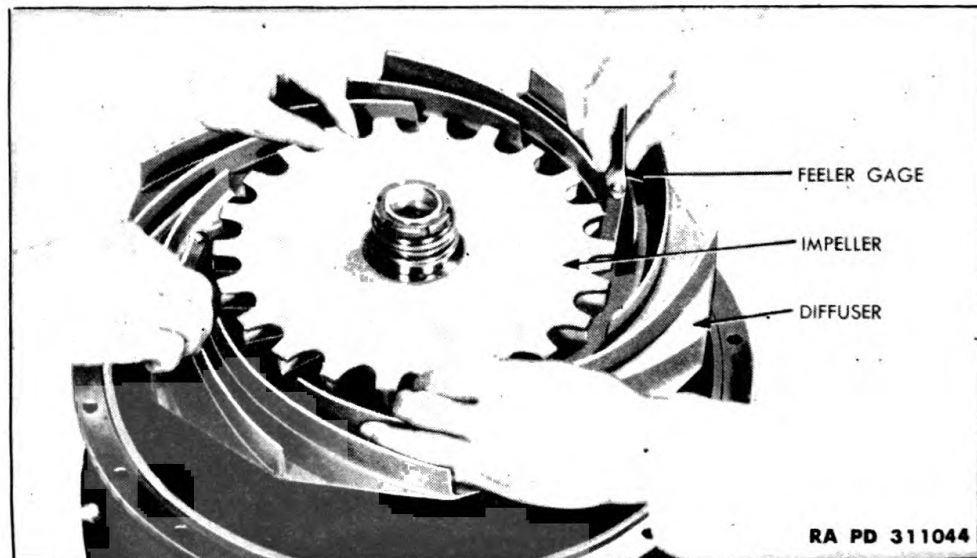

Figure 56 — Checking Impeller Clearance

ORDNANCE ENGINE MODEL RD-1820

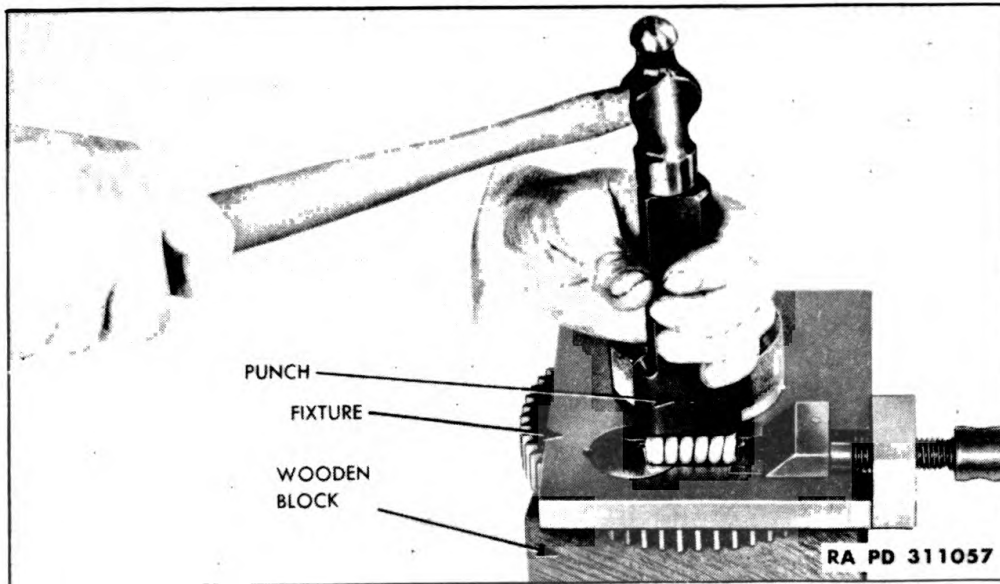

Figure 57 – Installing Spring and Retainer Pins, Using Fixture 5A2315

(5A2170). Tighten impeller front nut using lug wrench (5A2264) (fig. 48). Bend one tab of impeller nut lock into a slot in nut. **CAUTION: Make certain tab does not crack or break on bending.** Remove tools from the supercharger rear housing.

(3) **ASSEMBLE ACCESSORY DRIVE SHAFT** (fig. 57). Place accessory drive gear on accessory drive shaft and turn gear to engage internal lugs of gear with mating ears of shaft. Install spring and pin assemblies using fixture (5A2315).

(4) **INSTALL ACCESSORY DRIVE SHAFT.** Install bronze accessory drive shaft thrust ring in recess of impeller shaft retainer. Install accessory drive shaft in position in impeller shaft, meshing accessory drive shaft gear with intermediate impeller shaft pinion (fig. 47). Insure that splines on front end of accessory drive shaft do not scratch or score impeller shaft bushings, and that impeller shaft retainer oil seal ring is not damaged. Check end movement of accessory drive shaft. To do this, install rear supercharger housing cover and gasket temporarily, and secure with three attaching nuts on each side. Locate a dial indicator on rear cover through accessory drive bore, so that indicator spindle contacts drive gear on accessory shaft. Move the shaft up and down by hand, holding end of shaft which extends through impeller shaft. Note difference in indicator readings, which is end movement of shaft (par. 22). If the end movement is insufficient, surface-grind the required amount from bronze accessory drive shaft thrust ring. If the end movement is excessive, install a new thrust ring. When proper end movement is obtained, remove supercharger

ORDNANCE MAINTENANCE — ORDNANCE ENGINE MODEL RD-1820 (CATERPILLAR)

rear housing cover. Place oil pump drive gear in position in supercharger rear housing, meshing with accessory drive gear (fig. 47).

(5) **INSTALL SUPERCHARGER REAR COVER.** Insure that parting surfaces of supercharger rear housing and cover are clean and smooth. Install new gaskets on supercharger rear housing. Lower cover onto supercharger rear housing, making certain that ends of all shafts in rear housing enter their respective bushings in rear cover. Secure supercharger rear housing cover to rear cover by installing elastic stop nuts on rear cover attaching studs. Install accessory drive cover plate to rear supercharger housing cover, securing in place with elastic stop nuts.

(6) **ACCESSORY DRIVE** (fig. 51).

(a) *Install Governor Drive.* Install rubber seal in groove in governor drive shaft bearing assembly. Insert governor drive shaft gear through bearing assembly so that gear end of shaft is on anti-oil-seal end of bearing assembly. Install key in shaft and place gear on key and shaft so that large internal diameter hub is against bushing of bearing assembly. Secure gear on shaft with nut and tab lock. Bend lock up on nut and down on flat on gear. Place gasket over studs on rear supercharger cover, lining up oil holes in gasket with oil holes in cover and install bearing and gear assembly into rear cover, mating large spur gear with supercharger drive shaft gear in rear housing. Insure that rubber oil seal on bearing assembly enters rear housing without binding.

(b) *Assemble Governor and Revolution Counter Drive.* Press revolution counter drive shaft thrust button into accessory drive housing. Install governor, revolution counter shaft, and plug assembly into bushing in housing. Place gasket over studs in housing. Install rubber oil seals on governor drive shaft bushing assembly, and place assembly over shaft into housing. Tighten bushing assembly, and check end clearance of governor, revolution counter shaft, and plug assembly. If end clearance is below 0.013 inch, replace gasket under bearing assembly to obtain this dimension. Install oil seal over shaft into housing at splined end of shaft, and place governor drive coupling in place at opposite end of shaft.

(c) *Assemble Revolution Counter Drive.* Place key in revolution counter drive shaft. Install revolution counter drive gear over key and shaft, so that extended hub will be towards end of shaft. Hold gear so that distance from end of shaft to opposite face of gear is 0.878/0.870. Drill a 0.0943- to 0.0938-inch diameter hole through shaft and gear by piloting drill in hole in gear hub. Drive grooved locking pin through hole to secure gear on shaft. In driving pin into hole, enter ungrooved end of pin into hole first. Place revolution counter drive shaft assembly in housing so that end of shaft bottoms on button in housing and gear meshes with governor and transfer pump drive shaft gear. Place gasket

ORDNANCE ENGINE MODEL RD-1820

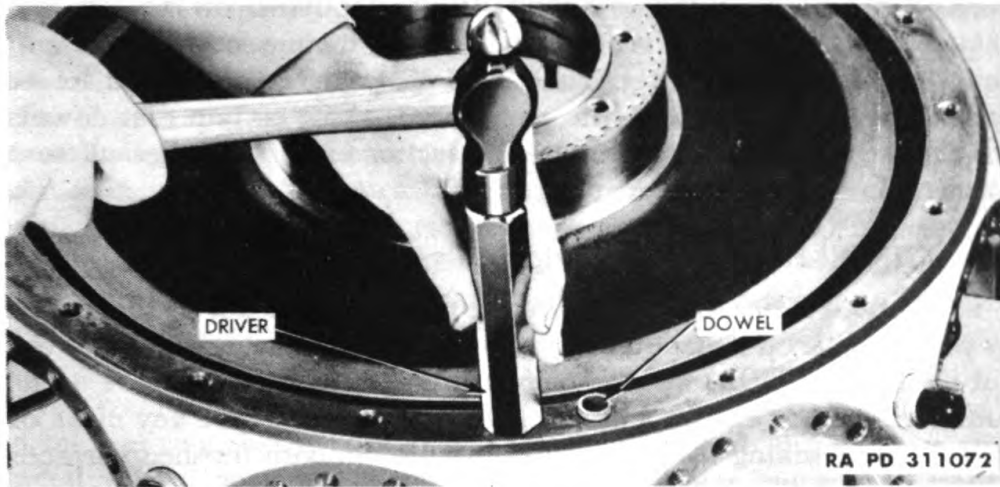

Figure 58 – Installing Crankcase Dowels, Using Driver 5A2156

over studs, and install adapter plate assembly over revolution counter drive shaft. Secure plate in place with elastic stop nuts. Place oil seal over shaft and drive into bore of adapter plate.

(d) *Install Accessory Drive.* Install gasket and mesh gears in each assembly. Secure in place with elastic stop nuts.

18. CRANKCASE MAIN REAR SECTION.

a. **Disassembly.** Remove 18 nuts which secure crankcase rear main section to supercharger front housing. Lift section off supercharger front housing.

b. **Cleaning.** Wash part in dry-cleaning solvent.

c. **Inspection.** Inspect housing and seal support for cracks, galling and chafing, particularly at parting surfaces and cylinder mounting pads. Inspect rear bearing location for scoring and galling. Check fit of bearing (par. 22).

d. **Assembly.**

(1) **ASSEMBLE SUPERCHARGER FRONT HOUSING.** Install impeller shaft bearing support by placing gasket on front face of supercharger front housing, support on gasket and ring on support. Line up holes and insert eight screws from inside of supercharger front housing. Lock screws to ring by staking them at threaded end with a center punch. Stake screws as near to ring as possible.

(2) **ASSEMBLE CRANKCASE REAR SECTION.** Assemble eight hollow dowels and eight rubber seal rings in crankcase main rear section by driving dowels into position with driving tool (5A2156) (fig. 58) and placing seal rings on protruding portion of dowel.

ORDNANCE MAINTENANCE — ORDNANCE ENGINE MODEL RD-1820 (CATERPILLAR)

(3) **ASSEMBLE SUPERCHARGER FRONT HOUSING ON TO CRANKCASE REAR SECTION.** Place crankcase rear main section front end down on bench. Place larger rubber oil seal ring in place, and lower supercharger front housing onto crankcase making certain that dowels are properly alined. Secure these two sections with 18 spherical seat washers and 18 attaching cap screws.

19. MISCELLANEOUS ITEMS.

a. **Intake Pipes.** Straighten intake pipes that are not badly dented by placing pipe on a mandrel of proper size and shape, and hammering out dents with a light wooden or fiber mallet. Use extreme care when hammering not to reduce wall thickness of pipes. Remove any nicks or burs from attaching flanges with a fine file. Smooth finished surfaces with crocus cloth.

b. **Air Deflectors and Cowling.** Straighten bent or dented cylinder air deflectors and cowling. Small cracks may be repaired by welding.

CHAPTER 2 — cont'd

Section IV

ASSEMBLY

	Paragraph
Preliminary instructions	20
Assembly instructions	21

20. PRELIMINARY INSTRUCTIONS.

a. In the final assembly of engine it is presumed that all engine parts and components have been inspected and that replacements have been made where needed as described in the preceding paragraphs. It is important that each subassembly be reexamined before it is installed in engine. Take positive precaution to assure that all parts are clean. Parts which have been coated with a rust-preventative compound must be washed and all traces of this material removed (Refer to par. 7.) It is also assumed that engine is mounted in a suitable rotating assembly stand.

21. ASSEMBLY INSTRUCTIONS.

a. **Install Crankcase Rear Main Section.** Install supercharger front housing and crankcase rear section assembly on rear engine support. Install bolts holding assembly to rear engine support, putting bolts marked "Y" in holes directly opposite each other. These bolts are used for alining rear engine support. Install washers and elastic stop nuts.

ORDNANCE ENGINE MODEL RD-1820

b. Install Supercharger (fig. 21). Turn the engine on the assembly stand so that propeller shaft points downward. Place lifting eye (5A2207) on rear cover plate studs and secure with plate retaining nuts. Coat impeller shaft front oil seal ring assembly with engine oil, and stagger ring gaps evenly. Install a new gasket on supercharger front housing parting surface. Thoroughly inspect diffuser section and inside of intake pipe bosses to insure no foreign material is present. Lower supercharger rear housing onto supercharger front housing, exercising care to prevent damage to impeller oil seal rings. If rear section sticks or any other difficulty is encountered while supercharger rear housing is being installed, lift it from engine and inspect impeller shaft oil seal rings for possible damage. Insure that rings are not twisted. An oil seal ring that is twisted will prove ineffectual, and must be replaced with a new part. Secure supercharger rear housing to front housing with elastic stop nuts. Remove lift eye and install cover plate.

c. Install Crankshaft (fig. 20). Turn engine on stand so that supercharger is downward. Install lifting eye (5A2265) on front of crankshaft at flywheel retaining nut threads. Lower crankshaft assembly carefully on to rear main section, placing master rod in No. 1 cylinder pad location and articulated rods in their respective locations. Remove lifting eye and install crankshaft front end protector (5A2342). Use extreme care when lowering assembly not to damage outer race of rear main bearing.

d. Install Crankcase Front Main Section (fig. 19).

(1) **ASSEMBLE BEARINGS AND SEALS.** Assemble outer race and rollers in bearing retainer of crankcase front main section. If necessary, tap into position with a fiber drift. However, if outer race is loose in crankcase main front section, install bearing assembly on crankshaft. Note that bearing outer race is marked "Propeller End" for proper installation. Install cam driving gear spacer and ring assembly into inner bore of crankcase main front section. Tap spacer into place against front main bearing outer race. Check rings for proper gap and side clearance (par. 22). Coat matching surfaces of both front and rear sections with cement Type B Joint and thread compound and install nine short rubber seals at these surfaces on crankcase rear main section. Make certain that seals are in their proper position before continuing assembly.

(2) **INSTALL CRANKCASE FRONT MAIN SECTION.** Install crankcase front main section and cam drive gear assembly over the crankshaft, locating proper cylinder pads and insuring that oil dowels are lined up. Install crankcase attaching nut and tighten with wrench (5A2306) (fig. 59). Insert cotter pins. Cut off rubber oil seals between front and rear main sections flush with cylinder bores.

ORDNANCE MAINTENANCE — ORDNANCE ENGINE MODEL RD-1820 (CATERPILLAR)

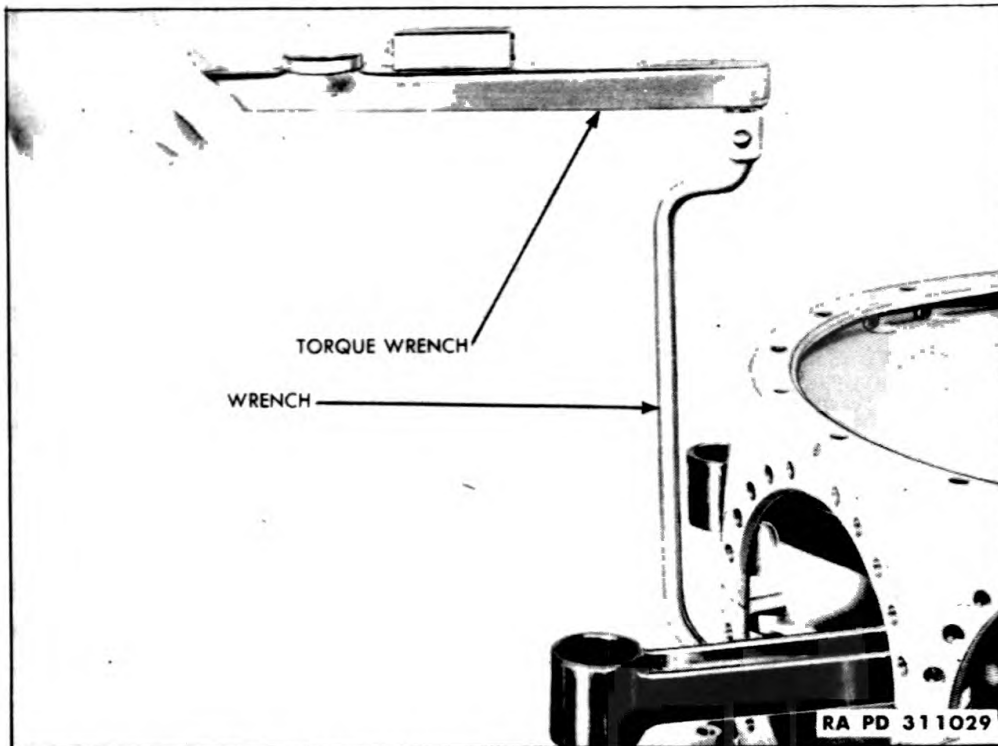

**Figure 59 — Tightening Crankcase Main Section Nuts,
Using Wrench 5A2306**

(3) **TIME CAM DRIVING GEAR.** Turn intermediate cam drive gear until timing marks on pinion gear line up with similar marks on cam. In this position, timing marks on teeth of intermediate cam drive gear nearest crankshaft should be directly in line with center line of crankshaft. Turn crankshaft until the marked spline tooth lines up with timing marks on internal spline of cam driving gear. The timing mark on cam driving gear should then be meshing with timing marks on intermediate cam drive gear (fig. 37).

(4) **CHECK PISTON COOLING NOZZLE CLEARANCE.** Check clearance between piston cooling nozzles and front counterweight by rotating crankshaft 360 degrees and checking clearance as counterweight passes each piston cooling nozzle. Should interference exist, the piston cooling nozzle should be replaced.

e. Install Crankcase Front Section.

(1) **INSTALL SEALS.** Install sealing ring on pilot diameter of crankcase front section (fig. 60). Install "T" section oil passage seal into oil manifold groove that transmits lubricating oil to valve tappets (fig. 61).

(2) **INSTALL CRANKCASE FRONT SECTIONS.** Place complete crankcase front section on to crankcase main section. Place a pencil

ORDNANCE ENGINE MODEL RD-1820

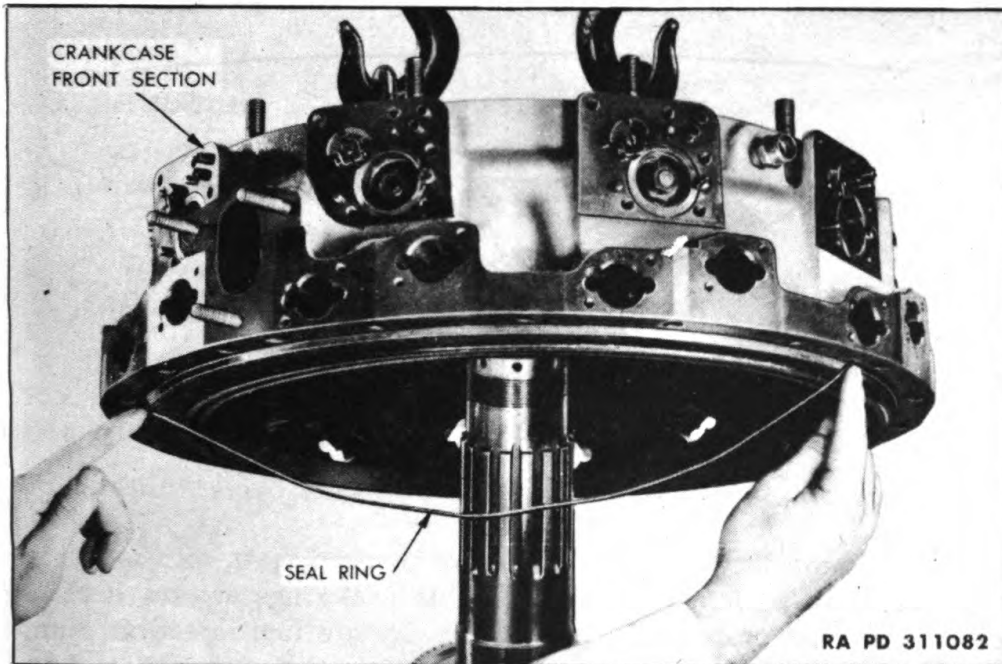

Figure 60 – Installing Crankcase Seal

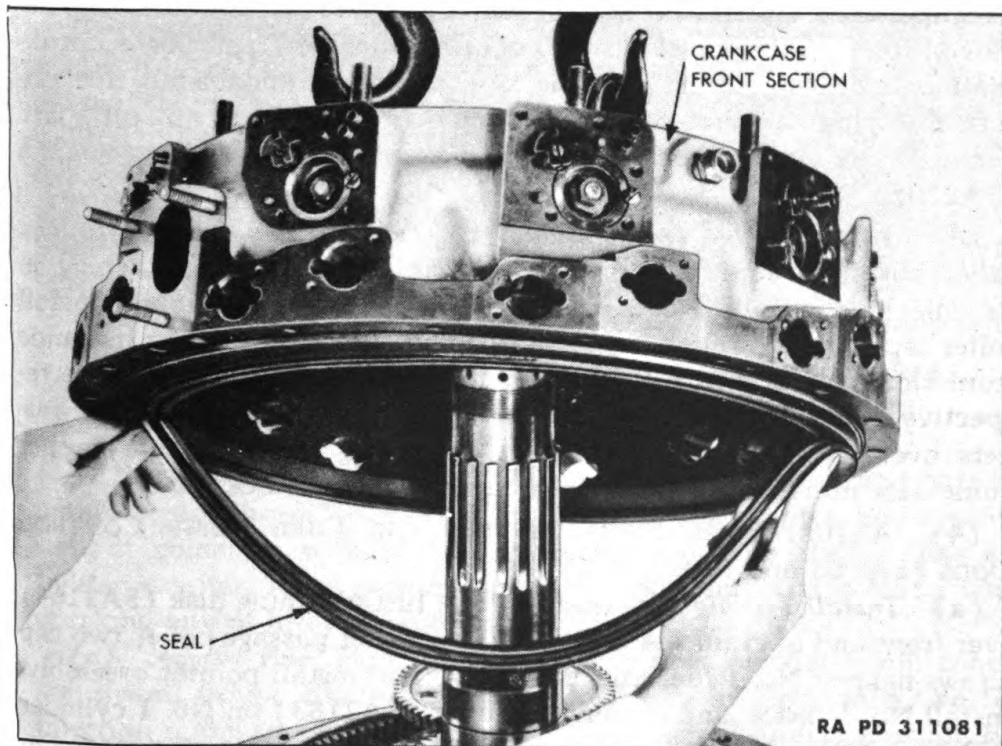
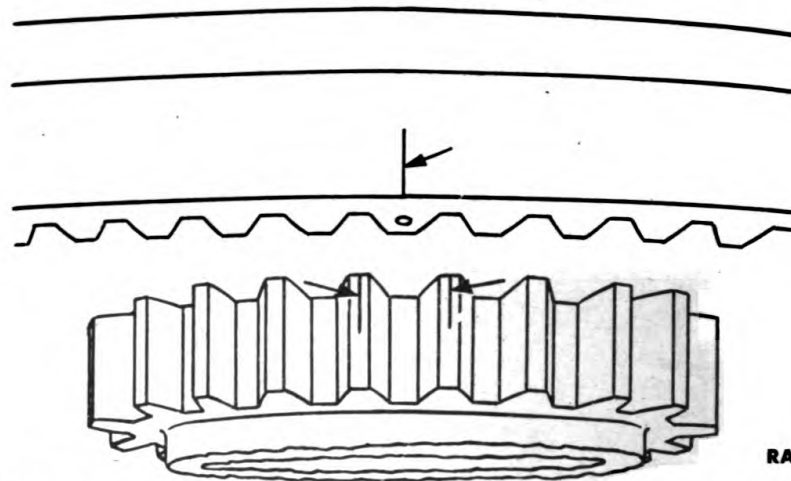

Figure 61 – Installing Crankcase Oil Passage Seal

ORDNANCE MAINTENANCE — ORDNANCE ENGINE MODEL RD-1820 (CATERPILLAR)



RA PD 311036

Figure 62 — Pencil Marks on Cam and Cam Drive Pinion

mark on the top land of each of the two marked teeth on fuel injection cam drive pinion. Check to see that seal rings are on each of hollow dowels in crankcase main section. Rotate fuel injection pump cam or cam drive pinion as required to line up timing marks and engage marked teeth (fig. 62). Be sure also that hollow dowels in the main section enter the dowel holes in front section as it is pulled into position. Secure front crankcase in place with cap screws. (Tighten securely but do not torque cap screws as they must be removed for installation of piston cooling manifold.) Lubricate crankshaft ball bearing thrust nut and ring assembly, and install nut. Insure that rings are not damaged when screwing thrust nut on shaft. Tighten nuts securely, using crankshaft thrust bearing nut lug wrench (5A2297).

(3) **INSTALL VALVE TAPPETS.** Lubricate valve tappet rollers, roller bushings, and pins, with engine oil. Insert a roller bushing in its roller and install these parts in slotted end of valve tappet. Install roller tappet pin through tappet and roller. Install tappet in its guide from slotted end. Insure that each tappet is assembled with its respective guide. Place locking circlet in position in guide. Install gaskets over each valve tappet guide mounting. Install valve tappet guide assemblies and secure with cap screws and lock wire.

(4) **ADJUST FUEL PUMP LIFTERS AND FUEL PUMP CONTROL DOGS** (figs. 63 and 64).

(a) *Install Timing Disk and Fixture.* Install timing disk (5A2164) over front end of crankshaft. Remove from fuel passage cover two cap screws nearest No. 1 fuel injection pump and install pointer assembly. Install No. 1 piston and dummy cylinder (5A2183) on No. 1 cylinder and mount a dial indicator so that anvil will bear on piston near top dead center.

(b) *Establish Top Dead Center.* Install crankshaft turning bar

ORDNANCE ENGINE MODEL RD-1820

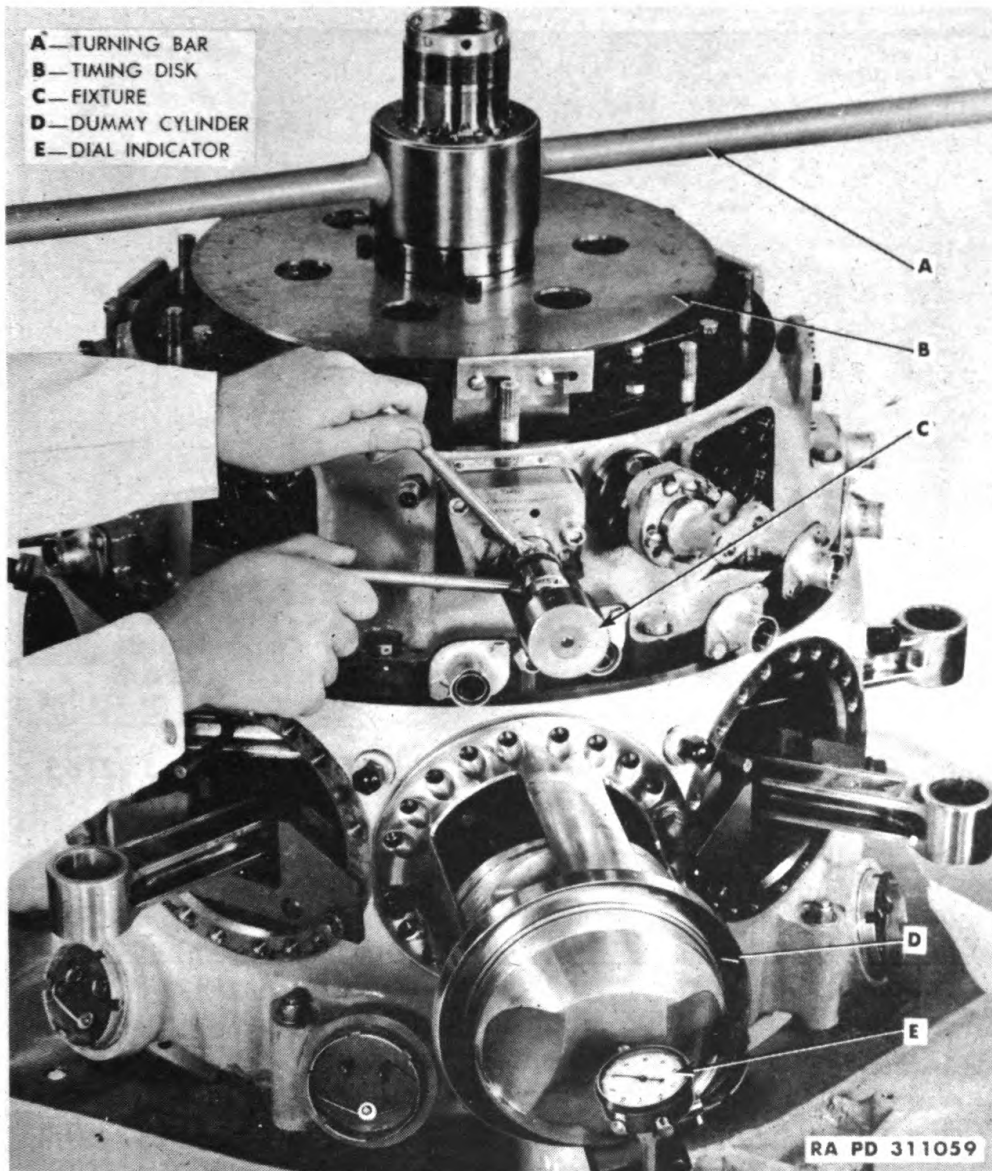

Figure 63 — Adjusting Fuel Pump Lifters, Using Bar 5A2165, Disk 5A2164, Fixture 5A1368, and Cylinder 5A2183

(5A2165) and turn crankshaft in normal direction of rotation until dial indicator shows No. 1 piston to be at top dead center. Slide pointer until it coincides with No. 1 top center mark on timing disk and tighten pointer. After pointer is set, do not change its position when checking any of lifter assemblies.

(c) *Adjust Fuel Pump Lifter.* Loosen dogs on fuel pump control and install timing fixture (5A1368), securing in place with two fuel injection pump screws. Turn crankshaft in normal direction of rotation until "injection begins" mark before top dead center on compression stroke for cylinder being checked is in alinement with pointer. The

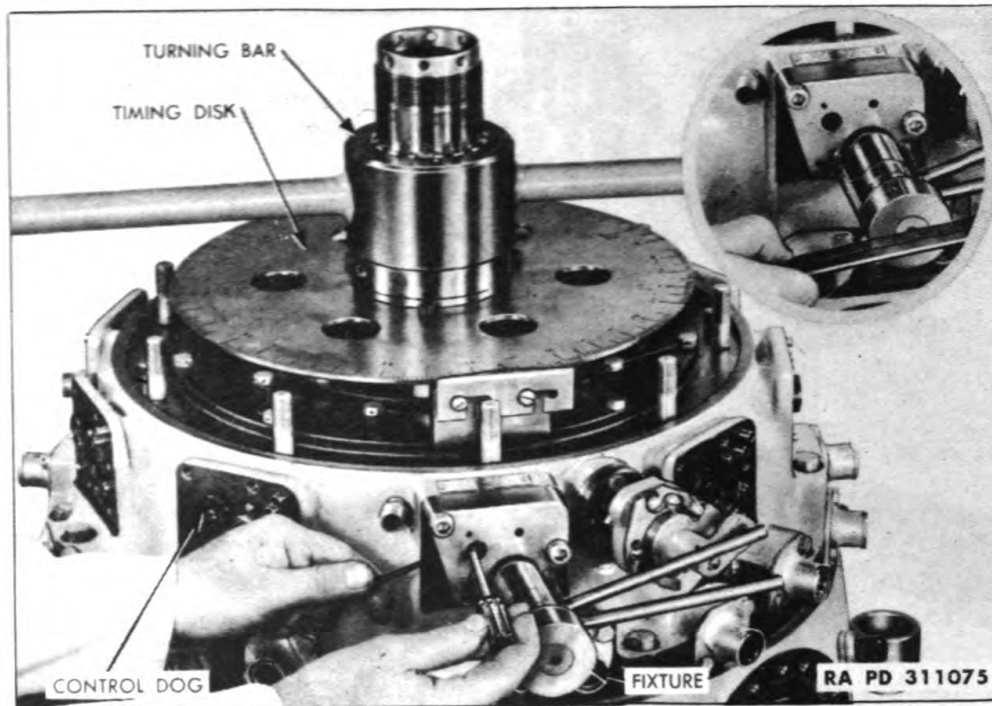

Figure 64 — Adjusting Fuel Pump Control Dogs, Using Bar 5A2165, Disk 5A2164, and Fixture 5A1368

inner rod of timing fixture must be flush with top surface within plus or minus .001 inch. To vary lifter setting, loosen nut lock and turn lifter screw with wrenches provided in fixture. If the crankshaft is turned passed the "INJECTION BEGINS" mark, back it up approximately one inch on dial and then turn it back in normal direction of travel until "INJECTION BEGINS" mark lines up. This procedure will remove backlash from timing gears.

(d) *Adjust Fuel Pump Control Dogs.* With timing fixture (5A1368) in place, rotate governor fuel pump control lever counter clockwise as far as possible to off position and hold it in this position. Using a screwdriver in slot in end of pinion control shaft, rotate shaft counter clockwise to take up any backlash between shaft and face gear. Tighten dog clamping screw.

(e) *Repeat Procedure.* Continue this procedure of setting lifters and removing backlash for each pump (steps (c) and (d)).

f. Install Pistons and Cylinders.

(1) **INSTALL NO. 1 PISTON.** Install engine turning bar (5A2165) on the crankshaft. Rotate crankshaft until master rod in No. 1 cylinder is approximately at top of stroke. Install piston pin retainers in rear side of each piston before assembling piston on rod. Make certain retainer is properly seated in retainer grooves (fig. 15). Lubricate master rod piston bushing and piston pin with engine oil. Start pin

ORDNANCE ENGINE MODEL RD-1820

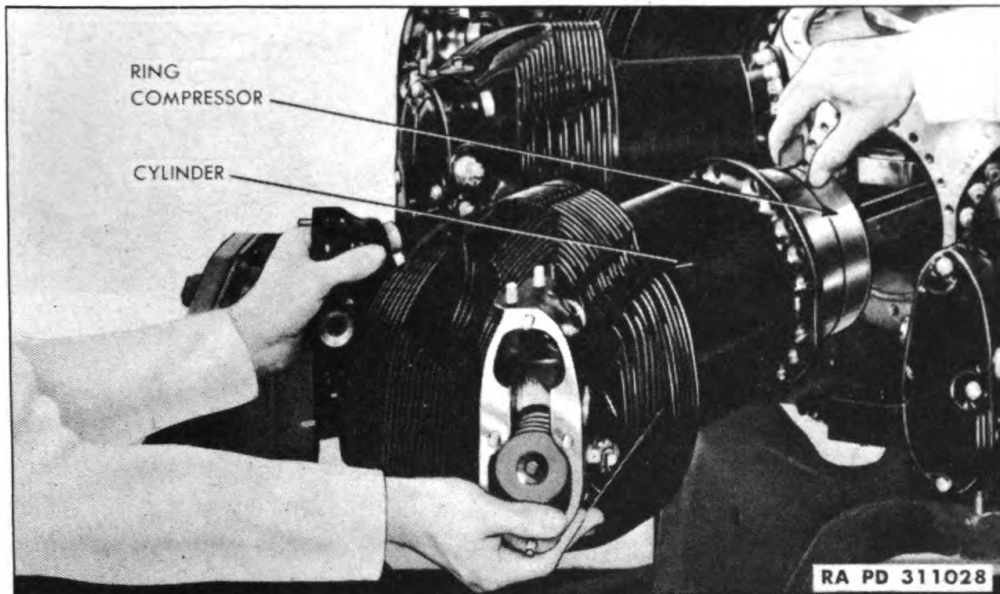

Figure 65 — Installing Cylinder

in front side of piston, place piston in position on rod and push pin through bushing and opposite side of piston until it bottoms against rear retainer. Install front piston pin retainer. **CAUTION:** *Pistons are to be installed with sloping surface towards front of engine.*

(2) **INSTALL NO. 1 CYLINDER.** Lubricate barrel of No. 1 cylinder with engine oil and install new rubber oil seal ring. Make certain all piston rings are properly installed and gaps set so that they are equally spaced (staggered) around piston. Coat piston freely with engine oil. Insure that cylinder flange and crankcase mounting pad are clean and free from dirt and enamel. Compress piston rings using a ring compressor and slide cylinder over rings (fig. 65). The cylinders are secured to crankcase by means of spherical seat washers and cap screws. When installing these cap screws, carefully apply a small amount of glyptal to the threads to prevent oil leakage at these points. When cylinder has been installed, secure it immediately by tightening two cap screws 180 degrees apart. Do not install all cap screws for cylinder No. 1 must be removed to check clearance between cylinder skirt and piston cooling nozzle. Check for possible interference between piston cooling nozzle and piston skirt.

(3) **INSTALL REMAINING PISTONS AND CYLINDERS.** Install pistons and cylinders Nos. 9, 8, 7, 6, 5, 4, 3 and 2, checking for interference after each cylinder is in place. After installing cylinder No. 2, remove No. 1 and check No. 2 for interference. Should interference exist, the piston cooling nozzle must be replaced. Tighten cylinder hold-down cap screws evenly with wrench (5A2268) torqued to the proper value

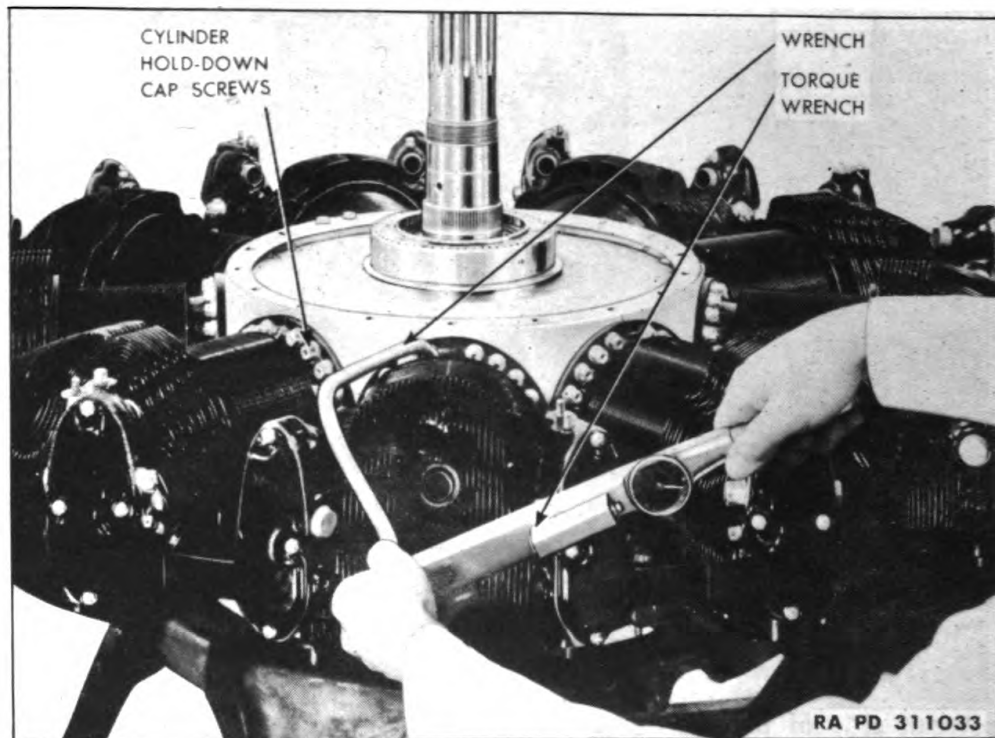

Figure 66 — Tightening Cylinder Hold-down Cap Screws, Using Wrench 5A2268

(fig. 66.). (Refer to par. 42). Speed wrench (5A2269) is used to run in cap screws. Lock wire cap screws.

g. Install Rocker Arms and Push Rod Housings.

(1) **INSTALL VALVE TAPPET BALL SOCKETS.** Insert each valve tappet spring and valve tappet, insuring that all parts are thoroughly coated with engine oil before assembly.

(2) **INSTALL PUSH ROD HOUSINGS** (fig. 31). Install short hose on rocker end of push rod housing. The rocker end of push rod housing may be identified by location of heading which is approximately $\frac{3}{8}$ inch from the end. Install long hose connections and two clamps per connection on crankcase end of housing. The heading at this end of housing is directly at the end. With hose connections and clamps assembled on push rod housing, install housing on engine, pushing it all the way on to its rocker arm connection and tighten clamp. Slide crankcase end hose connection over tappet guide and tighten both clamps. Oil push rod ends with clean engine oil and insert push rods in housings through rocker box.

(3) **INSTALL ROCKER ARMS** (fig. 11). Loosen adjusting screws and insert clamping screws in rocker arms. Do not tighten clamping screws. Lubricate rocker arms and bolts with clean engine oil. Install rocker arm and insert rocker bolt with spherical washer and rubber

ORDNANCE ENGINE MODEL RD-1820

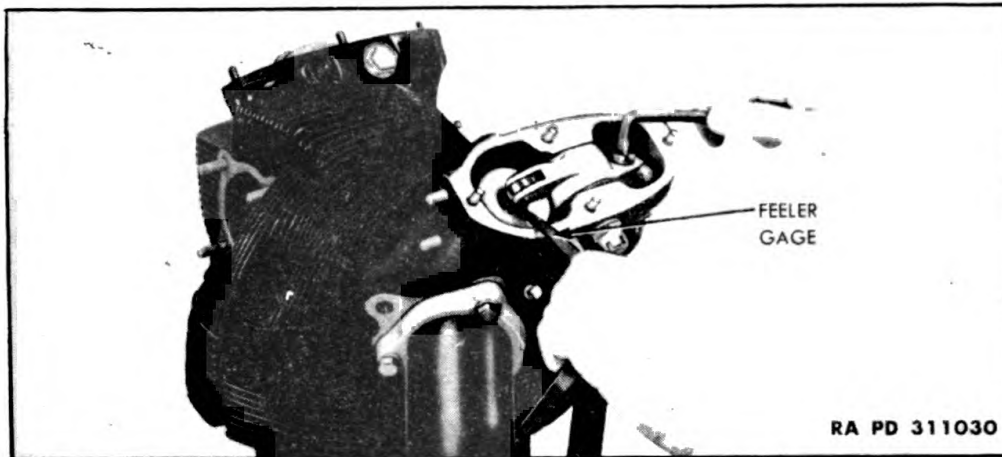

Figure 67 – Adjusting Valve Clearance, Using Gage 5A2281

seal through hub. The bolt should be installed with its head facing center line of cylinder head. Tighten rocker bolt nut. If it is necessary to exceed the recommended torque value (par. 24) to line up cotter pin hole, select another washer and nut. Insert and bend cotter pin. When installing rocker arms, be careful not to install intake rocker arms in exhaust rocker box and vice versa.

(4) **ADJUSTMENT OF VALVE CLEARANCE** (fig. 67). To adjust clearance between the valve stem and rocker arm roller, turn crankshaft until the piston in No. 1 cylinder is on top dead center on compression stroke. In this position valve tappet rollers are at their lowest point of travel on cam ring which places both valves in fully closed position. To check that No. 1 cylinder is on its firing stroke, test two adjacent valves, No. 2 exhaust and No. 9 intake. When intake valve to left is approximately one-half open and exhaust valve on right is approximately one-half closed, viewed with crankshaft vertically up, piston in cylinder being checked is on top dead center on firing stroke, with both valves closed. Loosen lock screw and tighten adjusting screw until there is no clearance between valve rocker and end of valve stem. This will compress spring in valve lifter assembly and assure that all clearance has been removed from push rod assembly. Loosen adjusting screw until a 0.010 feeler gage can be inserted between valve rocker arm and end of valve stem. This adjustment is made cold. The top face of adjusting screw is marked with three small circles which indicate location of holes that conduct oil from hollow push rods to rocker arm bearings on cylinders which are located above center line of engine. Care must be taken that none of these marks line up with slot in rocker arm. If, after obtaining correct adjustment, one of these marks does line up with slot, the clearance should be increased until mark is at least $\frac{3}{32}$ inch away from slot in rocker arm. After valve adjustment has been made, clamping screw must be tightened. After adjusting valve clearances on No. 1 cylinder, continue to next cylinder

ORDNANCE MAINTENANCE — ORDNANCE ENGINE MODEL RD-1820 (CATERPILLAR)

in the firing order, namely No. 3. The firing order of the engine is 1, 3, 5, 7, 9, 2, 4, 6, 8. The top center position of piston in each cylinder can be determined as described for No. 1 piston. In each case the inlet valve in one adjacent cylinder and the exhaust valve in other will each be half open.

(5) **INSTALL ROCKER BOX COVERS.** Place gaskets over studs on rocker box covers. Install rocker box covers, securing them with lock washers and nuts.

h. Install Cylinder Oil Drain Mechanism.

(1) **EXHAUST NO. 6 CYLINDER** (fig. 29). Place rubber seal on rocker box cover bushing and install into rocker box cover (do not tighten). Position cam through bushing, locate gasket on No. 6 exhaust rocker box and install rocker box cover. Secure cover with lock washers and nuts. Drive oil seal over cam into bushing. Locate key in cam and position lever on cam over key. Start cap screw with lock washer into lever.

(2) **INTAKE NO. 5 CYLINDER** (fig. 29). Proceed in same manner as mentioned above, except use No. 5 cylinder intake rocker cover and different lever arm. Install rod between lever arms and secure in place with bolts, nuts, and cotter pins. This is a free fit, do not tighten bolts to cause a binding action. With exhaust valve on No. 6 cylinder and intake valve on No. 5 cylinder closed, maintain $\frac{7}{16}$ -inch gap between stop on lever and stop on rocker box cover at No. 6 exhaust cylinder. With lever in this position, adjust bushing assembly on No. 6 exhaust cover so that cam surface just touches rocker arm roller. With same lever positioning, adjust bushing assembly on No. 5 intake cover so that cam surface just touches rocker arm roller. After proper adjustment has been made on bushing assemblies, lock them in place with screws and cotter pins. Tighten cap screws on both levers.

i. Install Intake Pipes (fig. 14). Install a new packing ring in each intake port in supercharger front housing and loosely install nine packing nuts. Install a new packing ring under intake pipe attaching flange at cylinder end. Coat crankcase end of intake pipe with clean engine oil and insert in supercharger front housing. Place a new gasket under intake pipe flange, and secure flange and gasket to intake port with lock washers and cap screws. Tighten cap screws evenly. Tighten packing nut at the crankcase end of the intake pipe, using a wrench (5A2287).

j. Install Crankcase Ventilator (fig. 2). Place gasket over studs in crankcase ventilator pad at top of supercharger front housing. Install ventilator pipe, securing in place with elastic stop nuts. Screw assembly into end of breather pipe.

k. Install Air Deflectors. Install cylinder head air deflector on cylinder head and secure in place with screws. Tighten screws and lock wire. Place rubber grommet into position between gap at web of rocker

ORDNANCE ENGINE MODEL RD-1820

box covers. Place intercylinder air deflectors into position through hole in rubber grommet. Secure in place with grommet clamp plate and elastic stop nut. Intercylinder air deflectors are numbered according to their position on engine. Place intercylinder deflector lower clamp between second and third fins at bottom of cylinder barrels. Install intercylinder air deflector lower clamp screw spacer between clamp and deflector. Install bolt through deflector spacer and clamp, locking in position with elastic stop nut. This assembly provides support for intercylinder air deflector. Assemble long spacer and two short spacers with bolts and nuts between intercylinder air deflectors at rear of each cylinder barrel. Tighten nuts and lock wire.

l. Governor to Fuel Pump Control Rod (fig. 73). Position anti-adjustable yoke of fuel pump control rod through hole in intercylinder air deflector 1 and 2 on governor fuel pump control lever at crankcase front section. Insert bolt through control rod yoke and lever. Secure in place with nut and cotter pin.

m. Install Oil Pipe to Piston Cooling Manifold. Install pipe through hole in intercylinder air deflector 9 and 1 and secure to inlet opening of piston cooling manifold. Tighten nut.

n. Install Fuel Oil Inlet and Outlet to Manifold. Position fuel oil inlet tube through hole in intercylinder air deflector 7 and 8 and secure to fitting in crankcase front section. Secure other end of tube to junction block. Position fuel oil outlet tube through hole in intercylinder air deflector 8 and 9 and secure to fitting in crankcase front section. Secure other end of tube to junction block.

o. Install Oil Sump (fig. 11). Place oil sump gaskets on mounting pads of front supercharger housing and pad of crankcase front section. Install oil sump and secure in place with plain washers and elastic stop nuts. Install magnetic plug and gasket at bottom of oil sump. Install oil sump strainer and gasket into front of oil sump. Tighten plug and strainer securely and lock wire together.

p. Install Piston Cooling Tubes (fig. 11).

(1) **INSTALL MANIFOLD.** Remove four crankcase front section retaining cap screws, and install piston cooling manifold so that outlets on manifold line up with inlets to piston cooling nozzles in crankcase front section. Reinstall cap screws through manifold supports into crankcase. Install gasket and plug to ends of piston cooling manifold.

(2) **INSTALL NOZZLE TO MANIFOLD TUBES.** Install piston cooling tubes from nozzle to manifold with ring and ring retaining nut at each end. Be certain that connecting tubes are bottomed in seats of nozzles and manifold fittings to insure against oil leaks at these points.

(3) **INSTALL CRANKCASE TO MANIFOLD TUBE.** Install connecting tube into crankcase front section and piston cooling manifold at No. 1 cylinder. Install rings and tighten ring retaining nuts.

ORDNANCE MAINTENANCE — ORDNANCE ENGINE MODEL RD-1820 (CATERPILLAR)

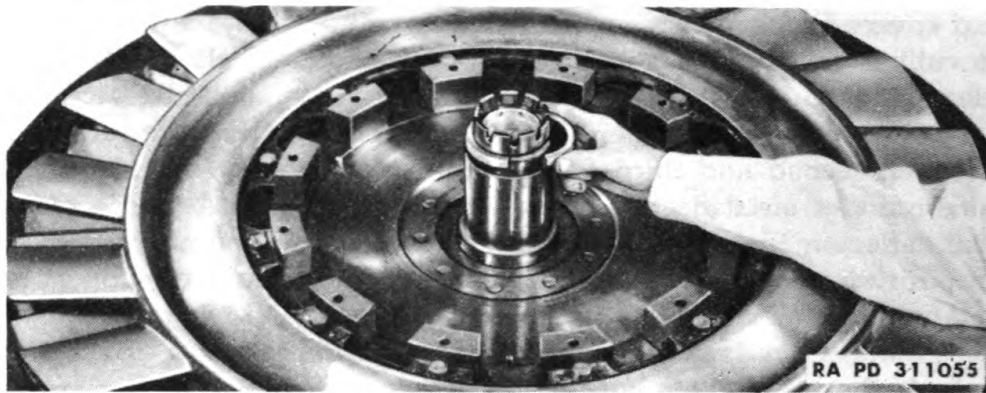

Figure 68 — Installing Flywheel Hub Cone

q. **Install Fuel Injection Pump** (fig. 11). Place gasket over fuel pump pads on crankcase front section and install fuel injection pumps with rubber seal. Insure that rubber seal does not bind on hollow dowels in crankcase front section. Secure pumps into position with screws and lock wire. **CAUTION: Fuel pumps are nonadjustable, do not attempt to adjust or disassemble.**

r. **Install Precombustion Chamber** (fig. 13). Coat threads of precombustion chamber with mica base anti-sieze compound and install chamber into cylinder head, using wrench (5A1937). Torque to proper value (par. 24).

s. **Install Fuel Injection Valves** (fig. 12). Coat threads of fuel injection valve with mica base anti-sieze compound and install valve into precombustion chamber but do not tighten. Install fuel lines by connecting one end to fuel valve and other to fuel pump. Tighten fuel valve into precombustion chamber with wrench (5A2167) while holding precombustion chamber in place with wrench (5A1943). Line up nipple end of valve with fuel line. Tighten fittings at each end of fuel line. Torque valve and fuel line fittings to proper value (Refer to par. 24).

t. **Install Front Engine Support** (fig. 10). Position front engine support over studs and dowels of crankcase front section. Install elastic stop nuts and tighten.

u. **Install Engine Cowl** (fig. 1). Install bottom section of engine cowl at cylinder oil drain mechanism. Start cap screws holding cowl to front engine support. Proceed with installation of cowl sections in direction of rotation of engine. Start but do not tighten cap screws. Install clamp assemblies about outer diameter of cowling, piloting clamps over pins in cowl. Install and tighten clamp cap screws holding cowl to front engine support and lock wire.

v. **Install Flywheel and Fan.** Position intermediate pressure plate retractor springs onto rear face of flywheel by placing spacer, two long

ORDNANCE ENGINE MODEL RD-1820

springs, one intermediate length spring, one short spring, and another spacer on flywheel, in order mentioned. Secure in place with cap screws and lock wire. Place cooling fan onto piloting diameter of flywheel and secure in place with body fit cap screws and lock washers. *NOTE: These cap screws are special and cannot be substituted by standard cap screws.* Place cone into position on crankshaft (fig. 68). Place flywheel and fan assembly onto cone on crankshaft front end. Install front flywheel retaining cone and nut. Tighten nut, lining up one slot in nut with hole in crankshaft. Install locking pin from inside and secure in place with washer and cotter pin.

w. **Install Clutch Cover Assembly** (fig. 27). Place clutch spindle assembly (with roller bearing and oil seal) onto hub of flywheel. Install clutch driven plate on splines of spindle with flat heads of rivets facing flywheel face. Install intermediate pressure plate into slots of flywheel. Install other clutch driven plate. Install clutch cover assembly over spindle, lining up holes in cover with tapped holes in ring gear. Position ring gear on clutch cover and secure cover and ring gear in place with special body fit cap screws and lock washer. Install retractor pin adjusting bolt and adjust bolt until 0.03-inch clearance is obtained between intermediate clutch pressure plate and end of adjusting bolt when clutch is engaged. This clearance is obtained by screwing retractor pin adjusting bolt against intermediate plate and then turning back $\frac{3}{4}$ of one complete turn. Lock bolt in place with washer and lock nut.

x. **Install Clutch Controls and Oil Cooler.** Hoist transfer case support and bring into position on front engine support (fig. 5). Turn clutch release shoes, so that flat face of shoes will be positioned against thrust bearing on clutch. Position arm and yoke assembly with clutch release shoes against thrust bearing. Install clutch release arm pins through transfer case support and through needle bearings of clutch release arm. Turn pin so that the recessed face provides a seat for shaft retainer plate. Install retainer plate sheet metal lock and cap screws. Tighten cap screws and bend up sheet metal lock. Lower transfer case support assembly over dowels on front engine support and secure in place with bolts and nuts.

y. **Install Transfer Case.** Coat clutch spindle with light graphite grease. Start spline of clutch spindle into internal spline of transfer case upper gear. Lower transfer case onto transfer case support (fig. 4). Install gasket and oil cooler inlet tube assembly on flange at bottom of each leg of cooler. Secure in place with cap screws and lock wire. Install clip which supports tube by removing two transfer case front drive gear bearing cover retaining nuts. Place rubber bushing over tube and clip over rubber bushing. Secure clip to position from which nuts were removed. Reinstall nuts.

ORDNANCE MAINTENANCE — ORDNANCE ENGINE MODEL RD-1820 (CATERPILLAR)

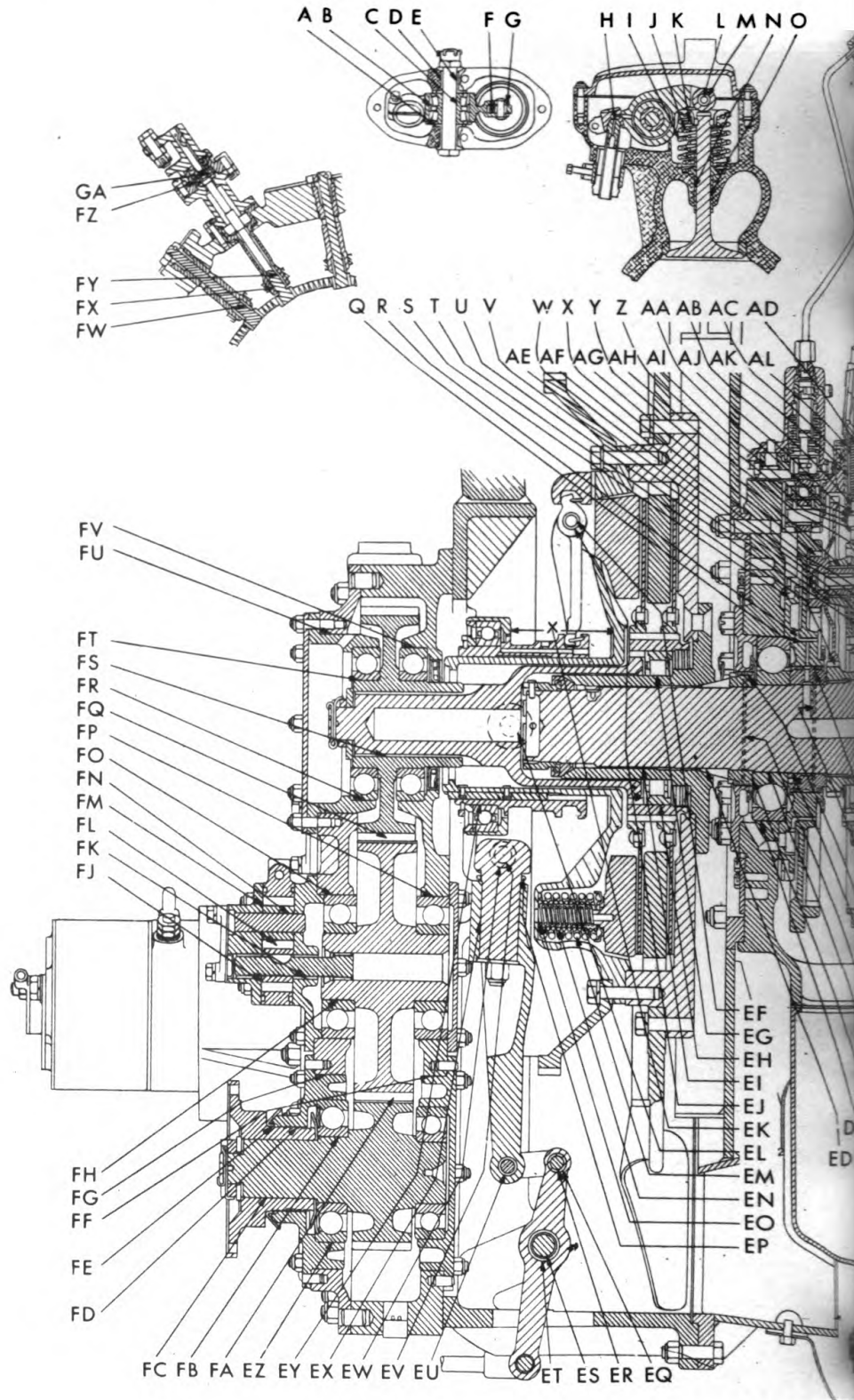
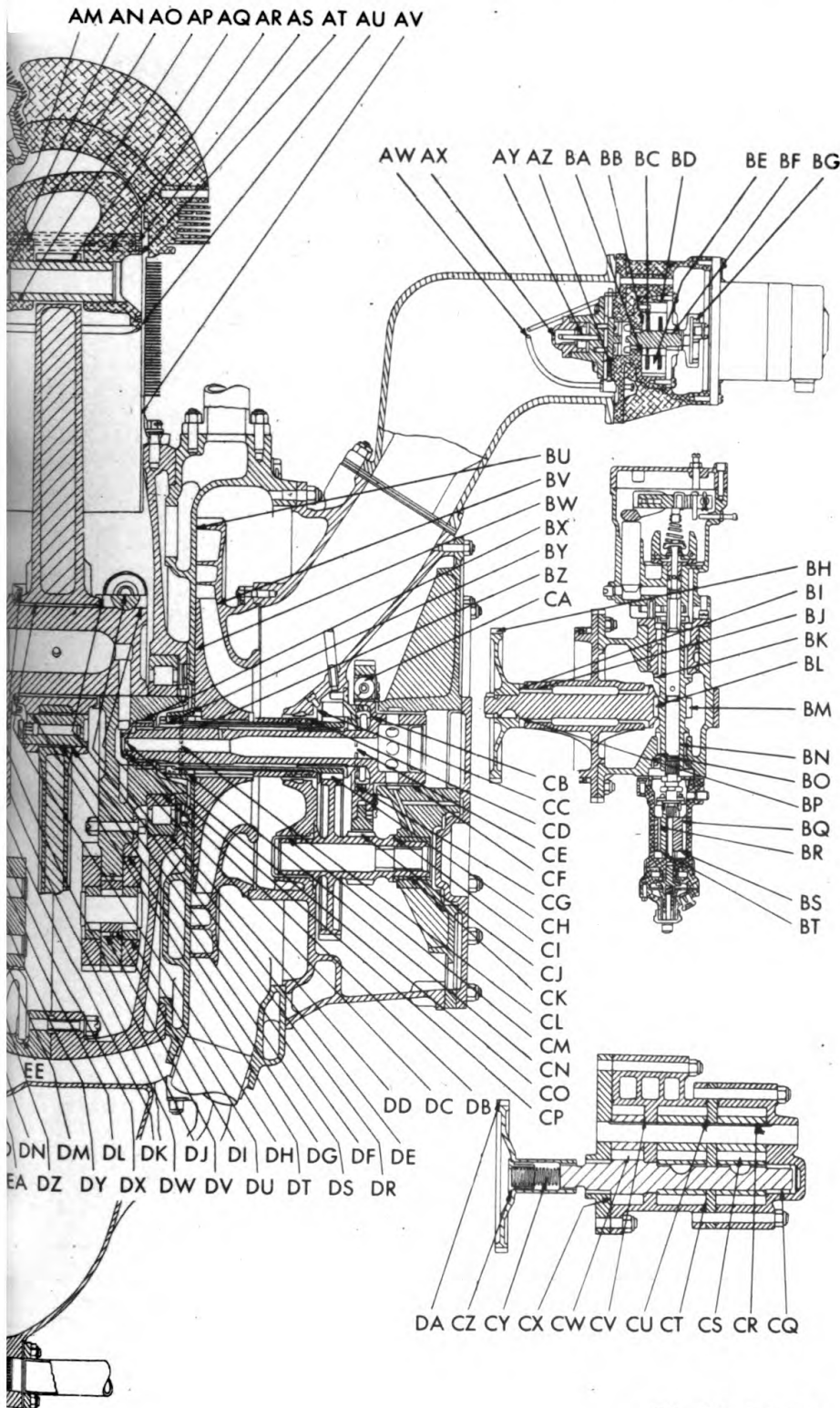

Figure 69 — Fit

ORDNANCE ENGINE MODEL RD-1820



RA PD 311078

erance Chart

ORDNANCE MAINTENANCE — ORDNANCE ENGINE MODEL RD-1820 (CATERPILLAR)

CHAPTER 2 — cont'd

Section V

FITS AND TOLERANCES

Table of limits	Paragraph 22
Spring data	23
Torque values	24

22. TABLE OF LIMITS.

a. Valve Mechanism.

Fig No.	Ref Key	Fit Location	Type	Manufacturing		Replace if Beyond
				Min	Max	
69	A	Rocker arm bearing and rocker box (before clamping)	Side	0.001L	0.007L	0.015L
69	B	Rocker arm bearing and rocker arm	Diam	0.0008T	0.0018T	0.000
69	C	Rocker hub bolt and rocker arm bearing	Diam	0.000	0.001L	0.004L
69	D	Rocker box bolt bushing and cylinder head	Diam	0.0009T	0.0024T	
69	E	Rocker hub bolt and bushing	Diam	0.0005L	0.0030L	0.005L
69	F	Rocker arm roller and rocker arm	Side	0.0095L	0.0155L	0.050L
69	G	Rocker arm roller hub and rocker arm	Side	0.000	0.001T	Rivet Tight
69	H	Push rod oil holes	Diam		0.032	0.032
69	L	Rocker arm roller hub and pin	Diam	0.001T	0.002L	0.002L
69	M	Rocker arm hub and roller	Diam	0.0015L	0.0035L	0.020L
69	N	Exhaust valve guide and cylinder head	Diam	0.0030T	0.0045T	
69	N	Intake valve guide and cylinder head	Diam	0.001T	0.003T	
69	O	Exhaust valve and guide	Diam	0.0035L	0.0050L	0.008L
69	O	Intake valve and guide	Diam	0.0020L	0.0035L	0.008L

ORDNANCE ENGINE MODEL RD-1820

b. Fuel Pump Cam.

Fig No.	Ref Key	Fit Location	Type	Manufacturing		Replace if Beyond
				Min	Max	
69	Q	Cam bushing and support	Diam	0.005L	0.007L	0.012L
69	R	Cam	Side	0.006L	0.018L	0.021L
69	S	Support and fuel pump control face gear	Diam	0.005L	0.008L	0.013L

c. Valve Cam and Tappet.

69	T	Cam drive gear and cam driving gear	Backlash	0.0015	0.0035	0.0085
69	U	Cam bearing and crank case main section	Diam	0.001T	0.002L	0.002L
69	V	Cam drive pinion and bracket	Side	0.010L	0.018L	0.024L
69	W	Cam bearing and cam	Diam	0.010L	0.013L	0.015L
69	X	Cam drive gear and pinion	Spline	0.000	0.002L	0.005L
69	Y	Cam bracket and bushing	Diam	0.0025T	0.0040T	
69	Z	Tappet bushing and tappet	Side	0.007L	0.012L	0.015L
69	AA	Tappet roller pin and bushing	Diam	0.0025L	0.0045L	0.006L
69	AB	Tappet and roller	Side	0.0075L	0.0125L	0.015L
69	AC	Tappet guide and crankcase front section	Diam	0.000	0.0015L	0.002L
69	AE	Cam drive gear and bushing	Diam	0.001L	0.003L	0.008L
69	AF	Cam	Side	0.002L	0.006L	0.015L
69	AG	Cam drive gear and fuel pump cam	Backlash	0.003	0.007	0.012
69	AH	Cam and drive pinion	Backlash	0.008	0.018	0.024
69	AI	Tappet roller pin and guide	Side	0.005L	0.011L	0.016L
69	AJ	Tappet roller and bushing	Diam	0.001L	0.002L	0.005L
69	AK	Tappet and guide	Diam	0.0010L	0.0025L	0.0035L
69	AL	Tappet and ball socket	Diam	0.0012L	0.0022L	0.0027L

ORDNANCE MAINTENANCE — ORDNANCE ENGINE MODEL RD-1820 (CATERPILLAR)

d. Pistons and Cylinders.

Fig No.	Ref Key	Fit Location	Type	Manufacturing		Replace if Beyond
				Min	Max	
69	AM	Piston and ring, No. 1 groove	Side	0.0050L	0.0066L	0.0066L
69	AN	Piston, ring, and spacer, Nos. 3 and 4	Side	0.0025L	0.0042L	0.0042L
69	AO	Piston Rings, Nos. 1 and 2	Gap	0.025	0.035	
69	AP	Piston and Pin	Diam	0.000	0.001L	0.003L
69	AQ	Piston pin and rod bushing	Diam	0.0020L	0.0035L	0.006L
69	AR	Piston Rings, Nos. 3 and 4	Gap	0.015	0.025	
69	AS	Piston and ring, No. 2 Cylinder Barrel and Piston	Side	0.0030L	0.0046L	0.0046L
69	AT	At No. 3 ring, parallel to crankpin	Diam	0.0355L	0.0385L	0.0485L
69	AT	At No. 3 ring, 90° from crankpin	Diam	0.0195L	0.0225L	0.0325L
69	AU	At bottom of skirt, parallel to crankpin	Diam	0.0335L	0.0365L	0.0465L
69	AU	At bottom of skirt, 90° to crankpin	Diam	0.0175L	0.0205L	0.0305L
69	AV	Cylinder bore out of round	Diam			0.005

e. Air Heater.

69	AW	Electrodes	Gap	0.012	0.015	
69	AX	Nozzle orifice	Diam	0.0670	0.0675	
69	BA	Pump shaft	End	0.002L	0.004L	0.007L
69	BB	Pump vane	End	0.000	0.003L	0.007L
69	BD	Pump rotor and housing	Diam	0.001L	0.003L	0.006L
69	BE	Pump shaft slot and vanes	Side	0.002L	0.005L	0.010L
69	BF	Pump shaft and bushing	Diam	0.001L	0.003L	0.006L
69	BG	Pinion and gear	Backlash	0.0045	0.0065	0.0095

f. Accessory Drive.

69	BH	Main drive gear and drive gear	Backlash	0.004	0.012	0.022
69	BI	Governor drive shaft	End	0.007	0.013	0.025

ORDNANCE ENGINE MODEL RD-1820

Fig No.	Ref Key	Fit Location	Type	Manufacturing		Replace if Beyond
				Min	Max	
69	BJ	Governor drive shaft bushings and bearing	Diam	0.001T	0.003L	0.003L
69	BK	Revolution counter and governor drive shaft	End	0.023	0.030	0.040
69	BL	Governor drive gear, revolution counter, and governor drive gear shaft	Backlash	0.002	0.008	0.013
69	BM	Revolution counter and governor drive shaft gear and revolution counter drive gear	Backlash	0.002	0.008	0.013
69	BN	Revolution counter and governor drive shaft and bushing	Diam	0.001L	0.003L	0.013L
69	BO	Accessory drive housing and revolution counter and governor drive shaft bushings	Diam	0.001T	0.003T	
69	BP	Governor drive shaft and bushings (installed in bearing)	Diam	0.001L	0.003L	0.013L

g. Fuel Transfer Pump.

69	BQ	Body sleeve and blades	Diam	0.0027L	0.0040L	0.0120L
69	BR	Rotor slot and blade	Side	0.0008L	0.0021L	0.0071L
69	BS	Blade	End	0.0012L	0.0022L	0.0062L
69	BT	Rotor shaft	End	0.0012	0.0022L	0.0062L

h. Supercharger and Drive.

69	BU	Front housing and diffuser plate vanes	Pinch	0.005T	0.012T	
69	BV	Impeller and diffuser plate	Side	0.020L	0.067L	0.067L
69	BW	Impeller and front housing	Side	0.034L	0.060L	
69	BX	Drive coupling and crankshaft rear	Diam	0.001T	0.002T	
69	BY	Impeller drive shaft and impeller oil seal front sleeve	Diam	0.0000	0.0025L	0.004L

ORDNANCE MAINTENANCE — ORDNANCE ENGINE MODEL RD-1820 (CATERPILLAR)

Fig No.	Ref Key	Fit Location	Type	Manufacturing		Replace if Beyond
				Min	Max	
69	BZ	Impeller drive shaft bushings and accessory drive shaft	Diam	0.002L	0.004L	0.006L
69	CB	Accessory drive shaft	End	0.020L	0.030L	0.040L
69	CC	Impeller drive shaft gear (adjust)	End	0.012L	0.017L	
69	CD	Impeller drive shaft gear and impeller shaft oil seal rear sleeve	Diam	0.000	0.003L	0.004L
69	CE	Impeller shaft retainer oil seal ring (hand fit)	Gap	0.006	0.008	
69	CF	Accessory drive shaft and bushing	Diam	0.002L	0.004L	0.006L
69	CG	Impeller shaft retainer and oil seal ring	Side	0.002L	0.007L	0.011L
69	CH	Impeller shaft gear and intermediate gear	Backlash	0.004	0.010	0.018
69	CI	Intermediate gear	End	0.016L	0.034L	0.034L
69	CJ	Intermediate gear and accessory drive gear	Backlash	0.006	0.014	0.025
69	CK	Intermediate gear and rear bushing	Diam	0.0015L	0.0035L	0.005L
69	CL	Impeller oil seal rings (hand fit)	Gap	0.010	0.012	
69	CM	Intermediate shaft and front bushing	Diam	0.0015L	0.0035L	0.005L
69	CN	Impeller oil seal rings and sleeves	Side	0.005L	0.009L	0.009L
69	CO	Drive shaft coupling rings	Gap	0.06	0.037	
69	CP	Drive shaft coupling rings	Side	0.002L	0.006L	0.008L

i. Lubricating Oil Pump.

69	CQ	Drive shaft and bushings	Diam	0.001L	0.003L	0.008L
69	CR	Idler gear and shaft	Diam	0.001L	0.003L	0.006L
69	CS	Drive gears and idler gears (wide)	Backlash	0.006	0.008	0.018
69	CT	Drive gear	End	0.004	0.008	0.013
69	CU	Idler gears (wide)	End	0.004	0.008	0.013
69	CV	Idler gears (narrow)	End	0.004	0.008	0.013

ORDNANCE ENGINE MODEL RD-1820

Fig No.	Ref Key	Fit Location	Type	Manufacturing		Replace if Beyond
				Min	Max	
69	CW	Drive shaft and idler gear (narrow)	Backlash	0.006	0.008	0.018
69	CX	Drive shaft	End	0.004	0.008	0.013
69	CZ	Drive gear and spring retainer	Diam	0.0005T	0.0035T	
69	DA	Drive gear and accessory drive gear	Backlash	0.005	0.012	0.025
j. Crankshaft, Connecting Rods, and Bearings.						
69	DB	Crankshaft rear and roller bearing	Diam	0.0010T	0.0024T	
69	DC	Crankshaft front and crankshaft rear (before tightening screw)	Diam	0.001L	0.001T	0.002L
69	DD	Crankcase main rear section and roller bearing	Diam	0.004L	0.006L	
69	DE	Crankcheek screw stretch		0.008	0.009	
69	DF	Master rod and knuckle pin bushing	Diam	0.007L	0.013L	0.030L
69	DG	Rear counterweight and stop		0.0268L	0.0388L	0.0438L
69	DH	Crankpin and bearing (bearing assembled in master rod)	Diam	0.0040L	0.0055L	0.0065L
69	DI	Counterweight rear bearing and bushing	Diam	0.0025L	0.0035L	0.0035L
69	DK	Oil seal ring (hand fit)	Gap	0.018	0.020	
69	DL	Crankshaft and oil seal ring spacer	Diam	0.0005L	0.0025L	
69	DM	Oil seal ring	Side	0.003L	0.008L	0.015L
69	DN	Thrust bearing oil seal ring (hand fit)	Gap	0.012	0.013	
69	DO	Crankshaft and thrust bearing spacer	Diam	0.0005L	0.0025L	
69	DP	Crankshaft and thrust bearing	Diam	0.0002T	0.0016T	
69	DQ	Crankcase front section and thrust bearing	Diam	0.0004L	0.0024L	
69	DR	Crankpin bearing (end play to be measured with master rod in extreme forward position)	End	0.012	0.034	0.065

ORDNANCE MAINTENANCE — ORDNANCE ENGINE MODEL RD-1820 (CATERPILLAR)

Fig No.	Ref Key	Fit Location	Type	Manufacturing		Replace if Beyond
				Min	Max	
69	DS	Knuckle pin and bushing	Diam	0.0027L	0.0041L	0.0061L
69	DT	Master rod and knuckle pin	Diam	0.0005T	0.0015T	
69	DU	Rear counterweight and bushing	Diam	0.0015T	0.0030T	
69	DV	Crankshaft rear and bushing	Diam	0.0010T	0.0025T	
69	DW	Crankpin plug and crankpin	Diam	0.0005L	0.0020L	
69	DX	Crankshaft front and roller bearing	Diam	0.0002T	0.0016T	
69	DY	Crankcase main front section and roller bearing	Diam	0.0020L	0.0042L	
69	DZ	Thrust bearing spacer and oil seal ring	Side	0.001L	0.006L	0.010L
69	EA	Thrust bearing nut and oil seal ring	Side	0.0030L	0.0075L	0.015L
69	EB	Thrust bearing nut oil seal ring (hand fit)	Gap	0.006	0.008	
69	EC	Thrust bearing and retaining flange	Side	0.0002L	0.0062L	
69	ED	Crankshaft runout				0.006

k. Piston Cooling Nozzle.

69	EE	Orifice	Diam	0.072	0.073	
----	----	---------	------	-------	-------	--

l. Flywheel Clutch.

69	EF	Pressure lever bearing bore	Diam	0.687	0.688	0.688
69	EG	Flywheel flange at pilot bearing location	Diam	4.1071	4.1079	4.0161
69	EH	Spindle and pilot bearing	Diam	0.0000	0.0022T	
69	EI	Flywheel and crankshaft flange	Side	0.0002L	0.0028L	0.0038L
69	EJ	Pressure lever pin at bearing	Diam	0.5000	0.5005	0.4950
69	EK	Cover adjustment		4.146	4.146	
69	EL	Yoke and shoe	Diam	0.0010L	0.0046L	0.006L
69	EQ	Release lever pin bearing bores	Diam	0.6870	0.6880	0.6880

ORDNANCE ENGINE MODEL RD-1820

Fig No.	Ref Key	Fit Location	Type	Manufacturing		Replace if Beyond
				Min	Max	
69	ER	Release arm and lever pins at bearings	Diam	0.5000	0.5005	0.4950
69	ES	Release lever pin at bearings	Diam	1.0000	1.0005	0.9950
69	ET	Release lever bearing bore	Diam	1.2495	1.2505	1.2505
69	EU	Release arm lower bearing bore	Diam	0.687	0.688	0.688
69	EV	Release arm pin at bearings	Diam	1.0000	1.0005	0.9950
69	EW	Release arm upper bearing bores	Diam	1.2495	1.2505	1.2505
69	EX	Yoke and release arm	Diam	0.0055T	0.0090T	0.0055T
69	EY	Sleeve and throwout bearing	Diam	0.0008T	0.0012T	
m. Transfer Case.						
69	EZ	Output gear bearing and cages	Diam	0.000	0.002L	
69	FA	Idler gear and output gear	Backlash	0.009	0.013	
69	FB	Output gear and bearings	Diam	0.001L	0.0011T	0.0001L
69	FC	Output gear and flange	Spline	0.0015L	0.0015T	
69	FD	Output flange and cage	Diam	0.006L	0.011L	0.011L
69	FE	Output flange and dirt thrower	Diam	0.012T	0.019T	0.012T
69	FF	Case and output gear bearing cage	Diam	0.000	0.002L	
69	FG	Cover and output gear bearing cage	Diam	0.000	0.002L	
69	FH	Idler gear and bearings	Diam	0.0001L	0.0011T	0.0001L
69	FJ	Oil pump drive gear	End	0.007L	0.009L	0.014L
69	FK	Oil pump drive shaft and bushings	Diam	0.001L	0.002L	0.007L
69	FL	Oil pump drive gear and idler gear	Backlash	0.000	0.000	0.005
69	FM	Oil pump idler gear	End	0.007L	0.009L	0.014L
69	FN	Oil pump idler gear and shaft	Diam	0.0015L	0.0025L	0.005L
69	FO	Idler gear front bearing and cover	Diam	0.000	0.002L	
69	FP	Idler gear rear bearing and case	Diam	0.000	0.002L	
69	FQ	Input gear and idler gear	Backlash	0.009	0.013	

ORDNANCE MAINTENANCE — ORDNANCE ENGINE MODEL RD-1820 (CATERPILLAR)

Fig No.	Ref Key	Fit Location	Type	Manufacturing		Replace if Beyond
				Min	Max	
69	FR	Input gear front bearing and cage	Diam	0.000	0.002L	
69	FS	Input gear and clutch spindle	Spline	0.001L	0.006L	0.011L
69	FT	Input gear and bearings	Diam	0.0001	0.0014T	
69	FU	Input gear front bearing cage and cover	Diam	0.000	0.002L	
69	FV	Input gear rear bearing and case	Diam	0.000	0.002L	

n. Fuel Pump Control.

69	FW	Gear and bushing	Diam	0.005L	0.0015L	0.008L
69	FX	Gear sleeve and needle bearing	Diam	0.000	0.001L	0.001L
69	FY	Gear and needle bearing	Diam	0.0000	0.0005L	0.0025L
69	FZ	Cover and ball bearing	Diam	0.000	0.006L	
69	GA	Gear and ball bearing	Diam	0.0002T	0.0005T	

23. SPRING DATA.

a. Valve.

Fig No.	Ref Key	Spring	Type	Test Length Inches	Load at Test Length-Pounds	
					Min	Max
69	I	Outer	Compr	1.969	63.9	78.1
69	J	Intermediate	Compr	2.094	46.8	57.2
69	K	Inner	Compr	2.000	30.6	37.4
69	AD	Tappet to push rod socket	Compr	2.14	10.0	12.0

b. Air Heater.

69	AY	Air and fuel nozzle	Compr	0.609	3.06	3.60
69	AZ	Lifter	Compr	0.563	4.74	5.56
69	BC	Pump vane	Compr	0.531	0.941	1.041
79	G	Ball check	Compr	0.330	0.034	.040
79	T	Inlet fuel nozzle	Compr	0.377	0.019	.023
79	S	Outlet check valve	Compr	0.50	0.028	.030

c. Accessory Drive.

69	CA	Gear	Compr	1.63	242.0	263.0
----	----	------	-------	------	-------	-------

d. Oil Pump.

77	K	Relief plunger, upper	Compr	2.82	41.7	48.9
77	K	Relief plunger, center	Compr	2.81	22.2	26.1
77	K	Relief plunger, lower	Compr	2.18	2.78	3.26
69	CY	Shaft	Compr	1.96	9.73	11.43

ORDNANCE ENGINE MODEL RD-1820

e. Connecting Rod.

Fig No.	Ref Key	Spring	Type	Test Length Inches	Load at Test Length-Pounds	
					Min	Max
69	DJ	Oil seal disk	Compr	.32	8.0	10.0

f. Clutch.

69	EM	Outer	Compr	2.44	306.8	360.2
69	EN	Intermediate	Compr	2.44	136.0	159.0
69	EO	Inner	Compr	2.44	73.0	86.0
69	EP	Yoke	Compr	0.40	50.0	59.0

g. Fuel Filter.

72		Element	Compr	.62	17.0	19.5
72		Inlet by-pass valve	Compr	1.03	1.59	1.75
72		Priming pump valve	Compr	.25	.040	.044

h. Miscellaneous.

73		Governor speed control return	Tension	10.5	11.1	12.3
73		Governor control lever extension	Tension	8.06	6.00	7.05
29		Oil drain control rod	Compr	2.0	118.8	131.3
23		Transfer case oil pump check valve	Compr	1.32	11.0	13.0

24. TORQUE VALUES.

	Size of Thread Nut End	Torque Values (Inch-pounds)	
		Min	Max
Standard bolts, screws and cap screws	10-32	35	40
"	12-24	45	50
"	1/4-28	80	85
"	5/16-24	160	175
"	3/8-24	225	250
"	7/8-20	350	375
"	1/2-20	550	600
"	9/16-18	825	875
"	5/8-18	1125	1200
Cylinder hold-down cap screws		425	450
Rocker hub bolt		350	375
Fuel injection line		350	375
Precombustion chamber		1200	1250
Fuel injection valve		700	725
Bendix clutch adjustment		1800	1850
Piston cooling nozzle nuts		425	450
Crankcase main section nuts		350	375

CHAPTER 3
FUEL SYSTEM

Section I
DESCRIPTION

	Paragraph
Description	25

25. DESCRIPTION.

a. The fuel supply for the engine is drawn from the fuel tank and passes through a primary filter before entering the fuel transfer pump. The transfer pump forces fuel through the secondary filter to the fuel injection pump manifold and fuel injection pumps. The fuel injection pumps (fig. 11) supply the required amount of fuel to the fuel injection valves. Fuel not required by the injection pumps is returned to the fuel tank. A hand priming pump is provided to prime the system in case it has been drained. The amount of fuel injected into the precombustion chambers is measured by the fuel injection pumps and controlled by the governor. The governor setting is controlled by the accelerator. Air entering the engine passes through either of two oil-bath air cleaners.

Section II
FUEL TRANSFER PUMP

	Paragraph
Description and data.....	26
External cleaning and inspection.....	27
Disassembly	28
Cleaning and inspection	29
Assembly of Unit	30

26. DESCRIPTION AND DATA.

a. The transfer pump is of the rotary, four-vane, positive displacement type with a capacity of 165 gallons per hour at 1,750 revolutions per minute. The pump consists essentially of a cast aluminum alloy housing, containing a sleeve with an eccentric bore in which a rotor with four vanes is driven by means of a drive shaft coupled with the engine drive gear. A floating center pin keeps the outer edges of blades in contact with bore of sleeve except at higher operating speeds when

FUEL SYSTEM

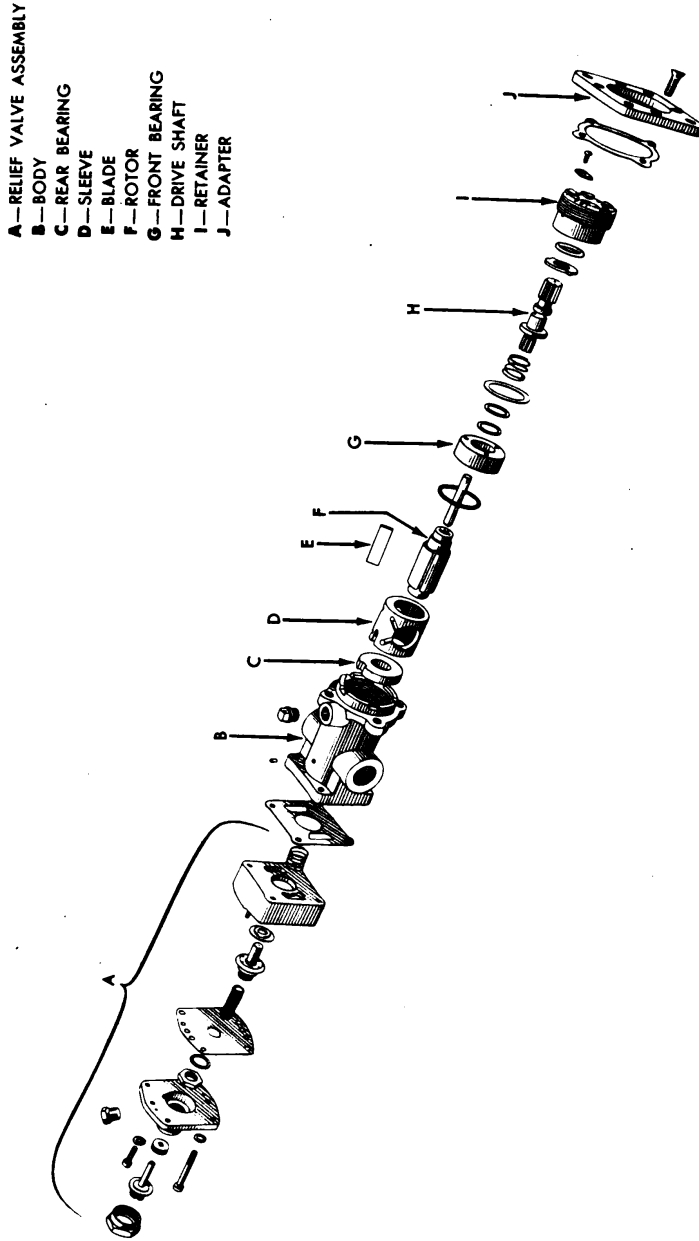

RA PD 311049

Figure 70 — Transfer Pump Disassembled

ORDNANCE MAINTENANCE — ORDNANCE ENGINE MODEL RD-1820 (CATERPILLAR)

centrifugal force alone is sufficient to maintain blade contact. A seal is incorporated in the pump to minimize leakage around rotor shaft. A composition rubber seal ring cushions the disk against retainer (lock nut) and compensates for slight universal action of coupling. This seal depends on a spring for sufficient thrust to be effective. The spring must have sufficient tension to overcome pressure of fuel that may by-pass around rotor shaft. A relief valve is contained in a separate housing mounted on pump. The valve is of the poppet type and is controlled by a spring whose tension can be varied by means of an external adjusting screw to provide any desired fuel pressure within the range of adjustment. This relief valve also incorporates a by-pass valve to allow fuel flow through pump when pump is inoperative.

27. EXTERNAL CLEANING AND INSPECTION.

a. Examine the unit for cracked housings and broken flanges. Check the relief valve assembly for tightness to main body. Check fittings for tightness.

28. DISASSEMBLY.

a. **Remove Valve Assembly.** Remove lock wire from relief valve screws and two pipe plugs (fig. 70). Remove lock screw and lock plate from drive end. Remove retainer. Remove seal, disk, drive shaft, spring, and two washers by hand. Remove front bearing. With a scribe, mark pump body and relief valve body on inlet side. The four vanes and pin will fall out. Remove relief valve assembly by removing four cap screws on corners of assembly.

b. **Disassemble Pump.** Heat rest of pump body to about 250°F. in an oven or oil bath to eliminate unnecessary wear on sleeve and bearings during disassembly. The sleeve and rear bearing can be removed by bumping parts out on a soft-wooden bench or block after body has been heated. Do not attempt to disassemble relief valve assembly.

29. CLEANING AND INSPECTION.

a. **General.** After disassembly, clean parts with dry-cleaning solvent and inspect carefully for damage and wear. All defective parts, as well as those indicating excessive wear, must be replaced (par. 22).

b. **Blades.** If sides of blades are rough or slightly scored, dress them carefully on a new, flat oilstone being careful to maintain original radius on edges. Smooth off any sharp corners at ends of blades which might score bronze bearings but do not make them round.

c. **Bearings.** Slight scoring of bronze bearings may be corrected by lapping carefully on a flat oilstone. Do not attempt to lap seal surface of front bearing.

FUEL SYSTEM

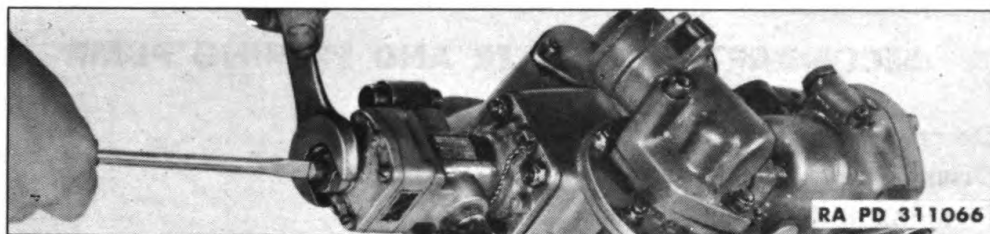

Figure 71 – Adjusting Transfer Pump

d. Universal Block. Examine seal surface and tongues and smooth off any rough edges. Substitute a new part if tongues are worn excessively. Do not attempt to repair seal surface as this surface must be absolutely true to seat properly on bearing face.

e. Seal Disk. If seal surface is noticeably worn or scored, substitute a new part. Do not attempt to repair seal surface.

f. Relief Valve. Inspect stem to see that it has free action in guide hole.

30. ASSEMBLY OF UNIT

a. Assemble Pump. Before any assembly is started, make certain that every part of pump is clean. Heat body to 250°F. and insert rear bearing and eccentric sleeve. Place center pin in bore of rotor and four blades in rotor slots. This assembly unit can be held together with a rubber band until partly inserted into bore of sleeve. While body is still warm, insert front bearing. Install seal parts, drive coupling, and tighten entire assembly with lock nut. While assembling seal parts, place enough oil on seal surface to provide a film of lubricant but do not oil excessively. Lock nut with plate and screw.

b. Install Valve. Mount valve housing on pump body, making sure that marked sides are together. If a new valve assembly is used, assemble side with inlet note plate near scribe mark. Fasten valve assembly to housing with four screws and lock six screws in groups of three with lock wire.

c. Adjust Valve. Adjust relief valve so that pump will deliver fuel at 20 to 25 pounds per square inch pressure (fig. 71).

CHAPTER 3 — cont'd

Section III

SECONDARY FUEL FILTER AND PRIMING PUMP

	Paragraph
Description and data	31
Disassembly	32
Cleaning and inspection	33
Assembly	34

31. DESCRIPTION AND DATA.

a. **Secondary Fuel Filter.** The secondary fuel filter contains six elements of cotton yarn wound around a core of coarse mesh copper screen which acts as a support for the element. The elements are attached to a plate which is held between the filter housing and cover. A rod with a plate on one end attaches element to main plate by a spring, retainer, and pin on top side of plate. Fuel passes through filter and along rod to cover compartment. A by-pass valve is provided in case the elements become clogged with dirt. A fuel pressure gauge indicates the condition of elements. The pressure with new elements is approximately 25 pounds and decreases as elements become clogged. Before pressure drops to five pounds, elements should be replaced as the bypass opens at this point and allows unfiltered fuel to pass into engine.

b. **Primary Pump.** After an engine has been disassembled, fuel lines disconnected, or new fuel filters installed, it will be necessary to prime the fuel system to remove air. The priming pump is of the plunger type, with two spring-loaded ball check valves.

32. DISASSEMBLY (fig. 72).

a. **Disassemble Filter.** Remove pump from housing by removing two cap screws and lock washers which attach pump base to filter housing. Remove fuel filter cover by removing 10 cap screws and lock washers which attach it to housing. Remove cover gasket, lift element plate and elements out of housing, and remove plate gasket. Remove by-pass spring retainer, being careful not to injure spring. Remove spring and plunger.

b. **Disassemble Pump.** Remove priming pump barrel from base by removing two cap screws and lock washers. The valves are removed by unscrewing retainer and removing springs and balls. Unscrew cap from barrel and remove plunger from barrel. Remove machine screw from end of plunger, lift out washer and replace screw. Unscrew valve bearing from plunger rod end. Remove jam nut, slide washers, springs and cups off rod and remove second jam nut. Slide cap from rod.

FUEL SYSTEM

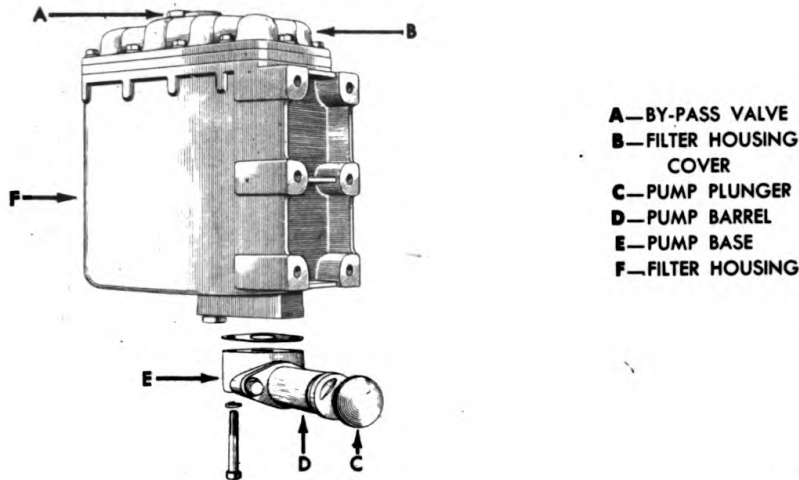

RA PD 311067

Figure 72 — Secondary Fuel Filter and Priming Pump

33. CLEANING AND INSPECTION.

a. **Cleaning.** Wash all parts carefully with dry-cleaning solvent except the filter elements which cannot be cleaned. Replace them as described in TM 9-756.

b. **Inspection.** Examine cup springs for broken ends and cracks. Check cups for wear and deterioration. Inspect bearing washer for wear. Check springs for proper tension (par. 23). Examine balls for nicks and scratches. Also check ball seats for nicks. Examine by-pass plunger to insure that it seats properly.

34. ASSEMBLY (fig. 72).

a. **Assemble Filter.** Place by-pass plunger on seat and spring on top of plunger. Drive in a new retainer, cup side down, until top is flush with top of housing. Place gasket with two large holes on filter housing; place plate with elements attached on gasket. Place other gasket on plate and cover on gasket. Tighten with 10 cap screws and lock washers.

b. **Assemble Pump.** Slide priming pump cap on plunger rod and start thread to hold it in place. Run one of jam nuts onto end of thread. Slide on one of two smaller washers, rounded edge up. Slide on spring and cup, open end down. Install larger washer, cup and spring, open end up. Put other small washer on, rounded edge down, and run up other jam nut by hand. Place washer on bearing and attach with screw. Tighten bearing on end of rod. Tighten jam nut against bearing. Slide cups, springs, and washers toward this nut, center on rod, and secure with other jam nut. Place this assembly in barrel, making certain that cups and springs are in contact with barrel all around. Place valve balls

ORDNANCE MAINTENANCE — ORDNANCE ENGINE MODEL RD-1820 (CATERPILLAR)

and springs in position, and screw in two retainers. Loosen cap from rod and run it onto barrel. Place barrel end of pump on base and attach with two cap screws and lock washers. Screw plunger handle onto cap.

c. **Install Pump.** Attach pump base to filter housing with two cap screws and lock washers.

CHAPTER 3 — cont'd

Section IV

**FUEL INJECTION PUMP, LINES, VALVES,
AND PRECOMBUSTION CHAMBER**

	Paragraph
Fuel injection pump	35
Fuel injection lines	36
Fuel injection valves	37
Precombustion chamber	38

35. FUEL INJECTION PUMP.

a. **Description.** An individual fuel pump (fig. 11) is provided for each cylinder. Each injection pump measures the amount of fuel to be injected, produces the pressure for injection, and times the injection. The governor actuates a circular rack which controls the angular position of each fuel injection pump plunger. The plunger determines the amount of fuel delivered by each stroke of each pump. **CAUTION:** *Do not disassemble the pumps.*

b. **Removal.** Refer to paragraph 6 d.

c. **Cleaning and Inspection.** Be sure caps are on fuel openings when not covered by fuel line connection. Keep gears and lifter surface clean by wiping with a rag. Check outlet connection threads for burs.

d. **Installation.** Refer to paragraph 21 j (1).

36. FUEL INJECTION LINES (fig. 11).

a. **Description.** The fuel line from injection pump to injection valve is a seamless steel tube. It is flared and fitted with washers and nuts at each end for connectors.

b. **Removal.** Refer to paragraph 6 d.

c. **Cleaning and Inspection.** The inside of lines must be kept clean at all times. The flared ends, washer and nut must be free from dirt to provide a good seal. Inspect line for cracks. Check flared ends for burs which may prevent a good sealing surface. Check nut threads for burs.

d. **Installation.** Refer to paragraph 21 j (3).

FUEL SYSTEM

37. FUEL INJECTION VALVES (fig. 11).

a. **Description.** Fuel pressure, developed by injection pump, actuates injection valve check and fuel is sprayed into precombustion chamber. An elbow at top of valve contains a spiral type strainer for further removal of foreign material from fuel. The check, which is seated by a single spring, is unseated by each pressure surge from injection pump. A loose nut, which cannot slip over elbow, tightens valve into precombustion chamber. **CAUTION:** *Do not disassemble valves.*

b. **Removal.** Refer to paragraph 6 d.

c. **Cleaning and Inspection.** Inspect elbow and nut threads for burs. Keep exterior wiped clean so that it will seat squarely in precombustion chamber recess.

d. **Installation.** Refer to paragraph 21 j (3).

38. PRECOMBUSTION CHAMBER.

a. **Description.** The precombustion chamber is screwed into cylinder head, and valve is screwed into precombustion chamber. The precombustion chamber conditions fuel for final combustion in cylinder and distributes fuel throughout the air in cylinder in such a way that complete, clean burning of all fuel is assured. The exterior of chamber is covered with fins. The lower fins are notched to match installing wrench.

b. **Removal.** Refer to paragraph 6 d. Do not remove unless for replacement.

c. **Cleaning and Inspection.** Keep both threads clean and free from burs to permit a tight fit. Keep all fin surfaces clean to permit maximum cooling.

d. **Disassembly.** The precombustion chamber is a welded unit and cannot be disassembled.

e. **Installation.** Refer to paragraph 21 j (2).

Section V

GOVERNOR AND CONTROLS

	Paragraph
Description and data	39
Removal	40
Disassembly	41
Cleaning and inspection	42
Repair	43
Assembly	44
Installation	45
Adjustment	46

ORDNANCE MAINTENANCE — ORDNANCE ENGINE MODEL RD-1820 (CATERPILLAR)

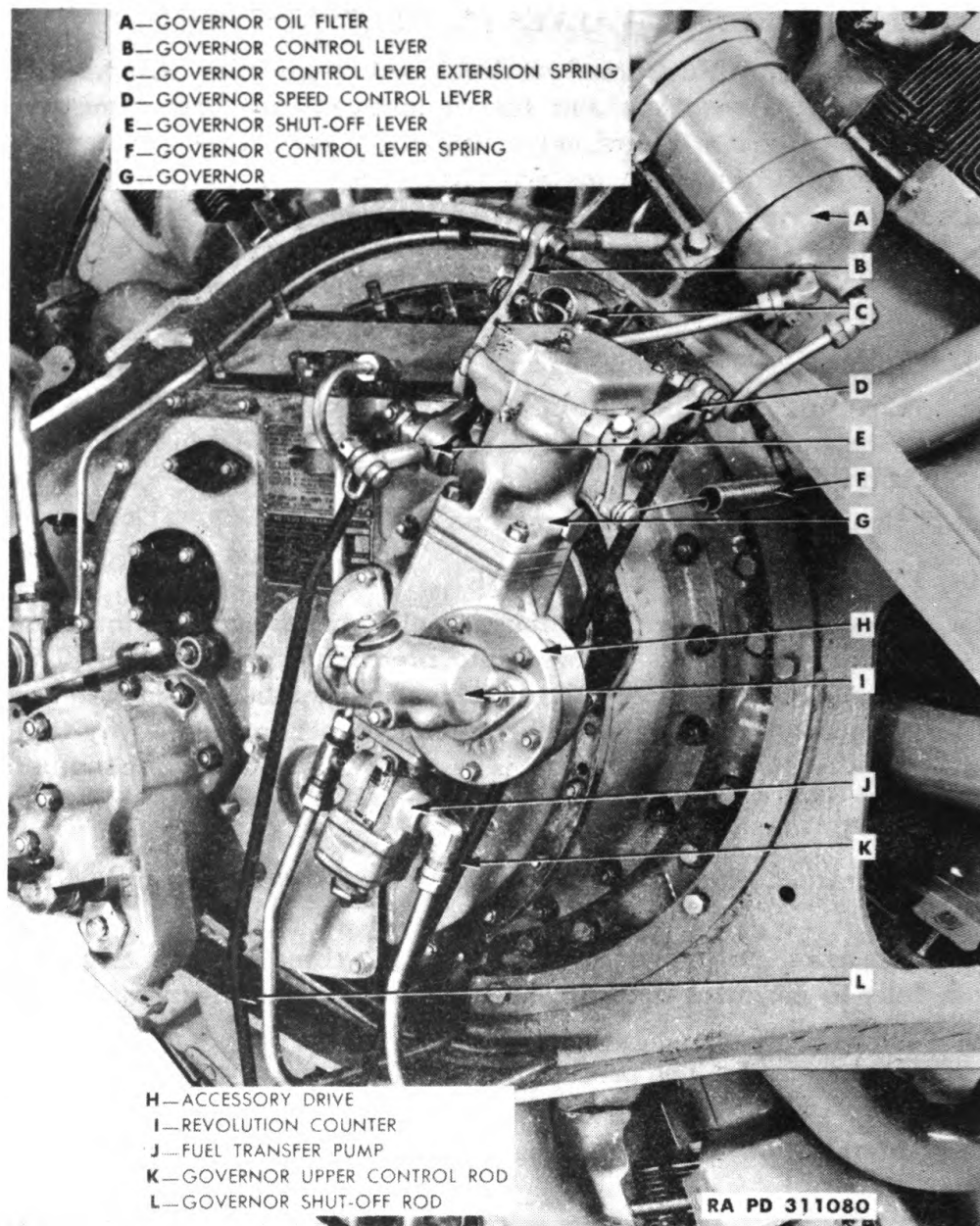

Figure 73 — Governor and Controls

39. DESCRIPTION AND DATA.

a. The governor is of the hydraulic type and uses engine lubricating oil under pressure as an energizing medium. A gear pump in governor base raises the oil pressure for use in governor. When the accelerator is kept in one position, the governor maintains constant engine speed during normal load variations. Under these conditions, hydraulic pressure balances the centrifugal force of flyballs. When this balance is upset by a change in accelerator position or a change in

FUEL SYSTEM

RA PD 311053

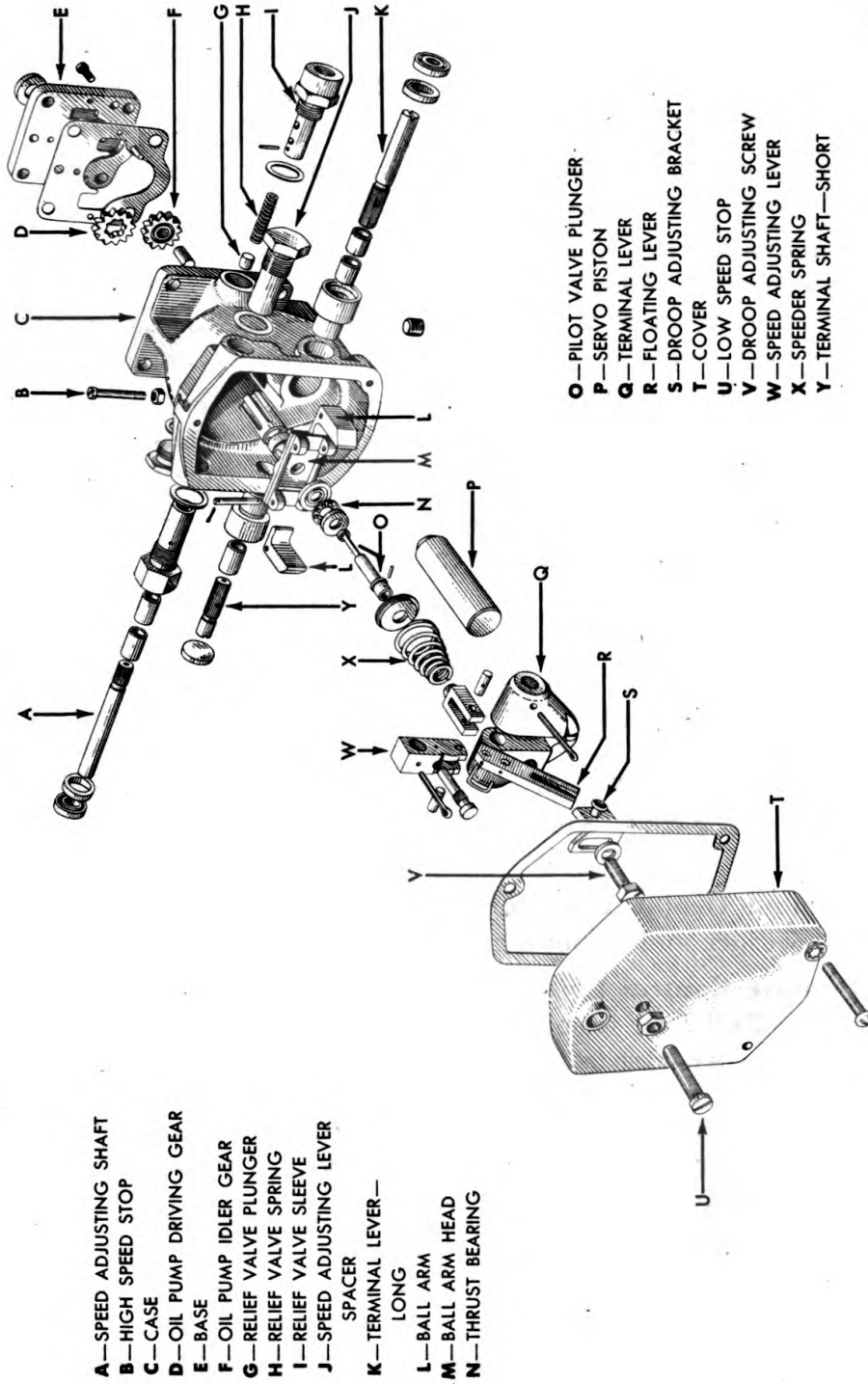

Figure 74 — Governor Disassembled

ORDNANCE MAINTENANCE — ORDNANCE ENGINE MODEL RD-1820 (CATERPILLAR)

engine load, a hydraulic plunger is actuated which in turn varies the amount of fuel delivered by the fuel injection pumps and thus tends to restore a balanced condition. Adjustments for speed droop, low idle, and high idle speeds are provided.

40. REMOVAL.

a. **Remove Governor.** With control rods and levers removed, remove four nuts attaching governor to housing. Pull governor and gasket off studs (fig. 73).

b. **Remove Control Rods.** All control rods are disconnected by removing cotter pins and nuts from yoke bolts.

c. **Remove Spring Controlled Levers.** These levers are disconnected by removing cotter pin, nut, washer and spring bolt. The levers are removed from shafts by removing taper pins, removing lock wire, and unscrewing capscrews until levers can be slipped off shafts.

d. **Remove Lower Bell Crank Levers.** These levers are removed by removing cotter pins and washers and slipping levers off bracket pins.

e. **Remove Lower Control Levers.** These levers are removed by removing cotter pins, nuts and pins which attach them to transfer case support.

f. **Remove Governor Shut-off Lever.** This lever may be slipped off governor sleeve after removal of governor oil filter outlet tube.

41. DISASSEMBLY.

a. **Remove Cover.** Remove three cover screws and lift cover and gasket off case (fig. 74). Remove the high speed and low speed stops and lock nuts.

b. **Remove Droop Adjusting Bracket.** Remove droop adjusting screw and washer and remove bracket.

c. **Remove Control Linkage.** Remove two cotter pins from terminal lever. Pull long terminal shaft from sleeve. Remove two oil seals. Remove core plug from short terminal shaft sleeve and remove shaft and lever. Press two sleeves from case. Remove cotter pin from speed adjusting shaft and pull shaft and gaskets. Unscrew shaft sleeve and spacer. Remove spring fork and disassemble levers by removing lockwire and two pins.

d. **Remove Plunger.** Unscrew spring from seat and remove plunger pin. Remove spring, seat, plunger and bearing, being careful not to damage plunger.

e. **Remove Drive.** From bottom, tap splined shaft with a soft instrument until it passes through collar. The head and arms will

FUEL SYSTEM

fall out. Avoid dropping assembly as splines may be damaged. Remove three machine screws from base and remove base and gasket. Remove pump gears and idler gear stud.

f. **Remove Ball Arms.** Remove cotter pins, ball arm pins, and remove ball arm. Remove plug and gasket from case.

g. **Remove Relief Valve.** Unscrew relief valve sleeve and remove with gasket. Remove relief valve pin from sleeve end and shake valve and spring out of sleeve.

42. CLEANING AND INSPECTION.

a. **Cleaning.** Wash all governor parts in dry-cleaning solvent. Handle parts carefully so that damage will not result; use particular care with pilot valve plunger and servo piston. Clean case and all oil passages thoroughly.

b. **Inspection.** Inspect droop adjusting bracket for wear and tightness of pin. Examine floating lever for roughness or wear of slot and pin holes. Check all lever connecting pins for wear. Examine speed adjusting lever for tightness of stop pin and condition of pin holes and internal spline. Inspect piston for burs, nicks and scratches. Examine speeder spring fork for wear of connecting pin holes. Check speeder spring for cracks. Inspect spring seat for tightness on plunger and examine for wear ridges and scratches on bottom surface. Examine plunger valve for nicks, burs and scratches. Check ball thrust bearing for pitting or corrosion of balls or races. Inspect arm ball head for pitting, galling, picking-up, and wear of splines. Check internal bore for scratches and wear ridges. Examine flyball holding lugs for wear of pin holes. Inspect flyballs for burs on contact faces and condition of pin holes. Inspect ball arm pins for wear. Inspect terminal shaft sleeve and bushings for burs and wear. Check relief valve for scratches and burs. Inspect oil pump gears for pitting and wear of teeth. Examine drive gear spline for pitting, galling and wear. Inspect idler gear stud for tightness in case and for galling or scoring. Inspect governor base for scoring, galling, and scratching, at oil pump gear location. Make certain all oil passages in case are free from obstruction.

43. REPAIR.

a. **Replace Bushings.** If bushings in speed adjusting and terminal shaft sleeves are scored or worn, they must be replaced. Press out old bushings. Press in new bushings; one in short terminal shaft sleeve, flush with inside surface; two in long terminal shaft sleeve; and two in speed adjusting shaft sleeve, each bushing being flush with one end of sleeve.

ORDNANCE MAINTENANCE — ORDNANCE ENGINE MODEL RD-1820 (CATERPILLAR)

b. **Replace Dowels and Studs.** In case of any damage, the base dowels and idler gear stud may be removed and new ones pressed in place.

44. ASSEMBLY.

a. **Assemble Ball Arm Head.** Assemble ball arms on head with pins and cotter pins. Place head assembly in case and hold in position. Put oil pump idler gear on stud and drive gear on spline. Place gasket and base in position on case and attach with three machine screws. Press collar on spline end until all end play is eliminated but a free rotation of ball head is still possible.

b. **Install Relief Valve.** Place spring and valve in relief valve sleeve and slip retaining pin in end hole. Tighten assembly in case. Tighten plug and gasket in hole opposite relief valve.

c. **Install Plunger and Linkage.** Assemble floating lever and speed adjusting lever to speeder spring fork with pins and lock wire. Attach fork to spring top. Assemble spring seat and plunger. Place retaining pin in position and tap pin in center to bend it slightly and prevent it from falling out, Attach spring to seat. Slide bearing on plunger and carefully place plunger and attached parts in hole in ball arm head. Plunger must be free to move up and down in ball arm head. Install speed adjusting shaft sleeve and gasket by screwing into case. Place shaft in sleeve, and attach speed adjusting lever to shaft with a cotter pin. Install two seals, back to back, in sleeve end. Install spacer and gasket in case. Install terminal lever sleeve in case by pressing into position. Place terminal lever in position, and install two terminal shafts. Lock lever to shafts with cotter pins. Install a new core plug in short terminal shaft sleeve. Install two seals, back to back, in long terminal shaft sleeve end. Place droop adjusting bracket in position and lock in place with cap screw and washer.

d. **Install Speed Stops and Cover.** Install high speed stop and nut in cover. Install cover and gasket and attach with three machine screws and two washers.

45. INSTALLATION.

a. **Install Governor.** Place gasket and governor on studs and attach with four nuts (fig. 73). Be certain governor name plate faces engine.

b. **Install Control Rods.** Connect control rods with bolts running through yoke ends and secure with nuts and cotter pins.

c. **Install Spring Controlled Levers.** The two spring controlled levers are attached to their shafts by a taper pin and a cap screw. Drive taper pin in position, tighten cap screw and lock with lock wire

FUEL SYSTEM

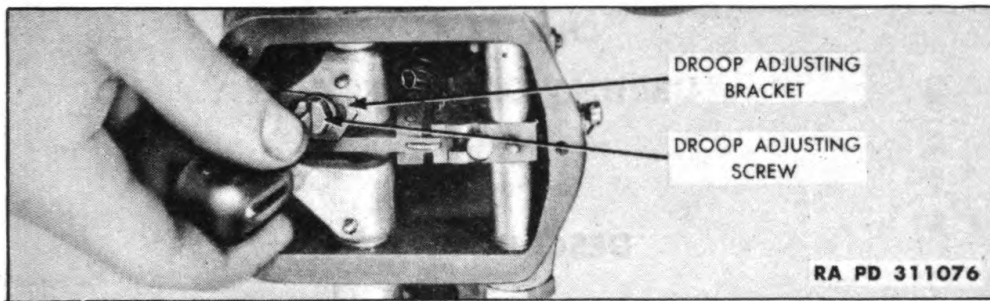

Figure 75 – Governor Droop Adjustment

running around lever arm. The springs are connected by bolts, washers, nuts, and cotter pins.

d. **Install Lower Bell Crank Levers.** The two lower bell crank levers are slipped on bracket pin, the washers are placed on pins and cotter pins hold washers in place.

e. **Install Lower Control Levers.** The two lower control levers are each attached to transfer case support by a pin, nut, and cotter pin.

f. **Install Governor Shut-off Lever.** This lever is slipped on governor sleeve and retained by governor oil filter outlet tube ferrule.

46. ADJUSTMENT.

a. **Set Droop Adjustment.** Locate droop adjusting screw in exact center of slot of droop adjusting bracket and tighten (fig. 75).

b. **Install Control Levers** (fig. 73). If original governor has been reinstalled, place speed control lever and shut-off lever in their original location and pin in place. If a replacement governor has been installed it will be necessary to relocate position of levers on their respective shafts. Position shut-off lever on terminal shaft (fig. 74) so that rod from lever to engine is in the full forward position when terminal shaft is rotated fully counterclockwise. Position speed control lever on speed adjusting shaft (fig. 74) so that governor does not restrict full travel of accelerator pedal and so that correct low and high idle speeds may be obtained.

c. **Set Low and High Idle Speeds** (fig. 73). These adjustments must be made with engine running. Loosen lock nut on set screw located on top of governor cover. With throttle in closed position, adjust screw to obtain a low idle speed of 650-750 revolutions per minute. Tighten lock nut and lock wire. Loosen lock nut on set screw on back side of governor housing. With throttle in fully advanced position, adjust screw to obtain a high idle speed of 2,050 to 2,200 revolutions per minute. Tighten lock nut and lock wire.

CHAPTER 4
LUBRICATION SYSTEM

Section I
DESCRIPTION

Description	Paragraph 47
-------------------	-----------------

47. DESCRIPTION.

a. The engine is lubricated by a full pressure dry sump system. Oil is circulated by a gear type oil pump (fig. 76) which returns oil that collects in a sump (fig. 11) to a supply tank, and circulates oil from the supply tank to an air cooled oil cooler (fig. 1), filters, and engine parts.

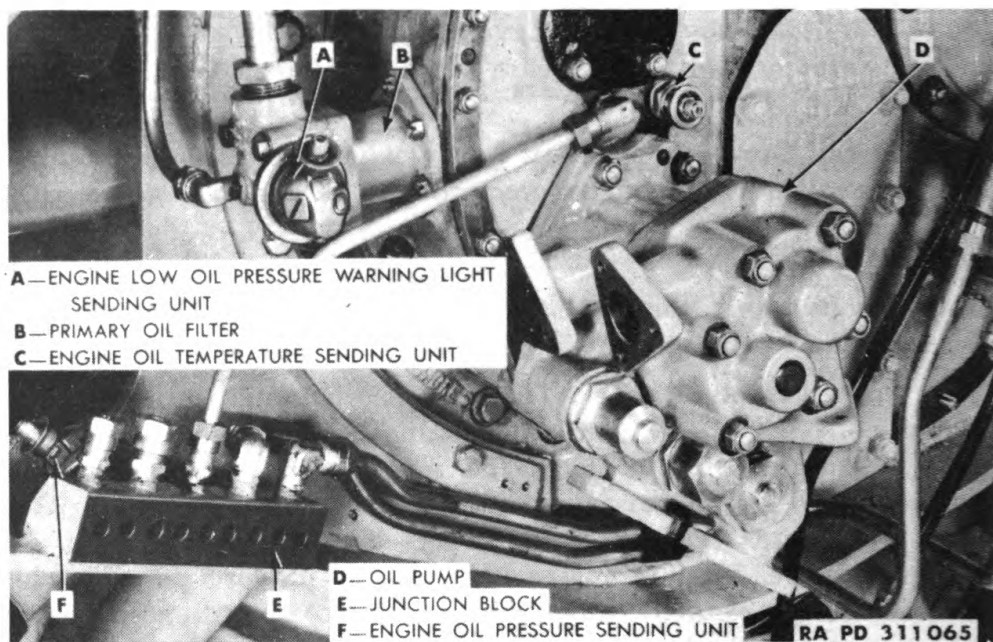

Figure 76 — Junction Block and Oil Pump

Section II
OIL PUMP AND LINES

Description and data	Paragraph 48
Disassembly	49
Cleaning and inspection	50
Assembly	51

LUBRICATION SYSTEM

RA PD 311051

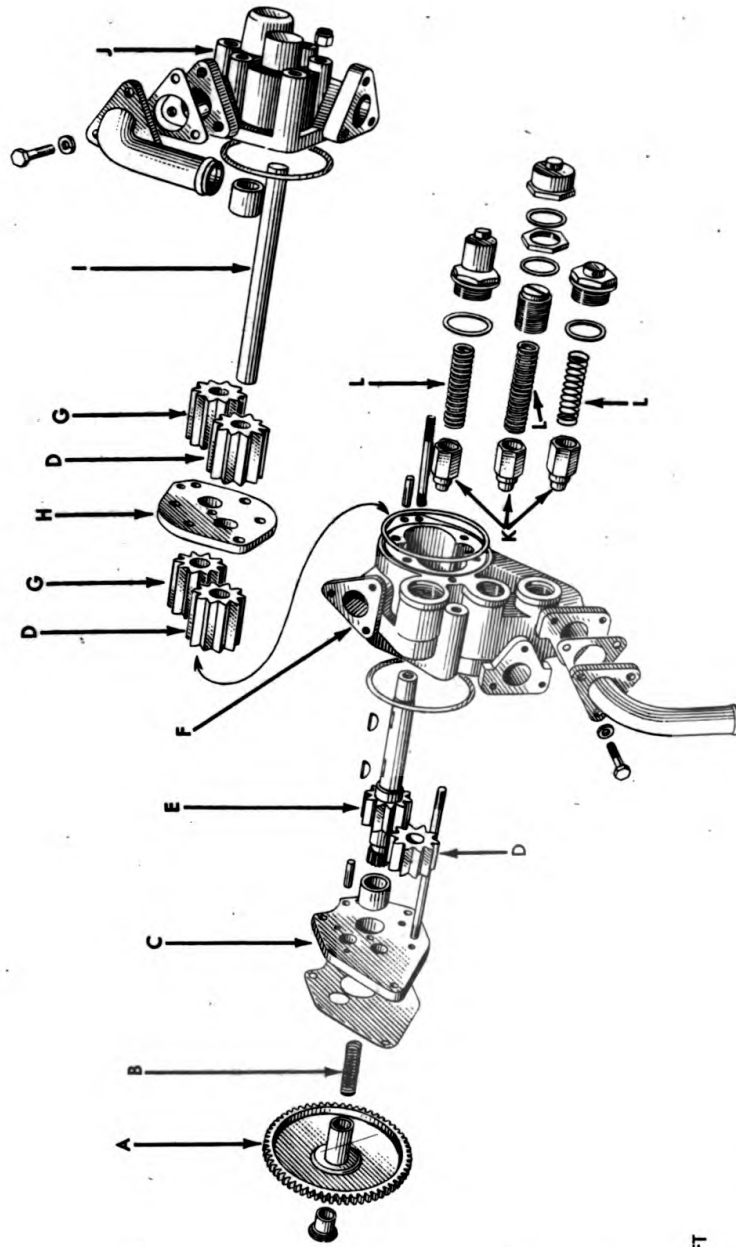

- A—DRIVE GEAR
- B—SHAFT SPRING
- C—END PLATE
- D—IDLER GEARS
- E—DRIVE SHAFT
- F—LOWER BODY
- G—DRIVE GEARS
- H—SEPARATOR
- I—IDLER GEAR SHAFT
- J—TOP BODY
- K—RELIEF PLUNGERS
- L—RELIEF PLUNGER SPRINGS

Figure 77 — Oil Pump Disassembled

ORDNANCE MAINTENANCE — ORDNANCE ENGINE MODEL RD-1820 (CATERPILLAR)

48. DESCRIPTION AND DATA.

a. The gear type oil pump contains three sets of gears. Each set acts as a pressure pump to circulate oil through part of the lubricating system. One set returns oil, which collects in the sump, to the supply tank. Another set circulates oil from the supply tank through the cooler to the third set of gears. The third set supplies oil under pressure to engine, governor and secondary oil filter. Flexible lines are used to carry oil to and from supply tank.

49. DISASSEMBLY.

a. **Remove Relief Valves.** Remove lock wire from two plugs and relief valve cover (fig. 77). Disassemble upper and lower relief valves by removing plugs, springs, plungers, and center relief valve by removing lock nut and adjusting screw. Do not mix these parts as they must be installed in their original location on assembly.

b. **Remove Gears.** Remove six nuts which retain pump top body and lift top body and idler gear shaft from pump lower body. One set of gears and drive gear key along with pump body separator can now be removed. Take out second set of gears and drive gear key; remove bottom plate assembly, idler gear, and drive shaft with integral gear. The sets of gears must not be mixed. Remove oil pump body rubber sealing rings.

50. CLEANING AND INSPECTION.

a. **Cleaning.** Wash all parts of pump in dry-cleaning solvent.

b. **Inspection.** Inspect all parts for cracks, burs, scoring, and condition of threads. Examine drive shaft bushing for tightness in end plate and wear. Inspect drive shaft for wear of splines and pump drive gear teeth. Examine shaft for cracks and mutilation of keyways. Check bushing surfaces for wear. Inspect gears for pitting, scoring and wear of teeth. Examine gear ends for scoring and scratching. Measure depth of all gear cavities in pump bodies and compare with over-all length measurement of proper gears to determine gear end clearance. Check idler gear shaft for fit (par. 22). Make certain all passages are free from obstruction. Inspect relief valves for wear ridges. Check springs for proper tension (par. 23).

51. ASSEMBLY.

a. **Install Sealing Rings.** Install new pump body sealing rings. Oil all moving parts thoroughly as they are assembled.

b. **Install Gears and Shafts.** Install pump drive shaft in pump lower body with gear on side opposite relief valve openings. Place proper mating idler gear in mesh with integral gear and install end plate in position with studs extending through pump lower body. In-

LUBRICATION SYSTEM

stall key in keyway in shaft nearest integral gear. Slide drive gear over key and install mating idler gear. Place separator plate in position. **CAUTION:** *Make sure all sealing rings are in place.* Install key in end keyway of shaft and slide drive gear over key. Place mating idler gear in position and install pump top cover. Slide idler gear shaft slowly through idler gears. With top cover in position, install six oil pump body retaining nuts.

c. **Install Relief Valves.** Install relief plungers with springs and retaining plugs. Install adjusting screw and lock nut. Make certain all relief plunger plug washers are in place.

CHAPTER 4 – cont'd

Section III

LUBRICATING OIL FILTERS

	Paragraph
Primary oil filter.....	52
Secondary oil filter.....	53
Governor oil filter.....	54

52. PRIMARY OIL FILTER.

a. **Description.** The primary oil filter (fig. 76) is located in supercharger rear housing. The filter is of the metallic type with a spring loaded relief valve which opens at 25 pounds per square inch pressure. The filter elbow carries the engine oil pressure indicator and engine oil low pressure warning indicator sending units.

b. **Removal.** Disconnect oil tubes and remove lock wire and six nuts which attach filter housing to supercharger rear housing. Pull filter housing and gasket off studs.

c. **Disassembly.** Remove lock wire and four cap screws which hold elbow to filter assembly and remove elbow. Lift relief valve from filter housing.

d. **Cleaning and Inspection.**

(1) **CLEANING.** Wash filter relief valve and filter elbow in dry-cleaning solvent.

(2) **INSPECTION.** Inspect relief valve to make certain valve will open and seat properly. Examine filter for holes and damage to end support cup.

e. **Assembly.** Install relief valve in filter and with new gasket attach elbow to filter with cap screws. Install lock wire in cap screw heads.

ORDNANCE MAINTENANCE — ORDNANCE ENGINE MODEL RD-1820 (CATERPILLAR)

f. **Installation.** Install gasket and filter on studs in supercharger rear housing. Install and lock wire six nuts. Connect oil lines.

53. SECONDARY OIL FILTER.

a. **Description.** The secondary or by-pass filter is of the absorbent type containing four individual replaceable elements. These elements are to be replaced every 100 hours. This filter is located in fighting compartment of vehicle.

b. **Removal.** Disconnect inlet and outlet tubes. Remove four cap screws supporting filter brackets.

c. **Disassembly.** Remove four cap screws which attach two support brackets to filter and take off brackets. Remove filter cover retaining screws and covers, element assemblies and cases. Remove lock wire from drain plug and cap screw. Remove remaining cap screws and take off filter base cover. Remove cotter pins, nuts and washers which retain outlet tubes and filter bottom plates. To disassemble filter cover, pry element retaining spring from groove in retaining screw and remove spring, screw and washer.

d. **Cleaning and Inspection.**

(1) **CLEANING.** The elements cannot be cleaned. Wash all other parts in dry-cleaning solvent.

(2) **INSPECTION.** Check filter base for tightness of dowels and condition of rubber seal rings. Replace any damaged seal rings. Make certain all passages in outlet tube are open.

e. **Assembly.** Place filter bottom plates on dowels in filter base and install outlet tubes. Attach filter base cover, using new gaskets. Make certain drilled head cap screw is installed near drain plug and lock wire drain plug to cap screw. Place new filter element on outlet tubes and install new gaskets in filter covers. Assemble cover, retaining screw gasket, retaining screw and spring. Place gasket on screw, insert through cover and slide spring on screw until upper coil locks in groove in retaining screw. Install filter case over element and secure by means of retaining screw. Install filter supporting brackets.

f. **Installation.** Attach filter assembly with four cap screws. Attach inlet and outlet tubes.

54. GOVERNOR OIL FILTER.

a. **Description and Data.** The filter (fig. 73) contains a single replaceable element and a 15—20 pounds per square inch pressure relief valve.

b. **Removal.** Disconnect inlet and outlet tubes. Remove lock wire and four band cap screws. Lift out filter.

LUBRICATION SYSTEM

c. **Disassembly.** Unscrew cover retaining screw and remove cover. Lift out filter element and remove gasket from cover. Unscrew fittings from filter case.

d. **Cleaning and Inspection.**

(1) **CLEANING.** The element cannot be cleaned. Wash case thoroughly with dry-cleaning solvent and make certain inlet pipe, relief valve and all fittings are clean and free from obstructions.

(2) **INSPECTION.** Check inlet tube for tightness in case. Make sure relief valve spring retainer is securely staked in inlet tube. Note if retaining screw is spun over sufficiently to retain washer and spring.

e. **Assembly of Filter.** Install new filter element and new gasket in cover. Place cover in position and tighten cover retaining screw. Screw fittings in place and line up properly.

f. **Installation.** Attach filter by means of bands and cap screws. Lock wire cap screws. Attach inlet and outlet tubes.

CHAPTER 5
ENGINE ELECTRICAL SYSTEM

Section I
DESCRIPTION

	Paragraph
Description	55

55. DESCRIPTION.

a. The engine is cranked by means of two 24-volt cranking motors. For cold weather starting an air heater mounted in intake manifold of engine supplements starters. A vibrator coil supplies high tension current to spark plug of heater. Fuel to heater is controlled by a magnetic valve. The engine is equipped with sending units for oil temperature, oil pressure and fuel pressure indicators, and a low oil pressure warning light (fig. 76).

Section II
CRANKING MOTORS

	Paragraph
Description and data	56
External cleaning and inspection	57
Disassembly	58
Cleaning and inspection	59
Assembly	60
Test of rebuilt unit	61

56. DESCRIPTION AND DATA (fig. 1).

a. **Description.** The electric cranking motors have a clutch type Bendix drive. The motors are mounted on transfer case support, and Bendix drive gears engage a ring gear bolted to engine flywheel.

b. **Data.**

Make	Leece-Neville
Model	1219M
Direction of rotation	Counterclockwise
Voltage	24-32 DC

57. EXTERNAL CLEANING AND INSPECTION.

a. **Cleaning.** Blow or wipe dust and dirt from starter exterior and Bendix drive. Do not spray pressure washing solutions against motor or wash motor in liquids.

ENGINE ELECTRICAL SYSTEM

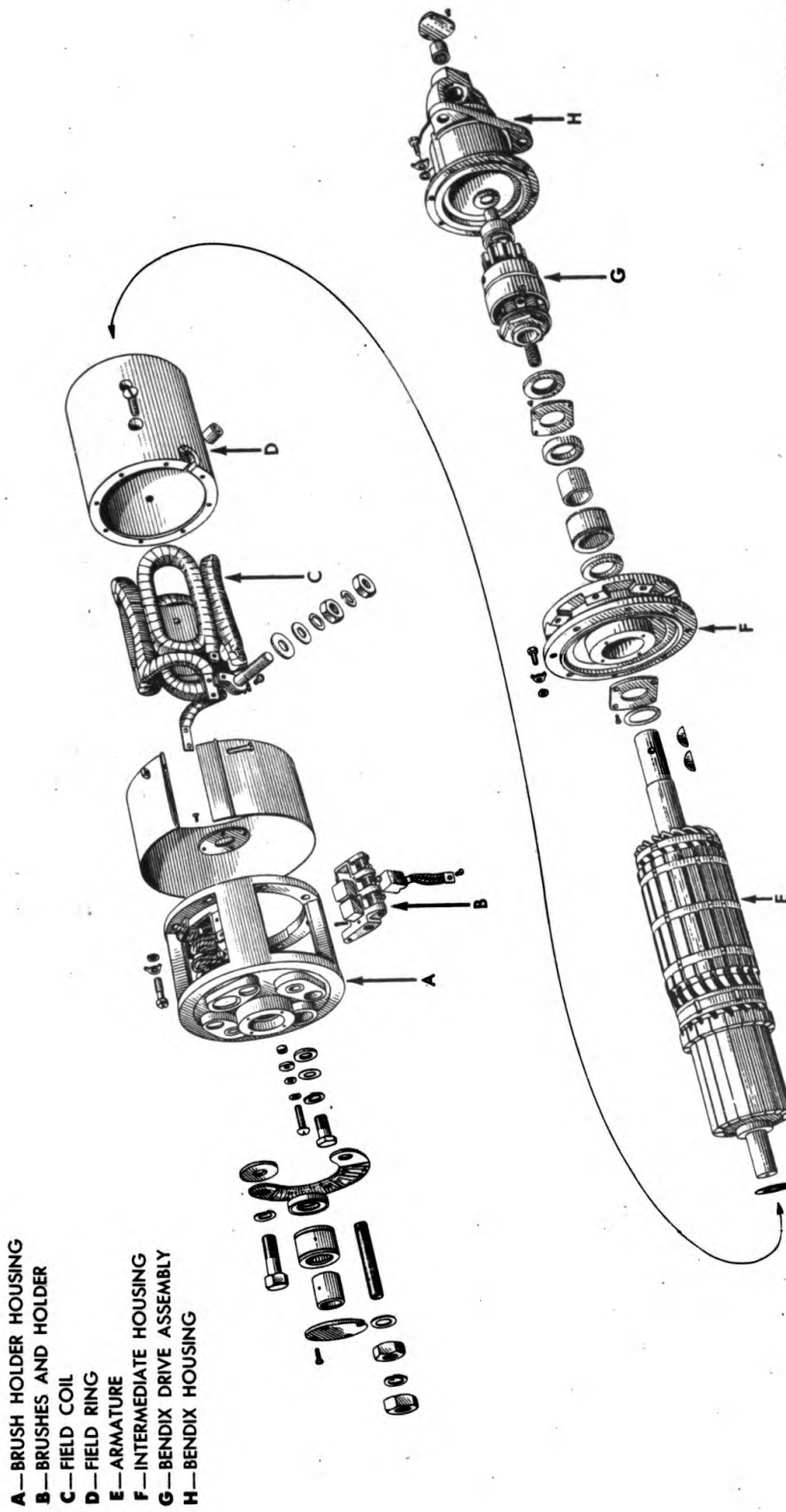

- A—BRUSH HOLDER HOUSING
- B—BRUSHES AND HOLDER
- C—FIELD COIL
- D—FIELD RING
- E—ARMATURE
- F—INTERMEDIATE HOUSING
- G—BENDIX DRIVE ASSEMBLY
- H—BENDIX HOUSING

RA PD 311045

Figure 78 — Cranking Motor Disassembled

ORDNANCE MAINTENANCE — ORDNANCE ENGINE MODEL RD-1820 (CATERPILLAR)

b. **Inspection.** Inspect the pinion screw shaft for gummy deposits and remove with dry-cleaning solvent if present. Lubricate screw with light oil only.

58. **DISASSEMBLY.**

a. **Remove Drive.** Mark relative location of field ring, intermediate housing, and Bendix drive housing (fig. 78). Remove Bendix housing from intermediate housing. Remove bearing retainer and bearing. Unscrew Bendix drive set screw and slide drive off armature shaft.

b. **Remove Intermediate Housing.** Remove cap screws from intermediate housing and pull housing off shaft away from field ring. Remove oil seal retainers from each end of housing and remove seals, bearing and sleeve.

c. **Remove Armature.** Remove armature from field ring, being careful not to damage insulation or commutator.

d. **Remove Brush Holder Housing.** Mark location of stud and screws in brush holder housing. Also mark location of brush assemblies. Remove stud nuts, washers, cap screws and washer from brush holder housing end. Remove jumper and insulators. Mark relative location of field ring and brush holder housing. Remove band and remove brush holder housing from field ring.

e. **Disassemble Field Ring.** Remove bolts, nuts, and insulators, from side terminal. Remove eight screws from field ring and slide coil and pole piece out brush end.

f. **Disassemble Brush Holder Housing.** Remove two cap screws supporting each brush holder assembly and remove four assemblies. Remove bearing retainers, oil seal, sleeve, and bearing, from brush holder housing.

59. **CLEANING AND INSPECTION.**

a. **Cleaning.** Wash Bendix housing, brush holders, intermediate housing, field ring, band end and brush holder housing in dry-cleaning solvent. Clean Bendix housing bearing retainer, housing oil seal retainers, commutator end bearing retainer and seal retainer by washing. **CAUTION: Do not wash Bendix drive clutch in cleaning fluids and do not lubricate.** Clean drive clutch, armature, jumper and field coil by blowing with dry compressed air or by wiping with a clean cloth. Brushes may be cleaned with oil free gasoline if they are dried before being used. **CAUTION: Do not soak brushes.** Any caked substances may be removed with No. 00 flintpaper. Do not change brush size by sandpapering and do not round contact surface of brush. Wash and oil bearings after cleaning. Wash nuts, washers, screws and studs in dry-cleaning solvent. If commutator becomes slightly

ENGINE ELECTRICAL SYSTEM

rough or coated, clean while rotating with No. 00 flintpaper. Hold sandpaper against commutator with a flat piece of wood or fiber. Do not use metal. Resurface if commutator is rough or out-of-round.

b. **Inspection.** Inspect all bearings by visual examination, using a magnifying glass, for pitted or worn rollers or races. Check Bendix drive assembly for condition of pinion drive screw. Inspect drive pinion for burred, chipped, cracked and worn teeth. Inspect armature for rough or coated commutator. Check armature shaft for straightness and examine near keyways for cracks. Inspect field coils for condition of insulation and terminal screw threads. Examine brush holders for condition of springs and cleanliness of brush locations. Check all insulators for cracks and deterioration.

60. ASSEMBLY.

a. **Assemble Brush Holder Housing.** Assemble sleeve, bearing, oil seal and two retainers in brush holder housing. Assemble brush holders in housing, making certain that all holders and screws and stud are in proper location. Install jumper and place nuts and washers on stud.

b. **Assemble Field Ring.** Place field coil and pole piece in field ring and tighten with eight screws. Make certain sheet of mica is properly located, extending toward brush holder housing. Place field ring against brush holder housing and connect coil to brush holders. Attach field ring to brush holder housing with eight cap screws, washers and tab washers. Attach fiber washer and nuts and washers to side terminal.

c. **Install Armature.** Slide washer on commutator end of armature and place armature in field ring and locate shaft in bearing. Place washer on armature shaft end.

d. **Assemble Intermediate Housing.** Assemble bearing, sleeve, oil seals and retainers in intermediate housing. Attach housing to field ring with eight cap screws, washers and tab washers.

e. **Assemble Bendix Drive.** Place plain washer on shaft and spring in Bendix drive shaft opening. The Bendix drive clutch should be set at proper torque by adjusting end nut (par. 22). Place Woodruff keys in shaft and assemble Bendix drive on shaft. Make certain set screw hole lines up with counterbore in shaft and tighten set screw. Assemble bearing in Bendix housing and attach bearing retainer. Place washer on Bendix drive shaft end and install Bendix drive housing, being sure to line it up with locating marks. Attach housing with eight screws, washers and tab washers. End play must not exceed 0.032 inch.

ORDNANCE MAINTENANCE — ORDNANCE ENGINE MODEL RD-1820 (CATERPILLAR)

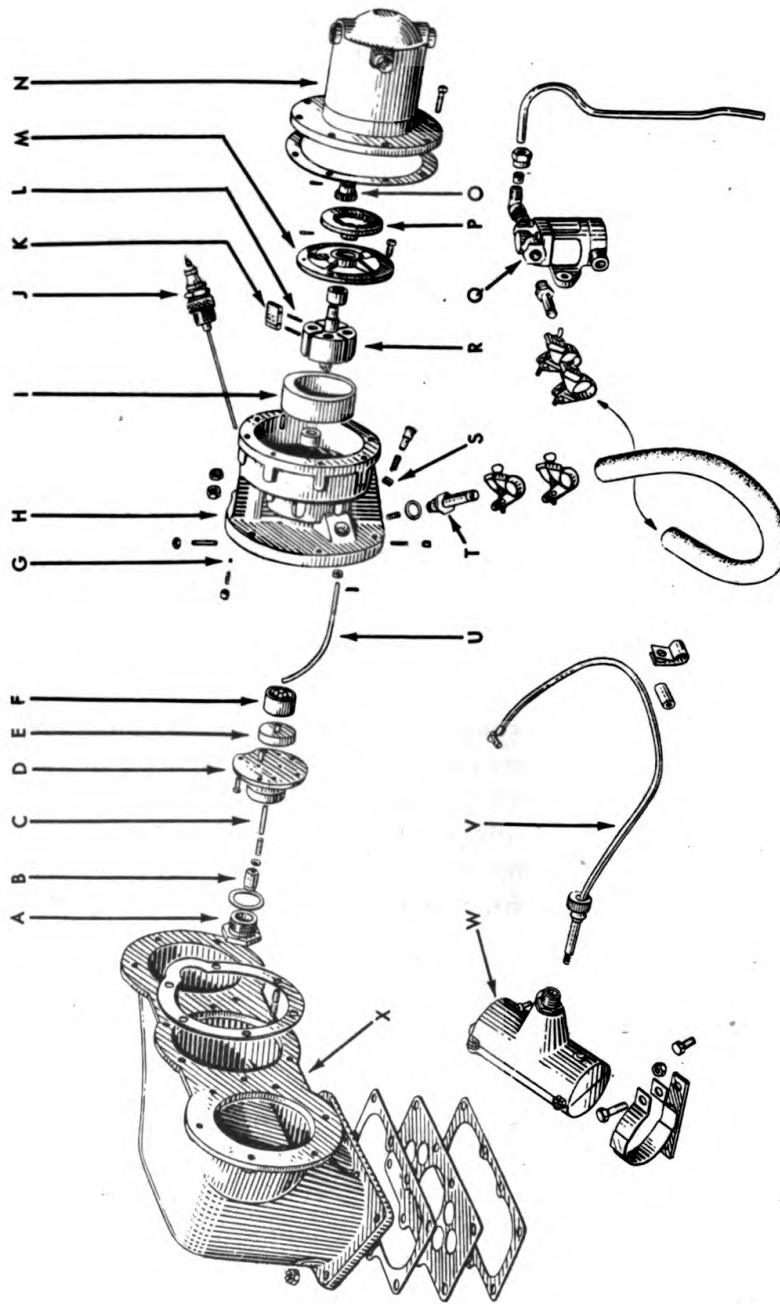

- A—NOZZLE BODY
- B—AIR AND FUEL NOZZLE
- C—FUEL TUBE
- D—END CAP
- E—LIFTER
- F—FUEL PUMP ROTOR
- G—AIR BY-PASS BALL CHECK
- H—HEATER HOUSING
- I—PUMP LINER
- J—SPARK PLUG
- K—YANE
- L—YANE SPRINGS
- M—PUMP COVER
- N—MOTOR
- O—PINION
- P—GEAR
- Q—MAGNETIC VALVE
- R—PUMP SHAFT
- S—FUEL CHECK VALVE
- T—FUEL INLET NOZZLE
- U—GROUND WIRE
- V—IGNITER CABLE
- W—VIBRATOR COIL
- X—MANIFOLD

RA PD 311012

Figure 79 — Air Heater Disassembled

ENGINE ELECTRICAL SYSTEM

61. TEST OF REBUILT UNIT.

a. Do not apply more than 12 volts to terminals of 24 to 32-volt motors when testing without load. Motor bearings should be sufficiently free turning and automatic drive pinion sufficiently free moving so that pinion will advance on screw shaft when 6 volts are applied to terminals. With brush opening band removed and motor cranking engine, note if vigorous arcing occurs between brushes and commutator. If this occurs, increase brush spring pressure. Arcing will occur if brushes are too short or are sticking in holders.

CHAPTER 5 – cont'd

Section III

AIR HEATER

	Paragraph
Description and data	62
Disassembly	63
Cleaning and inspection	64
Repair	65
Assembly	66
Test of rebuilt unit	67

62. DESCRIPTION AND DATA.

a. The air heater is located between the two air inlet elbows on intake manifold. Its function is to inject a stream of burning fuel into manifold, warming intake air.

63. DISASSEMBLY.

a. **Remove Motor.** Remove lock wire and eight machine screws (fig. 79) which attach motor; remove motor and gaskets from heater housing.

b. **Remove Pump Drive.** Remove taper pin from motor pinion hub and pull pinion off shaft. Remove lock wire and six cap screws from pump cover assembly. Pull slowly on gear, being careful to watch vane springs which may spring out. When completely out of housing, remove taper pin and pull gear off shaft.

c. **Disassemble Pump.** Remove cover from shaft. Pull liner out of housing. Remove spark plug. Remove ground wire by removing cotter pin and nut on end back of flange. Remove lock wire and five machine screws from end cap and remove cap and gasket. Loosen lifter set screw until lifter can be removed. Remove lifter and rotor assembly. Remove nozzle body from cap. The fuel and air nozzle will fall out of body end. Pull gasket and spring off fuel tube. Unscrew fuel inlet assembly and remove.

ORDNANCE MAINTENANCE — ORDNANCE ENGINE MODEL RD-1820 (CATERPILLAR)

d. **Remove Valves.** Remove air by-pass plug in housing face by putting a 5-40 N.C. screw in plug and pulling screw and plug out. Remove spring and ball. Screw an 8-32 N.C. screw in fuel check valve guide and pull guide from housing. Remove spring and valve.

64. CLEANING AND INSPECTION.

a. **Cleaning.** Wash all parts except motor in dry-cleaning solvent. Make certain all passages in housing, end cap and nozzle body are clean and free from obstruction. Clean fuel nozzle thoroughly.

b. **Inspection** (fig. 79).

(1) **PUMP DRIVE.** Examine motor driven pinion for cracks, pitting and wear of gear teeth. Check internal gear teeth for cracks, pitting and wear. Check both for burrs on hub face surfaces. Check pump cover for cracks and tightness of bushing in cover. Examine bushing for burrs and wear. Inspect shaft for burrs on faces and vane slot edges. Examine for wear at bearing locations.

(2) **PUMP.** Inspect vane springs for proper tension (refer to par. 23). Check vanes for scratches, cracks, and wear. Inspect pump liner for burrs, scratches and sharp edges. Make certain all passages in housing are open and free from obstruction. Inspect bushing for burrs, tightness in housing and wear. Inspect spark plug for broken or cracked porcelain. Examine fuel pump rotor for burrs, scratches, galling or scoring and condition of drive groove. Inspect plunger for burrs and wear. Check fit of plunger in rotor (par. 22). Inspect rotor plunger lifter for burrs, scoring and wear of lifter. Check heater end cap for tightness of pins and tube. Make certain all passages are clean and free from obstruction. Inspect spring for damage. Make certain fuel passages are open.

65. REPAIR.

a. **Replace Bushings.** If bushings in housing and cover are scored or worn excessively, they must be replaced (par. 22). The old bushing must be drilled out, so as not to damage bushing contact surface. Cool bushing sufficiently to easily slip into place. Ream to specified fit (par. 22).

66. ASSEMBLY.

a. **Install Valves.** Place ball and spring in air by-pass valve hole in housing front face. Press plug in so that top surface is flush with housing face. Place fuel check valve in hole, slotted side up. Place spring in hole. Coat large diameter of guide with liquid Type A, joint and thread compound and drive guide into hole until cap bottoms.

b. **Assemble Pump.** Lubricate housing and cover bushings with ball and roller bearing grease. Place air pump rotor shaft in rear

ENGINE ELECTRICAL SYSTEM

cover and attach driven gear with taper pin. Peen over small end of pin. Assemble four vanes and eight springs in rotor slots and slip eccentric lines on rotor. Place liner and assembled parts in pump end and locate liner on dowel. Holding liner in place, move rest of assembly sideways and locate shaft end in housing bushing. Turn cover to its proper location, install machine screws and turn pump by hand. If it turns freely, it is assured that all vanes and springs are properly located. Install lock wire. Place spring and gasket on fuel tube in cap. Place nozzle in end body, place gasket on body and screw body onto cap. Place fuel pump rotor in housing, making certain it lines up on drive shaft. Drop spring in hole on bottom of housing. Place lifter in position with groove vertical and end in slot of fuel pump plunger. Cover set screw with glyptal and screw into a temporary position and tighten with nut. Coat cap gasket on both sides with joint and thread compound (TPS 52) and place gasket and cap on housing. Install five machine screws and tighten.

c. **Install Spark Plug and Ground Wire.** Install spark plug and ground wire and adjust gap (par. 22). The ground wire may be bent to make this adjustment but do not bend in threaded section.

d. **Install Pump Drive and Motor.** Attach drive pinion to motor with taper pin. Peen over small end of pin. Pack both gears with grease before attaching motor. Install motor and tighten with eight machine screws and lock wire.

67. TEST OF REBUILT UNIT.

a. Use a suitable holding fixture for the unit and run motor at 4,000 revolutions per minute. Adjust screw on top of plunger lifter so that fuel pump will deliver 30 to 40 cubic centimeters of Diesel fuel per minute. Lock set screw with nut and lock screw with lock wire running through two top cover screws. Lock three lower cover screws with lock wire. Connect vibrator coil and check ignition.

CHAPTER 5 — cont'd

Section IV

**INDICATOR AND WIRING, VIBRATOR COIL
AND MAGNETIC VALVE**

	Paragraph
Indicator and wiring	68
Vibrator coil	69
Magnetic valve	70

68. INDICATOR AND WIRING.

a. **Description.** The indicator and wiring group consists of an electrical junction box with conduit connections to oil temperature and

ORDNANCE MAINTENANCE — ORDNANCE ENGINE MODEL RD-1820 (CATERPILLAR)

pressure indicators and fuel pressure indicator sending units, magnetic valve, vibrator coil, and air heater motor. Another conduit carries wires from junction box to an amphenol connector which is connected indirectly to the instrument panel. The conduits for air heater motor, vibrator coil, and magnetic valve meet at a cross and a single conduit carries these wires from cross to junction box.

b. Removal.

(1) **REMOVE SENDING UNITS** (fig. 76). After removal of wiring harness (fig. 2) the four indicators can be unscrewed and removed.

(2) **REMOVE WIRING HARNESS**. Disconnect amphenol connectors to instrument panel and air heater motor. Remove housing assembly at each of four sending units and disconnect each wire. Disconnect conduit nut at vibrator coil (fig. 79). Remove hexagon plug in coil case and disconnect wire. Replace plug. Disconnect conduit nut at magnetic valve and remove the valve cover (fig. 79). Disconnect wire and replace cover. Remove junction box from engine rear support by removing two attaching nuts and bolts. Remove entire assembly from engine.

(3) **REMOVE IGNITER CABLE** (fig. 79). Unscrew igniter cable nut from vibrator coil and remove cable. Disconnect wire terminal at spark plug. Remove clips on air heater flange and elbow flange.

c. Disassembly. Remove housing assemblies from conduits by unscrewing lock screw. Disassemble amphenol connectors and disconnect wires. Remove separate conduits from cross on junction box by unscrewing connector nuts. Remove elbows by removing retaining nuts.

d. Cleaning and Inspection. Remove dirt and oil from junction box and conduits. Wipe indicators carefully with a rag. Be careful to prevent any dirt from entering holes in pressure units. Inspect wires for breaks either in wire or insulation. Examine terminals to make certain they are securely fastened to wire. Check conduits for any sharp bends which might cause a permanent change in its circular shape.

e. Assembly. Refer to pertinent 100-series manual for wiring diagram. Be sure one of air heater motor wires is grounded to screw in junction box.

f. Installation.

(1) **INSTALL SENDING UNITS** (fig. 76). The straight type sending unit is screwed into rear supercharger cover. The other three are identical in general appearance but can be identified by numbers stamped on unit. The fuel pressure unit, stamped "30", is attached to junction block. The low oil pressure warning unit, stamped "11", is attached to primary filter elbow. The oil pressure unit, stamped "120", is attached to primary filter elbow.

ENGINE ELECTRICAL SYSTEM

(2) **INSTALL WIRING HARNESS.** Place assembly in its approximate position and attach junction box to engine rear support with two bolts and nuts. The cover screws are locked together with lock wire. Remove magnetic valve cover (fig. 79), run wire through conduit opening, and connect wire. Replace cover, tighten nut and connect conduit nut to cover. Run vibrator coil wire through conduit opening, remove hexagon plug and attach eyelet with screw and washer. Replace plug and connect conduit nut to coil housing end. Connect four indicator wires and attach conduit housings to units. Connect amphenol connectors to air heater and instrument panel plug. Refer to pertinent 100-series manual for wiring diagram.

(3) **INSTALL IGNITER CABLE** (fig. (79)). Connect wire terminal to spark plug. Install cable spring end in vibrator coil side and attach with nut. Adjust bushings and clips and attach to intake elbow cap-screw and air heater stud.

69. VIBRATOR COIL (fig. 79).

a. **Description.** The shielded vibrator coil provides spark for air heater. The coil itself is incased in a two-piece metal case. Two threaded openings are provided for battery wire and igniter cable assembly. A bracket for mounting is integral with case.

b. **Removal.** Disconnect wiring conduit and igniter cable. Remove lock wire and two machine screws which attach coil to engine rear support. Remove nut and bolt from side of clamp and spread clamp enough to allow removal of coil.

c. **Cleaning and Inspection.** Be sure that the wire and cable connections are clean at all times.

d. **Disassembly.** The vibrator coil cannot be disassembled.

e. **Installation.** Slide coil in clamp and attach coil to engine rear support with two cap screws. Secure cap screws with lock wire. Close clamp and connect open ends with bolt and nut.

70. MAGNETIC VALVE.

a. **Description.** The magnetic valve (fig. 79) consists of a fuel valve electrically controlled. It allows fuel to flow to air heater only when heater is in operation.

b. **Removal.** After removal of wiring assembly and fuel connection, remove two nuts attaching valve to supercharger rear cover. Pull valve off the studs and replace nuts.

c. **Cleaning and Inspection.** Be sure that exterior of valve is clean to prevent any dirt from entering fuel openings.

d. **Disassembly.** The magnetic valve cannot be disassembled.

e. **Installation.** Place magnetic valve on supercharger rear cover studs, cover down, and install nuts. Assemble wiring and fuel connection.

ORDNANCE MAINTENANCE — ORDNANCE ENGINE MODEL RD-1820 (CATERPILLAR)

CHAPTER 6
SPECIAL TOOLS

List of special tools	Paragraph 71
-----------------------------	-----------------

71. LIST OF SPECIAL TOOLS.

Manufacturer's Part Number	Name	Number Required
CME-5A2288 WAC-84564	Adapter, crankshaft, front main bearing inner race puller (used with WAC-84562)	1
CME-5A2289 WAC-84561	Adapter, crankshaft, rear main bearing inner race puller (used with WAC-84559)	1
CME-5A2267 WAC-84401	Adapter, master rod crankshaft bearing, install- ing plug and base	1
CME-5A2310 WAC-800307	Adapter, supercharger impeller removing and replacing	1
CME-5A2274 WAC-82125	Arbor, exhaust valve guide, installing	1
CME-5A2273 WAC-800573	Arbor, intake valve guide, installing	1
CME-5A2290 WAC-80443	Bar, crankshaft, aligning (used to aline front and rear section)	1
CME-5A2337 WAC-83576	Bar, crankshaft aligning (0.6248 dia)	1
CME-5A2338 WAC-83577	Bar, crankshaft aligning (0.6250 dia)	1
CME-5A2291 WAC-84869	Bar, crankshaft, rear counterweight bushing hole, alignment checking	1
CME-5A2165	Bar, crankshaft, turning drive end	1
CME-5A2283 WAC-84372	Bar, valve tappet guide, installing, aligning	1
CME-5A1935	Bar, lifting air cleaner	1
CME-5A2292 WAC-83523	Base, crankshaft, crank cheek bushing and crankshaft counterweight, removing and in- stalling (used with arbor press)	1
CME-5A2293 WAC-83526	Collar, crankshaft, rear crank cheek bushing, installing (used with arbor press)	1
CME-5A2294 WAC-800512	Collar, crankshaft, rear crank cheek bushing, installing (used with arbor press)	1
CME-5A2286 WAC-81409	Compressor, valve spring	1
CME-5A2270 WAC-800910	Cover, cylinder exhaust port	9
CME-5A2307 WAC-800907	Cover, packing nut protector	18

SPECIAL TOOLS

Manufacturer's Part Number	Name	Number Required
CME-5A2279	Cutter and bar, rocker arm hub bolt bushing	
WAC-800106	shoulder, facing	1
CME-5A2183	Cylinder, dummy, timing top dead center, valves, fuel pump lifters	1
CME-5A2157	Driver, core plug, supercharger rear cover.....	1
CME-5A2154	Driver, dowel, crankcase front section	1
CME-5A2156	Driver, dowel, crankcase main section	1
CME-5A2161	Driver, ferrule, crankcase main section	1
CME-5A2171	Driver, fuel pump sleeve, crankcase front section	1
CME-5A2158	Driver, seal, housing, governor and transfer pump drive	1
CME-5A2295	Extension, crankshaft cheek cap screw wrench	1
WAC-80198		
CME-5A2265	Eye, lifting crankshaft	1
WAC-83761		
CME-5A2318	Eye, lifting fan and flywheel	3
CME-5A2207	Eye, lifting supercharger rear cover.....	1
CME-5A2317	Eye, lifting transfer case	2
CME-5A2315	Fixture, assembling accessory drive gear springs	1
CME-5A2296	Fixture, holding, crankshaft disassembly and assembly	1
WAC-800710		
CME-5A2170	Fixture, holding, remove and replace impeller nut	1
CME-5A2308	Fixture, replace and remove knuckle pin.....	1
WAC-800260		
CME-5A1368	Fixture, setting fuel pump lifter and control dog	1
CME-5A2281	Gage, feeler (0.010 and 0.75).....	1
WAC-81405		
CME-5A2271	Grinder, valve seat angle.....	1
WAC-83115		
CME-5A2278	Nut, rocker arm hub bolt bushing shoulder (used with WAC-800106)	1
WAC-800101		
CME-5A2277	Plate, rocker arm hub bolt bushing, facing, locating (used with WAC-800106).....	1
WAC-800100		
CME-5A2266	Plug and base, master rod crankshaft bearing, installing (used with arbor press).....	1
WAC-84400		
CME-5A2341	Plug, knuckle pin installing.....	1
WAC-800283-1		
CME-5A79	Protector cap, fuel pump and injection valve ...	18

ORDNANCE MAINTENANCE — ORDNANCE ENGINE MODEL RD-1820 (CATERPILLAR)

Manufacturer's Part Number	Name	Number Required
CME-5A2182	Protector, cover for engine	1
CME-5A2342	Protector, crankshaft end	1
WAC-800986		
CME-5A2159	Protector, master and articulated rods	9
CME-5A1442	Protector plug, fuel lines	18
CME-5A2305	Puller, cam bearing	1
WAC-84535		
CME-5A2304	Puller, crankshaft bearing	1
WAC-800377		
CME-5A2299	Puller, crankshaft rear main bearing	1
WAC-84559		
CME-5A2298	Puller, crankshaft front main bearing inner	
WAC-84562	race, removing (used with WAC-85464)....	1
CME-5A2276	Puller, rocker arm hub bolt bushing, removing	
WAC-800099	and installing	1
CME-5A2263	Puller, supercharger impeller, removing and in-	
WAC-800304	stalling (used with WAC-800307)	1
CME-5A2282	Puller, valve tappet guide, installing	1
WAC-84802		
CME-5A2275	Reamer, exhaust valve guide cylinder hole,	
WAC-83477	hand expansion (0.005 oversize)	1
CME-5A2272	Reamer, intake valve guide cylinder hole, hand	
WAC-800341	expansion (0.7233 diam.) (0.005 oversize) ..	1
CME-5A2280	Reamer, rocker arm hub bolt bushing	1
WAC-800108		
CME-5A2301	Screw, crankshaft rear, removing and installing	
WAC-84699	(used with WAC-84765)	1
CME-5A2228	Sling, lifting engine assembly	1
CME-5A2300	Spreader, crankshaft, rear crankcheek (used	
WAC-84765	with WAC-84699)	1
CME-5A2302	Stop, crankshaft front and rear counterweight	
WAC-83445	bushing, installing	1
CME-5A2155	Stud assembly, remove and replace clutch	
	springs	4
CME-5A2164	Timing disk, fuel pump lifter and engine	
	valves	1
CME-5A2309	Wedges, support master rod flanges	2
WAC-800282		
CME-5A2306	Wrench, crankcase front main section to rear	
WAC-84356	section nuts	1
CME-5A2339	Wrench, crankshaft cheek capscrew, remove	
WAC-80309	and replace	1

SPECIAL TOOLS

Manufacturer's Part Number	Name	Number Required
CME-5A2303	Wrench, crankshaft rear main bearing retainer	
WAC-80409	nut	1
CME-5A2160	Wrench, crankshaft retainer nut.....	1
CME-5A2268	Wrench, cylinder hold-down capscrews, box	
WAC-82860	1/2 hex.....	1
CME-5A2269	Wrench, cylinder hold-down capscrews, speed	
WAC-83130	hex	1
CME-5A1943	Wrench, hold precombustion chamber.....	1
CME-5A2287	Wrench, intake pipe nut.....	1
WAC-84258		
CME-5A2264	Wrench, lug, remove and replace accessory	
WAC-802275	drive shaft impeller nut.....	1
CME-5A2184	Wrench, piston cooling nozzle and nut	1
CME-5A2167	Wrench, remove and replace fuel injection	1
	valve	1
CME-5A1937	Wrench, remove and replace precombustion	
	chamber	1
CME-5A2322	Wrench, removing and replacing starter nut....	1
CME-5A2297	Wrench, thrust bearing nut and ring assembly,	
WAC-82902	crankshaft	1

ORDNANCE MAINTENANCE — ORDNANCE ENGINE MODEL RD-1820 (CATERPILLAR)

REFERENCES

STANDARD NOMENCLATURE LISTS.

Tank, medium, M4A6	SNL G-104 Vol 13
Cleaning, preserving and lubrication materials, recoil fluids, special oils and miscellaneous related items..	SNL K-1
Soldering, brazing, and welding materials, gasses and related items	SNL K-2
Interchangeability chart of organizational special tools for combat vehicles	SNL G-19
Ordnance Maintenance Sets	SNL N-21
Tools, maintenance, for repair of automotive vehicles	SNL G-27
Tool-Sets, Motor transport.....	SNL N-19
Tool-Sets, for Ordnance Service Command, automotive shops	SNL N-30
Current Standard Nomenclature Lists are listed above. An up-to-date list of SNL's and other publications is maintained in the Index to Ordnance Publications	OFSB 1-1

EXPLANATORY PUBLICATIONS.

General.

List of publications for training.....	FM 21-6
Military motor vehicles.....	AR 850-15
Standard Military Motor Vehicles.....	TM 9-2800

Related Technical Manuals.

Medium tank M4A6	TM 9-1756
Ordnance Maintenance: Auxiliary generator (Home-lite HRUH-28) for Medium Tank M4 and modifications	TM 9-1731K
Ordnance Maintenance: Fire extinguishers.....	TM 9-1799
Ordnance Maintenance: Hydraulic traversing, mechanism (Oilgear) for medium tank M4 and modifications	TM 9-1731G

REFERENCES

Ordnance Maintenance: Stabilizers..... TM 9-1334

Ordnance Maintenance: Power train one-piece differential case for medium tanks M3, M4, and modifications, and related gun motor carriages..... TM 9-1750B

Automotive Material.

Automotive Electricity TM 10-580

The internal combustion engine..... TM 10-570

Diesel engines and fuels..... TM 10-575.

Electric fundamentals TM 1-455

The Motor vehicle TM 10-510

Care and Preservation.

Automotive Lubrication TM 10-540

Motor transport inspections TM 10-545

Basic Maintenance Manual..... TM 38-250

Motor Vehicle inspections and preventative Maintenance Services TM 9-2810

Cleaning, preserving, lubricating and welding materials and similar items issued by the Ordnance Department TM 9-850

Protection of Material.

Chemical decontamination, materials and equipment TM 3-200

Decontamination of armored force vehicles..... FM 17-59

Defense against chemical attack..... FM 21-40

Explosives and demolitions FM 5-25

Storage and Shipment.

Ordnance storage and shipment chart, group G— Major Items OSSC-G

Storage of motor vehicle equipment..... AR 850-18

Rules governing the loading of mechanized and motorized army equipment also major caliber guns, for the United States Army and Navy on open top equipment published by Operations and Maintenance Department of Association of American Railroads.

INDEX

A	Page No.		Page No.
Accessories, removal	11-13	governor oil filter	117
Accessory drive		indicator and wiring	126
fits and tolerances	90-91	instructions	72-85
inspection	63	oil cooler	31
removal	59	oil pump and lines	114-115
repair	65-66	pistons	38
spring data	96	primary oil filter	115
Accessory drive shaft		secondary fuel filter and	
assembly	69	primary pump	103-104
installation	69-70	secondary oil filter	116
Adjustment:		supercharger	66-71
clutch cover	35	transfer case	29-30
governor and controls	111		
Air deflector cowl, maintenance		C	
allocation	6	Ball arm head, assembly	110
Air deflectors		Bearing races, removal	49
installation	82-83	Bendix drive, assembly.....	121
removal	14	Breather assemblies, mainte-	
Air director, maintenance allocation.....	6	nance allocation	6
Air heater		Brush holder housing	
assembly	124-125	assembly	121
cleaning and inspection	124	disassembly	120
description and data	123	removal	120
disassembly	123-124		
fits and tolerances	90	B	
repair	124	Cam drive gear basket, repair.....	46
spring data	96	Cleaning:	
test of rebuilt unit	125	air heater	124
Air heater and manifold super-		clutch controls	31
charger, maintenance allocation....	6-7	crankcase front section	41
Alinement of crankshaft	56	crankcase main front section.....	44
Allocation of maintenance	4-7	cranking motors	120-121
Armature		crankshaft	50
installation	121	cylinder oil drain mechanism.....	35
removal	120	cylinders	38
Assembly:		flywheel clutch and fan	33
air heater	124-125	fuel injection lines	104
clutch controls	31	fuel injection pump	104
crankcase front section	44	fuel transfer pump	100-101
crankcase main front section....	46-49	governor and controls	109
crankshaft	53-59	governor oil filter	117
cylinders	40	indicator and wiring	126
flywheel clutch and fan	35	magnetic valve	127
fuel transfer pump	101	oil pump and lines	114
governor and controls	110	pistons	37

INDEX

B — Cont'd	Page No.		Page No.
Cleaning — Cont'd		Crankcase main rear section	
primary oil filter	115	assembly	71-72
push rods and push rod housing..	36	disassembly	71
secondary fuel filter and		installation	72
priming pump	103	Crankcase ventilator, installation....	82
secondary oil filter	116	Cranking motors	
transfer case.....	27-28	assembly	121
supercharger	61	cleaning and inspection	120-121
vibrator coil	127	description and data	118
Clutch assembly		disassembly	120
maintenance allocation	6	external cleaning and	
spring data	97	inspection	118-120
Clutch controls		test of rebuilt unit	123
assembly	31	Crankshaft	
cleaning and inspection	31	alinement	56
disassembly	31	fits and tolerances	93
installation	85	installation	73
removal	13	removal	20
Clutch cover assembly		Crankshaft front and rear main	
adjustment	35	bearings, inspection	50
assembly	34-35	Crankshaft rear, removal	49
disassembly	33	Cylinder oil drain mechanism	
installation	85	disassembly	35
Clutch driven plates, inspection.....	33	installation	82
Connecting rods		removal	15
fits and tolerances	93-94	Cylinders	
spring data	97	assembly	40
Control levers, installation.....	111	cleaning	38
Control linkage, removal	108	disassembly	38
Control rods, removal	108	inspection	38-39
Cooling system, description and		maintenance allocation	6
operation	8	repair	39-40
Crankcase front section		D	
assembly	44	Data	
disassembly	40-41	air heater	123
inspection	41	cranking motors	118
installation	74-78	governor and controls.....	106-108
removal	18	Description:	
repair	42-43	air heater	123
Crankcase main front section		cranking motors	118
assembly	46-49	engine electrical system	118
cleaning	44	fuel injection lines	104
disassembly	44	fuel injection pump	104
inspection	45-46	fuel injection valves	105
installation	73-74	fuel system	98
repair	46	fuel transfer pump	98-100
		governor and controls	106-108

ORDNANCE MAINTENANCE — ORDNANCE ENGINE MODEL RD-1820 (CATERPILLAR)

D — Cont'd	Page No.		Page No.
Description — Cont'd		Engine electrical system	
indicator and wiring	125-126	air heater	123-125
lubrication system	112	cranking motors	118-123
magnetic valve	127	description	118
oil pump and lines	114	indicator and wiring, vibrator	
ordnance engine model RD-1820	8	coil and magnetic valve	125-127
secondary fuel filter and		Engine coil cooler, maintenance	
priming pump	102	allocation	6
secondary oil filter	116	Engine oil filter, maintenance	
vibrator coil	127	allocation	6
Diffuser plate		Engine mounts, maintenance	
inspection	61	allocation	7
repair	63-65	Exhaust and intake manifold,	
Disassembly:		maintenance allocation	7
air heater	123-124		
clutch control and oil cooler....	30, 31	F	
crankcase front section.....	40-41	Fan assembly, maintenance	
crankcase main front section.....	44	allocation	6
crankcase main rear section....	71-72	Field ring	
cranking motors	120	assembly	121
crankshaft	49-50	disassembly	120
cylinder oil drain mechanism.....	35	Fits and tolerances	
disassembly instructions	13-20	spring data	96-97
flywheel clutch and fan	33	table of limits	88-96
fuel transfer pump	100	torque valves	97
governor and controls	108-109	Flywheel and hub assembly,	
governor oil filter	117	maintenance allocation	6
indicator and wiring	126	Flywheel clutch and fan	
miscellaneous items	72	assembly	35
oil pump and lines	114	cleaning	33
pistons and cylinders	37, 38	disassembly	33
preliminary instructions.....	11-13	fits and tolerances	94-95
primary oil filter	115	inspection	33
secondary fuel filter and		installation	84-85
priming pump	102	removal	13
secondary oil filter	116	repair	33-35
supercharger	59-71	Front engine support, installation..	84
transfer case	25-27	Fuel filter	
Droop adjusting bracket, removal..	108	maintenance allocation	6
Dowels and studs, replace	110	spring data	97
		Fuel injection lines, description.....	104
E		Fuel injection pump	
Engine assembly		description	104
data	8-11	installation	84
description	8	maintenance allocation	7
maintenance allocation	6-7	removal	13-14
Engine cowl, installation	84		

INDEX

F — Cont'd	Page No.		Page No.
Fuel injection valves		description and data	116
description	105	removal	116
installation	84	Governor shut-off lever, removal....	108
maintenance allocation	7		
Fuel manifold cover, installation....	44		
Fuel oil inlet and outlet,		H	
installation to manifold	83	Hour meter, maintenance allocation	7
Fuel pump cam			
disassembly	40	I	
fits and tolerances	89	Impeller, installation	66-69
Fuel pump control		Impeller drive, removal	60
disassembly	40-41	Indicator and wiring	
fits and tolerances	96	assembly	126
inspection	41	cleaning and inspection	126
repair	42-43	description	125-126
Fuel pump to governor control rod		disassembly	126
assembly, maintenance allocation	7	installation	126-127
Fuel system		removal	126
description	98	Inspection:	
fuel transfer pump	98-101	air heater	124
Fuel transfer pump		clutch control	31
assembly of unit	101	crankcase front section	41
cleaning and inspection	100-101	crankcase main front section....	45-46
description and data	98-100	crankshaft	50-52
disassembly	100	cylinder oil drain mechanism.....	35
external cleaning and inspection	100	cylinders	38-39
fits and tolerances.....	91	flywheel clutch and fan	33
maintenance allocation	7	fuel injection lines	104
Fuel valve lifters		fuel injection pump	104
inspection	41	fuel injection valves	105
installation of assemblies	44	fuel transfer pump	100-101
		governor and controls	109
G		indicator and wiring	126
Governor and controls		oil cooler	30
adjustment	111	oil pump and lines	114
assembly	110	pistons	37
cleaning and inspection	109	primary oil filter	115
description and data.....	106-108	push rods and push rod housings..	36
disassembly	108-109	rocker arms	36
installation	110-11	secondary fuel filter and	
removal	108	priming pump	103
repair	109-110	secondary oil filter	116
Governor assembly		supercharger	61-63
assembly	70	transfer case	28-29
maintenance allocation	6	Intake pipes	
removal	108	installation	82
Governor oil filter		removal	14
assembly and disassembly	117		

ORDNANCE MAINTENANCE — ORDNANCE ENGINE MODEL RD-1820 (CATERPILLAR)

I — Cont'd	Page No.	Page No.
Intermediate housing		
assembly	121	Oil pressure and scavenger pump
removal	120	assembly, maintenance allocation.. 7
Intermediate pressure plate, repair	33	Oil pump
		assembly
		inspection
		removal
		spring data
		Oil pump and lines
		assembly
		cleaning and inspection
		description and data
		disassembly
		installation
		Oil seal rings, repair
		Oil strainer, maintenance allocation 7
		Oil sump
		installation
		removal
		Oil supercharger (ring type),
		maintenance allocation
		P
		Pinion and gear, installation..... 46
		Piston cooling nozzle, fits and
		tolerances
		Piston cooling tubes
		installation
		removal
		Pistons
		assembly
		cleaning
		inspection
		repair
		Pistons and cylinders
		fits and tolerances
		removal
		Pistons and rings, maintenance
		allocation
		Power train, description and data.... 8
		Power unit, description and
		operation
		Precombustion chamber
		description
		installation
		maintenance allocation
		removal

INDEX

P — Cont'd	Page No.		Page No.
Primary oil filter		fuel filter	97
assembly and disassembly	115	oil pump	96
description	115	valve	96
installation	116	Starting motor assembly,	
Pump drive		maintenance allocation	7
inspection	124	Supercharger	
installation	125	assembly	66-71
removal	123	cleaning	61
Push rods and push rod housings		description and operation	8
inspection	36	disassembly	59-61
installation	80-82	fits and tolerances	91-92
removal	17	inspection	61-63
repair	36-37	installation	73
		maintenance allocation	7
		removal	20
		repair	63-66
		T	
R		Test of rebuilt unit.....	123
Rear main bearing, installation.....	59	Thrust bearing	
Reclamation, rebuild, repair,		disassembly	40
and replace defined	5	inspection	41
Relief valve		Torque values	97
inspection	101	Transfer case	
installation	110	fits and tolerances	95-96
removal	109	installation	85
Revolution counter drive,		maintenance allocation	6
assembly	70-71		
Rocker arms		U	
inspection and repair	36	Universal block, cleaning and	
installation	80-82	inspection	101
removal	15-16		
		V	
S		Valve (assembly)	
Sealing rings, installation	114	installation	101
Secondary fuel filter and priming		removal	100
pump		spring data	96
assembly	103-104	Valve cam and tappet, fits and	
cleaning and inspection	103	tolerances	89
description and data	102	Valve clearance adjustment	81-82
disassembly	102	Valve mechanism, fits and	
Secondary oil filter, removal		tolerances	88
and installation	116	Valve push rod, maintenance	
Service defined	5	allocation	7
Spacer and cam	46	Valve rocker assembly, maintenance	
Special tools	128-131	allocation	7
Spring controlled levers		Valve tappet, disassembly	41
installation	110-111	Valve tappet ball sockets,	
removal	108	installation	80
Spring data		Vibrator coil, removal and	
accessory drive	96	installation	127
air heater	96		
clutch	97		
connecting rod	97		

