

~~UNCLASSIFIED~~
UNCLASSIFIED

W1.35.
9-726

~~UNCLASSIFIED~~

DECLASSIFIED
Auth: NND 786097
By NNHP - NARS 11-3-78

TM 9-726

<p>WAR DEPARTMENT</p>
<p>TECHNICAL MANUAL</p>
<p>LIGHT TANK M3</p>
<p>July 15, 1942</p>

REGRADED UNCLASSIFIED BY
AUTHORITY OF DOD DIR. 5200.1 R
BY PKS ON 110204

LIGHT TANK M3

CHAPTER 1. Operating instructions.	Paragraphs
SECTION I. General-----	1-2
II. Military characteristics and mechanical specifications-----	3-4
III. Operating instructions and controls-----	5-15
IV. Lubrication-----	16-18
V. Inspections-----	19-24
VI. General care and preservation-----	25-26
VII. Painting-----	27-32
VIII. Armament-----	33-35
IX. Matériel affected by gas-----	36-39
CHAPTER 2. Organization instructions.	
SECTION I. General information on maintenance-----	40
II. Equipment and special tools-----	41-42
III. Engine, Continental W670, Series 9A-----	43-60
IV. Engine, Guiberson T-1020, and accessories-----	61-76
V. Fuel supply system-----	77-82
VI. Cooling system-----	83-84
VII. Clutch-----	85-94
VIII. Propeller shaft-----	95-97
IX. Transmission and differential-----	98-100
X. Oil coolers-----	101-102
XI. Final drives-----	103-106
XII. Tracks and suspensions-----	107-114
XIII. Hull and turret-----	115-116
XIV. Electrical system and equipment-----	117-136
XV. Nonelectrical instruments-----	137-141
XVI. Fire extinguishers-----	142-145
XVII. Gyro-stabilizer unit-----	146-150
APPENDIX. List of references-----	Page 241
INDEX-----	243

*This manual supersedes TM 9-726, February 5, 1942.

CHAPTER 1

OPERATING INSTRUCTIONS

	Paragraphs
SECTION I. General.....	1-2
II. Military characteristics and mechanical specifications.....	3-4
III. Operating instructions and controls.....	5-15
IV. Lubrication.....	16-18
V. Inspections.....	19-24
VI. General care and preservation.....	25-26
VII. Painting.....	27-32
VIII. Armament.....	33-35
IX. Matériel affected by gas.....	36-39

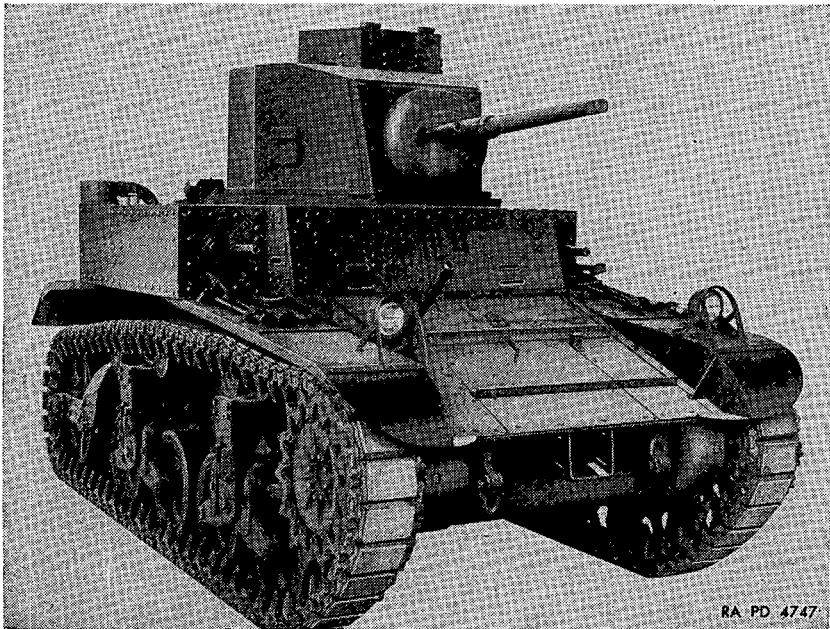

FIGURE 1.—Light tank M3.

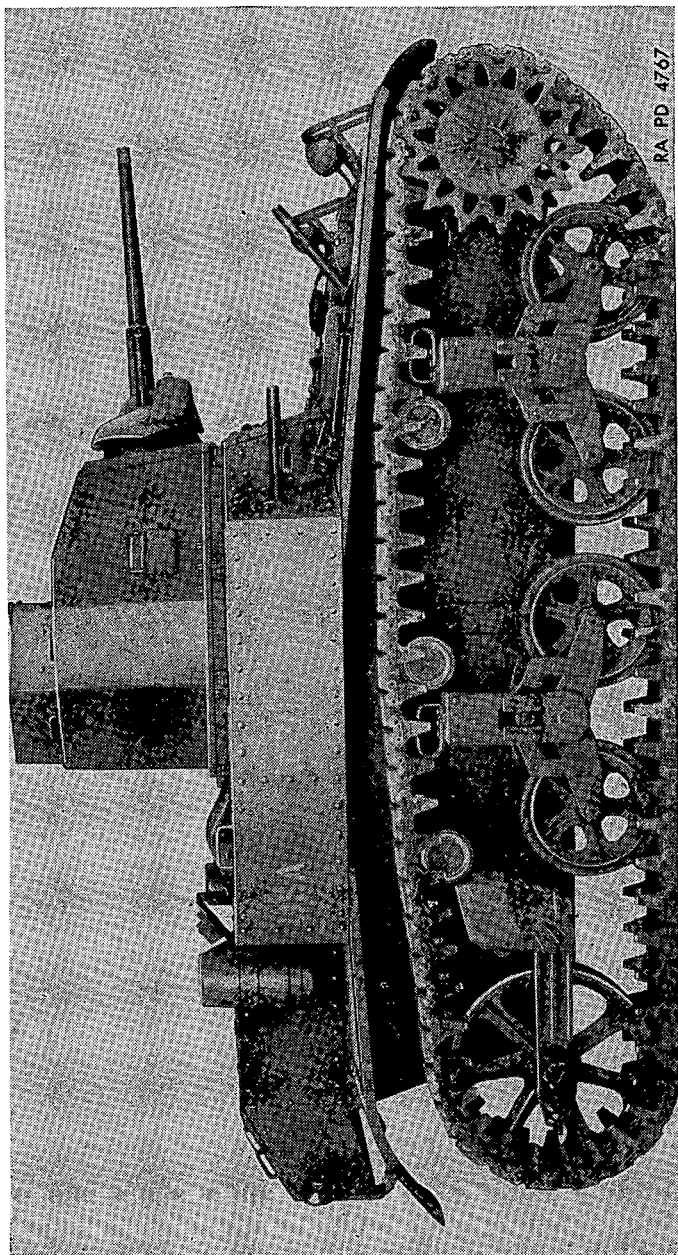
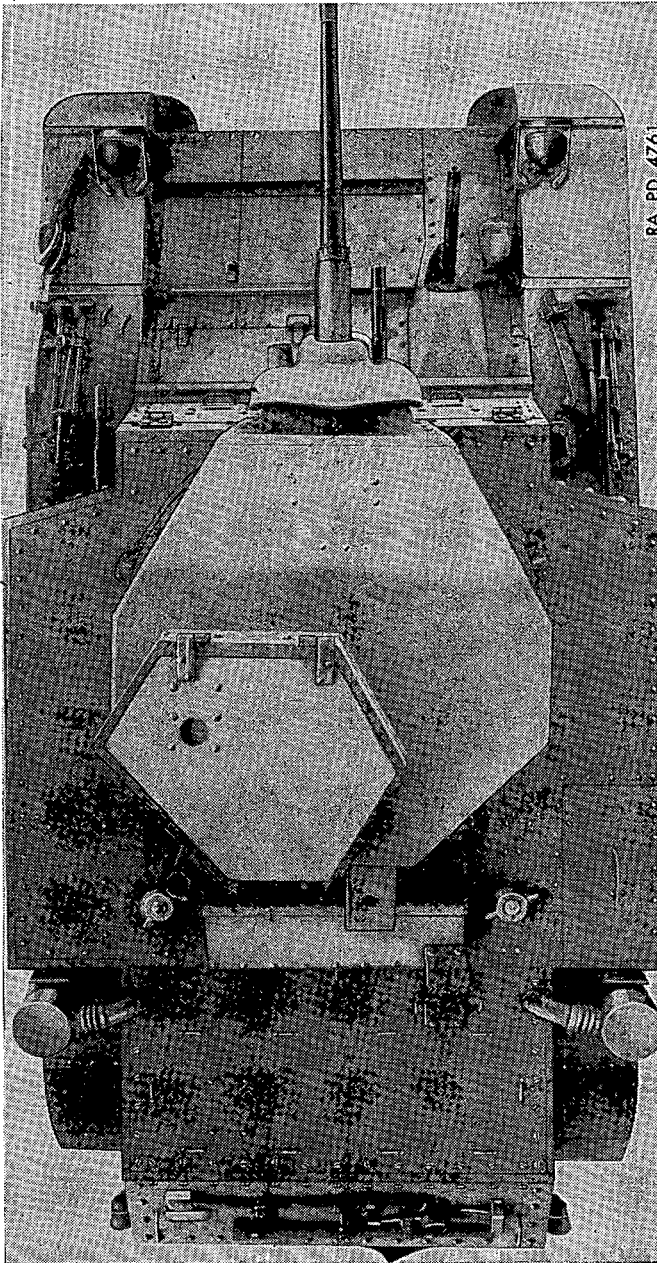

Figure 2.—Right side, light tank M3.

LIGHT TANK M3



RA PD 4761

FIGURE 3.—Top view, light tank M3.

LIGHT TANK M3

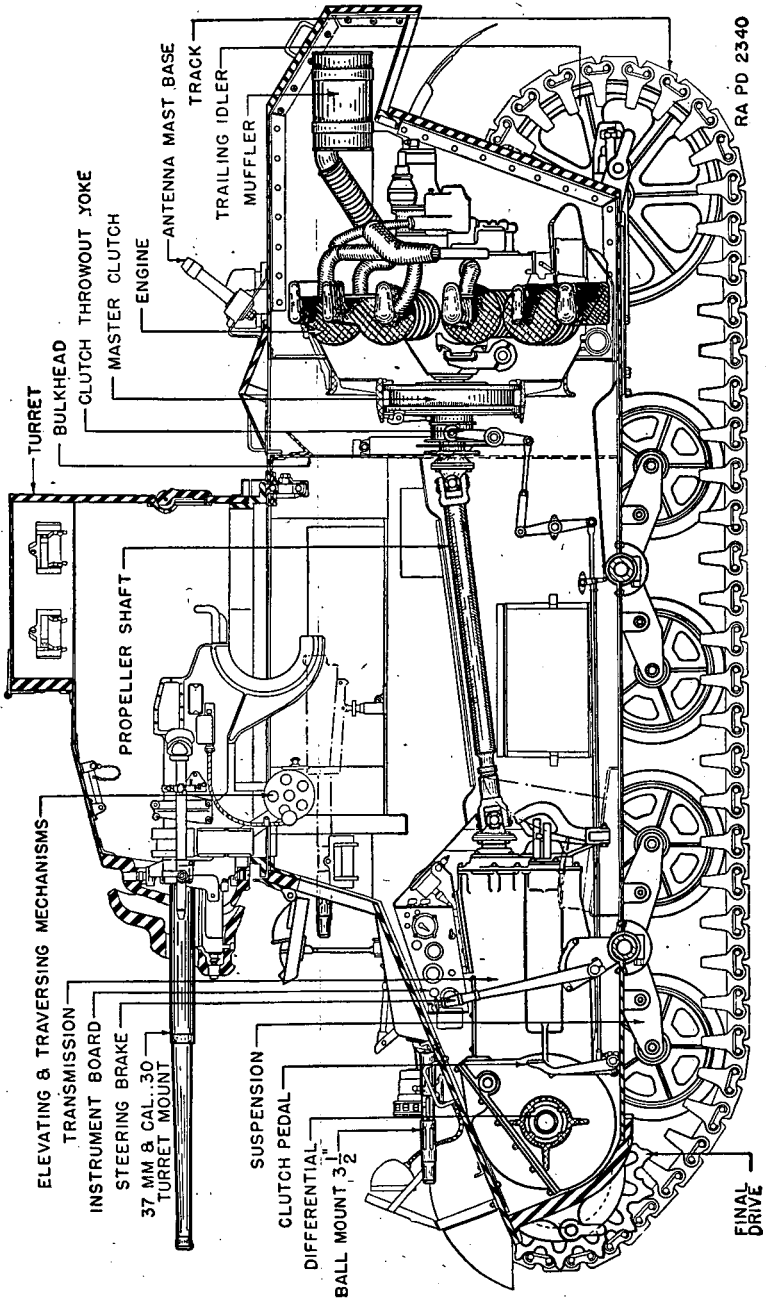

RA PD 2340

FIGURE 4.—Cross section, light tank M3.

SECTION I

GENERAL

Purpose and scope.....	Paragraph 1
Content and arrangement of manual.....	2

1. **Purpose and scope.**—These instructions are published for the information and guidance of the personnel of the using arm charged with the operation, maintenance, and repair of this matériel. They contain descriptions of the major units and their function in relation to the other components of the tank, as well as instructions for operation, inspection, minor repair, and unit replacement.

2. **Content and arrangement of manual.**—Sections I through IX, chapter 1, contain information chiefly for the guidance of operating personnel. Sections I through XVII, chapter 2, contain information intended chiefly for the guidance of personnel of the using arm doing maintenance work.

SECTION II

MILITARY CHARACTERISTICS AND MECHANICAL SPECIFICATIONS

Military characteristics.....	Paragraph 3
Mechanical specifications.....	4

3. **Military characteristics.**—*a. Armor thickness.*

Front.....	$\frac{5}{8}$ and $1\frac{1}{2}$ in.
Sides.....	1 in.
Top plate.....	$\frac{1}{2}$ in.
Rear.....	1 in.
Bottom:	
At front.....	$\frac{1}{2}$ in.
At rear.....	$\frac{1}{2}$ in.
Turret:	
Front plate.....	$1\frac{1}{2}$ in.
Vertical sides.....	$1\frac{1}{4}$ in.
Windshield.....	$1\frac{1}{2}$ in.
<i>b. Turret.</i>	
Arc of rotation.....	360°
Method of rotating.....	handcrank

c. Protected vision.—Protected vision is accomplished through the use of adjustable steel shutters at peepholes. In latest production, indirect vision devices called protectoscopes are provided in pistol ports and front doors.

LIGHT TANK M3

d. General data.

Crew-----	4 men
Weight (without accessories, fuel, or crew)-----	25,300 lb.
Weight (with accessories, fuel, and crew)-----	28,000 lb.
Width over-all-----	88 in.
Length over-all-----	178 in.
Height over-all-----	104 in.
Tread (center to center of tracks)-----	73 in.
Ground clearance-----	16½ in.
Ground pressure, on soft ground-----	10.47 lb. per sq. in.
Track:	
Shoe width-----	7 ⁵ / ₈ in.
Pitch-----	5½ in.

e. Performance.

Diameter of turning circle-----	42 ft.
Maximum grade-ascending ability (with grousers)-----	45°.
Maximum grade-ascending ability (without grousers)-----	30°.
Maximum grade-descending ability-----	30°.
Allowable list-----	22°.
Trench-crossing ability-----	6 to 7 ft.
Fording depth-----	40 in.
Maximum vertical obstacle-----	24 in.
Towing ability, drawbar pull-----	14,800 lbs.
Height of towing shackles above ground-----	20 in.
Location of towing shackles-----	1 at each corner of hull.
Speed, smooth roadway-----	31 mph.
Speed, cross country-----	20 mph.
Miles per gal. (gasoline engine)---	approximately 2 miles.
Miles per gal. (Diesel engine)-----	approximately 3½ miles.
Cruising range (gasoline engine)---	75 miles.
Cruising range (Diesel engine)-----	90 miles.
Oil storage tank capacity-----	6 gal.

f. Communication.

Radio-----	SCR 245—sending and receiving.
------------	--------------------------------

Useful radius:

Moving:

Voice..... 15 miles.

Code..... 25 miles.

Stationary:

Voice..... 20 miles.

Code..... 45 miles.

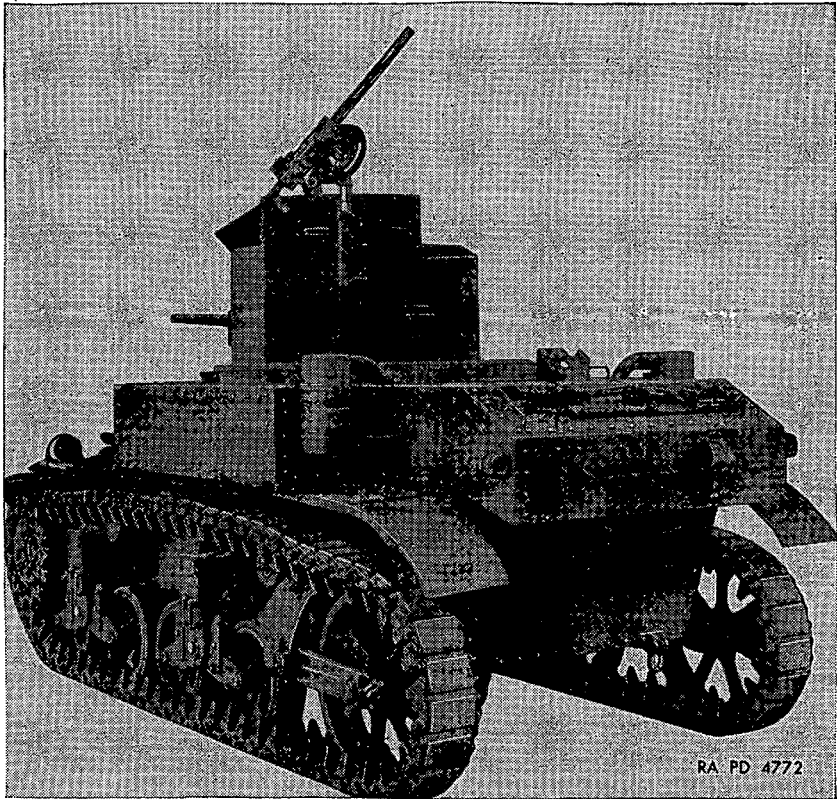

FIGURE 5.—Three-quarter left rear, light tank M3.

g. Armament.

- 1 37-mm gun and 1 cal. .30 machine gun mounted in a combination mount in the turret.
- 1 cal. .30 machine gun mounted in a ball mount in the bow.
- 1 cal. .30 machine gun mounted in a bracket mount, on the outside of the turret, for antiaircraft defense.
- 1 cal. .45 Thompson submachine gun.
- 2 cal. .30 machine guns mounted, one in each sponson.

h. Ammunition.

37-mm-----	103 rds., right and left side of crew compartment.
Cal. .30-----	5,900 rds., right and left sponson stowage boxes.
Cal. .30-----	700 rds., bow gunner stowage box; 1,670 rds., tunnel pocket ammunition racks.
Cal. .45-----	500 rds. in tank.

4. Mechanical specifications.—a. Engine and accessories.—*(1) Gasoline engine.*

Number used-----	1.
Make and type-----	Continental Static Radial.
Model and series-----	W 670 Series 9A.
Diameter (over-all)-----	42 $\frac{3}{8}$ in.
Length (over-all)-----	32 in.
Weight, with accessories-----	1,107 lbs.
Horsepower-----	250 hp. at 2,400 rpm.
Maximum engine speed-----	2,400 rpm.
Number of cylinders-----	7.
No. 1 cylinder location-----	Top.
Bore-----	5 $\frac{1}{8}$ in.
Stroke-----	4 $\frac{5}{8}$ in.
Firing order (clockwise, viewed at accessory case)-----	1-3-5-7-2-4-6.
Piston displacement-----	667.86 cu. in.
Compression ratio-----	6.1 to 1.
Magneto: Number used-----	2.
Make and model-----	Scintilla, Model VMN7-DFA.
Breaker point gap-----	.012 in.
Spring tension on breaker points-----	16 to 32 oz.
Starter:	
Make-----	Eclipse, Model EC 404-1-B.
Type-----	Electric.
Spark plugs:	
Make and model-----	BG 417-S, radio shielded.
Gap-----	0.15 in.
Valve tappet clearance, cold:	
Exhaust-----	.010 in.
Intake-----	.010 in.

(2) Diesel engine.

Number used-----	1.
Make and type-----	Guiberson Radial Diesel.
Model and series-----	T-1020, Series 4.

Dimensions:

Diameter, over-all-----	45 $\frac{7}{16}$ in.
Length, with starter-----	36 $\frac{15}{16}$ in.
Weight, with accessories-----	1,107 lbs.
Horsepower-----	250 hp. at 2,200 rpm.
Maximum allowable rpm, full load	2,250.
Maximum allowable rpm, no load..	2,325.
Method of starting-----	Cartridge.
Injection-----	Solid.
Number of cylinders-----	9.
Number 1 cylinder location-----	Top.
Bore-----	5 $\frac{1}{8}$ in.
Stroke-----	5 $\frac{1}{2}$ in.
Piston displacement-----	1,021 cu. in.
Compression ratio-----	14.5 to 1.
Firing order-----	1-3-5-7-9-2-4-6-8.
Starter:	
Make and type-----	Breeze cartridge starter, type L.
Model-----	G-1154 R.
Rocker roller clearance, cold:	
Exhaust-----	.020 in.
Intake-----	.020 in.
<i>b. Fuel system.</i>	
Number of tanks-----	2.
Location-----	One on each side, at front of engine compartment.
Capacity-----	28 gals. each tank.
Fuel pump (Continental engine), fuel pressure-----	1 $\frac{1}{2}$ to 2 lbs.
Carburetor (Continental engine):	
Make-----	Bendix-Stromberg.
Model-----	NA-R6B.
Type of choke-----	Manual.
Air cleaner, type-----	Oil bath.
<i>c. Cooling system.</i>	
Cooling medium-----	Air.
<i>d. Clutch.</i>	
Number of plates-----	5.

LIGHT TANK M3

Adjustments:

Free-travel on clutch pedal..... $\frac{1}{2}$ in.Clearance between clutch bearings and flange (clutch engaged)----- $1\frac{1}{8}$ in.*e. Transmission and differential.*

Transmission:

Type----- Synchromesh.

Number of speeds:

Forward----- 5.

Reverse----- 1.

Differential, type----- Controlled.

f. Steering system.

Method----- Levers.

Number of levers----- 2.

Location----- One on each side and ahead of driver's seat.

g. Tracks.

Type----- Rubber shoes.

Sag----- $\frac{3}{4}$ in.Pitch----- $5\frac{1}{2}$ in.

Size of shoes:

Width----- $7\frac{5}{8}$ in.Over-all width, with side plates----- $11\frac{5}{8}$ in.*h. Electrical system.*

Battery----- Lead—acid type.

Voltage----- 12 volts.

Radio take-off voltage----- 12, 8, and 2 volts.

Capacity----- 168 amp-hrs.

Filling level for electrolyte----- $\frac{1}{4}$ in. above level of plates.

Hydrometer readings:

Fully charged----- 1.285.

Half charged----- 1.220.

Discharged----- 1.150.

Terminal grounded----- Negative.

Generator:

Voltage----- 12 volt DC.

Drive----- Belt.

SECTION III

OPERATING INSTRUCTIONS AND CONTROLS

	Paragraph
General information on controls.....	5
Prestarting inspection.....	6
Continental engine starting instructions.....	7
Continental engine test.....	8
Guiberson Diesel engine starting instructions.....	9
Guiberson Diesel engine test.....	10
Operating the vehicle.....	11
Stopping Continental engine.....	12
Stopping Guiberson Diesel engine.....	13
Cautions.....	14
Special cold weather precautions.....	15

5. General information on controls.—*a. Spark control.*—The spark control is entirely automatic and requires no attention by the operator of the vehicle.

b. Accelerator and hand throttle (figs. 6, 7, and 8).—A foot accelerator pedal is located to the right of the clutch pedal convenient to the driver's right foot. In conjunction with the foot pedal, a hand-operated throttle button is provided on the instrument panel which will hold the throttle at any desired opening.

c. Steering levers (fig. 6).—Two steering levers are mounted on the floor of the vehicle, one on each side and ahead of the driver's seat. To steer the vehicle, pull the steering lever on the side toward which it is desired to turn. Pulling back either one of the levers slows down the track on that side, while the speed of the other track is increased. Thus the vehicle turns with power on both tracks at all times.

d. Brakes.—Pulling back simultaneously on both steering levers slows or stops the vehicle, depending on the effort applied. To keep the steering levers in this position, turn the knobs on the top of the steering levers 90°. To release levers, relieve tension on knobs by pulling levers back slightly, then rotate knobs to original position. No other brakes are provided for the vehicle.

e. Clutch (fig. 6).—The clutch pedal is located to the left of the transmission housing, convenient to the driver's left foot. To permit shifting of gears, the clutch is disengaged by depressing the clutch pedal. When the pedal is depressed, the connection between engine and power train is broken.

f. Gear shifting (fig. 6).—(1) *Description.*—Shifting of gears in the transmission for speed changes is accomplished by the gear shift hand lever, located on the transmission, to the right of the driver.

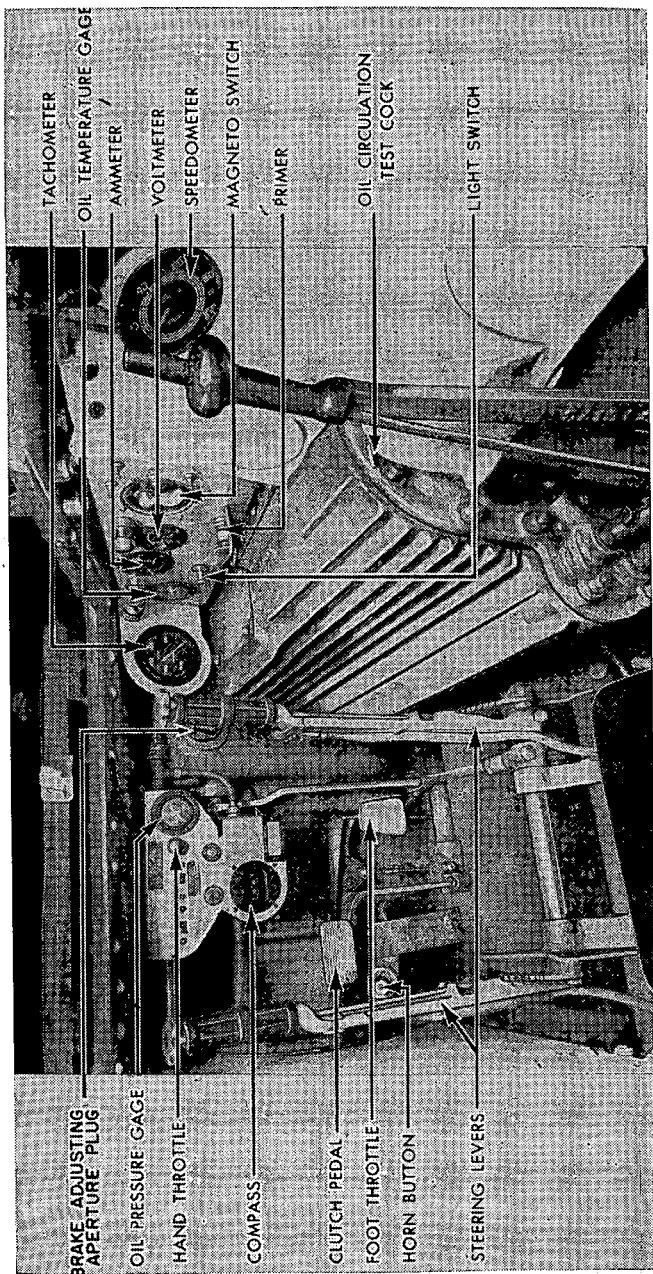
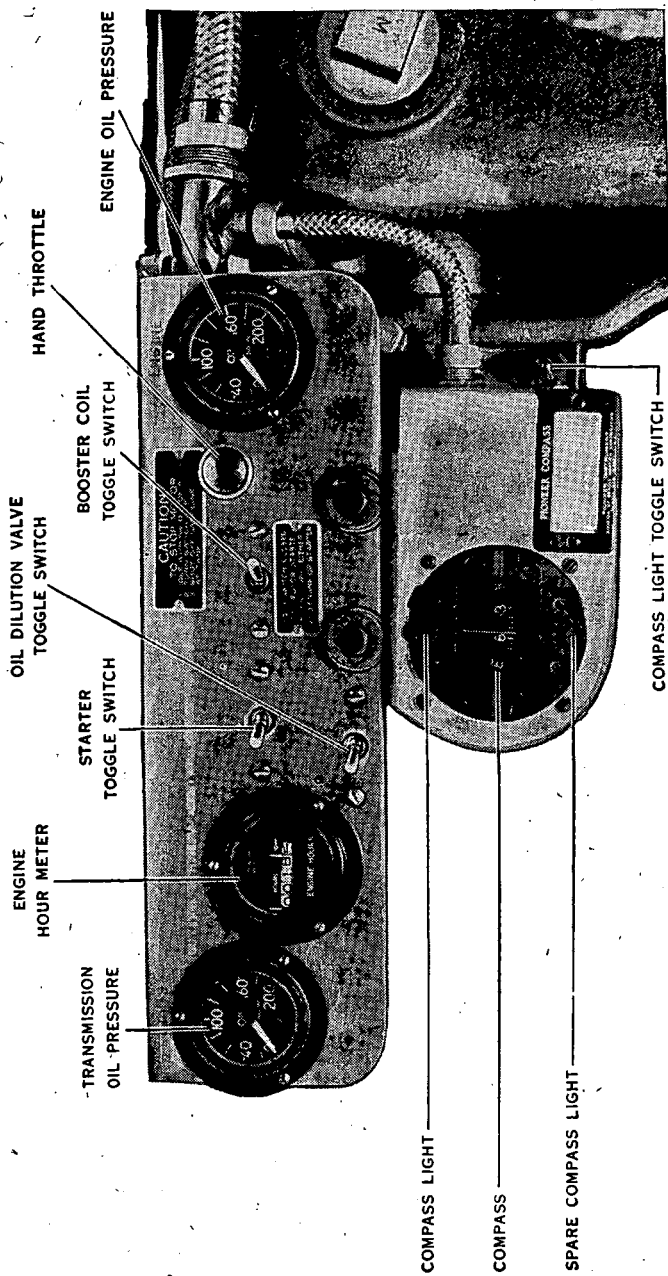

Figure 6.—Controls and instrument panel, driver's compartment.



RA, PD 5853

FIGURE 7.—Front instrument panel, Continental engine.

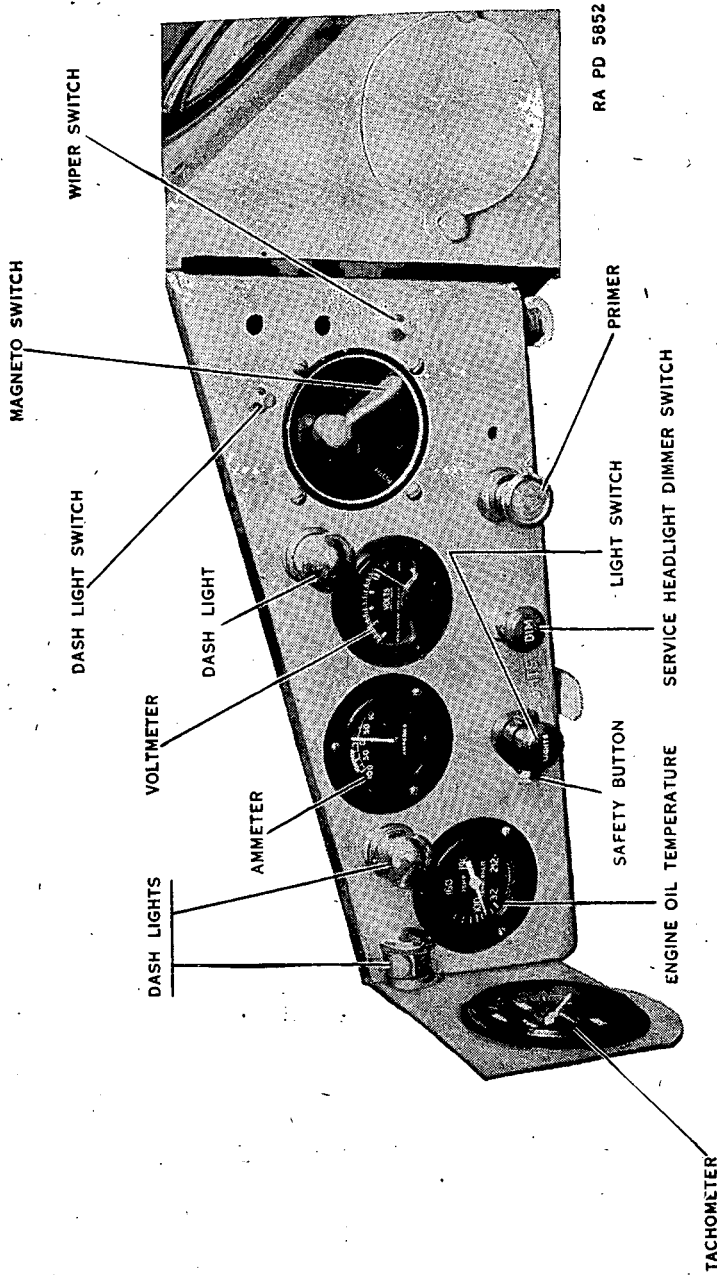

FIGURE 8.—Side instrument panel, Continental engine.

The positions of the gear shift lever for the various speeds are shown in the diagram (fig. 9).

(2) *Operation.*—The gear shift lever is equipped with a latch which prevents accidental shifting into first speed or reverse. The latch must be released by pressing down the button on the top of the lever before shifting into first speed or reverse. When it is desired to shift to low or reverse, the following procedure will make the shift possible without the clashing of gears which usually results. From neutral move the gear shift lever as though to shift into third gear.

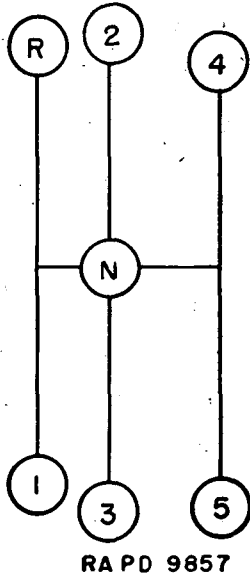

FIGURE 9.—Gear shift positions.

Maintain pressure in this direction long enough to stop the propeller shaft and then, with the clutch still held out, shift smartly into low or reverse. If when shifting to any of the higher speeds there is a raking of gears, go back to neutral and, still holding the clutch out, start the shift over. *Do not attempt to complete a shift that begins with a clashing of gear teeth.* There is but one right way to shift into second, third, fourth, or fifth speeds. Maintain a steady pressure toward the desired speed and, when a decreased resistance is felt, complete the shift. When the vehicle is in motion, three distinct movements are required to make a gear change: *one*, from the previous engagement to neutral; *two*, from neutral to pick up (the pressure required to cause one gear to pick up the speed of a second gear); and *three*, from pick up to completion.

6. Prestarting inspection.—Before the engine is started the pre-starting inspection outlined in section V must be made.

7. Continental engine starting instructions.—*a.* Hand crank engine 45 crank revolutions before starting.

b. Check engine oil and gas level.

c. Open gas shut-off valves and check for leaks. If the fuel tanks are full, run from right tank for 30 minutes before opening valves on left fuel tank.

d. Check voltmeter; if the battery switch is open, it should read 0.

e. Check voltmeter; if the battery switch is closed, it should read 13 volts.

f. Close booster switch. Check booster coil by buzz.

g. Put gears in neutral.

h. Check clutch pedal clearance; it should be at least $\frac{1}{2}$ inch for free travel.

i. Pull hand throttle out about $\frac{1}{4}$ inch.

j. Prime engine, three to nine quick pulls on primer depending on outside temperature.

k. Depress clutch pedal.

l. Close starter and booster switches.

m. Count 1,001—1,002.

n. Turn magneto switch to "both" position.

o. Engine should start readily.

8. Continental engine test.—*a.* As soon as the engine starts check oil pressure. Stop engine if the oil pressure is not indicated in 30 seconds.

b. Warm up at 800–1,000 rpm for 15 to 20 minutes.

c. Operate in second and third gear between 1,600 and 1,800 rpm for first 2 or 3 miles.

d. Check the operation of instruments and switches while warming up.

e. When engine is sufficiently warm check tachometer readings. Run on each magneto and compare it with the reading when both magnetos are used; should either magneto show a drop of over 125 to 150 rpm the cause should be investigated.

f. Never idle the engine at less than 800 rpm.

g. Never lug engine below 1,500 rpm at wide open throttle.

h. Proper engine operating range is 1,400 to 2,000 rpm. Maximum economy speed is 1,800 rpm.

i. Check oil pressure and temperature frequently.

(1) Normal oil pressure is 60 to 90 pounds.

(2) Normal oil temperature is 100° F. to 170° F.

9. Guiberson Diesel engine starting instructions.—*a.* Open engine compartment doors.

b. If the drain cock on the inlet manifold is open, close it. If the cock is closed, open it and permit all of the oil in the inlet manifold to drain out before closing it (see fig. 10).

c. Insure that engine is on decompression.

d. Use propeller shaft ratchet wrench and turn engine crankshaft through at least five complete revolutions.

e. Put engine on compression by depressing the accelerator to full length of travel.

f. Turn Cuno oil filter handle one complete turn.

g. Place cartridge in starter breech barrel (fig. 44).

(1) In order to place a cartridge in breech barrel, revolve the breech opening lever 90° upward and the breech housing downward about its axis; the breech is now open. Place a cartridge in the breech barrel, close the breech housing, and move the breech opening lever downward against the opening lever stop. The breech housing assembly is then in the closed position.

(2) Empty cartridge cases should be removed immediately after discharge.

(3) When removing empty cartridge cases, move the breech opening lever 45° upward and hold it in this position until any residual pressure in the system escapes.

(4) Raise the breech opening lever and move the breech housing downward; this operation will cause partial automatic ejection of the cartridge case. The cartridge case is then removed by hand.

(5) The breech should be loaded only prior to an immediate start. Always keep the breech closed.

(6) In cases of failure of a cartridge to fire upon the first attempt, at least three additional attempts should be made. If the cartridge fails to fire, it will not be removed from the breech for at least five minutes.

h. Depress the foot throttle to the full open position.

i. Depress the clutch pedal to reduce starting load.

j. Close the starter contact switch.

k. As soon as the engine starts, release the throttle control to allow the engine to operate at 800 rpm. Close engine compartment doors.

l. Watch the oil pressure gage. Do not operate the engine more than 30 seconds if the gage does not register some oil pressure.

10. Guiberson Diesel engine test.—*a.* After starting the engine and before moving the vehicle, run the engine 2 minutes at 800 rpm, 2 minutes at 1,000 rpm, and 3 minutes at 1,200 rpm.

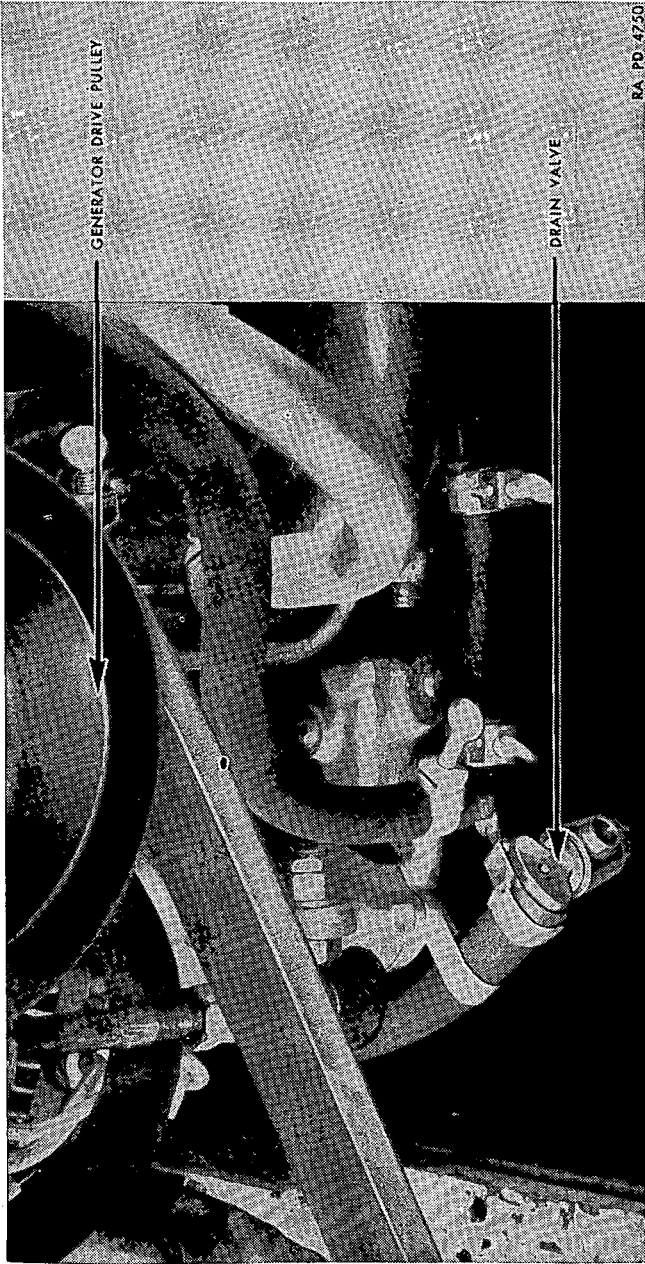

FIGURE 10.—Inlet manifold drain valve for Guberson T-1020, series 4.

b. Vehicle must not be moved until oil temperature has reached 80° F. The minimum safe oil temperature for full throttle operation is 100° F.

c. Operate the engine in third or fourth gear at a speed between 1,600 rpm and 1,800 rpm for 15 minutes.

d. Avoid "lugging" the engine at full throttle below 1,600 rpm.

Caution: Never apply full throttle suddenly while lugging.

e. The normal oil pressure is 90 to 100 pounds.

f. Maximum safe oil inlet temperature is 180° F.

g. Maximum allowable rpm with full load is 2,250.

11. Operating the vehicle.—Before attempting to drive the vehicle the prospective driver should be thoroughly familiar with all the instruments and the significance of their readings. (See figs. 7 and 8.) He must also know the function and operation of the controls in his compartment. Review of paragraph 5 will be helpful. The limitations of vehicle and engine are listed in paragraph 4.

a. Operating instructions.—With the driver in the driver's seat, the engine at idling speed, and all instruments showing normal readings, the driver may now operate the vehicle.

(1) Disengage the clutch by pressing clutch pedal down to the floor and holding it down.

(2) Move the gear shift lever into second gear, as shown in figure 9, for normal operation. First gear will be used only when shifting vehicle in building or over obstacles or descending extreme grades.

(3) Gradually release the clutch pedal, at the same time depressing the foot throttle. Except when under fire, do not move the vehicle in or out of close quarters without the aid of personnel outside of the vehicle serving as a guide.

(4) When the vehicle has started and is moving with engine speed of 2,000 rpm, release the foot throttle, depress the clutch again, and move the gear shift lever into the third gear position. Release the clutch and again depress the throttle to pick up the load of the vehicle.

(5) The procedure in (4) above is repeated until the highest gear is reached which will enable the vehicle to proceed at the desired speed without causing the engine to labor. Do not ride the clutch. The driver's left foot must be completely removed from the clutch pedal while driving, to avoid unnecessary wear on the clutch.

(6) To place the vehicle in reverse gear a complete stop must be made, the throttle closed until the tachometer reads 400 rpm (lowest idling speed). Depress the clutch pedal and move the gear shift lever to the reverse position (fig. 9). Backing the vehicle should never be attempted unless an observer is stationed in front to guide the driver.

(7) To steer, pull back the right hand steering lever to make a right turn or the left hand lever for a left turn. This action brakes the track on the inside of the turn and speeds up the outside track. The driver should anticipate each turn and be ready to apply more power as it is needed to compensate for the braking effort. The hands should be free of the steering lever when not actually steering the tank.

(8) To stop the vehicle, release the throttle and pull back on both steering levers at the same time, depressing the clutch when the vehicle has slowed down to approximately two to five miles per hour, depending upon which gear is being employed before stopping. If the vehicle is to remain stopped, turn the knobs on the top of the steering levers 90° to hold the brakes on and shift transmission into neutral. Set the hand throttle for a tachometer reading of 800 rpm for the duration of the halt.

(9) The tachometer, the oil temperature gage, and the oil pressure gage give the most satisfactory indications of the engine's performance. Should the indications of any of these instruments appear to be irregular, the engine should be throttled down and the cause investigated. The oil temperature should not exceed 190° F.

b. Towing instructions.—(1) *Equipment.*—A towing shackle is mounted on each corner of the hull of the vehicle about 20 inches from the ground. Two of these shackles are mounted in front and two in the rear. The shackles provide a quick method of attaching either the "towing bar" or cables.

(2) *Precautions.*—If the tracks are on the vehicle to be towed, always disconnect the propeller shaft at the transmission companion flange and leave the vehicle in fifth gear. This procedure insures adequate circulation of the transmission oil while the vehicle is in motion. If the tracks are removed before towing the vehicle, this precaution is not necessary. In towing there are several precautions that the driver must take to avoid trouble or unnecessary delay. Changes of direction are always to be made by a series of slight turns so that the vehicle being towed is as nearly as possible directly behind the one doing the towing or "tracking." This will prevent the cable from contacting the track, which might ruin both the cable and the track blocks. Soft muddy ground is to be avoided, since the tracks may slip on such a surface. If it is necessary to cross a muddy area, the driver should be careful to straighten out both vehicles before entering it, as it is more difficult to pull a tank at an angle than when following in tow. Grousers may be installed as required. The maximum speed when towing should not be more than

12 miles per hour and then only with an operator for steering and braking the towed vehicle.

NOTE.—Except in cases where a “short hitch” is absolutely necessary, a towing cable will not be coupled to another vehicle by other than the thimble eyes provided at both ends. Doubling the cable causes sharp bends in the wire rope which will cause rapid failure of the strands and will leave the cable extremely dangerous to handle. When a “short hitch” is desired, the two eyes of the cable are attached to the towing vehicle. The cable, with leads *crossed*, is then passed through both shackles of the towed vehicle. This provides an arrangement having a minimum of bending action and movement at the shackles, and furnishes clearance between cable and tracks.

(3) *Method.*—If no operator is available to steer the disabled vehicle, it may be towed by using a towing bar, or in an emergency the “short hitch” method outlined under (2) above. In cases where the tracks must be removed from the vehicle, the “short hitch” or towing bar greatly facilitates towing the disabled vehicle. If an operator is available to steer the disabled vehicle, one cable will facilitate tracking of the towed vehicle. Care must be taken on turning not to get the cable tangled up with the track of either vehicle.

12. Stopping Continental engine.—*a.* After completing a run, the engine must be allowed to operate at 800 rpm for 5 minutes to assure a gradual and uniform cooling of the various engine parts. When low temperatures are encountered the oil dilution valve switch (fig. 7) will be depressed for the recommended time just before the engine is stopped. Turn magneto switch to “off” position to stop engine.

b. To determine the amount of dilution required, estimate the lowest temperature anticipated at the next engine starting. Find this temperature in the table given below and hold the oil dilution valve open the length of time indicated opposite this temperature in the chart.

OIL DILUTION TABLE

Temperature ° F.	Dilution time (seconds)
+30	11
+20	23
+10	41
0	63
-10	95
-20	140
-30	210

Example: If the anticipated temperature is +10° F., we see from the chart that the oil dilution valve should be held open 41 seconds before the engine is shut off. During dilution period, idle the engine at 1,000 rpm and *shut the engine off immediately* after dilution.

c. Important points to remember.—(1) Engine *must* be operated for at least 30 minutes when started following a shut-down on diluted oil.

(2) Engine *must* be shut-down *immediately* after dilution.

(3) Dilution time greater than 210 seconds *must not* be used.

d. After engine stops, close main fuel supply valves and open battery switch.

13. Stopping Guiberson Diesel engine.—*a.* Avoid sudden stopping of engine. The engine should be operated, with no load, at 1,100 rpm for from 3 to 5 minutes and then at 800 rpm for 2 minutes. Throw the solenoid switch to stop engine.

b. If an unavoidable stop occurs during high speed operation, place the throttle lever on decompression, open drain cock (fig. 10), and turn the engine by hand through two or three revolutions before attempting to start the engine. This is to prevent damaging the engine due to an oversupply of oil between piston and cylinder head in cylinders five and six.

c. Open inlet manifold drain cock and leave open. Put engine on decompression.

14. Cautions.—*a.* After initial warming, the tank engine must be operated at appreciable engine speeds. Continuous operation of this type engine at idling speed will shorten the useful life of the engine considerably by causing increased wear and overheating. On no occasion, including military ceremonies, will idling of the engine at less than 800 rpm be permitted. After every half-hour of idling, run the engine at 1,000 to 1,200 rpm for 30 seconds to clear oil from the spark plugs. While damage to the engine is not immediately apparent, the total life of the engine will be greatly reduced.

b. The engine will be idled at about 800 rpm for 7 minutes before moving the vehicle. Do not operate the vehicle at full speed and under load until oil temperature gage reads 100° F. This is necessary to prevent damage to the engine working parts. Avoid rapid movement of the accelerator, since this causes a spray of fuel to be injected into the cylinders. This fuel washes the lubricant from the cylinder walls and causes excessive wear.

c. Do not attempt to start the engine by "towing" or "coasting" the vehicle under normal conditions. To do so may cause serious damage to the engine and transmission and should be attempted only in emergencies.

d. Care must be taken not to place any object in a position where it will block the flow of air from the cylinders. Blocking off any cylinder will cause overheating and preignition in the cylinder so affected.

15. **Special cold weather precautions.**—In order that the tank engine may be started and operated with a minimum of difficulty in very cold weather; it will be necessary to take the following precautions. If closed buildings or shelters of any kind are available, the tank should be placed in these shelters and some method of heating provided. Take due precautions against fire hazards from leaking fuel or oil. If such shelters are not available, tanks which must be kept ready for immediate use may be kept warmed considerably above prevailing temperatures by covering the tank with a tarpaulin.

SECTION IV

LUBRICATION

	Paragraph
General.....	16
Detailed lubrication and service instructions.....	17
Lubrication charts and notes.....	18

16. **General.**—The lubrication chart given in this section shows the various points to be lubricated, the periods of lubrication, and lubricants to be used. In addition to the items on the chart, other moving parts such as door and shield hinges, pistol port covers, door latches, and gun mounting pins must be lubricated at frequent intervals. Oil holes and lubrication fittings are painted red for easy identification.

17. **Detailed lubrication and service instructions.**—*a. Engine oil tank.*—Check oil level daily. Every 1,000 miles, flush oil tank only with engine oil SAE 10. Do not run engine while flushing tank.

b. Air cleaners.—Proper maintenance of air cleaners is essential to prolong engine life.

(1) Remove oil cup, clean and refill with engine oil of the grade specified in the lubrication chart.

(2) The service interval should be determined by the operator in accordance with the operating conditions. Under extremely dusty operation, service daily; paved road or wet weather, 250 miles.

(3) Inspect air outlet rubber hose connections for leaks and make sure ducts are in alinement.

(4) Replace connections if there is evidence of wear or deterioration.

c. Fuel filter.—At time of 25-hour inspection remove sediment drain plug, located at bottom of filter, to drain accumulated water. Turn at least once daily.

d. Bleed fuel system (Diesel engine).—When fuel flow is broken, air is permitted to enter fuel system. To bleed out air, use the following procedure:

- (1) Open fuel tank. It must be $\frac{3}{4}$ full to provide a gravity flow for bleeding.
- (2) Open shut-off valve.
- (3) Open bleeder valve on fuel filter in line. Close when no bubbles appear.
- (4) Open bleeder cap on fuel filter. This will bleed line from filter to fuel duct.
- (5) Remove pipe plug in fuel duct between cylinders 1 and 2. Allow fuel to run.
- (6) Loosen high pressure line. Remove cone, cone union nut, and check valve at No. 1 cylinder.
- (7) Replace cone, cone union nut, and check valve.
- (8) Repeat (6) and (7) on cylinders 8, 9, 1, 2, and 3 and the bleeding operation is finished.
- (9) Pump the decompression lever and listen for fuel injector chatter. Start engine.

e. Transmission and final drives.—(1) To flush inside of cases at drain periods indicated on lubrication chart, fill case to proper level with engine oil, SAE 10.

(2) Operate tank slowly in low gear for several minutes, and redrain.

(3) Fill cases to level indicated with lubricant specified on lubrication chart.

NOTE.—Follow instructions on the War Department lubrication chart for temperatures above $+15^{\circ}$ F. Below $+15^{\circ}$ F., oil, engine, SAE No. 50 (Navy Symbol L100) is *not* satisfactory. For temperatures from $+15^{\circ}$ F. to -20° F. procure and use a *straight mineral oil, high quality commercial SAE No. 80 gear lubricant* with a maximum channeling temperature of -20° F. For temperatures below -20° F., it will be necessary to heat the gear cases before attempting to move the tank. This should preferably be done in a heated tent or building, or by a special heating unit. In the absence of other facilities, a blowtorch may be used.

f. Rocker arm push rods.—Some early Continental engine models were equipped with fittings, lubricated with wheel bearing grease, every 250 miles.

g. Bogie wheels, track support rollers, and idlers.—For lubrication of these units refer to the lubrication chart.

h. Turret traversing gear housing.—(1) Check level every 250 miles; add lubricant if necessary.

(2) Every 1,000 miles, drain case.

(3) Replace drain plug; fill case to level plug with solvent.

(4) Operate turret, drain, and replace plug.

(5) Refill with lubricant specified on lubrication chart.

18. Lubrication charts and notes.

NOTES

ADDITIONAL LUBRICATION AND SERVICE INSTRUCTIONS ON INDIVIDUAL UNITS AND PARTS

1. *Intervals.*—Intervals indicated are for normal service. For extreme conditions of speed, heat, water, mud, snow, dust, etc., lubricate more frequently.
2. *Fittings.*—Clean before applying lubricant. Lubricate bogie wheels, trailing idler, and track support rollers until lubricant overflows relief valve. Lubricate other fittings until new grease extrudes from the bearings.
3. *Turret traversing gear housing.*—Drain, flush, and refill at end of first 250 miles; thereafter as indicated on guide.
4. *Turret support bearings.*—Lubricate weekly and after each rain. Remove pipe plug to drain water, replace pipe plug with fitting, and lubricate with ¼ pint EO. Rotate turret two or three revolutions, remove fitting, and allow to drain. Replace plug.

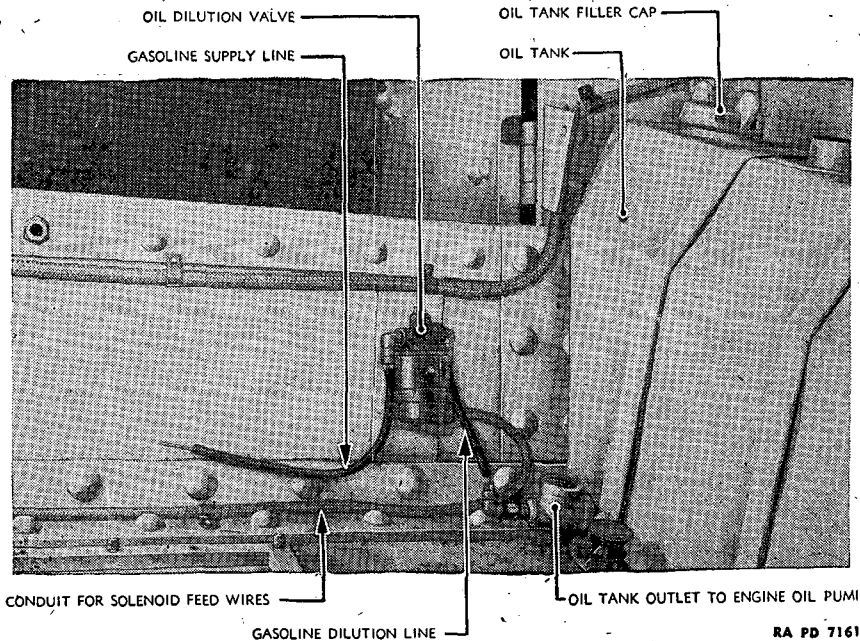

FIGURE 11.—Oil dilution valve.

RA PD 7161

5. *Oilcan points.*—Lubricate peep hole protector slides, door hinges and latches, shield hinges, control pins, clevises, and sponson machine gun adjusting screws, etc., with EO SAE 30 sparingly every 250 miles.
6. *Points requiring no lubrication.*—Bogie wheel suspension linkage and guides, volute springs, turret guide rollers, final drive sprocket bearings.

NOTES

ADDITIONAL LUBRICATION AND SERVICE INSTRUCTIONS ON INDIVIDUAL UNITS AND PARTS

1. *Air cleaners.*—Drain, clean, and refill with EO SAE 30 above 32° F. SAE 10 below 32° F., daily when operating on dirt roads or cross country. Service every 250 miles when operating on paved roads or during wet weather. Depending on operating conditions, remove air cleaner and wash all parts every 100 to 500 miles. **Caution:** Keep all air pipe connections tight.
2. *Engine oil tank.*—Check oil lever daily. Drain at intervals shown below only when engine is hot. Clean tank and oil filling tube strainer every 1,000 miles. Refill oil tank to FULL mark on bayonet gage, located under fill cap. **Caution:** Do not remove strainer when filling tank.

KEY

Lubricants	Intervals
EO—ENGINE OIL SAE 50 (below 32° F.) SAE 60 (above 32° F.)	1/4— 250 miles 1— 1,000 miles
CG—CHASSIS GREASE No. 0 (below 32° F.) No. 1 (above 32° F.)	

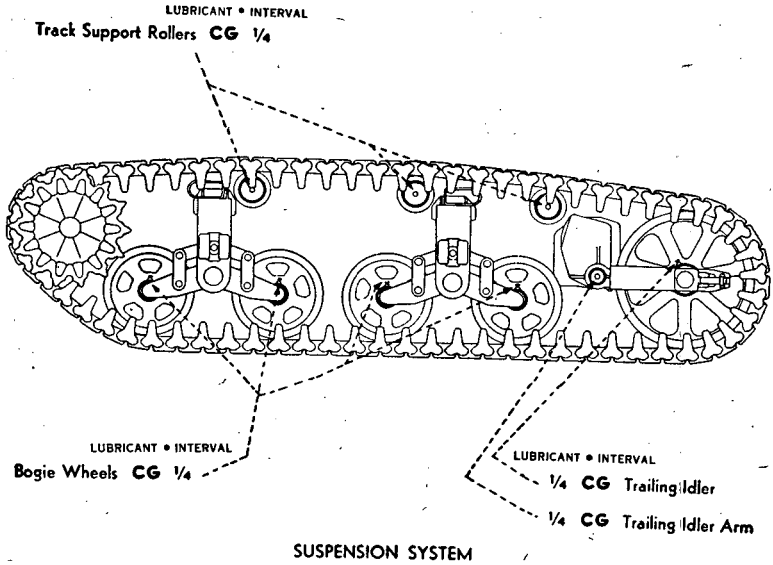

CAUTION LUBRICATE SUSPENSION SYSTEM POINTS ON BOTH SIDES OF TANK.

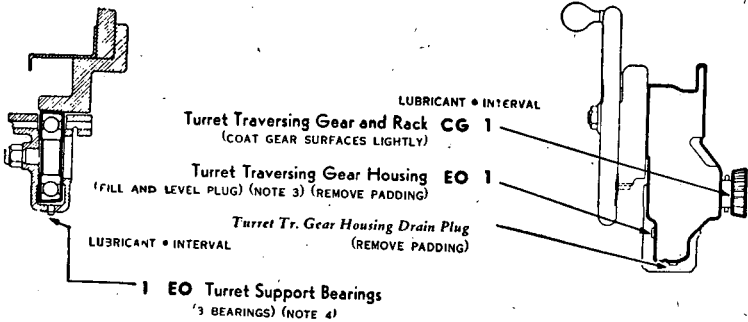

TURRET SUPPORT BEARING

RA PD 4726

TURRET TRAVERSING GEAR HOUSING

FIGURE 12.—Lubrication chart on suspension.

TABLE OF CAPACITIES AND RECOMMENDATIONS

	Capacity	Above 90°	Lowest Expected Atmospheric Temperature				
			+32°	+10°	-10°	-30°	Below -30°
Engine Oil Tank	24 qt.	SAE 60	SAE 60	SAE 50	SAE 50	For operation in these temperatures, refer to OFSB 6-G-3.	
Transmission and Differential	24 qt.	60	60	50	50		
Final Drive (each unit)	3 qt.	60	60	50	50		

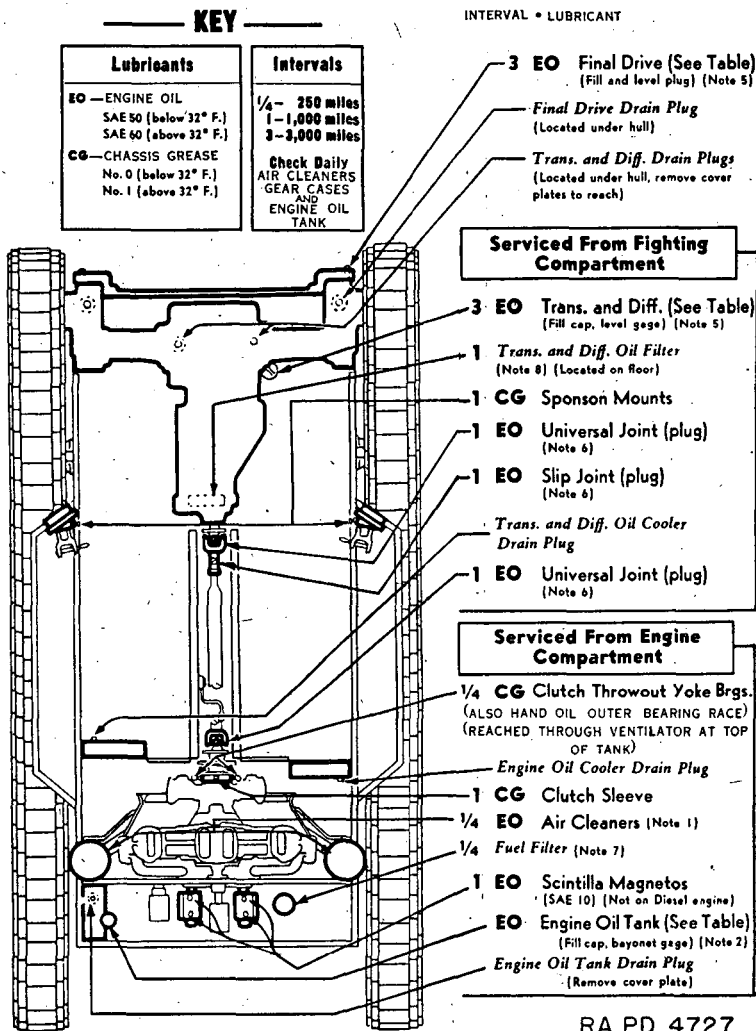

FIGURE 13.—Lubrication chart on power drive units.

Gasoline engine.—Drain and refill every 250 miles, or 25 hours when used for cross country or dirt road operation. Drain and refill every 1,000 miles or 100 hours for paved road or wet weather operation.

Diesel engine.—Drain and refill every 250 miles or 25 hours of operation under all operating conditions.

3. **Intervals.**—Intervals indicated are for normal service. For extreme conditions of speed, heat, water, mud, snow, dust, etc., change engine oil and lubricate more frequently.

4. **Fittings.**—Clean before applying lubricant. Lubricate until new grease extrudes from the bearing.

5. **Gear cases.**—Check level daily, add lubricant if necessary. Check with tank on level ground. Drain, flush, and refill at the end of first 250 miles; thereafter as indicated at points on guide. Clean transmission and differential filler strainer every 3,000 miles. **Caution:** Do not remove strainer when filling.

6. **Universal joint and slip joint.**—Remove tunnel shield over universal joints and slip joint. To lubricate remove plugs and insert fittings. Apply EO to universal joints until filled, and to slip joint until EO extrudes from end of spline. **Caution:** After lubricating remove fittings and replace plugs.

7. **Fuel filter.**—(a) *Gasoline.*—Turn handle on top of filter one full turn daily. Drain every 250 miles.

(b) *Diesel.*—Open vent cocks, drain through drain plug, and remove filter element. Wash element and case. Replace element and prime fuel system.

8. **Transmission and differential oil filter.**—Every 1,000 miles, remove brass plug and screen. Clean screen and replace. **Caution:** Tighten plug.

9. **Oilcan points.**—Lubricate door and shield hinges, peep hole protectors, door latches, control rod pins, and lever bushings, etc., with EO (SAE 30) every 250 miles.

10. **Points to be lubricated at time of engine removal for periodic inspection.**—Clutch pilot bearing and clutch hub bearing.

11. **Points to be lubricated by ordnance maintenance personnel at time of general engine overhaul.**—Clutch pilot bearing, clutch hub bearing, generator, magneto (except rollers), and starter (see OFSB 6-G-103).

SECTION V

INSPECTIONS

	Paragraph
Purpose-----	19
Prestarting inspection-----	20
Inspection during operation-----	21
Inspection at the halt-----	22
Inspection after operation-----	23
Periodic inspection-----	24

19. **Purpose.**—*a.* To insure mechanical efficiency, it is necessary that tanks be systematically inspected at intervals in order that defects may be discovered and corrected before they result in serious damage.

b. Cracks that develop in castings or other metal parts may often be detected through the medium of dust and oil deposits upon the completion of a run.

c. Suggestions toward changes in design prompted by chronic failure or malfunction of a unit or group of units; pertinent changes in inspection or maintenance methods; and changes involving safety, efficiency, economy, and comfort should be forwarded to the office of the Chief of Ordnance, through proper channels, at the time they develop. Such action is encouraged, in order that other organizations may profit thereby.

20. **Prestarting inspection.**—*a.* The tank has a crew of four men and it is essential that *all* men be utilized in inspection of the tank under direction of the tank commander. The inspection should cover the vehicle as well as the engine.

b. Check oil level in final drive; fill if necessary.

c. Look at the ground under the tank for oil and fuel leaks.

d. Check that all accessories (pioneer tools) are present.

e. Check general condition of sprockets, bogies, springs, guides, gudgeons, track supporting rollers, and idlers.

f. Check the track for wear, tightness and tension, and end connections for wear.

g. Check for tightness and wear of wedges and wedge nuts.

h. Check grousers (if used); otherwise check to see if a set is carried in the tank.

i. Check for loose air horn connections around top and bottom of air cleaners.

j. Check fuel level; fill if necessary.

k. Check radio antenna for breaks.

l. Oil clutch throw-out bearing.

m. Turn the engine over by hand two complete engine revolutions. On the Continental engine use the hand crank. If the engine is difficult to turn over, remove the spark plugs from the lower three cylinders to let the trapped fluid escape. On the Diesel (Guiberson) engine a hand cranking ratchet is provided on the propeller shaft on late series tanks only (fig. 14). Put the Diesel engine on decompression and open the drain cock on the lowest cylinder (fig. 10). After clearing the engine of trapped fluid, close the drain cock.

n. Check transmission oil level; fill if necessary.

o. Check for oil and fuel leaks on floor of fighting compartment.

p. Check for presence and condition of fire extinguishers and tank tools.

q. Check instrument panel and see that voltmeter reads zero with battery switch open and other instruments indicate normal shut-off readings.

r. Check that steering levers, clutch pedal, and gear shift lever operate freely and over the full range.

s. Close battery switch and watch the ammeter and voltmeter. If ammeter shows excessive discharge open the battery switch immediately. The voltmeter should read 13 or more volts.

t. Check to see that fuel valves are open.

u. Check lights and siren.

v. Check operation of turret and locking mechanism.

w. Check traverse and elevation of vehicle weapons.

x. Check to see that ammunition, flags, field equipment, and rations if carried are properly loaded.

21. **Inspection during operation.**—a. During operation the driver should be alert to detect abnormal functioning of the engine. He should be trained to detect unusual engine sounds or noises. He should glance frequently at the instrument panel gages to see if the engine is functioning properly. An unsteady oil gage needle in-

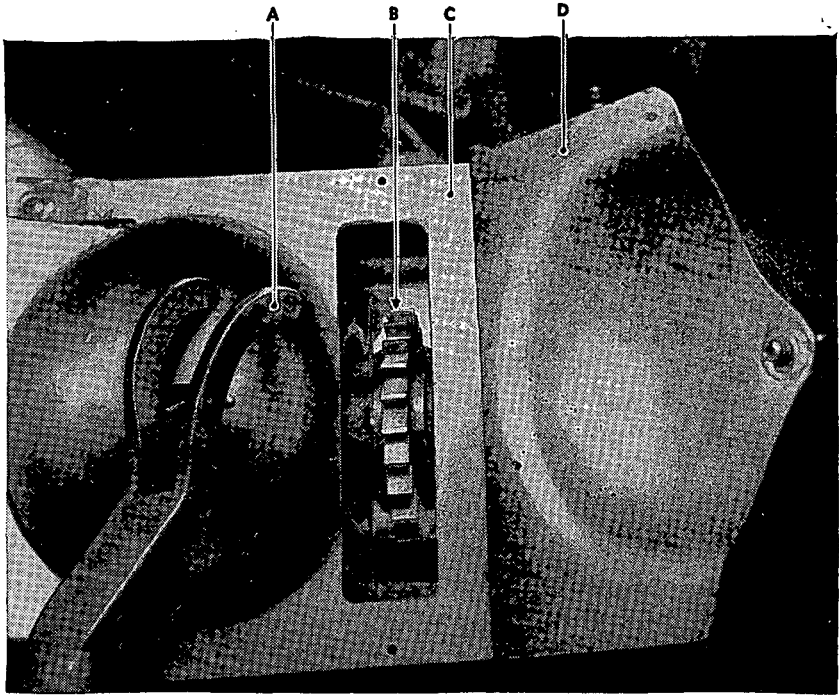

A. Propeller shaft turning wrench.
B. Propeller shaft ratchet.

C. Propeller shaft housing.
D. Hand cranking aperture cover.

RA PD 5862

FIGURE 14.—Hand cranking provision, Gulberson engine.

icates low oil pressure, provided that engine speed is fairly constant. The driver should notice continuously the amount of clearance of the clutch foot pedal (for proper adjustment see par. 89). The steering mechanism must be checked for clearance before engagement, intensity of pull required for braking, etc.

b. Only under exceptional circumstances will a tank be operated after indications of trouble have been observed. When in doubt, the engine will be stopped, and assistance obtained. Inspection during

operation applies to the entire vehicle and should be emphasized throughout the driving instruction period.

22. Inspection at the halt.—*a.* At each halt the operator should make a careful inspection of the tank to determine its general mechanical condition. Minor defects detected during the march together with defects discovered at the halt will be corrected before resuming the march. If the defects cannot be corrected during the halt, proper disposition of the vehicle will be made so that unnecessary delay may be avoided and a major failure prevented.

b. A suitable general routine is as follows:

(1) Allow the engine to run a short time at idling speed (800 rpm). Listen for unusual noises.

(2) Walk around the vehicle looking carefully for fuel or oil leaks.

(3) Remove all debris from suspension system.

(4) Feel track support rollers, bogie, and idler wheel bearings. If an unusual amount of heat is present, lack of lubrication or defective bearings are indicated.

(5) Examine tracks for adjustment and for worn, loose, broken, or missing parts.

(6) Inspect hull and fittings for missing, worn, or loose parts.

(7) Feel steering brake housings and gear case for evidence of overheating. If abnormally hot, check level of lubricant, and, if necessary, correct steering brake band adjustment.

(8) Inspect the lights, if traveling at night with lights.

(9) Check the amount of fuel in the tank.

(10) Wipe all windshields and vision devices. Do not use an oily or dirty cloth.

(11) Before stopping the engine open petcock to check circulation of transmission oil.

23. Inspection after operation.—At the conclusion of each day's operation, the tank commander should cause an inspection to be made, similar to that made at halts but more thorough and detailed. The inspection should be followed by preventive maintenance. If defects cannot be corrected, they should be reported promptly to the chief of section or other designated individual. The following points should be covered:

a. Examine the tracks and bogies.

b. Check track tension.

c. Inspect idler track support rollers.

d. Examine the drive sprockets for worn or broken teeth.

e. Examine the rubber track shoe units for unserviceable units.

- f. Check transmission oil level.
- g. Check differential oil level.
- h. Check, clean, and refill air cleaners during extremely dusty operations.
- i. Inspect lights, siren, and windshield wipers. Check for loss or damage of exhaust mufflers and accessories.
- j. Inspect the sighting and vision devices for breakage.
- k. Inspect guns and mounts for defective performance.
- l. Inspect guns, sighting equipment, and accessories and determine that covers are properly installed.
- m. Inspect ammunition and sighting compartments for cleanliness and orderly arrangement.
- n. Replenish oil, fuel, and ammunition.
- o. For continuous operation in hot weather, battery water must be replenished about twice a week. Check and clean battery and compartment weekly by removal of battery.
- p. Inspect engine compartment especially for oil or fuel leaks.
- q. Check and if necessary clean screen in needle bearing oil line.
- r. Inspect all control linkage to locate loose or broken parts.
- s. Inspect electrical wiring for loose connections and abrasions.
- t. Check to see that fuel shut-off valves are closed.
- u. Check to see that battery switch is open.

24. Periodic inspection.—*a. After 25 hours or 250 miles of operation (whichever occurs first).*—This check is made without removing the engine from the vehicle. (Check for leaks, etc., will be made with compartment open and engine running.) Make routine daily inspection and the following:

(1) Remove top deck armor assembly; refer to paragraph 60a, steps (1) through (13).

(2) Clean the engine and engine compartment. Clean the portion of the engine compartment between the bulkhead and engine fan. Clean the clutch release yoke.

(3) Inspect for oil leaks at oil tank.

(4) Check gasoline and oil lines for breaks, loose connections, and chafing. Make external inspection of rigid and flexible lines having sharp bends or kinks.

(5) Remove the Continental engine oil filter screen. If the oil filter screen is covered with an unusual amount of bearing metal flakes, show the screen to the ordnance personnel. If the deposit on the screen is normal, clean the screen with solvent, dry-cleaning, dry with air and install it on the engine.

(a) Remove, clean, and inspect the felt pad in the bottom of the air horn in the course of the regular check. Inspect it also in case of backfire or fire in the air horn, since it may burn through and fail to filter the air properly.

(b) This inspection is very important, since sand and dirt thrown into the engine because of a defective felt pad can cause severe wear.

(c) While the lower inspection plate is off, check the engine ignition cables, lower spark plugs, and scavenger pump connections at the rocker box, and clean out the dirt under the engine.

(6) Drain fuel strainer and clean. If excessive water or dirt is observed, drain and clean fuel tanks and outlet screens. Bleed air through small screw at top of filter when refilled.

(7) Service air cleaner; do not overfill with oil. Check all air induction pipes and air horn for leaks or missing plugs. Check carburetor flange gasket.

(8) Check push rod housing packing nuts for tightness.

(9) Check and adjust all control linkage for wear, free operation, and missing cotter pins. See that full travel of controls is obtained. This applies to all controls of the tank.

(10) Check all flexible conduits for breaks and worn sections.

(11) Tighten all engine mounting bolts and check for loose rivets where engine is mounted to hull.

(12) Check axle bolts and nuts, bogie gudgeon nuts, wedges, wedge nuts, cotter pins and lock wire for tightness or broken and missing parts.

(13) Check propeller shaft flange nuts for tightness.

(14) Check cowling studs where possible for presence and tightness.

(15) With engine running, place hand on each cylinder head and feel for cold or hot cylinder heads. Cold cylinder heads indicate cylinder not firing. Observe cylinder bases while engine is running, for cylinders working on the base pad of the crankcase. Check engine for excessive roughness. If the $\frac{1}{8}$ -inch pipe plug in the fuel pump near the mounting flange and on the underneath side of the fuel pump is present, remove it, and do *not* install it. This drain hole must be kept open to prevent the fuel leaking by the packing gland of the fuel pump from entering the engine crankcase. If one drop per minute of either lubricating oil or fuel leaks from this drain when the engine is running, the pump is defective and should be replaced with a serviceable unit. If lubricating oil continues to leak from the fuel pump drain, notify the ordnance personnel.

LIGHT TANK M3

(16) Check suspension system for track tension, bogie wheel tires, volute springs, and presence of foreign material.

(17) Change engine oil and check dilution valve (par. 47c(3)).

(18) Drain oil sump.

(19) Check oil level in final drives.

(20) Remove the battery from its compartment. Clean the battery and terminals. Wash the battery compartment with a washing soda solution. Fill the battery to $\frac{1}{4}$ inch above plates with distilled water. Install the battery.

(21) Check booster coil, listen for vibrations of points. Refer to paragraph 44a(2)(b)4.

(22) Check solenoids for operation. Check visually for excess condensation.

(23) Check all accessories for security and operation. Remove the bolts and elastic stop nuts attaching the head lamps and blackout head lamps to the front fenders. Install the bolts and nuts with the bolt heads underneath the fenders to facilitate future removal of these assemblies.

(24) Road test for proper operation.

b. After 25 hours or 250 miles of operation of Guiberson Diesel engine.—In addition to the instructions in *a* above—

(1) Turn disk type filter handle two or three revolutions.

(2) Remove, clean, and inspect fuel oil filter (sec. IV, ch. 2).

(3) Inspect all fuel pressure pumps and if leaking, notify ordnance personnel.

(4) Clean magnetic plug in oil sump.

(5) Drain and check bypass filters. A sample of oil from these filters will indicate whether the elements need changing.

(6) Clean the cartridge starter breech barrel if 25 cartridges have been fired, or each time a longer cartridge than the preceding one has been fired. Clean the combustion chamber of the cartridge starter unit if 50 cartridges have been fired. (Refer to par. 71b for directions.)

c. After 100 hours or 1,000 miles of operation (whichever occurs first).—Daily and 25-hour check will be repeated and the following in addition:

(1) Remove engine and place on inspection stand (par. 60).

(2) Clean with cleaning solvent.

(3) Disassemble clutch, inspect plates, lubricate clutch hub, spindle, and throw-out bearings.

(4) Check all exhaust pipes for cracks, burned-out spots, and rust.

(5) Check intake manifold packing and securing nuts for tightness.

(6) Remove oil radiators, clean all dirt in air passages, drain and flush out inside, completely removing flushing material. Remove the spring loaded bypass valve and clean it. Install the bypass valve and spring.

(7) Change all spark plugs. Check new plugs.

NOTE.—Do not install spark plugs until all other top cylinder work has been completed.

(8) Remove rocker arm.

(9) Check rocker rollers for flat spots.

(10) Check valve spring upper retaining washer for cracks.

(11) Inspect valve springs for breaks or distortion.

(12) Check for clearance between rocker arm and top of spring retainer.

(13) Remove push rod and blow out oil passage.

(14) Check rocker arm bearings for wear and roughness.

(15) Drain and clean rocker box sump.

(16) Reassemble valve mechanism.

(17) Set valve clearance 0.010 inch on Continental, 0.020 inch on Guiberson with engines cold.

(18) Check flywheel cap screws for tightness and presence of locking wire.

(19) Inspect magneto breaker and reset points to 0.012 inch, using feeler gage. Check points for pitting. If points show ash-colored burning, have condensers checked.

(20) Inspect carburetor for flooding and replace if necessary.

(21) Remove window straps of starter and generator and inspect brushes, commutator, and general internal appearance. If brushes need replacing or if other repairs are indicated, replace starter or generator.

(22) Check all nuts securing engine accessories, fan cowling, support brackets, front steady mounts, etc., for tightness.

(23) Check throttle rod at turnbuckle for loose jam nuts and cracks at weld.

(24) Check foot accelerator to see if it comes against stop at transmission with 0.005 inch clearance at throttle stop on carburetor in wide open position (after engine is reinstalled).

(25) Check air horn rubber connections for restricted passages.

(26) Clean magnetic plugs in transmission and check magnetic ability.

(27) Check transmission and final drives for oil. Check for tightness of final drive housing securing cap screws.

(28) Lubricate tank throughout in compliance with lubrication instructions.

(29) Check and blow out fire extinguisher lines.

(30) Check and, where necessary, replace or exchange unit accessories such as headlights, batteries, sirens, generators, wiring harness, etc.

(31) Check, repair, and adjust tracks. Check sprockets, bogie wheels, idlers, gudgeons, gudgeon guides, spring connectors, wedges, and wedge nuts for wear, breakage, and missing parts.

(32) Check clutch throw-out bearings for wear and flat spots on races.

(33) Road test.

d. After 100 hours or 1,000 miles of operation on Diesel engine.—
In addition to the applicable instructions in *c* above—

(1) Test all fuel injector valves and, if necessary, replace.

NOTE.—Remove fuel injector valves before attempting any top cylinder work, and do not replace until that work is completed.

(2) Clean cartridge starter breech barrel and assembly. Check safety disk. See paragraph 71 for service on cartridge starter.

(3) Replace Fram type cartridge filters if necessary.

(4) Clean or replace filter in fuel line.

(5) After installation of engine, bleed and recheck fuel lines for leaks.

(6) Replace all worn or defective rocker box connecting hoses.

(7) Inspect and, where necessary, replace the hoses on the intake manifold.

SECTION VI

GENERAL CARE AND PRESERVATION

	Paragraph
Records	25
Cleaning	26

25. Records.—*a. Use.*—An accurate record must be kept of each motor vehicle issued by the Ordnance Department. For this purpose the Ordnance Motor Book (O. O. Form No. 7255), generally called "Log Book," is issued with each vehicle and must accompany it at all times. This book furnishes a complete record of the vehicle from which valuable information concerning operation and maintenance costs, etc., is obtained, and organization commanders must insist that correct entries be made. This book will habitually be kept in a canvas cover to prevent its being injured or soiled.

b. Assignment record.—The page bearing a record of assignment must be destroyed prior to entering the combat zone. All other refer-

ences which may be posted regarding the identity of the organization must also be deleted.

26. Cleaning.—*a.* Grit, dirt, and mud are the sources of greatest wear to a vehicle. If deposits of dirt and grit are allowed to accumulate, particles will soon find their way into bearing surfaces, causing unnecessary wear, and, if the condition is not remedied, will soon cause serious difficulty. When removing engine parts or any other unit, in making repairs and replacements, or, if in the course of inspection, working joints or bearing surfaces are to be exposed, all dirt and grit that might find its way to the exposed surfaces must first be carefully removed. The tools must be clean, and care must always be taken to eliminate the possibilities of brushing dirt or grit into the opening with the sleeve or other part of the clothing. To cut oil-soaked dirt and grit, hardened grit, or road oil, use dry-cleaning solvent applied with cloths (not waste) or a brush. Care should be taken to keep water from the power unit, as it might interfere with proper ignition and carburetion. Detailed information on cleaning is included in TM 9-850.

b. Oil holes which have become clogged should be opened with a piece of wire. Wood should never be used for this purpose, as splinters are likely to break off and permanently clog the passages. Particular care should be taken to clean and decontaminate vehicles that have been caught in a gas attack. See section IX for details of this operation.

SECTION VII

PAINTING

	Paragraph
General.....	27
Preparing for painting.....	28
Painting metal surfaces.....	29
Paint as a camouflage.....	30
Removing paint.....	31
Painting lubricating devices.....	32

27. General.—*a.* Ordnance matériel is painted before issue to the using arms and one maintenance coat per year will ordinarily be ample for protection. With but few exceptions this matériel will be painted with enamel, synthetic, olive-drab, lusterless. The enamel may be applied over old coats of long oil enamel and oil paint previously issued by the Ordnance Department if the old coat is in satisfactory condition for repainting.

b. Paints and enamels are usually issued ready for use and are applied by brush or spray. They may be brushed on satisfactorily

when used unthinned in the original package consistency or when thinned no more than 5 percent by volume with thinner. The enamel will spray satisfactorily when thinned with 15 percent by volume of thinner. (Linseed oil must not be used as a thinner, since it will impart a luster not desired in this enamel.) If sprayed, it dries hard enough for repainting within $\frac{1}{2}$ hour and dries hard in 16 hours.

c. Certain exceptions to the regulations concerning painting exist. Fire-control instruments, sighting equipment, and other items which require a crystalline finish will not be painted with olive-drab enamel.

d. Complete information on painting is contained in TM 9-850.

28. Preparing for painting.—*a.* If the base coat on the matériel is in poor condition it is more desirable to strip the old paint from the surface than to use sanding and touch-up methods. After stripping, it will then be necessary to apply a primer coat.

b. Primer, ground, synthetic, should be used on wood as a base coat for synthetic enamel. It may be applied either by brushing or spraying. It will brush satisfactorily as received or after the addition of not more than 5 percent by volume of thinner. It will be dry enough to touch in 30 minutes, and hard in 5 to 7 hours. For spraying, it may be thinned with not more than 15 percent by volume of thinner. Lacquers must not be applied to the primer, ground, synthetic, within less than 48 hours.

c. Primer, synthetic, rust inhibiting, for bare metal, should be used on metal as a base coat. Its use and application are similar to those outlined in *b* above.

d. The success of a job of painting depends partly on the selection of a suitable paint, but also largely upon the care used in preparing the surface prior to painting. All parts to be painted should be free from rust, dirt, grease, kerosene, oil, and alkali, and must be dry.

29. Painting metal surfaces.—If metal parts are in need of cleaning, they should be washed in a liquid solution consisting of $\frac{1}{2}$ pound of soda ash in 8 quarts of warm water, or an equivalent solution, then rinsed in clear water and wiped thoroughly dry. Wood parts in need of cleaning should be treated in the same manner, but the alkaline solution must not be left on for more than a few minutes and the surfaces should be wiped dry as soon as they are washed clean. When artillery or automotive equipment is in fair condition and only marred in spots, the bad places should be touched with enamel, synthetic, olive-drab, lusterless, and permitted to dry. The whole surface will then be sandpapered with paper, flint, No. 1, and a finish coat of enamel, synthetic, olive-drab, lusterless, applied and allowed to dry

thoroughly before the matériel is used. If the equipment is in bad condition, all parts should be thoroughly sanded with paper, flint, No. 2, or equivalent, given a coat of primer, ground, synthetic, and permitted to dry for at least 16 hours. They will then be sandpapered with paper, flint, No. 00, wiped free from dust and dirt, and a final coat of enamel, synthetic, olive-drab, lusterless, applied and allowed to dry thoroughly before the matériel is used.

30. Paint as a camouflage.—Camouflage is now a major consideration in painting ordnance vehicles, with rust prevention secondary. The camouflage plan at present employed utilizes three factors: color, gloss, and stenciling.

a. Color.—Vehicles are painted with enamel, synthetic, olive-drab, lusterless, which was chosen to blend in reasonably well with the average landscape.

b. Gloss.—The new lusterless enamel makes a vehicle difficult to see from the air or from relatively great distances over land. A vehicle painted with ordinary glossy paint can be detected more easily and at greater distances.

c. Stenciling.—White stencil numbers on vehicles have been eliminated because they can be photographed from the air. A blue drab stencil enamel is now used which cannot be so photographed. It is illegible to the eye at distances exceeding 75 feet.

d. Preserving camouflage.—(1) Continued friction or rubbing must be avoided, as it will smooth the surface and produce a gloss. The vehicle should not be washed more than once a week. Care should be taken to see that the washing is done entirely with a sponge or a soft rag. The surface should never be rubbed or wiped, except while wet, or a gloss will develop.

(2) It is not desirable that vehicles, painted with lusterless enamel, be kept as clean as vehicles were kept when glossy paint was used. A small amount of dust increases the camouflage value. Grease spots should be removed with solvent, dry-cleaning. Whatever portion of the spot cannot be so removed should be allowed to remain.

(3) Continued friction of wax-treated tarpaulins on the sides of a vehicle will also produce a gloss, which should be removed with solvent, dry-cleaning.

(4) Tests indicate that repainting with olive-drab paint will be necessary once yearly, with blue-drab paint twice yearly.

31. Removing paint.—After repeated paintings, the paint may become so thick as to crack and scale off in places, presenting an unsightly appearance. If such is the case, remove the old paint by use of a lime-and-lye solution (see TM 9-850 for details) or remover, paint

and varnish. It is important that every trace of lye or other paint remover be completely rinsed off and that the equipment be perfectly dry before repainting is attempted. It is preferable that the use of lye solutions be limited to iron or steel parts. If used on wood, the lye solution must not be allowed to remain on the surface for more than a minute before being thoroughly rinsed off and the surface wiped dry with rags. Crevices or cracks in wood should be filled with putty and the wood sandpapered before refinishing. The surfaces thus prepared should be painted according to directions in paragraph 29.

32. Painting lubricating devices.—Oil cups, grease fittings, oil holes, and similar lubricating devices, as well as a circle about three-fourths of an inch in diameter at each point of lubrication, will be painted with enamel, red, water resisting, in order that they may be readily located.

SECTION VIII

ARMAMENT

	Paragraph
Gun mounts.....	33
Sighting equipment.....	34
Ammunition stowage.....	35

33. Gun mounts.—Detailed instructions on operation, care, and preservation of the gun will be found in various Technical Manuals on the subject matériel.

a. Combination gun mount M22 (figs. 15 and 16).—This gun mount is located in the turret and mounts a 37-mm and a cal. .30 machine gun. These are mounted together and move as one unit. The 37-mm gun is fired by depressing the plunger located in the hub of the elevating handwheel. Elevation up to 20° may be obtained by turning the elevating handwheel (fig. 15) toward the operator; a maximum of 10° of depression is obtained when the handwheel is turned in the opposite direction. A hand-operated traverse control handle on the right side of the gun provides 10° of traverse to the right or left. Clockwise rotation of the control handle traverses the gun to the right; anticlockwise to the left. A full 360° of traverse may be had by rotating the turret. The machine gun is fired by depressing the plunger in the center of the traversing handwheel. Both the 37-mm gun and the machine gun are operated by the turret gunner.

b. Gyro-stabilizer unit for combination gun mount.—(1) *General.*—The stabilizer attached to the combination gun mount M22 is used to maintain the positioning of the gun so that the gunner may accurately aim and fire the gun while the tank is in motion. The main parts

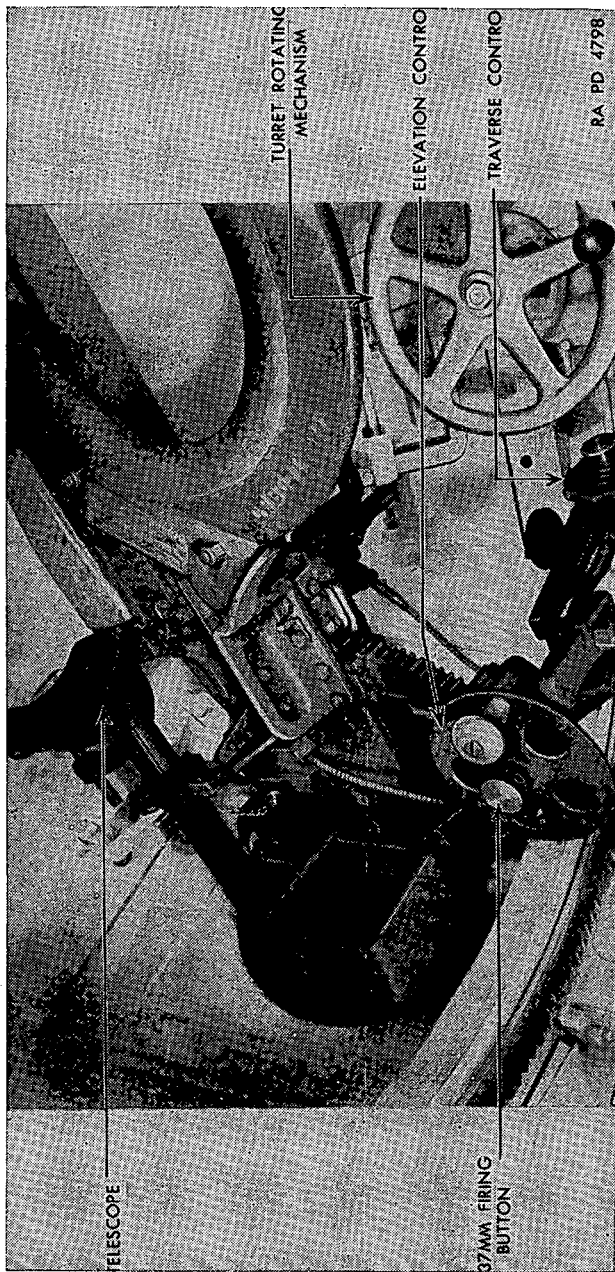

Figure 15.—37-mm gun mount, left side.

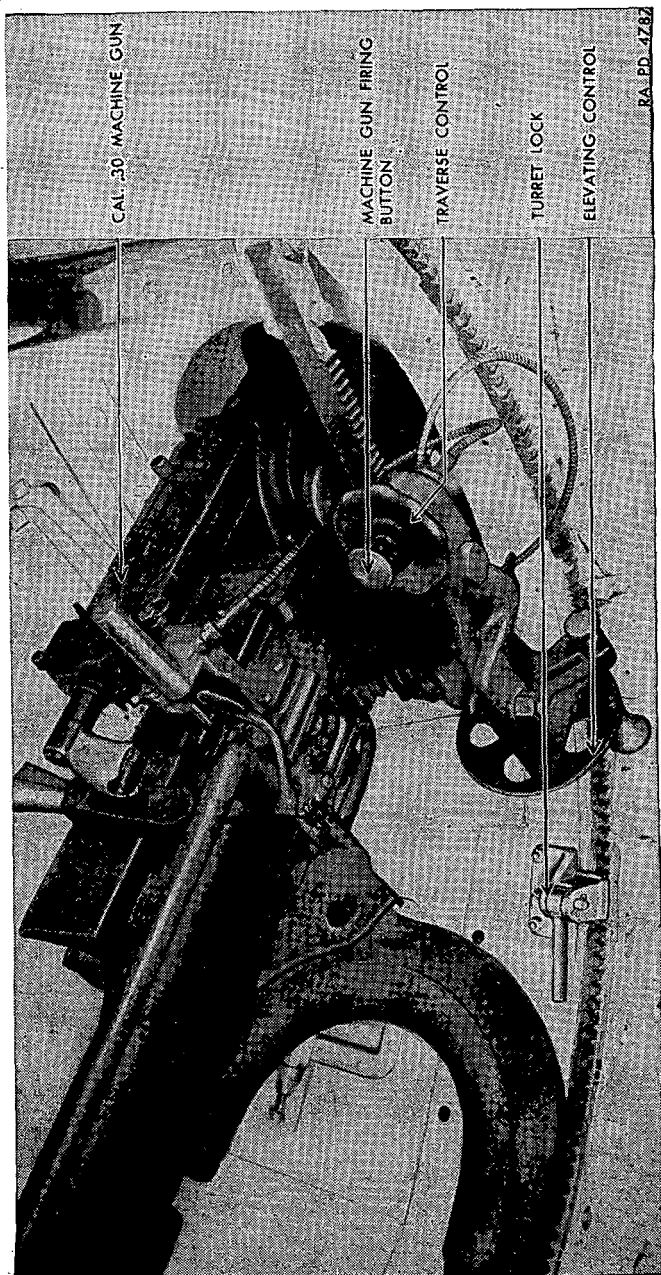

Figure 10.—37-mm gun mount, right side.

of the unit are the master switch, pump and motor assembly, stiffness and recoil control box, piston and cylinder assembly, the gyro-control unit, and the recoil switch (fig. 101). The current from the battery is transmitted to the master switch in the turret by means of a slip ring assembly mounted on the propeller shaft housing. The pump and motor assembly is mounted on the wall of the turret, directly behind the combination gun mount.

(2) *Starting the unit.*—Set the stiffness control (fig. 108) at zero, take the hand-elevating gears out of mesh, and turn the handwheel until the gyro-control unit is approximately in a vertical position. Start the oil pump motor by pushing the handle of the master switch to the "on" position. In cold weather the oil must be permitted to warm up to obtain full control from the gyro-stabilizer equipment. In subzero weather allow $1\frac{1}{2}$ minutes running time for each degree of temperature below 0° F., or a total running time of 30 minutes at 20° F. below zero.

(3) *Operation.*—(a) *Control of the gun.*—It is important that the stabilizer equipment be in operation only when the tank is moving and when control of the gun is desired. When the stabilizer equipment is in operation, the gun is elevated or depressed in the usual manner by turning the handwheel. This action changes the angular relation between the gun and the gyro-control unit, and the gun automatically takes up a new desired position. If the stabilizer equipment is operating satisfactorily, it will keep the gun very near its set angular position within its elevating range as limited by its mounting in the tank when the tank is in use and oscillating or pitching normally. Therefore, when the gun is aimed, the stabilizer must be allowed to control the position of the gun. The handwheel should not be turned after the gun has reached its maximum limits of travel in elevation or depression.

Caution: Continued turning of the handwheel with the gun against either stop will only displace the gyro-control unit from its vertical position and the result will be an excessive overload on the tank battery.

(b) *Adjusting the stiffness adjuster.*—The stiffness adjuster located in the control box (fig. 108) provides a means for the gunner to control the operation and effectiveness of the gyro-stabilizer. After the oil has warmed up as described above, the knob of the stiffness adjuster should be turned clockwise slowly. An indication of too stiff an adjustment is a vigorous vibration of the gun. An indication of insufficient stiffness adjustment is the gun hunting or slowly elevating and depressing from its aimed or set position. When the

gun starts to vibrate or hunt as the stiffness control knob is turned, decrease or increase the adjustment by turning the knob in the opposite directions until the hunting or vibration is eliminated. To check the operation further, press on the breech of the gun suddenly and release. If the gun starts to vibrate, the stiffness adjustment must be decreased slightly. If the gun comes to rest almost immediately after a sharp sudden displacement, it can be considered in proper adjustment. It may be necessary for the operator to change the stiffness adjustment from time to time as the viscosity of the oil changes and after the tank is in motion.

(c) *Adjusting the recoil adjuster.*—The recoil adjuster located in the control box (fig. 108) provides a means for the gunner to control the recoil of the gun. The recoil adjustment must be made by trial and error while the gun is being fired. The recoil adjustment knob should be gradually turned to the right or clockwise until a point is reached where the gun will keep its angular setting during recoil. If faulty operation is being obtained from the gyro-stabilizer during recoil, check for looseness in the mounting and the adjustment of the recoil switch as described in section XVII, chapter 2.

(d) *Test for effective operation.*—After the gyro-stabilizer is operating it should be checked for effectiveness or accuracy before the tank is used in combat. This can be determined in the following manner:

1. Start and check the operation of the gyro-stabilizer equipment as explained above.
2. Choose a suitable location for a trial run of the tank.

NOTE.—The terrain should be average rough, with no slopes and sufficient acreage to permit adequate cruising time for a test run.

3. Operate the tank over the average rough terrain at a normal speed.
4. Aim the gun in the usual manner, using the horizon as the target.
5. If the gun does not fluctuate above or below the horizon, the gyro-stabilizer can be considered to be operating satisfactorily. However, if the gun fluctuates above or below the horizon, check the items as listed under trouble shooting in section XVII, chapter 2.

(4) *Care and preservation.*—(a) *Oil level.*—The level of the oil in the oil reservoir (fig. 105) should be checked daily and should be maintained two-thirds full. Use oil, hydraulic, in the system. In subzero weather allow 1½ minutes running time for each degree of temperature below zero, or a total of 30 minutes for 20° below zero.

(b) *Lubrication.*—Alemite grease fittings are provided on the stabilizer unit. These fittings should be greased every 25 hours with grease, chassis No. 0. Refer to figure 113 for location of fittings.

c. *Bow gun mount.*—A 3½-inch ball mount in the bow gunner's compartment mounts a caliber .30 machine gun and is operated by the bow gunner (fig. 17). The gun is manually fired by a trigger, and elevation and traverse are manually controlled by the gunner.

d. *Sponson mounts.*—A ball mount of the swivel type, mounting a caliber .30 machine gun, is located in each sponson (figs. 18 and 19). Elevation is adjusted manually and traverse is accomplished by the steering of the vehicle. The sponson guns are fired electrically by the driver by compressing the switches near the top of each steering lever. Each switch connects with and fires its respective gun. The guns may also be fired manually by conventional triggers. Lubricate the ball mounts as shown on lubrication chart (fig. 13).

e. *Antiaircraft gun mount.*—A fifth mount (M20), located on the outside of the cupola, mounts a caliber .30 machine gun for anti-aircraft fire (see fig. 20), and is fired by the conventional trigger. Elevation is obtained by loosening the cradle lock and adjusting to desired position. Traverse position is locked and adjusted by means of a locking handle inside the cupola.

f. *Submachine gun.*—A .45 caliber submachine gun is carried in a vertical position on the bulkhead in the right rear corner of the fighting compartment.

g. *Additional mounts.*—One M2 caliber .30 machine-gun tripod mount is carried on the left front fender and one on the rear deck of the vehicle.

34. *Sighting equipment.*—A telescope sight is provided on the 37-mm combination gun mount (fig. 15). It is secured to the mount by a bracket and is equipped with a rubber face piece.

35. *Ammunition stowage.*—The stowage of 37-mm, .30-caliber, and .45-caliber ammunition is indicated in figure 21.

a. *Ammunition.*

<i>Items of equipment</i>	<i>Stowage position</i>
103 rounds, 37-mm-----	20 rounds in chest, right side, against bulkhead. ¹
	40 rounds in chest, right side, against hull.
	43 rounds in chest, left side against bulkhead.

<i>Items of equipment</i>	<i>Storage position</i>
9,850 rounds, .30-caliber (21 100-round belts) (31 250-round belts).	1,500 rounds, power tunnel drawer. 4,500 rounds in 3 boxes, left rear sponson. ³ 500 rounds in one box, left front sponson. 1,500 rounds in 3 boxes, right rear sponson. ^{1 2} 750 rounds in box at feet of bow gunner. 250 rounds in feed box, bow gun. 250 rounds in feed box, right sponson gun. ^{1 2} 250 rounds in feed box, left sponson gun. 100 rounds in feed box, coaxial .30-cal. machine gun. 250 rounds in feed box, antiaircraft mount.
350 rounds, .45-caliber-----	Five 50-round drums in bracket mounted to the rear and on top of the power tunnel. Two 50-round drums mounted on the right side of the power tunnel behind bow gunner's seat, on slide bracket.
12 grenades, hand-----	In box, left side of fighting compartment. Space exists for 14 grenades.

b. Unit train supply.—In addition to the 5,500 rounds of .30-caliber and 350 rounds of .45-caliber ammunition, 500 rounds of .30-caliber and eight 20-round clips of .45-caliber will be carried on unit trains.

¹ Installation of radio set SCR 245, in right sponson, eliminates.

² Installation of radio set SCR 210 or SCR 506, in right sponson, eliminates.

³ Installation of radio set SCR 508, SCR 528 or SCR 538, in left sponson, eliminates.

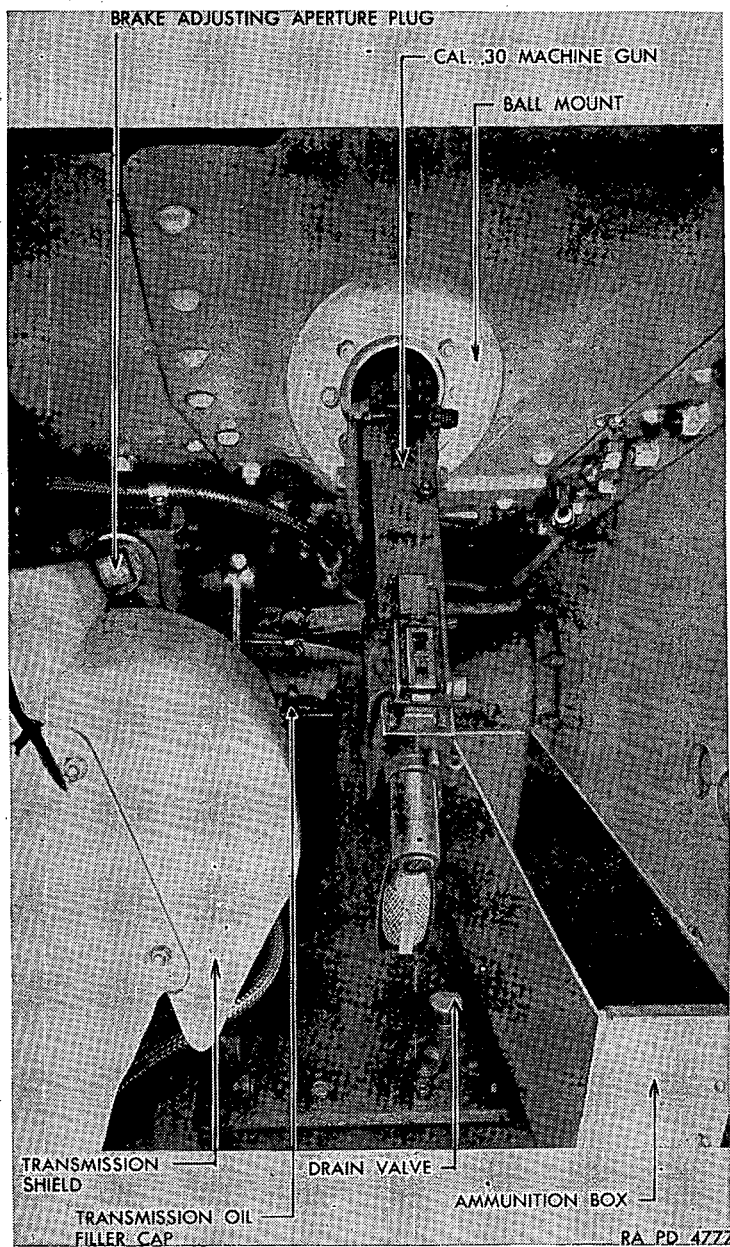

FIGURE 17.—Bow gunner's compartment.

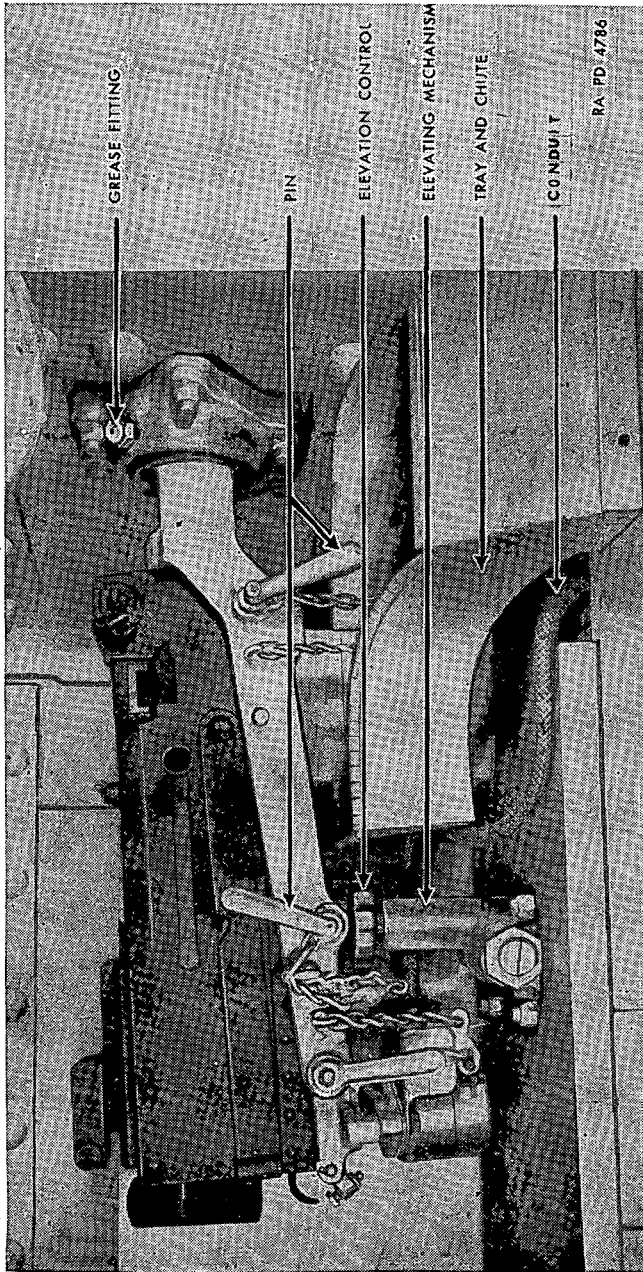

FIGURE 18.—Machine-gun mount, left sponson.

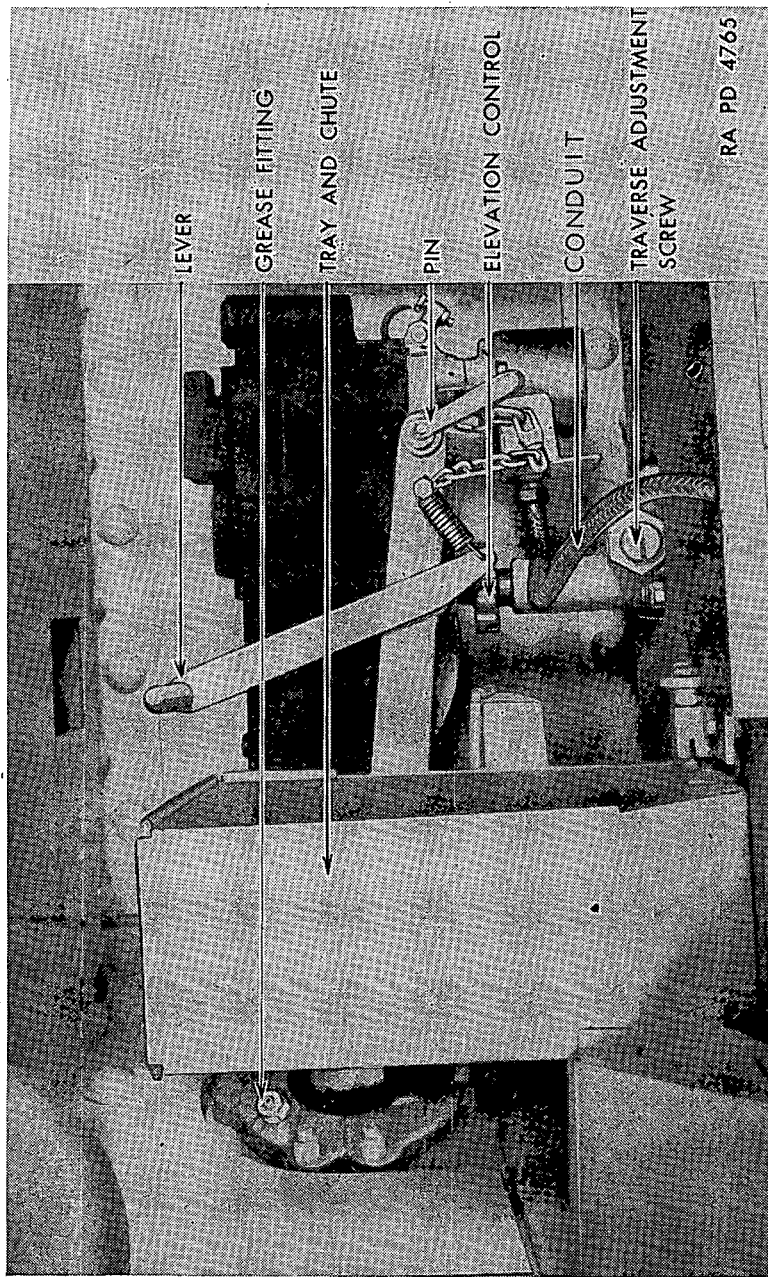

FIGURE 19.—Machine-gun mount, light sponson.

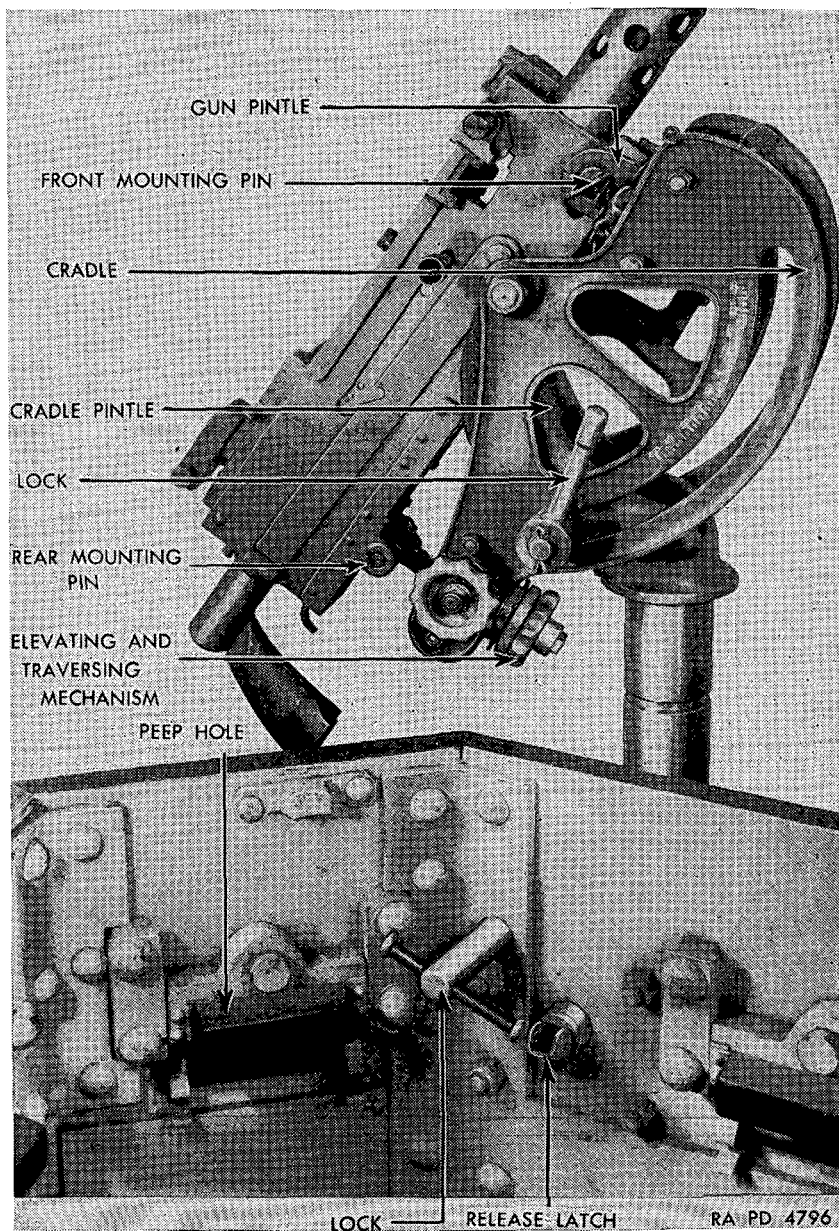
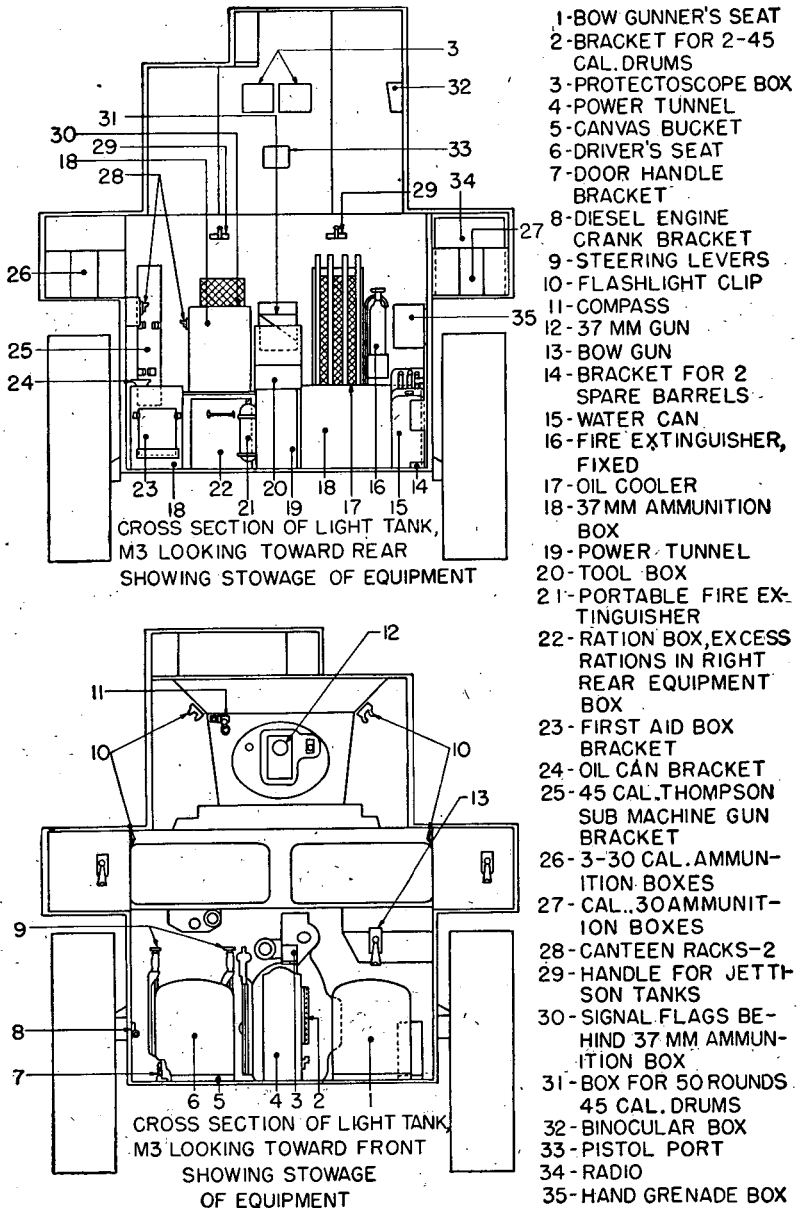

FIGURE 20.—Antiaircraft gun and bracket mount.



RA PD 10827

FIGURE 21.—Ammunition stowage.

SECTION IX

MATÉRIEL AFFECTED BY GAS

	Paragraph
Protective measures-----	36
Cleaning-----	37
Decontamination-----	38
Special precautions for automotive matériel-----	39

36. Protective measures.—*a.* When matériel is in constant danger of gas attack, unpainted metal parts will be lightly coated with oil. Instruments are included among the items to be protected from chemical clouds or chemical shells, but ammunition is excluded. Care will be taken that the oil does not touch the optical parts of instruments or leather or canvas fittings. Matériel not in use will be protected with covers as far as possible. Ammunition will be kept in sealed containers.

b. Ordinary fabrics offer practically no protection against mustard gas or lewisite. Rubber and oilcloth, for example, will be penetrated within a short time. The longer the period during which they are exposed, the greater the danger of wearing these articles. Rubber boots worn in an area contaminated with mustard gas may offer a grave danger to men who wear them several days after the bombardment. Impermeable clothing will resist penetration more than an hour, but should not be worn longer than this.

37. Cleaning.—*a.* All unpainted metal parts of matériel that have been exposed to any gas except mustard and lewisite must be cleaned as soon as possible with dry-cleaning solvent or denatured alcohol and wiped dry. All parts should be coated with engine oil.

b. Ammunition which has been exposed to gas must be thoroughly cleaned before it can be fired. To clean ammunition use decontaminating, noncorrosive agent, or if this is not available, strong soap and cool water. After cleaning, wipe all ammunition dry with clean rags. Do not use a dry decontaminating agent (*chloride of lime used for decontaminating certain types of matériel on or near ammunition supplies*) as flaming occurs through the use of chloride of lime on liquid mustard.

38. Decontamination.—For the removal of liquid chemicals (mustard, lewisite, etc.) from matériel, the following steps should be taken:

a. Protective measures.—(1) For all of these operations a complete suit of impermeable clothing and a service gas mask will be worn. Immediately after removal of the suit, a thorough bath with soap

and water (preferably hot) must be taken. If any skin areas have come in contact with mustard, if even a very small drop of mustard gets into the eye, or if the vapor of mustard has been inhaled, it is imperative that complete first-aid measures be given within 20 to 30 minutes after exposure. First-aid instructions are given in TM 9-850 and FM 21-40.

(2) Garments exposed to mustard will be decontaminated. If the impermeable clothing has been exposed to vapor only, it may be decontaminated by hanging in the open air, preferably in sunlight, for several days. It may also be cleaned by steaming for two hours. If the impermeable clothing has been contaminated with liquid mustard, steaming for 6 to 8 hours will be required. Various kinds of steaming devices can be improvised from materials available in the field.

b. Procedure.—(1) Commence by freeing matériel of dirt through the use of sticks, rags, etc., which must be burned or buried immediately after this operation.

(2) If the surface of the matériel is coated with grease or heavy oil, this grease or oil should be removed before decontamination is begun. Dry-cleaning solvent or other available solvents for oil should be used with rags attached to ends of sticks. Following this, decontaminate the painted surfaces of the matériel with bleaching solution made by mixing one part decontaminating agent (chloride of lime) with one part water. This solution should be swabbed over all surfaces. Wash off with water thoroughly, and then dry all surfaces.

(3) All unpainted metal parts and instruments exposed to mustard or lewisite must be decontaminated with a decontaminating, non-corrosive agent, mixed 1 part solid to 15 parts solvent (acetylene tetrachloride). If this is not available, use warm water and soap. Bleaching solution must not be used, because of its corrosive action. Instrument lenses may be cleaned only with lens tissue paper using a small amount of ethyl alcohol. Coat all metal surfaces lightly with engine oil.

(4) In the event a decontaminating agent (chloride of lime) is not available, matériel may be temporarily cleaned with large volumes of hot water. However, mustard lying in joints or in leather or canvas webbing is not removed by this procedure and will remain a constant source of danger until the matériel can be properly decontaminated. All mustard washed from matériel in this manner lies unchanged on the ground, necessitating that the contaminated area be plainly marked with warning signs before abandonment.

(5) The cleaning or decontaminating of matériel contaminated

with lewisite will wash arsenic compounds into the soil, poisoning many water supplies in the locality for either men or animals.

(6) Leather or canvas webbing that has been contaminated should be scrubbed thoroughly with bleaching solution. In the event this treatment is insufficient, it may be necessary to burn or bury such matériel.

(7) Detailed information on decontamination is contained in FM 21-40, TM 9-850, and Training Circular No. 38, War Department, 1941.

39. Special precautions for automotive matériel.—*a.* When vehicles have been subjected to gas attack with the engine running, the air cleaner should be serviced by removing the oil, flushing with dry-cleaning solvent, and refilling with the proper grade of oil.

b. Instrument panels should be cleaned in the same manner as outlined for instruments.

c. Contaminated seat cushions will be discarded.

d. Washing the compartments thoroughly with bleaching solution is the most that can be done in the field. When running under conditions of high temperature, operators should constantly be on the alert for slow vaporization of the mustard or lewisite.

e. Exterior surfaces of vehicles will be decontaminated with bleaching solution. Repainting may be necessary after this operation.

CHAPTER 2

ORGANIZATION INSTRUCTIONS

	Paragraphs
SECTION I. General information on maintenance.....	40
II. Equipment and special tools.....	41-42
III. Engine, Continental W670, Series 9A.....	43-60
IV. Engine, Guiberson T-1020, and accessories.....	61-76
V. Fuel supply system.....	77-82
VI. Cooling system.....	83-84
VII. Clutch.....	85-94
VIII. Propeller shaft.....	95-97
IX. Transmission and differential.....	98-100
X. Oil coolers.....	101-102
XI. Final drives.....	103-106
XII. Tracks and suspensions.....	107-114
XIII. Hull and turret.....	115-116
XIV. Electrical system and equipment.....	117-136
XV. Nonelectrical instruments.....	137-141
XVI. Fire extinguishers.....	142-145
XVII. Gyro-stabilizer unit.....	146-150

SECTION I

GENERAL INFORMATION ON MAINTENANCE

	Paragraph
Scope.....	40

40. Scope.—*a.* The scope of maintenance and repairs by the crew and other units of the using arm is determined by the ease with which the project can be accomplished, the amount of time available, the nature of the terrain, weather conditions, temperatures, concealment, shelter, proximity to hostile fire, the equipment available, and the skill of the personnel. All of these are variable and no exact system of procedure can be prescribed.

b. The definitions given below are included in order that the operation name may be correctly interpreted by those doing the work.

(1) *Service.*—Consists of cleaning, lubricating, tightening bolts and nuts, and making external adjustments of subassemblies or assemblies and controls.

(2) *Repair.*—Consists of making repairs to, or replacement of a part, subassembly, or assembly that can be accomplished without com-

LIGHT TANK M3

pletely disassembling the subassembly or assembly, and does not require heavy welding or riveting, machining, fitting, and/or alining.

(3) *Replace*.—Consists of removing the part, subassembly, or assembly from the vehicle and replacing it with a new or reconditioned or rebuilt part, subassembly, or assembly.

(4) *Rebuild*.—Consists of completely reconditioning and placing in serviceable condition any unserviceable part, subassembly, or assembly of the motor vehicle including welding, riveting, machining, fitting, alining, assembling, and testing.

NOTE.—The using arm personnel is authorized to remove and reinstall an engine or transmission assembly. However, the replacement of an engine with another engine, or the replacement of a transmission assembly with another transmission assembly, *must not be done by using arm unless authorization is received from ordnance personnel.*

c. The following are the maintenance duties which may be performed by the using arm personnel. All other replacements and repairs will be performed by ordnance maintenance personnel.

ENGINE GROUP

CONTINENTAL W670, SERIES 9A

Unit	Operation	Paragraph reference
Engine.....	Remove for 100-hour check.	60
Engine.....	Replace (see par. 40b(4) note).	60
Engine.....	Clean and service. { (Sec. III (gasoline)) (Sec. IV (Diesel))	
Valve clearance.....	Adjust.....	58
Valve rocker assembly.....	Replace.....	58
Exhaust manifold and mufflers.....	Replace.....	59
Valve push rod.....	Replace.....	58
Tachometer.....	Replace.....	137
Tachometer drive shaft assembly.....	Replace.....	137

OILING SYSTEM

Oil coolers.....	Replace.....	101, 102
Oil strainers.....	Clean.....	79
Oil filters.....	Replace.....	66
Oil pump.....	Replace..... { (gasoline) (Diesel)	46 65
Oil temperature gage.....	Replace.....	140
Oil pressure gage.....	Replace.....	139

COOLING SYSTEM

Intercylinder baffle spring.....	Replace.....	84
Cowling (gasoline engine only).....	Replace.....	84
Intercylinder baffle (gasoline engine only).....	Replace.....	84

FUEL SYSTEM

<i>Unit</i>	<i>Operation</i>	<i>Paragraph reference</i>
Carburetor.....	Replace.....	52
Air cleaner.....	Service or replace.....	54
Fuel lines.....	Repair and replace.....	79
Fuel pump.....	Replace.....	55 69
	{ (gasoline) ..	
	{ (Diesel) ..	
Priming pump.....	Replace.....	80
Fuel tanks.....	Clean or replace.....	78
Fuel filter.....	Service or replace.....	81

ELECTRICAL SYSTEM

Magneto.....	Replace.....	48
Ammeter.....	Replace.....	121
Voltmeter.....	Replace.....	121
Magneto switch.....	Replace.....	122
Generator.....	Replace.....	118
Voltage regulator.....	Replace.....	119
Starter assembly.....	Replace.....	71
Starter switch (dash).....	Replace.....	122
Starter switch (magnetic).....	Replace.....	122
Battery switch.....	Repair or replace.....	122
Battery.....	Charge and service.....	117
Battery.....	Replace.....	117
Spark plugs.....	Replace.....	50
Electrical wiring and conduits.....	Replace.....	133, 136
Ignition harness assembly.....	Replace.....	51
Booster coil.....	Replace.....	49
All lights.....	Aline, service, or replace.....	125, 126, 127, 128, and 129
Siren.....	Replace.....	130
Fuse and fuse block.....	Replace.....	120

TRANSMISSION AND CLUTCH

Transmission.....	Replace (see par. 40b(4) note).....	100
Clutch pedal.....	Adjust.....	89
Clutch release bearings.....	Replace.....	92
Clutch plate.....	Replace.....	94
Clutch.....	Adjust, clean, and serv- ice.....	87
Steering brake band assembly.....	Replace.....	99
Steering brake band.....	Adjust.....	99
Gear shift lever.....	Replace.....	98
Steering lever.....	Replace.....	99
Speedometer head and cable.....	Replace.....	138
Propeller shaft assembly.....	Replace.....	97
Final drive assembly.....	Replace.....	100
Sprockets.....	Replace.....	109
Sprocket hub.....	Replace.....	100

SUSPENSION

<i>Unit</i>	<i>Operation</i>	<i>Paragraph reference</i>
Bogie wheel.....	Replace.....	110
Trailing idler wheel w/spindle.....	Replace.....	112
Trailing idler wheel.....	Replace.....	112
Track supporting roller w/bracket.....	Replace.....	111
Bogie components.....	Replace.....	110
Track.....	Replace, rebuild, or re- verse.....	113
Axle (front and rear).....	Replace.....	108
Bearings (wheel, bogie, and idler).....	Replace.....	110
Wheel bearing and oil seals.....	Replace.....	110

HULL AND TURRET

Bolts, nuts, and screws.....	Tighten.....	115
Seats.....	Replace.....	115
Insulation.....	Replace or repair.....	115
Pads.....	Replace.....	115
Turret traversing mechanism.....	Replace.....	116
Turret lock.....	Replace.....	116
Turret rollers.....	Adjust, service, or replace.....	116
Pistol port and peep hole covers.....	Service or replace.....	116
Mud guard.....	Repair or replace.....	115
Protectoscope windows, prisms, or mirrors.....	Replace.....	115

ADDITIONAL FOR GUIBERSON DIESEL ENGINES

Fuel injector.....	Replace.....	68
Low pressure fuel lines.....	Repair or replace.....	68
High pressure fuel lines.....	Replace.....	68
Starter (cartridge type).....	Clean, service, or replace.....	71
Starter breech and tube.....	Clean, service, or replace.....	71

GYRO-STABILIZER UNIT

Oil lines and connections.....	Repair or replace.....	149
Oil cups.....	Repair or replace.....	149
Electrical wiring.....	Repair or replace.....	149
Pump assembly.....	Replace.....	149
Pump motor assembly.....	Replace.....	149
Piston and cylinder assembly.....	Replace.....	149
Flexible cable assembly and bracket.....	Replace.....	149
Gyro unit.....	Replace.....	149
Control box.....	Replace.....	149
Switch box.....	Replace.....	149
Bracket shaft complete with worm and gearing.....	Replace.....	149
Grease fittings.....	Replace.....	149

SECTION II

EQUIPMENT AND SPECIAL TOOLS

Equipment and location.....	41
Care of equipment.....	42

41. Equipment and location.—*a.* The items listed below constitute the equipment for Light Tank M3 as of Memorandum No. 63 of the Armored Force Board, dated April 15, 1942. The necessary boxes, brackets, etc., will be furnished when available.

	<i>Items of equipment</i>	<i>Stowage position</i>
(1) <i>Communication equipment.</i>	Radio set, type III—SCR-508, SCR-528, or SCR-538.	Left sponson.
	Radio set, SCR-245, SCR-210, or SCR-506.	Right sponson.
	1 case, CS-16 for 3 flags, signal, with staff.	Alongside oil cooler on bulkhead.
	Light, recognition, when provided.	To floor, rear of driver.
(2) <i>Fire-fighting and antigas equipment.</i>	1 antenna, complete (spare).	On rear deck.
	1 extinguisher, fire, 4 lb., CO ₂ (portable).	To rear of driver's seat, attached to power tunnel.
	1 extinguisher, fire, 10 lb., CO ₂ (fixed).	Left rear fighting compartment attached bulkhead.
(3) <i>Rations.</i>	1 apparatus, decontaminating, 1½ qt.	Left rear equipment box.
	2 days' rations, type C, 48 cans.	Bin type box without lid to be placed under the rear 37-mm ammunition box, right side of power tunnel, balance in right rear equipment box.
	1 days' rations, type D, 2 cans (24 bars).	
(4) <i>Water.</i>	1 container, water, 5 gal. (Q. M. C. standard).	To rear of driver, attached to left side of hull.
	4 canteens, with cups and cover, in case.	2 on clip over junction box, right side of hull; 2 on clip, right side of 37-mm ammunition box.
(5) <i>Equipment, miscellaneous.</i>	1 kit, first-aid.....	Rear of bow gunner, attached to 37-mm ammunition chest.
	1 bucket, canvas, folding, with spout, 8 quarts.	Under driver's seat.

LIGHT TANK M3

<i>Items of equipment</i>	<i>Stowage position</i>
3 flashlights.....	2 clips in turret, 1 to left and 1 to right, above 37-mm gun; 1 clip to left of driver.
2 mittens, asbestos, pairs.....	1 pair in turret; 1 pair in sponson.
1 compass (hull).....	On brass bracket in turret.
12 prisms, protectoscope.....	3 boxes, 2 mounted side-by-side, rear of turret above pistol port, and 1 box mounted below speedometer (4 prisms per box).
1 box, binocular.....	Left side of turret wall, case in cup.
2 nozzles, flexible.....	Left rear equipment box.
4 bags, canvas, field, OD, M1936.	Right rear equipment box.
4 rolls, blanket.....	Strapped to rear deck.
4 helmets, tank, C76072.....	On personnel.

(6) *Spare parts and accessories for guns.*

(a) *37-mm gun.*

1. *Spare parts.*

1 detent, operating handle, A25213.	Tool box on power tunnel.
1 extractor, L. H., B8441A....	Tool box on power tunnel.
1 extractor, R. H., B8441B....	Tool box on power tunnel.
1 guide, firing pin, A25200.....	Tool box on power tunnel.
3 pins, firing, A25201.....	Tool box on power tunnel.
1 plunger, cocking lever, A25205.	Tool box on power tunnel.
1 spring, cocking lever plunger, A25206.	Tool box on power tunnel.
3 springs, firing, A25204.....	Tool box on power tunnel.
1 spring, operating handle latch, A25207.	Tool box on power tunnel.
1 spring, retracting, firing pin, A25202.	Tool box on power tunnel.
1 nut, safety, S $\frac{5}{8}$ -18 NF-3, BBSX4AG.	Tool box on power tunnel.

LIGHT TANK M3

*Items of equipment**Stowage position*

1 spring, compression, .037 dia. stock .370 OD 8-coils FAAX1F (for trigger plunger and sear).	Tool box on power tunnel.
1 plug, filling recoil cylinder	Tool box on power tunnel.
2. <i>Accessories.</i>	
1 bag, empty cart., D47400 (for turret 37-mm mot. D47373).	On gun.
1 cover, muzzle, M302, D36817	On gun.
1 cover, receiver, 37-mm gun mount, T3, D38618.	On gun.
1 sight, bore, 37-mm	In gun or ammunition clip.
1 can, oil, 1-qt. 5/8 in. x 4 1/16 in. x 2 1/16 in., B101420.	Tool box on power tunnel.
1 oil, recoil, heavy, low pour point (quart).	Tool box on power tunnel.
1 book, arty. gun, O.O. Form 5825, blank.	Tool box on power tunnel.
1 brush, bore, 37-mm gun, M8, B157305.	Tool box on power tunnel.
1 staff, cleaning, M5A2	Tool box on power tunnel.

(b) .30-caliber machine gun.

1. *Spare parts.*

2 barrels, spare, D35233	Left side of fighting compartment, in brackets.
2 accelerators, C64142	Tool box on power tunnel.
2 bolts, assembly, B147299	Tool box on power tunnel.
1 bushing, belt feed lever pivot, A157374.	Tool box on power tunnel.
1 cap, belt feed lever pivot, A152730.	Tool box on power tunnel.
1 extension, barrel, assembly, C64139.	Tool box on power tunnel.
2 extractors, assembly, C64135	Tool box on power tunnel.
1 lever, cocking, B131317	Tool box on power tunnel.
1 lever, feed belt, B17503	Tool box on power tunnel.
1 lock, breech, B147214	Tool box on power tunnel.
1 nut, belt feed lever pivot bushing, A196284.	Tool box on power tunnel.
2 pawls, feed belt, C8461	Tool box on power tunnel.

LIGHT TANK M3

<i>Items of equipment</i>	<i>Stowage position</i>
2 pins, accelerator, assembly, B131253.	Tool box on power tunnel.
2 pins, belt feed, pawl assembly, B131255.	Tool box on power tunnel.
2 pins, belt holding pawl, split, B147217.	Tool box on power tunnel.
1 pin, cocking lever, A20567---	Tool box on power tunnel.
1 pin, driving spring rod, A20498.	Tool box on power tunnel.
2 pins, firing, assembly, C9186--	Tool box on power tunnel.
1 pin, trigger, A20503-----	Tool box on power tunnel.
1 trigger, C8476-----	Tool box on power tunnel.
1 rod, driving spring assembly, B147222.	Tool box on power tunnel.
2 sears, C64137-----	Tool box on power tunnel.
1 slide, feed belt, assembly, B131262.	Tool box on power tunnel.
1 spring, belt feed pawl, B147224.	Tool box on power tunnel.
1 spring, belt, holding pawl, B147225.	Tool box on power tunnel.
1 spring, driving, B147227-----	Tool box on power tunnel.
2 springs, cover extractor, B17513.	Tool box on power tunnel.
1 spring, locking barrel, B147230.	Tool box on power tunnel.
1 cover, assembly, C9801-----	Tool box on power tunnel.
1 pivot, belt feed lever, A157434.	Tool box on power tunnel.
2. Accessories.	
1 bag, empty cartridge, bow gun, D38703.	On mount.
1 bag, empty cartridge, turret gun, D50078.	On gun.
3 covers, muzzle, .30-cal. machine gun.	On gun.
1 cover, mount bracket, D39383.	On mount.
2 covers, tripod, mount M2, D30653.	On mounts.
2 screw drivers, combination, M1, C68338.	Tool box on power tunnel.
2 wrenches, comb., M6, C68334.	Tool box on power tunnel.

LIGHT TANK M3

Items of equipment

Stowage position

1 wrench, socket, front barrel bearing plug, B147277.	Tool box on power tunnel.
2 cases, spare bolt, M2, C59656.	Tool box on power tunnel.
2 extractors, ruptured cartridge, MKIV, C3854.	Tool box on power tunnel.
1 brush, chamber-cleaning, M6, B108828.	Tool box on power tunnel.
6 brushes, cleaning, cal. .30, M2, C4035.	Tool box on power tunnel.
1 can, tubular, B147310-----	Tool box on power tunnel.
2 envelopes, spare parts, M1, C59696.	Tool-box on power tunnel.
1 oiler, oval, 3 oz., with cap and chain, C59737.	Tool box on power tunnel.
1 reflector, barrel, cal. .30, B147001.	Tool box on power tunnel.
2 rods, cleaning, jointed, cal. .30, M1, D8237.	Tool box on power tunnel.
1 roll, spare parts, M13, D7349-	Tool box on power tunnel.
1 roll, tool, M12, D7389-----	Tool box on power tunnel.

(c) .45-caliber sub-machine gun.

1. Spare parts.

1 disconnecter, 6D-----	Tool box on power tunnel.
1 ejector, 4B-----	Tool box on power tunnel.
1 extractor, 15A -----	Tool box on power tunnel.
1 pin, firing, 14A-----	Tool box on power tunnel.
1 rocker, 16D-----	Tool box on power tunnel.
1 spring, disconnecter, 9A-----	Tool box on power tunnel.
1 spring, firing pin, 14C-----	Tool box on power tunnel.
1 spring, magazine catch, 9D--	Tool box on power tunnel.
1 spring, recoil, 17C-----	Tool box on power tunnel.
1 spring, sear, 9B-----	Tool box on power tunnel.

2. Accessories.

1 sling, gun, M1923, webbing--	On gun.
1 thong, C64183-----	Tool box on power tunnel.
1 brush, cleaning, cal. .45, M5, C4036.	Tool box on power tunnel.

LIGHT TANK M3

	<i>Items of equipment</i>	<i>Stowage position</i>
	1 brush, chamber-cleaning, M6, B108828.	Tool box on power tunnel.
	1 case, accessories and spare parts, M1918.	Tool box on power tunnel.
	1 envelope, fabric, one button, 3 x 3 $\frac{1}{4}$.	Tool box on power tunnel.
(7) Spare parts and accessories for the vehicle.		
(a) Spare parts.	1 clamp, hose, air cleaner, A145462.	Right rear equipment box.
	1 clamp, hose, air intake, A157626.	Right rear equipment box.
	8 connections, end, track, C64914.	Left rear equipment box.
	3 fittings, grease, CLDX1A	Right rear equipment box.
	3 fittings, grease relief, A143824.	Right rear equipment box.
	2 lamps, electric, 3 cp, 12-16v, SC, Mazda, #67.	Right rear equipment box.
	2 lamps, electric, 21 cp, 12-16v, SC, Mazda, #1141.	Right rear equipment box.
	8 nuts, elastic stop for track wedge, B145730E.	Right rear equipment box.
	2 pins, cotter, split S (type B), $\frac{1}{4}$ " x 2 $\frac{1}{4}$ ", BFAX9CC.	Right rear equipment box.
	4 shoes, track assembly, D34958.	Left rear equipment box.
	8 wedges, track shoe pin, A130906.	Left rear equipment box.
(b) Accessories.	1 tarpaulin, 12 x 12 ft.	Around blanket rolls.
	1 padlock	On tank.
	2 covers, headlamp, removable.	On lights stowed rear equipment box.
	1 net, camouflage	Strapped to rear deck, left side.
	1 cable, towing-S, hemp center, $\frac{3}{4}$ " dia. x 20 ft.	Over right side of tank.
	2 windshields	In box right front fender.
	1 crank, starting	(Gas) Rear deck.
	1 wrench, turning propeller shaft.	(Diesel) To left of driver.
	21 grousers	Left rear equipment box.
	1 can, oil, 1 pt., trigger type	On rack near engine bulkhead.
	1 handle, door	On floor to left of driver.
	1 Check-Chart Lubrication Guide.	Holder provided.

	<i>Items of equipment</i>	<i>Stowage position</i>
	1 Manual, Technical, 9-726....	Holder provided.
	1 book, O.O. Form 7255, (blank).	Holder provided.
(8) <i>Pioneer tools.</i>	1 mattock, pick, M1, 5 lb.....	Rear deck, existing bracket.
	1 axe, chopping, single bit, 5 lb.	Rear deck, existing bracket.
	1 shovel, D. H., round point...	Rear deck, existing bracket.
	1 crowbar, 5 ft.....	Rear deck, existing bracket.
	1 sledge, blacksmith, double- face, 10 lb.	Rear deck, existing bracket.
(9) <i>Vehicle tools.</i>	1 gun, lubrication, high pressure lever type, 1 lb.	Left rear equipment box.
	1 hose, lubrication, heavy duty, 15' b-hd. type.	Left rear equipment box.
	1 jack, simplex, with ratchet handle and connecting fix- tures for connecting track.	Left rear equipment box.
	1 wrench, trailing idler gudgeon nut, 3 $\frac{3}{4}$ ".	Rear deck (strapped under paulin).
	1 bar, cross, $\frac{1}{2}$ " sq.-drive.....	Tool box on power tunnel.
	1 hammer, machs., ball peen, 32 oz.	Tool box on power tunnel.
	1 handle, hinge, 15", $\frac{1}{2}$ " sq.- drive.	Tool box on power tunnel.
	1 pliers, combination, slip-joint, 8".	Tool box on power tunnel.
	1 ratchet, reversible, $\frac{1}{2}$ " sq.- drive.	Tool box on power tunnel.
	1 bag, tool.....	Tool box on power tunnel.
	1 screw driver, machs., extra heavy duty, all-steel hdl., 5" blade.	Tool box on power tunnel.
	1 screw driver (special purpose), 1 $\frac{3}{4}$ " blade.	Tool box on power tunnel.
	1 wrench, socket, draglink $\frac{1}{2}$ " sq.-drive.	Tool box on power tunnel.
	1 wrench, socket, double-hex., $\frac{1}{2}$ " sq.-drive, $1\frac{1}{16}$ " (extra thin wall).	Tool box on power tunnel.
	1 wrench, socket, double-hex., alloy-S., $\frac{1}{2}$ " sq.-drive, $\frac{9}{16}$ ".	Tool box on power tunnel.
	1 wrench, socket, double-hex., alloy-S., $\frac{1}{2}$ " sq.-drive, $\frac{3}{4}$ " (wedge nuts).	Tool box on power tunnel.

LIGHT TANK M3

	<i>Items of equipment</i>	<i>Stowage position</i>	
	1 wrench, socket, double-hex., alloy-S., 1/2" sq.-drive, 3/8" (extra thin wall) (grousers).	Tool box	on power tunnel.
	1 wrench, adjustable, single-end, 8".	Tool box	on power tunnel.
	1 wrench, engrs., single-end, 1 11/16".	Tool box	on power tunnel.
	1 wrench, engrs., double-hd., alloy-S., 1/2" and 3/8".	Tool box	on power tunnel.
	1 wrench, engrs., double-hd., alloy-S., 3/8" and 1/4".	Tool box	on power tunnel.
	1 wrench, engrs., double-hd., alloy-S., 3/4" and 7/8".	Tool box	on power tunnel.
	1 wrench, engrs., double-hd., alloy-S., 1 5/16" and 1".	Tool box	on power tunnel.
	6 wrenches, allen set screw, 3/16", 3/8", 5/8", 9/16", 3/4".	Tool box	on power tunnel.
(10) Gun tools.	1 gun, oil, recoil, with cap, B156647.	Tool box	on power tunnel.
	1 extension, oil gun, B194460.	Tool box	on power tunnel.
	1 gun, grease, B157465.	Tool box	on power tunnel.
	1 wrench, socket head set screw, 3/2" hex., BCTX1G.	Tool box	on power tunnel.
	1 wrench, socket head set screw, 3/8" hex., BCTX1H.	Tool box	on power tunnel.
	1 punch, drive pin std., 3/2" pt. x 4" long, TCFX1A.	Tool box	on power tunnel.

NOTES.—1. For those tanks which are not provided with protectoscopes, the three boxes shown will be eliminated.

2. Some light tanks M3, or early production date, are not equipped with rear equipment boxes, which must be provided in addition to list of boxes shown herewith to complete the stowage as planned.

b. The following list of equipment is given for reference in location of tools.

	<i>Name of tool</i>	<i>Vehicle tools</i>	<i>Organization tools</i>
Adapter, button head to bayonet type	-----	X	X
Adapter, final drive	-----	—	X
Bag, tool	-----	X	—
Cable, towing, S., hemp, 3/4-in. dia. x 20 ft.	-----	—	X
Can, oil, trigger type, 1 pt.	-----	X	—
Compressor, grease, portable, hand type, 25 lb. cap.	-----	—	X
Compressor, suspension volute spring	-----	—	X
Compressor, trailing idler spring	-----	—	X
Compressor, valve (Continental engine)	-----	—	X
Compressor, valve (Guiberson engine)	-----	—	X
Cone, assembling, bogie wheel oil seal	-----	—	X
Cone, assembling, idler oil retainer	-----	—	X

Name of tool	Vehicle tools	Organization tools
Cone, assembling, trailer idler oil retainer.....	—	X
Crank, starting.....	X	—
Disk, timing, with pointer (Continental engine).....	—	X
Disk, timing, with pointer (Guiberson engine).....	—	X
Fitting, lubr., button head type, straight, ¼-27NPT., male.....	—	X
Fixture, track connecting, with simplex jack.....	X	X
Gage (Guiberson engine).....	—	X
Gage, feeler, 0.010—0.124 (Continental engine).....	—	X
Gun, lubr., high pressure, lever type, 1 lb.....	X	—
Hammer, machs., ball peen, 32 oz.....	X	—
Hammer, slide bogie wheel gudgeon.....	—	X
Holder, top center indicator (Guiberson engine).....	—	X
Hose, lubr., heavy duty, 7-ft, b-hd type.....	X	X
Hose, lubr., heavy duty, 15-in., b-hd type.....	X	—
Indicator, piston top dead center (Continental engine).....	—	X
Indicator, piston top dead center (Guiberson engine).....	—	X
Lift, bogie.....	—	X
Pliers, combination, slip-joint, 8-in.....	X	—
Pliers, side-cutting, parallel jaw, 8-in.....	X	—
Puller, bogie gudgeon screw.....	—	X
Puller, fuel injection pump (Guiberson engine).....	—	X
Puller, slide hammer, clutch spindle, complete (consisting of 1 adapter, 1 hammer).....	—	X
Puller, bearing, rear clutch.....	—	X
Screw driver, mach., extra heavy duty, all-steel handle, 5-in. blade.....	X	—
Screw driver, special purpose, 1¼-in. blade.....	X	—
Sling, engine.....	—	X
Sling, transmission.....	—	X
Socket, wrench, double-hex., ½-in. sq.-drive., 1⅛-in. extra thin wall (grouser).....	X	—
Socket, wrench, single-hex., 1⅛-in. (Continental engine spark plug).....	—	X
Socket, wrench, single-hex., 1-in. (Continental engine spark plug).....	—	X
Stand, inspection, engine.....	—	X
Stand, transport, engine.....	—	X
Wrench, adjustable, single-end, 8-in.....	X	—
Wrench, bogie axle cap, 2⅝-in., 6 in. long.....	—	X
Wrench, box, special (Continental engine starter).....	—	X
Wrench, boxocket, offset (Continental engine cylinder base nuts).....	—	X
Wrench, brake.....	—	X
Wrench, crankshaft turning (Guiberson engine).....	X	—
Wrench, engrs., double-hd., alloy-S., ½-in. and ⅝-in.....	X	—
Wrench, engrs., double-hd., alloy-S., ⅝-in. and ¾-in.....	X	—
Wrench, engrs., double-hd., alloy-S., ¾-in. and 1-in.....	X	—
Wrench, engrs., double-hd., alloy-S., 1⅛-in. and 1-in.....	X	—
Wrench, engrs., double-hd., 45° and 90°, ⅝-in.....	—	X
Wrench, engrs., single-end, 1⅝-in.....	—	X

Name of tool	Vehicle tools	Organization tools
Wrench, engr., single-end, alloy-S., 1 $\frac{7}{8}$ -in. (bogie wheel gudgeon nut)-----	—	X
Wrench, final drive-----	—	X
Wrench, flywheel hub nut, 2 $\frac{1}{16}$ -in. (Guiberson engine)-----	—	X
Wrench, magneto, $\frac{1}{4}$ -in. (Continental engine)-----	—	X
Wrench, set, socket, alloy-S., $\frac{1}{2}$ -in. sq.-driver, consisting of-----		
1 bar, cross, $\frac{1}{2}$ -in. sq.-drive-----	X	—
1 handle, hinge, 15-in., $\frac{1}{2}$ -in. sq.-drive-----	X	—
1 socket, wrench, $\frac{1}{16}$ -in-----	X	—
1 socket, wrench, $\frac{3}{4}$ -in-----	X	—
1 socket, wrench, $\frac{5}{8}$ -in. hex-----	X	—
1 socket, wrench, $1\frac{1}{16}$ -in. hex-----	X	—
Wrench, set, socket, ferret, $\frac{3}{8}$ -in. drive, (consisting of-----		
1 bar, sliding-----	X	—
1 extension, bar, 3-in-----	X	—
1 extension, bar, 6-in-----	X	—
1 extension, bar, 12-in-----	X	—
1 joint, universal, $\frac{3}{8}$ -in. sq.-drive-----	X	—
1 ratchet, reversible, $\frac{3}{8}$ -in. sq.-drive., 6 $\frac{1}{16}$ in. long-----	X	—
1 speeder, 17 $\frac{3}{4}$ -in. long-----	X	—
1 socket, wrench, ferret, $\frac{3}{8}$ -in-----	X	—
1 socket, wrench, ferret, $\frac{7}{16}$ -in-----	X	—
1 socket, wrench, ferret, $\frac{1}{2}$ -in-----	X	—
1 socket, wrench, ferret, $\frac{9}{16}$ -in-----	X	—
1 socket, wrench, ferret, $\frac{3}{8}$ -in-----	X	—
1 socket, wrench, ferret, $1\frac{1}{16}$ -in-----	X	—
1 socket, wrench, ferret, $\frac{3}{4}$ -in-----	X	—
Wrench, trailing idler shaft-----	—	X
Wrench, trailing idler wheel nut-----	—	X
Wrench, valve adjusting (Guiberson engine)-----	—	X
Wrench, valve adjusting screw (Continental engine)-----	—	X
Wrench, valve push rod housing gland nut (Continental engine)-----	—	X
Wrench, valve push rod housing gland nut (Guiberson engine)-----	—	X
Wrench, valve push rod housing gland retaining nut (Continental engine)-----	—	X

42. Care of equipment.—An accurate record of all tools and accessories should be kept in order that their location and condition may be known at all times. Items becoming lost or unserviceable should be immediately replaced. All tools and equipment should be cleaned and in proper condition for further use, before being returned to their location. Care must be used in fastening the tools carried on the outside of the tank, and frequent inspection and oiling is necessary to prevent corrosion.

SECTION III

ENGINE, CONTINENTAL W670, SERIES 9A

	Paragraph
General description and data.....	43
Engine trouble shooting.....	44
Accessory case.....	45
Oil pumps.....	46
Engine lubrication.....	47
Magnetos.....	48
Booster coil.....	49
Spark plugs.....	50
Ignition shielding harness.....	51
Carburetor.....	52
Governor.....	53
Air cleaners.....	54
Fuel pump.....	55
Starter.....	56
Generator.....	57
Valve mechanism.....	58
Manifolds.....	59
Engine replacement.....	60

43. General description and data (fig. 22).—*a.* The Continental W670-9A is an air-cooled, 7-cylinder, static radial engine of the aviation type.

b. The engine is mounted on an engine beam which is supported on brackets riveted to each side of the engine compartment. A bracket on the front section of the crankcase clamps a steady rest bar whose ends are clamped in supporting brackets on the sides of the engine compartment.

c. The magnetos, an electric starter, generator drive pulley, oil pumps, and fuel pump are mounted on the accessory case. The generator, located below and to the left of the accessory case, is mounted on a movable bracket attached to the engine support beam. The carburetor is centrally mounted on the lower side of the rear crankcase section.

d. In this section the flywheel end of the engine will be referred to as the “front” of the engine. The accessory end of the engine will be referred to as the “rear” of the engine. The terms “right” and “left” are used with reference to the engine as viewed from the rear. Horizontal and vertical positions of the engine will be referred to with respect to the crankshaft. (When the crankshaft is in the horizontal position the engine is in the vertical position.)

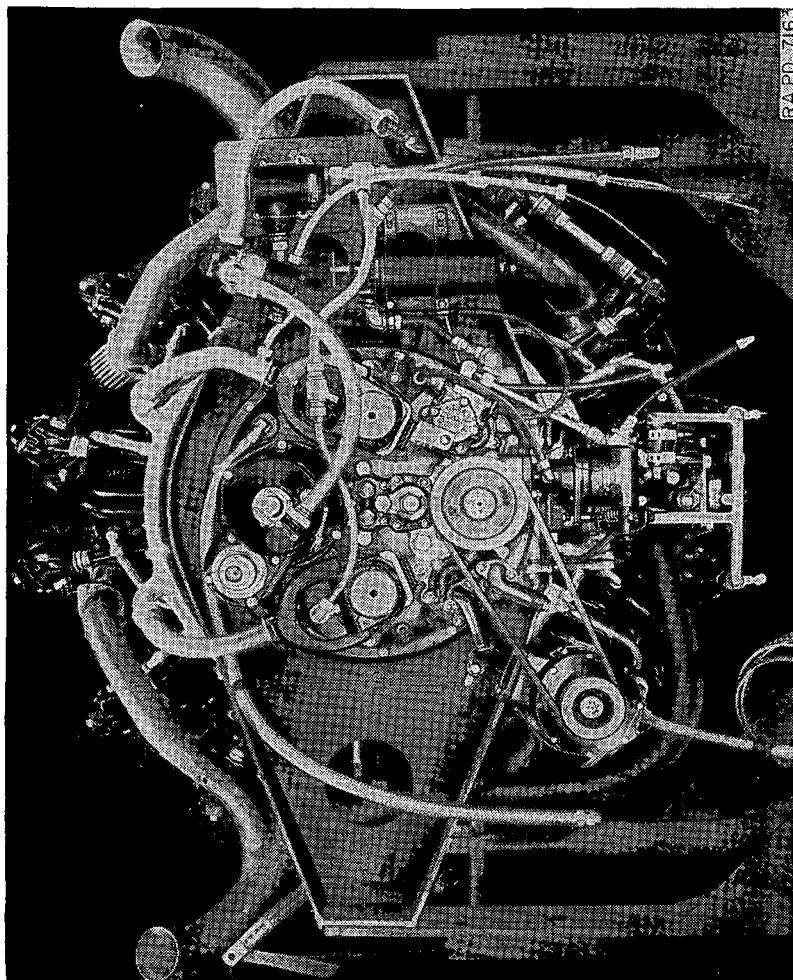

RA PD 7163

FIGURE 22.—Continental engine W670, series 9A.

Direction of rotation is determined by viewing from the rear of the engine, or in the case of side drives, by looking at the crankshaft.

e. The following data include the general information and engine characteristics which are frequently required for reference:

Make and type	Continental Static Radial.
Model and series	W 670, series 9A.
Over-all diameter	42 $\frac{3}{8}$ in.
Weight, with accessories	1,107 lb.
Horsepower	250 hp at 2,400 rpm.
Maximum allowable rpm	2,400.
Number of cylinders	7.
Bore	5 $\frac{1}{8}$ in.
Stroke	4 $\frac{5}{8}$ in.
Piston displacement	667.86 cu. in.
Compression ratio	6.1 to 1.

Direction of rotation (viewed from rear of engine):

Crankshaft	Clockwise.
Cam	Anticlockwise.
Tachometer	Anticlockwise.
Fuel pump	Clockwise.
Starter	Anticlockwise.
Generator	Clockwise.
Magnetos	Anticlockwise.

Accessory speeds:

Tachometer	$\frac{1}{2}$ crankshaft speed.
Generator	$\frac{39}{20}$ crankshaft speed.
Magnetos	$\frac{7}{8}$ crankshaft speed.

Magneto:

Make and model	Scintilla, Model VMN7-DFA.
Breaker point gap	.012 in.
Spark plug gap	.015 in.
Valve clearance (between valve stem and roller, engine cold)	.010 in.
Carburetor make and model	Bendix-Stromberg, Model NA-R6B.

Firing order (clockwise, viewed at accessory case) 1-3-5-7-2-4-6.

Number one cylinder location Top.

44. Engine trouble shooting.—*a.* Before starting, turn the engine crankshaft by hand two complete engine revolutions. If extra resistance is felt, or if the engine crankshaft cannot be turned by hand, remove the spark plugs in the lower three cylinders and drain the trapped engine oil. If the engine crankshaft cannot be turned by hand after draining, call ordnance personnel. If the engine crankshaft can be turned by hand, but not by the starter, proceed with a check of the conditions given in (1) below. If, however, the engine fails to start when the starter turns the engine crankshaft satisfactorily, carefully check the engine accessories as outlined in (2) below.

NOTE.—In cold weather the sluggish operation of the starter motor can often be traced to cold engine oil. If this stiffness is felt when the engine crankshaft is turned by hand, it will be necessary to hand-crank the engine between 5 and 10 additional revolutions prior to attempting to start the engine.

- (1) *Engine fails to turn over when starter switch is pressed.*—
- (a) First check the battery gravity.
1. If reading is 1.225 or less, replace with a fully charged battery and have the discharged battery recharged.
 2. If reading is approximately 1.280 the battery is fully charged. See hydrometer correction chart (fig. 94).
- (b) Next check the condition of battery cables.
1. Examine battery terminals for corrosion, battery cable for a short circuit or broken sections. If such conditions exist, clean the terminals and replace the broken cables.
 2. Examine for loose connections; tighten clamps.
- (c) Operate the starter toggle switch to ascertain whether the starter solenoid is functioning.
1. Have one man listen at solenoid for click as switch is closed. If no click is heard replace the solenoid; or—
 2. Disconnect the battery-starter motor cable at the starter motor, and while another person operates the starter toggle switch, hold the cable against the housing and observe whether a spark occurs. If no spark is seen, replace the solenoid.
- (d) If the starter does not operate after obtaining a click, or a spark, replace the starter.
- (2) *Engine turns but does not start.*—(a) Check the fuel system.
1. Check the amount of fuel in fuel tanks, and be sure the fuel valves are open.
 2. Examine the carburetor for flooding (carburetor will be

- wet and leaking). If this condition exists, replace the carburetor.
3. The throttle must be kept nearly closed until the engine starts to fire.
 4. If there is water in carburetor, remove the float chamber drain plug (fig. 28) and fuel strainer and drain off the water.
 5. For underprime, reprime engine with two or three additional strokes. For overprime, place throttle in full open position and turn engine over with starter five or six revolutions with magneto switch in "off" position.
 6. Check the fuel flow. Disconnect the inlet line at the carburetor, turn the engine over, using the starting motor, and watch for fluid flow. If no fluid flows, disconnect the carburetor inlet line at the fuel pump and blow through the line to determine if it is plugged. If it is plugged, clean by blowing compressed air through the line. If the inlet line is open, the trouble may be in the fuel pump. Test as follows: Disconnect the inlet fuel line to the fuel pump; if the line is open, fluid should flow. If fluid does not flow, the lines are plugged. Clean the fuel lines. If fuel does flow, reconnect the line to the pump, turn the engine over by starter motor, and if no fluid appears at the discharge side of the pump, replace it.
- (b) Check the ignition system.
1. Check the ignition wires for breaks, worn sections, loose connections and short circuits. Remove a wire from the spark plug and check for length of spark.
 2. If the length of spark exceeds $\frac{3}{8}$ inch, it is an indication that the booster coil and magnetos are functioning properly.
 3. Next remove an upper and lower cylinder spark plug and examine for broken insulation, corroded, burnt, or dirty electrodes. If dirty, clean and adjust all the spark plugs. Replace all broken or burnt spark plugs.
 4. If the spark is not of sufficient length, then check the booster coil and magneto. Inspect the booster coil by listening for a buzzing sound while the operator presses the starter switch. If a buzz is not heard, replace the coil. Check the output of the booster coil by disconnecting the high tension line to the right magneto at the magneto and turn

the engine over by starter motor. The spark which occurs should be approximately $\frac{3}{8}$ inch long. If the spark is shorter than $\frac{3}{8}$ inch replace the coil. *Do not attempt to adjust the spark.*

5. Check the magneto contact points (gap 0.012 inch). Inspect the points for pitting or burning. If the points are pitted or burnt, it may be due to a loose or defective condenser or overlubrication of the magneto. If the points are pitted slightly, the points may be smoothed with a fine file or abrasive stick. (Adjust gap.) If the points are badly pitted or burnt replace the magneto. *Do not attempt to replace the points.*

(c) If the engine will not start after performing *all* the checks enumerated, substitute a new carburetor and attempt a start. If the engine will not start then remount the *original* carburetor and call ordnance personnel. If the engine does start, send the replaced carburetor to the ordnance shop for overhauling and cleaning.

b. Miscellaneous.—(1) *Loss of oil pressure.*—Ordnance personnel will be notified. *Stop engine immediately.*

(2) *High oil consumption and excessive oil temperature.*—Check for obstruction to engine cooling and engine oil cooling systems. Ordnance personnel will be notified if check does not correct the above condition. Do not attempt to operate at high oil temperatures.

(3) *Low power and uneven running.*—Low power and uneven running may be traced to any of the following causes:

(a) *Mixtures.*—Too rich a mixture is evidenced by uneven running and continuous black smoke from the exhaust. Too lean a mixture is evidenced by uneven running, overheating, or backfiring through the carburetor.

(b) *Leaks in induction system.*—Examine the intake pipes for cracks and for leaks at the cylinder and crankcase connections. Examine the carburetor and intake manifold flanges for tightness. Also examine all gaskets (carburetor and body).

(c) *Spark plugs.*—See that all the spark plugs are clean, that they have the proper gap, and that they are not burned; test them for proper sparking. Be sure the spark plugs are in good condition and of the recommended type.

(d) *Valve and valve gear trouble.*—Check the valve tappet clearances, and the springs, washers, rocker arms, and push rods. Make sure the valves are not sticking.

(e) *Poor fuel.*—Use only the recommended grade of gasoline and see that it flows freely to the carburetor.

(f) *Magneto breaker points.*—See that the magneto breaker points are clean and properly adjusted. Check the operation of the magneto (fig. 23).

(g) *Ignition wiring deteriorated or burned.*—Check condition at terminals. Check for moisture in the ignition harness.

(h) *Engine overheating.*—Excessive engine temperature may be due to any of the following causes:

1. Air flow restricted at fan guard screen.
2. Engine operating on too lean a fuel mixture.
3. Engine oil worn out, of improper grade, of insufficient quantity.
4. Flow of air through engine oil cooler obstructed.
5. Relief valve of oil cooler stuck in the open position. Remove and clean.

(i) *Fuel pump.*—Check fuel delivery system; replace fuel pump if there are indications that fuel is not reaching the carburetor.

45. *Accessory case* (fig. 23).—The accessory case is a one-piece aluminum alloy casting attached to the rear section of the main crankcase. It houses all accessory drives and mounts all accessories except the carburetor and generator.

46. *Oil pumps.*—*a. Description.*—A dual purpose gear type oil pump supplies oil under pressure to the various engine parts and incorporates a scavenger pump which draws oil from the engine sump and returns it to the supply tank. A second scavenger pump transfers oil from the two lower rocker boxes to the main engine sump.

b. Replacement.—(1) *Removal of oil pump assembly* (fig. 22).—

- (a) Disconnect the inlet and outlet lines at the pump.
- (b) Remove the locking wire and five retaining nuts.
- (c) Remove the oil pump.

(2) *Installation of oil pump assembly.*—To install the oil pump, proceed in reverse order to (1) above.

(3) *Removal of the rocker box scavenger oil pump.*—(a) Remove the fuel pump.

- (b) Remove the locking wire and retaining nuts.
- (c) Remove scavenger pump.

(4) *Installation of scavenger pump.*—Proceed in reverse order to (3) above.

Caution: Care must be exercised to prevent the entrance of foreign matter into the crankcase during the above operations.

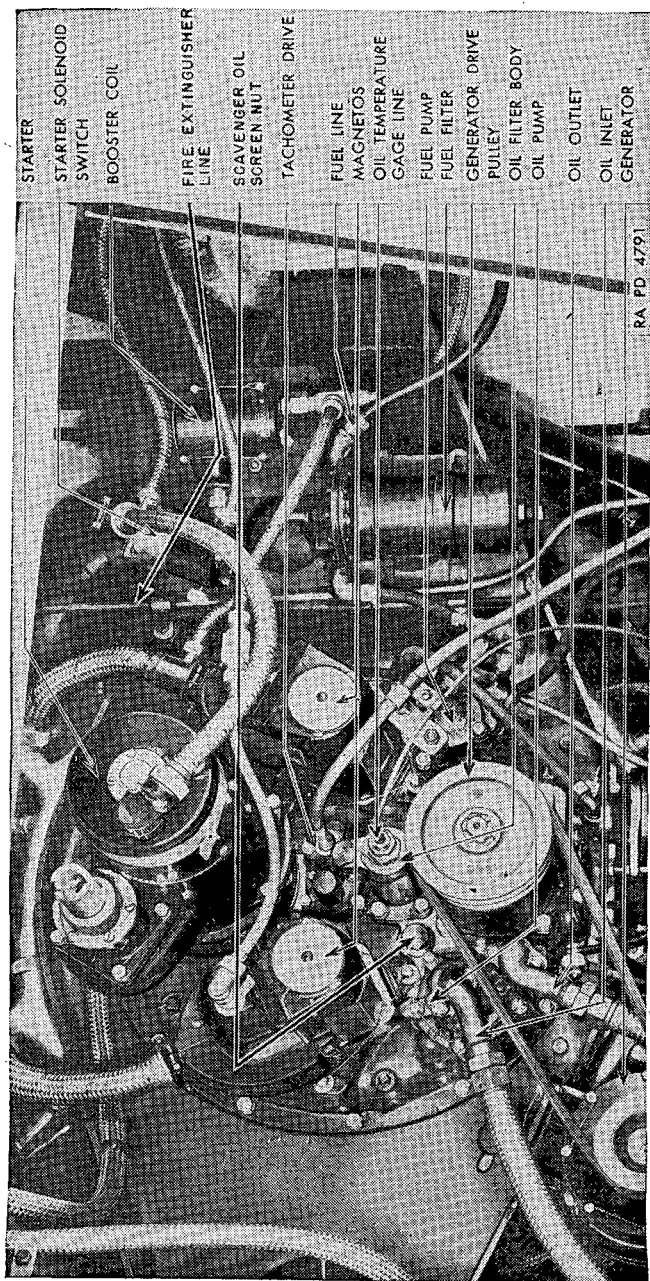

RA. PD. 4791

FIGURE 23.—Engine accessories, Continental series 9A.

47. Engine lubrication.—*a. General.*—Oil is drawn from the oil tank and delivered under pressure through an oil screen to all drive bearings and through the crankcase to the crank pin and knuckle pin bearings. There are two pressure relief valves. One, set at 70 pounds, at 2,000 rpm, regulates the flow of oil to all engine parts except the overhead oiling system. The second, or low pressure relief valve, is set at 20 pounds pressure and regulates the pressure to the overhead oiling system only.

b. Oil filters.—(1) *Oil pressure pump filter.*—A screen type oil filter is employed to remove foreign matter from the engine oil. The filter body is located on the accessory case above the generator drive pulley and provides a receptacle for the oil temperature gage thermometer. After each 25-hour operating period remove the filter screen, clean with dry-cleaning solvent, and dry with compressed air.

(a) Loosen retaining nut and remove oil temperature thermometer.

(b) Remove locking wire from oil filter screen nut.

(c) Loosen filter screw nut and remove screen.

(d) Reverse above procedure to install.

(2) *Scavenger oil pump filter.*—A screen type filter is used to remove foreign matter from the scavenger lines. Remove and clean the screen after each 25 hours of engine operation. To remove screen, remove locking wire and screw screen assembly out of accessory case (fig. 23).

c. Oil dilution valve.—(1) *General.*—The oil dilution valve is bracket-mounted below the engine compartment door sill near the oil supply tank. It is used prior to stopping the engine in cold weather to dilute the oil in the engine crankcase to facilitate starting.

(2) *Operation.*—A toggle switch on the front instrument panel completes the circuit through the solenoid in the dilution valve. With the switch "on" the solenoid plunger holds the dilution valve open, permitting gasoline from the fuel pump to mix with the engine oil at the engine oil inlet pipe connection at the bottom of the oil tank. Care will be taken to insure against the switch being held open longer than the specified number of seconds as given in paragraph 12.

(3) *Maintenance.*—At the 25-hour check period while the oil supply tank is empty the valve will be checked for leakage. Open gasoline shut-off valves. Disconnect oil dilution valve line at oil tank. If gasoline runs or drips from the line while disconnected, replace the oil dilution valve.

(4) *Replacement.*—When deemed unserviceable the oil dilution valve will be replaced as follows:

(a) Removal of dilution valve.

1. Open battery switch.

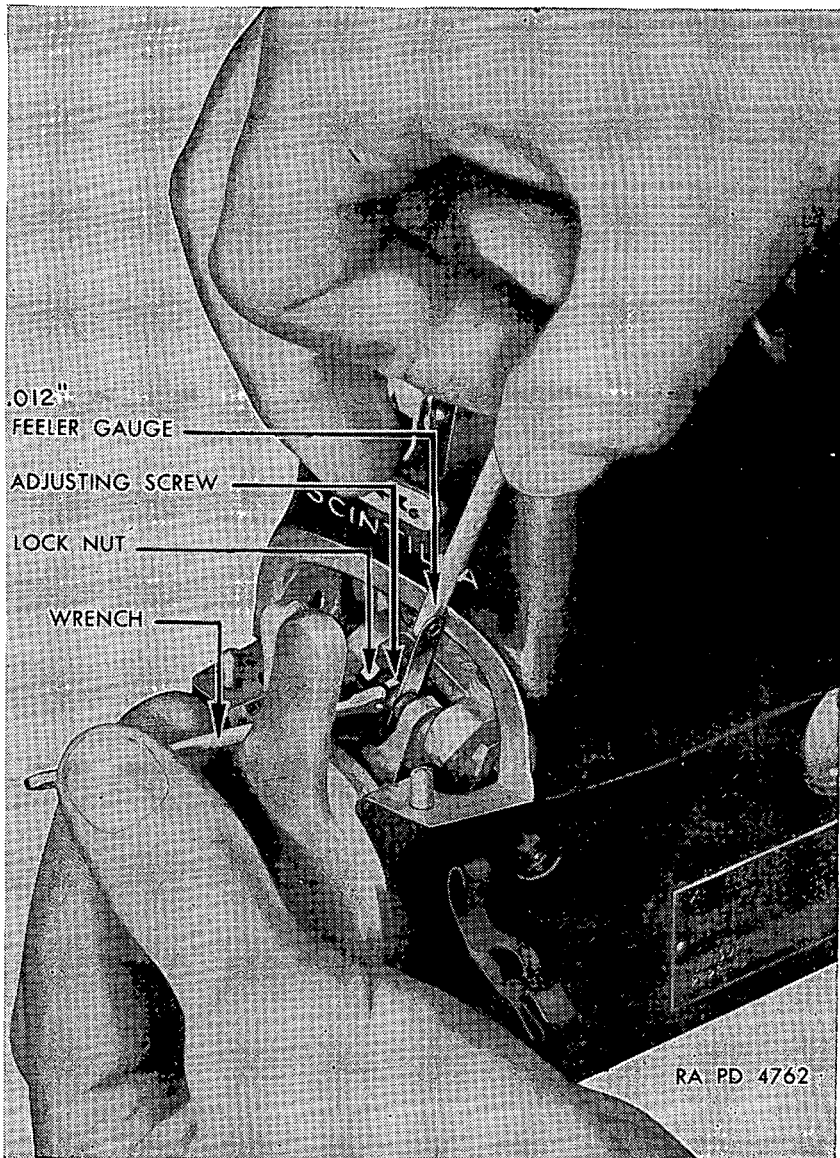

FIGURE 24.—Magneto breaker point gap adjustment.

2. Close gasoline shut-off valves.
3. Drain oil supply tank.

4. Disconnect two 1/8-inch-gasoline lines at valve.
5. Disconnect wiring conduit.
6. Disconnect wiring by pulling plug.
7. Remove clamping bolt and remove valve.

(b) *Installation of dilution valve.*—Reverse removal procedure and install.

48. **Magnetos.**—*a. Description.*—Dual ignition is furnished by two radio-shielded Scintilla VMN7-DFA magnetos which are flange-mounted on the accessory case. The right magneto fires the front set of spark plugs; the left magneto, the rear set of plugs.

b. Breaker point adjustment (fig. 24).—Release safety ring on both sides of the magneto and remove the breaker cover. Hand crank the engine until the breaker points reach their maximum gap. The correct gap is 0.012 inch. If the gap is less than 0.010 inch or more than 0.014 inch loosen the lock nut on the stationary contact screw and reset the screw using the 0.012-inch feeler. When the correct gap is obtained tighten the lock nut.

c. Lubrication.—Examine the felt wick at the bottom of the contact breaker to make sure it is saturated with oil. If oil appears on the surface of the felt when it is squeezed with the fingers no additional lubricant is needed. If it is dry, however, add a few drops of engine oil, grade SAE 30.

d. Replacement (fig. 25).—The following procedure, covering removal and installation of the magnetos and the retiming operation, must be closely observed if the replacement is to result in a smoothly running engine.

<i>Specific step</i>	<i>Equipment</i>	<i>Procedure</i>
(1) Remove radio shielding.	Screw driver wrench, 3/8 in., O. E., B. or soc.	Loosen set screw on side of radio shield near outlet. Remove two hex-hd. 3/16-in. bolts and nuts clamping shield together at top. Remove safety pins on each side of shield at bottom. Swing lower clamps away from shield.
(2) Remove distributor blocks and terminal block.	Screw driver	Remove safety pin locking terminal block retaining screw. Remove screw.
(3) Disconnect magneto ground connection.	Pliers	Disconnect at union coupling on coil cover.
(4) Align marks on magneto.	None	Rotate engine crankshaft until the marks on the driven magneto distributor gear coincide with corresponding marks on the magneto front plate.

Specific step	Equipment	Procedure
(5) Remove magneto..	Pliers Wrench, $\frac{1}{2}$ in., O. E., B. or soc.	Note position of stud in slotted hole of magneto mounting flange. Remove locking wire, washers, and nuts from studs holding magneto mounting flange to engine case.

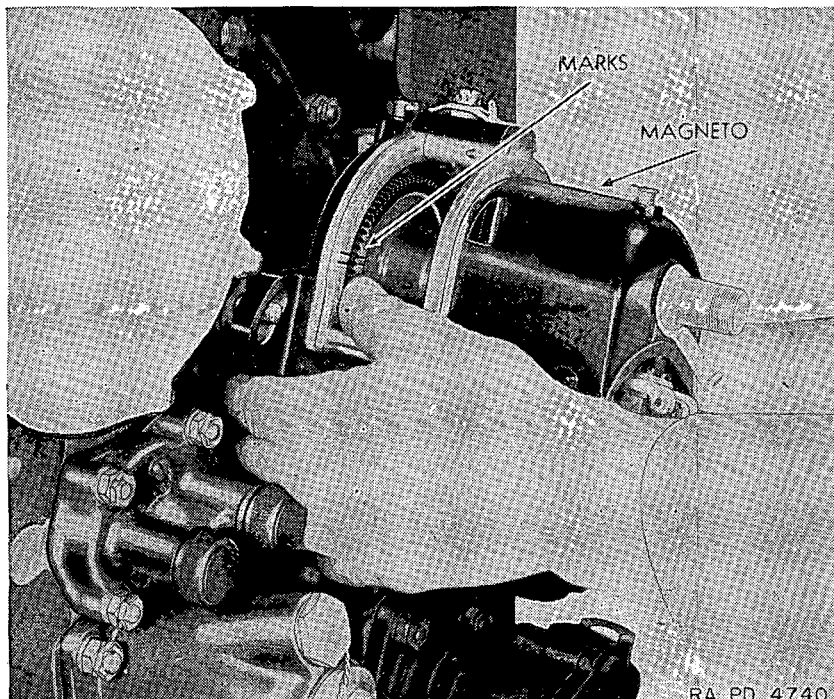

FIGURE 25.—Magneto timing and installation, Continental engine.

e. Installing magneto.—If the magneto removal procedure as outlined above was followed and the crankshaft setting has not been disturbed, the replacement procedure will be as follows:

(1) Set the marks on the driven magneto distributor gear so they coincide with the marks on the magneto front plate. Mount magneto so the position of the studs in the slotted holes of the magneto mounting flange is as close as possible to the original position without moving the magneto distributor gears or the engine crankshaft.

(2) Insert the spark plug cable for number 1 cylinder into the distributor block cable hole marked number 1 (fig. 26). The cable for number 3 cylinder, the next to fire, is placed in the magneto distributor block hole marked number 2. *The numerals on the distributor blocks*

indicate the order in which sparks are delivered by the magneto, and have no relation to engine cylinder numbers or engine firing order.

f. Ignition timing of the engine.—(1) The right magneto fires at 20° before top dead center, and the left magneto fires at 17° before top dead center.

(2) To find the positions of the piston in number 1 cylinder that correspond to 17° and 20° before top dead center, use the following procedure:

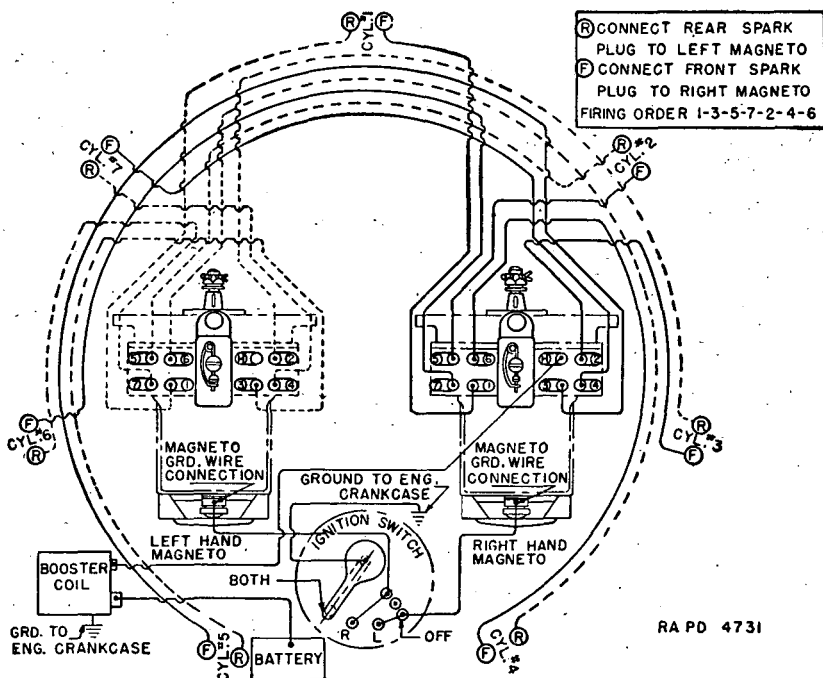

FIGURE 26.—Ignition wiring diagram, Continental engine.

(a) With a screw driver, remove cowling over rear spark plug in number 1 cylinder.

(b) Disconnect high tension lead to spark plug.

(c) Remove spark plug.

(d) Rotate engine crankshaft until number 1 piston is coming up on compression, using either of the following methods: Remove valve rocker box cover for inlet valve on number 1 cylinder, or close spark plug hole with finger until compression is felt.

(e) Hold top dead center indicator (fig. 27) so that its arm points downward. Screw in top dead center indicator adapter in spark

plug hole until it seats firmly against the cylinder head. Make certain that face of scale is vertical, or edge of scale points directly to center of crankshaft of engine.

(f) Slowly turn crankshaft until pointer end of the indicator reaches its maximum downward travel. *Note this reading.*

(g) Turn engine hand crank 18 revolutions then turn slowly until needle of indicator is five divisions from the reading noted when the piston was at top dead center. This piston position is 20° advance. When there are only four divisions, the piston position is 17° advance.

(h) For instructions on installing magneto see *d* and *e* above.

49. Booster coil.—*a. Description.*—A battery-operated booster coil, wired through the right magneto, is provided to supply ignition spark during the “coming in speed” of the magneto.

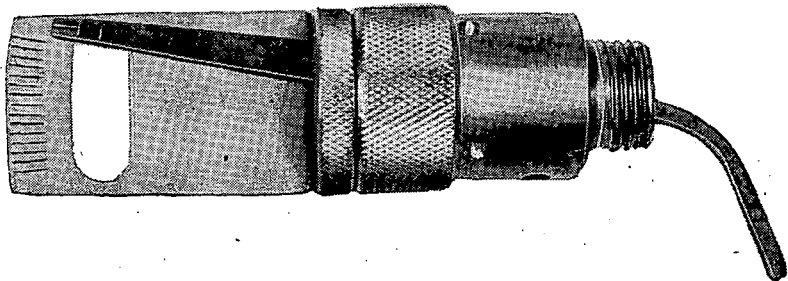

RA PD 4746

FIGURE 27.—Top dead center indicator, Continental engine.

b. Replacement.—Whenever replacement of the booster coil is found necessary the unserviceable coil will be removed and exchanged for a serviceable one. Replacement procedure is as follows:

- (1) Open battery switch.
- (2) Disconnect high tension conduit coupling at booster coil and pull out wire connector plug.
- (3) Loosen high tension connector lock nut.
- (4) Loosen low tension connector lock nut.
- (5) Remove locking wire and four screws securing booster coil cover and remove cover.
- (6) Disconnect low tension wire at coil.
- (7) Remove two bolts securing coil to mounting bracket and remove coil.
- (8) Install serviceable coil by reversing removal procedure.

50. Spark plugs.—*a. Description.*—Two BG 417-S radio-shielded spark plugs are used in each cylinder. The correct spark plug gap is .015 inch.

b. Replacement.—(1) *Removal.*—(a) Remove fan guard grille.

(b) Remove transmission oil cooler from bulkhead by disconnecting oil cooler inlet and outlet connections and removing four bolts securing cooler in bulkhead.

NOTE.—To facilitate the removal of front spark plugs use a spark plug socket wrench on a 7-inch extension with a ratchet handle and work through the opening in the bulkhead. Rear spark plugs may be removed with a spark plug socket wrench and a 9-inch extension.

(2) *Installation.*—When installing spark plugs, use only new solid copper gaskets. Care must be taken not to install plugs too tightly, especially when the engine is hot. For safety, the wrench handle length should not exceed 10 inches.

51. Ignition shielding harness.—*a. Description.*—The engine ignition system is completely shielded to prevent radio interference.

b. Replacement.—The shielding harness may be replaced without removing the engine. It should be carefully inspected at each 100-hour check and, if defective, replaced at that time with the engine out of the tank. For inspection and maintenance see paragraph 133.

52. Carburetor (fig. 28).—*a. Description.*—The carburetor is a Bendix-Stromberg model NA-R6B and is attached directly to the intake manifold duct cast in the bottom of the engine crankcase.

b. Adjustments.—An idle adjustment lever is provided on the crankcase side of the carburetor body. Moving this lever laterally on its quadrant enriches or thins the idle mixture. When the upper end of the lever is against the long stop, the leanest point has been reached. The throttle stop on the throttle shaft should be adjusted so that the engine idle speed is 400 rpm. However, the engine should never be allowed to idle under 800 rpm in the vehicle. To get a smooth idle, both of the above adjustments must be made when the engine is hot.

c. Maintenance.—Once the carburetor is properly installed and the idle adjustments made, very little attention is required in service. A fuel strainer is provided below the fuel inlet of the carburetor, and it may be removed by the removal of a square-headed nut. The strainer will be removed at the 25-hour inspection to clean out any dirt or water which may have accumulated in the strainer chamber. The entire carburetor will also be inspected to see that all parts are tight and properly locked, and a small quantity of oil will be put in the pump operating mechanism.

d. Removal (fig. 29).—When it becomes necessary to remove a defective carburetor, use the following procedure:

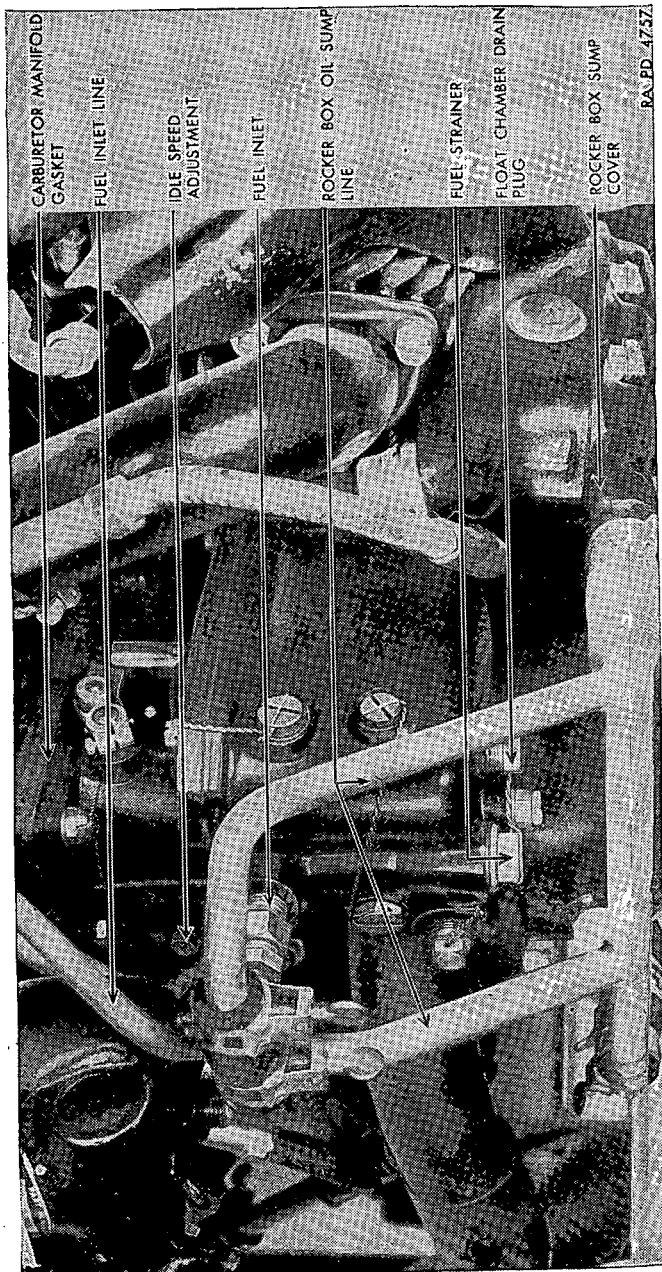
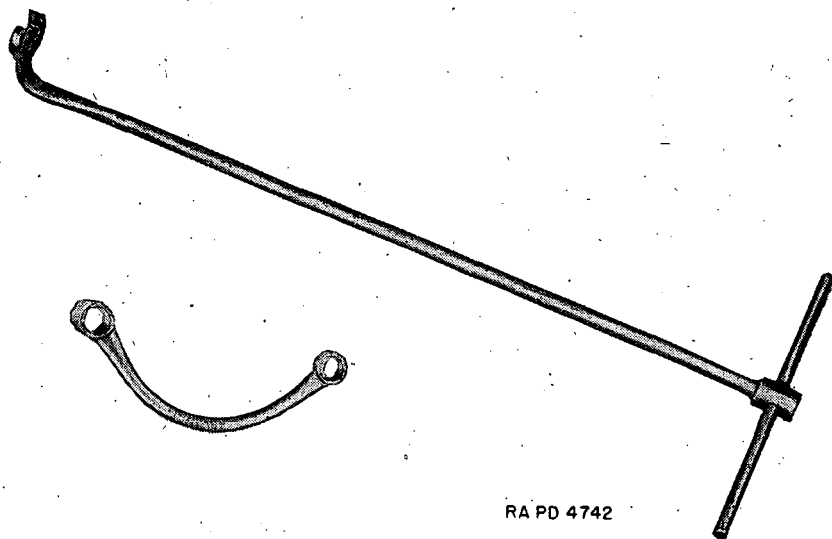

Figure 28.—Carburetor drain and rocker box scavenger line.



RA PD 4742

FIGURE 29.—Carburetor and starter wrenches.

<i>Specific step</i>	<i>Equipment</i>	<i>Procedure</i>
(1) Close fuel shut-off valves at tanks.	-----	-----
(2) Remove inspection plate from floor of engine compartment.	-----	See engine removal, par. 60a(28).
(3) Remove carburetor air horn.	-----	See engine removal, par. 60a(29).
(4) Remove rocker arm oil scavenger line clamp.	Wrench, $\frac{1}{16}$ in. O. E.	Remove $\frac{1}{16}$ -in. hex-hd. nut from stud of carburetor holding oil line clamp.
(5) Disconnect fuel lines.	Wrenches, $\frac{1}{2}$ in., $\frac{1}{16}$ in., $1\frac{1}{16}$ in., $\frac{3}{4}$ in., O. E.	Disconnect fuel line from fuel pump to carburetor at carburetor end of line. Disconnect bypass fuel line at fitting on copper tube nearest flexible tube.
(6) Remove throttle lever.	Wrench, $\frac{1}{2}$ in., O. E. Pliers.	Remove cotter pin and $\frac{1}{16}$ -in. hex-hd. nut on end of carburetor throttle shaft, and remove lever with linkage attached. Mark lever to indicate proper position for assembly.
(7) Disconnect throttle rod.	Pliers	Pull cotter pin and clevis from adjustable clevis on end of throttle rod.

<i>Specific step</i>	<i>Equipment</i>	<i>Procedure</i>
(8) Remove governor	Wrench, $\frac{11}{16}$ in., O. E. Wrench, $\frac{1}{16}$ in., O. E. or B.	Disconnect oil line to governor at governor end. Remove four $\frac{3}{8}$ -in. hex-hd. palnuts and nuts from studs holding governor to engine accessory drive. Remove governor.
(9) Remove carburetor	Special wrench, $\frac{1}{2}$ in., B. Regular wrench, $\frac{1}{2}$ in., B.	Remove locking wire and $\frac{3}{16}$ -in. hex-hd. nuts from studs holding carburetor to manifold. Use special wrench for nuts nearest cylinders, and be careful not to drop carburetor. Remove carburetor through inspection plate hole in floor.

e. Carburetor installation.

<i>Specific step</i>	<i>Equipment</i>	<i>Procedure</i>
(1) Install carburetor	Special wrench, $\frac{1}{2}$ in., B. Regular wrench $\frac{1}{2}$ in., B.	Using a new gasket, install carburetor on manifold, securing in place with $\frac{3}{16}$ -in. hex-hd. nuts. Install locking wire.
(2) Install governor	Wrench, $\frac{11}{16}$ in., O. E. Wrench, $\frac{1}{16}$ in., B. or O. E.	Put governor in place on engine accessory case and secure with four $\frac{3}{8}$ -in. hex-hd. palnuts and nuts.
(3) Connect throttle rod	Pliers	Install clevis pin and cotter pin on end of throttle rod.
(4) Install throttle lever	Wrench, $\frac{1}{2}$ in., O. E. Pliers.	Place lever on carburetor throttle shaft, making certain that serrations slip into the same position as on removal. Install $\frac{3}{16}$ -in. hex-hd. nut and cotter pin.
(5) Connect fuel lines	Wrenches, $\frac{1}{2}$ in., $\frac{3}{16}$ in., $\frac{11}{16}$ in., $\frac{3}{4}$ in., O. E.	Connect fuel lines to carburetor.
(6) Install rocker arm oil scavenger line clamp.	Wrench, $\frac{3}{16}$ in., O. E.	Install $\frac{3}{16}$ -in. hex-hd. nuts on stud of carburetor holding oil line clamp.
(7) Install carburetor air horn.		See engine installation, par. 60b (14).
(8) Install inspection plate in floor of engine compartment.		See engine installation, par. 60b (15).
(9) Open fuel valves at tanks.		
(10) Check all lines for leaks.		
(11) Adjust carburetor		See <i>b</i> above for carburetor adjustment.

53. Governor.—An engine-driven, centrifugal type governor is provided to prevent an engine speed in excess of that recommended by the manufacturer. The governor is mounted on the accessory case below the generator driving pulley. No adjustment, maintenance, or replacement will be attempted by the using arm personnel.

54. Air cleaners.—*a. Description.*—Two oil bath type air cleaners are used and are mounted on the left and right rear sponson plates.

b. Maintenance.—After each 25-hour period of normal use, or daily, when conditions are extremely dusty, the air cleaner will be serviced as follows (fig. 30) :

- (1) Loosen thumbscrews on cup retaining rods and remove cup.
- (2) Remove cup disk and retaining spring (fig. 30).
- (3) Empty oil and dirt and thoroughly clean cup, disk, and spring (fig. 30).
- (4) Carefully fill to oil level line with SAE 10 oil and replace cup disk and retaining spring.

(5) Replace cup in cleaner and tighten retaining rod nuts.

c. Replacement.—(1) Loosen air cleaner outlet hose clamps and hose.

(2) Remove bolts clamping air cleaner support bands and remove cleaner.

(3) To install, reverse above procedure.

d. Cleaning filter element.—(1) Remove air cleaner.

(2) Remove cup and disk assembly.

(3) Wash filter element with cleaning fluid or gasoline.

(4) Apply compressed air through the cleaner outlet connection to blow out loosened dirt and to dry the filter element.

(5) Assemble and install air cleaner.

55. Fuel pump.—*a. General.*—The fuel pump is mounted on the accessory case to the right of the generator drive pulley. Fuel is drawn from the supply tank through the fuel filter and pumped to the carburetor. No maintenance will be attempted in the field. Should the fuel pump become inoperative it will be removed and replaced by a serviceable unit.

b. Replacement.—(1) Close fuel shut-off valves.

(2) Disconnect fuel lines at pump.

(3) Remove palnuts and nuts securing pump body to accessory case.

(4) Remove the fuel pump and pump drive shaft.

(5) To install, reverse the above procedure, being careful that no dirt or foreign matter enters the fuel pump drive aperture.

56. Starter.—*a. Description.*—An Eclipse Model EC 404-1-B 12-volt electric starter, with provision for hand cranking, is flange-mounted at the top of the accessory case.

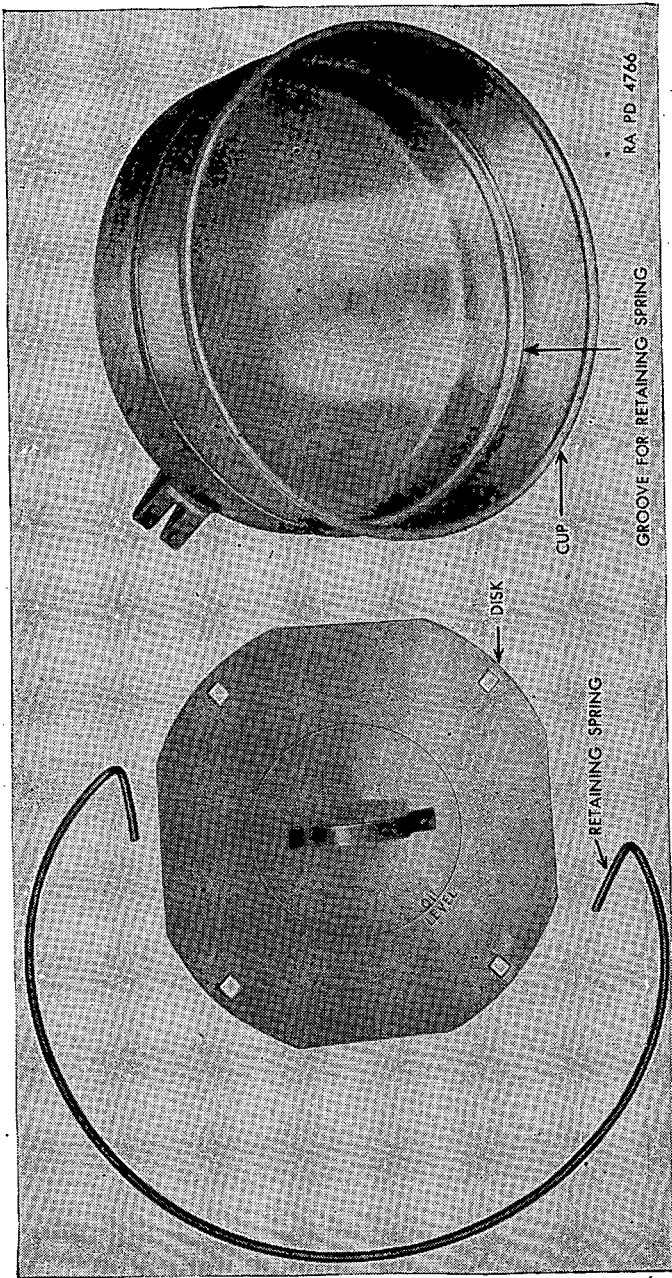

FIGURE 30.—Air cleaner parts requiring cleaning.

b. Maintenance.—Starter failure or faulty operation, if caused by other than loose or corroded terminals, will not be corrected by the using arm personnel.

c. Lubrication.—No attempt will be made to lubricate the starter by company maintenance. Starters are only lubricated by manufacturer and ordnance at major overhauls.

d. Replacement.—(1) Open battery switch.

(2) Remove terminal guard and disconnect starter end of starter switch cable.

(3) Remove locking wire and six nuts securing starter to accessory case.

(4) Remove the starter and gasket.

(5) To install, reverse the removal procedure, making certain that the starter mounting flange and mounting pad are clean and that a proper flange gasket is in place.

57. Generator.—*a. Description.*—A 12-volt generator is bracket-mounted on the web of the lower left side of the engine support beam. The generator is driven by two V-belts from a pulley on the accessory case.

b. Maintenance.—No maintenance, other than belt adjustment, will be attempted by the using arm personnel. The generator will require no lubrication between engine overhaul periods. Inspection to insure clean, tight terminals will be made every 25 hours of engine operation.

c. Replacement.—The generator when found to be defective will be removed and replaced by a serviceable unit, using the following procedure:

(1) Open battery switch.

(2) Remove locking wire and four cap screws holding generator to generator mounting bracket.

(3) Tilt pulley end of generator upward and remove drive belts.

(4) Remove locking wire and screws from terminal guard cover.

(5) Remove terminal guard cover.

(6) Remove nut from terminal post and disconnect terminal.

(7) Remove clamp holding conduit.

(8) Disconnect conduit from generator and remove generator.

(9) To install, reverse the above procedure, being sure to properly secure the conduit clamp and cable terminal.

(10) Adjust drive belts.

(a) Remove locking wire and loosen the four cap screws in the adjusting slots so that the mounting bracket can be moved by tapping.

(b) Move generator mount as is needed to provide the correct belt

tension (easy thumb pressure on the belts at the center point between pulleys should depress the belts approximately $\frac{1}{2}$ inch). Tighten cap screws and replace locking wire.

58. Valve mechanism.—*a. General.*—The valve mechanism is completely enclosed and is lubricated by the low pressure side of the engine oiling system. Because of the limited space most of the operations on the lower cylinders can only be accomplished with the engine out of the vehicle.

b. Maintenance.—Frequent inspection will be made to insure that rocker box covers are tight and that the cover gaskets are in good condition. Should an oil leak appear the leaking cover gasket will be replaced.

c. Replacement.—Valve rockers and valve push rods may be replaced by the using arm personnel when these parts are proved defective; To make these replacements use the following procedure:

(1) *Valve rocker replacement.*—(a) Remove rocker box cover and gasket.

(b) Hand crank engine until the piston in the cylinder being worked on is at top dead center of the compression stroke, so that the valves are closed.

(c) Remove cotter pin, nut, and washers from rocker shaft.

(d) Remove rocker shaft and outside washer, using aluminum drift.

(e) Remove rocker and two inside thrust washers.

(f) *Valve rocker installation.*—With the valve adjusting screw lock nut loose and the screw backed off as needed, proceed in reverse order to valve rocker removal. A new rocker box cover gasket will always be used. After installation the valve clearance will be adjusted as in (3) below.

(2) *Push rod replacement.*—(a) Remove rocker as described in (1) above.

(b) Remove push rod.

(c) To install, reverse above procedure.

(3) *Valve adjustment* (fig. 33) (engine out of vehicle).—(a) Remove front set of spark plugs to facilitate turning crankshaft.

(b) Remove rocker box cover.

(c) Close spark plug hole with thumb and rotate crankshaft until pressure indicates the compression stroke. Continue the rotation slowly until no added pressure is felt, indicating that top dead center has been reached.

(d) Using a 0.010-inch feeler gage, check the clearance between the rocker roller and the valve stem on both the intake and exhaust valve.

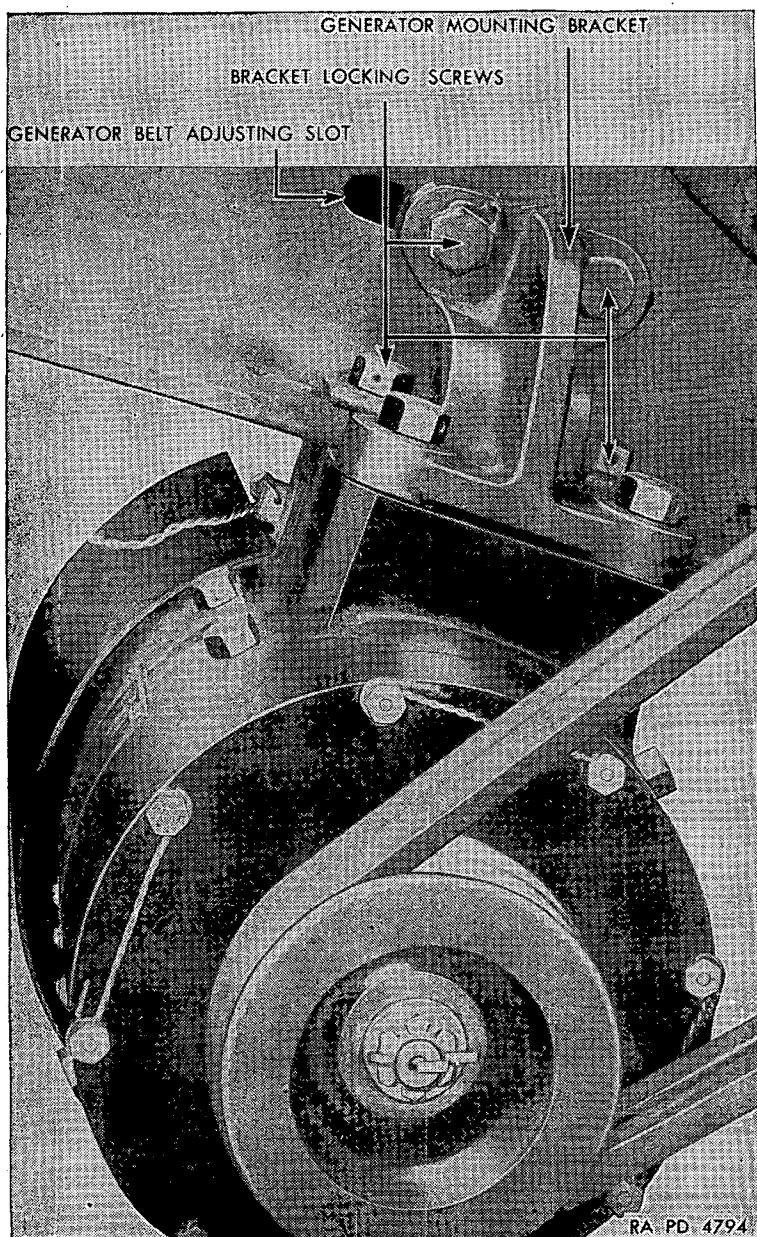

FIGURE 31.—Generator belt adjustment.

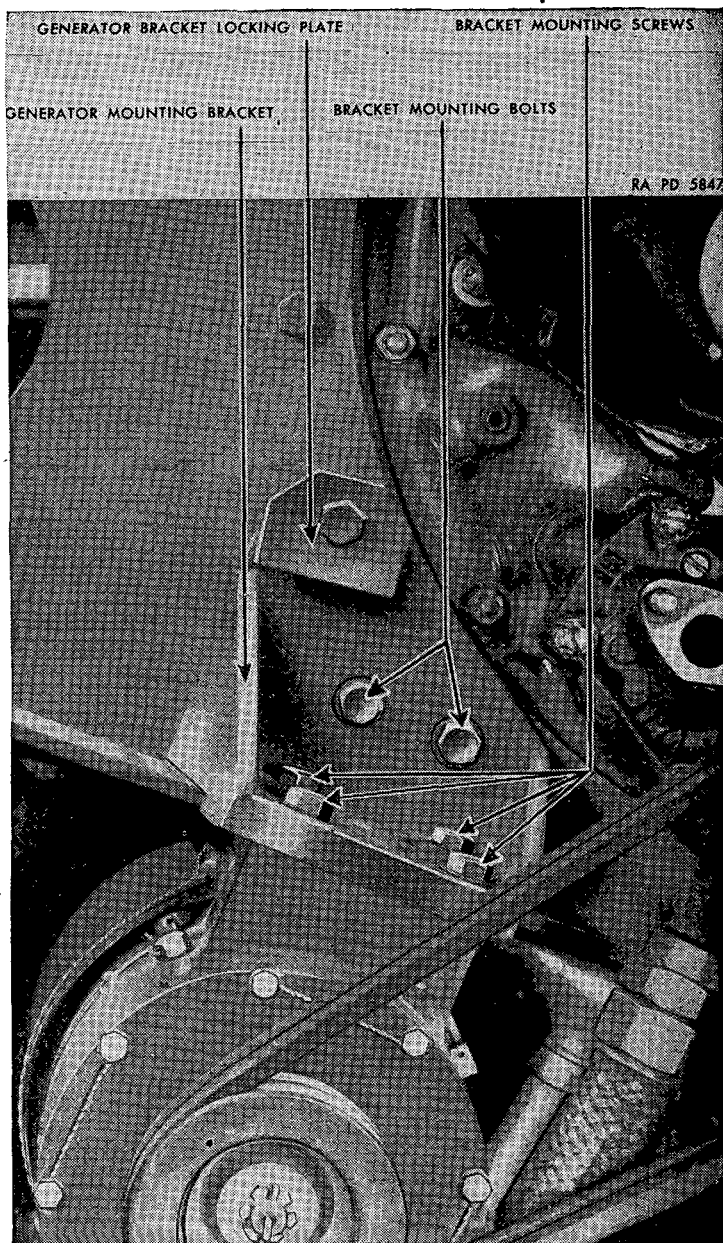

FIGURE 32.—Generator mounting bracket.

RA PD 4735

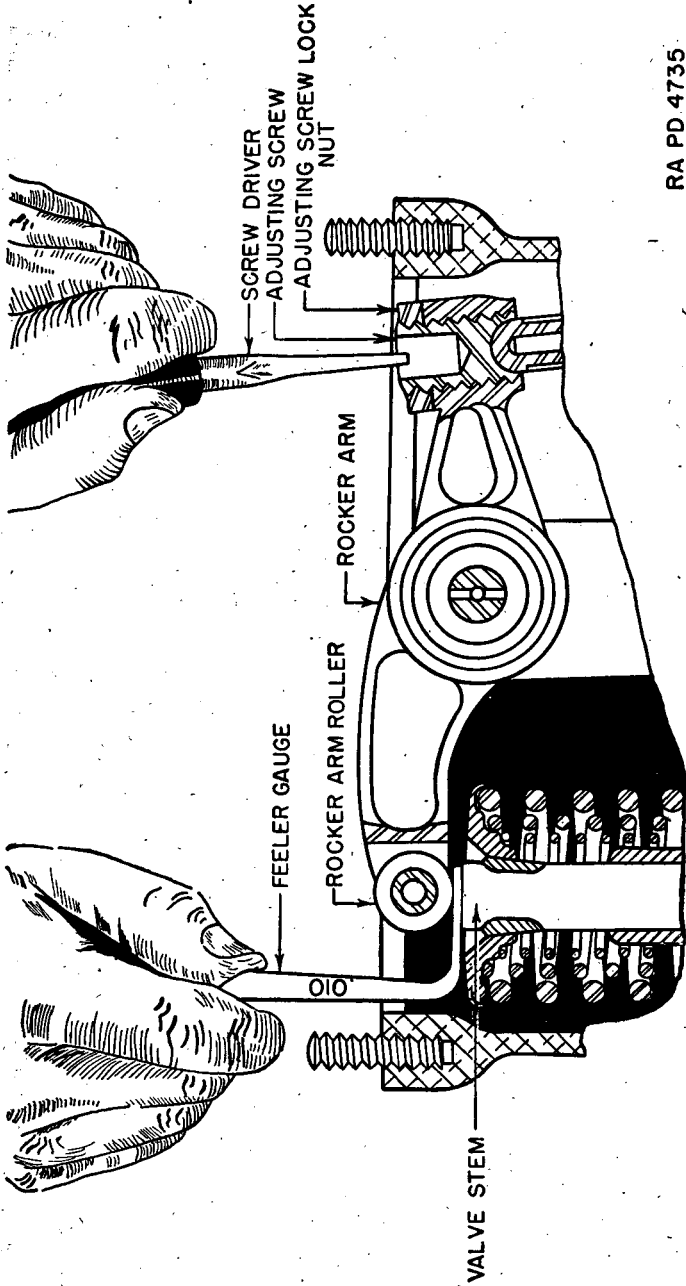

FIGURE 33.—Adjusting valve clearance, Continental engine.

The feeler gage should slide between the roller and valve stem with only a slight drag when the clearance is correct. If the clearance is correct, no further adjustment is necessary. If not correct, proceed with steps (e), (f), and (g) below.

(e) Loosen adjusting screw lock nut (fig. 33).

(f) Using a screw driver having the right bit size ($\frac{3}{32}$ by $\frac{1}{2}$ inch), turn the adjusting screw until the correct clearance is obtained.

(g) Tighten adjusting screw lock nut and recheck valve clearance.

(h) Using a new rocker box cover gasket, install rocker box cover.

(i) When both valves are checked and adjusted, repeat the above procedure on all cylinders.

59. Manifolds.—*a.* Inlet manifolds in the form of ducts are cast into the rear crankcase section. From these ducts the gas mixture is drawn through inlet pipes to the individual cylinders.

b. The exhaust manifold is in two sections, one on the right and one on the left side of the engine. The manifolds are connected to the individual cylinder exhaust pipes by means of slip joints. The manifolds will be carefully inspected for cracks at the time of the 100-hour check and necessary replacements will be made at that time.

c. Replace exhaust muffler and connecting flexible pipe as follows:

(1) Remove the bolts and nuts from the muffler clamp.

(2) Drop the clamps and pull the muffler and flexible pipe away from the exhaust manifold.

(3) Muffler installation is accomplished by reversing the above procedure.

60. Engine replacement.—The removal and installation of the engine will be accomplished by the using arm personnel only when time, favorable terrain, available personnel, and equipment are assured. The operations will never be attempted unless a satisfactory hoist and engine stand are available.

a. Engine removal.—Use the following procedure to remove the engine from the vehicle:

Specific step	Equipment	Procedure
(1) Open battery switch.....		
(2) Shut off fuel lines... None.....		Close fuel line valves below fuel tanks.
(3) Remove pioneer tools from armor plate.		
(4) Remove engine rear screen.	Wrench, $\frac{3}{4}$ in.....	Remove four $\frac{1}{2}$ -in. hex-hd. cap screws.
(5) Open engine compartment doors.	Wrench, $\frac{3}{4}$ in.....	Remove three $\frac{1}{2}$ -in. hex-hd. cap screws in door.

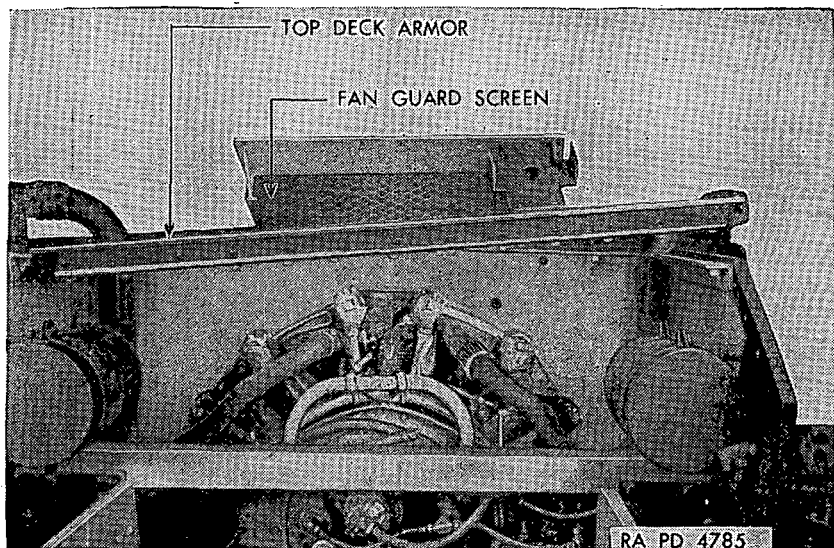

FIGURE 34.—Removal of fan guard and top deck armor.

<i>Specific step</i>	<i>Equipment</i>	<i>Procedure</i>
(6) Remove tail lamps from support brackets.	Screw driver-----	Remove two screws from bracket. Allow lamp to be supported by leads.
(7) Remove fan guard screen.	Wrench, $\frac{1}{16}$ in.-----	Remove two $\frac{3}{8}$ -in. cap screws nearest turret.
(8) Disconnect aerial bracket from fan guard and screen.	Wrench, $\frac{3}{4}$ in.-----	Remove two $\frac{1}{2}$ -in. hex-hd. cap screws on aerial bracket.
(9) Remove fan guard plate and screen.	Screw driver drag-link.	Remove nine $\frac{1}{2}$ -in. slotted-head cap screws.
(10) Remove shroud bolts from rear top deck armor plate.	Screw driver drag-link.	Remove four $\frac{3}{8}$ -in. slotted-head cap screws.
(11) Disconnect expansion tank end of wet breather line and remove reservoir.	Wrenches, $\frac{7}{8}$ in., $1\frac{1}{16}$ in., O. E.	Disconnect line fittings at tank and reservoir.
(12) Remove breather line clamp from banjo housing.	Wrench, $\frac{1}{2}$ in., O. E.	Remove clamp bolt and nut.
(13) Remove top deck armor plate.	Hoist, Drag-link, Screw driver.	Remove slotted-head screws and lift armor plate.
(14) Remove mufflers--	Two wrenches, $\frac{3}{16}$ in.	Remove $\frac{3}{8}$ -in. nuts on upper ends of muffler support clamps. Remove muffler and short length of flexible tubing. Close exhaust pipes by tying cloth over ends.

LIGHT TANK M3

<i>Specific step</i>	<i>Equipment</i>	<i>Procedure</i>
(15) Remove tail light cable clamp.	Screw driver-----	Remove clamp screw in engine door upper cross-member.
(16) Disconnect inlet oil line at engine pump.	Wrench, 1¼ in., O. E.	Disconnect 1¼-in. coupling. Plug ends with cloth.
(17) Disconnect outlet oil line at engine pump.	Wrench, 1¼ in., O. E.	Disconnect 1¼-in. coupling. Plug ends with cloth.
(18) Remove booster coil	Wrench, ½ in., O. E. Pliers.	Disconnect conduit coupling at each magneto and remove high tension connector. Disconnect conduit coupling at booster coil and remove connector. Remove booster coil from bracket mounting by removing two bolts and nuts. Let booster coil hang from conduit leading to terminal box.
(19) Remove starter solenoid switch.	Wrench, ⅝ in., soc. Pliers. Screw driver.	Remove terminal shield cover from starter by removing locking wire and two screws. Disconnect conduit coupling from shield. Disconnect starter lead from starter terminal post. Pull starter lead with conduit away from starter. Remove two bolts and nuts holding switch to bracket. Let starter solenoid switch hang from the two conduits leading to the terminal box.
(20) Disconnect governor oil line.	Wrenches, ⅝ in., 1¼ in., O. E.	Disconnect line at end of flexible tube. Plug ends with cloth.
(21) Disconnect fuel bypass line.	Wrenches, ⅝ in., ½ in., O. E.	Disconnect at end of flexible tube. Plug ends with cloth.
(22) Disconnect primer line.	Wrenches, ⅝ in., ¾ in., O. E.	Disconnect at union. Plug ends with cloth.
(23) Disconnect fire extinguisher line.	Wrench, 1¼ in., O. E.	Disconnect at union. Plug ends with cloth.
(24) Disconnect tachometer drive.	Pliers, 8 in-----	Disconnect coupling at engine. Plug ends with cloth.
(25) Remove tachometer drive support bracket.	Wrench, ½ in., O. E.	Remove nut holding bracket to oil pump cover.
(26) Remove oil temperature indicator bulb.	Wrench, ¾ in., O. E.	Remove holding nut and pull bulb out of engine.
(27) Remove throttle rod passing under engine.	Pliers-----	Pull cotter and clevis pin, connecting bell crank lever to throttle rod passing under engine.
(28) Remove inspection plate from floor of engine compartment.	Wrench, ⅝ in-----	Remove locking wires. Remove ⅝-in. hex-hd. cap screws holding plate to floor.

<i>Specific step</i>	<i>Equipment</i>	<i>Procedure</i>
(29) Remove carburetor air horn.	Wrenches 1 in., ½ in. Pliers.	Remove two 1-in. hex-hd. brass drain plugs from air horn. Remove special nuts exposed by removal of drain plugs. Remove ⅙-in. nuts from air horn flanges.
(30) Loosen hose from carburetor air horn.	Pliers	Loosen hose clamps on air horn end of hose, swing air horn down.
(31) Disconnect oil pump sump line.	Pliers	Disconnect line underneath carburetor air horn by loosening hose clamp. Pull line toward rear of tank to clear hose. Plug ends with cloth.
(32) Remove generator.	Wrench, ⅙ in.	Remove four ⅙-in. hex-hd. cap screws from generator mounting flange. Remove belts and protect from oil.
(33) Remove engine shroud.	Two wrenches, ⅙ in., O. E.	Remove bolts and nuts from brackets on fuel tanks. Bow shroud in middle, then pull up.
(34) Remove ground strap.	Wrench, ⅙ in.	Remove ⅜-in. hex-hd. cap screw from engine support bracket.
(35) Disconnect banjo housing from engine support brackets.	Two wrenches, ⅙ in.	Remove four ⅜-in. hex-hd. bolts and nuts from each side.
(36) Remove propeller shaft tunnel cover.	Wrench, ⅝ in. soc.	Remove eight ⅝-in. nuts from cover, lift away to expose propeller shaft companion flange.
(37) Disconnect propeller shaft from engine.	Two wrenches, ¾ in.	Remove four ½-in. bolts and nuts from clutch and propeller shaft companion flanges.
(38) Disconnect clutch linkage.	Pliers	Pull cotter and clevis pin from lever attached to clutch yoke.
(39) Disconnect steady bar.	Wrench, ¾ in. soc., 30 in. handle.	Remove two ½-in. hex-hd. cap screws holding steady bar caps to each end of bar.
(40) Remove engine.	Hoist, Continental engine lifting hooks.	Attach lifting hooks (fig. 35) to eyes attached to studs between cylinders 1 and 2 and cylinders 1 and 7. Lift the engine vertically until engine clears top deck armor plate. Pull engine away from tank.

b. Engine installation.—Use the following procedure to install the engine in the vehicle:

<i>Specific step</i>	<i>Equipment</i>	<i>Procedure</i>
(1) Clean engine compartment thoroughly before installing engine.		

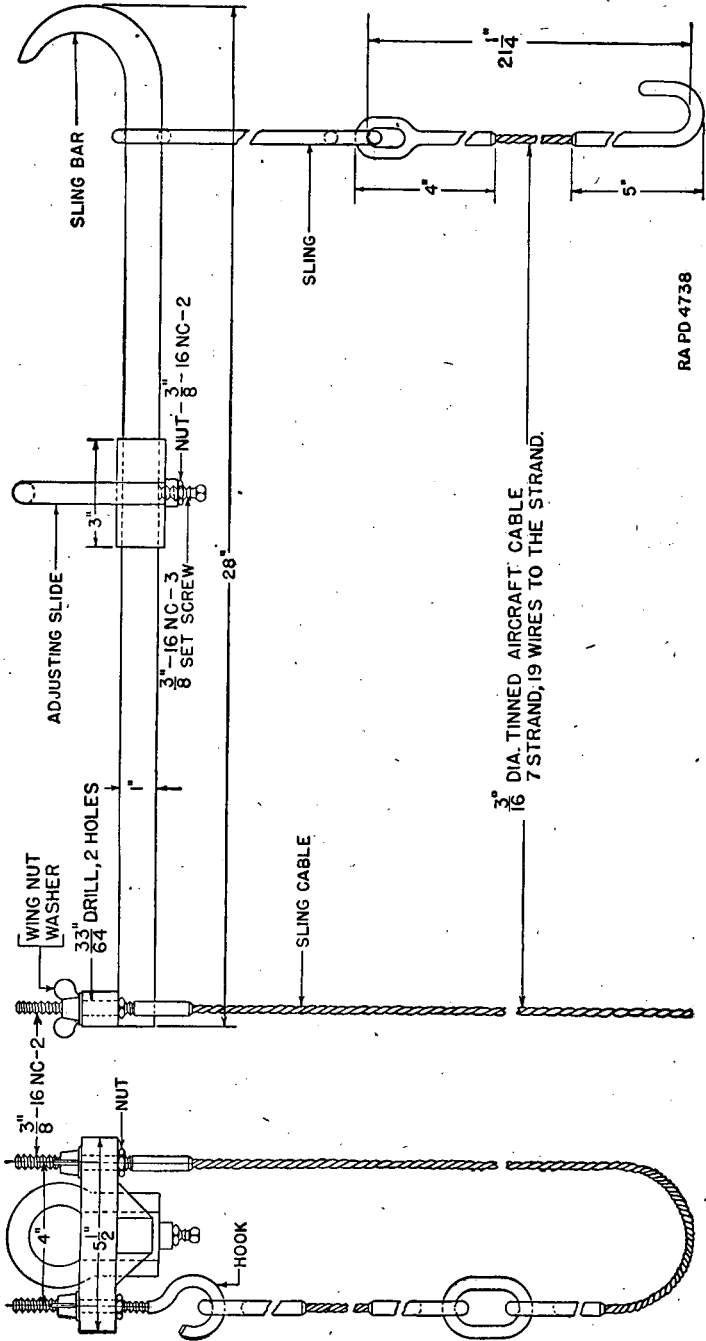

RA PD 4738

FIGURE 35.—Lifting hook, Continental engine.

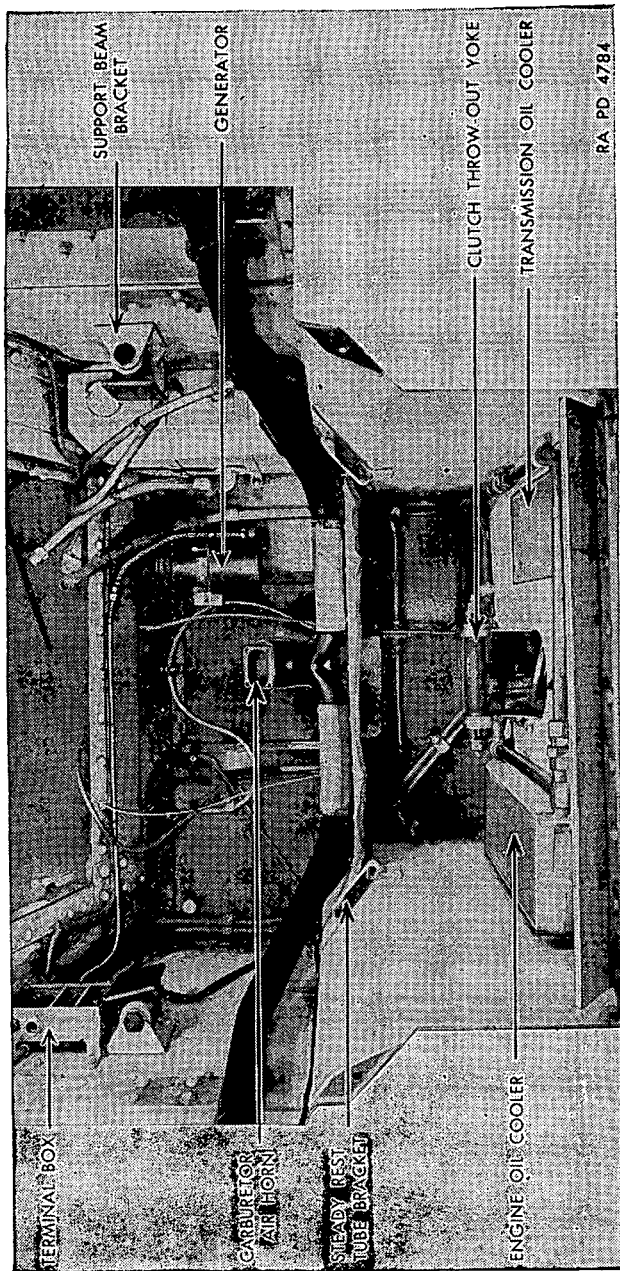

FIGURE 36.—Engine compartment.

LIGHT TANK M3

Specific step	Equipment	Procedure
(2) Inspect all fluid lines for breaks and possible leaks before installing engine.		
(3) Install engine.....	Hoist, Continental engine lifting hooks.	Using engine lifting sling, lift engine vertically, high enough to clear the top deck armor plate. Place engine in engine compartment. Have one man on top of tank to make certain clutch release bearings enter collar. Be sure generator does not interfere when installing engine. Place clutch yoke so that release bearings are as close to the propeller shaft companion flange as possible. Lower engine until banjo housing and steady bar rest in their respective places.
(4) Connect steady bar.	Wrench, $\frac{3}{4}$ in. soc., 30 in. handle.	Install two $\frac{1}{2}$ -in. hex-hd. cap screws holding each steady bar cap.
(5) Connect clutch linkage.	Pliers.....	Install clevis and cotton pins on lever attached to clutch yoke.
(6) Connect propeller shaft with engine.	Two wrenches, $\frac{3}{4}$ in.	Install four $\frac{1}{2}$ -in. bolts and nuts to connect clutch and propeller shaft companion flanges together.
(7) Install propeller shaft tunnel cover.	Wrench, $\frac{3}{8}$ in. soc..	Attach cover to tunnel by means of eight acorn nuts.
(8) Attach banjo housing to engine support bracket.	Two wrenches, $\frac{5}{16}$ in.	Using four $\frac{3}{8}$ -in. hex-hd. bolts and nuts on each side, bolt engine support beam to engine support bracket.
(9) Attach ground strap.	Wrench, $\frac{5}{16}$ in....	Attach strap to engine support bracket using a $\frac{3}{8}$ -in. hex-hd. cap screw and washers.
(10) Install engine shroud.	Two wrenches, $\frac{5}{16}$ in., O. E.	Bow shroud in middle and install. Install bolt and nut connecting shroud to bracket on each fuel tank.
(11) Install generator...	Wrench $\frac{5}{16}$ in....	Install one $\frac{3}{8}$ -in. hex-hd. cap screw connecting generator to mounting flange. Install belts. Install remaining three cap screws.
(12) Connect oil pump sump line.	Pliers.....	Slip line into hose and tighten clamp. Caution: In connecting lines, do not connect the wrong lines together. Pay particular

<i>Specific step</i>	<i>Equipment</i>	<i>Procedure</i>
(13) Aline carburetor air horn and tighten clamps.	Pliers-----	attention to the large oil lines leading to the main oil pump of engine. Do not expose open ends of lines until ready to connect them. Lift carburetor air horn up into position and tighten clamps.
(14) Install carburetor air horn.	Wrenches, 1 in., ½ in. Pliers.	Install ⅝-in. nuts on studs holding carburetor body and air horn together. Install special nuts, working through drain plug holes. Install drain plugs.
(15) Install engine inspection plate.	Wrench, ⅝ in.---	Put inspection plate in place on lower side of floor and secure with ⅜-in. hex-hd. cap screws. Install locking wire.
(16) Install throttle rod passing under engine.	Pliers-----	Install cotter and clevis pin in lever mounted on governor.
(17) Install oil temperature indicator bulb.	Wrench, ⅝ in., O. E.	Insert bulb in oil screen receptacle and secure with retaining nut.
(18) Install tachometer drive.	Pliers, 8 in.-----	Aline shaft and connect coupling at engine.
(19) Install tachometer drive support bracket.	Wrench, ½ in., O. E.	Install bracket under retaining nut on fuel pump cover.
(20) Connect fire extinguisher line.	Wrench, ⅝ in., O. E.	Connect at union.
(21) Connect primer line.	Wrenches, ⅞ in., ⅝ in., O. E.	Connect at union.
(22) Connect fuel bypass line.	Wrenches, ⅝ in., ½ in., O. E.	Connect at end of flexible tube.
(23) Connect governor oil line.	Wrenches, ⅝ in., ¼ in., O. E.	Connect line at end of flexible tube.
(24) Install booster coil.	Wrench, ½ in., O. E. Pliers.	Mount booster coil on bracket, using two bolts and nuts. Connect high tension leads of booster coil. Connect leads to magnetos.
(25) Install starter solenoid switch.	Wrench, ⅝ in. soc. Pliers, Screw driver.	Mount switch on bracket, using two bolts and nuts. Connect lead to starter terminal post. Install terminal shield cover, screws, and locking wire.
(26) Connect outlet oil line to engine oil pump.	Wrench, 1¼ in., O. E.	Connect line at 1¼-in. coupling.
(27) Connect inlet oil line at engine oil pump.	Wrench, 1¼ in., O. E.	Connect at 1¼-in. coupling.

<i>Specific step</i>	<i>Equipment</i>	<i>Procedure</i>
(28) Install mufflers----	Two wrenches, $\frac{1}{16}$ in.	Install short lengths of flexible tubing on exhaust pipes. Install mufflers in place. Tighten clamps.
(29) Install top deck armor plate.	Hoist, Drag-link, Screw driver.	Place armor plate in position and secure with 14 slotted-hd. screws.
(30) Connect wet breather line at expansion tank and install line from expansion tank to oil reservoir.	Wrenches, $\frac{1}{8}$ in., $\frac{1}{16}$ in., O. E.	Connect line at oil expansion tank.
(31) Install wet breather line clamp.	Wrench, $\frac{1}{2}$ in., O. E.	Install clamp on engine support beam, using bolt and nut.
(32) Install shroud bolts in rear top deck armor plate.	Screw driver, drag-link.	Install four $\frac{3}{8}$ -in. slotted-hd. cap screws.
(33) Install fan guard screen.	Screw driver, drag-link.	Install nine $\frac{1}{2}$ -in. slotted-hd. cap screws.
(34) Install aerial bracket on fan guard and screen.	Wrench, $\frac{3}{4}$ in.----	Install two $\frac{1}{2}$ -in. hex-hd. cap screws securing aerial bracket to top deck armor plate.
(35) Install fan guard screen.	Wrench, $\frac{1}{16}$ in.----	Install two $\frac{3}{8}$ -in. hex-hd. cap screws.
(36) Install tail lamps on support bracket.	Screw driver.-----	Install two screws securing each lamp to bracket.
(37) Install tail lamp conduit clamp.	Screw driver.-----	Install screw securing conduit clamp to engine door upper cross-member.
(38) Install engine rear screen.	Wrench, $\frac{3}{4}$ in.----	Install four $\frac{1}{2}$ -in. hex-hd. cap screws.
(39) Test fuel lines for leakage.	None-----	Open fuel line valves below fuel tank and check all fuel lines for leakage.
(40) Close engine compartment doors.	Wrench, $\frac{3}{4}$ in.----	Close doors and install three $\frac{1}{2}$ -in. hex-hd. cap screws in door.
(41) Install pioneer tools on armor plate.	None-----	Put tools in place on hull and secure.
(42) Inspect after installation.	-----	Start engine and inspect all oil and fuel lines for leaks. Stop engine.

SECTION IV

ENGINE, GUIBERSON T-1020, AND ACCESSORIES

	Paragraph
General description.....	61
Engine installation.....	62
Tabulated data.....	63
Accessory case.....	64
Oil pump.....	65
Engine lubrication.....	66
Fuel pressure pump.....	67
Fuel injector.....	68
Fuel supply pump.....	69
Air cleaners.....	70
Cartridge starter.....	71
Generator.....	72
Valve mechanism.....	73
Manifolds.....	74
Engine replacement.....	75
Trouble shooting.....	76

61. General description (fig. 37).—*a.* A single row air-cooled radial Diesel aviation type engine is used.

b. The cartridge starter, engine oil filter, fuel supply pump, governor, and decompression operating mechanism are mounted on the accessory case.

c. In this section the flywheel end of the engine will be referred to as the “front” of the engine, and the accessory case end will be referred to as the “rear” of the engine. The terms “right” and “left” are used with reference to the engine as viewed from the rear. Horizontal and vertical positions of the engine will be referred to with respect to the position of the crankshaft. (When the crankshaft is in horizontal position the engine is in the vertical position.) Direction of rotation is determined by viewing from the rear of engine, or in the case of side drives by looking toward the crankshaft.

62. Engine installation (fig. 37).—The rear of the engine is supported by a banjo type beam bolted to the crankcase. The ends of the support beam are attached to the sides of the hull by means of a double bracket incorporating a rubber mounting. The front of the engine is supported by means of a tubular steady bar attached to the crankcase. The ends of the steady bar are supported by brackets welded to the hull.

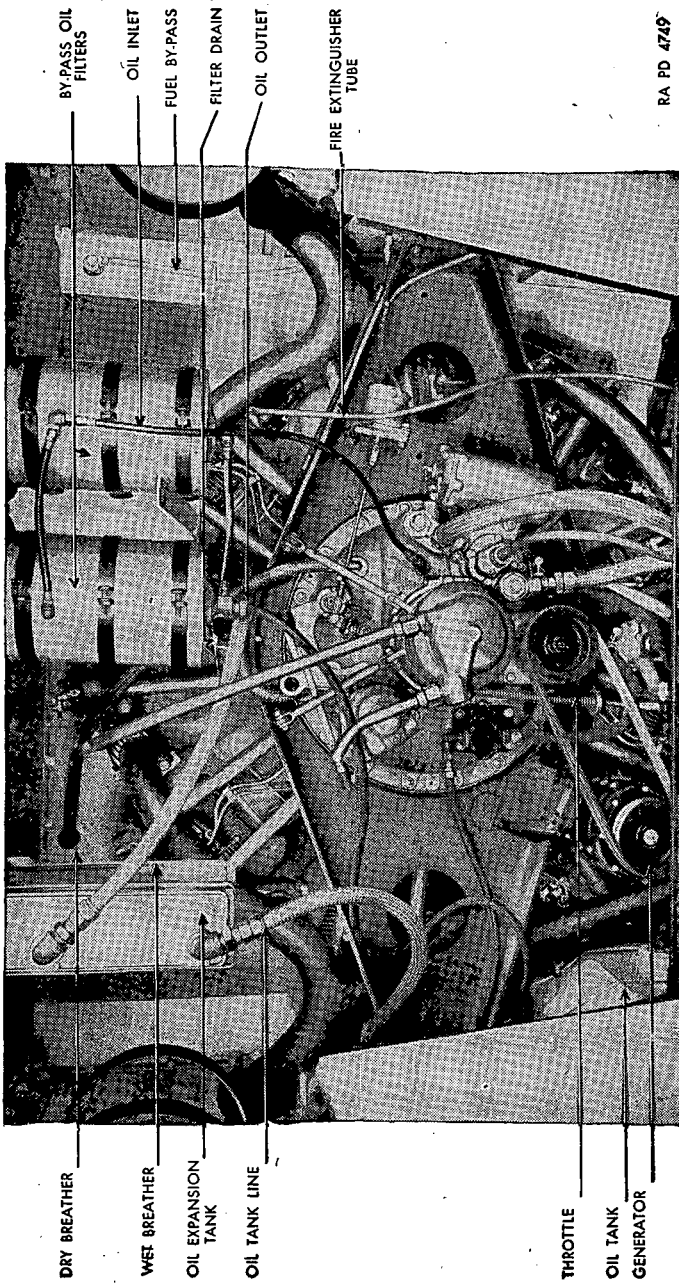

RA PD 4749

FIGURE 37.—Engine compartment, Guberson T-1020.

63. Tabulated data.

Make and type.....	Guiberson Radial Diesel.
Model and series.....	T-1020, series 4.
Over-all diameter.....	45 $\frac{7}{16}$ in.
Weight, with accessories.....	1,107 lb.
Horsepower at 2,200 rpm.....	250.
Maximum allowable rpm, full load.....	2,250 rpm.
Maximum allowable rpm, no load.....	2,325 rpm.
Number of cylinders.....	9.
Bore.....	5 $\frac{1}{8}$ in.
Stroke.....	5 $\frac{1}{2}$ in.
Piston displacement.....	1,021 cu. in.
Compression ratio.....	14.5 to 1.
Direction of rotation (viewed from rear of engine):	
Crankshaft.....	Clockwise.
Cam.....	Anticlockwise.
Tachometer.....	Anticlockwise.
Fuel pump.....	Clockwise.
Starter.....	Clockwise.
Generator.....	Clockwise.
Accessory speeds:	
Tachometer.....	$\frac{1}{2}$ crankshaft speed.
Generator.....	Twice crankshaft speed.
Valve clearance (between valve stem and roller, engine cold).....	0.020 in.
Firing order (clockwise, viewed from rear of engine).....	1-3-5-7-9-2-4-6-8.
Number one cylinder location.....	Top.

64. Accessory case (fig. 38).—The accessory case is an aluminum alloy casting, attached to the rear crankcase, and contains the entire gear train. Standard SAE flange mountings are provided for the starter, generator drive, and fuel supply pump. The accessory case also carries the oil pump, oil pressure relief valve, throttle control shaft, outlet oil connections, and engine vent holes.

65. Oil pump.—*a. Description.*—The combination oil pump consists of a pressure pump, a scavenger pump for the crankcase, and a separate scavenger pump for the rocker boxes. The two scavenger pump outlets are connected together and a single outlet from the crankcase scavenger pump housing serves as the outlet for both scavenger pumps.

b. Replacement.—(1) To replace oil pump assembly:

(a) Disconnect the inlet and outlet lines at the pump.

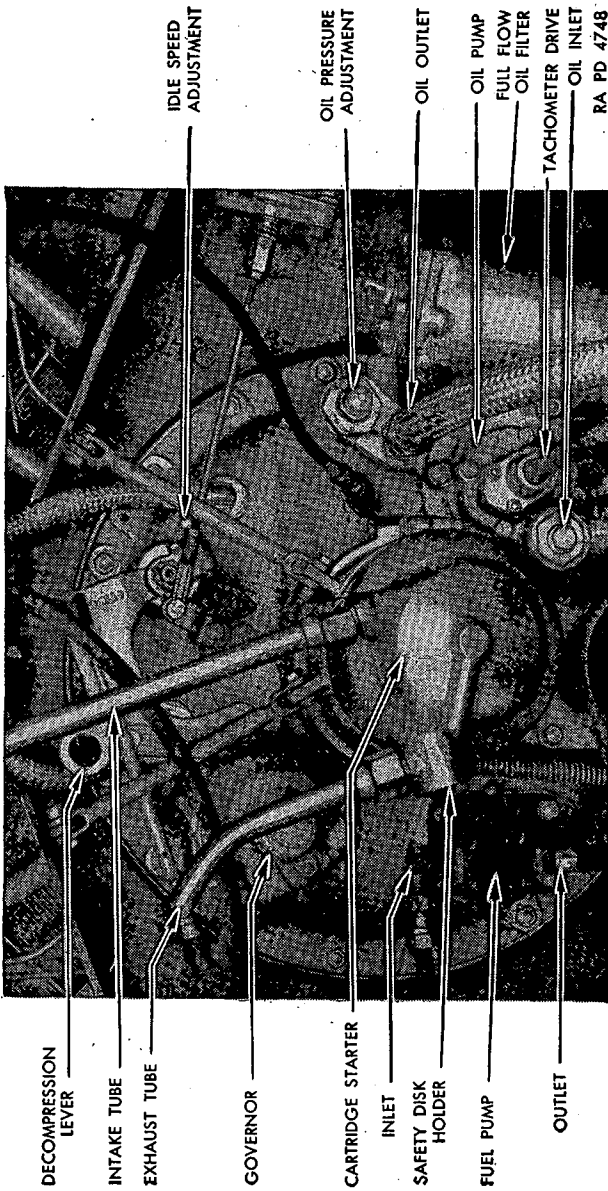

FIGURE 38.—Accessory case, Guiberson T-1020, series 4.

- (b) Disconnect the tachometer drive at the pump.
- (c) Remove the palnuts and nuts holding oil pump to accessory case.
- (d) Slide out oil pump assembly.
- (2) To install oil pump, reverse the above sequence of operations.

Caution: Care must be exercised to prevent the entrance of foreign matter into the crankcase and oil lines during the above operations.

66. Engine lubrication.—*a. Engine oil circulation* (fig. 39).—Oil is drawn from the oil tank and delivered under pressure through a full flow oil filter into a cored passage in the accessory housing. Part of this oil is forced by the spring-loaded pressure regulating valve into a second cored passage which is connected to the oil return line. A small part of the oil on the pressure side of this pump is passed slowly through the two clarifiers for the purpose of removing small particles of dirt and carbon in the oil. The remaining oil is used to lubricate the various parts of the engine. See figure 57 for the external engine oil circulating diagram. The oil pressure must not be less than 40 pounds per square inch with 160° F. oil at 500 rpm and a maximum of 95 pounds per square inch at 2,250 rpm. Normal oil pressure at 2,250 rpm is 85 pounds per square inch.

b. Oil filters.—(1) *Full flow disk type oil filter.*—The full flow oil filter is a disk type filter whose element may be cleaned by turning the handle on the head of the filter one complete revolution in either direction. Never use a wrench or tool to turn the handle of this filter. If the handle cannot be turned one complete revolution by hand, remove filter element and clean.

(a) *Maintenance.*

1. Turn handle one complete revolution at every opportunity.
2. Every 25 hours of operation remove the plug from the bottom of the filter body and allow the filter to drain.

(b) *Replacement.*

1. Remove nuts from studs of filter body and lift filter element out of body. This element is easily damaged and should not be dropped or roughly handled (fig. 38).
2. Proceed in reverse order to install new filter element.

(2) *Bypass filter.*—To remove the smaller particles of carbon and dirt in the lubricating oil, two large oil filters connected in parallel, are used (fig. 39).

(a) *Maintenance.*

1. Every 25 hours of operation remove the 1/8-inch pipe plug from the bottom of each filter body and allow the filter to drain.

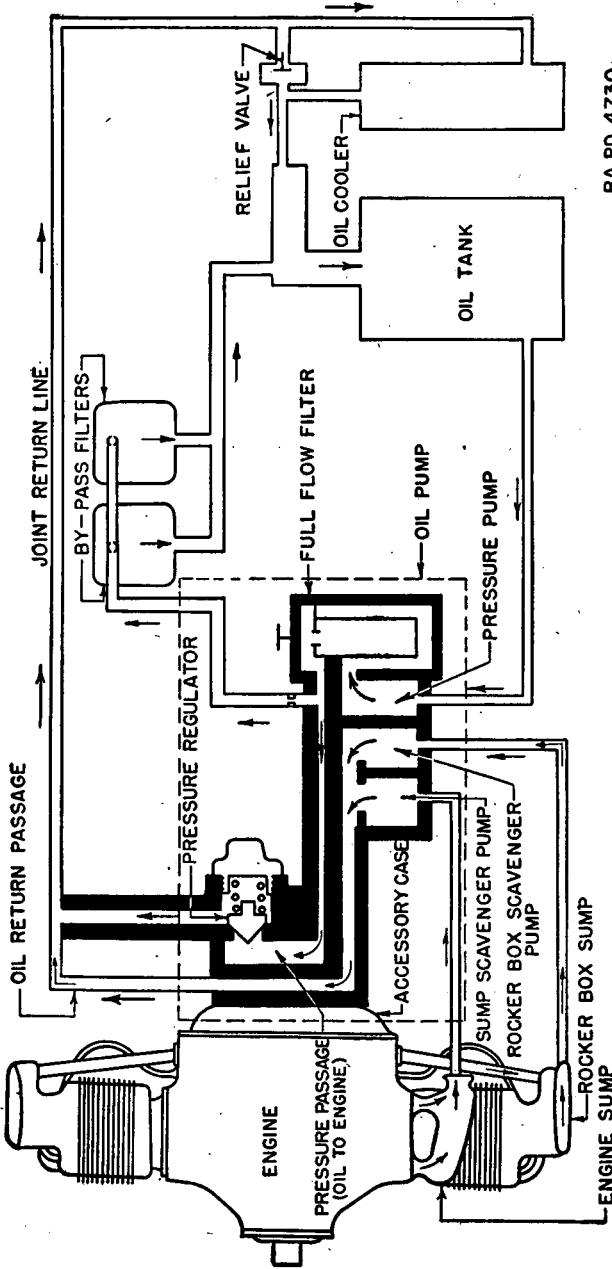

RA PD 4730

FIGURE 39.—Oil circulation diagram, Guberson Diesel engine.

2. Replace the filtering element of each filter when a sample of oil taken from the filter discharge line does *not* compare favorably in color with new oil. A sample of oil will be taken at the 25-hour inspection.

(b) *Replacement.*

1. Remove the lines between the filters and disconnect the inlet and outlet lines at the filters.
2. Remove nuts and bolts from clamps holding filters to support bracket.
3. Remove filters.
4. Remove nuts holding filter head to body.
5. Remove head and used element, preserving gasket if possible.
6. Using a new element, and if necessary a new gasket, reverse procedure for installing the filters.

67. Fuel pressure pump (fig 40).—Each cylinder has an independent high pressure pump connected to the fuel injector by means of thick wall high pressure tubing (fig. 42). The pumps are mounted on the rear half of the crankcase in back of their respective cylinders. In operation these pumps produce enough pressure to force fuel through the fuel injector valves, and also control the quantity of fuel going into the combustion chambers. Replacement of a fuel pressure pump will not be attempted by the using arm personnel.

68. Fuel injector (fig 42).—*a. Description.*—On each cylinder head a fuel injector atomizes the fuel sprayed into the combustion chamber.

b. Replacement.—(1) To remove the fuel injector, use the following procedure:

- (a) Disconnect high pressure pump line at high pressure pump end.
- (b) Disconnect fuel return line at crankcase end.
- (c) Remove palnuts and nuts from studs in cylinder head holding injector in place.
- (d) Lift out injector.

(2) In installing a new fuel injector always use a new copper gasket. Always mark the same number on the injector as the cylinder number on which it is to be used. Tighten nuts holding fuel injector to cylinder head *evenly*, since the copper gasket is the injector seal, and the injector flange does *not* contact the cylinder head. After starting engine, check lines for leaks.

69. Fuel supply pump.—*a. Description.*—A positive displacement fuel supply pump mounted on the accessory case to the left of the starter draws fuel from the tank via the fuel filter. The fuel

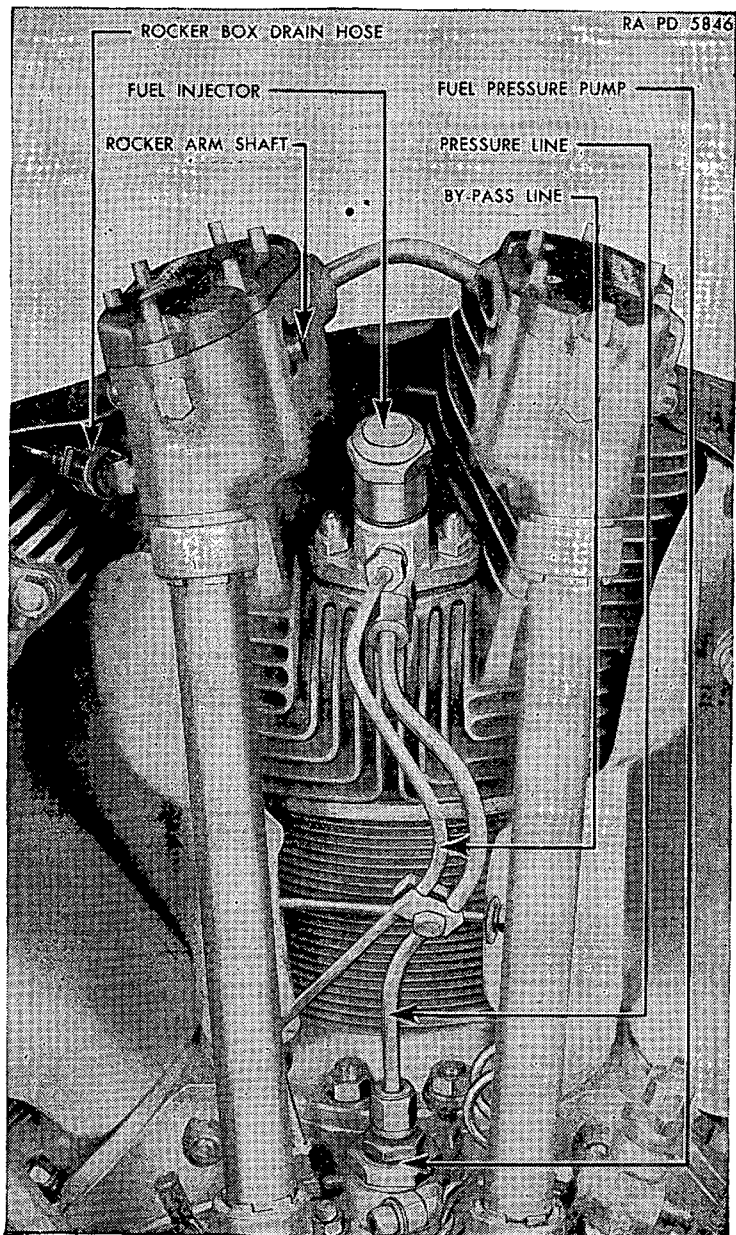

FIGURE 40.—Rear view of No. 1 cylinder, Guiberson T-1020.

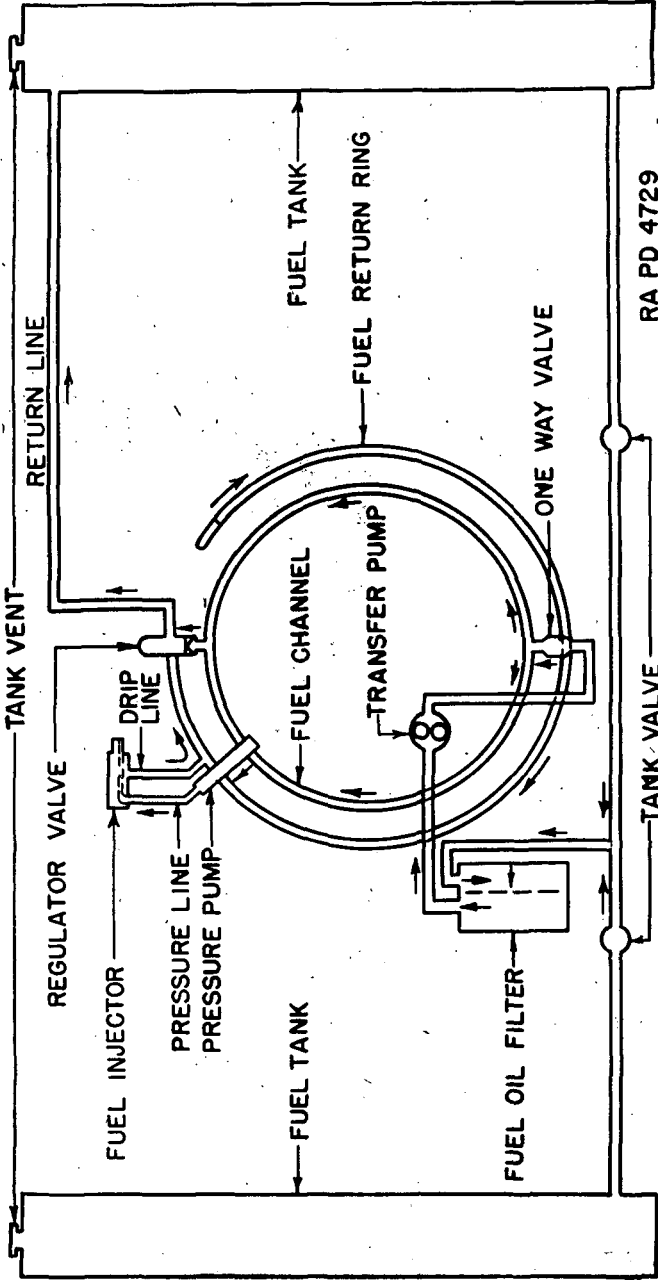

FIGURE 41.—Fuel circulation diagram, Guiberson engine.

is delivered to the pressure pumps of the engine through a one-way check valve located between the fuel supply pump and engine fuel channel. This check valve serves to prevent fuel draining from the channel.

b. Maintenance.—At the 25-hour inspection, check for leakage at the joints and fittings. Remove the $\frac{1}{8}$ -inch pipe plug located behind the pump outlet line on the lower side of the pump body. If fuel continues to drip out of this hole with the fuel tank valves open, replace the pump with a serviceable one.

c. Replacement.—(1) In the event the fuel pump fails to supply

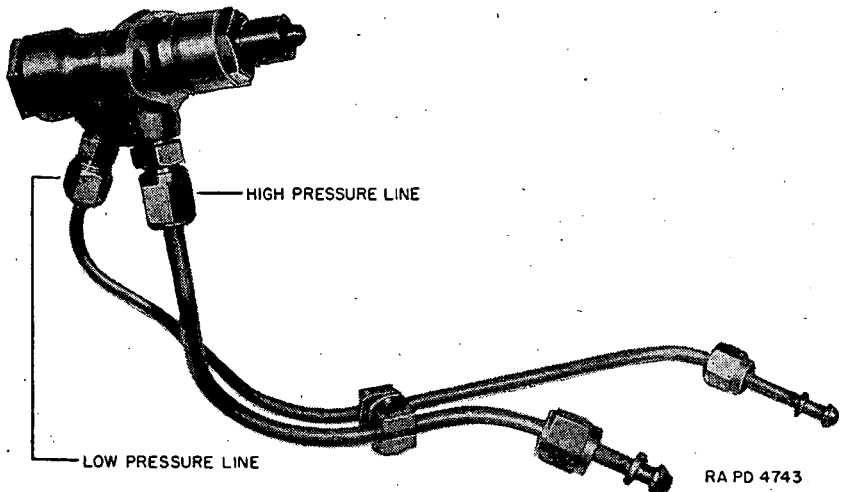

FIGURE 42.—Fuel injector valve, Guiberson engine.

fuel under 3- to 8-pound pressure, depending on the engine rpm, replace the pump using the following procedure:

- (a) Close fuel shut-off valves.
 - (b) Open doors to engine compartment.
 - (c) Disconnect fuel lines attached to pump.
 - (d) Remove palnuts and nuts from studs of accessory case holding pump to accessory case.
 - (e) Remove pump.
- (2) To replace pump, proceed in reverse order.

70. **Air cleaners.**—See paragraph 54.

71. **Cartridge starter** (fig. 42).—*a. Description.*—Cartridge engine starters derive their power for operation from the gas pressure developed when a cartridge is fired. A fresh cartridge is required for each start. The complete starter and breech assemblies consist of—

(1) *Starter unit.*—The starter is located on the engine accessory case and utilizes the gas pressure developed by the firing of the cartridge to revolve the crankshaft of the engine.

(2) *Breech assembly.*—This assembly is located in the driver's compartment and is the mechanism in which the cartridge is fired.

(3) *Intake tube assembly.*—This assembly transmits the gas pressure from the breech assembly to the starter assembly.

(4) *Exhaust tube.*—The exhaust tube releases the gas pressure to atmosphere.

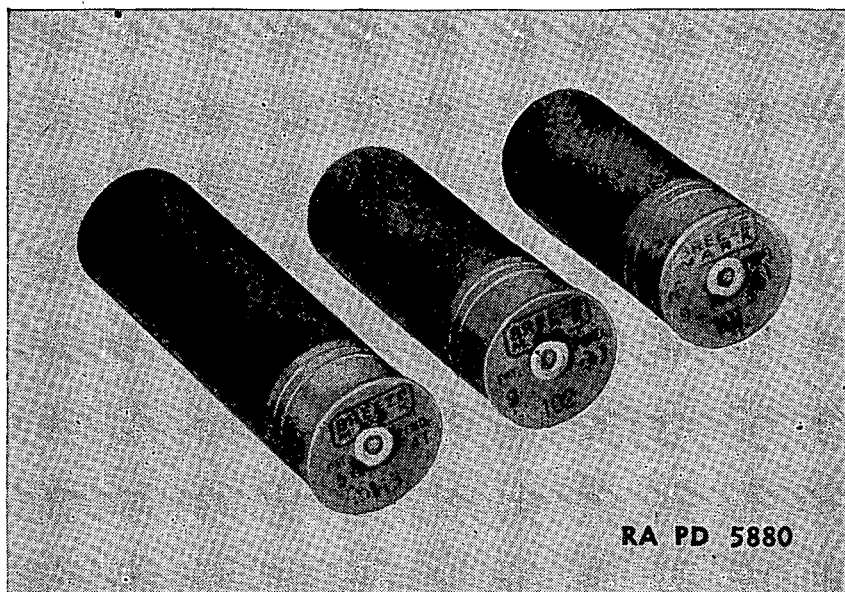

FIGURE 43.—Cartridges—cartridge starter.

(5) *Toggle switch.*—A switch is provided on the dash to transmit an electric current to the breech assembly for firing the cartridge.

(6) *Safety disk and holder.*—The safety disk holder is a screw plug in the starter assembly located near the exhaust tube flare nut.

b. Maintenance.—(1) Using a cotton swab soaked with penetrating oil, clean the breech barrel each time a longer cartridge is used than the preceding one or if 25 cartridges have been fired.

(2) When 50 cartridges have been fired, use the following procedure for cleaning the combustion chamber.

(a) Disconnect the intake and exhaust tubes at the starter unit.

(b) Install a dummy nut on the combustion chamber exhaust connection.

(c) Using a soft hammer, tap the dummy nut to loosen the combustion chamber. The combustion chamber is attached to the cylinder by means of a milled right-hand thread. Remove the combustion chamber.

(d) Clean the interior of the combustion chamber and the exhaust valve.

(e) Clean the holes and the surfaces of the perforated disk, sliding it away from the cylinder to prevent dirt from dropping in the cylinder.

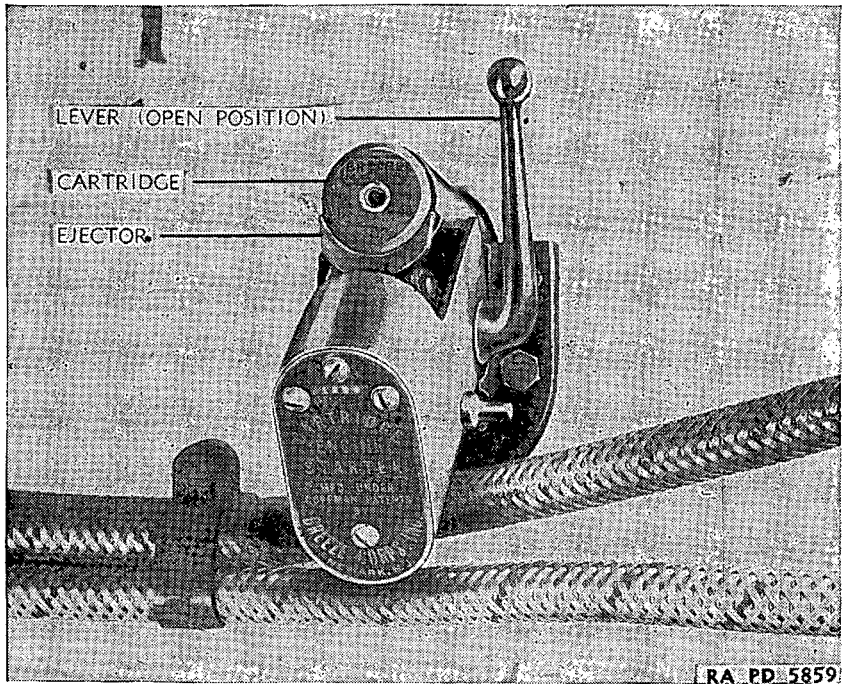

FIGURE 44.—Cartridge starter breech assembly.

(f) Reverse the above sequence of operations to install the combustion chamber.

(3) After 100 hours of operation, replace the breech and starter assemblies.

c. Replace starter assembly.—(1) Disconnect intake and exhaust tubes at starter (fig. 38).

(2) Loosen clamp bolt and nut on starter.

(3) Remove bolts and nuts from clamp end of support arms.

(4) Remove nuts from studs on accessory case holding starter to accessory case.

(5) Remove starter.

(6) To install starter, proceed in reverse order, adjusting tension on support arms by correctly locating the clamp around the body of the starter.

d. Replace breech assembly.—(1) Remove fan guard screen (see par. 60a(7)).

(2) Disconnect intake tube from breech assembly at flare nut on end of breech barrel.

(3) Disconnect electrical connections at breech assembly end.

(4) Remove bolts and nuts holding breech assembly to bulkhead.

(5) Remove breech assembly.

(6) To install, reverse the above procedure.

e. Replace safety disk and holder (fig. 46).—(1) Remove locking wire.

(2) Remove holder.

(3) Remove the defective safety disk by inserting a pointed tool through the notch in the safety disk holder being careful *not* to nick the shearing edge of the safety disk shearing ring.

(4) To install the safety disk in the holder, place the new safety disk with the asbestos side visible. Proceed in reverse order to install the safety disk holder.

f. Trouble shooting.—(1) *Emergency firing method.*—In an emergency, when the usual source of electrical energy to the breech is not available, the cartridge may be fired by use of one cell of a flashlight battery as follows: Place one pole of the unit cell against the breech barrel, and the other pole against the wire extending from the flexible shielded conduit.

(2) *Failure of cartridge to fire.*—If a cartridge fails to fire, at least three more attempts to fire it should be made. If cartridge does not fire after the fourth attempt, wait five minutes before removing the cartridge from the breech. Then inspect the hole in the cartridge base and the contact pin in the breech housing for foreign matter. Also check the wiring system for loose connections before inserting a new cartridge.

(3) *Failure of engine to start.*—If a start is not accomplished after discharging three cartridges, investigate as follows:

(a) Insert another cartridge in the breech mechanism. Station a man at the engine (standing clear of the starter) to see if engine turns over when the cartridge is discharged. If the engine does *not* turn over it may be due to any or all of the following reasons:

1. *Safety disk.*—Blown; if such is the case replace. If the

disk continues to blow out examine the safety disk shear ring for nicks. Replace if such is the case.

2. *Cartridge*.—Check identification mark to ascertain if it is the proper cartridge.
3. *Breech assembly*.—The gases may be leaking through the assembly because of worn parts. If such is the case replace the breech assembly.
4. *Loose connection*.—Tighten all connections.
5. *Starter*.—If the above steps have been followed and the engine does not turn over replace the starter.

(b) If starter turns engine and engine fails to start, refer to paragraph 76.

72. *Generator*.—See paragraph 57.

73. *Valve mechanism*.—*a. General*.—The rocker mechanism has a separate enclosure for each valve. The engine oil pump supplies lubrication for the ball and socket joints of the push rod ends and the rocker arm bearings. The oil which collects in the rocker arm boxes drains through a system of intercylinder drain hoses to the oil pump rocker box covers of number 5 and number 6 cylinders.

b. Maintenance.—At the 25-hour inspection, check to be sure that the rocker box covers and the hose, between cylinders, connecting the rocker boxes are oiltight. Replace the hose connecting the rocker boxes at every 100-hour check period when the engine is out of the vehicle, if necessary.

c. Valve rockers and push rods may be replaced by the using arm personnel when these parts are defective. With the engine out of the vehicle use the following procedure to make these replacements.

(1) *Push rod removal*.—(a) Remove all fuel injectors from cylinder heads (par. 68b).

(b) Remove rocker box cover and gasket.

(c) Make certain engine is not on decompression.

(d) Rotate engine crankshaft until piston of cylinder being worked on is at top dead center, compression stroke.

(e) Loosen valve clearance adjusting screw lock nut (fig. 47).

(f) Remove valve clearance adjusting screw.

(g) Remove push rod through tapped hole.

(2) *Push rod installation*.—Install push rod end marked "DWN" into valve tappet, and proceed in reverse order to (1) to complete installation. Adjust the valve clearance (see (5) below). Use a new gasket when installing rocker box cover.

(3) *Valve rocker removal*.—(a) Perform steps (1)(a), (b), (c), and (d) above.

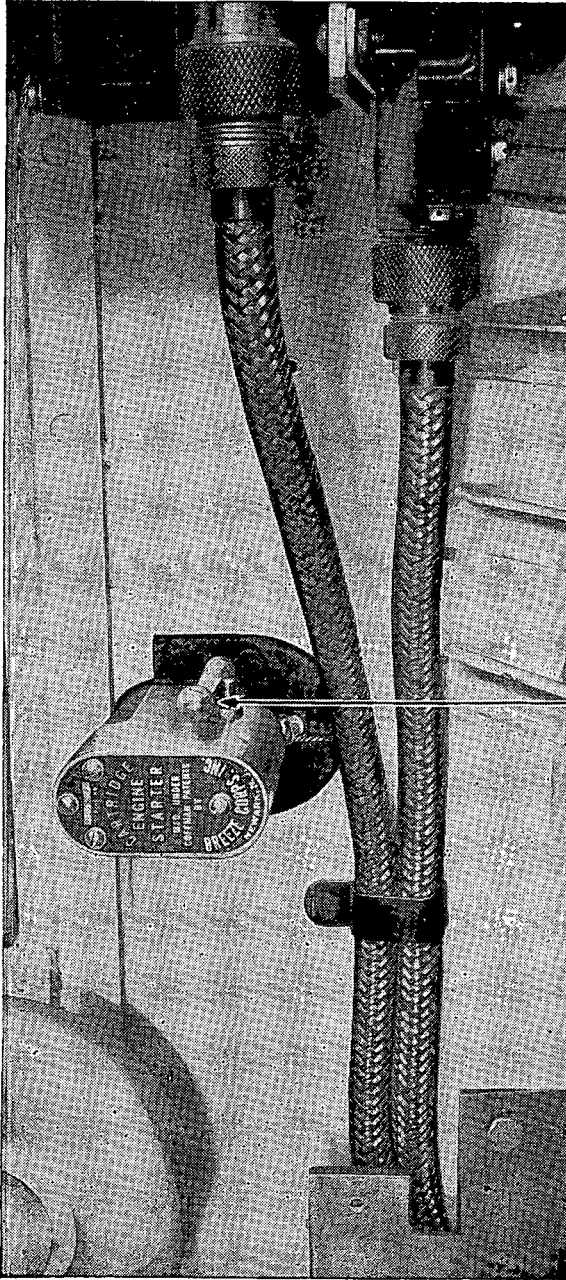

RA PD 5858

LEVER (CLOSED POSITION)

FIGURE 45.—Cartridge starter breech assembly.

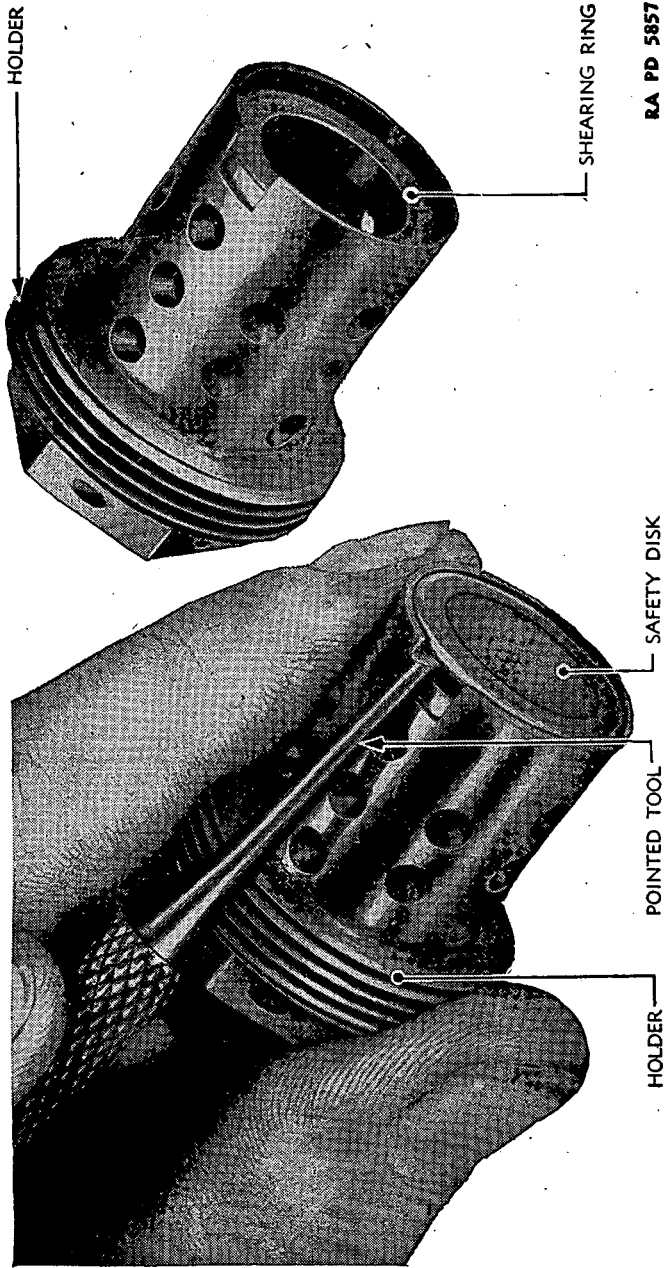

FIGURE 46.—Cartridge starter safety disk holder.

(b) Remove cotter pin and nut from the rocker support pin.

(c) Using a $\frac{3}{8}$ -inch round brass rod of suitable length for a hammer, remove the rocker support pin.

(d) Remove valve rocker.

(4) *Valve rocker installation.*—(a) If the valve rocker has been removed because of a defective rocker bearing, use a new support pin when installing a new rocker arm.

(b) If the rocker arm roller has a flat spot and the rocker arm bearing is not defective, use the old support pin.

(c) To install the new valve rocker, reverse the procedure in (3) (b), (c), and (d) above.

(d) Adjust valve clearance (see (5) below).

(e) Use a new gasket when installing rocker box cover.

(5) *Valve clearance adjustment* (fig. 47).—For push rod removal perform steps (1) (a), (b), (c), and (d) above.

NOTE.—Using a 0.020-inch feeler gage, check the clearance between the rocker roller and the valve stem on both the intake and exhaust valves. The feeler gage should slide between the roller and valve stem with only a slight drag when the clearance is correct. If incorrect proceed as follows:

(a) Using a screw driver having the correct bit size ($\frac{3}{32}$ by $\frac{1}{2}$ inch), turn the adjusting screw until the correct clearance is obtained (fig. 47).

(b) Tighten adjusting screw lock nut and recheck valve clearance.

(c) Using a new gasket, install rocker box cover.

74. Manifolds.—*a. Intake manifold.*—(1) *Description.*—The intake manifold is an integral part of the fan shrouding. It is composed of the intake manifold fan shroud body and the intake elbows. The elbows are flanged to each cylinder head and connected to the intake manifold fan shroud body by means of short lengths of rubber hose. The shroud body is mounted on the engine steady bar by means of special fittings.

(2) *Maintenance.*—On the 100-hour check, inspect interior of hoses and tighten clamps. As part of the air induction system to the engine, the intake manifold must be kept airtight to exclude dirt and dust from the engine.

b. Exhaust manifold.—(1) *Description.*—The exhaust manifold is composed of a right and left half. Branch pipes to the cylinder heads are connected to the two halves by means of slip joints.

(2) *Maintenance.*—On the 100-hour check, carefully examine the exhaust manifold for cracks and holes. Replace all defective parts.

c. Muffler.—See paragraph 59c.

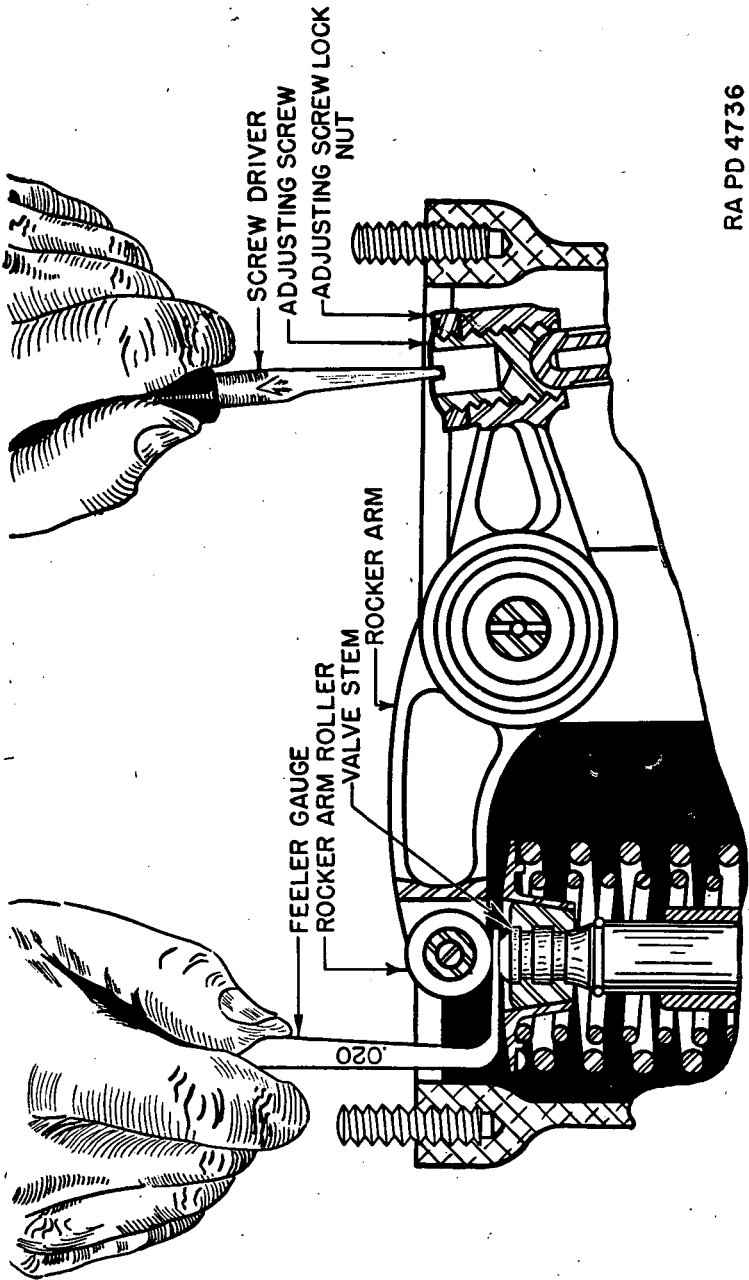

RA PD 4736

FIGURE 47.—Adjusting valve clearance, Guiberson engine.

75. Engine replacement.—The removal and installation of the engine will be accomplished by the using arm personnel only when time, favorable terrain, available personnel, and equipment are at hand. A suitable hoist and engine stand must be available.

a. Engine removal.—The removal of the Guiberson Diesel engine follows substantially the method outlined in paragraph 60a.

b. Engine replacement.—Follow the method outlined in paragraph 60b.

76. Trouble shooting.—*a. Failure to start.*—Failure of the engine to start or excessively hard starting may be due to one or a combination of several causes.

(1) *Fuel tanks.*—Check that fuel tanks are at least three-fourths full and that tank valves are open.

(2) *Defective fuel transfer pump or clogged line.*—Disconnect inlet line between fuel filter and fuel transfer pump at fuel transfer pump end.

(a) If fuel flows from the inlet line, reconnect the inlet line and disconnect the fuel transfer pump discharge line. Remove the fuel transfer pump and turn the driveshaft of the transfer pump by hand *counterclockwise when facing the driveshaft*. If fuel flows from the discharge passage, the transfer pump is operative. If fuel does not flow, replace the transfer pump.

(b) If fuel does not flow from the inlet line, disconnect the line at the fuel filter end. Remove line. Blow out line with compressed air and reassemble.

(3) *Clogged line or defective fuel tank or fuel filter.*—(a) Disconnect fuel line between fuel tank and fuel filter end. If fuel flows, replace fuel filter, and reassemble line.

(b) If fuel does not flow, disconnect fuel line between fuel tank and fuel filter at tank end.

1. If fuel does not flow from tank, drain and replace fuel tank (see par. 78).

2. If fuel flows from tank, remove line between tank and filter, blow out line with compressed air, and reassemble.

(4) *Fuel system within engine air-bound.*—Bleed engine fuel system as follows:

(a) Open fuel tank. It must be three-fourths full to provide a gravity flow for bleeding.

(b) Open fuel shut-off valve. Put engine on decompression.

(c) Open bleeder valve on fuel filter in line. Close when no bubbles appear.

(d) Open bleeder cap on fuel filter. This will bleed line from filter to fuel duct.

(e) Remove pipe plug in fuel duct between cylinders 1 and 2. Allow fuel to run until no bubbles appear.

(f) Loosen high pressure line. Remove cone, cone union nut, and check valve at cylinder 1.

(g) Replace cone, cone union nut, and check valve.

(h) Repeat (f) and (g) on cylinders 8, 9, 1, 2, and 3, and the bleeding operation is finished.

(i) Pump the decompression lever with throttle in idle position, and listen for fuel injector chatter. Start engine.

b. *Fuel knock*.—Fuel knock in the Diesel engine can be traced either to incorrect timing or to faulty operation of one or more fuel injectors. Defective fuel injectors should be replaced but the retiming of the engine injection system will be done only by ordnance personnel.

c. *Power loss*.—Loss of power can usually be traced to an inadequate supply of fuel or air. It is therefore important that fuel lines be kept clean and that the air cleaners and ducts, at all times, admit their rated flow of air. Other conditions which may contribute to power loss are—

(1) *Plunger frozen in fuel injector*.—Replace injector.

(2) *Sticking valve or broken valve spring*.—Engine overhaul indicated.

(3) *Obstructed exhaust passage*.—Remove and clean out.

(4) *Obstruction in air induction system*.—Remove cloths or other material which obstruct the flow of air into the air cleaner from the fighting or battery compartment.

d. *Misfiring, all cylinders*.—Engine misfiring intermittently on all cylinders can be due to any of the following conditions:

(1) *Improper fuel*.—Drain system and replace fuel.

(2) *Water in fuel*.—Drain system and replace fuel.

(3) *Sticking fuel injector valve nozzle stem*.—Replace injector.

(4) *Sticking fuel pressure pump*.—Notify ordnance personnel.

(5) *Leaking intake or exhaust valves*.—Engine overhaul indicated.

Caution: *Strict cleanliness* is of first importance in handling fuel injectors. Cover the bench area to be used with waxed paper. Use clean fuel oil and clean lubricating oil. Use a type of wiper that will not drop lint.

e. *Misfiring, one or two cylinders*.—To determine which cylinder or cylinders are missing, loosen the nuts connecting the fuel lines to the fuel injectors, one at a time. If the operation of the engine remains unchanged, a missing cylinder is indicated. If the engine slows down and the exhaust loses its rhythm, the cylinder is functioning.

- (1) *Faulty fuel injector.*—Replace injector.
- (2) *Exhaust or intake valve stuck or leaking.*—Engine overhaul indicated.
- (3) *Fuel pressure pump stuck or leaking.*—Notify ordnance personnel.
- f. *Overheating.*—Overheating may be due to—
 - (1) *Late fuel injection timing.*—Notify ordnance personnel.
 - (2) *Oil supply low.*—Refill oil tank.
 - (3) *Oil contaminated or of improper grade.*—Drain system and refill with correct lubricant.
 - (4) *Oil pump inoperative.*—Replace pump.
 - (5) *Flow of air to fan compartment obstructed.*
 - (6) *Flow of air through engine oil cooler obstructed.*

SECTION V

FUEL SUPPLY SYSTEM

Description and operation.....	Paragraph
Fuel tanks.....	77
Fuel lines and valves.....	78
Priming pump.....	79
Fuel filter.....	80
Grades of fuel.....	81
	82

77. Description and operation.—*a. Description.*—Two 28-gallon fuel tanks are vertically located, one on each side, at the front of the engine compartment. A drain plug, accessible from beneath the hull, is provided in the bottom of each tank. A fuel shut-off valve and strainer are located in the tank outlet.

b. Operation.—(1) *Continental engine* (fig. 48).—The two tanks are interconnected so that either or both of the tanks may be used. The fuel pump draws fuel from the tank through a filter and delivers it to the carburetor. A second line returns the excess fuel to the top of the right tank. The priming pump located on the instrument panel is fed from the right fuel tank through an additional line, delivering fuel to the intake pipes to aid starting.

(2) *Guiberson Diesel engine T-1020.*—The two fuel tanks are interconnected so that either or both of the tanks may be used. The fuel pump draws fuel from the tank through a filter and delivers the fuel to the fuel channel through a check valve which prevents it from draining out of the channel (fig. 41). A fuel pressure pump at each cylinder obtains fuel from the fuel channel and pumps it to a fuel injector valve, located in each cylinder head. Due to the construction

of the fuel injector valves, more fuel is required for their operation than is actually injected into the cylinder. This excess fuel returns to the top of the right fuel tank via a fuel return ring and through the transfer pressure regulating valve.

78. Fuel tanks.—*a. General.*—The fuel tanks are mounted in wooden-lined pockets and are supported on rubber spacers. The tank is secured to the hull top plate by a nut on the filler.

b. Maintenance.—The fuel tank outlet screens should be removed and cleaned at each 100-hour check. Remove drain plugs frequently for the removal of water and sediment. Do not remove the tank unless a leak develops or a large amount of sediment makes a thorough cleaning necessary.

c. Removal of fuel tank from vehicle.—The following tools will be required:

Drag link screw driver.	Wrench, $\frac{7}{16}$ -in., open-end.
Hexagon bar, $\frac{9}{16}$ -in. dia., 3 in. long.	Wrench, $\frac{9}{16}$ -in., box.
Pliers.	Wrench, $1\frac{1}{16}$ -in., open-end.
Spanner wrench.	Wrench, $\frac{3}{4}$ -in., open-end.
Wrench, $\frac{3}{8}$ -in., open-end	Wrench, $1\frac{1}{16}$ -in., socket.
	Wrench, $1\frac{1}{8}$ -in., box.

(1) *Drain fuel tanks.*—Perform these operations on each of the two fuel tanks. Using pliers, remove the locking wire from the four cap screws which attach the fuel tank drain plate to the engine compartment hull floor plate. Using a $\frac{9}{16}$ -inch box wrench, remove the cap screws. Remove the plate with gasket. Using a hexagon bar, $\frac{9}{16}$ -inch diameter across the flats, 3 inches long, and a $\frac{9}{16}$ -inch box wrench for a handle, remove the fuel tank drain plugs from right and left fuel tank assemblies. Drain both fuel tanks.

(2) *Remove screen outlet assembly from fuel tanks (Continental engine).*—Using an $1\frac{1}{16}$ -inch and $\frac{3}{4}$ -inch open-end wrench, disconnect the connector on each end of the tube which connects the right fuel tank assembly with the left fuel tank assembly. From the cross attached to the right tank angle valve, disconnect the connector attaching the fuel filter tube, using an $1\frac{1}{16}$ -inch and a $\frac{3}{4}$ -inch open-end wrench. With a $\frac{3}{8}$ -inch open-end wrench, disconnect the coupling attaching the $\frac{1}{8}$ -inch diameter primer tube to the cross. Using a $\frac{7}{16}$ -inch open-end wrench, remove three bolts and locking washers attaching the screen outlet assembly to the right and left fuel tank assemblies. From the left fuel tank remove the screen outlet assembly, with a nipple, angle valve, one-half of the connector, and a gasket. From the right fuel tank remove the screen outlet assembly,

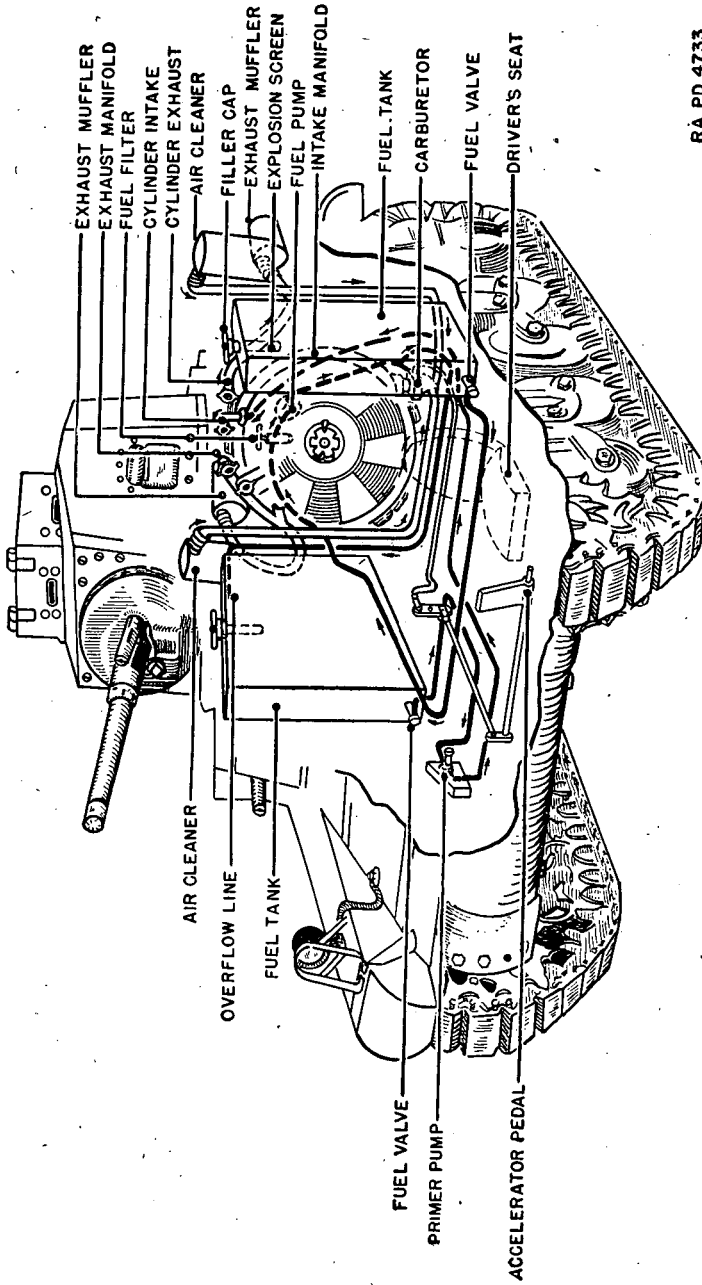

RA PD 4733

FIGURE 48.—Fuel system, Continental engine.

with two nipples, angle valve, elbow, a cross, one-half of each of the three connectors attached to the cross, and a gasket.

(3) *Remove screen outlet assembly from fuel tanks (Guiberson engine).*—Using an $1\frac{1}{16}$ -inch and a $\frac{3}{4}$ -inch open-end wrench, disconnect the connector on each end of the tube which connects the right fuel tank assembly with the left fuel tank assembly. From the tee attached to the left fuel tank assembly angle valve, using an $1\frac{1}{16}$ -inch and a $\frac{3}{4}$ -inch open-end wrench, disconnect the connector attaching the fuel filter tube to the tee. Using a $\frac{7}{16}$ -inch open-end wrench, remove three bolts and locking washers attaching the screen outlet assembly to the right and left fuel tank assemblies. From the left fuel tank assembly remove the screen outlet assembly, with a nipple, angle valve, tee, elbow, and one-half of the connectors. From the right fuel tank assembly remove the screen outlet assembly, nipple, angle valve, and one-half of the connector.

(4) *Remove right and left hull fuel tank cover plates.*—Remove one fuel tank filler cap from the right fuel tank assembly and one from the left fuel tank assembly. Using a spanner wrench, remove the locking nut from the flange of the flame arrester assembly of the right and left fuel tank assemblies. Using a drag link screw driver, remove nine slotted-head bolts attaching the left hull fuel tank cover plate to the hull. Remove plate. Using a drag link screw driver, remove nine slotted-head bolts attaching the right hull fuel tank cover plate to the hull. Remove plate.

(5) *Remove right fuel tank assembly fuel return line adapter.*—Using a $\frac{7}{16}$ -inch open-end wrench, remove six bolts with lock washers attaching the flame arrester assembly to the right fuel tank assembly. Remove the flame arrester assembly. From inside the engine compartment, using a $\frac{1}{2}$ -inch open-end wrench, disconnect the fuel return line tube and connector from the elbow screwed into the fuel return line adapter. Using a $\frac{9}{16}$ -inch open-end wrench, remove the elbow from the adapter. Two men are required for the next operation. Using a $1\frac{1}{8}$ -inch box wrench, one man prevents the head of the adapter from rotating, working through the opening in the fuel tank caused by removal of the flame arrester assembly. Using a $1\frac{1}{16}$ -inch socket wrench, the second man removes the safety nut with washer from the adapter, working in the engine compartment. Remove the adapter, with gasket. Remove both fuel tanks from the vehicle.

d. Fuel tank installation.—Reverse above procedure. Be careful to have rubber spacers and protecting jacket in the correct position.

79. Fuel lines and valves.—*a. Fuel lines.*—All fuel lines are loom-covered where necessary for protection against rubbing and traffic. Frequent inspections of all lines and connections will be made to insure against fuel leaks.

(1) *Maintenance.*—At the 100-hour check, all fuel lines will be removed, carefully inspected, and blown out with compressed air.

(2) *Replacement.*—When a defective fuel line is to be replaced it is of extreme importance that the new line be made to conform exactly to the shape of the original line.

b. Fuel valves.—A fuel shut-off valve for each tank is provided on the crew compartment side of the bulkhead.

(1) *Maintenance.*—At the 100-hour check, remove and clean the fuel valves and strainers.

(2) *Replacement of fuel valve and strainer.*—(a) Drain tank.

(b) Disconnect fuel line.

(c) Remove three screws.

(d) Remove valve and strainer.

(e) When replacing valve use a new gasket and check completed job for leaks.

80. Priming pump.—*a. Description and operation.*—A priming pump located on the instrument panel provides a means of injecting gasoline into the seven inlet valve ports of the Continental engine to aid starting. Pulling the pump plunger fills the pump cylinder with fuel. Pushing the plunger discharges the fuel and forces it into the inlet pipes.

b. Maintenance.—Should the primer pump leak or lose its pumping ability it will be replaced by a serviceable unit.

c. Replacement.—Use the following procedure after removal of fuse box (par. 120):

(1) Disconnect inlet and discharge lines.

(2) Remove pack nut and pull out pump plunger.

(3) Remove pump retaining nut from front of panel.

(4) Remove pump.

(5) Reverse the above sequence of operations to install a new primer pump.

(6) Test new installation for leaks.

81. Fuel filter.—*a. Continental engine.*—The Cuno fuel filter is of all metal construction and has no replaceable cartridge. Rotate the filter handle one full turn daily to comb foreign substances from the filtering element. The vent screw in the filter hand permits priming and pressure relief. Remove and clean the filter sump at the 100-hour check. A plug in the bottom of the sump facilitates

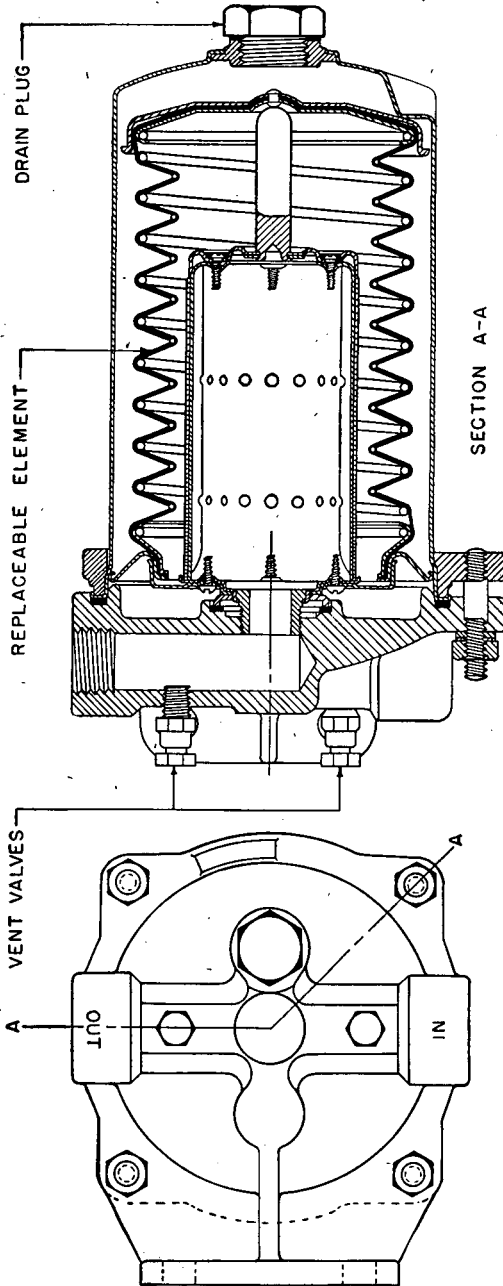

RA PD 5848

FIGURE 49.—Guiberson fuel filter.

the draining of water and sediment and will be removed after every 8 hours of engine operation.

b. *Guiberson Diesel engine, T-1020* (fig. 49).—(1) *Description*.—The “Purolator” Diesel fuel oil filter is of the renewable cartridge type. The fuel first passes through a wool element, then through a metal element.

(2) *Maintenance*.—After every 8 hours of engine operation drain the dirt and water from the filter case assembly by removing the drain plug at the bottom of the case. Every 25 hours remove the element and wash thoroughly in clean fuel oil, being careful not to damage the wool element. To remove the case assembly, remove nuts from the clamping ring studs and pull straight down on the case assembly to avoid damaging the filter element. Remove the filtering element by unscrewing the element from the head. Replace the fuel filtering element every 100 hours of service. When installing the case assembly tighten the right stud nuts evenly to avoid a fuel leak at this point. Use a new gasket if necessary.

82. *Grades of fuel*.—a. *Continental engine*.—The engine is designed to use a commercial motor gasoline with an octane rating of 80. Gasoline with a rating as high as 90 octane may be used. Avoid using fuel whose rating is less than 80 octane.

b. *Guiberson Diesel engine T-1020*.—The minimum fuel rating is 50 cetane for successful operation on this engine. Since most of the trouble encountered on this engine can be traced directly or indirectly to dirty fuel, the fuel must be free of all foreign matter.

Caution: Because of the close fits in the fuel pressure pumps and fuel injector valves, extreme care must be exercised in handling Diesel fuel. Fuel exposed to dust will pick up fine particles of dirt which may pass through the filtering element and cause the fuel injector and pressure pumps to stick.

SECTION VI

COOLING SYSTEM

Description.....	Paragraph
.....	83
Inspection and maintenance.....	84

83. *Description*.—Engine cooling is accomplished by air drawn through the fan guard screen (fig. 50), and circulated by the engine fan around and over the finned cylinders and cylinder heads. Sheet metal baffles and a shroud are employed to direct the air flow for the most effective cooling.

84. Inspection and maintenance.—Make frequent inspections to determine the condition and tightness of cylinder baffles and shroud. At the 100-hour check, clean the baffles, shroud, and engine fan thoroughly with cleaning fluid. Examine all parts carefully for cracks and make replacements where needed.

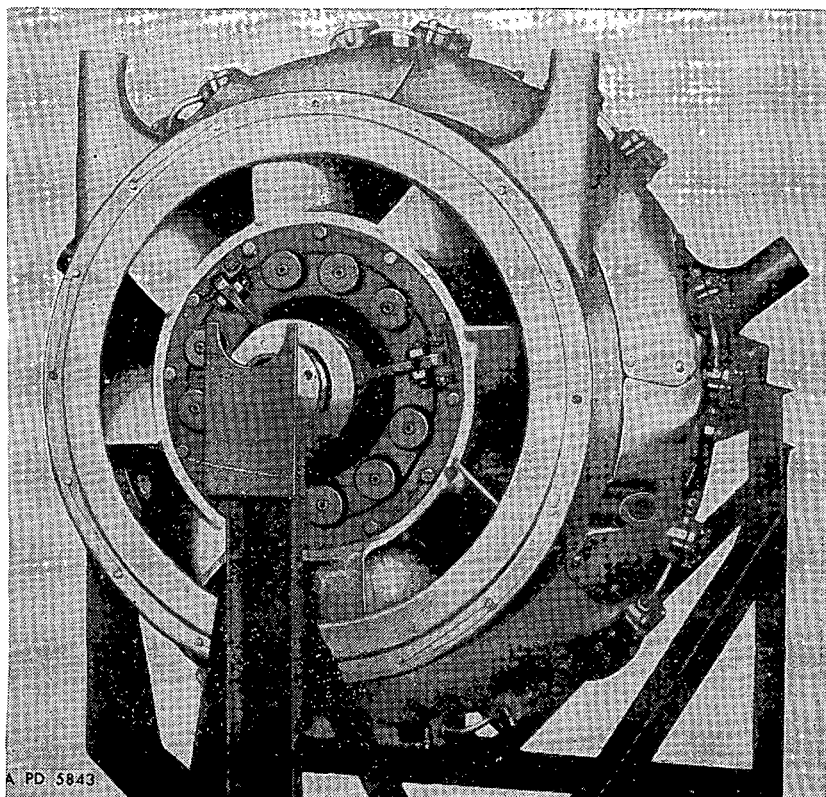

FIGURE 50.—Front view, Guiberson T-1020, series 4.

SECTION VII

CLUTCH

	Paragraph
Purpose.....	85
Operation.....	86
Maintenance.....	87
Inspection.....	88
Adjustment of linkage.....	89
Clutch and accelerator pedals.....	90

	Paragraph
Lubrication	91
Release bearings.....	92
Clutch disassembly.....	93
Clutch assembly.....	94

85. Purpose.—The clutch provides a means of gradually applying the power of the engine to the power train of the vehicle. The power train group includes the transmission, differential, final drives, and sprockets.

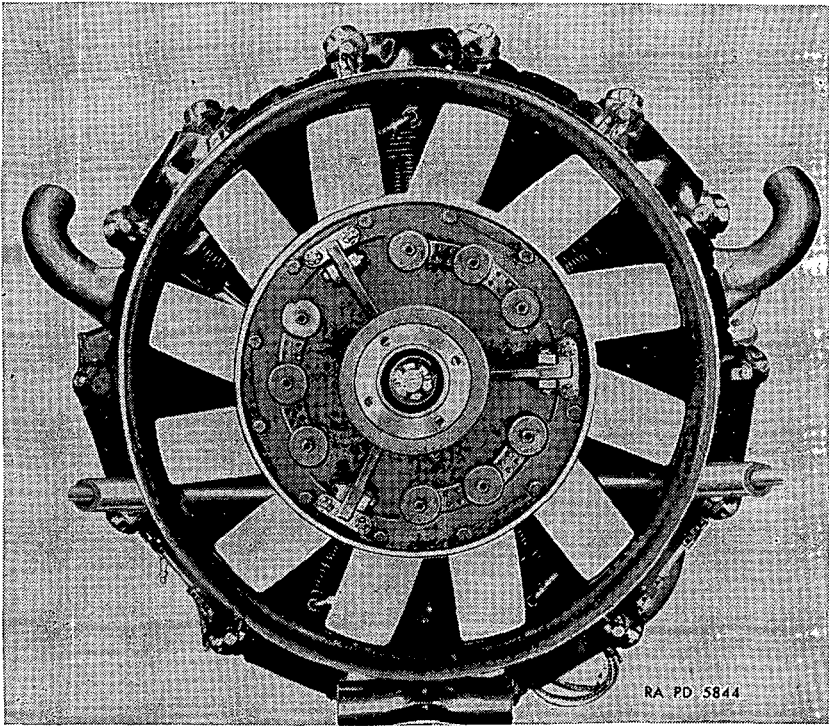

FIGURE 51.—Front view, Continental engine.

86. Operation.—When disengaged, the clutch drive and driven plates are separated and impart no motion to the power train. Gear changing is done only with the clutch disengaged. Clutch engagement after gear selection, and especially when the vehicle is at rest, must be gradual to insure against stalling the engine or damaging the power train.

87. Maintenance.—No maintenance, other than inspection, linkage adjustment, and lubrication will be required on the clutch.

88. Inspection.—At the 100-hour check, disassemble and clean the clutch (see fig. 52). Check facings carefully for wear and inspect unlined plates for cracks and abrasions. Check the condition of all bearings carefully. Make necessary replacements at this time.

89. Adjustment of linkage.—*a. General.*—As the clutch facings wear, the amount of “free travel” or “lash” in clutch pedal decreases. Unless this free travel is maintained by adjustment, the pedal will finally “ride” the stop and prevent full engagement. This condition allows the clutch plates to slip and burn and makes early replacement necessary. Report promptly unusual noise or any change from normal operation.

b. Adjustments.—Adjust the clutch rod (fig. 53) to obtain at least $\frac{1}{2}$ -inch free travel on the clutch pedal with from $\frac{1}{16}$ -inch to $\frac{1}{8}$ -inch clearance between the clutch release bearings and the flange with the clutch engaged.

90. Clutch and accelerator pedals.—*a. General.*—The clutch and accelerator pedals and their respective cross shafts are mounted in brackets bolted to the floor at the front of the driver's compartment (fig. 6). Lubricate the cross shafts and yoke pins at regular intervals. Should the clutch or accelerator pedal or either of the two cross shafts require replacement, remove the pedals, shafts, and brackets as an assembly.

b. Replacement.—Use the following procedure in replacing the clutch and accelerator controls.

(1) Open battery switch.

(2) Remove cotter pin and $\frac{1}{4}$ -inch pin connecting hand throttle rod to foot accelerator.

(3) Remove left steering lever cotter pin and straight pin at left steering lever link.

(4) Pull left steering lever all the way back and lift link out of way.

(5) Disconnect accelerator and clutch pedal pull-back springs.

(6) Remove cotter pin and pull out straight pin connecting accelerator linkage at cross shaft.

(7) Remove cotter pin and drive out straight pin connecting clutch release linkage at cross shaft.

(8) Remove five bolts from under side of hull floor. A second man inside the tank will hold the nuts at the brackets.

(9) Remove pedals, shafts, and brackets.

(10) To install, reverse the above procedure.

RA PD 5860

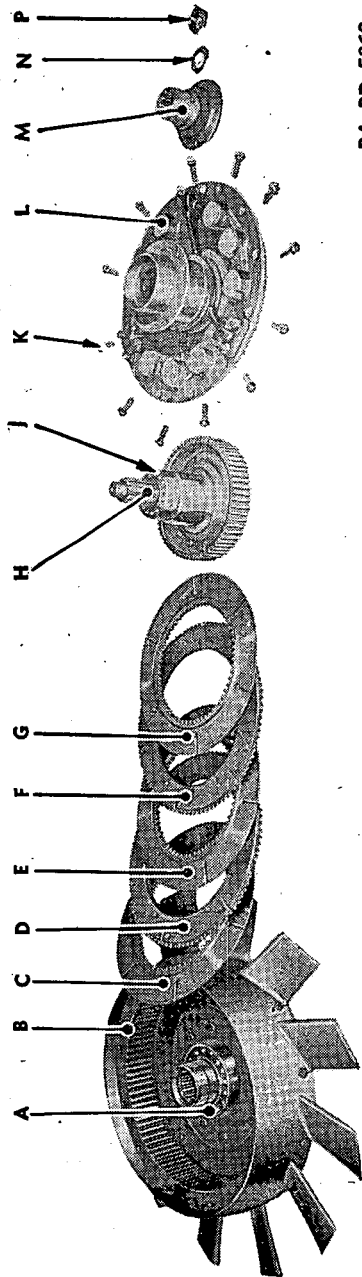

A. Inner hub bearing.
B. Flywheel.
C. Unlined plate.
D. Lined plate.
E. Unlined plate.

F. Lined plate.
G. Unlined plate.
H. Spindle.
J. Spring housing cap screw.

L. Spring housing.
M. Driven hub.
N. Washer.
P. Nut.

Figure 52.—Disassembly of clutch.

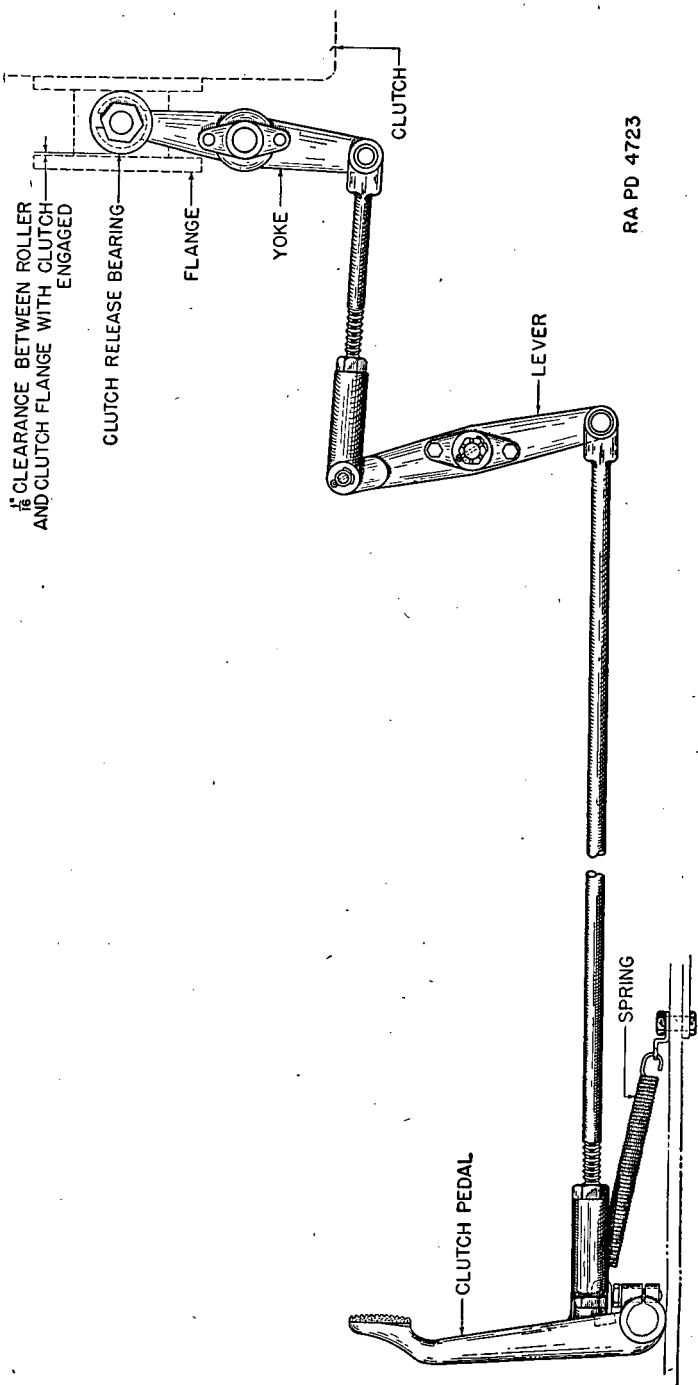

RA PD 4723

FIGURE 53.—Adjustment of clutch control linkage.

91. Lubrication.—Follow recommendations of the lubrication chart (fig. 13) with regard to the lubrication of clutch hub and clutch release bearings.

92. Release bearings.—*a. General.*—Check the clutch release bearings for free rotation and lubricate every 8 hours of engine operation.

b. Replacement.—Should one or both of the bearings become inoperative, replacement may be made by the using arm personnel using the following procedure:

- (1) Remove fan guard screen (par. 60a(7)).
- (2) Remove lubrication fitting.
- (3) Loosen lock nut until washer is free on shaft.
- (4) Lift bearing assembly out of slot in yoke.
- (5) To install, reverse the above procedure.

93. Clutch disassembly.—With the engine out of the vehicle use the following procedure:

- a.* Remove clutch driven hub nut and washer.
- b.* Bolt clutch spindle slide hammer adapters to companion flange.
- c.* Attach slide hammer puller and pull flange.
- d.* Punch mark clutch spring housing and flywheel for proper position in reassembly.
- e.* Screw clutch spring securing studs into pressure plate through holes in spring housing and tighten to relieve tension on spring housing bolts and nuts.
- f.* Remove 12 cap screws securing housing.
- g.* Remove clutch spring housing with pressure plate, release arms and sleeve as a unit.

NOTE.—Do not disassemble this assembly.

h. Remove clutch spindle, using slide hammer puller.

i. Remove clutch drive and driven plates.

94. Clutch assembly.—Carefully clean and inspect all parts and pack clutch hub bearings with lubricant according to lubrication chart recommendations. Replace the clutch plates where needed and assemble clutch by reversing sequence of operations in paragraph 93, except that clutch spindle must be installed before clutch plates.

NOTE.—Assembly of the spindle on the inner hub bearing is accomplished by tapping with a brass hammer on the face of the geared portion of the spindle as it is turned on the bearing.

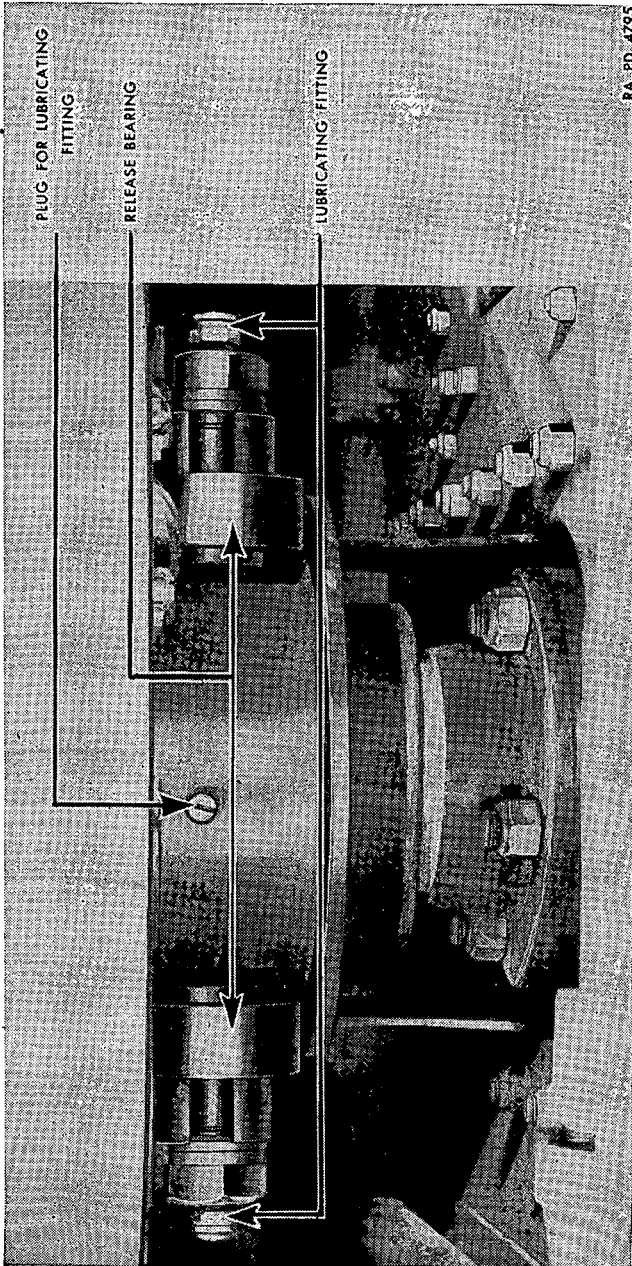

FIGURE 54.—Clutch release bearing, grease fittings.

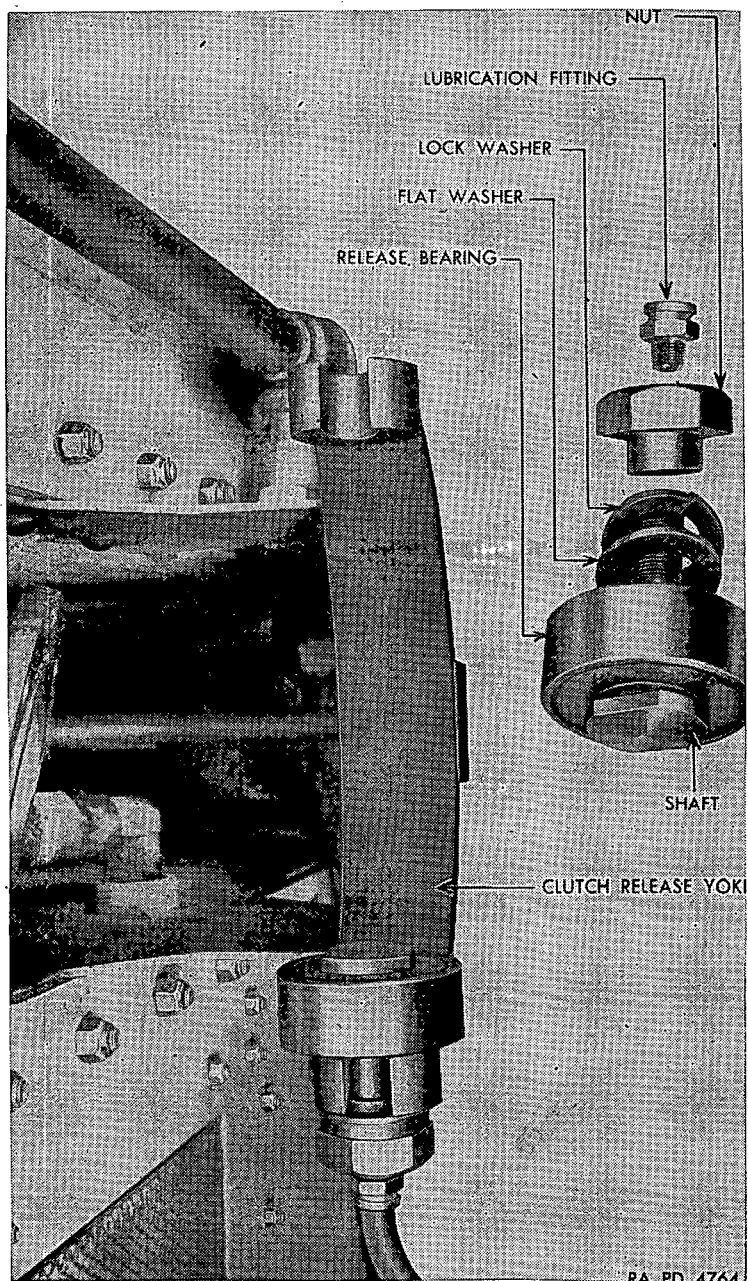

FIGURE 55.—Clutch release and parts.

SECTION VIII

PROPELLER SHAFT

Description.....	Paragraph 95
Lubrication.....	96
Replacement.....	97

95. Description (fig. 56).—The propeller shaft transmits power from the clutch to the transmission. It is inclosed in a housing or “tunnel,” which also mounts a padded gunner’s seat. The propeller shaft is equipped with a universal joint at either end and a slip joint which permits it to be telescoped.

96. Lubrication.—Every 1,000 miles the universal joints and slip joint require lubrication with general purpose grease. Use the following procedure for lubricating these parts: Remove the tunnel shield sections over universal joints and the slip joint at the ends of the tunnel shield. Remove one plug from each universal joint and one from the slip joint and insert grease fittings. Apply grease until it overflows from the universal joint relief valve and extrudes from the end of the slip joint. Do not use a high pressure gun. After lubricating, remove grease fittings and install plugs.

97. Replacement.—Do not attempt to replace worn parts of the propeller shaft assembly. Replace the entire propeller shaft assembly when noise or undue vibration is observed during operation. Use the following procedure:

- a. Removal.*—(1) Remove propeller shaft housing cover.
- (2) Remove speedometer housing (par. 100a(18)).
- (3) Remove propeller shaft guard straps (par. 100a(27)).
- (4) Remove 4 bolts and nuts clamping the companion flanges together on each end of propeller shaft.
- (5) Telescope propeller shaft and remove.

b. Installation.—Lubricate the new propeller shaft assembly as outlined in paragraph 96 and install by reversing the sequence of operations for removal. Discard old safety nuts and replace with new nuts upon reassembly.

Caution: When installing a propeller shaft, check to see that the alinement marks on the propeller shaft slip joint are in alinement. (This is merely a check on the proper assembly of the shaft by third or fourth echelons.)

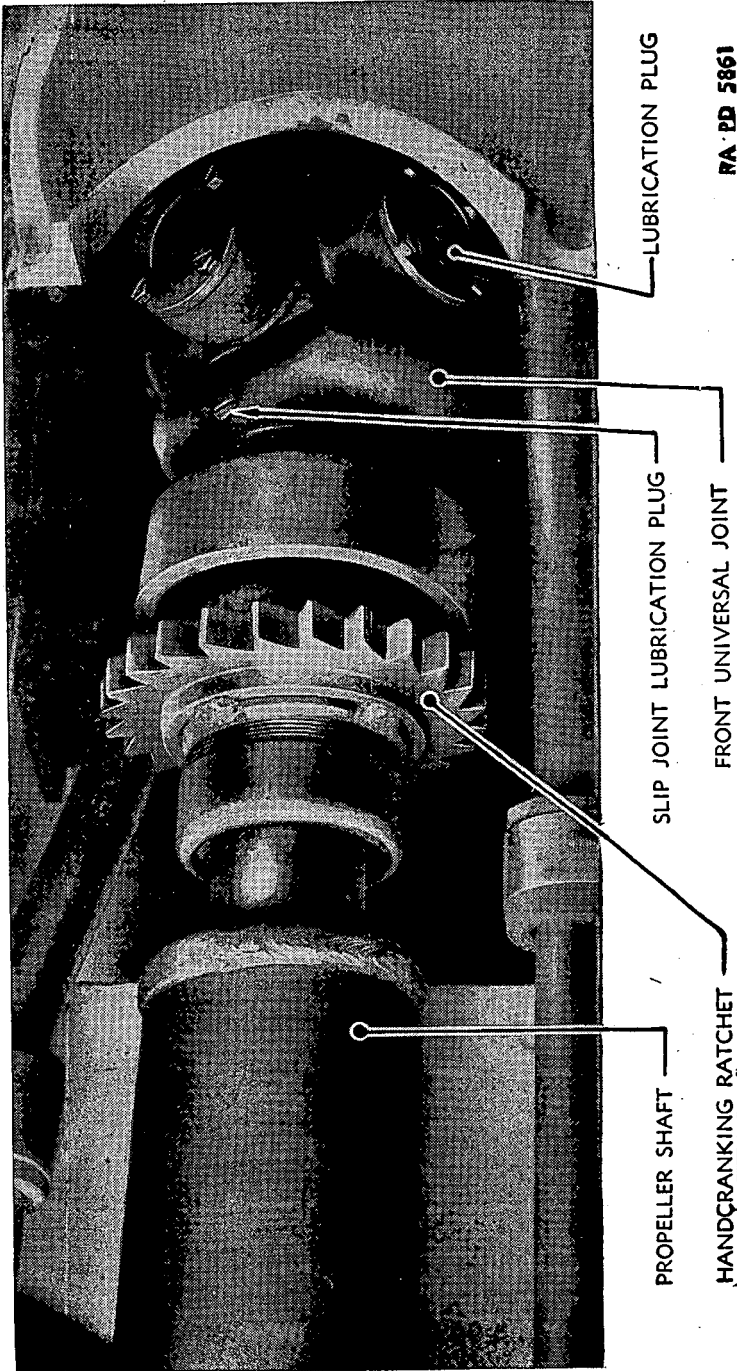

FIGURE 56.—Propeller shaft and front universal joint, Guiberson engine.

SECTION IX

TRANSMISSION AND DIFFERENTIAL

Transmission.....	Paragraph 98
Differential.....	99
Transmission replacement.....	100

98. Transmission.—*a. General.*—The transmission is of the synchromesh type having five forward speeds and one reverse. First and reverse speeds are through a sliding gear. The transmission and differential are inclosed in one main case called the transmission case.

b. Lubrication (fig. 57).—The transmission and differential are lubricated by the same oiling system. An oil pump, mounted in the transmission case, draws oil from two screened pockets in the bottom of the differential case. The oil pump outlet is located on the right side of the transmission case near the steering brake arm. From this point the main oil line carries oil to the top of the oil cooler. The outlet line from the bottom of the cooler returns the oil to the oil gallery of the transmission. A second and smaller line from the oil pump outlet carries oil through a screen type filter and delivers it to the needle bearing on the transmission output shaft. While the needle bearing oil screen is not a part of the transmission, its cleaning and servicing have an important part in the function of the transmission. It is the purpose of the screen to allow only clean oil to get to the needle bearings on the transmission output shaft. Clean the screen every day to insure that the line to the needle bearings remains open. See lubrication chart for complete details on lubrication and oil filter maintenance.

c. Replacement of gear shift lever (fig. 58).—If the gear shift lever is bent or broken use the following procedure for replacement.

(1) *Removal.*—(a) Remove cotter pin "C" from latching rod and remove rod from plate.

(b) Remove two caps screws "D."

(c) Remove nut "A."

(d) Drive out bolt "B."

(e) Remove lever with latching rod.

(2) *Installation.*—Proceed in reverse order, reinstalling quadrant exactly as removed.

99. Differential.—*a. General.*—The controlled differential transmits engine power to the final drive and incorporates a device for steering the tank. The differential contains two halves, each half being separately controlled by a brake drum and brake band. When

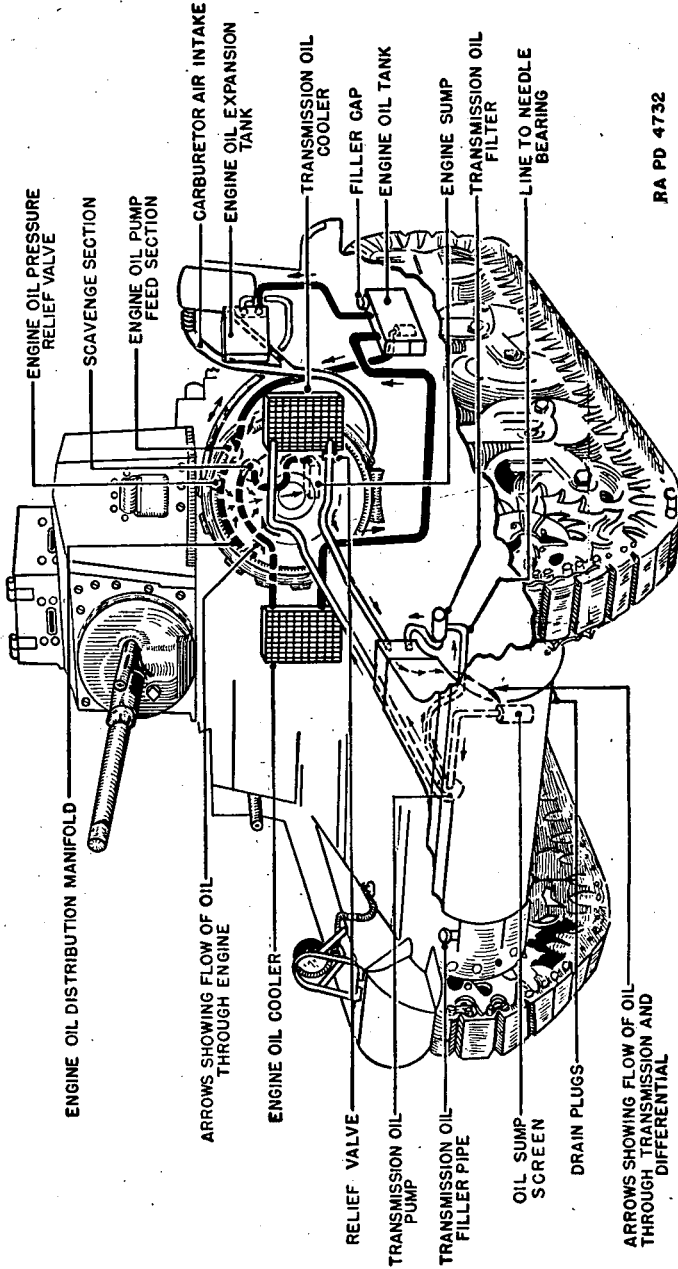

RA PD 4732

FIGURE 57.—Engine and transmission oiling system.

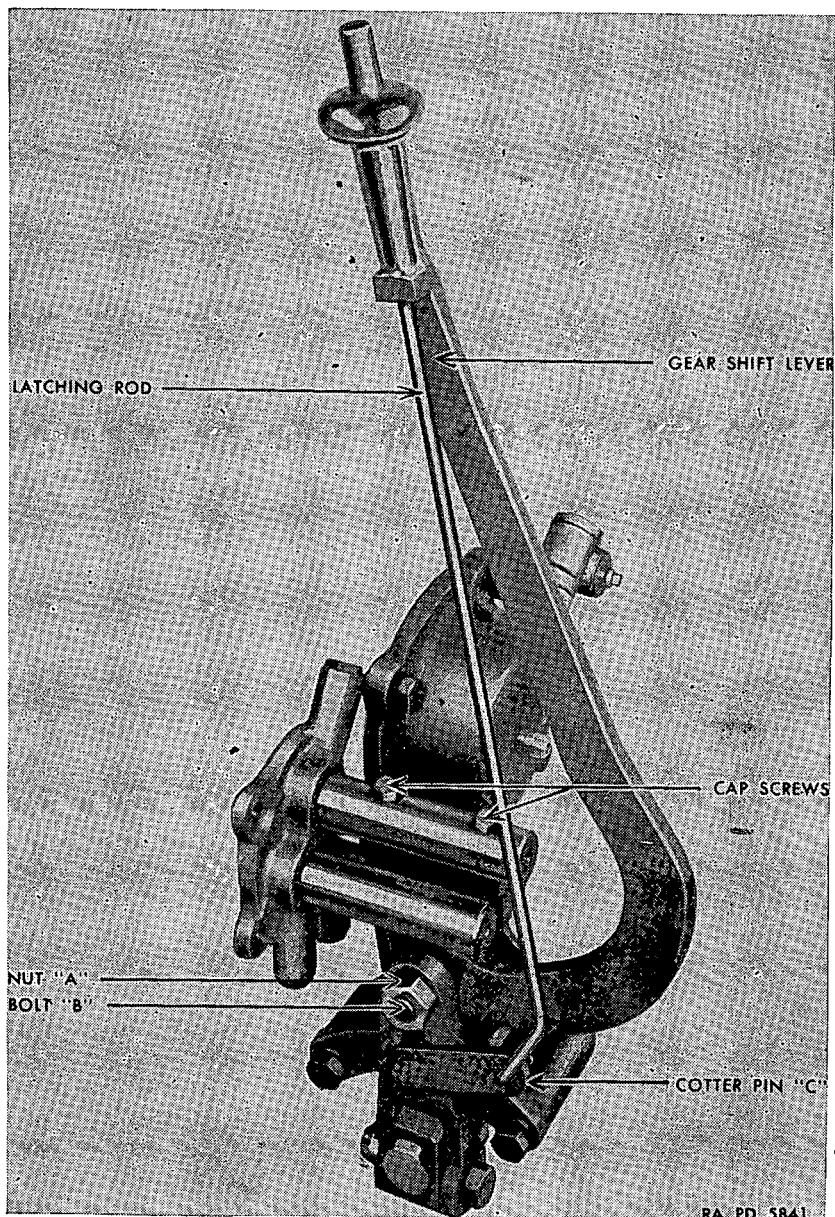

FIGURE 58.—Gear shift lever.

one brake is applied, one half of the differential slows down while the other half speeds up. By this means the vehicle is steered. It is impossible to lock one final drive sprocket as long as the other sprocket is in motion. The vehicle will stop only when both steering levers are locked in position with the brake bands contracted.

b. Steering brakes.—(1) *Adjustment* (fig. 59).—(a) Remove pipe plugs (figs. 6 and 17).

(b) Insert through the hole a $1\frac{1}{16}$ -inch-deep socket wrench and engage the brake adjusting nut.

(c) The brake adjusting nut must be turned in $\frac{1}{2}$ -turn steps. Clockwise rotation decreases the clearance between the brake band and drum.

NOTE—The brake adjusting nut has a cylindrical surface on the end that contacts the cross pin. Be certain the nut is placed in such a position that the cross pin seats firmly in the cylindrical end surface of the nut.

(d) The correct adjustment will be obtained when the band just engages with the steering lever almost in the vertical position. The cushioning effect of the differential oil being squeezed out between the band and the drum should be felt as the lever is pulled back from the forward position.

(2) *Replacement of brake bands* (fig. 59).—(a) *Removal.*

1. Remove the portion of the front sloping armor plate that is directly over the differential case cover.
2. Remove differential case cover.
3. Remove cotter pins holding brake band rod end pins in place.
4. Remove brake rod end pins.
5. Slide out brake band.

(b) *Installation.*

1. Loosen brake band adjusting nut.
2. Proceed in reverse order of removal instructions (a) 3 to 5 above.
3. Using a feeler gage, adjust the clearance between the band and the drum to between .020 inch and .030 inch all the way around the band. To perform this adjustment, use only the brake band adjusting nut. If it is not possible to perform this adjustment because the brake band contacts the drum at one place, and is too far away at other places, notify ordnance personnel. The linkage between the steering lever and brake band may not be set correctly.

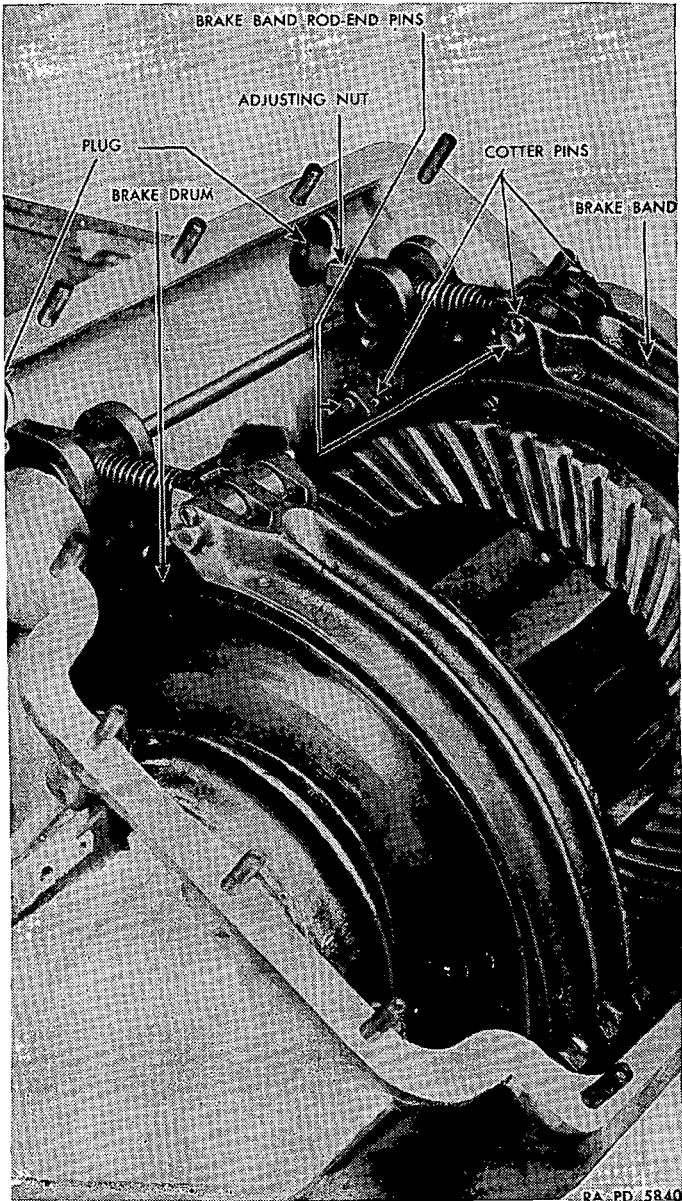

FIGURE 59.—Steering brake bands.

(3) *Replacement of left steering brake hand lever.*—When bent or broken, the lever will be replaced as follows:

(a) Open battery switch.

(b) Remove gun firing switch clamp screw and loosen conduit retaining clips.

(c) Lay firing mechanism on vehicle floor.

(d) Remove steering lever clamping bolt.

(e) Remove lever.

(f) Install steering lever by reversing removal procedure.

(4) *Replacement of right steering brake hand lever.*—For removal proceed as in (3) above, steps (a) through, (d). Then disconnect brake lever connecting link in bow gunner's compartment and drive or pry shaft out of steering brake hand lever. Install right steering lever by reversing removal procedure.

100. Transmission replacement.—Replace the transmission unit only when suitable conditions prevail (see note, par. 40b(4).)

a. Removal of transmission.

<i>Specific step</i>	<i>Equipment</i>	<i>Procedure</i>
(1) Remove siren lead...	Pliers.....	Disconnect lead at front armor plate end.
(2) Remove light leads...	Pliers.....	Disconnect lead at front armor plate end. (One lead for each headlight.)
(3) Remove fenders.....	Wrench, $\frac{1}{16}$ -in., O. E., B., or soc.	Quantities in the following refer to one fender only. Remove seven $\frac{3}{8}$ -in. hex-hd. bolts and nuts from front sloping armor plate. Remove three $\frac{3}{8}$ -in. hex-hd. cap screws from front sloping armor plate. Remove five $\frac{3}{8}$ -in. hex-hd. bolts and nuts from side armor plate. Remove four $\frac{3}{8}$ -in. hex-hd. bolts and nuts from sponson. Lift fenders off.
(4) Disconnect tracks.....		See paragraph 113.
(5) Remove sprockets...	Wrench, $1\frac{1}{16}$ -in., soc. Pinch bar.	Lock steering levers in full stop position. Remove eight $\frac{3}{8}$ -in. hex-hd. nuts from studs on each final drive shaft flange. Insert pinch bar between hull and sprocket to loosen sprocket hub on studs, and remove sprocket.
(6) Drain oil from final drive.	Sq. stock, $\frac{3}{8}$ -in. Wrench, $\frac{1}{16}$ -in., sq. soc. Drain pan.	Remove two $\frac{1}{2}$ -in. recessed-head pipe plugs on bottom of differential case near the right and left final drive housing. Replace plugs after draining.

LIGHT TANK M3

<i>Specific step</i>	<i>Equipment</i>	<i>Procedure</i>
(7) Drain oil from transmission.	Wrench, $\frac{1}{16}$ -in., B., soc., or O. E. Sq. stock, $\frac{3}{4}$ -in. Wrench, $\frac{3}{4}$ -in., O. E. Drain pan.	Remove four $\frac{3}{8}$ -in. hex-hd. nuts from studs on either plate underneath differential. Remove plate. Remove $1\frac{1}{4}$ -in. magnetic pipe plug by means of $\frac{1}{4}$ -in. square rod inserted in recessed head of plug. Replace plug after draining.
(8) Disconnect final drives.	Wrench, $\frac{3}{8}$ -in., soc.	Remove locking wire. Remove 17 $\frac{5}{8}$ -in. hex-hd. cap screws holding each final drive housing to differential case.
(9) Remove final drive.	$2\frac{1}{2}$ -in. bolts, 3 in., #12 thread. Wrench fit bolt.	Screw bolts in tapped holes in flange of final drive contacting differential case. Turn bolts evenly and rock final drive by hand until it is free. Two men are needed to lift final drive away.

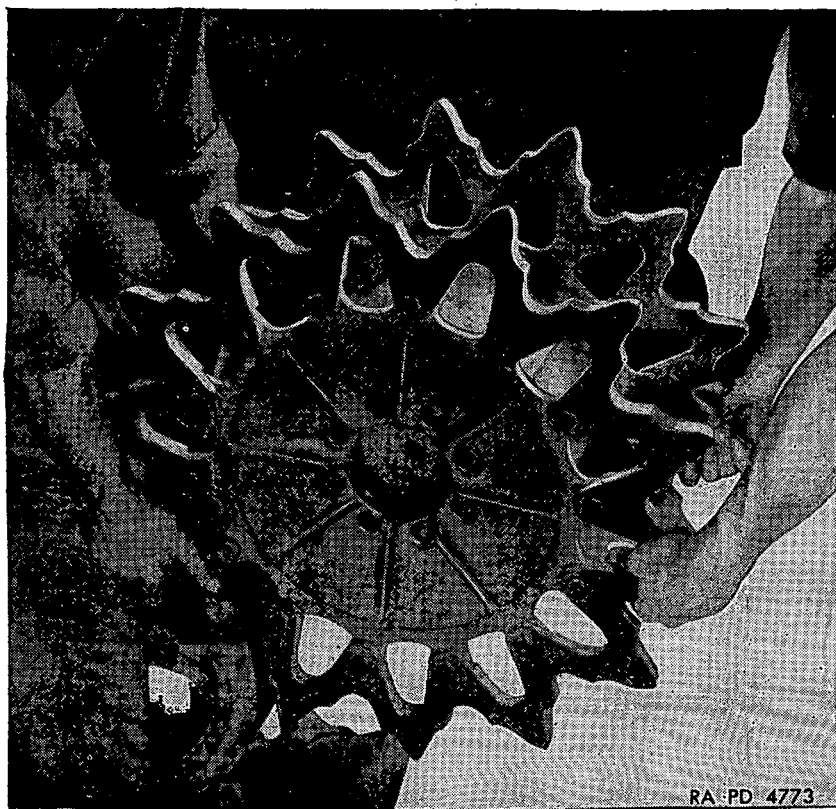

FIGURE 60.—Removal of drive sprocket.

<i>Specific step</i>	<i>Equipment</i>	<i>Procedure</i>
(10) Remove conduit elbows in front sloping armor plate.	Wrench, $\frac{15}{16}$ -in., O. E., B., or soc.	Remove hexagon nut holding conduit elbows for headlamps and siren. From inside tank pull elbows away from front sloping armor plate.
(11) Remove front sloping armor plate.	Screw driver drag-link wrench, $\frac{15}{16}$ -in.; O. E., B., or soc.	Remove the following bolts, nuts, and cap screws that hold the front sloping armor plate to hull: 4 $\frac{3}{8}$ -in. slotted-head cap screws; 12 $\frac{3}{8}$ -in. slotted-head bolts and hex-hd. nuts; 1 $\frac{3}{8}$ -in. slotted-head bolt and hex-hd. nut supporting compass. Disconnect instrument panel from armor plate. Remove plate.
(12) Remove spotlight switch support brackets from transmission.	Wrenches, $\frac{1}{2}$ -in., O. E., $\frac{1}{16}$ -in., O. E.	Remove 4 $\frac{1}{4}$ -in. bolts holding switch brackets to transmission case (one on each side).
(13) Disconnect oil pressure gage line.	Wrench, $\frac{1}{16}$ -in., O. E.	Disconnect line at gage. Close end of line with cloth.
(14) Disconnect hand throttle cable.	Pliers, two wrenches, $\frac{1}{16}$ -in., O. E. wrench, 1-in., O. E.	Remove cotter and clevis pins from accelerator shaft lever near clutch pedal. Loosen lock nuts holding adjustable clevis. Remove adjustable clevis. Remove 1-in. hex-hd. nut holding cable to support bracket. Remove cable.
(15) Remove leg shield in bow gunner's compartment.	Two wrenches, $\frac{1}{2}$ -in., O. E.	Remove three $\frac{1}{16}$ -in. hex-hd. bolts and nuts holding leg guard and speedometer shield together. Remove one $\frac{1}{16}$ -in. hex-hd. cap screw holding forward end of leg shield to transmission. Remove shield.
(16) Remove propeller shaft housing cover.	Wrench, $\frac{3}{8}$ -in., soc.	Remove eight $\frac{1}{16}$ -in. hex-hd. acorn nuts from cover. Remove cover.
(17) Remove windshield fans.	Screw driver.....	Loosen screws holding mounting sockets together until ball slips from socket. Permit both fans to be supported from their motor leads.
(18) Remove speedometer housing.	Wrench, $\frac{1}{2}$ -in., O. E. Pliers.	Open inspection cover on speedometer housing. Remove two $\frac{1}{16}$ -in. hex-hd. Cap screws attaching housing to transmission case. Disconnect speedometer cable at transmission. Lay speedometer housing carefully to one side on floor of bow gunner's compartment.

LIGHT TANK M3

- | <i>Specific step</i> | <i>Equipment</i> | <i>Procedure</i> |
|--|---|--|
| (19) Remove instrument panel rear cover. | Wrenches, $\frac{1}{16}$ -in., O. E., $\frac{1}{8}$ -in., O. E., $\frac{1}{2}$ -in., soc. | Remove four $\frac{1}{4}$ -in. nuts holding cover to instrument panel. Remove cover. |
| (20) Remove instrument panel from transmission case. | Extension with universal joint and ratchet handle 12 in. or longer. | Remove four $\frac{5}{16}$ -in. hex-hd. nuts from studs in transmission case holding instrument panel in place. Remove $\frac{3}{8}$ -in. hex-hd. cap screws holding stop light switch cable clamps to hand hold covers of transmission case. Lay instrument panel carefully on floor of bow gunner's compartment. |
| (21) Remove ammunition box on floor of bow gunner's compartment. | Wrench, $\frac{1}{16}$ -in., soc., long extension. | Remove two $\frac{3}{8}$ -in. hex-hd. cap screws and nuts holding ammunition box to hull. Remove two $\frac{3}{8}$ -in. bolts and spacers through bottom of ammunition box at front and remove ammunition box. |

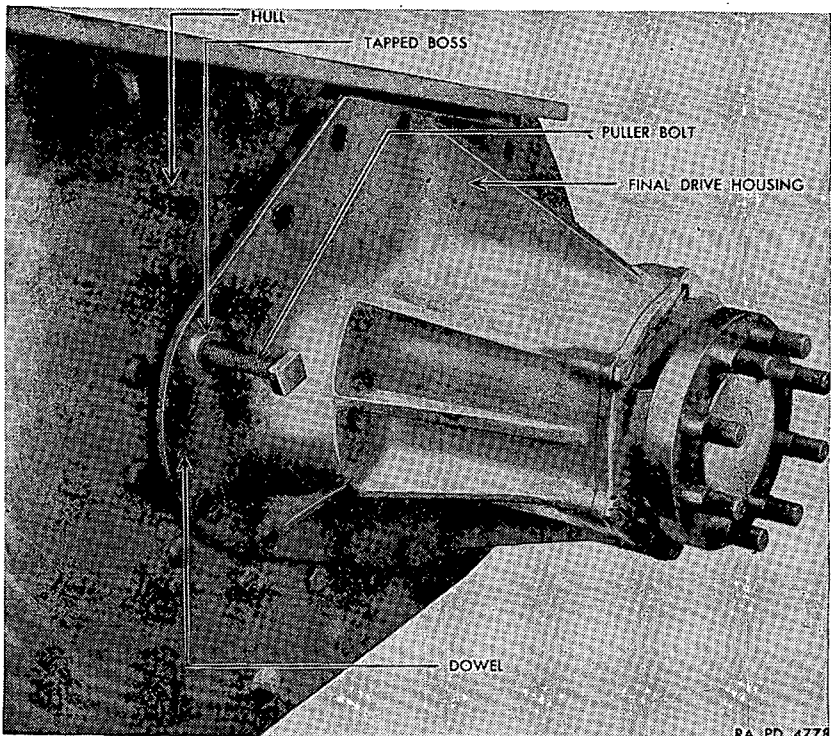

FIGURE 61.—Method of separating final drive from differential housing.

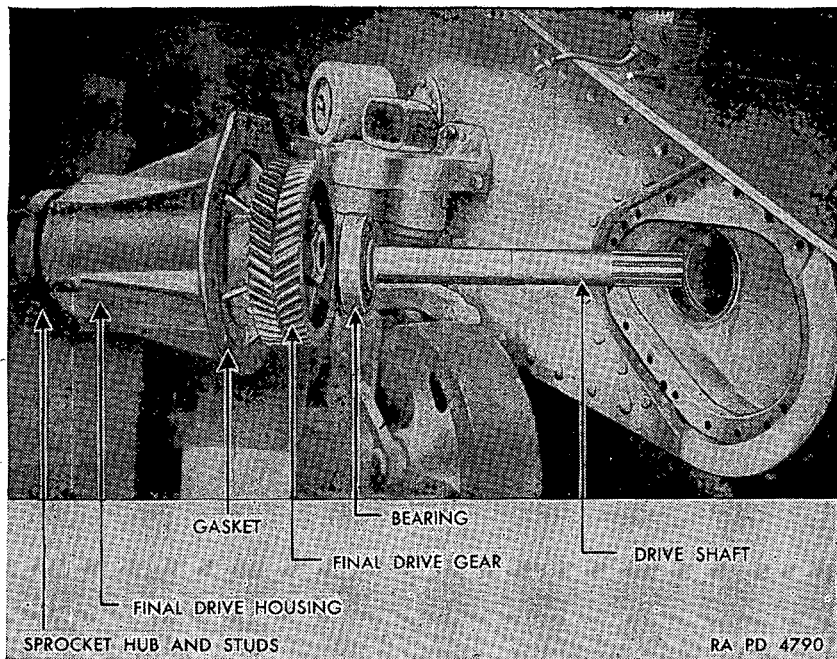
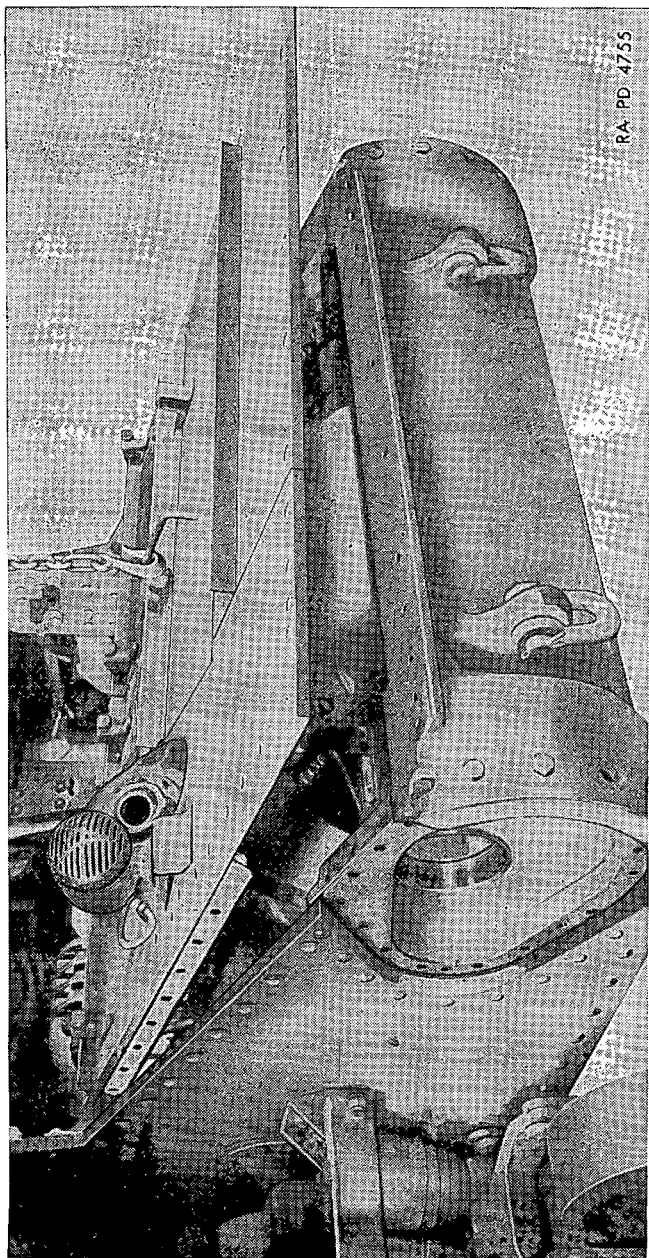

FIGURE 62.—Final drive.

<i>Specific step</i>	<i>Equipment</i>	<i>Procedure</i>
(22) Remove siren switch.	Wrench, ½-in., O. E. or soc.	Remove ½-in. hex-hd. nuts on switch support bracket. Lay on floor of gunner's compartment.
(23) Disconnect steering lever linkage.	Pliers.....	Remove cotter and clevis pins from adjustable clevis on each steering lever.
(24) Disconnect clutch linkage.	Pliers.....	Remove cotter and clevis pins from pedal shaft lever located underneath transmission case.
(25) Disconnect transmission-oil pump discharge line.	Wrenches, 1½-in., O. E., 1¼-in., O. E.	Disconnect line at fitting on discharge side of pressure relief valve. Close end of line with cloth.
(26) Disconnect needle bearing oil line.	Wrench, ¾-in., O. E.	Disconnect line at elbow near pressure relief valve. Close ends of line with cloth.
(27) Remove propeller shaft guard straps.	Wrench, ¾-in., O. E.	Remove four ½-in. hex-hd. cap screws holding guard straps to brackets inside propeller shaft housing. Remove guard straps.



RA PD 4755

FIGURE 63.—Removal of front sloping armor.

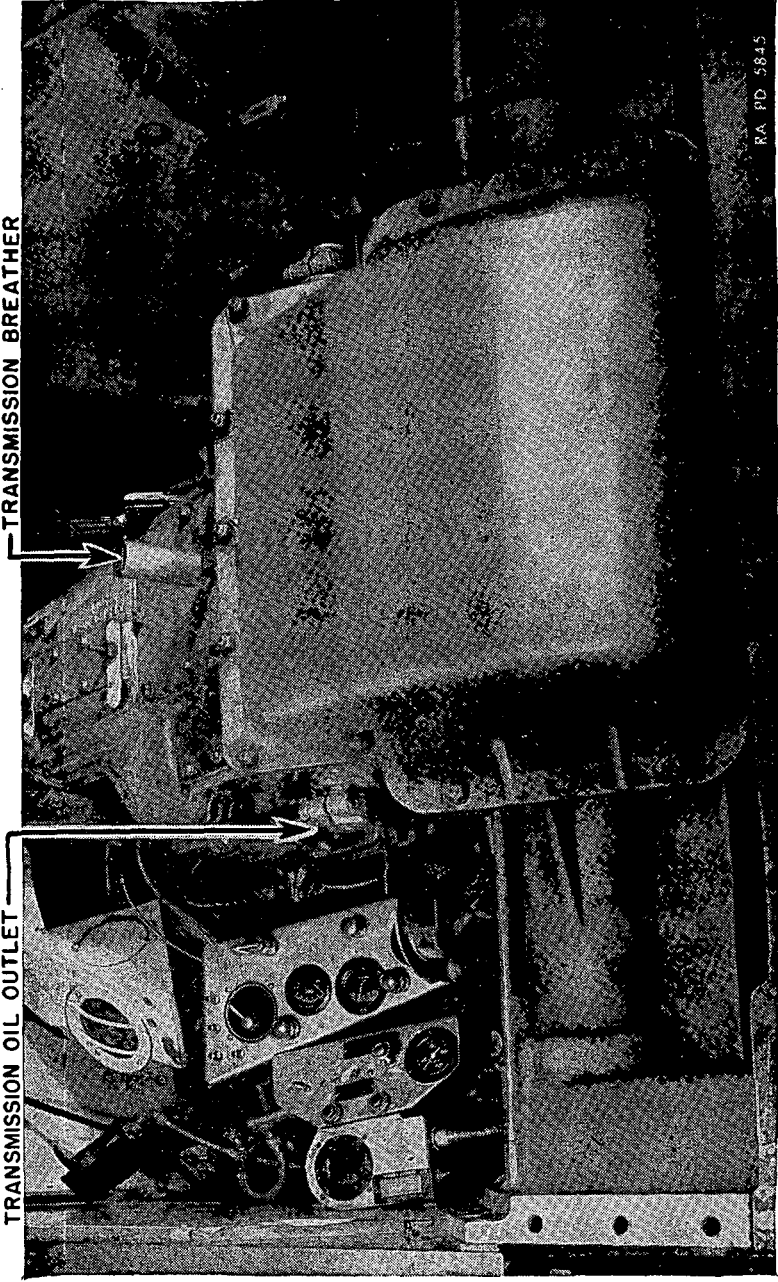

PA PD 5845

FIGURE 64.—Disposition of instruments before transmission removal.

Specific step	Equipment	Procedure
(28) Disconnect propeller shaft.	Two wrenches, $\frac{3}{4}$ -in., B.	Remove four $\frac{1}{2}$ -in. bolts and nuts which hold propeller and input shaft companion flanges together. Propeller shaft may be held out of the way by means of a block inserted between the shaft and propeller shaft housing.
(29) Remove right and left propeller shaft housing brackets.	Wrench, $\frac{3}{4}$ -in., O. E. Wrench, $\frac{5}{16}$ -in., O. E. Screw driver.	From each bracket remove four $\frac{1}{2}$ -in. hex-hd. cap screws holding bracket to transmission. Remove three $\frac{3}{8}$ -in. slotted head bolts and nuts from left side of propeller shaft housing bracket supports. Remove five $\frac{3}{8}$ -in. bolts and nuts from right side of propeller shaft housing bracket supports.
(30) Disconnect transmission inlet oil line.	Wrenches, $1\frac{1}{8}$ -in., O. E., $1\frac{1}{4}$ -in., O. E.	Disconnect at fitting on copper tubing nearest transmission. Close ends of line with cloth.
(31) Remove clamps holding oil line to propeller shaft housing.	Two wrenches, $\frac{1}{2}$ -in., O. E.	From each clamp remove a $\frac{1}{4}$ -in. bolt and nut that fastens clamp to propeller shaft housing. Support line to clear transmission by inserting block between line and propeller shaft housing.
(32) Disconnect speedometer drive gear housing.	-----	Lay housing and gear shift lever on floor.
(33) Remove bolts and cap screws holding transmission to hull.	Two wrenches, $\frac{3}{4}$ -in., O. E., B., or soc. Wrench, $1\frac{5}{16}$ -in., soc.	Remove 10 $\frac{5}{8}$ -in. cap screws from front of hull attaching transmission final drive flanges to hull (5 on each side). From each side of hull remove 9 $\frac{1}{2}$ -in. hex-hd. bolts and nuts attaching transmission final drive flange to hull.
(34) Remove spacers between hull and transmission final drive flanges.	Drift hammer-----	With a suitable drift and hammer, drive spacers toward rear of tank in a horizontal direction (one spacer on each side).
(35) Attach chains-----	Chains. Hoist-----	Place the hook or ring of hoist directly above the transmission breather and about 6 in. from it. Loop a chain around the input shaft and right and left transmission brake band shafts. Adjust length of chains so that

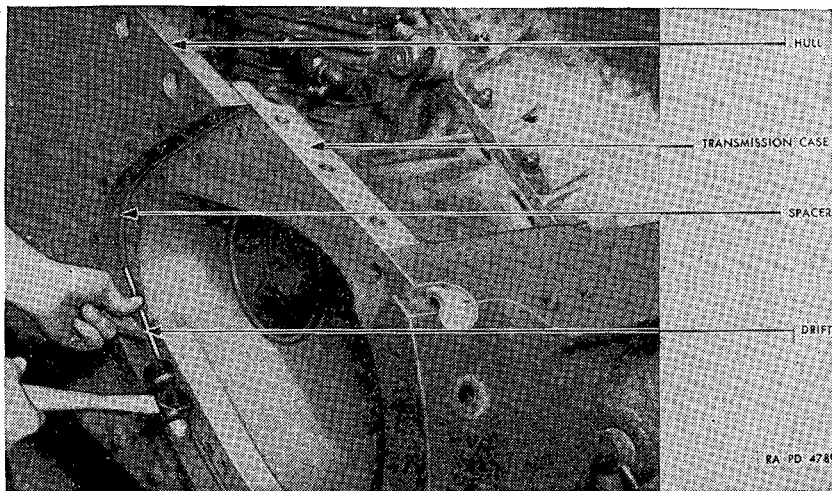
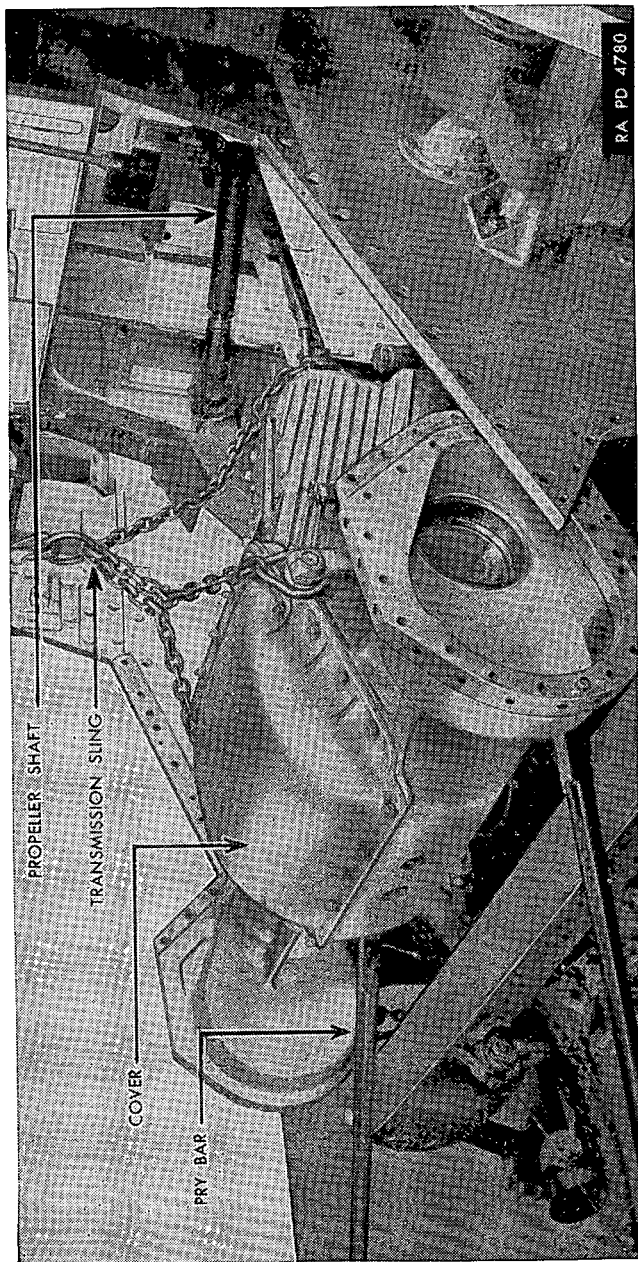

FIGURE 65.—Method of removing spacers.

<i>Specific step</i>	<i>Equipment</i>	<i>Procedure</i>
(36) Remove transmission from hull of tank.	Chains. Hoist. Two pinch bars, 5 ft. long,	<p>center of lift is directly above breather and about 10 in. from it.</p> <p>Place one man in driver's seat to see that no parts interfere with removal of transmission. Insert pinch bars between transmission case and front of hull and on each side of differential case so that transmission may be moved toward rear of tank. Lift and pry at the same time until transmission is raised far enough to clear front of hull. If the transmission is placed on a level surface, rest it on three 6-in. by 6-in. blocks, one under each final drive flange and one under the transmission case.</p>

b. Installation of transmission.

<i>Specific step</i>	<i>Equipment</i>	<i>Procedure</i>
(1) Clean interior of tank, particularly floor.	None.....	
(2) Place one man in driver's compartment to prevent injury to the accessories laying on floor.	None.....	



RA PD 4780

FIGURE 65.—Removing transmission.

<i>Specific step</i>	<i>Equipment</i>	<i>Procedure</i>
(3) Make certain rubber pads are on brackets attached to floor of tank beneath transmission case.	None-----	
(4) Install transmission in hull of tank.	Chains. Hoist. Two pinch bars, 5 ft. long.	To attach chain to transmission, place the hook or ring of hoist directly above transmission breather and about 6 in. from it. Loop a chain around the input shaft and right and left transmission brake band shafts. Adjust length of chains so that center of lift is directly above breather and about 10 in. from it.
(5) Install first spacer---	None-----	Insert spacer, making certain that it does not overlap the final drive aperture in side of hull at any point. Any overlap will cause oil to leak from the transmission in the final drive in a few miles of operation. Hold first spacer firmly by at least three bolts before installing the second spacer.
(6) Install second spacer (fig. 67).	Jack-----	Place a jack between transmission steering brake band shaft and hull in such a manner as to spread hull slightly to permit installation of second spacer. Make certain spacer does not overlap final drive aperture in hull.
(7) Install bolts and cap screws holding transmission to hull.	Two wrenches, 3/4-in., O. E., B., or soc. wrench, 1 1/8-in., soc.	Install 10 3/8-in. cap screws in front of hull attaching transmission final drive flanges to hull (5 on each side). On each side install nine 1/2-in. hex-hd. bolts and nuts attaching transmission final drive flange to hull.
(8) Install speedometer drive, gear housing.	Wrench, 3/4-in., O. E.	Install four 1/2-in. hex-hd. cap screws holding housing to rear of transmission case.
(9) Install right and left propeller shaft housing brackets.	Wrenches, 3/4-in., 1/2-in., O. E. Screw driver.	Install three 3/8-in. slotted head bolts and nuts and five hex-hd. bolts attaching brackets to propeller shaft housing. Install two 1/2-in. hex-hd. cap screws holding bracket to transmission.

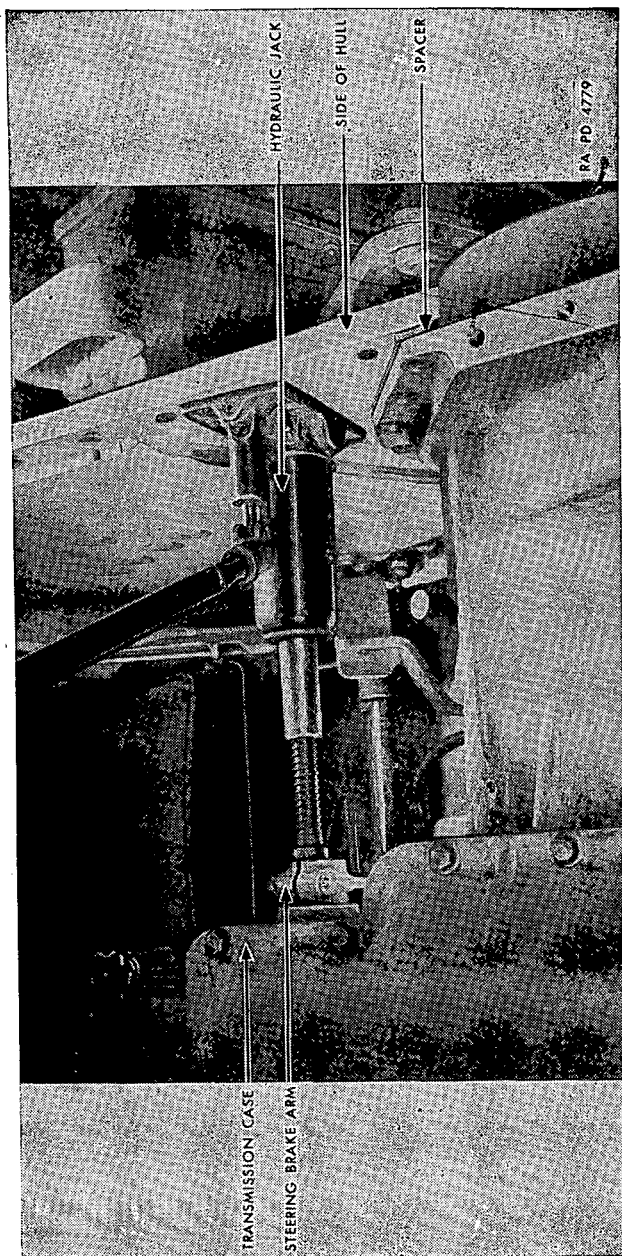

FIGURE 67—Second spacer installation.

<i>Specific step</i>	<i>Equipment</i>	<i>Procedure</i>
(10) Install clamps holding-oil line to propeller shaft housing.	Two wrenches, $\frac{1}{16}$ -in., O. E.	Attach clamps to propeller shaft housing by installing $\frac{1}{4}$ -in. bolts and nuts.
(11) Install propeller shaft.	Two wrenches, $\frac{3}{4}$ -in., B.	Install four $\frac{1}{2}$ -in. bolts and nuts which hold propeller and input shaft companion flanges together.
(12) Connect transmission inlet oil line.	Wrench, $1\frac{1}{8}$ -in., O. E. Wrench, $1\frac{1}{4}$ -in., O. E.	Connect at fitting on copper tubing nearest transmission.
(13) Install propeller shaft guard straps.	Wrench, $\frac{3}{4}$ -in., O. E.	Install four $\frac{1}{2}$ -in. hex-hd. cap screws holding guard straps to brackets inside propeller shaft housing.
(14) Install needle bearing oil line.	Wrench, $\frac{3}{4}$ -in., O. E.	Connect line at elbow near pressure relief valve.
(15) Connect transmission oil pump discharge line.	Wrenches $1\frac{1}{8}$ -in., $1\frac{1}{4}$ -in., O. E.	Connect line at fitting on discharge side of pressure relief valve.
(16) Connect clutch linkage.	Pliers-----	Install clevis and cotter pins connecting clutch pedal shaft and linkage underneath transmission case.
(17) Connect steering lever linkage.	Pliers-----	Install clevis and cotter pins attaching adjustable clevis to each steering lever.
(18) Install siren switch.	Wrench, $\frac{3}{4}$ -in., O. E. or soc.	Attach switch to bracket with $\frac{1}{2}$ -in. hex-hd. nuts.
(19) Install ammunition box on floor of bow gunner's compartment.	Wrench, $\frac{9}{16}$ -in., soc., long extension.	Install two $\frac{3}{8}$ -in. hex-hd. cap screws and nuts holding ammunition box to hull.
(20) Install instrument panel on transmission case.	Wrenches, $\frac{9}{16}$ -in., O. E., $\frac{1}{2}$ -in., soc. Extension w/universal joint and rtc. handle, 12 in. or longer.	Install four $\frac{5}{16}$ -in. hex-hd. nuts on studs in transmission case holding instrument panel in place. Install $\frac{3}{8}$ -in. hex-hd. cap screws holding stop light switch cable clamps to handhole covers of transmission case.
(21) Install instrument panel rear cover.	Wrench, $\frac{7}{16}$ -in., O. E.	Secure cover to instrument panel with four $\frac{1}{4}$ -in. nuts.
(22) Install speedometer housing.	Wrench, $\frac{1}{2}$ -in., O. E. Pliers.	Working through inspection cover on speedometer housing, install two $\frac{1}{16}$ -in. hex-hd. cap screws attaching housing to transmission case.
(23) Install windshield fans.	Screw driver-----	Install ball mounting in socket. Hold in position by tightening socket clamping screw clamping socket.

<i>Specific step</i>	<i>Equipment</i>	<i>Procedure</i>
(24) Install propeller shaft housing cover.	Wrench, $\frac{3}{8}$ -in., soc.	Install eight $\frac{1}{16}$ -in. hex-hd. acorn nuts holding cover to housing.
(25) Install leg shield in bow gunner's compartment.	Two wrenches, $\frac{1}{2}$ -in., O. E.	Hold leg guard and speedometer shield together by installing three $\frac{5}{16}$ -in. hex-hd. bolts and nuts. Hold forward end of leg shield to transmission case by installing $\frac{1}{16}$ -in. cap screw to transmission.
(26) Connect hand throttle cable.	Pliers. Two wrenches, $\frac{1}{16}$ -in., O. E. Wrench, 1-in., O. E.	Install adjustable clevis and hold in position by tightening lock nuts. Install clevis and cotter pin connecting accelerator shaft lever near clutch pedal to adjustable clevis. Hold cable to support bracket by installing hex-hd. nut.
(27) Connect oil pressure gage line.	Wrench, $\frac{1}{16}$ -in., O. E.	Connect line at gage.
(28) Install stoplight switch support brackets on transmission.	Wrenches, $\frac{1}{2}$ -in., $\frac{1}{16}$ -in., O. E.	Install 4 $\frac{1}{4}$ -in. bolts holding switch brackets to transmission case (one on each side).
(29) Install front sloping armor plate.	Screw driver. Drag-link wrench, $\frac{1}{16}$ -in., O. E., B., or soc.	Install the following bolts, nuts, and cap screws holding the front sloping armor plate to hull: 4 $\frac{5}{8}$ -in. slotted-hd. cap screws; 12 $\frac{5}{8}$ -in. slotted bolts and hex-hd. nuts; 1 $\frac{3}{8}$ -in. slotted hd. bolt. and hex-hd. nut supporting compass.
(30) Install conduit elbows in front sloping armor plate.	Wrench, $\frac{15}{16}$ -in., O. E., B., or soc.	Install hexagon nut holding conduit elbows in front sloping armor plate for head lamps and siren.
(31) Install final drive...	Wrench, $\frac{3}{8}$ -in., soc.	Using two men, place final drive in position. Start four equally spaced cap screws holding final drive to flange of transmission case. Rock final drive to make certain that dowel pins enter final drive flange holes before cap screws are tightened. Tighten evenly so as to keep final drive in alinement. Install remaining 13 $\frac{3}{8}$ -in. hex-hd. cap screws.
(32) Install sprockets...	Wrench, $1\frac{1}{16}$ -in., soc.	Using two men, mount sprocket on final drive flange. Install 8 $\frac{3}{8}$ -in. hex-hd. nuts holding each final drive to final drive shaft flange.

<i>Specific step</i>	<i>Equipment</i>	<i>Procedure</i>
(33) Install fenders.....	Wrench, $\frac{7}{16}$ -in., O. E., B., or soc. Wrench, $\frac{7}{16}$ -in., O. E., B., or soc.	Quantities in the following refer to one fender only. Install 7 $\frac{7}{16}$ -in. hex-hd. bolts and nuts holding fender to front sloping armor plate. Install 3 $\frac{7}{16}$ -in. hex-hd. cap screws holding fender to front sloping armor plate. Install 5 $\frac{7}{16}$ -in. hex-hd. bolts and nuts holding fender to side armor plate. Install 4 $\frac{7}{16}$ -in. hex-hd. bolts and nuts holding fender to sponson.
(34) Install light leads...	Pliers.....	Connect leads at front sloping armor plate.
(35) Install siren lead...	Pliers.....	Connect lead at front sloping armor plate.
(36) Fill transmission with oil.	Wrench, $\frac{7}{16}$ -in., B., soc., or O. E. Sq. stock, $\frac{3}{4}$ -in. Wrench, $\frac{3}{4}$ -in., O. E. Drain pan.	After cleaning, install 1 $\frac{1}{4}$ -in. magnetic pipe plug. Hold pipe plug cover plate to hull by installing 4 $\frac{3}{8}$ -in. hex-hd. nuts on studs in hull.
(37) Install oil drain plugs of final drive.	Sq. stock, $\frac{7}{8}$ -in. Wrench, $\frac{7}{16}$ -in., sq. soc. Drain pan.	Install 2 $\frac{1}{2}$ -in. recessed-head pipe plugs on bottom of differential case near the right and left final drive housing.

NOTE.—Follow lubrication chart with regard to grade and quantity of lubricants used in filling transmission.

NOTE.—See lubrication chart. Put in oil.

SECTION X

OIL COOLERS

Engine oil cooler.....	Paragraph 101
Transmission oil cooler.....	102

101. Engine oil cooler.—*a. General.*—A cellular, radiator type cooler is located on the right side of the fighting compartment bulkhead (fig. 36). Oil from the engine is pumped through the cooler and returned to the supply tank. A relief valve is incorporated to bypass the oil flow before pressures are reached which might damage the cooler.

b. Maintenance.—Inspect all oil line connections and cooler mounting bolts frequently to insure against oil leaks. Remove the cooler and thoroughly clean it with cleaning fluid at the 100-hour check. Replace the cooler if defective or leaking.

c. Replacement.—To remove the cooler with engine out of vehicle, disconnect the inlet and outlet lines, and remove the four bolts sup-

porting the cooler in the bulkhead. With the engine in the vehicle, the following procedure will be used:

(1) *Engine oil cooler removal.*—(a) Remove inspection plate under engine compartment.

(b) Remove fan guard screen.

(c) Disconnect oil inlet at cooler by reaching up through inspection hole in front of fan shroud.

(d) Disconnect oil outlet through fan guard screen opening.

(e) Loosen inlet oil line support bracket on left side of bulkhead.

(f) Remove bolts from upper and lower cooler brackets while one man holds bracket bolt nuts on engine side of bulkhead.

(g) Lift cooler through fan guard screen opening.

(2) *Engine oil cooler installation.*—Reverse above procedure.

102. Transmission oil cooler.—*a. General.*—This unit is similar, in structure and function, to the engine oil cooler. The oil is pumped from the transmission and differential through the cooler and returned to the transmission. A pressure relief valve in the cooler outlet provides for by-passing the oil, when cold, to avoid damaging the core of the cooler. Maintenance of the cooler will be the same as described in paragraph 101*b*.

b. Replacement.—The replacement of the transmission oil cooler will require two men. The procedure is as follows:

(1) Remove fan guard screen.

(2) Remove inspection plate on under side of engine compartment.

(3) Remove 37-mm ammunition box in front of transmission oil cooler.

(a) One man will hold the $\frac{3}{8}$ -inch bolt heads in fighting compartment.

(b) Remove six $\frac{3}{8}$ -inch nuts underneath floor of vehicle.

(c) Disconnect fire extinguisher line.

(d) Lift ammunition box and fire extinguisher toward front of compartment.

(4) Remove four guard channels.

(5) Disconnect oil inlet line at cooler.

(6) Remove four bracket-mounting bolts.

(a) One man will hold nuts in engine compartment while bolts are loosened.

(b) Remove bolts.

(c) Pull cooler forward and to the right until oil outlet connection is exposed.

(d) Disconnect oil outlet and remove cooler.

(e) Reverse the sequence of operations to install.

SECTION XI
FINAL DRIVES

	Paragraph
Description.....	103
Operation.....	104
Lubrication.....	105
Replacement.....	106

103. **Description** (fig. 62).—The right and left final drive housings are bolted to each side of the front end of the case which houses the differential and transmission assemblies. Each final drive comprises reduction gearing which terminates in a hub mounting the drive sprocket.

104. **Operation**.—Torque is transmitted from the differential compensating gear, through a splined shaft, to the smaller gear in the final drive. This gear meshes and drives the larger final drive gear which, in turn, drives the sprocket through a second shaft, splined at the inner end.

105. **Lubrication**.—An oil filler hole through the front armor plate is provided for each final drive. The hole is closed by a square-headed pipe plug. A similar plug is located in the bottom of the hull for draining each unit. The lubrication chart (fig. 12) recommendations will be followed for the periodic lubrication.

106. **Replacement**.—Instructions covering the removal and installation of the final drive units will be found in paragraph 100.

SECTION XII
TRACKS AND SUSPENSIONS

	Paragraph
Description and operation.....	107
Axles.....	108
Sprockets.....	109
Bogies.....	110
Track support rollers.....	111
Trailing idler.....	112
Tracks.....	113
Grousers.....	114

107. **Description and operation**.—Four 2-wheeled, rubber-tired bogies or suspensions (fig. 68) are trunnioned on the front and rear axle ends. They support the vehicle on volute springs and ride the inside of the endless track. The drive sprocket draws the track over trailing idler and track support rollers and lays it in the path of the bogie. A volute spring on the trailing idler arm provides constant pressure on the idler to maintain track tension. The action of the

volute springs and articulating bogie links keeps track tension constant while negotiating obstacles or irregular terrain.

108. Axles.—*a. General.*—Tubular front and rear axles (fig. 69) are retained in brackets bolted to the sides and floor of the hull. Hardened steel bushings on the axle end act as the bearing surfaces for the suspension.

b. Replacement of front axle.—Replace a broken or bent axle or one whose bushings show wear of more than .020 inch.

(1) *Removal of front axle.*—Open battery switch and block up tank in front of front axle (fig. 70).

NOTE.—Disconnect tracks and roll vehicle off.

(a) Disassemble front bogies on both sides of tank (par. 110*d*).

(b) Remove four 1/2-inch bolts and nuts and remove bow gunner's seat and support bracket.

(c) Remove driver's seat as described in (b) above.

(d) Remove two 3/8-inch cap screws at axle and two 3/8-inch oval-head screws and spacers at front and remove bow gunner's ammunition box.

(e) Using long ratchet handle with 6-inch extension and 15/16-inch thin hexagon socket, remove six 5/8-inch cap screws holding steering brake lever brackets on axle in driver's compartment.

(f) Remove two 5/8-inch cap screws holding steering brake lever bracket to axle in bow gunner's compartment.

(g) With one man holding nuts on inside of vehicle loosen and remove twenty-three 1/2-inch bolts and 5 nuts from bottom of axle retaining bracket.

NOTE.—After loosening, a 12-inch speed wrench will lessen the time required to remove all bolts. Five bolts are inverted to give required clearance to brake shaft levers.

(h) Place jack to support center of axle.

(i) With nuts held on inside use ratchet wrench and 3/4-inch socket to loosen and remove four bolts from each outside axle bracket.

(j) Lower jack and remove axle.

(2) *Installation of front axle.*—Reverse the above removal procedure.

c. Replacement of rear axle.—Replace an unserviceable rear axle using the following procedure.

(1) *Removal of rear axle.*—Open battery switch.

(a) Block up tank on both sides behind rear axle.

(b) Remove rear bogie assemblies (par. 110*d*).

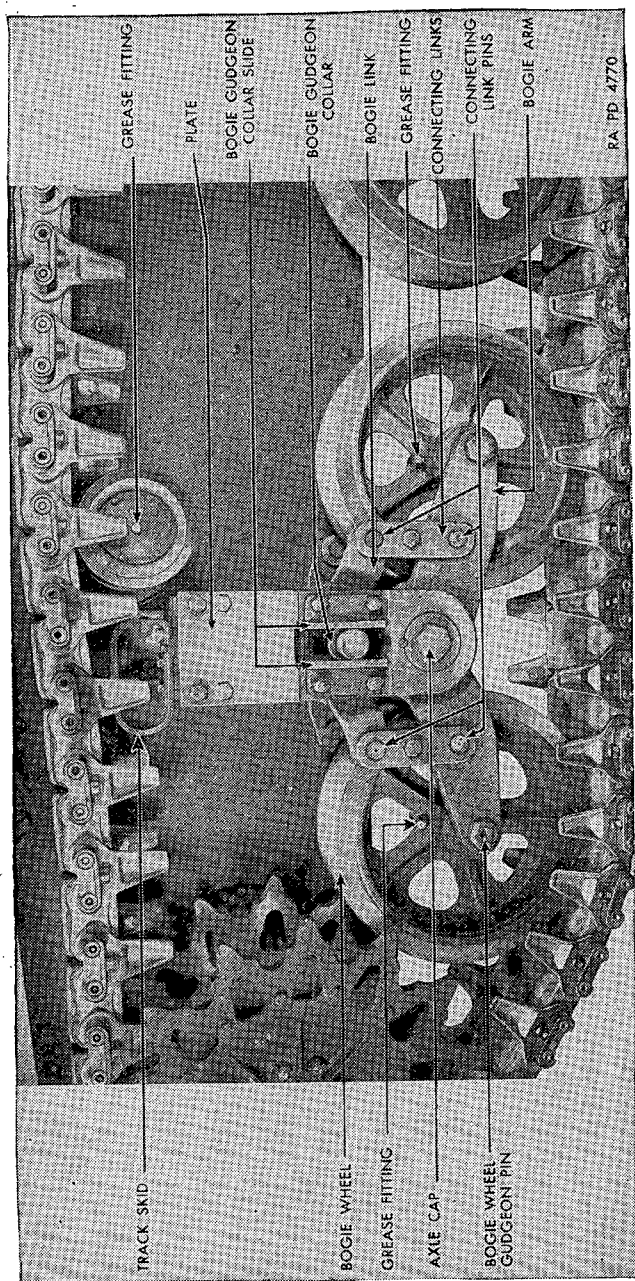

FIGURE 68.—Front bogie and track support rollers, grease fittings.

(c) Remove two cotter pins and two bracket retaining pins and remove 37-mm stowage box from bulkhead.

(d) Using two men, remove two $\frac{3}{8}$ -inch bolts (remove nuts from bottom) and remove 37-mm stowage box on right side of fighting compartment.

(e) Using two men, remove six $\frac{3}{8}$ -inch bolts (remove nuts from bottom) and remove 37-mm stowage box on left side.

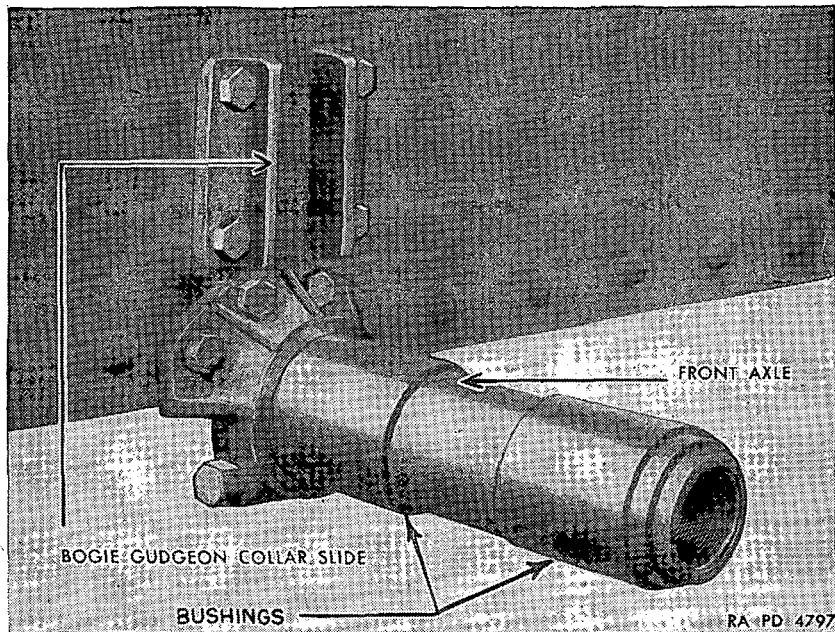

FIGURE 69.—Front bogie axle.

(f) Remove tunnel housing ammunition box.

(g) With man in fighting compartment holding nuts, remove 28 bolts from axle flange..

(h) Place jack under center of axle to hold it in position.

(i) With man holding nuts inside compartment remove four bolts from each vertical axle bracket.

(j) With a man steadying axle at each end, lower the supporting jack and pull axle out.

(2) *Installation of rear axle.*—Reverse the above removal procedure.

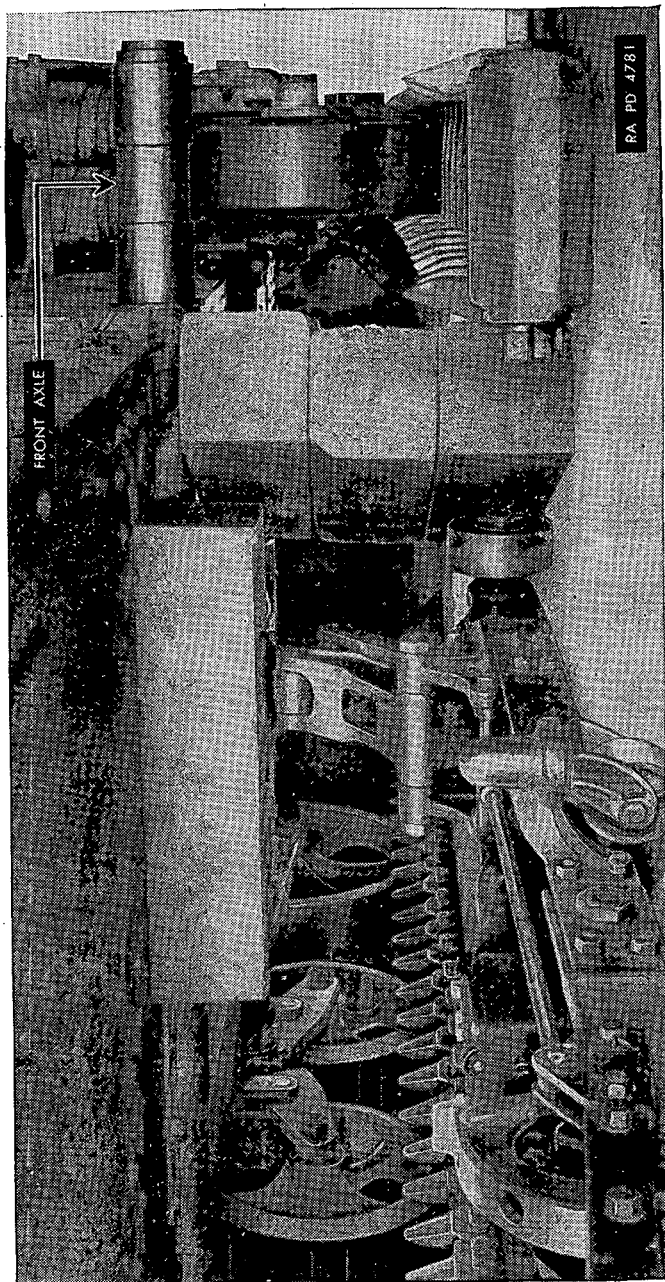

FIGURE 70.—Method of blocking front of tank.

109. Sprockets.—*a. Description.*—The track drive sprocket assemblies are made up of two tooth-plates bolted to a sprocket hub which, in turn, is bolted to the flanged end of the final drive sprocket shaft. The right and left drive sprockets are interchangeable.

b. Maintenance.—Inspect sprockets frequently to insure that tooth-plate bolts and hub bolts are sufficiently tight. When appreciable wear is noted on the sprocket teeth, interchange the right and left sprockets to bring the track in contact with the unused area of the teeth.

c. Replacement.—Replace drive sprockets when worn or deemed unserviceable as follows:

(1) *Removal.*—(a) Disconnect track (par. 113*d*) and lift away from sprocket.

(b) Remove eight cotter pins and nuts.

(c) Remove sprocket.

(2) *Installation.*—To install sprocket, reverse order of removal and connect and adjust track.

d. Replacement of sprocket tooth-plates.—(1) Disconnect track (par. 113*d*) and lift away from sprocket.

(2) Remove 14 cap screws and washers holding outside tooth-plate on sprocket hub, and remove plate.

(3) Remove cap screws from inside tooth-plate.

(4) Turn plate one serration and slide off over hub.

(5) Install new tooth-plates by reversing order of removal.

NOTE.—Always replace *both tooth-plates* to insure equal tooth contact on both sides of track.

110. Bogies (fig. 68).—*a. General.*—The bogies, or suspensions, support and convey the vehicle on the inside of the track. Vertical movement of the wheels is transmitted, through the articulated links, to the shock absorbing volute springs. A skid at the top of the bogie prevents the track from striking the spring seat.

b. Lubrication.—Lubrication fittings are provided on bogie wheels. Follow the recommendation shown on the lubrication chart (fig. 12).

c. Replacement.—(1) *Wheel bearings and oil seals.*—(a) *Removal.*—With the wheel removed from the bogie assembly (see *d* below) use a copper drift to drive out spacers with oil seals. Drive out wheel bearings.

(b) *Installation of wheel bearings and oil seals.*

1. Aline one bearing in wheel and drive or press in until stopped by shoulder.

2. Install bearing spacer and other bearing.

3. Install spacers and oil seals.

(2) *Bogie wheels and gudgeons.*—When tires become badly worn or gouged, replace the entire wheel with bearings and oil seals. When the wheel or wheel gudgeon is rendered unserviceable for any reason replace the defective part without disconnecting the track as follows:

(a) *Remove bogie wheel.*

1. Place bogie lift on track (fig. 71) and roll vehicle slowly toward it until lift is vertical.
2. Remove cotter pin and nut from bogie wheel gudgeon.
3. Install gudgeon pin puller (fig. 73).
4. Drive the gudgeon pin out.
5. Remove bogie wheel.

(b) *Install bogie wheel and gudgeon.*—Replace the bogie wheel as a complete assembly with bearings and grease retainers. Reverse the removal procedure for installation. Check bogie wheel gudgeon pin for wear and use a new one if necessary.

d. *Disassembly of bogie* (fig. 74).—When failure of any of the bogie components makes replacement necessary or when it is desirable to check components for wear, disassemble the bogie using the following procedure:

<i>Specific step</i>	<i>Equipment</i>	<i>Procedure</i>
(1) Disconnect track	-----	(See par. 113.)
(2) Remove track skid	Wrench, $\frac{1}{16}$ -in., O. E.	Remove three $\frac{3}{8}$ -in. hex-hd. cap screws holding skid to bogie bracket.
(3) Remove pipe plugs in bogie bracket.	Wrench, $\frac{3}{4}$ -in., hex., Allen.	Remove $1\frac{1}{2}$ -in. recessed head pipe plugs in bogie bracket (one for each volute spring).
(4) Compress volute springs.	Volute spring compressor.	Insert volute spring compressor stud through pipe plug hole and engage at least 1 in. of thread in the spring seats. Install hexagon nut and washer on compressor stud. Turn compressor nut until force of spring is taken up by compressor stud.
(5) Block up tank	Jack and block	Using a 6 by 6 block on the jack, lift the front of the tank and place jack and block next to and in front of front axle. When the desired height is obtained, place blocks under the axle, as shown in figure 70, and remove jack.
(6) Remove bogie plate	Wrench, $\frac{1}{16}$ -in., O. E., B., or soc. Wrench, $2\frac{1}{4}$ -in., B. Screw driver	Remove lock screw on dead axle cap and remove cap. Remove four $\frac{3}{8}$ -in. hex-hd. cap screws holding plate to upper bracket.

LIGHT TANK M3

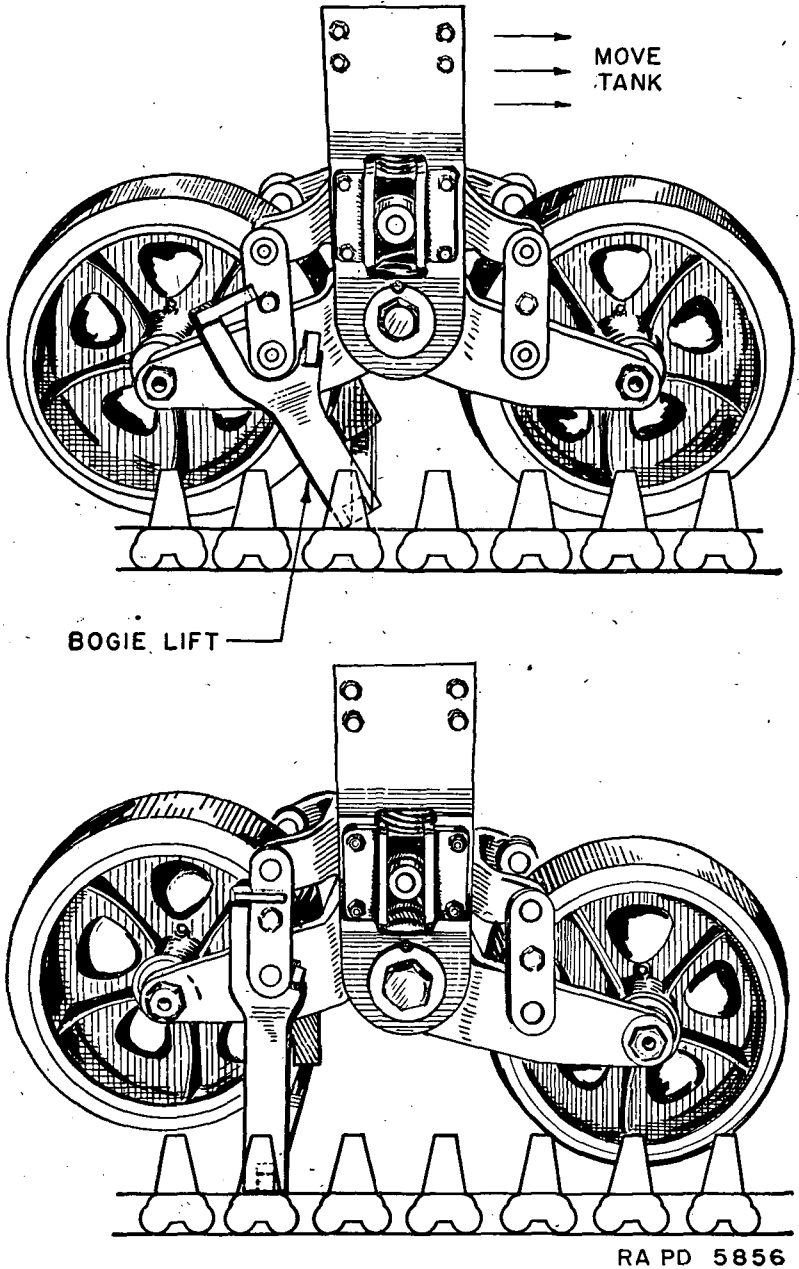

RA PD 5856

FIGURE 71.—Use of bogie lift to raise wheel for removal.

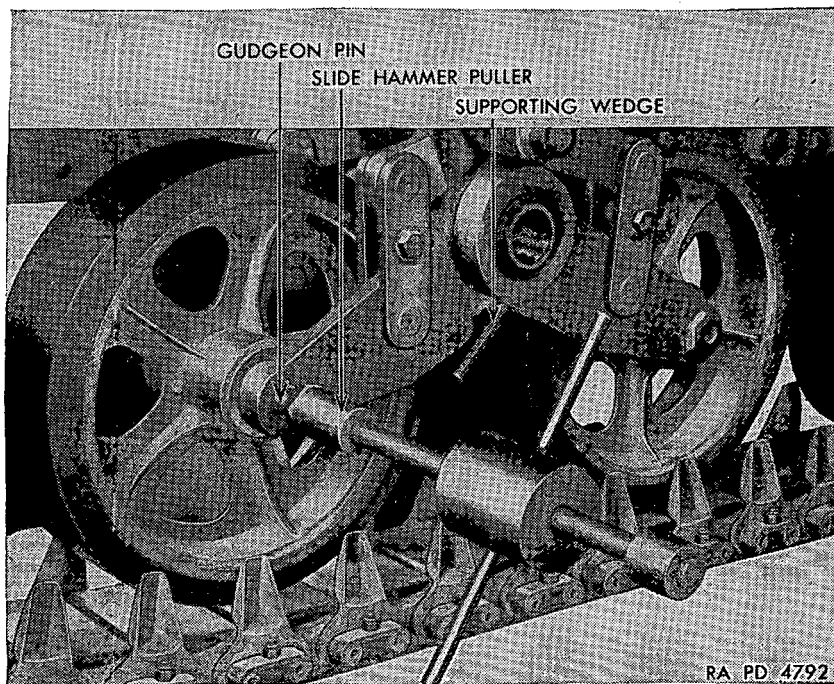

FIGURE 72.—Gudgeon pin removal.

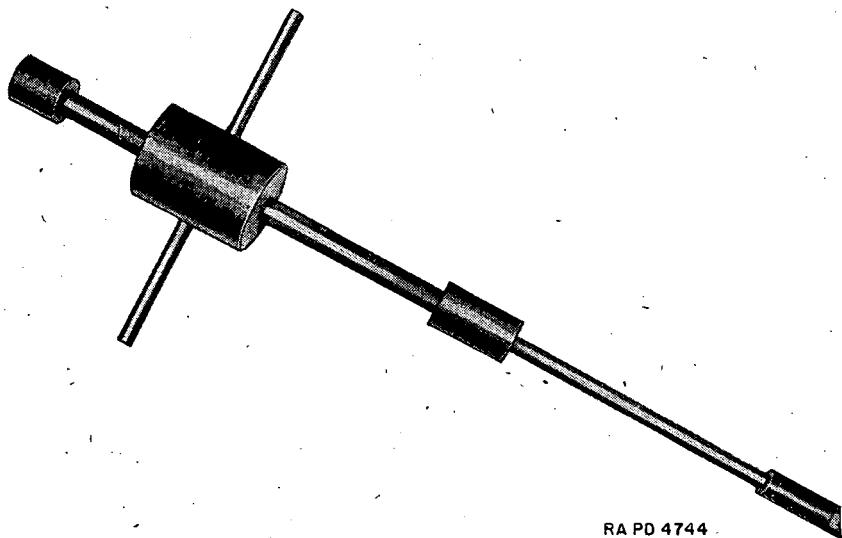

FIGURE 73.—Bogie wheel gudgeon pin puller.

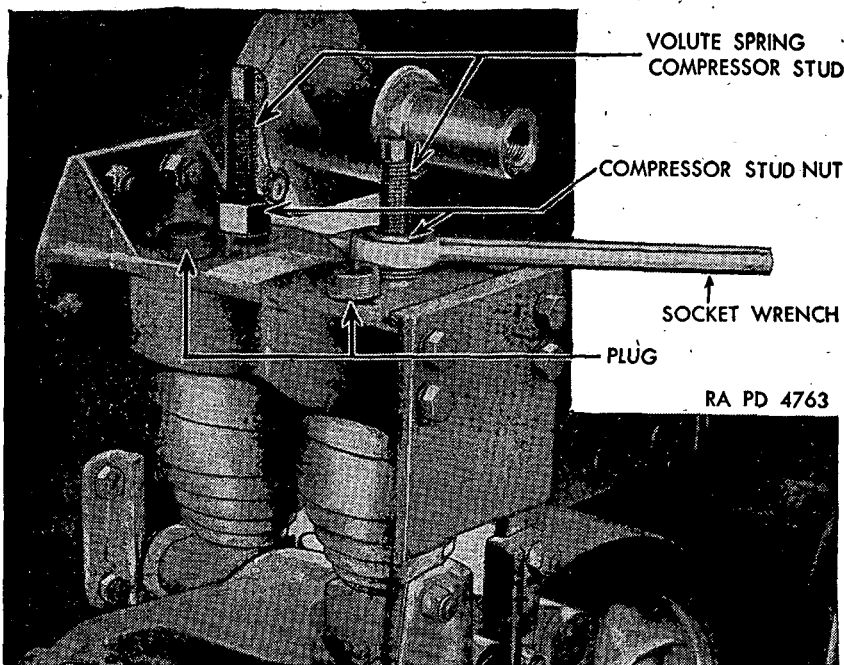

FIGURE 75.—Compressing volute springs.

<i>Specific step</i>	<i>Equipment</i>	<i>Procedure</i>
(7) Remove holding bracket.	Wrenches, 1½-in., O. E., 1½-in. B., 1½-in. soc.	Remove six ¾-in. hex-hd. bolts and nuts securing bracket to side of hull.
(8) Remove bogie hull bracket and volute springs.	Wrench, 1½-in. B.	Loosen nuts on compressor studs alternately so as to maintain flange of bogie hull bracket parallel with side of tanks. When springs are fully decompressed, unscrew compressor studs and remove bracket and volute springs.
(9) Remove bogie wheels.	Pliers. Gudgeon pin puller. Wrench, 1½-in., B.	NOTE.—As the spring is decompressed, the compressor stud will be held with a wrench to prevent its turning. Pull cotter pin from inside end of bogie wheel gudgeon pin. Remove gudgeon pin nut. Remove gudgeon pin with special puller (fig. 73).
(10) Remove connecting links and bogie link.	Wrench, 1½-in., soc. Soft hammer.	By removing four cap screws holding four sets of two links together, the connecting links may be driven off the connecting link pins.

Specific step	Equipment	Procedure
(11) Remove bogie gudgeon.	Pliers, special	Remove locking wire spring.
(12) Remove bogie arms.	None	Remove arms.

e. Assembly of bogie.—Certain components of the bogie assembly will be replaced when 0.020 inch or more wear is evident. These parts are: bogie axle, bogie wheel arm, connecting link, shoulder pin, bogie link, bogie link pin, bogie gudgeon and volute spring seat plug. Reverse the disassembly order and assemble.

NOTE.—Clean all parts carefully but do not lubricate except as shown in lubrication chart (fig. 13).

111. Track support rollers.—*a. General.*—This assembly requires no service other than lubrication and grease retainer replacement. In the event of roller failure, replace the assembly with bracket.

b. Replacement.—Support tracks to remove weight from roller and proceed as follows:

(1) Remove locking wires and five bolts holding roller bracket to side of hull.

(2) Remove bracket and roller and return to ordnance personnel.

c. Removal of support roller.—When necessary to replace the inside grease retainer, the roller must be removed from the spindle. This will be done using the following procedure:

(1) *Roller removal.*—(a) Disconnect track (see par. 113*d*.)

(b) Remove locking wire. Remove six $\frac{1}{4}$ -inch hex-hd. cap screws holding track support roller plate to roller, and remove plate (fig. 77).

(c) Remove lock screw of track support roller retaining nut and remove retaining nut.

(d) Arrange puller (fig. 76) to pull against inside edge of support roller, with jack screw pressing against a disk protecting end of shaft. When a moderate pull is exerted on roller, hit end of jack screw with hammer. Repeat process until roller is loosened. Remove roller.

(2) *Grease retainer replacement.*—(a) Remove unserviceable retainer as shown in figure 77.

(b) Install new retainer by using adapter and tap lightly until it is seated against the bearing.

(3) *Install roller.*—(a) Aline inner bearing with spindle and drive roller on until inner bearing is flush with spindle shoulder.

(b) Install roller retaining nut, nut locking screw, and plate.

(c) Install locking wire and connect track.

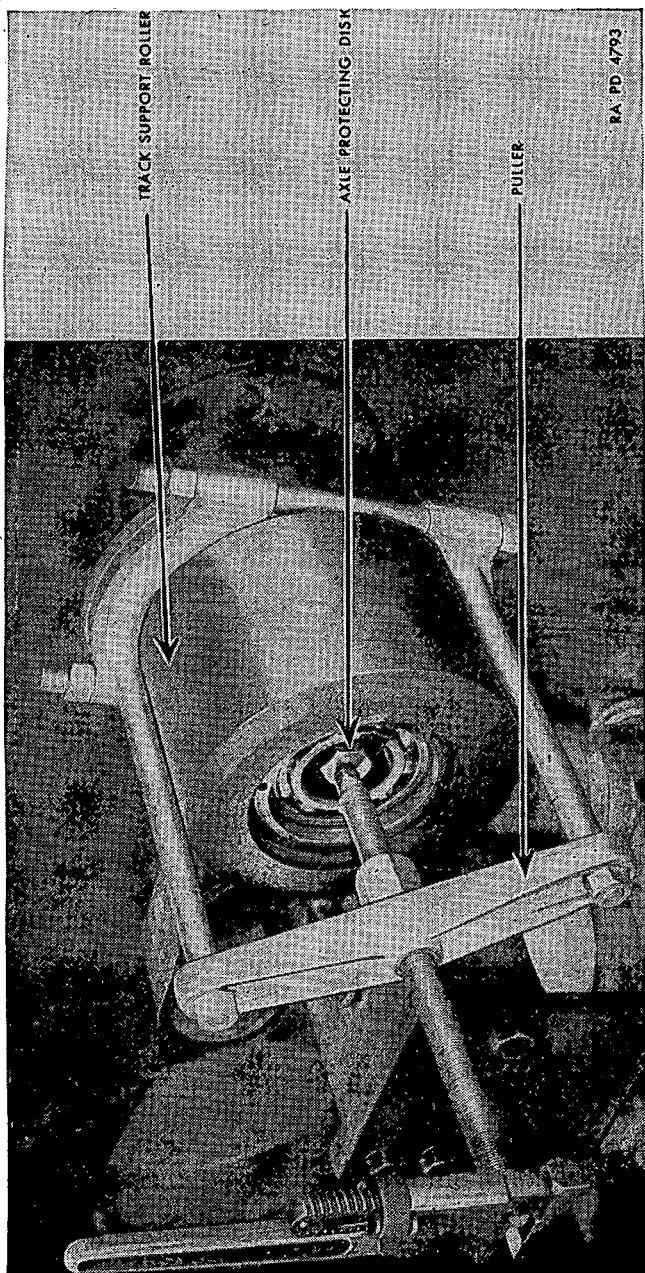

FIGURE 76.—Removal of track support roller.

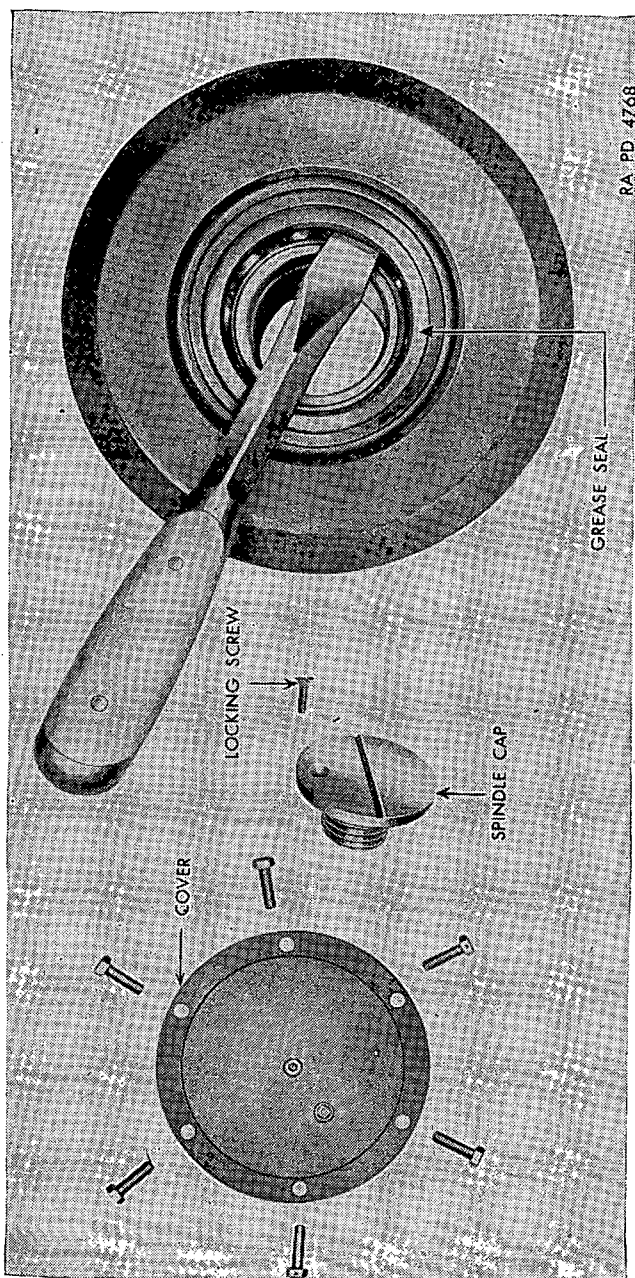

FIGURE 77.—Removing grease seal, track support rollers.

112. Trailing idler (fig. 78).—*a. General.*—A trailing idler is used to give additional support to the rear of the vehicle as well as to perform its primary function of maintaining track tension. The idler wheel is gudgeoned in the trailing idler arm, against which a volute spring maintains a constant tension. The construction of the idler arm and idler assembly provides a means of track adjustment.

b. Maintenance.—Be careful to see that gudgeon nuts and track adjusting nuts are kept tight and that the idler wheel bearings hold the wheel in correct alinement.

c. Lubrication.—The idler wheel and the idler arm gudgeon pins are provided with grease fittings which will be lubricated according to the lubrication chart (fig. 13).

d. Replacement.—Replace the trailing idler wheel using the following procedure:

(1) *Removal of trailing idler wheel (fig. 79).*—(a) Disconnect track (see par. 113*d*).

(b) Support idler wheel trailing arm by inserting wedge between forward lip of arm and trailing idler support housing.

(c) Lift tank with jack placed under hull near trailing idler wheel. Lift until idler wheel just clears track.

(d) Remove cotter pins from each end of trailing idler wheel gudgeon pin. Loosen both nuts until serration plates are free. Pull trailing idler wheel to rear as far as it will go by means of turning both track tension adjusting nuts to the right. Remove nuts, serration plates, and guide blocks from gudgeon pin. Working from a position between the tracks of the vehicle, drive the gudgeon pin out, using a brass drift and hammer. Remove idler wheel.

(2) *Installation of trailing idler wheel.*—To install a new or rebuilt idler wheel, reverse the removal procedure.

113. Tracks.—*a. Description (fig. 80).*—The tracks are of the rubber block type, each shoe consisting of a rubber block vulcanized around a metal link. Rubber-bonded pins pass through the shoe and are connected into an endless chain by drop-forged steel end connectors. The inside surfaces of the connectors serve to guide the track while the outer ends act as driving lugs and are engaged by the teeth of the sprocket.

b. Maintenance.—Replace the rubber shoe when so worn that further wear would cause the tubular section of the metal link to become dented or deformed. Replace damaged shoes immediately. Track shoes may be reversed when practicable.

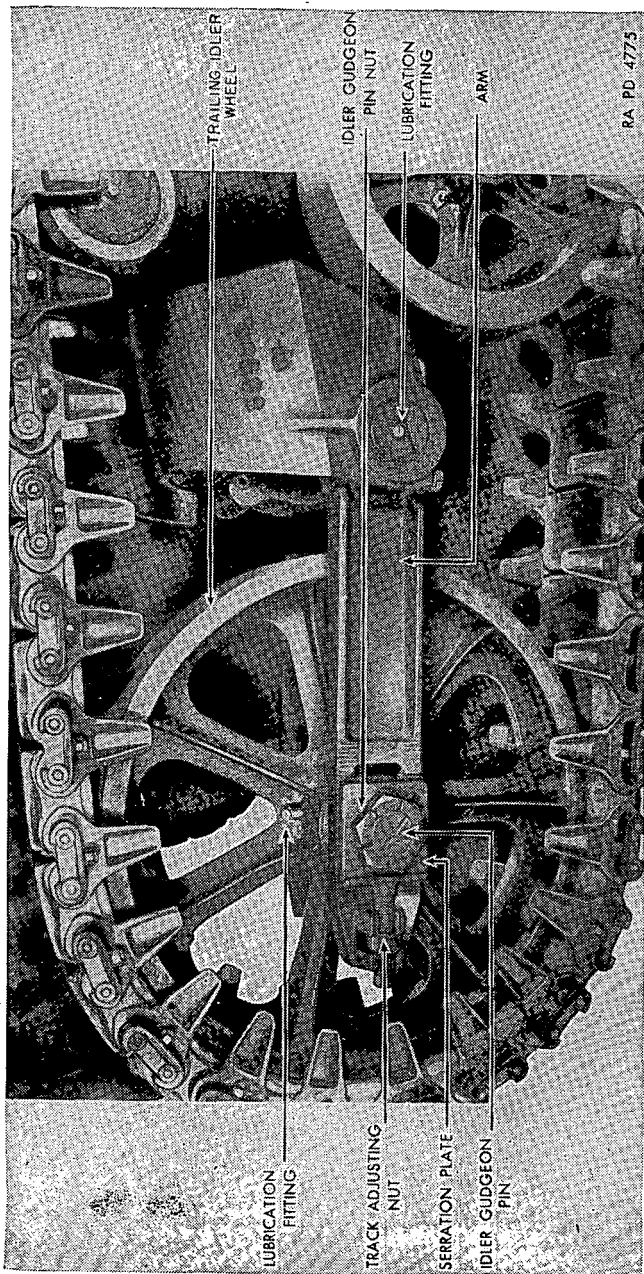

FIGURE 78.—Trailing idler, grease fittings.

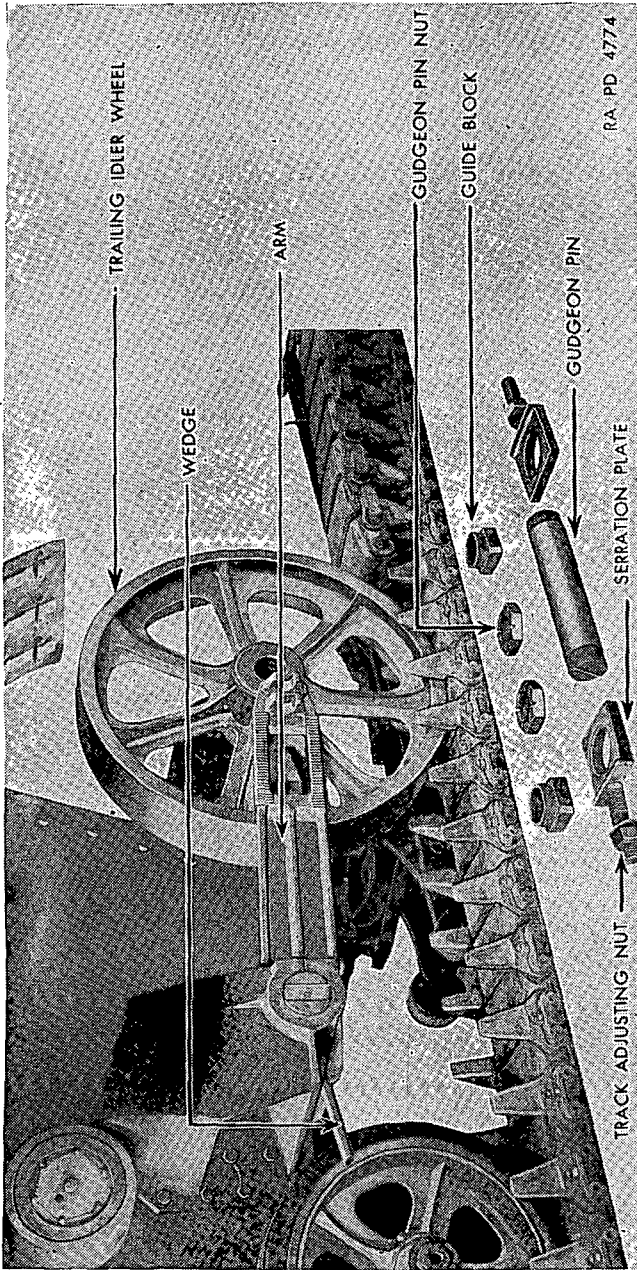

FIGURE 79.—Trailing idler wheel disassembly.

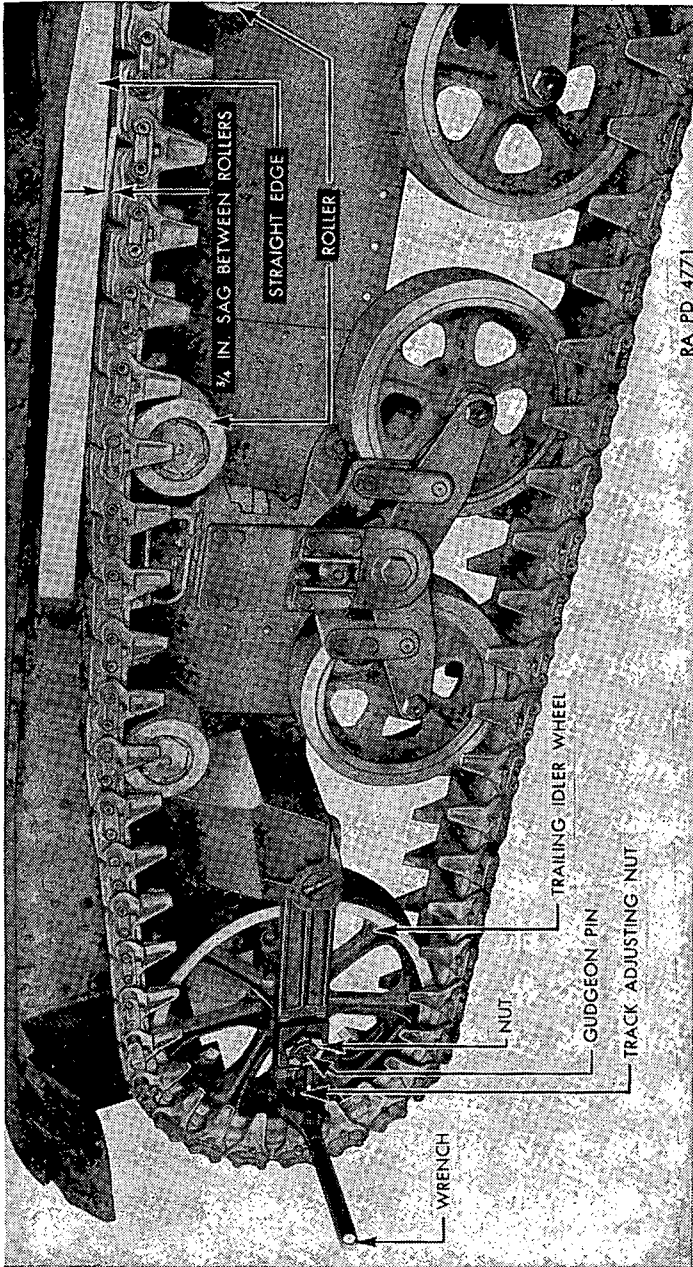

FIGURE 80.—Track adjustment.

c. Adjustment of track (fig. 80).

<i>Specific Step</i>	<i>Equipment</i>	<i>Procedure</i>
(1) Engage steering brakes.		
(2) Loosen trailing idler gudgeon nuts.	Wrench, 3/4-in., O. E. Pliers.	Pull cotter pins locking trailing idler gudgeon nuts. Loosen nut on ends of gudgeon until serration plates are free from serrations on trailing idler support arms.
(3) Adjust track	Two wrenches, 1 1/16-in., O. E., one 36-in. Stght. edge, 1/4-in. diam. rod or stud.	Turn adjusting nuts on serration plate studs in unison to adjust track (fig. 80). Facing rear of tank, a clockwise direction of rotation tightens track. A properly adjusted track has 3/4-in. sag measured at a point midway between the two forward track support rollers. Measure this dimension by laying a straight-edge on top of track above the two front track support rollers (fig. 80).
(4) Lock track idler	Pliers, Wrenches, 3/4-in., O. E., 1 1/16-in., O. E.	If serrations do not engage, tighten track adjusting nuts until they do engage. Do not move track adjustment nuts more than one-half turn from the correct setting. Tighten trailing idler gudgeon nuts and install cotter pins.

d. Disconnect track (figs. 81 and 82).—(1) Be sure vehicle is on level ground. Engage brakes, loosen trailing idler (c (1) and (2) above), and proceed as follows:

<i>Specific step</i>	<i>Equipment</i>	<i>Procedure</i>
(2) Remove wedge nuts	Wrench, 3/4-in. O. E., B., or soc.	At a point between drive sprocket and front bogie wheel (fig. 81) remove nut holding wedges.
(3) Remove wedges	Soft hammer	Drive out wedges.
(4) Remove outside track connector.	Drift, about 24 in. long with pointed driven end Pinch bar Soft sledge hammer.	Place pinch bar behind track connector with sprocket as fulcrum (fig. 81). Hold pointed end of drift in hole of track pin. Drive against drift with hammer while pressure is being exerted against track connector by means of pinch bar. Drive against track pins until track connector is removed.
(5) Remove inside track connector.	Drift, 24-in., soft sledge hammer.	Place point of drift against track side of inside track connector

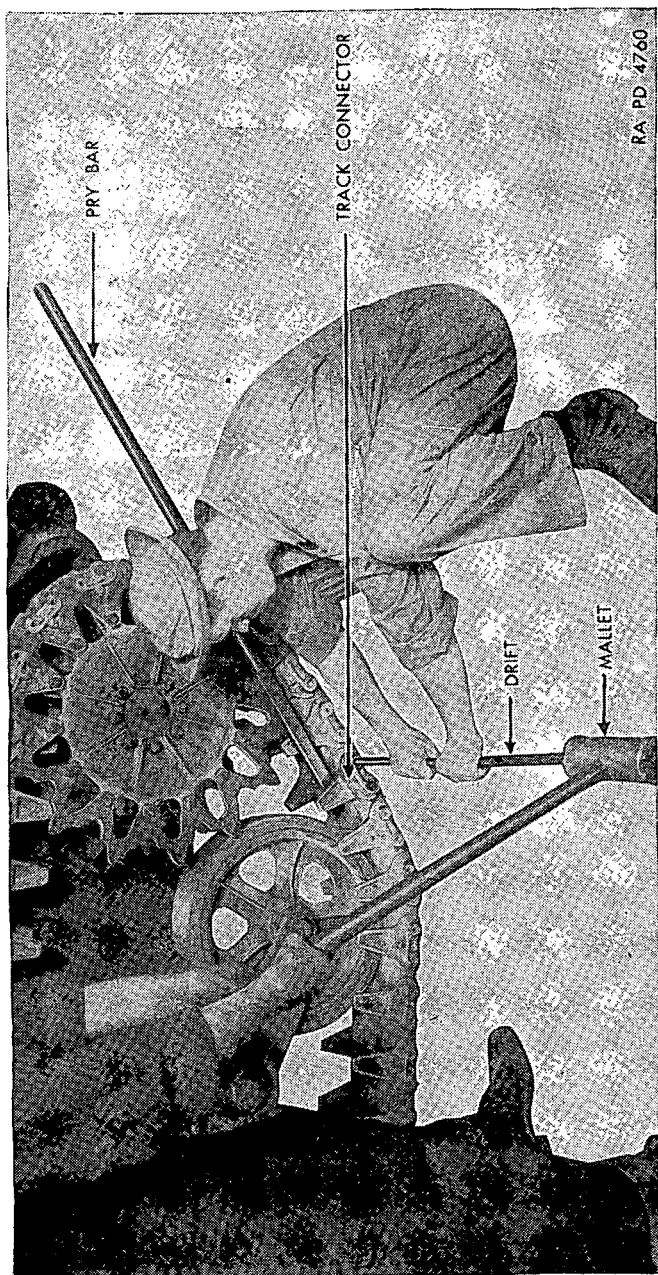

FIGURE 81.—Removal of outside track connector

Specific step

Equipment

Procedure

- (6) Remove track from driving sprocket.

None-----

(fig. 82). Drive against drift with hammer until connector is removed. Release steering brakes and place transmission in neutral. Have one man stand in front of driving sprocket turning it, the other three men pulling track toward rear of tank. Keep oil away from track.

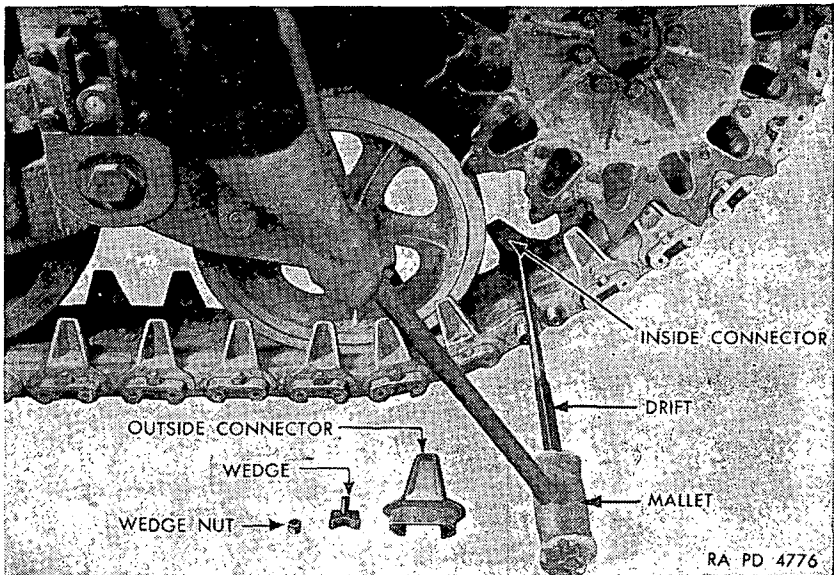

FIGURE 82.—Removal of inside track connector.

e. Connect track.—This procedure is described under replacement of track (*g* below).

f. Replacement of track shoe.—After the track is broken, the track shoe to be replaced may be removed. If several shoes are to be replaced, lay the entire track on the ground. Procedure is otherwise the same as for removal of one shoe. To assemble new shoes in the track it is necessary only to drive the end connectors on and replace the wedges and nuts.

NOTE.—Before installing new track shoes, grind the rubber tread on both sides of each new shoe to the same thickness as the other shoes which comprise the track.

g. Replacement of tracks.—Disconnect tracks as described in *d* above.
 (1) Roll vehicle off track.

(2) Install track.

(a) Lay the track on the ground and push the vehicle over it so the track end projects beyond the front bogie wheel 16 inches.

(b) Bring the other end of the track over the idler and track support rollers to the drive sprocket.

(c) Take up slack by revolving sprocket forward with a long bar.

(d) Mount track connecting tool (fig. 83).

(e) Draw the end shoes together and drive the end connectors on the shoe pins.

(f) Remove connecting tool.

(g) Be sure connectors are driven all the way on and install wedges and nuts on each side of track.

(h) Adjust track (c above).

114. **Grousers.**—*a. General.*—When tracks lack sufficient traction to negotiate slippery hillsides, heavy mud, snow or ice, a grouser at-

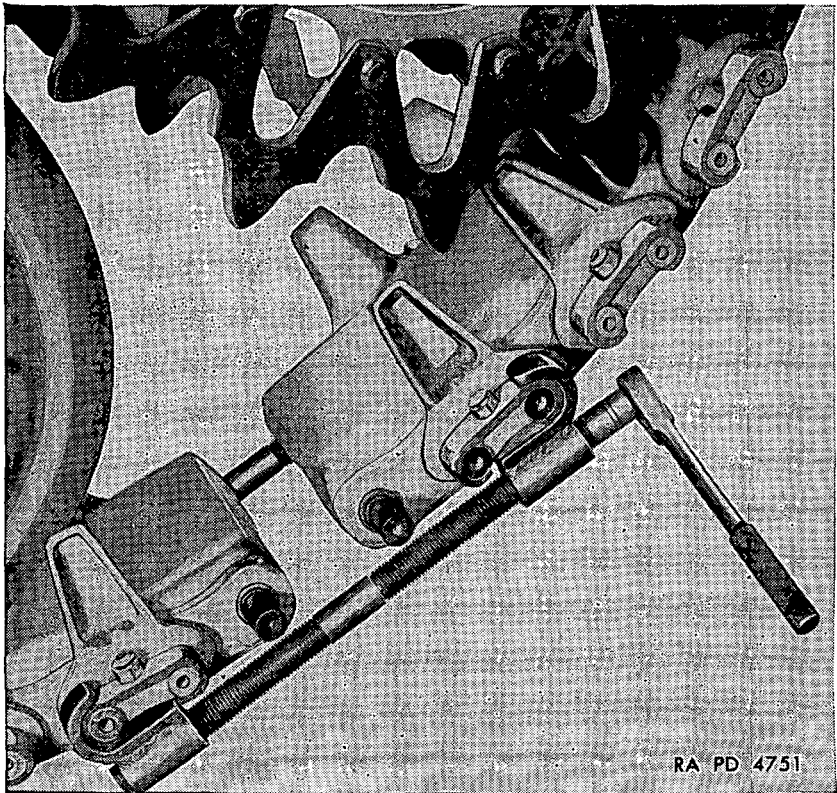

RA PD 4751

FIGURE 83.—Track connecting tool.

tached to every fourth track shoe will greatly reduce the tendency of the tracks to slip.

b. Installation.—Two pins at either end of the grouser fit into holes at either end of the track shoe pins. A cap screw requiring a special hexagon socket locks the grouser pin mounting in place.

SECTION XIII

HULL AND TURRET

	Paragraph
Hull.....	115
Turret.....	116

115. Hull.—*a. General.*—The hull of the light tank M3 consists of armor plates of various thicknesses, joined together by steel angles and gussets. All joints are sealed with putty. The driver and bow gunner occupy compartments at the front of the hull interior. The fighting compartment is approximately at the center and the engine compartment is at the rear. These two compartments are divided by a partition or bulkhead, immediately in front of the engine fan. Air is drawn from the fighting compartment through the oil coolers mounted in this bulkhead into the engine. This serves to ventilate the fighting compartment when the guns are fired. Sponsons at both sides bring the width of the upper half of the hull nearly even with the width across tracks.

b. Doors.—Two hinged doors, located in the rear of the hull, provide access to the engine compartment. The bow gunner and driver each have forward vision through peephole protectors and protectoscopes located in the front doors, which are hinged at the top and swing upward (fig. 84). Entrance to the fighting compartment is effected through the door or doors in the roof of the turret, or by opening both the driver's front door and the door hinged on the front sloping armor plate immediately above and in front of the driver's seat.

c. Protectoscopes (fig. 85).—(1) *Description.*—This device affords protection for the eye of the user. A recess is provided in the deflector, behind mirror "2," to prevent bullets or fragments from ricocheting and destroying the mirrors and windows in the instrument.

(2) *Maintenance.*—Keep the windows and mirrors of the protectoscope clean and free of oil. Keep the deflector trunnions, blocks, and adjusting screws of the windows oiled to prevent corrosion. Adjust the upper and lower mirrors to obtain the best vision. The upper mirror (mirror "2") may be adjusted by loosening the locking screw on each cam (fig. 86) and setting the mirror at the desired angle. Tighten cam locking screws when the desired angle is obtained. See

replacement instructions for procedure on making these cam locking screws accessible. The lower mirror is adjusted by means of adjusting screws near the ends of the mirror and beneath it (fig. 86). Turning these screws clockwise rotates the mirror closer to the horizontal position, anticlockwise toward the vertical position. Since turning one screw only changes the angle and tilts the mirror, the adjusting screws will be turned together when changing the angle of the mirror.

(3) *Replacement.*—(a) *Removal.*

1. Remove brass countersunk screw and remove door.
2. Rotate bullet deflector forward, or anticlockwise as shown on figure 86.
3. Rotate window "1" backward, or clockwise as shown on figure 86.
4. Lift out window "2" (fig. 87).
5. Remove two deflector trunnion bearing block fastening pins holding each block in place.
6. Remove blocks, noting that the blocks are not interchangeable and that the counterbored hole goes toward the mirror.
7. Rotate deflector backward or anticlockwise on figure 86, until mirror "2" is alined with the slot milled in the housing. Mirror "2" in this position is parallel with the door.
8. Loosen the cam locking screws (fig. 88) and remove mirror "2," or remove deflector and clean mirror, deflector trunnions, and bearings.
9. Loosen ledge locking screws (fig. 86).
10. Rotate ledges one-half turn.
11. Lift out mirror "1."
12. Loosen headless set screw locking pivot screws of window "1" shaft.
13. Remove pivot screws and shaft with window.

NOTE.—Window "1" is cemented in shaft. Mirror "1" can be removed without removing window "1." Mirror "2" can be removed without removing either window "1" or mirror "1." Window "2," mirror "1," and window "1" can be removed without removing the door on which the headrest is attached. This door can be rotated 90°.

d. Interior.—The interior of the hull is lined throughout with "Masonite" type insulating material $\frac{1}{2}$ inch thick and surfaced with $\frac{1}{32}$ -inch sheet steel. The driver and bow gunner are seated, respectively, in the left and right adjustable bucket seats which are raised above the floor a few inches. These seats are provided with safety belts and are adjustable to suit personnel of various statures. Drain

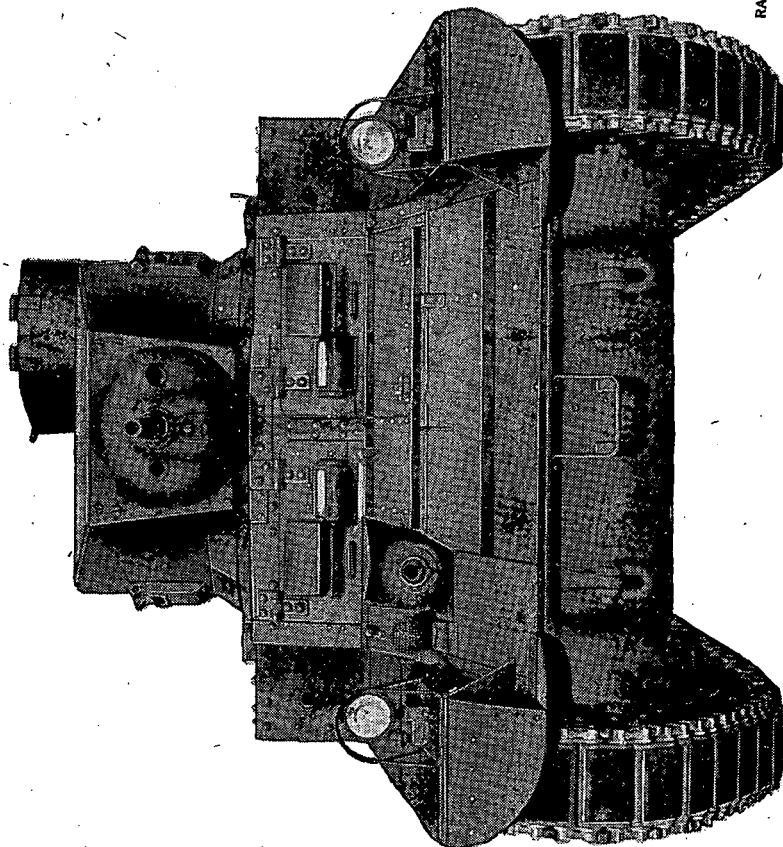

RA PD 5854

FIGURE 84.—Later series light tank M3, showing protectoscope doors and rolled turret.

valves in the floor of the hull when depressed allow liquids to escape (fig. 17):

e. Inspection.—Inspect the hull frequently for loose bolts, nuts, screws, and rivets. The using arm tightens or replaces all defective threaded fasteners. In case of loose rivets, either in the hull or turret, notify the ordnance company.

f. Painting.—The using arm is responsible for the appearance of

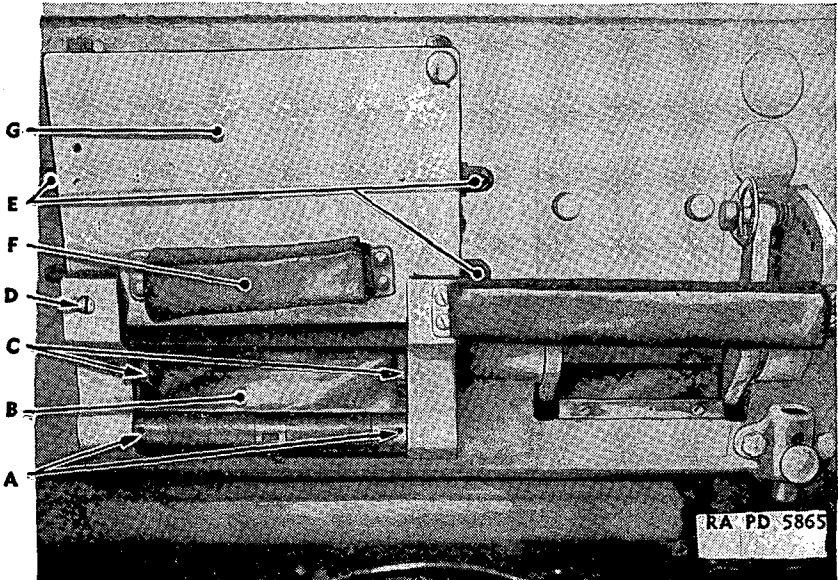

A. Headless set screw.
B. Window No. 1.
C. Ledge.
D. Brass countersunk screw.

E. Fastening pins.
F. Headrest.
G. Door.

FIGURE 85.—Front door protectoscope.

the vehicle. Follow instructions in section VII with regard to vehicle appearance and painting.

g. Replacement of certain hull components.—The using arm replaces damaged or defective insulation, seats, pads, mud guards, fenders, and the bulletproof glass in the peephole protectors. Paragraph 100a(3) contains directions for replacement of the front fenders.

116. Turret.—*a. General.*—The main body of the turret on earlier vehicles has an irregular octagon shape and may be of either riveted or welded construction. The cupola of these models has an irregular hexagon shape and a single hinged door in roof. Later model tanks

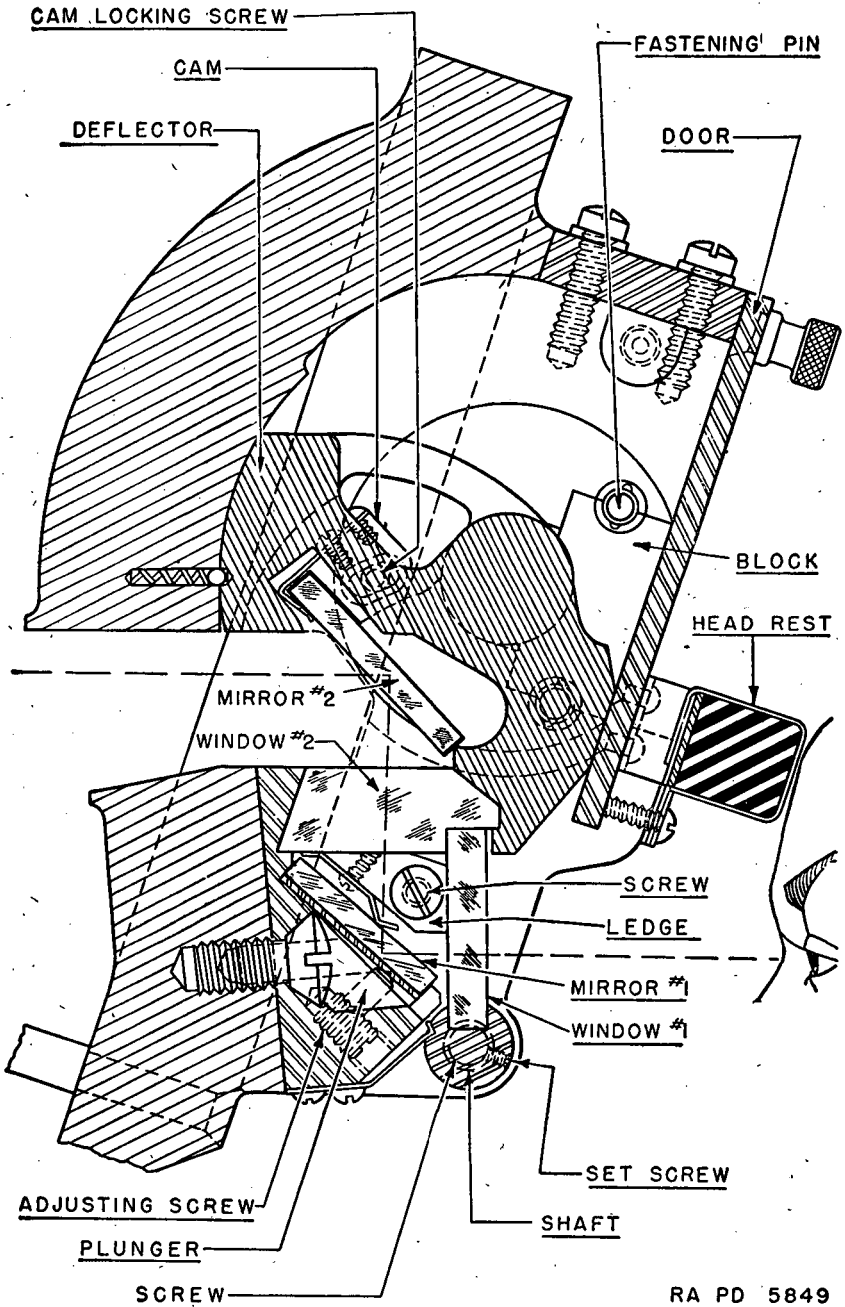

FIGURE 86.—Front door periscope.

RA PD 5849

have a homogeneous or "rolled" turret. The main body is approximately cylindrical in structure with an oval-shaped cupola having two doors in the roof. The inside of the later model turret is lined with sponge rubber and protectoscopes are incorporated in the pistol port doors. Peepholes on all turrets are protected by bulletproof glass when in use. The turret may be locked in position by means of the turret lock (fig. 16). This lock is the same on all models of

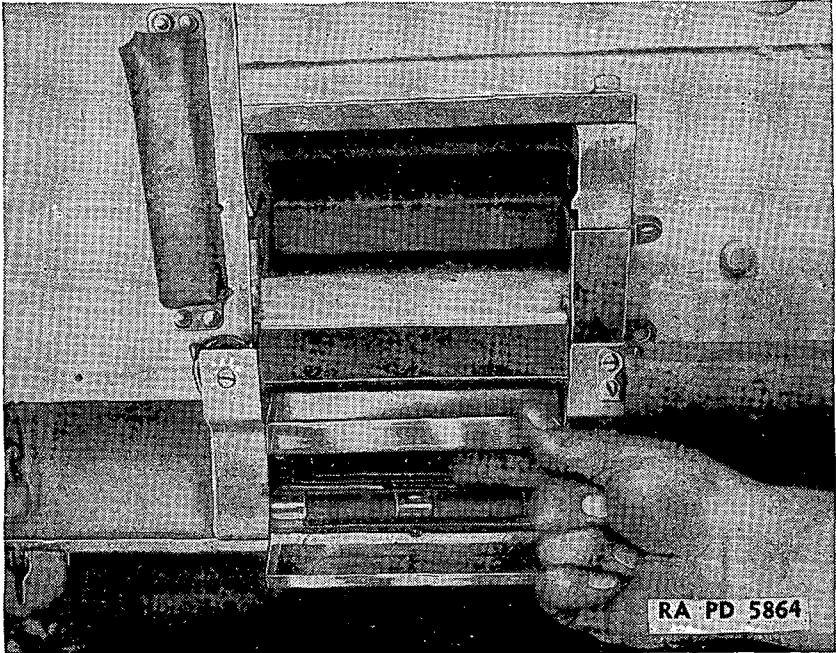

FIGURE 87.—Removal of window No. 2.

turrets. The turret is supported by three turret support rollers, spaced 120° apart, which project through a circular ring-gear track fastened to the hull. The turret may be rotated through 360° by means of a handwheel-controlled turret rotating mechanism, which is bolted to the turret. When the handwheel of the turret rotating mechanism is turned, a pinion of this mechanism which is in constant mesh with the gear of the circular track rotates, causing the turret to turn (fig. 15). The portion of the turret that rests on the turret supporting rollers is called the turret ring. Lateral and vertical motion of the turret is prevented by means of bearings and rollers which contact the side and the upper surface respectively of the turret ring. These bearings and rollers are contained in eight brack-

ets which are bolted to the hull at irregularly spaced intervals around the circumference of the ring gear track. Each bracket carries one bearing and roller (figs. 89 and 90).

b. Maintenance.—(1) *Lubrication.*—Lubricate the three turret support bearings and the turret traversing mechanism according to the lubrication chart.

(2) *Trouble shooting.*—In case of failure of the turret support rollers, notify the ordnance company. If a turret does not rotate

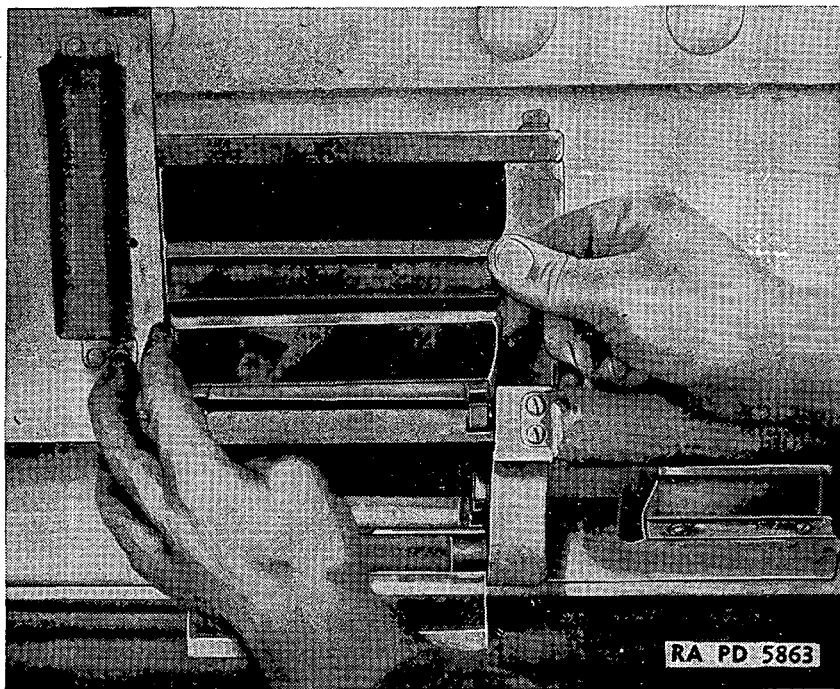
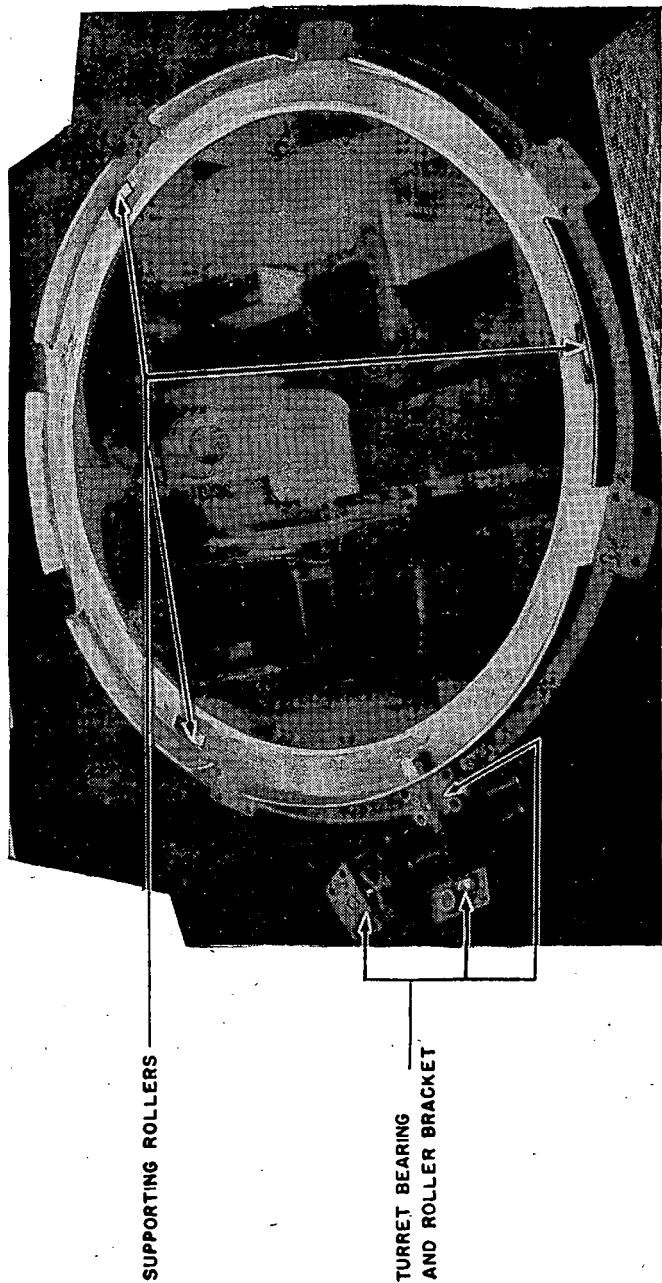

FIGURE 88.—Removal of mirror No. 2.

freely, the most common cause is foreign matter that wedges between the turret ring and the hold-down rollers. Clean the upper surface of the turret ring with a cloth or brush after removing one of the eight bearing and roller brackets which gives access to it. If the turret does not rotate freely after cleaning the upper side of the turret ring, loosen the hold-down brackets one at a time, trying the turret for ease of rotation each time a bracket is loosened. If the loosening of a bracket causes the turret to rotate freely, remove the bracket and check the ball and roller bearings. If these are satisfactory, insert a 0.005-inch shim between the bracket and hull and



RA PD 4788A

FIGURE 89.—Turret ring and rollers.

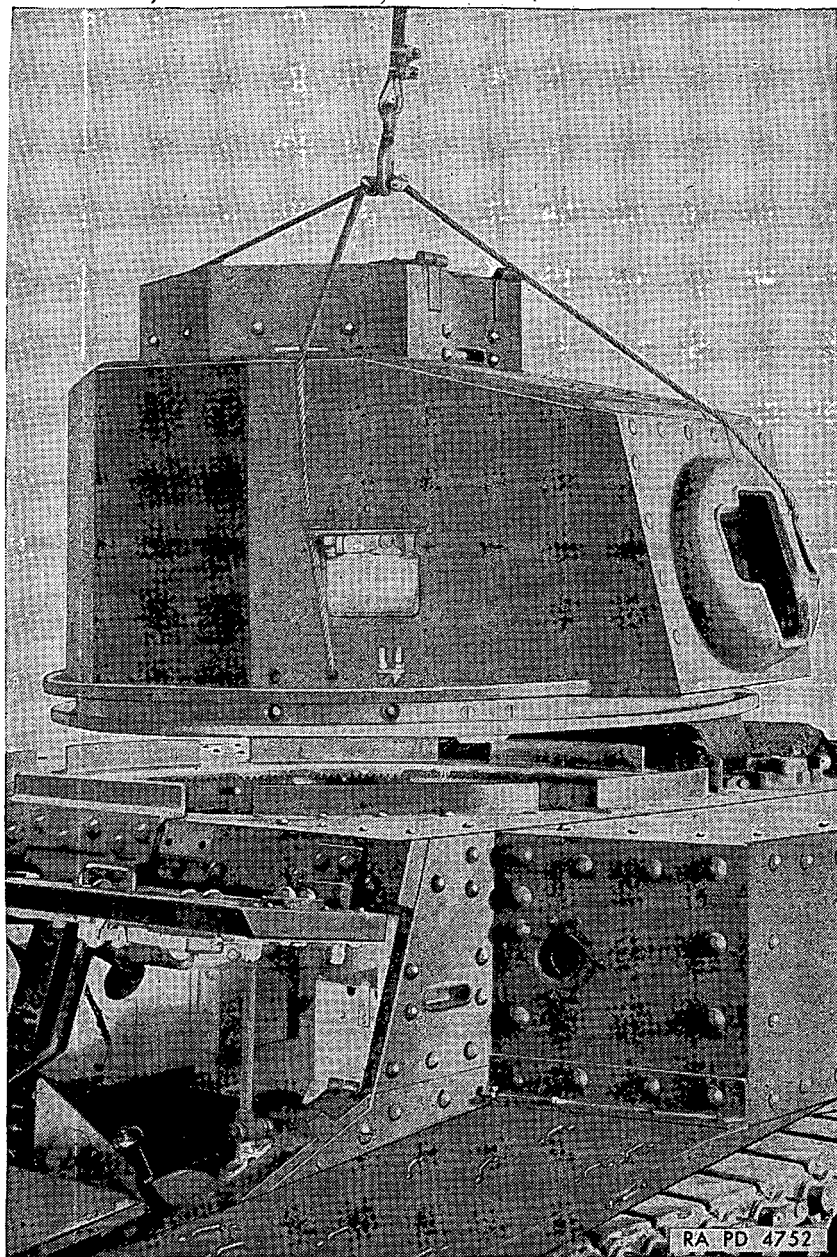

FIGURE 90.—Removal of turret.

install bracket. Try the turret for ease of rotation each time a bracket is installed. Do not oil the turret ring or rollers after cleaning.

c. *Replacement of turret components.*—(1) *Protectoscope.*—The protectoscope mounted in the pistol port door protects the eye of the user (fig. 91). The two optical parts consist of a prism and

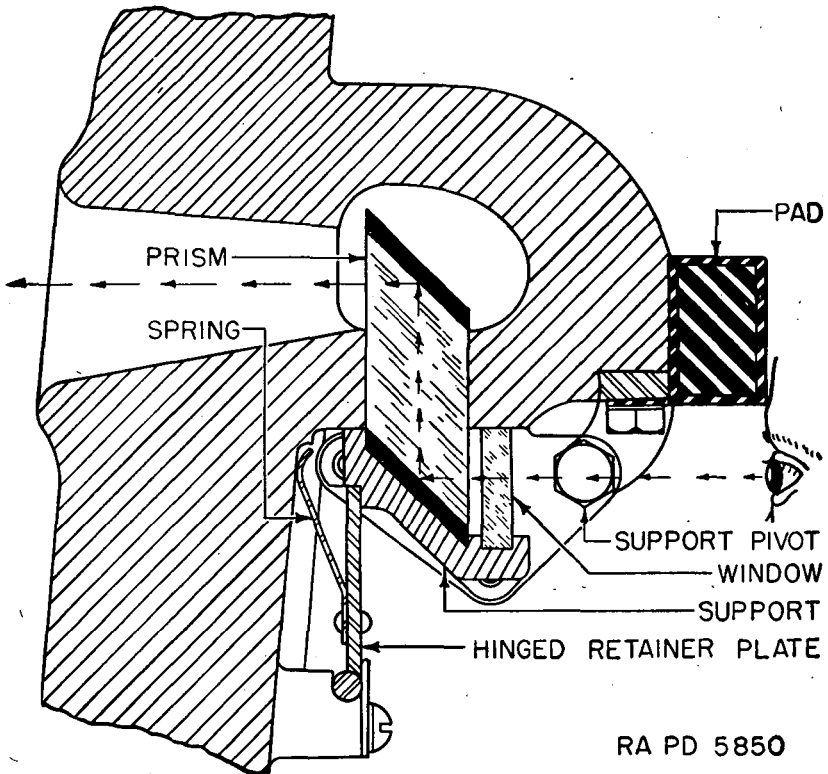

FIGURE 91.—Pistol port door protectoscope.

window. Either part may be replaced without the use of tools. To remove the prism, press on the hinged retainer plate with sufficient force to move the plate away from the support. Swing the support down and remove the prism and window. No adjustment is possible. Keep the prism and window clean and free of oil. To remove the window, remove the two cap screws holding the window frame to the cover frame. Remove two screws from one end of window frame and slide window out.

(2) *Pistol port covers.*—(a) *Description.*—If the operating

mechanism or the cover is defective, notify the ordnance company. To operate the pistol port door, proceed as follows (see fig. 92) :

1. Move lever locking spring catch downward.
2. Raise lever to horizontal position, until knurled knob drops in notch in lever.
3. Unlatch cover bolt.
4. Pull down on lever until knurled knob drops in place again, locking the cover in the open position.

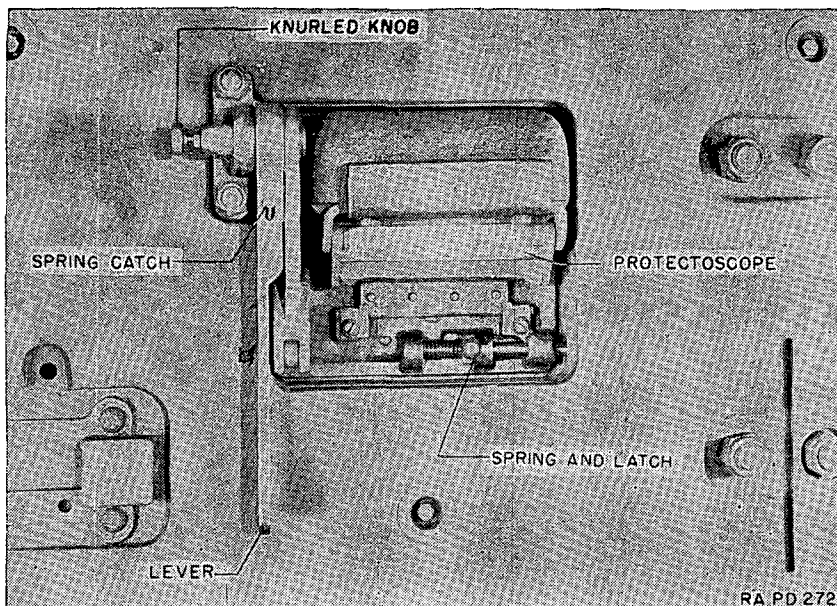

FIGURE 92.—Pistol port door protectoscope.

(b) *Replacement.*—Use the following procedure in replacing defective pistol port covers:

1. Support cover in open position.
2. Remove pin attaching link of operating mechanism to cover.
3. Drive out small pin anchoring hinge pin to cover.
4. Drive out hinge pin and remove door.
5. Reverse above procedure to install new cover.

(3) *Peepholes.*—The peepholes are protected by a movable shutter incorporating a frame for the bulletproof glass. When not in use, the peephole may be protected by allowing the shutter or shield to drop to the lower position. When in the upper position, protection to the eye of the user is obtained through the use of bulletproof glass window over the peephole. To replace the window, remove the shield or shut-

ter and exchange broken window for a new one. The shutter may be held in any desired position by means of the knurled-head set screw near the top of the shutter.

(4) *Turret lock*.—The turret lock is bolted to the turret ring. If unserviceable, remove two mounting bolts and nuts and exchange the defective assembly for a new one (fig. 15).

(5) *Turret rotating mechanism*.—The turret rotating mechanism is attached to the hull by means of five $\frac{5}{8}$ -inch slotted-head bolts and hexagon-head nuts. If this mechanism is defective, replace the assembly (fig. 15).

(6) *Turret ball bearing and roller brackets* (fig. 89).—The brackets are attached to the hull with $\frac{1}{2}$ -inch hexagon-head bolts and nuts. Replace this assembly if the original is defective.

SECTION XIV

ELECTRICAL SYSTEM AND EQUIPMENT

	Paragraph
Battery	117
Generator	118
Voltage control box and generator filter	119
Fuse box and panel	120
Electrical instruments	121
Switches	122
Sponson gun relays	123
Solenoids	124
Headlamps	125
Taillamps	126
Dash lamps	127
Trouble lamp	128
Compass lamp	129
Siren	130
Electrical equipment of engine	131
Sockets	132
Conduit and cables	133
Instrument panels	134
Trouble shooting	135
Wiring	136

117. **Battery**.—*a. Description*.—A 12-volt storage battery is installed in the battery compartment in the rear of the right sponson (fig. 93). It is accessible only from the outside of the vehicle. The battery compartment cover serves as a part of the upper side of the sponson and may be removed by first removing four retaining screws. Radio take-off terminals are provided to supply 12 volts, 8 volts, and 2 volts.

b. Maintenance.—(1) *Care.*—Battery terminals and terminal posts will be frequently checked, cleaned, and coated with petrolatum. Check the battery fluid level once a week and after every long run. Maintain the level to $\frac{1}{4}$ in. above the plate assemblies by adding distilled water. Take a specific gravity reading every 25 hours and exchange a battery having a specific gravity of 1.225 or less at 80° F. for a fully charged one.

(2) *Capacity and temperature data.*—At temperatures below freezing, the load on the battery becomes greater and the relative capacity

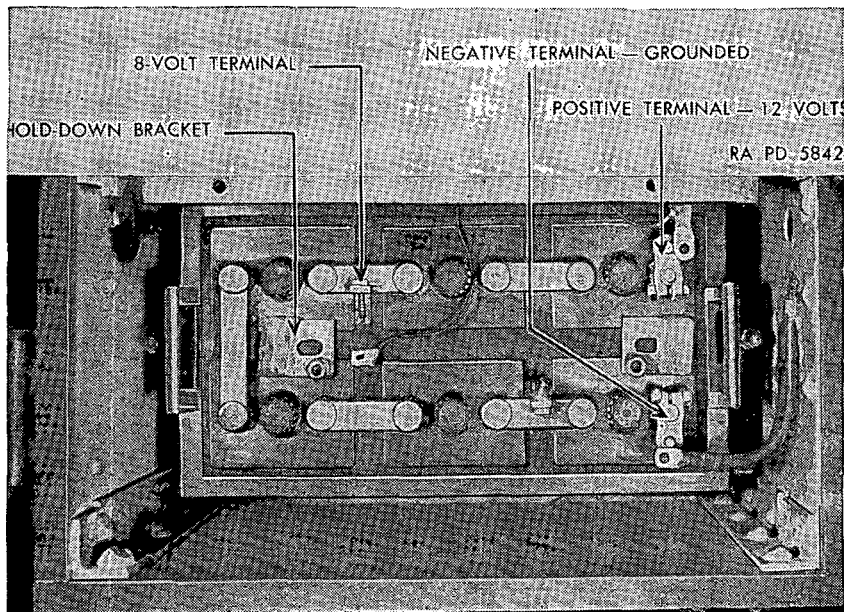

FIGURE 93.—Battery and compartment.

of the battery is reduced. For this reason, when low temperatures prevail, it will be necessary to maintain the specific gravity of the battery electrolyte at 1.250 or higher and to replace the battery when its gravity reading is below that point. The following data show the capacity of the batteries and the relative freezing point of the electrolyte.

<i>Capacity</i>	<i>Actual specific gravity</i>	<i>Freezing temperature</i>
Battery charged	1.285	-96° F.
Battery $\frac{1}{3}$ discharged	1.255	-60° F.
Battery $\frac{1}{2}$ discharged	1.220	-31° F.
Battery $\frac{3}{4}$ discharged	1.185	-8° F.
Battery normally discharged	1.150	+5° F.
	1.100	+18° F.

(3) To determine the actual specific gravity of the electrolyte, it is necessary to check the temperature of the solution with a thermometer. If the temperature is normal (80° F.) the specific gravity reading will be correct. However, if the temperature is above or below 80° F. it will be necessary to make an allowance to determine the actual specific gravity. This is due to the fact that the liquid expands when warm and the same volume weighs less than when it is at normal temperature. The reverse is also true and when the temperature is below normal or 80° F. the liquid has contracted and the same volume weighs more than it does when normal. The correction chart (fig. 94) shows the figures to be used to make these corrections. For example, when the specific gravity as shown by the hydrometer reading is 1.290 and the temperature of the electrolyte is 60° F., it will be necessary to subtract eight points or 0.008 from 1.290 which gives 1.282 as the actual specific gravity. If the hydrometer reading shows 1.270 at a temperature of 110° F. it will be necessary to add 12 points or 0.012 to the reading which gives 1.282 as the actual specific gravity.

c. Replacement.—(1) *Battery removal.*—(a) Open battery switch.

(b) Remove battery compartment cover.

(c) Loosen all battery connections and terminals and remove hold-down brackets and nuts (fig. 93).

(d) Lift out battery. (**Caution:** Battery is heavy and will require two men to lift it.)

(2) *Battery installation.*—(a) Clean battery compartment and if necessary cover inside of compartment with a coat of acid-resisting paint.

(b) Clean all cables and cable terminals.

(c) Inspect all terminal bolts and nuts and replace where needed.

(d) Install battery.

(e) Connect terminals and coat all connections with petrolatum.

(f) Install hold-down brackets and replace compartment cover.

(g) Have unserviceable battery charged.

NOTE.—After installing a fully charged battery a check will be made to insure that the generator and current control devices are operating properly (see par. 119c(1)).

118. Generator.—The engine of the vehicle drives a 12-volt direct current generator. Under normal operation of the vehicle, the generator supplies enough current to operate all of the electrical equipment. Consult the wiring diagram (fig. 98). For replacement and other details of this unit see paragraph 57.

119. Voltage control box and generator filter.—*a. Description.*—This box, which is mounted on the bulkhead of the vehicle in the fighting compartment, consists of the following units (fig. 95):

(1) The voltage regulating unit, whose function is to control the output of the generator and keep the battery correctly charged regardless of the use or lack of use of the other electrical accessories.

(2) The reverse current relay or generator cut-out prevents the battery from discharging through the generator when the generator is not producing enough voltage to overcome the voltage of the battery.

(3) The current limiter limits the maximum output of the generator to a value slightly in excess of the rated capacity of the generator.

b. Generator filter description.—The generator filter reduces radio interference and is located directly below the voltage control unit.

c. Replacement.—(1) *Voltage control unit.*—If the voltmeter reading is consistently above or below normal, or if the ammeter readings are consistently erratic, exchange the voltage control box cover for a new one. To replace the voltage control unit release the spring catch and lift the cover straight up. This action lifts the pronged connectors from their respective sockets.

(2) *Generator filter.*—Replace this unit if electrical trouble or radio interference have shown it to be defective. Use the following procedure:

(a) Remove ammunition box by the junction box.

(b) Remove clamps holding conduit from the voltage control box to the bulkhead of vehicle.

(c) Disconnect the conduit and wires that run to the voltage control box at the junction box end.

(d) Remove the trouble lamp (see par. 128).

(e) Remove three bolts and nuts holding voltage control box support bracket to bulkhead. Remove voltage control box and bracket.

(f) Reverse above procedure to install.

120. Fuse box and panel.—*a. Description* (fig. 96).—A fuse panel mounting 7 fuses is enclosed in the fuse box, located behind the side instrument panel. The fuse panel is marked directly behind each fuse with the amperage of the fuse required for each circuit. A duplicate set of fuses is clipped to the cover of the fuse box for replacement purposes. Clip these fuses in place as shown on figure 96.

NOTE.—Use only the fuse designated. Larger, smaller, or makeshift fuses will not be used.

b. Replacement (fig. 96).—(1) Fuse box.—(a) Open battery switch.
 (b) Remove two screws holding fuse box cover to box. Remove cover.

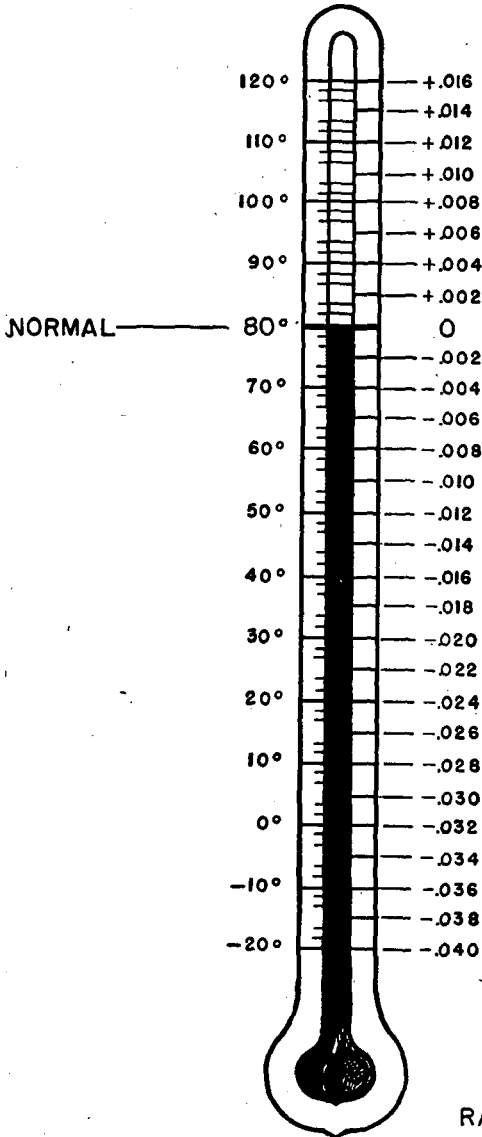

RA PD 5851

FIGURE 94.—Hydrometer correction chart.

(c) Remove wires from each fuse terminal, tagging or marking each wire and fuse panel terminal as wire is removed. Pull wires through rubber grommets of fuse box.

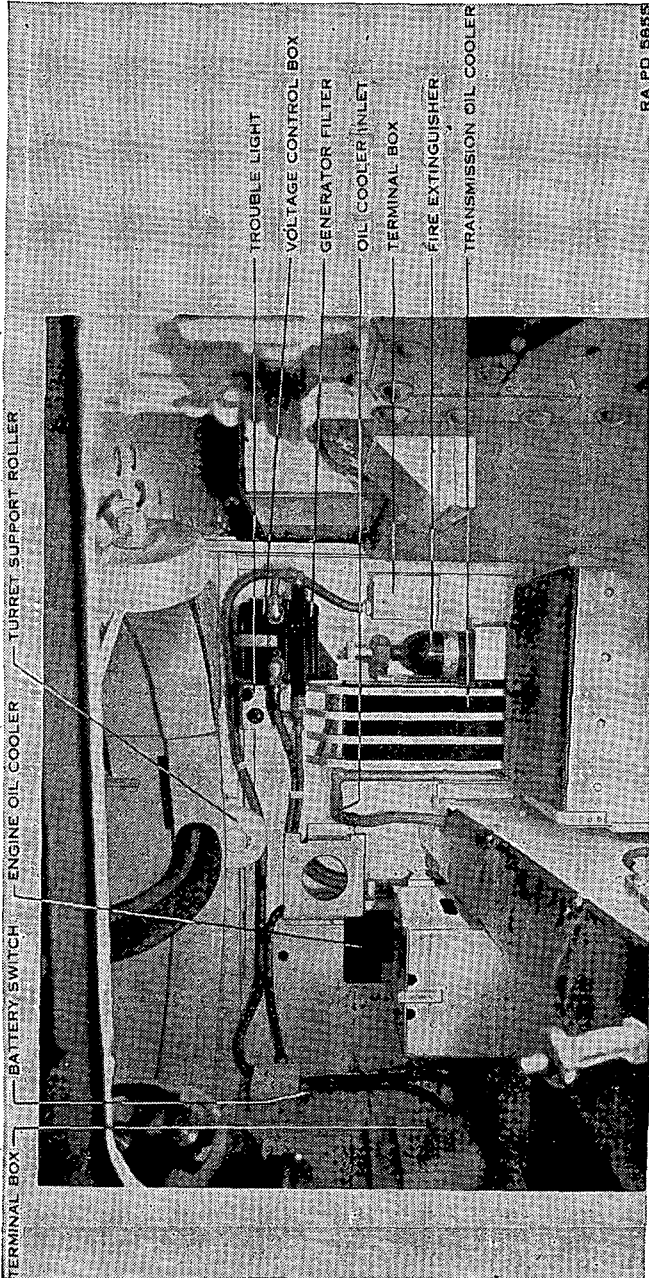

RA PD 5855

Figure 95.—Bulkhead of fighting compartment.

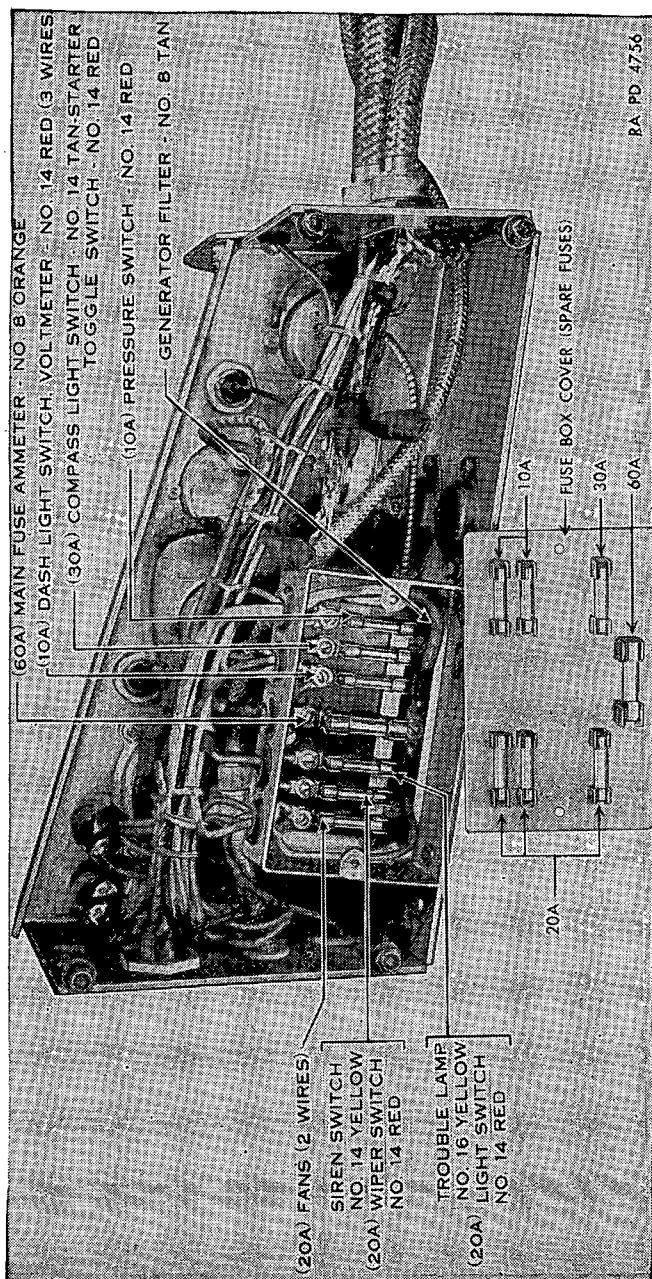

FIGURE 96.—Fuse box.

(d) Remove two bolts and nuts attaching fuse box to floor of instrument housing. Remove fuse box with fuse panel.

(e) Reverse the above procedure for installing fuse box.

(2) *Fuse panel.*—(a) Open battery switch.

(b) Remove fuse box cover.

(c) Remove wires from each fuse terminal, tagging or marking each wire and fuse panel terminal as wire is removed.

(d). Remove three bolts and nuts attaching panel to fuse box. Remove panel.

(e) Reverse the above procedure to install new fuse panel.

121. Electrical instruments.—*a. Ammeter.*—(1) *Description.*—The ammeter, located on the side instrument panel, registers the amount of current going into the battery when the needle is on the plus side of the scale. When the needle is on the minus side of the scale, the current consumed from the battery by all of the electrical equipment except the current used by the engine direct electric starter is registered.

(2) *Replacement.*—If the ammeter is defective, use the following procedure for replacement (refer to fig. 96 and wiring diagram, fig. 98):

(a) Open battery switch.

(b) Remove back cover of panel by removing four screws.

(c) Remove and tag wires connected to ammeter.

(d) Remove three screws and nuts holding ammeter to instrument panel. Remove ammeter.

(e) To install, reverse the above procedure.

b. Voltmeter.—(1) *Description.*—A voltmeter, located on the side instrument panel, indicates the voltage supplied to the circuit. The reading of this instrument when the generator is not charging the battery and no current is being used elsewhere constitutes a rough check on the percent of charge remaining in the battery. A fully charged battery should have a voltage reading of approximately 14 volts. If the voltmeter reads 11 volts or less, with no electrical accessories being used, the cause should be investigated. The second purpose of the voltmeter is a rough check on the behavior of the voltage regulator. A flickering needle or a consistently high or low reading when the generator is charging the battery is cause for investigation.

(2) *Replacement* (refer to fig. 96 and wiring diagram, fig. 98).—

(a) Open battery switch.

(b) Remove back cover of panel by removing four screws.

(c) Remove and tag wires connected to voltmeter.

(d) Remove three screws and nuts holding voltmeter to instrument panel. Remove voltmeter.

(e) To install, reverse above procedure.

c. *Engine hour meter.*—(1) *Description.*—The engine hour meter, located on the front dash, registers the total number of hours the engine is in operation. An electrical pressure switch, operated by engine oil pump pressure, completes a circuit from the battery to the engine hour meter when the engine is running. If the engine hour meter fails to operate when the engine is running and oil pressure is normal, the trouble is either in the pressure switch or the engine hour meter. If connecting the two terminals of the pressure switch together with a piece of wire does not cause the hour meter to operate (with engine running), replace the defective hour meter.

(2) *Replacement.*—(a) Open battery switch.

(b) Remove back cover of panel by removing four screws.

(c) Disconnect wire at pressure switch leading to hour meter.

(d) Remove three screws and nuts holding hour meter to instrument panel. Remove hour meter.

(e) To install, reverse the above procedure.

122. *Switches.*—a. *Battery switch* (fig. 97).—(1) *Description.*—The battery switch is enclosed in a metal box with the switch knob protruding through the bottom of box. This box is mounted on the right side wall of the fighting compartment, near the roof and close to the bulkhead.

(2) *Operation.*—To open battery switch, pull the knob all the way down and rotate it one quarter turn. The knob pin will then drop into a notch and keep the switch open. To close the switch, pull knob all the way down, rotate one quarter turn and release knob. The knob pin drops in a deep notch, and does not interfere with the closing of the switch. Opening the battery switch cuts off all current to the electrical system except the 8-volt lead to the radio terminal box.

(3) *Replacement.*—(a) Remove cable from battery leading to battery switch and tape cable terminal.

(b) Remove four screws holding battery switch box cover to battery switch box. Remove cover.

(c) Disconnect and tag wires attached to switch.

(d) Remove pin attaching switch knob to shaft. Remove knob.

(e) Slide shaft of switch plug upward, and plug of switch downward, until plug and spring can be removed. Remove shaft.

(f) Remove safety nuts from screws attaching switch socket insulation block to switch box. Remove switch.

(g) To install, reverse the above procedure.

b. Magneto switch.—(1) *Operation.*—The magneto switch located on the side instrument panel has four positions as indicated on the switch. When the handle is to the extreme right, directly over the word “off,” both engine magnetos are inoperative; to the right of center with the handle over the letter “R,” the right magneto is in use and the left magneto inoperative; to the left of center with the handle over the letter “L,” the left magneto is in use and the right magneto inoperative; to the extreme left with the handle over the word “both,”

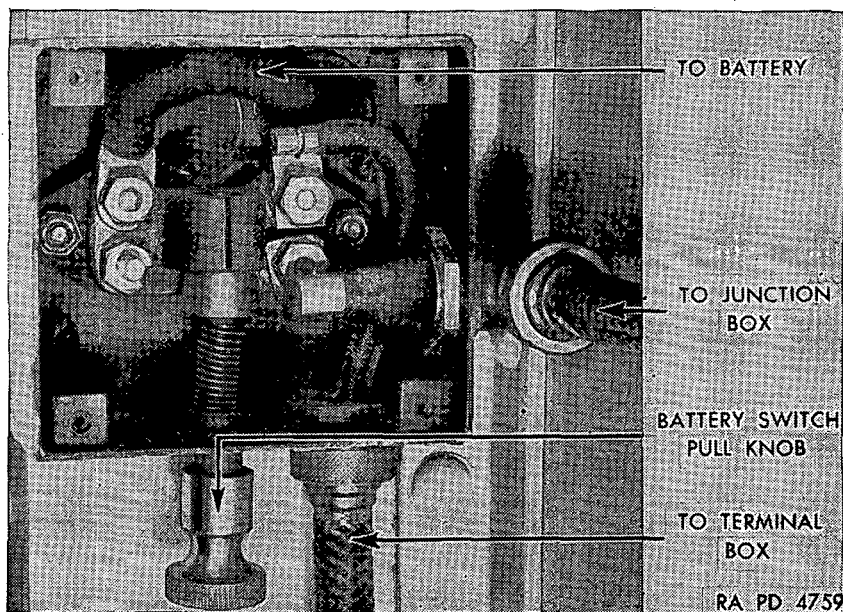

FIGURE 97.—Battery switch box.

both magnetos are in use. Use the following procedure for replacement of a defective magneto switch:

- (2) *Replacement* (figs. 8, 26, and 96).—(a) Open battery switch.
- (b) Remove back cover on panel by removing four screws.
- (c) Disconnect couplings on conduit of “T” connector attached to housing of switch.
- (d) Remove nuts from studs attaching switch cover to switch.
- (e) Remove four screws and nuts attaching housing of switch to panel.
- (f) Pull switch away from cover sufficiently to disconnect and tag wires.
- (g) Pull wires out of holes in switch sufficiently to cut wires as close to terminals as possible. Remove switch.

(h) Install switch by reversing the above procedure and observing the following precautions: When cutting off the wire terminals from

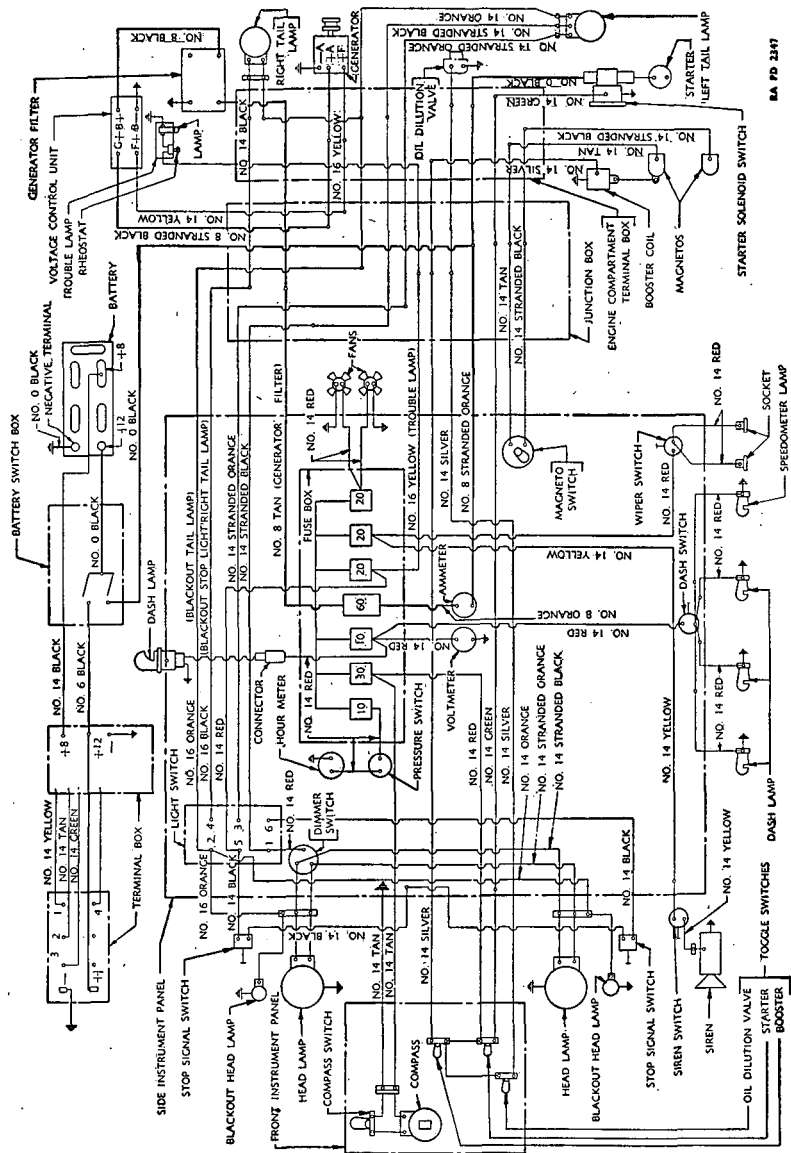

FIGURE 98.—Wiring diagram.

BA PD 2347

the wires, cut wire as close to the terminal as possible, and pull the wire through the hole of the switch enough to have sufficient slack to solder on a new terminal. Use extreme care in soldering on new

terminals, since one small drop of solder falling into the switch may cause a short circuit. If there is not sufficient slack in the wires leading to the magneto switch from the junction box, install new wires. Consult the wiring diagram (fig. 98).

c. Toggle switches (figs. 7 and 8).—(1) *Description*.—Two types of toggle switches are found on the light tank M3. The “spring-loaded” type, used on the front instrument panel for the oil dilution valve, starter, and booster coil, requires a constant pressure on the handle to remain in the closed position. The other type, a “snap toggle switch,” used only for the compass light, is mounted on the side of the compass panel, which remains in either the “on” or “off” position, depending upon the position of the handle. Use the following procedure in replacing defective toggle switches. See paragraph 141 for compass switch replacement.

(2) *Replacement*.—(a) *Spring-loaded type*.

1. Open battery switch.
2. Remove cover from back panel by removing 4 nuts.
3. Remove and tag wires from switch (see wiring diagram, fig. 98).
4. Remove two screws and nuts attaching switch to panel.
Remove switch.
5. To install, reverse the above procedure.

(b) *Snap type*.

1. Open battery switch.
2. Remove cover from back panel by removing four nuts.
3. Remove and tag wires from switch.
4. Remove lock nut attaching switch to instrument panel.
Remove switch.
5. Reverse the above procedure to install a new switch.

d. Starter solenoid switch.—(1) *Operation*.—When the starter toggle switch is closed, the starter solenoid switch, mounted on the engine support beam, closes and allows current from the battery to operate the direct electric starter. Replace this unit, if defective, following the procedure outlined below for the Leach starter solenoid switch.

(2) *Replacement*.—(a) Open battery switch.

(b) Remove cover of switch box.

(c) Disconnect starter leads from switch.

(d) Disconnect the three conduit couplings going into box and pull wires out of box.

(e) Remove two nuts and bolts attaching switch box to bracket.
Remove switch and box.

(f) Reverse the above procedure to install a new starter solenoid switch.

e. Lighting switch (fig. 99).—(1) Operation.—The exterior lights on the vehicle are controlled by a 4-position push-pull switch. Starting from the “off” position, pulling the knob of the switch out to the first notch provides current for the blackout headlights, taillight, and stoplights. A safety button must be depressed before the switch knob can be pulled to the second position. This position supplies current for the operation of the service headlight, taillight, and stoplights. A dimmer switch in the headlight circuit must be in the “on” position for full illumination of the terrain in front of the vehicle. The third position of the switch provides current for the service stoplight only.

(2) *Replacement.*—The members near the terminal screws in figure 99 correspond with the numbers in wiring diagram figure 98. Use the following procedure in replacing the lighting switch:

(a) Open battery switch.

(b) Remove back cover of panel by removing four screws.

(c) Disconnect wires leading to switch one at a time; tagging or marking both the wires and the terminal of the switch from which it was removed.

(d) Loosen set screw in knob and unscrew knob.

(e) Working from rear side of instrument panel, unscrew nut.

(f) Depress safety button and remove switch.

(g) Reverse above procedure to install a new switch.

f. Two position push-pull switches.—(1) Operation.—The service headlight dimmer, dash, wiper, and sponson gun relay switches are of the two position push-pull type. The first three are located on the side instrument panel. The sponson gun relay switch, mounted on the sponson gun relay box, is accessible to the driver. The sponson gun relay box is mounted on the side wall of the fighting compartment. Pulling the switch knob out operates the switch. Pushing the knob in makes the switch inoperative.

(2) *Replacement* (see figs. 8 and 96 and wiring diagram, fig. 98).—Use the following procedure in replacing defective push-pull switches:

(a) Open battery switch.

(b) Remove cover behind panel by removing four screws.

(c) Remove and tag wires connected to switch.

(d) Loosen lock nut on switch body.

(e) On the light dimmer switch only, remove knob.

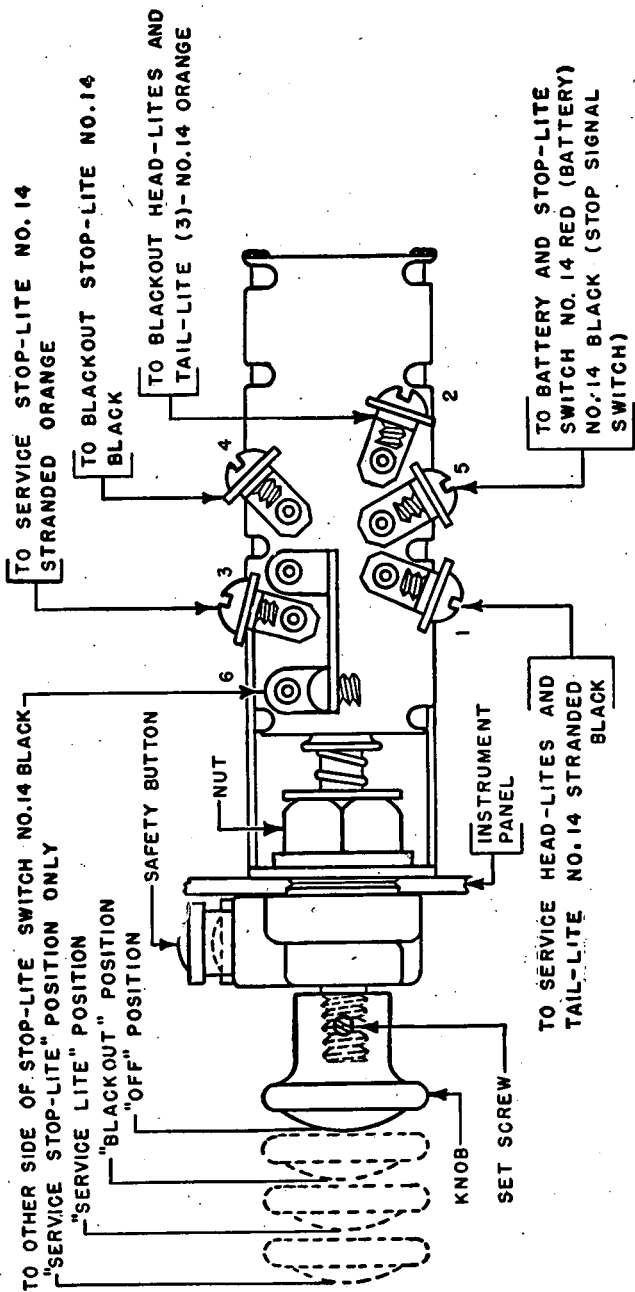

RA PD 4741

Figure 99.—Light switch.

(f) Remove knurled or hex lock nut from end of switch body in front of instrument panel. Remove switch.

(g) To install switch, reverse the above procedure.

g. Siren switch.—(1) *Operation.*—The siren switch is operated by the driver's left foot and is located near the clutch pedal. This switch is welded to a bracket, whose ends are attached to the final drive flange and clutch shaft support bracket.

(2) *Replacement.*—Replace the switch and bracket assembly if the switch is defective, using the following procedure:

(a) Open battery switch.

(b) Disconnect bracket.

(c) Remove and tag wires connected to switch.

(d) Remove switch and bracket assembly.

(e) Reverse the above procedure to install a new siren switch.

h. Stop signal switch (fig. 98).—(1) *Operation.*—Two stop signal switches, connected in series, are used to complete the electrical circuit for operation of the service and blackout stoplights. Each steering lever operates one switch through a linkage. Since the switches are in series, both steering levers must be pulled back, or the brake bands contracted on the drums, before the circuit is completed and the stoplights function. These switches are mounted on the transmission case on either side of the differential.

(2) *Replacement.*—If either or both switches are defective, use the following procedure for replacement:

(a) Open battery switch.

(b) Disconnect and tag wires connected to switch.

(c) Disconnect rod to steering brake linkage.

(d) Remove two bolts and nuts attaching switch to transmission case. Remove switch.

(e) Reverse the above procedure to install a new switch.

i. Pressure switch.—(1) *Operation.*—The pressure switch, operated by engine oil pressure, completes the electrical circuit for operation of the engine hour meter. This switch is bolted to the transmission case in front of the driver.

(2) *Replacement.*—If defective, use the following procedure for replacement:

(a) Open battery switch.

(b) Remove locking wire and nut holding cap to body of pressure switch.

(c) Remove cap; disconnect and tag wires connected to pressure switch.

(d) Disconnect oil line at pressure switch.

(e) Remove nut and bolt holding switch to case. Remove switch.

(f) Reverse the above procedure to install a new pressure switch.

j. *Steering lever gun firing switch* (fig. 100).—(1) *Operation*.—Each steering lever has a lever-operated switch mounted close to the hand grip of the steering lever. When the switch is not in use, the lever operating it may be rotated downward, out of the way of the hand grip of the steering lever. To close a switch, rotate the switch lever to the up position and compress the switch lever against the hand grip of the steering lever. The switch on the left steering lever fires the left sponson machine gun and the right one the right sponson gun.

(2) *Replacement*.—(a) Open battery switch.

(b) Remove cover of sponson machine gun relay box.

(c) Remove wires from the relay leading to the defective switch.

(d) Tie a stout piece of twine to each wire.

(e) Remove cotter and clevis pin attaching switch lever to switch housing. Remove lever.

(f) Remove screw attaching switch to housing.

(g) Pull out switch far enough from switch housing to disconnect and tag wires. Remove switch.

(h) Reverse the above procedure to install a new switch.

123. Sponson gun relays.—a. *Operation* (fig. 100).—Two relays are mounted in a box on the hull just below the machine gun in the left sponson. The electrical circuit to the relay is completed when both the push-pull switch on the relay box and the steering lever firing switch are closed. Use the following procedure in replacing a defective relay:

b. *Replacement*.—(1) Open battery switch.

(2) Remove cover of relay box.

(3) Disconnect and tag wires removed from defective relay.

(4) Disconnect wire from relay leading to solenoid of left sponson machine gun.

(5) Disconnect coupling of conduit on relay box leading to left sponson machine gun.

(6) Remove three clamps and disconnect union on nonflexible conduit that connects the relay box to the right sponson machine-gun solenoid.

(7) Pull relay box away from side of hull enough to clear hull insulation and rotate box with conduit enough to remove the 2 flat-headed screws from the back of the relay box. Remove relay.

(8) Reverse the above procedure to install a new relay.

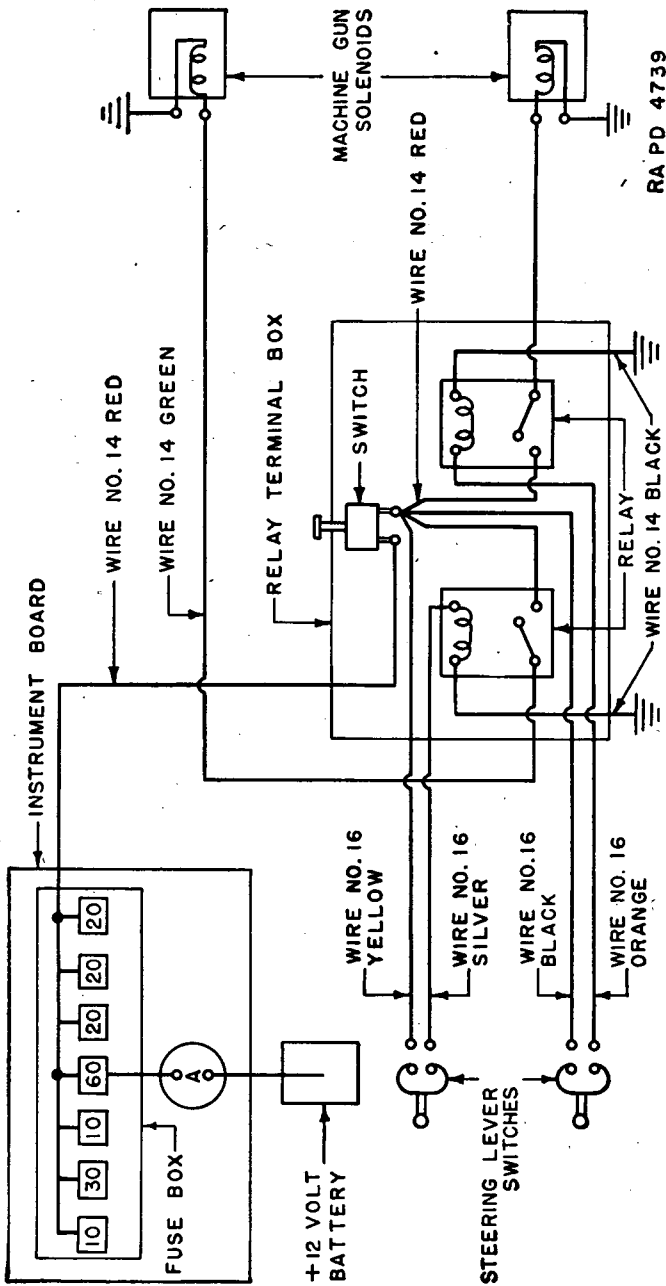

RA PD 4739

FIGURE 100.—Wiring diagram, sponson machine guns.

124. Solenoids.—*a. Operation.*—Each sponson machine gun is fired by a solenoid. Some Diesel engine installations have a solenoid-operated idle speed adjustment screw stop. This solenoid is mounted on a bracket attached to the engine support beam (fig. 37).

b. Replacement.—(1) Open battery switch.

(2) Remove screw attaching wire to solenoid and remove wire.

(3) Remove two cap screws attaching solenoid to gun mount. Remove solenoid.

(4) Reverse the above procedure to install a new solenoid.

NOTE.—When replacing the solenoid that operates the idle speed adjustment screw stop, loosen the set screw that locks the plunger to the rod.

125. Headlamps.—*a. Description.*—Each front fender of the vehicle mounts a service headlamp and blackout headlamp mounted on a bracket. The light switch on the instrument panel operates these lamps. The service headlamp uses a double contact bayonet base, 12-volt, 2-filament, 32-cp lamp. The blackout headlamp uses a single contact, 12-volt, bayonet-base, 3-cp lamp. Use the following procedures in replacing defective lamps or headlamps.

b. Replacement.—(1) *Lamps.*—(a) Open battery switch.

(b) Remove screw attaching lens frame to body of headlamps. Remove frame with lens.

(c) Remove lamp.

(d) Reverse the above procedure to install a new lamp.

(2) *Headlamps.*—Due to the method used in mounting the headlamps, if one headlamp is damaged, both headlamps mounted on that bracket are replaced.

(a) Open battery switch.

(b) Disconnect conduit coupling from bulkhead connector in armor plate and pull out three pronged plugs.

(c) Remove three bolts and nuts attaching headlamp mounting bracket to fender. Remove headlamps with bracket and conduit.

(d) Reverse the above procedure to install new headlamp assembly. Focus the service headlamps.

c. Service headlamp focusing.—After a suitable headlamp testing target has been set up, the correct light silhouette may be obtained by turning the focusing screw on the back of the headlamp. The correct position of the lamp may be obtained by adjusting the pivot and trunnion beneath the headlamp.

126. Taillamps.—*a. Description.*—A taillamp is mounted on the side armor plate, just above each rear fender. The lamps in the two taillamps are operated by the light switch. Each taillamp consists of two seal-beam units, having pronged-type electrical connec-

tions to the filaments. The two sealed-beam units for each lamp are held in place by a frame, attached to the metal housing or body of the lamp with a screw. The left taillamp assembly has three filaments, for service, blackout tail, and service stoplight respectively. The right taillamp has two filaments for blackout stop and blackout tail respectively. Use the following procedure in replacing the taillamp or the seal-beam lamp.

b. Replacement.—(1) *Seam-beam lamp.*—(a) Open battery switch.

(b) Remove screw attaching lens frame to body of taillamp. Remove frame.

(c) Pull the defective sealed-beam lamp straight out to remove it.

(d) Reverse the above procedure to install a new sealed-beam lamp.

(2) *Taillamp.*—(a) Working from the inside of the side armor plate, disconnect the conduit coupling and pull out plug type wire connector. Remove lock nut from bulkhead connector.

(b) Working from the outside, remove bulkhead connector with conduit.

(c) Remove two bolts and nuts fastening taillamp support bracket to side armor plate. Remove taillamp with bracket and conduit.

(d) Reverse the above procedure to install a new taillamp.

127. Dash lamps.—*a. Description.*—Two dash lamps are used to illuminate the side instrument panel. A small amount of light from a dash lamp close to the tachometer illuminates the front instrument panel. On later model vehicles a dash lamp on the back of the bow gunner's side instrument panel housing illuminates the fuse box cover. The speedometer dial receives light from a lamp within the transmission guard shield. The five dash lamps use the same size lamp, a 3-cp, single-contact, bayonet-base, 12-volt lamp. The push-pull dash lamp switch mounted on the side instrument panel must be closed to complete the electrical circuit to operate all dash lamps except the one in the bow gunner's compartment. The three exterior dash lamps in the driver's compartment each have a built-in switch. To close this switch, push against the lamp shield and turn to the right. The dash lamp in the bow gunner's compartment has a handle-operated switch incorporated in the dash lamp assembly.

b. Replacement of instrument panel lamps in driver's compartment.—(1) Open battery switch or dash lamp switch.

(2) Rotate lamp shield to the right and pull shield away from body of dash lamp. Remove shield.

(3) Remove bayonet-base lamp.

(4) Reverse the above procedure to install a new lamp. The notch in the socket must be lined up with the indentation in the lamp shield before the shield can be pushed into place.

c. Replacement of bow gunner's lamp.—(1) Open battery switch.

(2) Remove lamp shield by pulling away from body of dash lamp.

(3) Remove bayonet-base lamp.

(4) Reverse the above procedure to install a new lamp.

d. Replacement of speedometer lamp.—(1) Open battery switch.

(2) Open cover over hand hole in transmission guard shield.

(3) If the bayonet-base lamp cannot be removed by working through the hand hole opening, loosen the transmission guard shield sufficiently to permit removal of lamp (see par. 100a for transmission guard shield removal).

(4) Reverse the above procedure to install a new speedometer lamp.

e. Replacement of dash lamp bodies or sockets (general instructions).—(1) Open battery switch.

(2) If necessary remove back of side instrument panel of transmission guard shield (see par. 100a for transmission guard shield removal).

(3) Remove tape on wire connectors to dash lamp body.

(4) Disconnect and tag wires.

(5) Remove lock nut from body of dash lamp.

(6) Reverse the above procedure to install a new dash lamp.

128. Trouble lamp (fig. 95).—*a. Description.*—A 3-cp, bayonet-base lamp with socket and shield is attached to a 6-foot length of extension cord wound on a reel. This reel operates similarly to a window-shade roller, that is, the extension cord is under tension when in use and the reel winds the cord up when the trouble lamp is returned to its place. When the trouble lamp is pulled 3 or 4 inches away from the reel, a switch in the housing enclosing the reel and rheostat closes, thereby completing the electrical circuit through the rheostat to the battery. The rheostat provides an adjustment for the amount of light furnished by the lamp. If the rheostat, switch, cord, or socket of the trouble lamp is defective, use the following procedure to replace the assembly.

b. Replacement.—(1) Open battery switch.

(2) Disconnect conduit coupling from housing of trouble lamp.

(3) Remove trouble lamp cover.

(4) Disconnect wire from trouble lamp.

(5) Remove bolts and nuts holding trouble lamp support bracket to bulkhead. Remove trouble lamp with bracket.

(6) Reverse the above procedure to install a new trouble lamp.

129. Compass lamp.—A very small lamp mounted on a screw plug is connected to the compass light switch and illuminates the compass (fig. 7). The lower screw plug contains the spare. Replace the original spare lamp as soon as possible after putting the spare lamp in service. Use the following procedure to replace the compass lamp: Remove the screw plug containing the defective lamp. Exchange the assembly for a new one.

130. Siren.—A siren, operated by the siren switch, is mounted on the front sloping armor plate close to the right front fender. Use the following procedure to replace a defective siren:

a. Disconnect conduit coupling from bulkhead connector in front sloping armor plate and pull out plug.

b. Remove two cap screws holding siren to mounting bracket. Remove siren.

c. Reverse the above procedure to install a new siren.

131. Electrical equipment of engine.—For information on all electrical accessories in the engine compartment, use the following references:

Booster coil, paragraph 49.

Generator, paragraph 57.

Ignition harness, paragraph 51.

Magneto, paragraph 48.

Magneto wiring diagram, figure 26.

Starter, paragraph 56.

132. Sockets.—Several sockets without switches are provided near the side instrument panel to provide an electrical outlet to operate the fans and windshield wipers. The following is only a general procedure for replacing defective sockets:

a. Open battery switch.

b. Remove or loosen whatever is necessary to gain access to the rear side of the socket.

c. Remove tape from wires leading to socket.

d. Disconnect and tag wires.

e. Remove lock nut from socket. Remove socket.

f. Reverse the above procedure to install a new socket.

133. Conduit and cables.—*a. Description.*—Two objectives are achieved by the use of flexible metal conduit over the high and low tension automotive wire used in these vehicles. The conduit protects the insulation of the wire against wear and abrasion and it is oil and water spray proof. Radio interference is cut to a minimum because

the conduit provides a continuous grounded circuit over the entire wiring system. The radio shielding required for the magneto high tension wiring is formed in a unit known as a "harness" and is described in section III.

b. Maintenance.—(1) During the 100-hour check, inspect all conduits for wear and abrasion, loosening of coupling nuts, and loose or missing conduit support clamps or brackets. At any point where abrasion of the conduit appears, the spot should be strapped down or covered with friction tape to prevent further wear.

(2) Conduit supports and clamps should grasp the conduit firmly to prevent abrasion. Replace missing supports and clamps. Tighten loose supports, clamps, and conduit couplings.

(3) Clean all dirty conduit, ignition harness, and spark plug shields. In cleaning couplings or spark plug shields use dry-cleaning solvent if carbon tetrachloride is not available. After cleaning and drying, the threads of each coupling and connector should be cleaned with a wire brush to remove oxidation which sometimes forms on the threads of aluminum couplings. This oxidation, particularly on the ignition harness fittings, breaks the grounded circuit and causes radio interference.

c. Replacement.—Replace wires that show broken or hardened insulation at points of extrusion from a conduit, or that have become oil-soaked through failure of a conduit. If the conduit is badly crushed, replace that section of the conduit and the wires contained therein. Before disconnecting any wire from the circuit, fasten a tag to the terminal post being worked on stating the number of wires, size and color of each wire, and where the other end of each wire is connected. If this precaution is not followed it will be necessary to consult the wiring diagrams and trace out the circuit.

(1) *Removal.*—Disconnect the conduit couplings and the inclosed wires. Remove bracket or clamp supporting conduit. Attach a piece of strong twine to the end of each wire before removing the wire from the conduit. The twine can be used in pulling cleaning cloths through a dirty but otherwise serviceable piece of conduit.

(2) *Installation.*—Use only standard automotive ignition or primary wire of the same size and color as the wire removed. The wire may be pulled through the conduit by means of the heavy twine left in the conduit when the defective wire was withdrawn. Clean terminal posts and wire terminals before connecting wire into circuit. If the tags or marks on terminals are missing, consult the wiring diagram (fig. 98).

134. Instrument panels (figs. 6, 7, and 8).—Replace any instrument panels that are cracked or unserviceable. Use the following procedure for the front panel:

- a. Open battery switch.
- b. Remove 2 nuts and bolts attaching compass mounting to instrument panel. Let compass mounting hang by conduit.
- c. Disconnect engine oil pressure gage line at gage.
- d. Disconnect transmission oil pressure gage line at gage.
- e. Remove two $\frac{3}{8}$ -in. nuts attaching panel to front sloping armor plate. Support panel.
- f. Disconnect and tag wires connected to the toggle switches. Remove panel.
- g. Reverse the above procedure to install a new panel.

135. Trouble shooting (figs. 26 and 100).—In the following discussion, the voltage control unit, battery, and generator filter are assumed to be in operating condition. The functions of the above items are discussed in paragraphs 117, 118, and 119, respectively. The two general types of electrical trouble are open and short circuits.

a. *Short circuits.*—If the battery switch is closed, all other switches open, and the engine not running, the ammeter should read practically zero, since the only current being used from the battery is the small amount used by the voltmeter. If there is an appreciable difference in the ammeter reading between battery switch open and battery switch closed, close battery switch and remove the smaller fuses one at a time, noting whether the ammeter returns to zero when the defective circuit is located. This method checks all circuits except the circuit of the ammeter itself which comprises the wire between the ammeter and the main fuse, the wire between the fuse panel bus-bar and the sponson machine-gun relay box, and the wire between the fuse panel bus-bar and the reverse current relay in the voltage control unit. After removing the 60-ampere fuse, check the last two circuits. If the battery is completely discharged, and no discharge shows on the ammeter, check those circuits that do not go through the ammeter. These circuits consist of the 8- and 12-volt leads to the radio terminal box, the No. 0 black wire to the starter solenoid switch, and the No. 8 stranded orange wire between the junction box and the ammeter. A short circuit in a switch can generally be checked by disconnecting the wires at the switch terminals and noting the readings of the ammeter before and after the operation. A change in the ammeter reading will indicate trouble.

b. *Open circuits.*—The various terminal boxes and the junction box in the fighting compartment provide places to break any circuit in

order to check a portion of that circuit. One of the fans, or a 12-volt bulb in series with the ground, will be used to check the circuit. Conditions to look for in locating electrical troubles are, in the order of their importance, as follows:

- (1) Loose, dirty, or corroded connections.
- (2) Inoperative or defective equipment.
- (3) Defective or corroded switches and plug connectors.
- (4) Worn conduits and broken or bare wires.

136. Wiring.—The wiring diagram (fig. 98) gives the wire size and color used in the various circuits. Not all of the terminal boxes are shown. When it is necessary to install new wires, it will generally be necessary to solder the terminals on the wire after the wire has been installed in the conduit. The color scheme should be adhered to and do not, for any reason, change the wire size in any portion of a circuit. Tag all wires during change. In stripping insulation from a wire to make a connection, do not damage the wire. Allow 3 or 4 inches of slack in installing the wires to switches where the terminals must be clipped off in order to replace the defective switch. Since oil and gasoline are injurious to insulation, keep all exposed wires clean, and check frequently for loose or corroded connections.

SECTION XV

NONELECTRICAL INSTRUMENTS

	Paragraph
Tachometer.....	137
Speedometer.....	138
Pressure gages.....	139
Engine oil temperature gage.....	140
Compass.....	141

137. Tachometer.—*a. Operation.*—The tachometer registers the revolutions per minute of the engine crankshaft. It is driven by a flexible shaft encased in flexible casing, the assembly being called the tachometer drive shaft assembly. The tachometer drive shaft assembly connects to the accessory case of the engine, passes through the propeller shaft housing or tunnel, and connects to the tachometer close to the front instrument panel. Use the procedure in *b* below to replace a defective tachometer or drive shaft assembly.

b. Replacement.—(1) *Tachometer.*—(a) Disconnect tachometer drive shaft assembly from tachometer.

(b) Remove nuts and washers from studs in rear of instrument holding clamps against rear of instrument panel. Remove clamps.

(c) Remove tachometer.

(d) Reverse the above procedure to install a new tachometer.

(2) *Tachometer drive shaft assembly.*—(a) Disconnect tachometer drive shaft assembly from tachometer and tie a 10-foot length of stout twine or small rope to it.

(b) Disconnect tachometer drive shaft assembly from accessory case of engine.

(c) Remove brackets and clamps in engine compartment supporting tachometer cable.

(d) Using one man to guide the drive shaft assembly through support brackets in propeller shaft tunnel, pull the assembly out of tank, leaving twine in tunnel.

(e) Reverse the above procedure to install a new drive shaft assembly, using the twine to pull the new assembly into place.

138. Speedometer.—*a. Operation.*—The speedometer, mounted on the transmission guard shield, registers the miles per hour and the total miles traveled by the vehicle. The instrument is operated by a flexible shaft encased in a flexible casing. The assembly is referred to as the speedometer drive shaft assembly. One end of the assembly is attached to the rear of the transmission, the other end to the speedometer. Replace a defective speedometer or drive shaft assembly using the procedure in *b* below.

b. Replacement.—(1) *Speedometer.*—(a) Open battery switch.

(b) Open transmission guard shield band hole cover.

(c) Disconnect speedometer drive shaft assembly from speedometer.

(d) Remove nuts from studs holding transmission guard shield support bracket to transmission case.

(e) Remove five nuts and bolts attaching transmission guard shield to transmission leg shield and transmission case.

(f) Pull transmission guard shield away from transmission case far enough to disconnect wires from windshield wiper sockets.

(g) Disconnect wire connected to speedometer lamp.

(h) Disconnect wires from fans and pull wires through hole in transmission guard shield. Remove transmission guard shield.

(i) Remove four screws and nuts attaching speedometer to transmission guard shield. Remove speedometer.

(j) Reverse the above procedure to install a new speedometer.

(2) *Speedometer drive shaft assembly.*—(a) Working through hand hole cover of transmission guard shield, disconnect speedometer drive shaft assembly from speedometer.

(b) Disconnect speedometer drive shaft assembly from transmission case. Remove assembly.

(c) Reverse the above procedure to install a new speedometer drive shaft assembly.

139. Pressure gages.—*a. Operation.*—Two pressure gages, registering pounds per square inch, are mounted on the front instrument panel. The gage on the right side registers the engine oil pressure. The gage on the left side registers transmission oil pressure. Replace defective gages, using the procedure in *b* below.

b. Replacement.—(1) Open battery switch.

(2) Disconnect tubing from gage.

(3) Remove three screws and nuts securing gage to instrument panel. Remove gage.

(4) Reverse the above procedure to install a new gage.

140. Engine oil temperature gage.—*a. Operation.*—The engine oil temperature gage, mounted on the side instrument panel, registers the temperature in degrees Fahrenheit of the oil entering the engine. The gage, connected to the accessory case by a tube encased by a flexible casing, is one unit and will not be taken apart. Replace a defective gage, using care in handling the bulb and metal tubing. Use the procedure in *b* below.

b. Replacement.—(1) Open battery switch.

(2) Disconnect the flexible metal casing and withdraw bulb from the engine accessory case.

(3) Remove all clamps and supports in engine compartment that interfere with removal of flexible tube.

(4) Tie a 12-foot length of stout twine or small rope to flexible tube close to bulb.

(5) Remove 3 screws and nuts holding gage to instrument panel.

(6) With one man guiding the flexible casing through the support brackets, remove gage with flexible metal casing and bulb, leaving heavy twine in tunnel.

(7) Reverse the above procedure to install a new engine oil temperature gage, tying the twine to the casing just in back of the bulb. Tape the nut and the bulb to the twine. This will prevent the nut sliding along the casing and will also prevent the end of the bulb from catching on obstructions.

141. Compass (fig. 7).—*a. Description.*—A compass is mounted on an individual panel bolted to the front instrument panel. Vibration transmitted by the front panel to the compass panel is decreased by the use of rubber washers on the bolts.

b. Compensation.—(1) To correct or compensate for the attraction of the various metal components near the compass, a means of compensation is provided within the instrument. By removing the two

screws, the upper lamp holder or shield may be removed, thus exposing the compensating screws. Using the small brass screw driver provided for this purpose, turn the screws until the white dot in the screw slot alines with the white dot on the compass body.

(2) With all equipment of a magnetic nature in place, head the vehicle due magnetic north, as determined by an instrument outside and away from the vehicle. (A surveyor's transit may be used.) Turn the "N-S" screw until the compass reads "N." Head the vehicle due west and set the compass at "W" by turning the screw marked "E-W." Head the vehicle due south and remove *one-half* the existing error by turning the "N-S" adjusting screw. Head the vehicle due east and remove *one-half* the existing error by turning the "E-W" adjusting screw.

(3) Recheck by heading the vehicle on the magnetic headings shown on the compensating card and record the corresponding compass readings in the spaces provided.

(4) The compensating card is carried in the deviation card holder, attached to the panel above the compass.

c. Maintenance.—At frequent intervals, inspect the instrument for the appearance of bubbles in the bowl, and if necessary, remove the filler plug and refill with ethyl alcohol. Compensation for error due to variable magnetic conditions should be made whenever such conditions arise.

d. Replacement.—Replace the panel, compass switch, and compass as a unit when any part of this unit is defective. Use the following procedure:

(1) Disconnect conduit coupling at compass panel.

(2) Remove bolts, nuts, and rubber washers attaching the compass panel to the front instrument panel. Remove panel with compass, compass switch, and wiring.

(3) Reverse the above procedure to install a new compass, compass switch, or panel.

SECTION XVI

FIRE EXTINGUISHERS

	Paragraph
Installation.....	142
Operation.....	143
Maintenance.....	144
Handling.....	145

142. Installation.—Two sizes of carbon dioxide fire extinguishers are carried in each vehicle. A fixed 7½-pound unit is clamped in

a vertical position near the transmission oil cooler on the bulkhead of the fighting compartment (fig. 95). This unit connects to a tube leading to the engine compartment and is used for extinguishing fires in the engine compartment only. A 4-pound portable hand-operated extinguisher is strapped in a vertical position at the right of the transmission and to the left of the bow gunner. Later vehicles have the portable extinguisher to the left of the propeller shaft housing near the transmission.

143. Operation.—*a.* Carry the portable extinguisher in the left hand and the hose in the right hand. Direct the discharge at the base of the flame, with the discharge cone as close to the flame as the operator can safely hold it. Increase the discharge from the extinguisher as the fire is put out.

b. In case of a fire in the engine compartment, set the fixed extinguisher in operation by breaking the seal wire, removing valve locking pin, and turning hand wheel of the cylinder valve to the left. This floods the engine compartment with carbon dioxide gas, and will extinguish a fire with the engine running up to 1,200 rpm. If conditions permit, however, stop the engine.

144. Maintenance.—After use, the extinguisher should immediately be exchanged for one that is fully charged. At the 100-hour check, weigh each extinguisher, and if less than 3½ pounds for the 4-pound extinguisher, or 6½ pounds for a 7-pound one, exchange the extinguisher for a fully charged one.

145. Handling.—Any cylinder containing gas under high pressure is as dangerous as a loaded shell. The extinguisher cylinders should never be dropped, struck, handled roughly, or exposed to unnecessary heat.

SECTION XVII

GYRO-STABILIZER UNIT

	Paragraph
General.....	146
Maintenance.....	147
Inspection.....	148
Replacement of assemblies.....	149
Charging with oil and removing air from system.....	150

146. General.—The gyro-stabilizer unit must be maintained properly to insure the accuracy and sensitivity required for proper operation of the unit. Repairs must not be made to the individual assemblies, but rather the assemblies will be replaced. Figure 101 shows the complete assemblies of the stabilizer unit which will be

replaced as units. The pump and motor assembly is mounted on the turret wall opposite the combination gun mount. Figure 102 shows the mounting of the gyro-control unit, the piston and cylinder assembly, and mounting bracket assembly. The master switch is located on the end of the pump.

147. Maintenance.—At the 25-hour inspection, check the following items:

a. Tighten the packing gland on the oil pump shaft by first removing the cover plate (fig. 103) and take up on the packing gland nut slightly, using a screw driver, turning it in a clockwise direction (right-hand thread). Do not get it too tight.

b. Check and grease the four alemite fittings on the gyro-stabilizer equipment.

c. Check the external electrical connections for looseness or broken wires.

d. Check all oil line connections for leaks and tighten or replace.

e. Check for oil leaks around the piston and cylinder assembly and replace the assembly if oil leakage is found.

f. Check for free motion between the gyro-control unit and the handwheel, and adjust the backlash between the worm gear and worm wheel (fig. 104) if free motion exists. The backlash may be eliminated by loosening the lock nut (fig. 104) and screwing in the adjusting screw. Use care not to get excessive pressure between the worm and worm wheel and be sure to tighten the lock nut after adjusting.

g. Check for free movement in the mounting of the piston and cylinder assembly.

h. The adjustment of the recoil switch (fig. 107) must be checked periodically to eliminate the possibility of its not functioning properly. The recoil switch is mounted so its contacts are held open until the gun is fired. Immediately after the gun is fired the switch closes its contacts. Therefore, the recoil switch must be adjusted on its mounting so the contacts will close with the first recoil movement of the gun. However, it must also be adjusted on its mounting so that the contacts will not close unless the gun is fired.

Caution: This is a very critical adjustment and must be tried over and over as explained for the recoil adjuster until the correct operation is obtained. If the contacts close due to loose mounting or poor adjustment of the recoil switch, the gyro-stabilizer circuit will not function properly. For details on the adjustments of the recoil switch see paragraph 149*d*.

i. Check for presence of air in the oil system (see par. 150).

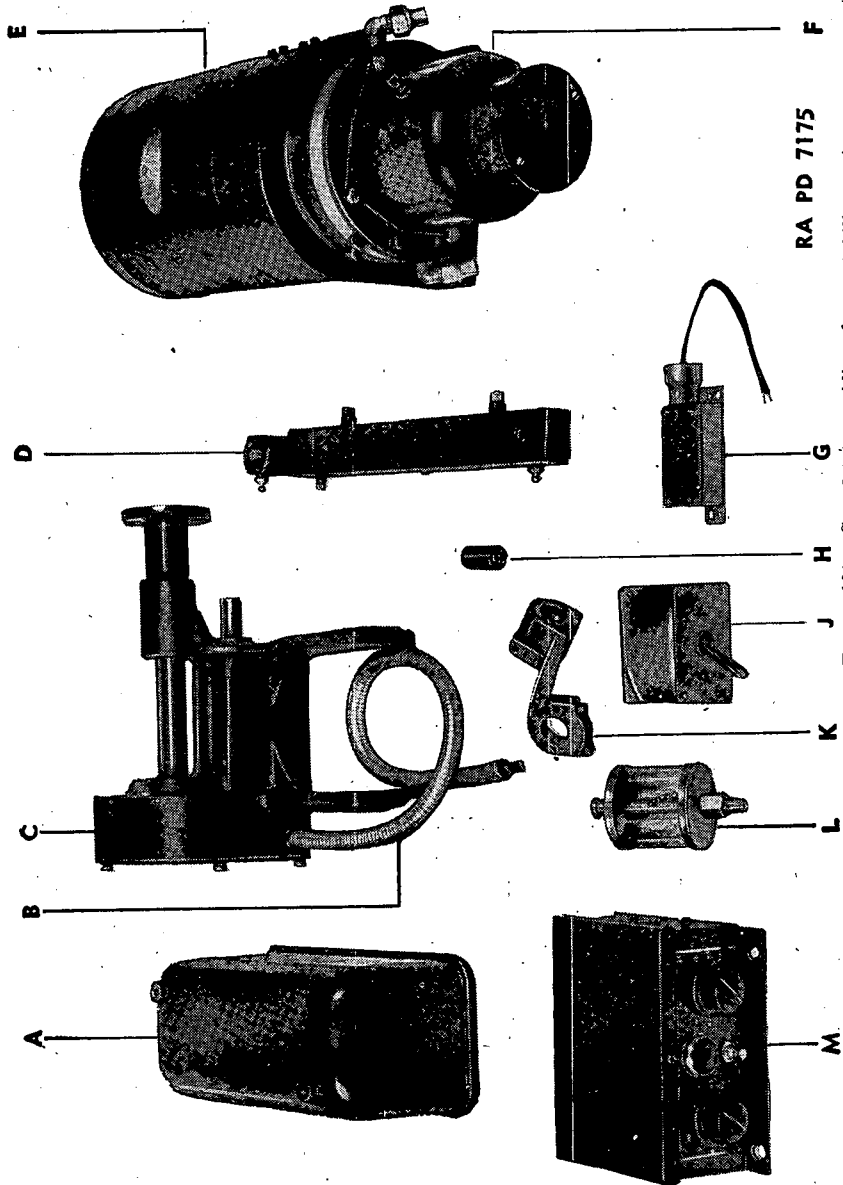

- A**—GYRO CONTROL UNIT
- B**— FLEXIBLE SHAFT
- C**— MOUNTING BRACKET ASSEMBLY
- D**— PISTON AND CYLINDER ASSEMBLY
- E**— OIL PUMP MOTOR
- F**— OIL PUMP
- G**— RECOIL SWITCH
- H**— FLEXIBLE SHAFT ADAPTE
- J**— MASTER SWITCH
- K**— FLEXIBLE SHAFT MOUNTING BRACKET
- L**— OIL LEVEL RESERVOIR
- M**— CONTROL BOX

RA PD 7175

Figure 101.—Complete assemblies of gyro-stabilizer unit.

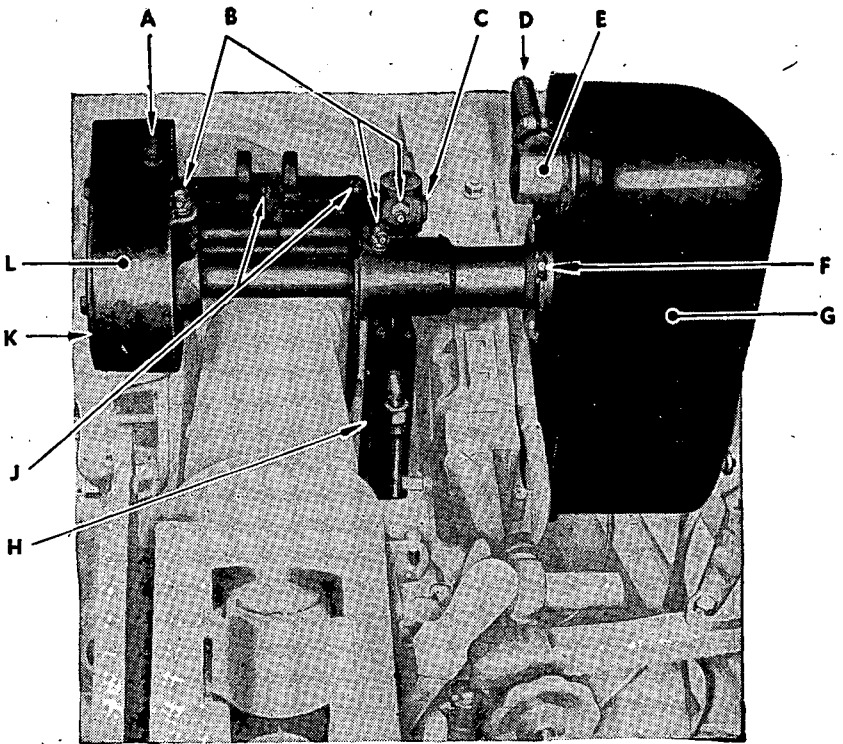

- A — WORM BEARING ADJUSTMENT
- B — GREASE FITTINGS
- C — PISTON ROD PIVOT PIN
- D — SHIELDED CONDUIT
- E — MULTI-PRONG CONNECTOR
- F — GYRO CONTROL MOUNTING BOLTS
- G — GYRO CONTROL UNIT
- H — PISTON CYLINDER ASSEMBLY
- J — SET SCREWS
- K — GEAR COVER PLATE
- L — MOUNTING BRACKET ASSEMBLY

RA PD 7171

FIGURE 102.—Gyro-control, mounting shaft, and mounting bracket, gyro-stabilizer unit.

148. **Inspection.**—*a.* Check the oil level in the oil reservoir. It must be two-thirds full at all times.

b. Check for air in the oil lines, oil pump, and piston and cylinder assembly (see par. 149*c*).

c. Check and grease the four alemite fittings on the gyro-stabilizer equipment and any grease fittings on the turret assembly.

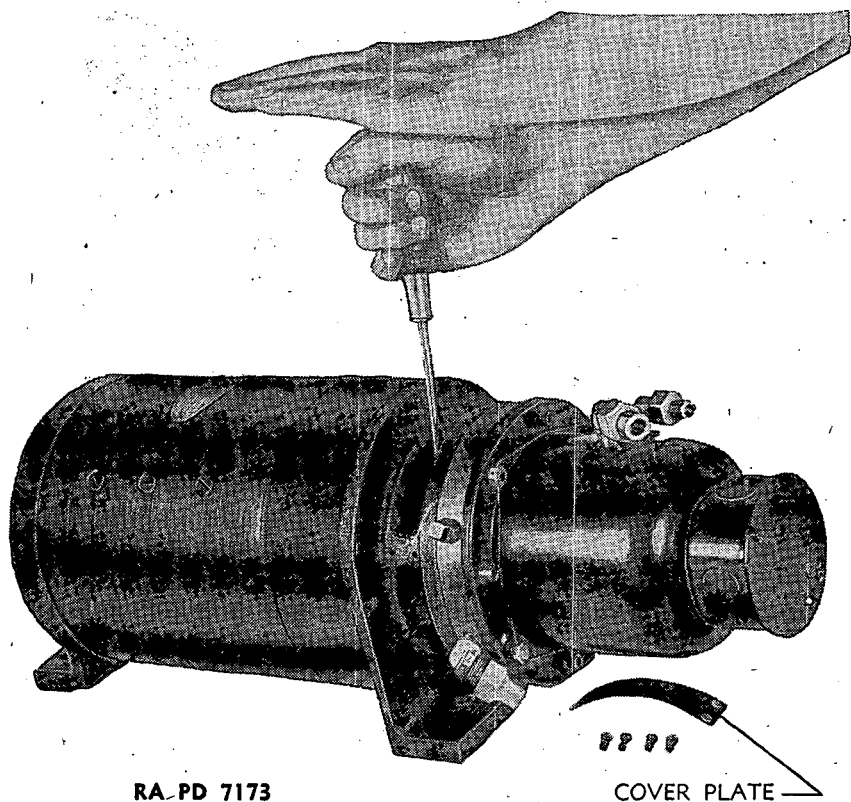

FIGURE 103.—Oil pump and motor, showing tightening of pump packing gland, gyro-stabilizer unit.

d. Check for free movement between the gyro-control unit and the handwheel.

e. Check for free movement between the gyro-control unit and the gun.

f. Check for free movement in the mounting of the piston and cylinder assembly.

g. Check the adjustment of the recoil switch (see par. 147*h*).

h. Check the external electrical connections for looseness or broken wires.

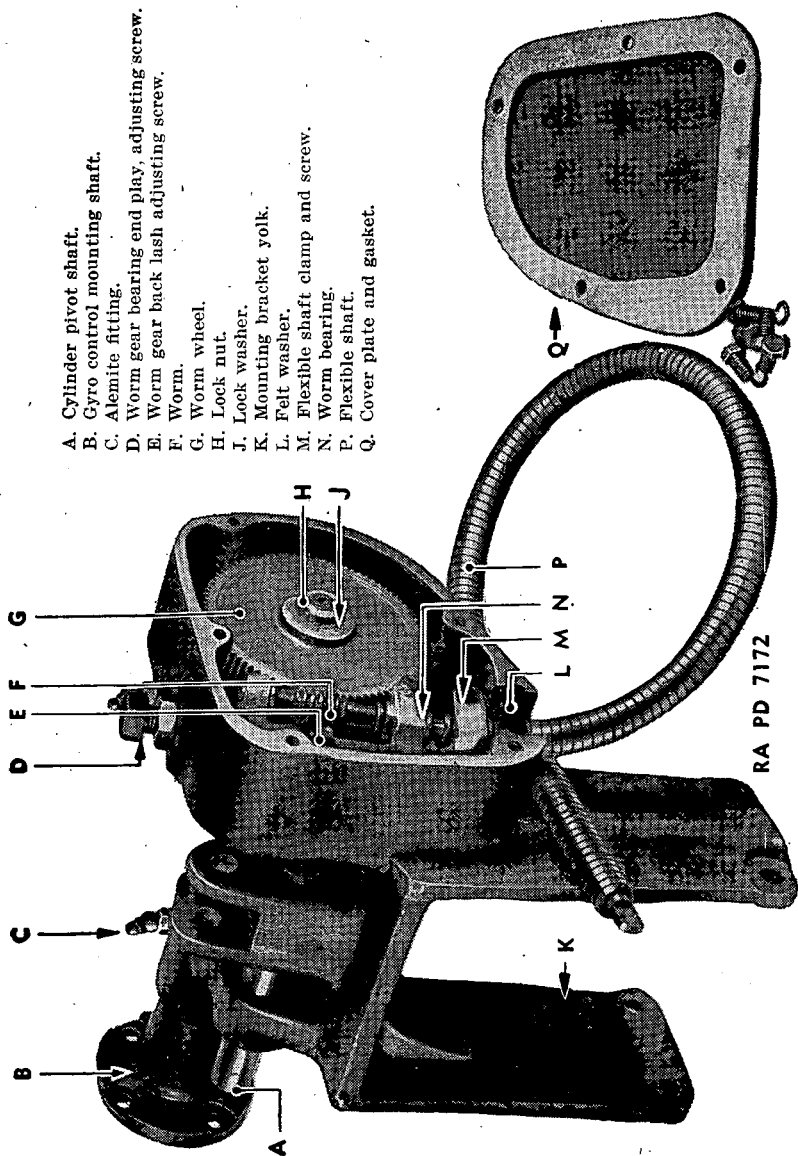

- A. Cylinder pivot shaft.
- B. Gyro control mounting shaft.
- C. Alemite fitting.
- D. Worm gear bearing end play, adjusting screw.
- E. Worm gear back lash adjusting screw.
- F. Worm.
- G. Worm wheel.
- H. Lock nut.
- J. Lock washer.
- K. Mounting bracket yolk.
- L. Felt washer.
- M. Flexible shaft clamp and screw.
- N. Worm bearing.
- P. Flexible shaft.
- Q. Cover plate and gasket.

RA PD 7172

FIGURE 104.—Mounting bracket assembly, gyro-stabilizer unit.

i. Check the tank voltage.

j. Check for undue friction in the gun mounting and any unbalance in the gun as determined by the gunner.

k. If trouble still exists in the gyro-stabilizer equipment after making the above checks, the various assemblies should be replaced in the following order until the source of trouble is located:

- (1) Gyro-control unit.
- (2) Oil pump.
- (3) Piston and cylinder assembly.
- (4) Recoil switch.
- (5) Control box.
- (6) Oil pump motor.

149. Replacement of assemblies.—a. Gyro-control unit.—(1)

Throw the master toggle switch to the "off" position, disconnecting the power supply to the gyro-stabilizer.

(2) Disconnect and remove the multiprong connector from the gyro-control base.

(3) Remove the four nuts on the gyro-control mounting shaft (fig. 102) and remove the gyro-control unit.

(4) The replacement of the gyro-control is the reverse of dismounting.

NOTE.—The lead seals on the gyro-control unit must *never* be broken except by ordnance personnel.

(5) The complete gyro-stabilizer should be checked for operation.

b. Oil pump and motor (fig. 105).—(1) Throw the battery switch to the "off" position.

(2) Throw the master switch controlling the gyro-stabilizer equipment to the "off" position.

(3) Remove the cover of the master switch (not shown in illustration).

(4) Take out the two screws holding the switch box to the terminal box on the oil pump.

(5) Disconnect the three wires, green, yellow, and white, from the hydraulic valve terminals. These are accessible through the master switch box.

(6) Remove the screws holding the master switch box to the pump conduit box.

(7) Disconnect the pump motor lead from the master switch and remove the shielded cable and fittings from the master switch box.

(8) Disconnect and plug the oil lines from the oil pump.

(9) Remove the oil reservoir and fittings.

(10) Remove the four cap screws holding the motor clamp, and remove clamp.

(11) Take out the two bottom bolts holding the motor to the motor base plate.

(12) Have one man hold the pump and motor while another man removes the two remaining top bolts.

(13) Transfer the shielded cable fittings and motor lead from the defective motor to the replacement motor.

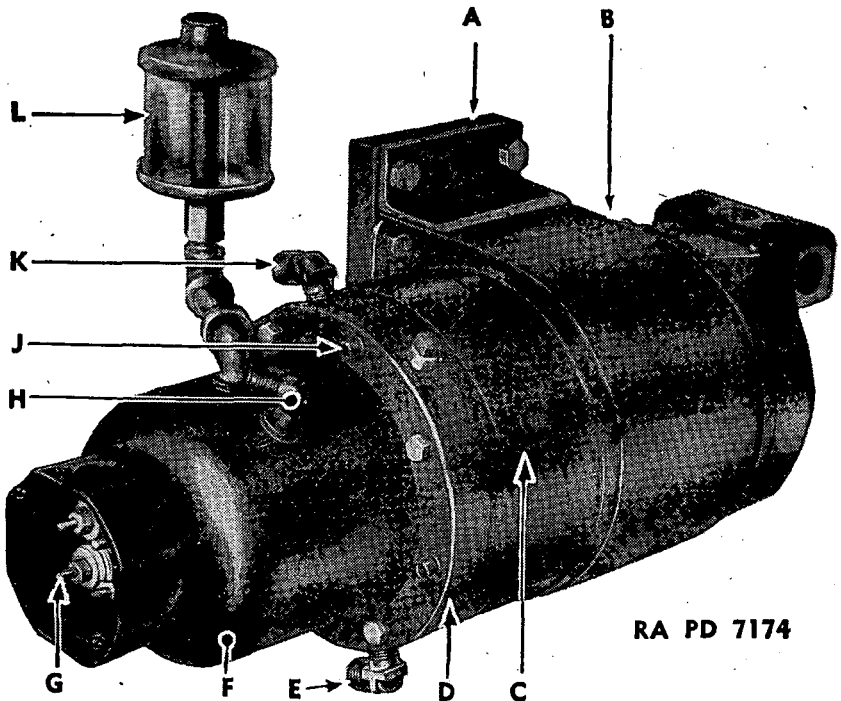

A. Mounting plate.

B. Motor clamp.

C. Cover plate.

D. Base plate.

E. Lower oil connector.

F. Pump cover.

G. Hydraulic valve terminals.

H. Oil return connection.

J. Allen head screw.

K. Upper oil connection.

L. Oil reservoir.

FIGURE 105.—Oil pump and motor assembly, gyro-stabilizer unit.

(14) Remove the four Allen head screws, not connected together by the wire lock.

(15) Tap the base plate with a light hammer while pulling on the oil pump.

(16) Remove the oil pump from the oil pump motor.

NOTE.—The oil pump cover must *never* be removed except by ordnance personnel.

(17) The reassembly of the pump and motor is the reverse of the dismantling with the exception of the following:

(18) Care must be exercised when placing the pump on the motor, so the two shafts will be properly meshed.

(19) Remount the pump and motor assembly in the turret and remake the electrical and oil line connections in the reverse order of the above procedure.

(20) Additional oil must be added to the oil system and the air removed. This operation must be performed as outlined in paragraph 150.

(21) The complete gyro-stabilizer should be checked for operation.

c. Piston and cylinder assembly.—(1) Throw the master toggle switch to the "off" position, disconnecting the power supply to the gyro-stabilizer.

(2) Disconnect and remove the oil lines, and plug with flare plugs (fig. 102).

NOTE.—Provision should be made to catch the oil that will be lost on disconnecting the lines.

(3) Disconnect and remove the firing pin cable (fig. 106).

(4) Loosen the set screw and remove the collar on the cylinder pivot pin (fig. 106).

(5) While holding the gun in position to free the piston and cylinder assembly, work the piston rod end and the cylinder end off their respective pivot pins.

(6) The replacement of a piston and cylinder assembly is the reverse of the dismantling with the exception that the system must be recharged with oil and air removed from the system as outlined in paragraph 150.

(7) The complete gyro-stabilizer should be checked for operation.

d. Recoil switch (figs. 106 and 107).—(1) Throw the master toggle switch to the "off" position, disconnecting the power supply to the gyro-stabilizer.

(2) Remove the screws holding the switch to the switch mounting bracket.

(3) Remove the cover plate from the switch.

NOTE.—The cover plate screws on some switches will require heating so as to melt the solder while removing.

(4) Disconnect the electrical wiring.

(5) Unscrew the recoil switch from the shielded conduit fitting.

(6) To install the new recoil switch, which will have a different type of conduit fitting, it will be necessary first to unsolder and remove the original adapter from the shielded conduit. Place a

new ferrule nut on the conduit and solder the ferrule itself to the shielded conduit (conduit size $\frac{3}{8}$ inch ID, ferrule nut $1\frac{1}{16}$ -24 thread).

(7) Reconnect the wiring and remount the switch.

(8) Adjust the recoil switch in the following manner: When the switch is mounted as shown in figure 107, the gun pushes in the plunger so the contacts are open. When the gun is in battery position (fig. 107), the plunger must be pushed in approximately one-half of its total travel. If the plunger is not pushed in sufficiently, it will be necessary to place a shim between the switch mounting bracket and the rear machine-gun bracket. If the plunger is pushed in too far, it will be necessary to elongate slightly the two holes which are used for mounting the switch to the bracket. This will allow the switch to move toward the muzzle of the gun the desired distance as determined by the elongation of the holes. Be sure to tighten the mounting screws as tightly as possible so the switch will not shift.

e. Control box (fig. 108).—(1) Throw the master toggle switch to the "off" position, disconnecting the power supply to the gyro-stabilizer.

(2) Remove the top cover.

(3) Disconnect the three external wires to the control box (see wiring diagram, fig. 112).

(4) Remove the screws holding the control box.

(5) To rewire the new type control box provided with a gyro-circuit push-pull switch, connect the black lead entering the control box (fig. 112) to the vacant terminal in the switch. Connect a jumper from the other terminal of the push-pull switch to the terminal on the recoil adjuster, shown in figure 112, which takes the black lead. Connect the white lead and red lead as shown.

(6) Remount the box and replace the cover.

f. Gyro-control mounting bracket assembly (fig. 104).—Remove the gyro-control mounting bracket assembly in the following manner:

(1) Remove the gyro-control unit as described in paragraph *a* above.

(2) Loosen the two piston rod pivot pin set screws (fig. 102).

(3) Slide the piston rod pivot pin out through the piston rod end.

(4) Loosen the flexible shaft clamp screw on the flexible shaft bracket (fig. 106) and remove the shaft.

(5) Remove the four bolts holding the mounting bracket assembly to the gun mount.

(6) Lift the mounting bracket up and toward the breech of the gun to remove.

(7) To replace the mounting bracket, lift the mounting bracket assembly up and over the breech of the gun.

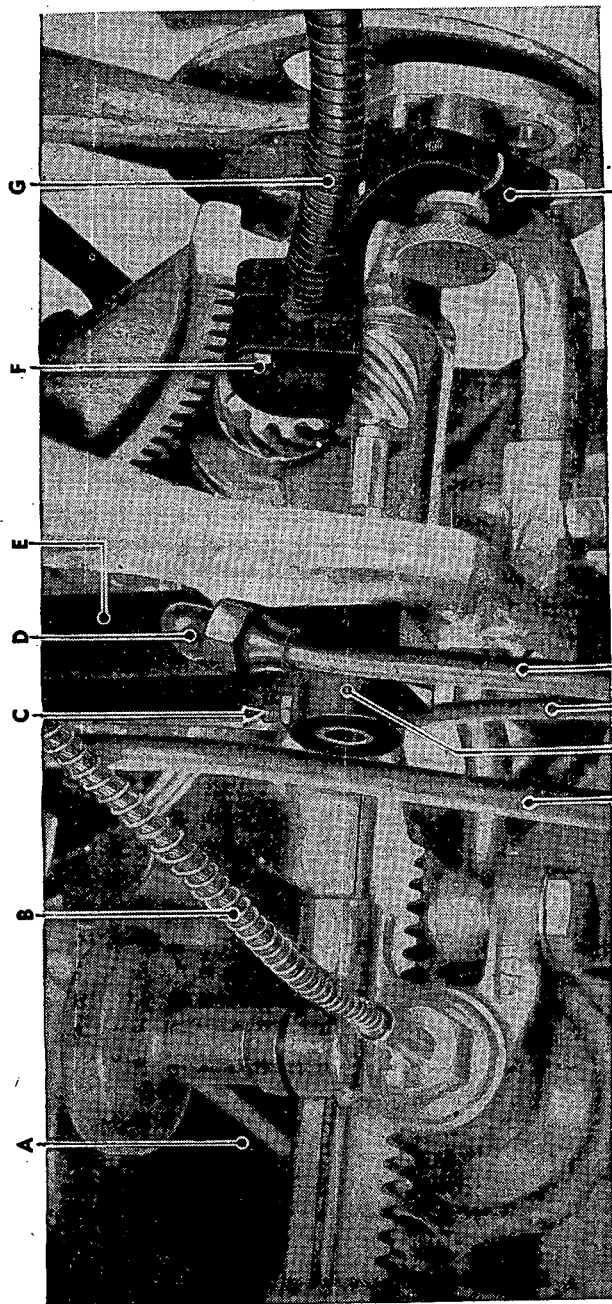

H RA PD 7168

A— FIRING PIN CABLE
 B— TO UPPER CYLINDER CONNECTION
 C— SET SCREW AND LOCK NUT
 D— ELBOW

E— CYLINDER
 F— CLAMP SCREW
 G— FLEXIBLE SHAFT
 H— FLEXIBLE SHAFT BRACKET

J
 K
 L
 M

J— TO LOWER PUMP CONNECTION "B"
 K— OIL RETURN LINE
 L— COLLAR
 M— TO UPPER PUMP CONNECTION

Figure 106.—View showing lower end of cylinder and flexible shaft bracket, gyro-stabilizer unit.

(8) Lower the mounting bracket assembly on the gun mount and place in position as shown in figure 102.

(9) Install and tighten the four mounting bolts to hold the mounting bracket securely to the gun mount.

(10) Slide the piston rod pivot pin, through the piston rod end bearing, into place in the mounting bracket assembly (fig. 102).

(11) Tighten the two pivot rod pivot pin set screws.

(12) Reinstall the gyro-control unit as described in *a* above.

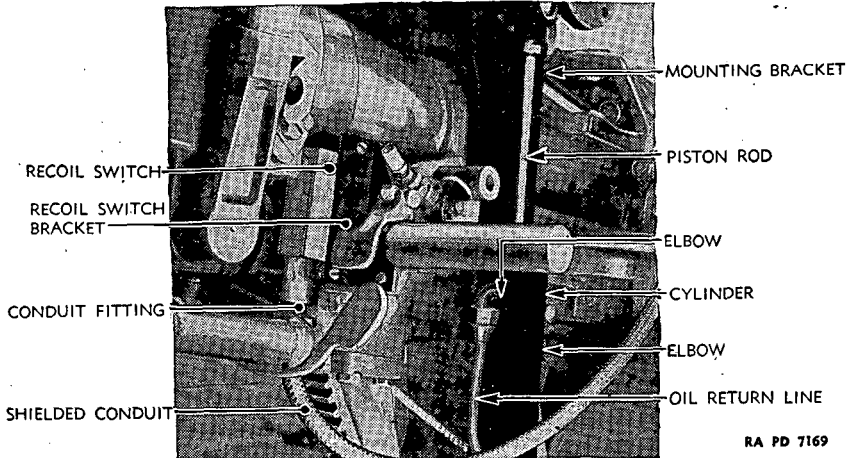

FIGURE 107.—Recoil switch, cylinder, and mounting bracket mountings, gyro-stabilizer unit.

g. Gyro-control mounting shaft (fig. 109).—(1) Place all control switches in the “off” position.

(2) Disconnect the multiprong connector from the gyro-control unit.

(3) Remove the four gyro-control mounting bolts.

(4) Remove the worn gear housing cover plate.

(5) Remove the worn wheel lock nut and lock washer.

(6) Remove the worn wheel from the gear housing and shaft end.

(7) Remove the metal washer, clutch spacer, and 2 clutch springs.

(8) Pull the gyro-control mounting shaft from the mounting bracket assembly.

(9) If necessary, drive the two oil seals from the mounting bracket assembly.

(10) The assembly of a new gyro-control mounting shaft is exactly the reverse of the above, beginning with the installation of new oil seals, if they are required.

NOTE.—After the shaft has been reinstalled, the backlash between the worm and worm wheel must be adjusted as outlined in paragraph 147f.

h. Flexible shaft mounting bracket.—(1) Loosen the flexible shaft clamp on the flexible shaft bracket (figs. 106 and 110).

(2) Remove the flexible shaft.

(3) Remove the two shaft bracket cap screws (fig. 106).

(4) Remove the shaft bracket.

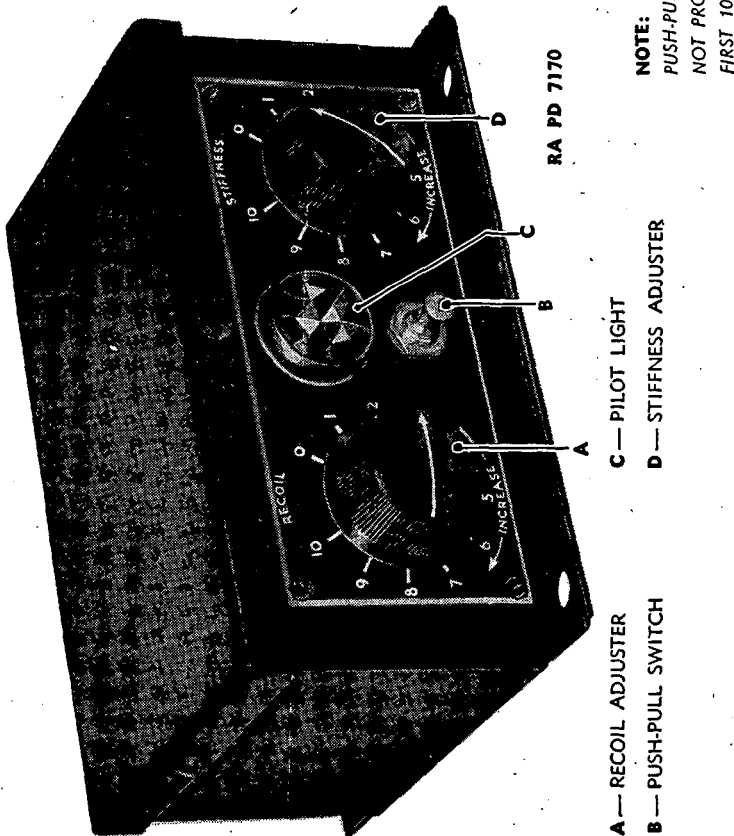

(5) The replacement of the flexible shaft bracket is the reverse of the preceding steps.

i. Replacement of flexible shaft.—(1) Remove the mounting bracket cover plate (fig. 104).

(2) Loosen the flexible shaft clamp on the worm bearing and remove the flexible shaft.

(3) Loosen the flexible shaft clamp on the flexible shaft mounting bracket (fig. 106).

(4) Remove the flexible shaft.

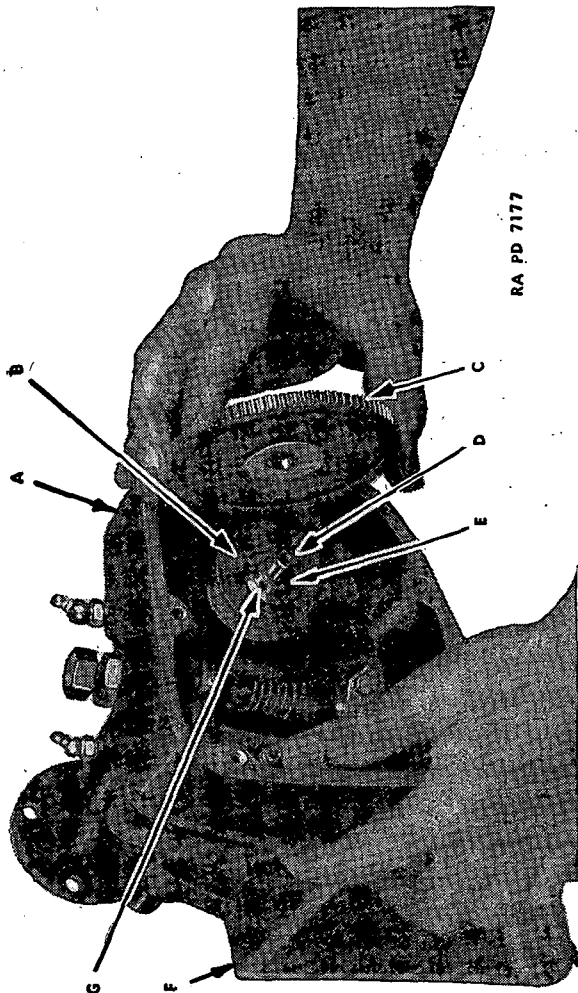

RA PD 7177

E. Washer.
F. Mounting bracket.
G. Clutch spacer.

A. Gear housing.
B. Clutch springs.
C. Worm wheel.
D. Gyro-control mounting shaft end.

FIGURE 109.—Placing worm wheel in position inside gear housing, gyro-stabilizer unit.

(5) The replacement of the flexible shaft is the reverse of the preceding steps.

NOTE.—Be sure the couplings of each end of the flexible shaft are in mesh before tightening the flexible shaft clamps.

j. Repair and replacing of defective oil lines.—(1) Disconnect the defective oil line and catch any oil drainage from the affected part of the system in a container.

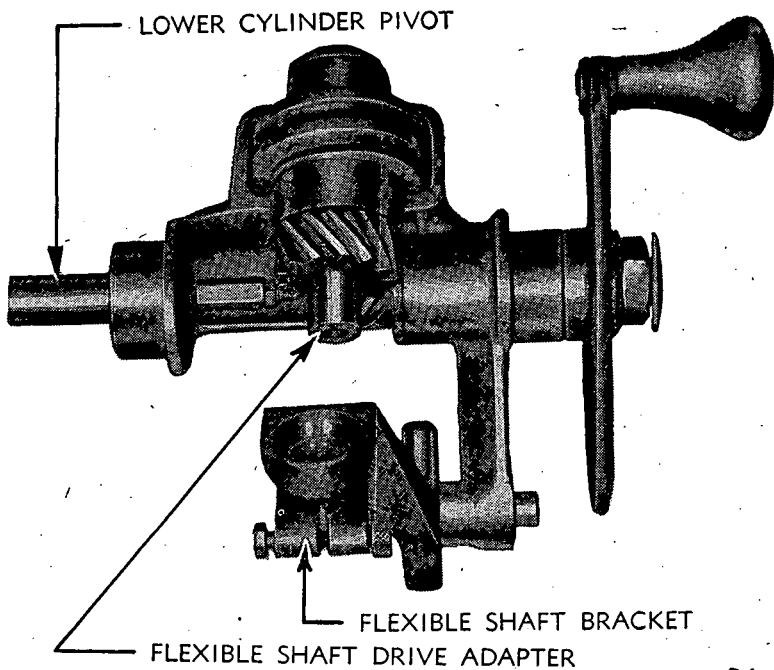

RA PD 7167

FIGURE 110.—Elevating gear and flexible shaft mounting adapter, gyro-stabilizer unit.

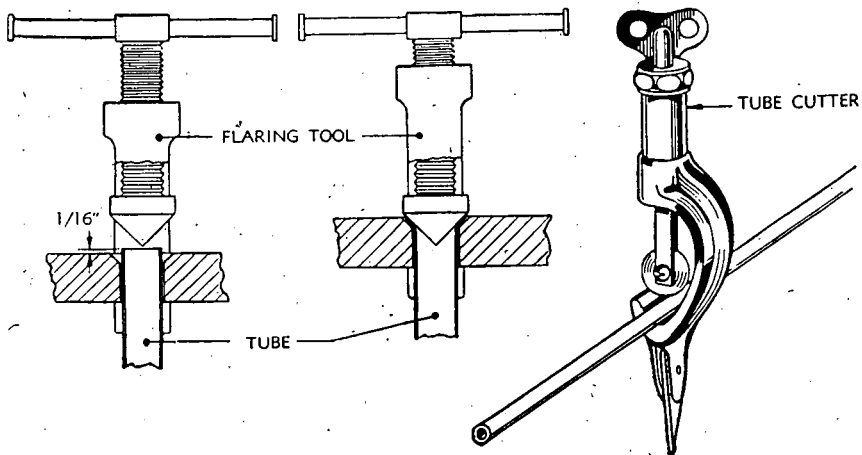

RA PD 7166

FIGURE 111.—Use of tube cutter and flaring tool.

(2) Reflare the tubing using a standard flaring tool (fig. 111). The tubing should be cut as close as possible to the flare with a tubing cutter and *not* with a hacksaw.

NOTE.—Place flarenut on the tubing before the flare is made.

(3) Reconnect the flarenut to its proper connection.

(4) Replace completely any damaged oil lines.

(5) If connecting elbows cannot be tightened sufficiently to stop leakage, remove and tin threads with soft solder.

(6) Recharge the system with oil as outlined under paragraph 150.

k. Replacing shielded cable and wires.—(1) If the shielded cable connecting any part of the gyro-stabilizer becomes frayed or broken it should be replaced. Refer to wiring diagram (fig. 112).

(2) Disconnect all wires running in the defective shielded cable.

(3) Disconnect and remove the defective shielded cable and wiring.

(4) Measure a new piece of shielded cable to the proper length.

(5) Tin the new shielded cable at least $\frac{1}{2}$ inch on each side of where the cut is to be made.

NOTE.—Use a noncorrosive flux.

(6) Hold the cable securely and cut as measured, using a fine-toothed hacksaw.

(7) Tin the inside of a cable adapter fitting.

(8) Insert the cable in the fitting and sweat solder it in place.

NOTE.—The torch flame must be on the fitting only, and never directly on the cable itself.

(9) Measure and cut to length new wire of the correct size and color.

(10) Run the wires through the shielded cable.

(11) Reconnect all wiring by colors to the same connections from which the damaged ones were removed. Refer to wiring diagram (fig. 112).

l. Replacing the grease fittings.—(1) The grease fittings are of the alemite type and are located as follows (fig. 113):

(a) Two on mounting bracket, greasing the gyro-control mounting shaft.

(b) One on lower side of the piston, greasing the cylinder pivot pin.

(c) One on piston rod end, greasing the piston rod end pivot pin.

(2) These fittings may be replaced by unscrewing and replacing with new ones.

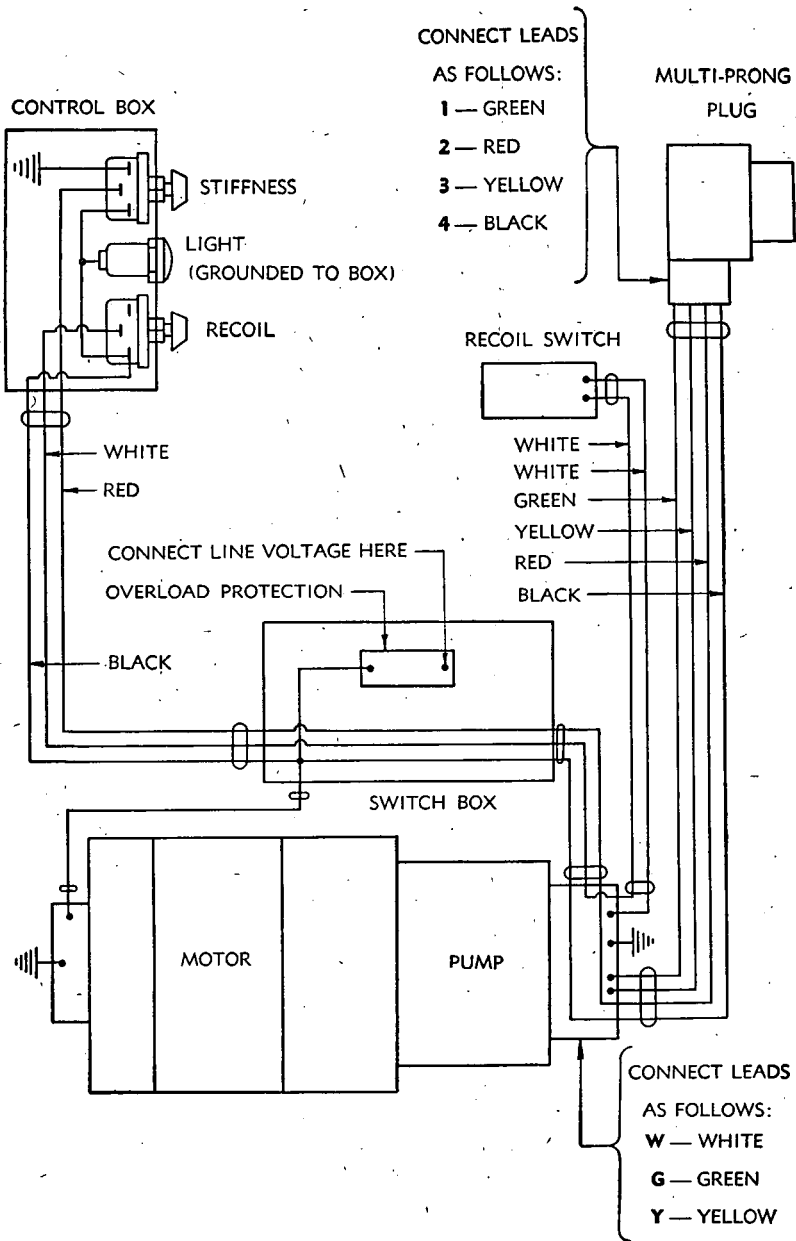

RA PD 7164

FIGURE 112.—Wiring diagram, gyro-stabilizer unit.

150. Charging with oil and removing air from system.—When charging the system with oil it is very important that all air that may be trapped in the system be removed for proper operation of the gyro-stabilizer. Therefore, the following procedure must be adhered to:

- a. Throw the master switch to the "off" position.
- b. Disconnect the flarenut on the oil return line at the piston (fig. 113). Loosen but do not remove the flarenuts at the upper and

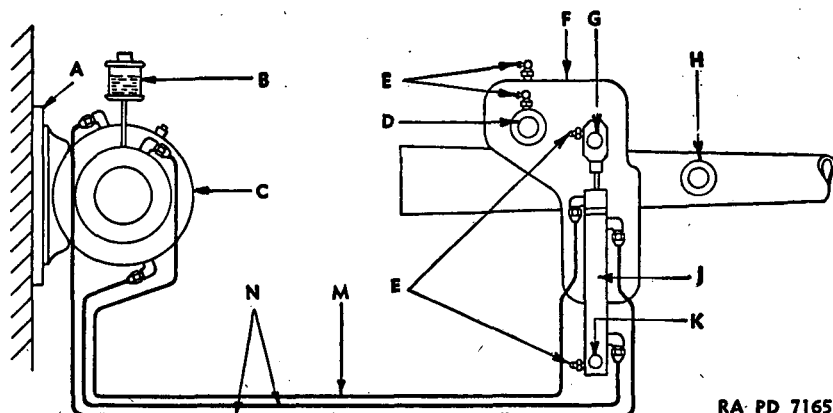

RA PD 7165

- | | |
|--|---|
| A. Mounting plate. | G. Upper cylinder pivot. |
| B. Oil reservoir. | H. Gun trunnion bearings. |
| C. Motor and pump assembly (pump end). | J. Piston and cylinder assembly. |
| D. Gyro shaft. | K. Lower cylinder pivot (fixed). |
| E. Grease fittings. | M. Oil return line, $\frac{1}{4}$ inch. |
| F. Mounting bracket. | N. Main oil lines, $\frac{3}{8}$ inch. |

FIGURE 113.—Oil lines and grease fittings, gyro-stabilizer unit.

lower connections of the cylinder. This will permit venting the air from the oil lines and from the cylinder (fig. 113).

- c. Remove the cap from the oil level cup.
- d. Fill the pump and lines with oil through the oil reservoir until an oil drippage is noticed at the upper and lower connections of the cylinder, and the oil flows freely from the oil return line.

NOTE.—The oil should be at approximately 70° F. temperature. If necessary, heat the oil before charging the system.

- e. Reconnect the oil return line and tighten the flarenut permanently.
- f. Take up the upper cylinder flarenut sufficiently to prevent leakage, but do not tighten permanently.
- g. With the hand elevating gear out of mesh, slowly push the breech of the gun all the way down to the end of the piston stroke. This action pushes the air out of the lower side of the cylinder.

h. With the breech being held in the lowest position, tighten the lower flarenut snugly and then loosen the upper cylinder flarenut ($\frac{3}{8}$ -inch).

i. Slowly move the breech to the uppermost position, raising the piston to the top of the stroke, and tighten the upper cylinder flarenut ($\frac{3}{8}$ -inch) snugly. This action pushes the air out of the upper side of the cylinder.

j. Loosen the bottom flarenut and repeat steps *g*, *h*, and *i* above. Tighten both flarenuts permanently.

k. Disconnect the multiprong connector from the gyro-control unit.

l. Throw the master switch to the "on" position.

m. Operate oil pump for 15 to 30 minutes.

Caution: Keep the oil reservoir two-thirds full throughout this operating period.

n. Throw the master switch to the "off" position.

o. Slowly pump the breech of the gun up and down until no more bubbles appear in the oil reservoir.

p. Replace the oil reservoir cap.

q. Reconnect the multiprong connector to the gyro-control unit.

r. Start the gyro-stabilizer equipment and check operation.

NOTE.—At the 25-hour check, the oil system must be checked for presence of air by repeating step *o* above. Repeat the same step at any time to check for air in the system as a cause of erratic operation.

APPENDIX
LIST OF REFERENCES

1. Standard Nomenclature Lists.

Gun, machine, cal. .30, Browning M1919A4, fixed and flexible.....	SNL A-6,
Gun, 37-mm, M5 and M6, and cradle, tank, 37-mm, T2.....	SNL A-45
Cleaning, preserving, and lubricating materials.....	SNK K-1
Tank, light, M3.....	SNL G-103

Current Standard Nomenclature Lists are as tabulated here. An up-to-date list of SNL's is maintained as the "Ordnance Publications for Supply Index".....

(OPSI)

2. Technical Manuals.

37-mm gun M6 (mounted in tanks).....	TM 9-1250
Cleaning, preserving, lubricating, and welding materials.....	TM 9-850
Automotive electricity.....	TM 10-580

3. Field Manuals.

37-mm gun M6 (mounted in tanks).....	FM 23-81
Defense against chemical attack.....	FM 21-40
Motor transport.....	FM 25-10
Tank units.....	FM 7-10

4. Miscellaneous publications.

Light tank M3.....	OFSB 6-G-103
Light tank M3.....	Lubrication Chart



INDEX

	Paragraph	Page
Accelerator.....	5	12
Pedals, replacement.....	90	133
Accessory case:		
Continental engine.....	45	76
Guiberson Diesel engine.....	64	106
Air cleaner:		
Continental engine.....	54	88
Guiberson Diesel engine.....	70	113
Service instructions.....	17	24
Ammeter.....	121	202
Ammunition.....	4, 35	9, 46
Armament.....	3, 33-35	6, 41
Armor plate.....	3	6
Assignment record.....	25	37
Axles, suspension.....	108	163
Battery.....	117	195
Battery switch.....	122	203
Blackout headlamp.....	125	212
Bleeding fuel system (Diesel engine).....	17, 76	24, 122
Bogies.....	110	167
Service instructions for bogie wheels.....	17	24
Booster coil, Continental engine.....	49	83
Bow gunner's lamp.....	127	213
Brakes, general information.....	5	12
Bypass filter, Diesel engine.....	66	108
Carburetor, Continental engine:		
Description.....	52	84
Inspection.....	24	33
Make and model.....	43	70
Trouble shooting.....	44	73
Care and preservation.....	25, 26	37, 38
Cartridge starter, Diesel engine.....	71	113
Cautions in operation.....	14	23
Charts:		
Lubrication:		
Suspension.....	18	26
Power drive units.....	18	26
Cleaning.....	26	38
Matériel affected by gas.....	37	53

INDEX

	Paragraph	Page
Clutch:		
Adjustment of linkage.....	98	141
Disassembly and assembly.....	93, 94	136
General information.....	5	12
Inspection.....	87	132
Maintenance by using arm.....	40	56
Operation.....	86	132
Pedals.....	90	133
Release bearings.....	92	136
Cold weather precautions.....	15	24
Compass.....	141	220
Compass lamp.....	129	215
Conduit and cables.....	133	215
Control box of gyro-stabilizer, replacement.....	147	223
Controls.....	5	12
Cooling system:		
Description.....	83	130
Inspection and maintenance.....	84	131
Maintenance by using arm.....	40	56
Crew.....	20	30
Dash lamps.....	127	213
Data, tabulated.....	4	9
Decontamination of matériel affected by gas.....	38	53
Description, light tank M3.....	3	6
Description and data:		
Continental engine.....	43	70
Guiberson Diesel engine.....	61-63	104
Differential. (See also Transmission; Differential.)		
Description.....	99	141
Lubrication.....	98	141
Steering brakes.....	99	141
Doors, hull.....	115	184
Electrical system and equipment.....	117-136	195
Electrical equipment of engine.....	131	215
Trouble shooting.....	135	217
Wiring.....	136	218
Electrical system, maintenance by using arm.....	40	56
Engine, Continental W670, series 9A.....	43-60	70
Data.....	4, 43	9, 70
Fuel supply system.....	77	124
Grades of fuel.....	82	130
Maintenance by using arm.....	40	56
Replacement.....	60	95
Starting.....	7	17
Stopping.....	12	22
Test.....	8	17
Engine, Guiberson T-1020, and accessories.....	61-76	104
Data.....	4, 63	9, 106
Fuel supply system.....	77	124
Grades of fuel.....	82	130

INDEX

Engine, Guiberson T-1020, and accessories—Continued		Paragraph	Page
Maintenance by using arm.....	40	56	
Replacement.....	75	122	
Starting.....	9	17	
Stopping.....	13	23	
Test.....	10	18	
Engine hour meter.....	121	202	
Engine oil cooler.....	101	160	
Engine oil tank, servicing.....	17	24	
Engine oil temperature gage.....	140	220	
Equipment and special tools.....	41, 42	60, 69	
Field manuals.....	3	6	
Filters:			
Fuel.....	17, 81	24, 128	
Generator.....	119	198	
Oil.....	47, 66	78, 108	
Final drives:			
Description.....	103	162	
Lubrication.....	105	162	
Operation.....	104	162	
Replacement.....	106	162	
Fire extinguishers:			
Handling.....	145	222	
Installation.....	142	221	
Maintenance.....	144	222	
Operation.....	143	222	
Flexible shaft and mounting bracket of gyro-stabilizer unit, replacement.....	149	228	
Free travel in clutch pedal, adjustment.....	89	133	
Fuel and oil, tabulated data.....	4	9	
Fuel capacity.....	4	9	
Fuel filter.....	81	128	
Service instructions.....	17	24	
Fuel injector, Guiberson Diesel engine.....	68	110	
Fuel knock in, Diesel engine.....	76	122	
Fuel lines, Continental and Diesel engines.....	39	55	
Fuel pressure pump, Guiberson Diesel engine.....	67	110	
Fuel pump, Continental engine:			
Replacement.....	55	88	
Trouble shooting.....	44	73	
Fuel supply pump, Guiberson Diesel engine.....	69	110	
Fuel supply system:			
Trouble shooting, Continental engine.....	44	73	
Fuel tank or fuel filter, Diesel engine, trouble shooting.....	76	122	
Fuel tanks.....	78	125	
Fuel transfer pump, Guiberson Diesel engine, trouble shooting.....	76	122	
Fuel valves.....	79	128	
Full-flow disk type oil filter, Diesel engine.....	66	108	
Fuse box.....	120	198	
Fuse panel.....	120	198	

Gages:	Paragraph	Page
Engine oil pressure.....	11, 139	18, 220
Engine oil temperature.....	11, 140	18, 220
Transmission oil pressure.....	139	220
Gas, matériel affected by:		
Cleaning.....	37	53
Decontamination.....	38	53
Protective measures.....	36	53
Special precautions.....	39	55
Gear lubricant.....	17	24
Gear shift lever, replacement.....	98	141
Gear shifting.....	5	12
Generator:		
Continental engine.....	57	90
Guiberson Diesel engine.....	72	117
Inspection.....	24	33
Replacement.....	57	90
Generator filter.....	119	198
Governor, Continental engine.....	53	88
Grades of fuel.....	82	130
Grease fittings, gyro-stabilizer unit, replacement.....	149	228
Grousers.....	114	183
Gun, machine, 37-mm.....	3	6
Gun, submachine, cal. .45, Thompson.....	3	6
Guns, machine, cal. .30.....	3	6
Gyro-control mounting bracket, assembly and shaft replacement.....	149	228
Gyro-control unit of gyro-stabilizer, replacement.....	149	228
Gyro-stabilizer unit:		
Care and preservation.....	33	41
Charging with oil and removing air from system.....	150	239
Components.....	33	41
Description.....	146	222
Lubrication.....	33	41
Maintenance.....	40, 147	56, 223
Operation.....	33	41
Recoil adjuster operation.....	33	41
Replacement of assemblies.....	149	228
Starting.....	33	41
Stiffness adjuster, operation.....	33	41
Trouble shooting.....	148	226
Hand cranking ratchet for Guiberson Diesel engine.....	20	30
Hand throttle.....	5	12
Handling of extinguisher cylinders.....	145	222
Headlamps:		
Description.....	124	212
Replacement.....	125	212
Service headlamp focusing.....	125	212
Hull.....	115	184
Maintenance by using arm.....	40	56
Hydrometer correction chart.....	117	195

INDEX

	Paragraph	Page
Idlers, service instructions.....	17	24
Idling the engine, cautions.....	14	23
Ignition shielding harness, Continental engine.....	51	84
Ignition system, trouble shooting.....	44	73
Induction system, Continental engine, trouble shooting.....	44	73
Inspections:		
After operation.....	23	32
At halt.....	22	32
Carburetor, Continental engine.....	24	33
Clutch.....	87	132
Cooling system.....	84	131
During operation.....	21	31
Generator.....	24	33
Hull.....	115	184
Periodic.....	24	33
Prestarting.....	20	30
Suspensions.....	24	33
Tracks.....	24	33
Instrument panel lamps.....	127	213
Instrument panels.....	134	217
Lash in clutch pedal, adjustment.....	89	133
Lighting switch.....	122	203
Linkage, adjustment of clutch.....	89	133
Log book.....	25	37
Lubrication:		
Bogies.....	110	167
Charts and notes.....	18	26
Continental engine:		
General.....	47	78
Oil dilution valve.....	47	78
Oil filters.....	47	78
Detailed instructions.....	17	24
Final drives.....	105	162
Guiberson Diesel engine:		
Oil circulation.....	66	108
Oil filters.....	66	108
Gyro-stabilizer unit.....	33	41
Magnetos.....	48	80
Propeller shaft.....	96	139
Starter, Continental engine.....	56	88
Trailing idler.....	112	176
Transmission.....	98	141
Magneto switch.....	122	203
Magnetos, Continental engine.....	48	80
Breaker point adjustment.....	48	80
Breaker point, trouble shooting.....	44	73
Ignition timing.....	48	80
Lubrication.....	48	80

	Paragraph	Page
Maintenance:		
Air cleaner.....	54	88
Battery.....	117	195
Cartridge starter, Diesel engine.....	71	113
Compass.....	141	220
Conduit and cables.....	133	215
Engine oil cooler.....	101	160
Fire extinguishers.....	144	222
Fuel lines.....	39	55
Fuel tanks.....	78	125
Fuel valves.....	79	128
General.....	40	56
Gyro-stabilizer unit.....	147	223
Priming pump.....	80	128
Replacements and repairs by using arm.....	40	56
Sprockets, track drive.....	109	167
Starter, Continental engine.....	56	88
Terms.....	40	56
Tracks.....	113	176
Trailing idler.....	112	176
Transmission oil cooler.....	101	160
Turret support rollers.....	116	187
Valve mechanism, Continental engine.....	58	91
Valve mechanism, Guiberson Diesel engine.....	73	117
Manifolds:		
Continental engine.....	59	95
Guiberson Diesel engine.....	74	120
Mount, antiaircraft gun M20.....	33	41
Mount, bow gun.....	33	41
Mount, combination gun M22.....	33	41
Mount, sponson.....	33	41
Oil coolers.....	101, 102	160, 161
Oil dilution time.....	12	22
Oil dilution valve, Continental engine.....	12, 47	22, 78
Oil filters:		
Continental engine.....	47	78
Guiberson Diesel engine.....	66	108
Oil lines of gyro-stabilizer, replacement.....	149	228
Oil pressure gage, indication of engine performance.....	11	20
Oil pressure pump filter, Continental engine.....	47	78
Oil pump and motor of gyro-stabilizer, replacement.....	149	228
Oil pumps:		
Continental engine.....	46	76
Guiberson Diesel engine.....	45	76
Oil storage tank capacity.....	4	9
Oil temperature gage, indication of engine performance.....	11	20

INDEX

	Paragraph	Page
Oiling system:		
Maintenance by using arm.....	40	56
Transmission and differential.....	98	141
100-hour or 1,000-mile check:		
Operating instructions and controls.....	5-15	12
Operating personnel, information for guidance of.....	2	6
Operating vehicle.....	11	20
Ordnance Motor Book.....	25	37
Overpriming.....	44	73
Paint as a camouflage.....	30	40
Painting.....	27-32	38
Painting lubricating devices.....	32	41
Painting metal surfaces.....	29	39
Pedals, accelerator and clutch.....	19	29
Peepholes, turret.....	116	187
Performance of engine.....	3	6
Periodic inspection.....	24	33
Pistol port covers, turret.....	116	187
Piston and cylinder assembly of gyro-stabilizer, replacement.....	149	228
Power train group.....	85	132
Preparing for painting.....	28	39
Pressure gages.....	139	220
Pressure switch.....	122	203
Prestarting inspection.....	20	30
Priming pump, Continental engine.....	80	128
Propeller shaft:		
Description.....	95	139
Lubrication.....	96	139
Replacement.....	97	139
Protected vision.....	3	6
Protectoscopes:		
Hull.....	115	184
Turret.....	116	187
Radio for light tank M3.....	4	9
Rebuild, definition.....	40	56
Recoil switch, gyro-stabilizer.....	147, 149	223, 228
Records of operation and maintenance.....	25	37
References:		
Field manuals.....	3	6
Miscellaneous publications.....	4	9
Standard nomenclature lists.....	1	6
Technical manuals.....	2	6
Release bearings, clutch.....	92	136
Removing paint.....	31	40
Repair, definition.....	40	56
Replace, definition.....	40	56

INDEX

	Paragraph	Page
Scavenger pump, Continental engine.....	46	76
Seats.....	4, 115	9, 184
Service, definition.....	40	56
Service headlamp.....	125	212
Servicing.....	17	24
Shielded cable of gyro-stabilizer, replacement.....	149	228
Short circuits.....	135	217
Sight, telescope.....	34	73
Siren.....	130	215
Siren switch.....	122	203
Sockets.....	132	215
Solenoids.....	124	212
Spark control.....	5	12
Spark plugs, Continental engine.....	50	83
Trouble shooting.....	44	73
Specifications:		
Continental engine. (See Description; Continental engine.)		
Guiberson Diesel engine. (See Description; Diesel engine.)		
Light tank M3. (See Data, tabulated.)		
Speedometer.....	138	219
Drive shaft assembly.....	138	219
Lamp.....	127	213
Sponson gun relays.....	123	210
Sprockets, track drive.....	109	167
Standard nomenclature lists.....	1	6
Starter, Continental engine.....	56	88
Starter, Diesel engine. (See Cartridge starter.)		
Starter solenoid switch.....	122	203
Steering brakes:		
Adjustment.....	99	141
Replacement of brake bands.....	99	141
Replacement of hand levers.....	99	141
Steering lever gun firing switch.....	122	203
Steering levers.....	5	12
Steering mechanism, inspection.....	21	31
Stop signal switch.....	122	203
Stopping:		
Continental engine.....	12	22
Guiberson Diesel engine.....	13	23
Stowage. (See Ammunition.)		
Suspensions. (See Tracks; Bogies.)		
Switches.....	122	203
Tachometer.....	137	218
Drive shaft assembly.....	137	218
Indication of engine performance.....	11	20

INDEX

	Paragraph	Page
Taillamps	126	212
Technical manuals	2	6
Tests:		
Continental engine	8	17
Guiberson Diesel engine	10	18
Toggle switches	122	203
Tools, special. (<i>See</i> Equipment.)		
Towing	11	20
Track support rollers:		
Replacement	111	173
Service instructions	17	24
Tracking. (<i>See</i> Towing.)		
Tracks	113	176
Data, tabulated	4	9
Tracks and suspensions:		
Description and operation	107	162
Maintenance of suspension by using arm	40	56
Trailing idler	112	176
Transmission	98	141
Lubrication	98	141
Maintenance by using arm	40	56
Replacement	100	146
Replacement of gear shift lever	98	141
Transmission and differential	98-100	141
Transmission and final drives, lubrication	17	24
Transmission oil cooler	101, 102	160, 161
Trouble lamp	128	214
Trouble shooting:		
Cartridge starter, Diesel engine	71	113
Continental engine	44	73
Electrical system	135	217
Guiberson Diesel engine	76	122
Gyro-stabilizer unit	148	226
Turret support rollers	116	187
Turret	116	187
Armor plate	3	6
Maintenance	40, 116	56, 187
Traversing gear housing, service instructions	17	24
25-hour or 250-mile check	24	33
Two position push-pull switches	122	203
Using arm personnel, maintenance duties	40	56
Valve mechanism:		
Continental engine	58	91
Trouble shooting	44	73
Guiberson Diesel engine	73	117

INDEX

	Paragraph	Page
Voltage control box-----	119	198
Voltmeter-----	121	202
Windshield-----	3	6
Wiring of electrical circuits-----	136	218

[A. G. 062.11 (3-27-42).]

BY ORDER OF THE SECRETARY OF WAR:

G. C. MARSHALL,

Chief of Staff.

OFFICIAL:

J. A. ULIO,

Major General,

The Adjutant General.

DISTRIBUTION:

D 2, 7, 17 (4); IR 17 (6); IBn 9 (2), 17 (4); IC 9 (4), 17 (5).

(For explanation of symbols see FM 21-6.)