

CONFIDENTIAL

For Official and Confidential use
within the Ordnance Department
U. S. Army

No. 1861

HANDBOOK
OF
ORDNANCE DATA

NOVEMBER 15, 1918



WASHINGTON
GOVERNMENT PRINTING OFFICE
1919

**WAR DEPARTMENT,
OFFICE OF THE CHIEF OF ORDNANCE,
Washington, December 1, 1918.**

This handbook of Ordnance Data compiled in the Information Section of the Administration Division, Office of the Chief of Ordnance, by Capt. Herbert T. Wade, Ordnance Department, United States Army, is published for the information of the officers of the Ordnance Department.

**C. C. WILLIAMS,
Major General, Chief of Ordnance, U. S. A.**

100
100
100

UF563
A18
1919

CONTENTS.

	Page.
I. Artillery, general.....	15
II. Field artillery.....	35
III. Railway and seacoast artillery.....	83
IV. Antiaircraft guns and carriages.....	108
V. European artillery.....	117
VI. Artillery ammunition.....	139
VII. Ammunition loading and supply.....	190
VIII. Explosives.....	199
IX. Nitrate plants.....	209
X. Trench-warfare material.....	217
XI. Aircraft armament.....	248
XII. Pyrotechnics and chemical apparatus.....	287
XIII. Machine guns.....	296
XIV. Small arms—rifles, pistols, and revolvers.....	319
XV. Small-arms ammunition.....	343
XVI. Motors, tractors, and tanks.....	357
XVII. Equipment, personal.....	411
XVIII. Proving grounds and arsenals.....	419
XIX. Gauges.....	453
XX. American ordnance base depot in France.....	472
XXI. Index.....	482

LIST OF PLATES.

I.

	Page.
1. Frontispiece, 8-inch howitzer at Midvale Steel and Ordnance Co. shop.....	14
2. 75-mm. gun carriage, model of 1916, right side, gun at 0° elevation, extreme right traverse.....	16
3. 12-inch mortar in coast-defense emplacement.....	20
4. Sample of ordnance machine work—spring counterrecoil cylinder for United States 75-mm. gun carriage, billet before machining.....	22
5. Shrinking of tube for 14-inch wire-wound gun—cooling equipment.....	23
6. 75-mm. gun (French), model of 1897.....	28
7. 4.7-inch field gun, model of 1906.....	31

II.

8. 37-mm. gun on portable mount.....	34
9. 75-mm. gun carriage, model 1916, gun at 53° elevation, maximum traverse to the left.....	38
10. 3-inch gun caisson, model of 1916, rear view, apron up.....	40
11. 3-inch gun caisson, model of 1916, left front view, door open, apron down, fuze-setter bracket down.....	40
12. 75-mm. field gun, model of 1897 (French).....	41
13. 75-mm. field gun, model of 1897 (French), breechblock open to receive cartridge.....	42
14. 75-mm. field gun, model of 1897 (French), breechblock closed.....	43
15. 75-mm. field gun, model of 1917 (British).....	45
16. 4.7-inch field gun, model of 1906, showing panoramic sight, recuperator, and breech.....	48
17. 155-mm. gun, model of 1918 (Filloux).....	50
18. 155-mm. gun, model of 1918 (Filloux), section.....	52
19. 6-inch Bethlehem howitzer, model of 1917, pilot gun and carriage.....	54
20. 155-mm. howitzer, model of 1918 (Schneider), section.....	55
21. 155-mm. howitzer, model of 1915 (Schneider).....	57
22. 8-inch British howitzer.....	60
23. 9.2-inch howitzer carriage, model of 1917, Vickers, Mark I.....	62
24. 240-mm. howitzer, model 1918 (Schneider), section.....	66
25. 240-mm. howitzer, model 1918 (Schneider).....	67
26. Panoramic sight for United States mobile Field Artillery.....	70

III.

27. 5-inch and 6-inch seacoast guns on pedestal or barbette mounts.....	82
28. 8-inch and 10-inch seacoast guns on barbette carriages.....	84
29. 5-inch and 6-inch seacoast guns on improvised wheel mounts.....	86
30. 7-inch Navy gun on railway mount.....	90
31. 8-inch gun on railway mount, side view.....	92
32. 8-inch railway mount, showing struts and floats.....	93
33. Ammunition train, United States railway artillery.....	94

	Page.
34. Schneider railway mounts for 10-inch guns.....	96
35. Batignolle railway mount for 12-inch gun.....	98
36. 12-inch United States mortar on 16-inch railway mount.....	100
37. 12-inch gun and 14-inch mortar, unmounted.....	102
38. 16-inch howitzer on railway mount.....	104
39. 14-inch United States Navy guns and mount; locomotives for moving arma- ment trains.....	107

IV.

40. United States 75-mm. antiaircraft gun on truck mount.....	109
41. United States 3-inch antiaircraft gun on trailer mount.....	109
42. United States 3-inch antiaircraft gun on front-drive truck.....	110
43. French 75-mm. antiaircraft gun on auto trailer carriage.....	111
44. French 75-mm. antiaircraft gun on auto truck mount.....	112

VI.

45. Assembled round of fixed ammunition, showing cartridge case, projectile, and fuze.....	139
46. United States Artillery ammunition—exterior views of shrapnel and shell; shrapnel assembled with time fuzes.....	142
47. Sections of shrapnel and base fuzed shell.....	143
48. Section of assembled shrapnel.....	144
49. High-explosive shell—Cross sections.....	145
(a) Semisteel shell.	
(b) Steel shell.	
(c) Steel shell, filled and fuzed with Mark III fuze.	
50. Section of high-explosive base fuze shell, American type.....	146
51. High-explosive nose fuze shell, English type, section.....	147
52. High-explosive nose fuze shell, French type, section.....	148
53. Common steel gas shell, section.....	149
54. Markings of ammunition, diagram.....	150
55. Point detonating fuze, Mark I, section.....	156
56. Point detonating fuze, Mark II, section.....	157
57. Point detonating fuze, Mark III, assembly and section.....	158
58. Point detonating fuze, Mark III, section.....	159
59. Point detonating delay fuze, Mark IV.....	160
60. Point detonating delay fuze, Mark IV.....	161
61. Point detonating fuze, Mark V, section.....	162
62. Point detonating fuze, Mark V, assembly and section.....	163
63. Base percussion fuze, minor caliber, Baldwin type, diagram.....	163
64. Base percussion fuze, minor caliber, Mark II, section.....	164
65. Base detonating fuze, section.....	165
66. Base detonating fuze, Mark III (Simple type).....	166
67. Combination time and percussion fuze, 21 seconds—before arming.....	167
68. Combination time and percussion fuze, 21 seconds—after arming.....	167
69. Antiaircraft time fuze (Type "S"), Mark II.....	168
70. Mechanical time fuze parts, Mark I.....	169
71. Adapter and booster casing, Mark II, section.....	172
72. Adapter and booster casing, Mark III, section.....	172
73. Adapter and booster casing, Mark IV, section.....	173
74. 110-grain percussion primer.....	176

	Page.
75. 21-grain percussion primer.....	176
76. 20-grain primer with 37 mm. ammunition.....	177
77. 49-grain primer, Mark I.....	178
78. Friction primer, T. model, Mark IV.....	179
79. Friction primer, Mark I, section.....	181
80. Bracket fuze setter for 21-second combination fuze.....	183
81. Hand fuze setter for 31 and 45 second combination fuzes.....	184
82. Packing box for artillery ammunition, showing marking.....	186

VIII.

83. Filling high-explosive shells with TNT at Rock Island Arsenal.....	200
--	-----

X.

84. Types of grenades used in United States service—defensive, offensive, gas, and phosphorus.....	218
85. Defensive hand grenade, handle released.....	219
86. Defensive hand grenade, Mark II, section.....	220
87. Offensive hand grenade, Mark III, section.....	222
88. Phosphorus hand grenade, Mark II, section.....	223
89. Gas hand grenade, Mark II, section.....	224
90. Thermit hand grenade, Mark I, section.....	225
91. Incendiary hand grenade, Mark I, section.....	226
92. V. B. rifle grenade, Mark I, section.....	227
93. Rifle grenades showing United States service rifle, cartridges, grenade, and section.....	228
94. Rifle grenade discharger.....	229
95. 3-inch Stokes mortar, loading.....	232
96. 3-inch Stokes trench mortar, Mark I, placed in trench, diagram.....	233
97. 3-inch Stokes trench mortar shell, diagram showing tubing construction..	234
98. 6-inch trench mortar, loading projectile and charge.....	236
99. 6-inch trench mortar, Mark I, placed in trench, diagram showing mortar..	237
100. 6-inch trench mortar shell, Mark I, section.....	238
101. Craters formed by 6-inch trench mortar projectile.....	239
102. 240-mm. trench mortar—loading with projectile carried in handled tray..	240
103. 240-mm. trench mortar placed in trench, diagram showing mortar.....	241
104. 240-mm. trench mortar shell, diagram.....	242
105. Trench mortar fuze, Mark VII, diagram.....	243
106. Trench mortar fuze, Mark VI, assembly and section.....	244
107. Trench mortar fuze, Mark VI, diagram.....	245
108. Livens projector, Mark I, diagram.....	246
109. Livens projector shell, Mark I, diagram.....	247

XI.

110. Free gun mount—Lewis guns mounted on jumelage on tourelle.....	250
111. Fixed machine gun mount on spad plane.....	256
112. Types of aerial drop bombs.....	260
1. Mark II H. E. drop bomb.	
2. Mark II incendiary bomb.	
3. Mark I drop bomb.	
4. Mark I incendiary bomb.	
5. Dummy drop bomb.	

	Page.
113. High-capacity drop bomb, Mark II.....	262
114. Dummy drop bomb.....	262
115. High-capacity drop bomb, Mark III, diagram.....	263
116. High-capacity drop bombs, Mark I.....	264
117. Fragmentation drop bomb, Mark I, diagram.....	266
118. Barlow drop bomb, diagram.....	268
119. Barlow drop bomb with release mechanism, showing rod extended.....	269
120. Incendiary drop bomb, Mark I, section.....	270
121. Incendiary drop bomb, Mark I.....	271
122. Incendiary drop bomb, Mark II.....	271
123. Incendiary drop bomb, Mark II, section.....	272
124. Mark III H. E. bomb on Mark V release mechanism, DH 4 airplane.....	279
125. Mark III H. E. bomb on Mark V release mechanism, DH 4 airplane.....	280
126. Mark I-A bomb sight. Top view, aiming position with sighting for 7,000 feet altitude and 100 miles per hour speed.....	283
127. Side view of bomb sight, Mark I-A.....	284

XII.

128. Very signal pistol.....	290
129. Portable knapsack flame projector.....	295

XIII.

130. Lewis aircraft machine gun.....	297
131. Browning machine gun, water-cooled type.....	297
132. Browning automatic rifle.....	299
133. Browning aircraft gun.....	299
134. Marlin aircraft machine gun.....	301
135. Marlin tank gun.....	302
136. Vickers machine gun on Browning mount.....	303
137. Cartridges for machine gun with metal disintegrating link.....	304
138. Hotchkiss machine gun.....	305
139. Chauchat automatic rifle.....	306
140. Colt machine gun.....	307
141. United States machine-gun cart, model 1917.....	310
142. United States machine-gun ammunition cart.....	311
143. Plane table with angle site instrument and clinometer.....	313
144. Brunton compass.....	314
145. Prismatic compass.....	314
146. Lensatic compass.....	315

XIV.

147. Rifle-barrel straightening at Rock Island Arsenal.....	322
148. United States service rifles.....	325
Caliber .30, model 1903.	
Caliber .30, model 1917.	
Russian rifle.	
149. United States rifle, model 1903, with extension magazine.....	328
150. Extension magazine for United States rifle.....	329
151. Periscopic attachment for United States service rifle.....	332
152. Model 1903 rifle with telescopic sight and Maxim silencer.....	334
United States riot shotgun, Winchester design.	
United States riot shotgun, Remington design.	
153. United States Army service revolvers and pistols.....	337

XV.

	Page.
154. United States Army service ammunition .30 caliber cartridge, model 1906 for rifle, and .45 caliber cartridge for pistol and revolver.....	342
155. United States Army service .30 cartridge, section.....	343
156. Tracer cartridge, caliber .30, model 1917.....	345
157. Armor-piercing cartridge, caliber .30, model 1918.....	346
158. Incendiary cartridge, caliber .30, model 1918.....	347
159. United States .45 caliber service ammunition for pistols and revolvers....	351
160. Ammunition for rifles and machine guns.....	352
8 mm. Lebel cartridge.	
7.62 Russian cartridge.	
11 mm. incendiary cartridge.	
161. 7.62 mm. cartridge, section.....	352
162. 8 mm. cartridge, French, section.....	353
163. 11 mm. incendiary cartridge, section.....	353
164. Clip-loading machine, model 1918, caliber .45, for revolver ball cartridges.	354
165. Cartridges for United States machine gun and ammunition box—disintegrating link belt above, webbing belt below.....	355

XVI.

166. Types of United States Army motor vehicles and tractors.....	358
167. Ammunition truck for hauling field guns.....	364
168. Reconnaissance car.....	371
169. Light repair truck.....	372
170. Equipment repair truck.....	374
171. Artillery repair truck.....	375
172. Artillery supply truck.....	377
173. Trailer with 4-ton crane.....	381
174. Trailer for United States 75 mm. field gun.....	383
175. Trailer for United States 75 mm. field gun, diagram.....	384
176. 10-ton trailer.....	385
177. Self-propelled caterpillar mount for guns.....	389
178. 2½-ton tractor.....	391
179. 5-ton tractor.....	393
180. 10-ton tractor.....	395
181. 20-ton Artillery tractor.....	396
182. 20-ton Artillery tractor with cover.....	397
183. Mark VIII tank.....	404
184. 6-ton tank.....	407

XVII.

185. Cavalry and officer's sabers.....	411
186. Bolo and scabbard.....	412
187. Light laminated armor.....	413
188. Laminated breast and back plates and plain breastplate.....	414
189. Inside view breast and back plates, showing sponge rubber cushions....	414
190. Necklet.....	415
191. Body armor for sentinel.....	415
192. (a) A jazeran.....	415
(b) A jazeran.	
193. Wilmer eye shield for use with helmet.....	415
194. Gun-proof helmet.....	415
195. Helmet No. 5, bow salade.....	416

	Page.
196. Face guard with helmet.....	416
197. Helmet with rotating visor.....	416
198. Arm defense.....	416
199. Leg armor.....	416
200. Shin guard.....	416
201. Jazeran as worn under tunic.....	417
202. Sentinel's armor.....	417
203. Face guard worn with helmet No. 5.....	417
204. Helmet No. 5 contrasted with British helmet.....	417

XVIII.

205. Assembling 75-mm. field guns at Rock Island Arsenal.....	438
206. Press for gun forging at Watertown Arsenal.....	446
207. Electric furnace at Watertown Arsenal.....	447
208. 14-inch gun in gun shop at Watervliet Arsenal.....	449
209. Lathe for rifling gun at Watervliet Arsenal.....	450

XIX.

210. Miscellaneous types of gauges, figures 1 to 4.....	454
211. Type of gauge used to inspect thickness of wall of shell and shrapnel.....	456
212. Indicator, height, and snap gauges, figures 5 to 8.....	457
213. Type of gauge used to inspect thickness of base of shell and shrapnel.....	458
214. Type of gauge used to inspect total length of profile of shell.....	458
215. Thread, pin, diaphragm, snap and plug gauges, figures 9 to 13.....	459
216. Gauges used for inspecting a screw.....	461
217. Gauges used for inspecting a nut.....	462
218. Ring and snap gauges.....	462
219. Thickness and ring gauges, figures 14 and 15.....	463
220. Taper and cavity gauges, figures 16 and 17.....	464
221. Micrometer to test the diameter of plug gauges.....	465
222. Concentricity gauge for fuzes.....	466
223. Concentricity gauges.....	467
224. Profile of screw thread.....	468
225. Definitions of screw characteristics, diagram.....	468
226. Micrometer to test the pitch diameter of thread-screw gauges.....	470

LIST OF TABLES.

I.	
1. Characteristics of United States Army cannon	Facing 26
II.	
2. Characteristics of United States Field Artillery—Carriage data.....	29
3. Characteristics of United States seacoast cannon for field use.....	33
4. Basic assumptions on which requirements schedules of 8 inch, 9.2 inch, and 240 mm. howitzers were made.....	68
5. Fire-control equipment for divisional Artillery.....	77-78
6. Fire-control equipment for Army Artillery.....	79-81
IV.	
7. Antiaircraft fire-control instruments.....	114-115
V.	
8. British gun data.....	116
9. Characteristics British 9.2-inch B. L. guns, Marks, X, XIII, XIV.....	117
10. Characteristics of French Army guns and shells, and mortars, howitzers, and shells.....	120
11. List of French guns, howitzers, and mortars in service at the front.....	121
12. German gun characteristics.....	132
13. Maximum range of German guns, howitzers, and mortars.....	133
14. Artillery matériel of Austro-Hungary.....	134
VI.	
15. Artillery ammunition—general characteristics.....	138
16. Artillery ammunition—projectiles, dimensions, and characteristics..	Facing 140
17. Fuzes, kinds and uses.....	154
18. Adapter and booster casings—drawings and uses.....	155
IX.	
19. United States nitrate plants	Facing 209
X.	
20. Grenades.....	219
21. Trench mortars and trench mortar bombs.....	231
XI.	
22. Machine guns for aircraft installation.....	249
23. Aerial drop bombs used by the allies.....	258
24. Aerial drop bombs—components.....	259
25. Aircraft bomb fuzes as used by the allied forces.....	276
26. Bomb carriers as used by the allied forces.....	278

XII.

27. Pyrotechnics—matériel and nomenclature.....	292
---	-----

XIII.

28. Machine guns—chief characteristics.....	308
29. Articles transported by machine gun units motorized.....	309

XIV.

30. Particulars of military magazine rifles.....	317
Particulars of military magazine rifles.....	318
31. Breech-loading magazine rifles of small caliber of various armies....Facing	318
32. Small arms, rifles, and ammunition of different nations.....Facing	318
33. Principal dimensions and weights of United States rifle, caliber .30, model 1903.....	323
34. Principal dimensions and weights of United States rifle, caliber .30, model 1917.....	327

XV.

35. United States machine guns and small-arms ammunition.....Facing	354
36. Comparative table of rifle ammunition for various armies.....	356

XVI.

37. Motor trucks and cars, chassis only.....	362
38. Motor trucks and cars, complete.....	363
39. Motor trucks supplied by Ordnance Department.....	365
40. Trailers—trailer chassis.....	382
41. Artillery tractors.....	387
42. Comparative data of tanks.....	401
43. United States tanks.....	403

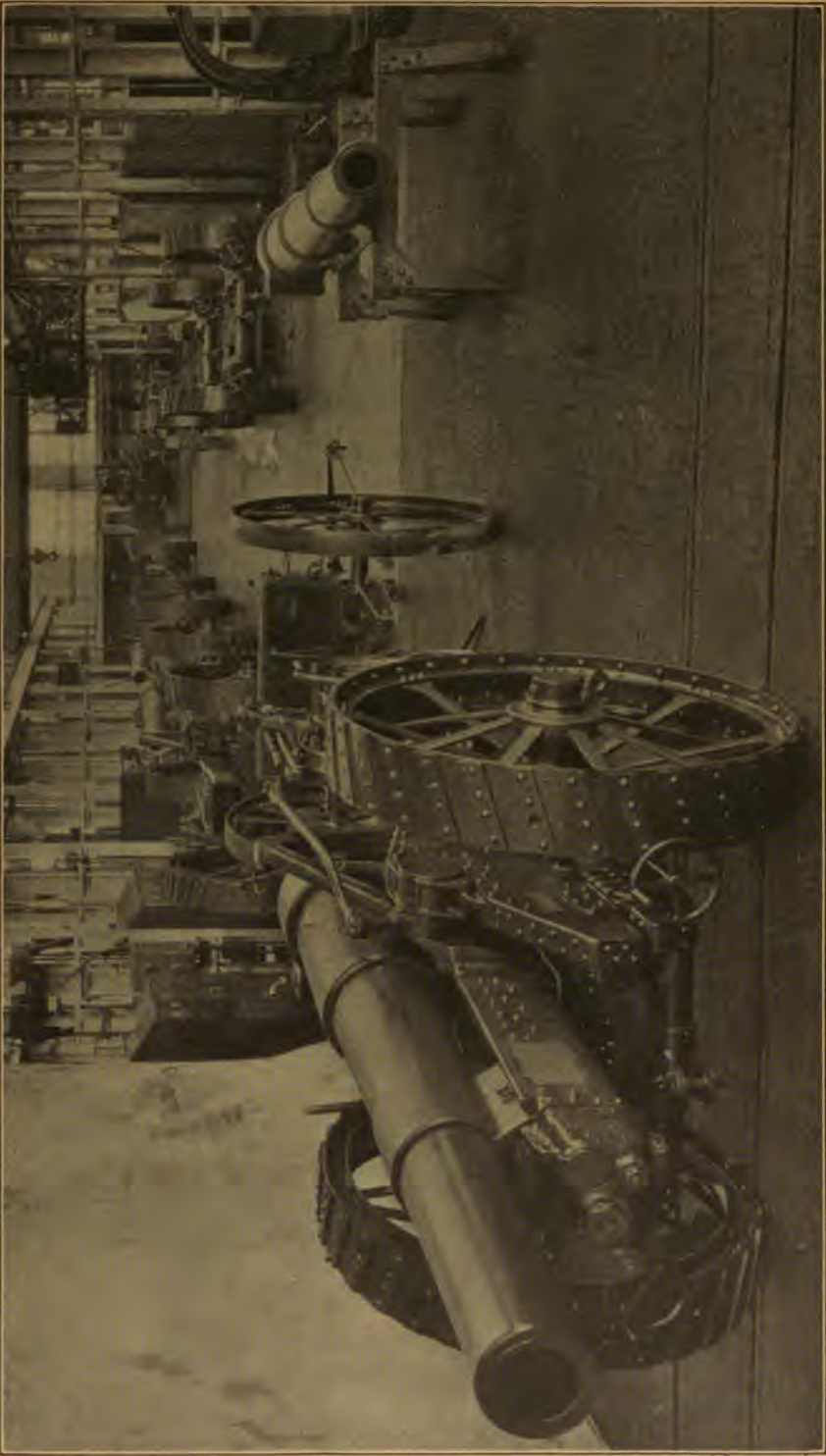

FIG. 1.—8-inch howitzer at Midvale Steel and Ordnance Co. shop.

I. ARTILLERY.

GENERAL SUMMARY.

General statement.—Artillery as used to-day by the forces of the United States may be divided into two classes, namely, mobile artillery and seacoast artillery.

Mobile artillery is for use in the field, seacoast artillery for use at fortifications. Under the first head, however, are included several types of seacoast guns which have been removed from the stationary carriages and have been shipped to Europe.

Types of mobile artillery.—Mobile artillery falls into three classes according to the three types of weapon which it embraces.

Mobile artillery:

Guns.

Howitzers.

Mortars.

Guns.—Guns are distinguished for high-muzzle velocity, ranging from 1,750 to 3,300 feet per second. The length of the barrel varies from 30 to 50 calibers, i. e., the length of barrel ranges from 30 to 50 times the diameter of the bore. On account of the high muzzle velocity of guns as distinguished from mortars and howitzers, longer ranges are obtained with a comparatively low elevation of the gun. The trajectory of flight of the shell, therefore, describes a much flatter arc, or, in other words, the fire is more direct.

Classification of gun mounts.—The guns that are being used by the United States forces in the field are classified as regards their mounts as follows:

Gun mounts:

Wheeled mount.

Antiaircraft mount.

Railway mount.

Wheeled mounts.—Under wheeled mounts are included the following guns:

75 mm. model of 1916 (American).

75 mm. model of 1917 (British).

75 mm. model of 1897 (French).

4.7 inch, model of 1917 (Bethlehem).

4.7-inch, model of 1917 (Bethlehem).

155 mm. model of 1918 (Filloux).

5-inch, seacoast.

6-inch, seacoast.

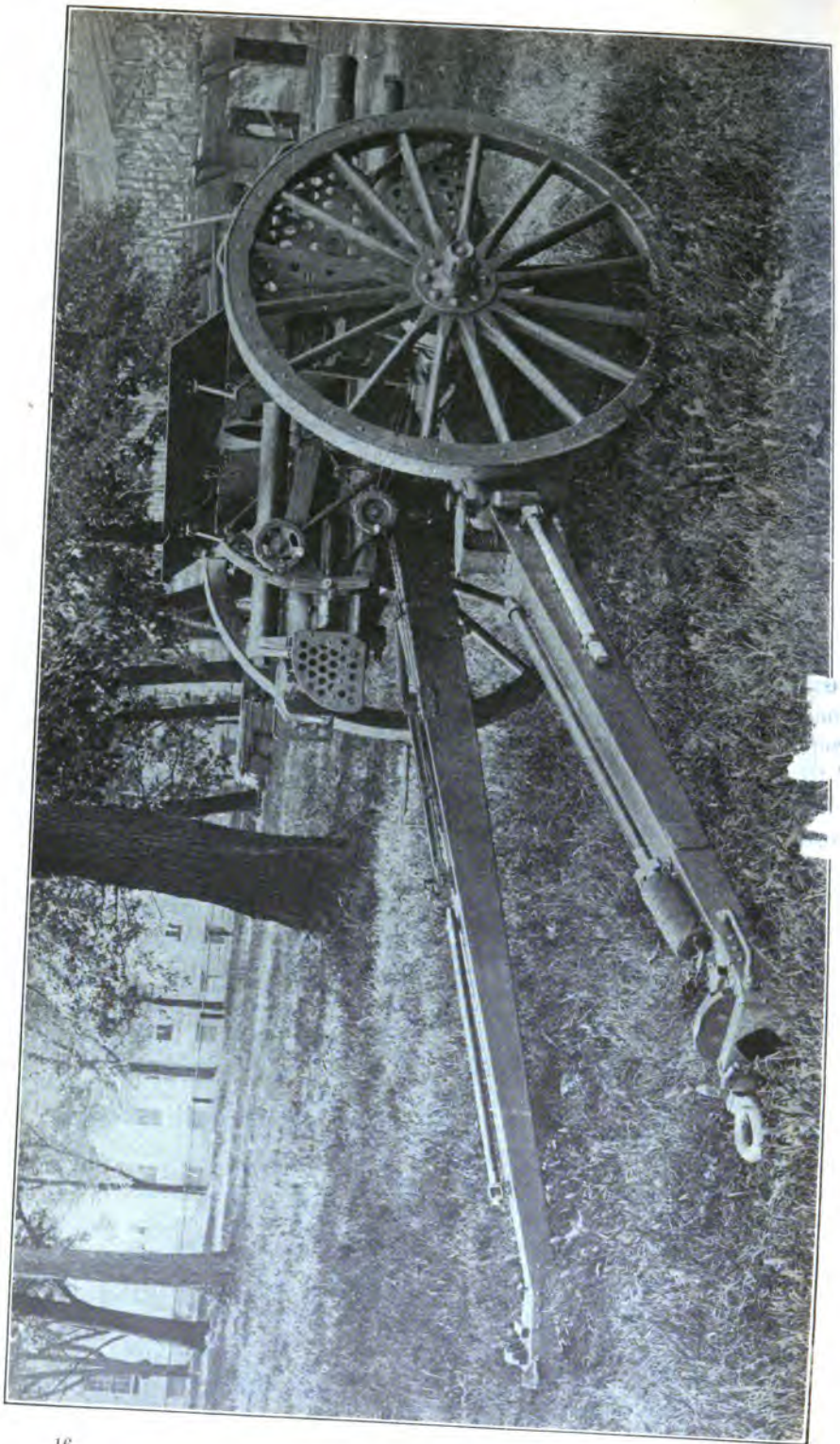

FIG. 2.-77 U. S. Army carriage, m/r 16: r4 t 0 degrees elevation. extr. r. 16: r4

Field guns.—Three types of 75-mm. field guns have been provided for the American forces. These are the American model 1916; the British model of 1917; and the model of 1897 (French).

The American model 1916 was continued, as it has the advantage of a wide traverse and a high elevation permitted by a split-trail carriage. The model of 1917 (British) was ordered shortly after the declaration of war to expedite production, inasmuch as the Bethlehem Steel Co. had orders for this type of gun and carriage from the British Government, and was in a position to proceed with the manufacture according to drawings, specifications, and gauges already on hand.

The French 75-mm. gun is longer than either the United States model 1916 or the British type by about 6 calibers. The French type was adopted in preference to lengthening the United States model 1916 type, as this would require entire rebalancing of the tipping parts of the carriage.

In addition, however, to the intrinsic merits of the French 75-mm. gun which are discussed in a subsequent section, there were also other considerations that led to its adoption as an important and pre-empting element in the American artillery program. At the conference between the Anglo-French military commission and the representatives of the United States Government, it was decided that the United States troops should operate in conjunction with the French Army, at least at the beginning. Furthermore, the French Ordnance works were in a position to supply 75-mm. guns to the first of the American troops, and also to continue their manufacture along lines of efficient production. In other words, there was a well-tested gun available. Artillery officers who had used it during the war were ready to give instruction, and so far as could be seen no distinctly superior weapon that would warrant delay in waiting for its manufacture was in sight.

Antiaircraft guns.—The antiaircraft guns used in the American service are as follows:

United States antiaircraft guns:

75-mm.

3-inch.

4.7-inch (proposed).

For antiaircraft work the regular 75-mm. French type field guns are mounted on improvised carriages, and the 75-mm model of 1916 on truck mounts. The model of 1918, 3-inch antiaircraft gun is more powerful than the other types referred to and is mounted on a special trailer mount.

4.7-inch field gun.—To secure a greater range and power than is possible with the 75-mm. field gun, the 4.7-inch gun is employed. The

model of 1906 is used with a 45-pound shell, securing a greater range and greater muzzle velocity than with the 60-pound shrapnel. The 1906 model was improved in the model of 1917 (Bethlehem) and a split trail and variable recoil mechanism were introduced. The 4.7-inch gun is motorized and has mobility along with power and range.

155-mm. gun.—To secure still greater range and power, a new gun was secured in the form of the 155-mm. model of 1918 (Filloux), which represented the best European practice and was adopted by the United States Ordnance Department after a careful consideration of all the guns of this caliber in service in Europe. Inasmuch as there was no design of this type in the former ordnance program of the United States, it was possible to start entirely fresh and to consider the matter simply on the score of ballistic efficiency, mobility, and ease of production. This gun, as well as the others referred to in this brief summary, will be found discussed and illustrated elsewhere in the Handbook.

Five-inch and six-inch seacoast guns on improvised wheel mounts.—The importance of using guns of this caliber on wheel mounts in the field early was realized, and arrangements were made whereby a number of these pieces were removed from the fortifications and a special type of mount designed which could be constructed rapidly and with ordinary manufacturing facilities. While these guns were not necessarily of the latest types, nevertheless, they were well suited for field use, particularly with motor transport, and production of carriages was secured at a comparatively early date. For this purpose both 5-inch and 6-inch guns were used, and pending the fabrication of new cannon of modern design, were in a position to render excellent service.

Railway mounts.—The following calibers of seacoast guns have been taken from the fortifications to be placed on railway mounts—8-inch, 10-inch, and 12-inch. The railway mount for the 14-inch seacoast gun is in the experimental stage. The more important data of these guns are as follows:

Caliber of gun.	Weight of gun, with-out carriage.	Length of gun.	Range.
	<i>Pounds.</i>	<i>Inches.</i>	<i>Yards.</i>
8-inch	32,200	278	21,000
10-inch	67,000	367	26,000
12-inch	115,000	442	29,000
14-inch (model of 1919)	140,000	581	139,000

¹ Estimated.

These guns are mounted on specially designed carriages, which are in turn mounted on a railway car. The elevation ranges from 36

degrees in the 10-inch and 12-inch guns to 42 degrees in the 8-inch. The latter has all-around traverse, the others a traverse of 10 degrees which is augmented by the use of a curved track if changes in azimuth greater than 10 degrees are demanded.

Howitzers.—Howitzers are distinguished by low-muzzle velocity, ranging from 1,200 to 1,900 feet per second. Their ranges are obtained by the high angle of the elevation of the gun from the horizontal plane, and their fire is designated as high angle fire.

Various types of howitzers.—The United States 6-inch howitzer, model of 1908, was not sufficiently powerful, and the 155-mm. Schneider howitzer was adopted to take its place, as it appeared to be a better design than the 6-inch British howitzer and also more desirable from a production standpoint.

8-inch howitzers.—A number of 8-inch howitzers, Mark VI, of the type being manufactured for the British Government, were ordered from the Midvale Steel & Ordnance Co., largely because their facilities could not be utilized at that time in the manufacture of 240-mm. howitzers. Contracts later were let for the Mark VIII $\frac{1}{2}$ howitzer, which is about 1 $\frac{1}{2}$ calibers greater in length than the Mark VI and has a correspondingly greater range.

9.2-inch howitzer.—The 9.2-inch howitzer is a heavy siege-type motorized howitzer, which has been tested in service and was manufactured for the United States Government by one of the large ordnance companies which had been manufacturing them in America for the British Government.

240-mm. howitzer.—The 240-mm. howitzer was originally a 9.5-inch piece. It was designed by Schneider & Co., of France, through the Midvale Steel & Ordnance Co. It has long range and high power, and with its motorized transport has been thoroughly tested in service.

16-inch howitzer mount.—One 16-inch howitzer railway carriage, mounting a 16-inch howitzer, model E, has been built at the Watertown Arsenal. The mount provides an all-around traverse for the gun, with a maximum range of approximately 23,000 yards. The length of the gun is 308 inches. The weight of the gun is about 90,000 pounds.

Mortars.—Mortars are distinguished by low-muzzle velocity, ranging from about 480 to 1,500 feet per second. The length of the barrel is 10 calibers or less, and the range varies from 2,500 to 15,000 yards. For any given weight of projectile the maximum range is obtained by using the powder charge which gives the highest muzzle velocity and setting the elevation at 45 degrees. There is one active caliber employed in the United States service—the 12-inch which has been given mobility by being mounted on a special railway mount.

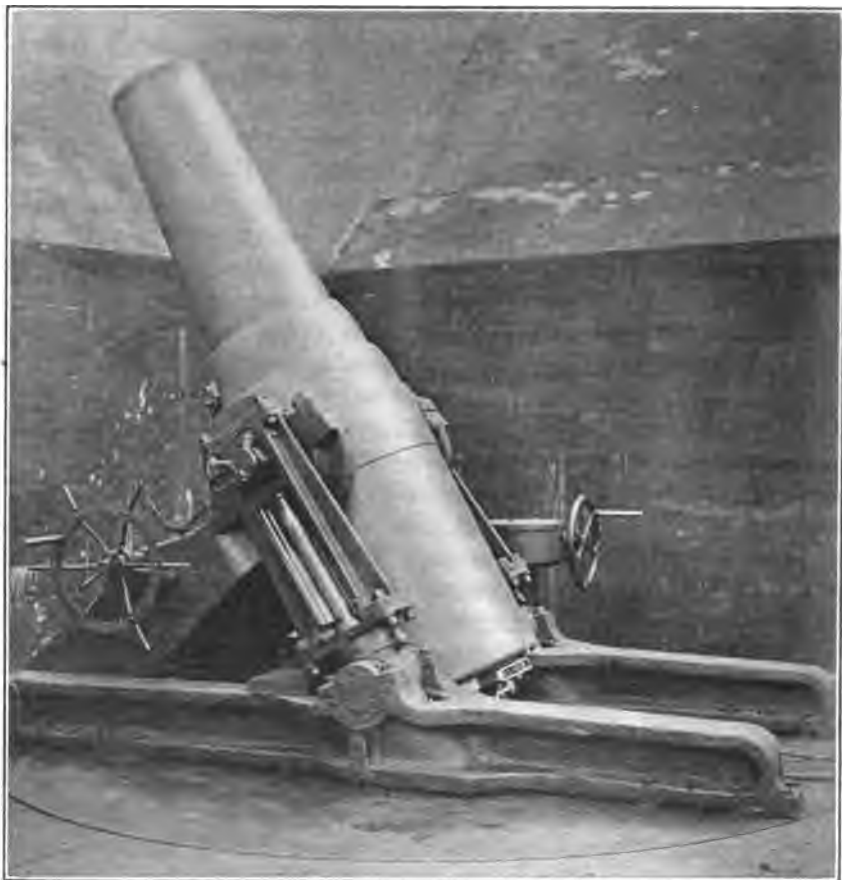

FIG. 3.—12-inch mortar in coast defense emplacement. Mortars of this type were removed and placed on special railway mounts.

12-inch mortars.—The 12-inch mortar, model 1890, is mounted on a specially designed carriage, which is in turn mounted on a railway car. The carriage permits a maximum elevation of the mortar of 65 degrees and an all-around traverse. The maximum range is approximately 15,000 yards. The weight of the gun alone is 29,120 pounds and the length 141 inches.

Comparative designs.—From the foregoing outline it is apparent that types of cannon of French and British designs and calibers have been adopted in the formation of an artillery program by the United States, and conversely American designs have been submitted to British and French war commissions for criticism and suggestions. With the aid of their experience and advice improvements in new construction were incorporated and the assistance of both our allies was most valuable.

American private ordnance plants.—The problems of construction were even more serious than those of design. There were at the outbreak of the war but two privately owned plants in the United States that were experienced in the manufacture of cannon forgings. These were the Midvale Steel Co., whose capacity was allotted to the Navy, and the Bethlehem Steel Co., whose capacity was assigned to the Army. The Bethlehem Steel Co. had orders from foreign Governments for war material fully occupying the plant until approximately July, 1918. And even had this not been the case, the orders of the Ordnance Department for 52,000,000 pounds of gun forgings would fully have occupied the Bethlehem Steel Co. for many months.

New sources developed.—The Ordnance Department, therefore, was forced to obtain other manufacturing organizations to produce gun forgings, and to secure necessary facilities in the way of buildings and equipment for such production.

Typical instance 155-mm. howitzer.—At the outset—to take a single instance—seven companies without previous experience in this field received orders for the manufacture of forgings for the 155-mm. howitzer. The processes involved may be considered typical of the general development of the various types of ordnance in the United States. On January 26, 1918, these plants had received an average of only 34 per cent of the necessary equipment. They were especially deficient in a supply of forging presses, which are the most difficult part of this equipment to secure, and which are required for the first forging operations; and to manufacture a 2,000-ton press essential in forging requires about nine months.

New ingot molds required.—Gun forgings must be made from a certain size ingot in order to obtain the required physical strength and the proper reduction from the ingot to the forging. This involves the design and casting of a special ingot mold, a process in which few plants had had previous experience. In January, 1918, one plant was able to produce 10 sets of forgings for the 155-mm. howitzer from such ingots, as a result of negotiations started with this company on June 29, 1917.

Rough machining.—After the forgings are made from the ingots they must be rough machined, tested for quality, and heat treated, all of which are processes involving compliance with exact specifications. They are then ready for machine work.

Machining.—Special machines are required for machining gun forgings, a process involving accurate work with very small tolerances. In the 155-mm. howitzer, the barrel is approximately 92 inches long, and machining the bore, which is over 6 inches in diameter, is accomplished to within $\frac{3}{1000}$ of 1 inch. Such accurate workmanship naturally can not be done rapidly.



FIG. 4.—Ordnance machining—Spring counterrecoil cylinder for U. S. 75-mm. gun, and steel billet before machining.

New plants.—Inasmuch as the Bethlehem Steel Co. and the Watervliet Arsenal were the only experienced sources of supply available to the Ordnance Department for machining cannon, and as these were occupied—in the one case with foreign orders and in the other up to a capacity which was but one-tenth of the number of guns required—facilities had to be provided for new companies who were willing to undertake the work. For these plants were erected and specially designed equipment was secured; but on January 26, 1918, these plants had received but 55 per cent of the equipment which they had ordered. However once started rapid progress was made, and by the time of the armistice on November 11, 1172 cannon had been shop finished for the 155 mm. howitzer.

Necessary equipment.—To manufacture 155-mm. howitzers at the rate of 10 per day the following machines were required: For machining the gun proper, 90 machines; for machining the breech mechanism, 227 machines; for machining in the tool room, 78 machines; for the gauge section, 20 machines.

Shrinking on the jacket.—The jacket or outer section of the howitzer, after being finished and accurately star-gauged for its entire length, is heated, placed on a tube turned to the same dimensions plus a shrinkage of $\frac{3}{1000}$ of an inch or more, and allowed to cool, setting over the tube for the entire length of the jacket.

Parts of 155-mm. howitzer.—A 155-mm. howitzer is composed of 88 parts, of which the major forgings are tube, jacket, breechblock, and spindle, weighing nearly 3,500 pounds. The tube forging alone weighs approximately 1,800 pounds. Machining the breech mechanism and the gun proper, together with the assembly work, requires a total of approximately 1,200 hours.



FIG. 5.—Equipment for cooling tubes at shrink pit, Watervliet Arsenal. Shrinking of 14-inch wire-wound gun.

Time required in manufacture.—Two typical instances may be cited to show the time required for the manufacture of ordnance. In the fall of 1915, Vickers (Ltd.), of England, designed a Mark VI, 8-inch breech-loading howitzer, which required eight months in their highly organized and developed shops, which are among the largest in the world, and which had been for a year on a war basis. On May 1, 1916, the Midvale Steel & Ordnance Co., of Philadelphia, received an order from Great Britain for 100 of these identical howitzers. Ground was purchased, shops built and equipped, and the first howitzer was proof fired in nine months and five days. This company also had an experienced engineering staff, and in the execution of the equipment preparations as well as in the execution of the order itself, no expense was spared.

A new American plant.—The American Brake Shoe & Foundry Co., of Erie, Pa., submitted a proposal on June 29, 1917, for a plant for finish machining and for the assembly of the 155-mm. Schneider howitzer. This plant was completed and practically fully equipped, and had manufactured and shipped two of these howitzers complete with breech and firing mechanism, but without carriages, sights, and limbers, seven months and sixteen days after the original order was given and the plant was regularly receiving forgings and manufacturing cannon in quantity by June 1, 1918. Orders were given to other plants, of course, but the above instance is cited as typical.

Construction.—The guns used in modern military service are principally of the "built-up" type, in which a jacket alone, or a jacket and several hoops, are shrunk upon a tube which is held from longitudinal slippage by shoulders on the inner member which abut against corresponding shoulders on the inner surface of the outer member. When the accuracy life of a gun has been expended, on account of wear and erosion, the tube is bored out and the entire gun heated in order to expand the inner bore. A lining tube is inserted cold and the cooling of the gun produces a shrinkage pressure sufficient to hold the liner in place. This liner is rifled and the gun is then practically as good as new.

Approximate cost and cost of relining.—The approximate cost of certain types of cannon without carriages and of relining, is as follows:

Type.	Cost.	Estimated relining cost.
75-mm. gun, model 1916.....	\$3, 800	\$1, 500
3-inch antiaircraft gun.....	5, 000	2, 000
4.7-inch gun, model 1906.....	7, 600	2, 300
155-mm. howitzers.....	7, 700	2, 500
155-mm. (Filloux).....	13, 000	4, 000
240-mm. howitzer.....	18, 000	5, 400

Relining requirements.—The relining requirements indicated in the accompanying tables have been figured from information secured from British and French sources, and while repairs will not be started immediately upon issuing the cannon, the liners must be available when needed and the necessary equipment for the relining must be available at the ordnance base depots in Europe.

The accompanying figures, derived from British and French experience as to the percentage of active guns going monthly to the repair shop, are taken from a memorandum by Lieut. Col. Symon, of the British artillery mission. These figures include all the repairable casualties, but inasmuch as guns sent to the repair shop for other purposes than relining form an unimportant portion of the whole, no reduction is made in estimating the requirements for liners.

PERCENTAGE OF ACTIVE GUNS SENT MONTHLY TO REPAIR SHOP BASED ON
 "NOTES ON GUN PROGRAM" BY LIEUT. COL. SYMON, BRITISH ARTILLERY
 MISSION.

[Unofficial.]

Caliber and type of gun.	Kind.	Per cent to repair shop.
75-mm.....	United States.....	8
18-pounder.....	British.....	8
	French.....	6.8
75-mm. antiaircraft gun.....	United States.....	8
3-inch antiaircraft gun.....	do.....	18
4.7-inch field gun.....	do.....	17
60-pounder.....	British.....	17.3
4.7-inch antiaircraft gun.....	United States.....	17
155-mm. field gun.....	do.....	19
6-inch.....	British.....	17 and 21
	French.....	22.5
155-mm. howitzer.....	United States.....	7.4
6-inch.....	British.....	7.4
	French.....	4.5
8-inch howitzer.....	United States.....	8.5
	British.....	8.5
9.2-inch howitzer.....	United States.....	7.5
	British.....	7.5
240-mm. howitzer.....	United States.....	7.5
8-inch seacoast gun.....	do.....	17
6-inch.....	British.....	17
155-mm.....	French.....	22.5
6-inch seacoast gun.....	United States.....	19
6-inch.....	British.....	17 and 21
155-mm.....	French.....	22.5
8-inch seacoast gun.....	United States.....	30
10-inch seacoast gun.....	do.....	30
9.2-inch.....	British.....	30
12-inch seacoast gun.....	United States.....	30
	British.....	30
12-inch seacoast mortar.....	United States.....	9.5
12-inch howitzer.....	British.....	9.5
6-inch Navy gun.....	United States.....	19
	British.....	17 and 21
155-mm.....	French.....	22.5
8-inch Navy gun.....	United States.....	30
10-inch Navy gun.....	do.....	30
9.2-inch.....	British.....	30
12-inch Navy gun.....	United States.....	30
	British.....	30

¹ Based on 75-mm. field gun.

² In absence of British 8-inch and 10-inch guns, these figures are based on 9.2-inch gun.

NOTE.—The base to which these percentages are to be applied is the total initial equipment of active guns at the front.

Accuracy life of United States guns.—The accuracy life of some of the United States cannon, without relining, follows. The figures below based on early estimates, show only the actual accuracy life, and it is probable the cannon could be fired up to about 50 per cent above these figures before relining:

	Rounds
75-mm. model 1916.....	approximately 10,000
3-inch antiaircraft gun, model 1918.....	do 5,000
4.7-inch model 1906.....	do 5,000
155-mm. (Filloux).....	do 2,500
155-mm. howitzer.....	do 7,000
240-mm. howitzer.....	do 6,000
5-inch seacoast gun.....	do 1,000
6-inch seacoast gun.....	do 1,000
8-inch seacoast gun.....	do 800
10-inch seacoast gun.....	do 700
12-inch seacoast gun.....	do 600

When more complete data was available the accompanying tabulation of the estimated life in rounds of different guns with given muzzle velocities was compiled from estimates made in the spring of 1918:

	American.	British.	French.	Aberdeen Proving Ground.
	<i>Rounds.</i>	<i>Rounds.</i>	<i>Rounds.</i>	<i>Rounds.</i>
2.95-inch mountain gun.....	12,000			15,000
75-mm. field gun.....	9,000	12,500	10,000	8,000
3-inch antiaircraft, heavy.....	1,000	2,400		
3-inch antiaircraft, light.....	5,000	4,915		
4.7-inch field gun.....	5,000	4,815	6,000	
155-mm. howitzer.....	7,000	10,486	78,000	10,000
155-mm. gun.....	4,500			1,000
8-inch howitzer, Mark VI.....	6,000	7,852		8,000
8-inch howitzer, Mark VII-VIII.....	6,000	3,165		
9.2-inch howitzer, MI.....	6,000	8,377		
9.2-inch howitzer, MII.....		8,544		
240-mm. howitzer.....				6,000
				Sandy Hook Proving Ground.
2.24-inch seacoast gun.....	1,200			
3-inch seacoast gun.....	1,000			
4-inch seacoast gun.....	800			
4.72-inch seacoast gun.....	700			
5-inch seacoast gun.....	700		2,000	
6-inch seacoast gun.....	600	2,384	2,000	
8-inch seacoast gun.....	410		1,500	400
9.2-inch seacoast gun.....		450/550		
10-inch seacoast gun.....	350		1,000	200
12-inch seacoast gun.....	300	420	500	
14-inch seacoast gun.....	250	400	300	
16-inch seacoast gun.....	100			

The above estimates, in some cases, unquestionably are based on incorrect or insufficient data. The European estimates which are materially higher than the American are probably more accurate as they are based on more extended experience.

T

h

P
i
d
n

l
p

MOBILE ARTILLERY.**SUMMARY.**

75-mm. field guns.—Three types of 75-mm. field guns are being provided for the United States Army—the model of 1916 (American), the model of 1917 (British), and the model of 1897 (French). The model of 1916 carriage was originally a 3-inch gun carriage with a split trail.

Model of 1916.—The 75-mm. gun, model of 1916, is the United States 3-inch field piece, model of 1916, redesigned to fire 75-mm. ammunition, and is illustrated on pages 16 and 38. It is slightly heavier than the French design, but is provided with a split trail and a variable recoil mechanism allowing wide traverse and high elevation. These advantages warranted the continued manufacture of the model of 1916. Using 75-mm. American shrapnel weighing 15.95 pounds, a muzzle velocity of 1,693 foot-seconds is secured. The maximum range is 8,900 meters (9,733 yards) with an elevation of 45 degrees. It is not necessary to depress the trail of the 75-mm. gun carriage, model of 1916, when firing for maximum range, since the maximum elevation permitted by the carriage is sufficient to cover this.

Model of 1917.—The 75-mm. gun, model of 1917 (British), is ballistically similar to the model of 1916, and it is provided with a spring counterrecoil system. The model of 1917 (British) were ordered after the declaration of war in order to expedite production. The Bethlehem Steel Co. at that time had orders for that type of guns and carriage for the British Government, and therefore was in a position to proceed at once with their manufacture under drawings, specifications, and gauges already on hand.

75-mm. model of 1897 (French).—The 75-mm. gun, model of 1897 (French), was the principal field gun that had been used by the French armies and been thoroughly proven in service. It is exceptionally light weight, allowing a high degree of mobility. By depressing the trail a range of 9,000 meters (9,842 yards) at 45 degrees elevation can be obtained. The French gun was available from French ordnance works, and in addition to orders placed in Europe the Ordnance Department arranged for the manufacture of this matériel in the United States. The secret drawings were received in the United States August 11, 1917, and were straightway studied and translated. The Puteaux Arsenal Model was definitely adopted on February 8, 1918, and on February 15, 2,927 carriages were ordered without recuperators which were the subject of special outside contracts as they formed a difficult and special branch of the work. Contracts for gun forgings were placed with two large machine works and production was established during the year.

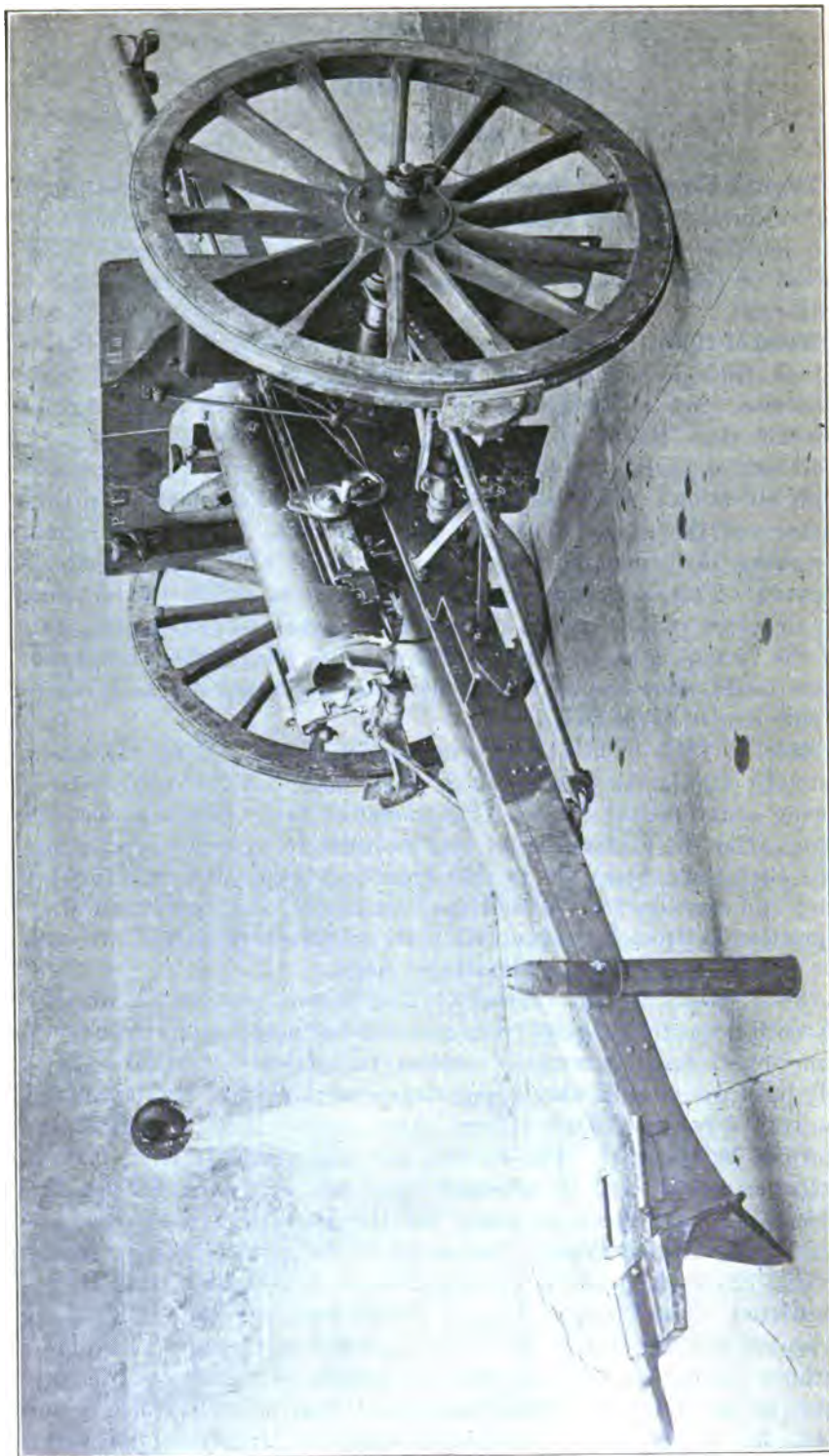

FIG. 6.—75-mm. field gun, model of 1897 (French).

TABLE 2.—Characteristics of United States field artillery—Carriage data.

	Weight of projectile.	Muzzle velocity.	Maximum range.	Number of loads.	Weight of carriage and gun in firing position.	Type counterrecoil.	Length of recoil.	Angle of elevation.	Total traverse.
	<i>Lbs.</i>	<i>Feet per sec.</i>	<i>Meters.</i>		<i>Lbs.</i>		<i>Inches.</i>	<i>Degrees.</i>	<i>°</i>
75-mm. gun carriage, 1916:									
Shell.....	11.85	1,742	8,400	1	3,029	Spring.....	46-18	7+53	45
Shrapnel.....	15.96	1,693	8,900	1					
75-mm. gun carriage, 1917 (British):									
Shell.....	11.85	1,742	5,600	1	2,887	Spring.....	41	5+16	8
Shrapnel.....	15.96	1,693	5,900	1					
75-mm. gun carriage, 1897 (French):									
Shell.....	11.85	1,805	6,400	1					
Shrapnel.....	15.96	1,755	7,130	1	2,657	Hydropneumatic.	47	-10+19	6
4.7-inch gun carriage, 1906:									
Shell.....	45	2,050	8,750	1					
Shrapnel.....	60	1,700	7,260	1	8,068	Spring.....	70	5+15	7 50
4.7-inch gun carriage, 1917 (Bethlehem):									
Shell.....	45	2,050		1	8,700	Hydropneumatic.	66-28	5+40	0
Shrapnel.....	60	1,700							
155-mm. gun carriage, 1918 (Filloux):									
Shell.....	96	2,410	16,000	1	24,600	do.....	43-31-70-87	0+35	90
155-mm. howitzer carriage, 1918 (Schneider):									
Shell.....	95	1,470	11,500	1	7,280	do.....	53.6	0+42°20'	6
155-mm. howitzer carriage, 1917 (Bethlehem):			<i>Yards.</i>						
Shell.....	90	1,700	14,000	1					
Shrapnel.....	120	1,300	10,000	1	8,650	Hydropneumatic.	66-28	5+40	40
8-inch howitzer carriage, 1917 (Vickers, Mark VI):									
Shell.....	200	1,300	10,500	1	19,100	do.....	60-24	0+50	52
8-inch howitzer carriage, 1918 (Vickers, Mark VII):									
Shell.....	200	1,525	13,000	1	20,045	do.....	52-24	0+45	52
9.2-inch howitzer carriage, 1917 (Vickers, Mark I):									
Shell.....	290	1,187	10,060	3	16,240	do.....	40-19	+15+50	60
9.2-inch howitzer carriage, 1918 (Vickers, Mark II):									
Shell.....	290	1,508	12,700	3	19,040	do.....	44-19	+15+50	60
240-mm. howitzer carriage, 1918 (Schneider):									
Shell.....	360	1,700	17,000	5	37,920	do.....	49	+10+60	20
12-inch howitzer carriage, model E.....									
Shell.....	700	1,475	15,000	4	53,000	do.....	60	0+40	30

Comparative characteristics.—The United States model of 1916 and the British types of 75-mm. guns are shorter than the French by about 6 calibers, and while early consideration was given to the question of increasing the length of the model of 1916 type to agree with the French, this would have required extensive redesign and entire rebalancing of the tipping parts of the carriage. This does not mean there was no opportunity for improvement in this excellent piece, for studies were made of an adaptation of the Puteaux recoil mechanism to the 75-mm. gun carriage, model of 1916, to eliminate counterrecoil springs and variable recoil.

Motorization.—At the beginning of the war all 75-mm. guns were horse drawn, but with the development of motor transport, the necessity for motor hauling under many circumstances became apparent. It was decided to motorize at least 10 per cent of the guns in the United States service, and early requirements called for motorizing 5 per cent.

75-mm. and 3-inch antiaircraft guns.—For antiaircraft firing a special type of mount, permitting extreme elevation and facility of traversing, is required. The first designs in the United States aimed to adapt the regular 75-mm. French type field guns to improvised carriages, while the 75-mm., model of 1916, guns were given truck mounts. The model of 1918, 3-inch antiaircraft, a more powerful weapon than the other types referred to, is mounted on a trailer mount and discussed more at length in a subsequent section. This caliber was made 3 inches (76.2 millimeters) instead of 75-mm., in view of the fact that the ammunition would be interchangeable with the 3-inch gun in this country, model of 1898–1902 (15-pounder), and the projectiles would be interchangeable in the larger chambered type of antiaircraft gun in the United States service.

4.7-inch antiaircraft gun.—For the 4.7-inch antiaircraft gun, model of 1918, a caterpillar trailer mount was designed. The gun and carriage weigh about 17,000 pounds, and the caterpillar trailer some 10,000 pounds. The gun has a maximum horizontal range of approximately 16,500 yards and will fire vertically a distance of about 11,000 yards. Its maximum elevation is 80 degrees and its traverse 360 degrees.

4.7-inch guns, model of 1906.—The 4.7-inch, model of 1906, is a motorized, highly mobile field gun, designed to fire shrapnel or shell at greater ranges than the 75-mm. guns. It is the regular department model of 1906 type, but is provided with a 45-pound shell in place of the old type 60-pound shell, in order to increase the range. The 45-pound projectile redesigned for use in this gun gives considerably higher muzzle velocity and longer range than the model 1905, 60-pound projectile. Using the 60-pound shrapnel, a muzzle velocity of 1,700 foot-seconds is obtained at which a range of 11,000 yards is secured with an elevation of 26 degrees. With the 45-pound shell, above referred to, a muzzle velocity of 2,050 foot-seconds is secured which gives a maximum range of 13,100 yards, with an elevation of 40 degrees 15 minutes. This ballistic data was obtained from actual proof-firing made at Aberdeen Proving Ground.

4.7-inch guns, model of 1917.—The 4.7-inch gun, model of 1917 (Bethlehem), is ballistically similar to model of 1906, except that the carriage is provided with a split trail and a variable recoil mechanism allowing wide traverse and high elevation. A considerably longer range than with the model of 1906 gun will be obtained with this weapon without the necessity of burying the trail.

155-mm. gun (Filloux).—The 155-mm. gun (Filloux) is a long range, high-power, motorized field gun, provided with a split trail and variable recoil mechanism, allowing wide traverse and high ele-

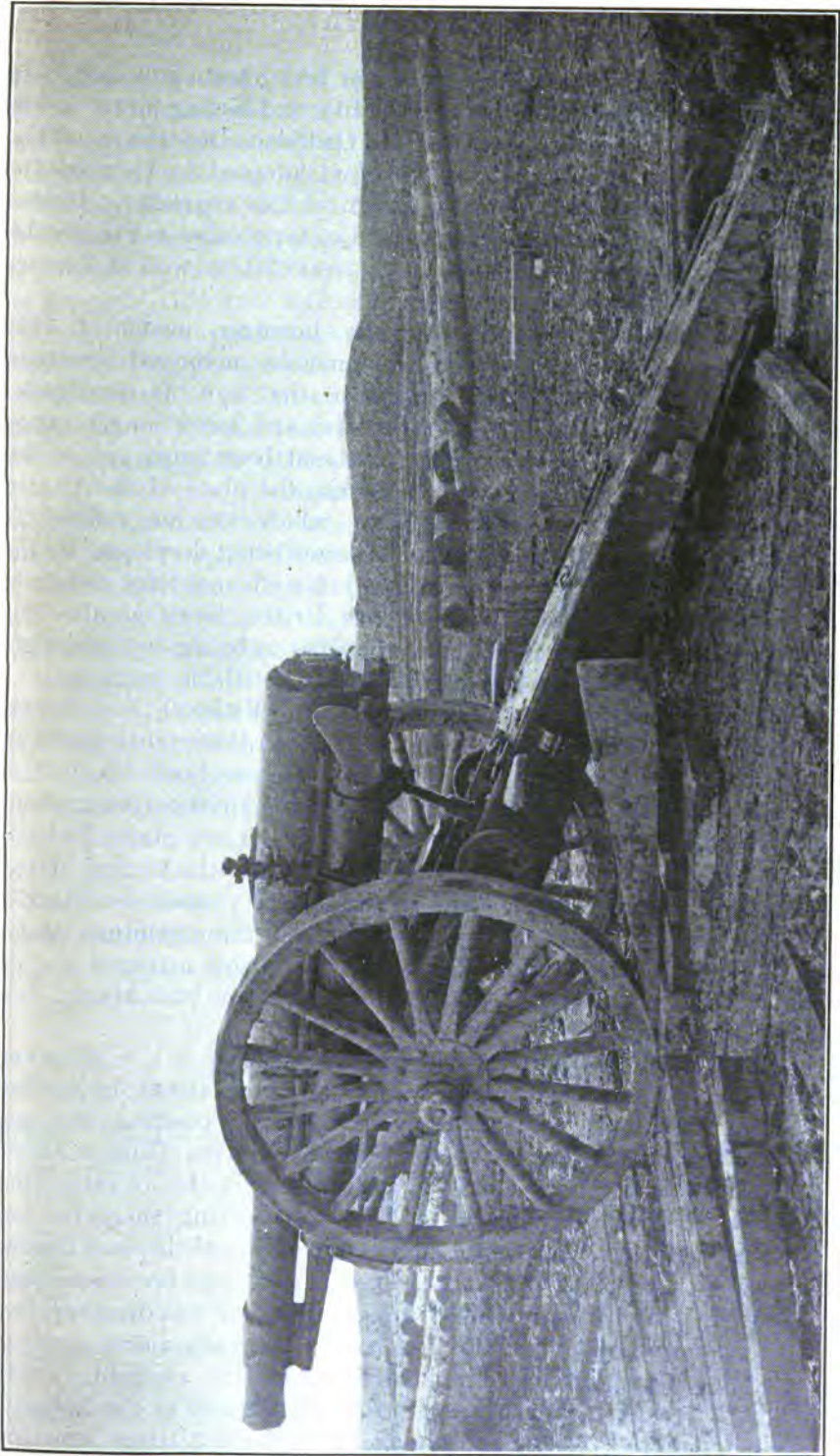

FIG. 7.—4.7-inch field gun, model of 1906.

vation. Previous to its adoption it had been thoroughly tested in service, and from a point of range, mobility, and hitting power it was the best gun of its caliber known to the Ordnance Department at the time. This French design was therefore adopted in view of the fact that the department had no design of this character. It was chosen in preference to the Schneider Co. type (also a French design), because it appeared to be more powerful, as well as a more satisfactory design.

155-mm. field howitzer.—The 155-mm. howitzer, model of 1918 (Schneider), is an exceptionally light, mobile, motorized howitzer, which had been employed throughout the war. It is lighter (weighing with its carriage 7,290 pounds) and has a longer range (13,100 yards) than any howitzer that had been employed at the front. This howitzer was adopted to take the place of the United States 6-inch howitzer, model of 1908, which was not sufficiently powerful, while the more powerful howitzer being developed by the Bethlehem Steel Co. was not sufficiently far advanced for orders to be placed in this country. The 6-inch British howitzer also was considered, but the Schneider type appeared to be the better design, as well as more readily produced with the available facilities.

9.2-inch howitzer.—The 9.2-inch howitzer (Vickers) is a heavy, siege type, motorized howitzer, which has been thoroughly tested in service, and was selected because the Bethlehem Steel Co. in this country had been manufacturing them for the British Government, and would continue their manufacture for the United States Government. The Mark I type is being manufactured in the United States. The weight of the carriage and gun is 16,240 pounds for Mark I howitzer, and 19,040 pounds for Mark II, and the maximum ranges are 10,060 and 13,123 yards, respectively. As this material was of British type, it was also possible to place orders for both Mark I and Mark II abroad.

8-inch howitzer.—The 8-inch howitzer (Vickers) is a high-power motorized howitzer, which has been thoroughly tested in service. The Mark VI weighs 19,100 pounds in firing position and has a range of 10,500 yards. It was selected for the United States because one of the largest ordnance companies in this country (the Midvale Steel & Ordnance Co.) had been making them for the British Government and was prepared to continue their manufacture for this Government. Therefore, a number of these howitzers were ordered from the Midvale Steel Co. soon after war was declared, for, in addition to the fact that this company was already manufacturing them, it had additional manufacturing capacity available which could not be utilized at that time in the manufacture of the 240-mm. howitzer because designs and specifications for the latter were not

yet completed. Additional orders for 8-inch howitzers, Mark VI and Mark VII, complete, were also placed in England, and deliveries were made comparatively early. Additional orders for Mark VI and Mark VIII $\frac{1}{2}$ also were placed with the Midvale Steel & Ordnance Co.

240-mm. howitzer.—The 240-mm. howitzer, model of 1918 (Schneider), is a heavy, long-range, siege type, motorized howitzer, which is capable of rapid transportation and which has been thoroughly tested in service. Howitzer and carriage weigh about 37,920 pounds and the maximum range is approximately 17,000 yards. From a point of range, hitting power, and mobility it was considered the best siege type howitzer of its caliber known to the department. The type was originally a 280-mm. howitzer, designed by Schneider & Co., of France, through the Midvale Steel & Ordnance Co., which company had an order for the manufacture of this type before war was declared. This original order was supplemented by orders to other manufacturers and to Watertown Arsenal, aggregating about 1,500.

12-inch howitzer.—The 12-inch howitzer, model E, is an exceptionally heavy, motorized, mobile howitzer, designed with particular reference to ease of mobility.

Seacoast guns, mortars, and howitzers on mobile carriages.—The 5-inch, 6-inch, 8-inch, 10-inch, 12-inch, and 14-inch guns, 12-inch mortar and 16-inch howitzer are all department designs of seacoast artillery which are being adapted for use in the field, the 5-inch and 6-inch on wheel mounts, and the remaining calibers on railway car mounts. In addition, a number of 6-inch, 7-inch, 8-inch, 10-inch, and 12-inch naval guns of an obsolescent type were secured by the United States Navy Department. These various types are discussed in a subsequent section.

TABLE 3.—*Characteristics of United States seacoast cannon adapted for field use.*

	5-inch sea- coast (wheel).	6-inch sea- coast (wheel).	8-inch sea- coast (R. R.).	10-inch sea- coast (R. R.).	12-inch sea- coast (R. R.).	12-inch mortar (R. R.).	14-inch gun (R. R.).	16-inch how- itzer (R. R.).
Length.....calibers..	45.1	50	32	35	35	10	40	18
Weight.....pounds..	7,583	20,000	32,200	67,000	119,850	29,120	145,000	90,180
Powder-chamber ca- pacity,cubicinches.	660	2,100	3,617	7,120	12,183	2,674	19,323	10,298
A m m u n i t i o n , 1-l type.	Bag.	Bag.	Bag.	Bag.	Bag.	Bag.	Bag.	Bag.
Powder charge, pounds.....	16	27	83	160	280	65	440	225
Travel of projectile, inches.....	195.50	257.7	206	275	343	98.92	471.7	241.43
Maximum pressure, pounds.....	38,000	38,000	38,000	38,000	38,000	37,000	38,000	37,000
Muzzle velocity.....	2,600 1,950	2,600 1,950	2,600 1,950	2,400 1,800	2,600 1,950	1,500	2,350 2,025	1,900
W e i g h t — s h e l l , pounds.....	52	90	200	510	700	700	1,200	1,660
Elevation.....degrees.	0-40	0-40	0-42	-3+38	-5+38	0-65	0-30	20-65
Maximum range, yards.....	*18,400	*18,200	*21,000	*26,248	*29,000	15,000	*30,000	*23,000
Breech mechanism...	Screw.	Screw.	Screw.	Screw.	Screw.	Screw.	Screw.	Screw.
Firing mechanism....	Friction.	Friction.	Friction.	Friction.	Friction.	Friction.	Friction.	Friction.

* Approximate.

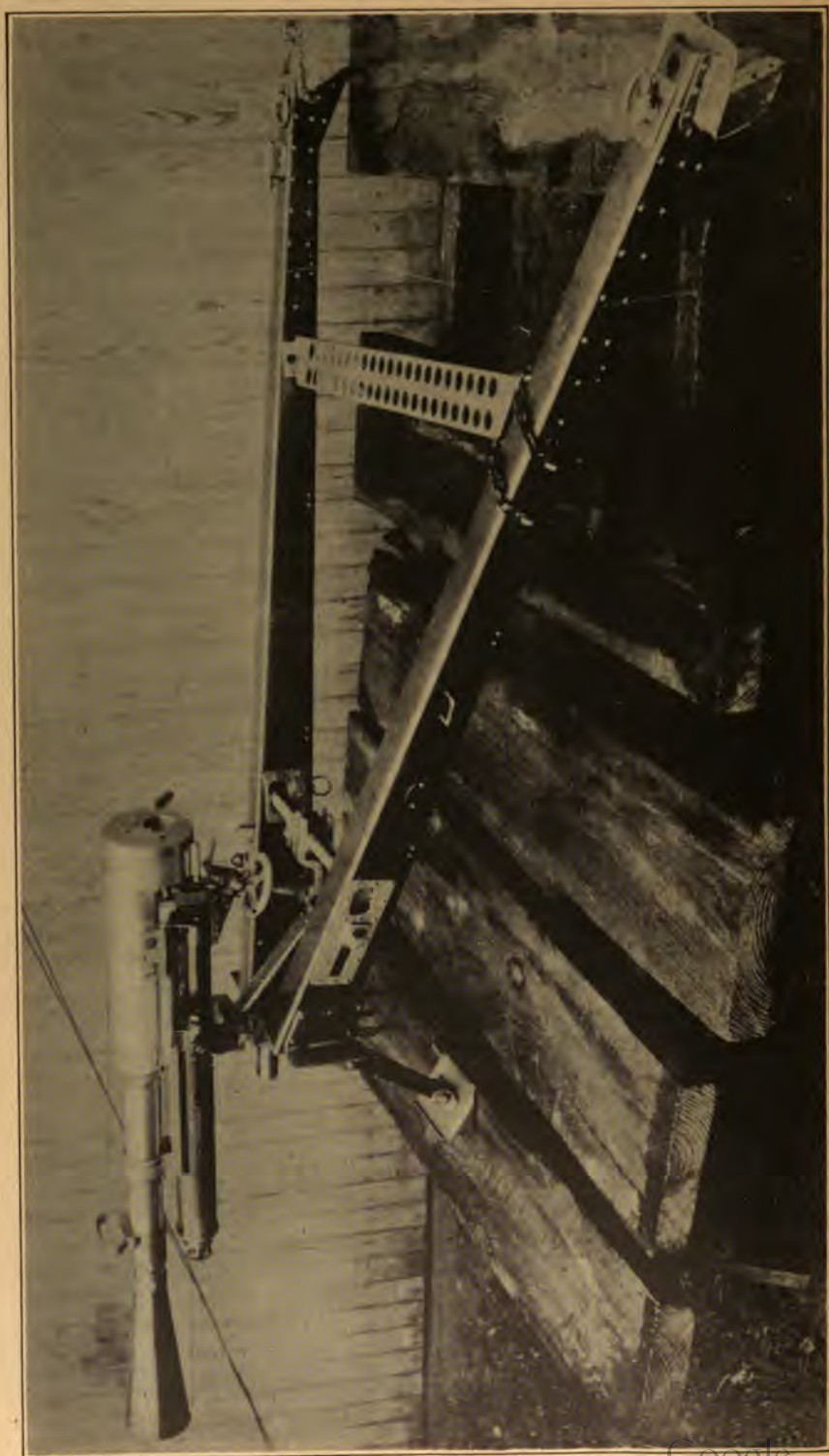

FIG. 8.—37-mm. gun on tripod mount.

II. FIELD ARTILLERY OF THE UNITED STATES ARMY.

THE 37-MM. GUN.

37-mm. gun.—One of the developments of the recent war has been the 37-mm. gun, which with its various modifications has found wide application. Originally hand loading, it has been improved so that now it is issued in automatic and semiautomatic form. It can be used not only with infantry, on account of its extreme portability, but it is also especially adaptable for aircraft and for tanks and tractors.

Model 1916.—The 37-mm. gun, model 1916, is used with advancing troops and is for destroying concrete machine gun emplacements and other centers of resistance. It was developed by Maj. Garnier, of the French artillery. The barrel has left-hand rifling and is mounted on a tripod mount of split-trail type with elevating and traversing mechanism, the recoil being taken up by spades. The gun is divided for transportation. One portable group, which weighs 106 pounds, consists of the barrel, breech and recoil mechanism, and is carried by two men. The second group, weighing 63 pounds, consists of the tripod mount and is carried by two men. The gun is provided with telescopic sight for direct fire and a quadrant sight for indirect fire, which is frequently employed. With the combination tripod mount, the gun is transported on a wheeled carriage, which is limbered to a two-wheeled ammunition cart, drawn by one horse. This cart is practically identical with the machine gun ammunition carts of service type. One gun is attached to each platoon, and the personnel, commanded by a lieutenant, consists of a sergeant, a corporal, six gunners, and one driver.

Ballistic properties.—The ballistic properties of the 37-mm. gun are indicated below:

- Muzzle velocity, 1,310 feet per second.
- Maximum possible range, 2,400 meters.
- Maximum effective range, 1,500 meters.
- Possible rapidity of fire, 35 shots per minute.
- Possible length of recoil, 10 inches.
- Usual recoil (approximately), 8 inches.

Plan of manufacture.—The plan of manufacture adopted in the United States involved separation into groups of parts, and at first

orders were placed covering 1,200 each of the required groups and gauges for assembling. The various groups of parts for the contractors were divided as follows:

Barrel groups.
Breech groups.
Recoil groups.
Mount groups.

Axle groups.
Ammunition carts.
Telescopic sights.

By May 20, 1918, manufacturers of the various groups were directed to ship their various assembly groups to the Maryland Pressed Steel Co. for assembly, and 10 units were assembled and shipped to the Aberdeen Proving Ground, where they were proof fired and their performance was considered satisfactory. In the meantime, it had been desired to acquire a number of modified 37-mm. guns for tanks, and manufacture was started on these in the summer of 1918.

THE 37-MM. SEMIAUTOMATIC MOTOR GUN, MODEL 1918.

Development.—The 37-mm. semiautomatic motor gun of the Ordnance Department, originally was developed by the French Government for use in the air service in the latter part of 1917. It was straightway considered a remarkably successful weapon, and it was stated that in using it excellent results were obtained by Capt. Guynemer and Nungesser.

Nature.—This motor gun is designed for use in combat planes and is mounted directly to the crank case of the Liberty or King Bugatti motors. It is mounted between the two rows of cylinders and is geared up from the crank shaft. The American gun is almost an exact copy of the French gun, but it has been modified slightly to make it adaptable to the two American motors named above. It is provided with two barrels—one rifled for high explosive and incendiary ammunition, and the other smoothbore for canister. (See Aircraft armament, page 251.)

Weights and dimensions.—The weights and dimensions of the American gun of 1918 model are as follows:

Weight (complete), 105 pounds.
Total length, 71.57 inches.
Total area across section of bore, 1.7275 square inches.
Length of bore, calibers 45.55.
Diameter over powder chamber, 2.91 inches.
Diameter of muzzle, 2.05 inches.
Capacity, with cartridge case in place, 113.29 cubic inches.
Grooves, 12.
Grooves, width, 0.3223 inches.
Grooves, depth, 0.0157 inches.
Width, lands, 0.0591 inches.
Velocity of rotation at muzzle, 21,806 revolutions per minute.
Twist calibers, 1 in 29.9.

Operation of the gun.—The semiautomatic feature of the gun consists of an arrangement for opening the breech and ejecting the cartridge case during the counterrecoil after the gun has been fired. The breechblock is of the drop-block type, and its opening is effected by cams suitably mounted on bracket plates and bolted to the crank case. The recoil is practically identical with the recoil mechanism of the 37 mm. gun, model 1916, which is of the combination oil and spring type.

Ammunition.—The semiautomatic motor gun is provided with ammunition which gives a muzzle velocity of 400 meters per second to high-explosive supersensitive fuze incendiary and canister shell. This high-explosive supersensitive fuze is of the differential air-pressure type, and is stated to be very satisfactory. The canister charge is contained in a light brass case slotted on the side in order to facilitate the spread after the charge has left the muzzle.

Use of the gun.—The 37-mm. gun is used in connection with a synchronized machine gun, which is also mounted on the airplane. This synchronized gun is provided with tracer bullets, and the pilot is able to determine whether the machine points in the direction of the target by observing the course of these tracer bullets. When he finds that the synchronized gun is pointing directly at the enemy plane, the 1-pounder gun is fired. The first order was put under way in the early summer of 1918 and was for 100 of these guns which were ready for proof-firing in October, 1918.

THE 37-MM. FULL AUTOMATIC CANNON MODEL 1918 FOR AIRPLANE SERVICE.

The 37-mm. full automatic Puteaux gun was a European development of the semiautomatic weapon by the French engineers, and in the spring of 1918 drawings were received in the United States from France, and officers who had experience both in France and in the construction of guns for aircraft use were assigned to the development. Two types of guns were evolved from the French model, one of which was an exact copy of the Puteaux full automatic, while the other was designed entirely in the United States by the Poole Engineering and Machine Co., and was known as the 37-mm. Baldwin full automatic motor gun. Both of these weapons were in the experimental stage in the early autumn of 1918, and neither had been adopted as a service weapon, although 100 of the French type were under order at the time of the signing of the armistice, and would probably have been available for issue in February of 1919 for field test by the air service.

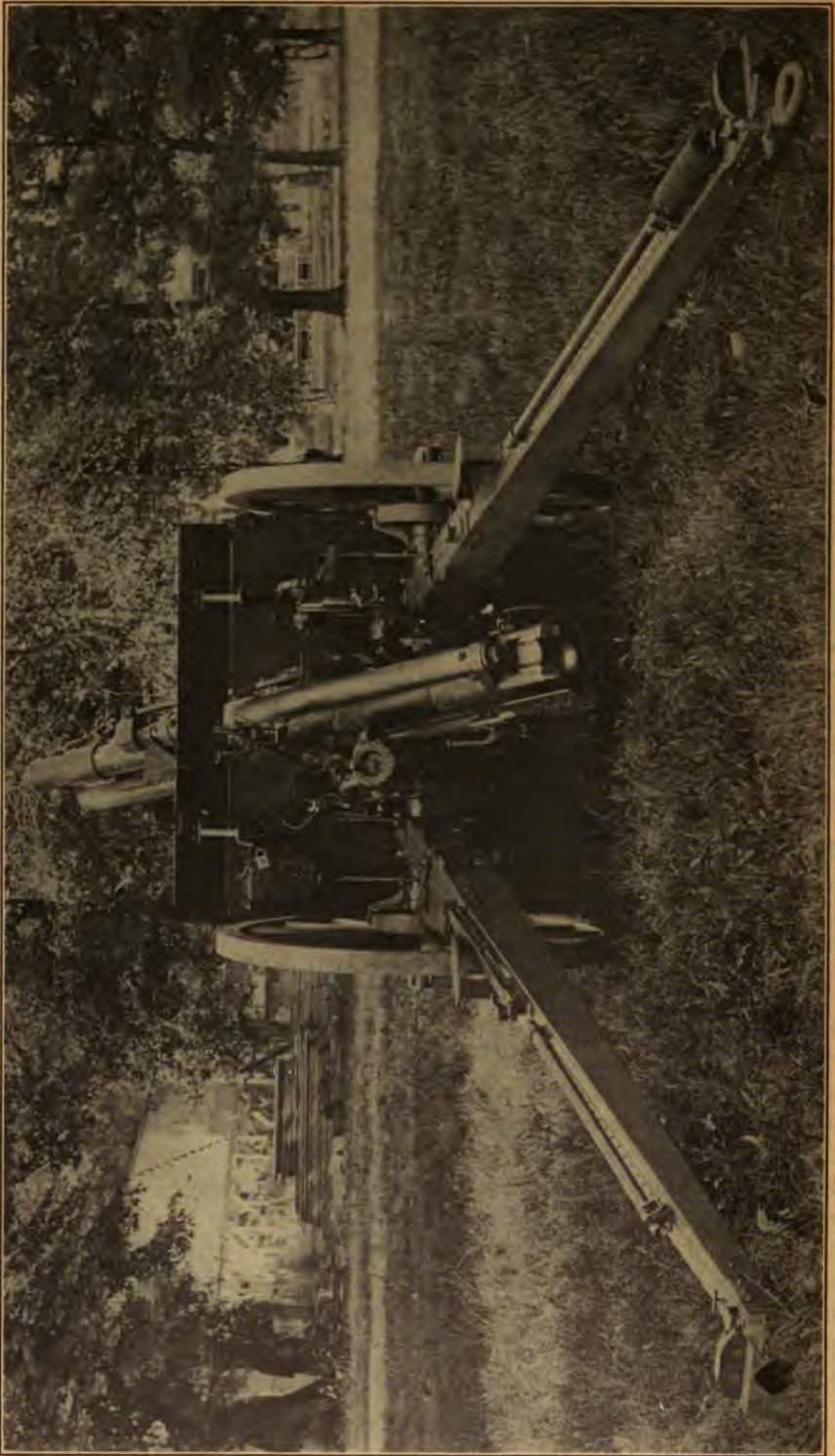

FIG. 9.—75-mm. field gun, model 1916, rear view, gun 23° elevation, maximum left traverse.

75-MM. GUN—UNITED STATES MODEL 1916.

General nature.—The United States model 1916, 75-mm. field gun, is an adaptation from the United States 3-inch field gun, arranged with a split trail and having greater traverse and greater elevation than either the French or British models of this caliber.

Construction.—The model 1916 gun is arranged with hydrospring recoil or recuperator, located above and below the gun, which affords a smooth recoil action. The gun proper consists of a tube and jacket and a breechblock opened and closed by means of a handle on the right-hand side of the breech. With the breechblock closed, the handle is in vertical position, and to open, the handle is pulled toward the back of the gun and the breechblock opens downward. When the cartridge is pushed home into the breech, the breechblock is automatically closed, and after firing, pulling down the handle not only opens the breech, but ejects the cartridge case. This breechblock mechanism lends itself to rapid operation and for speed compares favorably with the French model 1897.

Carriage.—The carriage is arranged with a split trail and with a pintle traverse, which permit a greater depression, elevation, and traverse than is possible with either the French or the British model, and as far as this advantage is concerned the American gun is distinctly superior. With small elevations and small traverse, as in the French and British models, the pointing of the gun must be arranged by the position in which the trail is located in the ground by the shock at the time of firing, but with the American gun a single setting of the trail and the adjustment of direction and elevation on the carriage enables a wider angle of fire to be secured than with the other models.

Recoil mechanism.—The recoil mechanism involves one cylinder containing oil, located above the gun, and two cylinders containing springs, located below. The spring cylinders are attached to the carriage, and the rods by means of which the springs are compressed at the time of recoil are attached to the breech-ring forging. The upper cylinder is also attached to the breechblock forging, and its piston rod is secured to the carriage. The adjustment of the recoil and counterrecoil depend upon graduated ports in the oil cylinder, and the gun is returned to firing position by means of the springs.

Original orders.—Original orders were placed for several thousand of the United States model 1916 gun, but it was decided later to change the production at one of the most important plants to the French model, which, while involving a loss of time, facilitated quantity production for the future. Of 250 guns which had been completed by July 1, 1918, 51 were taken for use as antiaircraft guns on auto mounts.



FIG. 10.—3-inch gun caisson, model of 1916, rear view.

Limbers, etc.—Limbers, caissons, caisson limbers, battery wagons, forge limbers, store wagons, store limbers, two-horse reels, and six-horse reels and carts are the same for the United States, British, and French guns.



FIG. 11.—3-inch gun caisson, model of 1916, left front view, door open, apron down, fuze setter bracket down.

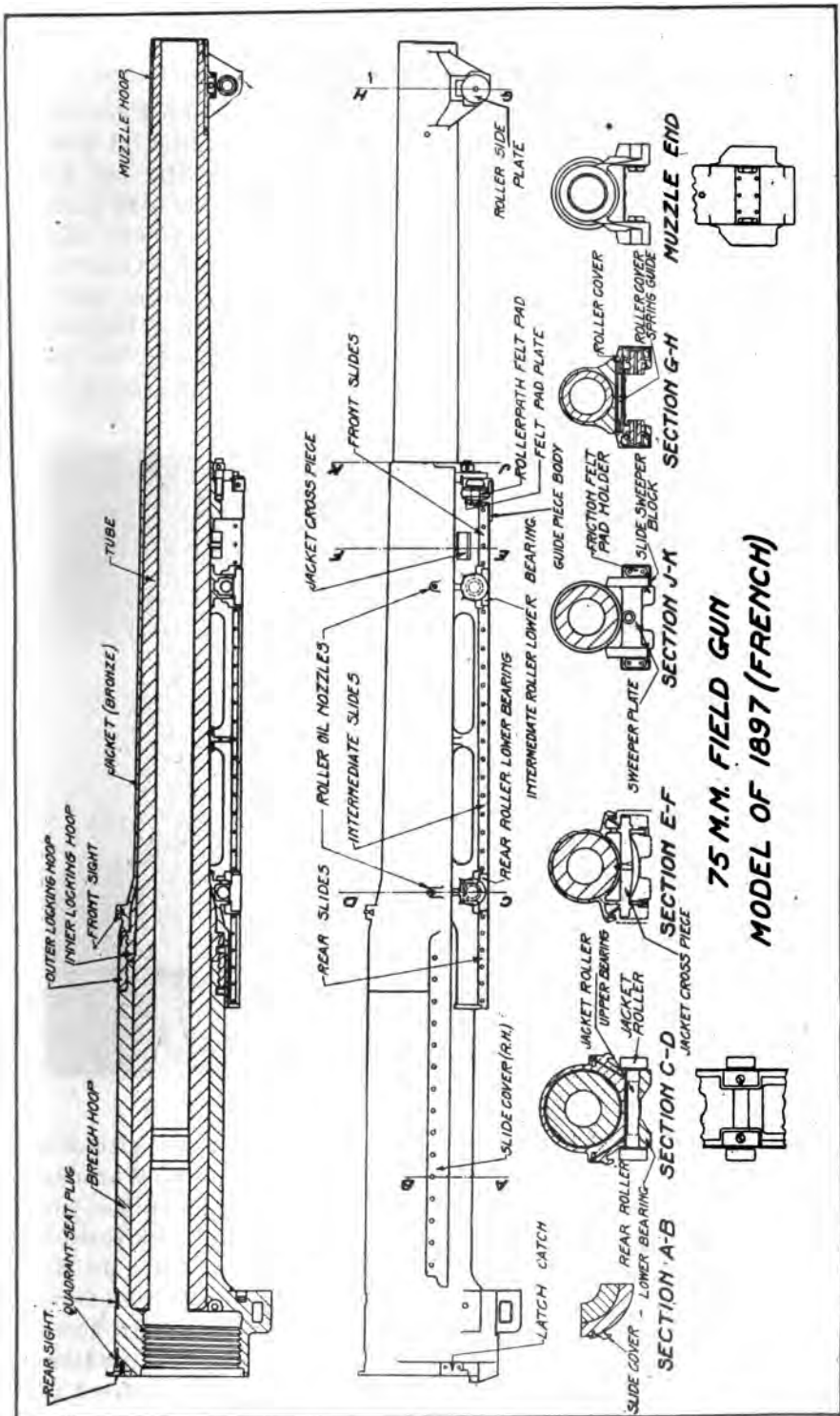

Fig. 12.—75-mm. field gun, model of 1897 (French).

THE FRENCH 75-MM. FIELD GUN.

General nature.—The French 75-mm. field gun, adopted for the service of the United States troops in Europe, dates back to 1897, when it was perfected by Captains Sainte Claire Deville and Rimailho and adopted for the French Army. This gun consists essentially of a steel tube 33 calibers in length with rifled bore and reinforced on the outside near the breech by a breech hoop. Over the middle section there is a bronze envelope known as the jacket, which surrounds the tube. The breech hoop and jacket are joined together to the interior tube by two hoops known, respectively, as the outer locking hoop and the inner locking hoop, thus preventing all sliding with respect to the tube.



FIG. 13.—75-mm. field gun, model of 1897 (French), breech open.

Breech mechanism.—The breech mechanism consists essentially of a movable screw or breechblock which turns in the breech recess around an imaginary axis parallel to the axis of the bore of the cannon, but situated below the bore. The breechblock is provided with threads which engage in corresponding threads of the breech hoop. In the unlocked position an opening in the breechblock is directly in front of the powder chamber, so that the cartridge can be introduced through the breech. In the locked position, effected by a rotation of 120 degrees, the solid portion of the block is directly in front of the chamber and completely closes it. The breechblock is rotated

by means of a handle fixed on an arm fastened to the rear face of the breechblock, so that a single movement suffices either to open or close the breech. After the gun is open and the breech closed, it is fired by a spring hammer operated with a lanyard, which forcibly strikes the firing pin. The firing pin is seated in the breechblock, and only when the breech is in the locked position is it directly in line with the primer at the center of the base of the cartridge. This is one of the mechanical arrangements provided to prevent premature firing and thus insure safety. Obturation, or the retention of the gases generated by the explosion of the propelling charge, is secured by the expansion of the metal cartridge case against the interior wall of the gun. When the breech is opened the shoulder

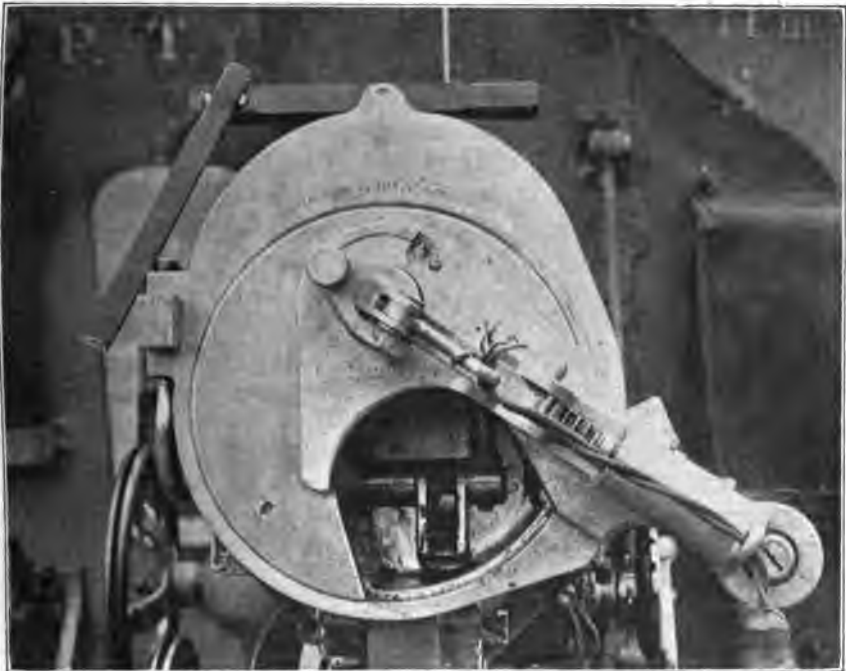

FIG. 14.—75-mm. field gun, model of 1897 (French), breech closed.

of the empty cartridge case is seized by the extractors and ejected from the gun. The recoil of the gun is at the rate of probably 9 meters per second, and the recoil weight is 500 kilograms. The recoil mechanism of this 75-mm. gun is hydropneumatic and is provided with a recuperator. The braking action is caused by the resistance offered to the movement of a piston by the liquid, and the return of battery is accomplished by the force of compressed air in the recuperator.

Carriage.—The carriage of the 75-mm. gun has a trail spade to fix it in the ground and a special brake for the wheels, which has two

solid metallic shoes fitted with projecting parts, which engage in the ground. The 75-mm. carriage is provided with an independent line of sight. In the modern French 75-mm. field gun, as in the weapons of most services, the sighting is done almost entirely by indirect observation based on the observations of an officer or other observer at a distance.

Shrapnel.—In the French service the projectiles are propelled by a charge of 720 grams of powder B.S.P. (AM), which is composed of lamellæ, 140 mm. long, 18 mm. broad, and 0.9 mm. in thickness. This powder is somewhat translucent, supple, and of hornlike appearance, burning very slowly in free air, but when confined the pressure of combustion reaches 2,400 atmospheres on the inside of the gun, and as no solid residue is left, it is on that account known as smokeless powder. In order to obtain simultaneous ignition of the elements of the charge, an amount of 1 to 2 per cent black powder is added.

The shrapnel discharged from this gun weighs 7.2 kilograms and consists of a cylindrical ogival steel envelope, in which there are 300 balls, weighing 12 grams each, formed of lead, hardened with anti-mony and mixed with compressed black powder. This shell is traversed along its axis by a tube, perforated at the bottom, by means of which flame coming from the fuze in front is transmitted to the base of the charge. When the explosion of the charge is thus brought about, the ogive or head is easily forced off, and the bottom of the shell acts like a small cannon, shooting out the interior shot. For American Ammunition, see Table 15, Artillery Ammunition, on page 138, and also Table 16, Projectiles, facing page 138, as well as the accompanying text on Artillery Ammunition.

French and German field guns.—A comparison of the two field guns most prominently used on the battle fields of Europe, namely, the French 75 and the German 77, is given in the accompanying table and also further on, on page 130 in the chapter on European Artillery where other types of foreign guns and howitzers are discussed.

	French.	German.
Caliber.....	75-mm.....	77-mm.....
Length.....	2.47 m.: 33 cal.....	2.1 m.: 27.3 cal.....
Weight of projectile.....	7.2 kg., 5.3 kg.....	6.85 kg.....
Initial velocity of projectile.....	529 m.....	465 m.....
Velocity at 1,000 meters.....	413 m.....	369 m.....
Velocity at 3,000 meters.....	290 m.....	279 m.....
Number and weight of shrapnel balls.....	300 of 12 gr.....	300 of 10 gr.....
Danger zone for a target (1 meter in height):		
At 1,000 meters.....	41 m.....	31 m.....
At 3,000 meters.....	7.6 m.....	6.5 m.....
Weight of gun and carriage.....	1,100 kg.....	950 kg.....
Weight of limber.....	1,900 kg.....	1,800 kg.....
Weight of caisson loaded.....	1,950 kg.....	1,850 kg.....
Maximum number of shots per minute.....	20.....	20.....

75-MM. FIELD GUN, MODEL 1917, BRITISH.

General characteristics.—This gun is built up of alloy steel, consisting of a tube, a series of layers of steel wire, jacket, and breech ring. The tube extends from the rear end of the chamber to the muzzle, and over the rear portion are wound 15 layers of 0.04 by 0.25 inch steel wire. The jacket is fitted over the exterior of the wire and the tube, and is secured longitudinally by shoulders. The breech ring is screwed on the jacket at the rear and secured by a set screw. The breech ring on its upper side has a lug for the attachment of the hydraulic buffer. The longitudinal projections on each side of the jacket form guides for the gun when in the cradle of the carriage.



FIG. 15.—75-mm. field gun, model 1917, British.

Weights and dimensions.—The principal weights and dimensions of the British 75-mm. field gun are as follows:

Weight.....	1, 010 pounds	Rifling:	
Caliber.....	2. 95 inches	Number of grooves.....	24
Total length.....	88. 21 inches	Width of grooves... ..	0. 2874 inches
Length of bore.....	83. 915 inches	Depth of grooves... ..	0. 02 inches
Length of rifled portion		Width of lands.... ..	0. 0992 inches
of bore.....	72. 72 inches		

Twist, right hand, zero turns at origin to one turn in 75 inches (25.4 calibers) at 9.72 inches from muzzle, thence uniform.

Breech mechanism.—The breechblock is of the interrupted screw type, tapering toward the rear with two threaded and two blank sectors, in the rear of which is a cylindrical section, larger in diameter, on which is a thread for securing the block to the carrier. The breech recess of the gun is threaded and slotted to correspond with the threads on the block.

The block carrier is hinged on the right of the breech recess by the carrier hinge bolt and is bored out and threaded to receive the block as already mentioned. Hinged to the rear face of the carrier is the hand lever, provided with bevel teeth which engage with corresponding teeth on the rear face of the breechblock so arranged that when the lever is pulled to the right the first movement of the lever unlocks the breechblock and the block and carrier are swung into the loading position. The hand lever is retained in the closed position by means of a catch with a flat spring, pivoted in the lever, one end of which engages in a recess in the lower lug on the rear face of the carrier.

The firing mechanism is of the continuous pull type so arranged that a gun can not be fired before the breechblock is home and the hand lever locked. It consists of a striker with firing pin, rebound block and securing pin, firing spring, guide for spring and tripping pieces, and is fitted to the center of the breechblock.

The extractor is of steel and is hinged to the right side of the gun, and on the inner end are two arms which clip the rim on the cartridge, while its outer end forms a lug by means of which the extractor is automatically actuated in opening the breech.

Action of the breech mechanism.—The breech is opened by grasping the hand lever and at the same time compressing the hand-lever retaining cap. This releases the catch from the recess on the carrier. The hand lever is then rotated to the rear.

During the first part of this movement (120 degrees) the block is rotated and its threads disengaged from those of the gun, at which time the retaining catch in the carrier will drop into its notch in the block at the moment of swinging the carrier from the gun. The block is now locked against further rotation in either direction. During a further rotation of the hand lever of about 110 degrees the block and carrier swing about the carrier hinge bolt clear of the breech recess, the pallet on the carrier forces the extractor lever inward, unseating the cartridge case before the end of the 110 degree movement, and finally ejects the case free of the gun. When another round is inserted the rim of the cartridge case comes in contact with the extractor and forces it partly home. In closing the mechanism the movements are simply reverse of opening; as the block carrier comes in contact with the breech face of the gun, the retaining catch is forced rearward, unlocking the block

from the carrier. Further rotation of the operating lever rotates the breechblock, causing its threads to engage those of the gun. This engagement of threads moves the block forward, due to the pitch of the threads, and firmly seats the cartridge in the gun. At the final motion of the hand lever its catch engages in the recess in the left face of the lower hand lever hinge bolt lug, locking the block in the closed position.

Action of the firing mechanism.—The trigger is actuated by a direct pull on the firing gear of the carriage, thus partially revolving the firing lever, by means of which the striker is forced to the rear, and the guide for the spring to the front. The main spring is thus compressed until the projecting toe on the inner end of the firing lever slips past the front end of tripping piece, in striker guide block, when the striker is free to go forward with momentum, due to the energy stored up in the compressed main spring, and detonates the percussion primer of the cartridge.

Source of supply.—On May 21, 1917, 268 of the British field guns were ordered from the Bethlehem Steel Co., chambered to 3-inch caliber for the regular U. S. field gun ammunition, in place of the 3.3-inch of the British service. On June 29 these orders were changed so that all the American field guns would use the same 75 mm. ammunition. The first delivery was made in March, 1918, and the original order for 268 was increased to 700 in May. By July, 180 had been finished, proof-fired, and distributed to the various proving grounds and training camps, and then guns were shipped abroad as fast as available. Additional orders were placed, so that, at the time of signing the armistice there were 2,868 75 mm. guns Model 1917, British, on order, and of these 822 had been completed to December, 1918.

75-MM. AIRCRAFT GUN AND MOUNT.

General nature.—A 75-mm. aircraft gun has been designed as an experimental model with the intention of using it for bombardment purposes. This gun was sent to the Aberdeen Proving Grounds for test late in the summer of 1918, and embodies a number of novel features. It consists of a 2.95-inch mountain gun and mount, equipped with the recoil springs and buffer, and is designed to hang normally downward through the floor of the fuselage of an airplane.

Ballistic data.—This gun will give about 600 foot-seconds velocity with a 12½-pound projectile, with a reaction of approximately 1,500 pounds on the trunnions. The mount and gun will weigh about 1,150 pounds, and can be traversed about 45 degrees from the vertical, fore and aft, and 10 degrees from the vertical sideways.

Operation.—The gun is operated by means of two handwheels about 4 feet from the rear of the gun. An open sight is attached by means of links to the gun, and is also operated by means of the same handwheels.

4.7-INCH FIELD GUN.

Models used.—Two types of 4.7-inch guns are used in the United States service, as follows—4.7-inch field gun, model of 1906, and 4.7-inch antiaircraft trailer mount gun, model of 1918.

4.7-inch field gun, model 1906.—The field gun, model 1906, is manufactured in the United States and on a war footing is motorized. The important parts of the gun and equipment include the carriage, the gun itself, the tractor, motor truck for ammunition, sights, two-wheeled limber, caisson, fire control, tools, and accessories.



FIG. 16.—4.7-inch field gun, model of 1906.

Gun carriage, model 1906.—The gun carriage is the type known as a long recoil, in which the gun is permitted to recoil on the carriage to render the latter stationary under firing stresses. The recoil consists of a hydraulic cylinder filled with oil, placed parallel to the gun, and attached to the cradle on the carriage. The recoil cylinder controls the backward travel of the gun upon discharge and springs return the piece to the original firing position. The carriage may be considered as composed of the following principal parts—wheels, axle, the cradle (for housing and supporting the recoil mechanism and the gun), the trail, a heavy steel beam extending from the axle approximately 9 feet to the rear, equipped with a spade at the end, the traversing mechanism, operated by hand, to move the gun horizontally

to the right or left as required; the elevating mechanism, operated by hand, controls the necessary elevation of the gun.

Limber.—The limber, a two-wheeled vehicle, to which the trail of the carriage is fastened to form a four-wheeled complete carriage for the gun when traveling consists only of a pair of wheels and axle, the top carriage pivoting on the axle to make the fifth wheel and a connecting pole. Attachments are provided for carrying certain small implements.

Caisson.—The caisson is built primarily to carry ammunition and is provided with an ammunition chest of sufficient size to carry either shrapnel or high explosive steel shell. It is also equipped with fixtures for holding picks, shovels, and other tools on the outside of the ammunition chest. By removing the connecting pole and adding double and single trees, this vehicle may be transformed into a caisson limber suitable for horse traction.

Motorized 4.7-inch battery.—One battery consists of four guns. One regiment consists of six batteries or 24 guns. A motorized 4.7-inch artillery regiment is equipped with 24 guns, 64 tractors, four 2½-ton tractors, and sixty 5-ton tractors, distributed as follows:

- (a) One 2½-ton tractor on headquarter's reel and cart.
- (b) Three 2½-ton tractors on battery reels.
- (c) Twenty-four 5-ton tractors on 24 guns.
- (d) Thirty-six 5-ton tractors on 72 caissons, each tractor pulling 2 caissons.
- (e) One hundred ammunition trucks, individual motor driven.

No caisson limbers are used in motorized batteries as the caisson limber is replaced by a second caisson. On good roads it is considered that one 5-ton tractor can pull a complete gun section.

Ammunition.—Fixed ammunition is used in the 4.7-inch field gun, made up either with shrapnel or high-explosive common steel shell.

Range of model 1906.—The maximum elevation of the 4.7-inch field gun, model of 1906, carriage, without digging trail in, is 15 degrees.

Elevation, 15 degrees.

Projectile.	Range (meters).
60-pound shrapnel	7, 600
45-pound shell, short fuze	8, 250
45-pound shell, long fuze	8, 100

Greater elevations.—The quadrant attached to the carriage is graduated to 25 degrees, and this elevation can be obtained by digging in the trail.

Elevation, 25 degrees.

Projectile.	Range (meters).
60-pound shrapnel	9, 900
45-pound shell, short fuze	10, 200
45-pound shell, long fuze	10, 050

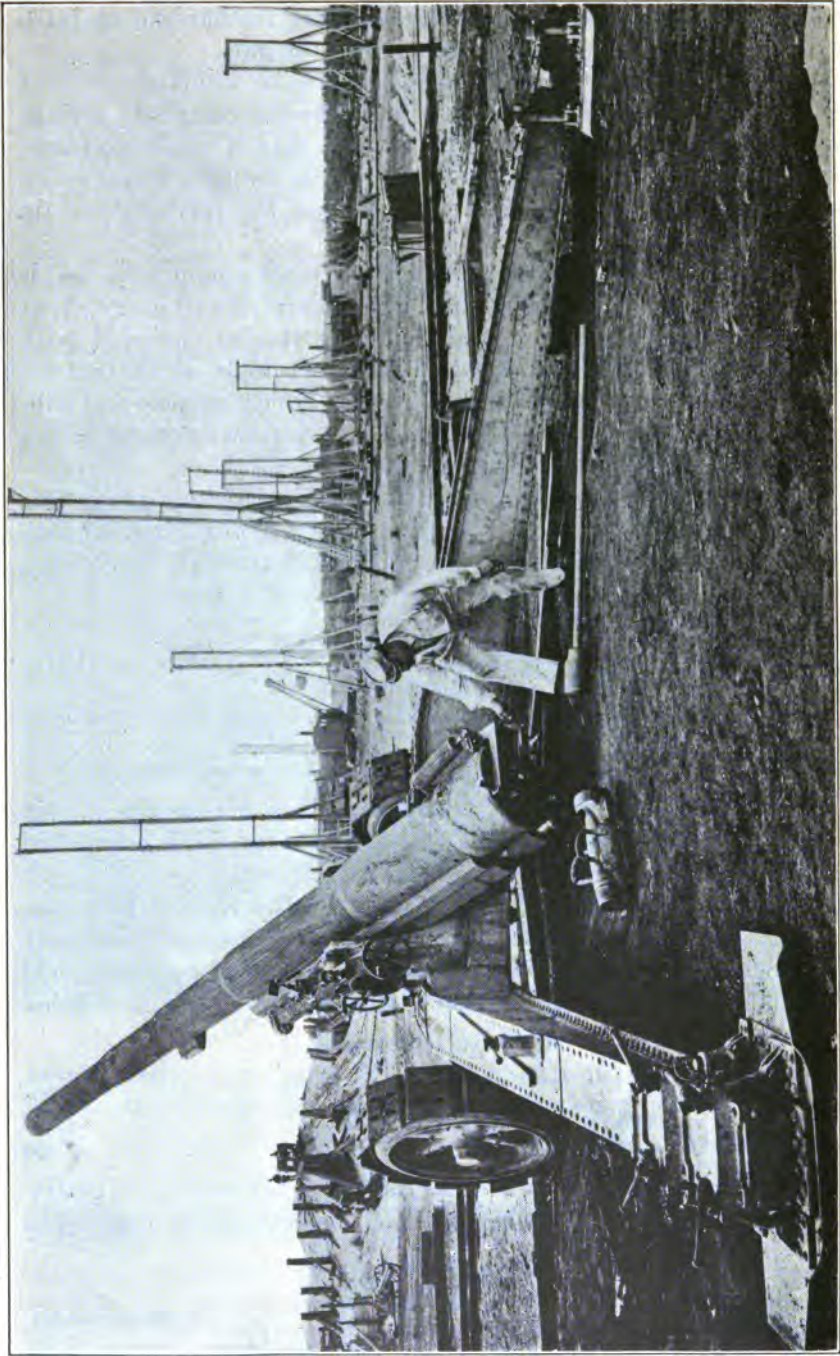

FIG. 17.—155-mm. gun (Filloux).

The above ranges are taken from the provisional range table for the 4.7-inch gun, model 1906, dated April 22, 1918.

Maximum elevation.—By sinking the trail and using a hand quadrant the maximum possible range at an elevation of 41 degrees is obtained.

Elevation, 41 degrees.

Projectile.	Range (meters).
60-pound shrapnel	11,600
45-pound shell, short fuze	12,000
45-pound shell, long fuze.....	11,800

These ranges at 41 degrees elevation are calculated ranges and are approximate only.

4.7-inch antiaircraft trailer mount gun model 1918.—This gun is designed for antiaircraft work and is hauled by tractors of caterpillar type. The gun and equipment consist of trucks for ammunition, fire control, sights, carriages, tools, and accessories. This gun is in the experimental stage. It has a range of 11,000 yards at an elevation of 80 degrees; muzzle velocity, 2,400 feet per second.

Source of matériel.—The 4.7-inch field gun is exclusively an American production, and at the beginning of the war there were 64 pieces of this caliber on hand, of which two belonged to the Navy and two to the United States Marine Corps. Of the balance, the greater number was shipped to France, the few remaining being distributed between the different proving grounds, while the manufacture of the new guns was being undertaken on a large scale by a number of manufacturers.

155-MM. GUN, MODEL 1918 (FILLOUX).

General nature.—The 155-mm. model of 1918 MI (Filloux) is built of a tube strengthened by the following jacket and hoops: Beginning at the breech end, the breech ring, the jacket, the hoop "A," hoop "B," the clip hoop set on the hoop "B." The jacket, hoop "A," and the clip hoop have on each side a projection fitted with bronze clips which are engaged in the corresponding guides of the cradle when the gun is either at rest or in recoil. The counterbalance bracket is attached to the jacket. The breech ring is screwed cold on the jacket and fixed by a screw. The breechblock is of the interrupted screw type. The block carries with its operating lever hinge pin and rack, the obturating mechanism, the firing mechanism, and the counterbalance. The firing mechanism block is interchangeable with that used on the 155-mm. howitzer, model of 1918 (Schneider), the 155-mm. howitzer, model of 1917 (Bethlehem), the 8-inch howitzer, model of 1917 (Vickers, Mark VI), the 240-mm. howitzer, model of 1918 (Schneider).

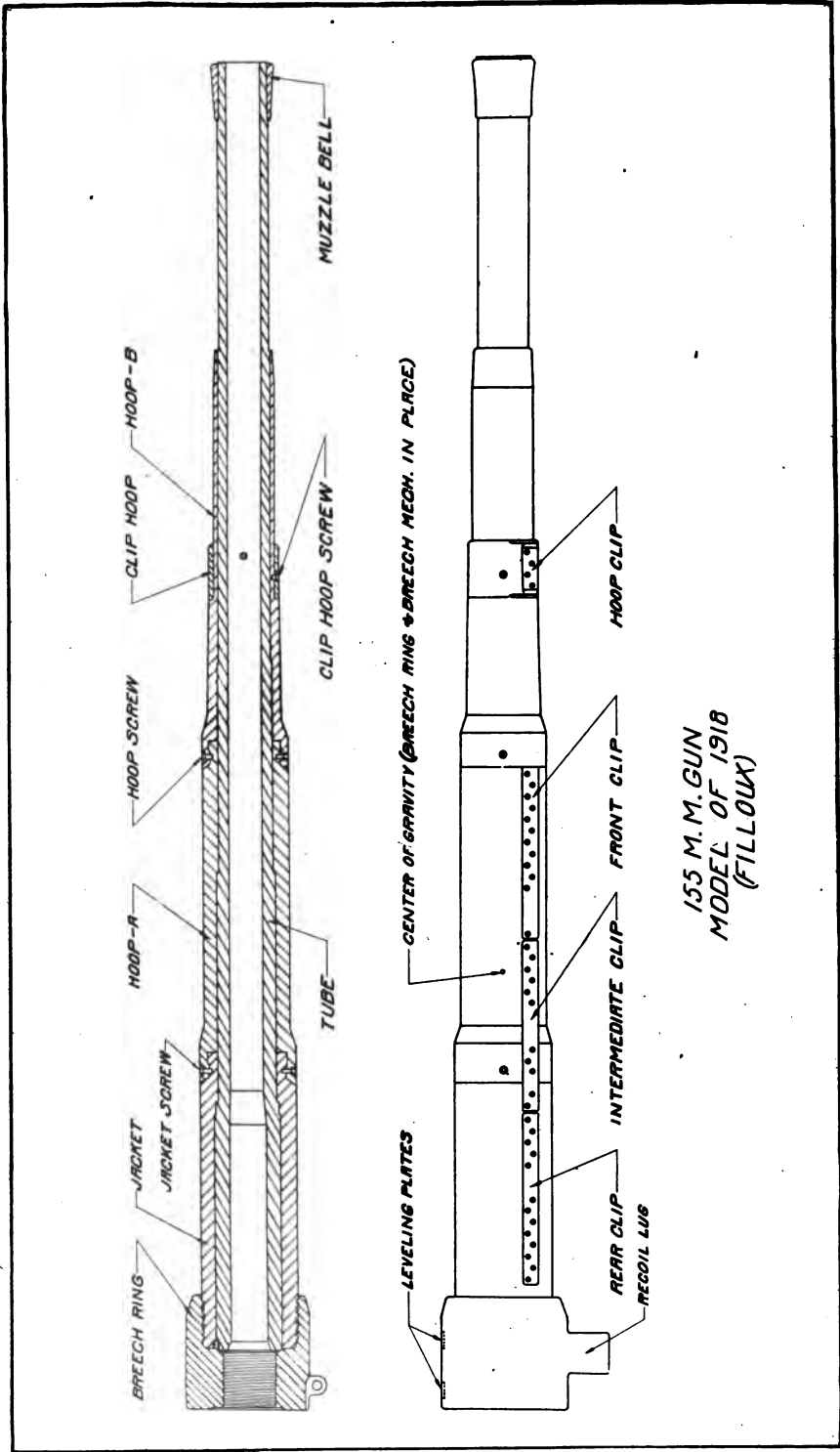

155 M. M. GUN
MODEL OF 1918
(FILLoux)

FIG. 18.—155-mm. gun, model of 1918 (FILLoux).

Important data.—The weights, dimensions, etc., of this gun are as follows:

Material.....	Alloy steel.
Weight, including breech mechanism.....	8,795 pounds.
Length (muzzle to rear face of breech ring).....	232.87 inches.
Caliber.....	155 millimeters (6.1024 inches).
Chamber:	
Diameter.....	6.6929 inches.
Length to base of projectile.....	37.0865 inches.
Capacity.....	1,342 cubic inches.
Rifling:	
Number of grooves.....	48
Twist of rifling right hand, uniform one turn in 29.89 calibers, inclination.....	6 degrees.
Travel of projectile.....	185 inches.
Firing mechanism.....	Percussion.

155-MM. HOWITZER.

Schneider model used.—As the 6-inch United States howitzer, model of 1908, was not sufficiently powerful to meet the conditions of modern war, the 155-mm. (Schneider), model of 1918, was adopted. This is an exceptionally light, mobile, motorized howitzer, thoroughly tested throughout the war and having a longer range than any other howitzer of approximately this caliber that had been used during the conflict. The howitzer and its equipment are of French design and were built in the United States from copies of the French drawings.

Bethlehem type.—A powerful howitzer of 6-inch caliber developed for the United States Army by the Bethlehem Steel Co. had not reached a stage at which it was possible for orders for prompt delivery to be placed in the United States. This Bethlehem type was, however, placed under construction previous to the outbreak of the war, and the pilot piece was completed early in 1917. The Bethlehem howitzer is mounted on a carriage almost identical in design with that of the 4.7-inch gun carriage, model of 1917 (Bethlehem), having the same traverse of 40 degrees and elevation to 40 degrees. The counterrecoil system is hydropneumatic. It was expected that an increased velocity would be obtained over that of the Schneider, namely, 1,600 feet per second, with a 95-pound shell. The breech mechanism is identical with that of the United States type of 155-mm. (Schneider). The original order called for 55 of these 6-inch howitzers which were designed to use a 6-inch brass cartridge case, but it was later decided to bore them for 155-mm. ammunition, using separate loading with powder bags. No further orders were placed for howitzers of this type.

General description.—The 155-mm. (Schneider) howitzer, model of 1917, differs from the model of 1915 howitzer in that it employs

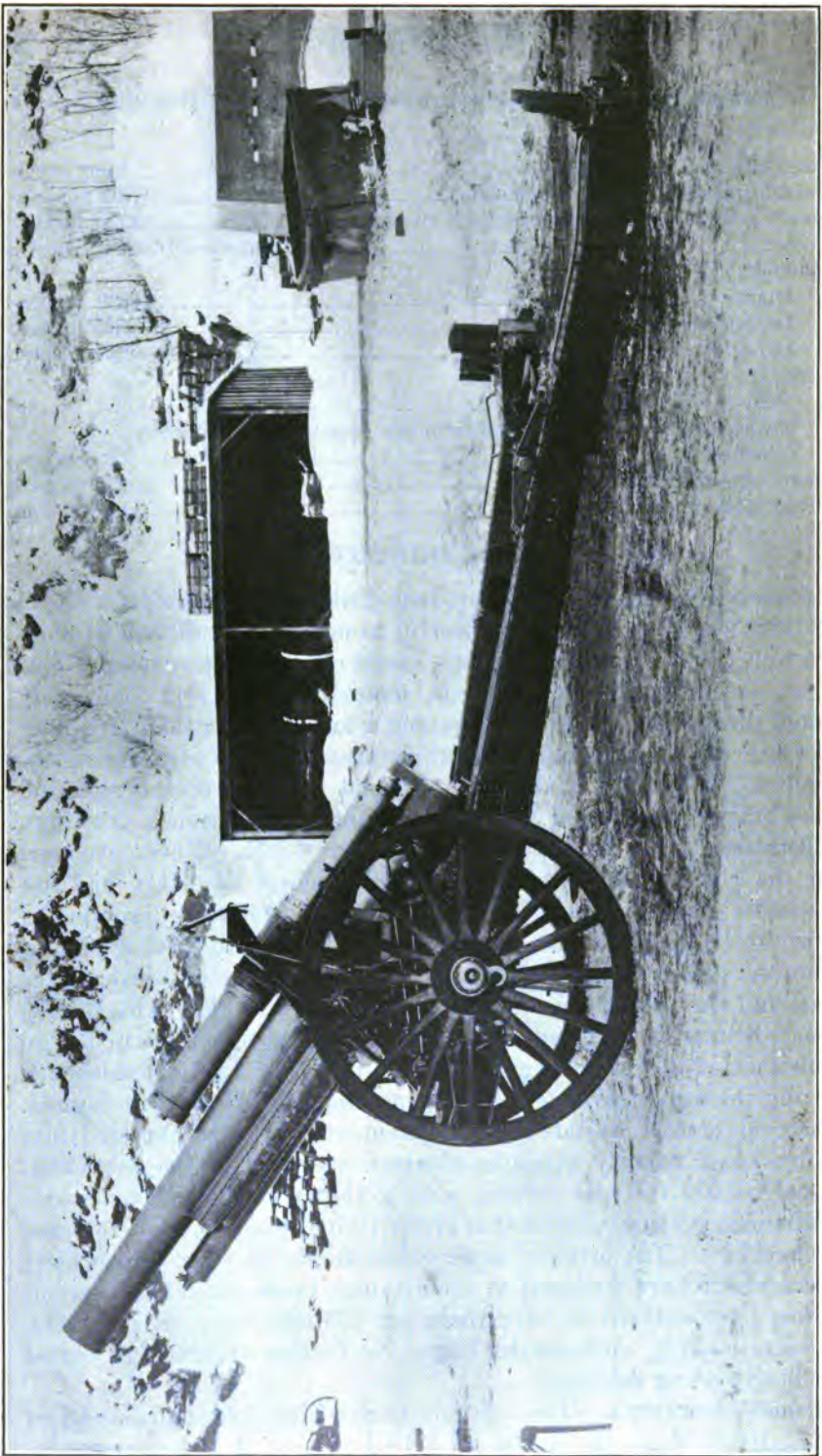

FIG. 19.—6-inch howitzer, Bethlehem type, pilot piece.

**155 MM HOWITZER
MODEL OF 1918
SCHNEIDER**

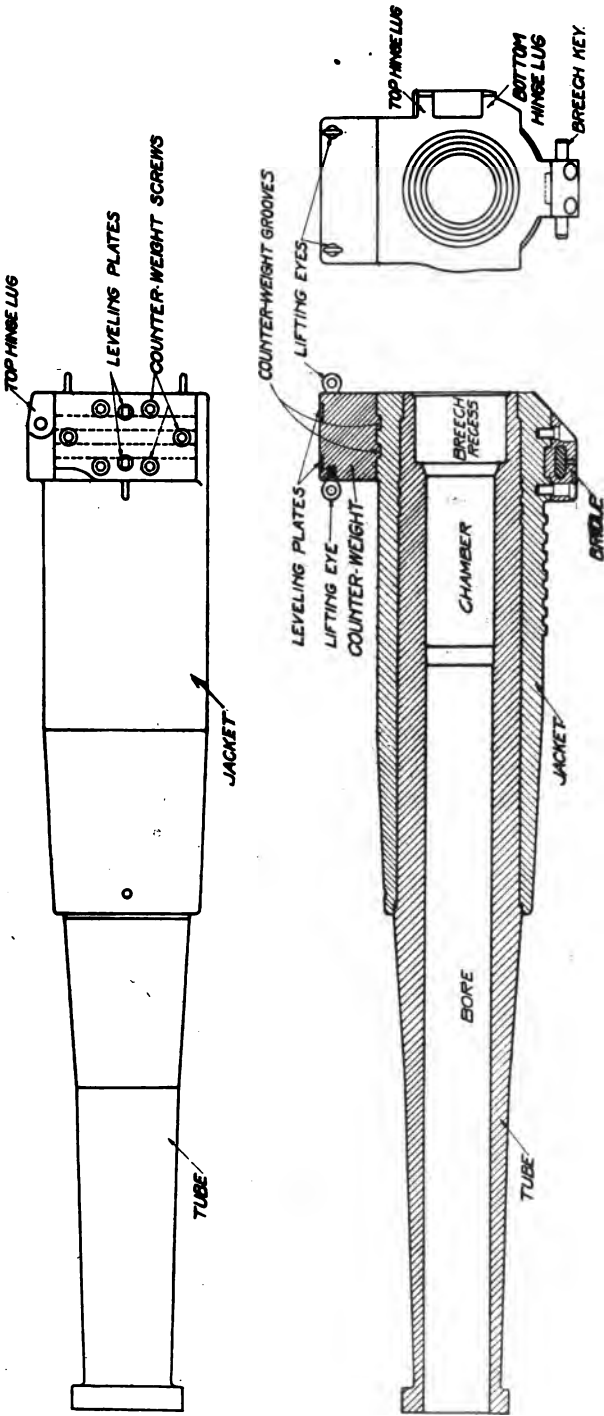

FIG. 20.—155-mm. howitzer, model of 1918 (Schneider).

separate loading instead of the fixed ammunition used by the earlier model. The 155-mm. howitzer and carriage, model of 1918 (Schneider), manufactured in the United States, the dimensions and other constants of which are given in the table of the United States Army cannon, is practically identical with the 155-mm. Schneider howitzer, model of 1917. The principal difference is in the wheels, which are rubber-tired on the American carriages, and in the firing mechanism.

Carriage.—The 155-mm. Schneider howitzer is mounted on a carriage having a trail composed of two pressed steel flasks. At the front end these flasks are connected by the axle housing and at the rear end by a fixed spade. The trail terminates in a float to prevent the rear end from sinking into soft ground, and also carries a movable spade, which may be set at two different angles during the firing and which may be folded up when traveling.

Recoil.—The recoil mechanism or recuperator is of the hydropneumatic type, and consists of a sleigh containing the interior parts which make up the complete mechanism. The sleigh recoils with the howitzer, and has two longitudinal cylinders through the lower half and two air chambers in the upper forward portion. The recoil cylinder slides over a piston which has a central annular orifice, which in turn slides over a tapered throttling bar. In recoiling the liquid contained in the cylinder is forced from one side of this piston to the other through this variable orifice, which gradually closes, until the howitzer is brought to a stop at the end of the movement. The counterrecoil cylinder slides over a packed piston, which forces the liquid beyond it up into the air chambers which are under pressure. This stores up energy to bring the gun back to the firing position.

Traversing and elevating.—This howitzer can be traversed through a total angle of 6 degrees, 3 degrees each side of the center line. This is accomplished by sliding along the axle, and is known as the axle traverse type of carriage. The traversing mechanism consists of a train of bevel gears, actuating a screw which carries a nut attached to the axle. Operating this mechanism slides the carriage back and forth on the axle. The Schneider howitzer is capable of a maximum elevation of $42\frac{1}{2}$ degrees. The elevating mechanism is of the "Hindley worm type" and elevates the cradle by means of segmental racks attached thereto.

Accessories.—This howitzer is entirely motorized both as regards the carriage and the necessary accessories. The full equipment for a battery is as follows:

Four carriages.

Four carriage limbers.

Ten 5-ton tractors.

Fourteen ammunition trucks, for transportation of ammunition and cannoneers.

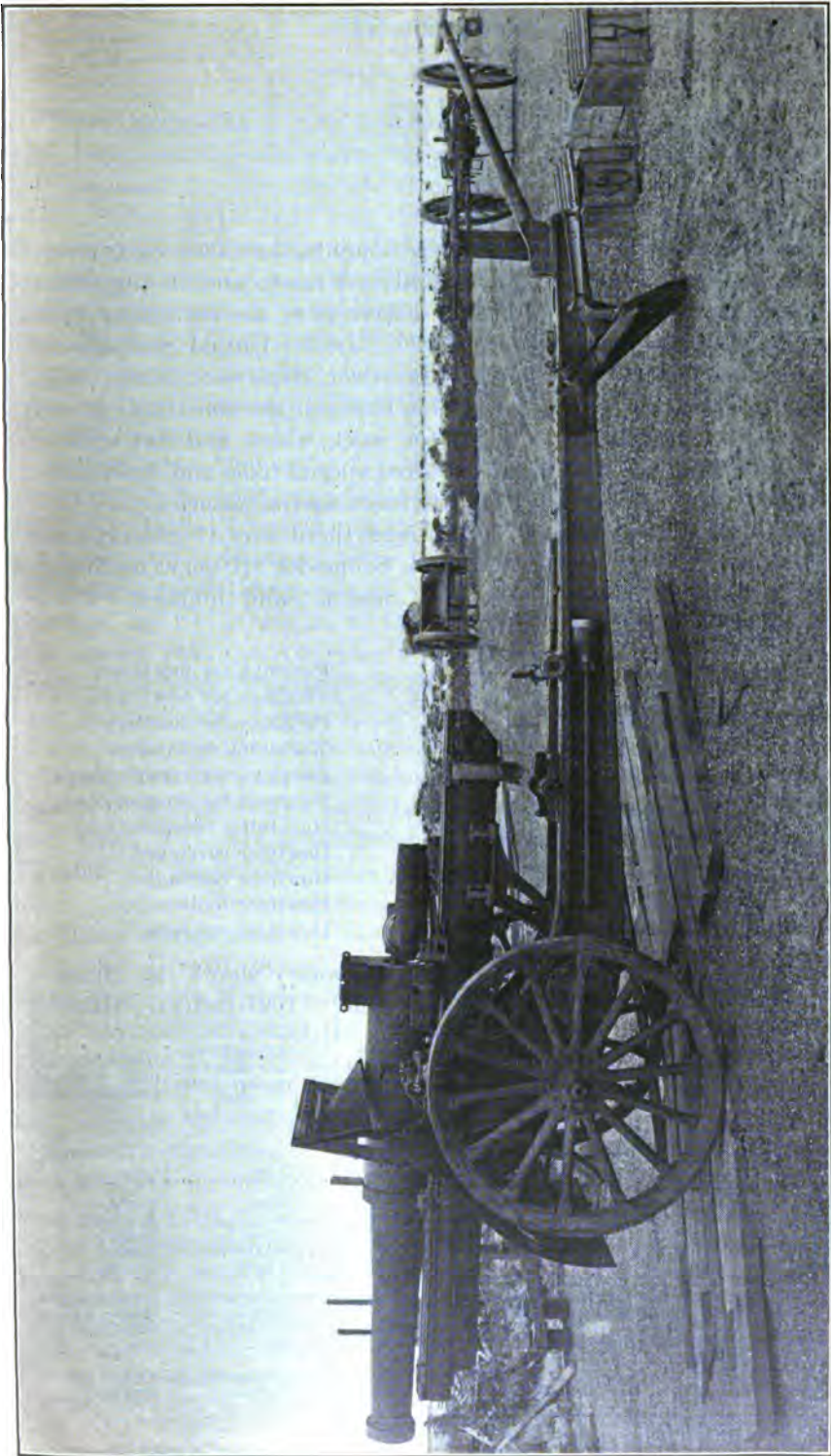

FIG. 21.—155-mm. howitzer, Schneider, model 1915.

One artillery supply truck.
 One tractor with 6-horse reel and cart.
 Two antiaircraft machine guns.
 Three motor cars.
 One reconnaissance motor car.
 Twelve motorcycles with side cars.

Sources of supply.—Orders for the 155-mm. howitzer early were placed both in the United States and in France, and in the latter country there have been numerous deliveries of the Schneider type to the American Expeditionary Forces. In the United States, once the decision was made to adopt this howitzer, steps were immediately taken for extensive production. This required the construction and equipment of numerous factories for work which had not existed previous to the war, and which required special tools and machinery equipment for constructing both howitzers and accessories.

American manufacturers.—In July, 1918, there were 11 concerns engaged in the manufacture of 155-mm. Schneider artillery, including the howitzers themselves, carriages, caissons, and limbers. These companies were as follows:

Bethlehem Steel Co.....	Forgings for howitzers.
Standard Steel Works Co.....	Forgings for howitzers.
Standard Forgings Co.....	Forgings for howitzers.
American Brake Shoe & Foundry Co.....	Machining howitzers.
Mesta Machine Co.....	Forgings for recuperators.
Watertown Arsenal.....	Forgings for recuperators.
Dodge Bros.....	Machining recuperators.
Mosler Safe Co.....	Howitzer carriages.
Osgood Bradley Car Co.....	Howitzer carriages.
Maxwell Motor Co.....	Howitzer limbers.
Ford Motor Co.....	Howitzer caissons.

Comparison of Types.—The following summary shows the characteristics of four types of 6-inch and 155-mm. (6.1024-inch) howitzers:

	United States 6-inch howitzer carriage, model 1908, Mark I.	Vickers 6-inch howitzer carriage.	Schneider 155-mm. howitzer carriage, model 1917. (U. S. 1918.)	Bethlehem 155-mm. howitzer carriage, model 1917.
Weight of carriage in firing position, pounds.....	7,247.....	8,142.....	7,280.....	8,800.
Weight of carriage with limber in traveling position..... pounds.....	8,610.....	9,262.....	8,194.....	10,100.
Weight of projectile..... do.....	90 and 120.....	100.....	95.....	95.
Range..... yards.....	9,000 and 6,700.....	10,000.....	13,100.....	10,936.
Muzzle velocity..... feet per second.....	900-1,150.....	1,240.....	1,420-1,480.....	1,600.
Elevation..... degrees.....	5-40.....	0 to 45.....	0 to 42.....	5 to 40.
Total traverse..... do.....	6.....	8.....	6.....	40.
Type of recoil mechanism.....	Variable length.....	Variable length.....	Variable length.....	Variable length.....
Type of counterrecoil mechanism.....	Springs.....	Hydro pneumatic.....	Hydro pneumatic.....	Hydro pneumatic.....
Initial pressure in counterrecoil system, pounds per square inch.....	600.....	440.....	450.
Type of breech obturation.....	Powder case.....	Plastic pad.....	Plastic pad.....	Plastic pad.....
Type of spade.....	Folding.....	Fixed.....	Folding.....	Driven.

8-INCH HOWITZER.

Types used.—The 8-inch howitzer which was manufactured for the American Expeditionary Forces both in the United States and in England by the British Government, was made in several types. The Mark VI has a lower muzzle velocity and consequently a shorter range than the Mark VII. It is of built-up construction in contrast with the Mark VII, which has a barrel of wire-wound construction. The Mark VII in turn has been superseded by a Mark VIII $\frac{1}{2}$, as it was found necessary to increase the thickness of the powder chamber walls of the former model, they having cracked in proof firing. The walls of the Mark VI type are of satisfactory thickness.

Distribution.—Due to the fact that the Mark VIII $\frac{1}{2}$ howitzer has a greater muzzle velocity and consequently a greater maximum range than the Mark VI by some 15 to 20 per cent, the Mark VIII $\frac{1}{2}$ is the preferred type. However, since it was decided that the manufacturing resources of Great Britain would be used in conjunction with those of the United States in the manufacture of these howitzers, it was agreed that the American and British armies would share and share alike with respect to the production of each mark, and that each Army would be armed with the long and the short range types in the same relative proportions.

Supply from England.—At the beginning of the year 1918, the American and British Armies in France were each armed with Mark VI and Mark VII 8-inch howitzers in the proportion of three Mark VI and one Mark VII, these howitzers being furnished from England. This supply continued to the American Army through the first half of the year.

In the United States a number of these howitzers were ordered from the Midvale Steel Co. (see frontispiece), and the latter type was adopted, with the contractor being permitted the option of supplying either wire-wound or built-up construction, with the understanding that the United States Government might request at any time the exclusive adoption of either type.

Necessary accessories.—Special auxiliary equipment items included in one 8-inch howitzer battery are as follows:

Four 8-inch howitzers, model of 1917 (Vickers, Mark VI).

Four 8-inch howitzer carriages, model of 1917 (Vickers, Mark VI), complete, with sight gear, panoramic sight, dial sight, and range quadrant.

Four 8-inch howitzer carriage limbers, model of 1917.

Four 8-inch howitzer firing platforms, model of 1917.

Four 120-horsepower tractors (20-ton).

Twelve ammunition-carrying trucks.

Eight 3-ton trucks (personnel).

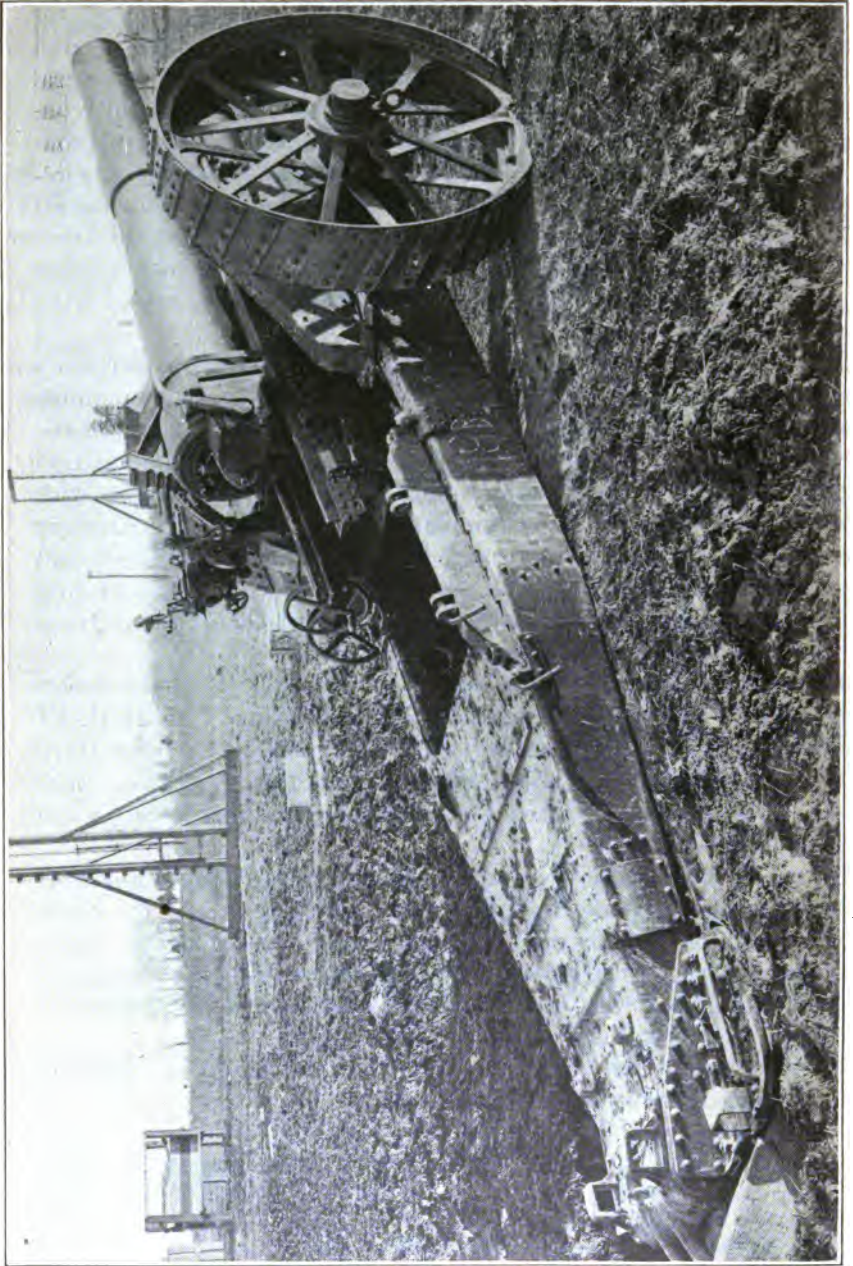

FIG. 22.—8-Inch British howitzer.

- Two supply trucks.
- Two tool trucks (ammunition type).
- One artillery repair truck.
- One artillery supply truck.
- One tank truck (gasoline).
- Three 5-passenger automobiles.
- Twelve motorcycles, with side car.
- One kitchen, rolling trail.
- One reconnaissance car.
- One 6-horse reel and cart.
- One telephone truck.

Table of weights, dimensions, etc., of 8-inch howitzer, model of 1917 (Vickers, Mark VI).

Weight (including breech mechanism)-----	pounds--	6, 552
Caliber-----	inches	8
Total length-----	do	127. 6
Length of bore-----	do	117. 7
Length of rifle portion of bore-----	do	102. 11
Number of grooves-----		48
Width of groove-----	inch	. 349
Depth of groove-----	do	. 08
Width of lands-----	do	. 1745
Twist, in calibers, uniform 1 in 15, right hand.		
Powder chamber :		
Diameter-----	inches--	8. 5
Length-----	do	12. 74
Capacity-----	cubic inches--	750
Total capacity of bore-----	do	6, 130
Weight of projectile-----	pounds--	200
Obturation-----		Pad.
Firing mechanism-----		Percussion.

Principal ballistic characteristics of Mark VI and Mark VII howitzers.

	Mark VI.	Mark VII.
Weight of powder charge-----	¹ 10 lbs., 12 ozs.	¹ 16 pounds
Powder charge (number of increments)-----	4	6
Maximum muzzle velocity (feet per second)-----	1, 300	1, 525
Maximum range (yards)-----	10, 500	12, 100

¹Approximately.



FIG. 23.—Vickers 9.2-inch howitzer, Mark I.

VICKERS 9.2-INCH HOWITZER, MARK I.

General nature.—This howitzer consists of a tube, muzzle stop ring, a series of layers of steel wire, jacket, breech bushing, and breech ring. Over the exterior of the tube is wound a series of layers of steel wire extending from the breech end to the stop ring, which is shrunk over the tube at the muzzle. Over the exterior of the tube, wire, and muzzle stop ring is shrunk the jacket, secured longitudi-

nally by the breech bushing, which is screwed into the rear end of the jacket. The bushing is also prepared for the reception of the breechblock. The breech ring is screwed and shrunk over the jacket at the rear.

Characteristics.—The breech mechanism is so arranged that by partially revolving the operating lever the breechblock is unlocked and the block with the gas-check pads and disks withdrawn from the seating in the chamber. The breech mechanism can then be swung into the loading position by means of a handle on the rear face of the breechblock. The breech is closed by a parallel screw having five portions of the screw thread removed longitudinally, each one-tenth of the circumference. The main characteristics of the Vickers 9.2-inch howitzer, Mark I are indicated in the accompanying table, giving the more important dimensions and the weight of the guns. The differences between the Mark I and Mark II howitzers will appear on reference to the table on the following page.

Material.....	Nickel steel (wire construction).
Weight of gun with breech mechanism.....	6,810 pounds.
Length, total.....	133.5 inches.
Bore:	
Caliber.....	9.2 inches.
Length.....	121.5 inches.
Chamber:	
Diameter.....	9.8 inches.
Length to base of projectile.....	8.1 inches.
Capacity.....	660 cubic inches.
Rifling:	
System.....	Polygroove, plain section.
Length (approximate).....	110 inches.
Twist.....	Uniform, 1 turn in 15 calibers.
Number of grooves.....	56.
Firing mechanism.....	{ Friction T-tube. French type percussion.

VICKERS 9.2-INCH HOWITZER, MARK II.

General nature.—The Vickers 9.2-inch howitzer Mark II consists of an "A" tube, a "B" tube, a muzzle stop ring, a series of layers of steel wire, jacket, breech bushing, and breech ring. Over the exterior of the tube are wound a series of layers of steel wire extending from the breech end to the muzzle stop ring, which is shrunk over the "A" tube at the muzzle. Over the exterior of the muzzle stop ring, wire, and tubes is shrunk the jacket, and the breech bushing is screwed into the rear end of the jacket. Owing to its greater length the Mark II howitzer has greater muzzle velocity and range than the Mark I.

Characteristics.—The breech mechanism consists of a parallel screw of the Welin type with corresponding interruptions in the breech bushing to enable the breech block to be locked in place. The main features of this howitzer are indicated in the accompanying table:

Material.....	Steel (wire construction).
Weight, average.....	9,576 pounds.
Length, total (approximate).....	170½ inches.
Bore:	
Caliber.....	9.2 inches.
Length.....	159.16 inches—17.3 calibers.
Capacity.....	11,085 cubic inches.
Chamber:	
Diameter.....	9.8 inches.
Length to base of projectile.....	34.035 inches.
Capacity.....	2,600 cubic inches.
Rifling:	
System.....	Polygroove, plain section.
Length.....	121½ inches.
Twist.....	Uniform 1 turn in 25 calibers.
Number of grooves.....	56.
Firing mechanism.....	{ Friction, T-tube. French type percussion.

VEHICLES USED BY HOWITZER UNITS.

	How- itzer car- riage.	How- itzer car- riage limber.	How- itzer plat- form wagon.	How- itzer car- riage trans- port wagon.	How- itzer trans- port wagon.	How- itzer orad- trans- port wagon.	How- itzer top car- riage trans- port wagon.	Limber for trans- port wagon.
8-INCH HOWITZER MATÉRIEL.								
Basic assumptions:								
Initial equipment per Army.....	288	288	288					
Field reserve (spare).....	None.	None.	None.					
Total net loss.....	95	72	72					
Time required to repair, months.....	4	4	4					
Maximum in repair shop.....	20	10	14					
Reserve in France.....	14	9	10					
Reserve at United States ports.....	9	7	7					
9.2-INCH HOWITZER MATÉRIEL.								
Basic assumptions:								
Initial equipment per Army.....	288		288	288	288			
Field reserve (spare).....	None.		None.	None.	None.			
Total net loss.....	55		44	44	44			
Time required to repair, months.....	4		4	4	4			
Maximum in repair shop.....	19		14	14	14			
Reserve in France.....	14		10	10	10			
Reserve in United States ports.....	6		4	4	4			
240-MM. HOWITZER MATÉRIEL.								
Basic assumptions:								
Initial equipment per Army.....	288		288		288	288	288	1,152
Field reserve (spare).....	None.		None.		None.	None.	None.	None.
Total net loss.....	52		30		30	30	30	155
Time required to repair, months.....	4		4		4	4	4	3
Maximum in repair shop.....	44		26		26	26	26	102
Reserve in France.....	30		17		17	17	17	92
Reserve in United States ports.....	13		7		7	7	7	38

NOTE.—The initial issue per Army per 8-inch and 9.2-inch howitzer vehicles is listed as if the Army were equipped with either caliber only, but the balance of figures are actual requirements.

240-MM. HOWITZER.

Types used.—The 240-mm. howitzer, or the Schneider model of 1918, was redesigned in the United States from the Schneider 280-mm. howitzer of French design. In 1918 the American Army was not equipped with this howitzer, but as the type seemed most desirable, it was planned to use it as soon as possible for replacing the 8-inch and 9.2-inch howitzers, with which our troops were being equipped and which could be supplied much more readily and expeditiously.

Source of supply.—In January, 1918, orders placed for 240-mm. howitzers with the Bethlehem Steel Co. and with the Midvale Steel Co. were canceled. These corporations were ordered to work to their full capacity on 8-inch and 9.2-inch howitzers, for the manufacture of which they were already equipped with tools and machinery. The Bethlehem Steel Co., however, was allowed to retain an order for one complete unit of 240-mm. howitzers, the design of which was made by the engineers of that corporation.

Orders at Watervliet Arsenal.—On November 20, 1917, an order was placed with the Watervliet Arsenal for the machining of 250 240-mm. howitzers, and a new shop was erected for this special purpose which started production in the summer of 1918, and was arranged on a basis of a maximum production of four howitzers per day early in 1919. On February 26, 1918, an additional order of 250 more howitzers of this caliber was placed at the Watervliet Arsenal, making a total of 500 from this source.

Forgings.—For these howitzers, 1,467 forgings were ordered from the Bethlehem Steel Co., the Edgewater Steel Co., the Tacony Ordnance Corporation, the Watertown Arsenal, and the United States Steel Corporation. Deliveries of these forgings began, and by June 1, 1918, four sets had been received, which number increased until in November, 1918, the maximum capacity of these plants for 240-mm. howitzers was attained.

Recuperators.—Twelve hundred and eighty-nine recuperators for this howitzer were ordered, the forgings to be furnished by the Carnegie Steel Co. and the machining to be done by the Otis Elevator Co., and Watertown Arsenal. The Otis Elevator Co. finished its first recuperator early in November and would have secured regular production early in 1919. Watertown Arsenal completed its first recuperator on October 28 and had 16 finished by December 31, 1918.

Carriages.—Twelve hundred and fourteen carriages for the 240-mm. howitzers were ordered from the Standard Steel Car Co. and the Watertown Arsenal. The pilot carriage was completed during the early part of October, 1918, and by November production of the main parts had so far advanced that the required output would have been attained by December.

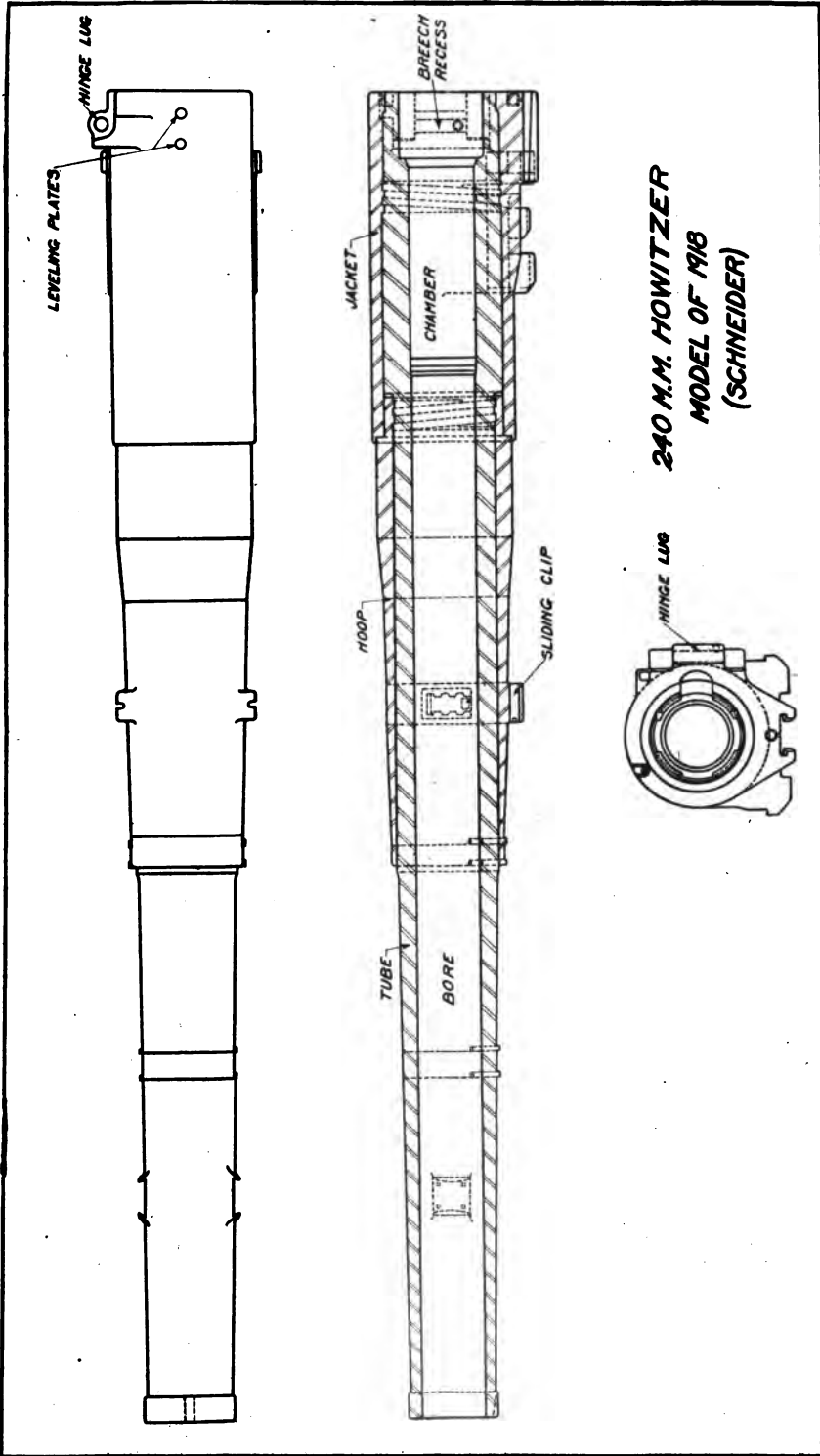

FIG. 24.—240-mm. howitzer, model of 1918 (Schneider).

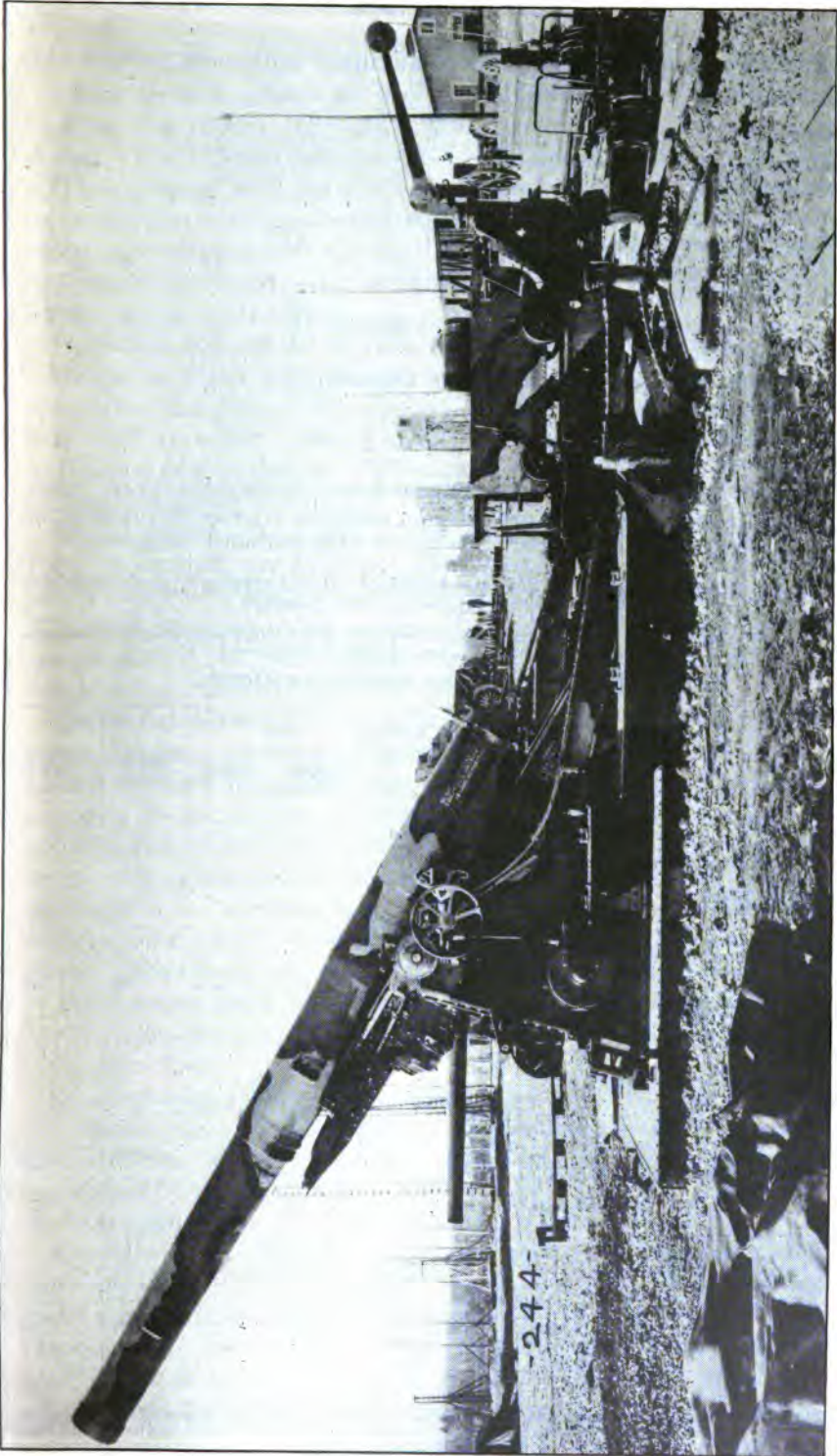

FIG. 25.—240-mm. howitzer, left side view. Elevation 30 degrees (Schneider).

Auxiliary equipment.—The special auxiliary equipment for the 240-mm. howitzer is as follows:

- Carriage (for howitzer).
- Firing platform (for howitzer).
- Wagon, transport (for howitzer).
- Wagon, transport (for howitzer cradle).
- Wagon, transport (for top carriage).
- Wagon, transport (for firing platform).
- Limbers (for transport wagons).

Instruments, optical and fire-control as follows:

- Rulers B. C.
- Sights, bore, sets of (1 breech and 1 muzzle).
- Mounting, sight.
- Tables, range.
- Tables, range, abridged.

In addition to these items are required breech mechanisms, liners, spare parts, and replacement parts, and also the necessary tractors for hauling the four loads, and motor trucks for carrying the tools and other equipment.

TABLE 4.—8-inch, 9.2-inch, and 240-mm. howitzer—Basic assumptions from which requirement schedules were to be made.

[From narrative report on 8-inch, 9.2-inch, and 240-mm. howitzers, July 1, 1918, Progress Section, Estimates and Requirements Division, Ordnance Department.]

HOWITZER BARREL AND BREECH MECHANISM.

	Howitzer complete, less breech mechanism.	Breech mechanism.	Liners.	Spare parts.	Replacement parts.
8-INCH HOWITZER MATÉRIEL.					
Basic assumptions:					
Initial equipment per Army.....	144	144		36	
Field reserve (spare).....					
Total net loss..... per cent..	1.23	1.1	8.5		16½
Time required to repair..... months..	4				
Maximum in repair shop..... per cent..	34				
Reserve in France..... do.	21.3	21.3	25.5	100	100
Reserve at United States ports.....	(1)	(1)	(1)		
9.2-INCH HOWITZER MATÉRIEL.					
Basic assumptions:					
Initial equipment per Army.....	144	144		36	
Field reserve (spare).....					
Total net loss..... per cent..	1.3	1.17	7.5		
Time required to repair..... months..	4				
Maximum in repair shop..... per cent..	30				
Reserve in France..... do.	18.8	18.8	22.5	100	100
Reserve in United States ports.....	(1)	(1)	(1)		
240-MM. HOWITZER MATÉRIEL.					
Basic assumptions:					
Initial equipment per Army.....	288	288		72	
Field reserve (spare).....					
Total net loss..... per cent..	1.3	1.17	7.5		
Time required to repair..... months..	4				
Maximum in repair shop..... per cent..	30				
Reserve in France..... do.	18.8	18.8	22.5	100	100
Reserve in United States ports.....	(1)	(1)	(1)		

¹ 2 months net loss.

NOTE.—These schedules are based on tentative strength Table 10-D and the program that one-half of the first Army would be equipped with 8-inch howitzers and one-half with 9.2-inch howitzers, and that the second Army would be wholly equipped with 240-mm. howitzers.

SIGHTS.

Sights for field guns.—All Field Artillery guns and howitzers excepting the 75-mm. (French), will be equipped with panoramic sights. The 155-mm. howitzer, 155-mm. gun, and 240-mm. howitzer will be equipped with the quadrant sight, model of 1918 (Schneider), in connection with panoramic sight. The 8-inch and 9.2-inch howitzers are equipped with the British rocking bar sight, in addition to the panoramic sight. All anti-aircraft batteries are equipped with special anti-aircraft sights.

Panoramic sight, model of 1917.—The panoramic sight is a vertical telescope so fitted, with an optical system of reflecting prisms and lenses that the gunner with his eye at the rubber eyepiece can bring into view an object situated at any point in a plane perpendicular to the axis of the telescope. The instrument has a magnifying power of four diameters and field of view of 10 degrees.

Optical system.—The optical system is such that the rays coming from the object are reflected downward from the rotating head prism into the rotating prism. The rotating prism rectifies the rays. After their passage to the achromatic objective lens the lower reflecting prism reflects them in such a way that there is presented to the eyepiece the reflected image which the eyepiece magnifies.

Mechanical parts.—Mechanically, the principal parts of the panoramic sight are the rotating head mechanism, the angle of site mechanism, the azimuth mechanisms, the rotating prism mechanism, the counting device, the shank and the elbow. The rotating head forms a housing for its movable parts, and provides seats for the elevation worm, ball socket and cap, and rotating head prism holder. The front opening of the rotating head is closed by the prism shield, which forms a dust guard. The bottom threaded seat of the rotating head screws upon the upper end of the azimuth circle. Upon the rear face of the rotating head is engraved the scale which is used for measuring the elevation of the rotating head prism holder, thus measuring the angle of site.

Rotating head prism.—The rotating head prism is mounted within the rotating head prism holder. The movement of this holder is accomplished by the elevation worm, and the length of travel is controlled by seven brass stop rings limiting it to six revolutions of the elevation worm.

Elevation worm.—The elevation worm has a micrometer mounted on one end, the periphery of which is graduated into 100 equal divisions representing 100 mils and numbered every 10 mils. One complete turn of this worm is equal to one of the divisions upon the scale on the rear face of the rotating head. The line of sight is horizontal when the elevation scale reads three.

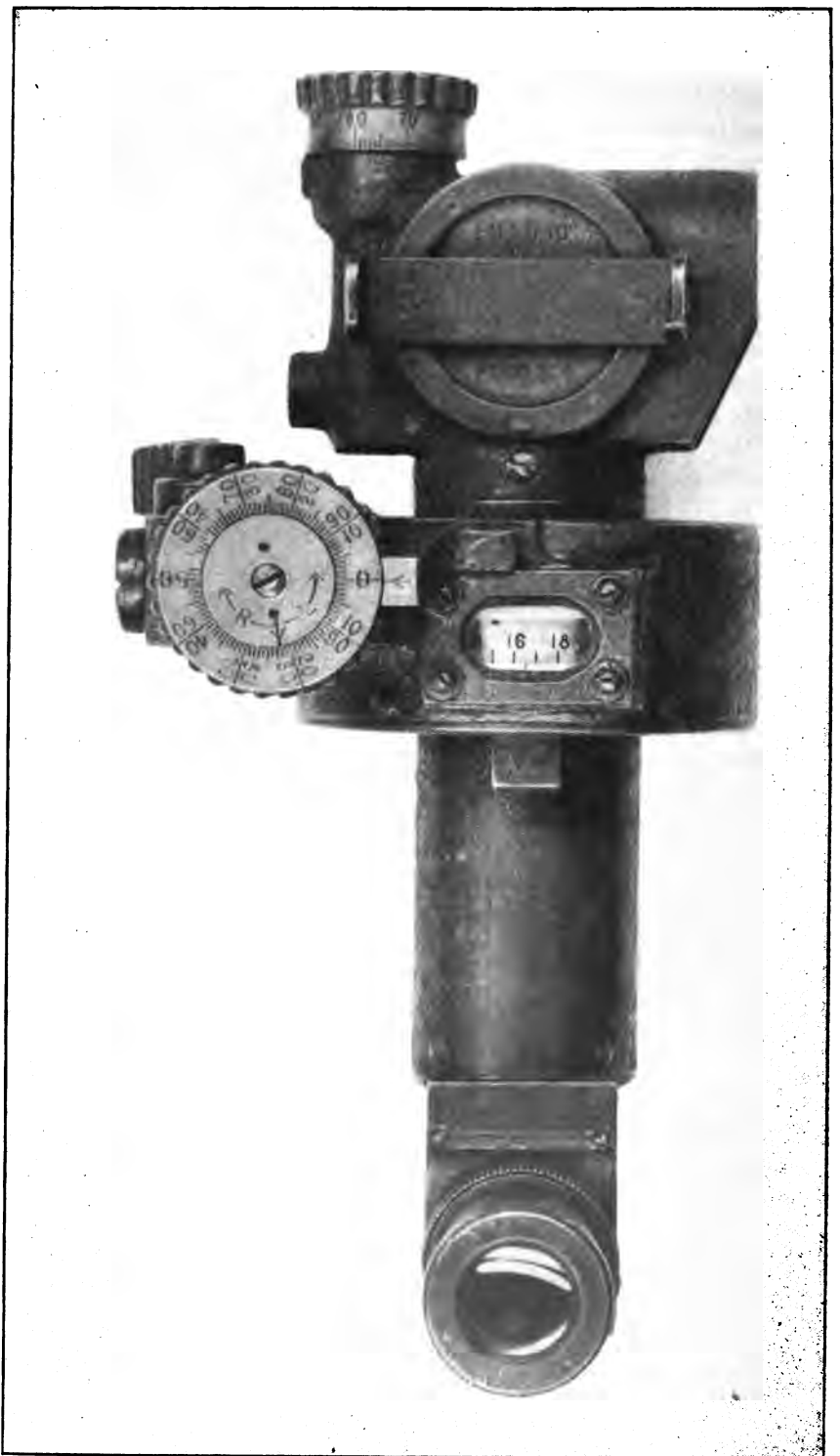

Open sight.—Upon the right side of the rotating head, and attached to its cover an open sight is secured for giving quick approximate directions to the instrument. It consists of a bronze plate bent to shape with projecting arms at either end, each arm containing a hole. A bronze knee is soldered to the interior of the front projecting arm over the center of the hole, so as to form a sight for quick sighting.

Azimuth circle.—The shank forms the body for the instrument and provides a seat for the azimuth-circle hood which houses the azimuth mechanism, which connects it with the rotating head. The rotating prism mechanism sets inside the shank, and is so geared through the azimuth mechanism that the rotating head revolves twice as fast as the rotating prism. There are 64 gradations on the azimuth circle. One complete turn of the azimuth micrometer causes the azimuth circle to revolve through the space of one graduation. The azimuth-circle micrometer is graduated with 100 divisions representing mils on its circumference, numbered every 10 mils. Thus each of these gradations represents one sixty-four one-hundredths of the circumference, or 1 mil. As the azimuth micrometer may be turned independently of the worm, it can be so set as to be used for a counting device.

Lens system.—The elbow which screws into the bottom of the shank contains the lower reflecting prism, the reticule cell, the achromatic field lens, and eye lens. The reticule cell has engraved on it a mil scale on its horizontal cross line and the vertical line is plain.

Differences in type.—The 1915 model is practically the same as the 1917, except for mechanical changes in the azimuth worm and elevation worm, and no counting device, but a deflection dial.

Adjustment.—Allowance is made for adjusting and cleaning the 1904 model in the field, but in the two later models the instruments are sealed and no adjustment is made except by specially trained men of the Ordnance Department. The 1904 model has no provision for elevating the rotating head prism, and mechanically is quite different, though optically the same as the later models.

FIRE-CONTROL INSTRUMENTS.

Battery commander's telescope, model of 1915.—The battery commander's telescope, model of 1915, is a binocular, periscopic, stereoscopic, telescopic observation instrument of the scissors type. The telescope has a magnification power of 10 and an actual field view of four degrees fifteen minutes. It has a clear aperture of 1.78 inches. The whole instrument is designed throughout with a view of overcoming all possible lost motion and wear, so as to enable the taking of the most accurate practical angular measurements. The objectives of the telescope are 12 inches

above the eyepieces when the tubes are in the vertical position and slightly over 24 inches apart when the tubes are in the horizontal position. The interpupillary distance is adjustable when the tubes are in either position. In the left telescope there is a reticule graduated for instantaneous reading of either vertical or horizontal angles. This is used primarily for determining the position relative to a known point at which a burst takes place. The telescope is mounted on an azimuth mechanism through an elevating worm and worm wheel.

The azimuth mechanism has the standard graduations for fire-control instruments and is equipped with a micrometer screw, so that very accurate readings are obtainable. The azimuth mechanism is mounted on the tripod proper through a ball-and-socket joint. This ball-and-socket joint, together with a universal spirit level mounted on the top of the azimuth mechanism case, enables the quick leveling of the azimuth mechanism for the obtaining of accurate readings. The tripod is the standard wood and steel tripod, model of 1919, used for fire-control instruments.

Mounted above and between the eyepieces of the telescope is the angle of site level. It has the standard angle of site graduations and is equipped with micrometer worm for obtaining accurate readings. The telescope is carried in a substantial leather case, which is fitted with a leather carrier and strap for carrying it on the saddle. The tripod and tripod mount (azimuth mechanism) are carried in a leather container. This container consists of two reinforced leather hoods, held together by heavy straps and fitted with a shoulder-carrying strap.

Periscopic azimuth instrument, model of 1918.—The periscopic azimuth instrument, model of 1918, is designed for measuring horizontal angles and for observation purposes. It is designed principally for trench warfare. It differs from azimuth instruments of earlier design in that the optical system is so arranged that the telescope is vertical, which permits the greater part of the instrument and also the observer to remain under the protection of a shield or parapet. The principal parts of the instrument are the periscope, the mount with the azimuth and slow motion mechanisms, and the tripod. The periscope, which has a total reflection prism in front of the objective, has a field of view of 6 degrees and a magnifying power of eight times. The clear aperture of the objective is 2 inches and its focal length 12.4 inches. The periscope is supported by a trunnion band, and secured rigidly in any desired position by clamping nuts. The mount carrying the periscope provides means of leveling the instrument as well as support, and means of imparting motion in a horizontal plane, and scales accurately to determine this motion. The reticule and azimuth circle are illuminated by small electric lights supplied with current from a storage battery governed by a rheostat.

Battery commander's periscope, model of 1918.—The battery commander's periscope, model of 1918, is a telescopic periscopic instrument for measuring azimuth angles and adapted for use in the trenches. The periscope is 651.71 millimeters between the centers of the eyepiece and the objective window. It has magnification power of 6 and a field view of 6 degrees. It has an exit pupil of approximately 5 millimeters.

The optical parts of the instrument are contained in a cylindrical case pivoted near its center about a horizontal axis perpendicular to the line of sight. The bracket supporting this case is attached to the top of the azimuth mechanism.

The azimuth mechanism, the same as that of the battery commander's telescope, has the standard graduations for fire-control instruments, and is equipped with a micrometer screw to permit the taking of accurate readings.

The azimuth mechanism is mounted on the tripod proper through a ball-and-socket joint, which, together with a universal spirit level, which is attached to the top of the azimuth mechanism case, enables the quick leveling of the azimuth mechanism in order to obtain accurate readings.

The tripod model of 1919 is the standard wood and steel type used by Field Artillery fire-control instruments. The tripod and tripod mount (azimuth mechanism) are carried in a leather container, consisting of two reinforced leather hoods held together by heavy straps and fitted with a shoulder-carrying strap.

The periscope and bracket are carried in a specially designed light fiber carrying case, provided with a leather strap for carrying over the shoulder.

Aiming circle, model of 1916.—The aiming circle, model of 1916, is a telescopic instrument for measuring azimuth and site angles. The telescope of the aiming circle has a power of magnification of approximately 4 degrees and an actual field view of 10 degrees.

The instrument consists primarily of a small telescope, compass and azimuth mechanism, with a micrometer worm, having the standard fire-control graduations; and angle of site level, with a worm micrometer for accurate reading. The aiming circle mount (adjusting mechanism) is mounted on a standard Field Artillery fire-control instrument tripod, model of 1919, and is fitted with ball-and-socket joint, which, together with a universal spirit level on the instrument, enables the instrument to be quickly set up on uneven ground. A stand is issued with the aiming circle. One edge of this stand forms a straight edge which permits the instrument to be used as an alidade for sketching or reading maps.

The whole instrument is designed for the overcoming of all possible lost motion and wear, so as to enable the taking of the most

accurate, practical, angular measurements. In the top of the instrument is a needle compass for measuring the magnetic azimuth angle. The aiming circle, mounted on the stand, is carried in a small substantial leather case fitted with convenient straps for carrying it either on the belt or slung over the shoulder. The tripod, mount and tripod are carried in a leather container. This container consists of two reinforced leather hoods, held together by heavy straps and fitted with a shoulder-carrying strap.

One-meter base range finder, model of 1916.—The 1-meter base range finder, model of 1916, is an inverted, single, coincidence, self-contained 1-meter base, stereoscopic, telescopic instrument for determining ranges. It has a magnification power of 15 degrees and an actual field view of 3 degrees. The exit pupil is one-tenth inch. The range readings are in meters.

Essential parts.—The instrument consists principally of a seamless steel tube, containing the optical and range finding parts, the mount (azimuth mechanism), tripod, adjusting bar, and carrying cases.

The range finder is mounted on the mount by means of a quick-locking mechanism. The mount consists principally of the support, elevation-worm case, elevation worm, elevation-worm wheel, elevation-worm wheel support, azimuth adjusting lower worm case, azimuth-worm wheel, azimuth worm, and angle of site mechanism.

The support is secured to the elevation-worm case by means of clamping screws. The elevation-worm case is fashioned to receive the elevation worm, and it is fastened to the elevation-worm wheel by means of the elevation-worm case bearings, forming a hinge about which, by means of the elevation worm, the instrument can be elevated or depressed to ascertain the angle of site by means of the angle of site mechanism, which is fixed to the elevation-worm case. The elevation-worm wheel is fastened to the elevation-worm wheel support by means of the worm-wheel bearing, forming a hinge, about which the instrument can be rotated from the horizontal to the vertical when used in measuring the range of objects whose distinctive lines run horizontal. A clamp is provided for clamping the instrument at any desired angle between vertical and horizontal. The azimuth and angle of site mechanisms have the standard Field Artillery fire-control graduations and are provided with micrometers for accurate readings.

The range finder is carried in a heavy cylindrical leather case, which is reinforced with steel. The tripod mount, tripod, and adjustment bar are carried in a separate reinforced leather case.

Battery commander's ruler, wooden.—The battery commander's ruler is a simple instrument for the quick and approximate determination of angles. It consists of a wooden ruler and cord. On the outer edges of the ruler are scales for determining angles, while

in the center of the ruler are scales, different for each gun and class of ammunition, for determining heights the projectile will clear at given distances.

Firing board, model of 1917.—The firing board for Field Artillery, model of 1917, is a zinc-covered plotting board, 30 inches long and 20 inches wide. It is fitted on the underside with pockets for carrying necessary drawing instruments for plotting and map making.

Semicircular protractor, model of 1917.—The semicircular protractor, model of 1917, made from zylonite, is 0.07 inch thick and $8\frac{1}{2}$ inches in diameter, the curved edge being graduated in mils and the straightedge being graduated in the metric system. Two of these protractors are issued with each of the firing boards, model of 1917.

Slide rule, model of 1917.—The slide rule, model of 1917, is an instrument for the rapid solution of triangles. The scales of the rule represent the logarithms of angles and distances. One of these rules is issued with each firing board, model of 1917.

24-inch straightedge.—The 24-inch straightedge, made from zylonite, is 0.07 inch thick, 2 inches wide, and 24 inches long.

Prismatic compass, model of 1918.—The prismatic compass, model of 1918, is an instrument for obtaining clinometer and magnetic azimuth readings. The compass proper is mounted on a tripod, model of 1918, by means of a ball-and-socket joint, which enables the instrument to be quickly set up and leveled. The clinometer, which is an accurately balanced, sensitive instrument, is actuated by gravity. Both the clinometer and the compass dial have the standard Field Artillery fire-control graduations. The compass and its tripod are carried in a small leather case, which is fitted with a shoulder strap.

Sitogoniometer, model of 1918.—The sitogoniometer is a pocket instrument used for rapid approximate measurements at any time when a more accurate instrument is not available. It is used for measuring the angle of site, determining the minimum range that will clear the mask, and measuring azimuth; the readings are in mils.

The sitogoniometers are marked with range scales on the body. The scale on the edge of the case is 1 to 80,000. The sitogoniometers vary for each size of gun.

Zinc square.—A zinc square stamped from a sheet of zinc 0.022 inch thick has a longer arm, approximately $4\frac{1}{2}$ inches long, and shorter arm, approximately $3\frac{1}{4}$ inches long, each arm being approximately $1\frac{1}{2}$ inches wide. It has three scales, two on the inner edge of the square, each graduated from 0 to 1,000, and an outer scale graduated from 0 to 2,000 on a scale of 1 to 20,000. The zinc square is used in connection with the grid maps for accurately locating a point.

The 12-inch semicircular protractor.—The 12-inch semicircular protractor is divided on its straight edge metrically and on its circum-

ference in mils, there being two sets of figures running in opposite directions.

12-inch rule.—The 12-inch rule has a straight edge indented for use on plotting boards, maps, and wherever required.

Observation circle, model 1918.—The observation circle is used to measure horizontal angles. It consists principally of a semicircular wooden table, semicircular zinc protractor, field-glass support, and a tripod. The table provides a semicircular support for the field glass. It is pivoted to the tripod vertical spindle. The semicircular zinc protractor is graduated in mils on both sides for the quadrants of a circle. One side reads from zero to 1,600 and 4,800 to 6,400; the other side is graduated from zero to 1,600 and 1,600 to 3,200. All readings increase in a clockwise direction. The field-glass support is pivoted to the semicircular table and rotates on the face of the zinc protractor. It consists of a rectangular base upright and a field-glass bracket. The base is provided with a vernier graduated for 1-mil readings. The field-glass bracket is arranged to hold the binoculars in a fixed relation to the upright.

Rocket board, model 1918.—This is a wooden board 2 feet square with a circle outlined on its upper surface and a steel arrow pivoted at the center. The circle is graduated at regular intervals of 50 mils and numbered for every 200 mils, increasing in a clockwise direction reading from zero to 3,200 for each semicircle. A metal plate is fixed to the center of the board. This plate is drilled and threaded to take the thumbscrew on which the arrow swings. The plate is secured to the face of the board with three screws. Three screws are supplied for securing the board to a post or other type of mount. A pocket of olive-drab cotton duck is provided and secured to the bottom of the board. This pocket carries the arrow, screws, and targets when the board is not in use. The steel arrow has an open sight. A thumbscrew attached to the center of the arrow secures it to the metal plate in the center of the board. This thumbscrew is not detachable from the arrow, but is arranged to allow perfect rotation when secured in place. The targets are small white wooden pegs and are placed in the different holes on the graduated circle.

The rocket board is used by the battery to locate the point from which a rocket has been fired in order that a barrage may be established in that sector. The board is placed 20 meters in front of the center of the battery. The front edge of the board is divided by means of targets into sections corresponding to the different zones covered by the battery. The lookout on night duty upon observing a rocket from the front line steps behind the board and swings the arrow in line with the rocket. In this manner the zone for establishing the barrage is located and the fire of the battery can be directed and regulated accordingly.

TABLE 5.—*Fire-control equipment, divisional artillery.*

[Total fire-control equipment for a regiment of 75-mm. gun, 4.7-inch gun, 155-mm. howitzer, horsed and motorized.]

ORDNANCE MATERIAL.

	Classification.	Battery.	Each headquar- ters.	Total regi- ment.		Brigade head- quarters.
				Light.	Heavy.	
B. C. telescope, Model 1915, tripod, cases, accessories.....	22-39-1	2	1	15	16	1
Aiming circle, tripod, and cases (Model 1916).....	22-41-1	1	1	9	10	0
Observation telescope monocular, tripod, and cases.....	22-92	1	1	9	10	1
B. C. periscope, Model 1918, tripod, and cases.....	22-62-1	1	2	12	14	0
Range finder, 1-meter base, tripod, and cases.....	22-44-1	1	1	9	10	0
Sitogoniometer and case.....	22-78	2	1	15	16	1
Observation circle with field-glass support, tripod, and cases.....	22-88	2	1	15	16	1
Prismatic compass, tripod, and cases (Model 1918).....	22-53-1	2	2	18	20	2
Firing board, 50 by 76 cm., zinc covered, with waterproof cover.....	22-57-1	2	1	15	16	0
Ruler, xylonite or zinc, 60 cm., graduated.....	22-86-1	2	1	15	16	1
Protractor, zinc, semicircular, in mls.....	22-86-1	2	1	15	16	1
Squares, zinc.....	22-86-1	2	2	18	20	2
B. C. ruler, wooden, with string.....	22-36-1	10	10	90	100	10
Strings, extra, for B. C. ruler.....	22-36-1	8	8	72	80	8
Steel tape, 30-meter.....	(1)	1	2	12	14	1
Slide rule, Model 1917, for solution of triangles, and case.....	22-54-1	1	1	9	10	1
Time interval recorders, chains, and shock absorber.....	22-90-1	3	3	27	30	3
Flash lights, with hoods.....	14-4-17	5	5	45	50	5
Flash lights, without hoods.....	14-4-17	16	16	144	160	16
Aiming posts.....	(1)	12	0	72	72	0
Rocket board.....	22-89	2	1	15	16	0
Jacks staff and field glass support.....	22-87	3	1	21	22	3
Zinc sheets, 50 by 76 cm., for maps.....	(1)	4	4	30	32	4
Protractor, celluloid, semicircular (Model 1917).....	22-56-1	3	3	27	30	3
Dry cells, No. 6, extra for lighting device and case.....	14-4-77	16	0	96	96	0
Fire mallet and carrier (Infantry).....		2	2	18	20	2
Dry cells, batteries, extra for flash lights, and case.....		30	30	270	300	30

SIGNAL CORPS MATERIAL.

Accumulators, 4-volt, 100 ampere hours.....	0	2	2	2	2	2
Accumulators, 40-volt, 3 ampere hours.....	0	0	2	2	2	2
Batteries, dry, No. 6.....	0	9	9	12	4	4
Amplifiers, 3 terminal, French.....	0	1	1	1	1	1
Batteries, Everready, No. 703, extra.....	6	12	48	52	12	12
Bells, vibrating, 50 ohm. or equivalent.....	0	6	6	8	2	2
Carts, wire, hand (Brouette Doroulense).....	1	3	9	10	3	3
Books, field message.....	0	25	25	25	100	100
Cases, battery.....	1	2	8	9	2	2
Climbers, with straps (pairs).....	1	3	9	10	1	1
Clips, testing, Muller, Universal, or Frankel.....	8	18	66	72	18	18
Fuses, 1 ampere, for 4 and 12 line boards.....	24	24	168	180	24	24
Field glasses, Huet, 6 power (pairs).....	8	8	69	74	11	11
Headsets, telephone.....	4	4	33	34	0	0
Insulators, wooden knob.....	100	100	700	700	100	100
Flag kits, combination, standard.....	12	50	122	137	16	16
Inspector's pocket kits.....	3	6	24	26	6	6
Electrician's knives.....	4	8	32	36	0	0
Megaphones.....	2	3	15	16	0	0
Nails for insulators.....	100	100	700	700	100	100
Panels, Artillery brigade, black.....	0	0	0	0	1	1
Panels, Artillery brigade, white.....	0	0	0	0	1	1
Panels, Artillery type, white.....	0	3	3	4	0	0
Panels, Artillery type, black.....	0	3	3	4	0	0
Pliers, side cutting, 8-inch.....	2	6	18	20	6	6
Poles, sectional bamboo (2 section, 2 m. each).....	0	6	6	8	6	6
Projectors, 24 cm., with batteries.....	0	10	10	13	5	5
Projectors, 14 cm., 3-inch case, complete with battery and cases.....	1	0	6	6	0	0
Receiving sets, Artillery type "A-1", complete (French).....	0	4	4	5	2	2
Reels, breast.....	0	0	0	0	6	6
Radio sets, type "E-10" Bis. (French).....	0	0	0	0	1	1
Switchboards, telephone, 12-line monotype.....	0	3	3	4	2	2
Tape, friction, pounds.....	3	6	24	26	3	3
Telephones, Western Electric.....	6	12	48	52	12	12
Watches, wrist, luminous dials.....	0	20	20	25	20	20
Wire, outpost, twisted (pairs K/M.).....	8	24	72	80	86	86
Thermometer, Centigrade and Fahrenheit.....	3	0	18	18	0	0
Switchboards, telephone, 4-line monotype.....	2	6	18	20	0	0

TABLE 5.—*Fire-control equipment, divisional artillery—Continued.*

ENGINEER MATERIAL.

Classification.	Battery.	Each headquar- ters.	Total regi- ment.		Brigade head- quarters.
			Light.	Heavy.	
Allidade, Brass, open sight, levelling	1	3	9	10	1
Allidade, miniature telescopic, with declinator	0	1	1	1	0
Allidade, periscope	0	1	1	3	0
Abney, clinometer	1	3	9	10	1
Clinometer, telescopic, with slide rule	1	3	9	10	0
Planetable, 18 by 24, tripod attachment, fiber case, waterproof cover	1	3	9	10	1
Planetable, 16 by 16, tripod attachment, fiber case, waterproof cover	1	3	9	0	0
Tripod, extension leg, Gurley movement, with case	1	3	9	0	0
Tripod, extension leg, Johnson movement, with case	(1) (2)	3	9	20	1
Declinator with 2 clamp screws	2	6	18	20	1
Drawing instruments, (1 pair compasses, extension leg, drawing pen and proportional dividers)	1	3	9	10	1
Stadia rod, 10-foot, folding	1	3	9	10	0
Plumb line	2	6	18	20	1
Scales, plotting, 1/20,000 and millimeters	3	9	27	30	2
Steel arrow (tally pins, 10 in set)	1	3	9	10	1
Glass, magnifying, pocket	1	3	9	10	1
Chests for topographic equipment	1	3	9	10	1
Protractor, xylonite, rectangular	1	3	9	10	1
Compass, watch	20	60	180	200	20
Compass, marching	10	30	90	100	10
Boards, sketching, with extension tripod	1	6	12	14	1
Ruler, boxwood, triangular, 8-inch	1	6	12	14	1
Tally machine	1	6	12	14	1
Clinometer, reconnaissance	1	6	12	14	1
Celluloid sheets	12	72	144	168	12
Eraser, pencil, art gum	1	6	12	14	1
Eraser, drawing, rubber	2	12	24	28	2
Holders for timing pads	1	6	12	14	1
Thumb tacks, box	1	6	12	14	1
Pencils, drawing	12	72	144	168	12
Pads, timing	4	24	48	56	4
Pencils, colored, assorted	12	72	144	168	12
Protractors, pencil point	4	24	48	56	4
Knife, steel eraser	2	12	24	28	2
Pocket for pencils	1	6	12	14	1
Tape, adhesive, rolls	2	12	24	28	2
Sandpaper pads	2	12	24	28	2
Paper, drawing, single 24 inch by 5 yrdas roll in japanned tube	1	3	9	10	1
Chest for sketching equipment	1	6	12	14	1
Allidade, boxwood, open sight	1	3	9	10	1
Planetable, 24 by 31 inch, tripod attachment, fiber case, waterproof cover	2	4	0	10	0

¹ Issued to 75-mm. battery only.

² Not issued to 75-mm. battery.

TABLE 6.—*Fire-control equipment, Army artillery.*

[Total fire-control equipment for a battery and battalion of 155-mm. gun, 8-inch howitzers (Vickers) Mark VI and Mark VII; 9.2-inch howitzer (Vickers), Mark I and II; 240-mm. howitzer (Schneider).]

ORDNANCE MATERIAL.

	Class and division.	Battery.	Battalion.
Prismatic compass	22-53	2	3
30-meter steel tape	(1)	2	3
Arms, metal, 1 meter long graduated. 1/20000	22-5	3	3
Azimuth instrument	22-77	2	2
Periscopic azimuth instrument	22-80	2	2
Protractor, metal, 6-inch radius, graduated, mils.	22-86	2	2
Aiming rule		5	
Batteries, extra for flashlights	(1)	18	16
Wilson computing device		1	4
Bulbs, extra for flashlights	(1)	4	8
Flashlights, electric	(1)	9	8
Range tables		12	12
Range tables abridged		12	12
B. C. telescope	22-39	1	1
Stop watches	(1)	6	6
Plotter aircraft observation		1	1
Deviation board	22-93	1	1
Aiming circle	22-41	2	

SIGNAL CORPS MATERIAL.

Amplifiers, comp. three 4-volt and two 40-volt storage batteries		1	
Axes, hand		8	4
Bags, tools, service		1	1
Bars, digging, standard		2	2
Batteries, extra, tungsten, type A		9	8
Batteries, extra, eveready, No. 703		24	24
Batteries, extra, for T. M. signal lamp		5	5
Bells, vibrating, 110 chm., 15-volt.		2	2
Belts, lineman's with safety strap		1	1
Binding posts		15	10
Books, field message		10	10
Bulbs, extra for flashlight		4	4
Cable, 1 pair, lead, km		1	1
Carts, reel, hand		2	2
Charging sets, 15 and 110 volts			1
Climbers, pairs with straps		1	1
Barometer, grad. millim's and ins		1	1
Cross arms, 1 m. by 10 cm. by 5 cm.		140	93
Electrolyte, 28° Baumé, 10 large carboys			1
Envelopes, field message			500
Flashlights, electric, complete		9	8
Fuzes, extra, 1 ampere for 4 by 12 line boards		40	40
Glasses, field, Huet, 8-power		4	4
Grips, buffalo, No. 2		1	1
Hammers, sledge		2	2
Hydrometers, Baumé		1	2
Insulators, clamp		16	12
Insulators, pigtail		100	60
Insulators, porv.		23	17
Insulators, wooden knob, French, 2.5 cm.		220	220
Insulators, wooden knob, French, 4.5 cm.		640	600
Knives, electricians'		8	4
Lamps, signaling type, T. M., French		5	5
Marlin (pounds)		5	5
Pliers, wire cutting, 8-inch		8	8
Megaphones		1	1
Nails, 10 cm. long, kg.		2	2
Panels, each side 9 meters long, white		1	1
Panels, each side 9 meters long, black		1	1
Panels, each side 3 meters long, white		3	3
Panels, each side 3 meters long, black		3	3
Panels, rectangular (sapinottes), white		3	3
Panels, rectangular (sapinottes), black		3	3
Poles, lance		100	60
Projectors, 24 cm., with batteries			2
Projectors, 35 cm., with batteries, tripod			1
Projectors, 14 cm. Case		1	
Pullever blocks, double W. E. No. 760, 330		2	
Radio sets, type E., 10, complete			1
Receiving sets, type A, complete		1	
Reels, breast, French type		1	
Ropes, 15-mm. diameter (meters)		35	
Screw drivers, 6-inch		4	2

1 Commercial.

TABLE 6.—*Fire-control equipment, Army artillery—Continued.*

SIGNAL CORPS MATERIAL—Continued.

	Class and division.	Battery.	Battalion.
Screws, lag, 10 mm. by 10 cm. (for cross arms).....		300	220
Screws, wood, 5 mm. by 50 mm. (gross).....		2	4
Spoons, digging.....		1	1
Staples, insulated, Blake.....		400	660
Switchboard, telephone, 4-line, monotype.....		2	2
Switchboard, telephone, 12-line, monotype.....		1	1
Tape, friction (pounds).....		3	3
Tape, rubber (pounds).....		2	2
Telephone, Model 1375-B.....		12	12
Voltmeter, Weston, No. 280.....			1
Watches, wrist, luminous, with wristlet.....		5	1
Wire, galvanized iron, for guys, No. 12 km.....		1	1
Wire, twisted, pair, outpost, km.....		8	8
Mercurial barometer, graduated mm.....			1
Thermometers, graduated, centigrade and Fahrenheit.....		2	2
Poles, 2.3 to 2.5 m. long, 10 cm. diameter (sapinottes).....		250	220

ENGINEER CORPS MATERIAL.

Alidade, open sight.....		1	2
Alidade, telescopic.....		2	2
Artillery board (planchette de tir).....		1	3
Chest, instrument.....		1	1
Chest, rod.....		1	2
Clinometer, hand.....		1	2
Field sheet.....		1	1
Level rod plane table with tripod.....		1	2
Ranging poles.....		4	6
Record, hand tally.....		2	4
Stadia rod.....		2	4
Tally pins.....		12	24
Tape, repair outfit.....		1	2
Tape, steel, 100 m. long.....		1	2
Transit.....		1	1
Beam compass bar.....		1	2
Bureau of Standards Circular No. 47.....		1	1
Contour pens, swivel.....		1	1
Curvimeter.....		1	1
Curves, irregular.....		1	1
Dividers, bow spring.....		1	1
Dividers with pen and pencil.....		1	1
Drawing boards 24 by 38 inches.....		1	2
Drawing boards 18 by 24 inches.....		1	2
Drawing instruments.....		1	1
Engineer field manual.....		1	1
Ephemeris, French if possible.....		1	1
Geometry.....			1
Johnson's surveying.....			1
Log tables, 7 place (degrees).....		2	2
Log tables, 5 place (grades).....		2	2
Log tables, 5 place (mils).....		6	6
Orienteur officer's manual.....		2	2
Parallel rulers, 12-inch rolling.....		2	2
Pens, large.....		1	1
Pens, medium.....		1	1
Pens, small.....		1	1
Planimeters.....			1
Proportional dividers.....		1	2
Protractors, 12 inches diameter (degrees).....		2	2
Protractors, 6 inches diameter (degrees).....		2	2
Protractors, 12 inches diameter (grades).....		2	2
Protractors, 6 inches diameter (grades).....		2	2
Protractors, 12 inches diameter (mils).....		2	2
Protractors, 6 inches diameter (mils).....		2	2
Reconnaissance sets.....		1	1
Scales, map, 30 cm. metric 1/20000 and 1/50000.....		4	6
Scales, map, 30 cm. metric 1/10000 and 1/50000.....		4	6
Searles, field.....			1
Section liner.....			1
Smithsonian geographic tables.....			1
Spline weights 3½ to 3¾ pounds.....			12
Spline, xylonite, grooved, 36 inches.....			1
Straightedge, 2 meters long.....			1
Straightedge, 1 meter long.....		2	3
Tape, map, steel.....		2	4
Tapes, pocket, steel.....		4	6
Transit books.....		12	12
Trautwine's handbook.....			1

TABLE 6.—*Fire-control equipment, Army artillery—Continued.*

ENGINEER CORPS MATERIAL—Continued.

	Class and division.	Battery.	Battalion.
Triangles, 12-inch, 30 and 60 degrees		2	2
Triangles, 6-inch, 30 and 60 degrees		2	2
Triangles, 12-inch, 45 degrees		2	2
Triangles, 7-inch, 45 degrees		2	2
Trigonometry, plane			1
Typewriter, Corona			3
Typewriter ribbon, Corona			3
T square, 36-inch		1	3
Vertical angle tables		2	2
Willcox's French military dictionary			1
Celluloid sheets 20 by 35			2
Clock oil, bottle		36	36
Computation paper pads, ruled		3	3
Computation paper pads, unruled		30	30
Cross-section paper, opaque		30	30
Cross-section paper, transparent		2	2
Drawing ink, black, waterproof		2	2
Drawing ink, green, waterproof		9	9
Drawing ink, blue, waterproof		2	2
Drawing ink, brown, waterproof		2	2
Drawing ink, brick red, waterproof		2	2
Drawing paper, double mount, para, 24 by 36 inches		24	22
Drawing paper, thin, eggshell, 24 by 36 inches		36	32
Drawing paper, single mount, 35 inches by 10 yards		3	6
Erasers, pencil, ruby		15	13
Erasers, ink, typewriter, disk		9	8
Erasers, steel		3	9
Erasers, art gum		9	3
Erasers, sponge		6	9
Glue, pint cans		3	6
Horn centers, 0.5 inch diameter		3	3
Ink, fountain pen (bottles)		4	3
Lumber crayon boxes, red		3	4
Magnifying glass, pocket		1	3
Manila envelopes, 10 by 15 inches		48	42
Manila paper, sheets 24 by 36 inches		512	518
Map tube, galvanized iron, 6 by 37 inches		2	2
Oilstone, 3-inch, with case		1	2
Paint boxes		1	2
Paste jar		3	1
Pencils, red		15	13
Pencils, blue		15	15
Pencils, brown		15	15
Pencils, green		15	15
Pencils, drawing, Venus, 9H		36	35
Pencils, drawing, Venus, 6H		36	36
Pencils, drawing, Venus, 3H		36	36
Pencils, writing, No. 2		84	86
Pencil points for beam compass		36	34
Pencil points for dividers		36	36
Penholders, writing		8	6
Penholders, drawing		8	8
Penholders, crowquill		3	8
Pens, crowquill		14	13
Pens, drawing, Gillett No. 303		60	64
Pens, drawing, Gillett No. 170		24	20
Pens, drawing, Gillett No. 290		24	24
Pens, drawing, Gillett No. 404		24	64
Pens, drawing, Gillett No. 291		36	30
Pens, red, blue, black, and green, cubes		18	16
Reading glass, 3-inch		1	8
Rubber bands (box)		4	2
Sandpaper pads		7	4
Sealing wax, stick		2	7
Shears, 12-inch		1	2
Sponges for cups		6	2
Sponge cup with sponges		2	6
Thumb tacks		288	282
Tracing linen, roll, 36 inches by 10 yards		2	2
Tracing paper, roll, veg. 30 inches by 1 yard		2	2
Water colors, extra sets for boxes		1	1
Water color ink, Prussian blue		3	3
Water color ink, burnt siennas		3	3
Water color ink, Hocker's green		3	3
Water color ink, crimson lake		3	3
Water color ink, burnt umber		3	3
Water color ink, Chinese white		13	3
Water color ink brushes		24	24

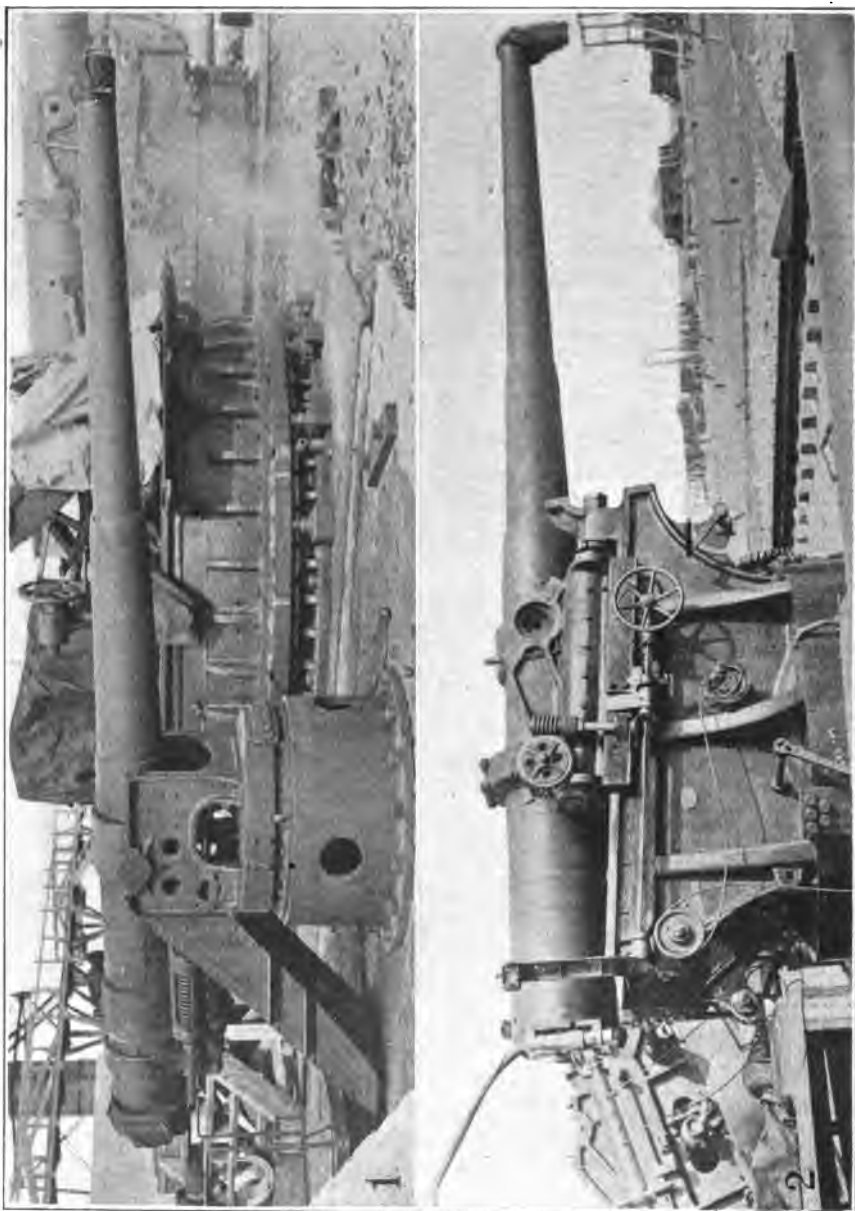

FIG. 27.—Types of 5-inch and 6-inch seacoast guns removed from fortifications to be mounted on improvised wheeled carriages.
1. 5-inch, model 1897. 2. 6-inch Crozier wire-wound gun, model 1900.

III. LONG-RANGE ARTILLERY—SEACOAST GUNS ON WHEELS AND RAILWAY MOUNTS.

General statement.—The present war has seen the adaptation to mobile mounts of much of the larger artillery which hitherto was associated with permanent emplacements. Therefore, there has been not only the construction of new guns, howitzers, and mortars to be placed on wheeled mounts, or in the case of the larger calibers, mounted on specially designed railway carriages, but also the utilization of various guns previously emplaced in seacoast or other fortifications or mounted on naval vessels.

Demand from abroad.—Early in the war a demand for large guns and mortars, even for short ranges, came with particular force from the American Army abroad. Heavy artillery with proper proportions of guns, howitzers, and mortars was stated by Gen. Pershing to be absolutely essential for successful operations, and the absence of these elements might invite failure. Accordingly, as the most accessible and available matériel of this kind was to be found mounted in the coast fortifications of the United States, it was realized that by removing a certain number of the guns, howitzers, and mortars from their permanent emplacements and preparing improvised mounts, something at least could be done to meet the needs of the American Expeditionary Forces in this respect. There was developed in this connection a well-defined program for spare guns and mortars, not only to be shipped abroad for replacement purposes and for additional strength, but also to make good the guns taken from the forts, at as early a date as possible. Furthermore, it was found necessary to consider the entire question of the construction of additional heavy ordnance.

Spare guns and mortars.—In the first connection, the experience of both the British and French showed that for each high-powered gun in action, during contemplated campaigns of two years, a spare gun eventually must be available for replacement on the same mount. In the case of mortars it was estimated that one spare mortar should be provided for each two mortars in action. Consequently it was essential that an adequate supply of spare guns and spare tubes be maintained in reserve.

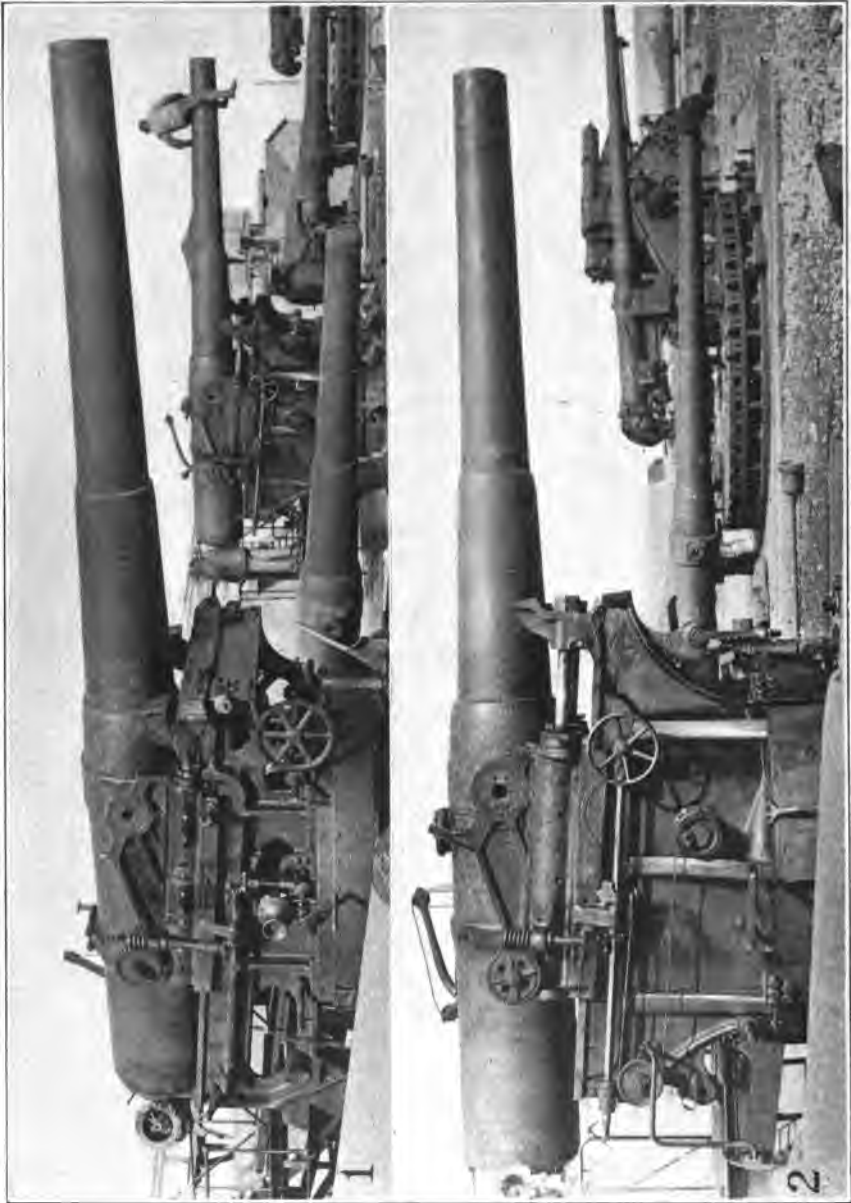

FIG. 28.—8-inch and 10-inch guns on seawall barrette carriages.
1. 10-inch gun, model 1865. 2. 8-inch gun, model 1888.

Production of large guns and howitzers.—Under the assumption that 14-inch guns and 16-inch howitzers must be provided for the oversea force or for the replacement of seacoast guns taken from coast fortifications to be transferred for railway or other mounts for use in France, there was developed early in the war a complete consideration of the manufacturing situation, which reduced itself largely to the question of facilities in forging and machining.

Forging.—For the first year of the war, the capacity for manufacturing forgings for guns, howitzers, and mortars of large size existed only at the private plants of the Bethlehem Steel Co. and the Midvale Steel & Ordnance Co. It was decided to install facilities of this kind at the Watervliet and Watertown Arsenals, and to provide important additional sources of supply. A plant was therefore arranged in the Pittsburgh district, with the cooperation of the United States Steel Corporation. This was located at Neville Island accessible to fuel supply and raw materials and here it was proposed to fabricate the largest guns.

Machining.—Machining facilities at the outbreak of the war existed only at the plants of the Bethlehem Steel Co., the Midvale Steel & Ordnance Co., the Watervliet Arsenal, and the Washington Navy Yard. For the guns of smaller calibers, such as the 75-mm. and 4.7-inch field pieces, it was possible to install machining facilities at new plants that were established, but the necessary presses, lathes, and other machine tools for the large caliber pieces were not as easily secured.

Problems in big gun manufacture.—The problems in the manufacture of large guns, howitzers, and mortars in the United States depended on the relative importance of such guns with those of smaller caliber put under manufacture and required immediately. If the making of the smaller caliber guns under manufacture could have been suspended, the facilities of the four plants named could have been diverted to the production of 14-inch and 16-inch howitzers, preferably the latter, as a much greater number of this type could have been turned out in a given time.

Necessary machine tools.—In the construction of guns both large and small the governing condition seemed to be the securing of adequate machine tools. Lathes of the sizes suitable for the smaller parts of these guns could not be procured in quantity in less than eight months and the larger lathes could not be procured in quantity for fifteen months, so the question was whether it was desirable to divert the tools that were being used for the manufacture of mobile artillery from that purpose.

Developing facilities.—New forging capacity on a large scale for large guns could not be developed under twelve to fourteen months, and machining capacity in less than from fifteen to eighteen months.

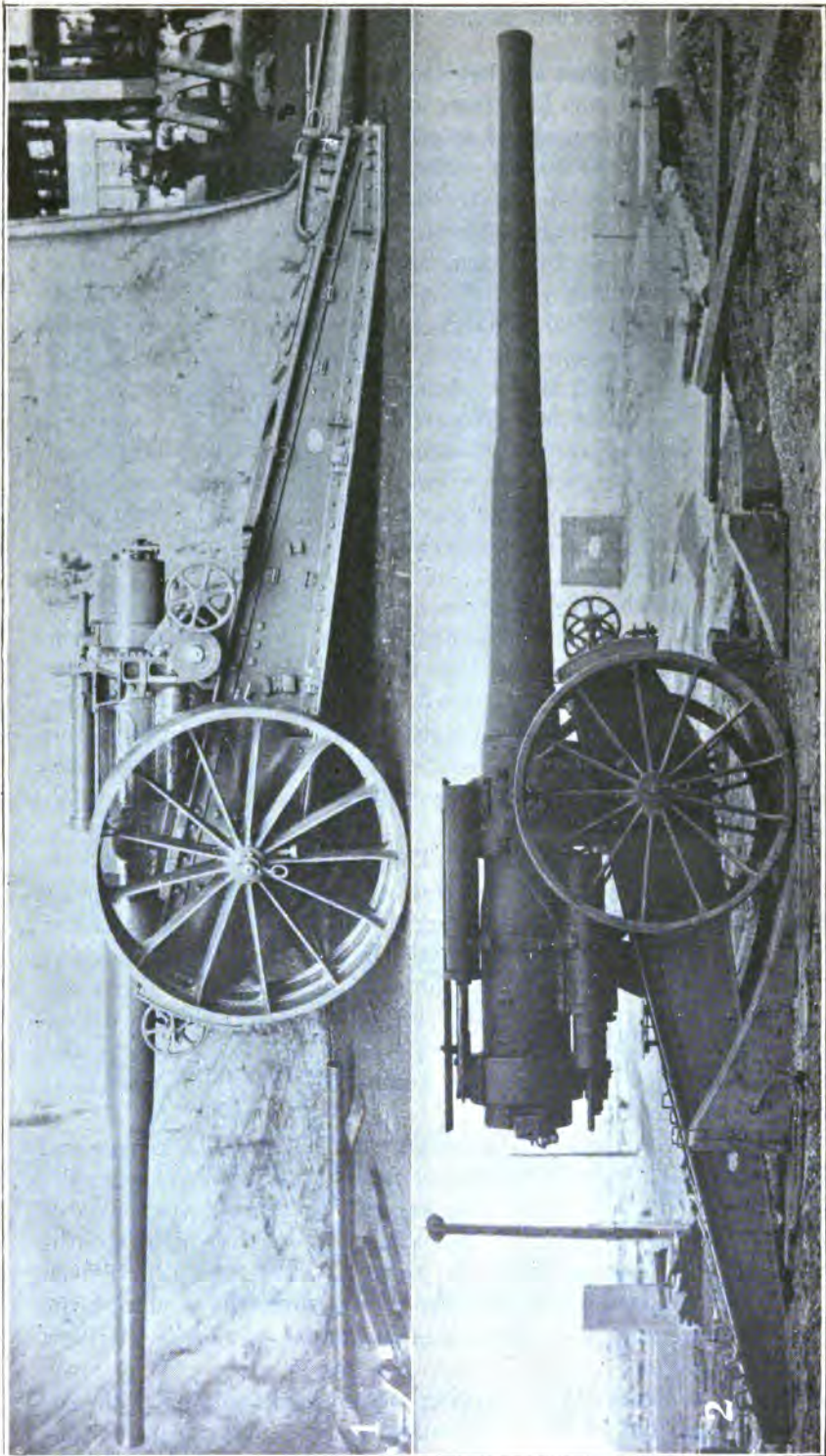

FIG. 29.—5-inch and 6-inch guns on improvised wheel mounts.
1. 5-inch improvised wheel mount, model 1917. 2. 6-inch improvised wheel mount, model 1917, type "A."

This would inevitably result in a serious delay in volume production. Hence the decision was reached that the only method of getting large guns in quantity at an early date was to use as far as possible existing facilities. Furthermore, it was decided still further to strip from the fortifications certain types of guns, and to use other types that the Navy Department had in storage which could be provided with railway mounts and placed on the western front in Europe at a comparatively early date. These it was proposed to follow with large guns from existing plants, while for future needs and replacements the proposed increased facilities of the new Neville Island plant were to be drawn on, as soon as construction and equipment had reached a point to make them available.

Plan decided upon.—In view of the foregoing considerations, the immediate work of the Ordnance Department was first to provide the 5-inch and 6-inch seacoast or naval guns with wheeled mounts, making them available for motor transport, and then, with the cooperation of the French, to develop an essential system of railway artillery, using 8-inch guns and those of larger caliber as fast as they could be shipped to Europe. These are discussed in the ensuing paragraphs.

SEACOAST GUNS ON IMPROVISED MOUNTS.

5-inch and 6-inch seacoast guns.—In response to the urgent demands from abroad already referred to, 5-inch and 6-inch guns required for this project were removed from the fortifications and provided with improvised wheeled mounts for service abroad. Their withdrawal from the fortifications was approved by the Secretary of War. In the case of the 5-inch guns, model of 1897, and the 6-inch guns, model of 1900, the cradles of the barbette carriages on which they were mounted were retained, but modified for 40 degrees elevation with the new improvised wheeled mounts. For the 6-inch guns, models of 1903 and 1905, formerly mounted on disappearing carriages, complete new carriages were designed known as the model 1917 to distinguish them from these just mentioned designated model of 1917A and the model of 1917 mentioned below.

The design of the mounts was as simple as possible, so as to facilitate their rapid manufacture by an inexperienced concern. The maximum range of these guns is about 18,000 yards, with a normal muzzle velocity of 2,600 foot-seconds; an increase of the muzzle velocity of 3,000 foot-seconds would afford a maximum range of approximately 22,000 yards. This muzzle velocity had been attained at the Sandy Hook Proving Ground. The carriages permit an elevation of 40 degrees, but by burying the trail an elevation up to 60 degrees can be obtained and the guns made available against captive balloons, as desired by Gen. Pershing. The guns are mounted on a cradle with

oil cylinders and spring recuperators. No traverse of the guns on the carriage is provided, but the carriages can be equipped with spades. Designs, drawings, and specifications were prepared for a firing platform and spade for the 5-inch wheel mount, model of 1917, and for the 6-inch wheel mount, models 1917 and 1917 A and B, and platforms and spades were under production. The platform provides 50 degrees traverse to the carriage. Work was also under way on the design and test of a 90-pound 6-inch common steel shell to obtain maximum range for the 6-inch gun.

The Navy 6-inch 30-caliber guns required an adaptation of the mount just described, the carriage designed for them being known as 6-inch wheeled carriage, model of 1917, type B. This gives a maximum elevation of 45 degrees without burying the trail. The guns have a normal velocity of 1,950 foot-seconds, and, using a 90-pound projectile, they have an approximate maximum range of 15,000 yards.

Sights.—Each carriage is provided with a shank type of sight mounted on the cradle. The sight mounts the panoramic sight, model 1917, at its upper end. The sight is graduated in degrees and also in meters.

Transport.—Six-inch mounts, except Type B, are provided with a transport vehicle, in which the gun is carried when it is transported. These batteries are completely motorized, and the necessary motor trucks and tractors are also provided.

RAILWAY ARTILLERY.

General.—Along with the demand for motor transport for all artillery with which it could be used, the war developed to an extent never before realized the importance of railway artillery whereby large guns could be moved to desired points. With the increase of regular and narrow gauge railway lines essential for the supply of an army came also the use of railway track for bringing up the heavier guns, so that with the exception of a comparatively small number of guns permanently emplaced for long range fire or for defensive operations the greater part of the heavy artillery was mounted on some form of railway carriage. With this increased mobility and increased facilities for handling heavy guns, howitzers, and mortars, a special use of railway artillery developed.

Fire of railway artillery.—The fire of railway artillery guns includes:

(a) Fire of destruction against enemy positions usually well protected by earth, timber, and concrete.

(b) Counter-battery work.

(c) Fire of interdiction on railways, railway stations, cantonments, roads, and other arteries of traffic.

Fire of destruction.—Fire of destruction is delivered by howitzers and mortars almost exclusively. These are either transported on 60-cm. (23.62 inches) track, or on standard gauge track. There is a very high proportion of shots for fire of destruction, and in a period of 14 days along the Chemin des Dames 41,000 shots were fired by heavy artillery, including railway artillery, of which number 31 per cent were from howitzers and mortars of 270 mm. or above. Gen. Pershing early cabled that the use of 12-inch mortars was absolutely necessary.

Counter-battery work.—Counter-battery work is relatively unimportant for railway artillery, though it has been carried on by French 194-mm. and 240-mm. guns with 360 degrees traverse fired from normal track without preparation. Heavy tractor-drawn artillery, such as the French 155-mm. Filloux guns, has been developed, so that except in rare cases counter-battery work by railway artillery will be unnecessary. The 5-inch and 6-inch United States seacoast improvised mounts would be valuable for such work, and the long ranges over 9 miles for the 5-inch gun and over 10 miles for the 6-inch gun—make them especially useful. Being drawn by tractors they are naturally more mobile and readily placed than railway mounts.

Fire of interdiction.—Fire of interdiction is the function of the long-range, high-powered railway guns in which range and traverse are most important. These elements were necessary to cover a tremendous area in the rear of the German lines, especially villages and railways where such fire is least expected, so as to prevent bringing up supports and to interfere with transportation. The guns are placed within a short distance of the rear of the lines, and the heaviest batteries of railway artillery are frequently located not more than 4 miles from the front in order to secure the maximum field of fire and long range. Such location makes concealment necessary, as the railway artillery is within range of the lighter artillery or even the Field Artillery of the enemy. The 8-inch, 10-inch, 12-inch railway mounts are mainly used for fire of interdiction.

7-inch railway project.—The original 6- and 8-inch railway gun cars, model of 1918, were used for mounting some 7-inch mounts secured from the Navy. These particular railway mounts were gotten out for use along the coast in antisubmarine coast defense work. The main features of this railway artillery are the 7-inch Navy gun mounts, the adapter casting, and the gun car.

Gun mount.—This gun carriage is a pedestal type carriage, having 360 degrees traverse and 15 degrees elevation. The mount is known as the 7-inch Navy mount, Mark II, Model III. The guns are known as the Navy 7-inch 40-caliber gun, Mark II. The muzzle velocity of this gun is 2,700 foot-seconds and the range at this velocity is



FIG. 30.—7-inch Navy railway mount, model of 1918.

approximately 17,000 yards. The recoil of the gun is 19 inches and the carriage embodies all the general characteristics of a navy mount of this caliber.

Adapter casting.—In order to mount this gun carriage on the railway car it was necessary to utilize existing bolt holes in the car underframe, and raise the center line of the trunnions so that the muzzle of the gun would have sufficient clearance above the car platform. A pedestal adapter casting was therefore designed, which accomplishes the two objects just named. The gun carriage is, of course, mounted on this casting and is secured firmly thereto by means of holding-down bolts. These adapter castings are of special design and weigh in the neighborhood of 13,000 pounds each.

Railway gun car, model 1918.—This car represents the first design of the Ordnance Department for gun cars, utilizing several calibers of guns and mortars. The car is of a drop-frame type and is raised and lowered by means of hydraulic jacks working through the body bolsters of the underframe. The mount does not use any firing platform, but the drop portion of the underframe is lowered onto the rails for firing. In the transport position the car is raised approximately 6 inches above the top of the rails. The hydraulic jacks are unique in their construction in that the ram of the jack forms the pintle of the trucks. The side bearings, which of course must be raised and lowered with the underframe, are automatically moved by means of a rack and pinion arrangement operated when the ram is raised or lowered. The pump for the jack is separate and mounted on the car body so that it will not interfere with maneuvering the piece. The outriggers, four of which are provided, are the same as

those used on the 8-inch railway mount in so far as their struts and floats are concerned. The attachment of the outriggers to the car body is different, however, in that a bracket casting having a pivoted joint is used in place of the ball-and-socket joint as described later for the 8-inch railway gun car. The bracket casting with its hinge portion is so designed that it can swing out at right angles from the car body. It is necessary to put out all four outriggers in firing this mount, and the angle at which the struts stand with respect to the car body is dependent, of course, upon the angle of traverse of the gun. No clamps of any nature are used with this mount. As in the case of the 8-inch car, model of 1918, Mark I, the trucks are not withdrawn at any time in maneuvering the mount. A loading platform is also provided at the breech end of the car, which is designed to receive the ammunition from the ammunition car and to transport it from that position to the breech of the gun. This loading platform, however, can be used only when the gun is in the same straight line as the tray of the loading platform. These cars are provided with both hand and air brakes and M. C. B. draft gear and couplers. The trucks are the Pennsylvania standard 50-ton trucks, having $5\frac{1}{2}$ by 10 inch M. C. B. journals. The entire weight of this amount is approximately 170,000 pounds. The car is so designed that the outriggers can be folded back against the car sides and the outrigger equipment, such as spades, foot plates, and so on, can be carried on the body of the car, to which they are securely lashed. No narrow-gauge equipment is provided for this project, but each gun car is equipped with an ammunition car for transporting 7-inch Navy ammunition. Furthermore as they were intended for use exclusively in the United States it was not necessary to furnish European types of couplings as for other mounts. The usual outfit of tools and accessories and spares are provided the same as in the 8-inch project.

8-inch railway artillery project.—This project consists of standard gauge railway cars upon which 8-inch barbette carriage with their guns are mounted, and auxiliary cars and trucks of both standard and narrow gauge. Work on the carriages and cars and trucks was vigorously undertaken and the pilot 8-inch railway mount was sent to Aberdeen for test on June 6, 1918. By the end of 1918, 24 units of 8-inch railway artillery together with ammunition cars and accessories had been completed and were ready for use. A more detailed discussion of the various elements of this project is given herewith.

8-inch railway car, model of 1918, Mark I.—This car is a drop-frame type with structural steel underframe mounted on Pennsylvania Railroad standard 70-ton trucks. The car is equipped with air brakes as well as hand brakes, and is provided with French State standard screw couplers and buffers. Outriggers and floats are also provided for the purpose of taking up the shock of recoil.



FIG. 31.—8-inch railway mount, model of 1918, showing firing platform formed by crossties laid on H-beams.

Firing platform.—This mount is fired from the firing platform, which consists of four 8-inch H-beams which lay on the ties and which have six oak crossties laying across their upper flanges. This platform can be carried on the car while in transport and laid in position on ordinary track in a few minutes. In maneuvering the car into battery position, it is first necessary to lay down the H-beams on the ties, after which the car is run into position and jacked approximately 1 inch. After the car is in this last position the six oak crossties are placed underneath and the car lowered so that the weight rests on the firing platform. This relieves the trucks of the firing shock.

Outriggers.—The outriggers are all attached to the car and are swung into position when the car has been placed on the firing platform. Eight outriggers form the complete equipment of one car, two or four of which are used at any one time, depending on the angle of traverse. These outriggers have their outer end equipped with a screw-ball joint which rests against the wooden floats banked into position on the ground. The wooden floats consist merely of oak timbers bolted together so that they present a surface of approximately 20 square feet, which is at right angles to the center line of the outrigger strut.

Trucks.—The standard-gauge trucks for this mount as mentioned above are Pennsylvania Railroad standard 70-ton trucks having four wheels with M. C. B. 6- by 11-inch journals. The trucks are at no



FIG. 32.—8-inch railway mount, model of 1918, arranged for firing at right angles with the track. Note the outriggers and floats.

time withdrawn from the car, except in the event that the mount is to be transported on narrow-gauge track.

8-inch Barbette carriage, Model 1918.—This carriage is of a special design, and is so made that 360 degrees traverse and 42 degrees elevation can be secured. The carriage is mounted on a base ring, and is traversed by means of rollers attached to a racer. The base ring is bolted to the drop-frame portion of the car underframe. The recoil mechanism is the ordinary hydraulic buffer and counter recoil spring type which allows 48 inches of recoil.

Ammunition car.—The ammunition car is an especial designed car and used as a standard for all railway artillery. It is an all-steel box car, using standards as existing on the United States Government cars in so far as possible. The interior of the car is provided with ammunition racks for storing both powder charges and projectiles, and which are so designed that they can be withdrawn and the car used as an ordinary box car. A trolley I-beam ammunition hoist is also provided for handling the ammunition from the racks to the gun car.

Narrow-gauge equipment.—For the purpose of transporting this railway mount on 60-centimeter narrow-gauge track, a complete outfit of trucks and auxiliary cars are provided. This equipment con-

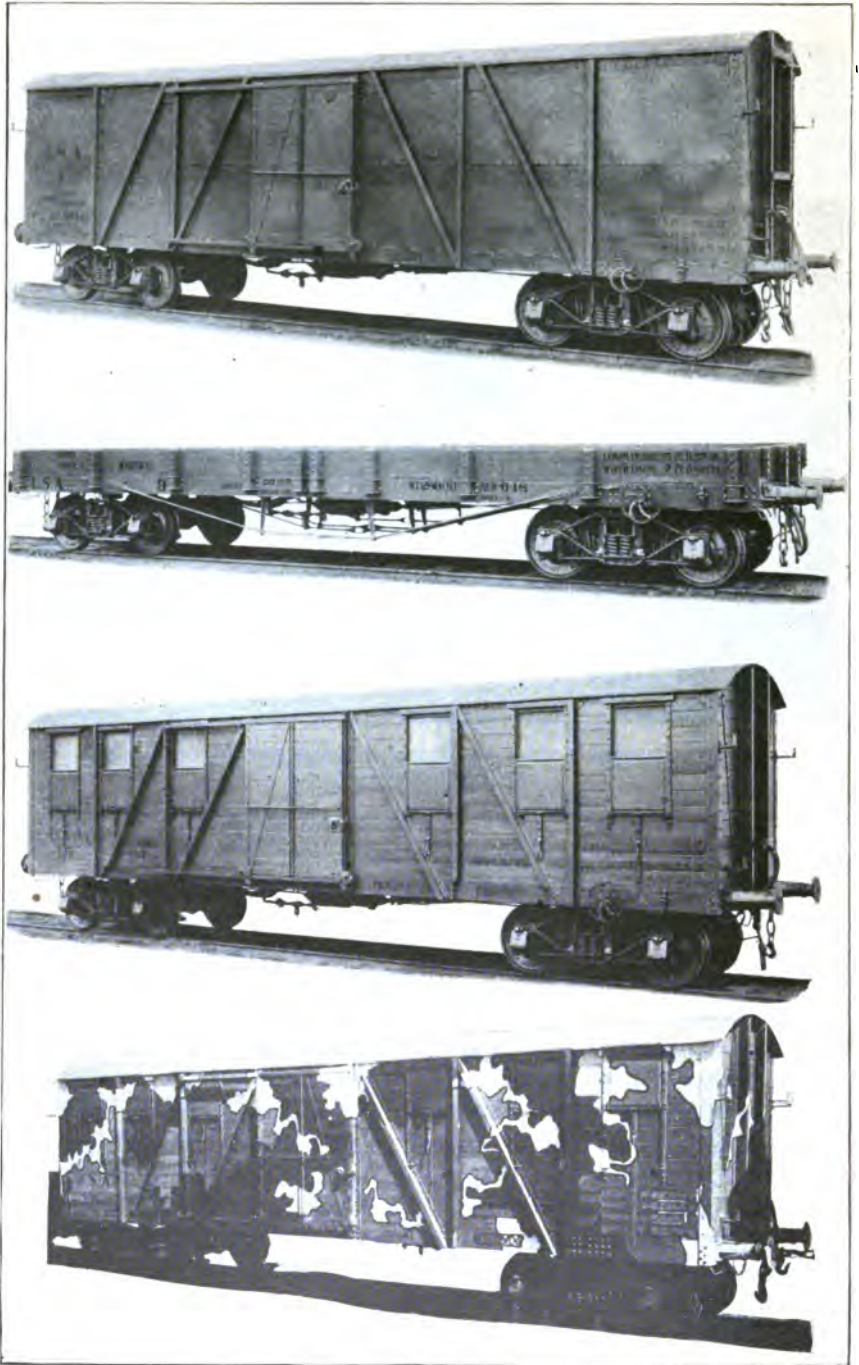

FIG. 33.—Railway artillery cars, model 1918. The upper car is for ammunition; immediately below is a supply car which carries spare parts, tools, and accessories; under that is a fire-control car in which the range-firing data are computed. At the bottom is the same type of car camouflaged.

sists of 12-wheel narrow-gauge trucks which support the railway mount, a gun transport car for transporting the gun after it is withdrawn from its cradle, and narrow-gauge ammunition cars. In addition, a loading and unloading rig is furnished for withdrawing the gun from the cradle. The great weight of this mount makes it necessary to utilize two 12-wheel trucks for each gun car, and it is also necessary to withdraw the gun when it is transported. This withdrawal is accomplished by utilizing an inclined runway made up of structural shapes and having two small trucks which support the gun. The gun is pulled from the cradle by means of a cable and winch mounted on the platform of the gun car. The small trucks travel down the inclined runway onto the gun-transport car, to which they are bolted. The shell car is a narrow-gauge gondola car provided with shell racks and trolley I-beam hoist. The powder car is a high-side gondola car in which the powder cans are stored.

Armament train.—The armament train for one regiment consists of 24 seacoast guns; twenty-four 8-inch barbette carriages, model 1918; 24 railway cars, model 1918, Mark I, standard gauge; 48 ammunition cars, standard gauge; 3 automobile supply trucks and 3 automobile repair trucks. The narrow-gauge equipment for armament train for one regiment will have, in addition to the gun in its carriage, the railway-gun car and the repair and supply trucks: Forty-eight 12-wheel narrow-gauge trucks, 24 gun-transport cars with their loading and unloading rigs, 48 shell cars, and 48 powder cars. Fire-control instruments, spare parts, and tools and accessories in accordance with the organization tables are also included in the armament-train equipment.

305-mm. railway mount.—Arrangements were made between the French Government and the United States Government whereby the United States could use the drawing of the Schneider 305-mm. sliding railway mount for getting out partially fabricated material for a railway mount to mount the Army 10-inch guns, models of 1888 and 1895. This material was to be only partially fabricated in the United States and shipped to France, where fabrication could be completed and mounts assembled. The principal parts of the mount are the car body, trucks, translating mechanism, jackscrews, sleepers, elevating mechanism, loading mechanism, shuttle car, and I-beam track stringers.

Car body.—The car body consists of two box girders, at approximately the center of which the gun is supported by its trunnions in the trunnion castings placed on the top cover plates of the girders. The gun is carried in the trunnion castings, both during transport and firing. This mount is not provided with a recoil mechanism, but recoils along the track and the shock of firing is absorbed by the friction of the sleepers on the I-beam track stringers.



FIG. 34.—306-mm. railway mount (Schneider) for U. S. 10-inch guns, models 1888 and 1895.

Trucks.—The car body is supported by two 12-wheeled trucks, having $5\frac{1}{2}$ - by 10-inch journals. The front truck is provided with two translating mechanisms, for use in moving the car back into firing position after having been fired. The rear truck is equipped with a pair of oak shoes which can be raised and lowered by means of screw jacks. Before firing these shoes are lowered onto the special I-beam track stringers. They act as a positive stop for the truck and take any load transmitted to the truck, thereby relieving the springs.

Jackscrew.—The mount is provided with jackscrews attached to the underside of the girders. These jacks carry the heavy wooden sleepers which are let down onto the special I-beam stringers before firing. The vertical component of the force due to firing is transmitted directly from the girders to the I-beam stringers through the sleepers and the horizontal component is overcome by the friction of the sleepers on the I-beam as the entire mount recoils.

Translating mechanism.—The mount is not provided with any lateral movement of the gun with respect to the car body; it is therefore necessary to use this mount on a curved track to provide traverse. To accomplish this a translating mechanism is provided which consists of a crank and train of gears which transmit the hand power to the car axles where it is applied in tractive effort to move the mount along the curved track.

Elevating mechanism.—The gun is elevated by hand power applied to a handwheel at either side of the mount. This force is transmitted through a train of gears to an elevating rack attached to the side of the gun by which means the gun may be elevated or depressed.

Loading mechanism.—A shuttle car is provided to carry the projectile and powder from the ammunition car to the gun mount. The projectile and powder are in turn picked up by an overhead trolley and placed in a chain rammer case. The projectile is then seated by the hand-operated chain rammer.

10-inch and 12-inch gun railway carriage project.—The 10 and 12 inch gun railway carriage, model of 1918, is a ground-platform type of mount, the ground platform being the means by which the carriage is held in a stationary position when firing. These carriages mount the 10-inch guns, models of 1888 and 1888, MI and MII, and the 12-inch guns, models of 1895 and 1895, MI. The 10-inch carriage permits of 36 degrees elevation and the 12-inch of 38 degrees elevation. With these elevations the 10- and 12-inch guns have approximate maximum range of 24,700 and 25,000 yards, respectively. The 10- and 12-inch carriage are practically the same, differing only in the cradle, elevating mechanism, folding platforms on the top carriage, and the gun supports and rests. These differences were necessary

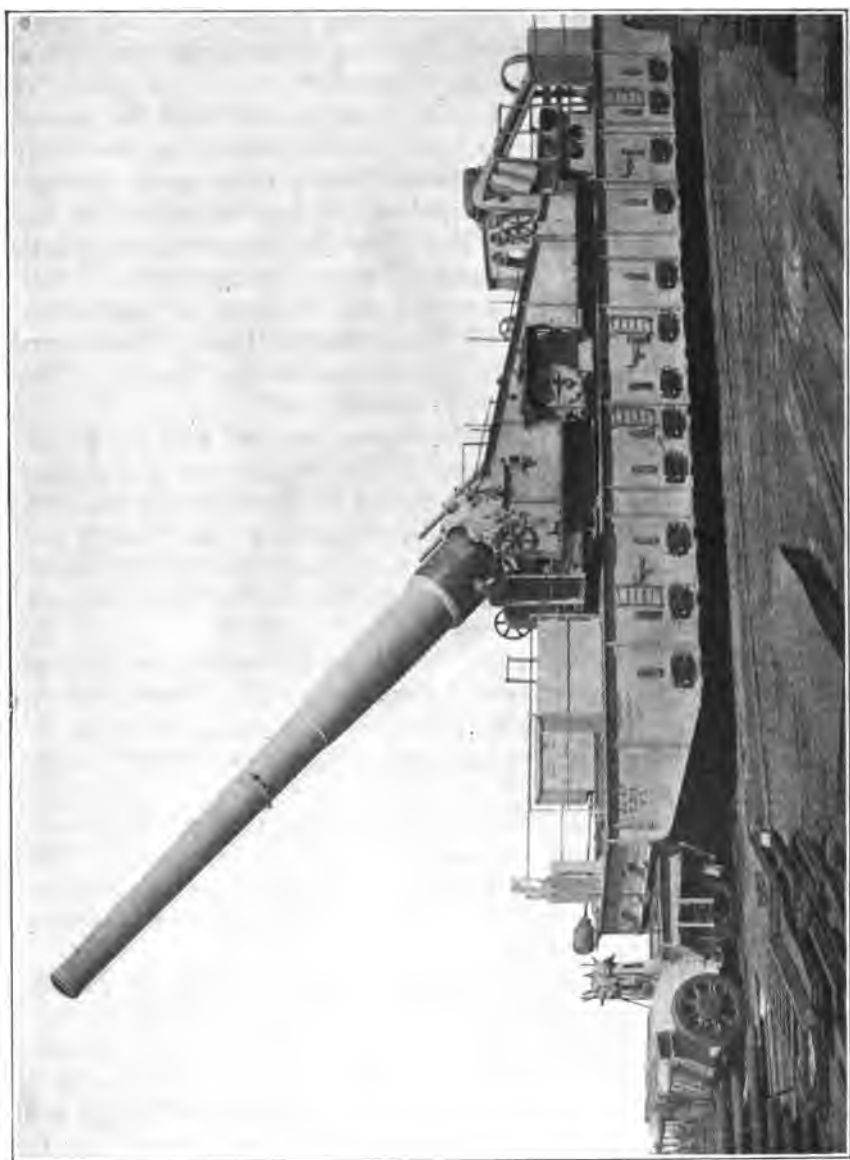

FIG. 35.—12-inch gun railway mount, model 1918, showing gun at maximum elevation.

on account of the difference in the diameters of the 10- and 12-inch guns.

The gun is mounted in a cradle provided with two recoil cylinders and a recuperator. The cradle is supported by its trunnions on the top carriage and the top carriage in turn is mounted on the car. The car is carried by two 8-wheel trucks, having 6.693 by 12.2 inch inside journals. Both of these carriages permit of 5 degrees traverse either side of the normal position. Two ground platforms and ground-platform cars are furnished with each carriage so that a greater range of azimuth than 10 degrees may be had by placing the two ground platforms at any given angle apart in removing the carriage from one platform to the other. Each of these ground platforms is composed of six sections, these sections being carried on the ground-platform car, model of 1918. This car is equipped with a trolley hoist and a hoist-runway extension and winch for use in removing the ground-platform sections from the car and placing them in position in the previously prepared excavation.

In placing the carriage on the ground platform it is brought up to the approximate position and then by means of the warping mechanism in the trucks, it is moved to its exact position over the ground platform. The wedges and tension screws are then put in place and wedges tightened up until the entire weight of the carriage is taken off of the trucks, after which the tension screws are tightened in order that the platform and carriage are fastened so that they can not separate during firing.

These carriages are equipped with a loading rig, consisting of a loading stand, loading tray, and ammunition crane. The projectile and powder charge are brought to the ammunition crane by means of a trolley hoist in the ammunition car and then placed in the loading stand. The loading tray is put in position, forming a bridge from the stand to the breech of the gun, which is loaded at 5 degrees depression. These carriages are equipped with a panoramic sight, panoramic telescope, and elevation quadrant.

12-inch Mortar railway project.—The manufacture of railway mounts for 12-inch mortars withdrawn from fortifications was authorized by the Secretary of War. The carriage as designed permits of a maximum elevation of 65 degrees, affording an estimated maximum range of about 15,300 yards. These mortar mounts are provided with narrow-gauge equipment, so that they may be pushed well forward for the most effective use. This special railway mount consists of a 12-inch mortar, model of 1890, mounted without any modifications on a specially designed carriage, which is in turn mounted on the railway car (model of 1918 MI) described. All around traverse of the mortar is also provided. The cradle in which the mortar is

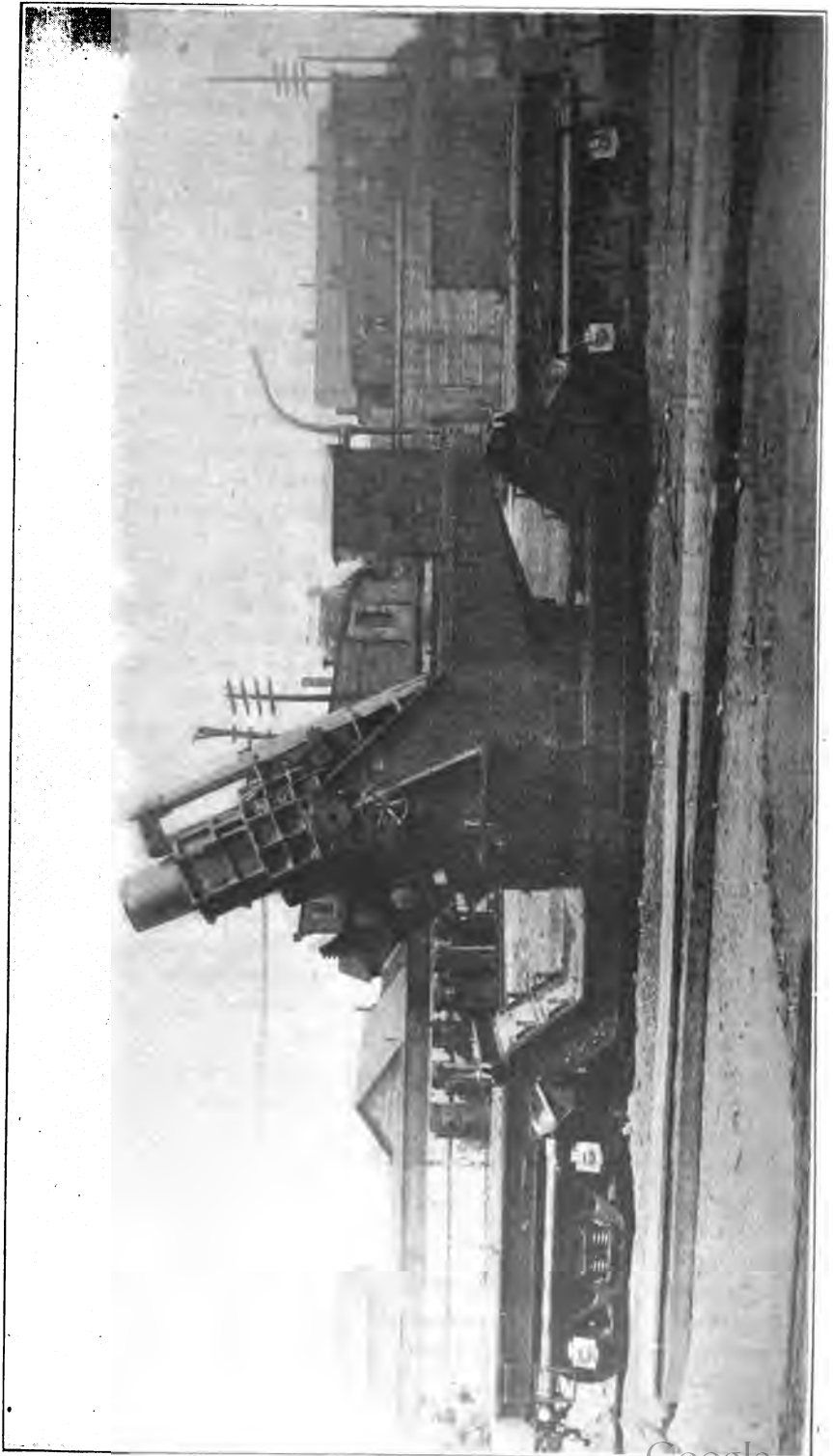

FIG. 36.—12-inch mortar railway mount, model of 1918.

mounted is provided with recoil cylinders and air recuperator. The railway car is also arranged so that the standard-gauge trucks may be removed and replaced by narrow-gauge trucks. Complete armament trains for both broad and narrow gauge track, similar to the trains provided for the 8-inch railway mounts, are also furnished for these mounts. Each mount is provided with a panoramic telescope and elevation quadrant and the usual railway artillery fire control equipment as listed on page 106 is supplied.

Sliding railway mount, model 1918.—The sliding railway mount, model of 1918, for 12- and 14-inch guns has been designed to mount these guns, both for transport and for firing, on railroad track of standard gauge. The principal parts of the mount are the car body, the span bolsters, the trucks, the translating mechanism, the bearing stringers and sleepers, the lifting wedges, the elevating mechanism, and the panoramic sight, telescope, and elevation quadrant.

Car body.—The car body consists of two heavy box girders, at approximately the center of which the gun is supported on its trunnions in trunnion castings, placed on the top cover plates of the girders, and between which it swings in elevation.

Span bolsters and trucks.—This body is in turn supported and pivoted at each end on a span bolster, which extends between two eight-wheel trucks. The entire mount is thus supported on 4 trucks, 16 axles, and 32 wheels. The trucks are provided with hand and air brakes, and the span bolsters have standard French couplers, etc., in addition to M. C. B. couplers, on the outer end of each.

Translating mechanisms.—Four translating mechanisms are furnished on the two inner trucks. These include an operating handle and a train of gearing, through which the wheels may be rotated by hand power and the mount thus caused to move along a curved track. This is effectively the traversing mechanism of the piece, as no movement is arranged for between gun and carriage in a horizontal plane. The training in azimuth is obtained by moving the mount along a curved track.

Supporting mechanism.—The gun is mounted rigidly in the car body without recoil mechanism of any kind. The recoil energy is absorbed through sleepers under the car body, which bear on special bearing stringers. These sleepers consist of wooden beams extending transversely under the car body, and the bearing stringers are steel beams laid on the ties parallel to the rails. The lifting wedges are devices by which the sleepers may be lowered in contact with the bearing stringers.

Elevating mechanism.—The elevating mechanism is of the ordinary type, and serves to move the gun in a vertical plane between the girders.

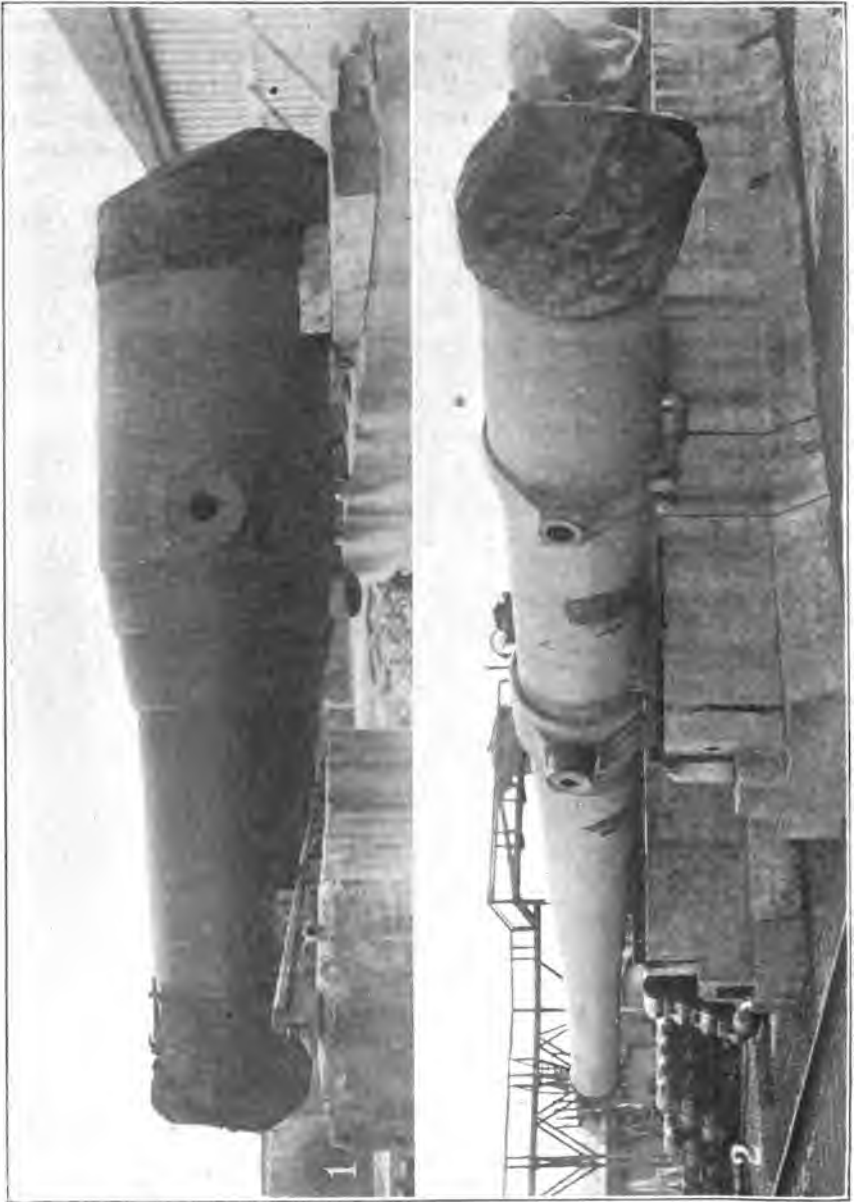

FIG. 37.—1. 12-inch mortar, model 1890, M.I. 2. 14-inch gun, model 1910, M.I.

Sights.—Panoramic sight, telescope, and elevation quadrant are special instruments used in training the gun.

Weight and other characteristics.—The total weight of the mount, including the trucks and gun, is approximately 575,000 pounds. This is approximately 36,000 pounds on each axle and the total weight is distributed over a wheel base of 92 feet 2 inches. The mount has been designed to meet railroad clearances and to go round a curve of 492 feet (150 meters) radius (11 degrees 40 minutes). The extreme height of mount over top of rail is 168.5 inches, and the total length from end to end of buffers is 100 feet 5¼ inches.

12-inch (50 cal.) railway project.—The 12-inch gun, model of 1918, 50 calibers length, is mounted on a sliding railway mount, model of 1918, and is accompanied by ammunition and shuttle cars. This gun is of the built-up type, of nickel steel throughout. A counter-balance of cast steel in two parts bolted together fits over the breech end of the gun and extends from within 10.5 inches of breech face 134.85 inches toward muzzle of gun.

14-inch gun railway carriage, model E.—This carriage mounts a 14-inch gun in a cradle with hydraulic recoil brake and spring return. The elevating gear is of the screw type. A cast-steel base plate of two semicircular sections is carried on a separate car, as is also a rear support made in sections. After emplacing the base plate and rear support, the mount is lowered thereon by means of hydraulic and screw jacks which are incorporated in the mount, and the trucks are then run back. The carriage may be traversed through 360 degrees on the base plate. When so mounted the carriage is capable of firing at angles from 0 degree to plus 30 degrees elevation. The carriage is also equipped with steel shoes, which, after lowering by means of the jacks, permit firing directly from a curved track. Under these conditions, change in azimuth is accomplished by moving the car along the track, and the final setting is made by means of a traversing gear built in between the car frame and the trucks. Thus used the elevation is limited between 0 and plus 22 degrees.

16-inch howitzer railway mount, Model E.—This car was designed to mount the 16-inch howitzer, model of 1918; to fire from a special emplacement providing 360 degrees traverse and 65 degrees elevation. This design provides a railway mount suitable for seacoast-defense purposes. The special emplacement has a base ring 27 feet in diameter embedded in the ground and on which the mount is traversed. In the center of the base ring is a circular pit, approximately 12 feet in diameter and 7 feet deep to allow for the recoil of the howitzer.

Cradle.—The howitzer is mounted in a cast-steel cradle. Each cradle is provided with two hydraulic recoil cylinders and four spring counter-recoil cylinders.

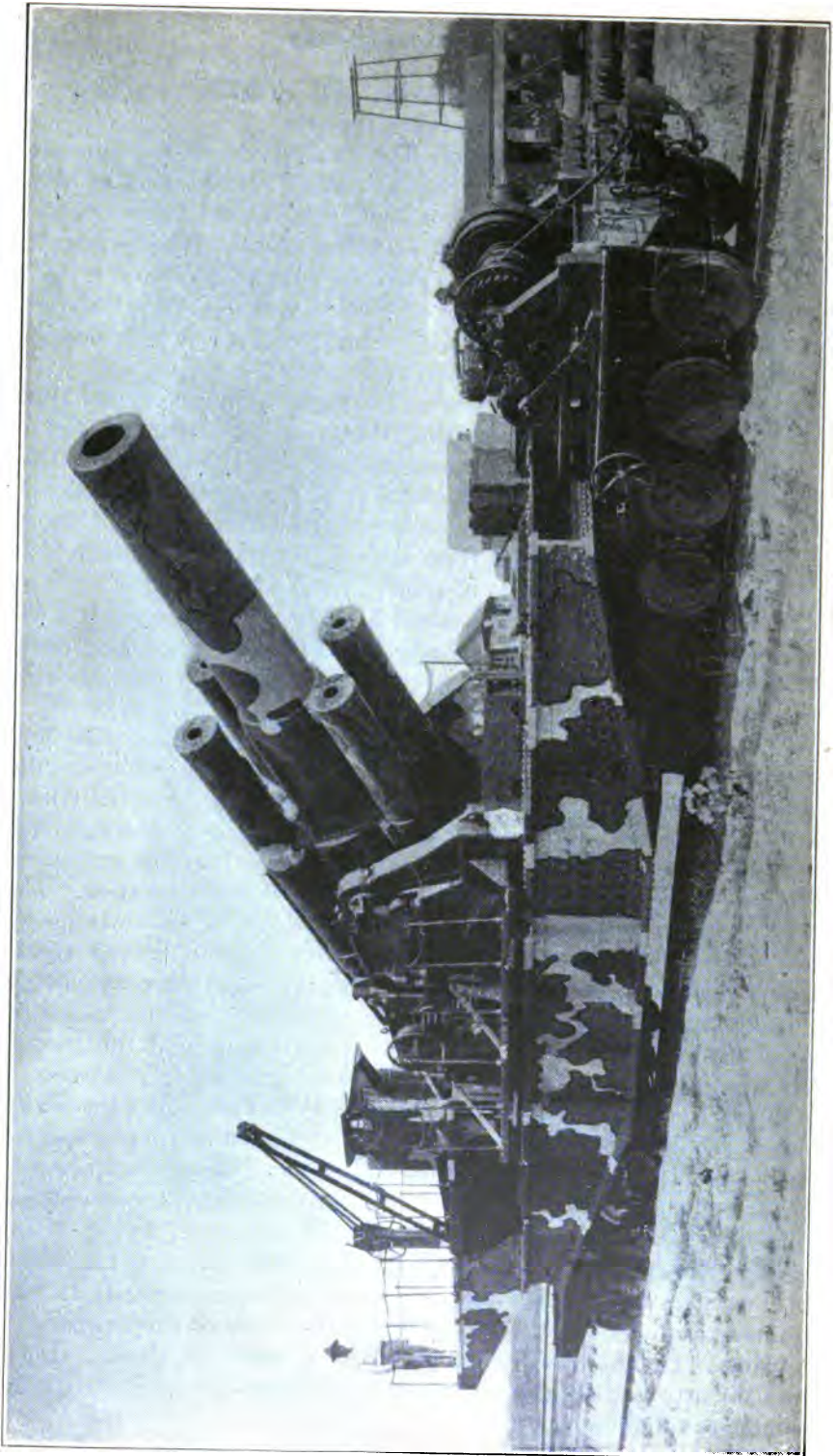

FIG. 38.—16-inch howitzer railway mount, model of 1918.

Elevating gear.—The elevating gear is of the elevating rack-and-worm type operated by handwheels on each side of the car.

Transport trucks.—The trucks for transporting the gun mount are of the six-wheel equalized type, having 6 by 11 inch M. C. B. standard outside journals. These trucks are known as the Lehigh Valley type of heavy duty trucks.

Base ring.—The base ring on which the mount rests when put on its emplacement is of cast steel in four sectors of approximately 25,000 pounds each. It has a box section 40 inches wide, 30½ inches deep under rails, and 27 feet in diameter between center line of the outer rails. On the upper surface of the castings there is a finished vertical projection to which the traversing rack is fixed and which also serves as the pintle-bearing surface. An 80-pound rail, on which the carriage traverses, is bolted on both sides of this rack.

16-inch howitzer railway mount, Model of 1918.—The 16-inch howitzer railway mount, model of 1918, mounting the 16-inch howitzer, model of 1918, was developed to provide a mount for use in the field capable of firing a high-explosive projectile weighing 1,660 pounds at from plus 20 degrees to plus 65 degrees elevation and to be traversed 5 degrees either side of the normal position.

A ground platform built up of timber acts as an emplacement and spade, the force of firing being transmitted through steel struts and jacks placed under the car frame.

The mount may also be fired without the ground platform from plus 20 degrees to plus 45 degrees elevation directly from the trucks.

The tipping parts are the same as used on the 16-inch howitzer carriage, model E, with slight modifications.

Railway artillery fire control.—The fire-control instruments required for railway artillery consist of the panoramic telescope, the elevation quadrant, and various accessories and instruments listed below.

Panoramic telescope.—A large panoramic telescope with magnifications, 4 and 10 power, is also provided for each railway mount. This panoramic telescope is similar to the Field Artillery panoramic sight, and is mounted in a special type of mounting somewhat similar to that used with the 75-mm. gun carriage, model of 1916. This mounting automatically corrects the line of sight and compensates for the amount which the base ring is out of level.

Elevation quadrant.—An elevation quadrant graduated in degrees and minutes is provided for each of the United States railway mounts. This elevation quadrant has a cross level so that correction can be made for the amount that the gun trunnions are out of level.

Fire-control instruments required for railway mounts.—The following instruments are required for each battery and each battalion of railway artillery:

FIRE-CONTROL EQUIPMENT FOR RAILWAY HEAVY ARTILLERY.

Item.	Drawing.			Specification No.	Number active required per battery.	Number spare required per battery.	Number required at battalion headquarters.	Number spare required per battalion.	Number replacement per regiment depot for 1 year.	Total number per regiment, active, spare, and replacement.
	Class.	Division.	Drawing.							
Aiming, rule.....	22	5	10		4	1				
Arm, metal.....	22	77	1	3098	2	2	2		23	50
Azimuth instrument, model of 1918.....	22	77	1	3098	2	2	2		16	34
Azimuth instrument, instrument case.....	22	77	1	3098	2	2	2		16	34
Azimuth instrument, telescope carrying case.....	22	77	1	3098	2	2	2		16	34
Azimuth instrument, tripod.....	22	77	1	3098	2	2	2		16	34
Azimuth instrument, tripod carrying case.....	22	77	1	3098	2	2	2		16	34
Azimuth instrument, storage battery ¹					2		2		16	34
Azimuth instrument, replacement part set for 100 instruments.....	27	54	2							
Azimuth instrument, periscopic.....	22	80	1	3100	2		2		16	34
Azimuth instrument, periscopic, instrument case.....	22	80	1	3100	2		2		16	34
Azimuth instrument, periscopic, telescope chest.....	22	80	1	3100	2		2		16	34
Azimuth instrument, periscopic, tripod.....	22	80	1	3100	2		2		16	34
Azimuth instrument, periscopic, tripod carrying case.....	22	80	1	3100	2		2		16	34
Azimuth instrument, periscopic, storage battery ¹					2		2		16	34
Azimuth instrument, periscopic, replacement part set for 100 instruments.....	27	54	1							
Battery, extra storage for electric lantern ¹					9		8		78	156
Battery charging switchboard.....	14	10	1		1				6	12
Battery charging switchboard replacement part set for 100 instruments.....	27	54	3							
Compass, prismatic.....	22	53	1		2		2	1	17	36
Compass, prismatic, carrying case.....	22	53	1		2		2	1	17	36
Compass, prismatic, tripod.....	22	53	1		2		2	1	17	36
Compass, prismatic, tripod carrying case.....	22	53	1		2		2	1	17	36
Compass, prismatic, replacement part set.....										
Computing device, Wilson.....	22	99	1		1		1		8	17
Computing device, Wilson, carrying case.....	22	99	1		1		1		8	17
Computing device, Wilson, replacement part set for 100 instruments.....	27	54	4							
Deviation board, Pirie.....	22	93	1	3104	1		1		8	17
Deviation board, Pirie, replacement part set for 100 instruments.....	27	54	5							
Lantern, electric with battery ¹					9		8		78	156
Lantern bulbs ¹									156	156
Protractor, metal.....	22	91	1		1	1	1			
Table, range, abridged.....					12		12		243	351
Telescope, B. C. model of 1915.....	22	39	1	522	1		1		6	15
Telescope, B. C. carrying case.....	22	39	1	522	1		1		6	15
Telescope, B. C. tripod.....	22	39	1	522	1		1		6	15
Telescope, B. C. tripod carrying case.....	22	39	1	522	1		1		6	15
Telescope, B. C. replacement part sets per 100 instruments.....					1		1		8	20
Tape, steel (30 meters long) ¹					6		6		98	152
Stop watch "standard".....					6		6		98	152
Shock absorber and thong.....	22	90	1		6		6		98	152
Circle, aiming, model of 1916.....	22	41	1	523	2		1			
Circle, aiming, model of 1916, carrying case.....	22	41	1	523	2		1			
Circle, aiming, model of 1916, tripod.....	22	41	1	523	2		1			
Circle, aiming, model of 1916, tripod carrying case.....	22	41	1	523	2		1			
Circle, aiming, model of 1916, replacement part sets for 100 instruments.....										
Level, micrometer cross.....					4	1			6	36
Level, micrometer cross, case.....					4	1				
Plotter, aircraft observation.....					1					
Posts, aiming, circular head.....					8					
Posts, aiming, square head.....					8					
Quadrant, gunners, model of 1918.....	15	12L	1	3046	4	1			4	
Quadrant, gunners, model of 1918, pouch.....	15	12L	1	3046	4	1			4	
Quadrant, gunners, model of 1918, chest.....	15	12L	1	3046	4	1			4	
Ruler, B. C.....	22	36	(*)		10		10			

¹ Commercial material.

² Requires special drawing for each gun and charge.

SPECIAL NOTE.—No 50 per cent replacement.

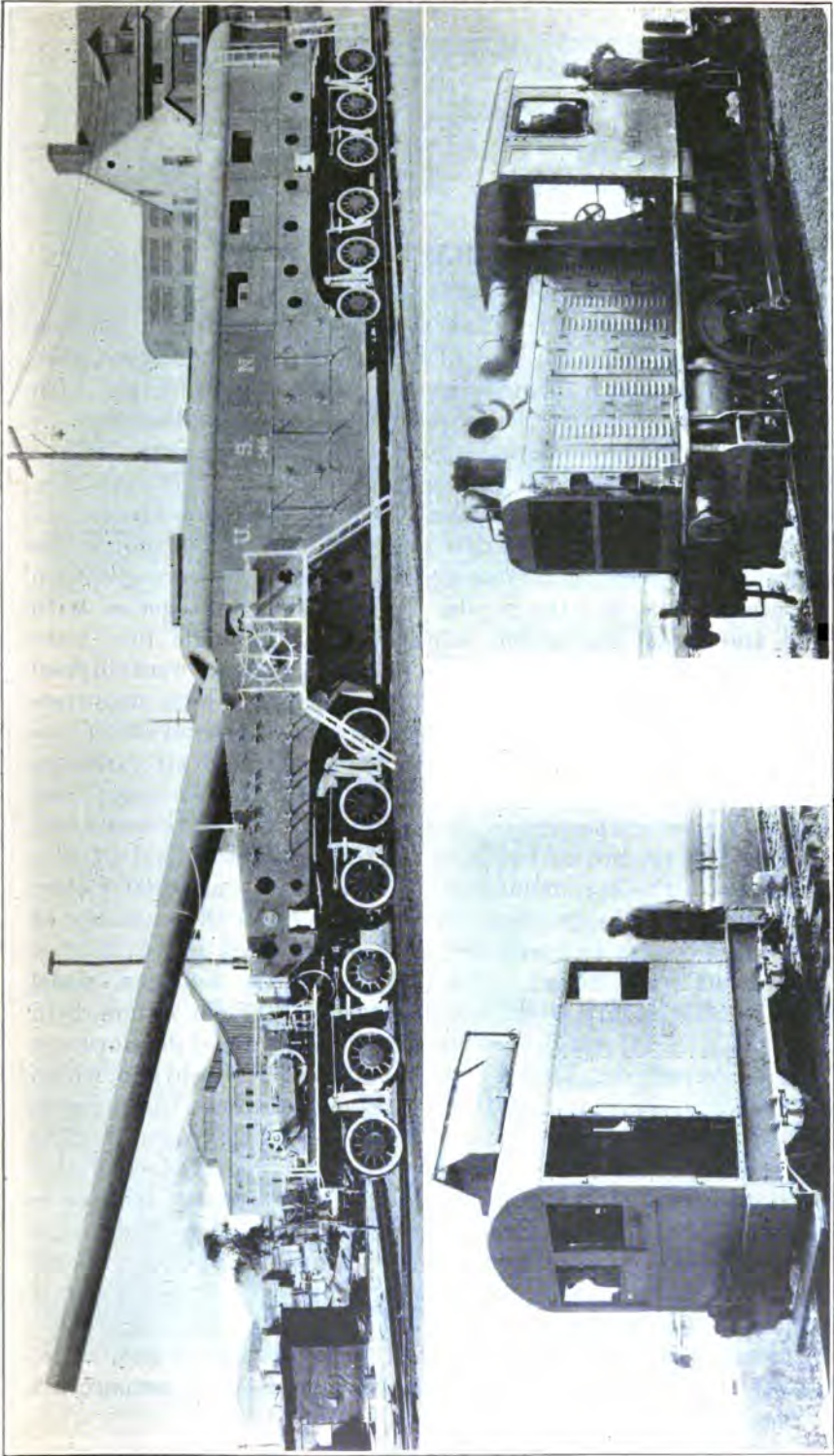

FIG. 39.—U. S. Navy 14-inch gun on railway mount. 200-horsepower gasoline-electric locomotive for railway artillery.

IV. ANTI-AIRCRAFT MATÉRIEL.

Types of anti-aircraft mounts.—Five types of anti-aircraft mounts have been designed for the United States service. Four types were under manufacture in quantity in 1918, and a pilot for the fifth type had been completed. Two French types are also illustrated.

Improvised anti-aircraft carriage, model 1917, for 75-mm. gun, 1897.—The improvised anti-aircraft carriage, model 1917, for 75-mm. gun, 1897, was designed as an emergency mount to take the 3-inch field gun, model of 1902. The design was later changed to mount the 75-mm. French field gun, model 1897. Carriages were built in the United States, and the regular French field gun, together with cradle and recoil mechanism adjusted for high-angle fire, were ordered in France to be placed on this mount. Carriages were shipped equipped with open sights. Telescopic sights were later manufactured in this country to replace the open sights. A total of 50 carriages were ordered and no more contemplated, and all carriages were delivered and proof fired. The gun, gun carriage, and necessary limber are carried on $3\frac{1}{2}$ -ton trailers. The maximum recoil of the gun is 49 inches; elevation, 22 to 85 degrees; field of fire, 360 degrees. The maximum vertical range is about 6,200 meters and the horizontal range about 10,000 meters. For the assembly of this carriage consult Ordnance Department drawings 2-76-2, 2-76-3.

Anti-aircraft truck mount, model 1917, for 75-mm. field gun, model 1916.—The anti-aircraft truck mount, model of 1917, for 75-mm. field gun, model of 1916, was the next step in the design and development of an anti-aircraft gun carriage. It is to take the 1916 field gun, which has since been rechambered for the French ammunition. The gun is on a $2\frac{1}{2}$ -ton gasoline-driven truck, model T. B. C. Fifty-one of these mounts were manufactured. It was not expected that more of this type of mount would be required. The weight of carriage and gun is 5,300 pounds; length of recoil, 33 inches; elevation, 31 to 82 degrees; field of fire, 240 degrees. The maximum vertical range is about 6,000 meters and the horizontal range is about 9,000 meters. Consult drawings 31-5-2, 31-5-3, 31-5-4.

Auto-trailer carriage, model 1917, for 3-inch anti-aircraft gun, model 1918.—The auto-trailer carriage, model 1917, for 3-inch anti-aircraft

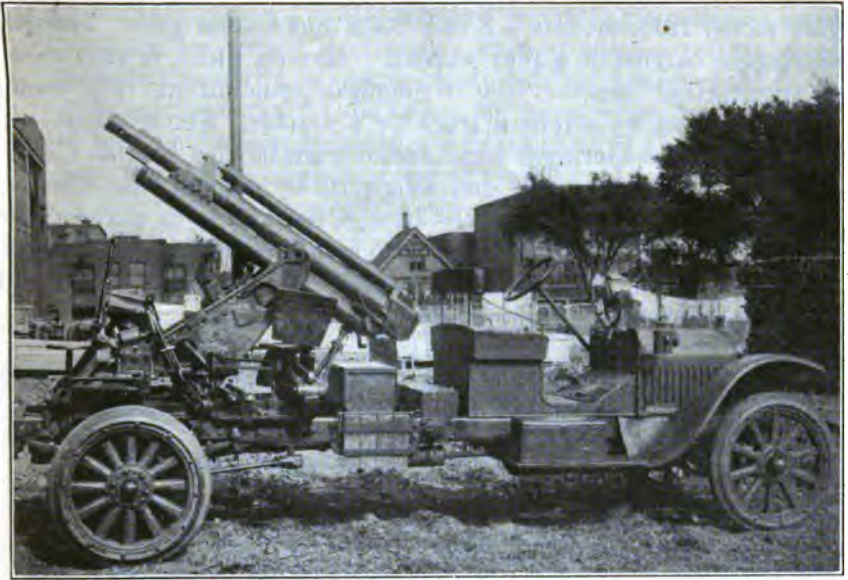

FIG. 40.—75-mm. field gun, model 1916, on A. A. truck mount, model 1917, 24-ton White truck.

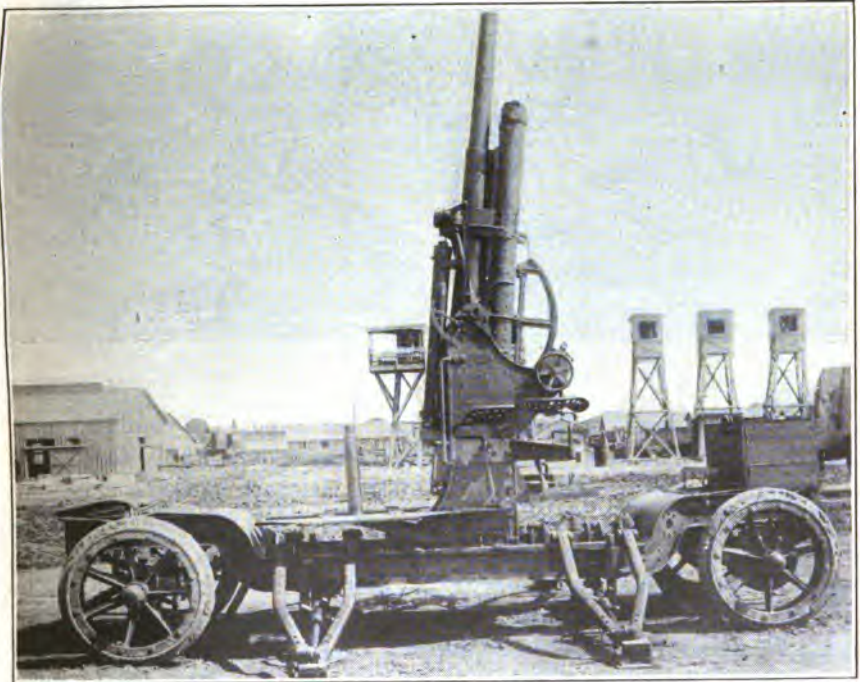

FIG. 41.—3-inch A. A. gun, model 1916, carriage, model 1917, on 3-ton A. A. trailer mount.

gun, model 1918, mounts a 3-inch 2,400 foot-second gun. The gun carriage is carried on a four-wheeled trailer on which is also placed an ammunition chest carrying 16 rounds of ammunition. The trailer is to be drawn by either a truck or a tractor. Six hundred and twelve of these carriages were under manufacture in the United States. The carriage and gun weigh 10,000 pounds; the recoil is variable, 16 to 40 inches; the elevation is from 10 to 85 degrees; the field of fire, 360 degrees; the maximum horizontal range is 11,000 meters; the vertical range at 90 degrees is 7,200 meters. Consult drawings 31-15-2, 31-15-3, 31-15-4.

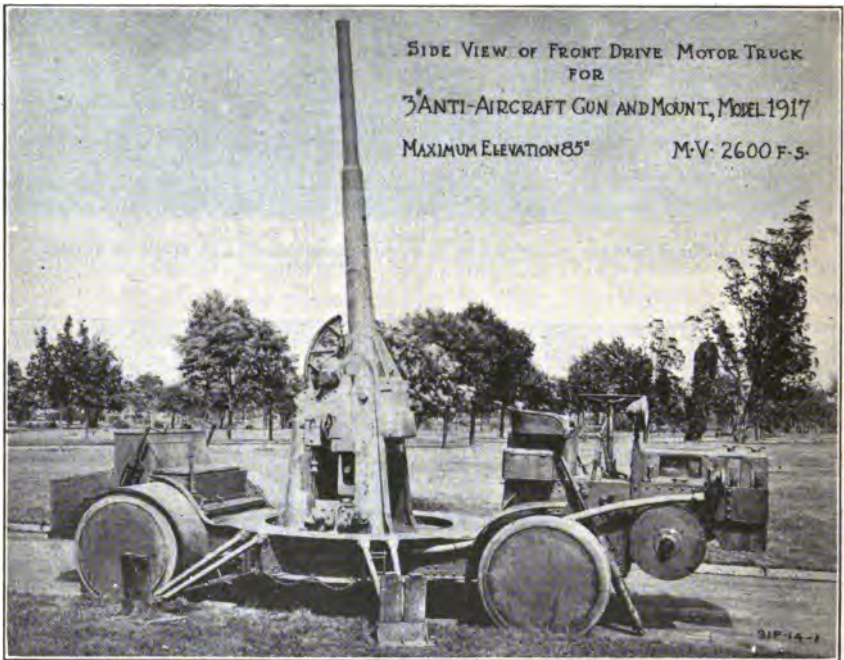

FIG. 42.—3-inch A. A. gun and mount on front-drive truck.

3-inch antiaircraft mount, model 1917, for 3-inch (15-pounder) gun, model 1917.—The 3-inch antiaircraft mount, model 1917, for 3-inch (15 pounder) gun, model 1917, is of the seacoast barbette type and permits all-around firing from zero to 90 degrees in elevation. It is expected that the gun will not be fired over 85 degrees in elevation on account of the possible danger to the personnel in the vicinity of the piece. The gun was designed with a maximum velocity of 3,000 foot-seconds, although it has been decided that 2,600 will be its service velocity. The Coast Artillery project was approximately 500 of these mounts, and there were manufactured and delivered 160 guns and carriages; but upon recommendation the Secretary of War directed

that all manufacturing facilities be used for producing mobile guns and carriages for troops in France. Five of these carriages were mounted experimentally on special gasoline-driven trucks of the front drive type as illustrated on the preceding page, which had been developed for this purpose, and assigned to the chief of Coast Artillery, to be used for defense of cities, from aircraft attack. The maximum vertical range of this gun and mount is 8,300 meters and the horizontal range 12,000 meters. This mount is shown on ordnance office drawings 5-26-4, 5-26-5, 5-26-8, 5-26-9.

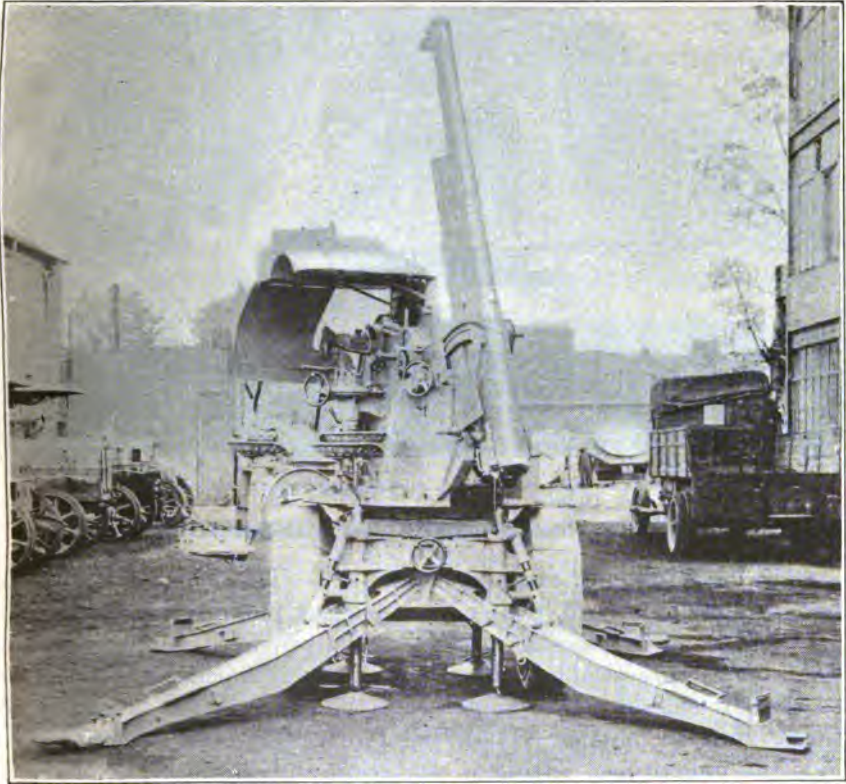

FIG. 43.—French 75-mm. A. A. gun on trailer carriage.

4.7-inch caterpillar trailer mount, model 1918, for anti-aircraft, model 1918.—The anti-aircraft trailer mount, model E, for 4.7-inch anti-aircraft gun, model of 1918, was designed and the design is complete. The gun and carriage weigh approximately 25,000 pounds, and it is proposed to place this mount on a caterpillar trailer with a smooth tread, weighing about 10,000 pounds according to the computations made in designing this gun and mount it would have a maximum horizontal range of 15,000 meters and would fire vertically to a dis-

tance of 10,000 meters. The recoil is variable from approximately 36 inches to 20 inches, and the field of fire is from zero to 80 degrees in elevation and 360 degrees in azimuth.



FIG. 44.—French 75-mm. A. A. gun on auto truck carriage.

SIGHTS FOR ANTI-AIRCRAFT CARRIAGES.

Sight for anti-aircraft carriage, model 1917.—This type of sight was designed for the truck, trailer, and seacoast mounts. It was originally intended to place it also on the improvised mount, but this was found impracticable, as the design was developed. The operator on the left side of the carriage keeps the sight on the target at all times, and by moving certain pointers causes other operators to give the gun proper setting in elevation and azimuth. The truck mount will be equipped with this sight.

Sight for anti-aircraft carriages, model 1918.—Upon recommendation from Gen. Pershing that the eyepiece of the sight be revolved through 90 degrees, so as to coincide with the axis of rotation of the objective, the sight model 1917 was slightly redesigned and the new sight called the model of 1918. This sight differs from the sight model 1917 only in the telescope and the method of mounting. This telescope is similar in design to panoramic sight for the revolving head and revolving prism, the eyepiece being stationary and placed in such position that the operator faces toward the gun.

Upon receipt of further information from France, it was found that this sight did not correct for "complementary error," and that the sight had no way of correcting for lateral windage except by placing it on lateral deflection correction scale. Drawings were at once made changing this sight in accordance with these suggestions. This sight is known as anti-aircraft sight, model of 1918, MI. A universal joint is placed between the sight telescope and the elevation pointer. This automatically takes care of the "complementary error." Another lateral deflection correction scale was added to take care of cross windage. (See Ordnance Department assembly drawings 15-15UA-2 and 15-15UA-3.)

Sights for anti-aircraft trailer mount for 4.7-inch anti-aircraft guns.—The sight for the anti-aircraft trailer mount for the 4.7-inch anti-aircraft gun is similar in construction to the sight for anti-aircraft carriages, model of 1918, MI. In it are incorporated a universal joint for the "complementary error" and also means for correcting for lateral windage. The fuze-setter range disk has been made larger to facilitate reading and a few necessary minor changes to conform to this enlarged disk. (See Ordnance Department assembly drawings 15E-15 TA-1.)

ANTI-AIRCRAFT FIRE-CONTROL INSTRUMENTS.

Anti-aircraft fire-control in France.—The subject of anti-aircraft fire control has presented many difficulties, and the evolution of methods and instruments toward definite standards of practice has been slow and difficult. To show briefly the status of anti-aircraft fire control in France after three years of service, the following is quoted from the report of three United States Army officers, who in 1917 made a special trip to France to investigate this matter. "It was not foreseen that such a chaos of instruments, methods, and conflicting ideas would be encountered. There is no such thing as a French system of aircraft defense. There are systems of defense, some of which are taught in L'Ecole de Tir contre Avions at Arnouville * * * and the result is a combination of systems and methods which appall one who has heard of the French system mentioned as if it were a tangible thing. Instruments themselves differ in type."

System of United States Army.—The anti-aircraft section of the carriage division about April, 1917, designed instruments to furnish firing data under a proposed system of firing control based upon the latest information from France. In general, this system consisted in the determination of the altitude of the target, combining this altitude with the observed angle of site to find the fuze-setter range, then correcting this range for angle of travel, wind, drift, etc.

The altitude is determined by means of two instruments, known as goniometers and altimeters, placed at each end of a known line. Having determined the altitude, it is combined with the angle of site by means of an instrument known as an altitude telemeter. By a slide rule, the angle of travel during time of flight is determined for the sight settings; and the travel during the time of flight and dead time (time of loading) is computed to determine the predicted fuze-setter range.

Instruments ordered from France.—The accompanying lists indicate the types of anti-aircraft fire control instruments provided. Drawings of the Telemetre d'altitude avec correcteur automatique, Altimetre, Mle 1917; Telemetre de distance horizontale, Tac hyscope, Grille d'observation, Mle 1917, were received from the French Government and retraced so that these instruments could be manufactured in this country. The Brocq Tachymetre E. M. is an electrical instrument which continually gives horizontal and vertical deflection corrections. The Correcteur Mechanique, R. A. (Routin), is a mechanically operated apparatus which gives continually horizontal and lateral deflection corrections in the future fuze-setter range.

The Telemetre d'altitude is an instrument which combines the vertical Brocq reading, angle of site, and known altitude, giving the future fuze-setter range. The Altimetre, model 1917, is a height-finding apparatus similar to our goniometers. The Tachyscope is an instrument for measuring target velocity or wind velocity by the use of a smoke bomb. The Grille d'observation is an instrument used in pair at either end of a known base line to determine the deflection between the instantaneous position of the target and the burst of projectile.

TABLE 7.—*Anti-aircraft fire-control instruments.*

Fire-control instruments to be used with improvised anti-aircraft mount; each battery consists of two guns.

Drawing No.	Name.	Required for battery.
	Correcteur E. M. (Brocq).....	1
22-82-1.....	Altitude telemeter (French).....	1
22-84-1.....	Altimeter, model 1917 (French).....	3
	Wind drum.....	1
22-81-1.....	Tachyscope (French).....	1
22-85-1.....	Lateral observation grille (French) (made in France).....	2
	Observation telescope.....	1
14-4-17.....	Flashlights with hoods.....	8
14-4-17.....	Flashlights without hoods.....	16
	Range tables (sets).....	3
Commercial.....	Amber-colored eyeglasses.....	6
Commercial.....	Steel tape.....	1
Commercial.....	Time-interval recorders.....	6
Commercial.....	Rolls tape (black insulating).....	2
Commercial.....	Rolls tape (okonite).....	6

TABLE 7.—*Antiaircraft fire-control instruments*—Continued.

[Fire-control instruments to be used with 3-inch antiaircraft mount, model 1917; each battery consists of two guns.]

Drawing No.	Name.	Required for battery.
22-84-1.....	Correcteur mécanique, R. A. (Routin).....	1
	Altimeter, model 1917 (French).....	3
	Wind drum.....	1
22-81-1.....	Tachyscope (French).....	1
22-85-1.....	Lateral observation grille (French) (made in France).....	2
	Observation telescope.....	1
14-4-17.....	Flashlights with hoods.....	8
14-4-17.....	Flashlights without hoods.....	16
	Range tables (sets).....	3
Commercial.....	Amber-colored eyeglasses.....	6
Commercial.....	Steel tape.....	1
Commercial.....	Time-interval recorders.....	6
Commercial.....	Rolls tape (black insulating).....	2
Commercial.....	Rolls tape (okonite).....	6

[Fire-control instruments to be used with antiaircraft truck mount, model 1917; each battery consists of three guns.]

22-82-1.....	Correcteur E. M. (Brocq).....	1
22-84-1.....	Altimeter, model 1917 (French).....	3
	Wind drum.....	1
22-81-1.....	Tachyscope (French).....	1
22-85-1.....	Lateral observation grille (French) (made in France).....	2
	Observation telescope.....	1
14-4-17.....	Flashlights with hoods.....	12
14-4-17.....	Flashlights without hoods.....	24
	Range tables (sets).....	4
Commercial.....	Amber-colored eyeglasses.....	9
Commercial.....	Steel tape.....	1
Commercial.....	Time-interval recorders.....	8
Commercial.....	Rolls tape (black insulating).....	2
Commercial.....	Rolls tape (okonite).....	9

[Fire-control instruments to be used with 3-inch antiaircraft trailer mount, model 1917; each battery consists of three guns.]

22-81-1.....	Correcteur mécanique, R. A. (Routin).....	1
	Altimeter, model 1917 (French).....	3
	Wind drum.....	1
22-81-1.....	Tachyscope (French).....	1
22-85-1.....	Lateral observation grille (French) (made in France).....	2
	Observation telescope.....	1
14-4-17.....	Flashlights with hoods.....	12
14-4-17.....	Flashlights without hoods.....	24
	Range tables (sets).....	4
Commercial.....	Amber-colored eyeglasses.....	9
Commercial.....	Steel tape.....	1
Commercial.....	Time-interval recorders.....	8
Commercial.....	Rolls tape (black insulating).....	2
Commercial.....	Rolls tape (okonite).....	9

TABLE 8.—British gun data.

	18-pounder, field.	60-pounder, Mark II and Mark II.	6-inch howitzer, 26 hundred- weight, Mark I.	6-inch howitzer on 6-inch 60-pounder carriage.	6-inch Mark XIX, 35 caliber.	8-inch howitzer, Mark VIII.	9.2 inch howitzer, Mark II.
Diameter of bore.....	3.3.....	5.....	6.....	6.....	6.....	8.....	9.2.....
Total length of gun.....	96.96.....	192.25.....	57.55.....	134.15.....	219.22.....	149.3.....	170.51.....
Length of gun.....	23.1.....	37.....	13.3.....	21.....	35.....	17.3.....	17.3.....
Chamber length.....	10.445.....	21.926.....	11.53.....	23.45.....	36.....	35.66.....	34.035.....
Chamber capacity.....	97.....	618.75.....	380.....	780.....	1,715.....	2,050.....	2,600.....
Projectile weight.....	134.....	60.....	100.....	100.....	100.....	200.....	280.....
Charge weight.....	1 lb. 6 ozs. 15 drs.	9 lbs. 7 ozs.....	4 lbs. 11 ozs. 8 drs.	10 lbs.....	23.....	17.5.....	23 lbs. 12 ozs.
Charge nature.....	M. D. 8.....	M. D. 16.....	M. D. 8.....	N. C. T. 16.....	M. D. 16.....	M. D. 8.....	M. D. T. 20/19.
Muzzle velocity.....	1,615.....	2,150.....	1,240.....	1,630.....	2,350.....	1,525.....	1,503.....
Muzzle energy.....	335.....	1,023.....	1,066.....	1,940.....	3,530.....	3,225.....	4,545.....
Maximum elevation.....	30.....	35.....	45.....	40.....	38.....	45.....	50.....
Maximum range.....	{ 2 c. r. h., 9,000 yards.	{ 8 c. r. h., 15,500 yards. 2 c. r. h., 13,900 yards.	{ 2 c. r. h., 10,100 yards.	{ 6 c. r. h., 13,500 yards. 2 c. r. h., 12,000 yards.	{ 4 c. r. h., 17,500 yards.	{ 2 c. r. h., 12,100 yards.	{ 2 c. r. h., 12,700 yards.

1 c. r. h. stands for caliber radius of head and refers to shell outline.

Compiled from the Vickers table.

V. EUROPEAN ARTILLERY.

These pages represent extracts from information supplied to the Ordnance Department during the war and do not pretend in any way to summarize technical studies of enemy matériel turned over after the armistice or to catalogue the various types used by the allies.

British matériel.—The table on the preceding page gives weights, dimensions, and other constants for leading types of British field guns. Of somewhat general interest is the following table, which shows the proportion of guns to yards of front in the whole British second army front of 10,250 yards on August 28, 1917, when it was a “defensive front,” and the proportion decided upon as necessary for the attack on the “offensive front” of 6,800 yards:

	Defensive front, Aug. 28, 1917.	Offensive front, Sept. 12, 1917.
18-pounder.....	1 gun per 404 yards.	1 gun per 9 yards.
4.5 inch howitzer.....	1 gun per 121 yards.	1 gun per 27 yards.
60-pounder.....	1 gun per 373 yards.	1 gun per 48 yards.
6-inch howitzer.....	1 gun per 138 yards.	1 gun per 25 yards.
8-inch howitzer.....	1 gun per 456 yards.	1 gun per 76 yards.
9.2 inch howitzer.....	1 gun per 606 yards.	1 gun per 85 yards.
12-inch howitzer.....	1 gun per 1,825 yards.	1 gun per 377 yards.

TABLE 9. *Railway and seacoast carriages, British 9.2-inch B. L. guns, Marks X, XIII, and XIV.*

1. The more important data concerning British 9.2-inch B. L. guns, Marks X, XIII, and XIV of these guns are contained in following table:

	Mark X.	Mark XIII.	Mark XIV.
Material.....	Steel (wire construction).	Steel (wire construction).	Steel (wire construction).
Length, total.....	442.35 inches.	335.025 inches.	427.025 inches.
Position of center of gravity without breech mechanism.....	164.5 inches from face of breech.		
Weight with breech fittings (nominal).....	28 tons.	24 tons.	27 tons.
Weight without breech fittings.....	27 tons 19 hundredweight.		
Preponderance.....	Nil.		
Bore:			
Caliber.....	9.2 inches.	9.2 inches.	9.2 inches.
Length.....	429.33 inches.	322 inches.	414 inches.
Capacity.....	32,235 cubic inches.	24,579 cubic inches.	
Diameter—			
Largest.....	13 inches.	13.6 inches.	13 inches.
Smallest.....	10.2 inches.	10.2 inches.	10.2 inches.
Chamber:			
Length.....	71 inches.	45.23 inches.	71 inches.
Capacity.....	8.123 cubic inches.	5,500 cubic inches.	
Length.....	353.8 inches.	271.3 inches.	338.475 inches.
System.....	Polygroove, plain section.	Polygroove, plain section.	Polygroove, plain section.
Twist.....	Uniform 1 turn.	Uniform 1 turn.	Uniform 1 turn.
Rifling, Mark II:			
Number of grooves.....	46.	46.	46.
Depth.....	0.07 inch.	0.07 inch.	0.07 inch.
Width.....	0.4188 inch.	0.4188 inch.	0.4188 inch.
Means of rotation.....	Driving band.	Driving band.	Driving band.
Firing mechanism.....	Percussion.	Percussion.	Percussion.
System of obturation.....	Pad (steep coned).	Pad (steep coned).	Pad (steep coned).

2. The ammunition for the 9.2-inch gun is as summarized on the accompanying table:

Projectiles.				Fuze.	Cartridges.				
Description.	Mark.	Weight.	Fuze hole.		Nature.	Weight.	Size.		
Shell, breech-loading, 9.2-inch gun: High-explosive.	IX	Pounds. 380	G. S.	Fuze percussion, D. A. Impact No. 44.	Cordite, M. D.	60 pounds, one-half charge.	37		
Do.....	XIII	380	2-inch....	Fuze percussion, D. A. Impact No. 44, with No. 2 adapter, or fuze percussion No. 101E, with No. 2 Gaine.				30 pounds, one-fourth charge.	37
Shrapnel.....	VIII	380	G. S.	Fuze, T. and P., No. 64.					
Shell, breech-loading, 9.2-inch gun: High-explosive.	{ IX-A XII-A XIII-Z	380	G. S.	{ As for Mark IX..... As for Mark XIII.....	Cordite, M. D.	53 pounds 8 ounces, one-half charge, 26 pounds, 12 ounces, one-fourth charge.	26		
Do.....		380	2-inch....	Fuze, T. and P., No. 64, with adapter No. 1				26	
Do.....		380	2-inch....						
Shrapnel.....	X-A	380	2-inch....	{ Fuze, T. and P., No. 83. Fuze, T. and P., No. 88.					

Some high-explosive shells were fitted with hollow points of aluminum to increase the point to 8-caliber radius head. When using these a special range table is required.

The shell shrapnel Mark X-A was to be issued as soon as a satisfactory design of long-burning fuze had been approved.

Railway truck for breech-loading 9.2-inch Mark II.—The railway truck used with the 9.2-inch gun is of the type known as “straight back” in English railway terminology. It is constructed throughout of plate and angle steel, and is mounted on standard-gauge bogies of 4 feet 8 inches. The truck, or car proper, is specially designed and fitted with hydraulic jacks, so that the central portion of the gun can be lowered onto or raised from the permanent way.

The principal dimensions are as follows:

Length of headstocks.....	Ff.	in.
Length of bearing on sleeper.....	43	3
Length over buffers.....	18	0
Centers of bogies apart.....	47	0
Wheel base of bogie trucks.....	30	0
Width over side girders.....	8	0
Centers of buffers.....	8	5
Buffer projection from headstock.....	5	8½
Height from rail to center of buffer.....	1	10½
Truck capable of being lowered.....	3	5
Diameter of wheels on tread.....	1	4½
	2	9

Center to center of journals.....	Ft.	In.
Size of journal.....	4	0
Width over brake wheels.....	10	5½
	8	11

The truck consists of two main side girders built up of plate and angle steel connected by cross girders and stays. The center of the truck on top carries a seating for the roller path, while the steel framework bolted to the top of the truck at each end carries a hydraulic jack by means of which the truck can be lowered onto or raised from the permanent way, the front and rear of the truck being shaped to clear the bogies.

For firing, the front and rear ends are raised by the hydraulic jacks until clear of the siding chocks, which support the main frame when in a traveling position, and these are moved clear and the jacks eased off so that the main frame of the truck comes down on to the permanent way. Various devices are provided to hold the frame in connection with the bogie and to provide for its ready detachment. Furthermore, there is a strut to support the gun in a traveling position, and four cast-steel spade arms are hinged at their inner ends to brackets fastened to the truck at the front and rear and on either side. These spade arms are swung out at right angles to the truck and are braced by a strengthening stay pinned to the truck and spade arm, respectively.

In shipping or remounting, the truck is lifted off the bogies, which are first placed on the truck in position and ready to receive the truck frame proper. A warping winch is provided to enable the truck to be moved a short distance to the front or rear, while the hydraulic jacks are arranged on the top of the truck at either end.

Several additions to the Mark II are provided to enable it to be used with various mountings, but in most respects the mountings are interchangeable and the truck requires but few changes.

Approximate weight and dimensions of the various 9.2-inch guns and mountings of this form are as follows:

	Tons.
Mark X gun.....	33. 25
Mark XIII gun.....	24. 25
Mark XIV gun.....	30. 5
Truck and mounting.....	48. 75
Two bogies.....	14. 0

Minimum radius of curve round which the truck can be lowered for fire is 250 feet, and there is a clearance between the rail and girders of the truck of 8 inches.

TABLE 10.—*Characteristics of French cannon and projectiles.*

CHARACTERISTICS OF FRENCH ARMY GUNS AND SHELLS.

Caliber.		Weight of shell.		Weight of bursting charge.		Explosive (per cent).	Muzzle velocity.		Maximum range.	
Milli-meters.	Inches.	Kilo-grams.	Pounds.	Kilo-grams.	Pounds.		Meters per second.	Feet per second.	Meters.	Yards.
65.....	2.54	3.740	8.245	0.450	0.99	11.8	330	1,083	5,500	6,015
75.....	2.95	5.315	11.72	.635	1.53	13.0	350	1,805	8,000	8,749
80.....	3.15	8.900	13.00	.890	1.87	14.4	473	1,552	7,500	8,202
90.....	3.54	8.500	18.30	.980	2.16	11.8	442	1,450	7,500	8,202
95.....	3.74	12.250	27.01	2.200	4.83	18.0	418	1,371	8,200	8,948
105.....	4.13	15.450	34.03	1.850	4.08	13.0	570	1,870	12,300	13,451
120.....	4.72	20.350	44.84	4.210	9.28	20.7	535	1,919	11,000	12,030
155 ¹	6.10	43	94.80	10.280	22.49	23.7	562	1,844	(¹)
155.....	6.10	42	92.50	7.120	15.70	17.0	735	2,411	17,000	18,591

CHARACTERISTICS OF FRENCH SEACOAST AND NAVY GUNS AND SHELLS.

100.....	3.94	13.500	29.76	1.800	3.97	13.4	760	2,493	14,500	15,891
14 cm.....	5.51	30.500	67.24	5.340	11.77	17.6	825	2,707	17,400	19,029
145.....	5.71	33.700	74.30	5.950	13.12	17.7	810	2,657
19 cm.....	7.48	85.350	188.17	16	35.27	18.7	555	1,821	12,000	13,123
240.....	9.45	162	357.15	33	72.75	20.7	528	1,726	15,050	17,006
274.....	10.79	216	476.20	33.150	75.07	16.0	835	2,740	22,500	24,606
305.....	12.01	350	771.62	30.600	67.46	8.5	795	2,608	27,400	29,965
32 cm.....	12.60	338.500	746.27	70	154.32	21.3	620	2,034	20,300	22,200
340.....	13.39	540	1,190.50	22	48.50	4.06	30,000	33,808
340.....	13.39	465.400	1,026.25	52.530	115.85	11.3	850	2,789	31,000	33,902

CHARACTERISTICS OF FRENCH MORTARS AND HOWITZERS AND SHELLS.

220.....	8.66	98.400	216.94	23.450	62.72	29.0	415	1,362	10,000	10,936
270.....	10.63	229	504.84	66	145.51	28.8	293	958	5,000	5,468
280.....	11.02	205	451.95	63	138.89	30.7	418	1,371	10,950	11,975
293.....	11.54	276	605.48	63	138.89	22.8	464	1,529	12,250	13,387
370.....	14.57	505	1,113.33	150	330.69	28.7	320	1,050	8,200	8,948
400.....	15.75	640	1,410.96	180	396.83	28	465	1,526	15,000	16,404
520.....	20.47	1,400	3,066.47	300	661.39	21.4	13,000	19,685

¹ Range not determined as yet for this weight of projectile.² Elongated shell with large explosive capacity.³ Type B (thick-walled shell).⁴ Armor piercing shell.⁵ Semisteel shell.

FRENCH ARTILLERY.

The tabulation on the preceding page and the following list indicate the characteristics of the more important French Army and Navy guns and shells used on the battle front during the war. Numerous discrepancies will be noted in the different lists, due to the conditions of proof firing and range testing, but the various tabulations are given as forming an interesting basis of comparison, subject to further correction when a more accurate catalogue of the French matériel with detailed ballistic data is available.

TABLE II.—List of the French guns, howitzers, and mortars in service at the front.

Caliber.	Class.	Model.	Maximum muzzle velocity.	Maximum range.
			<i>Meters.</i>	<i>Meters.</i>
37-mm.....	Gun T. R.....	1916.....	402	2,500
47-mm.....	do.....	1885.....	610	4,008
65-mm.....	Mountain gun.....	1906.....	330	5,500
75-mm.....	Field gun.....	1897.....	550	9,000
75-mm.....	Field gun (Schneider).....	1912.....	500	7,500
80-mm.....	Field gun.....	1877.....	525	8,700
80-mm.....	Mountain gun.....	1878.....	254	4,100
90-mm.....	Field gun.....	1877.....	500	9,700
95-mm.....	do.....	1888.....	440	9,800
100-mm.....	T. R. naval gun on wheels.....	1897.....	760	14,500
105-mm.....	Field gun.....	1913.....	570	12,500
HEAVY ARTILLERY.				
120-mm.....	Gun.....	1878.....	584	11,000
120-mm.....	Howitzer.....	1890.....	284	5,700
14-cm. (138.6).....	Naval gun on wheels.....	1910.....	830	18,500
14-cm.....	do.....	1891.....	770	16,200
145-mm.....	do.....	1910.....	825	17,600
145-mm.....	St. Chamond.....	1916.....	810	17,600
155-mm.....	Gun.....	1877.....	534	12,600
155-mm.....	do.....	1877-1914.....	562.5	13,600
155-mm.....	do.....	Schneider, 1917.....	670	16,000
155-mm.....	do.....	G. P. Filloux.....	735	16,800
155-mm.....	Howitzers.....	1881.....	318	7,700
	do.....	1890.....		
	do.....	1904 T. R.....		
155-mm.....	do.....	1881-1912.....	325	7,800
155-mm.....	Schneider.....	1915.....	450	11,900
155-mm.....	Schneider, St. Chamond.....	1915.....	334	8,000
155-mm.....	Gun for turret.....	1907.....	457	9,000
16-cm.....	Naval gun on wheels.....	1891-1893.....	775	17,300
16-cm.....	Gun on railway carriage.....	1870-1886.....	675	16,500
200-mm.....	Schneider howitzer on railway carriage.....		428	11,400
220-mm.....	Mortar.....	1880-1891.....	300	7,100
220-mm.....	Howitzer (Schneider).....		415	10,800
220-mm.....	Gun (Schneider).....	1918.....	775	22,000
24-cm.....	Gun on railway carriage.....	1870-1847, 1893.....	610	17,450
240-mm.....	do.....	1884-1903 T. R.....	687	17,400
270-mm.....	Mortar.....	1885.....	378	7,880
270-mm.....	Coast-defense mortar.....	1899.....	420	10,400
274-mm.....	Gun on railway carriage.....	1893-1896.....	355	27,000
280-mm.....	Howitzer.....	Schneider.....	418	10,950
285-mm.....	Gun on railway carriage.....		740	27,100
293-mm.....	Howitzer on railway carriage.....	Schneider.....	466	12,250
305-mm.....	Gun on railway carriage.....	1893-1896.....	811	27,600
32-cm.....	do.....	1870-1841.....	550	16,300
	do.....	1870-1893.....		
	do.....	1870-1884.....		
30-caliber.....	do.....	1870-1893.....	650	21,600
340-mm.....	do.....	1912.....	850	31,000
370-mm.....	Mortar on wheels.....		375	10,500
370-mm.....	Howitzer on railway carriage.....		535	16,400
40-cm.....	do.....		465	15,110
520-mm.....	do.....		500	18,000

¹ Will be increased by using a lighter projectile.

LIFE AND MUZZLE VELOCITY OF FRENCH GUNS.

Average life of guns.—In connection with extensive studies as to the probable average life of guns in constant service and the muzzle velocity developed, the Ordnance Department, in addition to its own investigations, early had placed at its disposal the results of many elaborate experiments and the carefully maintained and comprehensive records of the ordnance establishments and artillery of the French and British Armies. In this way it was able to act with fuller knowledge in preparing its programs and schedules.

French practice.—The French artillerists and ordnance experts united in stating that it is very difficult to fix definitely the number of rounds that may be fired before the gun may be considered as worn out. This is due to many conditions which vary in different guns, such as the quality of steel, rate of fire, kind of metal, care taken of the material, good order, etc.

Three years' experience.—Three years' experience of the French Army enables the opinion to be expressed as to the average life of the guns mostly used in somewhat the following manner:

75-mm. gun.—In the case of the 75-mm. field gun, model 1897, the average number of rounds fired before wear was about 10,000. Some guns need replacement after 4,000 rounds, while others, on the contrary, fire 20,000 rounds before being worn out.

105-mm. field gun.—The average life of the 105-mm. field gun can be reckoned at 6,000 rounds, as in the case of the 75-mm. gun just cited, this number being considered as an average, which varies according to the conditions.

155-mm howitzer.—The average life of the 155-mm. howitzer, according to the model, is about 7,000 to 8,000 rounds.

120 and 155 mm. gun.—The 120-mm. gun, model 1898, and 155-mm. gun, model 1877-1914, fired with muzzle velocity, has an average life of about 6,000 to 7,000 rounds.

220-mm. mortar.—For the 220-mm. mortar, model 1881-1892, an average life of about 10,000 rounds is assumed.

Recent guns and mortars.—French authorities stated early in 1918 that the 155-mm. G. P. Filloux gun, 155-mm. Schneider, model 1917, and the 220-mm. Schneider howitzer then had been in service at the front for too short a time to enable them to express an opinion as to their average possible life. With the more extensive use of these larger pieces the data accumulated will prove of great interest particularly as these or similar guns and howitzers figure in the United States program.

Maximum muzzle velocity.—In connection with the maximum muzzle velocity and maximum range of French artillery, attention may be directed to the accompanying table, on which are listed the various French guns, howitzers, and mortars in service at the front.

GERMAN ARTILLERY—ORGANIZATION AND MATÉRIEL.

Emplaced artillery.—Emplaced artillery is at the disposal of the divisional commanders and under the orders of the artillery commander, with the exception of a few long-range guns and batteries of railway artillery. Within the division, the artillery commander has under his orders artillery survey troops, artillery information section, and periscope observing stations, numbering one to two for each division. He further has the tactical disposition of a balloon and flying squadron.

Foot artillery.—Foot artillery is attached in variable quantities according to tactical necessities to divisional sectors. Formerly a battalion of heavy 15-cm. mortars were assigned to each army corps.

For an offensive, the assignment of heavy artillery to a division is usually one battalion comprising from two to three batteries of 15-cm. howitzers and a battery of 10-cm. guns.

Field artillery.—Field Artillery is always under the divisional commander. The very heavy artillery is under the commander of the army corps or army and not of the division, but of these pieces there are relatively few. The artillery staffs of the army corps and armies are not organs of command but are technical advisers in organizing the munition supply and in the use of fire.

Composition of batteries and battalions.—At the commencement of the war, batteries were universally of four pieces. In 1916 the 21-cm. mortar batteries were reduced to two pieces, though later increased to three pieces. Batteries of old-style 9-cm. cannon usually had eight pieces to the battery, but these were being withdrawn. Batteries of 13-cm. guns were reduced to two pieces. This was probably true of batteries of 21 and 24 cm. guns and 28-cm. and 30.5 cm. howitzers.

Mixed battalions of two batteries of 15-cm. howitzers supplanting batteries of 10-cm. guns were formed during 1917.

Munition columns are no longer assigned to battalion but are organizations of the army divided according to the amount of artillery in a division.

German artillery tendencies.—There was a tendency for the Germans to replace three batteries of each regiment of model of 1896 field guns by three batteries of model of 1916 matériel to arrive at the following:

3 batteries of model of 1896 field guns.

3 batteries of 105-mm. howitzers.

3 batteries of model of 1916 field guns.

Other developments in German artillery practice were the more extended use of long-range railway artillery; the use of "long" 77 field gun with high-explosive shell with a bursting charge of 2

pounds; a corresponding "long" high-explosive shell for the 105-mm. light field howitzer with a bursting charge of 4 pounds. Furthermore, to increase the range of projectiles by using false caps and improving the stream line.

Field Artillery.—At the beginning of the present war, German field artillery was outfitted with field cannon, 77-mm., model of 1896 n/A, and with a light field howitzer, 105-mm., model of 1898–1909. The following were added to these:

Field cannon, 75-mm., model 1916, on light howitzer carriage.

Light field howitzer, 105-mm., model 1916.

Light field howitzer, 105-mm., model Krupp.

These pieces have as their characteristics a notable increase in the ranges obtained both with the projectiles in service in the old cannon as well as with the new shell "C." These ranges are given in the following table:

	Elongated explosive shell.	Explosive shell, model 1915.	Shrapnel.	Shell C.
	<i>Meters.</i>	<i>Meters.</i>	<i>Meters.</i>	<i>Meters.</i>
Field cannon, model 96n/A.....	7,500	8,400	8,400
Field cannon, model 1916.....	9,300	9,500	8,200	10,300
Light howitzer, model 1898–1909.....	7,000	7,000	7,000
Light howitzer, model 1916.....	8,400	8,400	8,400	10,000
Light howitzer, model Krupp.....	8,900	8,900	8,900	10,250

Projectiles.—The German field matériel fires, normally, three regulation projectiles, namely:

1. An elongated explosive shell, steel, of great capacity and high-explosive charge (0.9 kilogram in shell for cannon, 2 kilograms for howitzers).

2. A steel explosive shell, model 1915, with thick walls and a smaller explosive charge (0.88 kilogram in shell for cannon, 1.4 kilograms in shell for howitzer).

3. A shrapnel, rear charge, and balls of 10 grams (cannon) or of 11 grams (howitzer). These balls are most often of steel.

Shell "C."—In addition, the new material fires a shell "C," whose shape recalls that of shells with profile Decaleux (chanfer base and pointed ogive). Shell "C" for cannon contains 0.55 kilogram of explosive; shell for howitzer, 1.5 kilograms.

Defects of elongated shell.—It will be noticed that the elongated shell for field cannon did not seem to have given entire satisfaction. Its ranges in the two cannon are smaller than that of the shell, model 1915, and its accuracy in distances greater than 5,000 meters is faulty enough, so that it is necessary to examine the question as to using shell, model of 1915, "with the safety of friendly troops and the nature of the objective in mind."

Other shell.—All the matériel fires besides gas shells of different kinds (blue cross, yellow, green cross, and various other types as materials were developed), and the cannon 1896 n/A, a semiarmor-piercing shell intending to attack hostile vehicles.

Detonating fuzes.—The fuzes for 1896 n/A and 1916 cannon, intended to arm explosive shells, are of two types:

1. Detonator fuze, combination originating from fuze KZ 11, which for armed unit shell, model 1911, no longer is manufactured.

2. Combination detonator fuze, which is divided as follows:

(a) Long fuze of conical form (LKZ 11 grams), which is only graduated up to 5,000 meters, while in 1916 its graduation was up to 7,200 meters. Firing with a time element is now replaced at distances greater than 5,000 meters by percussion firing with surface effects, obtained with shells armed with instantaneous fuzes.

(b) A short fuze with rounded head for shell, model 1915 (KZ 11 grams), was graduated up to 7,200 meters and reserved principally for firing against aircraft.

Percussion detonating fuzes.—The percussion detonating fuzes of type 1916 are relatively simple in construction. They have two safety devices, which function through centrifugal force. The one holds in position the primer bearer during transportation and at firing; the other consists of a bolt which is interposed between the detonator and the explosive and prevents premature bursting before the projectile has passed over a certain course after leaving the mouth of the cannon. There are a percussion fuze, long delay (LKZ 16 m V) which arms the two elongated explosive shells, and model 1915, and permits ricochet and firing with mine effects.

A long percussion fuze, instantaneous (EKZ 16), functions when arriving at the ground by throwing back the percussion pin. The stem of the percussion pin has the peculiarity of being placed on the fuzes only at the moment of charging. There is an instantaneous percussion fuze for shell "C" (EKZ 16C).

Fuzes for light howitzers.—For use with the ammunition employed with light howitzer, model 1898–1909, light howitzer, model 1916, and light howitzer Krupp, as listed above there were the following fuzes:

1. A detonator fuze, triple effect, which functions, percussion with delay and time (HZ 05 gram). This fuze is a simplification of fuze HZ 05, quadruple effect, which armed unit shell, model 1905, no longer employ. It is only graduated up to 5,000 after being graduated up to 7,200 meters in 1916.

2. A detonator percussion fuze, with or without delay (HZ 16).

3. A detonator percussion fuze, instantaneous (EHZ 17), analogous to the instantaneous fuze for cannon.

4. A percussion detonating fuze, instantaneous, for shell C (EKZ 16 C).

Summary of use.—Summarizing the explosive shells of cannon and light field howitzer may be fired by the following fuze systems:

Time system, at distances less than 5,000 meters.

Ricochet, at small and medium distances.

Percussion, with surface effects at medium and large distances.

Percussion, with or without delay, at all distances, to obtain effects of upheaval and destruction.

Fuzes for shrapnel.—Shrapnel of field cannon is armed with combination fuzes Dopp. Z 1896 n/A. This fuze, which at the beginning of the war was only graduated up to 5,350 meters, has been extended up to 7,000 meters since 1916. Shrapnel for howitzers, devised in 1916 to replace unit shells, has used a combination fuze HZOR Schr, derived from fuze HZ and also graduated up to 7,000 meters.

Development of the German 77-mm. field gun, model 1896, n/A.—With the success of the French 75-mm. field gun, the Germans, with the collaboration of Ehrhardt and Krupp, sought to bring out a gun that would compete with the French piece and at the same time would utilize certain parts of the older matériel. The result was the 77-mm. model 1896 (neuer art—new type), which resembled the French gun in that it has a gun shield and provided certain facilities of operation. Of the old matériel, the tube, ammunition, carriage wheels, and the gun itself were retained, while, on the other hand, the breech mechanism and the carriage were entirely remodeled.

General appearance.—The new German gun was 2.1 meters, or 27.3 calibers, in length. Its bore was composed of a progressive rifling which started from a smooth portion at the rear and developed with 32 grooves with rectangular profile, turning from left to right. In appearance the 77-mm. gun was somewhat thicker than the French 75-mm., and in the guns made, at least before the war, there were various markings which made it possible to distinguish the Kingdom or the Empire to which each piece belonged. The arms of the definite States, surmounted by the motto "Pro Gloria et Patria" were etched on each gun, and above the breech there was an imprint crowned with the monogram of William II and the crude inscription "Ultima Ratio Regis."

Gun.—The gun consists of an inner tube covered by a jacket shrunk in place and secured by a screw ring situated halfway between breech and muzzle. The breechblock is of the usual sliding wedge type. The firing device is of the axial percussion system.

Mechanism.—Instead of the interrupted screw or the eccentric breechblock rotating in a sleeve, the system of breech closing employed was the familiar Krupp design with a wedge operated by a crank. The modifications introduced and the development of the firing apparatus and the extractor of the cartridge case for its sim-

plicity and facility of handling could be compared with the French piece. The recoil system was a combination of hydraulic and spring mechanism instead of the hydropneumatic system of the French, and the recoil brake was placed under the cannon, being contained in a small or upper carriage. This small carriage includes also the cradle at the rear and the traversing mechanism. The recoil brake consists of a cylinder in connection with the gun proper. This cylinder contains glycerin and operates against a piston with a movable stem fastened to the front part of the cradle. The recuperator consists of a metallic spring whose compression as well as the pressure upon the liquid acts to bring back the gun to its firing position and moves along the gliding surface which carries the cradle. The German gun has its upper carriage mounted on a vertical axis, which permits the traversing of the piece, while the lower or large carriage remains fixed. The German gun carriage has a wheel brake which acts on the wheels, so they do not have to be placed on slide blocks and the guns do not have to be lowered when put in battery. In addition to a center spade which is buried in the earth at the first shot, there is a range lever which further acts to hold the piece in position.

Carriage.—The upper carriage consists of the cradle, recoil and counterrecoil systems, and traversing gear. Traversing is accomplished through a worm shaft and gear, which rotates the upper carriage about a pintle located over the axle. The diameter of the wheels is 53 inches, and the width of track is 60 inches. The lower carriage supports the upper, and consists of trail, shield, seats for cannoneers and elevating gear. Elevation of the piece is accomplished by an elevating handwheel located on the left side, which actuates an elevating screw. It may be noted that this carriage, equipped with low wheels, was being used for close battery work, their function being for antitank and close Infantry fighting. For antitank work a special armor-piercing projectile is provided using a point fuze.

Sight.—The sight consists of a sight shank guide fastened to the carriage by a bracket, containing a tooth-cupped shank, which, in turn, carries at its upper end the aiming collimator surmounted by the panoramic sight seat.

Vehicles.—The carriage limber has a steel pole. Draft is through a master bar on the end of the limber pole. Collars are used instead of breast harness. The limber ammunition chest is of rolled steel plate, carrying 36 rounds of fixed ammunition, shell, or shrapnel. When "long" shells are used, 24 long and 6 short are carried. The weight behind the team, gun carriage limbered, is 43 hundredweight. The caisson is of similar construction, and carries 54 rounds of shell or shrapnel (long shell are never carried in the caisson). Two steel

wagons accompany the battery. One is limbered and carries rations, medical and veterinary supplies; the other is four-wheeled and carries the forge, artificer's tools, spare clothing, equipment, and officers' baggage.

Ammunition.—The ammunition employed for the 77-mm. field gun, was as follows:

High-explosive shell, model of 1915.

The long high-explosive shell.

A modification of the 1915 shell, made of inferior material and provided with a reduced bursting charge.

Shrapnel, model 1896.

Modern variation of 1896 shrapnel.

A modification of 1915 shell fitted with a special fuze and armor-piercing head for antitank work.

A star or illuminating shell.

A tracer shell.

A phosgene or diphosgene gas shell.

Gas shell similar to long high explosive, known as "green cross," contents,

(a) diphosgene, or (b) diphosgene and chlorpicrin, or (c) bromketones.

Gas shell of same type as long high explosive, known as "yellow cross;" contents, dichlorethylsulphide and diluent (mustard gas).

Fuzes.—With the above ammunition the following types of fuzes are employed:

Percussion.

Antitank.

Percussion, delay action.

Combination.

Cartridge cases and propellants.—This gun employs fixed ammunition normally. The cartridge cases are of brass in one piece, or with body and base separate. The second class has body and base of steel or body of brass and base of steel. Specifications recently captured bear the manufacturing date "1917" for the first class and "1916" for the second. The weight of the case varies, 730 to 820 grams.

The body of the propelling charge is of nitrocellulose powder in the form of tubes, and weighs 488.6 grams. The dimensions of tubes are:

Length 182 mm.

Outside diameter 5 mm.

Wall thickness 1.05 mm.

The igniting charge is of nitrocellulose powder. The dimensions of the grains are:

Length 1.56 mm.

Outside diameter 1.40 mm.

The weight of the igniter, including bag, is 16 grams. In some cases a reduced propelling charge is used, giving about 1,200 foot-seconds velocity.

Comparative characteristics of ammunition for German 77-mm. guns, models 1896 and 1916.

	For 77-mm. gun, model of 1896 (German).	For 77-mm. gun, model of 1916 (German).
HIGH-EXPLOSIVE SHELL, MODEL 1915.		
Weight, ¹	pounds.. 14.96	14.96
Muzzle velocity with normal charge, ²	foot-seconds.. 1,526	1,571
Muzzle velocity with additional charge, ³	do.	1,745
Maximum range with additional charge.....	yards.. 9,186	9,405
Maximum range with additional charge.....	do.	10,389
"LONG" HIGH EXPLOSIVE SHELL.		
Weight, ⁴	pounds.....	16.2
Muzzle velocity with additional charge.....	foot-seconds.....	1,745
Maximum range with additional charge.....	yards.....	10,171
SHRAPNEL, MODEL OF 1896.		
Weight.....	pounds.....	14.96
Maximum range.....	yards.....	8,749
SHRAPNEL, MODEL OF 1916.		
NOTE.—Shrapnel, model 1896, contains 300 balls. Shrapnel, model 1916, contains an increased number of balls. The latter is used in both models of field guns.		
STREAM LINE HIGH EXPLOSIVE SHELL.		
Weight ⁵	pounds.....	13.5
Muzzle velocity with additional charge.....	foot-seconds.....	1,868
Maximum range with additional charge ⁶	yards.....	

- ¹ Weight of high-explosive bursting charge is .84 pounds.
- ² Weight of normal propelling charge, including igniter, is 21.65 ounces.
- ³ Weight of additional propelling charge, including igniter, is 24.8 ounces.
- ⁴ Weight of high-explosive bursting charge is 1.91 pounds.
- ⁵ Weight of high-explosive bursting charge is 1.21 pounds.
- ⁶ Recently captured German document states that the maximum range has been increased to about 10,900 meters (11,815 yards) by improving stream line.

77-mm. field gun, model 1916.—This matériel was designed to give a greater range and power than the 1896 matériel. This increase in range and power was obtained by:

- (a) Increasing the length of the gun 7.7 calibers (23.63 inches).
- (b) Mounting the new gun on a high-angle carriage (modified 105 mm. light howitzer carriage.)
- (c) Increasing the powder chamber, permitting of a larger powder charge.
- (d) Decreasing the resistance of the air against the projectile in flight by improving the stream line of the projectile by the tapering point and base.

Comparison with French gun—It is interesting to note that the new German gun is not longer than the French 75-mm. gun, model of 1897. The muzzle velocity given the French high-explosive shell weighing 12 pounds in the French gun, model of 1897, is 1,805 foot-seconds (550 meters per second). The velocity stated as being given by the new German gun, model of 1916, to the 13.4 pound stream line high explosive shell is 1,968 foot-seconds (600 meters). This velocity seemed large to artillerymen of the allies.

Comparative characteristics of 77-mm. and 75-mm. field gun matériel.

	77-mm., model 1896 (German).	77-mm., model 1916 (German).	75-mm., model 1897 (French).	75-mm., model 1916 (United States).
Guns:				
Weight with breech.....pounds..			1,015	765
Length over all.....inches..	82.67	106.3	107.13	90.90
Length of rifled portion.....do....	84.57	86.2	87.77	72.72
Length of rifled portion.....calibers..	20	28.4	29.72	24.24
Rifling:				
Right-hand.....	Yes.	Yes.	Yes.	Yes.
Number of grooves.....	32	32	24	24
Character of twist.....	(¹)	(²)	(³)	(⁴)
Angle of inclination.....degrees, minutes..	4-7	8-21	7
Carriages:				
Weight with gun equipped.....pounds..	3,080	(?)	2,550	3,050
Limits of elevation.....degrees, minutes..	+38 -1-30	+16 -12	+18 -10	+53 -7
Limit of traverse.....do.....	right, 2 left, 2	total, 7-15	right, 3 left, 3	right, 22-30 left, 22-30
Independent line of sight.....			Yes.	Yes.

¹ Increasing uniformly 1 in 45 calibers to 1 in 21 calibers.

² 1 in 21 calibers.

³ Uniform 1 in 25.6 calibers.

⁴ Increasing from 1 turn in 119 calibers to 1 in 25.4 at 72 calibers from muzzle.

* A second source of information gives 2,750 pounds. This weight should be checked by weighing captured matériel. It is possible that the figure 3,080 includes the firing platform, which weighs 315 pounds.

The new German gun has a uniform twist of rifling instead of increasing; the powder chamber is 80 mm. (3.15 inches) longer than in the old model. The counterrecoil system is of the spring type. The trunnions of the cradle are well to the rear, the muzzle preponderance being overcome by a spring. The length of recoil is from 43.3 to 47.2 inches.

A circular platform weighing 145 kilograms (319 pounds) has been provided. It is placed under the wheels to increase stability under fire and to provide easy means of traversing beyond the limits provided by the handwheel. The circular platform is attached to the carriage by two stay bolts.

Sight.—The sight is the same as provided for the light field howitzer 1898-1909, except as to graduations. The sight includes:

(a) A support rigidly attached to the left trunnion of the carriage.

(b) This support carries a range drum, elevation and cross levels, a movable range drum index, a height of sight and height of burst corrector device, for correcting for difference in trunnion level.

(c) A collimator for use in aiming in case the panoramic element is out of commission.

Drift is corrected by the construction of the support.

The range drum carries four scales:

(a) In degrees by 1/16 degrees.

(b) In meters from 100 to 9,850 for normal charge.

(c) In meters from 5,000 to 9,400 for additional charge.

(d) In meters for "Geschoss C" (stream line high-explosive shell).

Vehicles.—The limbers and caissons are assumed to be, in general, similar to the corresponding vehicles of the model 1896, 77-mm. matériel. In the ammunition vehicles used with the model 1916 matériel, the shell baskets are carried vertically instead of horizontally. The limber carries 24 rounds (separately loaded ammunition). The caisson carries 60 complete rounds and 54 additional propelling charges, and 20 antifeash charges.

Cartridge cases and propellants.—This matériel employs separately loaded ammunition normally. In an emergency, the fixed ammunition for the model of 1896 field gun may be used (as for repelling attack at less than 1,000 meters). It is stated that use of separately loaded ammunition permits of hand ramming with consequent improvement in uniformity of performance.

The composite cases (brass or steel body with steel base, riveted or welded together) did not appear to have given entire satisfaction.

GERMAN 13-CM. GUN.

General nature.—The German 13-cm. gun was used by the German Army before the war and was noted for its long range, great initial velocity, and rapid fire. These guns were manufactured in considerable numbers, and one made by Krupp in 1916 early was captured by the English. In this gun the recoil is taken up by a recoil chamber or frame, which can pivot in a U-shaped trunnion cradle resting on the carriage proper by means of two forward trunnions.

Barrel.—The barrel of the gun consists of an inner tube, upon which is shrunk a second tube, and a jacket covering the rear two-thirds of the barrel. On this jacket there are three guide bands to which the guide shoes are attached by means of nuts. The principal dimensions, weight, and other data of this gun are contained in the accompanying table:

Overall length of barrel, 35 calibers.....	4.74 m.
Length of rifled part, approximate.....	3.43 m.
Caliber	13.5 cm.
Length of powder chamber.....	91.5 cm.
Diameter of chamber.....	14.6 cm.
Number of rifling grooves.....	36
Width of rifling grooves.....	8 mm.
Spacing between grooves.....	4 mm.
Depth of grooves, approximate.....	1.5 mm.
Weight of barrel with breech mechanism.....	3,269 kg.
Weight of breechblock.....	132 kg.
Weight of gun, in battery.....	5,840 kg.

The breech mechanism is of the customary Krupp wedge type, with quick opening, and the gun is fired with a center firing pin, being automatically cocked.

The recoil apparatus and the apparatus for bringing back the gun to position are in the frame which is below the barrel. The recoil apparatus is of the constant recoil type. Total length of frame, 3.40 meters; normal recoil, 1.32 meters (approximate). The traversing mechanism permits of a movement 2 degrees on either side of the gun axis, and the maximum elevation of the gun is said to be about 26 degrees. The elevating mechanism comprises a double threaded screw.

Carriage.—The carriage consists of a trail made up of two side pieces of stamped steel braced with cross pieces, and possesses not only a small fixed spade, but also a large folding spade, which may be held rigid, both when let down in the ground and when folded up into the trail. The diameter of the wheels is 1.40 meters; the width, 10 cm. the thickness of the tires, 12.5 mm. A caterpillar tread is used for firing and for advancing in soft earth. The gun shield is supplied with a hinge and is folded behind the gun. On the march, the barrel is carried on a special carriage.

Ballistic properties.—The leading ballistic properties of the German 13-cm. gun are given in the following table:

Initial velocity.....	695 m.
Weight of projectile (explosive and shrapnel).....	40 kg.
Maximum explosive charge.....	4.1 kg.
Number of bullets in the shrapnel.....	1,170 of 11.1 grams.
Weight of firing charge.....	9 kg. of 800. R. P. 07.
There is only one firing charge.	
Maximum range (time fuze).....	14,000 m.
Maximum range (percussion).....	14,400 m.

TABLE 12.—*Characteristics of German Artillery.*

[From British reports.]

	Caliber.		Range.	Weight in battery.
	<i>Inches.</i>	<i>Pounds.</i>	<i>Yards.</i>	<i>Pounds.</i>
Matériel:				
77-mm. field gun.....	3.03	14.5-15.5	9,186
90-mm. field gun, old model.....	3.46	16.5	7,109
105-mm. light field howitzer, model of 1898-1909.....	4.13	34.5	7,655	2,520
100 mm. gun, model of 1904.....	3.93	39.5	11,264	6,358
120 mm. gun.....	4.73	36.0	7,984
130 mm. gun.....	5.11	88.0	15,748
150 mm. heavy howitzer.....	5.91	86.93	9,296
210 mm. mortar.....	8.26	183-262	10,280
Railway artillery:				
150 mm. naval gun.....	5.91		18,700
240 mm. naval gun.....	9.45		27,500
280 mm. naval gun.....	14.96		

TABLE 13.—*Maximum range of German guns, howitzers, and mortars (in yards).*

FIELD ARTILLERY.

	With time fuze.	With percussion fuze.	With time and percussion fuze.
FIELD GUNS.			
7.7-cm. field guns, 1896.....	7,874	¹ 9,186	
7.7-cm. K. I. H. field gun.....	7,874	¹ 8,968	
LIGHT FIELD HOWITZERS.			
10.5-cm. light field howitzer star shell, 1898.....	4,740		(1909) 7,655
10.5-cm. light field howitzer, 1916.....	7,655	9,077	
10.5-cm. light field howitzer, Krupp.....	7,655	9,264	

FOOT ARTILLERY.

MEDIUM RANGE GUNS.			
9-cm. guns, 1873-1888.....			7,109
12-cm. heavy gun.....	7,218	7,983	
15-cm. long-range chase rings.....	7,655	8,749	
15-cm. gun with chase rings.....	7,546	8,640	
15-cm. coast-defense gun, 1907.....		8,530	
15-cm. long gun.....	8,988	10,936	
21-cm. gun with chase rings.....	7,655	10,718	
HIGH VELOCITY AND LONG RANGE GUNS.			
10-cm. gun, 1914; 10-cm. gun, 1897.....			12,085
10-cm. gun; 10-cm. gun, 1904.....			11,264
10-cm. gun, with overhead shield.....			
10-cm. gun, with turret.....	9,796	11,811	
10-cm. gun, reinforced in turret.....			
10-cm. Q. F. gun, L/35.....			10,389
10-cm. coast-defense gun.....		11,264	
10-cm. coast-defense gun on wheeled carriage.....		16,295	
13-cm. gun.....	15,311	15,749	
15-cm. gun, with overhead shield.....	16,186	17,060	
15-cm. gun, reinforced on wheeled carriage.....	16,404	³ 18,187	
15-cm. gun, Q. F., L/40.....	14,983	³ 21,107	
1-cm. gun, Q. F., L/45.....		³ 18,500	
24-cm. naval gun, tapered shell and shell with false cap.....		³ 20,670	
38-cm. naval gun, tapered shell and shell with false cap.....		³ 29,200	
		27,500	
		41,500	
HEAVY FIELD HOWITZER AND MORTARS			
15-cm. heavy field howitzer.....			6,616
15-cm. heavy field howitzer, 1902.....			8,147
15-cm. heavy field howitzer, 1913.....			9,296
15-cm. howitzer in turret.....	7,118	7,814	
21-cm. mortar.....	7,834	8,968	
Do.....	9,452	10,280	
28-cm. howitzer on traveling carriage.....		12,030	
28-cm. coast-defense howitzer.....		12,467	
42-cm. mortar.....		⁴ 17,500	
CAPTURED RUSSIAN GUNS.			
7.62-cm. field gun.....	(?) 4,597	7,000	
10.67-cm. gun.....		10,827	
20.3-cm. howitzer.....		9,515	

¹ At least.

² Ordnance shell.

³ False cap.

⁴ Approximately.

TABLE 14.—*Artillery matériel of Austro-Hungary.*

Piece.	Fuze.	Projectile.
3.7 trench gun (caliber 37 mm.)	M. 98	Minogranate; brisantgranate, star shell
6-cm. gun, M. 98, in casemate mounting, or movable turret (caliber 57 mm.)	M. 95b	Powder-filled shell M. 98; shrapnel, M. 98/95; case shot.
6-cm. gun, M. 99, in casemate	M. 98	Powder-filled shell, M. 98
7-cm. mountain gun, M. 99, 8 and 9 (caliber 72.5 mm.)	M. 99, 7 cm. (with gaine)	Ekrasit shell, M. 99 and 8. Shrapnel shell, M. 99 and 8.
7.5-cm. mountain gun, M. 15	M. 99, 7 cm.	Shrapnel, M. 99.
8-cm. field gun, M. 5 and 5/8 (caliber 76.5 mm.)	7 cm., M. 15	Shrapnel/granate (universal shell)
8-cm. fortress gun, M. 5 and 5/9	M. 5, 8, and 8b (with gaines)	Ammonal shell, M. 5 and 8.
8-cm. gun in turret, M. 2	M. 5, 8, and 8b	Shrapnel, M. 5 and 8.
8-cm. gun, M. 95, in casemate (old field gun, 1875 pattern) (caliber 75 mm.)	M. 2	Shrapnel, M. 2
8-cm. gun, M. 94, in casemate (old field gun)	M. 75	Case shot.
8-cm. old field gun, M. 75 (fixed or movable armament.)	M. 75/85c	Segment shell, M. 75.
8-cm. gun, M. 94, in cupola	M. 75	Shrapnel, M. 75/85c.
8-cm. guns, M. 94 and 98, in casemate mountings	M. 75	Segment shell, M. 75.
8-cm. fortress gun, M. 94, on shielded carriage	M. 85	Do.
9-cm., old field guns, M. 75 and 75/96 (caliber 87 mm.)	M. 75	Shrapnel, M. 75/85.
9-cm. gun, M. 75/4 and 11, in casemate mounting	M. 95	Case shot.
10-cm. light field howitzer, M. 99 and 14 (caliber 104 mm.)	M. 75	Segment shell, M. 94.
10-cm. mountain howitzer, M. 99, 8, 10, and 16	M. 75	Shrapnel, M. 96/95 and 94/95.
10-cm. howitzer, in cupola, M. 99, 5, 6, and 9	M. 99, 10 cm. (with gaine)	Case shot.
10.4-cm. heavy gun, M. 14, 15, and 12/15 (caliber, 104 mm.)	M. 9	Ammonal shell, M. 99 and 8.
10-cm. heavy German gun, K. 04 (caliber 105 mm.)	M. 99, 10 cm.	Ekrasit shell, M. 99 and 5.
12-cm. heavy gun, M. 80 (caliber 120 mm.)	M. 99b	Shrapnel, M. 99.
12-cm. fortress gun, M. 80 and 96, in casemate or turret	10 cm., M. 14	Star shell, M. 6/99b.
12 cm. gun, M. 61 and 61/95 (mobile reserve of H. A.)	do	Universal shell.
15-cm. heavy gun, M. 80 (caliber, 149 mm.)	Gr. Z. 04	Do.
15-cm. coast-defense gun	H. Z. vst. 14	Shrapnel.
15-cm. fortress gun, M. 61 and 61/95 (reserve of H. A.)	Dopp. Z. 92	Steel shell.
15-cm. mortar, M. 78 (mobile reserve)	M. 80	10 cm. gr. 96.
15-cm. heavy field howitzer, M. 94, 99, 94/4, 99/4, and 15 (caliber 149 mm.)	M. 6, 12 cm.	Do
	M. 9	Shrapnel, 96.
	M. 12b	Powder-filled shell, M. 80.
	M. 93a	Ekrasit shell, M. 80.
	M. 61	Steel shell, M. 14/9.
	M. 66, 66/85 K., 80 K.	Shrapnel, M. 80/93a.
	M. I. and Ia.	New steel shell and shrapnel, M. 12.
	M. 80	Case shot.
	M. 6, 15 cm.	Shrapnel, M. 61.
	M. 9	Shrapnel, M. 66 and 78.
	M. 12b	Powder-filled shell, M. 61.
	M. 93a	Case shot.
	M. 80	Powder-filled shell, M. 80.
	M. 61	Ekrasit shell, M. 80.
	M. 66, 66/85 K and 80 K.	Ekrasit shell, M. 99/9.
	M. I. and Ia.	Steel shell and shrapnel, M. 12.
	M. 75	Shrapnel, M. 80/93a.
	M. 75 (with adapter)	Armor-piercing shell, M. 80.
	M. 80 and 66/85 K.	Shell.
	M. 93a	Shrapnel, M. 61.
	M. 93a (with Ergänzungs-zunder.)	Shrapnel, M. 66 and 78.
	M. 99a	Powder-filled shell, M. 6.
	M. 80	Powder-filled shell, M. 78.
	M. 6, 15 cm.	Percussion shrapnel, M. 66 and 78.
	M. 9, 15 cm.	Shrapnel M. 66 and 78.
		Shrapnel M. 78/93a.
		Star shell M. 6/99a.
		Powder-filled shell, M. 80.
		Ekrasit shell, M. 80.
		Ekrasit shell, M. 99/9.
		Steel shell, M. 15/9.

TABLE 14.—*Artillery matériel of Austro-Hungary—Continued.*

Pièce.	Fuze.	Projectile.
15-cm. howitzer in cupola, M. 94 and 99.....	M. 12a.....	Steel shell and shrapnel.
15-cm. mortar, M. 80, 98, 98/7, and 16.....	M. 93a (with Ergänzungs- zunder).	Shrapnel, M. 80/83a.
	M. 99a.....	Star shell, M. 6/99a.
15-cm. mortar, M. 80, in cupola or on sledge.	15-cm. M. 14.....	Universal shell, M. 14.
		Gas shell.
18-cm. heavy gun, M. 80 (caliber 180 mm.)..	M. 80.....	Powder-filled shell, M. 80.
	M. 12.....	Steel shell and shrapnel, M. 12.
	M. 6, 18 cm.....	
	M. 93a (with Ergänzungs- zunder).	
21-cm. coast-defense gun, L. 20.....	M. 6, 21 cm.....	Ekrasit shell, M. 99.
21-cm. coast-defense mortar, M. 80 and mortar, M. 15.....do.....	Do.
24-cm. mortar, M. 98, 98/7, 15/10, and 10/15 (caliber, 240 mm.).....	M. 99a.....	Star shell M. 99 a.
24-cm. gun, M. 16.....	M. 9, 24 cm.....	Ekrasitbombe, M. 98/9 and 6.9.
28-cm. howitzer or mortar.....	M. 99a.....	Star shell, M. 99a.
	M. 9, 30.5 cm.....	Ekrasitbombe, M. 11/9 and 15/9.
		Truppenbombe.
30.5-cm. mortar.		
35-cm. gun, M. 16.		
38-cm. naval gun.		
42-cm. mortar.		
42-cm. howitzer.		

ITALIAN 75-MM. FIELD GUN, MODELS 1906 AND 1911.

When the general rearmament of the field artillery of the European armies was in progress the Italians developed a gun that was an improvement on the French model of 1897, in that its carriage permitted of greater elevation and lateral movement or traversing, but it had less power. It was built in two models, namely, 1906 and 1911.

1. *Data relative to guns.*

Internal diameters:	75-mm., M. 1906.	75-mm., M. 1911
Caliber.....	75 mm.	75 mm.
Mean diameter of powder chamber.....	79	79
Length:		
From forward end of breechblock to base of projectile.....	456.5 mm.	338.5 mm.
From base of projectile to muzzle.....	1,793.5	1,793.5
Total.....	2,250	2,132
Calibers.....	30	28.43
Rifling:		
Number of riflings.....	28	28
Direction of riflings.....	Right to left.	Both.
Pitch of initial—1 turn in.....	50 calibers.	
1 turn in.....	3,750 mm.	Constant.
Final rifling—		
1 turn in.....	30 calibers.	30 calibers.
1 turn in.....	2,250 mm.	2,250 mm.
Weight of gun without obturator.....	318 kg.	281.700 kg.
Weight of obturator.....	27	20.700
Total weight.....	345 kg.	302.400 kg.

2. Data on munitions.

The projectiles used with the Italian field guns consist of high explosive shell and shrapnel, details as to the dimensions of which along with the loadings and weights are given herewith.

(a) Dimensions of projectiles:

Diameter cylindrical part.....	74.2 mm.	74.2 mm.
Diameter rotating band.....	74.5 mm.	74.7 mm.
Length:		
Without fuze	266 mm.	234 mm.
With fuze	283 mm.	283 mm.
Distance from base of projectile to rear of chamber cone.....	38 mm.	38 mm.
Round balls:		
Diameter.....	12-14 mm.	14 mm.
Weight.....	0.012-0.014 kg.	
Number	236-278	

(b) Loading and weight of projectiles:

Empty case.....	5.970 kg.	6.135 kg.
Bursting charge.....	² 0.400 kg.	0.075 kg.
	(Fuze ¹ ed trotyl.)	(Powder.)
Booster charge.....	0.054	
Priming charge.....	0.022	
Fuze with primer.....	0.114	0.310
Weight of projectile ready to fire.....	6.298	6.500

(c) Fuzes:

For the explosive shell, percussion fuze, model 1910, is used, while for shrapnel the double-acting fuze, model 1906 (maximum timing 19''.83).

(d) Powder.

Two powder charges are used with 75-mm. gun, model 1906 and 1911. The maximum of ballistite in flakes 1 by 210 mm., weight 362 grams, or ballistite in flakes 1.3 by 210 mm., weight 393 grams. These loads of ballistite may be replaced by American nitrocellulose powder, weight varying from 250 to 70 grams. The minimum ballistite charge in pieces, 0.5 by 5 by 5 mm. and weight 150 grams, is contained in a gauge sack 110 mm. in length and 146 mm. in circumference. The sack is tied with a cord about 20 mm. from the opening and is inserted in the casing, tied end up, pushing against the primer with a cardboard cap having its concave side toward the primer.

¹ The 12-gram balls are packed in lower part of the case, ranging in numbers from 136 to 141. Those of 14 grams are packed above those of 12 and vary in number from 115 to 119.

² This load may also be composed of 280 grams of compressed Schneiderite and 45 grams of compressed TNT.

(e) Cartridge with projectiles:

The following table gives the essential characteristics of the ammunition used for 75-mm. gun.

Length of cartridge case.....	mm..	278
Length of cartridge with projectile ready for firing.....	mm..	523
Weight of primed cartridge case.....	kg..	1.235
Weight of primer.....	kg..	0.065
Total weight of cartridge with projectile ready for firing:		
Maximum charge—		
Explosive shell.....	kg..	7.940
Explosive shell with timing ring.....	kg..	8.018
Shrapnel.....	kg..	8.142
Minimum charge—		
Explosive shell.....	kg..	7.728
Explosive shell with timing ring.....	kg..	7.806
Shrapnel.....	kg..	7.980

3. Data on carriage of 75-mm. gun, models 1906 and 1911.

		75-mm.,	75-mm.,
		M. 1906.	M. 1911.
Tread (outer line of the tires).....	mm..	1520	1595
Diameter of wheels.....	mm..	1300	1300
Trunnions:			
Height.....	mm..	950	851.15
Elevation.....	mm..	16°	+15°
Maximum sighting angles—depression.....		10°	—15—50°
Horizontal firing sector.....		70	52°—9°
Weight of cradle (with brake, springs, without elevation support and without glycerin).....	kg..	134	75
Total weight of carriage and accessories, including shields.....	kg..	670	771
Weight of shields.....	kg..	65	91
Mean recoil of gun on cradle.....	kg..	1.350	1.300

An Italian 75-mm. field gun had been sent to the United States and in 1918 was under study and test at Aberdeen Proving Ground by American ordnance officers, especially as regards its split trail mount. With this gun using shell weighing 14.3 pounds, a muzzle velocity of 1,440 feet per second was secured.

Italian gun characteristics.

Caliber.	Type.	Weight of shell.	Muzzle velocity.	Maximum range.	Maximum elevation.
<i>Inches.</i>		<i>Pounds.</i>	<i>Ft. per sec.</i>	<i>Yards.</i>	<i>Degrees.</i>
5.9.....	Howitzer.....	90.4	984	7,439	44
2.95.....	Gun.....	14.37	1,660	7,432	16

The above data are taken from Ordnance Office drawings 27-17-8 to 19, inclusive.

TABLE 15.—*Artillery ammunition, as used during the war.*

Projectile.	Arrangement of propellant.	Fuze.	Primer.	Remarks.
37-mm. (1-pounder) antiaircraft (black powder).	Fixed.....	Base percussion.....	20-grain percussion.....	Used against low flying aircraft.
75 mm. shrapnel, common.....	do.....	Combination time for common shrapnel. Time without percussion element for antiaircraft (21 seconds), Mark III; supersensitive for high-explosive and gas shell; Mark V, French type, point detonating with or without delay for high-explosive shell.	48-grain percussion, Mark I.....	
Shrapnel antiaircraft. Shell, high-explosive, common.	do.....	Antiaircraft time fuses without percussion elements and with detonation for high-explosive shell.	110-grain percussion.....	
Shell, gas. Shell, high-explosive, antiaircraft.	do.....	Combination time for common shrapnel. Time without percussion element for antiaircraft (45 seconds), Mark III; supersensitive for high-explosive and gas shell. Mark V, French type, point detonating with or without delay for high-explosive shell.	do.....	
3-inch shrapnel antiaircraft. Shell, high-explosive antiaircraft.	do.....	Gas, supersensitive Mark III; common high-explosive, point detonating, Mark II, delay.	Friction, model 1914.....	
4.7-inch, shrapnel, common.....	do.....	Mark II supersensitive for gas shell. Mark V with or without delay.	do.....	
Shrapnel, antiaircraft. Shell, high-explosive, common.	do.....	Mark III supersensitive for gas shell. Mark III; supersensitive for gas shell. Mark IV point detonating with or without delay.	21-grain percussion, Mark I.....	
Shell, high-explosive antiaircraft.	do.....	For high-explosive shell, Mark II, delay or nondelay; gas shell, Mark III, supersensitive.	21-grain percussion, Mark I for howitzer; and friction, model 1915, for gun.	Gun and howitzer, use same projectiles.
Shell, gas.	do.....	Mark II, delay or nondelay.	Friction, T model, Mark IV.....	
5-inch shell, high-explosive, common.	Separate loading.....	Mark II, point detonating, delay or nondelay.....	Friction, 1914.....	Seacoast gun, solid nose, base fused.
Shell, gas.	do.....	Base detonating, major caliber.....	do.....	
6-inch Shell, high-explosive.....	do.....	do.....	do.....	Solid nose, base fused.
155-mm. shrapnel.....	do.....	do.....	Friction.....	
Shell, high-explosive.	do.....	do.....	do.....	Do.
Shell, gas.	do.....	do.....	do.....	
8-inch shell, high-explosive.....	do.....	do.....	do.....	Do.
Shell, gas.	do.....	do.....	do.....	
9.2-inch British.....	do.....	do.....	do.....	Do.
20-mm. shell, high-explosive.....	do.....	do.....	do.....	
10-inch shell, high-explosive.....	do.....	do.....	do.....	Do.
12-inch shell, high-explosive.....	do.....	do.....	do.....	
14-inch shell, high-explosive.....	do.....	do.....	do.....	Do.
16-inch shell, high-explosive.....	do.....	do.....	do.....	

VI. ARTILLERY AMMUNITION.

General statement.—In this section of the Handbook are to be found outline descriptions, tables, and diagrams that show the essentials of the more important and established types of American ammunition as developed and manufactured for the European War, and to a certain extent used in actual service overseas with increased supplies available and in process of manufacture on a large scale at the time of the signing of the armistice. Many of these types, it will be apparent, are adopted from European practice, though with important modifications in many cases, and the relation established with the French Army and the decision to employ French matériel in the early operations of the A. E. F. naturally led to the employment of many French designs. However, in all cases these had to be adapted to American conditions of manufacture and American ordnance practice, retaining as far as possible the essential features of interchangeability. Furthermore, an important consideration to be taken into account was that prior to the war American manufacturers had been engaged in the production of munitions for the allies, and facilities were available in many cases for well-developed types.

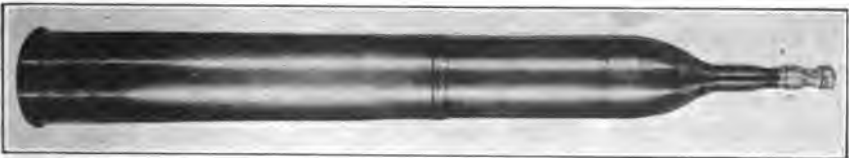

FIG. 45.—Assembled round of fixed ammunition showing cartridge case, projectile, and fuze.

Fixed and separate loading ammunition.—Projectiles and their propelling charges as employed with the various types of guns, howitzers, and mortars fall into two main divisions known respectively as *fixed ammunition* and *separate loading ammunition*. The distinction is self-explanatory, and, roughly speaking, depends upon the caliber of the piece. *Fixed ammunition* is used with guns and howitzers of the smaller sizes. In this type the base of the shell is inserted in and attached to a brass container, which carries the propelling charge, the latter being ignited by a primer located in the base of the case. With *separate loading ammunition* the shell is inserted in the cannon, and

the propellant—usually in a silken bag—and the primer are placed separately. An intermediate type, known as *semifixed ammunition* is used for certain calibers. This is similar to fixed ammunition, except that the cartridge case is not attached to the projectile.

The projectiles used with modern guns, howitzers, or mortars embody many variations, depending upon the pieces from which they are fired, the ranges employed, the targets against which they are used, the contents, such as balls in the case of shrapnel, or high explosives, gas, smoke-producing substances, and illuminants in shell.

Shell.—Ordinarily a shell is a steel cylindrical body with an ogival point and with a fuze at either the nose or base to detonate the bursting charge. Around the base of the shell is clamped a copper band in which the lands of the rifling of the bore of the gun cut, so that in its passage from breech to muzzle a twist or rotation is imparted to the projectile, and accuracy in flight is insured.

Material (forgings).—For the manufacture of shell a high quality of steel is required, which must possess requisite physical properties carefully determined and specified to insure against premature bursting or defective firing. The steel is first rolled into billets of certain dimensions, which at the forge shop are cut into slugs and then are forged into the rough shell bodies. These operations require extensive equipment such as furnaces and forging presses.

Machining.—After the shell forgings have been tested and passed as to quality, they are ready for machining. In the case of the 75-mm. shrapnel approximately 40 operations are required. The operations referred to concern the shell itself and generally are carried on in a single plant. Simultaneously other plants manufacture the fuzes, diaphragms, tubes, adapters, etc.

Production.—Each filled and fuzed 75-mm. shell contains some 68 parts, often representing the work of 35 to 40 contractors. The same holds true of other calibers also. A factory machining 40,000 shell per day represents a huge organization. By May, 1918, shell factories in the United States were not only producing forgings for 75-mm. shell, but production of other sizes was under way and arrangements were being made to establish manufacturing facilities for practically all the types of shell required by the artillery program. All available plants were working from 20 to 24 hours a day either in two shifts of 10 hours each, or three shifts of 8 hours each.

Filling.—In case of the 75-mm. shrapnel, the steel cases are filled with shot and resin, and then the bursting charge is inserted and the fuze, which requires a special loading operation for itself, is placed on the shell. There are shells, however, which contain high explosives, gas, or other materials, the filling of which is carried on with special facilities and in special loading plants.

Gun.

37 mm.....

1.457-inch pompom.....

Vickers-Maxim.....

2.95-inch mountain gun.....

75 mm. field gun (United States and French).

3-inch mountain howitzers

3-inch field guns.....

3-inch antiaircraft gun.....

3.2-inch field gun.....

3.6-inch mortar.....

3.6-inch gun.....

3.8-inch gun.....

3.8-inch howitzer.....

4.7-inch howitzer.....

4.7-inch gun.....

4.7-inch antiaircraft gun.....

5-inch siege gun.....

5-inch seacoast gun, wheel mount.....

6-inch howitzer.....

6-inch seacoast, wheel mount.....

155-mm. howitzer and gun.....

7-inch siege howitzer.....

7-inch siege mortar.....

8-inch howitzer.....

9.2-inch howitzer.....

240-mm. howitzer.....

United States types of ammunition.—For the United States mobile artillery, as distinct from the seacoast guns and mortars in the fortifications, the following types of ammunitions were being manufactured at the beginning of the war:

2.95-inch shell and shrapnel.

3-inch shell, common shrapnel, and high-explosive shrapnel.

3.8-inch shell and shrapnel.

4.7-inch shell and shrapnel.

6-inch shell and shrapnel.

Developing an ammunition program.—The first step toward a comprehensive ammunition program, taken shortly after the declaration of war, was to place, with the approval of the Council of National Defense, orders for approximately 9,000,000 rounds of shell and shrapnel ammunition for the 3-inch field guns. Following the visit of the French high commission and the conferences at which it was decided that for the first year of the war, at least, the French would furnish both guns and munitions to the American Artillery, it was determined to adopt the principal calibers of French field guns and howitzers, along with some British matériel then in manufacture in the United States. Accordingly, orders were placed in France in July, 1917, for 8,000,000 rounds of 75-mm. ammunition and 1,000,000 rounds of 155-mm. ammunition, and subsequently these calibers were placed on our project program for procurement in this country. A number of the American manufacturers having contracts for 3-inch ammunition were induced to change part of their contracts to 75-mm. while the full program was being formulated, and plants and equipment secured to manufacture ammunition as needed.

Semisteel shell.—While for many kinds of shell a high grade of steel is necessary, one of the developments of the present war has been the use of semisteel, both for high explosive and gas shell. This material has been used not only to conserve the supply of steel and on account of its ease of production, but especially in the case of gas shell on account of the decreased amount of explosives necessary to burst the shell. As the war progressed there were increased requirements for gas shell, and the economy of semisteel was manifest, while in action it was found that it caused less dispersion of the gas. Semisteel gas and high-explosive shell of various calibers have been designed in the United States Ordnance service, and after experimental orders had been placed for various calibers a large and comprehensive program for this matériel was developed, as it did not interfere with the manufacture of steel shell. In addition to giving better fragmentation, and thus having greater effect, semisteel shell are more easily machined and can be produced more quickly than the forged steel shell.

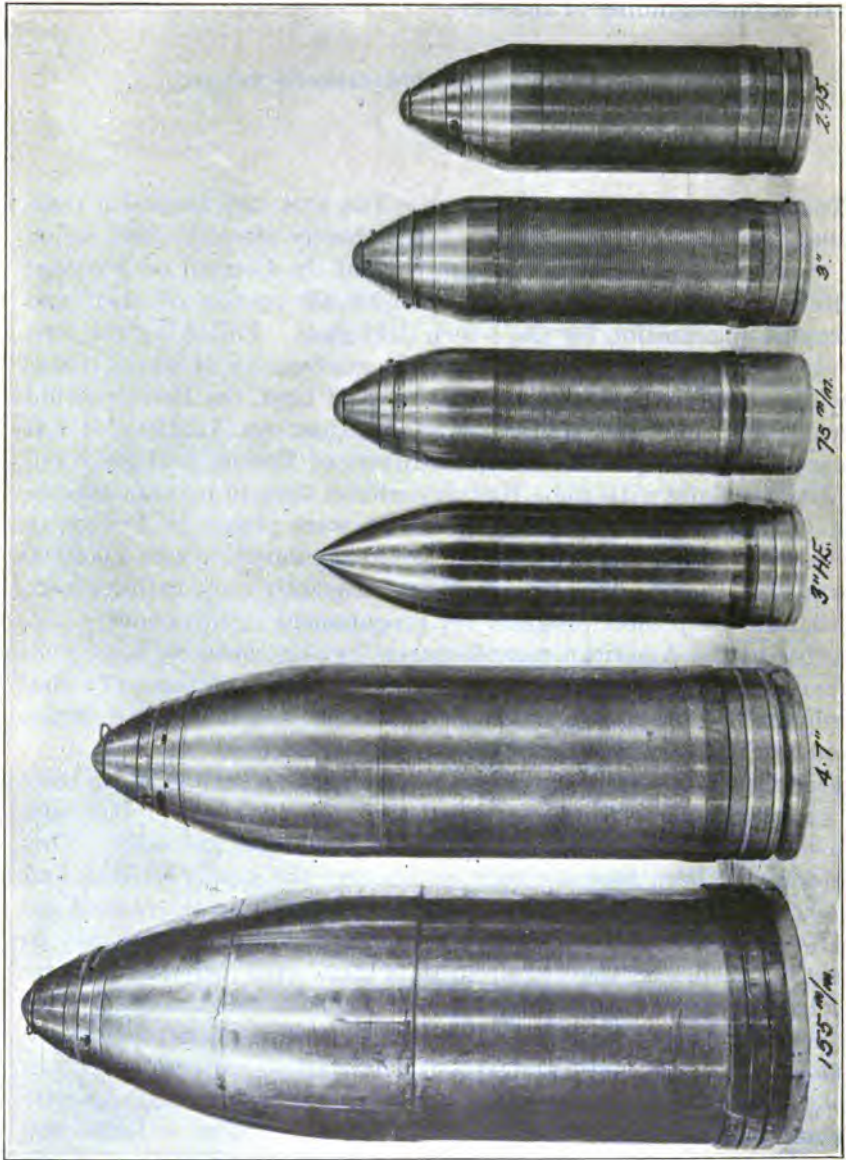
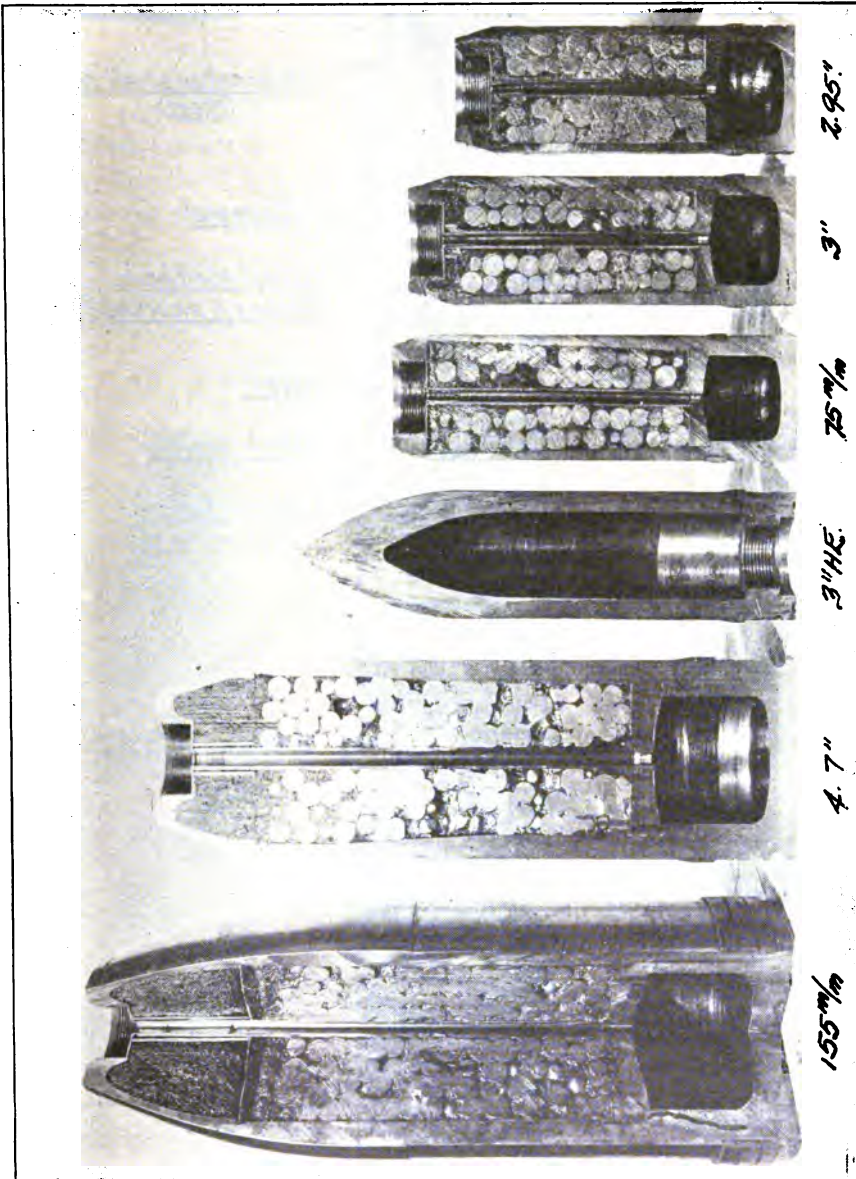

FIG. 46.—U. S. artillery ammunition. Exterior views of shrapnel and shell. Shrapnel assembled with time fuzes.



155 mm 4.7" 3" HE. 75 mm 3" 2.95"

FIG. 47.—U. S. artillery ammunition. Sections of shrapnel and shell shown in Fig. 46.

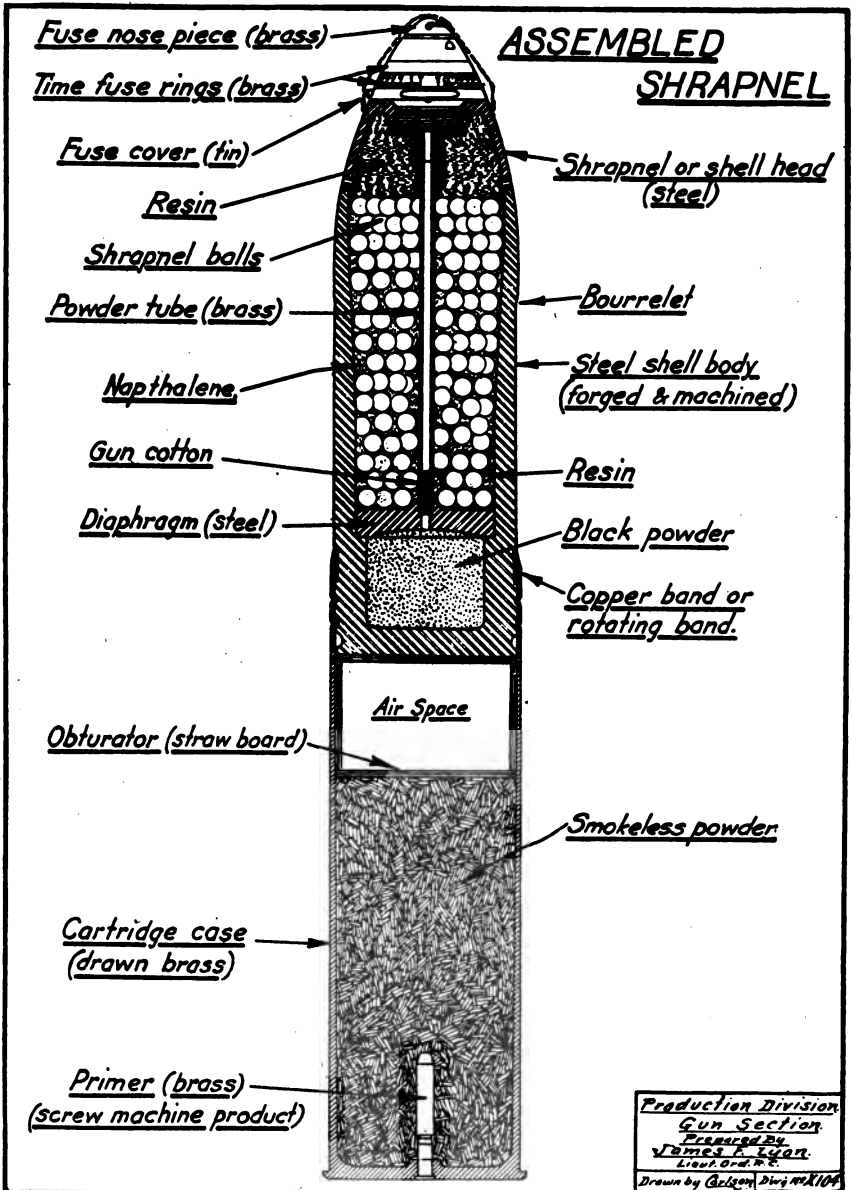

FIG. 48.—Section of assembled shrapnel.

Shrapnel.—The earliest departure of importance in the United States in regard to ammunition was the decision to manufacture shrapnel for the 75-mm. field gun. Projectiles of the following sizes similar to well-established types used by the United States were designed and put under manufacture in quantity, though the require-

ments of shrapnel subsequently appeared to be a much smaller percentage of the total than was first anticipated.

75-mm.

3.8-inch.

4.7-inch.

155-mm.

All of the above shrapnel used the Frankford type of combination fuze, described and illustrated on page 167. A typical section of American shrapnel is illustrated on the opposite page.

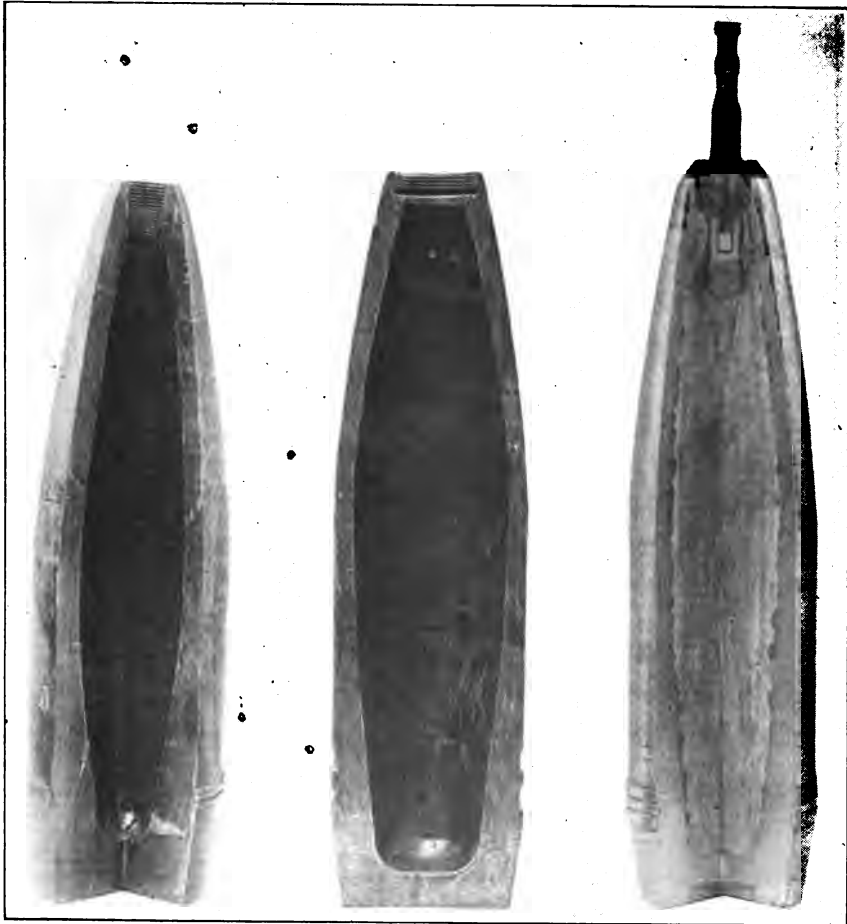

Semi-steel shell.

Steel shell.

Steel shell filled and fuzeed with
Mark III fuze.

FIG. 49.—High explosive shell—cross sections.

High-explosive shell.—This is the most commonly used and probably the most important type of projectile. Its use is general throughout all calibers and all types of guns, howitzers, and mortars, including

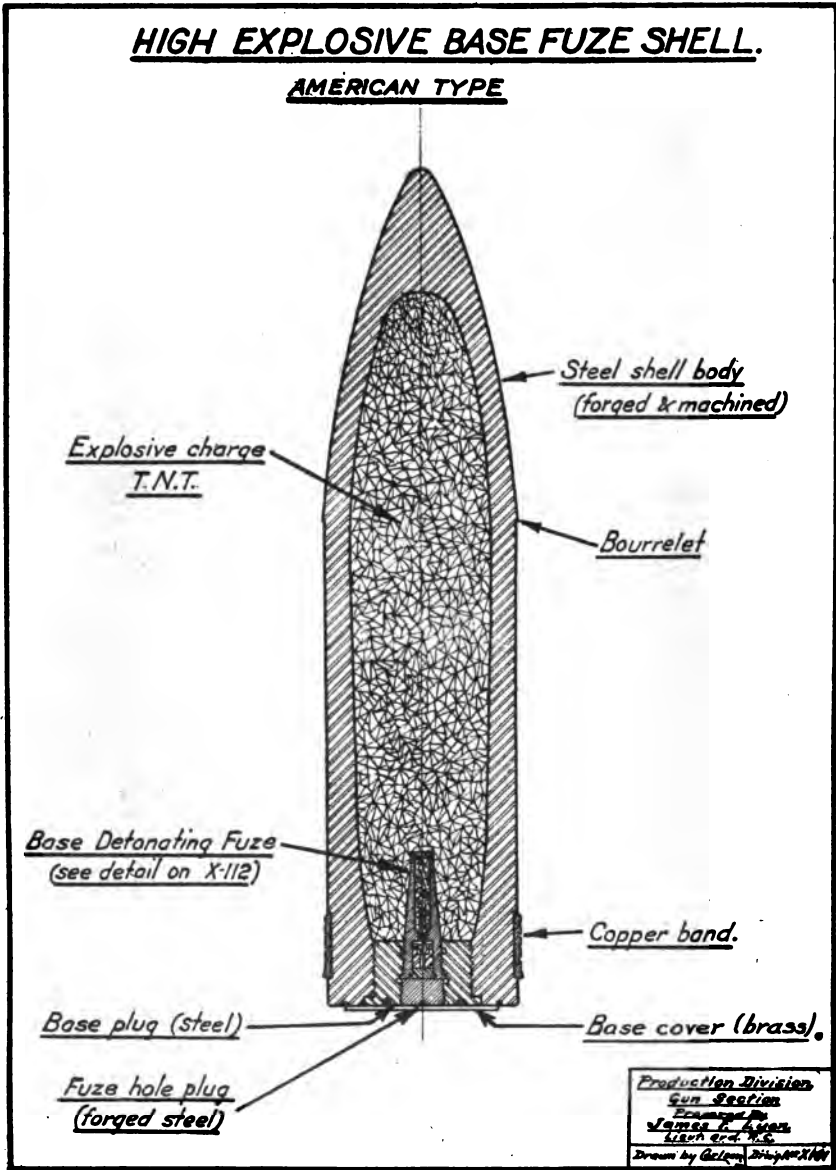
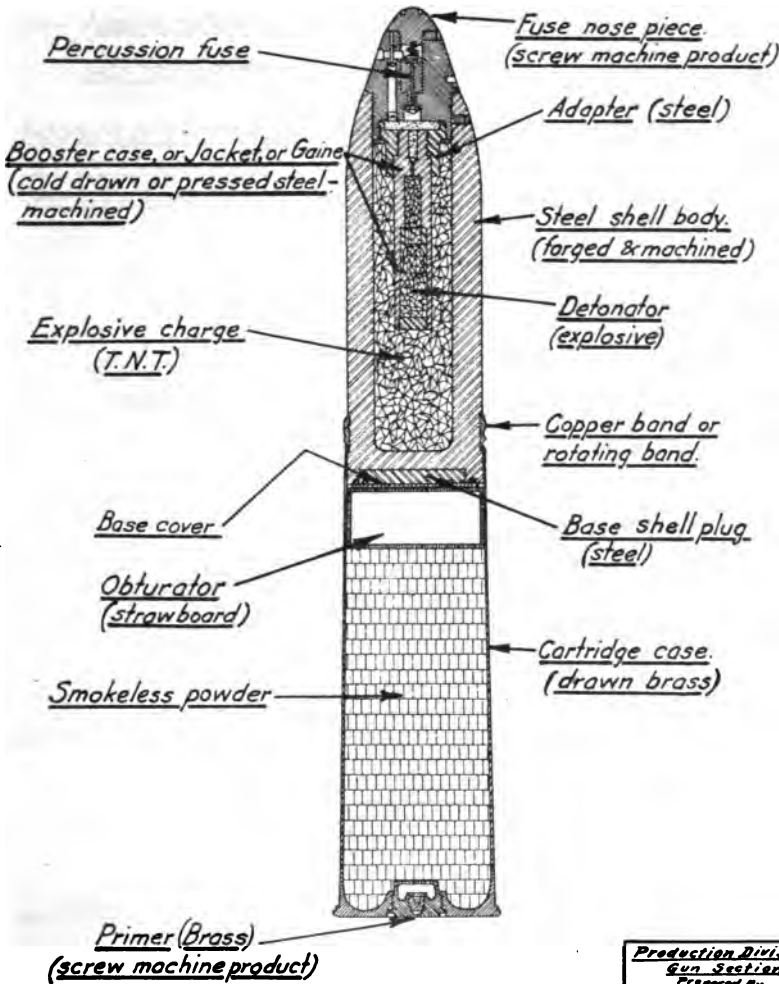

FIG. 50.—High-explosive base fuze shell, American type.

mobile and seacoast artillery and cannon on railway mounts. At the beginning of the war the American, British, and German designs called for thick walls and a relatively small charge of high explosive. The French, on the other hand, used large bursting charges and thin walls. In order to make these thin-walled shell

HIGH EXPLOSIVE NOSE FUZE SHELL,
ENGLISH TYPE



*Production Division
Gun Section
Designed by
James F. Lyon,
Chief, Gun Sec.
Drawn by G. L. G. Day 1914/102*

FIG. 51.—High-explosive nose fuze shell, English type.

safe for firing, they required that all shell bodies be heat treated to improve their physical properties.

The experience of the earlier years of the war indicated that larger bursting charges than had been used in our designs were desirable. It also demonstrated that point-fuzed shell were more

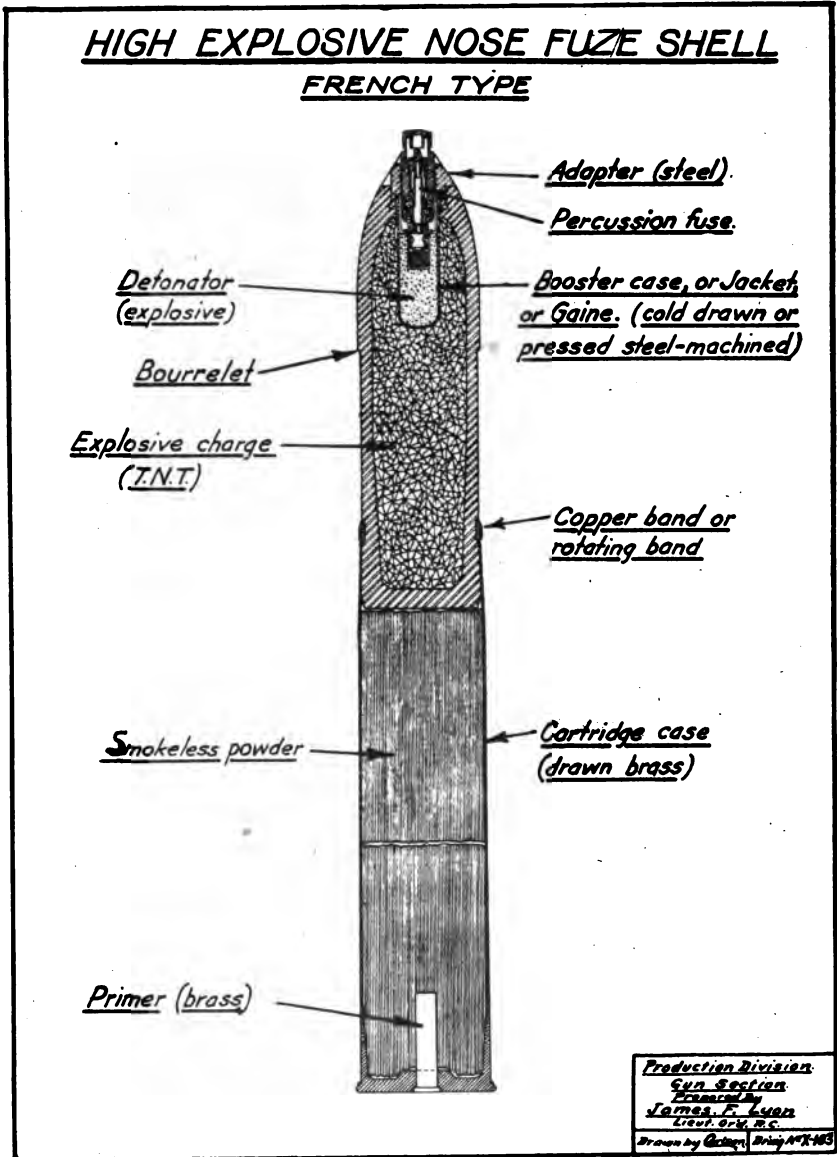

FIG. 52.—High-explosive nose fuze shell, French type.

effective for certain purposes than base-fuzed shell. New designs were therefore prepared embodying those features shown by experience to be desirable. In general these designs resemble those of the French with thin walls and high bursting charges.

Special shell.—An important development of the war was the use in large quantities of special shell, including gas shell of various

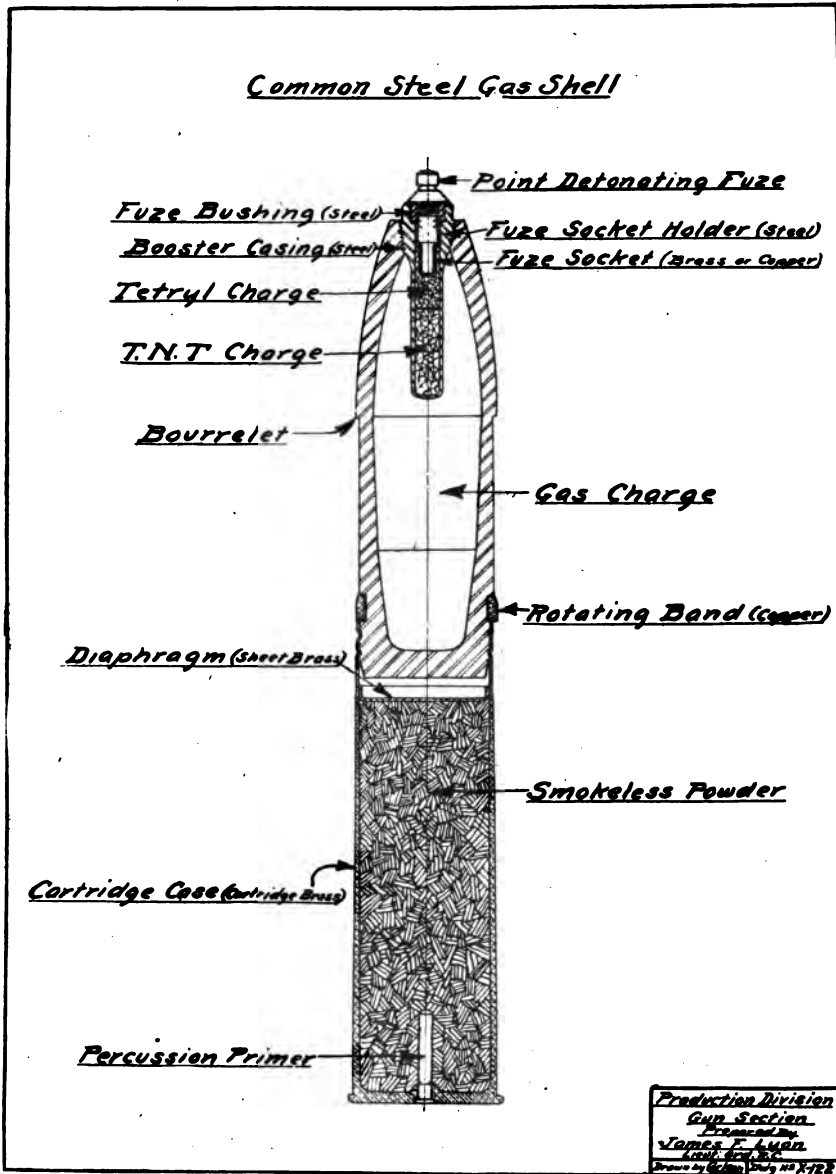

FIG. 53.—Common steel gas shell.

kinds, smoke, illuminating, tracer, and incendiary shell. All of these are similar in outline to the high-explosive shell.

Gas and smoke shell.—Gas and smoke shell require a larger booster charge than high-explosive shell, and all joints must be gas tight. To meet these requirements American designs employ a taper thread in the nose of gas shell, and the opening is made somewhat larger

than in the high-explosive type to accommodate the larger booster. Certain gases employed can not be kept in contact with iron or steel. For these gases, the interior surface of the shell is provided with an electrolytic lead lining. In addition a number of gas shell were manufactured in the United States with the inside lined with glass to prevent chemical action between the steel shell and the filler. This idea is taken from the French, who employed such shell and found them much more satisfactory after having been in store a reasonable time than those not so prepared.

Illuminating shell.—Illuminating shell are provided with a base which can be easily blown off, and are loaded with an illuminating composition contained in small steel cups. The shell is provided with a time fuze, which, when it functions, ignites the illuminating composition and blows out the base of the shell, and the contents now ignited burn and illuminate the vicinity as they fall. The illumination lasts for from 5 to 10 seconds.

Tracer shell.—In addition to ordinary shell carrying a tracer composition in a tube attached to the base there are special tracer shell developed for use against aircraft. The shell resembles ordinary shell and carries a charge of special composition. It has a solid base and the nose is closed with a flat head, to which is attached a time fuze. In the wall of the shell, just back of the nose, a series of holes are provided through which the flame and smoke of the burning composition issue and thus trace the flight of the projectile. These holes are closed by steel cups inserted from the outside under pressure and which are blown out when the fuze functions. This shell is also used as an incendiary shell against balloons and dirigibles.

Weight markings.—In order that allowance may be made for variations in the weight of loaded shells in computing firing data, various marks for quick identification by the gunners in the field are made. These marks are indented in the body of the shell, so that they are apparent by sense of touch as well as on sight. In the United States service it is customary to indicate the weight of shells by means of a prick punch, but in the case of the 75-mm. ammunition, the French system of marking is employed, and this is the only United States ammunition in which the prick punch is not used.

Marking 75-mm. ammunition, French system.—The weights of markings of the 75-mm. shell are as follows:

10 pounds 11 ounces to 11 pounds.....	L
11 pounds to 11 pounds 5 ounces.....	+
11 pounds 5 ounces to 11 pounds 11 ounces.....	+ +
11 pounds 11 ounces to 11 pounds 15 ounces.....	+ + +
11 pounds 15 ounces to 12 pounds 5 ounces.....	+ + + +

These marks are placed about one-half inch in rear of the bourrelet and spaced one-half inch apart. They are deep enough to be felt and be counted by sense of touch, enabling artillerymen to recognize weights of projectiles during night firing. For shell, the weights indicated by the marks indicate the weight of loaded projectile and booster, but without fuze. For shrapnel the weight of the fuze is included.

Marking 4.7-inch shells.—4.7-inch shells for the United States Artillery are classified by weight into three zones. These are indicated by punch marks as follows:

	Marks.
43 pounds up to and including 43 pounds 11 ounces.....	1
43 pounds 11 ounces up to and including 44 pounds 6 ounces.....	2
44 pounds 6 ounces up to and including 45 pounds 1 ounce.....	3

The marks are placed about five-tenths of an inch in rear of the bourrelet, spaced five-tenths inch apart. They should average one-tenth inch in diameter, and are punched deep enough to be felt and counted by sense of touch, enabling artillerymen to recognize weight of projectile during night firing. Each punch mark has a square of black paint stenciled over it for identifying weight zones by sight. The weight zones indicated by the marks are for shell containing bursting charge, adapter and booster charge, but without fuze. When Mark III fuzes are used there must be added 15 ounces to the shell's loaded weight, while for the Mark IV and Mark V fuzes 6 ounces is added. These elements are considered in connection with the various range tables and setting of the guns. Shrapnel for the 4.7-inch gun varies but 1 per cent in weight and has no weight zones. The system of marking can be understood by reference to figure 54.

Designating colors and marks for projectiles.—Projectiles of all calibers are distinguished by different colored paints, designating their type. Common steel shells are painted yellow when filled with high explosive and gray when filled with gas. Semisteel shells have the top painted black to the bourrelet, while above the bourrelet they are painted yellow if filled with high explosive, or gray if filled with gas. Common shrapnel is painted red. Marks are also stenciled on the projectile to indicate the caliber and the cannon in which they are to be used, whether guns, howitzer, or mortar. This is a matter of great importance and plain distinguishing marks for shell were urged by the American Expeditionary Forces as a matter of considerable importance in field service.

FUZES.

General considerations.—A fuze performs the function of igniting the bursting charge and initiating the explosion, either upon impact of the projectile or after a certain time of flight and before the projectile strikes. Fuzes are usually divided into time, percussion, and detonating, or combinations of two or more of these types in to one. With respect to form, they are divided into point and base, according to whether they are attached to the point or base of the projectile. Time fuzes are arranged so that they may be set to function at any time up to the maximum for which the fuze is designed. Percussion fuzes function due to the retardation of the projectile on impact. These fuzes simply ignite the bursting charge. Detonating fuzes usually function on impact of the projectile and carry a detonator of fulminate of mercury or some material, which initiates a very rapid explosion (several thousand meters per second), called a detonation, in the bursting charge. Combinations of time and percussion elements or time and detonating elements in the same fuze are very common.

Safety devices.—All fuzes are arranged with safety devices which restrain the firing pin from coming into contact with the primer until after the fuze has been subjected to acceleration or rotation nearly equivalent to that obtained in the bore of the gun. In addition, some of the detonating fuzes have what are known as bore safety devices. Such devices usually keep the detonator separated from the bursting charge in such a way that it would not ignite the latter, even though prematurely ignited, due to shock or other causes. The arrangement for bringing the detonator and bursting charge in such relation to each other that the fuze would function is designed so that it functions some time after the projectile has left the bore of the gun. From this the name "bore safe" or "bore safety" feature originated. The fuze, however, is equally safe in storage or transportation or even in ammunition dumps, should projectiles be stored fuzed.

American conditions.—In the United States at the outbreak of the war there was no satisfactory type of point-detonating fuze. The Frankford Arsenal design of combination time and percussion fuze was used for common shrapnel, while an adaptation of the Ehrhardt type of time detonating fuze was used on a few high-explosive shrapnel then manufactured. The high-explosive shell were fitted with detonating fuzes of the base type. The decision to employ the French 75-mm. and 155-mm. ammunition carried with it the adoption of the French fuzes, which were entirely different from any ever used in the United States. The French fuzes were carried separately with an adapter and booster casing carrying the booster or main detonating charge.

TABLE 17.—United States Ordnance Department fuzes and projectiles in which they are used.

Type.	Drawing.	Projectiles used in—	
Base percussion:			
Minor caliber, Mark I.....	73-2-42.....	37-mm. low-explosive cast steel shell. Low-explosive shell, medium and major caliber.	
Minor caliber, Mark II.....	73-2-46.....		
Medium and major caliber.....	73-2-29.....		
Base detonating:			
Minor caliber, Mark IV.....	73-2-57.....	37-mm. high-explosive and A. P. shell. For 2.24-inch 6-pounder cast-steel shell. Mobile, for 2.95 to 7 inch, inclusive. Seacoast, for 3 to 6 inch, inclusive. Mobile artillery ammunition. Seacoast ammunition above 3-inch. Seacoast, all calibers above 6-inch.	
Minor caliber, Mark VI.....	73-1-124.....		
Minor caliber.....	73-1-45.....		
Medium caliber ¹	73-2-37, 38.....		
Medium caliber.....	73-2-22, 36.....		
Medium caliber.....	73-3-96.....		
Mark III (Semple type).....	73-2-52, 53.....		
Mark V (Semple type).....	73-2-62, 63.....		
Major caliber.....	73-2-28, 33.....		
Major caliber.....	73-3-96.....		
Point detonating:			
Mark I.....	73-1-50, 51.....	Mobile 2.95 and 3-inch high-explosive shell and cast-steel shell. Mobile and seacoast 8-inch and above. Mobile and seacoast 75-mm., 3.8-inch, 4.7-inch, and above. Mobile and seacoast (3.8-inch, 4.7-inch, 6-inch, and above) howitzer or mortar, and 14-inch guns. Mobile, 155-mm. gun, high-explosive shell. Mobile and seacoast 75-mm., 4.7-inch, 5-inch, 6-inch, 8-inch, 10-inch, 12-inch guns.	
Mark II.....	73-2-43, 44, 45.....		
Mark III.....	73-2-39, 40, 41.....		
Mark IV.....	73-1-79, 80, 81.....		
Mark IV ¹	73-1-79, 80, 81.....		
Mark V.....	73-1-79, 80, 82.....		
Combination time and percussion:			
45-second, model 1907.....	73-3-47, 48, 95, 96.....		4.7-inch gun and howitzer, 3.8-inch howitzer, 6-inch howitzer, and 155-mm. gun and howitzer, shrapnel.
45-second, Mark I.....	73-3-101, 102, and, 103.....		
21-second, model 1907.....	73-3-93, 94, 95, 96.....		75-mm. gun, 2.95-inch mountain gun, and 3-inch field gun, shrapnel.
21-second, model 1915.....	73-3-104, 105, 106, and 107.....		
21-second, Mark IV.....	73-3-114, 115, 116.....		
21-second, I. A. F.....	73-3-99, 100.....		
Antiaircraft time fuzes:			
Antiaircraft, Mark II.....	73-3-109, 110.....	3-inch antiaircraft ammunition, all types. 75-mm antiaircraft ammunition, all types.	
Antiaircraft, Mark III.....	73-3-111, 112, 113.....		
75-second mechanical time, Mark I.....	73-7-1, 2, 3, 4, and 5.....	4.7-inch antiaircraft ammunition. 5 and 6 inch seacoast gun shell, A. B. ammunition. 155-mm. gun, A. B. shell and shrapnel.	

¹ This fuze had been condemned and will be extracted and replaced by Mark III, Semple type, in mobile artillery ammunition and by Mark V, Semple type, in the seacoast artillery ammunition.

² This fuze is no longer being produced and will be replaced as soon as possible by Mark V, Semple type.

Mark No.	Drawing No.	Size
I.....	73-1-52....	U. S. 4
II.....	73-1-84....	U. S. 4
IIA....	73-1-122....d
III.....	73-1-55....	U. S. 4
IIIA...	73-1-105...	U. S. 4
IIIB...	73-1-104...	U. S. 4
IIIC....	73-1-119...	Brigg
IIID...	73-1-120...	Brigg
IIIE...	73-1-121...	Brigg
IV.....	73-1-54....	Brigg
IVA....	73-1-91.....d
IVB...	73-1-93.....d
IVC....	73-1-111.....d
IVD...	73-1-116.....d
IVE....	73-1-123.....d
V.....	73-1-65....	Brigg
VA....	73-1-106.....d
VB....	73-1-107.....d
VC....	73-1-108.....d
VI.....	73-1-66....	Brigg
VIA...	73-1-90.....d
VIB...	73-1-109.....d
VIC....	73-1-110.....d
VID...	73-1-113.....d
VII.....	73-1-67....	Brigg
VIIA..	73-1-93.....d
VIIB..	73-1-112.....d
VIIIC..	73-1-114.....d
VIIID..	73-1-115.....d
IX.....	73-1-73....	U. S. 4
X.....	73-2-51....	U. S. 4
IV...	73-1-100...	Brigg
XVI...	73-1-127....d

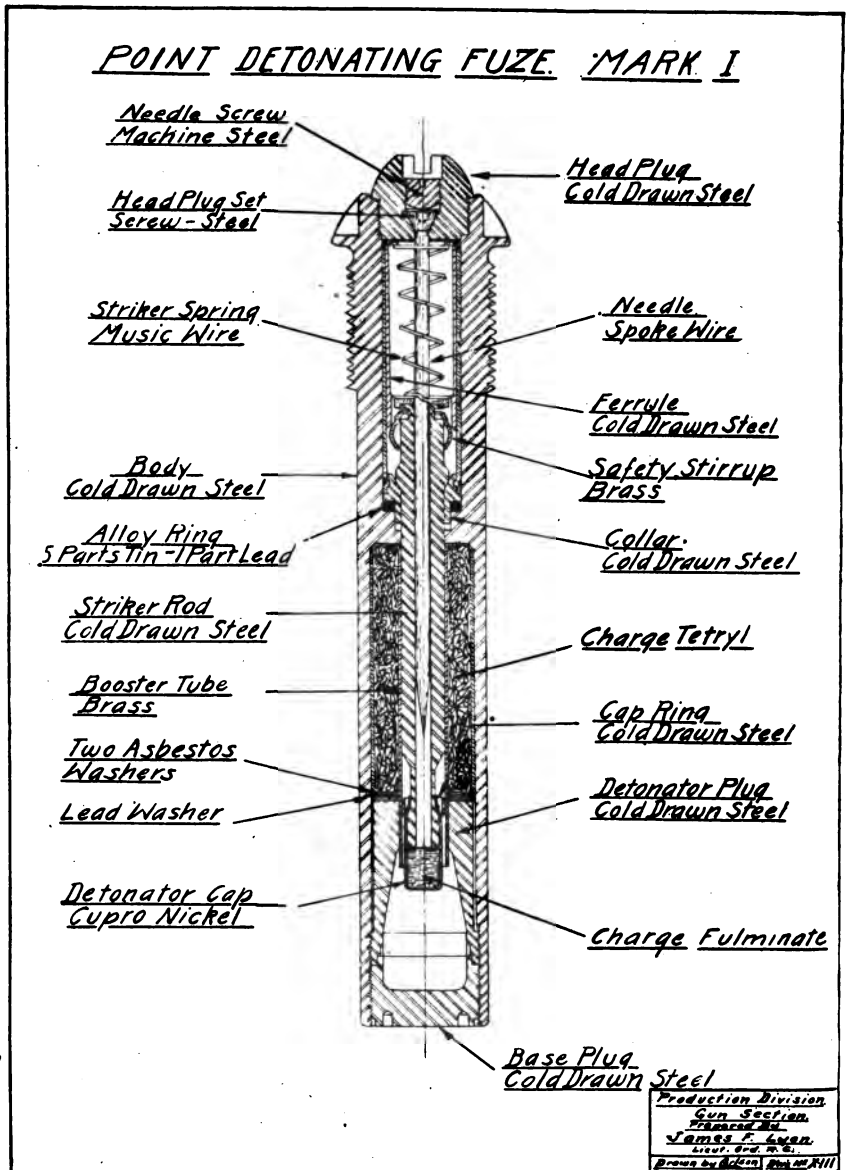

FIG. 55.—Point detonating fuze, Mark I.

Marks I and II fuzes.—Just previous to the outbreak of the war, some tests had been conducted with Russian 3 GT point-detonating fuzes, which had been produced in large quantities in this country, and which were considered very safe fuzes on account of an effective bore safety device. This type of fuze was early adopted, and referred to as the Mark I. At the same time, layouts were made and experiments inaugurated to modify the 4 GT Russian fuze—which is

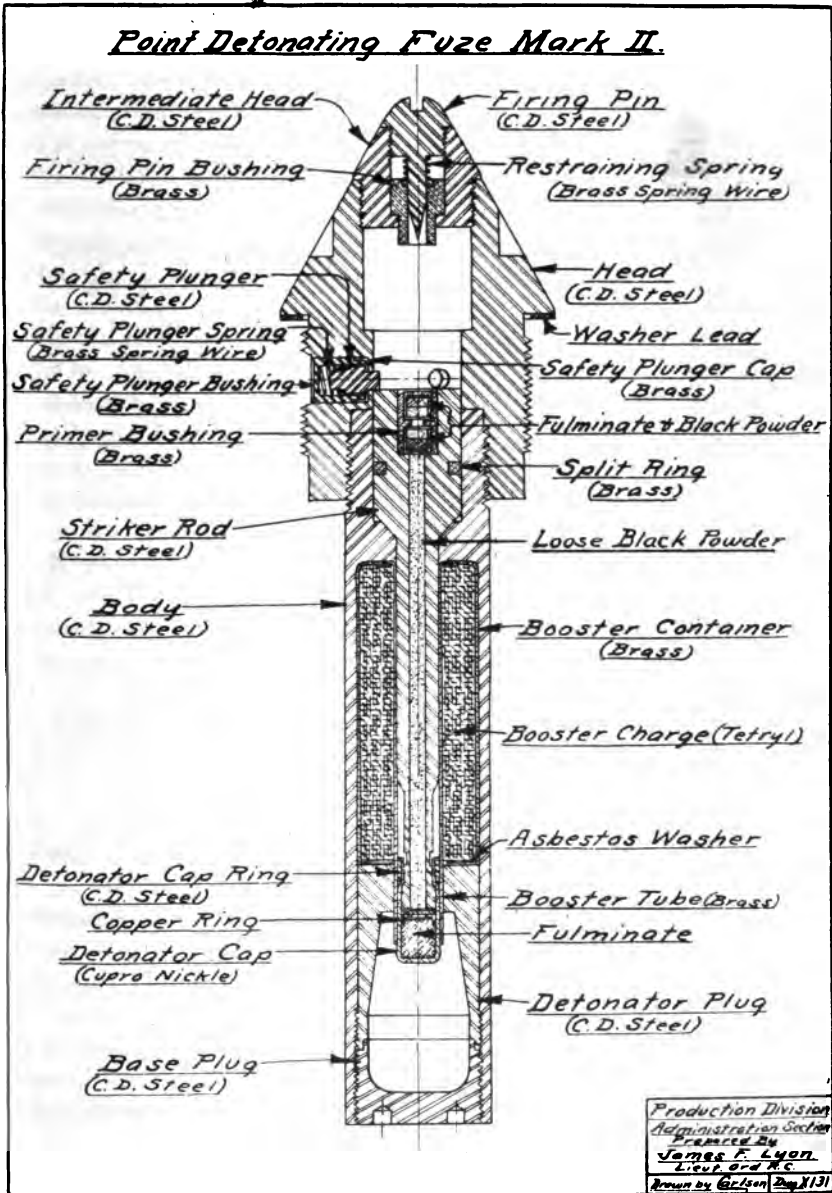

FIG. 56.—Point detonating fuze Mark II.

similar to the 3 GT except that it is larger—to provide arming by rotation instead of acceleration, and to provide a delay action feature. It was proposed to use this modified fuze, called the Mark II, in all shell above 3-inch.

The Mark I fuze was ordered in quantity for 3-inch shell ammunition, but many orders were canceled after the adoption of French types of fuzes.

French fuzes.—During the visit of the French commission headed by Marshall Joffre it was decided that we would procure considerable

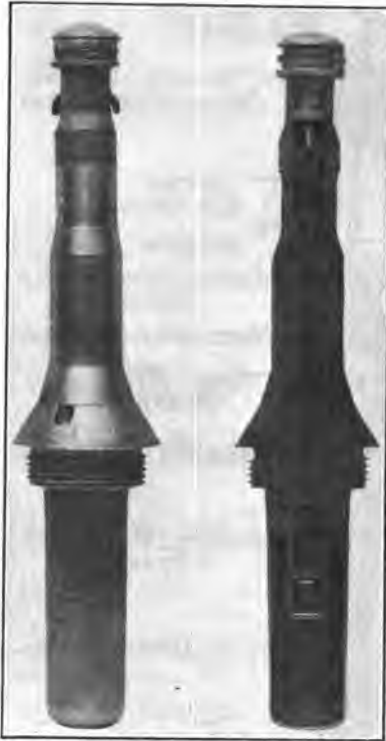

FIG. 57.—Mark III point detonating fuze, exterior view and section.

ordnance matériel, including guns, carriages, and ammunition, in France, in order to tide over the period until we could develop quantity production of this matériel. It was, therefore, decided that we would adopt certain French calibers, using the 75-mm. in place of our 3-inch and the 155-mm. in place of our 6-inch, and would make ammunition interchangeable for these calibers. This decision led to the quite general adoption of the French fuzing system, incorporated in our Marks III, IV, and V. These fuzes contain no bore safety features, and the considerable number of prematures obtained by the French indicate that they are not particularly safe, and, further, we could obtain no authentic information that these fuzes would arm and otherwise function satisfactorily in the

larger calibers. We therefore decided to continue the development of the Mark II fuze, which was bore safe, and to use this fuze for the 8-inch caliber and above. Information obtained at that time indicated that the French did not use the Mark IV or V fuze in any of their larger calibers, and effort to obtain information as to the type actually used resulted in the submission of a fuze considerably larger than the Mark IV and V, called the 30/45 Model 1878-1881, M. 15.

The French fuze system gives great flexibility to meet tactical requirements. The Mark III fuze (French I. A. L.¹) is a supersensitive type which bursts the shell above ground. This fuze is generally used for high-explosive shell fired against personnel, where the effect of shell fragments is desired. It is also generally used in gas and smoke shell where burst is desired before the shell buries itself. The Mark IV and V fuzes are in some degree interchangeable with respect to their functions. Both types are made up with nondelay, short-delay.

¹ Signifies Instante Allongé Lefevre, or instantaneous elongated fuze of Lefevre design.

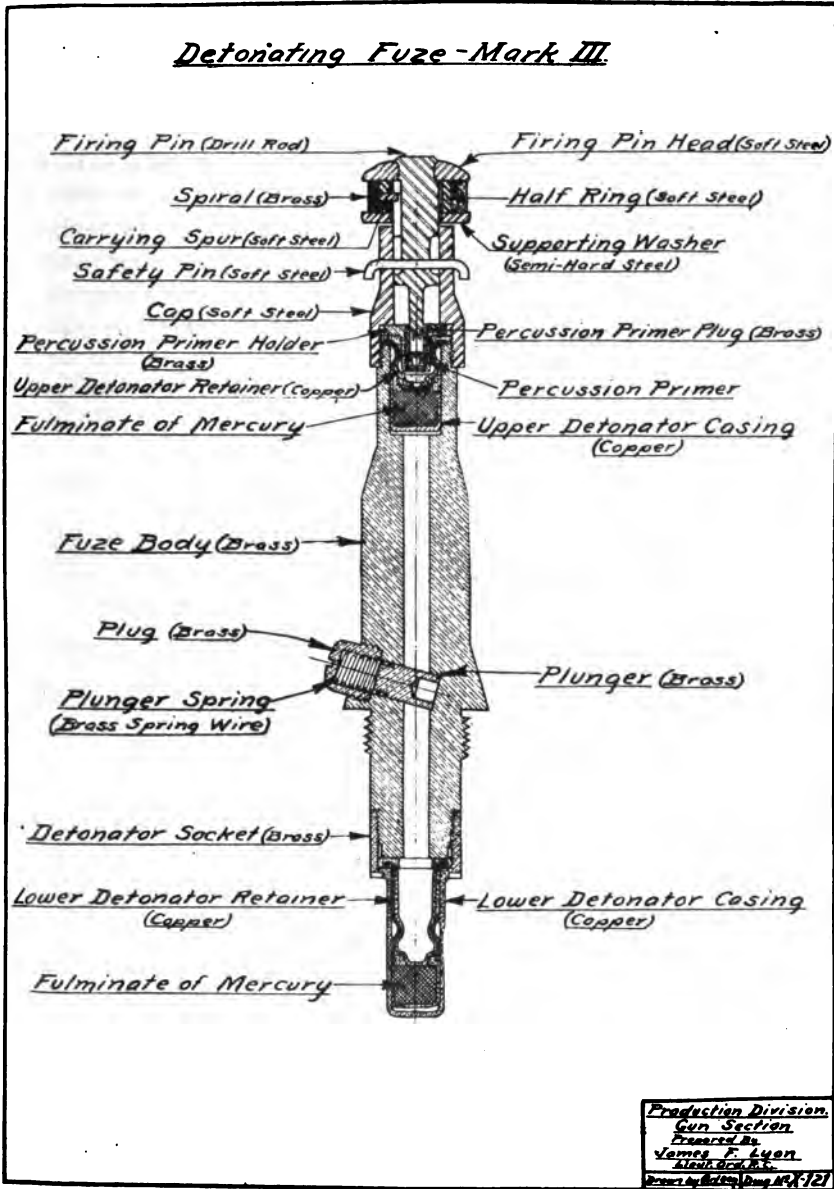

FIG. 58.—Point detonating fuze, Mark III.

and long-delay action. The main difference between the two is that the Mark V has an additional safety feature which requires somewhat higher acceleration to function than the Mark IV type. The method of introducing this safety feature, however, so weakens the fuze at the point that the Mark V is not suitable for the more powerful guns and is therefore generally used with 75-mm. shell.

Notes on the above fuzes.—The artillery ammunition section of the Engineering Division, after a consideration of the entire fuze program in 1918, noted the following conclusions in regard to the above fuzes: Mark I and Mark II fuzes were considered to be bore safe. Bore safe designs were needed to replace Mark III, IV, and V, and were being worked up at Frankford Arsenal. A bore safe type which may be used as a substitute for Mark II was also being developed at the Frankford Arsenal. A bore safe type to replace a medium and major caliber base-detonating fuze was being tested at the proving ground. There was also under test a design to replace the Mark III fuze. Studies and designs for Mark III fuze modified were also put under way, the modified type to be similar to the French fuze but without a primer, and with an elongated firing pin to strike directly on the upper detonator.

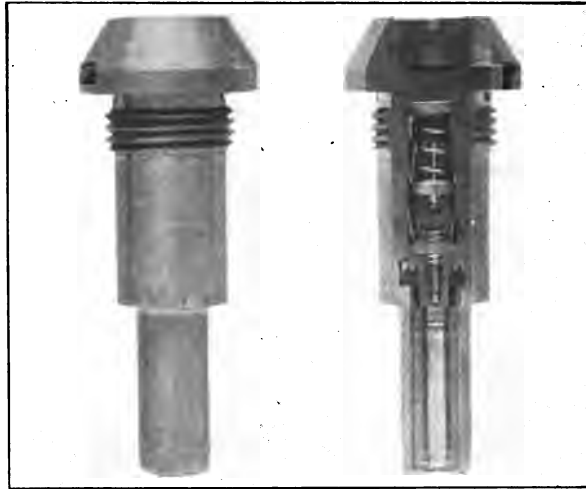

FIG. 59.—Detonating delay fuze, Mark IV. Exterior view and section.

Mark III fuze, safety device.—A partial bore safety device has been added to the Mark III fuze. This consists of a plunger operated by centrifugal force and set at an angle so that linear acceleration tends to oppose the centrifugal force and holds the plunger in a safe position. This plunger is located in the fuze body between the front and rear detonators. While the projectile is being accelerated in the bore, this plunger remains in a safe position and shuts off any premature action from the front detonator, or primer, making the fuze bore safe to that extent. After linear acceleration ceases, the centrifugal force throws the plunger out and opens the channel between the two detonators. This device is shown in the diagram of the Mark III fuze on the preceding page.

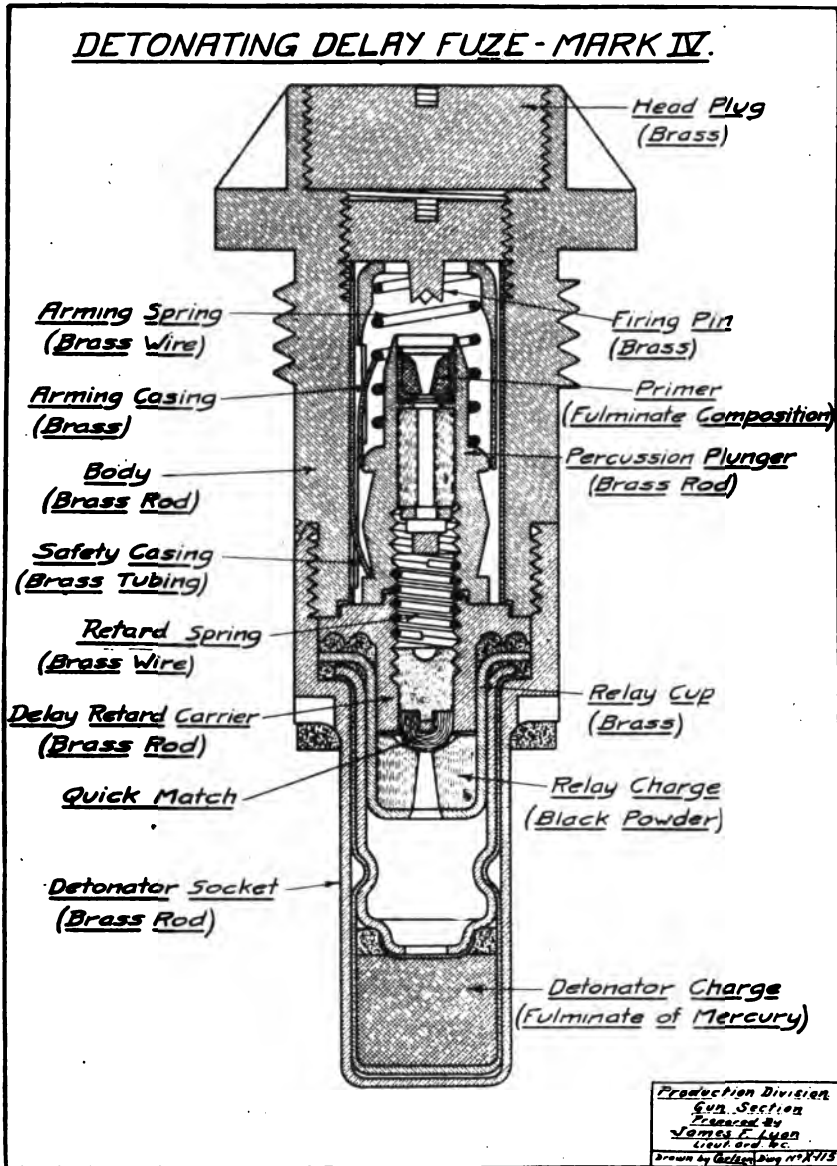

FIG. 60.—Point detonating fuze, Mark IV.

Mark IV and V fuzes.—The Mark IV and V fuzes are essentially copies of French designs. These, together with the Mark III, are the three types which the French high commission considered essential for the United States to adopt for manufacture in this country in order to obtain all the advantages of the French fuzing system, which includes a considerable additional number of types. These three fuzes fit the same adapter and booster and can be used

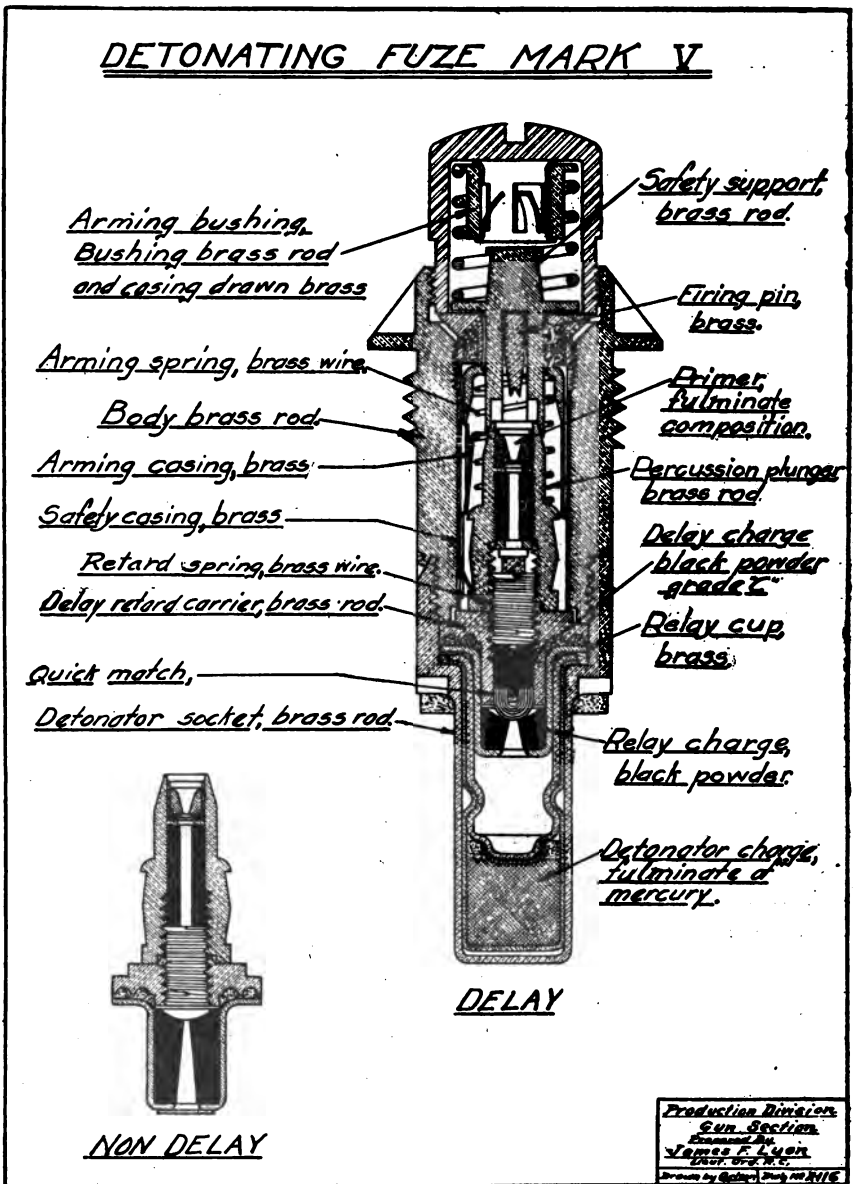

FIG. 61.—Point detonating fuze, Mark V.

interchangeably. The Mark IV fuze is easily armed and is specially designed for use with howitzer ammunition. The point-detonating fuze, Mark V, which is illustrated in the diagram above, like the Mark IV, is made up with delay and nondelay actions. The Mark IV is supplied for projectiles of 3.8-inch caliber and above, and for use in howitzers and mortars, and 14-inch guns.

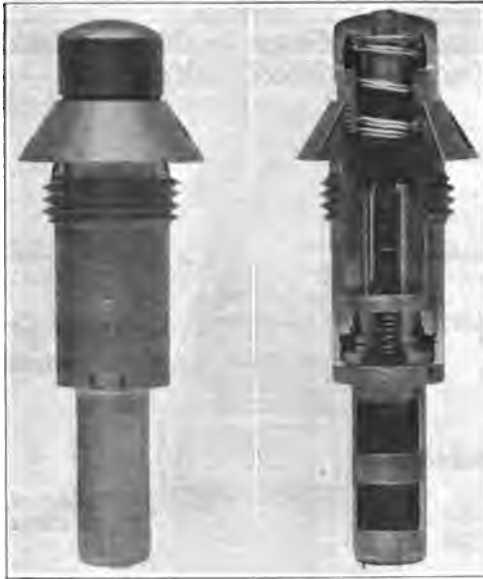

FIG. 62.—Mark V point detonating fuze, exterior view and section.

The Mark IV, Mark IV-A, and Mark V fuzes when made in nondelay form are distinguished by a painted white head. For short delay the top only is black, while for long delay a violet varnished socket is used. When reinforced retard springs are used with Mark IV and IV-A for the 155-mm. gun the truncated part of the head is painted green.

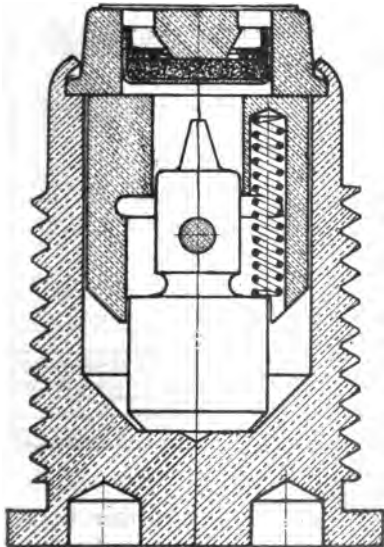

FIG. 63.—Base percussion fuze minor caliber, Mark I, Baldwin type.

Special fuze for 37-mm. shell.—In 1918, the Engineering Division undertook to develop designs, prepare drawings and specifications, determine the necessary gauges, and conduct the necessary experiments and tests for a 37-mm. airplane gun supersensitive point fuze. Likewise, for the same caliber, a balloon fabric fuze for use with the 37-mm. shell against balloons was developed; and studies for the design and manufacture of a 37-mm shell to be used with the above fuze were put under way.

Base percussion fuzes.—Three types of base-percussion fuzes are included in the American list of fuzes, and are used with 37-mm. low

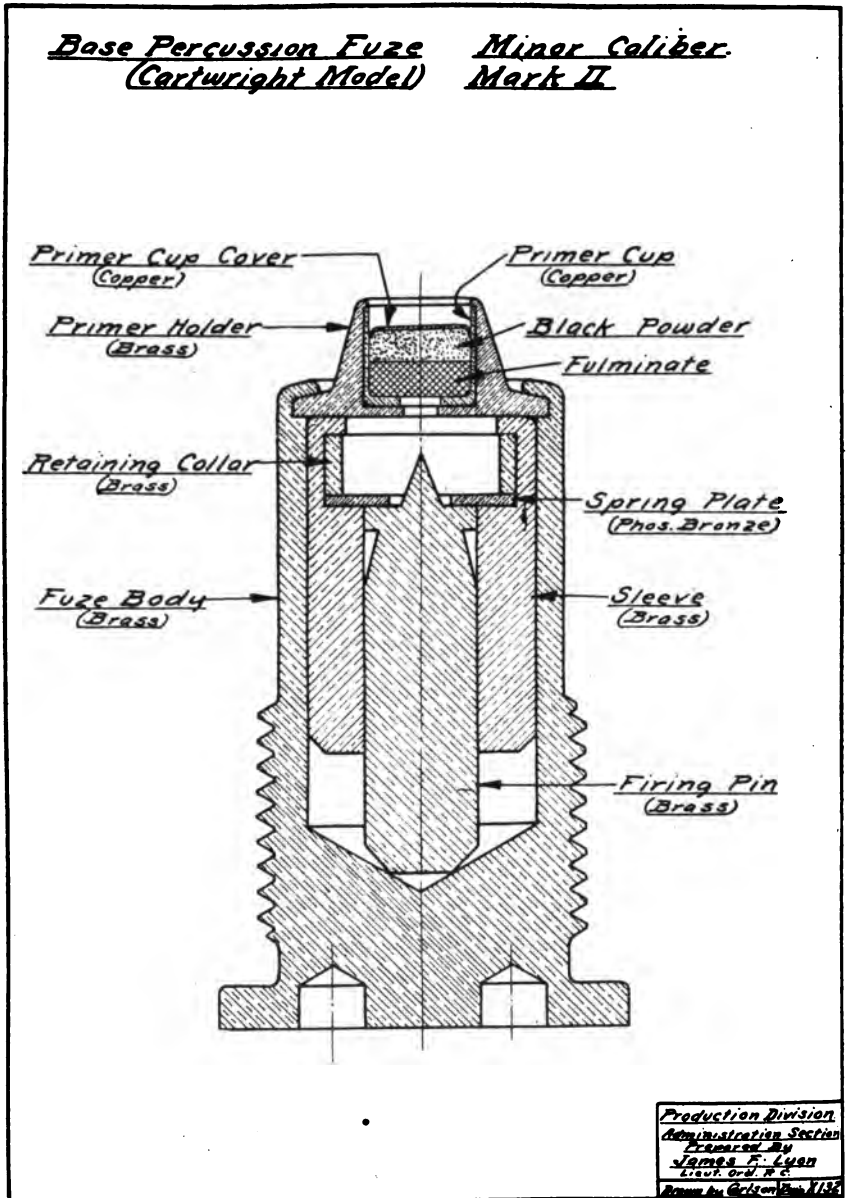

FIG. 64.—Base percussion fuze, minor caliber, Mark II (Cartwright model).

explosive common steel shell in the case of the minor caliber fuzes, and with low explosive shells in the case of the medium and major caliber types. Figure 63 shows base percussion fuze, minor caliber, Mark I (Baldwin Type), while base percussion fuze, minor caliber, Mark II, Cartwright Model, is illustrated in figure 64. The operation of these fuzes is apparent in either case from the diagram.

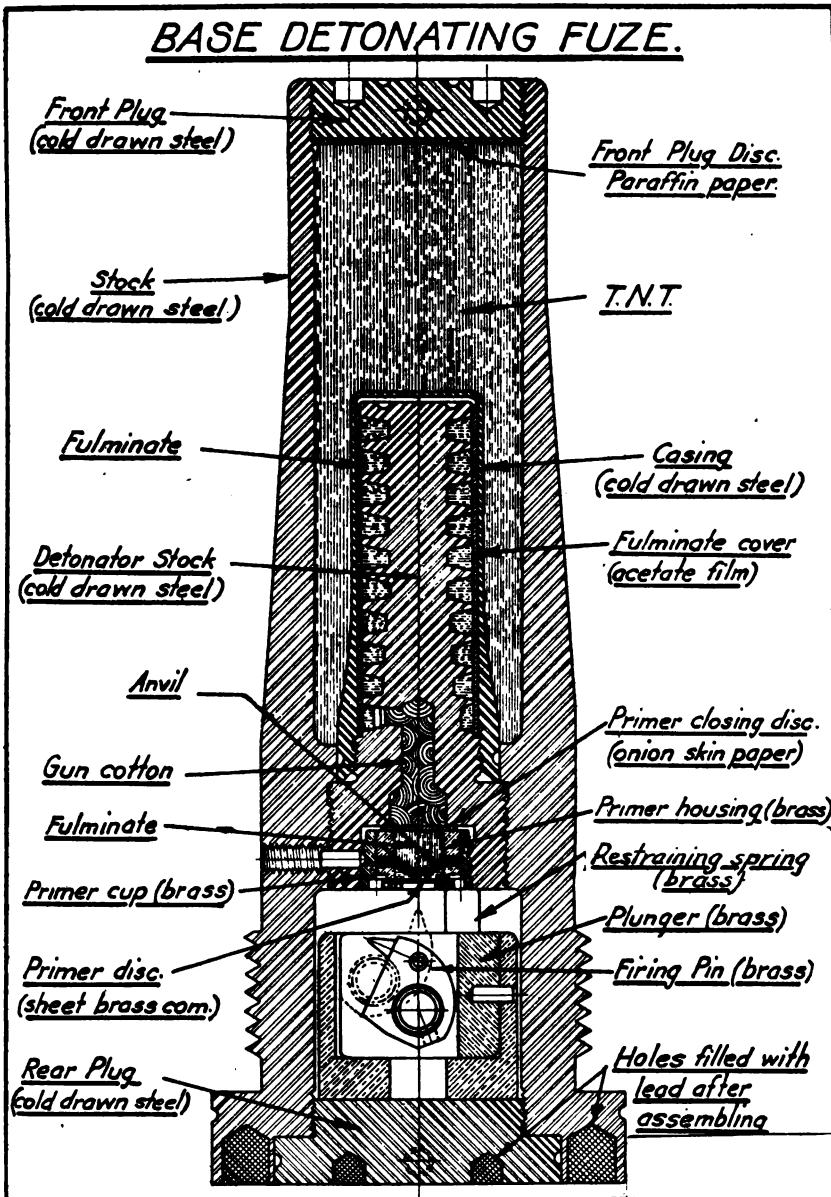
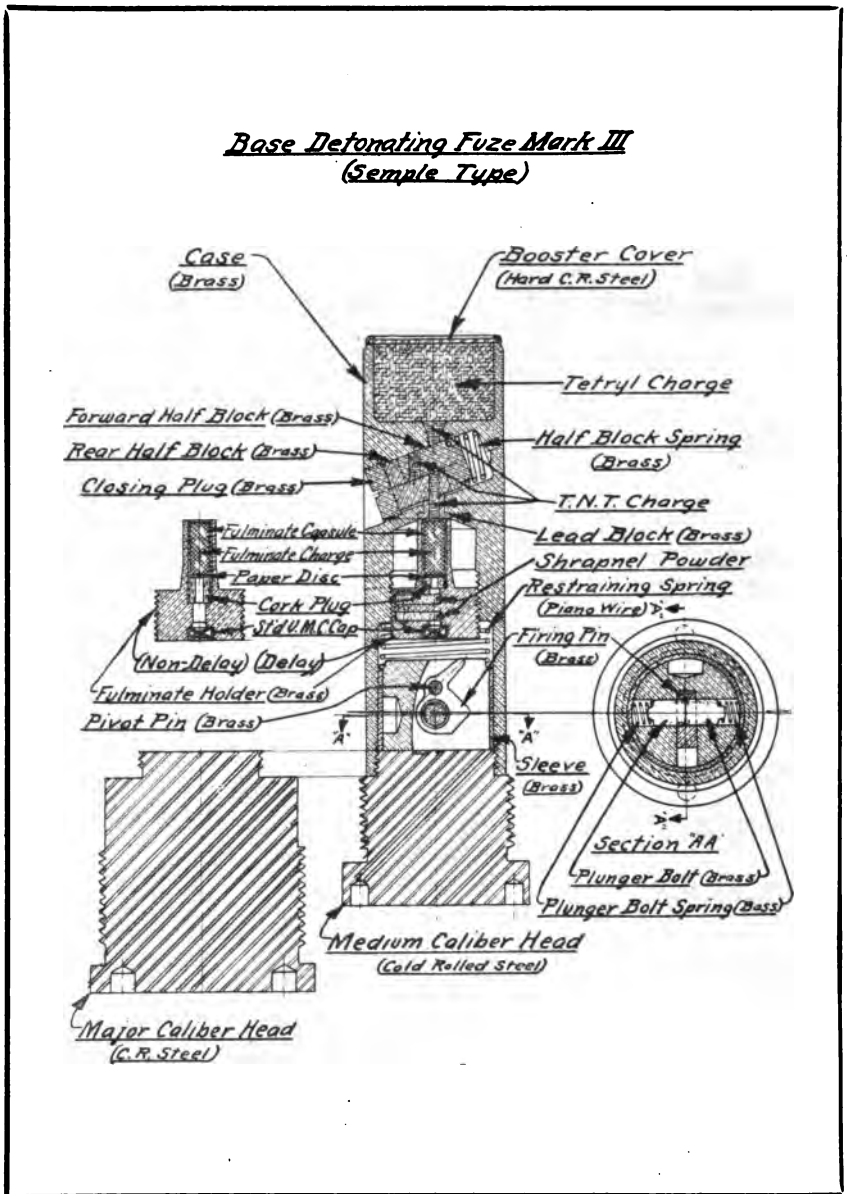

FIG. 65.—Base detonating fuze medium caliber (Model 1906).

Base-detonating fuzes.—The Ordnance Department at the beginning of the war had base-detonating fuzes of minor, medium, and major caliber. None of these is fitted with a bore safety device, and the medium and major caliber for mobile ammunition are replaced by the base-detonating fuze Mark III and for seacoast ammunition by the Mark V, both developed by a private company. This fuze has an efficient bore safety feature and is used in all base-fuzed shell



larger than the 2.24-inch. The main types of shell of this character are the armor-piercing shell and shot of all calibers using three types of projectiles and common steel shell for mortars and howitzers 12-inch and above. The minor caliber base-detonating fuze is very little used, only being prescribed for 6-pounder ammunition.

Time fuzes.—Time fuzes are most commonly used on shrapnel ammunition, where burst above the ground is necessary in order to secure effective action of the shrapnel balls. They are also used for

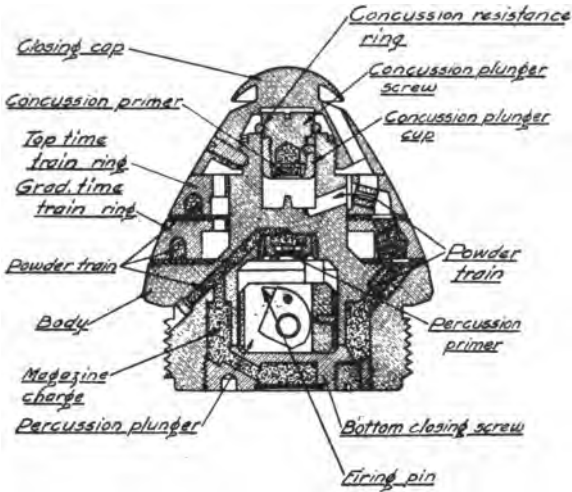

FIG. 67.—Combination time and percussion fuze—before arming.

antiaircraft ammunition, both shrapnel and shell. With the shell, the time element is combined with a detonator so as to secure detonation of the shell in air in the vicinity of the target. The Ordnance

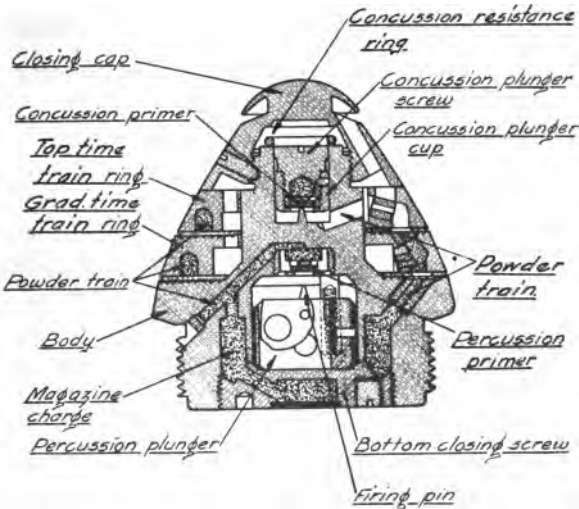

FIG. 68.—Combination time and percussion fuze—after arming.

Department design of time fuze was retained in preference to adopting the French, due to the fact that the records obtained from abroad indicated that functioning of this fuze was very satisfactory,

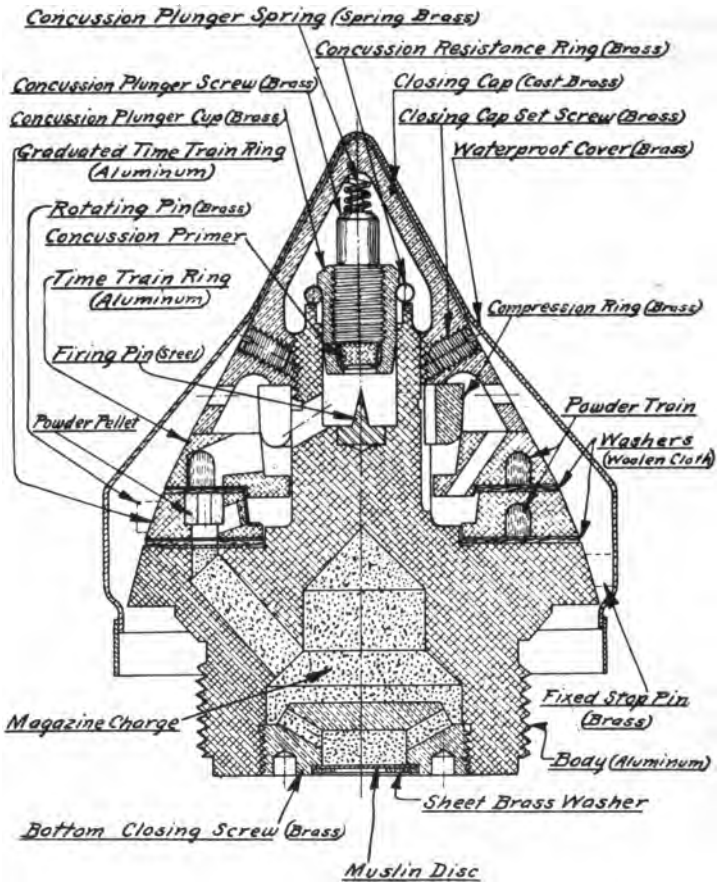

FIG. 69.—Anti-aircraft time fuze, Mark II, type "8."

and also to the fact that there was available in this country all the manufacturing capacity which was required, while no capacity was available for manufacturing the French type of fuze. The combination time and percussion fuzes 21 seconds and 45 seconds are most commonly used on Field Artillery shrapnel. The 21-seconds fuze is shown in the accompanying diagrams, figures 67 and 68, on the preceding page.

Time fuzes for antiaircraft shell.—The shell and shrapnel used against aircraft require a somewhat different type of fuze. The percussion element is not desired, inasmuch as direct hits on the target are rare and with the possible failure of the time mechanism to operate there would be an explosion on the return to the ground productive of no advantage and much possible danger. Time fuzes for

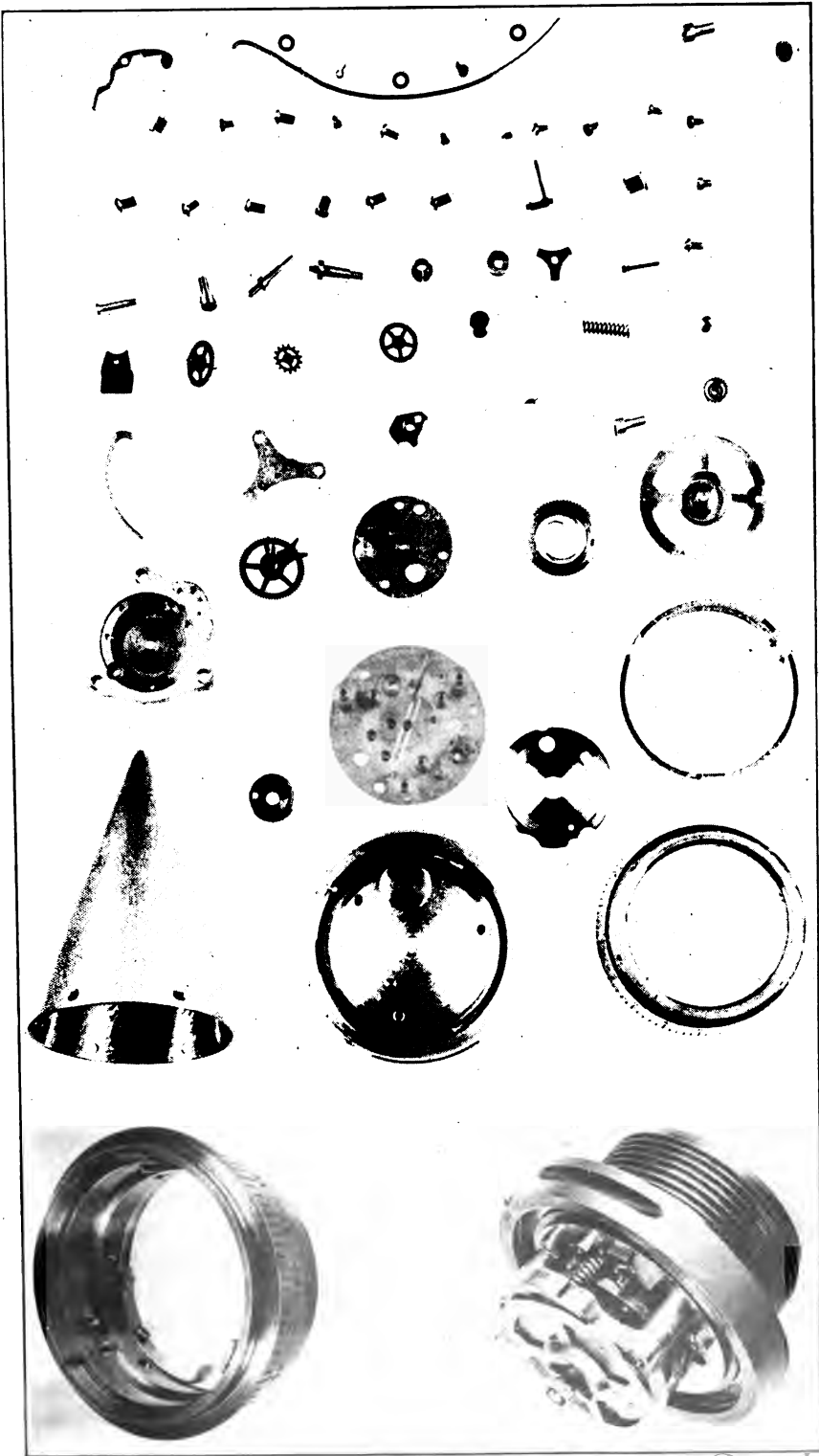

FIG. 70.—Mechanical time fuze, Mark I. Component parts. Digitized by Google 169

antiaircraft high-explosive shell are equipped with detonators which contain bore safety features.

Some of the special time fuzes employed with antiaircraft ammunition are of the Frankford Arsenal design, some of the Russian design adapted to the United States fuze setters, and others are mechanical time fuzes of the Waltham design, described below.

Waltham mechanical time fuze.—The Waltham mechanical time fuze is made up of approximately 65 parts and is similar in construction to a watch. The mechanism is driven by a steel watch spring which is wound by a special key through a recess in the top plate cover. This spring is connected by friction to a flat steel set plate on top of the fuze mechanism, by a flat steel spring washer which is held against the plate by a knurled nut.

To set the fuze for any desirable time of burst, the cap attached to the graduated ring is turned until the desired setting of time in seconds, on the scale, is opposite an indicator mark on the fuze body. When this cap is turned a steel hook on the inside of the same and fixed thereto, which is engaged in a small recess of the steel set plate, rotates this plate to the proper setting. This set plate makes one revolution in approximately 75 seconds (in the 75-second fuze) and therefore is moved through an arc proportionate to the time of burst desired, as indicated by the markings on the graduated ring on the outside of the same.

The mechanism is locked by a steel pin which is engaged in a forked arm attached to the main shaft of the mechanism. This pin has a small shoulder on it which rests against a spring steel cup, slotted to make it more elastic. On shock of discharge the pin sets down into the cup, thereby releasing the forked arm and allowing the mechanism to start.

When the shock of discharge starts the mechanism, the plate is slowly revolved by the spring until a notch in the periphery of the same rotates to the position opposite a projection on the trigger-releasing device, which then drops into place, releasing the trigger which restrains the firing pin. The firing pin is forced into the fulminate cap by a spring held in compression by the trigger.

The spring and the trains of gears are controlled by a governor, similar in construction to the escapement in a watch. This escapement is placed on the center of rotation of the fuze, so that its functioning will not be appreciably affected by centrifugal force.

This fuze has no percussion mechanism, as it is not desired to have the shell burst on impact with the ground.

Colored marking for fuzes.—There are special colored markings for the exterior of all fuzes in current use, to indicate long-delay, short-delay, nondelay, etc., and to serve for purposes of prompt and unmistakable identification. These are shown in detail on Ordnance Office drawings 75-14-69 and 75-14-70.

ADAPTERS AND BOOSTERS.

Definition.—In general, an adapter is a collar or bushing which adapts the fuze to fit a shell of a certain caliber. A booster is a combination of a booster charge of high explosive and its container, which is usually a metal tube screwed into or otherwise attached to the adapter, and extending down to the explosive charge of the projectile. The fuze, when inserted in the combined adapter and booster, has its detonator extended into the booster charge. The adapter and booster, as already mentioned, represented a new and radical departure in American artillery ammunition, never having been used previous to the war. In addition to a booster charge being required with certain modern high explosive and gas shell, the adapter and booster casing permits the use of various types of fuzes in one shell with corresponding tactical advantage.

Action of the fuze.—When the fuze acts, setting off its detonator, the detonating wave detonates the booster charge, which in turn detonates the explosive charge of the projectile.

Use with gas shells.—Adapters and boosters are also employed in gas shells, the booster charge used being sufficient to open the neck of the shell and release the gas. Gas-shell adapters and boosters differ from those used with other shells, inasmuch as they are taper-threaded into the shell to make a gas-tight joint; and the method of attaching booster casing to the adapter is also designed to prevent leakage of the gas. Furthermore, in gas shells it has been found necessary to lead-plate or otherwise coat gas boosters, owing to the chemical action between the iron or steel and certain types of gas.

Adapters and boosters for high-explosive shell.—The adapters and boosters for high-explosive shell, Mark I, II, and III, are described in the following paragraphs, while on page 155 is given a complete list of these designed and in service. Other designs than those described, do not differ materially from these except the Mark X, which is a special type for use in anti-aircraft shell and which contains a centrifugal bore safe feature and will not be described here.

Adapter and booster casing, Mark I.—The adapter consists of a steel bushing which screws into the nose of the shell and is threaded on its inner circumference at the front to accept the French threading of the fuzes. The inner circumference at the rear is threaded to receive the threads on the booster casing. The booster casing consists of a tube containing a fuze-socket holder, and a fuze socket, and a high explosive charge composed of equal parts of compressed TNT and tetryl. A threaded plug holds the explosive in the tube and seals the booster casing from the rear end. Detonation of the high-explosive detonator of the fuze when inserted in the fuze socket detonates the booster charge, which in turn detonates the bursting charge of the projectile.

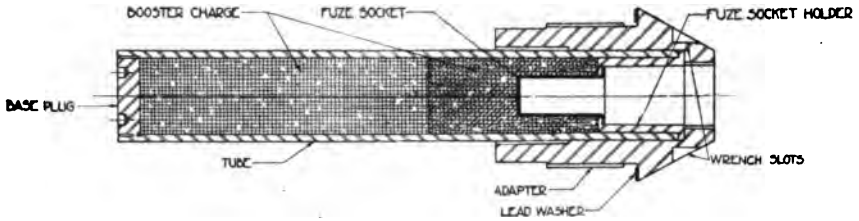

FIG. 71.—Adapter and booster casing, Mark II.

Adapter and booster casing, Mark II.—The adapter consists of a flanged steel collar threaded on the outside to fit the nose of the shell. The interior of the collar is threaded at the rear to take the steel tube of the booster casing, and is threaded at the front to take the French threading on the fuzes. A fuze socket holder, into which is soldered a fuze socket, is inserted into the front end of the booster tube, and held by the pressure of the booster tube when screwed in. The booster is filled with high explosive under pressure, and sealed by screwing a plug into the rear end. As shell containing this adapter are never fuzed until preparatory to firing, the adapter is stopped with a felt plug which prevents the entrance of dirt or moisture into the fuze socket.

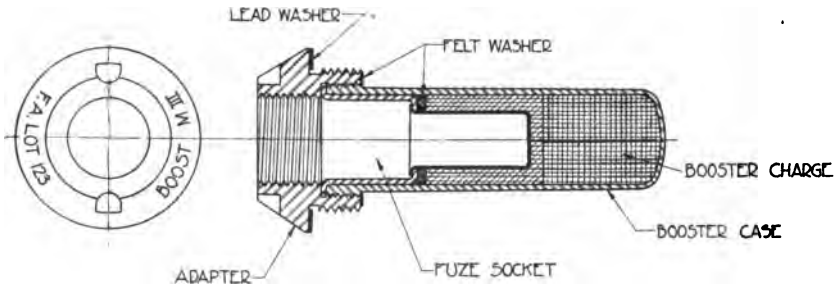

FIG. 72.—Adapter and booster casing, Mark III.

Adapter and booster casing, Mark III.—To adapt the French type fuzes Mark III and Mark V to the 75-mm. shell, an adapter embodying a high-explosive booster is used, which is shown in Plate V of the handbook on adapters and boosters. The adapter consists of a flanged steel collar, threaded on the outside with a standard thread to screw into the head of the shell up to the flange. The inner circumference below the flange is also threaded to receive the steel tube constituting the booster casing. Through the flanged section, the collar is threaded to receive the French threading on the fuze stocks. A tubular fuze socket holder of steel is fitted to the inside of the booster casing. It has an inner lip which supports the outer lip of the copper or brass fuze socket, which is passed through it and sol-

dered fast. Screwing the booster casing into the adapter plug brings the upper lip of the fuze holder tightly against the upper rim of the booster casing, holding the entire contents of the casing fast. The adapter and booster are now ready to be screwed into the shell. As the fuzes are never assembled to the shell until the round is about

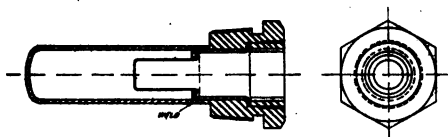

FIG. 73.—Adapter and booster casing, Mark IV.

to be used, an adapter plug is supplied which acts as a protection against the entrance of foreign substance or moisture into the socket. It consists of a compressed felt washer held between an upper washer of tin and a lower washer of tin or copper, both held together by a twisted wire link. The link is first passed over the circumference of a ring which acts as a means of unscrewing the plug.

CARTRIDGE CASES.

Nature and function.—The primary purpose of a cartridge case is to help make up an easily handled round by combining the projectile and powder charge so as to permit loading as a unit. The use of a cartridge case also insures obturation; that is, it prevents the escape of the gases of combustion without resort to obturating devices inside the breech; and particularly in the case of fixed ammunition the cartridge case acts as a protection for the propelling charge against the action of moisture and dampness. In fixed ammunition the cartridge case is crimped onto the projectile below the rotating band, while in semifixed ammunition the cartridge case is removable. Semifixed ammunition is used in howitzers where the necessity of removing powder bags to fire in zones requiring low-muzzle velocities precludes assembling as a fixed round.

Nature of cartridge cases.—All cartridge cases, whether for fixed or semifixed ammunition, are of the same general character, and are manufactured in the same way. They are drawn from solid metal disks by a series of operations consisting of one cupping and annealing, several cold drawings and annealings after each drawing, heading, tapering and finishing of the head. A projecting rim or flange is formed on the head of the cartridge case, which is engaged by the extractor in the breech of the cannon. The primer hole through the head of the case is punched or bored, and is then mandreled with a taper plug to toughen the surrounding metal. This

toughening process is necessary as the primer seat tends to expand under gas pressure, causing primers to fit loosely on repriming the case after it has been fired.

Diaphragm.—It was formerly the rule to solder a brass diaphragm down on top of the powder charge. This however is not the practice with the small caliber ammunition used by the French, and has been discontinued in United States 75-mm. ammunition.

Bursting charge.—The bursting charges for various shell vary in kind and amount, ranging from black powder in the case of some 37-mm. projectiles, to TNT, amatol, or other high explosives for the medium and larger calibers. (See section on explosives, page 199.) Full information in regard to the quantity and kind of explosive used in different projectiles can be obtained from the table of United States Army cannon and projectiles, Ordnance Pamphlet No. 1676, and in summary will be found on Table 1, "Principal Characteristics of U. S. Army Cannon and Projectiles," facing page 26 of this Handbook.

Propelling charge.—The charge contained in the cartridge case, or in the powder bags in the case of separate loading, consists of smokeless powder discussed in a subsequent section, while the qualities of each individual charge, either fixed or bag, are stated in the table of United States Army cannon characteristics, facing page 26.

The powder used by the United States Army is an ether alcohol colloid of pyro nitrocellulose containing diphenylamine as a stabilizer. For guns from .30 caliber to the 2.95-inch mountain gun, it is made in the form of a single perforated grain whose length is approximately 2.5 times its diameter. For guns larger than 2.95-inch mountain gun, the grain has seven perforations. The size of grain is varied to suit the requirements of the different guns. Instances of typical charges are given herewith.

Fixed ammunition, 75-mm. field gun.—The average charge of powder for the 75-mm. field gun firing shell weighs 21 ounces, and for shrapnel weighs 25 ounces. The powder is placed in the cartridge case and a cardboard obturator is placed on top of it, and the projectile forced in on top of this. This obturator is formed of a cardboard cylinder closed at both ends and is used to insure the powder being held against the primer.

Semifixed ammunition, 4.7-inch howitzer.—The average charge of powder for the 4.7-inch howitzer weighs 1.8 pounds. This charge is separated into three parts—base and two increments inclosed in silk bags—and these placed in the brass cartridge case. To obtain maximum range the full charge is used, and for the inner zones one or both of the increments are removed.

Separate loading ammunition, 8-inch howitzer.—The average charge of powder for the 8-inch howitzer weighs 10.7 pounds. This charge

is made up in silk bags in a base and three increments, corresponding to the four zones of fire. The increments are held to the base by four tying straps sewed on to the base, 90 degrees apart, so that when the increments are placed on top of the base charge these straps may be brought up over the top and tied, holding the charge securely together. The igniting charge in the base section consists of a pancake on the base of the charge. A howitzer charge is made up so that its diameter is that of the chamber.

8-inch gun railway mount.—The average charge of powder for the 8-inch modified seacoast gun weighs 70 pounds, and is placed in two bags. The charge is so divided that the base section gives three-fourths service muzzle velocity and the base and increment give service velocity. To secure a rigid charge the powder is placed in the bag and then rolled and wrapped with a strap of cartridge cloth. The wrapped increment is tied to the base by four straps which run up from the base section and are tied over the top of the increment when the two are placed end to end. Ignition is secured by a charge of black powder located in a pancake on the base of the base section, and in a core which extends from this pancake through the center of the base section and is continued through the increment section.

Gun charges are so made that their length is approximately that of the powder chamber.

PRIMERS.

Types of primers.	Ordnance Department drawing.	Used with.
20-grain igniting.....	74-3-1	For 1-pounder subcaliber seacoast.
20-grain percussion.....	74-2-1	For 1.7-pound subcaliber mobile.
Do.....	75-2-167	For 37-mm, common steel shell.
21-grain percussion, Mark II.....	74-2-17	For 155-mm. gun and howitzer, 8-inch and 240-mm. howitzer.
49-grain.....	74-2-18	For 75-mm. ammunition.
110-grain igniting.....	74-3-2	For 2.95-inch subcaliber ammunition.
110-grain percussion.....	74-2-3	For all other mobile service ammunition.
"T" model friction.....	74-2-26	For 8-inch and 9.2-inch howitzer.
Friction, model 1914.....	74-4-25	For seacoast cannon.
Obturator friction.....	74-4-9	For siege cannon with new model—vents used in 5-inch siege gun and 7-inch siege howitzer, mode 1898.
Do.....	74-4-1	For siege cannon with old model vents—used in 5-inch siege gun, model 1890; 7-inch siege howitzer earlier than 1898; 3.6-inch and 7-inch mortar.

PRIMERS.

Primers.—The ignition of the propelling charge is accomplished through the agency of a primer or device in which an explosion is readily produced. Primers are either of the *percussion* or *friction* type. For percussion primers used with fixed ammunition it was first thought that the standard 110-grain percussion primer could be employed in the 75-mm. French gun. Upon the arrival of this gun at the Sandy Hook Proving Ground it was found that there was a difference in the design of the breechblock and firing mechanism between the French guns and those manufactured in the United States. The 49-grain primer was developed which could function satisfactorily in either type of gun and maintain absolute interchangeability in the field between ammunition made in France and that made in the United States. Designs of this new primer proved

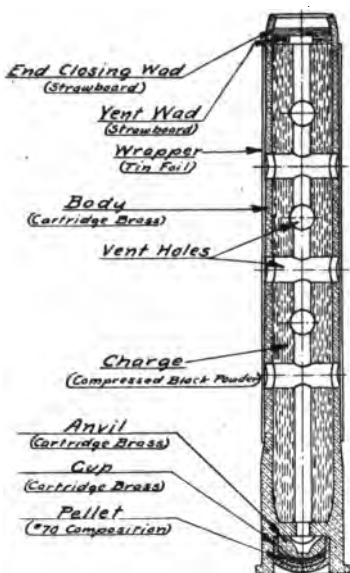

FIG. 74.—110-grain percussion primer.

successful in test and service, and manufacture straightway was begun. For 3-inch, 3.8-inch, 4.7-inch, and 6-inch mobile artillery the 110-grain primer as shown in the diagram is used, while for 75-mm. ammunition the 49-grain primer is employed.

For separate loading ammunition, 155-mm., 8-inch, 9.2-inch, and 240-mm., the 21-grain primer is used, except for some pieces obtained from the British, which use "T" tube primers. Primers of this type have been and are being manufactured in the United States. For 37-mm. mobile guns the 20-grain percussion primer is used.

The friction primer is used for seacoast guns on railway mounts, the model 1914 friction primer, shown in the diagram and discussed on page 181, being employed for many calibers.

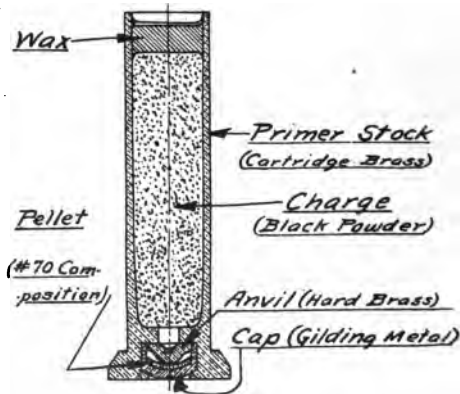

FIG. 75.—21-grain percussion primer.

The 20-grain percussion primer.—The 20-grain percussion primer used in the 37-mm. common steel shell ammunition resembles in shape a small arms cartridge as may be seen from the accompanying sectional diagram, figure 76. It is made of drawn brass and is counter-bored at the rear to take the percussion element consisting of a cup, anvil, and composition pellet. These are so arranged as to admit the flame from the pellet to the interior of the primer tube while the cup obturates and prevents the escape of gases to the rear. The primer charge consists of 20 grains of black powder.

The 21-grain percussion primer, Mark IIA.—The 21-grain percussion primer, Mark IIA, is drawn with a heavier head than the preceding primer. It is held in its seat by the firing mechanism of the cannon. It contains 21 grains of black powder. It is shown diagrammatically in figure 75 on the opposite page. It is used with 155 mm. gun and howitzer, 8-inch and 240-mm. howitzer separate loading ammunition.

The 110-grain percussion primer.—The 110-grain percussion primer is similar to those already described, except that it is larger and the powder charge consists of 110 grains of small-arms black powder pressed into place around a mandrel extending through the center of the charge. Six ventholes are drilled through the tube and charge, as shown on the accompanying sketch (figure 74 on the preceding page), in order to better distribute the flame from the primer through the propelling charge.

A tin-foil wrapper is shellacked over the vents to keep out moisture. As already stated the 110-grain percussion primer is used with ammunition of artillery of the distinctly American types, notably the 3-inch, 3.3-inch, 4.7-inch, and 6-inch.

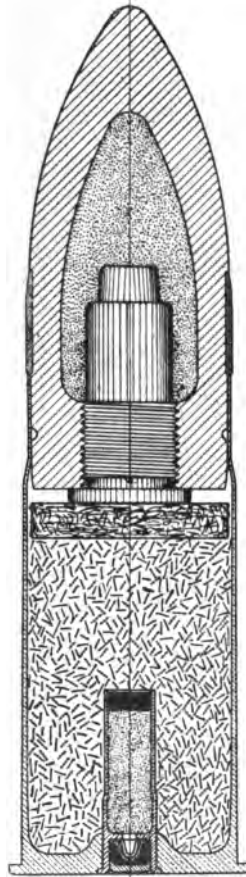

FIG. 76.—37-mm. ammunition with 20-grain primer.

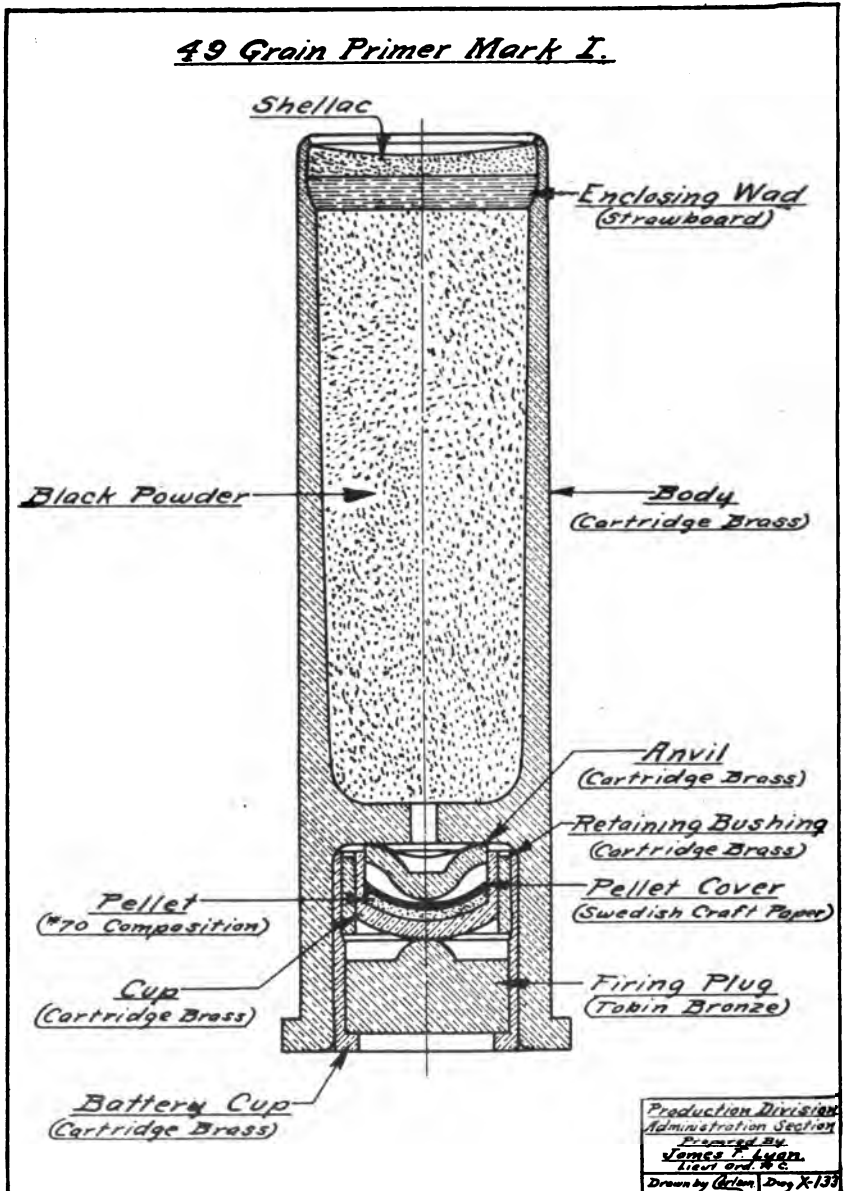

FIG. 77.—49-grain percussion primer, Mark I.

The 49-grain percussion primer, Mark I.—The 49-grain percussion primer, Mark I, differs from those previously described in having a firing plug inserted after the usual anvil and cap. This firing plug receives the blow of the firing pin of the cannon and transmits it to the percussion composition firing it. A battery cup retains the firing plug. The charge consists of 49 grains of black powder.

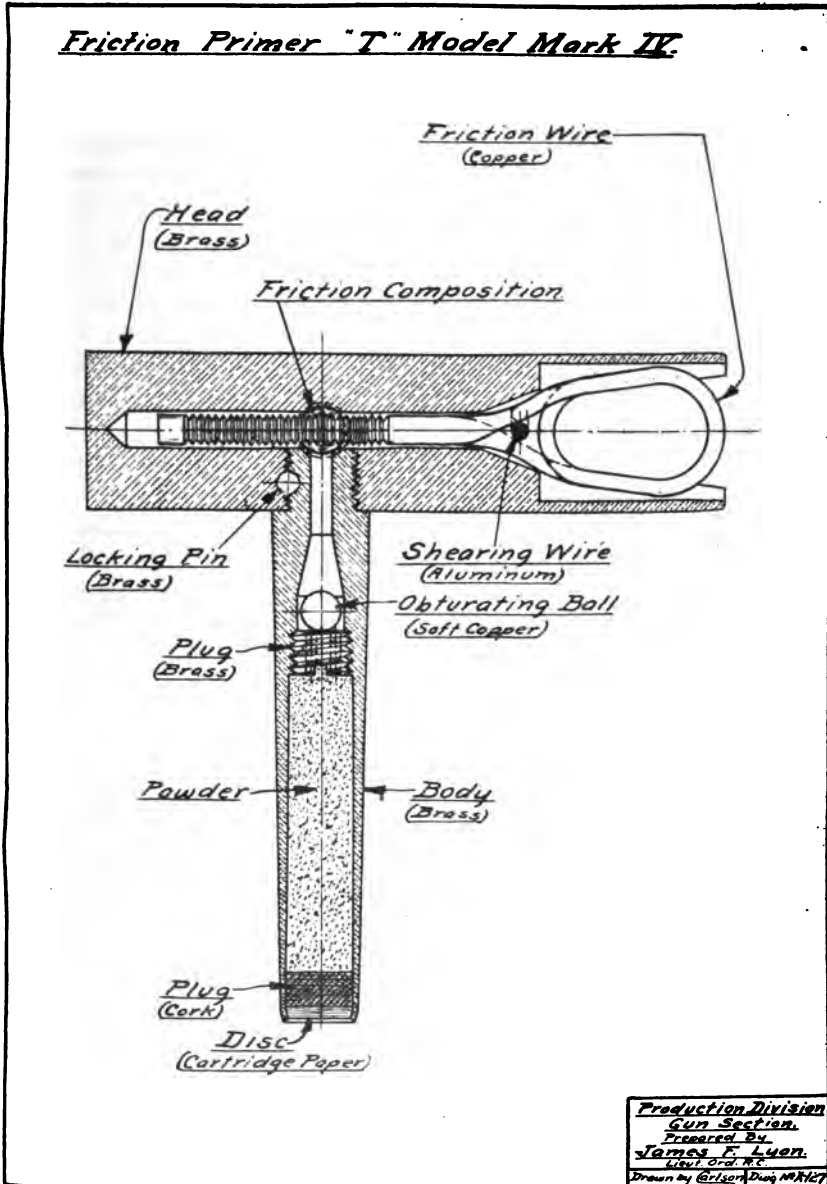

FIG. 78.—"T" model friction primer, Mark IV.

The "T" model friction primer, Mark IV.—The "T" model friction primer, Mark IV, is for cannon of British manufacture. It consists of the head, gun-metal brass; the body, solid drawn brass; the ball soft copper; and the friction bar of half-round copper wire. The latter is twisted into a round bar with a lanyard loop at one end. The other end is roughened. A copper-wire shear pin holds the friction wire in place. A hole in the side of the head over the friction bar is charged

with 3 grains of detonating paste laid over the roughened part of the friction wire, the hole being closed by a brass plug. The body is charged with 8 grains of black powder and sealed with a shellacked cork and paper disk. The end of the body is crimped to secure the cork. The body is prevented from unscrewing by a pin. The upper part of the body has a cylindrical opening, which is enlarged in its lower part into a conical recess. This recess receives the copper ball, which is retained in its seat by a threaded plug pierced with three fire holes. The tube is inserted in the axial vent of the breech mechanism after the breech is closed, and acts as follows: When the friction bar is drawn out by the lanyard hook, the composition is fired, the flash penetrates through the fire holes in the body plug, ignites the black powder in the body, blows out the cork, and fires the igniting charge of the cartridge, while the gas that is thrown back into the body of the tube drives the copper ball tightly into the coned recess, preventing any escape of gas rearward through the tube.

Percussion and friction compositions.—Percussion and friction compositions are subject to variation, provided certain tests are met, in order to achieve convenience in manufacture. A typical percussion composition standard for the 110-grain percussion primer is:

	Per cent.
Lead sulph-cyanate	25
Antimony sulphide	17
Potassium chlorate	53
Trinitro-toluene	5

A typical friction composition standard for friction primer, model 1914, is:

	Per cent.
Chlorate of potash	51.62
Antimony sulphate	26.88
Sulphur	8.96
Glass	12.54

The friction primer.—The friction primer, model 1914, consists of a Tobin bronze body resembling a small-arms cartridge case. This is drilled through the base to receive a wire, to which is assembled a gas check and a button to engage the firing leaf. A housing contains the friction composition and is separated from the priming charge by a perforated brass closing screw.

In assembling, the housing containing the friction pellet is screwed home, the gas check is inserted and the wire passed through it. The closing screw is then screwed in and the button screwed on the wire and riveted. The three tubular pellets of compressed shrapnel powder are then inserted and the center hole filled with 5 grains of loose shrapnel powder. The end pellet is then inserted, the closing cap is pushed down on top of it, and the end of the primer crimped and shellacked. In action the gas check is pulled back, igniting the

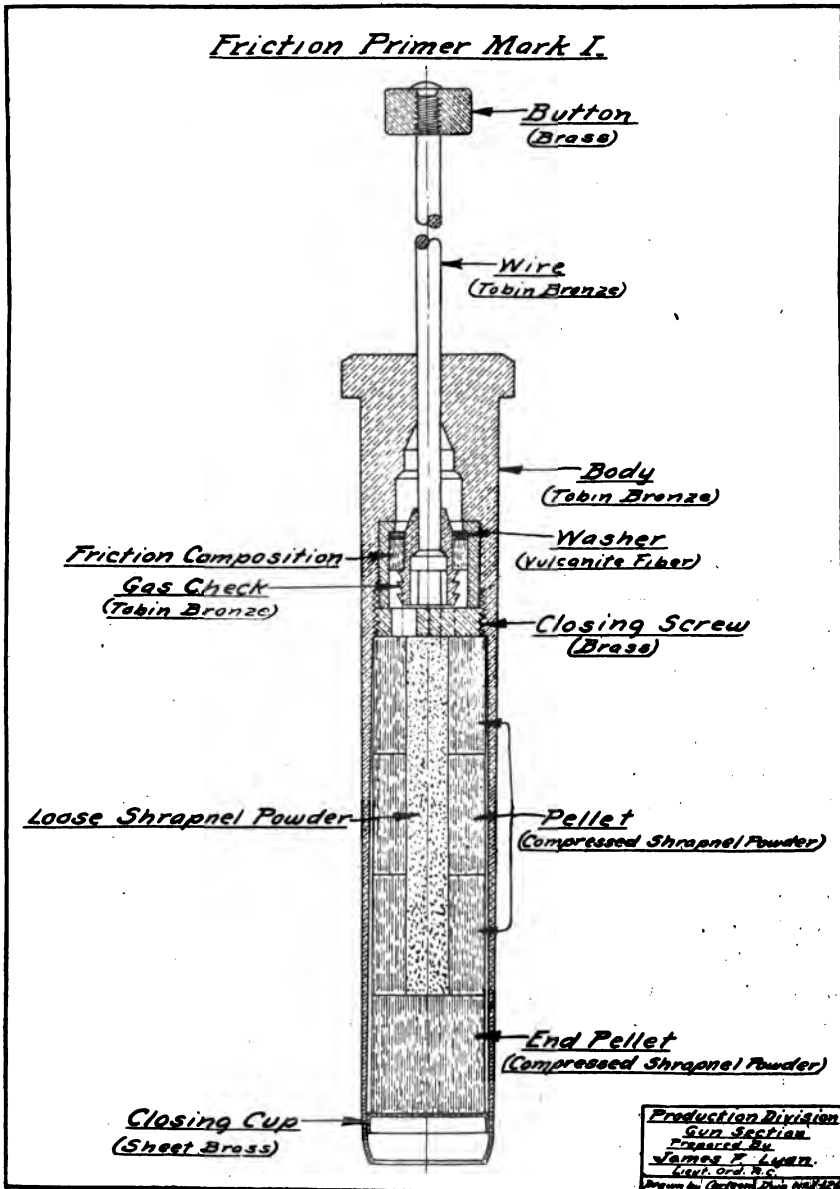

FIG. 79.—Friction primer, model 1914.

friction pellet. The flame penetrates the holes in the closing screw, igniting the loose black powder, which in turn ignites all the powder pellets and the priming charge of the cartridge. The obturating action is caused by the tube or body expanding and preventing the escape of gas between the vent channel and the primer. The gas check is blown back into its seat, preventing the escape of gas through the base of the primer.

FUZE SETTERS.

Use and types.—In connection with fuzes of shell of various types, it is necessary to employ some form of mechanical device whereby the time train ring may be turned quickly and accurately, so as to provide the proper time of burning for the range and corrector ordered or demanded under circumstances. The types of fuze setters used for the various fuzes of the United States artillery ammunition and those adopted from its allies are indicated in the accompanying table, and later discussed somewhat more in detail.

Model.	Type of fuze.	Used with.
Bracket fuze setter, model 1916..	For 21-second fuzes....	75-mm. field gun, 2.95-inch mountain gun, and 3-inch field gun.
Hand fuze setter, model 1912....	For 21-30-second fuzes.	75-mm. field gun, 2.95-inch mountain gun, and 3-inch field gun.
Hand fuze setter, model 1913....	For 31-45-second fuzes.	3.8-inch howitzer, 4.7-inch gun, howitzer, and antiaircraft gun, 155-mm. gun and howitzer, and 155-mm. gun (Filloux).
French bracket fuze setter.....		75-mm. gun.
Antiaircraft fuze setter.....		75-mm. antiaircraft gun, 3-inch (15-pounder) antiaircraft guns.
Do.....	For 75-second mechanical fuze.	

Bracket fuze setter, model 1916.—The bracket fuze setter, model 1916, is designed accurately to adjust the movable time-train ring on the fuze to the proper time of burning for the range and corrector decided upon, so as to produce the desired explosion at the proper time. This fuze setter is attached to the lower end of the fuze-setter bracket at the front of the caisson, and is fitted with a reversible range ring to comply on one side with the range tables of the American 75-mm. guns, and on the other side with the French 75-mm. guns when using American shrapnel. It is similarly adapted for use with the 2.95-inch mountain gun and the 3-inch field gun.

There is a bronze housing which is cast in one piece and drilled and machined to form seats and casings for the range and corrector worms, the latter turning the corrector ring which sets over and rotates around the base of the range-ring worm wheel. The range ring is graduated and is screwed fast into the ring worm wheel. The corrector index rotates underneath the dial cover and is turned by a pin on the pointer arm of the corrector ring. The range worm is operated by the range-worm crank, meshing with the range-ring worm wheel to which the range is screwed, while the corrector worm is operated by a corrector worm knob. It meshes with the corrector ring and turns the corrector index, which is connected to it by a steel pin on the pointer arm. To adjust the movable time ring on the fuze to the proper time of burning for range and correction decided upon, the corrector ring is slotted so that the rotating ring on the fuze rests in it, and the range-ring worm wheel is provided

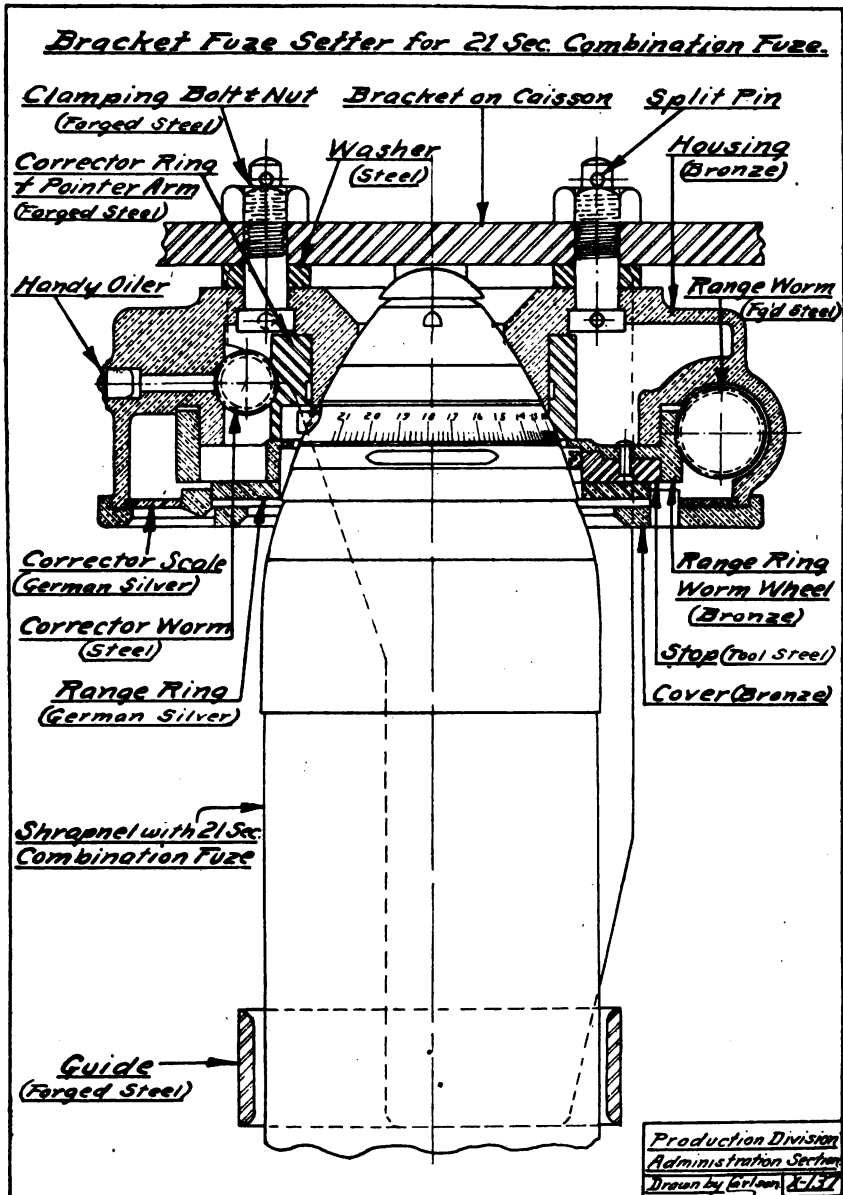

FIG. 80.—Bracket fuze setter, Model 1916.

with a steel stop which prevents the stop pin on the fuze body from rotating past the point at which it should remain set for firing. When the round is inserted in the fuze setter the rotating pin sets in the corrector-ring notch and holds the movable time-train ring until stopped by the stop pin of the fuze body striking the top or the fuze-ring worm wheel. This gives the time of burning required by the setting as read on the range and corrector indexes.

Hand fuze setter, model 1912.—The hand fuze setter, model 1912, is adapted to the different cannon with which it is used by use of reversible range dials. It is a rapid means of setting fuzes and may be used in addition to or as a substitute for the bracket fuze setter.

In this device a slot is cut through the top of the aluminum case to admit the projecting segment of the corrector scale support. The corrector scale is screwed to this segment and covers the slot, which

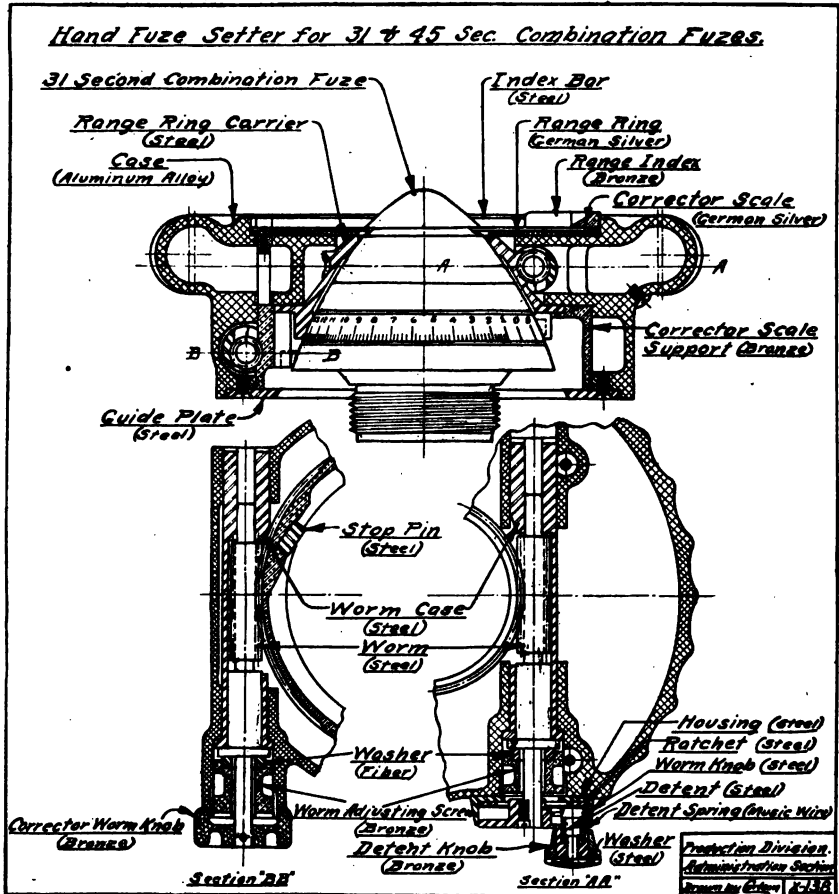

FIG. 81.—Hand Fuze Setter, Model 1912.

extends around half the circumference of the housing. The corrector scale is graduated with 120 divisions and subdivisions. Division 30 is the normal setting, indicated by an arrow. The range-ring carrier rotates in a circular central opening in the upper surface of the case and is seated in the corrector scale support, which is in turn seated against the guide plate which screws into the bottom of the case and secures its contents. This assembly forms a socket for the fuzes to rest in. Two steel worm cases are inserted in the worm housings

formed in the case, while the corrector worm meshes with the ranging carriers. In the upper right-hand part of the case the corrector worm meshes with the corrector scale, and in the lower left-hand part of the case the worms are mounted eccentrically in the worm cases, which are locked in position by two worm clamp plugs secured by screws.

A recent addition to this fuze setter consists of a ratchet device which takes the place of the range worm knob. There is a locking device which permits using less tension to prevent accidental turning and also allows greater speed in making range settings.

Hand fuze setter, model 1913.—The hand fuze setter, model 1913, is much the same as the model 1912, but is used for larger fuzes and has range dials divided into zones for howitzers and for guns using reduced charges. These dials are reversible for guns and howitzers of the same caliber except in the case of the 4.7-inch gun; in this will be fired all the remaining 31-second fuzes.

The French bracket fuze setter.—The French fuze setter, or fuze punching device, is attached to the lower end of the fuze setter bracket at the front of the caisson. It alternates with the American bracket fuze setter.

This French type of fuze setter functions by punching through the lead tubing of the powder train and into the explosive chamber of the percussion primer through the thin brass wall of the fuze head, so that the flame caused by the primer will ignite the powder train at the point where punctured.

There are shell cups which fit into the ogive with the projectile and are assembled to the shell cup bushings which are notched to receive the lug on the fuze. When the desired range of reading is indicated and the projectiles inserted, the fuze is punched by pushing down a punch lever. The blade holder supports, through which the blade carriers slide at their ends, rest in slides in the arms extended from the caps. There is also a lever and plunger set with springs.

The dial mechanism consists of the dial and support, the corrector and corrector scale, the crank, stops, clips, and lugs contained on the main plate. The distance around the lead tubing of the fuze at which the fuze setter blade enters decides the length of the time center train to be burned. As the lug on the fuze holds the fuze tube in absolute register with the threads on the shell cups, their rotation governs where the fuze shall be punched. Length of time train to be burned governs the time of the burning of the fuze. The time of flight for the projectile for different ranges decides for what time the burning of the fuze must be punched to burst the projectile at the proper distance from the pieces. The dial and train gears adjust time of burning to time of flight, requiring only that the number of meters of range be known. The corrector, when moved along its

scale, merely alters the position of the index by which the range is read. The graduations of the corrector represent the change of time of burning which will raise or lower the burst $1/1000$ of the range, at midranges, or 1 mil, as observed from the piece.

Hand fuze setter, Mark I.—The hand fuze setter, Mark I, has no corrector. It consists of an aluminum case in which is bored a housing for the range worm, a notched and toothed rotating ring, which fits the fuze, and a graduated ring which is screwed fast to the case and retains the rotating ring. The rotating ring has a handle for turning, and when the approximate range reading is reached, the worm is slipped back and used to secure accuracy by its slower motion. The datum line for range readings is engraved on the rotating ring. In action the lug on the movable time train ring seats in the notch of the rotating ring; when the fuze setter is turned, the time train ring is rotated till the steel stop, fixed to the bottom of the fuze setter case strikes the fixed stop on the fuze body. The distance between the notch and the fuze setter, as determined by the range set, governs the length of time train to be burned.

Antiaircraft fuze setter for 75-second mechanical fuzes.—The anti-aircraft fuze setter for 75-second mechanical fuzes is now under development. It is to be similar in design and operation to the Mark I fuze setter, as the 75-second mechanical time fuze is set by rotating a movable ring.

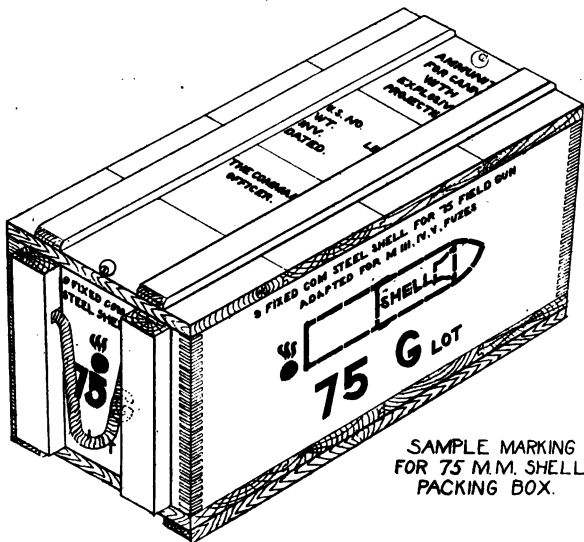

FIG. 82.—Packing case for 75-mm. shell.

PREPARING ARTILLERY AMMUNITION FOR SHIPMENT.

Packing boxes.—All packing boxes used in shipping artillery ammunition components must conform to designs prescribed by the artillery ammunition section of the Engineering Division. All primers, cartridge cases, empty gas and other special shell, loaded gas and other special shell, loaded shrapnel, loaded high-explosive shell which are to be used with brass cartridge cases, loaded shrapnel and high-explosive shell assembled with cartridge cases, adapter and booster casing not assembled with their shell, fuzes and fuze parts are shipped in wooden boxes. The boxes used for shipping loaded primers and fuzes are provided with hermetically sealed tin linings. All loaded adapter and booster casings, whether assembled with the projectile or shipped separately, are required to have the fuze holes closed with adapter plugs to protect the threads and keep out dirt and moisture.

Shipping without boxes.—Empty high-explosive shell and shrapnel cases, and loaded high-explosive shell to be used in separate ammunition, are shipped unboxed, but carefully packed according to detailed specifications. Fuze holes are closed with transit plugs or eyebolt lifting plugs. Projectiles of 5-inch caliber and larger are provided with rope grommets for the protection of rotating bands.

SPECIFICATIONS FOR PACKING OF AMMUNITION COMPONENTS.

Primers.—All primers will be packed for shipment in boxes of the design prescribed by Ordnance Office drawings for the particular kind of primer.

Cartridge cases.—Cartridge cases shipped from the manufacturing plant to the assembling plant will be shipped in such a manner as to insure their safe arrival at the point of destination, a manufacturer being held responsible for the safe arrival and being required to make such shipping arrangements as he deems desirable and necessary to accomplish this end.

Boxes.—Boxes for packing complete rounds of ammunition are in general designed to permit a number of complete rounds or twice the number of projectiles only to be packed therein. This allows, when projectiles are shipped abroad for assembly at the ordnance assembly plant, for a supply of packing material equal to 50 per cent of the needs. The other 50 per cent is expected to be salvaged in the field.

Shell.—(a) High-explosive shell up to 6 inches in caliber will be shipped to the loading plant so as to insure their arrival in the same condition as when accepted at the machine plant, the machine contractors being responsible for proper shipping arrangements and for supplying packing material of his own design. Shell so shipped will have their fuze seats protected by a suitable transit plug.

(b) High-explosive shell 6 inches in caliber and above will be shipped to the loading plant in cars without boxes, a rope grommet being used to protect the rotating band and the fuze hole being closed with a suitable transit plug. The method of packing in cars will be satisfactory to the inspector, and the shell manufacturer will be relieved of further responsibility for the safety of the shell due to such packing.

(c) Empty gas shell are to be packed for shipment to the gas-loading plants in boxes of prescribed design.

(d) Loaded high-explosive shell, assembled into complete rounds with their brass cartridge cases, shall be packed in boxes of prescribed design. When adapter and booster casings are assembled with the shell the fuze seats shall be closed with an adapter plug of specified design.

(e) Loaded high-explosive shell intended for assembly in complete rounds, with brass cartridge cases, but which are being shipped to Government assembling plants for assembly, shall be packed in boxes of approved design. Those shells which have adapter and booster casings shall have the fuze hole in the adapter closed with an adapter plug of the design specified.

(f) Loaded high-explosive shell for guns using separate loading ammunition shall be shipped unboxed with the rotating band protected by a rope grommet of specified design. Point fuzed shell shipped unfuzed shall have an eye-bolt lifting plug screwed into the fuze seat in the shell, or the adapter and booster casing.

(g) Loaded gas shell are to be packed in the boxes in which received at the gas-loading plant, and shell for guns using brass cartridge cases are to be shipped to Government assembling plants for assembling into complete rounds of ammunition.

Shrapnel.—(a) Shrapnel from the machining plant to the loading plant will be packed so as to insure its arrival at the point of destination in the same condition as when accepted at the machining plant; the machining contractor being responsible for the proper shipping arrangements, supplies packing material of his own design.

(b) Shrapnel, loaded and fuzed, assembled in the complete rounds with their cartridge cases, are packed in boxes of prescribed design.

(c) Shrapnel, loaded and fuzed, intended for firing in guns using cartridge cases, which are to be shipped to Government assembling plants are packed in boxes of prescribed design.

(d) Shrapnel, loaded and fuzed, to be fired from guns using separate loading ammunition, are shipped in boxes of prescribed design.

Adapter and booster.—(a) Metal parts of adapter and booster casings, shipped from the machining plant to the loading plant, are packed in such a manner as to insure safe arrival to the point of destination in the same conditions as when accepted; the machining

contractor being responsible for the proper shipping arrangement, supplies packing material of his own design.

(b) Loaded and assembled adapter and booster casing sent from the loading plant to the plant where shell are being loaded and assembled, shall be packed in such manner as to insure their arrival (without damage) at the point of destination; the loader of the adapter and booster casing being responsible for the proper packing arrangements, supplies packing material of his own design. The fuze seat should be closed with a suitable adapter plug.

Fuzes.—(a) Combination time and percussion fuzes shall be packed in the manner and in containers as provided by Ordnance Office drawings.

(b) Metal parts of point detonating fuzes will be packed for shipment to the loading plant in the boxes prescribed by the Ordnance Office drawings. With metal containers or metal linings, the covers shall not be soldered in place.

(c) Loaded point detonating fuzes are shipped in boxes of prescribed design.

(d) Basé detonating fuzes are shipped in containers and boxes of prescribed design.

General consideration.—In general, boxes or other packing material whose design is specified by Ordnance Office drawings, will be furnished by the United States. Whenever purchase orders are placed, calling for the use of this kind of packing material, they will, in general, specify whether the United States or the contractor will supply the packing material. Whenever specifications for various components are at variance with these specifications or with the purchase order, the conditions of the latter will govern.

Marking of ammunition packing boxes.—For quick and accurate identification, the ammunition packing box is marked on top, on both sides, and on each end. The symbol marking identifies the type of ammunition instantly. The smaller more explicit marking is a check, and teaches the significance of the symbols, also giving quantities. Black only is used in the marking of these boxes. The marking follows a fixed system in all cases. Full details of the markings are shown in ordnance office drawings 20-4-46, 20-4-47, and 20-4-48.

Marking of fuze packing boxes.—High-explosive shell requiring a booster can not safely be shipped fuzed. Special packing boxes are provided for each type of fuze, which are marked on the top, sides, and both ends. The marking follows a fixed system similar to that used on ammunition boxes. The ordnance inspector's stamp and place of packing appear on left top corner of the case. The sentence, "DETONATING FUZES, HANDLE CAREFULLY," appears next, to conform with interstate commerce requirements. Full details of the markings are shown in ordnance office drawing 20-4-51.

VII. AMMUNITION LOADING AND SUPPLY.

Loading plants.—For the loading and assembling of high-explosive shell, the United States Government owns a number of plants, as listed below. These were operated for the Government under agreement by various corporations, the names of which are indicated in the accompanying tabulation:

High-explosive shell—Loading and assembling plants.

Location.	Operating company.	Capacity daily.	Estimated plant cost.
Mays Landing, N. J.....	Tripartite agreement.....	25,000 75-mm.....	\$6,000,000
	Bethlehem Loading Co.....	12,000 155-mm.....	
	Bethlehem Steel Co. and United States Government. (Unit for loading adapter and booster casings.)	4,000 8-inch or larger shells.....	
Penniman, Va.....	Tripartite agreement.....	50,000 booster casings.....	500,000
	Du Pont Engineering Co.....	25,000 75-mm. shells.....	
	E. I. DuPont de Nemours & Co. and United States Government. (Unit for loading and assembling of adapter and booster casings.)	12,000 155-mm. shells.....	
Peth Amboy, N. J. (Morgan plant).	Tripartite agreement.....	4,000 8-inch or larger shells.....	500,000
	Tripartite agreement.....	50,000 booster casings.....	
Lakeland, N. J.....	T. A. Gillespie Loading Co.....	25,000 75-mm. shells.....	5,950,000
	T. A. Gillespie Co. and United States Government.	12,000 155-mm. shells.....	
	Tripartite agreement.....	4,000 8-inch or larger shells.....	
Lakeland, N. J.....	Tripartite agreement.....	25,000 75-mm. shells.....	6,000,000
	Atlantic Loading Co.....	12,000 155-mm. shells.....	
	Electric Bond & Share Co. and United States Government. (Unit for loading adapter and booster casings and hand and rifle grenades.)	50,000 booster casings.....	
		50,000 hand grenades.....	
		50,000 rifle grenades.....	500,000

The Morgan plant figuring in the above list was the scene of a disastrous explosion on October 4, 1918, but rebuilding was immediately begun and efforts made to restore the equipment to the same or greater capacity.

LOADING SMOKELESS AND IGNITION POWDER INTO CHARGES.

Powder charges in bags for cannon.—Powder charges are loaded into bags for the following cannon:

- 5-inch seacoast gun and railway mount.
- 5-inch siege gun.
- 155-mm. howitzer.
- 155-mm. gun.
- 6-inch seacoast gun on railway mount.
- 7-inch gun.
- 8-inch seacoast gun on railway mount.
- 8-inch howitzer, Mark IV and Mark VII.
- 9.2-inch howitzer, Mark I and Mark II.
- 10-inch seacoast gun on railway mount.
- 12-inch seacoast gun on railway mount.
- 12-inch mortar.
- 240-mm. howitzer.

Loading plants.—The three loading plants are situated at Woodbury, N. J., Tullytown, Pa., and Seven Pines, Va. The plant at Woodbury, though not fully completed, was put in operation on June 21, 1918, while that at Tullytown began operations on August 15, 1918, and that at Seven Pines began operations on September 15, 1918. The daily capacity of these plants at the end of November, 1918, was as follows: Woodbury, 25,000 rounds; Tullytown, 23,000 rounds; Seven Pines, 12,000 rounds. The yearly capacity for loading smokeless powder in 1919 would have amounted to some 550,000,000 rounds.

Nature of cartridge cloth.—The cloth used in the manufacture of cartridge bags to contain propelling charges is of three general classes, of which the first two are subdivided into five grades. *Cartridge bag cloth* proper is used in the manufacture of all parts of cartridge bags except igniting ends and cores, while *cartridge igniter cloth* is used for igniting ends and cores and *cartridge case cloth* for all parts of cartridge bags for semifixed ammunition. *Cartridge bag cloth* must be made of pure silk, wool, or mohair, without the admixture of any other materials whatever except those necessary for sizing the yarn. Definite specifications for the material and its test have been prepared. (See EE 331-0.) *Cartridge igniter cloth* must be made of pure silk without the admixture of any other materials whatever except those necessary for sizing the yarn. *Cartridge case cloth* must be made of cotton without the admixture of any other materials except those necessary for sizing the yarn.

Substitute for raw silk for cartridge bags.—No satisfactory substitute for raw silk has yet been obtained for the manufacture of powder bags for separate loading ammunition. In view of the scarcity of this material, particular effort should be made to discover a material that will be satisfactory for this purpose. Experiments have been made with cotton, paper, wood fiber, etc., in two directions. One to render them more combustible, so that they will be entirely consumed and not leave smoldering fragments in the bore of the gun, the other to render them absolutely fireproof. Neither of these methods has proved entirely successful and experiments are now being made with celluloid or pyroxyline containers which give promise of proving satisfactory after a few minor difficulties are overcome.

Three kinds of cartridge cloth.—The cloth of which cartridge bags to contain propelling charges for cannon are made must have not more than a trace of alkalinity under a water extract test with litmus paper, and must show no acidity due to organic acids or organic salts. A trace of acidity due to amino acids or other organic compounds, however, is allowed. The material extracted with ether must not exceed 10 per cent of the original weight of the sample.

Cartridge bag cloth.—Cartridge-bag cloth is made of pure silk, wool, or mohair. It is used for all parts of the bags for separate loading ammunition except the igniting ends and cores. In width it is from 36 to 72 inches, with a firm, close, and uniform weave, basket preferably, though other weaves are permissible. It must have a nearly uniform tensile strength in both directions (warp and fill), meeting the tests provided in the tensile strength tables. Its weight is not stipulated, but preferably it should be as light as is consistent with the requirements for tensile strength and stretch.

Cartridge igniter cloth.—Cartridge igniter cloth is made of pure silk. It is used for the igniting ends and cores for separate loading ammunition. It is 36 to 72 inches wide, single or double basket weave, firm and uniform.

Cartridge case cloth.—Cartridge case cloth is used for cartridge bags for semifixed ammunition. It is of pure cotton, 36 to 72 inches wide, close, uniform, and as light as possible.

Accessories.—Twine for lacing the cartridge bags is of heavy, smooth spun silk. Thread of both silk and cotton is used for sewing.

Duck, sheeting, drill, osnaburg, or a similar cloth is used in making primer protector caps. The felt used in these is a standard gray not less than two-thirds wool. Traces for same are of woven duck belting or its equivalent, 1 to 2 inches wide, and the twine is four-strand, smooth hand-finished hemp.

Cartridge bags.—Cartridge bags are made of materials furnished by the Ordnance Department or approved by it; and they are cut, sewed, and finished strictly in conformity with its drawings and specifications or with samples furnished when the order for manufacture is issued. They are handled in manufacture so that they are at all times kept free from moisture or foreign material.

Cartridge bag igniters.—Cartridge bag igniters are made from materials furnished or approved by the Ordnance Department. The amount of igniting powder for each end and core is separately and accurately weighed on scales which are tested daily. It is then inserted in each end and core and distributed uniformly therein, and the filling openings closed by sewing. Even distribution of the powder is maintained by cross quilting where this is necessary. The igniters are assembled to the bag bodies by sewing with silk.

Propelling charges for separate loading ammunition.—The cartridge bags, complete with igniters and the smokeless powder, are furnished or approved by the Ordnance Department. The prescribed weight of smokeless power for each section, separately and accurately weighed, is inserted in the bag, the opening secured closed by sewing with silk, and the charge laced and sections secured together with the tying straps where lacing or tying straps are provided, forming a compact and rigid charge of such diameter that it may readily be inserted into

the gun chamber. Primer protector caps are placed on the finished charges, and they are packed in tested air-tight containers.

All work in connection with igniters and the loading of smokeless powder is performed in suitable buildings, kept at normal temperature and free from undue moisture; and conditions imposed at all times are such that there is no possibility of igniters, bag bodies, or components being injured or unduly exposed to the atmosphere or moisture. The highest quality of workmanship is required and each step of the operation, as well as the finished work, must have the approval of the ordnance inspectors.

AMMUNITION AND EXPLOSIVE DEPOTS AT ATLANTIC PORTS.

General plan.—The Ordnance Department had more or less completed at Atlantic ports depots of large capacity for the storage of explosive components and fixed ammunition for overseas shipment. Ammunition was shipped into the depots as fast as manufactured, and held awaiting transportation overseas.

Raritan ordnance depot.—The Raritan general supply ordnance depot was established at the Raritan Arsenal near Metuchen, N. J., about 3 miles above Perth Amboy, on the Raritan River. This depot has rail connection with the Lehigh Valley and Pennsylvania Railroads. It has a dock frontage of 2,000 feet and a channel is being dredged to a minimum depth of 12 feet of water. Shipments are made to trans-Atlantic vessels at the anchorage provided at New York Harbor. At the depot packages are made up in sling loads at the various magazines, placed on flat cars, and transferred by locomotive cranes to lighters, which are towed to the anchorage of the steamers.

Sandy Hook.—At Sandy Hook Proving Grounds magazines for the storage of high explosives were erected. A large dock was being built, from which shipments could be lightered direct to trans-Atlantic vessels. A number of the magazines here were occupied by storage of picric acid belonging to the French Government.

Kearney depot.—At Kearney, N. J., the ammunition storage plant of the American Can Co. on the Passaic River, above Newark, was leased and the ammunition manufactured by this company was accumulated for shipment by lighters, by rail, or by motor trucks, direct to ships or to the Raritan depot.

Delaware.—The Delaware ordnance depot for the storage of explosives and ammunition was established on the Delaware River at Oldham Station, near Pennsgrove, Pa., and this site is reached by both the Pennsylvania and the Philadelphia & Reading Railroads. A large dock was to be built and a channel dredged to a mini-

imum depth of 15 feet of water, so that shipments by lighter can be made to the anchorage, which had been approved, in the Delaware River.

Baltimore—Curtis Bay ordnance depot.—On Curtis Creek, about 6 miles south of Baltimore, a depot for ammunition and explosives was being built at a point reached by the Baltimore & Ohio Railroad. Shipments were made by lighters through the channel, which was being dredged to a minimum depth of 18 feet of water at low tide. This was later to be increased to a minimum depth of 26 feet, when by widening the draw in the highway bridge across Curtis Creek from 55 to 90 feet, the passing of ocean-going ships will be permitted.

Turner ordnance depot.—A depot for the storage of ammunition by the Bartlett-Hayward Co. was developed at Turner Station, Md., on the site of the animal quarantine station of the Agricultural Department. A channel was dredged to a depth of 12 feet at low tide to the dock at this point, and shipments were made by lighter either to vessels or to the Curtis Bay depot. Rail or motor truck transportation is used on occasions in transporting ammunition to the Curtis Bay depot.

Hampton Roads—Pig Point depot.—The Pig Point general supply ordnance depot for the storage of ammunition and explosives was established at the mouth of the Nansemond River, having rail connections with the Atlantic Coast Line Railroad, which in turn connects with the seven railroads entering Norfolk at Portsmouth. A dock was being constructed to have a minimum depth of 13 feet of water at low tide, and shipments were to be made from this depot by lighter to the anchorage point which had been approved. Small quantities of high explosives are stored at this depot for the Engineering Corps.

Charleston ordnance depot.—On the Cooper River, above Charleston, S. C., a depot for the storing and handling of ammunition and explosives was approved and plans forwarded to the constructing quartermaster at Charleston, S. C. This is considered largely as an emergency depot to relieve congestion at the more northern ports. It is not so well situated in regard to railway facilities and points of freight origin as the more northern depots; but the site is well located with regard to the shipment of powder from the Government powder plants under construction at Charleston, W. Va., and Nashville, Tenn.

Use of these depots.—The general plan of these various depots was to provide for a volume of shipments that could be handled flexibly to meet the varying requirements of the shipping program. It involved the maintenance of large reserve stores at all depots, and in particular supplies of all types of ammunition and explosives at each depot. Thus the requirements for overseas could be filled at whichever port ships were available.

MOVING OF AMMUNITION SUPPLIES AT THE FRONT.

General principles.—The principles governing the moving of ammunition supplies for the French Army are as follows:

Ammunition allowance.—In each army the general in command of the Army grants to each of his Army Corps or similar groups according to their situation—

(a) An initial ammunition supply for the batteries and depots, which in the case of the artillery at the beginning of the battle of the Somme in 1916 consisted of ammunition for the batteries to be stored near the guns sufficient for three “days of fire” and also for the depots of three “days of fire” supply.

(b) After the daily reports on the consumption of ammunition sent by the army corps, the general in command of the Army grants to each Army Corps an amount of ammunition which varies, in his opinion, with the tactical necessities and the consumption effected. In this way the initial ammunition supply either may be kept at the same level or be decreased according to circumstances.

(c) From the reports on the consumption of ammunition sent by the batteries, the general in command of each army grants to each group of artillery a certain number of rounds, depending on circumstances, and also gives orders for the transportation of the said ammunition to the batteries.

Organization depots and delivering ammunition.—The organization of the depots and delivery of ammunition is regulated as follows:

(a) The general in command of each army assigns to each army group the duty of supplying ammunition to all the batteries in position and the army group is thus made responsible for the supplying of ammunition of its corps.

(b) This decentralization enables the general in command of the Army corps to unite all the means of transportation provided by the horse-drawn division of the army corps ammunition trains and caissons of the batteries of his corps, as well as to mobilize all horsed vehicles or Decauville railways (narrow-gauge portable) which can be placed by the army at his disposal in addition to his own corps means of transportation.

(c) The daily supply granted by the army corps and obtained from the various depots is carried to the batteries by means of transportation here indicated.

(d) The ammunition depots that supply the batteries are either army depots or army corps depots according to tactical and geographical circumstances or according to the ammunition which is required, or the quantity stored at each depot.

(e) Army depots or army corps depots are supplied with ammunition by the army either by means of regulation narrow-gauge trains or by means of motorized convoys belonging to the army.

Handling of depots.—Ammunition depots should be located on a good highway and good roads, and loading platforms should be provided in order to facilitate the heavy handling which has to be done effectively at all hours of the day, irrespective of the conditions of the weather. To locate ammunition depots next to railway lines, of course, is impossible, though this main item in transportation must be considered. The personnel must be adequate and well officered, including men capable of heavy work, and a proportion of one man per ton of ammunition, coming daily to the depot, is considered suitable. The personnel of the depots should include officers of the technical section or staff fully aware of the relation of the ammunition to the general progress of military situation. It is, of course, necessary to insure the homogeneity of the various lots of ammunition employed by the batteries in order to secure accuracy and efficiency of fire.

SUPPLY AND CONSUMPTION OF ARTILLERY AMMUNITION.

[Confidential French gun data furnished Dec. 14, 1917.]

Days of fire.—The initial allowance of ammunition for an Army in active operation comprises for field and heavy artillery a number of "days of fire" which vary according to the importance of the operation. This number may reach seven "days of fire" and during the operation a daily supply as one half "day of fire." In calculating the supply the theoretical "day of fire" is determined as follows:

Caliber 75-mm., 300 rounds per gun.

Caliber 155-mm., L-100 rounds per gun.

Caliber 220 mm., 80 rounds for old model howitzer; 100 rounds for rapid-fire howitzer.

Reserve of ammunition.—In calm sectors the reserve of ammunition may be only three "days of fire," but the supply is determined in advance for 5 or 10 days according to the circumstances, and varies with the activity of the sector. The reserve ammunition would be distributed as follows:

Active sector.—Three days of fire at the battery positions; four days of fire in the army stores and depots (last station of railroads).

Calm sector.—Two days of fire at the battery positions; one day of fire in the army stores.

Under certain circumstances the "army group" may have a reserve of one-half or one day of fire ready on railroad trains.

Trench mortars.—Additional allowance of ammunition for trench mortars are:

58 mm., 500 rounds per mortar (one-sixth of which are D. L. S. bombs).

240 mm., 350 rounds per mortar.

This allowance is generally only for an important attack and no daily supply is prepared for trench mortars. Inasmuch as the transportation of such bombs requires a considerable number of men it is necessary to begin the transportation as soon as possible and to have the stores prepared in the vicinity of the mortars.

Other ammunition.—The consumption of ammunition for the Brandt howitzer and the 37-mm. has been constantly variable and it was considered sufficient to have an initial allowance of 3,000 pounds per gun, one-half in the army stores and the other in the front line.

Daily consumption of ammunition.—The mean daily consumption per gun along the whole French front from April 1 to September 1, 1917, was as follows:

	Rounds.
Caliber 75-mm. (field gun).....	40
Caliber 75-mm. (antiaircraft).....	25
Caliber 155-mm.....	20
Caliber 220-mm. mortars.....	15
Caliber 58-mm. trench mortar.....	5
Caliber 240-mm.....	4
Caliber 37-mm.....	4
Brandt howitzer.....	4

It was stated that it was possible to determine the initial allowance of the whole of the artillery only by considering the possible output of the ammunition factories.

Instruction.—For the instruction course of the “army group” (field and heavy artillery) the following was reported as a mean consumption for training purposes in the camps:

	Rounds.
Caliber 75-mm.....	12,000
Caliber 155-mm.....	2,000
Caliber 90-mm. or 95-mm.....	6,000

In the instruction course of French artillery of one army the following is a mean consumption of trench mortar ammunition:

	Rounds.
58-mm.....	1,500
240-mm.....	200

Distribution of various models of ammunition.—The distribution of various models of ammunition for the purpose of replenishment is reported as follows:

	Per cent.
(a) 75-mm. high-explosive shells.....	85
Shrapnel.....	10
Gas shells.....	5
(b) 155-mm. high-explosive shells.....	95
Shrapnel.....	5

The gas shells are delivered generally upon special request of the armies. The supply of ammunition prepared for various attacks and the per cent of gas shells is varied between 15 and 20 per cent.

(c) 220-mm. high-explosive shells.	Per cent.
(e) 37-mm. armor-piercing shells.....	10
Cast-iron shells.....	45
Steel high-explosive shells.....	45

The above figures vary in the different armies.

In the ammunition for trench mortars, gas bombs are only a small per cent of the supply, and the consumption of gas bombs has never reached 10 per cent of the total expenditure of ammunition.

Fuzes for trench mortars.—The following distribution of types of fuzes for trench mortars is indicated:

Caliber 58-mm.....	20 per cent instantaneous type.
	50 per cent fuzes without delay.
	30 per cent fuzes with delay.
Caliber 240-mm.....	Only fuzes with delay.

Hand grenades and rifle grenades.—The mean supply of hand grenades and rifle grenades to be prepared for the army is:

- (a) 12,000 hand grenades (per 1,000 soldiers).
 65 per cent FI. or CF.
 30 per cent OF.
 5 per cent lachrymatory or incendiary.

In calm sectors the daily consumption of rifle grenades depends on the distance of the enemy's front line.

(b) For an attack it would mean a daily supply approximately as follows (per 1,000 soldiers):

- 16,000 hand grenades.
 500 rifle grenades.

Signal rockets.—The signal rockets required for one division were as follows:

	Calm sector.	Active sector.
Signal rockets with big stars:		
White.....	500	800
Red.....	500	800
Green.....	500	800
Serpentine (chenille).....	500	1,000
Yellow smoke.....	200	400
Flags.....	100	200
Light rocket 34.....	1,000	1,200
Cartridges viven bessieres.		
Parachute:		
White.....	600	2,000
Red.....	500	1,500
Green.....	500	1,500
1 star.....	600	1,500
3 stars.....	600	1,500
6 stars.....	600	1,500
Serpentine (chenille).....	300	800
Yellow smoke.....	250	400

VIII. EXPLOSIVES.

The explosives approved by the Engineering Division, Ordnance Department, for use in high-explosive shell, drop bombs, grenades, and mortar shell are listed in the following table:

High-explosive shell.....	TNT cast. 50-50 amatol. 80-20 amatol. Explosive "D." 60-40 sodatol.
Drop bombs (high-capacity).....	80-20 amatol.
Drop bombs (fragmentation).....	50-50 amatol. 80-20 amatol.
Grenades (hand and rifle).....	Trojan grenade powder. Grenite. TNT.
3-inch Stokes mortar shell.....	Trojan mortar powder.
6-inch trench-mortar shell.....	80-20 amatol.
240-mm. trench-mortar shell.....	80-20 amatol.

Explosives under investigation.—In addition to the approved explosives already tabulated, the following are considered promising for purposes indicated, but have not been approved pending complete investigation.

High-explosive shell.....	Anillite. Cresylite (trinitrocreasol and picric acid). Dinitrobenzol plus TNT. Dinitrobenzol plus TNA.
Drop bombs (high-capacity).....	Nitrostarch explosive. 80-20 amatol.
Grenades (hand and rifle).....	Chlorate or perchlorate explosives.

Suitability of service explosives.—In considering the suitability of service explosives attention must be given to the following questions:

1. Availability of raw materials.
2. Cost.
3. Ease of loading.
4. Toxic properties.

The disadvantages in these four respects may outweigh other apparent advantages.



FIG. 83.—Filling high-explosive shells with TNT at Rock Island Arsenal.

Picric acid and explosive "D" have the advantage of being produced from benzene, which is available in large quantities at a low cost.

Picric acid.—Picric acid is suitable as a substitute explosive for use in high-explosive shell, but its use has never been authorized. Attention is invited to the following points in regard to this explosive:

1. Entirely new loading plant would be necessary.
2. The large consumption of nitric and sulphuric acids in its manufacture.
3. It would require a protective lining in the shell to prevent action on the metal parts.

Amatol.—Amatol used as a shell filler for the greater portion of high explosive shell produced in this country during the war had the advantage of reducing the TNT shortage. Its cost was relatively low, and the strength developed on explosion was comparable with TNT.

Sodatol.—Sodatol, while having been authorized for use as a filler for high-explosive shell, was to be used only as a reserve on account of its requiring a larger proportion of TNT than amatol. Also the products of combustion are partly solid, hence the strength is not quite so great.

EXPLOSIVES UNDER TEST.

Anilite.—Anilite is a mixture of liquid NO_2 and a hydrocarbon or nitrohydrocarbon such as benzene or nitrobenzene in equal parts. These materials may be intimately mixed and loaded, or loaded separately; if the latter, they are separated by a diaphragm until explosion takes place. Benzene, one of the ingredients, is obtainable in unlimited quantities, and liquid NO_2 can be produced in sufficient quantities by the nitrate division of the War Department at their new nitrogen fixation plants. Anilite of the above composition has two distinct disadvantages.

1. High vapor tension.
2. Sensitiveness.

Experimental work on anilite to overcome the above-mentioned difficulties and also obviate the necessity of a compartment bomb or shell was in progress under direction of the Explosive Section, Engineering Division, with promising results.

Methyl tetryl.—This material is produced from the waste sulphite wash water used in the purification of trinitrotoluol. Batches of 50 pounds have been prepared in the experimental plant at Picatinny Arsenal, and tests carried on to date indicate this to be a powerful and relatively cheap high explosive. Complete information, however, is not yet available.

Nitrated ivory nut.—The scrap waste produced in the manufacture of buttons from ivory nut is nitrated in a manner similar to cellulose or starch, and has been successfully used in the commercial manufacture of caps and detonators. Experimental work carried on at Picatinny Arsenal, Dover, N. J., has demonstrated that this material is suitable for use in military detonators, and specifications are in preparation governing its manufacture and use.

MANUFACTURE AND SUPPLY OF HIGH EXPLOSIVES.

Trinitrotoluol (TNT).—Trinitrotoluol is a high explosive used as a shell filler, either alone or in different proportions with other materials such as ammonium nitrate. It can be produced by four different processes, known respectively as:

- One-stage process,
- Two-stage process,
- Three-stage process, and
- The continuous process.

The first three were used in the United States and the fourth only in England. The three-stage process is the only one now employed in this country.

TNT is manufactured by nitrating toluene, complying with Ordnance Department specifications under the process as above stated, namely, the three-stage. The toluene is first nitrated to mononitrotoluene in a special nitrating machine equipped with cooling coils, using a mixed acid produced by fortifying the spent acid from the denitration. The mononitrotoluene so produced is separated from the acid and stored until used in the next step. The spent acid from this nitration is denitrated and the separate acids concentrated for re-use.

Dinitrotoluene is produced by nitrating the mononitrotoluene with with a mixed acid produced by fortifying spent acid from the trinitration in a similar nitrating machine. The spent acid from this nitration is drawn off, leaving the dinitrotoluene in the nitrating machine. A strong nitrating acid is then added, producing trinitrotoluol.

The trinitrotoluol is separated from the spent acid and washed first in warm water, and then with a sodium sulphite liquor or with alcohol or solvent naphtha depending on what grade of the finished material is desired.

Three grades of purity are given in the Ordnance Department specifications, and are as follows:

Grade 1—Setting point, not less than 805° C., used for booster charges alone.

Grade 2—Setting point, not less than 79.5° C., used for shell filling or for 50-50 amatol.

Grade 3—Setting point, not less than 76° C., used for 80–20 amatol.

All grades of TNT must pass certain stability and chemical tests as given in specifications, said tests to be performed in accordance with methods there outlined.

Employees engaged in the manufacture and loading of TNT are usually kept on this work only about two weeks and then given a brief turn at outdoor work in order to overcome any toxic effects. Any such effects noted are not necessarily permanent.

Toluol.—The toluol supply from which TNT is made was ordinarily obtained, at the beginning of the war, from by-product coke ovens. The projected program, however, required an increased output and after experimental work this was accomplished in the following manner:

1. The installation of gas stripping plants throughout the United States.
2. By cracking solvent naphtha or crude oils obtained from the gas stripping plants.
3. By cracking crude petroleum or distillates obtained from the manufacture of kerosene from crude petroleum, preferably of an asphalt base.

Discussing the sources of supply, the following may be noted:

Toluol from by-product coke ovens.—To increase the production of toluol from the by-product coke ovens by 3,000,000 gallons per annum necessitated the construction of approximately 1,500 additional ovens, which is more than double the number of three years ago, at a cost of from \$50,000,000 to \$70,000,000. Plans were prepared for such ovens at plants able to handle the project, but at the time of the signing of the armistice these had not been completed. Their construction required approximately 75,000 tons of steel and 28,000 tons of pig iron, in addition to brick and other materials.

The by-product ovens under construction would have had a production of some 3,500,000 gallons of toluol per year, which would have been sufficient for approximately 49,000,000 pounds of TNT, and also would have produced approximately 62,000,000 pounds of ammonia, or an amount sufficient for 249,000,000 pounds of ammonium nitrate.

Gas stripping plants.—This plan involved the installation of additional gas stripping plants in the gas works of a number of cities, each of which was capable of producing 40,000 gallons or more of toluol per annum. The cost of the installation of the necessary plants at these works was approximately \$2,000,000, and the general plan provided for the erection of the necessary appliances by various firms experienced in by-product recovery construction, and then turning over the operation to the gas companies concerned. The crude toluol thus obtained would have approximately 70 per cent toluol content

and would have been forwarded in tank cars to the refining center, from which the refined toluol resulting from fractional distillation would be transported to the TNT plants.

Cracked crude petroleum or fractions thereof.—It was found that by cracking a distillate produced in working California petroleum into its various fractions, there would be produced sufficient distillate to furnish some 5,000,000 gallons of toluol per year. A plant was erected at the works of the General Petroleum Co. at Los Angeles, Cal., to operate under patents held by that company. The toluol so obtained had the disadvantage of containing a small percentage of paraffines, but experiments perfected the method of operation and the toluol later produced met Ordnance Department specifications. From July, 1917, to January, 1919, the TNT production in the United States was 111,940,000 pounds, and it was steadily increasing in amount.

Ammonium nitrate.—Two processes are used in the manufacture of ammonium nitrate, which are as follows:

1. Neutralization of weak nitric acid by ammonia liquor, aqua ammonia, or ammonia gas.
2. Fractional crystallization of a solution of proper strength of ammonium sulphate and sodium nitrate.

Ordnance Department specifications GE 312-1 were drawn to govern the manufacture and inspection of this material. Instructions have been issued that all ammonium nitrate produced by the neutralization process shall be made at a crystallizing temperature of not less than 290° F. This has been found necessary in order to get an ammonium nitrate of suitable crystalline formation to produce a satisfactory amatol for shell filling. The supply of ammonium nitrate is at the present time sufficient to meet all requirements and will probably be sufficient to meet any new estimated requirements on the completion of the new nitrogen fixation plant still in process of construction.

Shell filling.—Shells are filled in one of the following manners:

TNT fuzed.

50-50 amatol, cold or hot pressed.

80-20 amatol, cold pressed or hot mixed, using horizontal extruding machine.

Densities of loading are as follows:

TNT, not less than 1.55.

50-50 amatol, 1.45 to 1.5.

80-20 amatol, 1.4 to 1.45.

In loading it is essential to have equal densities throughout. Methods of loading are given in detail in specifications EE-313-3.

Amatol.—Amatol is a mixture of ammonium nitrate and TNT in proportion of 50-50 or 80-20. The 50-50 mixture is used for 10-inch shell or larger, the 80-20 from 10-inch down to 4.7 inch.

Sodatol.—Sodatol is a name used to designate a mixture of sodium nitrate and TNT for use as a bursting charge in high-explosive shell. The only sodatol mixture authorized for use is the 60-40 mixture, which is comparable in strength to TNT.

TNA.—Tetranitroaniline is used for booster charges. It is manufactured from benzene by passing it in successive stages to mono and dinitrobenzene, to metanitroaniline, to metanitroaniline sulphate and then, by the nitration of the latter, to tetranitroaniline. The manufacture is a patented process of English origin, invented by Dr. Florscheim, with whom the Ordnance Department has entered into a contract. TNA is manufactured in the United States by the Calco Chemical Co., in a plant newly built at Bound Brook, N. J. This plant will produce 200,000 pounds per month. Requirements of booster explosives at the signing of the armistice were approximately 2,500,000 pounds. TNA and tetryl can be used interchangeably.

Tetryl.—Tetryl, or tetranitromethylaniline is used for booster charges and is the same as the English explosive known as C. E. It is manufactured from benzene by a secret process, by passing it in successive stages to nitrobenzene, aniline, dimethylaniline, dimethylaniline sulphate, and by nitration of the latter to tetryl. It is manufactured in the United States by the Bethlehem Loading Co. and the E. I. du Pont Powder Co., who, while maintaining the process of manufacture secret, meet rigid specifications as regards stability, setting point, etc. The requirements of tetryl to September 1, 1918, were estimated at 1,500,000 pounds. Contracts had been made by the Production Division for 1,432,000 pounds of tetryl to be delivered by December 31, 1918.

Picric acid.—Picric acid is used as a shell filler, in boosters, as a basis for ammonium picrate, and in the production of poisonous gases, the last two being the only way in which it is used by this Government. It is made from phenol or carbolic acid by nitration. It is yellow in color, has a pungent odor, and is poisonous. It has an action on metal surfaces, so that shell filled with it must be coated to prevent the formation of metallic picrates which are very sensitive and dangerous. All of the picric acid made in the United States and to be used as such was for the French and Italian Governments and was subject to joint inspection.

Picric acid requirements.—The requirements by the Ordnance Department of picric acid for our own consumption were less than 10,000,000 pounds per annum. Probably not over 5,000,000 pounds in the form of ammonium picrate or picric acid were required—with the exception of toxic gases schedule requirements. Indications were that an increase in the picric acid capacity in the United States during 1919 to 340,000,000 pounds per annum was probable. The production from November, 1917, to the end of 1918 amounted to

41,358,317 pounds, and the 1918 capacity of the country was approximately 200,000,000 pounds per annum.

Explosive "D."—Explosive "D," or ammonium picrate, is used as a shell filler in all armor-piercing projectiles. It is produced by the neutralization of picric acid and ammonia.

Mercury fulminate.—Mercury fulminate is used in fuzes and detonators. It is a very sensitive compound made by dissolving mercury in nitric acid of 42° B. strength. This solution is then poured into grain alcohol, and the mercury fulminate that forms settles down as grayish-white crystalline powder. It is purified by washing with water and is kept under water at all times until ready to dry for loading, as it is very sensitive to shock and friction. Some mixtures are made wet and formed into caps and denotators, which are then dried, after which they are shellacked to render them waterproof. Mercury fulminate is very hygroscopic. There is adequate supply of fulminate, as it is made by most munition plants in the United States, especially those with loading facilities.

Nitrostarch.—Nitrostarch is an explosive which is applicable for bursting charges where the charges can be pressed in place, or where volume loading giving low densities can be used. For instance, a grenade powder has been developed which is a dry mixture of sodium nitrate, nitrostarch, and ammonium nitrate. Such an explosive may also be applicable as a drop-bomb charge under certain conditions.

Preparation.—Nitrostarch is prepared by nitrating purified starch with a mixture of nitric and sulphuric acids, the process and chemical reactions being similar to the nitration of glycerine. The separation from waste acids, the purification and drying are difficult and great care must be exercised to insure a stable product.

Characteristics.—The resulting product, nitrostarch, is a nearly white, finely divided and rather dusty explosive, more sensitive than TNT, though not as sensitive as dry guncotton or pure nitroglycerine. Its manufacture and use as an ingredient in explosives requires constant care to avoid the accumulation of the fine dust, which is unavoidably developed and is likely to settle in the packing and mixing rooms, and which must be carefully and frequently removed.

Commercial.—The development of nitrostarch was attended by a great deal of experimental work to insure its stability. It is used in commercial explosives to a limited extent as a substitute for nitroglycerine.

Trojan grenade powder.—Trojan grenade powder is a dry explosive which must be pressed as its nature is such that it can not be melted or cast. This powder and other nitrostarch powders may be taken as having an average nitrostarch content of 40 per cent, the balance being ammonium nitrate, sodium nitrate, etc. Such an explosive is very similar to the commercial nitrostarch powder produced by the

Trojan Powder Co., and the Arctic powder produced by the E. I. du Pont Powder Co.

Résources and capacity.—The Trojan Powder Co. and the E. I. du Pont Powder Co. both have sufficient capacity to insure against any shortage of nitrostarch.

Black powder.—Black powder is used as a shell filler in 37-mm. ammunition, in shrapnel, in fuzes and in the ignition of smokeless powder charges. It is manufactured by mechanically mixing potassium nitrate, sulphur, and charcoal. A shortage was indicated during the war because of difficulty in securing sufficient potassium nitrate.

SMOKELESS POWDER FOR CANNON.

Use.—Smokeless powder is used as the propelling charge in guns of all sizes. The United States Government employs pure nitrocellulose powder in preference to powders containing nitroglycerine, because of its lower temperature of burning and consequent reduced erosive action on the gun.

Manufacture.—Smokeless powder is manufactured by digesting purified cellulose in a mixed acid of approximately 1 part nitric and 2½ parts sulphuric acids. The resulting nitrocellulose is purified by boiling in water. The pulp is dehydrated with alcohol, and colloided by mixing with ether. This colloid is forced by hydraulic pressure through suitable dies, depending upon the size of the grain, this is turn depending upon the caliber of the gun. It is then either air-dried or water-dried. The water drying, which was not practiced before the war, has been developed to a point where it is satisfactory, and all powders up to a web thickness of 0.1 inch made at the present time are water-dried. All service powders made for the United States Army and Navy contain 0.4 per cent diphenylamine as a stabilizer. It prolongs the life of the powder about 10 years and arrests decomposition.

The use of wood pulp paper prepared as a substitute for cotton cellulose, has been investigated and authorized. One hundred thousand pounds of nitrocellulose from woods have already been prepared by the E. I. du Pont Powder Co., and its manufacture into smokeless powder put under way.

Specifications.—The specifications Nos. 450 and 451 under which powder is made or purchased provide for a nitrogen content of 12.60 per cent \pm 0.1 per cent. The prescribed volatile content depends on the required web thickness, and varies from approximately 2 to 7 per cent. From 0.3 to 1.3 per cent of the volatile content is water; the remainder is residual solvent (ether and alcohol).

Granulation.—The size of the grains of smokeless powder depends upon the size of the gun in which the powder is to be used. The rate

of burning, and consequently the pressure generated, depends primarily on web thickness. Generally the length of grain is $2\frac{1}{2}$ times the diameter. The outer surface is cylindrical or fluted. Larger longitudinal perforations increase the burning surface and thereby regulate pressure during combustion.

Deterioration.—Samples of each lot of powder in service are kept under surveillance at Picatinny Arsenal, and if at any time they show deterioration, a sample is called for from service and the balance segregated pending receipt of report as to its disposition. This practice was followed with regard to the powder in Europe, and especially that in such tropical regions as Panama, Hawaii, and the Philippines.

Production capacity.—From the beginning of the war to December 1, 1918, there was manufactured in the United States a total of 209,747,701 pounds of smokeless cannon powder, of which 44,953,396 pounds was allotted to France and 2,128,000 to Belgium. Picatinny Arsenal produced 2,970,010 pounds; the Carney's Point plant of the E. I. du Pont de Nemours & Co. produced 103,871,211 pounds; the Parlin plant of the E. I. du Pont de Nemours & Co. produced 69,069,591 pounds; the Emporium plant of the Aetna Explosives Co. supplied 3,044,185 pounds; the Silverford plant of the Aetna Explosives Co. supplied 3,796,678 pounds; the Drummondville plant of the Canadian Explosives Co. produced 1,000,600 pounds; the Kenvil plant of the Hercules Powder Co. supplied 6,565,789 pounds; the Old Hickory plant supplied 17,864,081 pounds; the Nitro plant supplied 1,250,000 pounds; and Picatinny Arsenal supplied 2,970,010 pounds.

The production of smokeless small arms powder from the beginning of the war to December 1, 1918, amounted to 30,048,524 pounds, of which the Carney's Point plant of the E. I. du Pont de Nemours & Co. supplied 25,907,021 pounds; the Haskell plant of the same company supplied 409,786 pounds; the Kenvil plant of the Hercules Powder Co. supplied 1,215,808 pounds; the Western Cartridge Co. 1,640,090 pounds; and Picatinny Arsenal 875,819 pounds.

TABLE 24.—United S.

[Prepared by nitrate division,

Name of location.	Manufacturing process and plant.	Product and capacity.	Raw (2)
United States nitrate plant No. 1, Sheffield, Ala.	Ammonium nitrate from synthetic ammonia (General Chemical Co.'s process) consists of plants: <ol style="list-style-type: none"> 1. Producer gas. 2. Synthetic ammonia. 3. Nitric acid absorption and concentration. 4. Ammonium nitrate. 	Ammonia—60,000 pounds per day, equal to 120,000 pounds ammonium nitrate per day.	Coal, coke, cast iron, steel, horsepower kiln 750
United States nitrate plant No. 2, Muscle Shoals, Ala.	Cyanamid process (American Cyanamid Co.), nitrogen fixation by carbides. Consists of: <ol style="list-style-type: none"> 1. Lime burning. 2. Carbide. 3. Liquid air. 4. Cyanamid. 5. Ammonia gas. 6. Ammonium oxidation and nitric acid absorption. 7. Ammonium nitrate. 	Ammonium nitrate, 110,000 tons per year by production of nitric acid from ammonia produced from cyanamid. Cyanamid is produced from calcium carbide, the first product formed in the plant. Carbide is made by fusing a mixture of coke and lime. Carbide fixes atmospheric nitrogen, forming cyanamid.	Coal, limestone, galls, potash, water 3,50
United States nitrate plant No. 3, at Cincinnati, and No. 4, at Toledo, Ohio. ¹	Cyanamid process of American Cyanamid Co. (same as plant 2).	110,000 tons of ammonium nitrate per year—capacity of two plants.	Lime, coal, plant, ammonia

¹ Later experience indicated the total cost of the plant would be 91485—19. (To face page 209.)

ates nitrate plants—Nitrate division, Ordnance Department.

Col. J. W. Joyes, and submitted by Lieut. Col. A. H. White, July 5, 1918.]

Materials (4 hours).	Value of product.	Cost of plant.	Power development.	Built and operated by.	Allotments authorized.
100 tons; 50 tons; stic soda, 1; water, 5,000 gallons; am, 3,000 rsepower; ver, 3,000 watts; labor, men.	\$6,600,000	Total cost of construction approximately \$13,082,000. First estimates increased, due to rising war prices of labor, materials, and special machinery.	Electric; steam-power plant of 3,000-kilowatt capacity. Plant will consume 3,000 kilowatts per 24 hours.	Built and operated directly by the United States Army Ordnance Department; J. G. White Engineering Corporation, general engineering and construction, including machine shops and 5,000-kilowatt power plant; General Chemical Construction Co., nitric acid and absorption plant.	From appropriation "Nitrate plants," July 25, 1917, \$3,600,000; Dec. 1, 1917, \$2,000,000; from appropriation "National security and defense," Mar. 18, 1918, \$3,500,000; from appropriation "Armament of fortifications B" July 2, 1918, \$3,000,000; in all, \$12,100,000.
400 tons; e, 325 tons; estons, 1,000; process wa- 50,000,000 ons; steam, 0 B. H. F. ver (in terms plant capac- 90,000 kilo- its; labor 0 men.	\$36,600,000	Total cost of construction, approximately \$36,000,000 (not including \$4,000,000, being expended for additional and reserve power supply).	Plant will consume 81,000 kilowatts per hour; steam electric plant of 60,000 kilowatts installed; Alabama Power Co. to furnish 30,000 kilowatts (1/3 total required, 90,000 kilowatts).	Air Nitrates Corporation, general contractors and operators of plant, both on cost plus basis with limit of profit; Westinghouse, Church, Kerr & Co., erection contractors; J. G. White Engineering Corporation, 60,000-kilowatt steam electric power plant; Chemical Construction Co., nitric acid and absorption system.	From appropriation "Nitrate plants," Nov. 28, 1917, \$200,000; Mar. 20, 1917, \$150,000; from appropriation "Armament of fortifications C," Nov. 28, 1917, \$30,300,000; funds available, \$30,650,000.
stone, coke, l, water (each it; about half unt used by at No. 2).	\$36,600,000	\$40,000,000	Electric energy, 50,000 kilowatts each from local steam plants.	Same as plant No. 2, by Air Nitrates Corporation, New York City.	From appropriation "Nitrate plants," Mar. 20, 1918, \$250,000; from appropriation "Armament of fortifications C," Feb. 7, 1918, \$40,000,000; funds available, \$40,250,000. (Of above amounts, \$3,000,000 diverted temporarily for United States nitrate plant No. 1.)

about \$80,000,000. * Construction of these plants was discontinued soon after the signing of the armistice.

IX. UNITED STATES NITRATE PLANTS.

General statement.—In order to supply nitrates for use in the manufacture of explosives, \$20,000,000 was appropriated for nitrate supply by the national defense act of 1917, and a nitrate board was formed to canvass the entire situation, and to make recommendations to the Secretary of War regarding the construction of large manufacturing plants, where nitrogen fixation would be accomplished. A number of sites at various locations throughout the United States were considered for the first of these plants, which, though of an experimental nature, would have a large capacity and would be available for commercial products after the war.

Nitrate Plant No. 1, Sheffield, Ala.—After thorough examination of sites, the Chief of Ordnance submitted three to the Secretary of War for consideration. The President on September 28, 1917, decided on Sheffield, Ala., as the site upon which plant No. 1 should be built. This plant makes use of the General Chemical Co.'s synthetic ammonia process. Though designed for making nitrates for munitions, its primary product (ammonia) may be converted into ammonium sulphate or ammonium phosphate and used directly as a constituent of commercial fertilizer. The latter has advantages of being the most popular form of fertilizing material, and is easy to transport.

Nitrate plant No. 2, Muscle Shoals, Ala.—This project was approved by the War Industries Board, November 16, 1917, and on the same day contractors went to work.

At this plant, the process used is that of the American Cyanamid Co. for the fixation of nitrogen by carbides. The product is ammonium nitrate, of which 110,000 tons per year were to be produced.

The advantages of the Muscle Shoals site are water power available from the Tennessee River, for the development of which Government provision has been made; steam power plants already there which constitute a valuable auxiliary to a water power plant; proximity to the Tennessee phosphate beds, which makes for ready production of the fertilizer material; and proximity to the great agricultural development of the South and Southwest for convenient distribution of the same.

Nitrate plants Nos. 3 and 4, Cincinnati and Toledo, Ohio.—In considering the establishment of nitrate project No. 3, the importance of using power already available was urged by the priority committee of the War Industries Board. Cincinnati and Toledo each offered power sufficient for half the proposed plant (110,000 tons per year), hence two units were to have been established, with capacity of 55,000 tons of ammonium nitrate each per year. Construction at both these plants, where a large amount of work had been completed, was discontinued soon after the signing of the armistice.

Research section.—Almost from its organization in July, 1917, the nitrate division has maintained a research section in charge of Lieut. Col. A. H. White, a distinguished chemist from Michigan University. In January, 1918, the personnel of this section consisted of 22 technically trained men, distributed in Washington, Sheffield, (Massachusetts) Institute of Technology, Bureau of Soils, the Laurel Hill plant of the General Chemical Co., Watertown Arsenal, and on foreign service. On June 1, 1918, the staff consisted of 16 commissioned officers, 12 enlisted men, and 14 civilians. There were also a number employed by institutions in cooperative work who were not listed as employees of the nitrate division. In addition six commissioned officers formerly carried as members of the research section had been transferred to the operating staff of plant No. 1. The reports showed 85 investigations of sufficient importance to merit record.

Housing.—The site of plant No. 1 comprises 1,923 acres; plant No. 2, 2,300 acres. There being no community adequate to house employees, a cantonment to care for 7,000 men at work on plants 1 and 2 was first constructed. In the summer of 1918 there were 12,000 living on the reservation and about 14,000 employed on the work.

Features of the plants.—The essential characteristics of these various plants are summarized in the accompanying table, and also in the various sections which deal with the plants separately.

NITRATE PLANT NO. 1.

Approval of project.—This project was approved by the Secretary of War July 13, 1917, following the report of the nitrate supply committee, and the site was decided upon by the President September 28, 1917. The location of this plant is at Sheffield, Ala., on the Tennessee River, just below the Muscle Shoals, and near the phosphate beds of central Tennessee. The plant site comprises 1,923 acres.

Construction and operation.—The plant was constructed by the United States Army, Ordnance Department, and the first material for it was delivered at the site October 22, 1917. The J. G. White Engineering Corporation, New York City, were contractors for

construction only. The cost of the plant will be mainly paid by funds from the \$20,000,000 appropriated by Congress for nitrate plants, national defense act of 1916. This plant is operated by the Government, as provided in section 124, national defense act, 1916, and not by contract with any private parties or corporation.

Manufacturing process.—The formal tender to the Government by the General Chemical Co., June 5, 1917, of the right to its synthetic ammonia processes was accepted by the Secretary of War on behalf of the President on July 14. On July 21 a nitrate division of the Ordnance Department, with Col. J. W. Joyes chief, was created to take charge of nitrogen fixation problems, and at once started active consideration of the construction of plants.

Products.—The products of United States nitrate plant No. 1 are ammonium nitrate from synthetic ammonia, produced by three ammonia process units. Two of these units have each a capacity of 15,000 pounds of ammonia per day; the third unit produces 30,000 pounds per day—60,000 in all—sufficient for the manufacture of 120,000 pounds of ammonium nitrate per day.

Buildings, water supply, and power.—A specially designed brick-and-steel structure accommodates the apparatus for the production of the foregoing materials. A supply of 5,250,000 gallons of water per day is pumped by centrifugal pumps for a distance of 4,000 feet from a spring creek, through a rapid sand filter, and distributed by booster pumps to the various departments of the plant. A steam-power plant of 5,000 kilowatt capacity is located on the reservation for the operation of the plant, pending development of water power from the Tennessee River.

Railroads.—A system of reservation railroad tracks for taking care of the classification and handling of 30 cars of freight per day was built and connected with the Southern and Louisville & Nashville yards.

Cost and appropriations.—The approximate estimate for the total cost of the construction work was \$13,082,000. The appropriations are from the appropriation "Nitrate Plants," July 21, 1917, \$3,600,000, December 1, 1917, \$2,000,000; from the appropriation "National Security and Defense," March 18, 1918, \$3,500,000—in all, \$9,100,000; and from the appropriation "Armament of Fortifications, C," July 2, 1918, \$3,000,000.

Completion of plant.—Some of the processes began operation in June and a complete trial run of the first unit of the plant was made during the month of September. The other two units were later owing to delays in delivery of apparatus. These delays were caused especially by difficulty in getting certain large forgings, but these units it was hoped would be in operation well before the close of the calendar year 1918.

NITRATE PLANT NO. 2.

Nature of project.—This project, located at Muscle Shoals, Ala., includes:

- (a) United States nitrate plant No. 2.
- (b) Warrior-Muscle Shoals transmission line.
- (c) Warrior steam-power plant extension.

Approval.—Nitrate plant No. 2 was approved by contract dated November 16, 1917, between the Air Nitrates Corporation and the United States of America by J. W. Joyes, colonel, Ordnance Department, United States Army, acting by authority of the Chief of Ordnance United States Army, and under the direction of the Secretary of War.

Construction.—Owing to the fact that the American Cyanamid Co. was the only organization in America familiar with the details of the cyanamid process of nitrogen fixation, the Ordnance Department engaged it to plan, build, equip, and operate plant No. 2. A subsidiary corporation, to be known as the Air Nitrates Corporation was organized to do this, as agent of the United States, by contract dated November 16, 1917, fixing a fee for plant construction, and for its operation up to June 1, 1921, and thereafter for so long as the United States should remain in the war. The construction fee in no event was to exceed \$1,000,000. The subcontractors were: Westinghouse, Church, Kerr & Co., general erection contractors; J. G. White Engineering Corporation, construction of steam electric plant; and Chemical Construction Co., erecting nitric absorption plant.

Contract.—The contract of November 16, 1917, referred to above, was superseded by one dated June 8, 1918, for building and operating all three plants (No. 3 at Cincinnati and No. 4 at Toledo, as well as No. 2 at Muscle Shoals). This later contract changed the maximum construction fee from \$1,000,000 (fixed by contract of November 16, 1917, for plant No. 2) to \$1,500,000 for the three plants. As these three plants were to cost an aggregate of about \$75,000,000, it was evident that this change of contract reduced the construction fee to about 2 per cent of the cost of the work, or less than is frequently paid by private corporations, even for nonengineering construction.

Operation.—Under the contract of June 8, 1918, the operating fee of one-fourth of a cent a pound for all ammonium nitrate produced was also reduced, in consideration of the larger volume of business offered, to one-eighth of a cent a pound, after the production in any one year of 110,000 tons, which is an amount equivalent to the capacity of the Muscle Shoals plant (No. 2). Operating all three plants at capacity, as expected, the operating fee each year would thus amount to about \$825,000, or less than 2 per cent of the value of the product.

Manufacturing process and capacity.—Plant No. 2 uses the cyanamid method, first producing calcium carbide, then combining with nitrogen from the air to form calcium cyanamid; from this ammonia is formed, part of which is converted into nitric acid, and then all combined to make ammonium nitrate. The cyanamid process was also to be used at plants 3 and 4. The capacity of plant No. 2 is 110,000 tons of ammonium nitrate per annum.

Buildings.—The buildings constitute a completely fireproof plant. The main buildings are of steel frame, hollow-tile walls, with cement-tile roof; floors are of vitrified paving brick and cement; windows of steel-sash construction. The necessary temporary buildings and equipment for construction employees are included, as well as certain permanent frame houses, together with hospitals, stores, commissaries, roads, sewerage, water and lighting systems, and local steam power plant—20 acres under roof—all upon a tract of land belonging to the United States, comprising about 2,300 acres, near the western edge of Sheffield, Ala.

Water supply.—The water supply is obtained from the Tennessee River. This system and the sewerage system within the plant and throughout the village are to be according to approved plans, which include organization for protection against fire.

Power plant.—The power plant is located on the reservation near the Tennessee River. It is built of concrete, steel, and brick, and designed to supply 60,000 kilowatts of the 90,000 kilowatts necessary to the operation of the plant. The balance is to be furnished by the Alabama Power Co. from its Warrior River steam-power plant extension, 88.03 miles distant.

Railroad.—A feature of the design was a classification yard of 16 tracks, amounting to a total approximate length of about 10 miles, giving railroad service to all necessary portions of the plant.

Cost and appropriations.—The estimated total cost of construction was \$40,000,000, including the steam-power plant extension to Black Warrior steam-power station and the erection of a transmission line to tap the system of the Alabama Power Co. The funds in 1918 available amounted to \$30,650,000. These were: From the appropriation "Nitrate plants," November 28, 1917, \$200,000; from the appropriation "Nitrate plants," March 20, 1917, \$150,000; from the appropriation "Armament of fortifications, C," November 28, 1917, \$30,300,000.

Completion of plant.—This plant was approximately 50 per cent completed in the summer of 1918. While delays were anticipated in the delivery of some of the special machinery, it was confidently expected that the plant would commence operations early in the winter of 1918 and reach full-rated capacity in the spring of 1919.

MUSCLE SHOALS TRANSMISSION LINE FOR PLANT NO. 2.

Construction and operation.—Under contract with the nitrate division, Ordnance Department, after approval by the Acting Chief of Ordnance, the Alabama Power Co. built (on cost-plus basis) a 110,000-volt transmission line 88.03 miles long, from Warrior steam-power plant to United States nitrate plant No. 2, Muscle Shoals, Ala., with "step-up" and "step-down" transformer substations at each end (60,000 kva. at sending station and 40,000 kva. at receiving station). The construction work involved clearing the right of way, erecting modern H towers, and stringing thereon copper cable and installing line. The operation of this transmission line is carried on by the Alabama Power Co. under the direction of the United States Army, Ordnance Department.

Cost and appropriations.—The cost was included in the estimate of \$40,000,000 for United States nitrate plant No. 2, and the appropriations were likewise included in the appropriations for this plant.

WARRIOR STEAM-POWER PLANT EXTENSION FOR PLANT NO. 2.

Construction and operation.—Under contract with the nitrate division, Ordnance Department, approved by the Acting Chief of Ordnance, the Alabama Power Co. made a 30,000 kilowatt extension of its existing power plant on Warrior River, at the mouth of Bakers Creek, including all necessary equipment and auxiliary apparatus, such as railroad tracks and housing facilities. The plant extension proper consists of one 30,000-kilowatt turbine and twelve 1,200-horsepower boilers. This will effect an increase of 150 per cent in the production of electric power at this station of the Alabama Power Co. The installation was made at Government expense, and will remain Government property until otherwise disposed of. The main building for this power plant is steel frame and brick, with steel sash and permanent type of roof. The operation is by the Alabama Power Co. as agent of the nitrate division of the Ordnance Department, at the cost of the United States.

Water supply and railroads.—The water supply is secured from the Warrior River, and the layout of water and sewerage systems are according to approved plans. Railroad facilities consist of sidetracks from Warrior River Slip to the plant, for handling construction materials.

Cost and appropriations.—The cost is included in the estimate of \$40,000,000 for United States nitrate plant No. 2, the construction work on power-plant extension and transmission line being estimated at about \$4,000,000.

The funds to meet this were included with the appropriations for United States nitrate plant No. 2.

UNITED STATES NITRATE PLANTS NOS. 3 AND 4.

Approval.—This project was approved by the Secretary of War. February 5, 1918, on the recommendation of the chief of the nitrate division and the nitrate committee appointed by the Secretary of War, March 26, 1918. Their recommendation was based on the opinion that the cyanamid process of the American Cyanamid Co. was the only one whose commercial development in this country had reached a stage where it afforded a certainty that ammonia could be produced without delay.

Location.—It being important to provide further nitrate plants with power from existing power systems as far as possible, without drawing upon the limited supply of generation equipment in course of manufacture, the nitrates committee recommended a location where existing power or power equipment was available. The project was accordingly split into two parts, to be known as plants Nos. 3 and 4, of combined capacity equal to the original project for plant No. 2. These plants were to be located at Ancor, Ohio (near Cincinnati), and at Toledo, Ohio.

Construction, operation, and process.—The Air Nitrates Corporation, New York City, engaged to plan, build, equip, and operate plants Nos. 3 and 4 under the same contract as applied to plant No. 2 at Muscle Shoals. Construction was at once begun. The cyanamid process will be used at plants Nos. 3 and 4 as at plant No. 2. Each of the two plants was to have a capacity of 55,000 tons ammonium nitrate per year, or a total production of 110,000 tons per year for the two.

Buildings.—The buildings are the same character of specially designed structures as have been erected for plant No. 2. The complete plant program includes the layout and construction of housing facilities, etc. The electric energy demands of Nos. 3 and 4 will be 40,000 to 45,000 kilowatts each. Local existing steam power stations furnish this. The completion of the plants and full operation was anticipated by the summer of 1919.

Cost and appropriations.—The approximate estimate of the total cost was \$40,000,000. The funds available in the summer of 1918 were \$40,250,000, as follows: From the appropriation "Armament of fortifications C," February 7, 1918, \$40,000,000; from the appropriation "Nitrate plants," March 20, 1918, \$250,000. Of this, there was necessarily diverted to United States nitrate plant No. 1, \$3,000,000.

Work discontinued.—Soon after the signing of the armistice on November 11, 1918, construction work on plants Nos. 3 and 4 was discontinued, since it was evident that their product would not be required. Work upon these plants was progressing satisfactorily and according to schedule at the time.

ORDNANCE DATA.

Estimated output of ammonium nitrate from synthetic plants in year 1919.

NITRATE PLANT NO. 1.

	Pounds.
Full operation, 20,000 tons, NH ₄ NO ₃ -----	40,000,000

NITRATE PLANT NO. 2.

50 per cent for first quarter-----	13,750
100 per cent for balance-----	82,500
	96,250
	192,500,000

NITRATE PLANT NO. 3.

Nothing for first quarter.	
50 per cent for second quarter-----	13,750
100 per cent for third and fourth quarters-----	55,000
	68,750
	137,500,000
	370,000,000

X. TRENCH WARFARE MATERIAL.

HAND GRENADES.

Nature and use.—Although hand grenades had been employed since the fifteenth century, and in the seventeenth century were favorite weapons, their use declined during the eighteenth and nineteenth centuries until they became practically obsolete. The special conditions at Port Arthur during the Russo-Japanese War, however, revealed their possibilities for fighting at close range. They were adopted by both armies and used with great effect.

That they were not taken up subsequently by other armies, and seriously considered as weapons of major importance, was probably due to the belief that such conditions as prevailed in the Far East were unlikely to arise again. At all events, when the combatants of the European war settled down to trench fighting after the first battle of the Marne they were unprovided with grenades, but soon discovered the use of them. They improvised at first, as the Russians and Japanese had done. Before long, however, they developed well-designed grenades of various types, to suit various ends, and these were improved and standardized.

The United States Army had the experience of the allies to guide it when, in 1917, it took up the design of hand grenades for the use of our troops. The problem was to choose and to adapt the manufacturing conditions in this country to the types that had proved most useful in trench warfare. After a year's effort, grenades were developed to meet the needs of the Army in any contingency, and production on an extensive scale was established.

Classification.—Hand grenades may be divided into several types according to their usage:

1. Defensive grenade.
2. Offensive grenade.
3. Gas grenade.
4. Phosphorus grenade.
5. Incendiary grenade.



FIG. 84.—Types of hand grenades.
Defensive hand grenade, Mark II. Offensive hand grenade, Mark III. Gas hand grenade, Mark II. Phosphorus hand grenade, Mark II.

TABLE 20.—Grenades.

Type.	Total weight.	Charge.	Material of body.	Automatic bouchon assembly.	Characteristics.
Defensive hand grenade, Mark II.	<i>Ounces.</i> 22	2-ounce Trojan grenade explosive.	Cast iron...	Primer—5-second fuze No. 6 detonator.	Thrown from cover; value depends upon fragmentation of body.
Offensive hand grenade, Mark III.	12	4-ounce Trojan grenade explosive.	Laminated paper.	Primer—5-second fuze No. 8 detonator.	Thrown in open effect from detonation of the high-explosive charge.
Gas grenade, Mark II.	22	5-ounce chemical filler.	Sheet steel.	Primer—5-second fuze No. 8 detonator.	Used to clean out dugouts, etc.
Phosphorus grenade, Mark II.	20	4-ounce phosphorus.do.....do.....	Used to create smoke clouds for screen.
V. B. rifle grenade, Mark I.	17	1.75-ounce Trojan grenade explosive.	Malleable iron.	8-second fuze.....	Thrown from V. B. discharger to range 200 yards.
Incendiary hand grenade, Mark I.	124	Thermit and oil.	Paper.....	5-second fuze.....	To fire ammunition dumps, etc.
Thermit hand grenade, Mark I.	130	Thermit.....	Tin.....do.....	To fuze breechblocks in cannon (captured).

¹ Approximately.

Defensive hand grenade, Mark II.—This was modeled on the lines of the Le Blanc and is similar in type to the well-known Mills grenade. The body is made of gray cast iron, and is of about the size and shape of a large lemon. It is scored longitudinally and transversely with deep grooves which provide for proper fragmentation.

Into the upper end of the body is screwed the bouchon assembly, consisting of the bouchon, the operating lever, and a sheet-metal sealer. The bouchon is a die casting composed of a tube which holds a standard Bickford fuze and a detonator, and a projecting head which



FIG. 85.—Defensive hand grenade, Mark II, leaving the hand—handle released.

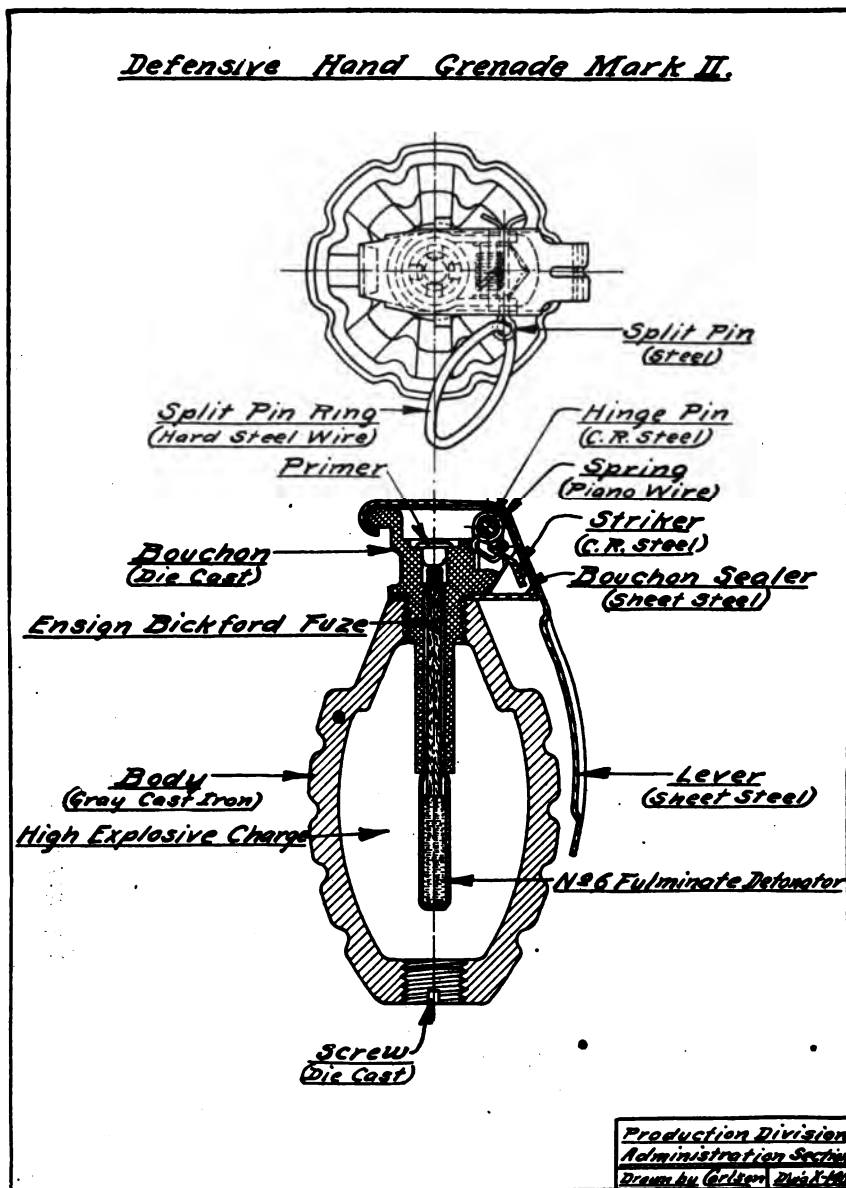

FIG. 86.—Sectional view of defensive hand grenade, Mark II.

holds the priming cap, the firing spring, and the striker. The operating lever fits over the head of the bouchon and is held in place by a safety pin with a ring attached to it. When this safety pin is pulled out, and the lever released from the hand of the thrower, the firing pin at once throws off the lever and drives the striker against

the priming cap. In other words, the grenade can not function as long as the lever is held in position against the body of the grenade.

After release, there is a delay of about 5 seconds before the fuze explodes the detonator, with the consequent explosion of the charge of $2\frac{1}{2}$ ounces of Trojan powder which fills the body of the grenade. The effective radius of dispersion is about 80 feet, although fragments may be thrown a much greater distance. The defensive grenade must therefore always be thrown from cover. It weighs, when loaded, approximately 22 ounces, and, following the French practice, is painted battleship gray.

Change of design.—In the first United States defensive grenades, an attempt was made to overcome the dangerous features of the Mills type of grenade in fixing the lever upon a pivot. The sideways thrust of the thumb, as the grenade left the hand, threw the lever to one side and allowed the functioning of the release mechanism. This device was abandoned.

Dummy hand grenade, Mark I.—The dummy grenade is made of cast iron, and resembles the defensive hand grenade, Mark II, in size, weight, and contour. It is used for practice and is painted bright red.

Method of marking.—The method of marking live and practice grenades has been taken from the French practice in order that no confusion will arise from our troops using grenades of American and French manufacture interchangeably. In general the bodies of all live grenades are painted gray while the bodies of practice grenades are painted red.

Packing for shipment and subsequent assembly.—Note should be made of the method of packing hand grenades and components for shipment, and the subsequent assembly of these components. Hand grenade bodies are packed 24 to a box. These bodies are loaded with high explosive and have in the bouchon hole a wooden plug. Packed in a separate box are 384 complete bouchon assemblies. These two boxes go forward to the place of assembly, ordinarily the regimental dump, where the wooden plug is removed from the body and the bouchon assembly secured into place. The completely assembled grenade is then replaced in the box in which the bodies were received and sent forward to the front-line trenches for issue to the various troops stationed there.

Testing grenades.—For grenades, no special facilities for testing are necessary, but experimental tests were conducted at Aberdeen, where perfectly adequate arrangements for this purpose are available. Regular practice drills with different types of hand grenades under instructors who had seen service in the trenches were held at a number of the large encampments in the United States before the troops were ordered overseas.

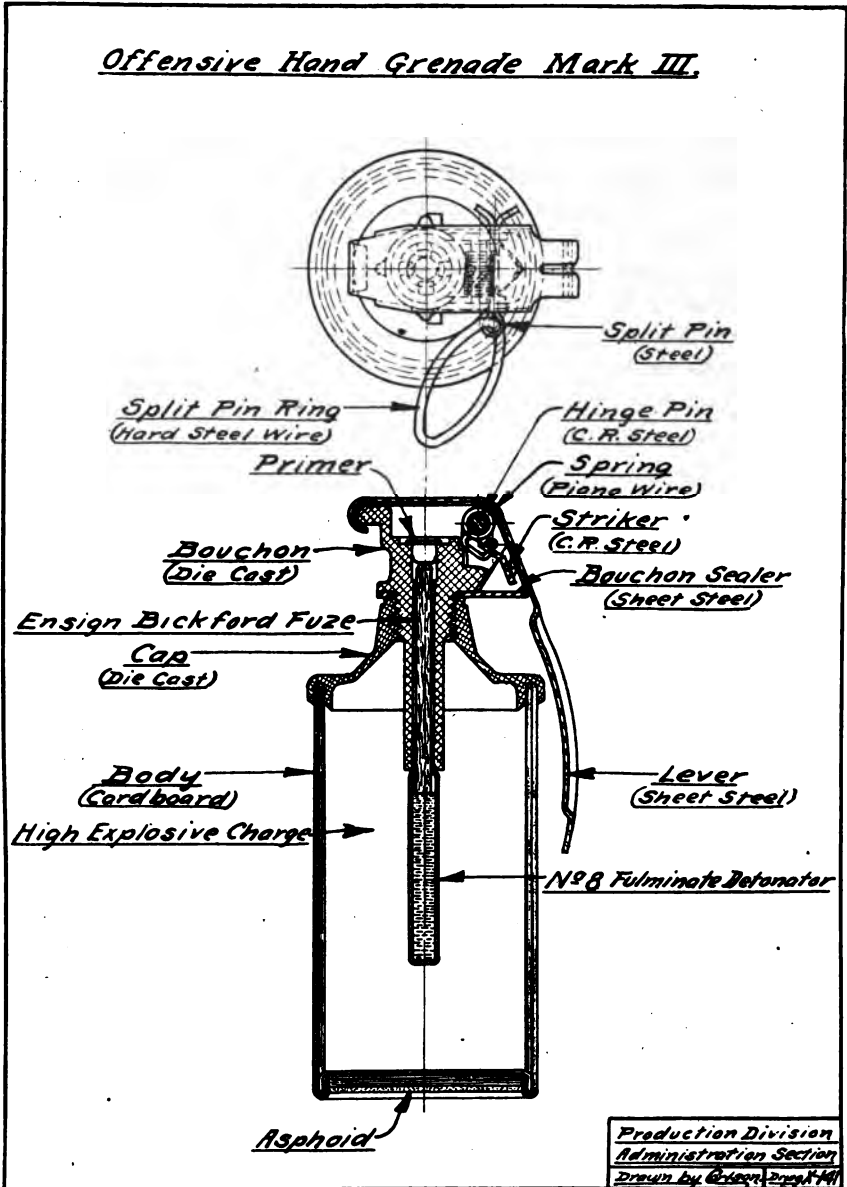

FIG. 87.—Sectional view of offensive hand grenade, Mark III.

Offensive hand grenade, Mark III.—A cylinder of laminated cartridge paper has a conical die-cast top, threaded to receive the bouchon assembly. The fuze and detonator are like those used in the defensive grenade, except for a slightly heavier charge. This grenade produces a violent concussion, but can be used in the open more safely than the defensive grenade, since there is no marked fragmentation.

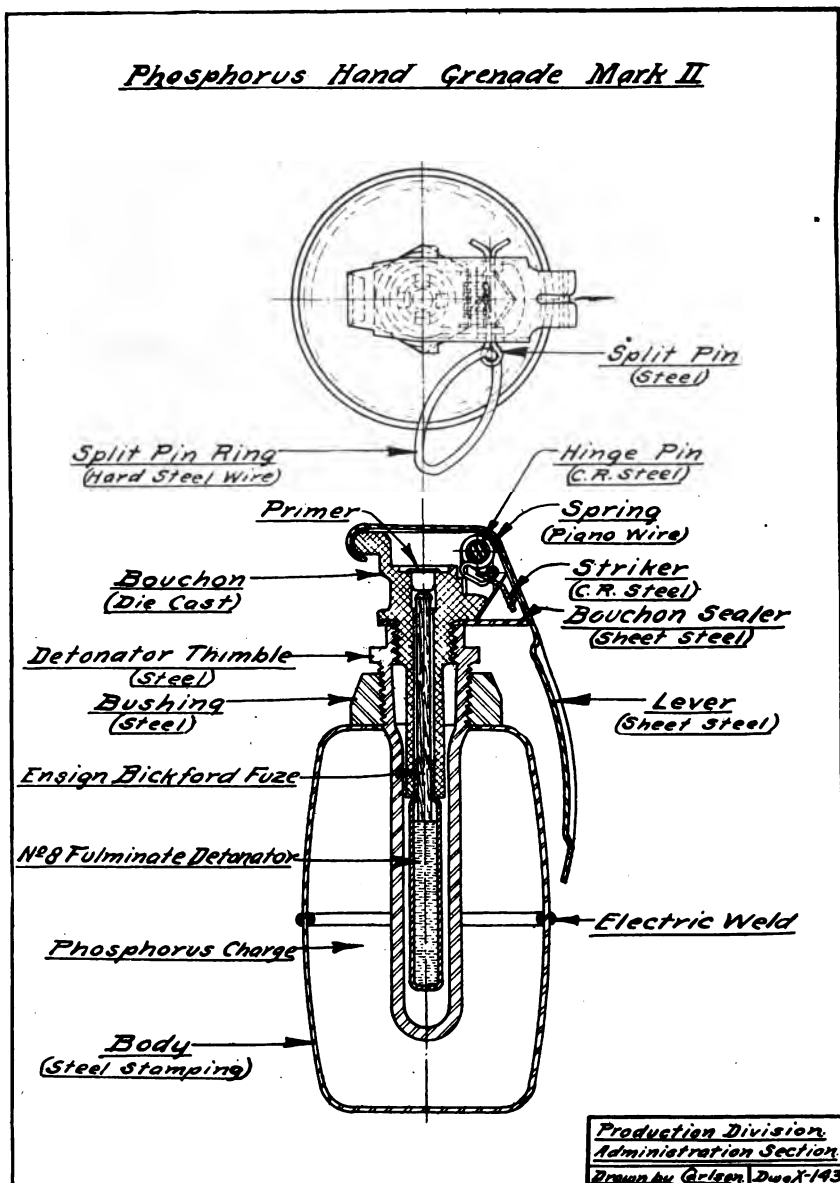

FIG. 88.—Sectional view of phosphorus hand grenade, Mark II.

Phosphorus hand grenade, Mark II.—The phosphorus grenade has a barrel-shaped steel container of about $3\frac{1}{2}$ inches long and $2\frac{1}{4}$ inches in diameter. Into the center is screwed a steel thimble, tapped to receive the standard bouchon assembly, and keeping the phosphorus charge from contact with the detonator and fuze. The explosion bursts the container and sets free the charge of phosphorus.

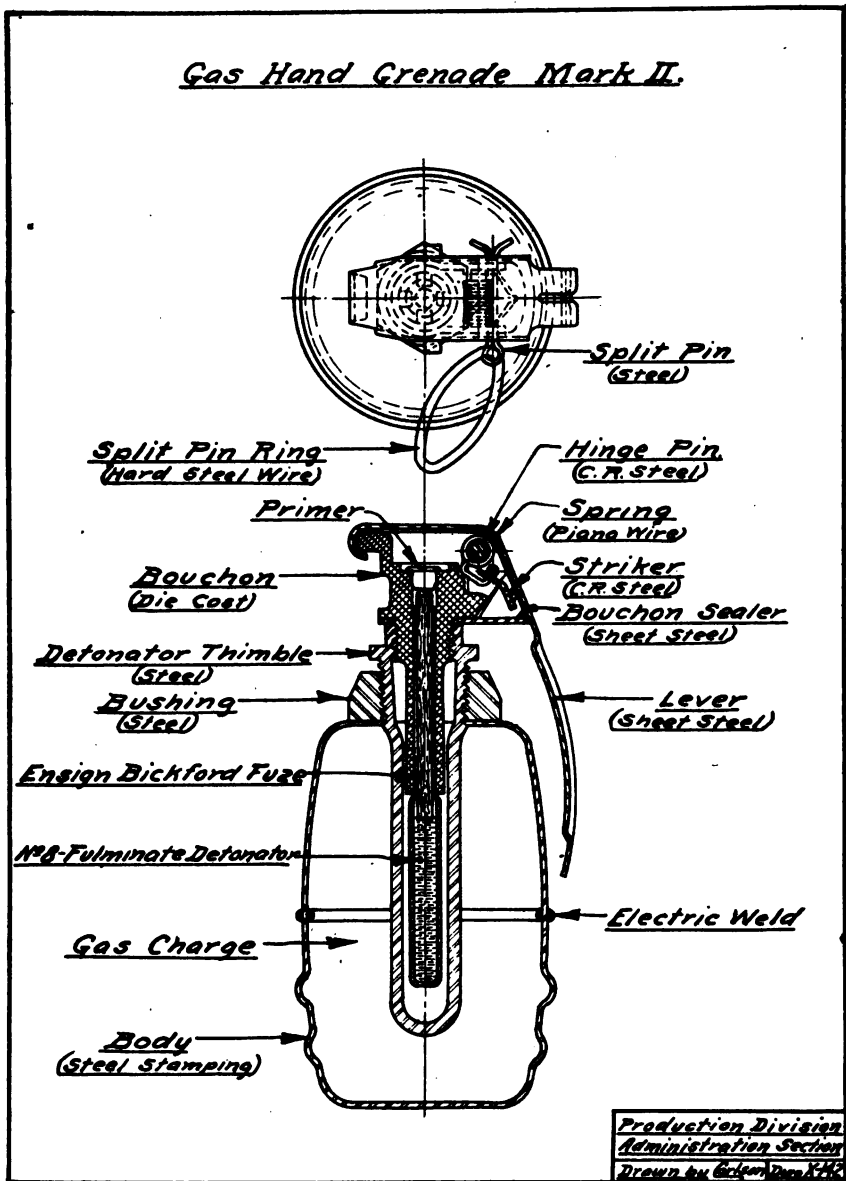
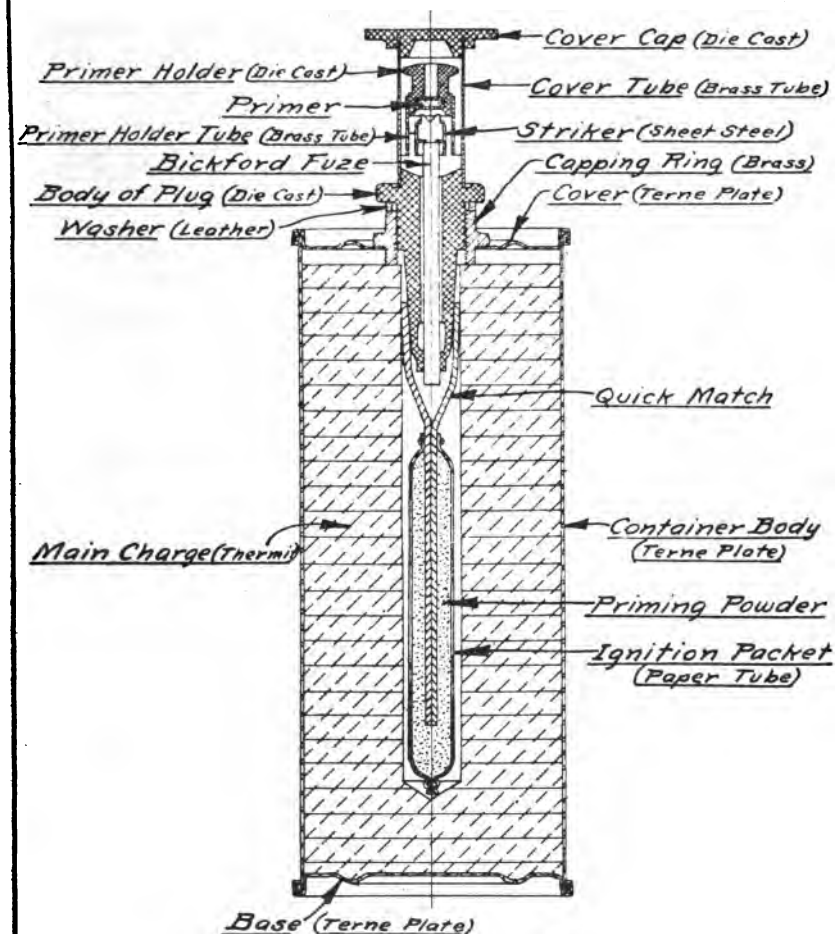

FIG. 89.—Sectional view of gas hand grenade, Mark II.

The phosphorus ignites on coming into contact with the air and is dispersed to a radius of about 30 feet.

Gas hand grenade, Mark II.—The gas grenade is similar in form to the phosphorus grenade, save for two annular corrugations on the body, near the bottom, to serve as a distinguishing mark. The normal charge is $1\frac{1}{4}$ ounces of stannic tetrachlorid.

Thermit Hand Grenade Mark I.

Production Division
Administration Section
Drawn by Carlson Disg X-108
9/10/16

FIG. 90.—Sectional view of thermit hand grenade, Mark I.

Thermit hand grenade, Mark I.—This grenade, copied from the French, has a cylindrical metal body. To operate, its bouchon cover is removed and the percussion element is struck to explode the primer, which ignites the fuze; after five seconds this ignites the thermit igniter, which in turn ignites the thermit charge. The grenade is designed to seal breechblocks of captured cannon or to fire captured stores.

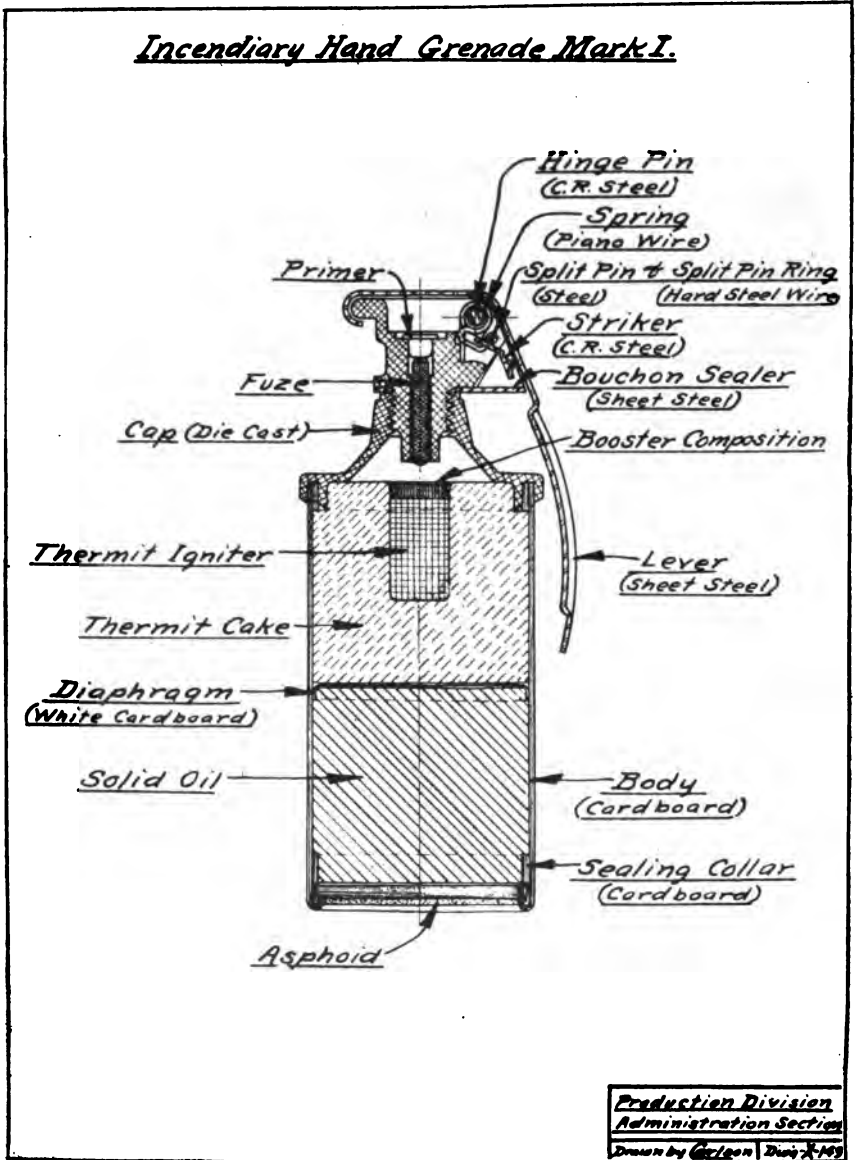

FIG. 91.—Sectional view of incendiary hand grenade, Mark I.

Incendiary hand grenade, **Mark I.**—This is made up of the standard offensive grenade paper body and standard bouchon assembly, except that the detonator is filled with thermit and solidified oil half and half. The thermit Mark I, however, having proven its value in France, was adopted and early manufactured here for the use of our troops, though an experimental quantity of incendiary hand grenades, Mark I, was sent overseas for test.

RIFLE GRENADES.

Use.—Rifle grenades are used to fill in the gap between the hand grenade and the light trench mortar. The type used by our Army originally was designed by two Frenchmen, Viven and Bessières, and in their honor is called the V. B. rifle grenade. It is about 2½ inches long, 2 inches in diameter, and is fired from the discharger, which fits over and is attached to the muzzle of the rifle in the same manner as a bayonet.

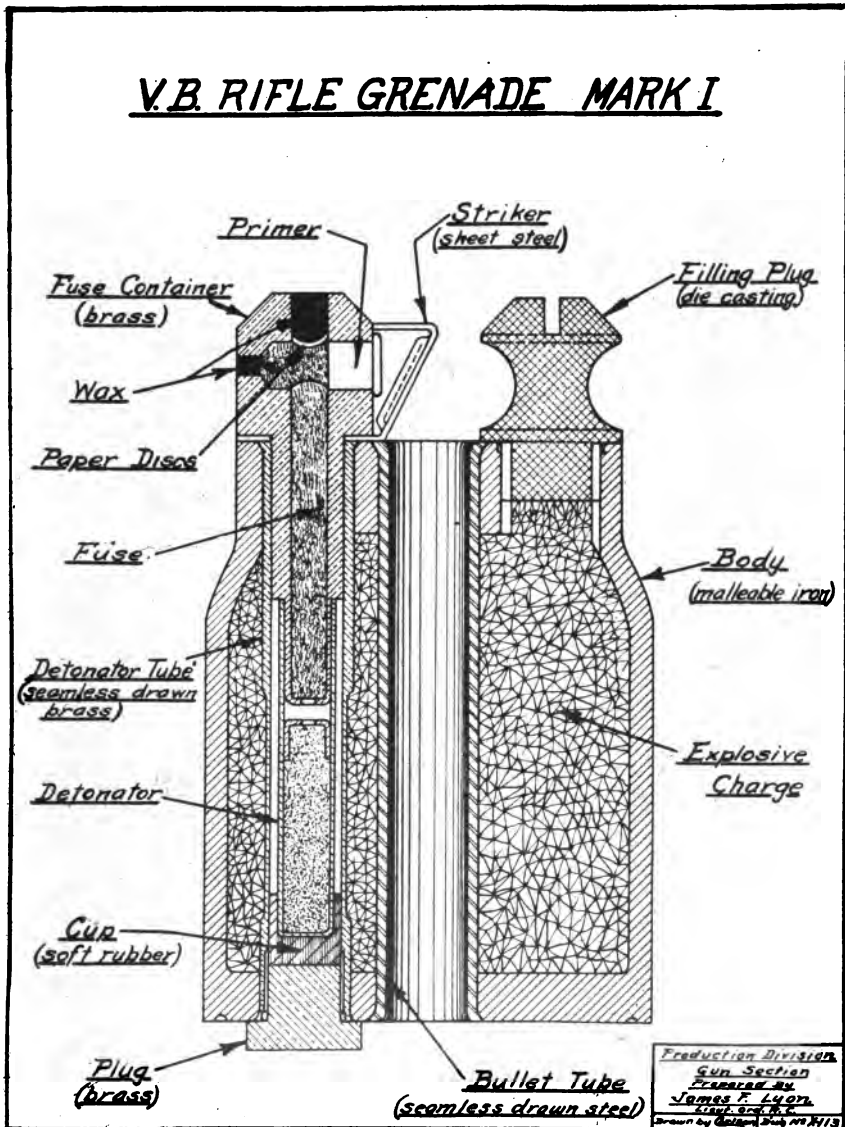

FIG. 92.—Detailed sectional view of the V. B. rifle grenade, Mark I.

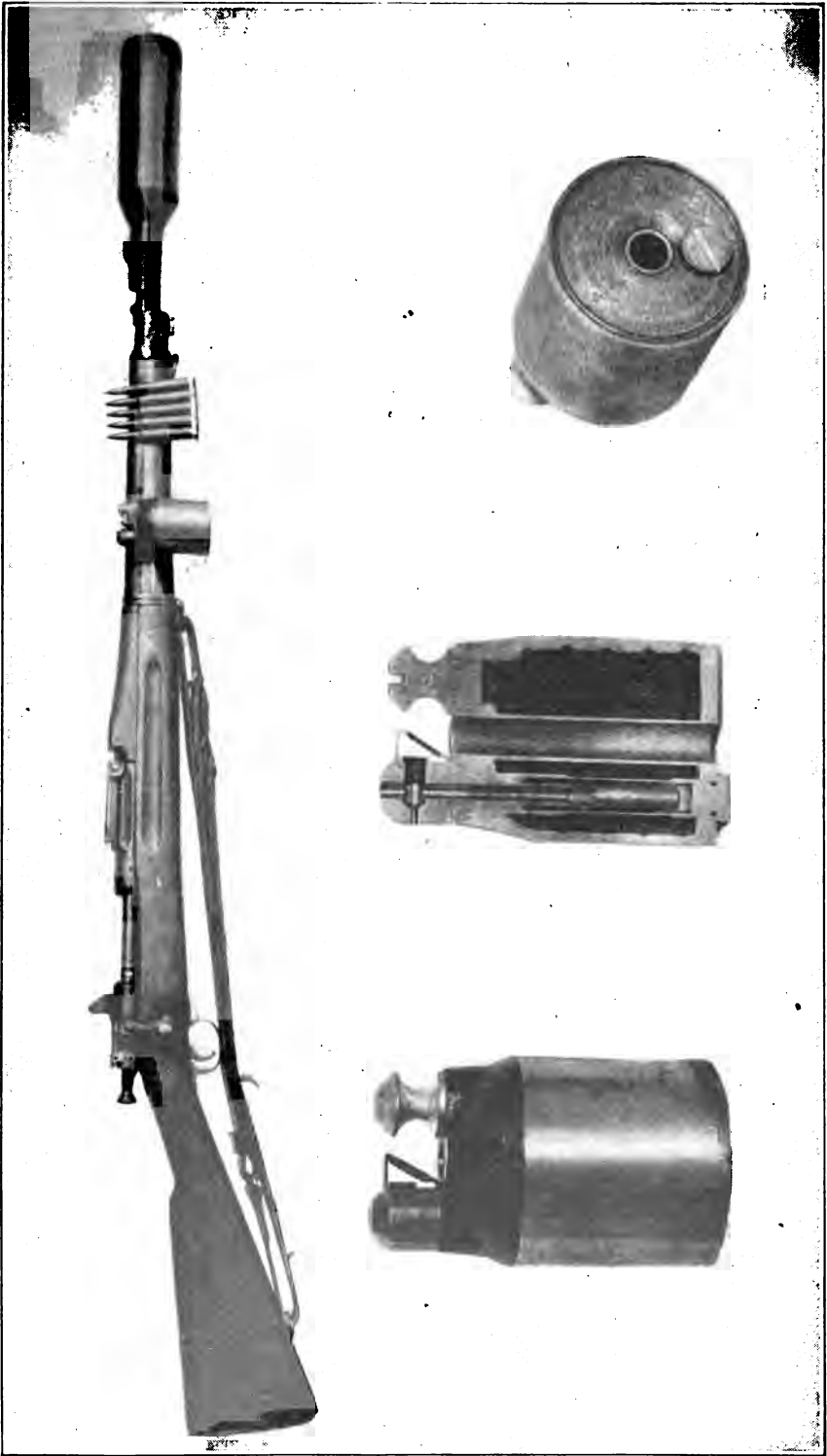

FIG. 83.—V. B. rifle grenade. Discharger mounted on rifle, together with grenade and cartridges. End view of grenade.
Side view of grenade. Sectional view of grenade.

V. B. rifle grenade, Mark I.—This grenade is copied from the French V. B. grenade. It is cylindrical, of malleable instead of cast iron—the French is cast—with rounded top and flat base, grooved on the inside to secure proper fragmentation. It is pierced longitudinally by a central tube through which the bullet from the rifle cartridge passes. The fuze container carries the primer at its upper end, with the striker projecting obliquely over the end of this bullet tube. When the bullet from the rifle cartridge has passed through the tube it hits the striker and thus fires the primer; from the primer the flash is transmitted to the fuze, which runs longitudinally through the center of the fuze container into the interior of the grenade, and is timed to burn 8 seconds. The fuze in turn fires the detonator attached to its lower end, which bursts the walls of the detonator tube and detonates the main charge. The grenade is fired from a discharger behind the bullet from the rifle cartridge, which exert their pressure on the flat base of the grenade. The normal range when the rifle is aimed at 45 degrees is about 200 yards. The weight of the grenade when loaded is about 17 ounces.

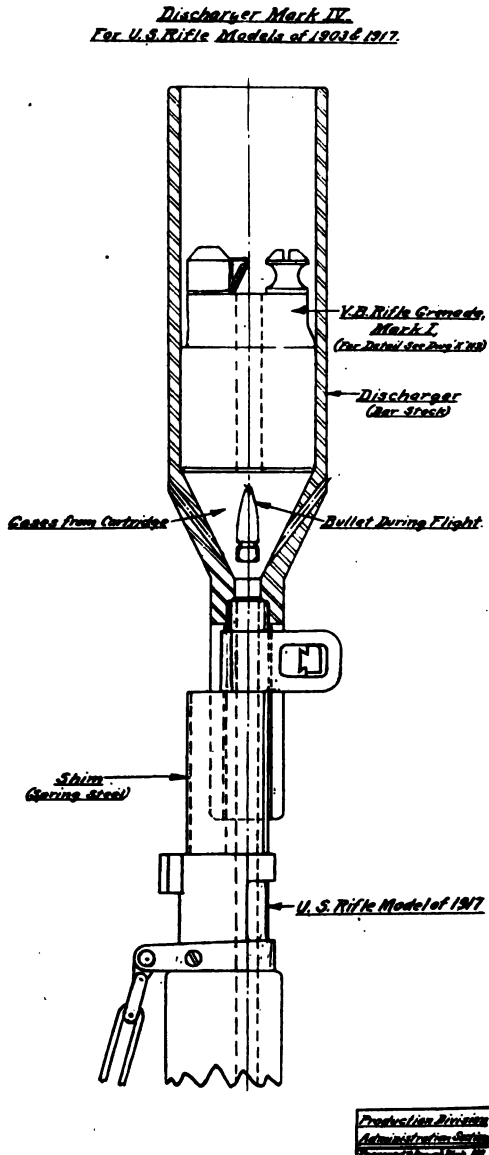

FIG. 94.—Rifle grenade discharger, Mark IV

The V. B. rifle grenade discharger, Mark IV.—This consists of two parts—the discharger proper and the shim. The former is a steel cylinder tapering below the middle to less than half of its largest diameter. This portion of the discharger has two slots, running its

entire length, and it is fastened securely over the rifle barrel by means of the shim. The United States rifle model of 1917 requires a discharger of slightly different design from the one used with the model of 1908.

Adaptation to United States rifle ammunition.—The V. B. grenade fired from the discharger has apparently been very satisfactory for use in the trenches. Considerable difficulty, however, was experienced in adapting this article for use with the United States rifle. The American rifle ammunition is more powerful than the French, the result being that the pressure exerted in the discharger was excessive, thereby causing the rifle stocks to split as a result of continuous firing of the grenades. The American V. B. grenade has a larger bullet than the French grenade, and this excessive pressure is vented through the bullet tube of the American grenade. In view of the fact that the supply of rifle grenades of the French and Americans are pooled for issue, it was found necessary to drill two ventholes in the American discharger to permit venting of the excess pressure in the discharges when French grenades are fired. The net result of this practice is that 30 yards less range is obtained with the American grenade than with the French. It was directed that all dischargers manufactured in the United States have the two ventholes referred to above drilled in them.

The dummy rifle grenade.—This grenade resembles the V. B. rifle grenade, Mark I, in contour and weight, but contains no ignition device or explosive charge.

TRENCH MORTARS AND AMMUNITION.

Nature and use.—Although the trench mortar was a weapon comparatively unknown before the present war began, it has proved to be of the first importance. None had been used by our Army except in an experimental way before we engaged in the conflict, and the entire field had to be developed by the Ordnance Department. The only weapon of the sort in existence in the United States Army was the 3.2-inch, which had never been in active service. None of the mortars designed by the allies, moreover, had been manufactured in this country before the declaration of war. It was, therefore, necessary for the military authorities to decide what type of mortars the American troops should use before the Ordnance Department could develop a source of supply. It was August, 1917, before the first definite decision was received from abroad, which was to adopt the British type of 3-inch Stokes mortar. Sixty of these mortars were thereupon imported from England for training purposes and were distributed among the camps. Subsequently other types were adopted, until now the five designs mentioned in the table were in regular production and others were being developed experimentally.

TABLE 21.—*Trench mortars and trench-mortar bombs.*

Type and caliber.	Weight of shell.	Weight and kind of charge in shell.	Fuze.	Maximum range.	Characteristics.
3-inch Stokes T. M., Mark I.	<i>Lbs. oz.</i> 11 11	Trojan shell explosive 2 pounds 6 ounces.	Mark VI.....	<i>Yards.</i> 750	An infantry weapon; total weight of mortar, about 150 pounds; muzzle-loading shell and propellant.
4-inch Stokes T. M., Mark I.	115	Gas, smoke, incendiary, high-explosive.	Mark VI and fuze to be developed.	950	A weapon used only by troops of chemical warfare service; muzzle-loading shell and propellant.
6-inch T. M., Mark I.	52	Trojan shell explosive 11 pounds.	Mark VII, delay and nondelay.	1,800	Artillery weapon; muzzle-loading shell and propellant.
240-mm. T. M., Mark I.	156	Trojan shell explosive 76 pounds.	Mark VII, delay...	2,400	Artillery weapon; muzzle-loading shell, breech-loading cartridge case.
11-inch Sutton.....	205	100 pounds.....	Mark VII, delay...	4,500	Experimental; loading same as for 240 mm.

¹ Approximately.*Trench mortar bombs (European manufacture).*

Bomb.	Propellant.	Fuze.	Packing.	Remarks.
3-inch Stokes (English manufacture).	One, 95 grain ballistite cartridge, four 110-grain cordite rings.	Pistol head or No. 146 (The Allways).	Three rounds complete or three rounds with propellant separate.	Note carefully if cartridges and rings present.
58-mm. (French manufacture).	Bags with igniters base charge 60 grams, ballistite compound, B Z, and two "apoints" of 25 grams weakened ballistite, "A.T.T."	10 per cent railway, 20 per cent P. R. 1916 nondelay, 30 per cent P. R. 1916 delay, 40 per cent 1899-1915.	Two-L. S. bombs in crate, one-P. L. 8 $\frac{1}{2}$ crate, charges and accessories except fuzes 50, 57, and 60, box.	Furnish 110 per cent simplified obturating primers.
6-inch Newton (English manufacture).	Four 1 oz. bags gun-cotton yarn, two 1 $\frac{1}{2}$ -ounce bags flaked cordite.	100 per cent No. 110.	Bomb in crate, 20 charges one box, 20 sets accessories one box.	
240-mm. (French manufacture).	In 155-mm. brass cases; charge I 1,300 grams ballistite; charge II 900 grams ballistite.	100 per cent P. R. 1916, delay.	Bomb in crate, 10 charges in box, 30 fuzes in box.	



FIG. 95.—3-inch Stokes trench mortar. Loading for firing. The nature of the projectile can be seen by the shell held by the soldier on the left.

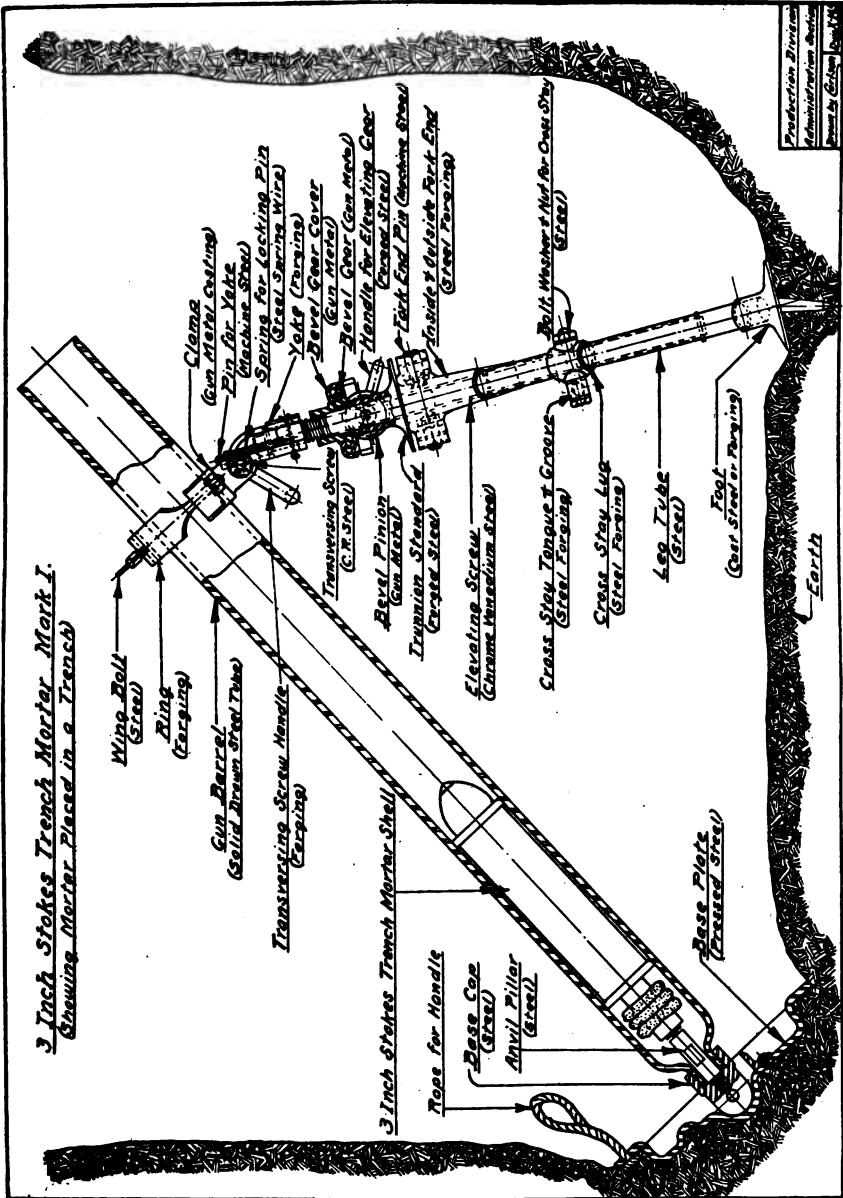
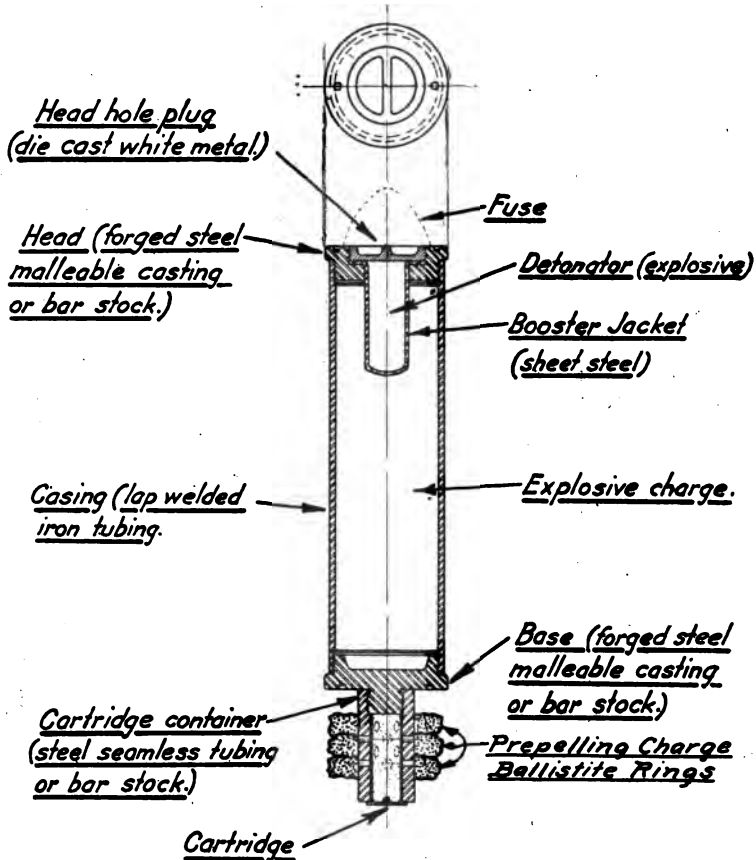

Fig. 96.—Method of placing 3-inch Stokes mortar in trench.

3 INCH STOKES TRENCH MORTAR SHELL.

Tubing Construction



Production Division
Gun Section
Engineering
James F. Luan,
Chief, Ordnance
Drawn by Arthur May #K-107

FIG. 97.—Detail of 3-inch Stokes trench mortar shell.

3-inch Stokes trench mortar.—The 3-inch Stokes trench mortar is an adaptation of a British device with the same name. It consists essentially of a barrel weighing 43 pounds, a mounting weighing 37 pounds, and a base plate weighing 28 pounds. These three parts, which can easily be transported to the front line by hand, are assembled when the gun is put in position. In spite of its light weight,

the mortar has a range of from 100 to 800 yards. Its mechanism is simple. The shell, which has a blank cartridge attached to one end, is dropped into the muzzle of the piece, cartridge end first. It slides easily downward to the breech, where the percussion cap of the cartridge strikes a firing pin or anvil pillar fixed in the base of the barrel. This fires the cartridge, which propels the shell from the gun. The cartridge case, being attached to the shell, leaves the barrel along with it. To obtain a range of more than 300 yards one, two, or three ballistite rings are placed around the cartridge as a supplementary propellant. When the shell strikes the ground a percussion fuze explodes the detonator, by means of which the booster charge and the bursting charge are in turn set off. The normal rate of firing of the gun is 10 rounds per minute.

4-inch Stokes trench mortar.—This mortar is adopted from the English and is the same as the 3-inch Stokes trench mortar in general design, with the exception of the size and weight of the barrel and the weight of the legs. It is used to fire gas, incendiary, and smoke shells, and, on account of the rapidity with which it can be handled, it is considered the best trench mortar for these particular shells. The rate of firing is 25 per minute. This makes it possible to spread 175 pounds of gas per minute. Like the 3-inch Stokes trench mortar, the 4-inch mortar consists of a barrel, a mounting, and a base, with a total weight of 132 pounds. The propelling charge consists of a 12-gauge cartridge containing 150 grains of cordite and three rings containing 250 grains of cordite each. The mortar is fired in the same manner as the 3-inch Stokes trench mortar; that is, the shell is dropped into the barrel, and the cartridge is fired by striking an anvil, which is screwed in the bottom of the barrel, the rings being fired by the flash of the bursting charge of the cartridge passing through holes in the cartridge container. On the gas shell an instantaneous fuze is used, while on the incendiary and smoke shells time fuzes are used. The maximum range, which is obtained by using the three cordite rings, is 1,160 yards.

6-inch trench mortar.—The 6-inch trench mortar, adopted from the English 6-inch Newton trench mortar, is a medium-weight mortar firing a 52-pound cast-iron shell loaded with high-explosive to a range of about 1,800 yards. It consists of a steel base mounted upon a wooden platform and a barrel which rests in a spherical recess and is supported and adjusted by guys with adjusting screws. The shell is of the vaned type. The propellant charge, ignited by a special cartridge, consists of bags of cordite or ballistite and gun-cotton yarn, the bags being held between the vanes by means of wire. This mortar, like the 3-inch and 4-inch Stokes trench mortar, is fired by dropping the shells into the barrel. It is used with an instantaneous fuze, primarily for breaking up wire entanglements.

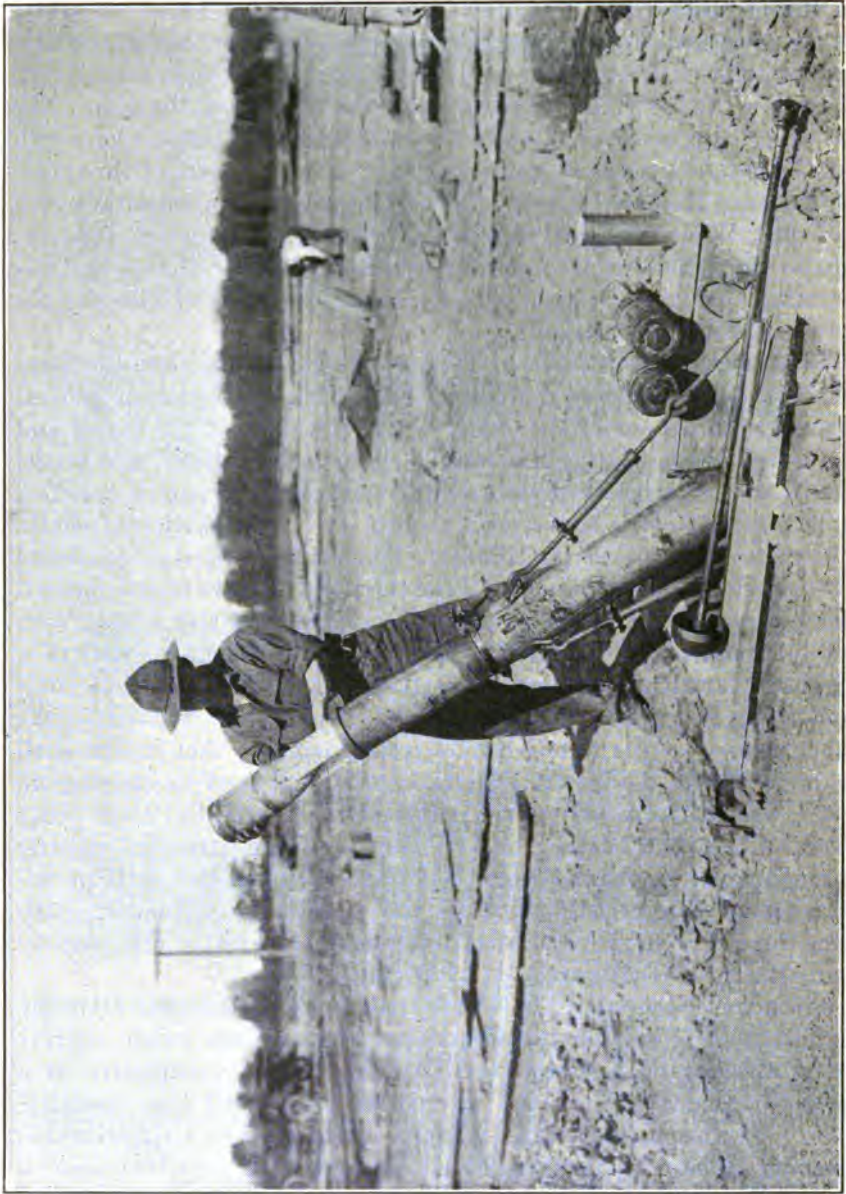

FIG. 86.—4-inch trench mortar. Loading projectile and charge. Note in the foreground gas ejector employed as a piston to expel gases after a discharge.

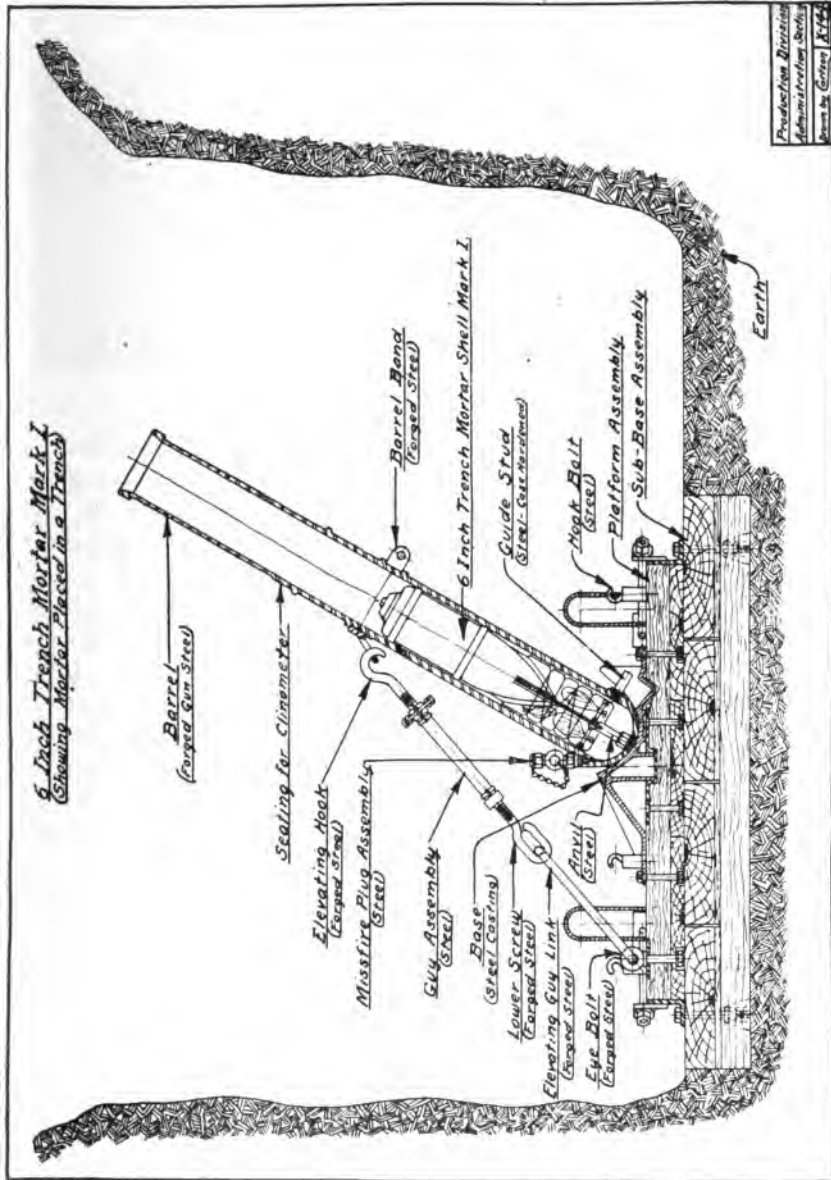

FIG. 96.—Method of placing 6-inch mortar in trench.

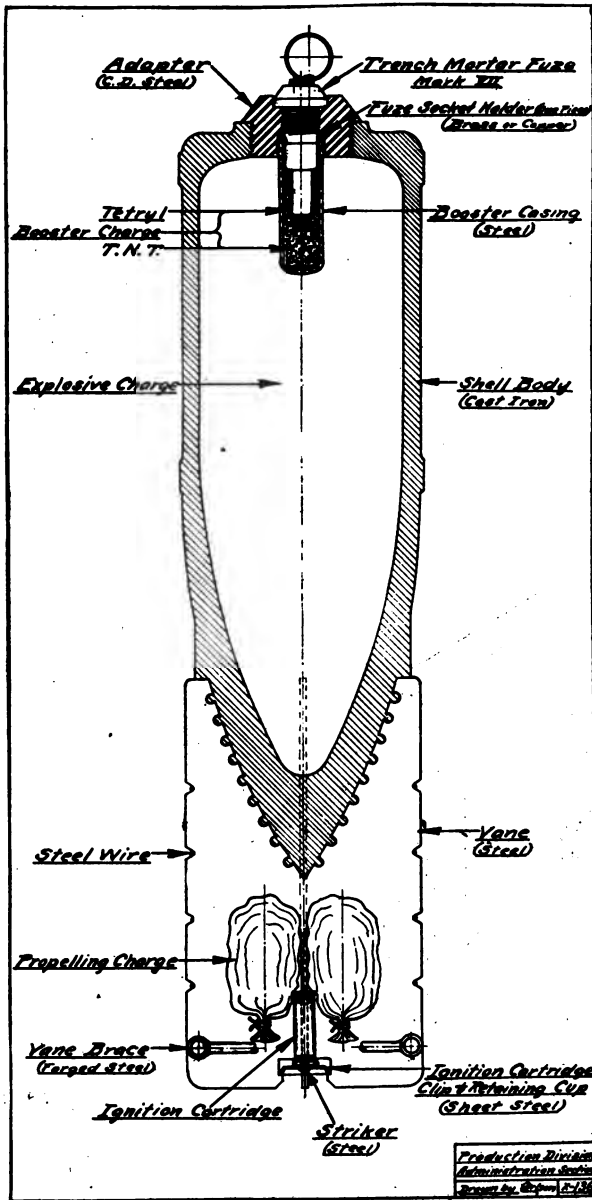

FIG. 100.—Detail of 6-inch trench mortar shell, Mark I.

6-inch trench mortar shell, Mark I.—The shell or bomb is made of gray iron with its front end threaded for an adapter, and the rear end fitted with steel vanes which serve to keep the bombs steady in flight. Steel wire is wrapped around the vanes to hold the powder bags in position. The rear ends of the vanes are strengthened by connecting vane braces of forged steel. The bomb weighs $39\frac{1}{2}$ pounds and the explosive charge is about 13 pounds of TNT.



FIG. 101.—Three craters formed by explosion of 6-inch Newton projectiles fired at same angle with delay fuze.

Propelling charge.—The propelling charge consists of 1-ounce bags of guncotton yarn and similar bags of ballistite tucked between the vanes in the wire wrapping according to the number used with the range desired. Four guncotton bags and two ballistite bags constitute the maximum charge and the range varies from 100 to 1,600 yards. The propelling charge is ignited by an igniting cartridge which contains $12\frac{1}{2}$ grains of guncotton yarn dusted with as much meal and black powder as it will hold.

Operation.—In firing this mortar a fuze of the Mark VII type shown on page 243 is screwed into the adapter, powder bags pushed between the wire vanes of the cartridge clip, and cartridge put into place after proper laying of the mortar, in which process a clinometer of special form is employed, and the shell is dropped into the muzzle of the barrel, fuze first, sliding down until it strikes the anvil, which is kept tight by a long-handled socket wrench. Contact with the anvil sets off the percussion element in the cartridge, which in turn ignites the powder and guncotton bags. After each round the gas ejector is pushed down the bore to force out the hot gas.

Bed.—The bed consists of a cast steel base plug secured to the platform by a boss on the inside of the plug. The base plug is prepared on the other side with a socket for the reception of the rounded end of the barrel. The lifting or traversing guys are arranged on the right end. Left and right upper sides, respectively, of the bed, secured at one end with eyebolts. The other ends of the guys are attached to the loops on the barrel when the latter is mounted in position on the bed. For the purpose of transportation hooks are placed on the bed, to which the ends of the guys are engaged and the barrel dismounted. Four wire handles are provided on the side of the bed to facilitate transportation.



FIG. 102.—240-mm. trench mortar. Loading with projectiles. These are carried in a tray with handles.

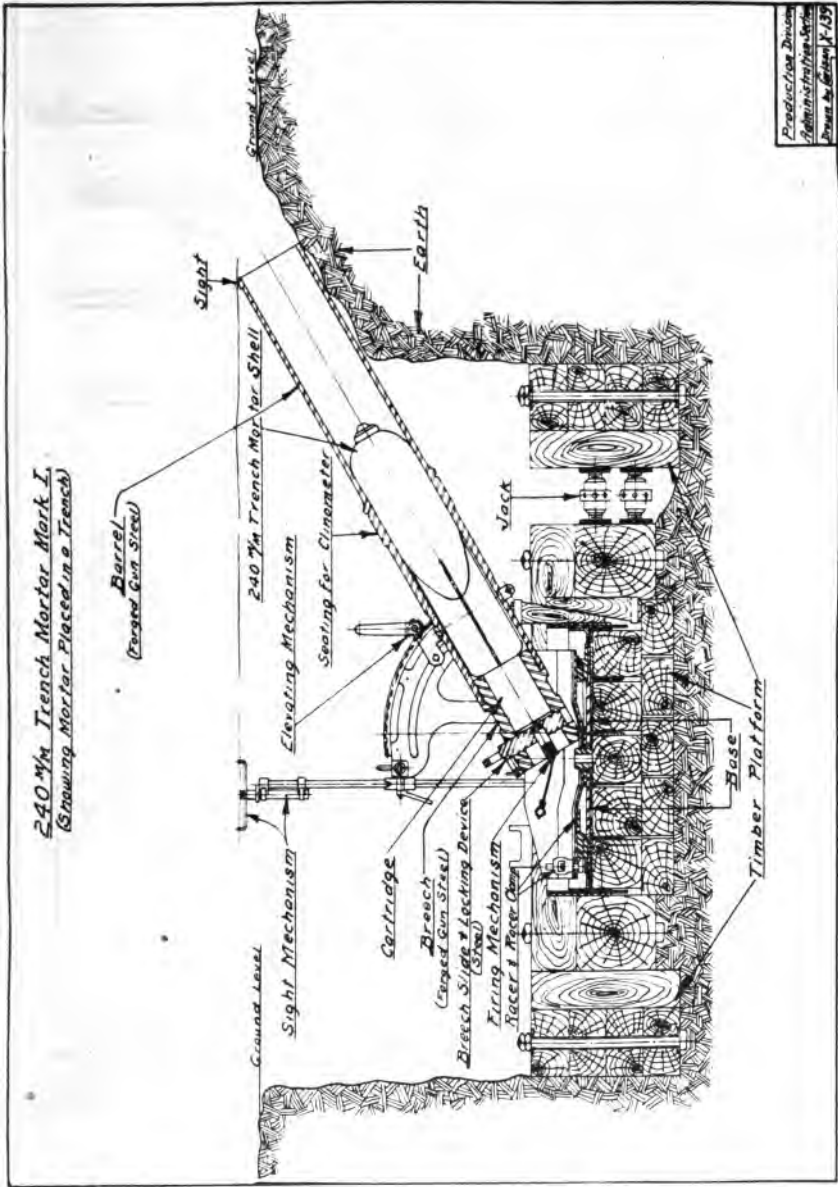

*240 mm Trench Mortar Mark I.
(Showing Mortar Placed in a Trench)*

FIG. 103.—Method of placing 240-mm. mortar in trench.

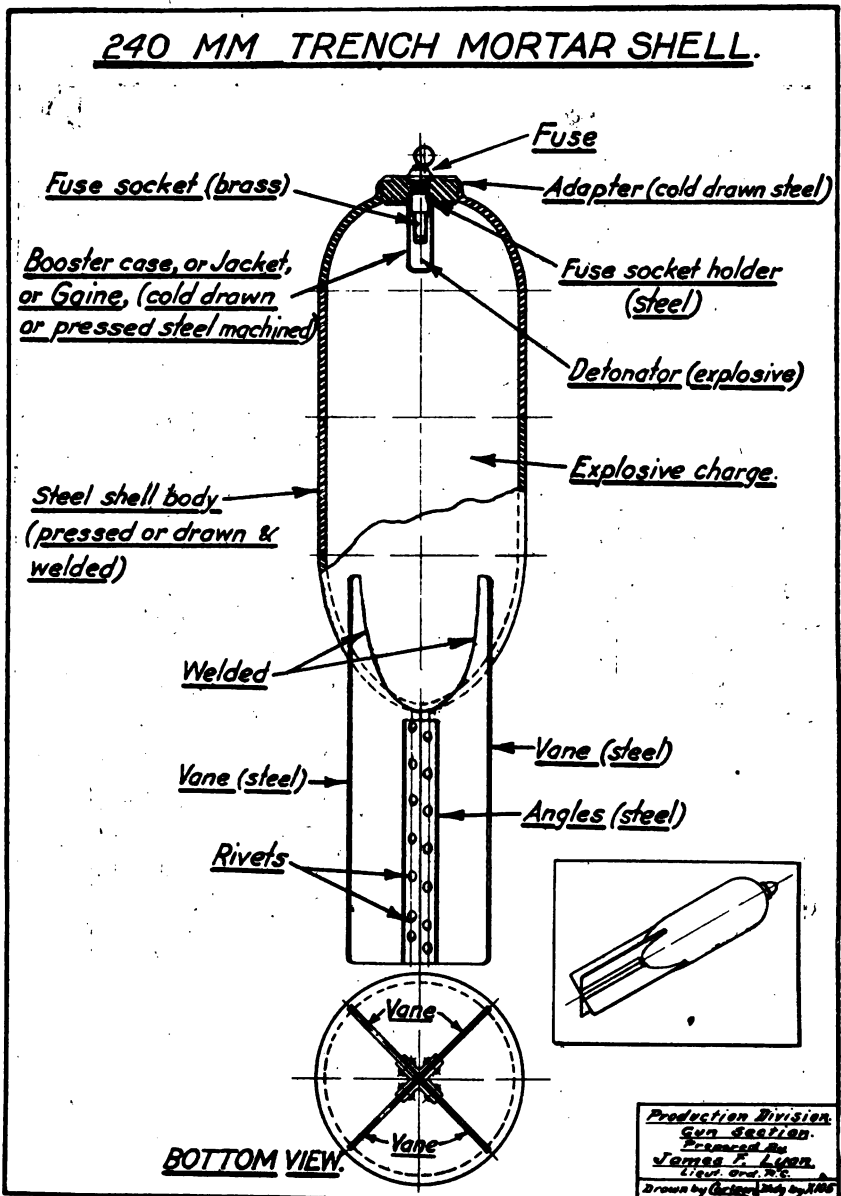

FIG. 104.—Detail of 240-mm. trench mortar shell.

The 240-mm. trench mortar.—This weapon is modeled on the French 240-mm. short trench mortar. This mortar weighs approximately 7,500 pounds, of which 5,500 pounds are for the wooden platform. The barrel is unrifled. The maximum range is about 2,400 yards and with a low charge of about 660 yards. The mortar is muzzle loading for the shell and breech loading for the charge.

Trench Mortar Fuze Mark VII.

FIG. 105.—Detail of trench mortar fuze, Mark VII.

Mark VII trench mortar fuze.—This fuze modeled on the French fuze, Mark IV, was supplied with a new interior mechanism where a firing pin ordinarily held safe by a small wire is thrown into alignment with the primer when the shell is accelerated. This fuze is of both the delay and nondelay types, the former for the 240-mm. trench mortar, and both types for the 6-inch trench mortar.

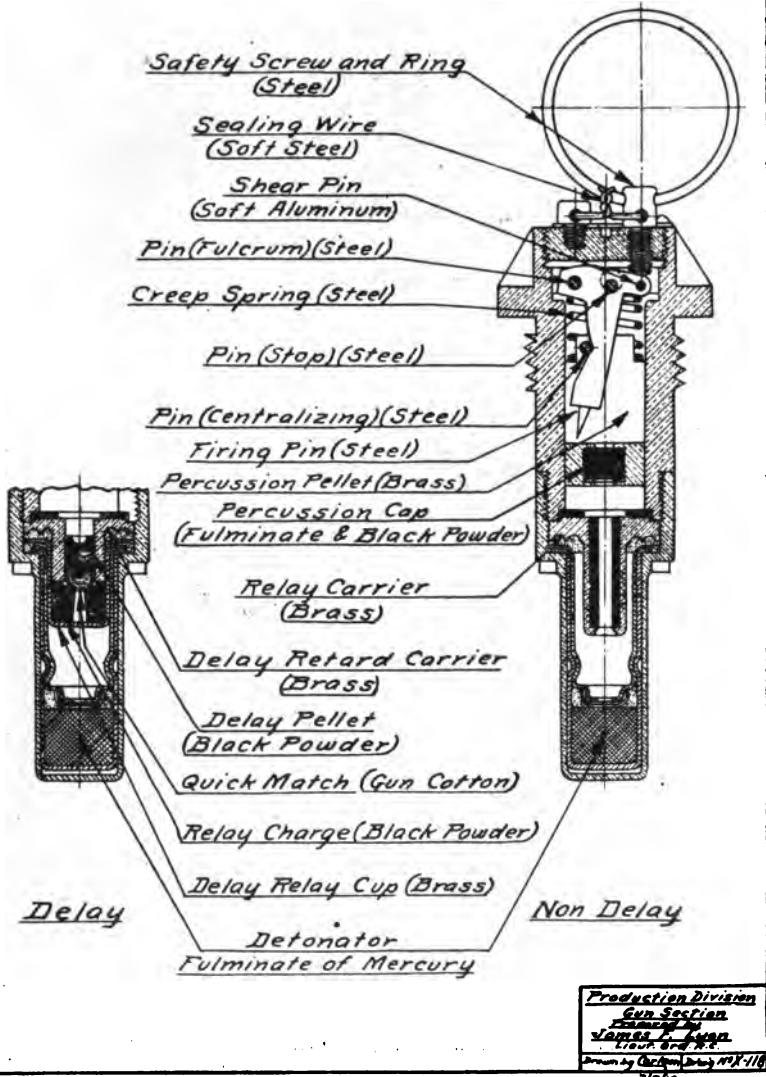
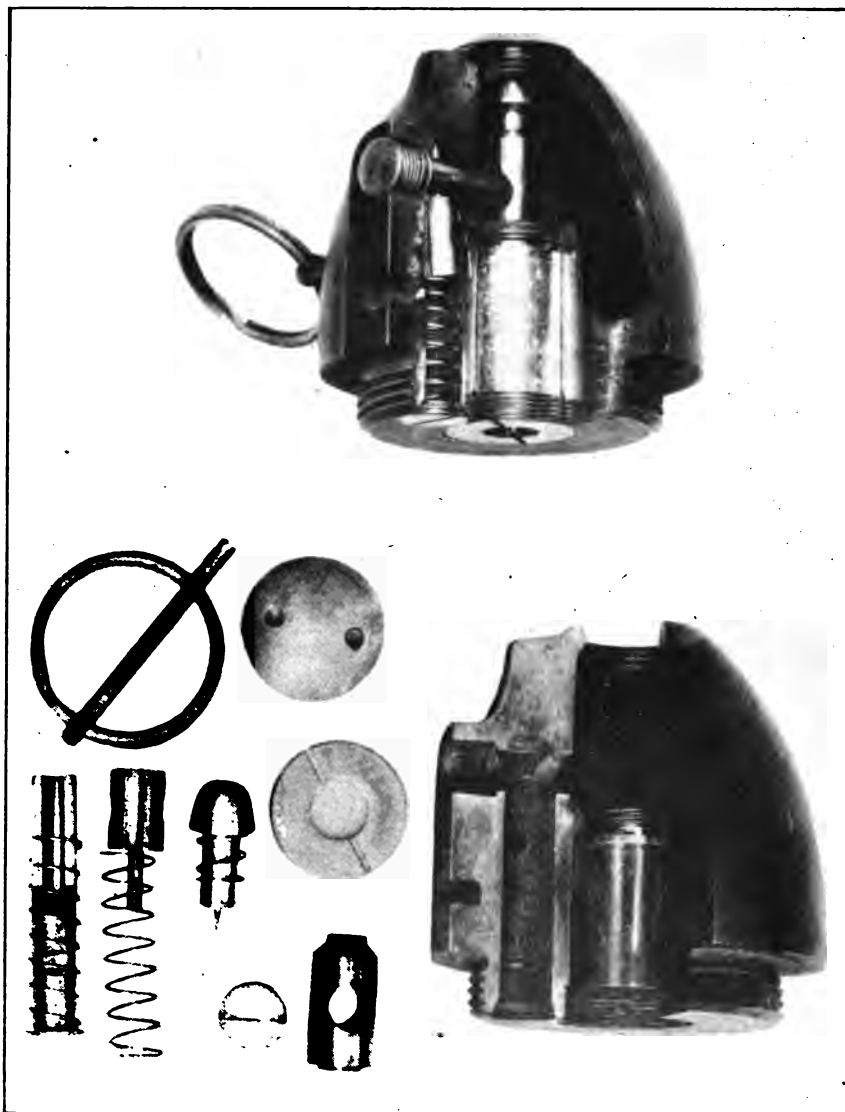

FIG. 106.—Trench mortar fuze, Mark VI. Assembly and section.

Mark VI trench mortar fuze.—Used with the 3-inch and 4-inch Stokes trench mortar shell, this fuze has a double percussion element which functions positively irrespective of the position in which the shell strikes on impact. It was designed by Lieut. F. A. Sutton, R. E., and improved by Lieut. Col. E. J. W. Ragsdale, U. S. A. The safety pin and ring must be removed before firing, leaving the set-back pellet supported by friction until the shell leaves the barrel. As acceleration of the shell starts the safety fork is ejected and the striker is

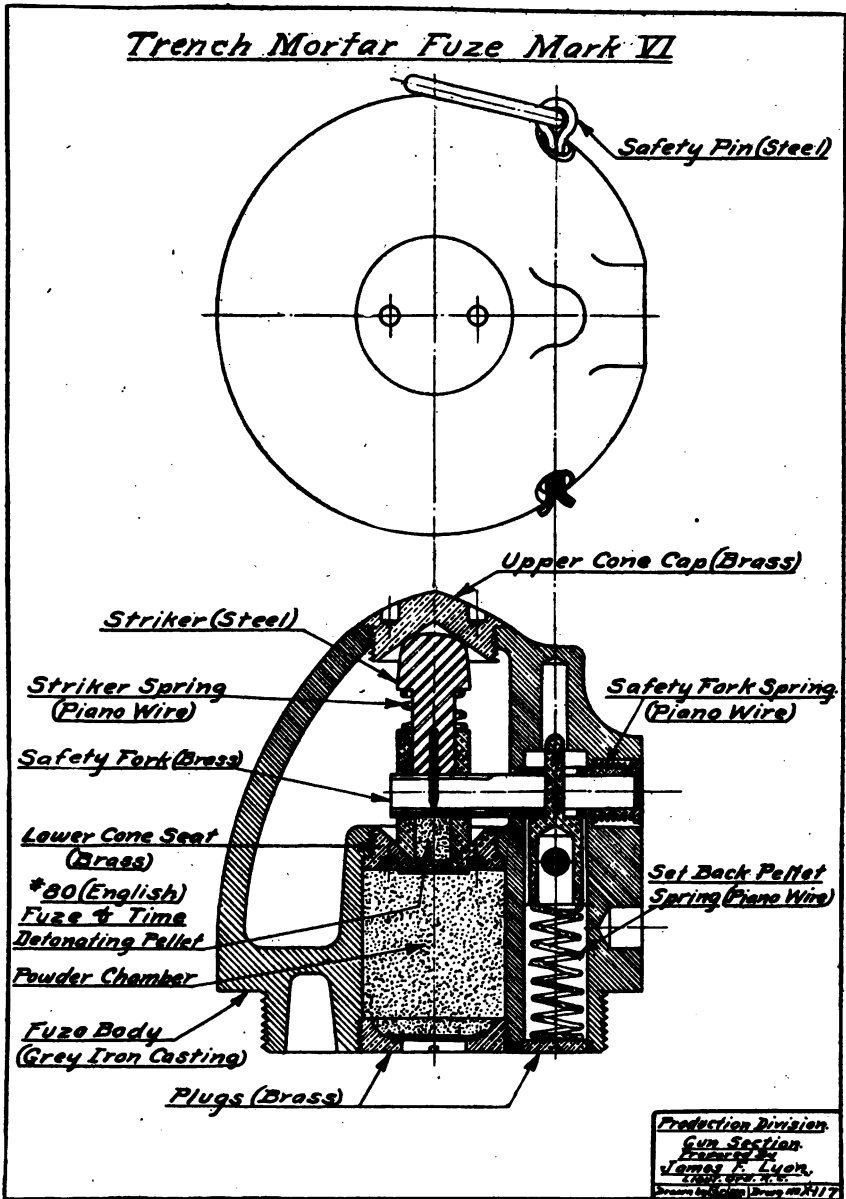

FIG. 107.—Detail of trench mortar fuze, Mark VI.

free to reach the detonating pellet or percussion element when impact takes place. This ignites shrapnel powder in the powder chamber and the flash then passes to the detonator and booster. The booster charge is contained in a cardboard tube and consists of two pellets of tetryl which fit around the detonator and one pellet of TNT below the detonator. The tube is closed with felt discs.

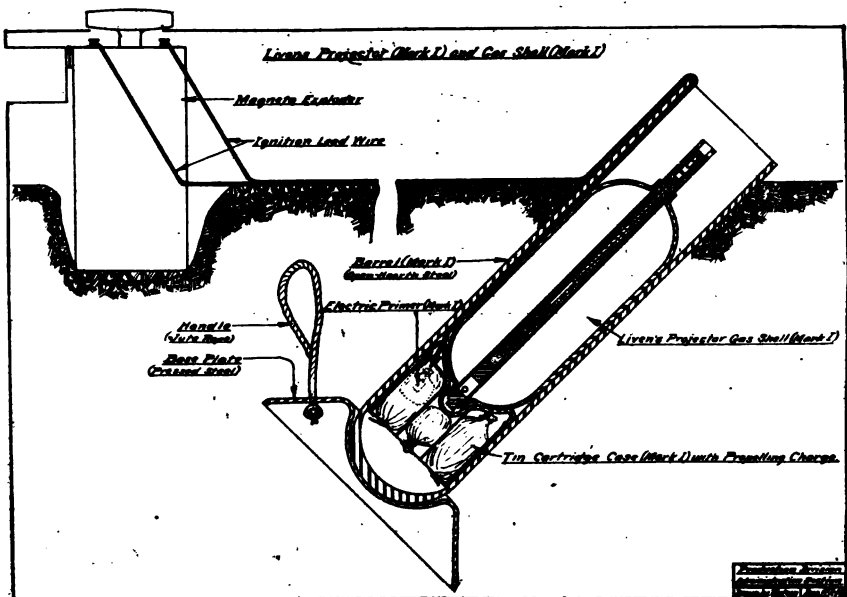

FIG. 108.—Method of placing Livens projector.

Livens projector.—The Livens projector is a mortar of the simplest type, which is used to discharge gas and incendiary shells. It consists of a straight cylindrical barrel of steel and a pressed-steel base, in the center of which is a concave recess shaped to receive the rounded breech of the mortar. The base is placed at the bottom of a hole dug to the proper depth some distance in front of the trenches. The barrel is placed therein and inclined at the proper angle; the earth is then replaced to support the projector and at the same time effectually conceal it from hostile observation. The muzzle alone remains uncovered. A cartridge case containing a number of bags of powder is dropped into the bottom of the projector with suitable wire connections leading from the electric primer in the powder to the point of operation. The shell is placed in the mortar over the cartridge case, the top of which is shaped to fit the base of the shell. The shell is provided with a length of Bickford fuze, which is ignited when the shell leaves the projector, and a standard type of detonator. A bursting charge of TNT is generally used with the gas shell, which contains a large charge of toxic materials. Black powder is usually employed to secure ignition of the incendiary materials in the incendiary shell, which may consist of cotton-waste balls or jute strands soaked in oil of some spontaneously inflammable mixture.

A large number of Livens projectors are usually placed in the ground, loaded and wired up ready for firing, being covered over with waterproof pieces or paper to keep out water or dust while others are being prepared. When as many have been set up as desired they

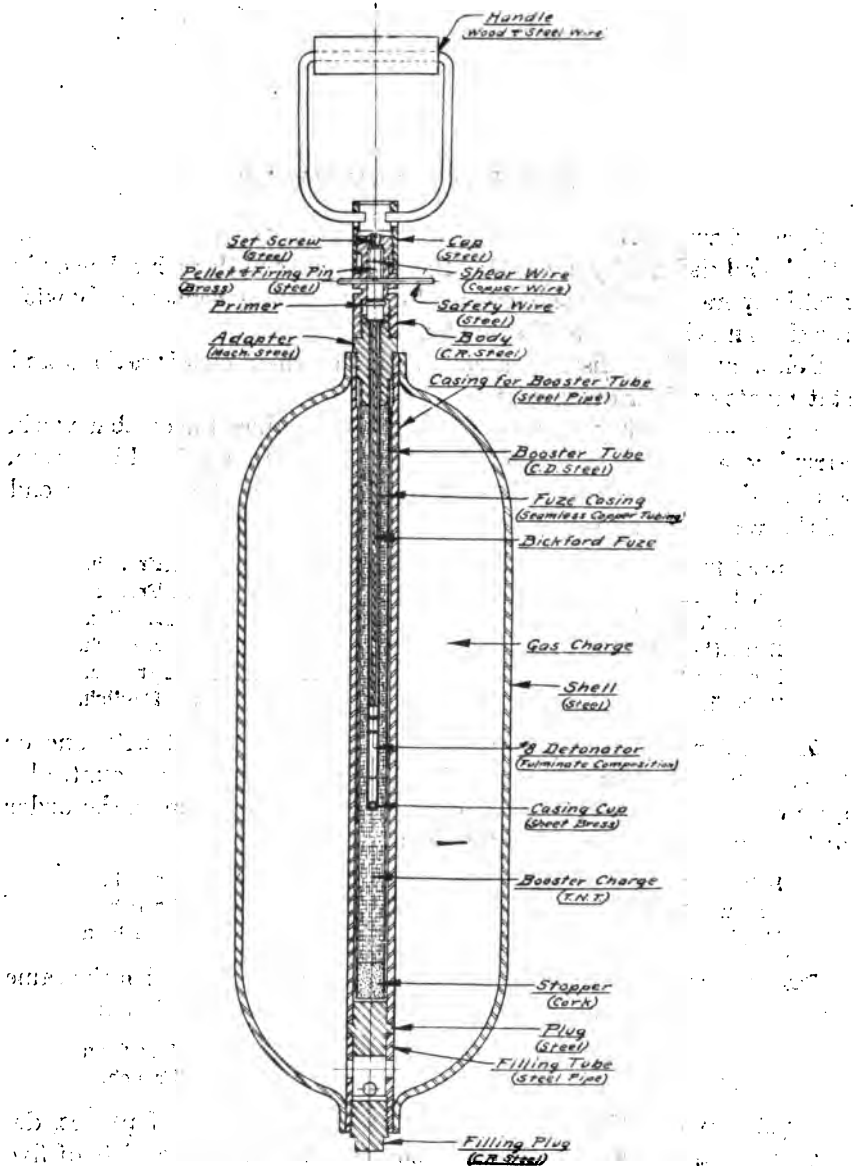

FIG. 109.—Livens projector shell, Mark I—section.

are fired by a blasting machine, the various projectors being connected in parallel and sufficient machines being used to secure proper functioning of the charges. As many as 6,000 or 7,000 of these bombs have been fired at once with but one or two malfunctions. The maximum range is about 2,200 yards with a wide dispersion, but since gas bombs are fired the object is to produce a large volume of gas in certain sections, and a wide dispersion is advantageous.

XI. AIRCRAFT ARMAMENT.

Types of airplanes.—The nature and extent of the armament used in attack and defense by aircraft, either in combat with each other or in hostile operations directed against the ground, vary considerably with the size and character of the airplanes.

Below are given lists of airplanes under their classifications and statements of their armament.

Pursuit.—Pursuit planes are monoplane machines for combat work, carrying generally two synchronized guns. Planes in this group, arranged in the order of their prominence at the front, at the end of the war were as follows:

Spad 13.....	French.
Spad 7.....	French.
Sopwith-Camel.....	English.
Sopwith-Delphin.....	English.
Nieuport 28.....	French.
S. E. 5.....	English.

Observation.—Observation planes are biplanes, armed with one or two synchronized guns and two Lewis guns in a tourelle mount, also a Lewis floor-mounted gun. Planes in use in this group in the order of their prominence were as follows:

Salmson 1 A 2.....	French.
Breguet 14 A 2.....	French.
D. H. 4.....	American.

Day bomber.—Day bombers are also biplane machines with the same armament as observation planes. Types in use at the front:

D. H. 4.....	American.
Breguet 14 B 2.....	French.

Night bomber.—Night bombers are the largest types of planes, designed for carrying heavy loads of bombs. Armament consists of five Lewis guns. Leading types were:

Handley-Page.....	American.
Caproni.....	Italian.

Deliveries had not been made up to the end of the war on the above two types, but a program was prepared for them.

The following planes are capable of being equipped with Cooper quadruple bomb carrier for bombing work in addition to their other work:

- Spad 13.
- Breguet 14 A 2.
- Salmson 1 A 2.

MACHINE GUNS.¹

TABLE 22.—*Machine guns for aircraft installation on American airplanes at end of war.*

Type of gun.	Used as—	Rate of fire per minute.	Increased to—	Remarks.
Vickers.....	Fixed gun synchronized.	450	800	Used entirely to Oct., 1918. Large use planned. Best for combat on pursuit planes; none in use Oct., 1918.
Marlin.....	do.....	750		
Browning.....	do.....	1,000		
Lewis.....	Free gun on tourelle.....	500	650	Very few in use; valuable for balloon attack. Experimental stage only; design for full automatic under way.
11-mm. Vickers.....	Fixed.....	450		
37-mm. cannon.....	Fixed gun on motor.....	(¹)		

¹ Semiautomatic. See description on page 36.

Vickers aircraft.—The Vickers machine gun is always used as a fixed gun, i. e., mounted on the fuselage of an airplane and synchronized to fire between the propeller blades by means of a mechanical or hydraulic gear. All Vickers guns received by the American Expeditionary Force were of the ground type, and therefore it was necessary to alter them in French factories to make them adaptable to aircraft requirements. The water-cooling apparatus was removed, the radiator slit to permit the passage of air, a trigger motor was mounted on the front cover, and the spade grips were removed. Since the normal rate of fire of the Vickers ground gun is about 450 rounds per minute, and it is desirable to have a greater rate of fire, several devices were tested with that end in view. One was designed to be attached to the muzzle of the gun instead of the ground muzzle attachment, which would increase the recoil of the gun and effect an increase in the rate of fire to between 700 and 800 rounds per minute. Two Vickers guns are shown in Fig. 111 on page 256.

Marlin aircraft.—The Marlin aircraft gun is a modification of the Colt ground gun, the lever action of the ground gun being removed and an improved lock mechanism and lock container designed, with the result that it is easily synchronized and readily adaptable to

¹ For fundamental design and construction of machine guns and automatic rifles and their ground use consult Part XIII, machine guns, page 296 et seq.

mounting on planes. All D. H. 4 planes were equipped with Marlins as fixed guns. Arrangements were made to have Spads and Salmsons altered so that Marlins could be mounted on them, and production on these types was taking place toward the end of the war. The rate of fire of the Marlin is much faster than the Vickers. Other planes were being prepared for the Marlin installation also, and it was expected to use primarily Marlins as fixed guns.

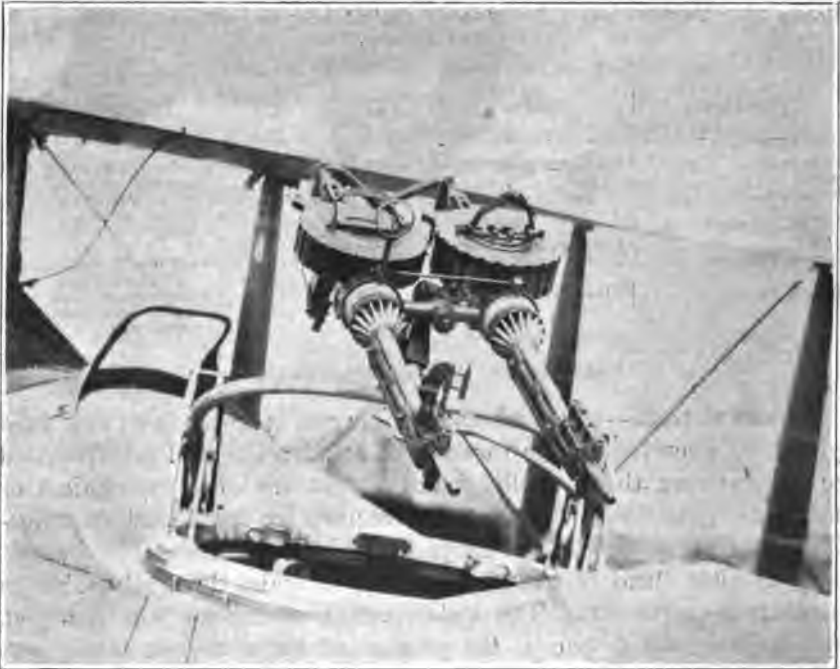

FIG. 110.—Two Lewis Guns mounted in jumelage in a tourelle or turret.

Lewis aircraft.—The Lewis gun, owing to the fact that it can not be readily synchronized, is used entirely as a free gun. At first it was necessary to modify the ground gun to adapt it to air use, but later a standard aircraft type was developed. It is mounted over the observer's seat in biplace planes by means of a scarf ring or tourelle. Two guns are mounted together in a yoke or jumelage, and the rotary action of the tourelle, combined with a joint permitting the perpendicular action of the jumelage, makes possible the aiming of the guns in all directions. Both guns are fired at once by means of a Bowden control. A recoil reinforcer is designed for the Lewis gun also, to make its action more positive and to increase its rate of fire a small extent.

Browning aircraft.—Tests of the Browning aircraft gun were made in England with a view toward determining the efficiency of its ac-

tion under all conditions of flight. Barring certain malfunctions, due to a fault in the workmanship on the gun, which could be easily remedied, it met all conditions with greatest success. No gun heater was found necessary after cold tests. It synchronized exceedingly well, as was shown by a comparative test with the Vickers on the same mounting. The shots grouped in an angle 14 degrees less than that of the Vickers. More tests later were to be made to subject the gun to the most severe conditions imposed in action. It was hoped that ultimately all pursuit planes could be armed with this gun.

11-mm. Vickers.—The 11-mm. Vickers gun is used in the same manner as the .30-caliber Vickers. Only a few were in use near the end of the war, but more were expected from the United States to be mounted on pursuit planes. They are especially desirable for use with incendiary ammunition as balloon destroyers.

Working-in plants.—The acceptance parks installed plants for the working in of all machine guns before they were mounted on planes. In these tests the guns are cleaned thoroughly and fired at the butts. After a maximum of 500 rounds is fired the guns are disassembled and inspected for signs of wear. All parts showing burrs or roughness left in machining are stoned and smoothed up. Any parts showing defects are replaced by new ones. The guns are then oiled and turned over to the installation department for mounting. This working-in plant serves to put guns in the condition of ones which have been fired 20,000 rounds, making them smoothly functioning pieces and removing all possibility of their failing to function through defects in workmanship.

Synchronization tests.—After the gun has been mounted on the plane and the synchronizing gear adjusted the plane is taken to the firing butts, where the gun is operated with the motor running. This serves as a check on the adjustment of the synchronizing gears and prepares the plane for immediate service on its arrival at the front.

37-mm. motor cannon.—The 37-mm. semiautomatic cannon is mounted in the V of a motor with the barrel extending through the hollow propeller hub. The propellers of most airplanes are directly connected to the crank shaft of the motor, which would prevent the installation of the cannon. A plane such as the Spad 13, with the motor driving the propeller through reduction gears, is therefore used in connection with the cannon. This permits the muzzle of the gun to project through the hub of the reduction gear, which drives the propeller. The cannon is semiautomatic; that is, the recoil ejects the empty case and cocks the gun. The gun is loaded and the breech is closed by the pilot. The breech mechanism consists of a block sliding with a vertical motion in the breech housing and a catch to hold the block in its upper position. As the gun returns to battery a cam raises the catch, allowing the block to drop until it strikes

on the base of the extractors, which are pivoted in such a way that their upper parts are forced backward and the empty case is thrown out through the opening in the block. The pilot takes a new cartridge from the rack at the right of his seat and pushes it into the chamber, at the same time raising the block with his fingers, and the loading is completed. The cannon is supplied with both smooth and rifle bore barrels, which are interchangeable. The gun weighs 44 kilograms, has a recoil of 28 centimeters, and a muzzle velocity of 400 meters per second. It is also discussed on page 36. A full automatic 37-mm. gun was in course of development, while, as mentioned before (see page 47), a 75-mm. aircraft gun and mount had been designed.

37-mm. ammunition.—Two types of ammunition—canister for smooth-bore barrels, 37 mm., and high explosive with extra sensitive fuze for rifled barrels—are at present the only ones used with airplane cannon. A number of other types, such as high-explosive armor-piercing shells, canister for rifled bores and incendiary shells, have been developed but are not suitable for airplane cannon. The high-explosive shell with extra sensitive fuze weighs 1.9 pounds. The projectile weighs 1.22 pounds; has a bursting charge of 30 grains of melinite. The extra sensitive fuze used in the projectile is so delicately adjusted that contact with plane fabric is sufficient to detonate the shell. The canister cartridge for smooth bore weighs 1.87 pounds, with a projectile containing 24 balls 16.3 mm. in diameter. The balls are held in a brass case filled with wax, the case being cut so that it breaks apart after leaving the barrel, permitting the balls to spread.

SYNCHRONIZING GEARS.

Synchronizing devices.—The fire of machine guns from aircraft when a fixed mount is used presents special features owing to the peculiar conditions that exist. These are that as the gun is fixed in the axis of the fuselage, aim is secured by pointing the airplane itself, and not by the training of the gun. It must therefore be arranged to fire between the blades of the propeller, which revolves in front of the airplane.

Inasmuch as the propeller revolves much faster than the rate of fire of the gun, it is necessary to provide a timer on the crank shaft of the engine to control the interval of fire, so that the bullets are sent without hitting the blades. An interlocking device for this purpose, consisting generally of a master cam on the crank shaft operating through either mechanical devices or hydraulic mechanism, governs the trigger or discharge action. Naturally, such devices are of considerable mechanical complexity and considerable improvement is still demanded in their design and operation.

Mechanical gears.—An engine cam is attached to the shaft of the airplane in such a way that two impulses are given for every revolution of the shaft. A push rod, riding on this cam, imparts the impulses to an oscillating rod, the other end of which is in contact with the trigger motor through a plunger lever. This plunger lever forces the plunger with firing finger forward, depressing the hand sear and firing the gun. Minor adjustments for wear are made by means of the blind nut on the end of the plunger. To procure proper adjustment of the firing mechanism with reference to the propeller blade, the engine cam is rotated about its fastening on the shaft. The whole mechanism is controlled from the pilot's seat by means of a device known as a Bowden wire, described on a following page, which, on being operated, throws the actuating lever in contact with the push rod. The different types of motors and planes necessitate a great many modifications in this system, but all operate on the same principle.

Hydraulic gears.—The C. C., or Constantinesco, hydraulic gear is mounted on D. H. 4 planes reaching the American Expeditionary Forces from America. In this type of gear a very light oil of non-freezing qualities is used as the conveyor of impulses instead of the mechanical system. A generator, connected to the motor of the airplane, originates an impulse through a piston riding against a cam on the shaft. From this generator lead two pipe lines of different size, the larger one being the main line and the smaller one the secondary line. The main line connects the generator with the trigger motor and the secondary line connects the generator with the reservoir which contains a chamber in which a plunger operates against a strong spring. When this plunger is pulled back by hand, the spring tends to force it back into its seat and thereby sets a pressure of 150 pounds per square inch in the system. The pilot controls the system by means of a Bowden wire control. Pressure on the trigger of the Bowden operates needle valves in the bottom of the reservoir. The pressure set up by the plunger is directed by these valves into the main line through the secondary line, forcing the piston in the generator against the cam on the motor. Impulses are then conveyed through the high-pressure oil to the trigger motor, thence to the gun. When the Bowden is released the pressure is removed from the system, the piston falls back from the cam and no more impulses are generated. The rapidity with which impulses are conveyed through the system is the advantage claimed for this gear. However, it has many weaknesses, owing to the possibilities of the leakage of oil and consequent reduction of pressure. It is necessary to have the system in perfect shape, with no air pockets in the pipe lines, nor loose connections, to have it function properly. Experience has shown that under certain conditions the vibration of the plane in flight is

sufficient to destroy the efficiency of the system. A mechanical gear similar to the ones described above has been experimented with as a substitute for the C. C. gear, and one squadron of D. H. 4 planes is being equipped with such a gear.

MACHINE-GUN MOUNTS AND OTHER ACCESSORIES.

Bowden control.—The Bowden control referred to above is a flexible wire in connection with the synchronizing gear or trigger of a machine gun by means of which the pilot controls the fire of his gun. There are two types of this device. The longer one used for control of the synchronized guns, has its trigger end attached to the pilot's stick within easy reach of his hand, and the other end attached to the control valve of the synchronizing gear. A long Bowden also may be used for a machine gun mounted on the top plane. The cable inside the casing is six-strand wire, one-sixteenth inch in diameter. The casing serves as a protection for the cable and permits of a flexible connection between the two points. In the case of two Lewis guns mounted in jumelage as described below the shorter Bowden is used. With two guns the trigger end is fastened to the grip of the right-hand gun, with the other end fastened to the grip of the left-hand gun, the yoke resting on the trigger. The trigger on the right-hand gun can be pulled and at the same time the trigger of the Bowden pressed, thus operating both guns.

Twin-gun mount.—The twin-gun mount, or jumelage, is the mounting yoke for two Lewis guns. The collars support the guns by gripping them just ahead of the magazine, and the crosspiece is attached by two bolts through the spade grip. This crosspiece with two guns was being replaced by another attachment which includes a shoulder rest, in which the operator braces for aiming. The stem between the yokes fits into a socket in the tourelle or turret.

Single-gun mount.—Two kinds of single-gun mounts have been in use, but the simple collar and stem is the only one now being used. The other consisted of the collar and stem, with the addition of arms to permit further movement of the gun and controlled by a hand-locking lever. It was called the Fourche Articules.

Floor mount.—A floor mount has been designed for mounting a Lewis gun to shoot down through the floor of the Breguet plane. It is operated by the observer, shooting backward and downward, and covers a point which heretofore has had no protection against attack. It is attached to the framework of the plane and two trapdoors are provided through which the gun is put into action.

Scarf ring.—The scarf ring, or tourelle, consists of two rings, one movable on the other. The lower ring is attached to the fuselage of the plane surrounding the rim of the observer's cockpit. The upper ring turns on the lower one. A yoke is mounted on the movable

ring, together with two arcs, with notches cut on the underside. Two lugs on the yoke engage the notches on the arcs. The hand lever at the top of the yoke controls the action of the tourelle in two movements. On being pressed halfway down it releases the upper ring from the lower one, permitting its rotation. Pressed all the way down, it releases the lugs from the notches in the arcs and permits the yoke to be raised or lowered on its hinge. Two elastics attached to the top of the arcs and looped around the base of the yoke serve to ease the yoke when it is released from the supporting arcs and permit the yoke to be raised and lowered on its hinge. The socket near the hand lever receives the stem of the mounts, which are locked in position by a spring to prevent the mount from jumping out of the socket. The American tourelle is essentially the same as the French, except that the arcs have their notches on the top.

Gunner's belt.—The gunner's belt is a leather belt which fastens about the observer's waist. Two straps connect the waist belt with the tourelle, permitting the observer to turn with the tourelle, and serving as a safety during maneuvers of the plane.

Ammunition box.—The ammunition box is the storage space for the belt of ammunition used in the synchronized gun. Its shape is varied in each type of plane used, for it must be adaptable to the space given after the motor and guns are installed. The loaded belt is stored in this box and is led up to the gun through a chute which bears against the feed box of the gun.

Ammunition links.—Disintegrating links are universally used on machine guns in the air. These are illustrated on page 304. Prideaux links on which the links for the American guns were modeled, were also used in many cases particularly before the Marlin links were developed to a satisfactory point.

Shell-ejection chute.—The shell-ejection chute is used in connection with the ammunition box installation. It leads out from the ejection side of the gun, receiving the ejected shells and discharging them out of the side of the fuselage.

Shell-ejection tube.—Shell-ejection tubes are no longer used, having been replaced by the chutes, which are more practical. This device consisted of a small tube three-fourths of an inch in diameter, which led the ejected shells from the Vickers gun. It was attached directly to the gun.

Shell-ejection bag.—The shell-ejection bags are used in connection with the Lewis gun only. They are made in two sizes—47 and 97 round. Fastened over the ejection slot, they receive the spent cartridges as they are ejected from the gun. They prevent injury to the observer from flying shells and also prevent shells getting in the mechanism.

Lewis magazine.—Lewis magazines are made in two sizes—47 and 97 round. The advantages of the 97-round magazine are obvious, as its larger capacity permits a greater number of rounds to be fired before changing magazines. Five magazines are generally carried in a rack convenient to the gunners. A rounds indicator could be attached to the top of the magazine to indicate to the gunner approximately how many rounds were in the magazine, without the necessity of his taking it off the gun.

Electrical machine gun heaters.—Gun heaters for Marlin, Lewis, Vickers, and Browning aircraft machine guns have been developed and ordered. It was planned to supply all aircraft machine guns with these heaters, which were found necessary by the British for use in cold weather and high altitudes. The capacity of these heaters is 36 watts, with the exception of the Marlin, which is 60 watts, and they are operated from a 12-volt generator, driven by small wind propellers mounted on the landing gear of the plane. The Vickers heater is attached to the gun at the cam on either side of the gun, making two units of 16 volts 25 watts each. Power is obtained from the motor. The Lewis heater is attached under the feed cover, and consists of one unit of 16 volts 36 watts.

FIXED MACHINE GUN SIGHTS.

5-inch ring and bead sight.—The 5-inch ring and bead sight is mounted for use with the fixed machine guns, either on the gun itself or on the plane. The first consideration is, of course, the ease of use



FIG. 111.—Two Vickers guns mounted parallel to motor axis of Spad XIII airplane.

by the pilot. The ring, 5 inches in diameter, with a smaller ring 1 inch in diameter suspended in its center, is mounted at a distance of 38 inches from the gunner's eye. The back sight, consisting of a

small red bead mounted on a conical steel pin, 3 inches high is placed at a convenient distance between the ring and the pilot's eye. With the target flying in a line dead ahead, the smaller ring is used at point blank fire, and with the target crossing the line of sight, which is also the line of flight, the outer ring is used as a basis of estimating the proper deflection, allowing for the course of the target and the flight of the bullets. The size of the ring and its distance from the eye is so fixed that the correct line of sight of an enemy plane, when flying at right angles to the line of sight at 110 miles per hour, will be found when the target is sighted at the outer circumference of the ring, flying toward the center, the bead centered on the small ring. These data are based on the use of American ammunition.

Chretien sight.—The Chretien sight is a French telescope sight which is mounted with the line of sight parallel to the axis of the bore of the gun. It is 1 inch in diameter and 9 inches long. It has no magnifying qualities, but serves to project upon the field of vision a system of etched lines in the shape of a small central circle, with a larger one, divided by 12 radial lines which extend on either side of the outer circle. It is used in exactly the same manner as the 5-inch ring and bead sight, but serves as a long-range sight, while the ring and bead is for closer quarters. It is not much desired by pilots, for it is too small and does not afford a good field of vision. It is also most liable to become filmed with flying oil from the motor and rendered useless.

Aldis sight.—The Aldis sight is the English adaptation of the Chretien and differs in size as well as in the character of the etched lines used. It is 1.8 inches in diameter and 25.2 inches long. The lines are shown as several circles of different diameters with two small segments of circles making a V-shaped center. An elaborate chart is used to instruct the pilot so that he may become accustomed to judging the distance of the target by its size as it appears against the etched lines, as well as its speed and the proper location on the sight to obtain a hit. It is much desired by pursuit pilots, as it affords a large field of vision. The few Aldis sights which were supplied from America were distributed among the pursuit squadrons. They are equipped with a cover for the front lens, with a spring hinge. The cover is pulled down by a small cable convenient to the pilot and the spring serves to snap it back into place when released. This cover serves to protect the front lens from flying oil.

FREE MACHINE GUN SIGHTS.

Norman wind vane sight.—The Norman wind vane sight is used in connection with the Lewis guns mounted in the tourelle to compensate for the deflections due to the movement of the target as well as

that of the guns. The 2½-inch ring sight, mounted at 19 inches from the gunner's eye, provides for the motion of the target, and the wind vane provides for the deflection of the bullet due to the motion of the plane. The front sight mounted on the barrel or radiator 38 inches from the eye consists of a bead mounted on a stem. This stem is hinged by means of two arms to a rotating support and a vane. The rotating support is fitted into the socket of a fixed base which is attached to the gun. The motion of the plane brings the vane to the rear and the bead to the front, thus making an automatic adjustment for the deflection given the bullet by the lateral motion of the gun. The rear ring is used as is the ring of the 5-inch ring and bead sight, to allow for the flight of the target. The sight is adjusted for a speed of 110 miles per hour.

Base for Norman wind vane sight.—An aluminum base has been designed with four sockets for use on the Lewis gun. It is attached to the muzzle of the gun, and the four sockets serve as an adjustment for the speed of the plane. A slower speed will require the sight to be moved to the rear, thus shortening the angle of sight which compensates for the deflection of the bullet imparted by the slower moving plane. The rear socket is for a speed of 80 miles per hour, as used with the 110 miles per hour sight.

Bases for 5-inch ring and bead sights.—Various styles of bases are used for the 5-inch ring and bead sight on planes. The squadron armament officer is often called upon to devise a special base to suit the individual pilot, and makes every effort to conform to his wishes.

AERIAL DROP BOMBS.

TABLE 23.—*Bombs in use by the allies in 1918.*

Kind.	Size.	Weight.	Fuze.	Charge.	Suspension.
Fragmentation:		<i>Pounds.</i>			
90-mm.....	24 inches long, 3½ inches diameter.	20.3	Nose instantaneous	M. M. N. ¹ ..	Horizontal.
90-mm., with Gros-Andreau key support.	22 inches long, 3½ inches diameter.	24.7do.....do. ¹	Horizontal or vertical.
Cooper (English)...	24.4 inches long, 5.12 inches diameter.	24do.....	Amatol...	Horizontal.
Demolition:					
115 mm. long...	46½ inches long, 4½ inches diameter.	44.5	Tail delay.....	M. M. N. ¹ ..	Do.
112-pound (English).	29.1 inches long.....	106	Nose and tail delay	Amatol...	Vertical or horizontal.
230-pound (English).	50.5 inches long, 10 inches diameter.	230	Tail delay.....do.....	Horizontal.
Penetration:					
155 bis.....	48 inches long, 6 inches diameter.	91.3do.....	M. M. N. ¹ ..	Do.
155 mm.....	32½ inches long, 6 inches diameter.	88	Tail instantaneousdo. ¹	Do.
Incendiary:					
Chanard.....	25.5 inches long, 4.7 inches diameter.	22	Special.....		Horizontal or vertical.
Illuminating:					
Michelin (parachute flare).	38.5 inches long, 4.5 inches diameter.	23.5do.....		Horizontal.
Bourges (parachute flare).	12.2 inches long, 1.3 inches diameter.	7.75do.....		None.

¹ Melinite, 70 per cent; mononitronaphthaline, 30 per cent; TNT., 20 per cent; ammonium nitrate, 80 per cent.

TABLE 24.—Aerial drop bombs, Ordnance Department, United States Army, November 19, 1918.

Designation of bomb.	Total weight.	Weight of casing.	Weight of charge.	Minimum thickness of casing.	Maximum diameter.	Overall length.	Firing mechanism.		Method of stowing.				Remarks.
							Type.	Delay in seconds.	For United States horizontal traps.		British vertical traps, carrying lug on nose of bomb.	British horizontal traps, carrying lug on body of bomb.	
									Strap on trap.	Double loops on bombs.			
	Lbs.	Lbs.	Lbs.	Inches.	Inches.	Inches.	Noes.	Tail.	Yes or No.	Yes (except first 12,000).	Yes or No.	Yes or No.	
Demolition: Mark I.....	104	52	52	1	7 1/2	50	IV or VII.	III.....	1 and 1.....	Yes.....	Yes (except first 12,000).	Auxiliary band and loop.	
Mark II.....	22	12 1/2	9 1/2	1 1/2	4 1/2	28 1/2	I.....	1.....	do.	None.	None.	Production stopped.
Mark III.....	55 1/2	27 1/2	28	6	12.20	36 1/2	IV or VII.	2.....	1 1/2-15.....	do.	do.	do.	
Mark IV.....	260	140	120	1 1/2	16.53	63	IV or VII.	2.....	1 1/2-15.....	do.	do.	Auxiliary band and loop.	
Mark V.....	550	270	280	1 1/2	16.53	63	IV or VII.	2.....	1 1/2-15.....	do.	do.	Yes.	
Mark I-A.....	105	65	40	1 1/2	7 1/2	39	IV or VII.	5.....	1 1/2-15.....	Yes.	Yes.	do.	Not yet authorized.
Mark IV-A.....	225	135	90	1 1/2	10.18	49	IV or VII.	5.....	1 1/2-15.....	None.	None.	do.	Do.
Mark V-A.....	560	320	240	1 1/2	12.20	50	IV or VII.	6.....	1 1/2-15.....	do.	do.	do.	Do.
Mark VI-A.....	1,000	560	450	1 1/2	20.875	63 1/2	IV or VII.	6.....	1 1/2-15.....	do.	do.	do.	Do.
Fragmentation: Mark I.....	94	80 1/2	12 1/2	5.55	6	58	(1)	Instantaneous.	Yes.	None.	None.	Do.
Mark II.....	19	17 1/2	1 1/2	3.03	2.952	30	(1)	do.	do.	do.	Tall loop.	
Mark II-A.....	49	17 1/2	1 1/2	.8225	3	30	(1)	do.	do.	do.	do.	
Mark III.....	49	45	6	.4825	4.7	50 1/2	(1)	do.	do.	do.	None.	
Mark II-B.....	24	20	4	1 1/2	5.12	24 1/2	Value.	do.	None.	do.	Tall loop.	Cooper.
Bealov heavy drop bomb.	68	82	11	1 1/2	6	80	(2)	do.	Special trap.	None.	None.	Production stopped.
Incendiary: Mark I.....	40	20	20	.02	6	38.2	(2)	(2)	do. 4	Yes.	None.	do.	Do.
Mark II.....	46	20	26	.06	6	37.2	(2)	None.	3 seconds.	do.	Auxiliary.	do.	10 pounds thermite; 16 pounds solid oil.
Mark III.....	100	50	50	1 1/2	7 1/2	48 1/2	(2)	(2)	do.	do.	Yes.	Auxiliary band and loop.	Not yet authorized.

1 Point detonating No. 11.

2 Service cartridge.

3 Percussion.

4 Or slight delay.

5 Simple percussion.

AERIAL DROP BOMBS.

Nature and use.—The perfection of the airplane engine, and the corresponding increase in the carrying capacity of the plane have resulted in the rapid development of bombing operations into a most active and efficient arm of modern warfare. The tactical advantages of bombing are limited only by the number of planes and bombs available and the degree of accuracy with which the targets are covered.

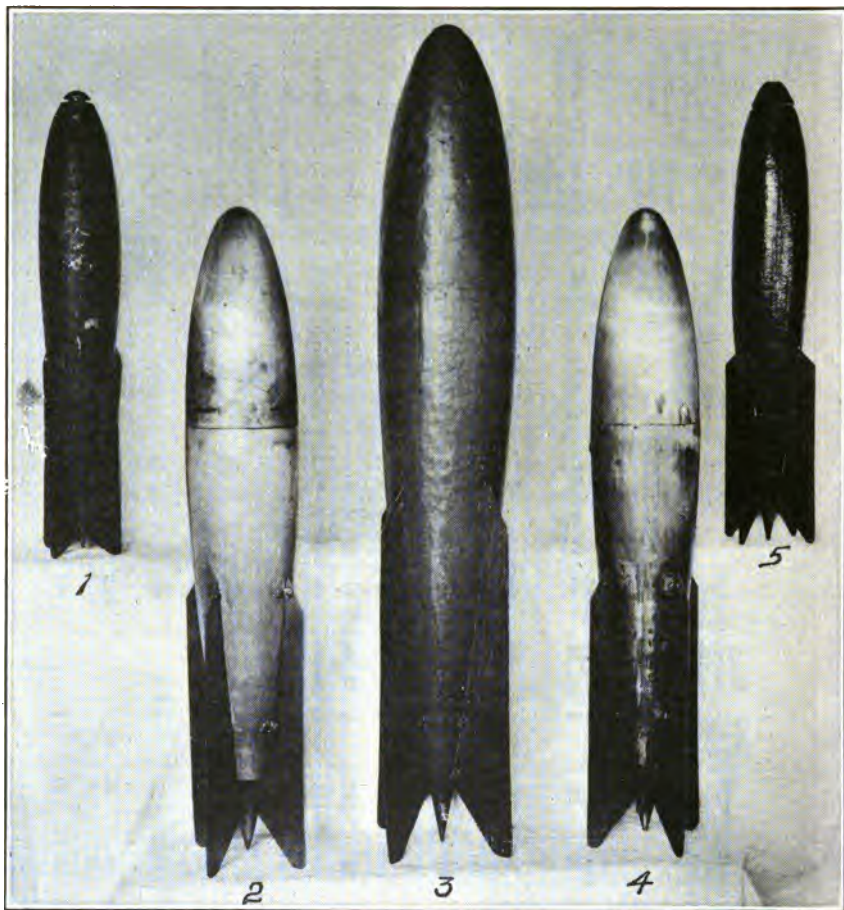

FIG. 112.—Types of aerial drop bombs. 1. Mark II, demolition drop bomb. 2. Mark II, incendiary drop bomb. 3. Mark I, demolition drop bomb. 4. Mark I, incendiary drop bomb. 5. Dummy drop bomb.

Types.—Aerial drop bombs are of three general types, viz:
 High capacity (demolition).
 Fragmentation.
 Incendiary.

The various types brought out by the Ordnance Department in the United States have been designed and equipped to conform to requirements abroad; changes were constantly being made in details, such as the method of suspension, to make possible the use of the bombs in the new release mechanisms and planes.^A Only one type, the high capacity, was under quantity production up to the summer of 1918. Therefore, in the following description, only such details are given as apply to the accepted designs of 1918.

High-capacity drop bombs, so-called because of the large ratio of the weight of the explosive to the weight of the container, are used for general demolition purposes. The targets engaged include fortified positions, railroad terminals and lines, heavy structures of all kinds, supply depots, ammunition dumps, etc.

Fragmentation bombs carry a relatively small charge of explosive in a heavy steel shell, and depend for their effect upon the fragmentation of the shell. They are used against personnel, such as troops in the field or on the march, or wherever the protection afforded is slight.

Incendiary bombs are used for incendiary purposes against ammunition dumps, aerodromes, grain fields, etc. Two types were under manufacture—the scatter and the intensive type.

Safety features.—All American bombs are equipped with a safety device whereby they may be dropped to explode or not to explode, in accord with the will of the bomber. This is accomplished through the use of a safety pin, which is withdrawn from the bomb at the moment of release if the bomb is to explode or is allowed to remain if the bomb is to fall safe. The movement of the pin is controlled by a safety wire engaging a hook which is moved to the operating position or withdrawn to the nonfunctioning position just before the bomb is released.

In the older type of firing mechanisms the detonators are carried outside the main charge until the bomb has left the plane. Accidental explosion of the detonator will not explode the bomb in this condition. In the new types other safety features are provided to make the bombs safe from accidental discharge. The bombs are loaded with a high explosive, which requires a powerful detonator to set them off. The charge can not be detonated by penetration of rifle bullets.

HIGH-CAPACITY DROP BOMBS.

High-capacity drop bomb, Mark II.—This bomb is modeled after the 120-mm. French bomb, having a light sheet steel stream-line body $4\frac{1}{2}$ inches in diameter and $28\frac{1}{4}$ inches long. The front half of the shell is five thirty-seconds of an inch thick, the rear half one-sixteenth of an inch thick. Its weight is 22 pounds, of which $9\frac{1}{2}$ pounds repre-



FIG. 113.—High capacity drop bomb,
Mark II.



FIG. 114.—Concrete dummy
drop bomb.

sents the explosive charge. It is provided with a single firing mechanism located in the rear, which explodes the bomb on contact. Tests show that a very slight delay action is obtained. The mechanism consists of a movable member, carrying the primer and detonator, which upon release from the plane slides down a central tube until it rests on the firing pin. In this position the detonator lies inside the booster cup, which contains pellets of hand-tamped tetryl. On contact the detonator is driven forward, and the firing pin sets off the primer. By means of a train of dry guncotton the fulminate is exploded. This detonates in turn the booster charge and the main charge.

The Mark II bomb is provided with an annular recess at the nose to fit the jaws of the vertical release mechanism. It is also carried in the horizontal mechanism by means of a strap on the release mechanism, which is secured around its circumference. The manufacture of this bomb was stopped on account of advice from abroad that its size was inadequate. Those already made were to be used in the United States for practice purposes.

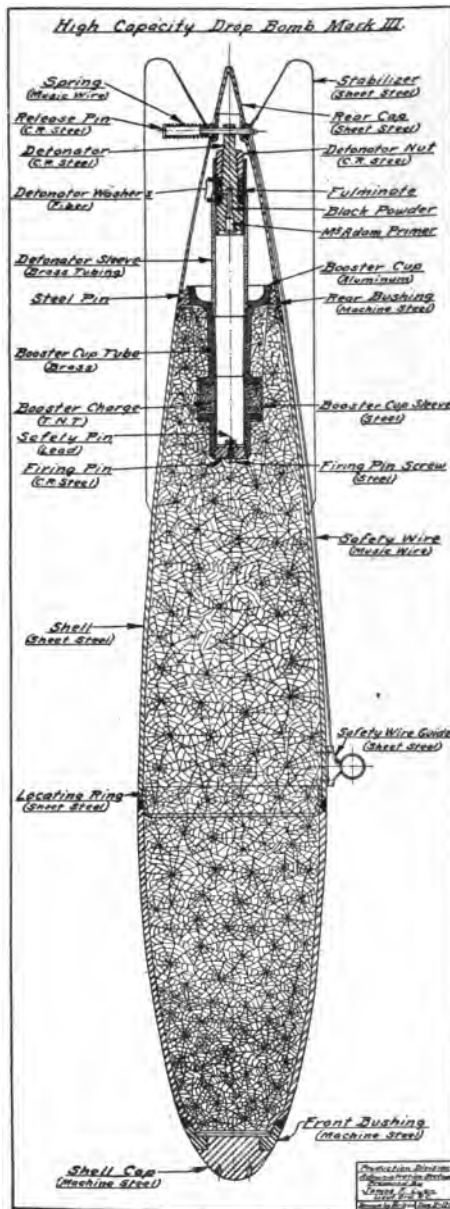

FIG. 115.—High-capacity drop bomb. Mark III.

High-capacity drop bomb, Mark III.—This bomb is slightly larger than the Mark II, measuring 6 inches in diameter and 36½ inches in length, with a sheet-steel casing thirteen sixty-fourths of an inch thick in front and one-eighth of an inch thick in rear. It is modeled after the French 155-mm. bomb, having the same stream-line shape as the Mark II. Its weight is 55 pounds, of which 28 pounds represent the explosive charge. It is provided with a single firing mecha-



FIG. 116.—High-capacity drop bomb, Mark I.

nism, identical with that of the Mark II. It can be carried horizontally, supported by the strap of the release mechanism, or vertically by means of an auxiliary nose loop, which is easily attached to the nose plug.

High-capacity drop bomb, Mark I.—This bomb was manufactured in quantities, as it was evidently the most efficient size for general demolition purposes. It is of the same shape as the Mark II and III, measuring $7\frac{1}{2}$ inches in diameter and 50 inches in length. The front half of the casing is nine thirty-seconds of an inch thick, while the rear is one-eighth of an inch thick. The weight is 104 pounds, of which 52 pounds represent the explosive charge. It is equipped with two new type firing mechanisms, one in the nose and the other in the tail. The former may be omitted when desired. These firing mechanisms can be arranged to explode instantaneously or after a delay of one-fourth second or 2 seconds. A quantity of this size were made up with the mechanism described under Mark II.

The Mark I bomb is provided with a nose loop (except the first 12,000 manufactured) for vertical suspension, two side carrying loops for the American horizontal release mechanism, and an auxiliary side loop for the British horizontal trap. It may also be carried in the Mark V release trap by means of a supporting strap on the mechanism. A device was designed to combine the vane type of nose firing mechanism with a nose carrying-lug; when the bomb is released the vane revolves and drops off with the lug, arming the mechanism.

High-capacity drop bomb, Mark IV.—This bomb is next larger in size to the

Mark I and is used for the demolition of more permanent structures, such as forts, concrete buildings, dry docks, etc. It is 50 inches over all and 12.20 inches in diameter. Its weight is 260 pounds, of which 120 pounds represent the explosive charge. The thickness of the front half of the shell, of cast or forged steel, tapers from three-eighths of an inch at the middle to three-fourths of an inch at the nose; the rear half of the shell is made of one-eighth inch sheet steel. Two firing mechanisms are used—a nose vane type in which the nose carrying lug is thrown off with the vane, and a sliding device in the tail. It is provided with a nose loop for the British vertical release trap, the side carrying loops for the United States horizontal release trap, and a single side loop for the British horizontal device.

High-capacity drop bomb, Mark V.—This was the largest type of bomb put under quantity manufacture in the United States. The over-all length, exclusive of the nose lug, is 59.04 inches, and the diameter is 16.53 inches. The front casing of forged or cast steel tapers from a thickness of one-half inch at the middle to 1 inch at the nose. The rear portion of the shell is made of sheet steel 0.156 of an inch thick. The total weight is 550 pounds, of which 280 pounds represent the weight of the explosive charge. Two vane type firing mechanisms are provided. Two side carrying loops for the United States horizontal release trap, and a single similar loop for the British horizontal trap, provide the means of suspension.

High-capacity drop bomb, Mark VI-A.—This design was completed for immediate production. The bomb measures 63.5 inches in length and 20.875 inches in diameter. The shell casing tapers from a thickness of seven-sixteenths of an inch in the rear to 1.75 inches at the nose. The weight is approximately 1,000 pounds, of which about half represents the explosive charge. Two vane type firing mechanisms are provided in nose and tail. Double loops for the United States horizontal release trap, and the single loop for the British horizontal trap, are welded to the body. This bomb replaced the Mark VI (later abandoned) of similar size but provided with a thin casing. The Mark VI-A had not been put into production up to the summer of 1918, as no planes then had been provided to carry this size.

High-capacity drop bombs, Mark I-A and V-A.—These are similar in details to the Mark I and V, respectively, except that considerably heavier casings are used throughout. For the increase in the weight of the casing there is a corresponding decrease in the weight of the explosive charge. Mark I-A is furnished with a permanent suspension loop for the British horizontal release trap, instead of the auxiliary loop provided for the Mark I. Up to the time of the armistice production on these designs had not been authorized.

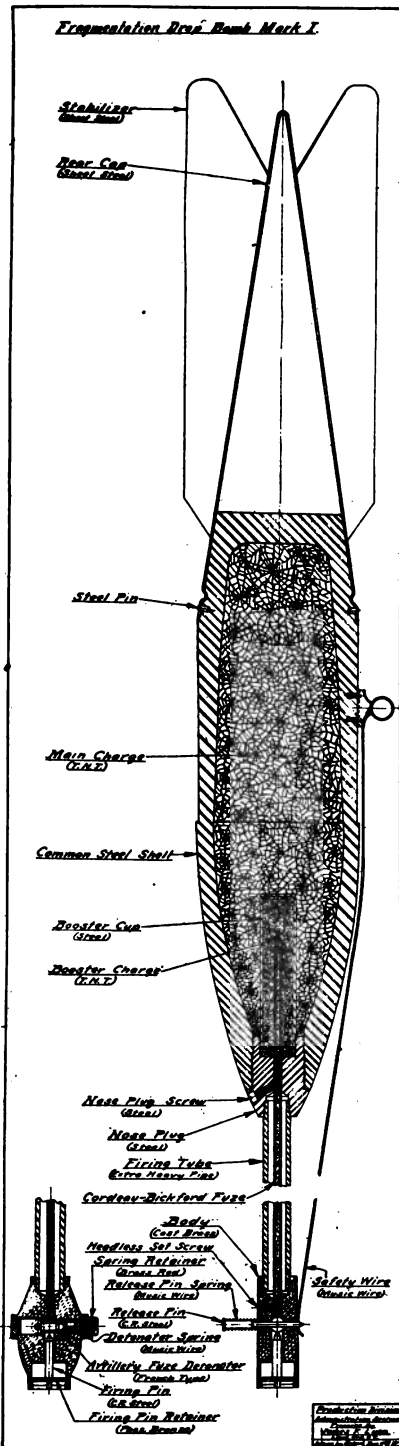

FIG. 117.—Fragmentation drop bomb, Mark I.

High-capacity drop bomb, Mark IV-A.—This type also has a heavy casing, and in all details except the firing mechanism is a duplicate of the French 100-kilogram bomb. It closely resembles the Mark IV in size and weight, the shell proper being 49 inches long and 10.18 inches in diameter, with a thick casing. It is provided with two vane type firing mechanisms and the same means of suspension as are provided for the Mark IV.

NOTE.—The new types of firing mechanism designed for the larger bombs are provided with an adjustable fuze arrangement that will provide for delay action up to 15 seconds.

FRAGMENTATION BOMBS.

Design and action.—In bombing operations against personnel, it is necessary that the explosion of the shell occur before it is buried in the earth to secure an efficient dispersal of the fragments. To meet this requirement bombs have been designed in which a common steel shell is used in connection with a very rapid detonating device protruding from the nose of the shell. Designs of four sizes were prepared, Mark I, II, II-A, and III, using the 6-inch, 75-mm., 3-inch, and 4.7-inch artillery shell, respectively. Only the Mark II-A, using the 3-inch shell, was put into production, as advices from abroad indicated that the larger sizes would not be required. The firing mechanism is carried in a brass casting at the forward end of a short length of steel pipe,

the rear end of which is screwed into the nose of the shell. A detonator in the body of the firing mechanism is arranged to slide into firing position when the bomb leaves the plane. On impact a firing pin is driven into the detonator, which now lies between the firing pin and a length of detonating fuze running into the booster cup of the shell. The action is very rapid, and explosion occurs well above the ground, insuring a lateral dispersion of fragments over a space 40 yards or more in diameter. The weights and dimensions of this type are as follows:

	Overall length.	Diameter.	Total weight.	Weight of charge.
	<i>Inches.</i>	<i>Inches.</i>	<i>Pounds.</i>	<i>Pounds.</i>
Mark II.....	30.1	2.925	19	1½
Mark II-A.....	30.2	3	19	1½
Mark III.....	50.38	4.7	49	6
Mark I.....	58.3	6	94	13½

All of the above are intended for horizontal release. The Mark II and Mark II-A are also provided with a loop at the tail, by means of which they may be carried in the British release mechanism for the Cooper bomb.

Barlow heavy drop bomb.—This is another type of fragmentation bomb. It consists of a forged steel war head or shell 6 inches in diameter and 18 inches long, which contains 16 pounds of high explosive. To this is connected a compressed-air mechanism of pressed steel and brass tubing, giving a total length of 80 inches in the safe or normal position. The mechanism consists of a forward extrusion rod carrying the firing device and a sliding stabilizer mounting which moves to the rear. On release from the plane the compressed air in the air chamber is released and drives the stabilizer tube back and the firing mechanism forward until the latter extends about 6 feet in front of the war head. Thus the bomb measures 15 feet over-all in the firing position. On contact a service cartridge, carried in the front end of the extruded tube, is discharged. The bullet passes up the tube and strikes a primer, which explodes the fulminate detonator, and explosion of the war head is thus produced when it is between 4 and 5 feet above the ground. The bomb was to be used against personnel in the field wherever adequate cover is lacking. As this bomb was designed to explode equally well above the water or on land, it was thought it could be used against landing parties and small boats.

Some difficulties arose in the manufacture of this bomb as well as in the method of handling it in the field. Advice was received from abroad that a fragmentation bomb of this size was unnecessary, and production was accordingly stopped until a thorough field test could be made. The bombs for this test were shipped.

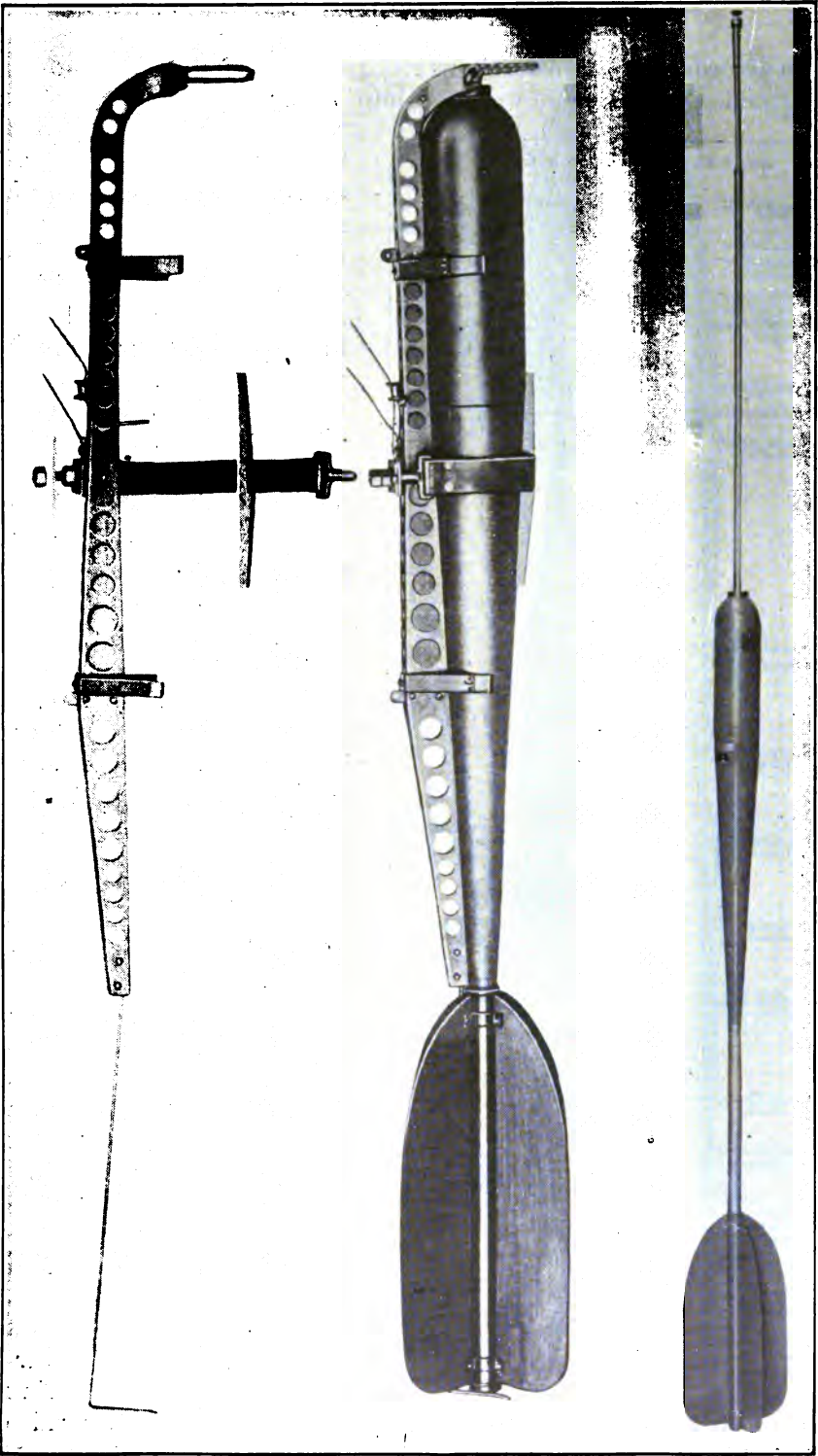

FIG. 119.—Barlow heavy drop bomb with release mechanism. Below.—Barlow heavy drop bomb with rod extended.

In accordance with instructions received from abroad, the English 20-pound Cooper bomb was put into production in the United States. It is a pear-shaped bomb with a simple vane-type arming mechanism and a sensitive percussion fuze. It is provided with a tail-carrying loop for the British release mechanism and has been designed as United States fragmentation bomb, Mark II-B. (See below, under European bombs.)

INCENDIARY BOMBS.

Incendiary drop bomb, Mark I.—This is the "scatter type" of incendiary bomb and is intended for use against grain fields, light structures, ammunition dumps, etc., where no great amount of igniting power is necessary. It has a diameter of approximately 6 inches and a length of 36 inches, with a weight of about 40 pounds. It carries a $1\frac{1}{2}$ -pound charge of black powder and 19 pounds of cotton-waste balls soaked in turpentine, or solid oil balls wrapped in burlap. The body is of pressed steel 0.187 of an inch thick at the front and 0.03 of an inch at the rear. It is provided with two firing mechanisms—one in the nose and the other in the tail. After release from the plane the firing pin in the rear mechanism is held away from the igniting cartridge by means of a spring

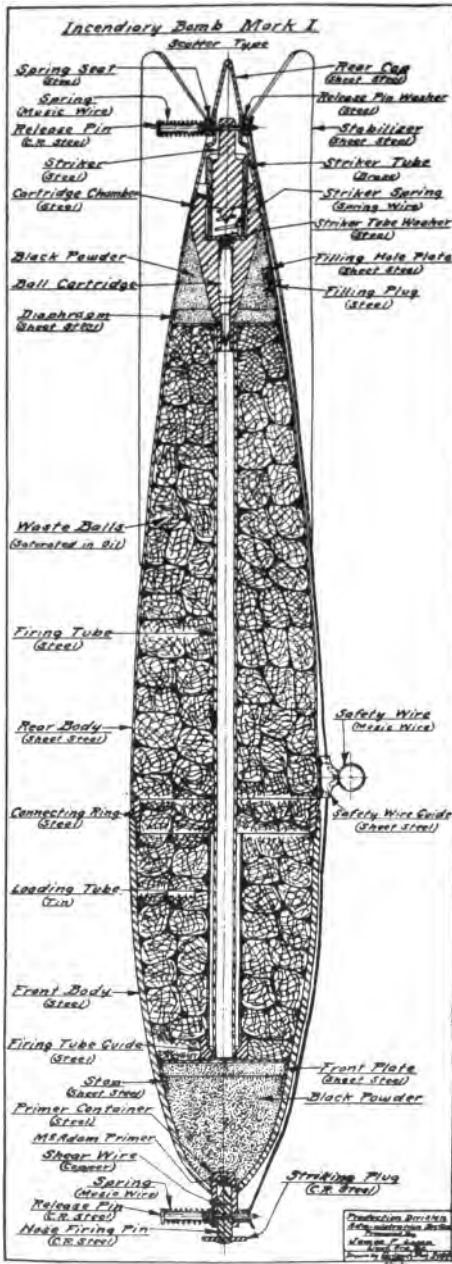

FIG. 120.—Incendiary drop bomb, Mark I.

until contact occurs. At that time the firing of the service cartridge drives the bullet through the central tube and ignites both powder



FIG. 121.—Incendiary drop bomb, Mark I.

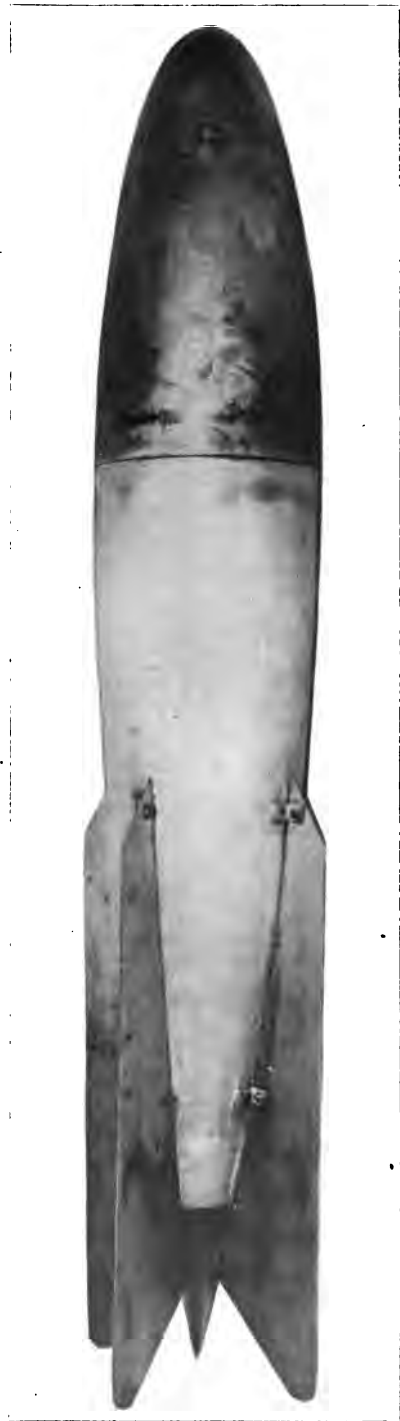

FIG. 122.—Incendiary drop bomb, Mark II.

charges. The explosion expels the incendiary material from the rear. The bomb is used in the horizontal release mechanism.

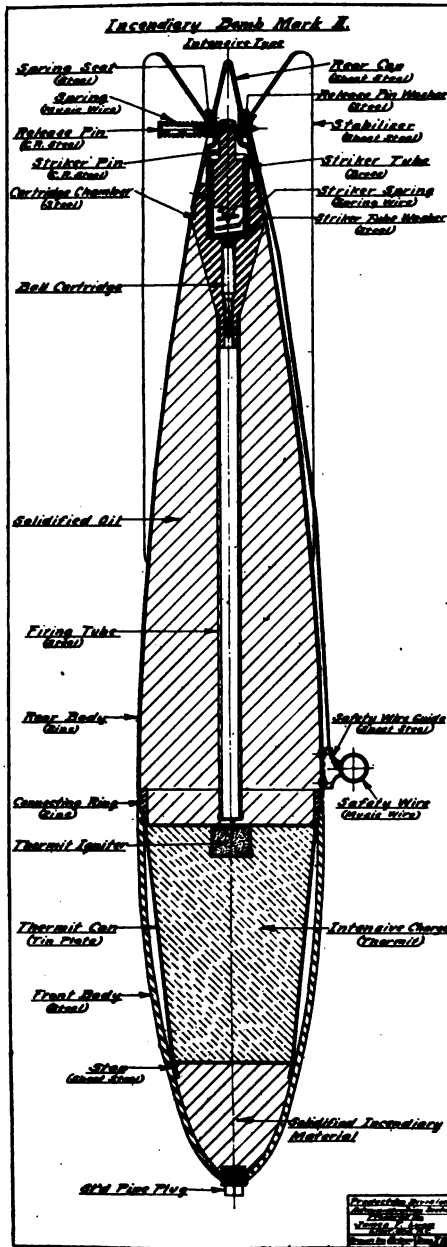

FIG. 123.—Incendiary drop bomb, Mark II.

pounds of oil emulsion. The rear body is made of sheet zinc 0.05 of an inch thick. The firing mechanism is the same as that used in the Mark I incendiary. The bullet is shot into a small container of

As a means of providing for exceedingly rapid functioning, such as would be desirable to make the bomb effective against grain fields, a nose-firing mechanism is provided. It is a simple percussion type, set in the nose of the bomb. On impact the firing pin is driven against the primer, the flash from which ignites the nose powder charge. Experiments were made with the supersensitive firing device employed in the fragmentation bombs, and bombs equipped with both types of firing mechanism were sent abroad for service tests and report.

Exhaustive tests were made to determine the proper incendiary material. Cotton-waste balls soaked in turpentine and carbon disulphide gave the best results, though faulty ignition was sometimes troublesome. It was hoped that a more rapid and more certain ignition would be developed.

Incendiary drop bomb, Mark II.—This is the “intensive type” of incendiary drop bomb and is intended for use against permanent structures which require a high degree of igniting power. The shape and size are the same as those of Mark I. Its weight is 46 pounds, and it carries 10 pounds of thermit and 16

igniting powder placed in the bottom of the thermit chamber, which fills the forward portion of the bomb.

It was proposed to include in the incendiary bombs a zinc container filled with metallic sodium. This was for the purpose of discouraging fire fighting, as the sodium will explode if water is thrown on the burning bomb. An auxiliary nose loop is provided for use in the United States vertical release mechanism. The bomb can also be carried in the horizontal trap by means of the strap.

Incendiary drop bomb, Mark III.—This type weighs approximately 100 pounds and contains thermit and oil somewhat similar in arrangement to Mark II.

Incendiary darts.—After much experimentation, a very satisfactory type of dart was developed. It consists of an elongated 12-gauge shotgun shell, measuring $11\frac{1}{4}$ inches and filled with an incendiary mixture which produces a long flame. The firing mechanism consists of a thimble carrying the firing pin, which fits over the base of the shell. Two crossed steel plates, 5 inches long, are fastened to the rear to act as stabilizers. A cloth tail 14 inches long has also been used for the same purpose with satisfactory results.

The dart has a black-powder primer, which ignites the booster charge of reduced iron, potassium nitrate, and sulphur. The main incendiary charge is made of barium chlorate, resin, aluminum, and varnish or some similar mixture. Ignition occurs when the dart strikes the ground. The thimble carrying the firing pin is driven up against the primer. Functioning is very rapid. This fact, as well as the low terminal velocity of the dart, make it an ideal incendiary for use against grain fields, ammunition dumps, or other unprotected material.

EUROPEAN BOMBS.

90-mm. fragmentation.—The 90-mm. fragmentation bombs are constructed from rejected 90-mm. shells, to which are added fins and a fuze. There are two types of fuzes used, which will be described under fuzes. The bombs with Michelin fuzes can be carried in the Michelin Type I or Type IV carrier and the modified Mark V American carrier on D. H. 4 planes. In this last case no band or button is required, but the Michelin carrier requires a band with a Michelin button and stud which fits in a shallow hole in the side of the bomb roughly opposite the center of gravity.

90-mm., with Gros-Andreau key support.—The 90-mm. bombs with Gros-Andreau key support are designed for use in the 120-mm. cells. The wire loop must be securely attached to the release mechanism, thereby retaining the collar and spring in the cell when the bomb is released. Both safety pins must be withdrawn after the bomb is in the cell. One safety pin passes through the collar and the other through the key.

Cooper bomb.—The Cooper bomb is made of cast steel or semisteel, the case being five-sixteenths of an inch thick. It can be carried in the quadruple Cooper bomb carrier on pursuit and observation planes, or, with some modifications to the American Mark V carrier, on the D. H. 4 planes. English practice requires that the bomb be dropped once before being fuzed to ascertain that the carrier is functioning correctly.

115-mm. long.—These bombs have a heavy nose, but the rest of the case is very light. They may be suspended on either the Michelin Type I carrier on Breguet planes, or may be mounted in the double-illuminating bomb carrier, Michelin Type IV, on Breguet A 2 planes. A much better explosive was found in those bombs, which were loaded during the last few months of the war, than in the older bombs. The new bomb has a central core of pure melinite, which makes the improvement. If old-type fuzes are used, experience shows that only the instantaneous type is satisfactory. With new fuzes a delay of 0.05 second is recommended.

112-pound English.—The 112-pound English bomb is made of cast steel, semisteel, or cast iron, the thickness of the case being 0.5 inch. It may be carried in the horizontal carriers under the wings of the D. H. 4 plane.

230-pound English.—The 230-pound English bomb is constructed of a heavy forged-steel nose, with body and fins of sheet steel, 10 gauge in thickness. Directions for this bomb are the same as for the 112-pound bomb above.

155-bis bombs.—155-bis Michelin bombs are provided with two bands with buttons as supports, and may be carried in the Michelin carriers on the Breguet B 2 or in the double-illuminating bomb carrier under the wings of the Breguet A 2.

155-mm. penetration bomb.—The 155-mm. penetration bomb is made from a defective 155-mm. shell. It is provided with a Gros-Andreau key support at the nose. It may be carried in the regular Michelin Type I carrier on Breguet B-2 planes, in which case a framework of bands and two buttons is necessary. It may also be carried in the American Mark V carrier on D. H. 4 planes, in which case no buttons and bands are necessary, nor is the key support. The key support should be sprung out of the plunger in this case or be replaced by a plug.

Chanard incendiary.—Chanard bombs are provided with either the Gros-Andreau key support at the nose or with the English eye lug support. They consist of a thin case containing a mixture of nitrate, cellulose, resin, etc. In the tail of the bomb is a quick match, which is ignited by the fuze and which in turn ignites a charge of powder, the incendiary material described above, and also a thermite mixture contained in tubes which run along opposite sides of the bomb

and through the center. The operation of the fuze is described later. The fuze ignites the quick match, which carries the ignition not only through the powder charge but also throughout the thermit mixture. The fuze functions about 5 seconds after the bomb is dropped, which corresponds to a fall of 200 to 250 feet from the plane. A powder charge gives a pyrotechnic delay of about 5 seconds more before the ignition reaches the main powder charge and the quick match. The ignition of the thermit in the tubes along the side of the bomb and traverse opens the bomb case, so that when the bomb strikes the target the case breaks open and the interior incendiary mixture, which is already burning fiercely, is liberated. French practice shows that this bomb is used generally by the leading plane of a flight more for illuminating purposes for the planes that follow than as an incendiary bomb. At present it can be carried only in the 120-mm. cells provided on certain planes, but a framework with buttons was to be available which would permit carrying this bomb also on the regular Michelin Type I carrier on the wings of the Breguet.

Michelin illuminating parachute flare.—The Michelin bomb is better known as the illuminating parachute flare. It is carried in the Michelin Type IV carrier, which is either double or single. Upon being released from the carrier the fuze end falls first and the firing pin is rotated by the propeller, screwing into the fuze the length of its threads. Pressure of the air then drives the pin against the primer, which ignites a charge of black powder. The powder in turn ignites a wick at the end of the illuminating charge and at the same time drives the entire charge in its cardboard envelope together with the parachute from which it is suspended out at the rear end of the tube. The illuminating charge burns eight minutes.

Bourges illuminating parachute flare.—This bomb was experimented with with a view toward its ultimate adoption. It is not supported in a carrier, but is dropped overboard by the observer. The tin cover of the fuze is first removed and the regulator set at the desired delay, which may be 7, 9, 12, or 15 seconds. The inner cover is then removed by pulling the loop on the side, which exposes a cord. Just before the bomb is launched this cord is pulled, removing a stop which frees the striker. The striker having primed the fuze, it burns through the delay set, down a chute to a powder pellet, which ignites the star and expels it and the parachute from the tube. The star burns two and one-half minutes.

Holt landing flare.—These flares, of English manufacture, illuminate the ground when landing at night. The illuminating material is contained in a cartridge 4-inches long and 2-inches in diameter, carried on the flare holder mounted on the underside of the lower wing. Each cartridge is connected to dry cells and spark coil and is ignited electrically by a push button.

TABLE 25.—*Aircraft bomb fuzes as used by the allied forces.*

Type.	Time.	Safety.	Use on—
French tail.....	Instant or delay...	Propeller unscrews releasing firing pin....	115 mm. long. 155 bis. 155 mm. 90 mm. Do.
French nose.....	Instant.....	Collar holds firing pin; lead-shearing wire..	
Gros-Andreu nose..	do.....	Key support holds collar which stops propeller; propeller releases ball.	
Chanard.....	Time.....	Three balls retain firing pin; functions in air.	Chanard.
Cooper nose.....	Instant.....	Firing pin offset from striker way; lead-shearing wire.	Cooper.
Stokes tail.....	Instant or delay...	Propeller unscrews releasing striker.....	112-pound English. 230-pound English. 112-pound English.
English nose.....	Instant.....	Cover over pressure plate unscrews with propeller; lead-shearing pin.	

AERIAL BOMB FUZES.

Tail fuzes (French).—All French fuzes have one feature in common, namely, that the firing pin is freed by rotation of an air propeller which operates after the release of the bomb. In the tail fuze, when the bomb falls, the propeller rotates and screws its shaft out of the firing pin. The firing pin is held away from the primer by a spiral spring. When the bomb is arrested by striking the target the firing pin continues its motion and strikes the primer. This in turn either directly or indirectly ignites the explosive in the detonator at the lower end of the fuze, in which case the fuze is said to be instantaneous, or it ignites a delay powder trail which communicates the ignition to the explosive of the detonator. The detonator is screwed into the end of the tube which forms the outer case of the fuze.

Nose fuzes (French).—The Michelin nose fuze is employed on Michelin 90-mm. bombs and has double security before the bomb is dropped from the plane. The firing pin is held by both a collar mounted on the air propeller and by a lead wire. When the bomb falls the propeller rotates and the collar screws off of the thread. When the nose of the bomb strikes the target, the lead wire is sheared, the point of the firing pin strikes the primer and instantly the flame is carried to the detonator. The type of nose fuze used on larger bombs has two differences from the fuze mentioned above. A collar in front of the air propeller prevents its rotation while the bomb is on the plane. This collar is fastened to the carrier, and when the bomb is released, is pulled off of the propeller shaft. The second difference is that provision is made for a pyrotechnic delay.

Gros-Andreu nose fuze for 90-mm.—The Gros-Andreu key is hooked on a pin through a plunger and its round end held firmly against a collar by means of a spring action on the plunger. A small safety pin through the key and the plunger serves to prevent its slipping

out prematurely. The key is fastened to the bomb release by means of the two holes in the other end. The collar is also securely fastened to the carrier by means of the wire loop. When the release is operated it exerts a lever action on the key, which serves to shear the small safety pin and snap the key off of the plunger. The collar is then pulled off and permits the rotation of the screw. As the propeller rotates it screws down the stem toward the nose of the bomb and finally off of the thread. It liberates the ball, which acts to hold the plunger up. When the plunger strikes the target it is driven against the primer.

Chanard fuze.—The Chanard fuze is entirely different from any other French fuze in that the operation of the firing pin depends on a spring rather than the arresting of the bomb. When the propeller rotates after the bomb is dropped, it screws its shaft out of the hollow firing pin which is held in position by three balls. When the shaft of the propeller leaves the firing pin, the balls fall out, and a stiff spring drives the pin against the primer.

Cooper nose fuze (English).—The Cooper fuze has two safeties—a wire holding the striker away from the primer and a guard which stops the striker. It is also covered by a cap which is removed just before the bomb is placed in the carrier. The vane is prevented from turning by a step on the carrier. After the bomb is released the vane rotates and turns the striker carrier by means of cogwheels until the striker is over the striker way, when it becomes unmeshed from the cogs. Upon impact the vane is driven back, shearing the safety wire and forcing the striker against the primer, exploding in the bomb.

Stokes assemblage (English).—Both the 112-pound and the 230-pound bombs are equipped with a tail fuze known as the Stokes assemblage. It consists of the usual vane and striker, with space for a delay detonator of 15, 2.5, or 0.05 seconds. When the bomb has been loaded in the carrier the cord is removed from the vane and the safety pin is pulled out. When the bomb is dropped the vane rotates, unscrewing itself and releasing the striker, which is held away from the primer until the bomb strikes, when the fuze is primed and the detonating charge ignited.

Nose fuze (English).—The nose fuze is used only on the 112-pound bomb. The eyebolt at the head of the fuze is used for vertical suspension, and in horizontal suspension, which is the type used in this service, does not function. The vane is prevented from turning by a step on the carrier. The vane, the pressure-plate cover, and the eye are one piece, which, when the vane rotates off, it carries them with it. The pressure-plate cover is a safety, as well as the shearing pin. Upon impact upon the pressure plate the striker primes the fuze.

TABLE 26.—Bomb carriers as used by the allied forces.

Type of carrier.	Mounted on—	Can carry.
Michelin Type IV, single and double.	Breguet 14 B 2.....	2 Michelin illuminating. 2 115-mm. longs (in double carrier only; single carrier takes only one of either of these bombs). 1 155-mm. (in double carrier). 16 90-mm. 8 115-mm. long. 8 155-bis. 8 155-mm., with special attachment. 8 Chanard, with special attachment. 5 90-mm. 5 155-mm. All American bombs with special attachment.
Michelin Type I, 8 or 16 bombs.....do.....	4 Cooper 20-pound. 1 112-pound English (single). 1 112 pound English (double). 1 230-pound English.
American Mark V, 5 bombs.....	D H 4.....	
Cooper quadruple, 4 bombs.....	Spad 13-Salmson 1 A 2.....	
112-pound carrier, single and double.	D H 4.....	
230-pound carrier, single.....do.....	

BOMB CARRIERS AND RELEASE MECHANISMS.

Nature and use.—Release mechanisms are provided on bombing planes for the purpose of carrying the desired bombs and dropping them at the will of the operator. The design of the various types of releases has presented many difficulties, particularly in view of the fact that no accurate information could be obtained as to the intended position for the trap, the desired capacity, or the method of suspension, whether horizontal or vertical. As certain portions of the release mechanisms are built in the plane, it followed that every change in the construction of the latter involved a change in the construction and installation of the release mechanism.

Many devices were completely designed, only to be altered or entirely abandoned upon the receipt of advices from the Signal Corps that the planes themselves had been altered and redesigned. It is, of course, quite evident that each type of mechanism must be peculiarly designed and adapted to fit the plane for which it is intended. Aside from these considerations, a serviceable release mechanism must possess the following characteristics:

1. Ease and certainty of operation.
2. Simplicity of control.
3. Structural strength with light weight.

The following devices were under development.

Mark V release mechanism.—This mechanism, which has been extensively produced, consists of an operating and controlling device, with two traps, one under each wing, carrying the following bombs horizontally:

- 10 high-capacity, Mark II, or
- 4 high-capacity, Mark I, or
- 6 high-capacity, Mark III, or
- 10 fragmentation, Mark II or II-A.

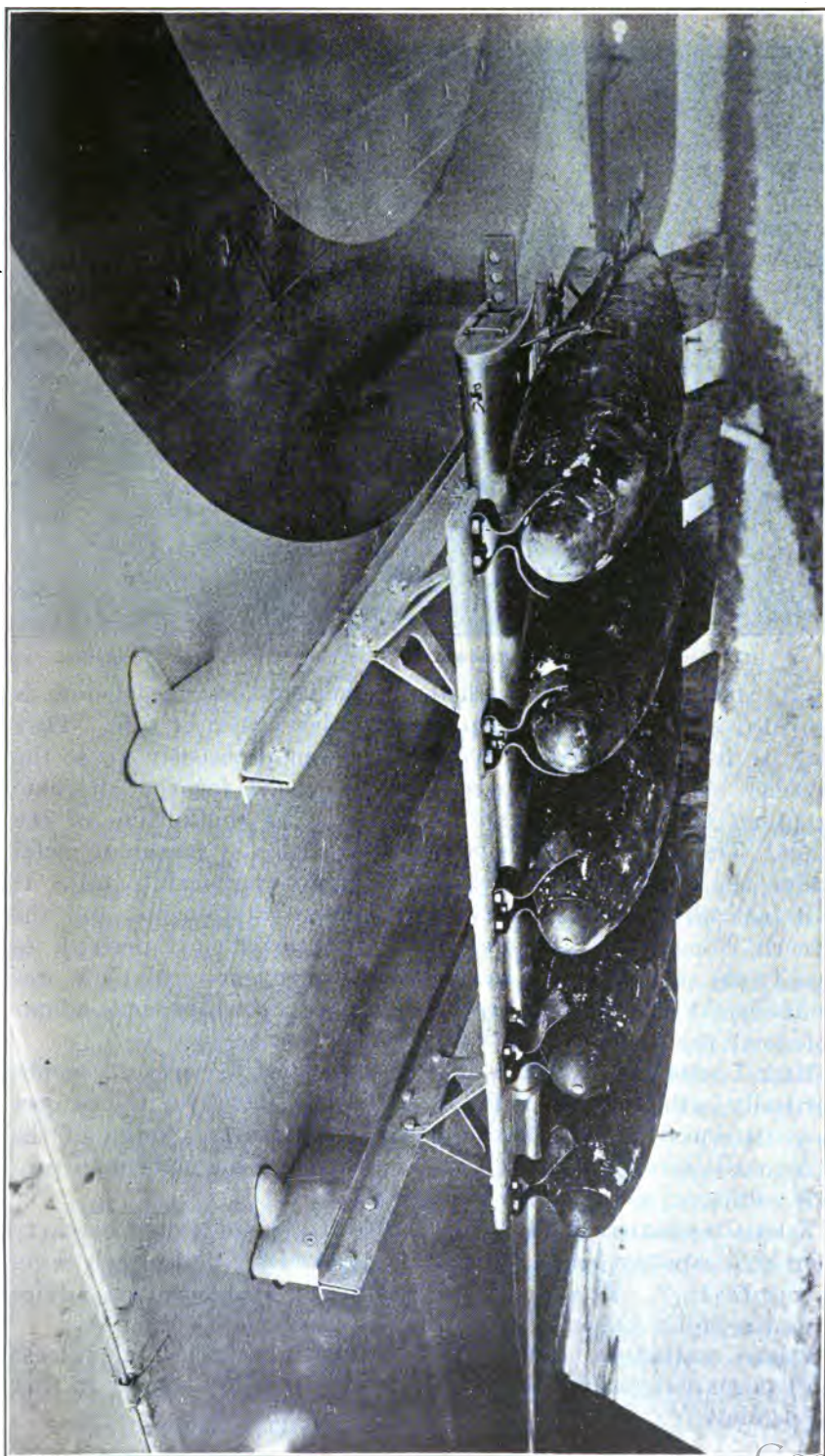

FIG. 124.—Mark III high-explosive bombs on Mark V release mechanism. D. H. 4 airplane.



FIG. 125.—Mark III high-explosive bombs and Mark V release mechanism on D. H. 4 airplane.

This device, in common with the mechanisms described below, is provided with a means to drop bombs, either armed or safe. They may be dropped singly, in string fire, or simultaneously up to the capacity of the trap. Provision is also made for the alternate dropping from the two traps to preserve the equilibrium of the plane. The Mark V carrier supports its bombs by means of metal straps, one end of which is released to permit the bomb to fall. It will take all American bombs, with special attachments, and the French 90-mm. and 155-mm. It is also possible, if desired, to modify the carrier to take the English Cooper bomb. Mark V was said to be the best of all the types in use, since it could be made adaptable to all types of bombs with a little modification.

Mark I release mechanism.—This was designed to carry 12 bombs vertically in the fuselage of the D. H. 9 plane. However, the project was abandoned in July, 1918, when a change in the design of the plane made necessary the removal of the release mechanism to provide additional space for the gasoline tanks.

Release mechanism, Mark VIII.—This type was designed to carry four high-capacity bombs, Mark III, horizontally under each wing of the D. H. 9. The design was eventually abandoned on advice from the Signal Corps, being superseded by the Mark VIII-A.

Release mechanism, Mark VIII-A.—This is a horizontal release mechanism designed for the D. H. 9, with a capacity similar to that of the Mark V. The bombs are carried under the wings.

Mark IX release mechanism.—This type is likewise a horizontal device for the D. H. 9, and is intended to carry one Mark I, one Mark IV, or two Mark III high-capacity bombs under the fuselage.

Mark II release mechanism.—With this release mechanism it is intended to carry 16 Mark I or 9 Mark IV high-capacity bombs in the fuselage of the Handley-Page.

Mark IX-A release mechanism.—A new type was designed to carry two Mark V high-capacity bombs under the fuselage of the Handley-Page. Another device was contemplated for the purpose of carrying fragmentation bombs in the fuselage of the same machine.

Mechanisms, as follows, were also proposed:

Mark III, Caproni, in fuselage, horizontal, 16 high-capacity, Mark I, or 9 high-capacity, Mark IV; Mark IV, Caproni, under fuselage, horizontal, 2 high-capacity, Mark V; Mark VI, Bristol Fighter, under wings, horizontal, same as Mark V.

Mark VII-B release mechanism.—This is the left hand trap of the Mark V, with a suitable controlling device. It is placed under the fuselage of the J. N. 4-B training plane, and is used for practice purposes. Its capacity is five high-capacity, Mark II, or three high-capacity, Mark I and III.

Mark XI release mechanism carries one French 100-kilo bomb (United States Mark IV-A) horizontally under the fuselage.

A copy of the English carrier for the Cooper bomb carries four Cooper bombs (our fragmentation Mark II-B) under the wings or fuselage of the plane.

Release mechanisms developed in Europe.—The foregoing types indicate what had been done in the United States toward developing release mechanisms and bomb carriers. In Europe naturally there had been considerable use of such devices, and the more important and efficient, are outlined in the following paragraphs.

Michelin, Type IV carrier.—This carrier is made in both single and double types. The single type consists of a simple rack for either end of the bomb. Near each end is a pincer which serves to hold the bomb in suspension by means of buttons which are attached to it. When the bomb is mounted it is merely forced up into the pincers until they snap over the button. Release is made by means of a Bowden control device, which opens the pincers and allows the bomb to fall. The double carrier will take either two Michelin illuminating bombs, or two 115-mm. longs, or one 155-mm.

Michelin Breguet, Type I.—This carrier consists of a frame containing two rows of eight groups of pincers the same as those in the Type IV carrier. The frame is mounted as an integral part of the wings of the Breguet B 2 plane, with one frame on each side of the fuselage. Release is controlled by a hydraulic system and pump, with a glycerin mixture as the liquid. It is used in connection with

the Michelin bomb sight and is set in accordance with figures arrived at by means of that sight. Bombs are released singly, alternating on either side, to preserve the balance of the plane. This carrier takes the 90-mm., the 115-mm. long, 155-bis, and, with special bands and buttons, the 155-mm. bombs. Plans were under way to make it possible to carry the Chanard in this carrier also.

Cooper quadruple 20-pound carrier.—This carrier is designed for the Cooper bomb only. The bomb is held by means of a trigger through the lug in its center and steadied by the two brackets at either end, with a stop at the forward end to prevent the vane from turning. There is a heavy loop in each of the slots through which the lug is thrust. This loop engages the lug at one end, and the other is locked in a trip which holds it in a horizontal position. Operation of the Bowden advances a lever, by means of a ratchet, far enough to release one bomb. It is necessary to operate the Bowden for each release. The bombs are dropped in a regular manner, the two center ones first, then the two outer ones.

112-pound carrier.—The 112-pound bomb carrier supports the bomb by the central lug, and steadies it by means of two braces. The trigger is hooked onto the lug on the bomb and its rear is engaged in the trigger sleeve. Operation of the Bowden withdraws the trigger sleeve through the section of the crank lever, permitting the trigger to fly up and the bomb to fall. This carrier is made in both single and double types, the double having two Bowdens. It can be attached to the D. H. 4 plane.

230-pound carrier.—The 230-pound bomb carrier is made for one bomb only, and is practically identical with the 112-pound bomb carrier. It can be attached to the D. H. 4 plane.

BOMB SIGHTS.

Nature and use.—A bomb sight is used to determine the range angle and direction required to strike a desired target with a bomb dropped from a moving airplane. Present-day bombing is done from high altitudes and with the plane traveling at tremendous speeds. To secure any fair degree of accuracy some device must be provided which will indicate (1) the proper direction of flight and (2) the proper time at which the bomb should be released from the plane.

French S. T. A6 bomb sight.—The first useful bomb sight to be brought to the attention of the Ordnance Department was the French S. T. A6 equal-distance bomb sight. It involved an original setting of the device for altitude, and the timing, by means of a special reversible stop watch, of the passage of a preliminary target between two pins on the sight. The sight is reset in accordance with this time, and the real target is brought under the sight pin. The stop watch is reversed and the bomb is dropped when the hand returns to zero.

A simplified design of this type for low-altitude bombing was completed and a small number were ordered, to be known as bomb sight Mark I. Advices from abroad, however, indicated that any sight involving the use of a stop watch was undesirable, because bombers in range of antiaircraft guns or hostile planes could not observe the conditions necessary to make the use of this sight reliable or accurate. The project was accordingly abandoned.

Various types.—Other types of bomb sights, at one time or another in marked favor abroad, have been studied and tested by the Ordnance Department, notably the English C. F. S. No. 4B. (equal distance) and negative lens sights, and the French Michelin sights, the last of which is described below. However, a decision was reached abroad to proceed with the manufacture of the Wimperis high-altitude drift sight, a simple device much favored by the British. This was accordingly put into production as our Mark I-A bomb sight, and all of the first bombing planes were equipped with the device. Some few changes were made in the British design, to accommodate it to American manufacturing methods and to simplify the operation of the sight. It is calibrated for bombing from heights of 3,000 to 25,000 feet.

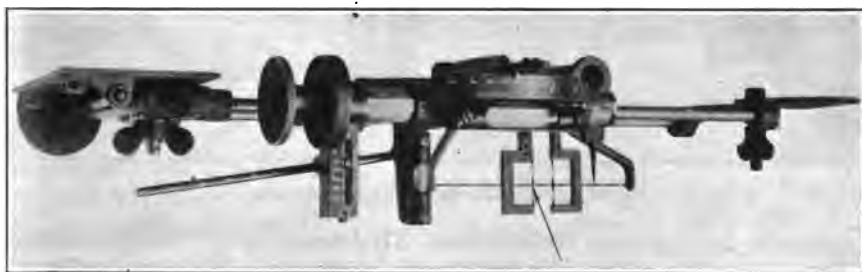

FIG. 126.—Bomb sight, Mark I-A. Top view.

Bomb sight Mark I-A.—The sight consists of two major parts:

1. The frame and leveling attachments.
2. The main bracket assembly, including the sight pins and drift bar.

The frame consists of the upper and lower frame bars of brass, and the front and rear end brackets of aluminum, by means of which the device is rigidly secured to the plane and leveled for use. The main-bracket assembly slides horizontally on the frame bars. Attached to the main casting are the altitude scale, the spirit levels, the stationary back-sight pin, the sight-plunger tube, and the sight-wire bracket and wire. The sight-plunger tube is a slotted cylinder set at a fixed angle to the vertical axis, in which the front-sight pin is adjusted according to the altitude. The air-speed tube, which is set according to the indicated air speed, is a hollow slotted brass cylinder, within

which is a horizontal shaft, with left and right hand thread controlling the rear-sight pins. This shaft is connected to the drift bar through a bevel miter gear. The drift bar slides through a sliding support, which is screwed into this windage shaft nut, and is attached to the main bracket through a collar and shoulder screw. The bronze altitude lever is attached at its elbow to the main bracket by the altitude lever shaft. Two air speed and windage scales are provided, one for horizontal and one for vertical releasing.

In setting the altitude lever for the altitude indicated by the altimeter, the operator automatically sets the front sight pin correctly. Adjustment of the air-speed tube to the speed indicated by the air-speed meter likewise sets the rear sights, when brought together,



FIG. 127.—Bomb sight, Mark I-A. Side view.

correctly for windless atmosphere. To determine the velocity of the wind, the operator first flies directly with the wind or against it, determining the proper direction by means of drift in relation to the lower sight wire. He then turns at an angle of 90 degrees by compass, so that the wind strikes the machine on the right (this being a right-hand sight). By operating the handwheel he adjusts the drift bar until objects on the ground appear to move along it. The operation automatically moves the "up" and "down" rear sight pins apart, and records the wind speed on the windage scale. The "up" sight pin is moved forward until its adjustment is proportional to the ground speed for up-wind flight, the ground speed being equal to the wind speed *subtracted* from the plane's indicated air speed. The "down" sight pin is moved back until its adjustment is proportional to the ground speed for down-wind flight, the ground speed being equal to the wind speed *added* to the plane's indicated air speed. The plane is now turned back so as to cross the target when flying with or against the wind. At the instant when

the appropriate rear sight pin, either up or down, according to which direction he is flying, comes in line with the front sight pin and the target, the pilot releases the bombs.

The disadvantages of this sight are the error due to pitching and rolling, the necessity for flying over the target either up or down wind, and the difficulties met with in maneuvering to set the drift bar when flying in squadron formation.

Bomb sight, Mark I-B.—This type is similar in details to the above except that it is intended for low-altitude bombing, from 200 to 2,500 feet. Only a few of these sights were ordered for experimental purposes, and the project later was abandoned.

A thorough study of the causes of errors in bomb dropping has led to the development of several new types of sights. Synchronizing sights have been built by the Ordnance Department, and tested with a degree of success that points to an early solution of the problem along these lines. The stabilizing principle may also be incorporated in the new designs. However, no definite information as to the new devices under consideration was available at the end of the war.

Michelin bomb sight.—The Michelin bomb sight has been named the "7th A. I. C. bomb sight" out of courtesy to the seventh aviation instruction center, which is located near the Michelin factory. It consists essentially of a collimator so suspended that it will hang vertically. Cross hairs are projected on the vision of the bomber by means of a mirror so that he can see the ground below as well as the cross hairs. Differences in the strength of light projections between the ground and the sky, which would make the reflection of the cross hairs difficult, is provided for by the installation of a small electric light which may be used to accentuate the reflection of the cross hairs, and by a film of varied colors, which can be moved across the collimator, thus weakening or strengthening the light from the ground. A stop watch is provided, with a handle large enough so that the operator can set it with gloves on.

Description.—The vertical bar is a part of the pendulum suspension. The slotted piece extending above the large thumb screw is pivoted on the vertical bar at its upper end, and may be either parallel to it or at an angle to it. The motion of the collimator is controlled by the slotted piece in connection with the L-shaped arm so that the line of sight for the collimator is approximately parallel to the slotted piece. Adjustment for altitude is made by the small thumb screw at the bottom of the vertical bar, which raises or lowers the whole mechanism, including itself, up or down the bar in accordance with the altitude scale in meters from 400 to 5,000. The large thumb screw advances itself in turning along a rack and varies the angle of the slotted piece in so doing. This large thumb screw has two scales graduated on its dial—an altitude in meters and a time in seconds. When it is set to

the actual altitude of the plane at the same time that the small thumb screw is also opposite the same figure, it puts the collimator at the correct position for measuring 600 meters on the ground. On the other hand, when it is placed on the graduation corresponding to the number of seconds required to pass over 600 meters, it gives the horizontal displacement to correct for the speed of the plane. This in connection with a correcting altitude setting completes the determination of the dropping angle.

Operation.—Both adjustments are set at the altitude of flight, thus throwing the line of sight 600 meters ahead of a point below the plane. While flying in the same direction as that in which the target is to be approached, select a suitable auxiliary point for aiming, and as it reaches the cross hair, start the stop watch. Immediately set the collimator at zero, or back to the vertical, and when the target again crosses the line of sight, stop the watch. Now set the large thumb screw at the number of seconds taken to traverse this distance, and when the real target crosses the sight the bombs can be dropped.

This sight is quite new, being an improvement over the previous sight, and was being installed as rapidly as possible in bombing squadrons. The tendency was to follow the French practice of equipping the leading plane of a flight with this sight. When the pilots see the leading plane drop its bombs they drop theirs. The use of the supporting brackets for suspending the sight from the side of the fuselage was being discarded, owing to the fact that the bomber must, with this suspension, lean out over the side of the fuselage in the high wind for his sighting. Drawings were made, and at least one installation completed, with the sight fastened inside the fuselage so that it may be used through a trapdoor in the floor of the plane. This affords the bomber every facility for the correct use of the sight and ease of controlling his release mechanism.

XII. PYROTECHNICS AND CHEMICAL APPARATUS.

Modern use.—Modern developments have lent increased importance to various forms of luminous night signals and to smoke devices used both as signals during the day and for obscuring the position or progress of troops. Particularly is this the case in connection with the use of aircraft, and the various surprise attacks and raids characteristic of trench warfare. Accordingly, a large number of pyrotechnic devices have been developed for communication or other special purposes, and those that have become standard in the United States Army are described in the ensuing paragraphs.

Rockets.—Signal star rocket, Mark I, is fired from a rocket tube to a height of from 1,000 to 1,200 feet. It is without parachute and includes the following types: White, red, or green; 1, 3, or 6 stars. The weight of the rocket is slightly less than 2 pounds, and its time of bursting is about 30 seconds. It is used entirely as a night signal.

Signal parachute rocket, Mark I.—This rocket is fired from a rocket tube to a height of from 1,000 to 1,200 feet, and is held suspended from a parachute during a time of ignition of about 30 seconds. It weighs about 2 pounds and includes the following types: Red or green; white, red, or green caterpillar; yellow smoke; flag. The caterpillar is a chain of small lights suspended vertically during ignition. All of these types are used as night signals with the exception of the yellow smoke and flag types, which are used for day signaling. The flag type contain a red, white, and blue striped flag, similar to the French tricolor. The dimensions of this flag are 7 by $5\frac{1}{2}$ feet, with the colors running up and down when suspended.

Signal illuminating rocket, Mark I.—This rocket is used to provide illumination as well as for signal purposes. It burns with a white light for about 30 seconds, and its weight and its altitude of burst are the same as in the case of other parachute rockets. All rockets are provided with a yellow-smoke tracer, which allows the entire flight of the rocket to be observed.

Star and parachute cartridge for V-B rifle grenade discharger.—In connection with the rifle-grenade discharger already described and illustrated pages 227–229, it is possible to use a special illuminating cartridge.

V-B star cartridge, Mark I.—The V-B star cartridge, Mark I, is fired from a V-B rifle discharger. It has a total weight of about 12 ounces, and rises to a height of about 300 feet if fired vertically. In the case of the white stars, if they are used for illumination and fired at an angle of 45 degrees, a range of from 400 to 600 feet may be obtained. The illuminant is without parachute, and burns about 15 seconds. The following types are included under this category: White, red, or green, 1, 3, or 6 stars. These devices are used for signaling and, in the case of white stars, for illuminating purposes as well. It is to be noted that in the case of the V-B star cartridge with a plurality of stars a slightly shorter time of burning is to be expected.

V-B parachute cartridge, Mark I.—The V-B parachute cartridge, Mark I, is similar in general design to the V-B star cartridge, Mark I, with the exception that a paper parachute is provided which holds the illuminant suspended during an ignition period of from 25 to 30 seconds. The height of range obtained is the same. A longer cartridge case is, however, necessary to contain the parachute. The weight also is slightly greater. The following types of this device are adopted: White, red, or green; white, red, or green caterpillar; yellow smoke. All these devices are used for signaling, except in the case of the white, which serves also for illuminating purposes. The yellow smoke is used for day signaling. The caterpillar design is similar to that described under the signal parachute rocket, Mark I. Both the V-B star and V-B parachute cartridge, Mark I, are thrown from the discharger by means of a special blank cartridge, which in shipment is attached to the signal cartridge itself. This arrangement minimizes the difficulty in providing this special ammunition for the rifle.

Position lights and smoke torches.—The position light, Mark I, ground, appears in three types: Red, white, or green. It is placed on the ground and is used to indicate a position to distant observers. The illuminant is contained in a cardboard case about 3 inches long. It weighs about 4 ounces and burns from 1 minute to 1 minute 10 seconds.

Position light, Mark II, hand.—The position light, Mark II, hand, is a white flare designed to indicate a position or to illuminate a landing field. The flare, which is slightly over a foot long, includes a wooden handle. It burns for about one minute.

Smoke torch, Mark I.—Smoke torch, Mark I, is a device used for screening an operation from enemy observers. The smoke composition is contained in a metal can about 6 inches in length, the whole weight of the device being from 3 pounds 10 ounces to 3 pounds 13 ounces. Its time of burning is from four to four and one-half minutes.

Airplane flare, Mark I.—The airplane flare, Mark I, is an illuminating bomb intended for the illumination of a target or landing place or similar purposes and is released from an airplane. The illuminant is contained in a case which is about $3\frac{1}{2}$ feet long and weighs about 32 pounds. The illuminant burns about seven minutes, with a candlepower varying between 300,000 and 400,000. It is held suspended during ignition by a silk parachute.

Wing tip flare, Mark I.—Wing tip flare, Mark I, takes its name from its situation at the extremity of the wings of an airplane. It is used to illuminate landing fields. Its length is about $4\frac{1}{2}$ inches, and its duration of burning about one minute, with a candlepower of about 22,000. These flares appear in two types, white and red.

Very pistol.—The Very pistol is a device used to project signal lights into the air by means of a cartridge specially designed for the purpose. It is made in two forms, Mark III and Mark IV, the Mark IV pistol now replacing the Mark III.

Very pistol, Mark III.—The Very pistol, Mark III, 10-gauge, is used for discharging signal lights Mark II, and is a steel and brass pistol weighing about $2\frac{1}{2}$ pounds. It is supplied with a holster, and pouch to contain the cartridges.

Major parts.—It consists of the following parts:

- (a) The barrel.
- (b) The handle.
- (c) The firing mechanism.
- (d) The extraction mechanism.

(a) The barrel is made of steel and its bore is that of a 10-gauge shotgun. Its length is 9.05 inches.

(b) The handle consists of a bronze frame and two walnut sides, with fastening devices. The barrel and handle are fastened together by a steel hinge screw, and are held in proper position by a barrel catch. This catch is an L-shaped piece of alloy steel.

(c) The firing mechanism consists of a trigger spring, hammer, mainspring, face plate, firing pin, and firing-pin sleeve.

(d) The extractor mechanism consists of the extractor, the extractor cam, and fastening device.

Operation of pistol.—To operate the pistol the barrel-catch nut is pressed with the thumb, which breaks open the barrel. The cartridge is then inserted and barrel returned to original position, and barrel and frame securely locked.

Signal light, Mark II, Very.—The signal light, Mark II, Very, is a 10-gauge cartridge fired from Very pistol, Mark III. It includes three types—red, green, or white—and is used exclusively for signaling. It is being replaced by the Very star and Very parachute 25-mm., Mark I, cartridge.

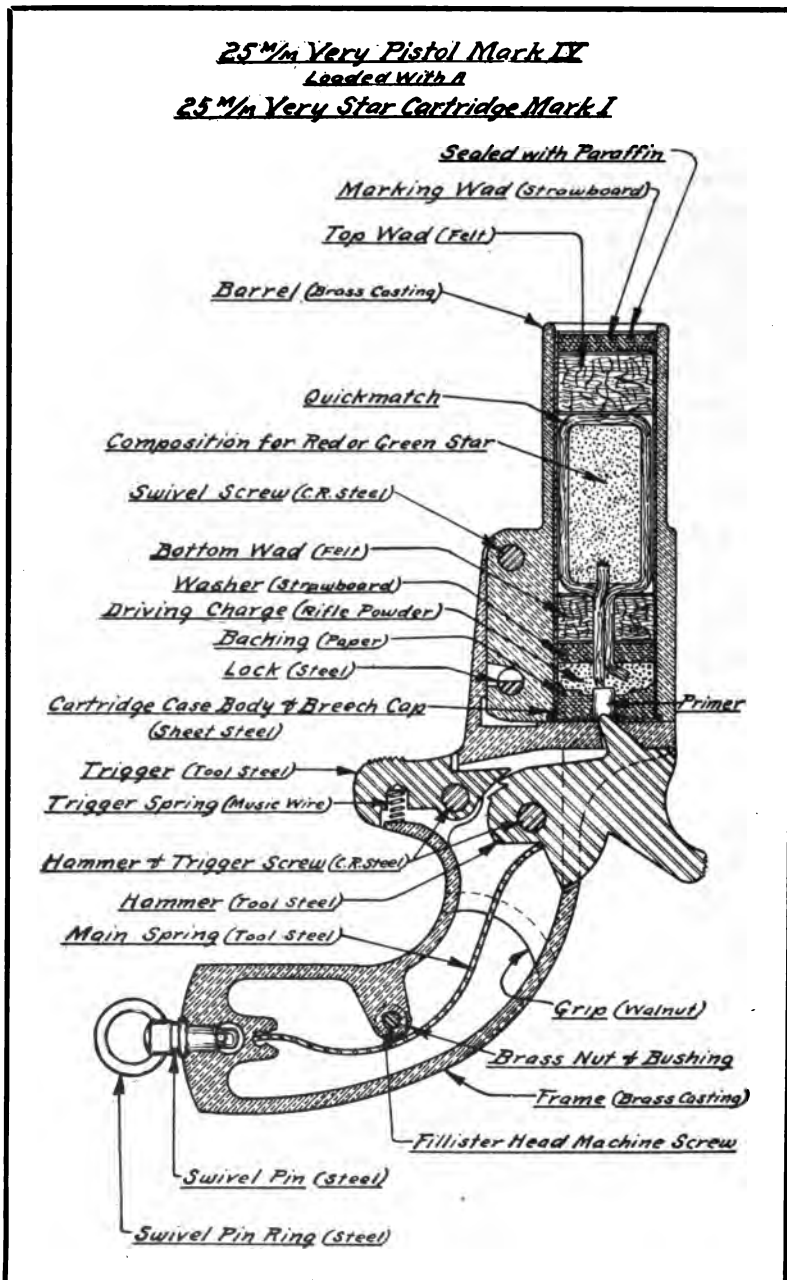

FIG. 128.—Very pistol, Mark IV, loaded with Very star cartridge, Mark I.

Very pistol, Mark IV.—This Very pistol of 25-mm. gauge is made of brass and weighs about 2 pounds. The length of its barrel is about 4 inches. It is used to discharge the Very star cartridge, Mark I, and the Very parachute cartridge, Mark I.

Very star cartridge, Mark I.—Very star cartridge, Mark I, 25-mm., is discharged from the Very pistol, Mark IV. Illuminating star or stars are contained in either a paper or metal cartridge case. It rises to a height of about 190 to 200 feet and burns from 5 to 6 seconds. The following types are included in this category: White, red, or green; 1, 3, or 6 stars. It is to be noticed that in the case of the 3 and 6 star cartridges an auxiliary metal case, providing an extension of the usual case, is used. All of these cartridges are used for signaling. With the white stars a certain amount of illumination is obtained.

Very parachute cartridge, Mark I.—The Very pistol cartridge, 25-mm., Mark I, is provided with a parachute, which holds the illuminant suspended at a height of about 200 feet during a time of ignition of from 10 to 15 seconds. An auxiliary case is used in connection with this device. It is represented by the following types: Red or green; white, red, or green caterpillar. These cartridges are used primarily for signaling, although a certain amount of illumination may be obtained from the white caterpillar. The caterpillar gives a chain of small lights suspended vertically during burning.

Aviation signal pistol and cartridge.—The 35-mm. signal pistol, Mark I, aviation, is made of aluminum and weighs about 2 pounds. The length of the barrel is about 5½ inches. It is used for discharging 35-mm. signal cartridges, Mark I, described below.

Signal cartridge 35-mm., Mark I, aviation.—The 35-mm. signal cartridge, Mark I, aviation, is fired from the 35-mm. signal pistol, Mark I, aviation, and is used for signaling from airplanes. It contains a propelling charge of powder only sufficient to carry the cartridge clear of the wings of the plane. Time of burning is from 10 to 15 seconds, except in the case of the white caterpillar, which burns from 20 to 25 seconds. The following types are included under this category: White, 1, 2, 3, and 6 stars; red or green, 1 and 6 stars; white caterpillar; yellow smoke. Two cartridge cases are employed, one 5 inches long, in case of the single stars, the other 6½ inches long in the case of a plurality of stars and the yellow smoke. All of these cartridges are used as signals.

Pyrotechnics laboratory.—The ordnance pyrotechnic laboratory at the American University, Washington, D. C., was equipped for experimental and development work. Tests of pyrotechnic matériel in the laboratory consist of candlepower, smoke, and time determinations.

Candlepower.—Candlepower is defined as the unit in which the intensity of a light source is measured. The present official unit of candlepower in the United States is the "international candle," which is equal to the French candle called the "Bougie decimale," and the English candle called the "Pentane candle."

TABLE 27.—*Pyrotechnics—Nomenclature.*

Under General Order No. 57, dated June 19, 1918, the following nomenclature has been adopted for the system of pyrotechnics now in use in our Army:

Name.	Purpose.	Remarks.
Signal star rocket, Mark I, white, 1, 3, and 6 stars.....	Signaling.....	Fired from rocket tube
Signal star rocket, Mark I, red, 1, 3, and 6 stars.....	do.....	Do.
Signal star rocket, Mark I, green, 1, 3, and 6 stars.....	do.....	Do.
Signal illuminating rocket, Mark I, white parachute.....	Signaling and illumination.	Do.
Signal parachute rocket, Mark I, red, green, white, caterpillar, red, caterpillar, green, caterpillar.	do.....	Do.
Signal parachute rocket, Mark I, yellow smoke.....	Day signaling.....	Do.
Signal parachute rocket, Mark I, flag.....	do.....	Do.
Very star cartridge, Mark I, 25 mm., white, 1, 3, and 6 stars.	Signaling.....	Fired from 25-mm. Very pistol.
Very star cartridge, Mark I, 25 mm., red, 1, 3, and 6 stars.	do.....	Do.
Very star cartridge, Mark I, 25 mm., green, 1, 3, and 6 stars.	do.....	Do.
Very parachute cartridge, Mark I, white, red, and green.	do.....	Do.
Very parachute cartridge, Mark I, white caterpillar, red caterpillar, green caterpillar, yellow smoke.	Signaling; day signaling.	Fired from 55-mm. Very pistol.
Very pistol, 25 mm. Mark IV.....	Used for discharging Very star and Very parachute cartridges.	
V-B star cartridge, Mark I, white, 1, 3, and 6 stars.....	Signaling.....	Fired from a V-B rifle discharger.
V-B star cartridge, Mark I, red, 1, 3, and 6 stars.....	do.....	Do.
V-B star cartridge, Mark I, green, 1, 3, and 6 stars.....	do.....	Do.
V-B parachute cartridge, Mark I, white, red and green.....	do.....	Do.
V-B parachute cartridge, Mark I, white caterpillar, red caterpillar, green caterpillar, yellow smoke.	Signaling; day signaling.	Do.
35 mm. signal cartridge, Mark I, aviation, white, 1, 2, 3, and 6 stars.	Signaling.....	Fired from aeroplane with 35-mm. signal pistol.
35 mm. signal cartridge, Mark I, aviation, white, caterpillar; red, 1 and 6 stars; green, 1 and 6 stars.	do.....	Do.
35 mm. signal pistol, Mark I, aviation.....	Used for discharging 35-mm. signal cartridges.	
Aeroplane flare, Mark I.....	Illumination.....	Dropped from aeroplane; is a slight adaptation of Michelin illuminating bomb.
Wing tip flare, Mark I.....	Illumination for landing of aeroplanes.	Situated at extremities of wings of aeroplanes.
Position light, Mark I, white, ground.....	Indicated position.....	Is placed on ground.
Position light, Mark I, red, ground.....	do.....	Do.
Position light, Mark II, white, hand.....	do.....	Held in hand.
Smoke torch, Mark I.....	Screen.....	Stands on ground; smoke is of yellow color.
Signallight, Mark II, Very, red, green or white.....	Signaling.....	Fired from 10-gauge Very pistol.
Very pistol, Mark III.....	Discharging signal lights, Mark II, Very.	10-gauge.
V-B rifle discharger.....	Discharging V-B parachute and star cartridge.	Is attached to end of rifle.

Smoke tests.—Candlepower measurements determine the illuminating and visibility value of pyrotechnic matériel. Since the smoke evolved may act in such a way as partially to obscure the light, an indication of the amount of smoke for the purpose of comparison is desirable.

Method of test.—The pyrotechnic material tested is burned under a metal hood which connects with a smokestack. The candlepower measured is free of smoke interference. At a suitable distance from the hood the pipe is pierced to permit smoke observations.

Smoke readings.—Smoke observations consist of measuring the apparent decrease in candlepower of an incandescent lamp caused by the passage of smoke between it and the photometer. The results are expressed in per cent of light transmitted through the smoke. Since the amount of smoke passing before the lamp is dependent on a number of factors, such as the time of burning, the weight of the sample, and the volume of air rising with the smoke, the results are only relative, apply only to a particular apparatus and to a particular type of flare, and are not used as a basis of comparison of different types of pyrotechnics.

Apparatus.—The portable devices most generally used by illuminating engineers in this country for measuring illuminations are the Sharp-Millar photometer and the McBeth illuminometer. The laboratory has two Sharp-Millar photometers, one for candlepower measurements and the other for smoke determinations.

The Sharp-Millar photometer or any other portable photometer is in principle a "stationary photometer reduced in size, with a test plate substituted for one of the photometric surfaces." The dimensions of the instrument are 28 inches long, 5 inches wide, 5 inches deep, and the weight is 8 pounds.

The photometric device is an adaptation of the Lummer Brodhun photometer. The movable comparison lamp is an incandescent electric, operated from either a 4-volt battery or from a regular lighting circuit. The photometer setting is observed on a scale on the front of the box. The scale is illuminated by the comparison lamp whose casing carries the indicator. The instrument is provided with absorption glasses to increase the range of measurement. For the reading of the higher illuminations an absorption screen is interposed between the test course and the photometer. For the reading of low illuminations the screen is interposed between the comparison lamp and the photometer.

Method of test and calculations.—The calibration of the Sharp-Millar photometer used by this laboratory for candlepower is checked at intervals at the National Bureau of Standards. The calibration of the instrument consists of placing a standard lamp at a convenient distance from the photometer. The indicator on the photometer is placed on the scale at a point corresponding to the candlepower of the standard lamp, and the current through the comparison lamp on the instrument is adjusted to give a photometric balance.

Laboratory methods.—The instrument used by this laboratory is calibrated to read candlepower, using a scale factor of 10 at a distance of 80 inches, when the current through the comparison lamp is 242 milliamperes (indicated on a Weston milliamperemeter). At any other distance than 80 inches the scale reading must be multiplied by a factor which is a ratio of the squares of the distances.

The photometric distance used by this laboratory is 42 feet, or 504 inches; therefore the scale factor is $\left(\frac{504}{80}\right)^2 \times 10 = 397$. When the neutral glass, No. 1 (transmission 15.5 per cent) is on the test side, the scale factor is $\frac{397}{0.155} = 2,560$. When the neutral glass No. 2 (transmission 6.87 per cent) is used on the test side, the factor is $\frac{397}{0.0687} = 46,680$.

The total range of the instrument used by this laboratory is from 10 candles to 950,000 candles.

The procedure for determining the smoke reading is as follows: The photometer is sighted through the smoke pipe on an incandescent lamp directly opposite. The current through the comparison lamp is then adjusted to give a convenient reading on the scale when no smoke is passing through the pipe. The ratio of the reading taken when the pipe is clear to the reading when the smoke is passing gives an indication of the density of the smoke.

Example: Reading clear=5; smoke reading=2; calling the transmission of light 100 per cent for the clear reading, the transmission of light through the smoke is $\frac{100}{50} \times 20 = 40$ per cent.

GAS AND INCENDIARY DEVICES.

Gas-emplacement set.—Gas-emplacement sets are used in producing so-called drift or wave gas attacks. Each set consists of four cylinders of gas attached to a manifold by flexible metal hose. Each cylinder is filled with poisonous gas. This gas must either be of a heavy nature or must be mixed with another poisonous gas sufficiently heavy in character to prevent rapid dissipation in the air.

Any number of manifolds and groups of cylinders may, if desired, be connected together. In general they are used in individual groups of four cylinders. The metal hose was developed in place of rubber hose, as the latter, under the influence of these poisonous gases, immediately deteriorates. The manifold is connected to a pipe leading from the parapet of the trench, on the end of which is a nozzle from which the liquefied gas emerges. The liquid vaporizes about 10 feet away from the trench. The whole outfit is carried up to the trenches by hand, and the cylinders of course have to be as light as possible. In practice the entire contents—about 60 pounds of poisonous gas—can be discharged from the cylinder through the special flexible hose and nozzle in about $3\frac{1}{2}$ minutes.

Flame projectors—Knapsack type.—The knapsack type of flame gun weighs about 70 pounds. It consists of a container filled with inflammable liquid under pressure. Ignition is accomplished by a pilot

on the end of the gun. To the container is attached a hose with a nozzle. When the valve in the nozzle is opened the liquid is driven out and immediately ignites. This apparatus is capable of projecting 10 to 12 shots of flaming liquid to a distance of about 100 feet.

Flame projector, tractor type.—A flame projector to be used with tanks for cleaning out trenches, dugouts, and similar close-range fighting. A hand operated projector was designed but later it appeared desirable to have a special type with electrical control and a weapon was developed with a range of 160 feet and a $\frac{3}{4}$ -inch nozzle, and an experimental model was constructed. None however was put into production.

Flame projector, parapet type.—A parapet type of flame projector for use in the trenches operated either by hand or in batteries by an electric blasting machine was also developed where the fuel tank was installed at the bottom of the trench or in a niche and the oil carried through flexible tubes to the nozzle built into the defense or fastened to the parapet. Work was suspended on two machines ordered before the time of signing the armistice.

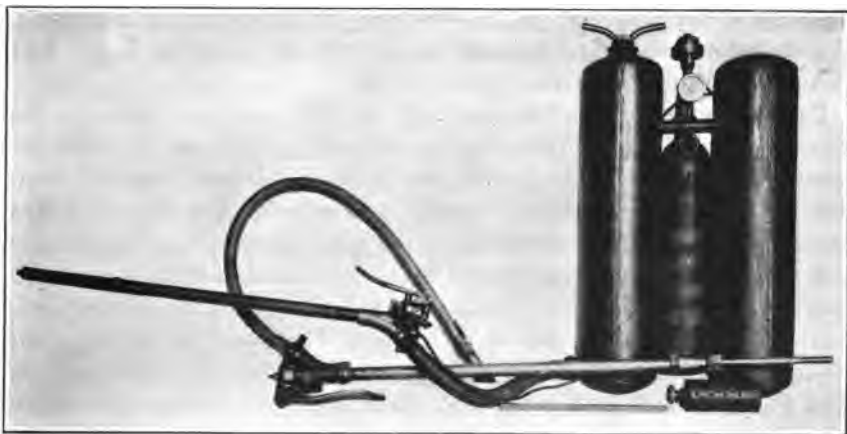

FIG. 129.—Experimental knapsack flame projector.

Smoke knapsack.—The smoke knapsack consists of two cylindrical containers with suitable valve connections and flexible hose. In one tank 30 pounds of silicon tetrachlorid is held under a pressure of 350 pounds of dry air; in the other are 14 pounds of anhydrid ammonia, which is expelled under its own pressure. The ammonia tank is fitted with a flexible hose running from the bottom to two spraying nozzles which face each other at an angle of 90 degrees. The third nozzle is between the other two and is attached to the tank containing the silicon tetrachlorid. It faces the front, so that when the valves are opened the intersecting cones of ammonia are met by the stream of silicon tetrachlorid from the other nozzle. The chemical reaction causes a dense white smoke.

XIII. MACHINE GUNS.

Method of fighting.—The British organization and system of fighting with machine guns is somewhat different from that of the French. In the former system the gun of intermediate weight, such as the Lewis, plays a vital part. In the latter system no such gun is used. The entire field of activity is covered by the heavy machine gun, weighing about 40 pounds, and by the light automatic rifle fired from hip or shoulder, weighing 16 pounds. In June, 1917, at the series of conferences held in Washington with the representatives of the allies it was decided that the American forces would cooperate with the French. This made it highly desirable for military reasons to organize and equip our men as the French were organized and equipped. We therefore could find no part in our program for the Lewis gun except for training purposes and aviation.

Condition at outbreak of the war.—At the time war was declared, the Savage Arms Co. was producing Lewis machine guns under a British contract for 10,000. The Lewis gun prior to this time had not been developed to a point where it would satisfactorily fire United States ammunition. As soon as a reasonable performance had shown this gun to be serviceable with United States service ammunition an order was placed with the Savage Co. for 1,300 Lewis guns, utilizing practically all the available funds on hand. This was April 12, 1917. Completion of delivery of these guns was made during January, 1918. The Savage plant had been kept fully occupied during this entire period, and they had been requested to increase their capacity and were assured of orders to cover when money would be available. A total of approximately 44,000 guns had been ordered. Most of these were of the aircraft type, which differs slightly from the standard type to meet the requirements of the aviation service.

Choice of guns.—The adoption of the Browning light gun, instead of the Lewis, for foot troops followed the practice of the French, who employ the Chauchat rifle, which is lighter than the Lewis and more like the Browning.

Lewis and Browning.—As a result of the Springfield test in May, 1917, the Lewis gun was adopted and was ordered in large quantity. The Browning guns were also adopted. The Lewis gun is mainly used for aircraft, as it is very satisfactory for this purpose. The Browning

guns are used on the ground; and until they were obtainable the French Chauchat and Hotchkiss, neither of which is suitable for aircraft work, were used by our troops.

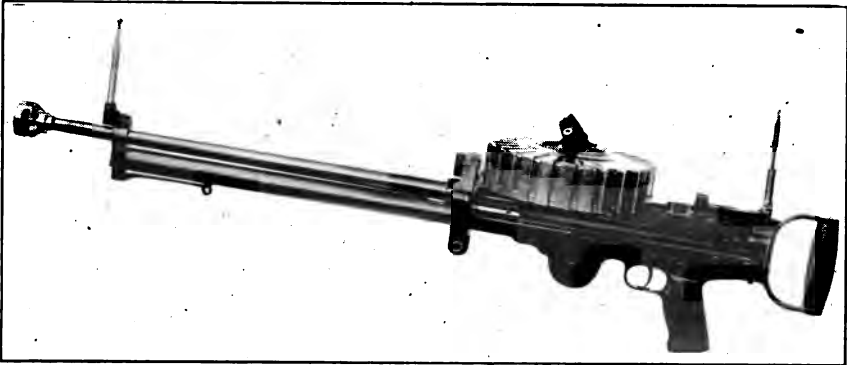

FIG. 130.—Lewis aircraft machinegun, model of 1917.

The Browning guns passed the prescribed firing and endurance tests more satisfactorily than other guns which had long been in active service and were recommended by the board, composed of high officers of long experience, for purchase in large number in view of our entrance into war.

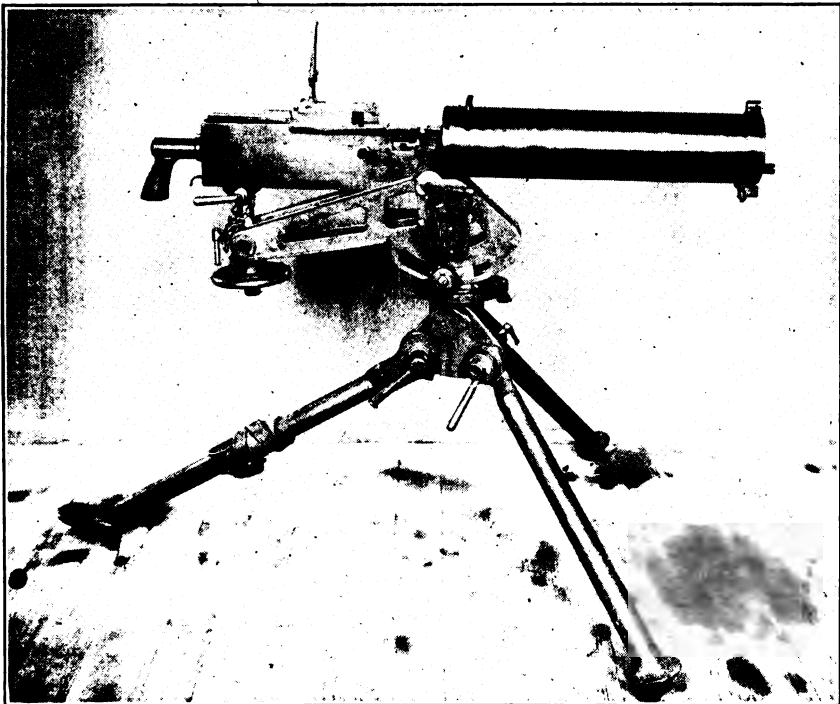

FIG. 131.—Browning machine gun, water-cooled type.

The Lewis gun was continued in manufacture after the completion of the British contracts, and the Ordnance Department urged the manufacturers to increase their capacity from about 65 per day, which the company produced under the British contract, first to 150 and then to 200 per day. The Lewis gun were therefore manufactured in quantity in a factory that was manufacturing them for the British Government when war was declared.

Production.—The time taken to develop plants for producing Browning machine guns was considerable, as also the time required for producing the Vickers machine gun. An order for 4,000 Vickers guns was given in December, 1916, but it was not until the early months of 1918 that this production was attained and the completed guns, in like amount, shipped to Europe. Obviously the machine-gun industry, which requires a vast amount of special and automatic machinery, could not be built up in a few months; nevertheless, the first Browning light guns were manufactured on a large scale since early in 1918, and in April production of the Browning heavy guns was begun by two contractors. By June quantity production from these and another contractor on an adequate scale was in progress.

Browning gun, water-cooled.—The Browning machine gun, water-cooled, model of 1917, caliber .30, uses United States service ammunition, model 1906, and is of the recoil-operated, water-cooled type, firing 500 shots per minute. This gun was invented and developed by Mr. John M. Browning, of Ogden, Utah, and is manufactured by Colt's Patent Fire Arms Manufacturing Co., Hartford, Conn., Westinghouse Electric Co., East Springfield, Mass., Marlin-Rockwell Corporation, New Haven, Conn., and the Remington Arms-Union Metallic Cartridge Co., Bridgeport, Conn.

The heavy type is fired from a tripod and fed from a webbing belt holding 250 rounds. The gun weighs, with the water jacket empty, 30 pounds, and with the water jacket full 36 pounds and 9 ounces. The tripod weighs 50 pounds, and the loaded belt 15 pounds 7 ounces. The complete outfit consists of one gun, one tripod, one spare-parts kit, two spare barrels, one belt-filling machine case, and four ammunition boxes, each box containing one belt. It is transported in the field on a regulation machine-gun cart.

Browning automatic rifle.—The light type or automatic rifle is fired from the shoulder or hip, and is fed from a magazine holding 20 rounds and weighing 1 pound 7 ounces. The weight of the gun is 15.5 pounds. There is no special provision for cooling, as the gun was not designed for sustained fire. It is carried by means of a sling similar to that of the service rifle, the gunner carrying the gun, spare-parts kit, and the six magazines. One assistant carries 20 magazines, a second assistant 18 magazines.

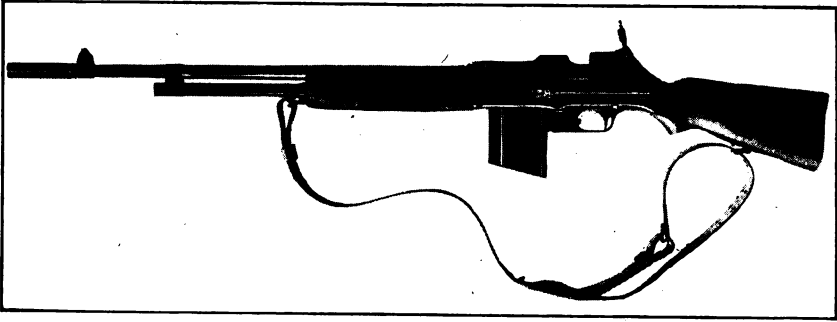

FIG. 132.—Browning automatic rifle, model 1918.

The Browning automatic rifle, model 1918, caliber .30, uses United States service ammunition, model 1906, and is of the gas-operated, air-cooled type, firing 600 shots per minute. Patents were applied for in 1917 by Mr. John M. Browning, of Ogden, Utah. The gun is manufactured by Colt's Patent Fire Arms Manufacturing Co., Hartford, Conn., the Winchester Repeating Arms Co., New Haven, Conn., and the Marlin-Rockwell Corporation, New Haven, Conn. It was developed for front-line work and represents the latest development in automatic rifles. It may be set to fire single shots, or automatic, until the magazine is emptied.

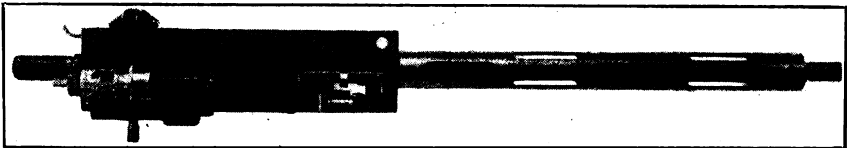

FIG. 133.—Browning aircraft machine gun, model 1918.

Browning aircraft machine gun.—The Browning aircraft machine gun, model 1918, caliber .30, uses United States service ammunition, model 1906, and is of the recoil-operated, air-cooled type, with the water jacket replaced by a skeletonized steel tube, which supports the barrel. It has a rate of fire of 1,150–1,250 shots per minute and can be used with a synchronizer to fire through propeller blades, being fired from a special aircraft mounting. It is fed from a metallic belt, and the gun weighs 22 pounds 8 ounces. The mechanism is essentially the same as that of the Browning water-cooled gun, with such changes as were necessary to adapt it to aircraft work. It is manufactured by the Marlin-Rockwell Corporation, of New Haven, Conn. The introduction of synchronizing gear involved a radical change in trigger mechanism, and the rate of fire was increased when these were made to 1,150–1,250 shots per minute. The feed mechanism was modified also so that the metallic disintegrating belt link designed for the Marlin gun can be used equally well in this.

Lewis machine gun, caliber .303.—The Lewis machine gun, model 1915, caliber .303, uses British ammunition Mark VII, and is of the gas-operated, air-cooled type. It is fed from a circular magazine holding 47 rounds and fires 600 shots per minute. Positive air cooling is insured by an aluminum radiator surrounding the barrel, through which a current of air is drawn by the action of the gases leaving the muzzle. This gun was invented by Col. I. N. Lewis, United States Coast Artillery, retired, and was first patented in 1896. The gun was developed by the British for front-line fire and came into extensive use by the British and Belgians. It is manufactured in the United States by the Savage Arms Corporation, Utica, N. Y., and several National Guard outfits were equipped with it on the Mexican border in 1916. The light type is fired from a light bipod mount or from the shoulder or hip. The gun alone weighs 25 pounds and 4 ounces, and the mount 3 pounds and 8 ounces. An outfit consists of one gun with both butt stock and spade grip, light field mount, spare barrels and spare parts, loading handle, and 12 magazines, and may be placed in a trunk for field transport by cart or motor car.

Lewis machine gun, army type.—The Lewis machine gun, army type, model 1917, uses caliber .30 United States service ammunition, model 1906, and is of the gas-operated, air-cooled type, firing 600 shots per minute. This gun is of the same general design as the British .303 model, with the difference that the parts are strengthened to take care of the increased chamber pressure of the American ammunition over the British, and the unlocking was further delayed for the same reason. In all 17 changes were made. It is largely used by the United States Marine Corps. It is used by the United States Army for training purposes only.

The light type is fired from a bipod mounted, or from the shoulder or hip, and is fed from a circular magazine holding 47 rounds. The weight of the gun is 36 pounds 8 ounces. The weight of the bipod mount is 1 pound 12 ounces, the weight of the loaded magazine 4 pounds 8 ounces. An outfit consists of one gun, one bipod mount, spare barrel, spare parts, one loading machine, and 36 magazines packed in ammunition boxes, 6 magazines to a box. It is transported in the field by the regulation type of machine-gun cart.

Lewis machine gun, aircraft type.—The Lewis machine gun, aircraft type, model 1917, caliber .30, uses United States service ammunition, model 1906, and is of the gas-operated, air-cooled type, firing 600 shots per minute. The entire mechanism of this gun is identical with that of the Army model with the exception of a few minor details, such as the large magazine, special sights, the substitution of a spade grip in place of regular butt stock, and rear mounting yoke complete in place of rear-locking piece as a means of locking the

barrel to the receiver. The radiator and radiator casing are removed and no special provision is made for cooling, as the high speed of the airplane and the low temperature encountered at high altitude, combined with the fact that in aircraft work not more than 25 or 30 rounds are fired at one time, make the radiator unnecessary. The light type is fired from a special aircraft mounting and is fed from a circular magazine holding 97 rounds. The weight of the gun is 18 pounds. (See Aircraft Armament, page 250.)

The Lewis aircraft gun also has been modified to improve its operation for use on a flexible scarf mount. A recoil check has been developed and a gas cylinder and gauge have been provided. The main-spring gear has been changed so that it is readily detachable without dismounting the gun. An indicator, which is sort of a tachometer to show the number of rounds left in the magazine after each burst is fired, is attached to each.

The shipping case for spare magazines contains six 97-round Lewis magazines. These are held on a center post, similar to the post on the gun, so that the rim of the magazine does not touch the container. A similar case is used by the French.



FIG. 134.—Marlin aircraft machine gun mounted on Colt tripod.

Marlin aircraft machine gun.—The Marlin aircraft machine gun, model 1917, caliber .30, uses United States service ammunition, model 1906, and is of the gas-operated, air-cooled type, firing 680 shots per minute. This gun was developed from the old lever-action Colt gun by the Marlin-Rockwell Corporation for aircraft work. The mechanism is similar to that of the Colt, with the main difference that the

gas piston has a reciprocating motion like that of the Hotchkiss and Lewis piston, instead of the swinging lever action of the Colt. The barrel is very light and no provision has been made for cooling, but it is adaptable for the synchronizing attachment. It is fired from special aircraft mountings, being fed from a disintegrating metal link belt made up in 250 to 500 round lengths. This metallic disintegrating belt link is of the same principle as the Prideaux used universally by the allies. The gun weighs 24 pounds. (See also under Aircraft Armament, page 249.) The Marlin gun is also used with tanks.



FIG. 135.—Marlin tank machine gun.

The Marlin aircraft gun has been developed for synchronizing, especially by the improvement of the lock mechanism and the lock container, so that it can be fired through a four-bladed propeller at all engine speeds with perfect safety. With the improved lock container, either the hydraulic or mechanical synchronizing gear can be attached readily. The synchronized Marlin gun has a total angle of dispersion less than any other type of gun as yet synchronized in Europe.

Mounting for four synchronized Marlin guns.—With the demand for increased rate of fire from synchronized fixed guns, mountings are being designed to accommodate four synchronized Marlin guns mounted on an airplane, so that they may be fired simultaneously at a rate of approximately 2,100 shots per minute.

Development of Marlin aircraft gun for use on flexible mount.—A special flexible mount holding two Marlin aircraft guns has been designed in connection with the work on the use of the Marlin aircraft gun as a flexible gun, in case the supply of Lewis aircraft guns is insufficient. A round aluminum ammunition box for use with the flexible gun is attached directly to the bottom plate. These boxes hold up to 500 rounds.

Vickers machine gun.—The Vickers machine gun, model 1915, uses caliber .30 United States service ammunition, model 1906, and is of the recoil-operated, water-cooled type, firing 600 shots per minute. It is fed from a webbing belt, carrying 250 rounds of ammunition.

All of these guns manufactured in the United States and sent abroad have been used in the airplane service. A heavy type of Vickers gun, however, may be fired from a tripod mount and the complete outfit may be transported in the field on a machine-gun cart especially designed to carry Vickers, Colt, Lewis, or Browning water-cooled guns.



FIG. 136.—Vickers machine gun mounted on a Browning machine gun tripod, model of 1917.

The Vickers gun is a modification of the Maxim automatic machine gun invented in 1889 by Sir Hiram Maxim, and has been developed by the British for general fieldwork. It is manufactured in England by Vickers (Ltd.), and in the United States by Colt's Patent Fire Arms Manufacturing Co., Hartford, Conn. The gun with the water jacket empty weighs 32.5 pounds and a loaded webbing belt, holding 250 rounds, weighs 16 pounds.

The outfit consists of one gun, one tripod, one belt-loading machine case, one spare barrel, one spare parts case, five ammunition boxes, one water box, and one condensing tube. The belt-loading machine case, the spare parts case, the water box, and ammunition box are all of the same shape and size. The belt-loading machine case, which contains also tools and equipment for repairing the belts, is marked with a longitudinal red band, while the spare parts case, which contains in addition, tools for disassembling and repairing, is marked with a blue band. In addition to the cart on which the outfit is transported, there is a second cart to carry 14 boxes of ammunition for this gun, and each machine gun company has two spare gun carts carrying two spare guns each, with the attending accessories but without any ammunition.

11-mm. Vickers aircraft machine gun for firing incendiary ammunition.—The Russian Vickers gun, which was immediately available at Hartford, was the subject of experiments and tests to the end that it

might use incendiary ammunition. The Signal Corps had requested 1,000 caliber .433 Marlin aircraft machine guns for use with the incendiary ammunition, and a sample gun of this type was modified and prepared for test. As it was found necessary practically to redesign the entire Marlin gun for this purpose, experiments were conducted with the Russian Vickers gun, one of which was bored and chambered for 11-mm. French ammunition, and necessary minor changes were made in the lock. The test of this gun was so successful that the Control Bureau was requested to secure from the Colt's Patent Fire Arms Manufacturing Co. the 800 Russian Vickers guns, either completed or in process, to obviate the difficult and expensive work of redesigning and producing 1,000 Marlin guns.

Vickers aircraft model.—An aircraft model was designed by the Vickers Co., in which the water jacket was replaced by the skeletonized tube which supports the barrel, decreasing the weight of the

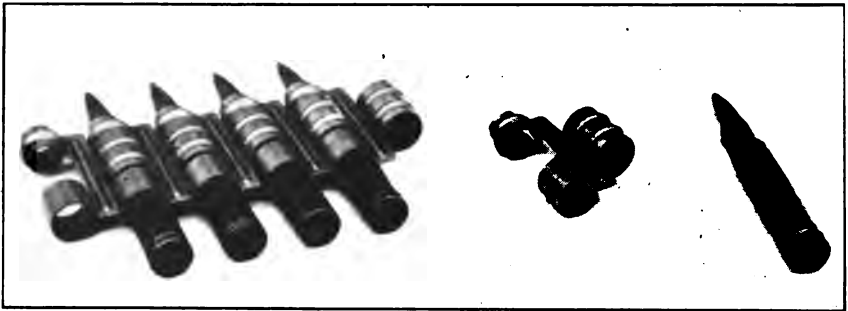

FIG. 137.—Metallic disintegrating feed belt for Vickers aircraft machine gun.

gun considerably. The mechanism is the same as in the gun supplied to the mobile army, except that there is no muzzle attachment, the feed box is made of aluminum, and when firing is suspended, the lock stops in the rearmost position so that the chamber remains open until the trigger is pulled, thus preventing a cartridge being exploded by a hot barrel. The gun is fed by a disintegrating metallic link belt similar to the Prideaux link, made up in 250 to 500 round lengths, and is fitted with a loading handle by means of which the complete loading operation can be accomplished with one hand.

A water-cooled model is also used in aircraft work, with the water-jacket mechanism arranged for the free circulation of air. This gun is also equipped with a loading handle and with a mechanism which permits the aviator to adjust the recoil-spring tension from the rear end of the gun.

A left-hand feed box has also been designed for the Vickers gun, to allow two guns being placed close together with just enough space between them for the ejection of the belt links, the belt being fed from opposite sides.

The Vickers aircraft gun can be used with a synchronizing attachment to fire through the propeller.

Hotchkiss machine gun.—The Hotchkiss machine gun, model 1914, caliber 8 mm., uses French (Lebel) ammunition, model 1886, and is of the gas-operated, air-cooled type, firing 400 shots per minute. This gun was invented by an Austrian, Capt. von Odkolek, in 1897, and was developed by the French for use in Africa, where water cooling would not be practical. It was used by the Japanese with great success in the Russo-Japanese War, and at present is the standard machine gun of the French Army, more than half of the heavy machine guns on the allied western front having been Hotchkiss guns.



FIG. 138.—Hotchkiss machine gun and tripod.

The heavy type is fired from a tripod, and is fed from a rigid metallic strip holding 24 rounds or from a flexible metallic band holding 250 rounds. The gun weighs 54 pounds, the tripod 54 pounds, and a loaded strip 1 pound 12 ounces. It is manufactured by the Hotchkiss Co., St. Etienne, France. A complete outfit consists of one gun, one tripod, one flash hider, one spare barrel, one spare parts case, one gunner's pouch, one resizing tool outfit, and six ammunition boxes holding 10 strips each. The complete outfit is transported in the field on a machine-gun cart, very similar to the American standard cart.

A lighter type, weighing 30 pounds, was developed by an American, Lawrence Benet, about 1900, and is known in England as the light Hotchkiss, and in America as the Benet-Mercie automatic machine rifle, having been adopted in 1909 as the standard automatic

rifle of the United States Army. It was used to some extent by the French, British, and Belgians, but has been discarded in favor of less complicated types. The United States discarded it as their official weapon in 1914.

Chauchat automatic rifle.—The Chauchat rifle, model 1915, caliber 8 mm., uses the French (Lebel) ammunition, model 1888, and is of the recoil-operated, air-cooled type, firing 300 shots per minute. This gun was developed by the French commission—Messrs. Chauchat, Suterre, Ribeyrolle, and Gladiator. It has been used to a large extent by the American Expeditionary Forces. The light type, which weighs 19 pounds, is fired from a bipod mount or from the shoulder



FIG. 139.—Chauchat automatic rifle and bipod.

or hip, and is fed from a semicircular magazine holding 20 rounds and weighing loaded 1 pound 13 ounces. The outfit, which is carried in the field by the gunner and his assistant, consists of one gun with attached bipod, one spare parts kit in a gunner's pouch, and 16 magazines.

Berthier light machine gun.—The Berthier light machine rifle, model 1917, caliber 0.30, uses United States service ammunition, and is of the gas-operated, air-cooled type, firing 600 shots per minute. This gun was invented by a Frenchman, Gen. Berthier, patented in Belgium, and perfected in the United States. Comparatively few of these guns were ordered and delivered, as manufacturing facilities did not seem to be available in the United States. The light type is fired from a bipod mount or from the shoulder or hip, and is fed from a magazine holding 30 rounds. The weight of the gun is 15 pounds, and the weight of the loaded magazine is 2 pounds 5 ounces. The radiating surface is increased by fluting the outside of the barrel.

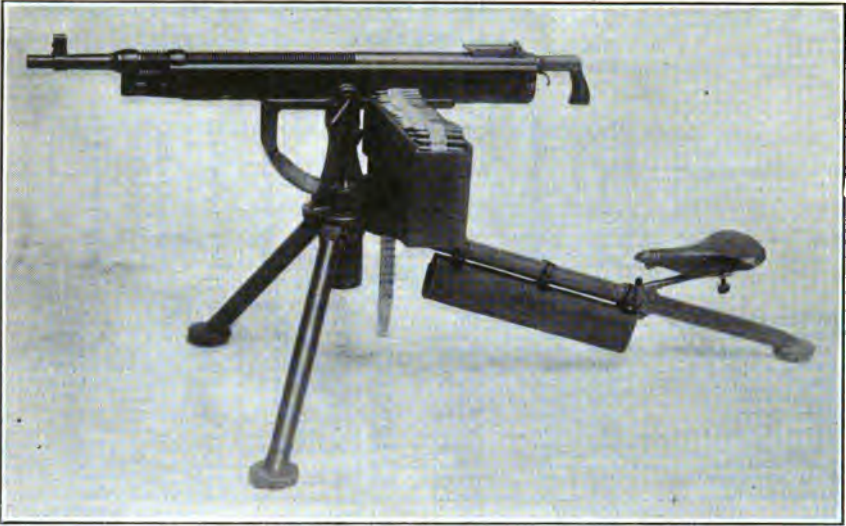

FIG. 140.—Colt machine gun and tripod.

Colt machine gun.—The Colt machine gun, model of 1917, uses caliber 0.30 United States service ammunition, model, 1906, and is of the gas-operated, air-cooled type, firing 450 shots per minute. It is fed from a webbing belt holding 250 rounds.

This gun has been used to some extent in the United States Army and Navy, and also by South American countries, by Russia, by France, and by England. Deliveries to the United States Government of this type were stopped early in the war, and those on hand were used for training purposes only. The Colt was patented in 1895 by John M. Browning, of Ogden, Utah, and was manufactured by the Colt's Patent Fire Arms Manufacturing Co., Hartford, Conn. The latest model was manufactured by the Marlin-Rockwell Corporation, New Haven, Conn., and from it was developed the Marlin aircraft and tank guns which have been already discussed. The heavy type of Colt machine gun is fired from a tripod as shown above. The gun weighs 35 pounds, the tripod 56 pounds, and the loaded belt 15 pounds. Cooling is facilitated through radiating fins turned in the outside of the barrel.

The complete outfit is transported in the field on the regular machine-gun cart the same as used for the Vickers gun and illustrated and described on pages 310, 311, and 312. The outfit consists of one gun, one tripod, one belt-loading machine case, and seven ammunition boxes, each ammunition box containing one loaded belt. The belt-loading machine case is considerably larger than the ammunition box, and the spare parts case is made of leather and hangs on the trial tube of the mount.

TABLE 28.—
MACHINE GUNS.

Make of gun.	Model (year).	Method of operation.	Method of cooling.	Shots per minute (rate).	Weight of gun.	Total length of gun.	Length of barrel.	Weight of mount.	Rounds per clip belt.	Weight of water.
					<i>Ebs.</i>	<i>Ins.</i>	<i>Ins.</i>	<i>Lbs.</i>		<i>Lbs.</i>
Hotchkiss, 8-mm.....	1914	Gas.....	Air.....	400	53.75	52	31	50.7	24-250
Colt-Lever.....	1917	do.....	do.....	430	33	42	28	56.5	250
Browning machine gun.....	1917	Recoil...	Water...	600	30	37	24	37	250	6
Lewis machine gun.....	1916	Gas.....	Air.....	500	25.25	51.75	26	3.50	47
Vickers.....	1915	Recoil...	Water...	500	32.5	42.8	28	37	250	7.8
Benet-Mercie.....	1909	Gas.....	Air.....	550	33	49	24	4.5	30
Maxim-German.....	1903	Recoil...	Water...	575	38	45	24	138	250	7.8
Madsen rifle and gun.....	1903	do.....	Air.....	480	18	3.8	20
Bergman gun.....	1914	do.....	Water...	600	28.3	43.5	26	250	8.8
Parrabellum gun.....	do.....	do.....	Air.....	600	250
Skoda-Japan and China.....	1902	do.....	Water...	300	28.66	(1)	8.8
Perino-Italian.....	1907	do.....	Air.....	Strip.
Fiat.....	1908	do.....	Hopper.
Schwarz Loee-Austria.....	1906	Recoil breech.	Water...	450	38.56	21.2	41	250	8.8

¹ Magazine fed 20 rounds.

AUTOMATIC RIFLES.

Berthier.....	{1904 1917	Gas.....	Air.....	500	15.75	48	24	20
Browning, automatic rifle.	1918	do.....	do.....	525	15.5	48.7	24	20-40
Hotchkiss, port.....	1907	do.....	do.....	550	19.13	30
Chauchat, 8-mm.....	1915	Recoil...	do.....	300	19.5	45.5	17.5	20
Chauchat, caliber .30.....	1918	do.....	do.....	300	19.5	45.5	17.5	20

AIRCRAFT MACHINE GUNS.

Lewis.....	1917	Gas.....	Air.....	500	18.37	51.75	26	47-97
Marlin, aircraft.....	1918	do.....	do.....	680	23.5	34	24	250
Vickers.....	1918	Recoil...	do.....	950	29.5	42.8	28	250
Browning, aircraft machine gun.	1918	do.....	do.....	1150 to 1250	24	37	24	250

¹ Approximate.

MACHINE-GUN ACCESSORIES.¹

Belt-loading machines for metallic links.—Belt-loading machines for loading ammunition in Marlin-Browning metallic links and Vickers metallic links were developed and were in production before the close of hostilities.

Armorer's tool kit.—A tool kit has been designed for squadron armorers for use in inspection and making minor repairs on guns mounted on airplanes. These pouches are made of heavy duck, impregnated with oil, and are provided with a strap for wearing over the shoulder or fastened about the waist.

Armorer's tool chest for use in air squadron.—Armorer's tool chests have been made up for use in the air-service training schools. These

¹ See also Aircraft armament, page 254.

chests include all necessary tools for making repairs in machine guns. Armorer's tools are also supplied for the armorer's trucks, one of which accompanies each air squadron.

TABLE 29.—Articles transported by machine-gun units (motorized).

Name.	By 1 machine-gun car, 8 men; full equipment for 8 men.	By 1 platoon car, 2 men; equipment for 2 men; motor-cycle riders, and others.	By 1 headquarters car equipment of officers, etc.	By 1 company.	By 1 battalion. ¹
Machine gun (water-cooled).....	1			12	24
Machine gun (spare).....		1		4	8
Tripod.....	1	1		16	32
Water boxes.....	4	1		52	128
Belt boxes for ammunition.....	14	28		480	960
Ammunition belts.....	14	28		480	960
Rounds of ammunition in belts.....	3,500	7,000		141,600	* 283,200
Belt-loading machine in box.....	1			12	24
Case of ammunition (1,200 rounds in each).....		6		18	36
Tool box and contents.....	1	1		16	32
Spare barrel.....	1	1		16	32
Spare-barrel case.....	1	1		16	32
Steam-condensing device.....	1	1		16	32
Pairs asbestos mittens.....	1	1		16	32
Brood hatchet.....	2	2		32	64
Pick mattock.....	2	2		32	64
Short-handled shovel.....	2	2		32	64
Cleaning rod, cleaning and preserving material.....	1	1		16	32
Collapsible canvas bucket.....	1	1	1	16	46
Flag kit.....		1	1	4	10
Canvas gun cover.....	1	1		16	32
Protractor, semicircular.....		1	1	4	8
Protractor, alidade.....		1	1	4	8
Range finder and tripod.....		1	1	4	8
Panoramic sight with tripod, attachable to gun or tripod.....		1	1	4	8
Angle of sight instrument.....		1	1	4	8
Clinometer.....	1	1	1	16	32
Prismatic or lensatic compass.....	1			6	12
Armorer's tool chest.....					1
Plane table with canvas cover and tripod.....		1	1	4	8

¹ Two motorcycles with side cars also furnished by the Medical Department.

* Plus additional supply in train.

NOTE.—The following vehicles are issued to 1 machine-gun company (motorized), in addition to the 12 machine-gun cars:

Three platoon headquarters cars. These cars carry articles shown in Column II. They are the same general construction as the machine-gun cars, of which there are 4 to a platoon. The platoon cars differ from the machine-gun cars in that the platoon cars have no trays and other devices used to carry the equipment in the gun cars. One 5-passenger motor car, 3 motor cycles with side cars, and 2 motor cycles without side cars are also issued to each platoon of a Machine Gun Company, Motorized.

Each company headquarters is equipped with one motor car similar to the platoon car and machine-gun car, two 5-passenger motor cars, and 3 motor cycles with side cars.

Each battalion headquarters is equipped with one 5-passenger motor car, 3 motor cycles with side cars, one 4-ton truck, four 1½ ton combat trucks, two 1½ ton ration and baggage trucks, and one 1-ton supply truck. Each company train also includes 1 light repair truck, and 1 supply truck for fuel, oil, water, and one spare gun.

Each company carries the following supply of ammunition—

Rounds.

3,500 rounds × 12 = 42,000 in 12 machine-gun cars.

7,000 rounds × 3 = 21,000 in belts in 84 ammunition boxes in three platoon cars.

1,200 rounds × 18 = 21,600 in cases in three platoon cars.

84,000

Plus 57,000 in belts in 228 ammunition boxes in train.

141,600

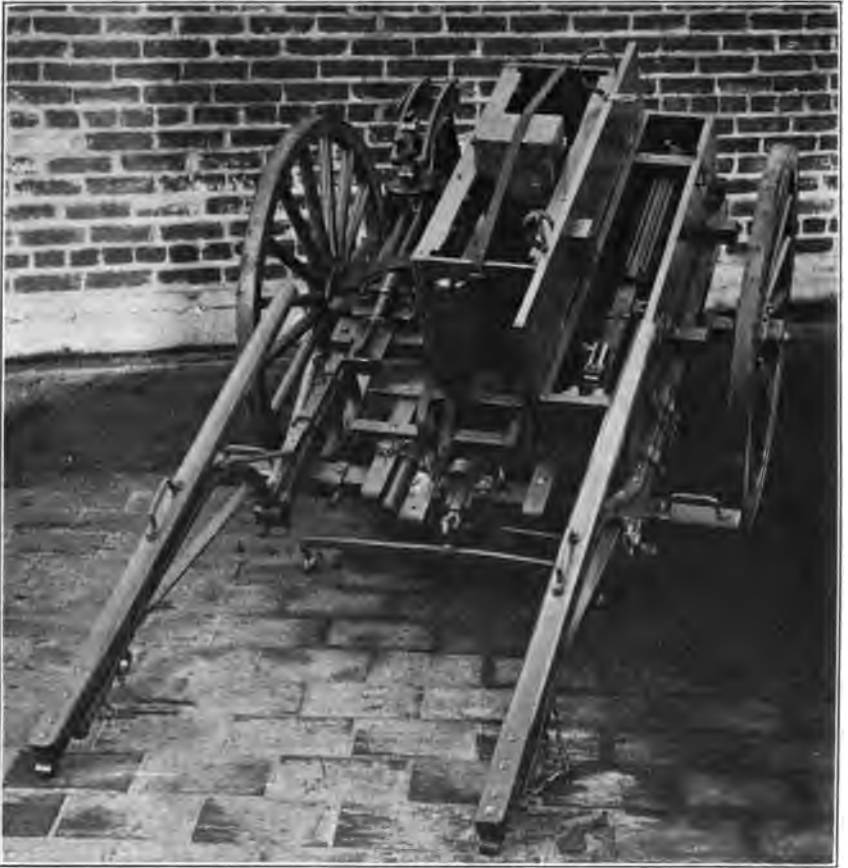

FIG. 141.—Machine gun cart.

Special aircraft ammunition.—Special .30-caliber armor-piercing incendiary and tracer ammunition was developed for use in the machine guns mounted on airplanes and was in quantity production before the war ended. These special types are discussed under Ammunition on pages 345 et seq.

Mounts for machine guns.—For machine guns, heavy type, a tripod conforming to the weight of the gun is found more satisfactory for field service. The tripods vary in strength and size with the type of gun and requirements of portability. For the Browning Machine Rifle, the Engineering Division of the Ordnance Department contemplated providing a light bipod. Such a bipod had proven very satisfactory in tests, but had not been officially adopted. An emergency bipod mount also was provided for the Browning Machine Gun, as well as a light tripod for both the Browning machine gun and Browning tank gun.

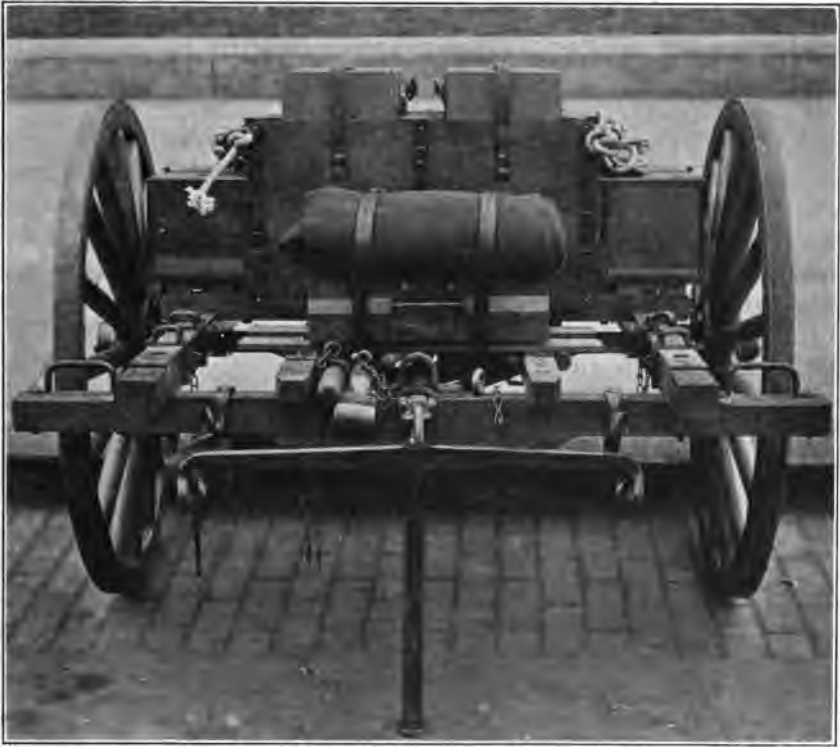

FIG. 142.—Machine gun ammunition cart.

MACHINE-GUN UNIT EQUIPMENT.

Machine-gun organization and supply.—To each infantry machine-gun company equipped with machine-gun carts are issued 16 water-cooled machine guns, 16 tripods, 12 gun carts, and the other items as indicated in Part VIII of Ordnance Department Handbook on Machine-Gun Cart, Model 1917, with such necessary changes and amendments as field experience and other considerations have found necessary. To each division 168 active and 56 spare machine guns are issued. Machine-gun organizations for France are equipped with machine-gun carts which are similar to the French *voiturettes*. Each machine-gun company has 12 active machine-gun carts, 12 ammunition carts, and 2 spare gun carts, though up to September 1, 1918, the two spare gun carts had not been authorized for issue to the American Expeditionary Forces. The active one carries a heavy gun tripod and 7 boxes, except in the case of carts arranged for the Lewis gun, where there are accommodations for but 6. In this way 5 ammunition boxes, with 1,250 rounds, in addition to the tool box and the water box, may be carried on a machine-gun cart. Each ammunition cart will provide for 3,000 rounds, while each spare cart will carry

2 spare guns and tripod. The machine-gun carts, ammunition carts, and spare gun carts or voiturettes are two-wheeled carts, drawn by one mule, and take an ordinary load of approximately 400 pounds, which in an emergency can be increased to 600 pounds.

The same general type of cart, with but minor modifications, has been designed to carry all of the machine guns used in the United States service, including the water-cooled Browning machine gun, model of 1917; the Vickers machine gun, model of 1915; and the air-cooled Colt machine gun, caliber .30, and the Lewis gun. These carts are of French pattern and were made by the International Harvester Co., of Chicago, Ill.; the Velie Carriage Co., of Moline, Ill.; and the St. Louis Car Co., of St. Louis, Mo. Full description of them and of the matériel carried is given in the Ordnance Department Handbook on Machine-Gun Carts, model of 1917, War Department Document No. 778, A. G. O. (In connection with this handbook it should be borne in mind that certain changes in reference to fire-control instruments have been required, and the list of articles shown in Part VIII should not be relied upon to give the correct information in reference to these instruments as conditions of field service demanded additions to equipment and the elimination of unnecessary articles.

Automatic rifles, organization and supply.—Sixteen automatic rifles are issued to each infantry company, or 768 automatic rifles to each division. In the American Expeditionary Forces no distinction was made between active and spare automatic rifles issued to each company in 1917–1918, the total number (16) being considered active weapons. All spare automatic rifles, however, may be used as active automatic rifles where conditions warrant. Automatic rifles are carried by the men to whom they are issued, but to relieve them of carrying part of their personal equipment, this is loaded on company combat wagons. Each automatic rifle is served by a rifle squad, consisting of one automatic rifleman, one first assistant, and one second assistant. The rifleman and first assistant are armed with pistols or revolvers and the second assistant with a caliber .30 rifle. Each man of the squad wears a belt about his waist in which ammunition is carried. The belts of the rifleman and first assistant are identical. The rifleman may carry in his belt 120 rounds of ammunition for the automatic rifle and two clips of pistol or pistol-ball cartridges. Since the first assistant does not carry a spare parts case he is enabled to carry 40 additional rounds of ammunition for the shoulder rifle. In addition to these belts the first and second assistant have each been provided with two bandoleers, each designed to carry 120 rounds of ammunition for the automatic rifle. All ammunition for the automatic rifle carried by the rifle squad is carried loaded in magazines, each magazine containing 20 cartridges, the total carried by the squad

being 20 rounds. In case the spare parts case is not carried, 20 additional rounds of ammunition may be carried.

Sights.—On the Browning machine gun, model of 1917, water-cooled, and on the Vickers machine gun, model of 1915, the rear sight is graduated in meters from zero to 2,800. On all automatic rifles the rear sight is graduated in yards. On the Browning Automatic rifle, model of 1918, air-cooled, the rear sight leaf is identical with the rear sight leaf of the United States rifle, model of 1917.

FIRE-CONTROL INSTRUMENTS.

Plane table.—The plane table is of wood construction, 40 centimeters square, with 3-inch compass, set in flush with the board. It is fur-



FIG. 143.—Plane table with clinometer and angle of site instrument.

nished with a canvas carrying case. It is attached to a wood tripod provided with extension legs, weighing approximately 5 pounds.

Machine gun panoramic sight, model of 1918.—The panoramic sight early was requested by headquarters American Expeditionary Force. The type adopted is similar to the French aiming circle, attached either to gun mount or tripod.

Machine gun clinometer, model of 1918.—The clinometer, used to lay the machine gun to any desired angle of elevation, is not attachable to the gun. The type adopted consists of a brass quadrant with a straightedge base and a radial arm carrying level bubble. The quadrant is graduated for each 20 mils up to 840 mils. The radial arm can be swung to any position through the arc and is provided with a micrometer scale, which makes the instrument accurate to 1 mil. This has a leather clip for attaching to the belt.



FIG. 144.—Brunton compass.

pass and clinometer is used in the same way as the Brunton compass and is supplied to units not equipped with the Brunton compass. It consists of a metal case, magnetic needle, and dial. The instrument is used by sighting through a prism, by which the line of sight is deflected to the dial, enabling the operator to read the dial at a fixed index. Used as a clinometer vertical angles may be measured.

Lensatic compass, model of 1918.—The lensatic compass was designed to supersede both the Brunton compass and the prismatic compass, and employed for the same uses. It consists of an aluminum case with a magnetic dial floating in a liquid. It has a fixed azimuth scale, and also a single leveling bubble. The outside of the case is graduated and is used as a protractor. All scales are graduated in units of 20

Brunton compass, machine gun type, model of 1917.—The Brunton compass is used to obtain direction and to measure horizontal angles. It consists of a magnetic needle inside of an aluminum case. The instrument is aimed by glancing at a mirror on the inside of the hinged lid. The azimuth circle is graduated for each 20 mils from zero to 6,400. The transit is furnished with a metal tripod having telescopic legs, and both the instrument and the tripod are provided with a leather case.

Prismatic compass and clinometers.—The prismatic com-



FIG. 145.—Prismatic compass.



FIG. 146.—Lensatic compass and case.

mils from zero to 6,400 and illuminated to provide for night reading. The instrument is provided with front and rear sights for aiming. The front sight is a hair line on glass; the rear sight a slot, cut in the magnifier. After the instrument is aimed reading can be obtained by glancing at the indicator through the magnifier and noting the reading of the dial. A leather carrying case is provided.

Angle of site instrument, model of 1917.—The angle of site instrument is used to measure vertical angles. An aluminum frame carries the sight tube at the base and above this the bubble carrier. The sight tube is provided with an eyepiece and horizontal cross wire. The bubble carrier is in the form of a lever, with pivot at the front end and adjusting screw and graduation plate at the rear end. The graduation plate is fixed to the frame and is graduated in units of 20 mils, from zero to 180, both above and below the horizontal. The adjusting screw provides a micrometer, which gives the instrument an accuracy of 1 mil. On the inside of the sight tube an inclined mirror gives the observer a view of the bubble and enables him to level up the bubble carrier. When the sight tube is on the object and the bubble carrier is level, the instrument may be lowered from the eye and reading taken.

Other instruments.—In addition to those mentioned above the following instruments are also included in fire-control equipment for machine guns: Semicircular protractor, alidade protractor model of 1918 Abaque, Corcelli's graph, zinc rule, zinc square, Hitt's-Brown rule, night-firing box, aiming stake, and 80-centimeter base range finder. The last named is a special self-contained optical instrument specially designed for range finding for machine guns.

SEMIAUTOMATIC RIFLES.

Progress.—Various inventions of semiautomatic rifles have been examined critically and tested by the small-arms section of the Engineering Division of the Ordnance Department.

Bommarito automatic rifle.—This rifle is of the recoil-operated type with toggle breech lock, similar to the Luger pistol. The barrel recoil is $1\frac{1}{4}$ inches and this, with the long toggle levers necessitated by the length of the service cartridge, render the rifle a very unwieldy one, with grave danger of injury to the firer's hands in use. In August, 1918, however, a contract was awarded for the construction of a test rifle.

Rychiger semiautomatic rifle (also called the Swiss rifle).—This rifle is of the recoil-operated type with a rotating and sliding breech bolt. An exceptionally well designed and constructed rifle was submitted and tested at the Springfield Armory. An unfavorable report was rendered, as the piece was found unsatisfactory, inasmuch as it would function only when kept well oiled. The argument was advanced that if a beautifully finished sample would not operate, similar rifles made by quantity production methods almost certainly would prove useless. Certain valuable features of the gun, however, were recognized and attempts were made to avail of them in the Elder semiautomatic rifle described below.

Elder semiautomatic rifle.—This is an experimental rifle evolved by Maj. Elder, of the Engineering Division of the Ordnance Department. It is recoil-operated, with a Mannlicher type of bolt action containing features selected from the Rychiger and Bang rifles and designed according to Maj. Elder's own ideas. The sear and trigger mechanism is an adaptation of the Bang construction. The test mechanism was constructed under Maj. Elder's personal direction at the Bureau of Standards.

Bang rifle.—The Bang rifle is a semiautomatic shoulder rifle which was submitted and finally tested with marked success at the Springfield Armory. It uses .30 caliber, model of 1906, ammunition. The cartridges are carried in a box magazine. The breech action is of the Mannlicher type, where the power for actuation is derived from an annular cup or chamber sliding along on the muzzle and drawn forward by the gas-blast discharge. The only defect, but a vital one, is the exceeding difficulty in dismounting the rifle. This process is stated to take an hour, and Maj. Elder, of the small-arms section of the Engineering Division, was led to design a modified construction intended to eliminate this defect, but to preserve the characteristic features of the Bang rifle. This piece was finally incorporated and known as the "Modified Bang rifle," and efforts to have a sample built for test were made in August, 1918.

TABLE 30.—Particulars of military magazine rifles.

[From "A Century of Guns" (1909), published by John Blanch & Son, gunsmiths, London, England.]

I.

Country.	Date.	Name of rifle.	Caliber.		Muzzle velocity.		Muzzle energy.		Recoil.		Weight of bullet.		Denser zones.*	
			Mm.	In.	M/s.	Ft./s.	Mqy.	Ft. lb.	Mqy.	Ft. lb.	Grms.	Grms.	M.	Yds.
France	1836-1833	Lebel.	8.00	0.315	632	2,073	306	2,211	1.31	9.5	15.00	232	537	587
Austria	1838-1890	Mannlicher.	8.00	0.315	620	2,034	310	2,240	1.29	9.5	15.80	244	530	579
Do.	1895	Do.	8.00	0.315	620	2,034	310	2,240	1.59	11.5	15.80	244	530	579
Denmark	1839	Krag-Jørgensen	8.00	0.315	625	2,050	306	2,211	1.28	9.2	15.40	238	511	558
Germany	1838	Mannlicher.	7.90	0.311	640	2,100	307	2,218	1.43	10.3	14.70	227	534	584
Do.	1898-1902	Do.	7.90	0.311	660	2,855	385	2,854	1.30	9.4	10.00	154	680	754
Great Britain	1838-1895	Lee.	7.70	0.303	630	2,065	281	2,060	1.07	7.7	13.90	215	530	579
Do.	1903	Do.	7.70	0.303	610	2,000	264	1,948	1.11	8.0	13.90	215	514	562
Belgium	1839	Mauser.	7.65	0.301	600	1,968	259	1,871	1.05	7.6	14.10	218	528	577
Do.	1889	Do.	7.65	0.301	652	2,138	287	2,187	1.25	9.0	13.70	212	528	577
Turkey	1890	Do.	7.62	0.300	620	2,034	267	1,928	1.05	7.6	13.60	210	520	568
Russia	1891	Mossin.	7.62	0.300	610	2,000	269	1,945	1.18	8.5	14.25	220	513	561
United States	1892-1898	Krag-Jørgensen	6.00	0.236	777	2,550	224	1,620	0.96	4.1	7.28	112	563	615
Do.	1895	Lee straight-pull.	6.00	0.236	825	2,700	338	2,427	1.14	8.2	9.70	150	661	723
Do.	1902-1906	New Springfield.	7.50	0.285	610	2,000	262	1,883	0.89	6.4	13.80	213	519	567
Switzerland	1839-1896	Schmid-Rubin.	7.50	0.285	691	1,937	246	1,777	1.02	7.4	13.80	213	519	567
Do.	1900	Do.	7.00	0.276	710	2,328	288	2,082	0.99	7.2	11.20	173	573	626
Spain	1883	Mauser.	6.50	0.256	700	2,295	263	1,900	0.91	6.6	10.50	162	558	610
Italy	1881	Paravidini-Carcano.	6.50	0.256	740	2,427	289	2,088	0.96	6.9	10.33	160	573	626
Roumania	1883	Mannlicher.	6.50	0.256	730	2,396	274	1,980	0.87	6.3	10.10	158	560	612
Norway	1884	Krag-Jørgensen	6.50	0.256	745	2,443	289	2,088	0.85	6.1	10.20	158	560	612
Holland	1885	Mannlicher.	6.50	0.256	730	2,396	274	1,980	0.87	6.3	10.10	158	560	612
Sweden	1886	Mauser.	6.50	0.256	730	2,396	286	2,068	0.93	6.7	10.50	162	600	661
Japan	1897	Artsaka	6.50	0.256	810	2,657	440	3,178	1.79	12.9	13.15	203	691	755
Do.	1904-1907	Mauser.	7.90	0.311	810	2,657	440	3,178	1.55	11.2	11.82	183	703	768
Do.	1904-1907	Do.	7.65	0.301	830	2,723	415	2,998	1.39	10.0	10.00	154	771	842
Do.	1904-1907	Do.	7.00	0.276	865	2,955	408	2,948	1.39	10.2	10.00	140	771	842
Do.	1904-1907	Do.	6.50	0.256	900	2,950	374	2,700	1.26	9.1	9.07	140	769	873

* "S" bullet, adopted end of 1908, sensibly same ballistics as German.

† Since abandoned.

‡ The new Springfield has all the essential features of the Mauser.

§ The French rifle now fires a solid copper alloy bullet ("balle D"), weight 12.8 grams; muzzle velocity, about 2,700 foot-seconds.

¶ Modified shape of grooves.

** "S" bullet ("Spitzgeschoss"), weight 10.0 grams, German; 9.7 grams, United States.

* Range at which the summit of trajectory is exactly the average height of a man, 1.70 m—66.9 inches above the line of sight.

NOTE.—Equivalent English dimensions of foreign rifles are approximate.

TABLE 30.—Particulars of military magazine rifles—Continued.
 [From "A Century of Guns" (1909), published by John Blanch & Son, gunsmiths, London, England.]

II.

Country.	Date.	Name of rifle.	Num-ber of grooves	Width of grooves.		Depth of grooves.		Pitch.	Length of barrel.		Length of rifle.		Weight of rifle.	
				Mm.	In.	Mm.	In.		Mm.	In.	M.	In.	Kg.	Lbs.
France.....	1886-1893	Lebel.....	4	4.20	0.165	0.0659	240	9.45	31.50	1.307	51.7	4.45	9.21	
Austria.....	1888-1890	Mannlicher.....	4	4.20	0.165	0.079	260	9.84	30.10	1.291	50.1	4.45	9.82	
Do.....	1905	4	4.20	0.165	0.079	260	9.84	30.10	1.272	50.1	3.85	8.63	
Denmark.....	1888	Krag-Jørgensen.....	6	3.00	0.118	0.0853	300	11.80	33.00	1.325	52.4	3.85	8.37	
Germany.....	1888	Mannlicher.....	4	4.40	0.172	0.0960	240	8.45	28.10	1.245	48.0	3.85	8.38	
Do.....	1898-1902	4	4.40	0.172	0.0960	240	8.45	28.10	1.245	48.2	4.51	9.16	
Britain.....	1888-1893	Lee.....	5	2.42	0.085	0.0850	284	10.00	30.20	1.287	44.3	4.50	9.70	
Do.....	1903	5	2.42	0.085	0.0850	284	10.00	30.20	1.287	44.3	3.75	8.27	
Belgium.....	1880	Mausser.....	4	4.45	0.175	0.0947	260	8.52	26.70	1.270	50.3	3.80	8.60	
Do.....	1890	4	4.20	0.165	0.0649	260	8.52	26.70	1.271	48.9	3.80	8.60	
Turkey.....	1890	Mausser.....	4	3.69	0.174	0.0649	240	8.40	31.50	1.285	50.1	3.89	8.75	
Russia.....	1891	Mosin.....	4	2.54	0.102	0.0440	284	10.00	31.00	1.247	47.1	3.87	8.75	
United States.....	1892-1898	Krag-Jørgensen.....	4	2.54	0.100	0.0440	284	10.00	31.00	1.209	47.6	3.89	8.75	
Do.....	1905	Lee Smith-Paul.....	6	2.54	0.100	0.0440	284	10.00	31.00	1.098	43.2	3.89	8.75	
Do.....	1905	New Springfield.....	3	3.63	0.145	0.0440	270	10.60	30.00	1.302	51.3	3.85	8.70	
Do.....	1900	Schmidt-Kubik.....	3	3.63	0.145	0.0440	270	10.60	30.00	1.302	51.3	3.85	8.70	
Switzerland.....	1890	Short rifle.....	3	3.68	0.154	0.0649	200	7.35	23.35	1.100	43.3	3.85	8.49	
Spain.....	1883	Mausser.....	4	3.70	0.122	0.0651	200	6.91	23.00	1.235	48.6	3.80	8.60	
Italy.....	1881	Parryvich-Carcano.....	4	3.15	0.120	0.0651	200	7.87	23.60	1.239	50.3	4.00	8.81	
Roumania.....	1883	Mannlicher.....	4	2.00	0.100	0.0659	200	7.87	23.60	1.239	48.4	4.00	8.81	
Norway.....	1884	Krag-Jørgensen.....	4	3.00	0.115	0.0659	200	7.87	23.60	1.237	50.7	4.00	8.65	
Holland.....	1885	Mannlicher.....	4	2.55	0.100	0.0659	200	7.87	23.60	1.237	49.6	4.00	8.65	
Sweden.....	1885	Mausser.....	4	2.60	0.100	0.0659	200	7.87	23.60	1.237	49.6	4.00	8.65	
Japan.....	1897	Arisaka.....	6	2.90	0.115	0.0659	240	9.45	28.10	1.270	50.0	3.90	8.60	
Do.....	1904-1907	Mausser.....	4	4.20	0.165	0.0649	240	9.45	28.10	1.280	48.2	4.10	9.04	
Do.....	1904-1907	4	3.20	0.125	0.0449	220	8.50	26.10	1.280	48.2	4.10	9.04	
Do.....	1904-1907	4	3.50	0.134	0.0449	220	8.50	26.10	1.280	48.2	4.10	9.04	
Do.....	1904-1907	4	2.55	0.100	0.0449	200	7.87	23.10	1.250	46.2	3.75	8.27	

Argentina.....
 Austria-Hungary.....
 Belgium.....
 Bolivia.....
 Brazil.....
 Bulgaria.....
 Chile.....
 China.....
 Colombia.....
 Costa Rica.....
 Denmark.....
 Ecuador.....
 France.....
 Germany (special
 ammunition).
 Great Britain.....
 Greece.....
 Guatemala.....
 Holland.....
 Honduras.....
 Italy.....
 Japan.....
 Mexico.....
 Montenegro.....
 Nicaragua.....
 Norway.....
 Paraguay.....
 Peru.....
 Portugal.....
 Rumania.....
 Russia.....
 Salvador.....
 Serbia.....
 Spain.....
 Sweden.....
 Switzerland.....
 Turkey.....
 United States.....
 Uruguay.....
 Venezuela.....

XIV. SMALL ARMS—RIFLES, PISTOLS, AND REVOLVERS.

General statement.—With the entrance of the United States into the war, there was no question more important to the Ordnance Department than the supply of rifles in adequate amount for the forces to be raised. It was obvious that these must be manufactured on a scale much greater than ever previously attempted, and that the facilities of the two Government arsenals which had been devoted to the making of small arms, together with such private plants as had specialized in this field, were far from adequate to turn out the United States service weapon promptly in the amounts required. From 1914 the private plants experienced in firearms manufacture or specially established for that purpose had been working on munitions for the allies and were not prepared to undertake immediately the manufacture of the service rifle. The various types of rifles used by the powers of the world are shown in the accompanying tables, and while in many respects they are similar, yet there are important differences in detail.

Prewar conditions.—In 1907 Great Britain adopted the Enfield rifle, model of 1907, which used a rimmed cartridge. Three years after the adoption of the above rifle Great Britain began the development of a new rifle using a rimless cartridge of good ballistic power, and shortly before the outbreak of the war in 1914 had completed its tests to the stage where the adoption of the rifle was warranted. After the war broke out Great Britain continued the manufacture of the model of 1907 rifle at home, but contracted for the manufacture in the United States of the model of 1910 rifle, modified to use the British service rimmed caliber .303 cartridge, so that the rifles made in this country and in Great Britain could use the same cartridge. The rifle manufactured in the United States was known as the Enfield rifle, pattern of 1914.

British contracts in United States.—The contracts placed by Great Britain in the United States resulted in the equipping of three private plants having a daily capacity of 6,000, 3,000, and 2,000, respectively. This capacity was not attained, however, by a single plant. Early in 1917 Great Britain reduced its contract for rifles in the United States, which resulted in the three plants completing the British contracts about June 1, June 21, and July 21, 1917, respectively. The reductions made in the contracts resulted in a material depletion of the working forces in the plants even prior to April 6, 1917.

American supply at outbreak of war.—At the outbreak of the recent war the United States had about 600,000 Springfield (model 1903) rifles and 160,000 Krag rifles, and a large supply of cartridges for the Springfield rifle. As the Springfield rifle and its cartridges were known to be the best in the world, it was obviously inadvisable to discard the aforementioned rifle and adopt a rifle firing a cartridge of inferior design and ballistic power and with which jams were known to have occurred. The three private companies each submitted a sample rifle under their original proposals, which were supposed to involve an interchangeability of about seven principal parts, but it was found that the bolt taken from one company's rifle would not enter the receiver of another company's.

Interchangeability.—If the bolts were not interchangeable in the field, because of too great "head space"—that is, lack of support of the front of the bolt against the head of the cartridge when in the chamber—there would be great danger of rupture of the cartridge case, and possibly of the rifle itself, with serious accident to the soldier. The War Department was therefore confronted with the alternative of approving and issuing a rifle that was liable to be unsafe or insisting that the bolts be made interchangeable in the field. There was only one choice—to fight this question out at the time in the shops instead of in the trenches later on.

The companies, however, were not quick in coming to the terms of the contract considered advantageous to the Government, the department desiring to include in the contract certain features which would stimulate the companies to cheaper and quicker production than would be possible under the contract finally accepted. In the meantime the companies were proceeding with the manufacture of the parts not affected by the change of cartridge or by the requirements for a greater interchangeability.

Advantages of standardization.—Aside from the great importance of interchangeability of parts that may have to be replaced in the field, the advantages of standardization as exacted by the War Department are shown by the marked reduction in rejections, which in the case of principal component parts have decreased from about 25 per cent to less than 10 per cent, and in the case of rejections of finished rifles for inaccuracy from about 12 per cent to less than 3 per cent. In assembling the rifles made under the British contracts in one of the plants, an average of but 40 rifles was assembled per man per day of 10 hours, on account of the large amount of fitting and filing required. In the same plant over 140 rifles being made for the United States were assembled per man per day of 10 hours.

While the date on which the first deliveries of rifles could be obtained was delayed by modifying the Enfield rifle to use the United

States cartridge, and by the War Department insisting upon a serviceable degree of interchangeability, the average rate of output was greatly increased by the standardization required, and the ultimate date of delivery was advanced. The Secretary of War authorized the placing of orders for the manufacture of the modified rifle on June 1, 1917. One company commenced deliveries about August 18, a second about September 10, and the third on October 28, and the production of the modified rifle from the three plants attained a rate of over 9,000 per day.

Production.—This exceeded the promises of the manufacturers; and as early as January 1, 1918, there were in each National Army camp enough Enfield rifles to equip completely every rifle-bearing man, and in addition 10,000 Krag rifles in each camp which had been previously issued. The Regular Army was completely equipped with the Springfield rifle and the militia was equipped with the same rifle, with the exception of four camps.

United States rifle, caliber .30, model of 1903.—This is a magazine rifle of the Mauser, bolt type, using for ammunition .30 caliber cartridges, model of 1906, mounted in clips holding five cartridges each. The magazine is situated under the bolt and is loaded through the top. It has a capacity of five cartridges. The barrel is right-hand rifling uniform twist with one turn in 10 inches. The sight is compensated for drift and adjustable for windage. The distance between the front and rear sights is 22.1254 inches. The rear sight is adjustable from 100 to 2,750 yards, and the battle-sight range is 547 yards.

The muzzle velocity of service ammunition is 2,700 feet per second, and the powder pressure in the chamber is about 57,000 pounds per square inch. There is a safety lock and also a cut-off to enable holding the loaded magazine in reserve while using the rifle as a single loader. The total weight without the bayonet is 8.7 pounds and the total length with the bayonet is 43.2 inches. All parts are interchangeable.

Exterior ballistics.—With the model of 1903 rifle, 23 aimed shots have been fired in one minute using it as a single loader, and 25 shots in the same interval, using magazine fire. Firing from the hip without aim, 30 shots have been fired using the rifle as a single loader and 40 shots using magazine fire. The maximum range at the elevation of 45 degrees is 4,891.6 yards and the time of flight of the bullet is 38.058 seconds. The maximum energy of free recoil of this rifle is 14.98 foot-pounds. At 1,000 yards 10.48 inches of white pine butts made of 1-inch boards and placed 1 inch apart can be penetrated, while at 500 yards one-tenth of an inch of low steel (boiler plate), which increases to 0.528-inch at a range of 50 feet, can be penetrated. The accompanying table shows the dimensions and other data of the rifle.

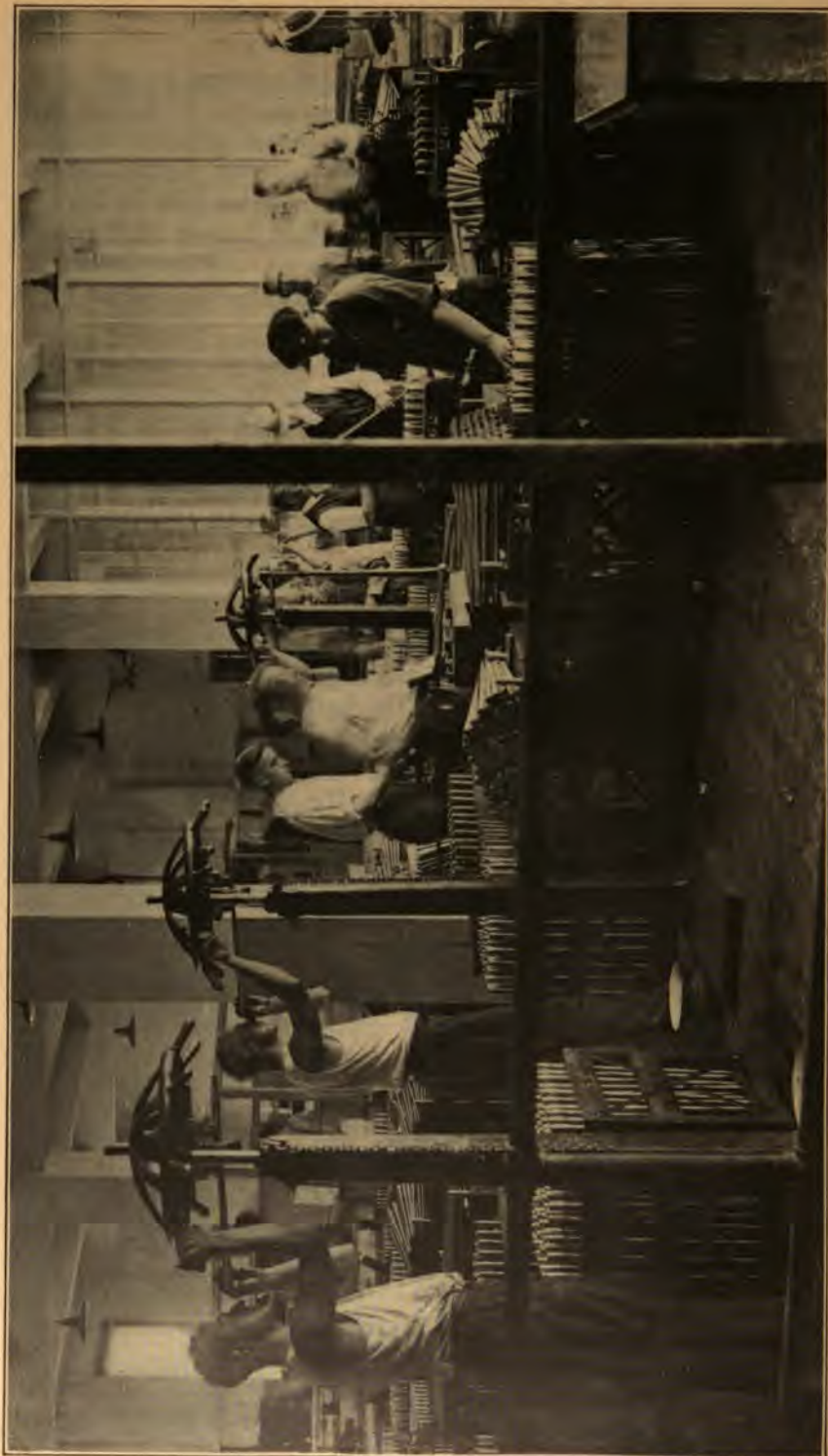

FIG. 147.—Examining and straightening rifle barrels at Rock Island Arsenal.

Source.—This rifle is manufactured at the Springfield Armory and at the Rock Island Arsenal. The rate of production is some 1,200 per day at the former, and at Rock Island 400 per day can be made when the plant is not engaged upon repair work.

TABLE 33.—*Principal dimensions and weights of United States rifle, caliber .30, model of 1903.*

[From Ordnance Pamphlet No. 1923; revision Jan. 22, 1917.]

DIMENSIONS.	
Barrel:	Inches.
Diameter of bore.....	0. 30
Exterior diameter at muzzle.....	. 619
Exterior diameter at breech.....	1. 14
Length of chamber and bore.....	23. 79
Length of travel of bullet in bore.....	21. 697
Diameter of chamber, rear end.....	. 4716
Diameter of chamber, front end.....	. 442
Diameter of neck of chamber, rear end.....	. 3425
Diameter of neck of chamber, front end.....	. 3405
Length of body of chamber.....	1. 793
Length of shoulder of chamber.....	. 16
Length of neck of chamber.....	. 396
Length of chamber, total.....	2. 3716
Rifling:	
Number of grooves, 4.	
Twist, uniform, one turn in.....	10. 00
Width of grooves.....	. 1787
Width of lands.....	. 0589
Depth of grooves.....	. 004
Height of front sight above axis of bore.....	1. 05
Distance from top of front sight to rear side of leaf, leaf raised.....	22. 1254
Stock:	
Length, with butt plate.....	40. 166
Crook, i. e., distance from axis of bore to heel of butt.....	2. 089
Distance from trigger to butt plate.....	12. 74
Length of gun complete.....	43. 212
Sight radius.....	22. 1254
Sight radius (battle sight).....	21. 5404
Width of single division on windage scale.....	. 0287

WEIGHTS.

	Pounds.
Barrel.....	2. 79
Barrel, with rear-sight base and front-sight stud.....	3. 00
Butt plate.....	. 26
Receiver.....	. 98
Bolt mechanism.....	1. 00
Magazine and trigger guard.....	. 44
Magazine mechanism, including floor plate.....	. 17
Bayonet.....	1. 00
Stock.....	1. 58

	Pounds.
Hand guard.....	0. 13
Front and rear bands, including swivels.....	. 25
Rear sight, not including base.....	. 20
Total weight of metal parts.....	7. 30
Oiler and thong case.....	. 19
Total weight of arm, including oiler and thong case, with bayonet.....	9. 69
Total weight of arm, including oiler and thong case, without bayonet...	8. 69
Weight to compress mainspring.....	16 to 18
Trigger pull (measured at middle point of bow of trigger).....	4 to 5

MISCELLANEOUS DATA.

Initial velocity	feet per sec. 2, 700
Powder pressure in chamber.....	lbs. per sq. in. ¹ 51, 000
Weight of ball cartridge.....	grains. ¹ 395. 5
Weight of bullet.....	do. 150
Weight of powder charge.....	do. ¹ 50

United States rifle, caliber .30, model of 1917.—This rifle is derived from the British Enfield, pattern of 1914, caliber .303, which was remodeled with the least possible change to adapt it to use the United States cartridge caliber .30 model of 1906, mounted in clips, holding five cartridges each, this being the same ammunition used in the U. S. rifle caliber .30, model of 1903. It is a magazine rifle of the bolt type. The sear interlocks with the bolt and prevents pulling the trigger until the bolt is locked. The magazine is situated under the bolt, is loaded from the top, and the capacity is six cartridges. The barrel is 26 inches in length as compared with 23.79 inches for the 1903 model. The rifling is one turn in 10 inches, left hand. The distance between the sights is 31.76 inches, but the sight is not compensated for drift nor adjustable for windage. The rear sight is mounted in the rear end of the receiver instead of on the barrel, as in the 1903 model. It is adjustable from 200 to 1,600 yards. The muzzle velocity of the piece is 2,700 feet per second. It is provided with a safety lock, but no magazine cut-off. The last forward motion closes the bolt and locks it. The total weight without the bayonet is 9 pounds 3 ounces, and the total length without the bayonet is 46.3 inches. The same cleaning rod is used in the 1917 model as in the 1903 rifle.

Breech mechanism.—The bolt is locked by a turning movement which causes lugs on the bolt to engage in recesses just in the rear of the chamber. A camming action of locking lugs seats the cartridges firmly and continues throughout the locking action. To preclude the possibility of the bolts unlocking under powder pressure, a safety stud is mounted on the sear and rises as the trigger is pulled to lock the bolt against the turning. This serves also to preclude pulling of the trigger unless the bolt is fully locked.

¹ About.



Russian Rifle



*U. S. Rifle, Caliber 30, Model 1917
with Bayonet, Model 1917*



*U. S. Rifle, Caliber 30, Model 1903
with Bayonet, Model 1905*

FIG. 148.—Service rifles manufactured in the United States, 1917 and 1918.

Magazine.—The magazine is directly beneath the bolt and is loaded from the top from a clip of five cartridges while the bolt is retracted. It contains a spring-actuated follower, above which the cartridges arrange themselves in laterally staggered relation.

Follower.—The follower feeds the top cartridge up into the path of the bolt when the latter is retracted, a ramp serving to guide the nose of the bullet upward and into the chamber as the carriage is forced forward on the succeeding forward movement of the bolt.

Extractor.—The extractor is of the hook type, swiveled on the bolt, and engages the groove of the cartridge as the latter moves upward in the magazine. Primary extraction is provided by an extracting cam operated by the turning of the bolt in unlocking and serving to start the bolt to the rear after it is unlocked.

Ejector.—The ejector is of the spring-actuated type and operated through a slot in one of the locking lugs at the limit of the rearward movement of the bolt. The ejector spring is integral with the ejector.

Firing pin.—The firing pin has no cocking knob and can not be cocked except by actuation of the bolt. It is halfcocked by the unlocking movement of the bolt, a cam and half-cock notch being provided on the rear end of the bolt to engage a lug from the cocking piece and perform this function. The sear notch of the cocking piece engages in the sear nose in the closing movement of the bolt, so that the piece is cocked by the act of closing the bolt. The locking of the bolt moves the half-cocking cam out of the path of the lug on the cocking piece. This arrangement precludes the closing of the bolt upon a cartridge with the point of the striker protruding through the end of the bolt. There is no cut-off. The follower rises and locks the bolt open when the magazine is empty; to prevent this, so that the rifle may be used as a single loader or in simulated fire drill, an accessory called the follower depressor is provided.

Safety lock.—The safety lock consists of a locking cam which engages a notch in the cocking device lug and lifts up the sear notch of the sear nose, and a sliding plunger which simultaneously enters a hole in the bolt handle and locks the bolt closed. These parts are operated by a thumb piece mounted at the right just in the rear of the bolt handle, in position for convenient actuation by the right thumb.

The firing pin and sleeve can be removed from the bolt and completely dismantled without the use of tools.

Sights.—The front sight is protected by lateral wing guards and will be adjusted laterally during assembly. Height adjustment is secured by the interchange of sights of various heights. The rear sight is protected by lateral wing guards. The battle sight is of the peep type, and being formed at the lower end of the leaf, rises to

a position as the leaf is laid. The leaf carries a peep sight on a slide which moves vertically, and hence makes no correction for drift.

Production.—The 1917 United States rifle was manufactured by the Midvale Steel & Ordnance Co., at Eddystone, Pa., by the Remington Arms-Union Metallic Cartridge Co., Ilion, N. Y., and by the Winchester Repeating Arms Co., New Haven, Conn. The total daily output was approximately 10,000 rifles and up to November 9, 1918, 2,202,429 had been delivered. This rifle was extensively used by the American oversea forces.

TABLE 34.—*Principal dimensions and weights of United States rifle, caliber .30, model of 1917.*

DIMENSIONS.	
Barrel:	Inches.
Diameter of bore.....	0.30
Exterior diameter at muzzle.....	0.60
Exterior diameter at breech.....	1.32
Length of chamber and bore (from face of bolt to muzzle).....	26.
Diameter of chamber, rear end.....	0.4716
Diameter of chamber, front end.....	0.442
Diameter of neck of chamber, rear end.....	0.3425
Diameter of neck of chamber, front end.....	0.3405
Length of body of chamber.....	1.785
Length of shoulder of chamber.....	0.16
Length of neck of chamber.....	0.396
Length of chamber, total.....	2.341
Rifling:	
Number of grooves, 5.	
Twist, uniform, left hand, one turn in.....	10
Width of grooves.....	0.0936
Width of lands.....	0.0936
Depth of grooves.....	0.005
Height of front sight above axis of bore (mean).....	1.06
Distance from top of front sight to rear side of leaf, leaf raised.....	31.76
Stock:	
Length, with butt plate.....	42.62
Crook, i. e., distance from axis of bore to heel of butt.....	2.12
Distance from trigger to butt plate.....	13.5
Length of gun complete.....	46.3
Sight radius.....	31.76
Sight radius (battle sight).....	31.69
WEIGHTS.	
Bayonet.....	Lb. Oz.
Oiler and thong case.....	1 2
Total weight of arm with oller and thong case and bayonet.....	3
Total weight of arm with thong case without bayonet.....	10 5
Total weight of arm with thong case without bayonet.....	9 8
Weight to compress mainspring.....	16-18
Trigger pull (measures at middle of bow of trigger).....	41-64

MISCELLANEOUS DATA.

Initial velocity.....	ft. per sec.	2,700
Powder pressure in chamber.....	lbs. per sq. in. ¹	51,000
Weight of ball cartridge, about.....	grains	395.5
Weight of bullet.....	do.	150
Weight of powder charge, about.....	do.	50



FIG. 149.—U. S. rifle, model 1903, with extension magazine.

Extension magazine.—An extension magazine for the United States rifle, caliber .30, model of 1903, has been developed to carry 25 rounds. In this extension magazine, a large number of which have been constructed for tests, a special follower and spring have been provided and the extension takes the place of the fore plate of the rifle.

Russian three-line rifle, caliber 7.62-mm. (0.30 inches).—This is a magazine rifle of the Mossin and Nagant type, using as ammunition the Russian 7.62-mm. rim cartridge, mounted five to a clip. This rifle was manufactured extensively in the United States for the Russian Government prior to its collapse, and was chambered for the standard Russian ammunition, which is a rimmed cartridge case with a greater degree of taper than the .30 caliber, United States cartridge case. The rifle has a magazine under the bolt which is loaded from the top. It has a capacity of five cartridges. The rifle has right-hand twist with one turn in 9.45 inches. The sight is not compensated for drift nor adjustable for windage, but can be set from 400 paces to 3,200 paces (300 paces equal 233 yards). The muzzle velocity (Russian factory loads) is 2,844 feet per second. It is provided with a safety lock but no magazine cut-off. The total weight without the bayonet is 9½ pounds and total length without bayonet is 51½ inches.

¹ About.

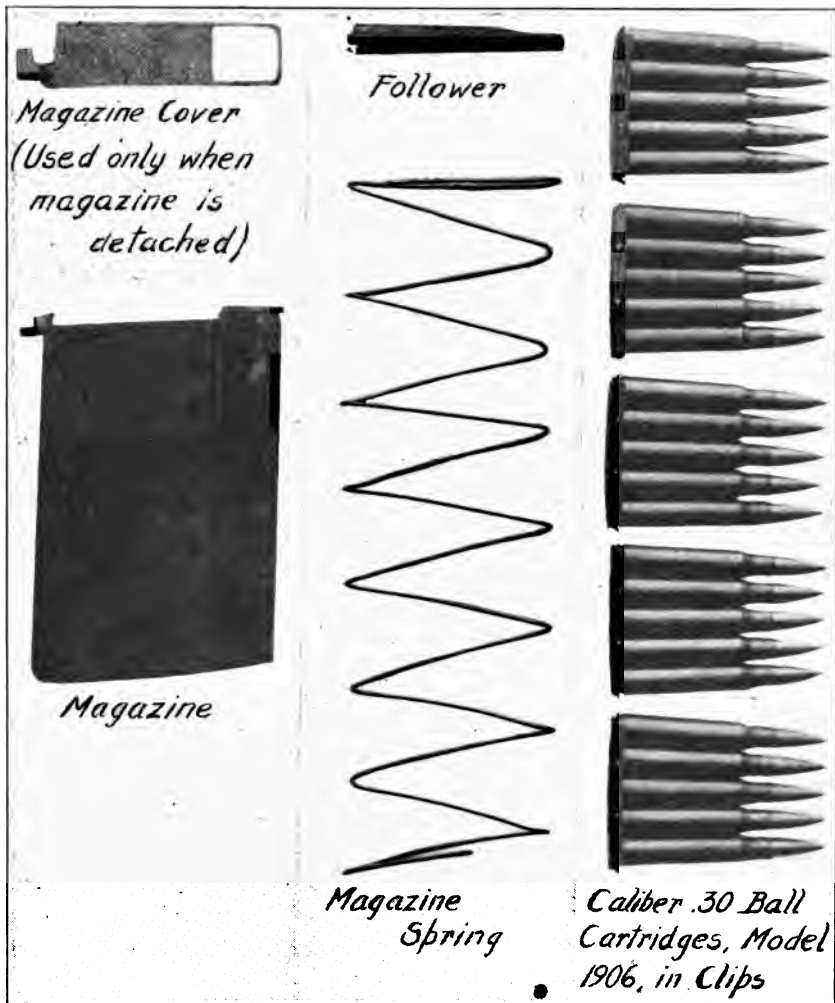

FIG. 150.—U. S. rifle, model 1903, extension magazine with parts and clips.

The Russian rifle was manufactured in the United States by the Remington Arms Co., of Bridgeport, Conn., and New England Westinghouse Co., Chicopee Falls, Mass. In the spring of 1918 both of these concerns were engaged on contracts for these rifles and the United States Government, in order to maintain the organization of skilled mechanics at the respective plants, agreed to take all rifles produced until such a time as both companies could prepare tools to make the Browning heavy machine gun. As a consequence, 280,049 Russian rifles were manufactured for the United States by the New England Westinghouse Co., and by the Bridgeport plant of the Remington Arms Co. These were in part distributed to the various States for the guard organizations.

United States Krag, model of 1898.—The United States Krag rifle, model of 1898, has been used only for training schools merely to utilize the supply on hand.

United States telescopic sight rifle, model 1918.—This rifle, which is derived from the United States rifle, model 1917, is adopted for the telescopic musket sight, model of 1918. It is intended primarily for sniping and most of its parts are interchangeable with the parts of the 1917 rifle. The exceptions are as follows:

Receiver.—There is no rear sight base and no rear sight. A dove-tail base for the rear telescope mount takes the place of these.

Barrel.—There is no front sight, the barrel being adapted to receive screws for the front telescopic parts. The rifling is right-hand twist with one turn in 10 inches and the standard tolerances and type of land of the Springfield rifle are employed. The stock is of special construction with no hand guard, nor upper band, while the lower band is of special design. The telescopic musket sight, model of 1918, used in connection with this rifle, is discussed in a subsequent paragraph.

SIGHTS.

Telescopic musket sight, model of 1913.—The telescopic musket sight, model of 1913, has a double reflecting type of telescope, with single-bracket mount and magnifying power of five times. It is equipped with cross hairs in the stadia and uses the wire principle for estimating ranges. This sight was used for the 1903 rifle, but was not satisfactory owing to the necessity of placing it out of line with original sight, and the consequent inability of the rifleman to bring the stock against his cheek for accuracy. It was consequently abandoned in favor of the model of 1918.

Winchester telescopic sight.—The Winchester telescopic sight, model A-5, produced by the Winchester Repeating Arms Co., with a special Marine Corps mounting, was found satisfactory in use by the Marine Corps and adopted as Marine Corps standard. The sight consists of a five-power direct telescope attached to the United States rifle, model of 1903, and has independent front and rear mounts with windage and range adjustment in the rear mount. Five hundred of these sights were purchased by the United States Army, Ordnance Department, for emergency training use.

Telescopic musket sight, model of 1918.—The telescopic musket sight, model of 1918, for use with the United States telescopic sight rifle, model of 1918, was formerly called the Winchester 2.6-2.7 telescopic sight, having been developed by the Winchester Repeating Arms Co. It was adopted as the United States Army standard in lieu of the model of 1913. It is mounted over the receiver and consists of

a direct or nonreflecting telescope 2.7 power, with independent front and rear mounts. On the rear mount there is a windage and range adjustment. At 100 yards the field is 44' 1". Aiming point is a post at the optical center of the telescope. A cross hair serves to level the instrument. This telescope possesses unusual optical and mechanical properties, and was adopted as standard after long competitive tests at Camp Meade. It is made by the Winchester Repeating Arms Co. As stated, it is used on the telescopic sight rifle, model of 1918, which is derived from the United States rifle, model of 1917.

The Warner objective sight.—This sight was developed in an effort to increase the sight radius, and to secure rapid sight setting for combat use in the United States rifle, caliber .30, model of 1903. It was developed by Mr. Warner, and designed to fit the dome of the receiver of the 1903 rifle, permitting setting for a desired battle sight range. This sight was carefully considered by the small-arms section, engineering division, and after further development a satisfactory sample was submitted, and 400 were ordered. It gives quick setting from 200 to 600 yards. The leaf is mounted on the rear of the receiver between guards, and is set by a cam operated by a milled wheel. The cam has flats corresponding to 200, 300, 400, 500, and 600 yards. For higher ranges the regular leaf is used.

The Elder windage sight.—This is a special experimental rear sight for the 1917 rifle. It consists of a leaf and slide, with drift compensation and windage adjustment. It was found successful for range use, but was considered too delicate for regular issue.

Sniper's micrometer sight.—A further development for rifle sights was a leaf and slide with interchangeable peeps and micrometer adjustment of elevation and windage. This sight was successful but very expensive to manufacture.

Winder telescoping tube sight for 1903 rifle.—A device invented by Maj. Winder, Ordnance Department, United States Army, and used for training purposes. It consists of a telescoping tube, one end fitted with front sight cover, and the other end fitting into a loop on the cap of the slide on the rear sight, made especially to receive it in battle sight position, or in field view of drift for elevation work. This sight can be used for ranges of 500 yards upward. It permits a windage correction. A special hand guard slide cap and front sight cover are the only deviations from the regular rifle. A limited number of these sights were authorized for training purposes and were distributed to different camps.

Periscopic attachment.—The Elder periscopic attachment, model of 1918, for attachment to United States rifles, models of 1903 and 1917, is shown in the accompanying illustration. It is a device for supporting and permitting the operation of a rifle resting above the parapet,

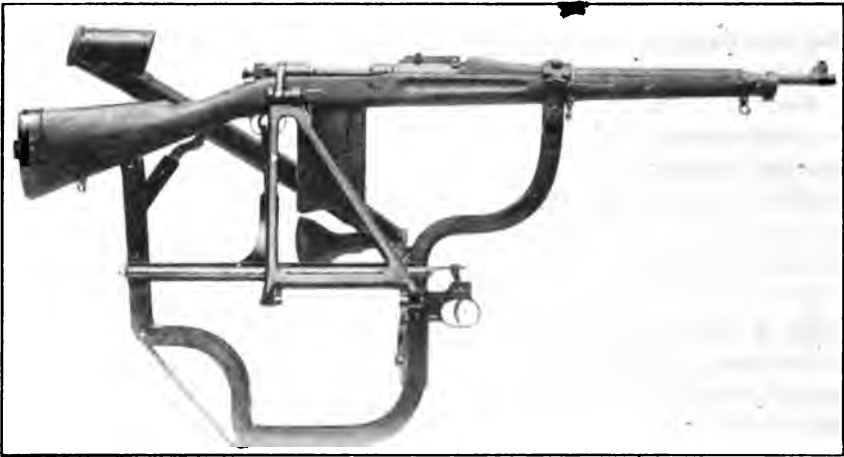

FIG. 151.—Periscope attachment for U. S. service rifle.

while the operator is below in the trench. The device was tested and developed for the Ordnance Department, and as a result the 1918 model is lighter in weight, more substantial, and permits using sights upon the rifle. The experimental development of this device was still in progress in the autumn of 1918. It consists of a rifle and shoulder brace with auxiliary mechanism, permitting the operation of the bolt by hand. It is not telescopic, and the rifle must be targeted. This device is not intended for use at long ranges.

Musketry rule, model 1918.—This consists of a mil scale with built-in slide rule for estimating and computing ranges, etc. It also includes an inverted sight for determining sight sets for the direct fire. The 1918 model is an improvement on that of the 1917 but is identical in principle. It is manufactured by the Gorham Manufacturing Co. and Graff, Washburne & Dunn. It is used in fire control when type E. E. field glasses are not available.

BAYONET.

Bayonet, model of 1917.—For the United States rifle, caliber .30, model of 1917, a knife or sword bayonet is used, which is the same as the British bayonet, model 80, with the addition of a clearing hole in the pommel. This bayonet consists of a blade and tang forged in one piece, with a guard forced on to the blade and brazed in place, and a pommel also brazed in place, so that these parts practically form a single piece. The guard is formed with a barrel ring to engage the end of the rifle barrel, while the pommel has a T-shaped stud slot to receive the bayonet stud in the upper band of the rifle. There is a bayonet catch with a catch spring which surrounds and partly guides the body of the cam, serving to hold it in an engaging

position, with a thumb piece which can be pressed in order to release the catch. On the tang of the bayonet are mounted right and left grips by screws and nuts. The scabbard is the model of 1917.

Weights and dimensions.—The principal elements in the specifications of the model of 1917 bayonet are given below :

Weight of bayonet.....	16 to 18 ounces.
Weight of blade.....	10½ to 13 ounces.
Length of blade.....	17½ inches.
Overall length.....	22 inches.
Material.....	Blade and guard of open-hearth steel.

Test.—The method of test is to take one blade in each batch of 200 and subject it to an overtest, rendering it unserviceable, to ascertain that the hardening and tempering are correct. The blades that stand the overtest are subjected to bending tests in the striking machine to determine quality and soundness of brazing.

Marking.—The first bayonets, taken over while in the course of manufacture for the British Government, were marked with a canceled British property mark, together with the lettering "U. S.," and the inspector's mark on the same side. On the reverse side was "1913" (the British designation of the model), also numbers representing the month and year of manufacture, and the maker's name. The bayonets are not serially numbered.

Bayonet, model of 1905.—This bayonet is used with United States rifle, caliber .30, model of 1905. It is a knife of sword bayonet, with scabbard latch. It uses a scabbard, model of 1905, 1910, and 1917. The model of 1905 bayonet consists of a blade, tang, and pomme, forged in one piece with the front and lower edge sharp along its entire length and the back for a distance of 5 inches from the point. On the blade is riveted a bayonet guard which has a hole for the barrel and a cut for the bayonet scabbard catch and scabbard mouth piece hook. On either side of the tang are mounted the bayonet grips.

Marking.—The blade is stamped on its left side with the Ordnance escutcheon and the initial of the place and year of manufacture and on the right side "U. S." and the serial number.

Bayonet scabbard.—Two types of bayonet scabbards have been issued, the first of which was discontinued. In each case the body was made of sole leather, flesh side out, stitched up the inner side, and painted olive drab. The ferrule and the mouthpiece are of sheet steel, browned. The old issue was provided with a hanger of russet leather which carried a double hook, but in the latter issue the hanger was dispensed with and the double hook was carried by a metal extension formed on the mouthpiece. In each type of scabbard the bayonet is retained by spring fingers which are inclosed in the mouthpiece and enter into frictional engagement with the sides of the blade.



*U. S. Rifle, Model 1903, with
Telescopic Sight, Model 1913, and Maxim Silencer, Model 1910*



*U. S. Riot Shotgun, Winchester Design,
with Bayonet, Model 1917*



*U. S. Riot Shotgun, Remington Design,
with Bayonet, Model 1917*

FIG. 152.—U. S. rifle model 1903 with telescopic sight and Maxim silencer; U. S. riot shotguns.

RIOT SHOT GUN.

Repeating shotguns, riot pattern.—The repeating shotguns adopted for the American Expeditionary Forces in France are of the ordinary commercial type as manufactured by the Winchester Repeating Arms Co. and the Remington Arms Union Metallic Cartridge Co. In times of peace they are manufactured for the use of sentries, police officials, express messengers, watchmen, prison guards, train hands, and are supplied also to people for home defense. For illustration see plate No. 152 on opposite page.

Winchester riot shotgun.—This is a pump-action gun of the hammer type, identical with commercial guns of this type in all respects, but with the addition of the bayonet attachment. The barrel is 20 inches long, 12-gauge cylinder bore. The bayonet attachment is a bracket to receive the model of 1917 bayonet. It is provided with a split sleeve which clamps around the muzzle of the barrel. A perforated metal hand guard is mounted over the barrel and connected with the clamping sleeve of the bayonet bracket.

Remington riot shotgun.—This is a hammerless pump-action gun, conforming to commercial standard. The barrel is 12-gauge cylinder bore and 20 inches long. The bayonet attachment consists of a bracket adapted to receive the model of 1917 bayonet. It is held on the end of the barrel by means of a split sleeve which clamps around the muzzle of the barrel. A wooden hand guard is provided.

Ammunition for riot shotgun.—These are metal base paper shells, loaded with nine buckshot in three layers, three shots to the layer. The shells are commercial-grade ammunition.

PISTOLS.

Automatic pistol, caliber .45, model 1911.—The caliber .45, model 1911, automatic pistol is of the Browning type with automatic recoil-operated barrel and a breech slide locked together in the first 4 inches of recoil. It uses the automatic pistol ball cartridge, caliber .45, model 1911. Each pistol in the military service is marked on the right side, "Model of 1911, U. S. A.," and on the left side "U. S. Property." They are also marked with the serial number of the pistol. The pistol weighs 2 pounds 7 ounces and its length is 8.6 inches. Its three principal parts are the receiver, the barrel, and the slide. The receiver has a suitable guide for the slide which moves on it. The magazine consists of a magazine tube closed at the bottom and containing the spring acting on the magazine follower, which serves as an immovable platform for the cartridge. The barrel of the pistol is largest at the breech and at the top has two transverse locking ribs, by which it is interlocked with the slide in

the firing position. The slide, which has a longitudinal movement carries both the front sight and the rear sight. There is a safety lock which locks the hammer and also a grip safety which locks the trigger whenever the handle of the pistol is released.

Operation.—The loaded magazine, which carries up to seven cartridges, is placed in the handle, and the slide is drawn back and released so that the first cartridge is introduced into the chamber. The hammer is thus caught and the pistol is ready for firing. By first inserting the cartridge into the chamber of the barrel and then inserting the loaded magazine the pistol may be prepared for instant use and for firing without the least possible delay the maximum number of shots.

Magazine.—The magazine has a charge of any number of cartridges from one to seven, and when exhausted may be readily released from the handle to be replaced by a loaded magazine.

Miscellaneous data.—The following items give the essential data concerning the automatic pistol:

Weight.....	2 pounds 7 ounces.
Trigger pull.....	6 to 7½ pounds.
Total length.....	8. 593 inches.
Barrel:	
Length.....	5. 025 inches.
Diameter of bore.....	0. 445 inch.
Rifling:	
Grooves—	
Number.....	6
Width.....	0. 1522 inch.
Depth.....	0. 008 inch.
Lands, width.....	0. 072 inch.
Twist, one turn in 16 inches, left handed.	
Front sight above axis of bore.....	0. 5597 inch.

Exterior ballistics.—The automatic pistol has been fired 21 times in 12 seconds, beginning with pistol empty and loaded magazines on a table beside the operator, firing at 25 yards distance at a target 6 by 2 feet Under such conditions 21 shots were fired in 28 seconds, making 21 hits with a mean radius of 5.85 inches. The drift or deviation due to the rifling of this pistol is more than neutralized when pulling the trigger if the pistol is fired from the right hand. The muzzle velocity is 802 feet per second and striking energy 329 pounds, which at a range of 250 yards diminish to 666 feet per second velocity and a striking energy of 226 foot-pounds. With a 25-yard range the penetration is 6 inches of pine, and in moist loam 9.95 inches, and in dry sand 7.8 inches. At 25 yards the penetration of 1 inch in white pine corresponds to a dangerous wound.

The trajectory is very flat up to 75 yards, at which range the pistol is accurate. With the angle of departure equal to 45 degrees the range



*Smith & Wesson Double-Action Revolver
Caliber .45, Model 1917*

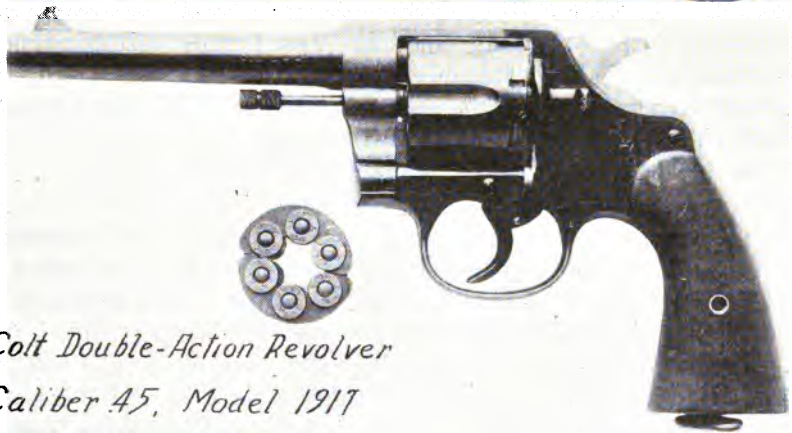

*Colt Double-Action Revolver
Caliber .45, Model 1917*



*Colt Automatic Pistol
Caliber .45, Model 1917*

FIG. 153.—U. S. service revolvers and pistol, models 1917.

is approximately 1,955 yards. The automatic pistol, model of 1911, has full description in Ordnance pamphlet No. 1866.

Extension magazine for automatic pistols.—A straight extension magazine, feeding as many as 30 cartridges, has been developed. The follower is positively guided, and two springs are used, one telescoping inside and the other outside a tubular guide.

Improved automatic pistols.—Various improvements in automatic and semiautomatic pistols have been brought to the attention of the United States Army Ordnance Department and have received careful consideration. Some of the more notable and important are discussed below.

Jolidon pistol.—This pistol is the same as the service automatic (automatic pistol, caliber .45, model 1911), except that the barrel rotates to lock with and unlock from the slide, instead of dropping at the breech to perform this function. Test pistols were constructed to ascertain the value of this mechanism.

Grant Hammond automatic pistol (sometimes called the "Liberty" pistol).—This is a recoil-operated pistol using P. B. cartridges, caliber .45, model 1911, and having a bolt similar to the Mauser pistol. Unlike the Mauser pistol, however, the magazines are inserted in the grip, as in the Colt. This pistol was very favorably regarded at Springfield and at Camp Perry after tests at each place, but at the end of the summer of 1918 was not considered then available for adoption. It has two novel features—when the last cartridge is fired the bolt lock opens and the magazine catch is released; and insertion of a loaded magazine automatically releases the bolt, which is moved forward by the recoil spring, chambering the first cartridge from the new magazine.

REVOLVERS.

Service revolvers, model of 1917.—The Colt double-action revolver, model of 1917, and the Smith & Wesson double-action revolver, model of 1917, are commercial types of revolvers modified to accept pistol ball cartridges, caliber .45, model of 1911, mounted in clips of three cartridges to a clip. The modification consists of increasing the head space to give room for the clips. These cartridges may be fired without clips, but in this case the shells must be picked out of the cylinder one by one.

These types of revolvers are made by the Colt's Patent Fire Arms Co. and the Smith & Wesson Co., and are issued mainly to artillery units, serving as an emergency, in case of shortage of automatic pistols. Up to November 9, 1918, the Colt's Patent Fire Arms Co. had delivered 134,300, while the Smith & Wesson Co. had delivered 134,051, maintaining a daily average production of about from 500 to 700 revolvers each.

Colt's double-action revolver, caliber .45, model of 1917.—Colt's double-action revolvers, caliber .45, model of 1917, are marked on the butt "U. S. Army, Model 1917," and are serially numbered. They consist of a barrel having a bore of 0.445 inch, firmly screwed into a frame which contains the lock mechanism. The front sight is brazed on the barrel, while the rear sight is merely a longitudinal groove in the upper surface of the frame. The lock mechanism is contained in the frame proper, which also supports the crane carrying the cylinder. There is a safety device which may be moved up in front of the hammer by a safety lever. The cylinder has six chambers and rotates upon and is supported on the central arbor of the crane. The crane fits in a recess in the frame below the barrel and turns on its pivot arm, which rotates in a hole in that part of the frame below the opening for the cylinder. There is an ejector with appropriate spring and rod which operates after the latch is pulled to the rear and the cylinder is swung to the left out of the frame. Pressing the ejector rod head to the rear will cause the ejector to engage the clips of the cartridges and carry them and the cartridges free of the cylinder, which may be reloaded with two clips and swung back into the frame. These clips may be saved and may be reloaded by hand.

Operation.—This revolver may be used either single or double action. In firing double action the pressure upon the trigger causes its upper edge to engage the hammer strut and thereby raises the hammer until nearly in full-cock position, when the strut will escape from the trigger and the hammer, under action of the mainspring, will fall and strike the cartridge. In firing single action the hammer is first pulled back with the thumb until the upper edge of the trigger engages in the full-cock notch in the front end of the lower part of the hammer. Pressure on the trigger will release the hammer, which under the action of the mainspring will fall and strike the cartridge.

DIMENSIONS.

Weight.....	2 pounds 7 ounces.
Total length.....	10. 8 inches.
Barrel :	
Length.....	5. 5 inches.
Diameter of bore.....	0. 445 inch.
Rifling, number of grooves.....	6 grooves.
Grooves :	
Width.....	0. 1522 inch.
Depth.....	0. 0033 inch.
Twist, one turn in.....	16 inches.
Lands, width.....	0. 0772 inch.
Cylinder :	
Length.....	1. 595 inches.
Diameter.....	1. 695 inches.

Chambers :

Number-----	6 chambers.
Diameter—Maximum-----	0. 480 inch.
Minimum-----	0. 473 inch.
Front sight, above axis of bore-----	0. 732 inch.

Exterior ballistics.—The Colt revolver, caliber .45, model of 1917, has been fired 18 times in 34 seconds, using clip ammunition, and beginning and ending with the cylinder closed and the chambers empty. At 25 feet the velocity is 780 feet per second. The drift of the bullet is to the left and is more than neutralized by the pull of the trigger when firing from the right hand. The drift is negligible at the short range at which this weapon is ordinarily used.

Smith & Wesson double-action revolver, caliber .45, model of 1917.—The Smith & Wesson double-action revolvers, caliber .45, model of 1917, in service are marked on the butt "U. S. Army, model, 1917," and are serially numbered. They consist of a frame to which the barrel is firmly screwed and held in position by a barrel pin. This barrel has a bore of 0.445 inch and to it is brazed, as an integral part, the front sight. The rear sight is a longitudinal groove in the upper part of the frame. The lock mechanism is contained in the frame.

Operation.—This revolver may be used either single or double action. In firing double action, pressure on the trigger causes its upper edge to engage the hammer strut and raises the hammer until the trigger nose itself comes into contact with the hammer. After this the trigger continues to raise the hammer until the hammer is nearly in its full-cock position, when the hammer will escape from the trigger nose, and, under action of the mainspring, will fall, causing the firing pin to strike the cartridge. In firing single action, the hammer is first pulled back with the thumb until the upper edge of the trigger engages in the full-cock notch in the front end of the lower part of the hammer. The pressure on the trigger will then release the hammer, which, under action of the mainspring, will fall and cause the firing pin to strike the cartridge.

Cylinder and ejector.—The cylinder has six chambers. It rotates upon and is supported by the central arbor of the crane. The crane fits into a recess in the frame below the barrel and turns on its pivot arm, which rotates in a hole in that part of the frame below the opening for the cylinder. The ejector, of which the ratchet of the cylinder is a part, consists of a rod and a star-shaped ejector head which engages the clip to cause ejection of the shell. It is forged in one piece. By means of a latch the cylinder can be released and swung outward to the left from the frame for ejecting the fired cartridges. The revolver can not be cocked until the cylinder is back in position in the frame and latch.

DIMENSIONS.

Weight.....	2 pounds 4 ounces.
Total length.....	10.79 inches.
Barrel :	
Length.....	5.5 inches.
Diameter of bore.....	0.445 inch.
Rifling, number of grooves.....	6
Grooves :	
Width.....	0.157 inch.
Depth.....	0.008 inch.
Twist, one turn in.....	14.659 inch.
Lands, width.....	0.075 inch.
Cylinder :	
Length.....	1.537 inches.
Diameter.....	1.708 inches.
Chambers.....	6
Diameter—	
Maximum.....	0.480 inch.
Minimum.....	0.4795 inch.
Front sight above axis of bore.....	0.794 inch.

Exterior ballistics.—The Smith & Wesson, caliber .45, model of 1917, revolver has been fired 18 times in 35 seconds, using clip ammunition, and beginning and ending with the cylinder closed and chambers empty. At 25 feet the velocity is 806 feet per second. The drift of the bullet is to the left and is more than neutralized by the pull of the trigger when firing from the right hand. The drift is negligible at the short range at which this weapon is ordinarily used.

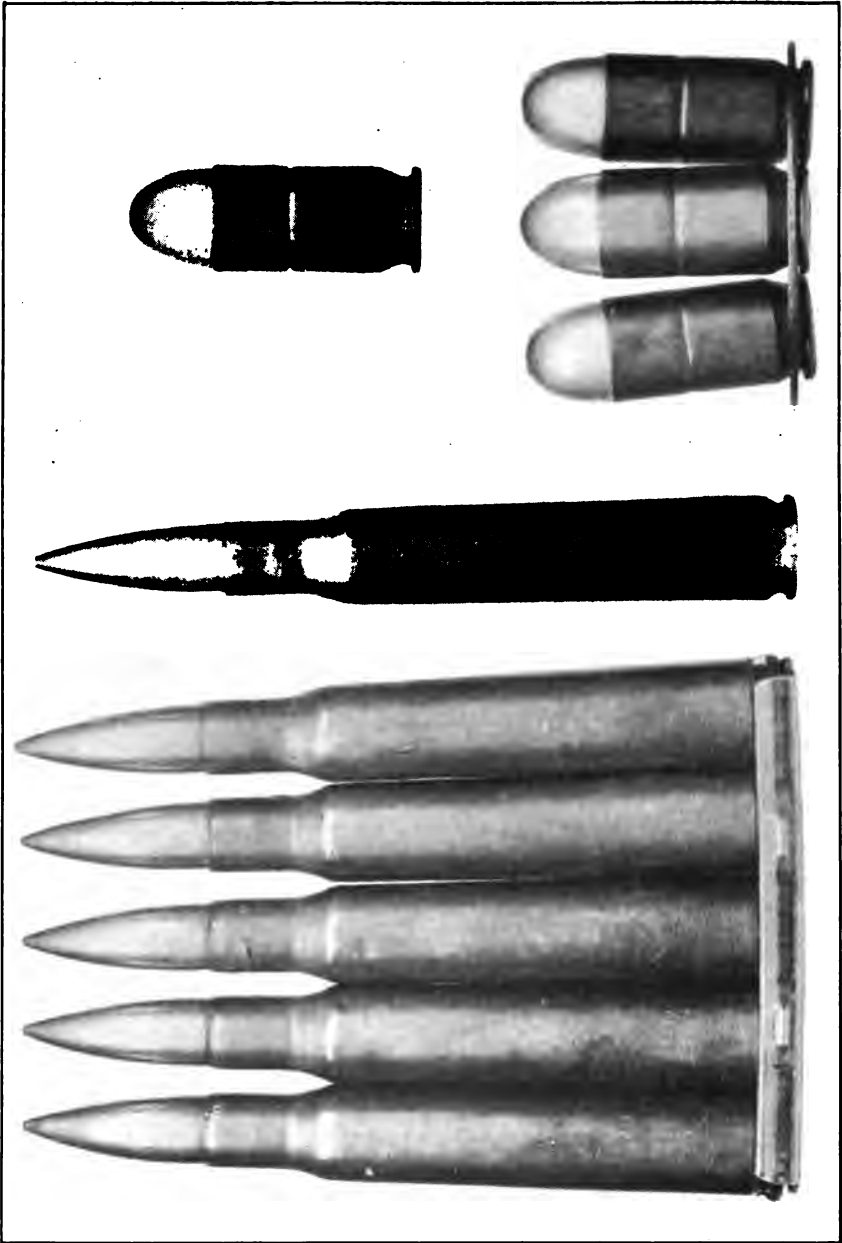

FIG. 154.—U. S. Army service ammunition. .30 caliber cartridge, model 1906, for rifles, and .45 caliber cartridge for pistols and revolvers.

XV. MACHINE-GUN AND SMALL-ARMS AMMUNITION.

Caliber .30, Model of 1906, service ammunition.—The caliber .30 ball cartridge, model of 1906, is the standard service ammunition. It is the type used in the model 1903 (Springfield) and United States model 1917 (American Enfield) rifles, as well as in machine guns. The cartridge complete weighs approximately 395.5 grains. The case is of drawn cartridge brass having a weight of 190 ± 5 grains, and contains a charge of pyro-cellulose powder weighing from 47 to 50 grains. Inserted into the head of the cartridge case is the primer having a weight of 5.5 grains. It consists of the cup of gilding metal, charge of percussion composition covered by a disk of shellac paper, and an anvil for receiving the blow of the firing pin.

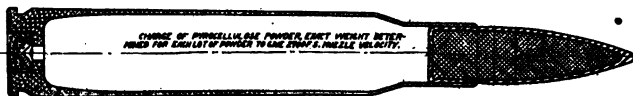

FIG. 155.—U. S. caliber .30, model 1906, service cartridge.

The bullet is made from a cupro-nickel jacket inclosing a lead core, hardened with antimony, and weighs 150 ± 1 grain. The ammunition is designed and loaded to give a muzzle velocity of about 2,700 feet per second.

Waterproofing of this ammunition is accomplished by shellacking the inside of the neck of the case and placing a drop of shellac on the joint between the primer and the case.

The cartridge case is of the rimless or cannelured type, the cannelure or groove at the head being turned into the case to provide a means for extraction. The bullet is of the pointed or spitzer type, and is secured into the neck of the cartridge case by crimping the mouth into a cannelure on the bullet. A force of 75 pounds is required to extract the bullet from the case. The overall length of the completed cartridge is 3.34 inches.

The primer is secured into the primer pocket by crimping, several methods of performing this operation being in use. The maximum pressure developed by this ammunition is 52,000 pounds per square

inch, and the arms in which it is used are designed safely to withstand this pressure.

No marks of any kind are permitted on the cartridge, except the initials of the manufacturer and the numerals indicating the year of fabrication, which are stamped on the cartridge head.

Classification and uses.—A classification for caliber .30, model of 1906, ammunition has been devised so that all manufactured falls into one of four classes indicated by the symbols, A-1, A-2, B-1, and B-2. The letter "A" indicates that the ammunition is packed in the containers without clips or bandoleers, and the letter "B" indicates that the ammunition is packed with clips and bandoleers.

A-1 ammunition is for aircraft use. This is especially selected and inspected for all defects including a test for slight hang-fires which might prove dangerous in the aircraft machine gun synchronized with the propeller. Every precaution is taken to eliminate defective cartridges from this class.

A-2, or ammunition for machine-gun use in the United States, is selected for its ability to function in machine guns of the current type and is issued for target practice only in the United States, for the reason that the accuracy of this ammunition might not be quite as good as that selected for combat purposes. This ammunition is packed without clips or bandoleers and in the same manner as A-1, or aircraft ammunition.

B-1 ammunition is issued packed in clips and bandoleers for use in both rifles and machine guns, except aircraft guns, and a large percentage of the ammunition manufactured falls into this particular class.

B-2 ammunition is issued for rifle target practice in the United States only. Ordinarily this ammunition has some slight inherent defect, not affecting its accuracy, but which does affect its functioning in machine guns. It is packed in clips and bandoleers.

Clips.—Cartridges are packed in clips for use in both service rifles, the clips consisting essentially of a body of steel or brass containing a flat brass spring. Five cartridges are inserted into the clip and are held firmly in place by the action of the spring against the head of the cartridge, and the retaining effect of the edge of the clip body which is inserted into the cannellure. On each end of the spring there is a small lip which when bent upward prevents the cartridges from sliding out of the clip during transit or handling.

A rifle is loaded by placing a clip of five cartridges above the magazine and receiver, when the bolt is open, and pressing down on the top cartridge. A slight pressure only is required to force the cartridges from the clip into the magazine or container of the rifle.

Bandoleers.—Twelve clips, or 60 cartridges, are packed in bandoleers. The purpose of the bandoleer is to afford an easy means of

essential to follow the line of flight or trajectory, as in aircraft work. The cartridge case and primer are the same as those used in service ammunition, but the bullet differs in that there is inserted into the nose of the bullet a small slug of lead, hardened with antimony, behind which is situated a cup, or capsule, of gilding metal. This capsule is a container for the tracing composition which consists of seventeen (17) parts of barium peroxide and two (2) parts of magnesium.

The powder charge is such as to give a dispersion at 500 yards equal to that of service ammunition, with the same allowable powder pressure which does not exceed 52,000 pounds per square inch. The tracing composition is ignited by the powder flash and burns with a bright white light during the first 500 yards of flight. This burning or tracing feature enables the machine-gun operator to follow easily and clearly the line of flight of the machine-gun bullets.

Tracer cartridges are loaded in machine-gun belts interspersed with service, incendiary, and armor-piercing bullets, one tracer to several of the other types. Tracer cartridges are distinguished from other types of ammunition by the black or bluish color of the cartridge case.

They are packed in the same style wooden packing cases as used for service ammunition and in the same manner as that described for the packing of aircraft ammunition; that is, in cartons without clips or bandoleers. There are 1,500 rounds of this ammunition in each box and the box is clearly marked with the type, lot number, date of packing, etc.

For details of construction of tracer cartridge, caliber .30, model 1917, see figure No. 156 on preceding page.

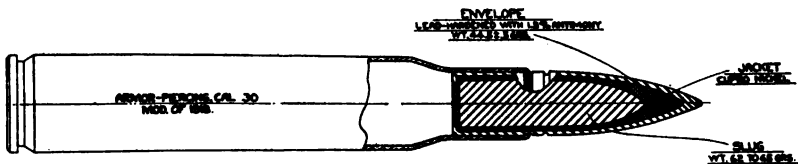

FIG. 157.—Armor-piercing cartridge, caliber .30, model 1918.

Armor-piercing.—The armor-piercing bullet, caliber .30, model of 1917, was developed for use against armor plate, with which airplanes, tanks, and other defenses are equipped. This bullet with its steel core, which involved the selection of the proper steel and its heat treatment, required considerable experimental work.

This bullet was developed by using a cupro-nickel jacket with a hardened steel slug, or core, the steel core being incased in a lead envelope, which was allowed to protrude from the open end of the

cupro-nickel jacket and then formed into a soft lead nose. The object of this lead nose was to give the bullet a purchase, when fired at a critical angle, on a smooth or rounded steel surface. This type of bullet was placed in production and a considerable quantity manufactured. However, it was later found that the American Expeditionary Forces objected to the use of it because the protruding lead nose caused it to have an action similar to the dum-dum bullets. In consequence of this it was discarded and the model of 1918 armor-piercing bullet developed.

This was accomplished by using a cupro-nickel jacket closed at the nose, or point, and conforming to the profile of the caliber .30 service bullet. Inserted in this jacket was the same type of steel core inclosed in a lead casing as before, except that no lead was permitted to protrude at the point of the bullet. The weight of this bullet is 154 ± 2 grains. It is loaded into the same case as the service ammunition and is distinguished from other types by a small ring, or cannellure, around the bullet, situated just above the mouth of the case in the assembled cartridge.

Armor-piercing ammunition is loaded with a charge of pyrocellulose powder to give a muzzle velocity of 2,700 feet per second. It is packed in cartons without clips or bandoleers and the wooden packing boxes clearly marked with the type and other relevant information.

For details of construction of this armor-piercing cartridge see figure 157 on the opposite page.

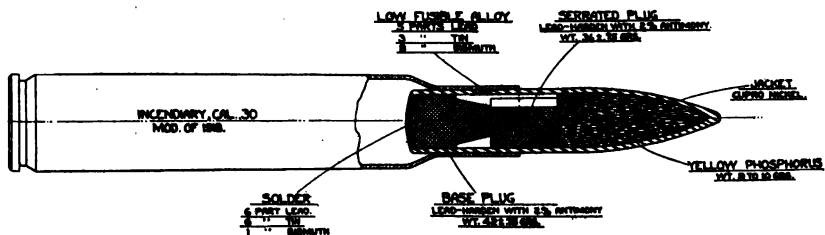

FIG. 158.—Incendiary cartridge, caliber .30, model 1918.

Incendiary.—With the extended use of observation balloons and dirigibles came the need for an incendiary bullet which would ignite gases or such other materials with which it might come in contact. The Buckingham bullet, which was of the incendiary type, was developed in England, and the style of incendiary bullet developed in the United States followed closely in principle this British design.

The caliber .30, model of 1917, incendiary cartridge which was the first adopted, consisted of the regular caliber .30 service cartridge case loaded with a blunt-nose bullet made from a jacket of cupro-nickel, inclosing in the nose a charge of yellow phosphorus. The phosphorus was backed up by a serrated lead plug which in turn was

acted upon by a lead base plug soldered to the rear and open end of the bullet jacket. A small hole was drilled in the side of the bullet jacket and filled with a low-fusible alloy. The heat generated by the passage of the bullet through the barrel of the gun caused this low-fusible alloy to melt, which subsequently allowed the yellow phosphorus to burn and leave a trail of smoke and fire streaming from this hole. Upon impact the serrated plug was driven forward and the remainder of the yellow phosphorus forced out of the jacket.

This blunt-nose type of bullet was adopted because of its greater effectiveness against balloon fabric, in that it would shear a small circular piece from the fabric and thereby allow a greater escape of gas, or a mixture of gas and air, with a resultant explosion. It was, however, found that some little difficulty was encountered in the functioning of ammunition loaded with a blunt-nose type of bullets, due to its sticking or jamming in some of the charging devices, used with the various types of machine guns. This difficulty resulted in the development of the caliber .30, model of 1918, incendiary cartridges.

The bullet used in this cartridge was constructed along practically the same principles as described above, with the exception that the cupro-nickel jacket has the same profile as the caliber .30 bullet jacket used in regular service ammunition. The model of 1918 incendiary cartridge is distinguished from other types of ammunition by the blackened, or discolored, bullet, and its details of construction are shown in the sectional diagram, figure 158.

Both of the types of incendiary bullets described trace satisfactorily over a range of approximately 300 yards, the yellow phosphorus having mostly been burned out when that range is reached.

Inspection.—The caliber .30 tracer, armor-piercing and incendiary ammunition is all inspected and packed by the same method employed in the inspection and packing of caliber .30, model of 1906, service ammunition, class A-1, except that certain variations in inspection are necessary for determining the merits of each lot of bullets submitted—that is, in the case of tracer ammunition, the length of trace is inspected for; in armor-piercing, its penetrative qualities; and in incendiary its length of trace. The accuracy tests are also somewhat different, but the gauging test and other parts of the inspection are practically the same.

CALIBER .30 AMMUNITION—MISCELLANEOUS.

High-pressure test cartridges.—Caliber .30 high-pressure test cartridges are used for proving rifles and machine guns. These cartridges are made to the same dimensions and profile as service ammunition, except that in some lots manufactured the head of the

cartridge case has been somewhat thickened to assist the case better to withstand the high pressure which this ammunition develops. The charge of powder is such as to develop a pressure of $68,000 \pm 2,000$ pounds per square inch. This ammunition is waterproofed and the cases are tinned so that they may easily be distinguished from other ammunition. As above stated these cartridges are used only for testing or proving rifles and machine guns and consequently should never be used for any other purpose. To further assist in identification the heads of these cartridges are marked "Test."

Caliber .30 blank cartridges, model 1909.—This ammunition is made from second-class cartridge cases accruing in the manufacture of service ammunition. By the term "second class" is meant cases with small dents, scratches, or other minor imperfections that do not affect the functioning of the case when loaded as a blank cartridge. These cases are charged with about 12 grains of E. C. blank powder, or equivalent, and the neck of the case is cannelered for the seating of a paper wad which is inserted above the powder, shellacked, and crimped in. Blank cartridges can, of course, be readily distinguished from other types of ammunition in that no bullet is present. Other models are indicated on the accompanying table facing page 354.

Dummy cartridges.—Dummy cartridges for the models 1903 and 1917 rifles are of two types. First, is the standard fluted dummy made from second-class cases and bullets, the cases being tinned and corrugated with six flutes, three holes being also drilled through the sides. The primer is not loaded with a pellet of percussion composition. These dummies are easily distinguishable even in the dark, and are issued to troops for practice in operating rifles. The other class of dummies are made in the manner described above, except for the fact that they are not fluted. These are known as "round" dummies and are made by the Frankford Arsenal only. They are issued to rifle plants for testing the functioning of rifles during inspection. This type, in place of the fluted type, is used for that purpose, as it has been found that fluted dummies did not always disclose imperfections in the rifles. The cartridges are distinguished by three holes drilled through the sides of the tinned cases.

Guard cartridges, caliber .30, model 1906.—Guard cartridges for the models 1903 and 1917 rifles are made from second-class cases and bullets obtained in the manufacture of caliber .30 service ammunition. These cartridges are loaded with a charge of approximately $9\frac{1}{10}$ grains of Bull's-eye smokeless powder, or its equivalent, and a muzzle velocity of 1,200 feet per second is obtained. This ammunition is waterproofed in the usual manner. It may be distinguished from other ammunition by six short flutes or corrugations just below the neck of the cartridge case. This ammunition is used, as the name implies, for guard purposes.

Caliber .30 gallery-practice cartridges.—The model 1906 gallery-practice cartridge, for use in the 1903 and 1917 rifles, are made in limited quantities for the Navy. The regular service case is used and is loaded with approximately $3\frac{1}{16}$ grains of Bull's-eye smokeless powder, or equivalent. The bullet is of lead and weighs 107 grains. This cartridge can be distinguished from other types by the lead bullet in addition to a cannellure in the neck of the case against which the bullet is seated.

CALIBER .30 AMMUNITION FOR MODEL 1898 RIFLE.

Caliber .30 service ammunition, model 1898.—Ammunition for the model 1898 rifle, known as the Krag, is of the same caliber as the present service ammunition, namely, caliber .30. However, the service cartridge for the model 1898 rifle differs from the cartridge for the 1903 and 1917 rifles, in that the case has a rim for extraction purposes, instead of a cannellure, and the bullet has a round instead of a pointed nose. The model 1898 cartridge is loaded to give a pressure not to exceed 42,500 pounds per square inch and a muzzle velocity of 2,000 feet per second. The bullet has a weight of 220 grains and is made of a cupro-nickel jacket inclosing a lead slug. The bullet is lubricated with Japan wax before being inserted into the case.

Caliber .30, model 1898, blank cartridges.—These blank cartridges used with the model 1898 rifle are made from the same type of case as is used for service cartridges, with the exception that the case is tinned for identification purposes. The bullet consists of paper covered with paraffin and packed, or loaded, with 5 grains of E. C. powder, this charge being held in place in the bullet with a thin coating of shellac. The blank charge in the bullet is ignited by the primer flash in a similar manner to the ignition of the blank charge, which in other types of ammunition is usually carried in the cartridge case rather than in a paper bullet.

Caliber .30, model 1898, dummies.—Cartridges for the model 1898 rifle are made by fluting or corrugating second-class service cases and drilling three holes through the sides. The case is also tinned and has inserted a second-class bullet. Neither the case nor the primer is charged. These cartridges were used for practice in operating rifles, as previously discussed on page 349.

Caliber .30 gallery practice cartridges for model 1898 rifle.—This type of ammunition was made by using the service case charged with 2.5 grains of Bull's-eye smokeless powder and loaded with a lead bullet weighing 107 grains. The neck of the case was cannellured and the bullet seated against the cannellure. This type of cartridge although having the same size case as service ammunition could be identified by both the cannellure on the neck and the lead bullet.

CALIBER .45 AMMUNITION FOR USE IN PISTOLS AND REVOLVERS.

Caliber .45 service cartridge.—The caliber .45 service ammunition is for use in the model 1911 automatic pistol and the two models of 1917 revolvers. The revolvers are known as the Colt and the Smith & Wesson. These cartridges consist of a drawn brass case, a primer,



FIG. 159.—Caliber .45 service cartridge.

charge of smokeless powder, and a bullet having a weight of 230 grains. The bullet consists of a gilding metal jacket which is tinned and then filled with a core of lead hardened with about 2 per cent of antimony. The cartridge cases are all of the cannellured, or rimless, type and a second smaller cannellure is located on the cartridge case in such a position as to prevent a bullet from being pushed back into the case. These cartridges are waterproofed by shellacking inside of the mouth and to make the joint between the case and the bullet tight, as well as by placing a drop of shellac at the joint between the primer and cartridge case.

Caliber .45 ammunition has a muzzle velocity of 800 feet per second and develops a pressure not exceeding 16,000 pounds per square inch.

To adapt it for use in the caliber .45 revolvers, clips have been designed, these being made of spring tempered steel 0.040 inch thick. Three cartridges are inserted into a clip so that when they are loaded into a revolver the clips afford a means of extracting the empty shells by giving a surface against which the extractor acts. See illustrations, pages 337 and 342.

Caliber .45 dummy cartridges.—These are made from second-class cases and bullets. The cases are tinned for easy identification and have three holes drilled through the sides to make them even more easily distinguishable. They are used for practice in operating pistols and revolvers.

Caliber .45 blank cartridges.—Caliber .45 blank cartridges are being developed but have not yet been placed in production. This ammunition is being designed so that it will operate the automatic pistol when fired in a special barrel and with a special magazine.

Caliber .45 high-pressure cartridges.—High-pressure cartridges are used for testing pistols and revolvers. They are loaded so as to give a pressure of 20,000 pounds per square inch, this pressure being 4,000 pounds in excess of that allowed for service ammunition. In consequence of this, the ammunition is dangerous and should never be used for any purpose whatever, except for proving arms.

Caliber .38 revolver ball cartridges.—Caliber .38 revolver ball cartridges are used in the old type of .38 caliber revolver. The ammunition is made from a brass case with a lead bullet and a charge to give a velocity of 750 to 800 feet per second, by developing a pressure not in excess of 15,000 pounds per square inch. Practically all of this type of ammunition recently procured is of the commercial type.

8-mm. Lebel
cartridge7.62-mm Russian
ammunition11-mm. incendiary
cartridge

FIG. 160.—Ammunition for rifles and machine guns.

Gallery practice cartridges, caliber .22.—This ammunition is used in a model 1903 rifle, chambered to take an adapter which holds these small cartridges. The .22 caliber cartridges are of commercial grade known as the .22 caliber short. As the name implies, this ammunition is used for gallery practice.

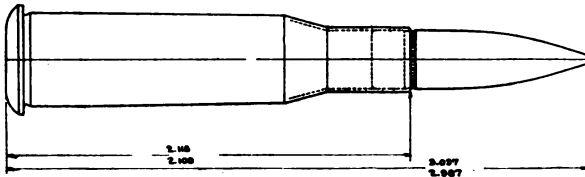

FIG. 161.—Caliber 7.62-mm. cartridge for Russian rifle.

Caliber 7.62 mm. ammunition for the Russian three-line rifle.—Ammunition for the Russian rifle consists of a cartridge case of brass, of the rim type, which is loaded with a charge of from 48 to 50 grains of powder, giving a maximum pressure not exceeding 45,500 pounds

per square inch, and producing a muzzle velocity of 2,866 feet per second. The bullet is made of a cupro-nickel jacket filled with a lead slug and having a weight of about 150 grains.

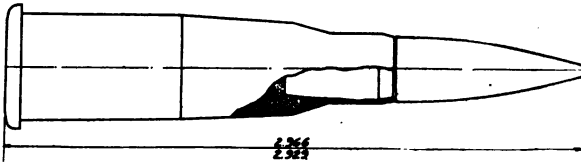

FIG. 162.—French 8-mm. Lebel cartridges.

French 8 mm. Lebel cartridges.—8 mm. cartridges have been made in this country, principally by the Remington Arms-Union Metallic Cartridge Co. and the Western Cartridge Co. The cartridge case, which is of brass, is loaded to produce a velocity of 692 meters per second, at a distance of 25 meters from the muzzle of the gun. The bullet is of copper, hardened with about 10 per cent zinc, and has a mean weight of 197.6 grains. The charge is usually 46 grains of Du Pont No. 22 or Hercules No. 20 powder. The French cartridge had an equivalent charge of BN_3F smokeless powder consisting of small square grains. The pressure developed does not exceed 45,000 pounds per square inch. The ammunition manufactured was for use in the 8 mm. French Chauchat rifle and the Hotchkiss machine guns, both of which were used by the first of the American Expeditionary Forces in France.

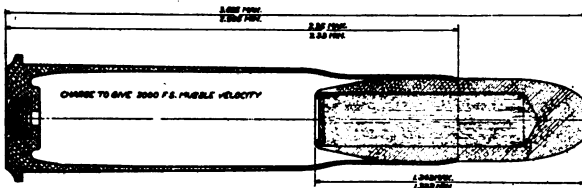

FIG. 163.—Incendiary cartridge, caliber 11-mm.

11 mm. ammunition.—Tracer-incendiary ammunition, caliber .11 mm., has been developed for use in the machine guns of this caliber adopted as part of aircraft armament. This ammunition has a muzzle velocity of about 2,000 feet per second, and the bullet differs from other types in that it is made of brass and is hollowed out to hold a charge of tracing composition, which consists of barium nitrate, magnesium, and a binder with a priming charge of red lead and magnesium. This charge of tracing composition is so large that the bullet not only traces but has excellent incendiary properties. It will trace its path for at least 1,000 yards. It is principally used against kite balloons and dirigibles.

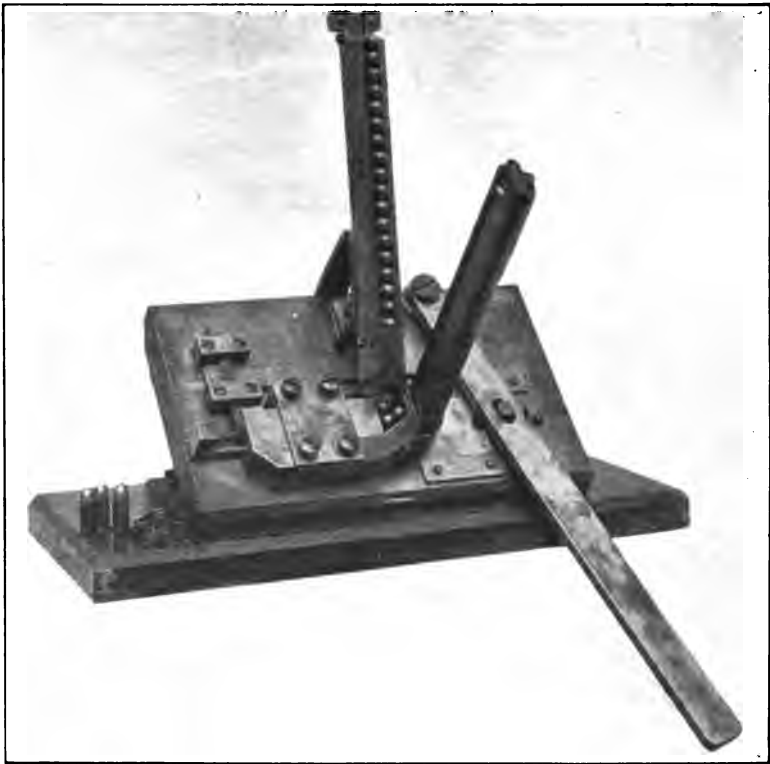

FIG. 164.—Clip-loading machine, model 1918, caliber .45, for revolver ball cartridges.

Clip-loading machine for caliber .45 revolver ball cartridges.—The clip-loading machine, model of 1918, for caliber .45 revolver ball cartridges, model of 1911, is designed to clip these cartridges for use in revolvers. The illustration indicates the nature and construction of the machine clearly and affords a good idea of how it functions. The magazine to hold the clips is not shown in the picture, as this addition was made after the construction of the model illustrated. The cartridge magazine opening at the top is fitted with a tool-steel gauge to detect cartridges which are too large to be clipped.

Small-arms repair and cleaning outfits.—The various repair chests and cleaning outfits for use in the field as issued are as follows:

Armor-repair chests, model 1910.—This chest contains tools and spare parts for the United States rifle, model of 1903. It is intended for use by the company's mechanics.

Armor-repair chests, model 1917.—This chest contains tools and spare parts for the United States rifle, model 1917. It is intended for use by the company's mechanics.

Tool roll for United States rifle, model 1903.—This contains taps, reamers, etc., for adjusting front sights on United States rifle, model 1903.

Caliber.	Model.
.22	Gallery practice.
.30	Armor-piercing, 1
.30	Armor-piercing, 1
.30	Multiball, 1898....
.30	Service, 1898.....
.30	Multiball, 1903....
.30	Service, 1903.....
.30	Service, 1906.....
.30	Incendiary, 1918..
.30	Tracer, 1917.....
.38	Revolver ball.....
.38	Revolver blank....
.45	Revolver ball, 190
.45	Pistol ball, 1911..
.45do.....
.45	Multiball, 1873....
.45	Revolver blank, 1
.45	Dummy, 1918....
.45	High-pressure....
.303	British, Mark VI,
.303	British, Mark VII
8-mm.	French Lebel.....
7.62-mm.	Russian.....
11-mm.	United States inc
.30	Blank, 1898.....
.30	Blank, 1906.....
.30	Blank, 1909.....
.30	Blank, 1903.....
.30	Dummy, 1898.....
.30	Dummy, 1903.....
.30	Dummy, 1906.....
.30	Gallery practice, 1
.30	Gallery practice, 1
.30	Guard, 1898.....
.30	Guard, 1906.....
.30	High-pressure....
.30do.....
.30do.....
.30	Incendiary, 1917..

91485—19. (To

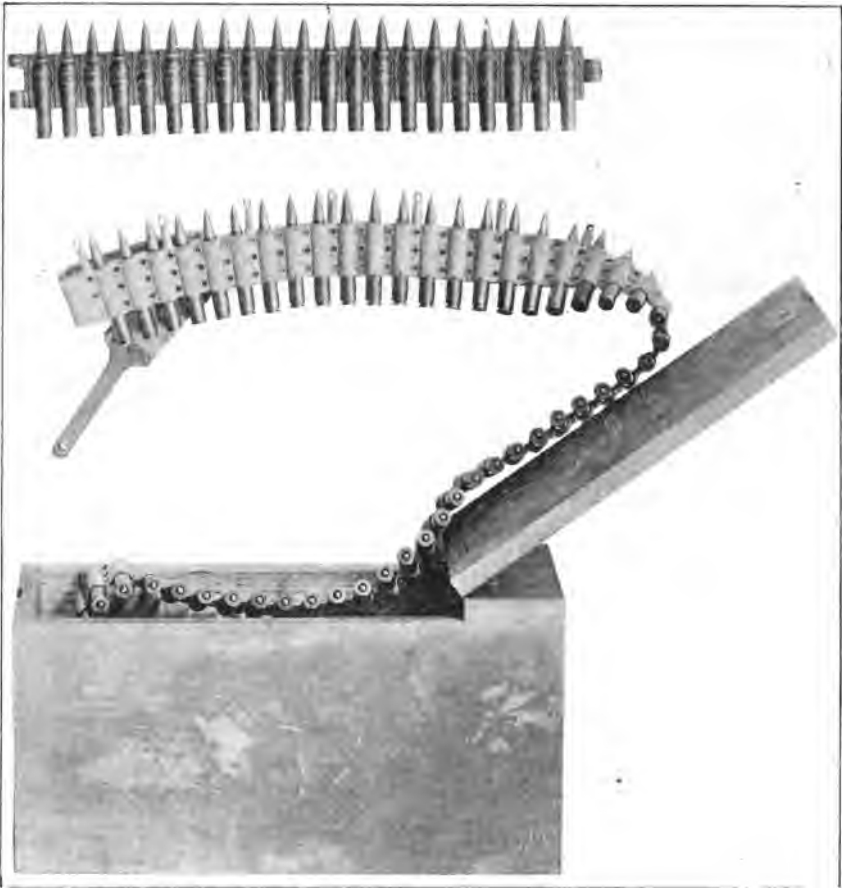

FIG. 165.—Cartridges for machine gun and ammunition box. Disintegrating belt (above) and webbing belt (below).

Cartridge belts.—For use with machine guns cartridges are loaded into belts of metal or webbing, and, as developed in 1918, into expendable cartridge belts of kraft paper, backed by muslin and asphaltum. Expendable metallic links joined to form the belt illustrated above, and also on page 304, are used with the Vickers, Marlin, and Browning guns. The webbing belts, made in strips of 250 rounds, were loaded and reloaded near the firing line and transported in boxes. To obviate this transportation and reloading, the expendable belt of kraft paper, reinforced by muslin and asphaltum, was devised, which was stitched by machinery and loaded by machinery at the factory. This belt was formed with a standard width of $1\frac{1}{8}$ inches and the cartridges were inserted and stapled at the proper intervals. These loaded strips are cut into lengths of 300 cartridges and packed in special expendable boxes hermetically sealed. These belts not only are far less expensive, but release members of the gun crew detailed to reload for combat duties.

XVI. MOTOR AND TRACTOR EQUIPMENT.

Advantages of motor traction.—The motorization of mobile artillery and auxiliary transportation not only gives added mobility to heavy units, but increases efficiency, as testified to by American artillery officers serving in France, and involves an important saving in the number of men and animals required that extends far back to the remount depots and purchasing service. This is, of course, a saving to be considered, with the original additional transportation required for men and animals and the large amount of ocean tonnage and railway facilities continually involved in their maintenance. According to Gen. Pershing, motorizing a 6-inch howitzer regiment saves 1,440 horses. The men released from the care of such a number of animals are either available for other duties or are saved entirely in the active strength and the necessary labor of the command. Gen. Pershing stated, however, that the strength of a 6-inch battery motorized should be at least 190 soldiers. The officers of the Field Artillery brigade at Valdahon early were unanimous in support of motorization as recommended, as was Maj. Gen. March, also in view of his earlier experience with batteries of the Eighth Field Artillery, equipped with motor trucks on the Texas border.

Economy of supply and maintenance.—The increased economy of supply and maintenance due to motorization is not based exclusively upon a monetary consideration, important and evident as that is, but it involves the serious question of available ocean transportation—one of the greatest problems with which the American forces had to deal. At the very outset one tractor for a 6-inch howitzer shipped abroad as the equivalent of 16 heavy draft horses and 3 riding horses is so compact in its packing that it occupies practically only 360 cubic feet. Furthermore, to consider the question of continuous supply for horsed artillery abroad, the question, so far as it concerns ship bottoms, is even more serious, as the following concrete example shows.

A horsed regiment of 6-inch howitzers consumes daily 14.7 tons (29,400 pounds) of forage, whether the animals are employed for useful draft or are simply idle. The same regiment with its equipment motorized consumes 4 tons (8,000 pounds) of fuel, oil, and grease in marching 50 miles, which incidentally represents a two days' march for a horsed regiment, while obviously little if any fuel

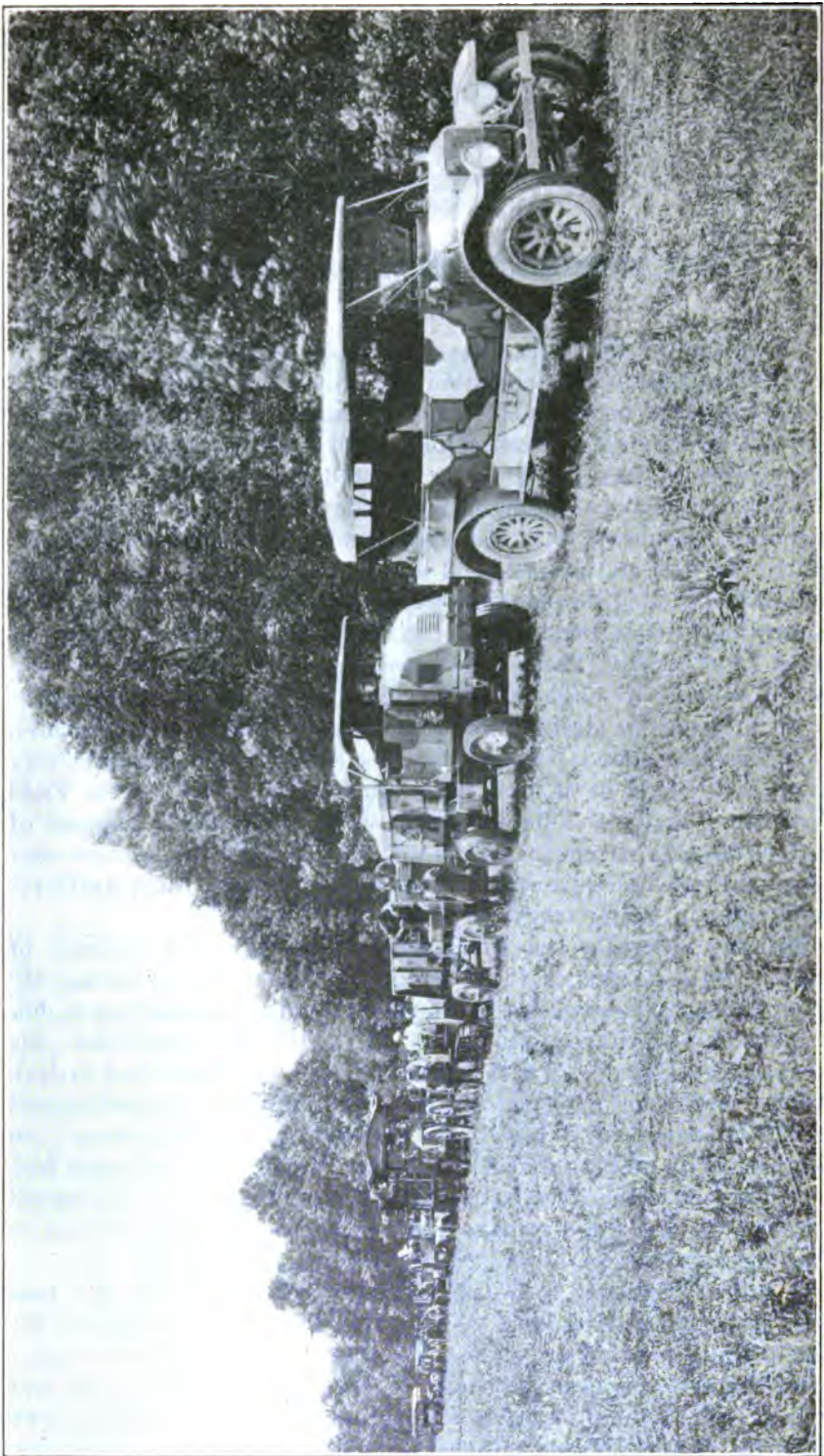

FIG. 166.—Types of U. S. Army Ordnance Department motor vehicles and tractors.

or lubricant is consumed when idle. In addition to relative weights, the space occupied in transporting fluids and grease as compared with oats and hay also figures in the all-important question of ocean and railway transportation.

Mobility.—The horse used for draft of medium caliber Field Artillery, such as the 4.7-inch gun or 6-inch howitzer, is capable of negotiating reasonable terrain and upon good roads can exert bursts of speed for short periods. Greater speed under favorable conditions and for short distances is the chief superiority claimed for horse draft, but the objection of the slow rate of march by mechanical transport has been practically overcome by the new model 5-ton artillery tractor, which has a maximum speed of 7 miles per hour and continuously maintained speed of 5 miles per hour on good roads. Moreover, the contemplated organization provides for the towing of guns and caissons, where road conditions permit, by four-wheel drive trucks. In this case the caterpillars would be placed on trailers, with rubber-tired wheels. The speed by such an arrangement would be limited only by the gun matériel itself. It may be added that all wheeled gun matériel in our service is to be rubber tired, including the 6-inch howitzer and larger and smaller calibers, for rapid transport on good roads.

The motor battery can thus attain a higher speed than is possible even for short distances, with heavy draft horses; and it can maintain this speed for long periods of time.

The tractor has positively demonstrated its ability to cross terrain impossible for the horse. It can cross ditches 7 to 9 feet wide. In tests in very muddy terrain, the caterpillar, of a design similar to that adopted by our service, handled a 4.7-inch gun section and men (18,000 pounds) where horses with one carriage could not even approach, owing to soft ground. These results are accomplished by having the weight so distributed over the bearing surface that the weight per square inch is practically 4.5 to 5.6 pounds, depending upon the width of the track shoes.

Vulnerability.—The question of vulnerability has often arisen and at first glance it would seem that the horse has a great advantage over the tractor where one direct shell hit will disable the whole vehicle, but certainly eight horses in draft present a target of much greater extent, although a direct hit will possibly leave a portion of the animals serviceable; on the other hand, one shrapnel properly placed will disable a whole team, but owing to the armor provided will not damage the tractor. From the foregoing the chances of destruction are about equal for each method of draft, and therefore this feature may be dropped from the discussion.

Leather saving.—The harness necessary to equip horse-drawn batteries is also a great factor. When the number of organizations con-

templated is considered and the fact that the leather supply was early affected by the war, it is obvious that leather will continue to become more difficult to secure. One regiment of medium heavy Field Artillery requires 125 sets of wheel harness and 333 sets of lead harness, the leather for which would make 11,720 pairs of shoes.

Supply of tractors unlimited.—The manufacturing plants in America had greatly enlarged their floor space with a view to greater output. This meant that the supply of tractors and trucks was unlimited, whereas the supply of horses was limited and becoming more so.

Ease of concealment.—Tractors are far more easy to conceal and camouflage than horses and are, therefore, seldom destroyed by air raids.

Sanitary conditions.—Animals, dead or alive, under conditions existing at the front, are a source of disease and are highly obnoxious. The tractor can not create these conditions.

Motorization of Field Artillery—75-mm. gun.—The motorization of 75-mm. guns and 155-mm. howitzers was early begun for the American Expeditionary Forces with the matériel in France. The first motorization of the 75-mm. gun was done by use of the 3-inch field gun trailers drawn by F. W. D. or Nash trucks. The 75-mm. gun regiments (French matériel) were converted in shops in France and drop-forge lunettes specially designed for the conversion of French matériel were ordered and delivered. By cutting the wooden pole furnished with the matériel and fitting the lunette with the necessary tie-rods this conversion was perfected with very little delay. The horse-drawn batteries as constituted in the summer of 1918 did not have a sufficient number of French limbers for motorization, and as a result special connecting poles had to be fabricated in France for each motorized battery until standard connecting poles were received from the United States.

Motorization of 155-mm. howitzer.—In order to convert the 155-mm. howitzer horse-drawn artillery to motor draft, the same procedure applied to the ammunition limbers as to the 75-mm. limbers referred to and all necessary matériel was early put under manufacture. The carriage limber for the 155-mm. howitzer required a special connecting pole, which in the case of the first group of howitzers was purchased from the Schneider Co.

Motorization of the 4.7-inch gun.—The 4.7-inch gun matériel arrived in France ready for motorization and no changes were necessary in the carriages, limbers, or other accessories.

Number of vehicles.—In a 75-mm. artillery regiment motorized, in accordance with the requirements of table of organization No. 30, series A, there are 264 vehicles, exclusive of the actual fighting material. These vehicles are trailers, tractors, trucks, artillery-repair

trucks, supply trucks, etc., and with the actual fighting material make a total of 393 vehicles. The fighting matériel proper for such a regiment consists of:

- 24 guns.
- 36 caissons.
- 60 limbers.
- 3 reel carts.
- 6 reel and fire-control carts.

Motor transport for one army, five corps.—The theoretical initial requirements of motor-conveyers for one army, as submitted May 11, 1918, were as follows:

Ammunition trucks -----	16,388
Artillery-repair trucks -----	815
Artillery-supply trucks -----	1,955
Equipment-repair trucks -----	124
Reconnaissance cars -----	414
Light repair trucks -----	428
Staff observation cars -----	386
Machine-gun cars -----	1,296
1-ton supply trucks -----	131
2½-ton artillery tractors -----	763
5-ton artillery tractors ¹ -----	3,468
10-ton artillery tractors -----	468
20-ton artillery tractors -----	360
3-inch field-gun trailers -----	300
3-inch antiaircraft trailers -----	260
4.7-inch antiaircraft trailers -----	40
4-ton trailers -----	368
10-ton trailers -----	450

Initial requirements.—The above estimates only include initial requirements; the motor vehicles necessary for replacements, reserves, training troops in the United States, etc., have been omitted. The motor equipment which is required in connection with the tank service has also not been included.

Repairs and replacements.—In the spring of 1918 the control bureau of the Ordnance Department decided upon the following percentages for replacements, reserves, etc., of motor equipment, and requirements were figured upon this basis:

- 25 per cent of the initial requirements as a fixed reserve in France.
- 20 per cent of the initial for repair shops.
- 8 per cent of the initial at the port of embarkation in the United States.
- 4 per cent depreciation per month.
- 10 per cent loss in overseas shipment.

¹ Substitution of tractors.—A board of officers appointed by paragraph 69, S. O. No. 242, W. D., Oct. 17, 1917, recommended on Jan. 25, 1918, the use of 5-ton artillery tractors in certain organizations in which the tables of organization called for 10-ton tractors. The 5-ton tractor will replace the 10-ton tractor in these organizations in the ratio of 2 to 1.

Repairs.—It was estimated that 10 per cent of the vehicles would be sent to the repair shops each month and that the average length of time elapsed until again in active service would be approximately two months. It was upon this basis that the above 20 per cent figure was arrived at.

Training in United States.—It was also understood that 50 per cent of the initial requirements of motor vehicles for one army would be needed for training troops in the United States.

TABLE 37.—Trucks and cars (chassis only).

Name.	Used for.	Rated load capacity (pounds).	Engine.	Over-all dimensions.			Net weight (pounds).	Maximum road speed, loaded (miles per hour).	Quantity on order or delivered.	Handbook reference.
				Length (inches).	Width (inches).	Height (inches).				
3-ton truck chassis, F. W. D., model B. and B.-1917.	Artillery repair truck, equipment repair truck, artillery supply truck, ammunition truck.	6,000	Wisconsin motor, T Hd., 36 Hp., ALAM, 4-cylinders, 4½ by 5½ inches.	210	71	84	7,308	*15	14,164	No. 1997
2-ton truck chassis, Nash model 4017, 4017A, 4017L, or 4017F.	Artillery repair truck, equipment repair truck, artillery supply truck, ammunition truck.	4,000	Buda motor, L Hd., 23.9 Hp., ALAM, 4 cylinders, 4½ by 5½ inches.	211	78½	85½	6,700	*15	16,113	1999
1-ton truck chassis, model 1918.	1-ton cargo truck; machine-gun car, Mark II.	2,000	Continental motor, L Hd., 22.5 Hp., ALAM, 4-cylinder, 4½ by 5 inches.	199	72	68	3,300	35	1,548	2012 1973
1-ton truck chassis, White model T. E. B. O.	Reconnaissance car, staff observation car, machine-gun car, Mark III.	2,000	White motor, T Hd., 45 Hp., 4-cylinder, 4½ by 6½ inches.	203	69	72	3,980	50	2,538	1973 1964 1976 1972
2-ton truck chassis, White model T. B. C.	Antiaircraft-gun truck, Mark I.	4,000	White motor, T Hd., 30 Hp., 4-cylinder, 3½ by 5½ inches.	114	74	4,100	30	51	1936
½-ton truck chassis, Dodge layout 9017.	Light repair truck	1,000	Dodge motor, L Hd., 24 Hp., 4-cylinder, 3¼ by 4½ inches.	153 ¹ ₁₆	65	62	1,725	45	1,012	2007
Truck, 3-ton, model 1918, Ordnance Department.	To replace F. W. D. and Nash chassis.	6,000	Wisconsin motor, T Hd., 36 Hp., ALAM, 4-cylinder, 4½ by 5½ inches.	223.87	84.87	107.25	9,800	*13

¹ At mud guards.² Top up.³ Governed speed.

TABLE 38.—Trucks and cars complete.

Name.	Component units.	Length.	Width.	Height.	Weight.	Number ordered or delivered.	Hand-book reference.
		<i>Inches.</i>	<i>Inches.</i>	<i>Inches.</i>	<i>Pounds.</i>		<i>No.</i>
Artillery repair truck.	Artillery repair truck body, model 1918; 3-ton truck chassis, F. W. D. model B-1917.	245	81	134	14,500	1,956	1962
Equipment repair truck.	Equipment repair truck, model 1918; 3-ton truck chassis, F. W. D. model B-1917.	245	81	134	13,550	298	1963
Light repair truck..	Light repair truck body, model 1918; 1-ton truck chassis, Dodge layout 9017.	157	72	78	2,238	800	2007
1-ton cargo truck...	1-ton cargo truck body, model 1918; 1-ton truck chassis, model 1918.	210	68	110	3,850	60	2012
Ammunition truck, 2-ton.	Ammunition truck body, model 1918; 2-ton truck chassis, Nash model 4017, 4017A, 4017L, or 4017F.	211½	64	85½	7,735	24,765	2002
Antiaircraft gun truck, Mark I.	Gun mount furnished by mobile gun carriage section; 2-ton truck chassis, White model T. B. C.	114	74	4,100	51	1936
Artillery supply truck, 3-ton.	Artillery supply truck body, model 1918; 3-ton truck chassis, F. W. D. model B-1917.	213.5	70.5	88	12,800	5,474	1997 2004
Staff observation car.	Staff observation car body, model 1918; 1-ton truck chassis, White model T. E. B. O.	204	72	90	5,840	1,475	1964
Machine-gun car, Mark II.	Machine-gun car body, model 1918; 1-ton truck chassis, model 1918.	224	70	95	4,500	1,500	1973
Reconnaissance car.	Reconnaissance car body, model 1918; 1-ton truck chassis, White model T. E. B. O.	224	70	95	5,080	1,081	1972

¹ Loaded.² Empty.³ Without top.⁴ Chassis weight only.

MOTOR TRUCKS.

3-ton truck chassis, F. W. D., models B and B-1917.—In the F. W. D. truck the application of power to the four wheels is secured by dividing the power at the subtransmission and transmitting it through propeller shafts to the front and rear axles, each of which is of the full-floating type. Inasmuch as the wheels are all used for steering as well as driving, a ball-and-socket construction is used to provide the necessary flexibility to the housing and a concentric universal joint is provided in the axle shaft to allow turning of the wheels.

Engine.—A four-cylinder Wisconsin engine of 4½-inch bore by 5½-inch stroke provided with a G-4, II edition Eisemann high-tension magneto equipped with an impulse starter and model G-3, Stromberg carburetor, is mounted on a subframe under the driver's seat and is accessible for adjustments and repairs by removing the lowered panels at the side of the seat frame. A spiral tube radiator and fan with an automatic belt tension adjustment is mounted in front of the dash. A gasoline tank of 30-gallons capacity is supported on the seat frame at the rear of the driver's seat and is provided with readily accessible shut-off and reserve lever cocks.



FIG. 167.—Ammunition truck used as a tractor for hauling field guns.

TABLE 39.—Motor trucks supplied by Ordnance Department.

Body or type of truck.	Purpose.	Chassis.	Motor.
Ammunition truck has a steel box body.	Transportation of ammunition, passengers, wireless equipment, telephone switchboards, fuel oil, water, baggage, and rations.	Bodies interchangeable on Nash 2-ton truck chassis; both chassis drive	Motor used in Nash is Buda 4-cylinder, $4\frac{1}{2}$ by $5\frac{1}{2}$ inches; motor rated at 23.9 horsepower at 1,100 revolutions per minute; motor used in F. W. D. is 4-cylinder, $4\frac{1}{2}$ by $5\frac{1}{2}$ inches, at 36 horsepower at 1,000 revolutions per minute.
Equipment repair truck has a steel body containing bins and drawers for parts and materials for repair of personal equipment, small arms, leather equipment, etc.; sewing machines for leather and canvas, and hand tools are carried.	Three of these trucks used in each mobile ordnance repair shop, for repair of personal equipment, small arms, leather equipment, etc.	on all four wheels and have speed of about 15 miles per hour; Nash chassis is being made by Nash Motors Co., Hudson Motor Car Co., National Motor Car & Vehicle Corporation; F. W. D. chassis being made by F. W. D. Auto Co., Mitchel Motors Co., Premier Motors Corporation and Kissel Motor Car Co.	
Artillery repair truck body is a complete small-arms machine shop having separate gas-motor generator which supplies power for motor-driven machine tools, which include a 9-inch lathe, a drill press, and a grinder, etc.	Issued to ammunition-train motorized artillery, and mobile ordnance repair shops for repair of artillery and motor materials.		
Artillery supply truck special steel body equipped for carrying spare parts, etc.	Takes place of old battery and store wagon; carries spare parts and supplies for artillery and motor material.		
Reconnaissance car steel body with seats for 12 men and chests for fire-control instruments.	Battery commander's car and also carries fire-control instruments.	White 1-ton truck chassis; speed 50 miles per hour, rear drive only.	4-cylinder 45-horsepower White motor, $4\frac{1}{2}$ by $6\frac{1}{2}$ inches.
Light repair truck small steel box body.	Carries carpenters', machinists', and automobile tools and supplies for emergency pair work.	Dodge commercial car chassis speed is about 40 miles per hour.	Standard Dodge engined 4-cylinder, 24 horsepower, $3\frac{1}{2}$ by $4\frac{1}{2}$ inch motor.
Staff observation car, large size, 9-passenger touring car body.	Used for transport of officers, also instruments and other special work.	White 1-ton truck chassis, 50 miles per hour, rear drive only.	4-cylinder 45-horsepower White motor, $4\frac{1}{2}$ by $6\frac{1}{2}$ inches.

Steering.—The steering column and all control levers are mounted on the right side of the driver's seat.

Clutch.—The clutch, consisting of 11 steel and 12 bronze V-notched disks running in oil, is bolted to the flywheel as a unit and is provided with a clutch brake.

Transmission.—Although cast in one piece, the transmission is made of two sections divided by a cast web to permit a difference in oil levels of these sections. The forward section contains a constant mesh type three-speed transmission gear set, gear shifting being accomplished by shifting dog clutches between the different gears. Power is taken from the main transmission shaft in the rear section through a link belt silent chain drive to the subtransmission, which consists of a large chain spur gear inclosing a hand locking bevel gear differential, in which are mounted the jack shafts which drive the front and rear propeller shafts through universal joints.

Brakes.—On the cross channel supporting the rear of the transmission, the service brake is mounted, which consists of a drum supported by the brake skein on two roller bearings, and connected to the transmission shaft by a combined cap and shaft (bolted to the brake drum) and a shaft collar. As this brake acts directly on the

main shaft, braking effort is distributed through the subtransmission differential to all four wheels.

Emergency brakes of the external contracting type acting on the rear wheels are controlled from the seat through an equalized lever control.

Axles.—Both axles are of the bevel gear drive, full floating type, the rear axle being of standard construction, the front provided with wheel spindles mounted on a ball-and-socket joint, which incloses the universal joint connection of the live axle shaft.

Chassis.—The truck frame is mounted on semielliptic front springs and platform rear springs, which perform the additional function of absorbing all driving stresses. Wheels are all cast steel and are either of the spoke or disk types. Standard Ordnance transoms and Ordnance pintles in special housings are mounted on all F. W. D. chassis.

Truck, 3-ton, model of 1918, Ordnance Department.—This truck chassis is of the four-wheel drive, two-wheel-steer type, and has a load capacity of 3 tons, with a load distribution of 45 per cent on the front axle and 55 per cent on the rear. This truck has been designed and developed by the Ordnance Department with a view to securing units and assemblies that have been demonstrated as efficient and simple, as well as to eliminate defects already shown in existing types. The aim has been to make the component parts, wherever possible, the same as parts now in use by the Ordnance Department, or by other departments in France, or in course of production. This is being done in order to simplify the repair and spare parts problem, and has been so successfully worked out that at least 75 per cent of the parts are interchangeable with parts of other vehicles in extensive use in the Army. For example, the engine selected has been used in the Ordnance truck and the transmission is employed in the Quartermaster's standard truck and new parts have been reduced in number by simplifying wherever possible. All four wheels are the same, as are the springs; and other departments of the Government, especially those using trucks of the four-wheel drive type, have been consulted in order to be sure that the standard truck will meet all needs.

Weight.—The total weight has been limited to 9,000 pounds, which is the maximum concentrated load that can be supported by temporary pontoon bridges. This conclusion was brought out by the motor-traction board in France, September 9, 1917, that vehicles assigned to divisional artillery must always accompany their units. This factor was the basis of the development of the 5-ton artillery tractor and was, therefore, also the governing consideration in the design of the four-wheel drive truck which must accompany and supply ammunition to divisional weapons.

Nature of units employed.—The following units are used in the standardized four-wheel drive truck:

Engine.....	Wisconsin.
Clutch.....	Hele-Shaw type.
Transmission.....	B type, Quartermaster.
Front seat, top, and dash.....	Signal Corps.
Differentials.....	M. & S.
Universals.....	Spicer.
Steering and control mechanisms.....	B type, Quartermaster.
Springs.....	B type, Quartermaster.

Interchangeable parts.—The following parts are interchangeable:

- All three differentials.
- All four springs with hangers and shackles.
- All nine universal joints.
- All four-wheel brakes, including drums and bands.
- Wheel brake band and transmission brake band.
- All four wheels.

Conditions to be satisfied.—The necessity of this vehicle arose on account of the available commercial four-wheel-drive trucks made in the United States not having the tractive effort to meet the conditions encountered in military service in the field, and not being entirely satisfactory in a number of respects, such as:

1. High road clearance under the axles.
2. High clearance under the driving mechanism in the center of the truck and under the extreme front end forward of the axles.
3. Great range of gear ratios to permit of 15 miles per hour road speed and maximum possible towing ability when used as a tractor.
4. Powerful brakes to meet extreme conditions of Army field service.
5. Elimination of weaknesses existing in commercial four-wheel-drive trucks now available for Government use.

Preliminary tests.—A sample truck was given preliminary tests on April 1, 2, 3, and 7, 1918. On hard road it was able to pull an F. W. D. truck and a Nash quad coupled together and exerting their combined maximum power in opposition to sample truck. On rough ground the sample truck was able to negotiate deep holes, steep terraces, and large piles of loose soil without at any time having any of the mechanism of the truck interfere with the action of the truck by striking the ground. The high clearance proved sufficient to permit the truck to negotiate most extreme conditions without difficulty. Under the same conditions the F. W. D. truck was entirely unable to operate.

Service test.—The sample truck was finally mired completely in heavy clay loam soil, together with the F. W. D. truck. Under these conditions the sample truck was able to revolve all four wheels, although two of the wheels were buried to a depth of 3 feet in the

ground. The F. W. D. was unable to revolve its wheels, although they were only embedded a maximum of 18 inches.

Results of tests.—Under the conditions of these various extreme tests, the sample truck at all times showed reserve motor power and strength in the various component parts. The power ratio was apparently ideal between the engine and wheels, whereas the commercial trucks under the same conditions were working at the limit of their engine power, as their power ratio was not sufficient to transmit the power from the engine to the wheels without causing excessive vibration.

Standardization.—As far as possible, standard units were incorporated in the construction of this truck and tractor. The Quartermaster class B transmission is used, also the Quartermaster class B steering gear. The motors are of the Wisconsin type and are in large production. Repairs for this motor are the same as now being supplied for the F. W. D. trucks in service.

Interchangeability of gears.—Arrangements are made in the transmission to permit of changing this truck from a comparatively high-speed, load-carrying vehicle for good road service to a heavy-duty tractor for rough field service by the interchanging of two gears. This change can be made with the tool equipment carried on each truck.

Two-ton truck chassis, Nash, model 4017 F. and L.—The Nash chassis is a four-wheel drive type of chassis. This chassis is intended to be used for all artillery purposes calling for a 2-ton truck. In general it is intended to use the Nash truck in positions closest to the line and the larger size truck—namely, the 3-ton—in artillery service further to the rear. The Nash 2-ton truck chassis is used in 75-mm. regiments (motorized), 4.7-inch gun regiments, 6-inch howitzer regiments, antiaircraft batteries, and divisional ammunition trains.

Power plant.—The engine used in this truck is a 30-horsepower Buda, having a bore and stroke of $4\frac{1}{2}$ by $5\frac{1}{2}$ inches. Improved Stromberg carburetor and Eisemann high-tension magneto, model G-4, II edition, with impulse starter, are fitted to the motor. Lubrication is combined force feed and splash. Water circulation is by pump. The cylinders are cast on block and are of the L-head type. Maximum speed is controlled by a Simplex governor.

Transmission.—The transmission is of the selective type, having four speeds forward and one reverse. Gears are constantly in mesh, and the various gear combinations are obtained by enmeshing jaws which are disposed on the gear hubs. This method of selecting gears prevents stripping of gear teeth by an improper manipulation of the gear-shaft lever.

Axles.—Power is delivered to the front and rear wheels by axle shafts, with drive pinions which enmesh with internal gears in

the wheels. Suitable universal joints are provided in the shafts, which permit the turning of the wheels for steering. In the older models of Nash trucks the steering was effected by turning all four wheels. The rear wheel steer has now been done away with, and it is expected that steering effort will be much less than heretofore. The trucks will also be more readily handled by the average driver, who is generally accustomed to driving a motor vehicle which steers on two wheels only.

Transoms.—Each Nash chassis has mounted upon its frame a series of cross transoms, which are adapted to form an interchangeable support for any of the bodies which are used by the Ordnance Department upon four-wheel driven chassis. Bodies of one type can be removed and replaced by another without alterations or machine work. The more important of these bodies are the artillery repair truck, equipment repair truck, artillery supply truck, and ammunition truck.

Speed of truck.—The Nash chassis is governed to a maximum road speed of 15 miles per hour when on high gear, and may average 10 miles per hour when fully loaded and driven over fair roads.

Staff observation car.—The staff observation car was built for the purpose of supplying a sturdy, serviceable car for staff use in artillery headquarters work, strongly constructed to stand up under rough use. It consists of a special steel seven-passenger touring-car body, with an arrangement of auxiliary seats so as to accommodate nine men. The body of the staff observation car is mounted on a 1-ton White truck chassis capable of developing 50 miles per hour with full load.

Operation and function.—Due to the staunch construction of this car, it can be used over very rough roads at high speeds, and it is very easy to handle.

Body and equipment.—The body of this car is of sheet-steel construction, following out the usual arrangement as to seats in seven-passenger touring cars, except that three persons are seated on each of the two regular seats, and on the auxiliary seat which is in two parts. A foot warmer, utilizing the exhaust, is attached to the heel board in front of the rear seat. There is a collapsible table carried in a compartment built in the floor of the tonneau, which easily can be erected for field work. A pocket extends across the back of the front seat, and a compartment is built in the floor between the two auxiliary seats for the purpose of carrying maps and papers. Boxes are secured to either side of the car, and two chests are carried on the rear, which are used for carrying necessary tools and equipment, all of which are easily accessible and in no way obstruct the doors of the tonneau. The body is fitted with a demountable top and a wind shield. Secured to the body are

artillery vehicle-equipment tools for emergency road work. The body load carried by this car consists principally of fire-control instruments.

Chassis and equipment.—The chassis is a White 1-ton truck chassis, with a 4-cylinder 45-horsepower White engine, 4½ by 6¾ inches. The tires are 36 by 6 inches, and one spare tire is carried on each vehicle. The chassis is equipped with necessary tools for minor repairs and adjustments. This car is equipped with a Leece-Neville electric lighting and starting system.

Reconnaissance car.—The reconnaissance car consists of a steel body mounted on a 1-ton White truck chassis capable of developing 50 miles per hour under full load. The body of this car is arranged with seats for 12 men and suitable compartments in which to carry necessary fire-control instruments.

Operation and function.—This car is of very rugged construction, easy to operate, and well able to negotiate bad roads at high speeds when necessary. These cars are supplied to battery commanders of motorized batteries for reconnaissance work.

Body and arrangement.—The body of this car is of sheet steel construction, built up in three sections, in order to facilitate production and assemblage. It is equipped with a semi-removable top, to which are fastened the storm curtains, and which joins the wind shield. The body contains four cross seats easily accommodating 12 men. Compartments for carrying apparatus are built in the body, utilizing available space under and between the seats, there being a large compartment under the rear seat, with doors opening to the rear, and two small compartments on either side of this compartment with doors opening on the sides. Another compartment is built in over these compartments just described, and just between the rear seat and the third seat, and its door opens on the right side of the body. Over this compartment is a rack in which to carry rifles. Under the seat in the rear of the driver's seat is still another compartment with doors opening on either side of the car. The load carried by the body consists of fire-control instruments necessary for reconnaissance work, which are carried in trays in the various compartments. The body of the car is equipped with artillery vehicle equipment tools for the purpose of emergency work on the road, these being shown in the plate on the opposite page.

Chassis, motor, tires, and equipment.—The chassis is a White 1-ton truck chassis, with a four-cylinder 45-horsepower White engine 4½ by 6¾ inches. The tires used on this chassis are 36 by 6 inches. The chassis is equipped with necessary tools for minor repairs and adjustments, etc., and carries one spare tire. A heater utilizing the exhaust is attached to front head board of center compartment for winter use. The lighting system consists of two oil headlights and oil tail light, and a Solar searchlight with gas generator.

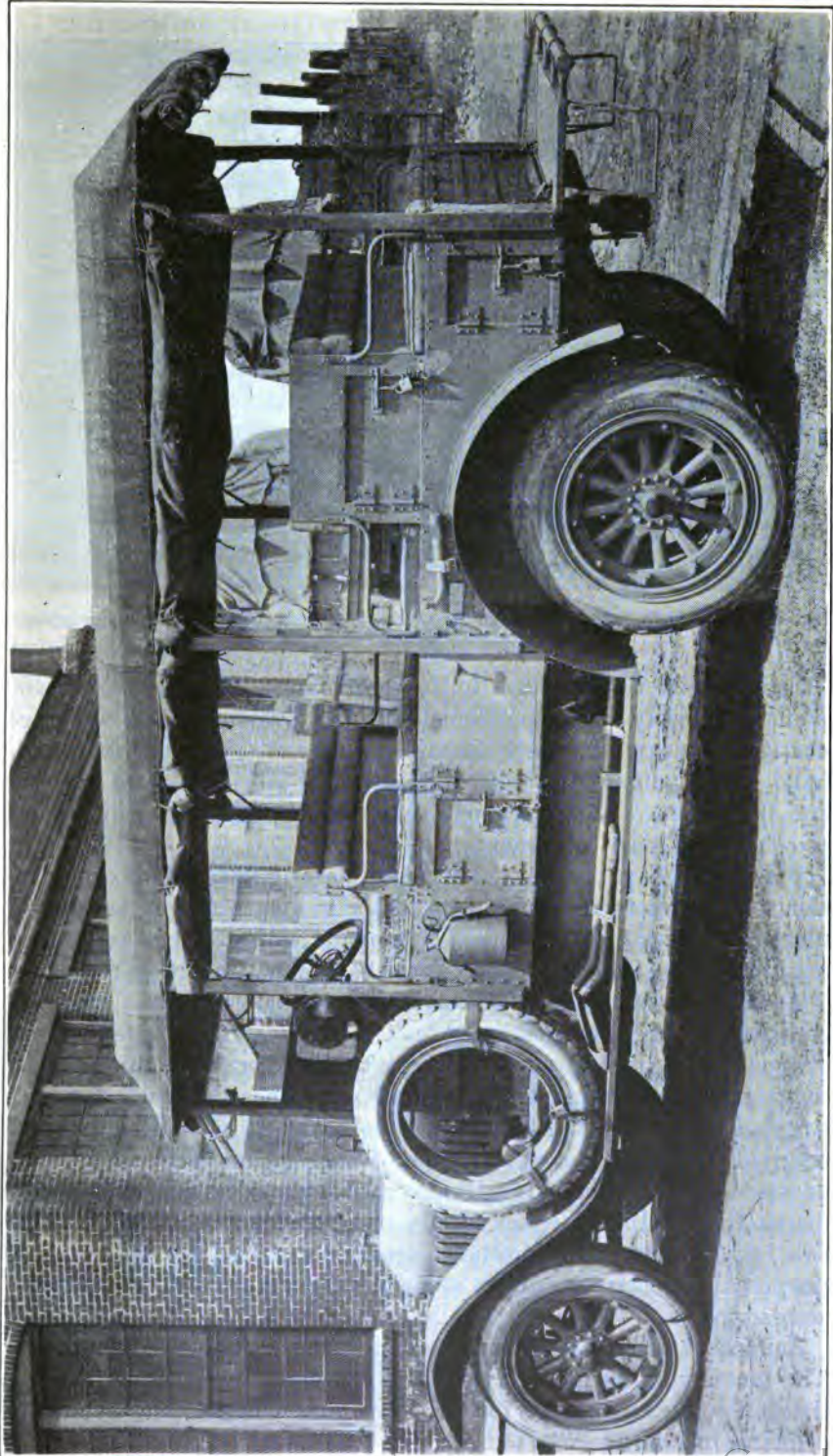

FIG. 166.—Reconnaissance an.1 machine gun car, model 1918, 1-ton truck chassis.



FIG. 100.—Light repair truck on $\frac{1}{2}$ -ton chassis. The type illustrated was later supplanted by an improved model.

Light repair truck.—The light repair truck weighs about 2,400 pounds, consists of a small steel box body, mounted on a Dodge chassis. It carries chests containing carpenter's and machinist's hand tools, automobile tools and supplies, lubricants and greases, and is used for light emergency repairing and general utility work possible with such equipment.

Use.—The above truck is furnished according to tables of organization to heavy motorized regiments, motorized machine-gun battalions, mobile ordnance repair shops, ammunition trains, Corps and Army artillery parks, and the trench mortar battalion attached to the corps.

Ammunition truck.—The ammunition truck illustrated on page 364 consists of a steel body mounted on a four-wheel drive type of truck chassis. It is issued to organizations to transport ammunition, passengers, wireless equipment, telephones, switchboards, fuel, oil, water, baggage, and rations. The body is so designed as to accommodate original packing boxes of any type of ammunition with a minimum of waste space. This body will also conveniently carry five 55-gallon drums for gasoline or water supply. In general it is intended to use this body wherever the ordnance truck is required for heavy cargo purposes. Each truck carries its own special equipment of tools and accessories.

Equipment for care, maintenance, and repair of ordnance matériel.—The motor equipment section of the engineering division furnishes the following equipment for the care, maintenance, and repair of ordnance matériel:

1. An artillery repair truck and its complementary vehicle, an artillery supply truck, attached to each battalion of motorized artillery.

2. A mobile ordnance repair shop, consisting of three artillery repair, three equipment repair, and six artillery supply, three ammunition, and two light repair trucks, one of the shops being attached to each division.

3. A heavy artillery mobile repair shop, consisting of two sections of 35 vehicles each, and two vehicles attached to the shop headquarters; one of these shops being attached to each brigade of 6-inch guns and heavy howitzers of Army artillery.

4. A light repair truck is also furnished, which is attached to such organizations as the motorized machine-gun battalion and the anti-aircraft machine-gun battalion. This truck is used for repairs of a decidedly minor nature and for other general utility purposes.

Repair vehicles.—To give an idea of the extensiveness of the provisions made for the repair of the ordnance matériel in France, a list of the ordnance-repair vehicles required for one army of 30 divisions is given herewith:

Artillery supply trucks, carrying loads, A, B, B-1, C, D, and E.....	1,887
Artillery repair trucks.....	983
Equipment repair trucks.....	126
Light repair trucks.....	424
11½ heavy artillery mobile repair shops, consisting of 23 sections of 35 vehicles each, or.....	805

Repair shop equipment.—The mobile ordnance repair shop and the heavy artillery mobile ordnance repair shop conform to items O-2 and O-202 of Gen. Pershing's American Expeditionary Forces ordnance project, and the organization of these shops is given in tables of organization Nos. 41 and 228, respectively.

Equipment repair truck.—The equipment repair truck consists of a series of steel chests, cabinets, and drawers, mounted on a four-wheel drive type of truck chassis. The equipment consists of cabinet "M" for tools, for machine-gun repairs, cabinet "A" for tools for repairing small arms, cabinet "L" for saddlery repair, and cabinet "P" for personal equipment repairs. There are two sewing machines carried on the truck, one suitable for canvas and one especially designed for sewing leather, such as harness and other leather articles. There are four vises and one hand-operated emery-wheel grinder mounted on workbench; one complete set of carpenter's tools and one set of saddler's tools are also carried on this truck.

Use.—The equipment repair truck is attached to the mobile shops, these trucks being assigned to each division and corps shops, and two of these trucks are assigned to each heavy artillery mobile repair shop, as per tables of organization.



FIG. 170.—Equipment repair truck for making minor repairs of small arms, machine guns, harness, and personal equipment.

Artillery repair truck.—The artillery repair truck consists of a small machine shop mounted on a four-wheel drive type of truck chassis. The equipment consists of a 9-inch motor-driven lathe, bench type, with milling and gear cutting attachment; a 14-inch motor-driven drill press; 12-inch motor-driven emery-wheel grinder; portable electric drill; oxy-acetylene welding and cutting apparatus; electric motor-driven air compressor, with air reserve tank; pneumatic riveting hammer; blacksmith outfit, including standard ordnance blacksmith forge and a complete assortment of necessary tools to repair artillery matériel and motor vehicles. The electric power for operating the motors on the machine tools and also for lighting purposes is supplied by a 4-kilowatt generator, which is direct-connected to a 4-cylinder gasoline engine and mounted on the floor of the truck. This truck is always accompanied by an artillery supply truck, load "D," which carries bar stock and raw materials for use in making repairs. The artillery supply truck is referred to and illustrated on pages 376 and 377.

Use.—The artillery repair truck is supplied to motorized artillery organizations, ammunition trains, corps and Army artillery parks, railway mounted artillery regiments, mobile ordnance repair shops,

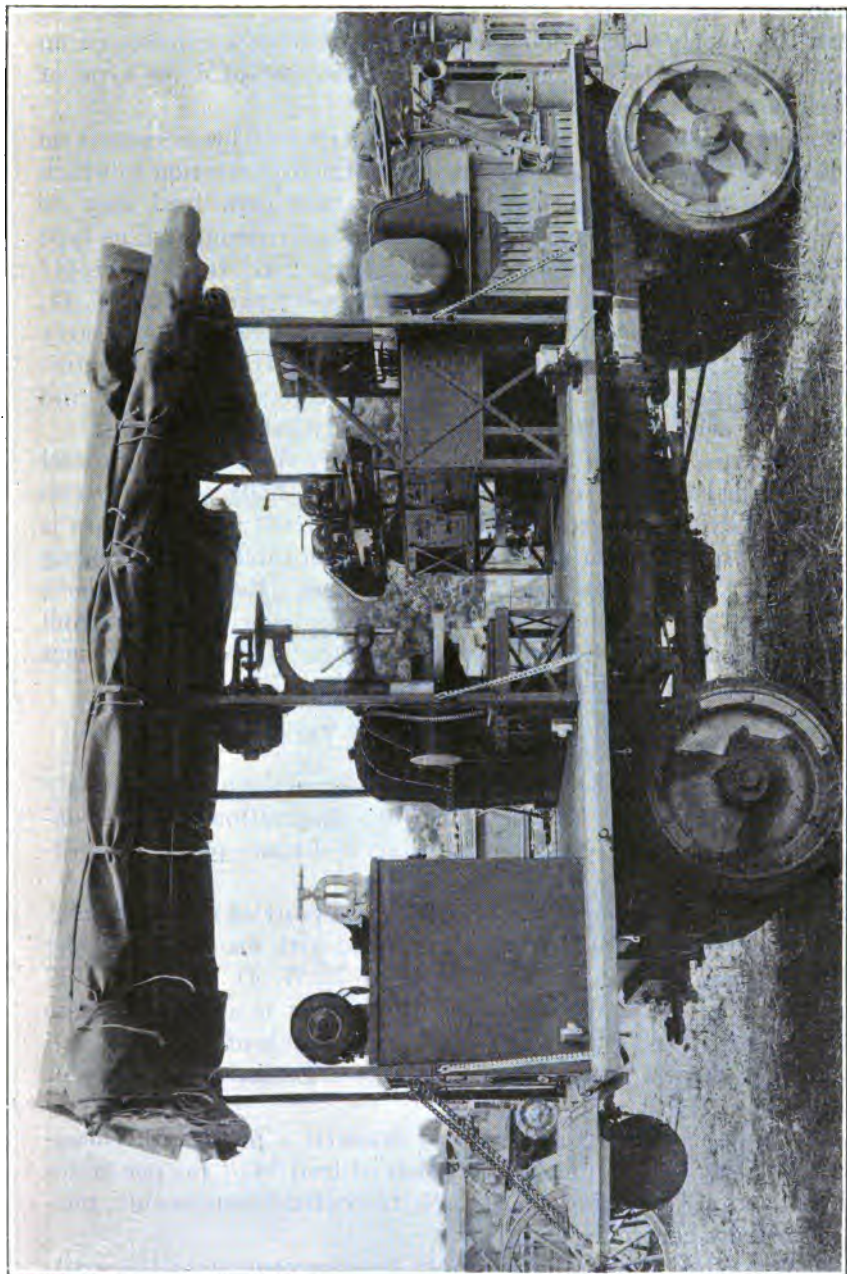

FIG. 171.—Artillery repair truck.

and the trench mortar battalion in the corps, as per tables of organization.

Artillery supply truck.—The artillery supply truck consists of an especially designed body, mounted on a four-wheel drive type of truck chassis of either 2 or 3 ton capacity.

Types of loads.—There are five different types of loads carried on the artillery supply truck, depending upon the organization to which the supply truck is attached. In order that each load may be readily distinguished, these trucks are familiarly designated as type "A" truck assigned to motorized batteries, type "B" truck to supply companies of motorized regiments to carry spare parts of F. W. D., "B-1" assigned to supply companies of motorized regiments to carry supply parts for Nash, type "C" to headquarters company of motorized regiments, type "D" truck to artillery repair truck, and type "E" truck or tool truck to heavy artillery batteries.

Chests carried.—In the rear of the steel body there is a large steel cabinet, called a bench chest. Under floor of body there are two steel floor boxes. Between bench chests and front of body there is carried any combination of the following removable chests: Spring chest, supply chest, forge chest, and fluid chest. Each of the above loads carries its own chests. These chests provide economical and portable storage space for the various kinds of small equipment which this truck carries.

USE OF ARTILLERY SUPPLY TRUCK.

Load A.—When attached to motorized batteries the artillery supply truck carries load "A" (as per tables of organization), which consists of cleaning and preserving materials and spare parts for artillery matériel.

Load B.—When serving with the supply company of motorized regiments the artillery supply truck is equipped with load "B" (as per tables of organization), which consists of F. W. D. model B-1917 spare parts, when the organizations of which it is a part comprise F. W. D. chassis, and with load "B-1" (as per table of organization), Nash motor vehicle spare parts, when the organization consists of Nash chassis.

Load C.—When the artillery supply truck is a part of the headquarters company the equipment consists of load "C" (as per tables of organization), covering spare parts for optical instruments, telephone, and fire-control apparatus.

Load D.—When the artillery supply truck accompanies the artillery repair truck, it is equipped with load "D" (as per tables of organization), which consists of raw material and bar stock for use in making necessary repairs in gun material.

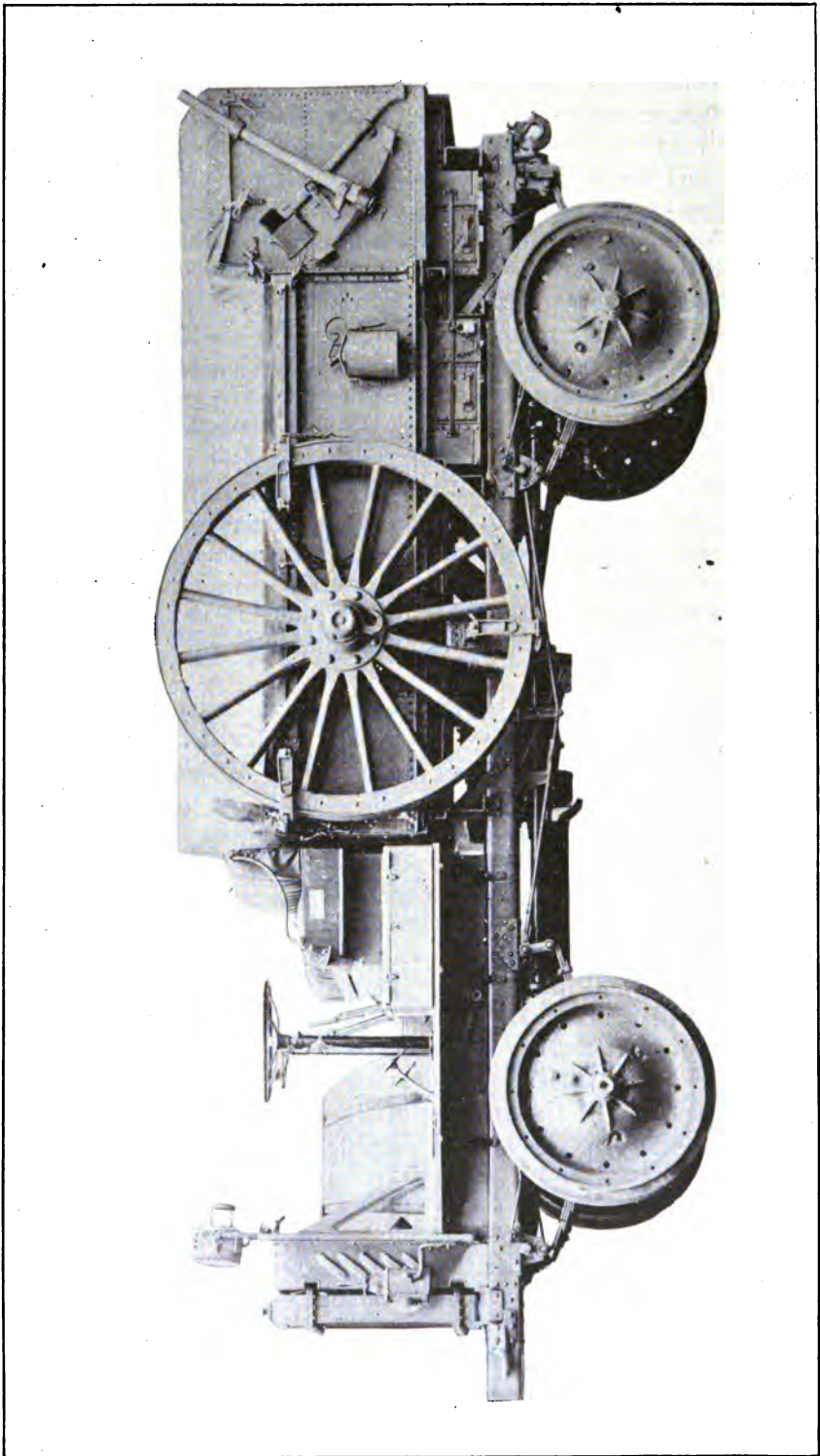

FIG. 172.—Artillery supply truck with equipment in place and spare wheel in position.

Load E (for heavy batteries).—In the 5-inch and 6-inch converted seacoast 155-mm. gun, 8-inch, 9.2-inch, and 240-mm. howitzer battery mobile ordnance repair shop, there is supplied an artillery supply truck with load "E" (as per tables of organization) and sometimes known as tool truck, which consists of tools and accessories pertaining to heavy gun and howitzer material, heavy spare parts (assemblies) for motor vehicles and supplies in bulk, such as large cans of grease, drums of oil, etc.

Organizations supplied.—The artillery supply truck is furnished to all motorized artillery regiments, trench mortar units, antiaircraft battalions, ammunition trains, corps and artillery parks, mobile ordnance repair shops, and railway mounted artillery regiments.

Heavy artillery mobile repair shops.—Definite equipment of small shops for divisional ordnance depots was prescribed as far back as 1908 and about 20 depots placed in store for war service. In 1916, during the border troubles, it became evident that the shops should be mobile, and the divisional mobile repair shop finally was developed in the summer of 1917, after the fullest consideration of the experiences on the border and conditions likely to be encountered. The equipment not only was of the best, but permitted any repairs possible in a small shop.

Special trailer.—A special trailer was needed to carry most of the heavy machine tools and heavy equipment. After determining the size and style of this trailer, work on the design of same was begun the latter part of December. A large quantity of machine tools, small tools, and special equipment was needed to equip the shops, and lists and specifications of the same were prepared. Purchase orders for all the heavy material, on which considerable manufacturing time was required, were placed in the early part of January, 1918.

The trucks used in connection with these shops (each truck of which is used to pull one of the trailers) are the F. W. D. model B-1917, on which are mounted the standard artillery repair and supply or ammunition truck bodies. The artillery repair bodies are used on all F. W. D. trucks in the heavy artillery mobile repair shop, with the exception of the raw materials truck, which is mounted with an artillery supply body, and the tank truck, which is mounted with an ammunition body. The artillery repair bodies were manufactured at the American Car & Foundry Co. for the artillery repair shops, and it therefore required merely a continuation of production of this type of body in order to equip the great majority of these trucks for use with the heavy artillery mobile shops.

Equipment and arrangement of a repair section.—By July 1, 1918, material had been ordered for a total of 24 heavy artillery mobile repair shops, each shop composed of two sections, the sections being duplicates in equipment. The following is a brief outline of the arrangement of each section:

One 3-ton truck, F. W. D. model, fitted up with complete gasoline engine-driven two-cylinder air-compressor unit and complete equipment of pneumatic tools, such as riveters, hammers, drills, and grinders.

One 3-ton truck, F. W. D. model, fitted up as tool-room truck, containing complete set of chests and drawers to carry full complement of small tools, such as drills, precision instruments, reamers, tool holders, and different machine-tool attachments; also a key-bitting machine, two-wheel high-speed bench grinder, and one combination tool and cutter grinder.

One 3-ton truck, F. W. D. model, to carry a 24-inch circular-saw table. This will rip wooden beams 8 inches square. Also one heavy automobile arbor press, large enough to press hubs into wheels or any other work of that nature.

Six 3-ton trucks, F. W. D. model, fitted up to carry all heavy or bulky spare parts, or complete assemblies, such as motors, transmission, etc.

Two 3-ton trucks, F. W. D. model, to be used to carry personal baggage for the personnel of the shop.

One 3-ton truck, F. W. D. model, to be fitted up as an office.

NOTE.—All of the trucks mentioned in the above list are fitted with the standard artillery repair body.

One 3-ton truck, F. W. D. model, to be fitted up as per the standard equipment repair truck, with full complement of tools and equipment as used in that truck.

One 3-ton truck, F. W. D. model, to be fitted with the ammunition-type body, to be used for carrying gasoline and oil in drums.

One 3-ton truck, F. W. D. model, supply truck, type "D."

One 1-ton delivery truck.

Four-ton trailer.—The 4-ton trailer, which has been designed and developed by the engineering division of the Ordnance Department, weighs about 4,500 pounds without any equipment and has a wheel base of 13 feet.

Body.—There is mounted on each trailer a rectangular body of the following dimensions—19 feet 4 inches inside length and 7 feet 1 inch inside width. The sides, front, and tailboards are 30 inches in height, mounted on hinges, so that they may be dropped and used as a platform when operating equipment. The sides and front and rear tailboards are made of United States 10-gauge sheet steel, which are lowered level to the floor of the trailer and are used as platforms for operating the equipment which is carried on each trailer.

Top.—Each trailer has an adjustable top. When top is lowered the distance from floor of trailer to top is 5 feet 8½ inches. When top is in raised position the distance from floor to top is 6 feet 11½ inches. Each trailer is supplied with canvas cover and is wired for electric lights.

Use.—The 4-ton trailer has been especially designed for carrying the machine-tool equipment used in the heavy artillery mobile repair shops. There are 13 of these trailers used to make up one unit of the heavy artillery mobile repair shops, and the equipment is divided as per the following list:

One trailer, equipped with No. 2-A Brown & Sharp motor-driven universal milling machine, one 9-inch Seneca Falls motor-driven bench lathe, one 6-inch

Dalton motor-driven bench lathe, and one Langeller motor-driven bench-type sensitive drill press.

One trailer, equipped with 16-inch Gould & Eberhardt motor-driven shaper and one 22½-inch Barnes motor-driven drill press.

One trailer, equipped with 18-inch by 10-foot Lodge & Shipley motor-driven engine lathe and one small Greenerd arbor press.

One trailer, equipped with two direct connected gasoline engine driven generators, each of 15 kilowatt capacity. Generators, Allis-Chalmers D. C. 110-volt compound type. Gasoline engines, type A, Wisconsin, 4 cylinder.

One trailer, equipped with Davis Bournonville oxy-acetylene welding and cutting apparatus, oxygen tanks, and a 50-pound low-pressure acetylene generator. Also complete electric arc welding outfit. Also to contain a complete blacksmith equipment.

Six trailers, to be used as parts stock rooms. Three of these trailers will be arranged with a complete set of standard adjustable steel bins for carrying small parts, and two trailers will be fitted with a plain body containing no bins in order that large and heavy stock can be carried and arranged on wooden racks built to meet the special demands of the shop, and one equipped with bar stock rack and hack saw for carrying bar stock of all kinds, also pipe and sheet metal.

One trailer, to be used with plain body, for carrying heavy baggage, such as tents, rations, etc.

One kitchen trailer, of the standard quartermaster type, is also to be provided.

In addition to the above-named trucks and trailers, with their equipment of machinery and tools, there will also be provided one seven-passenger touring car, three motorcycles with side cars, and one monomotorcycle.

In addition to the above machines, a full and complete set of small tools, portable air drills, portable electric drills, portable air and electric grinders, pneumatic riveters, etc., is also included, so that the widest possible range of repairs and replacements can be effected.

Four-ton trailer crane.—The 4-ton trailer crane, used for mounting and dismounting gun barrels from carriages and for wrecking purposes, consists of a 4-ton crane trailer mounted on a 10-ton trailer chassis, model 1918. This crane has been tested carefully and it handles easily its rated load. It is capable of lifting four tons a radius of 8 feet. The crane is equipped with an outrigger to prevent tipping of the trailer sideways when the boom is swung off the axis of the trailer.

When the trailer crane is transported the boom is held in place by two steel cables. It has been recommended that this crane be used for service in each tractor unit in addition to being scheduled for service in heavy mobile ordnance repair shop. With the increased weights of mobile artillery and the tanks and tractors of modern war, such a machine became highly essential, particularly for mounting and dismounting cannon from the carriages on which they were fired and transferring them to and from their transport vehicles. That such a device was essential indicates the weight of modern mobile matériel.

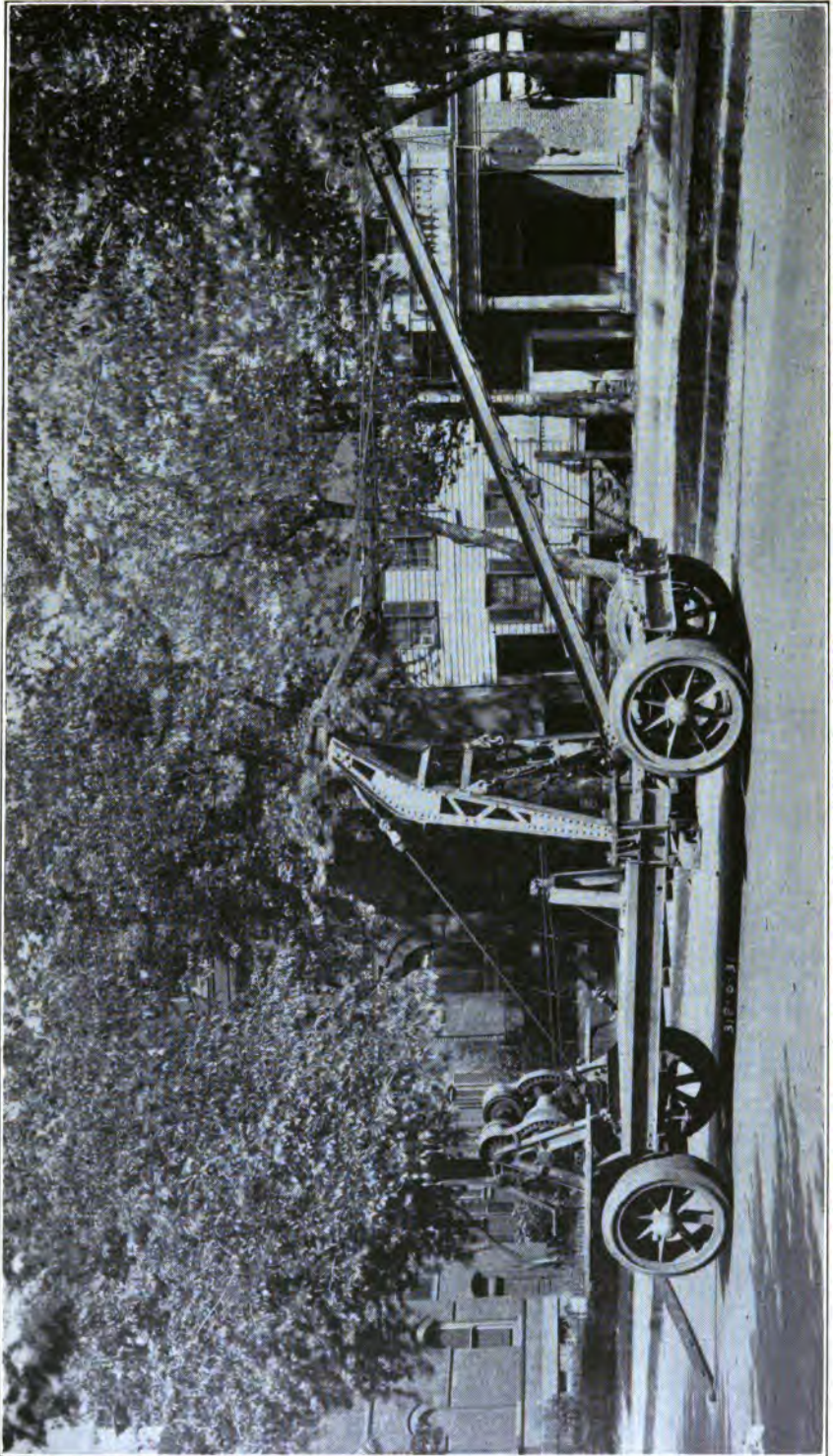

Fig. 173.—4-ton crane trailer mounted on 10-ton trailer chassis, model 1918.

TABLE 40.—Trailers and trailer chassis.

Name.	Component units.	Capacity.	Length.	Width.	Height.	Weight.	Number ordered or delivered.	Hand-book reference.
		<i>Tons.</i>	<i>Inches.</i>	<i>Inches.</i>	<i>Inches.</i>	<i>Pounds.</i>		
3-inch field-gun trailer, model 1918.	3-inch field-gun trailer body, model 1918.	3					830	1974
	3-ton trailer chassis		175	90½	26	4,700		
3-ton antiaircraft trailer, model 1918.	One unit only	5½	206			3,800	612	2008
4-ton shop trailer, model 1918.	Machine-shop trailer body, model 1918.	4	236	89	131½		576	1975
	4-ton shop trailer chassis model 1918.							
10-ton trailer, model 1918.	10-ton trailer chassis, model 1918.	10	210	91	30	9,300	540	2011
	10-ton trailer body, model 1918.			91	36	500		
Antiaircraft-gun trailer, improvised model 1917.	1½-ton trailer chassis, model 1917.	1½	126	68	43	1,750	150	
	Antiaircraft trailer body, model 1917.							
3-ton trailer	Cargo trailer body	3						
	3-ton trailer chassis		175	90½	26	4,700		
Antiaircraft machine-gun trailer, model 1918.	1½-ton trailer chassis, model 1917.	1½	126	68	43	1,675	2,139	1980
	Antiaircraft machine-gun trailer body, model 1918.							
4-ton trailer crane	4-ton crane, trailer mount, model 1918.	4	210	91	119	12,000		1981
	10-ton trailer chassis, model 1918.	10						

Trailer chassis.

Name.	Used for—	Length.	Width.	Height.	Weight.	Capacity.	Hand-book reference.
		<i>Inches.</i>	<i>Inches.</i>	<i>Inches.</i>	<i>Pounds.</i>	<i>Tons.</i>	
4-ton shop chassis, model 1918.	4-ton shop trailer, model 1918; heavy artillery mobile rep. shop trailers:	232	85	42½		4	1981
10-ton trailer chassis, model 1918.	10-ton trailer, model 1918.	210	91	30	9,300	10	2011
1½-ton trailer chassis, model 1918.	4-ton trailer crane						1981
	Antiaircraft gun trailer, improvised model 1917.	120	67½	31	1,956	1½	1980
	Antiaircraft machine gun trailer, model 1918.						
3-ton trailer chassis, model 1918.	3-inch field-gun trailer, model 1918.	175	90½	26	4,700	3	1974
	3-ton trailer						

¹ Complete.

² Body and chassis.

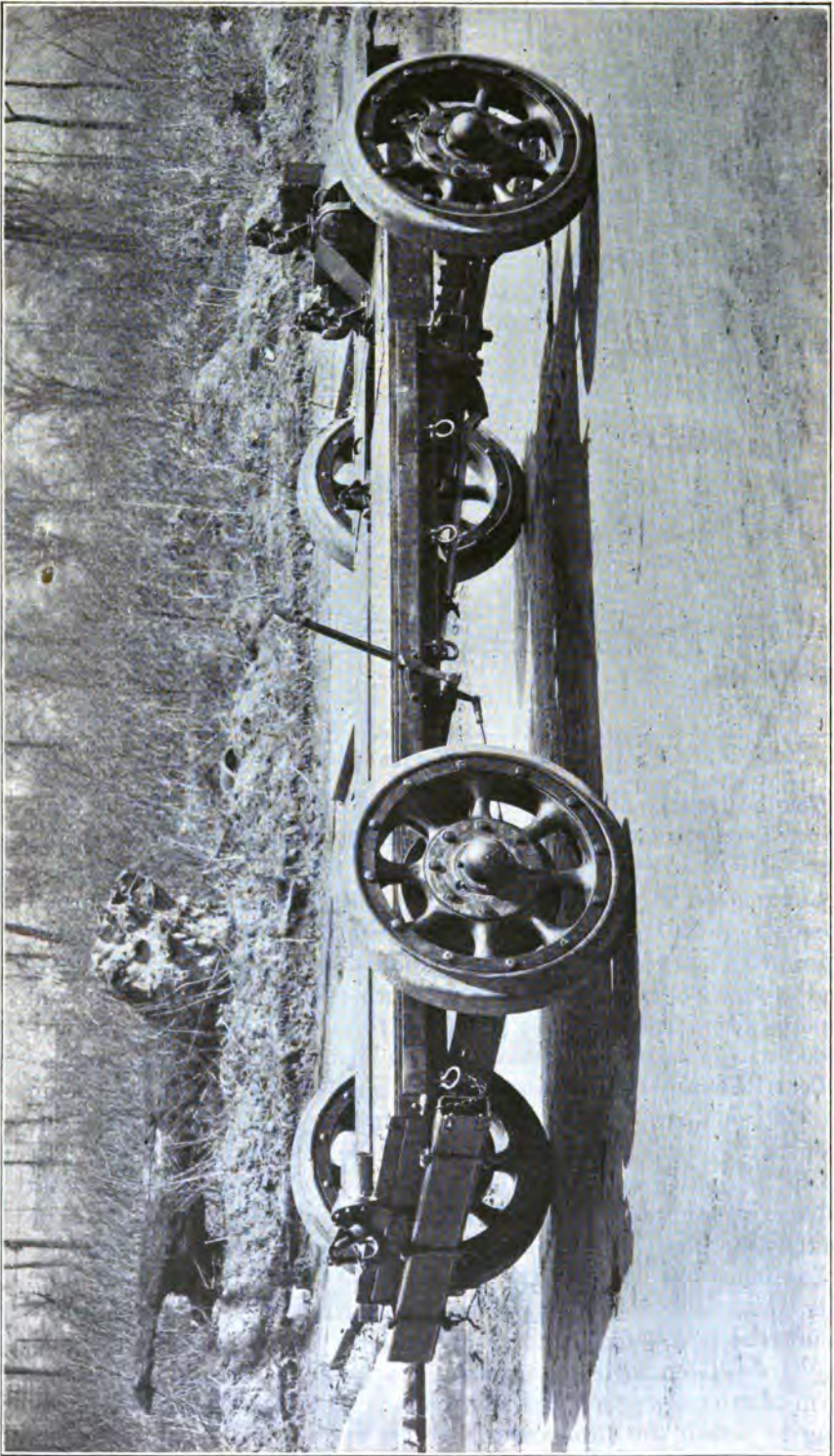

FIG. 174.—3-inch field gun trailer, model 1918, on 3-ton trailer chassis.

Three-inch field-gun trailer.—The 3-inch field-gun trailer, weighing about 4,700 pounds, is so designed that the 75-mm. or 3-inch field gun matériel may be easily loaded upon it and transported at high speed behind motor trucks without injuring the matériel. Two pintles are mounted on the forward end of the trailer in such a position as to properly accommodate the lunettes of the gun carriage and caisson. Suitable brakes operated by a single hand lever are provided.

After the guns are placed, the trailers are available for bringing up ammunition for which are provided side and end boards forming a body 10 inches deep.

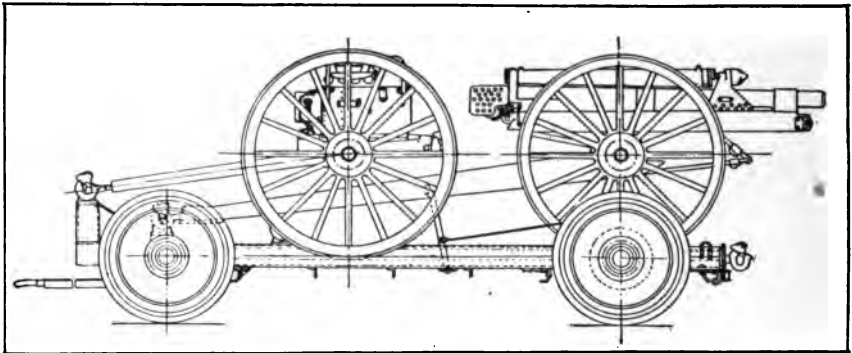

FIG. 175.—3-inch field gun trailer.

Ten-ton trailer.—The 10-ton trailer has been designed by the Ordnance Department for transporting the 5-ton artillery tractor, and especially the 6-ton U. S. tank, model 1917, in order that these vehicles may be transported more rapidly than their own normal speeds permit, thereby greatly increasing mobility. The frame is equipped at its rear end with the standard trailer pintle and housing, and at the front end it is equipped with the standard drawbar and lunette. In addition to the plain platform body this trailer is provided with a stake and removable side board body 36 inches high.

Construction.—The 10-ton trailer is simple in construction, being built up on a pair of channel bars, spring supported at each end. The front axle is the steering axle while the rear axle is fixed. The trailer is carried on metal wheels provided with 36 by 10 inch solid rubber pressed-on tires. A brake of the internal expanding type on the rear wheels is operated by a hand lever from the front end.

Loading.—For loading the 6-ton U. S. tank, model of 1917, on this trailer is furnished a pair of loading ramps, built up of heavy channel section sufficient to carry the load of the 6-ton tractor, and they are wide enough to permit the tractor to be run up on the platform of the trailer under its own power. The platform is sufficiently long to permit the 6-ton tractor to rest upon it without interfering.

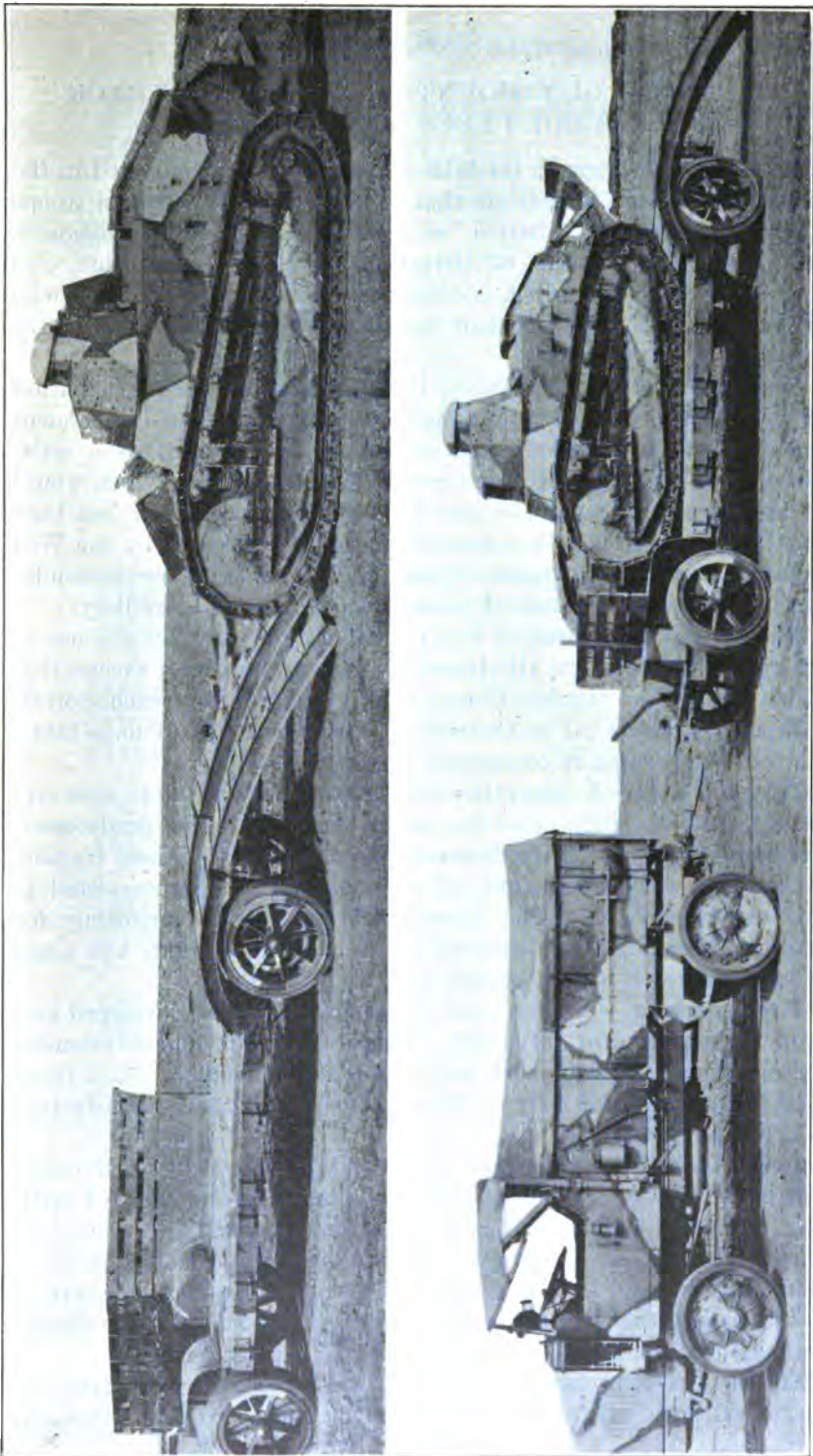

FIG. 176.—10-ton trailer, model 1918, with ramps for loading 6-ton tank, model 1917
Ammunition truck used as tractor to haul 10-ton trailer.

TRACTORS, GUN MOUNTS, AND TANKS—TRACK-LAYING TYPES OF VEHICLES.

Transport of artillery in the field.—The operations conducted in the recent war seemed to indicate that the advance of successful troops when in attack is limited to comparatively short distances, due to the impossibility of advancing artillery, ammunition, and supplies over ground which is often full of shell holes and otherwise difficult to cross with sufficient rapidity to keep up with Infantry troops.

Development of tractors.—Since the beginning of the participation of the United States in the recent war the Ordnance Department has devoted considerable attention to the development of a satisfactory tractor, primarily for use with Field Artillery, which would be able to negotiate almost any kind of terrain. Work has been done in cooperation with a continuing board appointed by the War Department for the purpose of studying and making recommendations upon the application of motor traction to Field Artillery.

The present equipment of Field Artillery provides for the use of caterpillar tractors for all classes of adapted artillery, except that which has railway mounts, 75-mm. equipment, and the trench mortar.

Types of tractors.—The Ordnance Department has to date taken the following action in connection with this problem:

Ten-ton tractor.—A caterpillar tractor, weighing about 10 tons and having approximately twice the power and speed of its predecessor, has been developed. Five thousand three hundred of these tractors were under manufacture and all of them were to be completed in 1918 or early in 1919. The 10-ton tractor is intended primarily for artillery breaking into loads of about 10 tons weight, but alone or in tandem will handle heavier weights.

Five-ton tractor.—A 5-ton tractor has similarly been developed and production started in July, 1918. This tractor is primarily intended for divisional artillery, such as the 155-mm. howitzer. Nine thousand six hundred and fifty of these tractors were under manufacture in the autumn of 1918.

Two-and-a-half-ton high-speed tractor.—A 2½-ton high-speed caterpillar tractor was developed for hauling the reels and carts of artillery regiments or similar loads requiring crossing bad ground at considerable speed. Orders were placed for approximately 3,800 of these tractors, and as a large number of the parts were standard it was expected that deliveries would be continuous. It is believed that this tractor is suitable for handling 75-mm. matériel.

Trucks.—In compliance with approved proceedings of artillery boards all cargo-carrying trucks attached to motorized batteries and

TABLE 41.—Artillery tractors.

Name.	Length over all armored (inches).	Width armored (inches).	Height to top of muffler (inches).	Length of ground contact (inches).	Road speed minimum and maximum (miles per hour).	Weight with full equipment (pounds).	Engine.	Number in process of construction or shipped Aug. 25, 1918.	Handbook reference (number).
Artillery tractor, 2½-ton, model 1913.....	105.5	56	62	42	2 - 12	6,200	Cadillac motor, L head, V type, 75 horsepower, 8-cylinder, 3½ by 5½ inches.	3,786	2,009
Artillery tractor, 5-ton, model 1917.....	133.5	63	72.5	91	1.94 - 7.37	9,200	Valve in head, 56 horsepower, 4-cylinder, 4½ by 6 inches.	9,650	1,996
Artillery tractor, 10-ton, model 1917.....	162	84	96	96	1.47 - 5.59	21,500	Holt motor, valve in head, 55 horsepower, 4-cylinder, 6½ by 7 inches.	5,302	2,003
Artillery tractor, 15-ton, model, 75 horsepower, Holt.	240	104	1120	75	2.125- 3	25,200	Holt motor, valve in head, 75 horsepower, 4-cylinder, 7½ by 8 inches.	269	2,005
Artillery tractor, 20-ton, model 120 horsepower, Holt.	252	104	1120	75	2.3 - 3.27	207 00	Holt motor, L head, 120 horsepower, 6-cylinder, 7½ by 8 inches.	1,347	2,006
Artillery wheeled tractor, model 1918.....	223.87	84.87	107.25	1.6 - 12.25	10,500	T head, 35 horsepower A.L.A.M., 4-cylinder, 4½ by 5½ inches.	1,979

1 Height with canopy.

2 Top up.

3 Empty.

ammunition trains are of the four-wheel-drive type, and the Ordnance Department planned to have approximately 28,000 of such trucks completed by December 31, 1918. These trucks will not, of course, traverse ground that vehicles of the caterpillar type will cross, but have much more mobility off the roads than the ordinary rear-wheel-drive truck, and if assigned to the organizations for which originally intended should facilitate the advance of the artillery by supplementing the efforts of the caterpillar-type vehicles.

Three-ton caterpillar trailer.—A caterpillar-type trailer of about 3 tons capacity has been extensively experimented with and samples have been built. This type of trailer has not met with great favor in the past, but many of the troubles were due to poor construction. It should be definitely determined whether this type of vehicle is useful for hauling ammunition and supplies when pulled by a caterpillar tractor.

Gun sleds.—Experiments have been made with large sledges resembling the ordinary stone boat for carrying heavy guns or supplies, the sledges being towed by any available tanks or tractors. A sledge suitable for carrying a 155-mm. Filloux gun or 8-inch howitzer has been built. These artillery sleds are approximately 8½ feet wide and 15 long, built of sheet and channel iron, with a deck.

Caterpillar tracks.—Experimental caterpillar tracks for replacing the wheels of gun carriages have been experimented with and sample sets have been made.

Eight-inch howitzer—240-mm. howitzer caterpillar.—A self-propelled mounting with an 8-inch howitzer thereon has been constructed and sufficient tests made to indicate the practicability of mounting guns of medium power on such mountings. A similar mount for a 240-mm. howitzer or gun of similar power built almost completely of parts identical with those used in one model of tank has been prepared, and, in view of previous experience, it is believed this mount will prove reasonably successful. Drawings of a gas-electric propelled caterpillar gun mount made by the St. Chamond Co. were sent to the United States, and necessary changes in the drawings to enable manufacture to be undertaken in the United States were made. Vehicles of this type, either for use as gun mounts or for cargo-carrying purposes, however, require considerable time for their construction.

Ford tank.—A small tank driven by two Ford engines, using a great many other standard parts and capable of rapid production, has been tested. This vehicle was primarily designed as a tank to meet the possible demand for a great number of light tanks to supplement the types that have been adopted. It is not known what the future of this vehicle will be, but the possibilities of rapid pro-



FIG. 177.—8-inch howitzer on self-propelled tractor, Mark I.

duction indicate that it should be considered in any program for rapidly advancing an army over country that has been subjected to the effects of modern warfare.

Caterpillar attachments for trucks.—Extensive experiments have been made with caterpillar attachments to replace the wheels of trucks, and it is possible that there is a place for attachments of this type. In general, the results have not been as successful as hoped for, the reason being that important structural changes are necessary in the case of most existing trucks; the increased mobility over that of the four-wheel-drive type of truck is not so great as might be anticipated, and the bearings in the rollers are subjected to such high pressures that their life is short.

Needs of cross-country mechanical transport.—In this connection it is interesting to note the following extract from the minutes of the meeting on June 5, 1918, of the inter-allied tank committee.

General Capper explained that the British commanders were convinced that in order to make a rapid advance the forces must be supplied with some sort of cross-country mechanical transport. Experience had shown that an advance was generally brought to a standstill owing to want of supplies. The importance of having some arrangement to get wheeled transport across country was fully recognized. It was thought that the general question of the supply of cross-country mechanical transport was closely connected with the question of fighting tanks. Gen. Estienne had then rightly remarked that this was a question which belonged to the artillery. But he would point out that all these questions relating to the carriage of infantry and carriage of munitions, supplies, etc., were closely connected, and the more uniform the type of vehicle obtained, the better it would be. He was convinced that no army could be complete, no army could exploit with success, unless it was made independent of roads.

TRACTORS.

Two-and-one-half-ton artillery tractor, model 1918.—The $2\frac{1}{2}$ -ton artillery tractor which has been developed by the Ordnance Department is a caterpillar type of tractor, weighing about 5,810 pounds. It has a range of speed from 2 to 12 miles per hour under normal motor speeds. The tractor should normally be run at 7 to 8 miles per hour, but when greater speed is necessitated the tractor may be run at 12 miles per hour for short duration of time over fairly smooth ground. Protection is secured against shrapnel and splinters of shell fragments by the provision of $\frac{1}{4}$ -inch armor over motor, radiator, and reserve gasoline tank. The tractor is most satisfactory at high speeds for a caterpillar type, and runs fairly quietly. The track extends sufficiently forward to enable tractor to climb steep banks and shell holes.

Operation.—The tractor is easy to operate, and two men ride comfortably on a spring-cushion seat without the aid of straps to hold them in place. The operator may easily crank the motor by rising

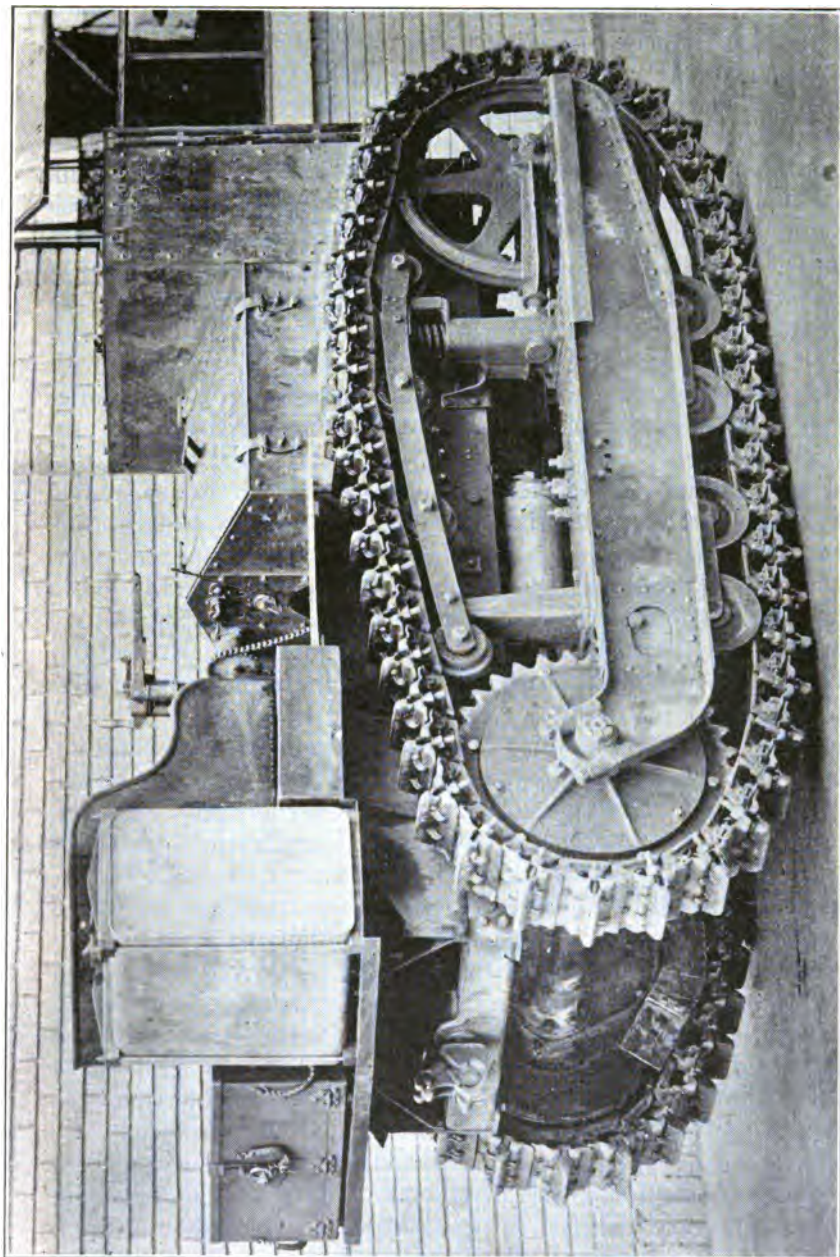

Fig. 178.—24-ton artillery tractor.

from his seat and leaning forward sufficiently to grasp a starting device handle. An emergency crank is provided for cranking motor from the front in the usual way. The tractor may be brought into place and hooked to trailed load much quicker than in the case of trucks or the larger tractors.

Description.—The main gasoline tank of 20 gallons and standard ordnance tool box are supported at rear of operator's seat. This tank is not armored. Quick detachable grousers are supplied for each track link, and may be carried when not in use in a box compartment under the driver's seat. The track link has 50 per cent surface in contact with ground and will not injure the roads when grousers are removed. The unit ground pressure when truck is sunk 3 inches in mud is 5.4 pounds per square inch. The tractor is supplied with artillery-vehicle equipment tools and oil lamps. Ordnance pintles provide quick hook-up at the rear end and towing hooks are provided at front end.

Engine.—The unit power plant, including 8-cylinder engine, clutch, and transmission, is practically the same as used in the Cadillac pleasure car, except minor changes in oiling system, carburetor, and ignition, which are necessitated to enable tractor to ascend grades of 45 degrees without loss of power. The engine is capable of developing 70 B. H. P. at a speed of 2,600 R. P. M. The standard Cadillac ignition has been replaced with a K. W. high-tension magneto with impulse starter attachment.

Use.—This tractor is supplied to brigade, regimental, and battalion headquarters of motorized artillery to pull reel and cart. Tractor will easily pull loads of 5,000 pounds. As this tractor has great mobility, sufficient power, and may readily be produced in quantities due to the number of standard parts used, it is proposed to motorize the 75-mm. gun regiments, each tractor releasing a six-horse team, and the manufacture of 5,000 units for this purpose was authorized.

Five-ton Artillery tractor, model 1917.—The 5-ton Artillery tractor which has been developed by the Ordnance Department, is a 4-cylinder caterpillar type of tractor, weighing about 9,000 pounds. It has a normal speed range of $1\frac{1}{2}$ to 6 miles per hour. The tractor should be normally run on fair roads at 5 to 6 miles per hour. Protection is secured against shrapnel and splinters of shell by the provision of a $\frac{1}{4}$ -inch armor over the engine, radiator, and reserve gasoline tank. As these pieces are employed with divisional artillery, they must be able to cross temporary pontoon bridges, where the maximum load is usually set at 9,000 pounds. This tractor is the result of extended study, experiments, and tests, and represents the most modern type of mechanical transportation for field artillery.

The tractor is easily operated and has ample room on the seat for two men to ride comfortably. An efficient starting device, easily ac-

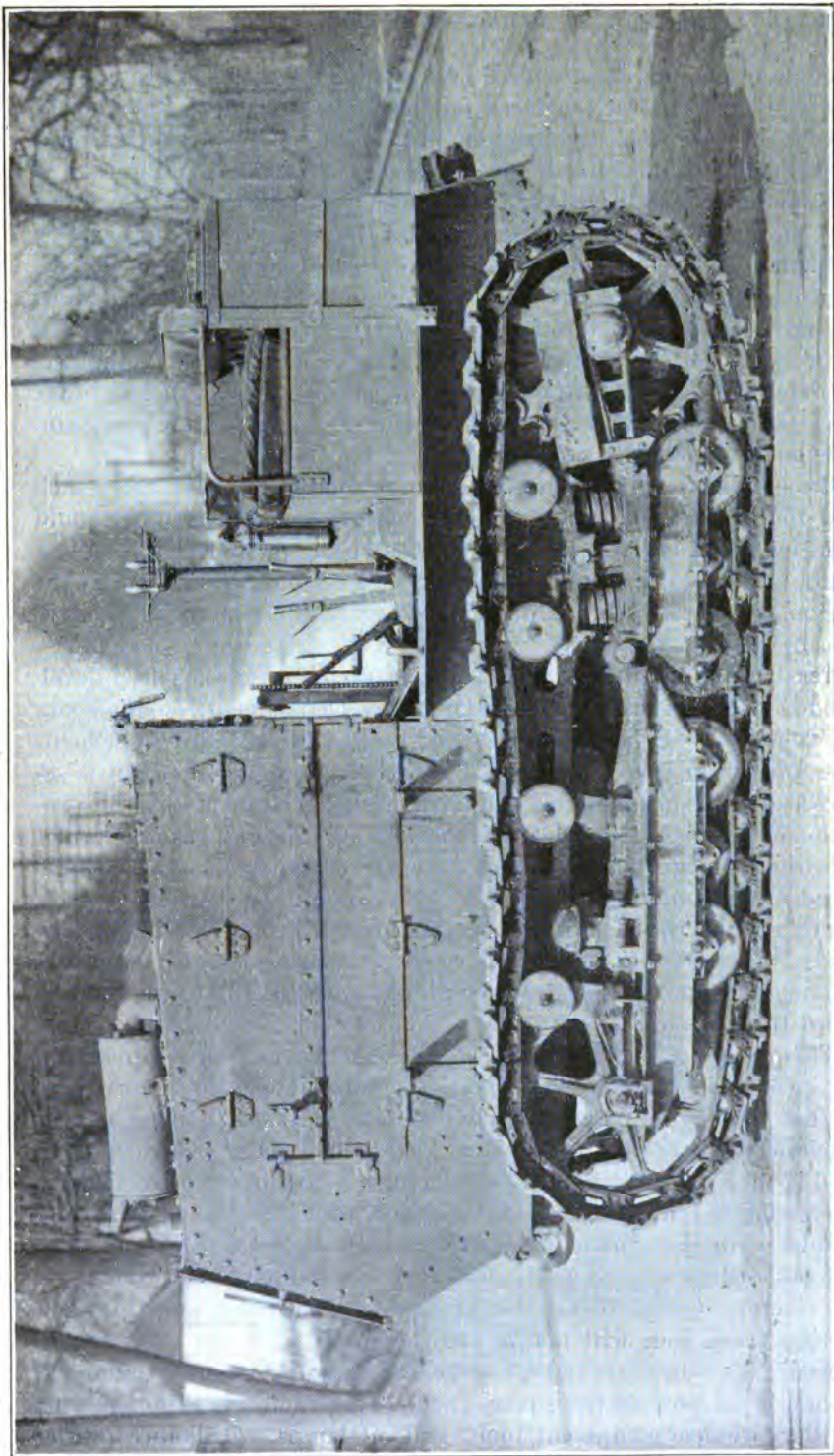

FIG. 179.—5-ton artillery tractor.

cessible to operate, is provided. An emergency crank is provided at the front. A muffler is placed on top of the armor to prevent the raising of dust when the machine is in motion. Two main gasoline tanks, and a standard ordnance tool box are supplied at the rear of the operator's seat. Neither tank is armored, and the main features are similar to those in the description of the 2½-ton tractor above.

Engine.—The engine is a 4-cylinder overhead poppet valve type designed by the Ordnance Department, and has many parts interchangeable with Quartermaster type B truck engine. It is equipped with Schebler carburetor, and Eisemann magneto with impulse-starting attachment. The engine is capable of developing 56 brake horsepower at 600 R. P. M., and efficient engine operation is obtainable on 45-degree slopes.

Use.—This tractor is employed in the motorization of the 6-inch and 155-mm. howitzers and the 4.7-inch guns. Each tractor should haul loads not exceeding 10,000 pounds, dividing some loads in sections, if necessary. It is also used as an alternate tractor to the 10-ton tractor for the 9.2-inch howitzer, two 5-ton being used in lieu of each 10-ton.

Ten-ton Artillery tractor.—The 10-ton tractor which has been developed as per specifications of the Ordnance Department, weighs about 21,500 pounds. It has a normal speed range of 1½ to 6 miles per hour. Best operating speed is about 4½ miles per hour. Protection is secured against shrapnel and splinters of shell fragments by the provision of a ¼-inch armor over the engine, radiator, and gasoline tanks. The roadability of this tractor is very flexible, due to the change-speed transmission having three forward and one reverse speeds, which enables the machine to traverse rough ground pulling heavy loads. The drive is direct connected to reduction transmission on second speed, and high speed is obtained by gearing up in the change-speed transmission.

This tractor is comparatively easy to operate and has ample room for two men on the driver's seat. A starting device is provided, so that the engine may be started without operator getting off the machine. The tractor is provided with starting bar, which may be used if the main starting device is damaged. As on the 5-ton tractor, the muffler is placed on top of the armor, which prevents the raising of dust while the tractor is in motion on a dusty road. A large gasoline tank, armored, and a standard ordnance tool box are provided on the tractor. Quick, detachable grousers are supplied, and the steel-casting track link will not injure the roads with the grousers removed. The unit ground pressure, when truck is sunk in mud 3 inches, is 6.5 pounds per square inch. The tractor is supplied with artillery vehicle equipment tools, and oil lamps. Ordnance pintles provide a connecting medium at both rear and front ends.

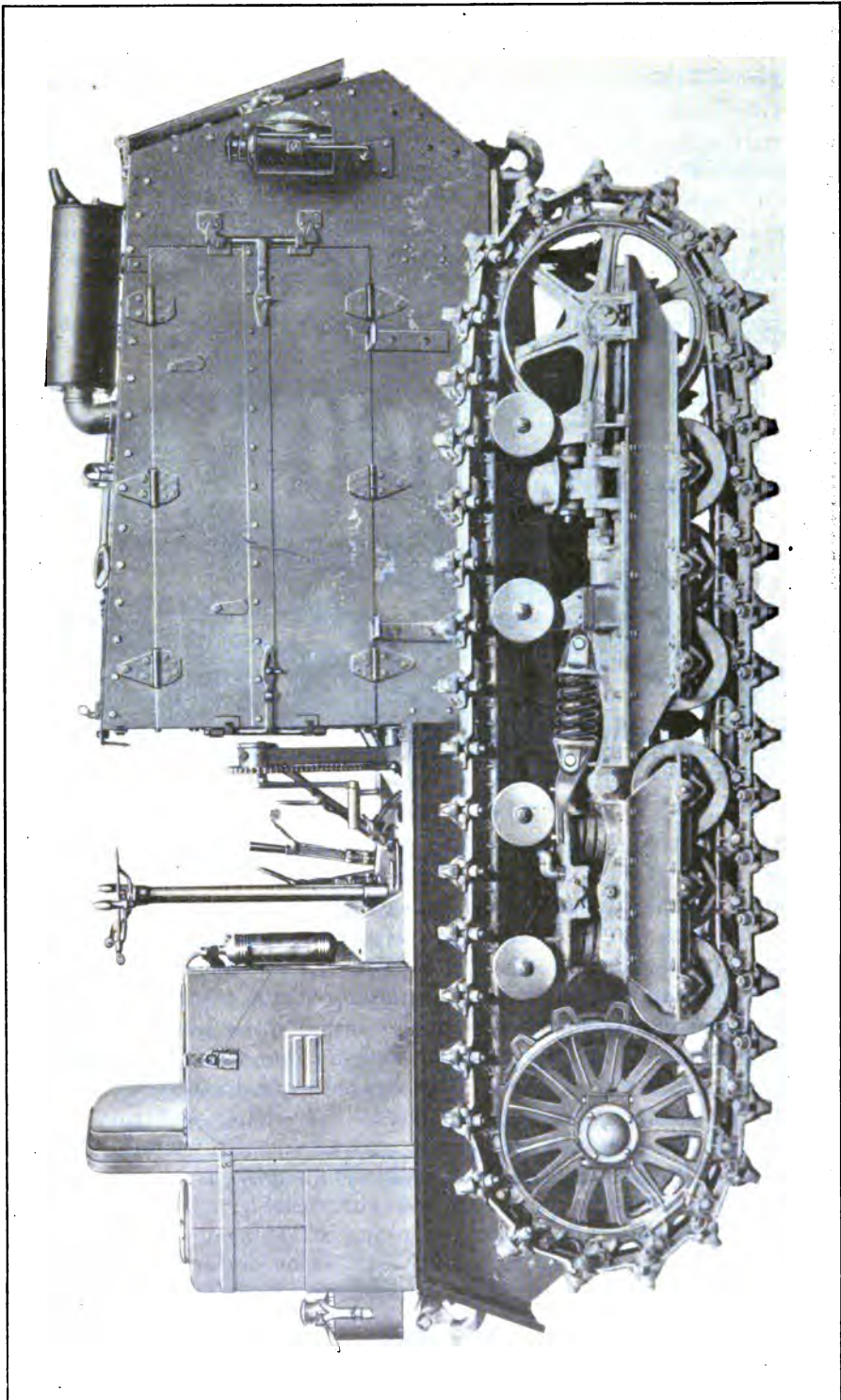

FIG. 180.—10-ton artillery tractor.

Engine.—The engine is 4-cylinder overhead valve type, developing about 75-brake horsepower at 800 revolutions per minute. It is equipped with a Kingston carburetor, a K. W. high-tension magneto, with impulse starting attachment, and Stewart vacuum fuel-feed system. Efficient engine operation is obtainable on slopes of 45 degrees.

Use.—This tractor is supplied to motorized regiments of 155-mm. guns. The tractor should pull loads of approximately 24,000 pounds. It is also used for 240-mm. and 9.2-inch howitzers, and as an alternate tractor for 5-ton with 4.7-inch gun material, one 10-ton replacing two 5-ton.

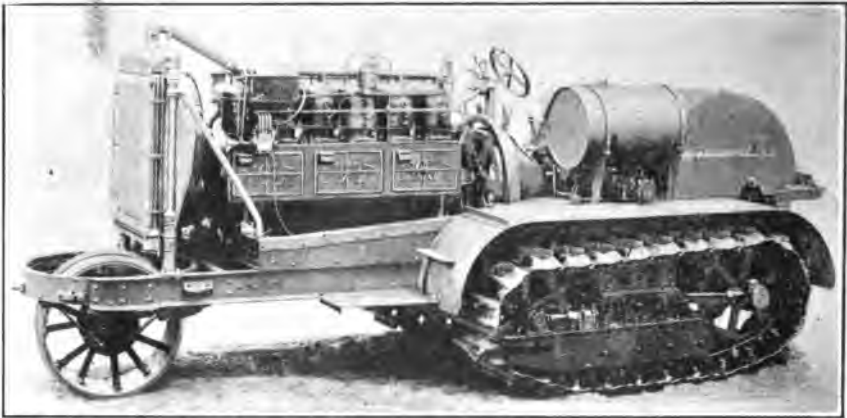

FIG. 181.—20-ton artillery tractor.

Fifteen-ton artillery tractor.—The 15-ton artillery tractor, model 75 horsepower Holt, is a 4-cylinder machine, with a speed of $3\frac{1}{2}$ miles per hour, and is employed to haul heavy field artillery. It is used in connection with the 5-inch and 6-inch converted seacoast guns, 8-inch howitzer regiments, and other large loads which do not subdivide for transportation. It is a track-laying type of tractor and weighs about 25,200 pounds. It has a normal speed range of $2\frac{1}{2}$ to $3\frac{1}{2}$ miles per hour. A 50-gallon capacity gasoline tank is furnished. Quick detachable grousers or mud cleats are supplied and may be carried in a box compartment when not in use. The track link has 50 per cent surface in contact with the ground and will not injure the roads when the grousers are removed. The engine is a 4-cylinder overhead poppet valve type, equipped with Schebler carburetor and Eisemann magneto with impulse starting attachment. It is rated at 75 horsepower. On November 17, 1917, an order for 200 of these 15-ton artillery tractors was placed with the Holt Manufacturing Company, and this was completed by the following April. Some 232 machines were shipped overseas before the signing of the armistice. This tractor was supplanted by the 20-ton tractor described on the opposite page, but that the latter is superior and more efficient was not the universal opinion in the American Expeditionary Forces.

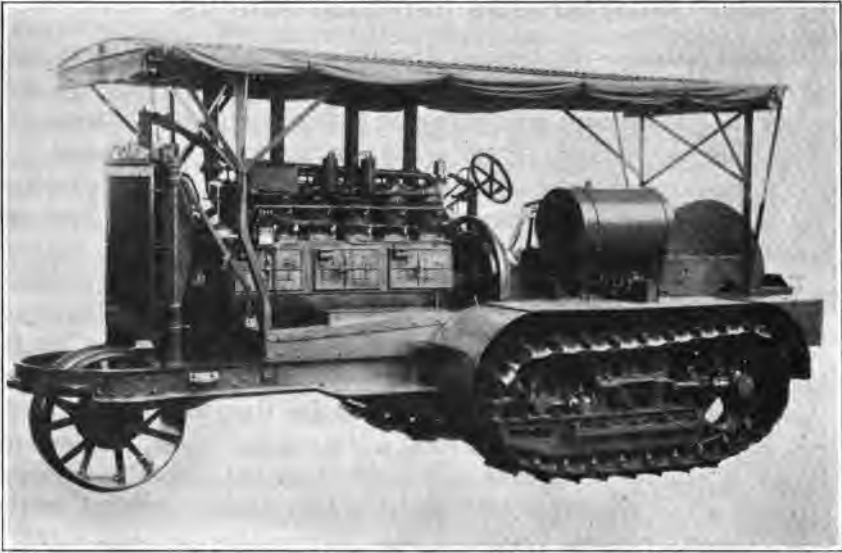

FIG. 182.—20-ton artillery tractor with cover.

Twenty-ton artillery tractor.—The 20-ton artillery tractor is a model 120 horsepower Holt, 6-cylinder tractor, with a speed of $2\frac{1}{2}$ to $3\frac{1}{2}$ miles per hour. Intended for use originally with such heavy artillery as the 8-inch howitzer, it was adopted in place of the 15-ton tractor. The engine is of the same type, but more powerful.

General description.—This tractor, which has been developed as per specifications of the Ordnance Department, weighs about 27,000 pounds, and is of the track-laying type. It is employed in the motorization of 8-inch and 9.2-inch howitzer regiments and has one reverse speed of about $1\frac{1}{2}$ miles per hour. This tractor is used for hauling exceptionally heavy loads. A 50-gallon tank is furnished, and the other elements of equipment are the same as in the smaller tractors. The track link has 50 per cent surface in contact with the ground, and will not injure the roads when grousers are removed.

United States productive capacity for tractors.—From a report on the productive capacity of the United States for ordnance material prepared in June, 1918, the following summary of the possible monthly production of tractors, with available facilities, was compiled:

Tractors.	Maximum monthly capacity.
5-ton artillery tractor, 35 horsepower.....	990
6-ton special tractor, model 1917-A.....	625
10-ton artillery tractor, 55 horsepower.....	550
15-ton artillery tractor, 75 horsepower.....	87
20-ton artillery tractor, 120 horsepower.....	43

CATERPILLAR ARTILLERY MOUNTS.

General features.—As distinct from tractors used to haul guns and howitzers of ordinary type, must be considered caterpillar mounts where the gun carriage is combined in a single unit with the track and propelling mechanism. Such arrangements have been found perfectly feasible in European experience and practice, and the principle has been adopted for a number of heavier United States guns and howitzers.

United States project for caterpillar Artillery mounts.—The program adopted in connection with caterpillar artillery involved placing orders for 50 caterpillar mounts for 8-inch howitzers thereon, 50 for 155-mm. G. P. F. gun, and 300 for 240-mm. howitzers. Studies were also made and orders were to be placed for the 194-mm. (7.6-inch) gun caterpillar. The experimental self-propelled caterpillar mounts for the 8-inch howitzer were thoroughly tested at Aberdeen Proving Ground with various tractors, and one type that underwent service tests is shown on page 389.

Weights of tractors.—The estimated weights of the above tractors are as follows:

	Pounds.
8-inch howitzer complete with gun.....	45,000
155-mm. G. P. F. complete with gun.....	45,000
240-mm. howitzer complete with gun.....	80,000

Models and motive power.—The 240-mm. howitzer caterpillar mount is so arranged that in event the total weight is too great for transportation on French railroads the howitzer can be removed, and thus bring maximum load on the single railway car within 30 tons.

With reference to the 240-mm. caterpillar, designs on self-propelled type and also electrically driven type were considered. On the self-propelled type it was decided to use the track furnished by the Holt Manufacturing Co. for their long track 20-ton tractors. The remaining caterpillar parts are to be similar to standard caterpillar construction, but heavier where necessary. Engines for this design are standard American make and of adequate power.

Three-ton caterpillar gun mount.—A 3-ton caterpillar gun mount has been designed by the motor equipment section to incorporate many parts of the 2½-ton tractor, including the complete power plant and power transmission mechanism. Its use will be to mount the 75-mm. gun and operate near the front lines, the weight and size being held to a minimum. The 8-cylinder Cadillac automobile engine as used in the 2½-ton tractor is used without alteration, while the transmission is identical with that of the 2½-ton tractor.

The track-supporting devices are of more simple construction than those of the 2½-ton tractor. Each roller is mounted on springs of limited movement to cushion them against the severe shocks of rapid travel on hard roads. The body or frame is of special design, but

very simple in construction. It is in general of a box construction, thus housing all vital parts of the power plant as a protection against shell fragments. Some light armor plate is used.

Gun.—The gun with its cradle, recoil cylinders, and elevating and traversing mechanism is used without change. A special box is provided to receive these. This box is slidably mounted to allow carrying the gun well toward the center of the vehicle during travel and well toward the rear during action to allow an unlimited accessibility for rapid firing.

Ammunition.—The vehicle will be capable of hauling a limber of about 2 tons weight when loaded with ammunition, and with or without its gun can be driven as a very efficient tractor.

Thirty-ton caterpillar gun mount.—A 30-ton caterpillar gun mount has been designed, the prominent feature of which is great simplicity. It is adequate for handling either a 155-mm. howitzer, a 220-mm. gun, a 6-inch 35-caliber gun, or 240-mm. gun, or a 6-inch 40-caliber gun. A 12-cylinder Liberty airplane engine with lowered compression and throttling governor limiting its speed is employed. The maximum horsepower under these conditions is 250, which is somewhat more than needed to handle the vehicle, thus leaving a reserve margin for emergencies. The transmission is identical with that of the Mark VIII tank, except that larger shafts are employed, and it was proposed to use as many standard parts as possible.

The track is identical with that of the Mark VIII tank, except number of shoes used. This includes all small track parts, rollers, etc., while for the track frame the general design is the same as that employed in the Mark VIII tank.

Traversing.—When in position the whole vehicle is traversed for aiming by moving one of the tracks by hand. This method is very satisfactory and accurate, as proven by the St. Chamond matériel. Approximate traversing is more convenient by power.

Recoil.—A large recoil pit is provided at the center of the vehicle. This is covered by a hinged trapdoor during loading. The carriage recoil is 26 inches. The total horizontal recoil is 72 inches. The recoil pull is about 85,000 pounds. The trunnion center is 95 inches above the ground.

Ammunition.—It is contemplated that ammunition be carried on a separate vehicle of identical construction, which will have a capacity of about 75 rounds.

220-mm. St. Chamond caterpillar Artillery.—The St. Chamond caterpillar matériel consists of two caterpillar vehicles per unit. The chassis of the two vehicles are identical in design. One functions as a gun carriage and one as a limber. Each unit is electrically driven by two motors placed in the body of the vehicle, the source of the power being a gasoline engine driven generator located in the limber. Thus

the gun carriage is dependent on the limber for electric power, and can not move without it except to be towed. The two vehicles can move together by means of a coupling bar, can operate electrically together without the coupling bar, or can move independently of each other when connected with an electric cable. Each vehicle weighs 23 tons and has track-bearing pressure of about 11 pounds per square inch. The first gun carriage of this type mounted a 220-mm. howitzer with top carriage, with brake, and a variable recoil brake on the gun. The power unit consists of a 120-horsepower 4-cylinder Panhard-Levassor gas engine, direct-connected to an 80 K. M. 400-volt direct-current generator. The limber carries 60 shells arranged on racks, one rack on each side, and carrying 30 rounds in three tiers. The space between the shell racks is occupied by the necessary powder charges and primers.

TANKS.

General features.—Combining the advantages of the protection furnished by armor with the added power of traction supplied by the caterpillar principle, the development of the so-called “tank” has been one of the noteworthy features of the war, with a corresponding effect upon battle tactics. Essentially, the tank is a large caterpillar with one or more armored compartments in which the machinery is installed and the various offensive weapons are mounted. These armored vehicles afford protection for a crew of two or more men armed with machine guns or quick-firing guns of various calibers. From the original crude machines, which early demonstrated their utility on European battlefields, various types were developed, as shown in the accompanying table. Of these the large tank of ever-increasing power and capacity and the small or two-man tank are perhaps the most conspicuous. Several types of the latter were developed, as shown by the table on page 403, and in addition to the American adaptation of the Renault or 6-ton tank, a smaller or 3-ton tank had been designed on a basis that made rapid quantity production possible.

Large tank.—The interior of the large tank is divided into two compartments by a bulkhead practically at the middle of the tank; the forward compartment is for fighting, the rear for the power plant. The forward compartment is large enough to carry sometimes as many as 15 infantrymen in addition to the fighting crew of 8 men, or it can carry 6 or 8 tons of supplies, such as ammunition or food.

Operation.—The tank is commanded by an officer located centrally in the fighting compartment with a conning tower giving all-around observation. The driving of the tank is in the hands of one man only. No more effort is required to control the tank than to control a light automobile.

TABLE 42.—Comparative data of tanks.
[From data furnished by motor equipment section, American Expeditionary Forces, Sept. 5, 1918.]

Model.	Weight (tons).	Engine (type).	Horse-power.	Transmission.	Speeds.		Ground pressure (pounds per square inch).	Armor (millimeters).	Armament.	Crew.
					No.	M. P. H.				
United States, Mark VIII tractor.	35	Liberty.....	300	Epicyclic (gear).	2	1.0 low, 5.25 high	7.5	12 sides, 16 front and back, 6 slopes.	2 6-pounder British in sprongs, 7 Hotchkiss British machine guns, 1 37-mm. on five-twelfths of tank, 1 machine gun and 1 spare on seven-twelfths of tank.	10 men and 1 officer. 2 men (driver and gunner).
United States, Ford.	6½	Buda.....	41.5	Bevel gear.....	4	0.9 first, 4.8 fourth.	6.3	16 sides, nose, and turret, 8 floor.	Proposed same as above	Do.
United States, British, Mark A, "Whippet," British, Mark B, medium.	3	Ford, 2 engines.	32	Ford.....	1	Reverse.	4.6	12.7 sides, 9.5 top, 6.3 back, 4.7 bottom.	1 2-pounder (possible), 4 machine guns, 1 2-pounder, 3 machine guns.	3 men.
British, Mark C, medium.	14	2 4-cylinder.....	106	Gear.....	4	Reverse, 1.25 low, 8.0 high.	7.0	12 sides, 6 slopes.	Do.	Do.
British, Mark IV.....	16	Daimler.....	100do.....	2	1.5 low, 7.0 high.	11.0	14 sides, 6 slopes.	4 machine guns.....	Do.
British, Mark V.....	20	Ricardo 6-cylinder.	150	Gear and epicyclic.	4	1.47 low, 7.9 high.	15	12 sides, 6 slopes.	2 6-pounders; 4 machine guns (male); 6 machine guns (female).	8 men.
British, Mark V.....	27.5	Daimler.....	105	Gear and w	4	0.9 low, 4.25 high.	15do.....do.....	Do.
British, Mark V.....	29	Ricardo.....	150	Gear.....	4	0.9 low, 4.6 high.	15do.....do.....	Do.
British, Mark 5*.....	32do.....	150	Epicyclic (gear).	4	0.9 low, 4.6 high.	10.8do.....do.....	Do.
French, St. Chamond.	1.23	Panhard, 4-cylinder.	92	Electric.....	Variable low, 7.5 high.	10.0	16 sides, 6 slopes.	1 75-mm. cannon (Standard F), 4 machine guns.	Do.
French, Renault (light).	7½	Renault, 4-cylinder.	27	Mechanical (gear) drive.	4	1.0 first, 5.0 fourth.	5.2	16 sides, 6 and 8 slopes, 16 turret.	1 37-mm. (male); 0.303 Hotchkiss gun (female).	2 men.
French, Schneider.	1.15	Schneider, 4-cylinder.	60do.....	1	Reverse.	8.9	16 sides, 6 slopes.	1 75-mm. cannon (short); 2 machine guns.	6 men.
German, Elftiede.....	35	2 Mercedes, 6-cylinder.	200	Mechanical individual tractor drive.	3	0.62 low, 4.20 high. 9½ maximum.....	8.6	30 front (untreated), 18 sides (treated).	1 87-mm. cannon Q. F., 8 machine guns (heavy).	18 men, including officer.

* Short.

1 Metric.

Sponsons.—The sponsons in which the 6-pounder guns are mounted are hung so as to swing in practically flush with the sides of the tank so that the tank can be shipped completely assembled over European railroads. A few minutes only are required to swing the sponsons into position and the machine is then in fighting trim. The Mark VIII tank, which represents the latest tank manufactured by the United States or Great Britain, is discussed in more detail in a subsequent section.

Small tank.—The design of the small tank was developed by the Renault Co. in France. This design was copied in the United States and called the 6-ton tank, model of 1917. It is built to carry two men only, with the minimum space and weight. The driver sits low down in the front of the machine and the gunner is in the revolving turret amidships.

Uses of both tanks.—The small tank is intended to follow after the large tank and to travel with and among the infantry, cleaning up trenches, dugouts, and machine-gun nests which have been overlooked by the large tank. The large tank is intended to precede infantry by smashing down wire entanglements, breaking across trenches, and reducing areas of resistance. Both types of tanks are intended to break through the enemy's lines and act as cavalry when the occasion warrants, while other tactical uses have been developed.

Steering.—Steering of both tanks is to be accomplished by holding one track while the other is being driven; and also, in the case of the big tank, by driving the two tracks at different speeds.

Fighting value.—It is conservatively estimated by English tank authorities that one of the large allied tanks is equal to 500 infantry for offensive purposes. It was estimated by the British war cabinet that to have reduced and captured an area equal to that taken at Cambrai early in 1918, according to the usual practice of preliminary bombardment, would have required 500,000 tons of projectiles. At \$250 per ton this is \$125,000,000. Taking cost of tanks at \$30,000, over 4,000 tanks could be built for the above figure, whereas only 432 were employed at Cambrai.

Equivalent in Artillery fire.—In the battle of the Aisne in October, 1917, the French expended 2,000,000 shells on an area 10,000 yards long and 500 to 600 yards deep. None of this would have been needed if a sufficient number of tanks had been available. It has been estimated by British officers that the number of man-hours required to reduce trenches and wire entanglements by means of artillery fire is 20 times the man-hours required to prepare the wire entanglements and the trench. The above facts were reasons given for an aggressive tank program which early was decided upon in various international conferences and put into execution as fast as the matériel could be supplied.

TABLE 43.—*Tanks.*

Name.	Length over all, armored.	Width, armored.	Height.	Length of ground contact.	Speed, minimum and maximum.
3-ton tank, model 1918.....	<i>Ft. in.</i> 166	<i>Ft. in.</i> 63	<i>Ft. in.</i> 64	<i>Ft. in.</i> 72	1 to 10 miles per hour.
6-ton tank, model 1917.....	187	69	90.5	79	½ to 4.85 miles per hour.
6-ton tank, Mark II.....	187	69	90.5	79	½ to 10 miles per hour.
Mark VIII tank ¹	34 2½	9	10 3	21	½ to 5.25 miles per hour.
Mark I tank.....	17 1	66		79	½ to 10 miles per hour.

Name.	Approximate weight.	Engine.	Number in process of construction or delivered.	Handbook reference.
3-ton tank, model 1918.....	<i>Pounds.</i> 6,000	2 Ford motors.....	15	In process of compilation.
6-ton tank, model 1917.....	14,500	Buda motor, L head, 32-horsepower, 4-cylinder, 4½ by 5½ inches.	1,000	No. 1995.
6-ton tank, Mark II.....	14,500	Hudson motor, L head, 60-horsepower, 6-cylinder, 3½ by 5 inches.	1	
Mark VIII tank ¹	71,680	Liberty motor, V type over head valves, 300-horsepower, 12-cylinder.	100	No. 1997.
Mark I tank.....	11,000	Hudson motor, L head, 60-horsepower, 6-cylinder.	1	

¹ Hull and armament being furnished by English Government.

MARK VIII TANK.

General nature.—The Mark VIII tank is a large or heavy type tank, which was being produced jointly by England and the United States. It was developed after the successful use of the English Mark IV and Mark V, and the original design was made by the interallied tank commission in London when the need of an offensive tank of the largest practicable dimensions became apparent. It carries more guns and men and is heavier and runs faster than any other previously made. England was furnishing the hull, armor plate, guns, ammunition, etc., while the United States provided engine, transmission, and power-transmission machinery in general.

Overall dimensions.—Mark VIII is of the rigid type; that is, the belt or track runs on rollers fixed positively in the hull. The overall length of the machine is 35 feet, the overall width for tracks is 8 feet, the overall distance across the sponsons or extreme width is 12 feet approximately, and the overall height is 10 feet 3 inches.

Armament.—Mark VIII is designed to carry two 6-pounder guns, one on either side mounted in sponsons. In addition it carries seven machine guns in ball mounts; two of the machine guns are in the forepart of the turret, one on each side of the turret, and one at the rear of the turret. A machine gun is also mounted in both doors, which are on either side of the machine amidships.

Ammunition.—Mark VIII will carry approximately 200 rounds of 6-pounder ammunition stowed in ammunition racks accessible to the

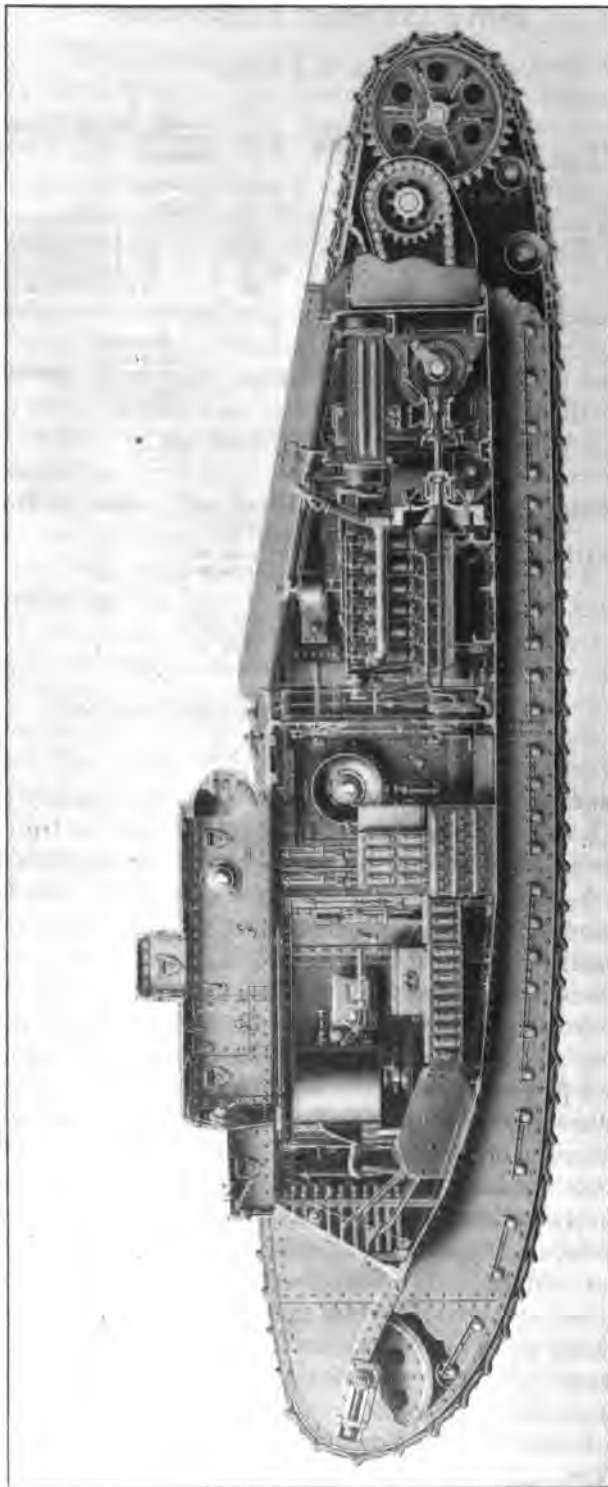

FIG. 183.—U. S. tank, Mark VIII (weight 35 tons, crew 11 men, armament 2 6-pounders, 7 machine guns).

guns, approximately 10 per cent of this being smoke shells. Of the machine-gun ammunition there is carried about 18,000 rounds.

Personnel.—The personnel carried by the machine will be 10 men and 1 officer. One of these men is the driver, who operates the machine, while the officer in command directs the movements and in addition can cooperate with other machines of the squadron from the officer's lookout, which is a small turret projecting above the main turret at the top of the tank.

Power.—The power in the Mark VIII tank is supplied by a 12-cylinder Liberty tank engine. The cooling is by a copper tube radiator mounted horizontally. Air is drawn into the engine compartment by a large 20-inch Sirocco type fan, which discharges through the radiator and out again through another armored screen.

Transmission.—The power from the engine is transmitted through a two-speed epicyclic transmission at the rear of engine compartment. Reverse speed is provided by a shifting dog which throws into operation a bevel gear located on the opposite side of the driving pinion from a forward speed bevel gear. The engine can be disconnected from the epicyclic transmission by a clutch.

Controls.—The engagement of the clutch and the shifting of the reverse dog is accomplished by levers mounted at the sides of the driver's seat, which is in the forward part of the tank. The epicyclic bands are operated by two levers, one for either side. These levers work in a gate; when in the inside of the gate a powerful spring pulls the lever and also the epicyclic gears into low speed. When levers are pushed down and outward the spring pulls the epicyclic gears and the lever into high speed, the lever on either side being independent. The track brakes are operated by one foot pedal and when both epicyclic gear levers are in neutral the foot pedal operates on both track brakes, but when epicyclic gear is driving on one side the track brake is prevented from operating on that side by a system of connecting levers in the control.

Engine room.—In the design of the machine, the engine room, which contains the engine, transmission, and all fittings incidental to driving the machine, is separate and distinct from the fighting compartment, which contains the turrets, 6-pounder guns, machine guns, and all the personnel. This is separated by a bulkhead, and ventilation is supplied by a small fan independent from the cooling fan, which throws air from the outside through the protected screens discharging into the fighting chamber. Access to the engine room is obtained through three sliding doors, one on either side of a horizontal trap-door, which gives access to the electrical connections on the engine which would otherwise be rather inaccessible because they are so close to the bulkhead. The general arrangement of the engine room as well as of the fighting compartment is indicated in figure 183.

Fire control.—Control of the machine by the commanding officer is accomplished by speaking tubes which lead to the driver and to the 6-pounder gun sponsons. In addition there is a fire-control instrument operated by the commanding officer which directs the fire to a given point for each 6-pounder gun. Cooperation with other tanks can be accomplished by means of a signaling semaphore which is mounted at the back end of the turret. In addition, a few of the tanks (one of each, perhaps) will accompany each squadron of tanks with wireless signaling apparatus of a new type adapted for use in the noise accompanying the operation of a tank.

Summary.—To sum up, Mark VIII tank is a 35-foot long machine of the rigid-hull type, weighing approximately 36 tons, carrying two 6-pounder guns and seven machine guns. It is driven by a 300-horsepower engine and a two-speed epicyclic transmission, giving a speed maximum of approximately $5\frac{1}{2}$ miles per hour on level terrain, or approximately 4 miles per hour on average going.

SIX-TON TANK.

Model.—The 6-ton tank, model 1917, is the Americanized Renault. The Renault was designed and first built by the Renault Co. in France. Four sample machines were sent to the United States, the first one arriving on December 1, 1917.

Plan.—Standard ordnance drawings were made, keeping the machine a Chinese copy of the French machine, except that all metric measurements were changed to inches and screw threads and gear teeth changed to American practice. An American engine was substituted for the Renault engine, the American engine being the Buda type H. U. with certain modifications of crank case and timing gear to fit the hull of the tractor. The 6-ton tank, Mark II, is practically the same as the model 1917, except that the 6-cylinder Hudson engine is used.

General character.—The six-ton tank, model 1917, has no wheels of any sort directly bearing on the ground, but is completely supported and propelled by two endless-chain tracks, one on each side. Each track works on a side frame called a longeron. The track runs on two wheels, one propelling it by means of the engine and the other keeping up the tension and aiding it in the return of the track. Traction is obtained by the lower part of the track being forced into the ground by the weight of the machine, which weight is supported by rollers on the back of the lower part of the track. The axles of these rollers are fixed to two rockers, called the front and rear chariots, placed inside the lower frame of the longeron.

Front chariot.—The front chariot has two trains of rollers, each train articulated to it by an axle. The forward train carries three rollers, the rear two rollers. The chariot is attached to the lower

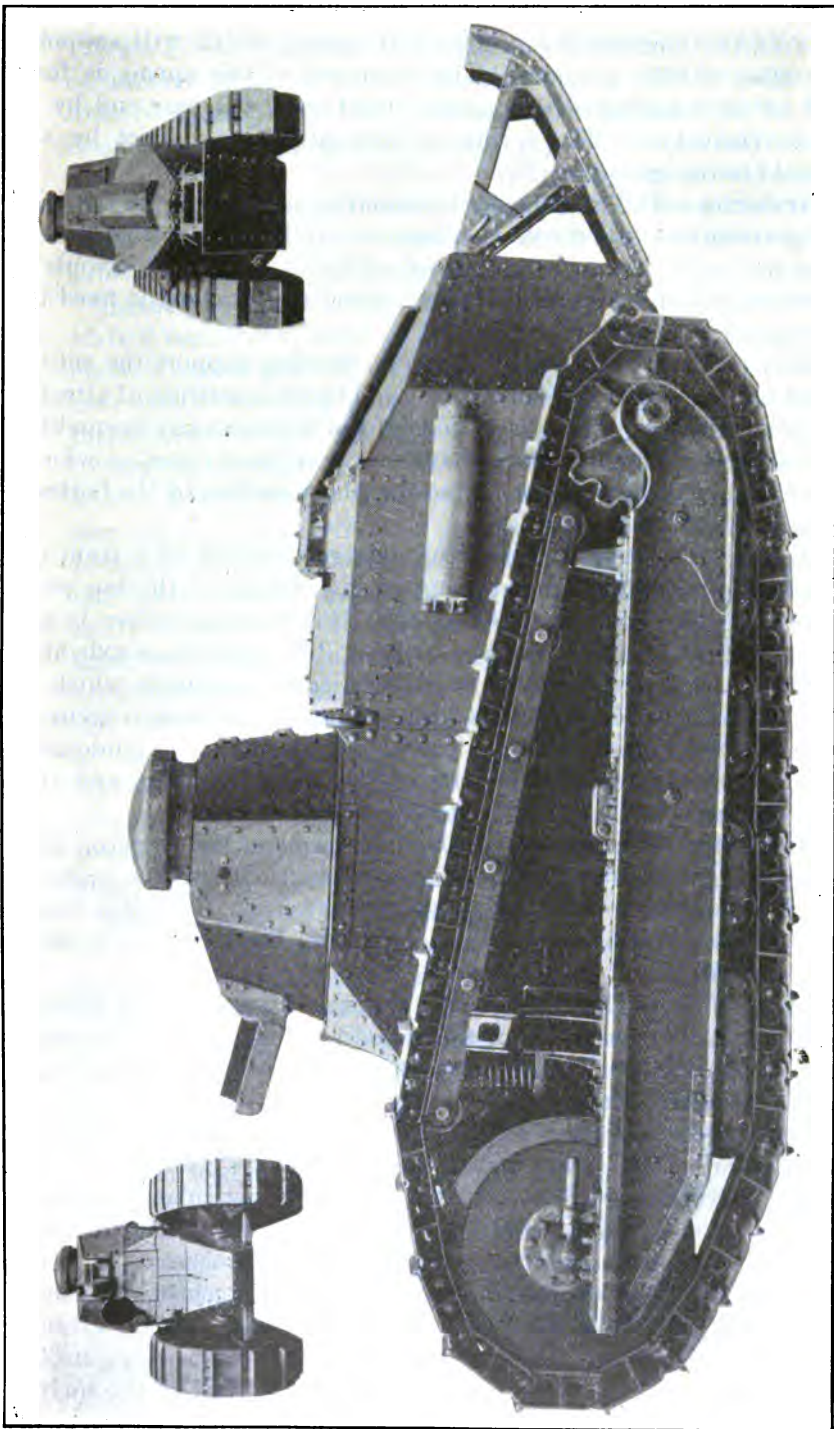

FIG. 184.—U. S. 6-ton tank.

frame of the longeron by a large leaf spring which will support 1,200 kilos (2,645.5 pounds). The front end of this spring is fastened to the longeron with an axle (fixed) and the rear end by a shackle (movable). The spring is fastened to the chariot by an axle held to the spring by clips.

Rear chariot.—The rear chariot is similar to the front, with the following exceptions: Its trains each have two rollers; its spring has 14 leaves and will sustain a weight of 1,700 kilos (3,747.8 pounds). The front end of the spring is shackled and the rear end is fixed to the longeron.

Rollers.—The nine rollers of these two chariots support the entire weight of the car, as mentioned above, and by their method of attachment allow the tread of the track to conform to almost any inequality of the ground. This is a marked advance over other types, in which the rollers are fixed permanently to the plane surface of the bottom of the car and have no springs.

Longeron.—The superframe of the longeron consists of a train of six rollers whose function is to support the weight of the top part of the chain and to insure its tension. This train of rollers is attached at its rear end to the main longeron by means of an axle and stanchion. At its front end it works vertically in a guide which is bolted to the main frame of the longeron, and its tension is secured by the action of a spiral spring placed just ahead of the guide and imprisoned between the lower end of the train of rollers and the top of the main frame of the longeron.

Tension wheel.—On the top of the main frame of the longeron and just ahead of the guide and spring above mentioned, is the support for the axle of the return pulley or tension wheel. This is a large metal disk wheel with steel shoe over which the track runs on its way to the ground.

Varying tension.—The tension of the track is permanently altered by the advance or retraction of this wheel by means of the Y or fork which holds its axle. This adjustment is made by means of an adjusting nut in the tail of the fork.

Support of chassis.—The weight of the chassis is supported by the two longerons at two points on each side.

Giving movement to track.—At the rear end the articulation is fixed by means of a dead axle which serves as the pivot for both the rear end of the longerons and the spur-gear-driven sprockets. It is by means of these sprockets that the engine gives movement to the track.

Front spring.—At the front end, the weight of the chassis is transmitted to the longerons through a large spiral spring working inside guides which allows play in a vertical plane. Fracture of the spring is prevented by means of a rubber bumper which comes into play in the case of excessive shock.

Track.—The movement of the tank is caused by two endless tracks, each about 12 inches wide with a single cross spur on each of the 32 links composing a chain. Each link is connected with the other by means of a connecting pin retained in position by a large cotter pin through each end. The whole chain is guided by the rollers and support wheels. At the rear of the longerons the chain rolls on the teeth of the sprocket, which, as above mentioned, is mounted on the dead axle at the pivot of the longeron.

Chassis and turret.—The chassis is composed of a floor of armor plate 8 mm. thick; sides of armor plate 16 mm. thick. The nose is made of armor plate 16 mm. thick. The two doors on the top of the nose open to the right and left. Above the nose rises the case of the turret surmounted by the turret. Behind the turret is the tail section containing the engine, etc. All of these parts are composed of 16-mm. armor plate. At the front end of the base of the turret are slits through which the driver can see, also a small shutter which, opening in conjunction with the doors of the nose, permits the driver to enter and leave the machine. The turret can turn through 360° and is easily moved by two handles on the inside, the rotation being facilitated by a ball-bearing contact. In the back of the turret is a door opening outward which allows the gunner to enter and leave the turret. Behind the section carrying the engine is an additional flat piece of metal called the tail. The purpose of this addition is to give added length to the tank and thus facilitate the crossing of large trenches. It is hinged at its lower end and supported by movable brackets at its upper end, and it thus may be lowered so that the engine may be cranked from the outside.

Gasoline tank.—The gasoline tank, with a capacity of 108 liters (114.13 quarts), is made of double sheet steel, the space between the two thicknesses of steel being filled with best-quality wool felt, so that if the tank is pierced by a bullet the expansion of the felt on being moistened by the gasoline will prevent excessive leakage. At the bottom of the outside case is a drainpipe leading to the outside of the tank, so that when the felt becomes thoroughly saturated the excess gasoline will flow outside. The carburetor is fed by a Stewart vacuum feed system.

Power plant.—The magneto is an Eisemann high-tension type. The carburetor is a Schebler model A. The radiator is of the ordinary Renault tubular construction, with pump circulation. Cooling is assured by a large fan placed just forward of the radiator, which draws the air for the cooling of the radiator through the foot of the gun tower, the air entering the gun tower through a ventilator at the top. By this means the cooling fan also serves to ventilate the tank. Main clutch is of the inverted-cone type, contained in the flywheel. Universal joints are of special construction, allowing a certain

amount of shock and strain to be taken up. It is a double hexagon-ended dumb-bell type, with a male and female end connecting the engine to the gear box. The gear box has two trains of gears, giving four speeds ahead and a reverse, but at no speed does the engine drive direct, as in an automobile, but always through a gear. The power is transmitted from the gear box to the tracks by means of two pinions which receive their power from a beveled gear, as is usual in a differential, but it should be noted that in the tank there are no spider gears and both tracks always rotate at the same speed. The two track clutches, one on each side, are fastened to the two ends of this pinion by a slotted keyway. Beyond the clutch the power is transmitted to a train of gears and spur gears through an Oldham coupling.

Mode of steering.—By means of the two side clutches which connect the engine to these two trains of gears the direction of the tank is altered. When, for example, it is desired to turn to the right, the right clutch is first released by pulling the starting lever. If a short change of direction is desired the starting lever is pulled more, applying the clutch brake on the right side, and the car spins round in place.

Inside cranking device.—At the back of the gun tower is situated the inside cranking device. A train of gears is used here because cranking from this end of the engine must be transmitted through the clutch and gear box.

Turrets.—The turrets are octagonal, made of rolled armor plate, and revolve through the full 360 degrees. Only one model of the machine is being built, but some are armed with 37-mm. guns, some with machine guns, and a few with wireless signal systems.

Armament.—The exact ratio is five machines to carry 37-mm. guns to seven machines to carry machine guns. The 37-mm. guns are the field gun, model 1916, mounted suitably for tank uses, and the machine gun used is the Marlin aircraft gun modified for tanks.

Ammunition.—Two hundred and fifty rounds of 37-mm. ammunition will be carried per tractor and of machine-gun ammunition 5,000 rounds per tractor.

Armor.—The armor is six-tenths inch thick on the sides and front and rear and the turret with thinner plates where not subject to direct fire.

Gunner and operator.—This is a "two-man" tank, there being a driver and a gunner. The driver sits on the floor in the front of the machine and the gunner stands up just back of him, with his shoulders and head in the turret, and so is able to operate the gun, which is mounted in one face of the octagonal turret.

Maneuvering ability.—This machine is able to negotiate trenches up to 7 feet wide, and if chained two machines in tandem, wider trenches may be crossed.

XVII. MISCELLANEOUS EQUIPMENT.

Cavalry saber, model 1913.—This is a straight Cavalry saber with heavy metal guard, as shown in the accompanying illustration. The specifications for the United States Cavalry saber call for the following weight, dimensions, material, and test:

Weight	2.125 pounds
Length of blade	35 inches
Overall length	41½ inches
Material.....	Simple open-hearth carbon steel

In order to determine the temper and quality of the blade, it is subjected to a bending and striking test, which must be satisfactorily made. This saber is illustrated in detail in engineering drawing, class 20, division 2B, drawing 19.

Officer's saber.—The officer's saber has a curved etched blade, is made in three lengths, with weights as specified below:

Weight:	Pounds.
30-inch saber with scabbard.....	2.18
30-inch saber without scabbard...	1.375
32-inch saber with scabbard.....	2.25
32-inch saber without scabbard...	1.4
34-inch saber with scabbard.....	2.31
34-inch saber without scabbard...	1.44

The blade is made of heat-treated simple carbon steel and the tang is of soft iron. All blades are subjected to a bending and striking test to determine the temper and quality. This saber is illustrated in detail in engineering drawing, class 20, division 2B, drawing 15.

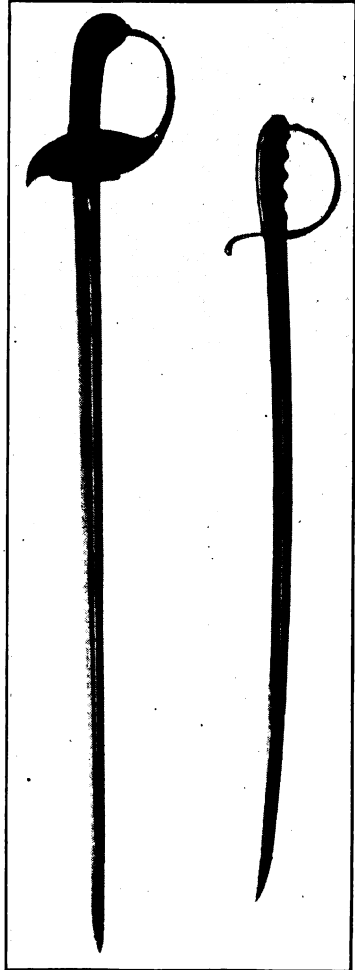

FIG. 185.—Cavalry saber (left) and officer's saber (right).

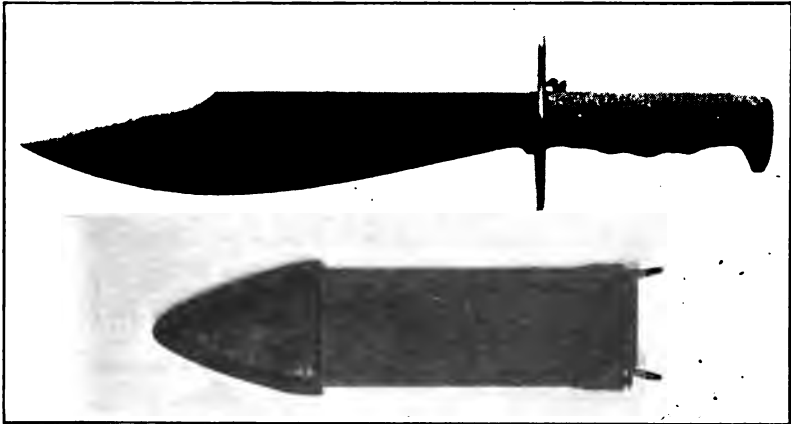

FIG. 186.—Bolo and scabbard.

Bolos, model of 1917 and model of 1917 C. T.—The bolo, as issued in the service, is a heavy brush knife, useful for clearing brush, sharpening pegs, or valuable for personal combat in extreme cases. Both models are similar to the model 1910, but lack the scabbard catch. In the model 1917 C. T. the pommel is integral with the tang, and the guard is welded. In the model 1917 the guard is slipped into place from the tang and the pommel is brazed on. Both use the same grips, therefore the grip and spare parts are interchangeable. They are manufactured by Fayette R. Plumb, American Cutlery Co., Bartlett Edge Tool Co., and others.

Miscellaneous equipment.—Miscellaneous, personal, horse, and other equipment, aside from weapons and munitions, supplied by the Ordnance Department, comprises many articles which are listed and described in various handbooks such as those in which the nature, construction, and care of infantry and cavalry equipment are discussed. These various articles, however, are so many and so diversified that lists, not to mention descriptions, are out of place in these pages, particularly as many changes were found necessary and desirable in view of developments in European warfare. Special or improved appliances such as trench knives, wire cutters, and other devices were adopted according to new designs of special efficiency to meet special conditions. In much of the new equipment there was a tendency to recognize the shortage of leather and to adopt webbing in its place. One development of the war, however, in which the Ordnance Department was concerned, and which represented entirely new conditions for the United States, was the necessity of manufacturing steel helmets. Experimental work on helmets and armor was carried on from the entrance of the United States into the war, and is discussed briefly in the following pages.

HELMETS AND BODY ARMOR.

Value of body armor.—The protective value of body armor in the recent war, and the advisability of providing certain types of this equipment early were recognized as a subject of considerable importance, and helmets of steel soon became regulation for the forces on the western front. The importance and value of such protective devices were shown by the statement of Gen. Adrian that 80 per cent of the hospital beds were tenanted by men wounded by missiles of low and middle velocities, whom armor might have saved. He further comments: "If I had made my helmets for a hundred instead of a million men, in my experimental lot, I might never have demonstrated their great protective value."



Front.



Rear.

FIG. 187.—Light laminated armor.

Armor experimental work of equipment section.—The experimental work of the equipment section, engineering division, of the United States Ordnance Department in armor had for its aim the development of whatever body defenses seemed practicable or desirable for modern use. Since the outbreak of the war models of helmets and body armor to the number of 19 were considered. Of this number, 12 are new models from designs furnished by Maj. Dean.

Types of armor proposed.—The accompanying diagrams show the types of armor proposed and designed in the equipment section, as follows:

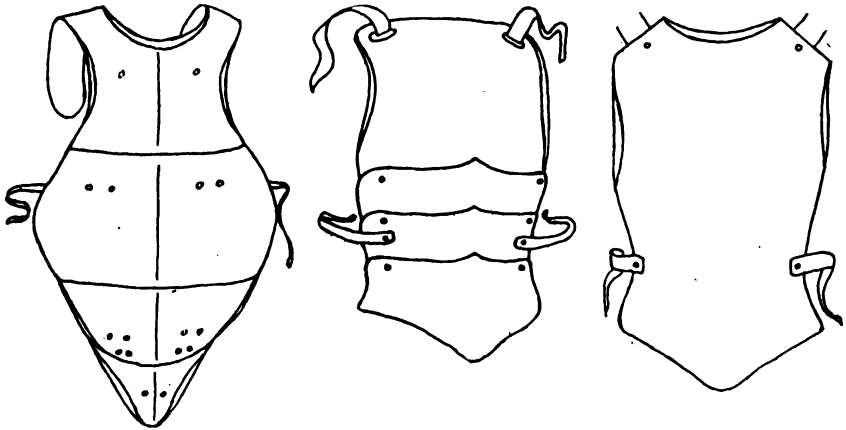

Figure 188.—A light body defense which shall not hamper movement, yet shall be proof against missiles of low and middle velocity, and be so cushioned with sponge rubber as to absorb shock appreciably.

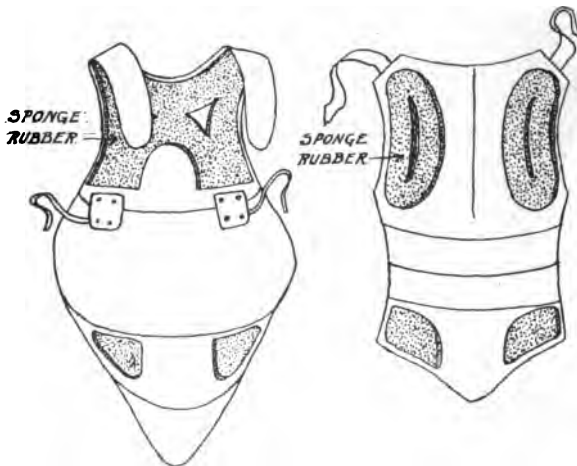

Figure 189.—View of inside of laminated body armor, showing sponge rubber cushions designed and so placed as to absorb shock through contact at points of the bony structure.

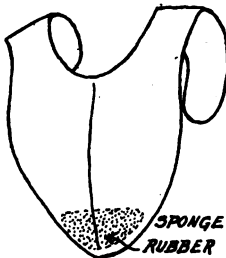

FIG. 190.

Figure 190.—A necklet, weighing 1½ pounds, for the protection of the upper chest, to be worn under the tunic or shirt.

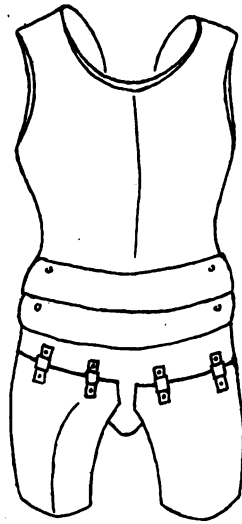

FIG. 191.

Figure 191.—A body armor for sentinels, designed to protect the wearer from chin to knees, with breastplate proof to a service rifle bullet at 40 yards, 2,750 foot-seconds. The weight of this armor, without thigh guards, is 24½ pounds, but this is evenly distributed.

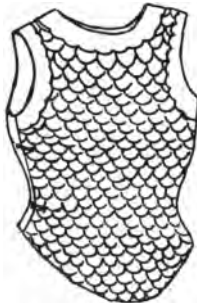

FIG. 192a.

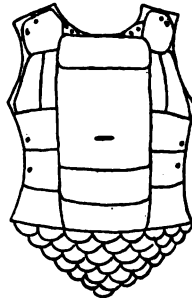

FIG. 192b.

Figure 192 (a-b).—A jazeran, a flexible light body defense, to be worn over or under the tunic, fitting more closely than the device shown in figure 188. Of this three types are proposed, one of which has withstood an automatic pistol shot at 10 feet 800 foot-seconds.

Figure 193.—An eye and face shield, outlined by Dr. Wilmer, weighing 7 ounces, of French helmet steel, rubber cushioned.



FIG. 193.

Figure 194.—A sentinel's or sniper's helmet, designed to protect the wearer from machine-gun fire.



FIG. 194.

Summary of experiments.—The helmet and armor project was somewhat modified by evidence obtained abroad by an officer of this section, but by the middle of August, 1918, the equipment section had about completed its series of helmets and body armor, and in nearly every case ballistic examples had been forwarded to headquarters, American Expeditionary Forces. Experimental lots of helmets submitted had been reported upon unfavorably; but it was also stated

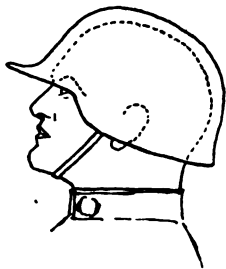

FIG. 195.

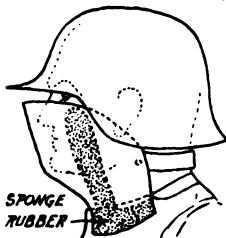

FIG. 196.

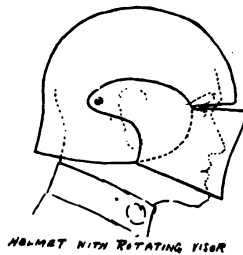

FIG. 197.

Figure 195.—A helmet which will give greater protection to the head than the British model, and shall fit more comfortably as well as be stronger. Developed as helmet No. 5.

Figure 196.—A face guard to be worn with various types of helmet, weighing $1\frac{1}{2}$ pounds and especially designed to withstand heavy shock.

Figure 197.—Helmet with rotating visor.

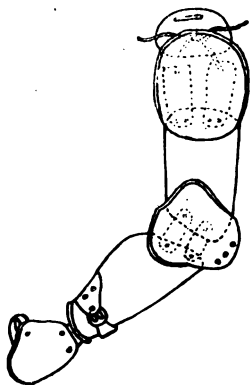

FIG. 198.

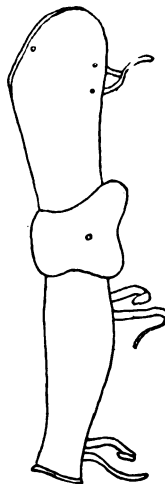

FIG. 199.



FIG. 200.

Figure 198.—An arm defense to weigh about 3 pounds.

Figure 199.—A complete leg armor, to weigh 4 pounds.

Figure 200.—A shin guard, weight, 1 pound.

(The above three proposed in view of the fact that over 50 per cent of wounds occur on the extremities.)



FIG. 201.—The jazeran as worn under the tunic conforms to the movements of the wearer and protects the vulnerable thoracic cavity.



FIG. 202.—The sentinel's armor is combined with the gun proof helmet for protection against sniper's fire.



FIG. 203.—Helmet No. 5 worn with face guard, showing the small degree of exposure notwithstanding there is perfect freedom of movement.



FIG. 204.—The greater protection afforded by the helmet No. 5 is here shown in contrast with the British Helmet which sits higher on the head. The figure to the right is wearing the British helmet.

that the British helmet in use was unsatisfactory. The experiments included:

- (a) The preparation of helmets of various models.
- (b) Face and eye guards of two types.
- (c) Body defense of six types.
- (d) Necklet and shoulder guards.
- (e) Armor for the extremities.

Types of armor needed.—A careful review of the data gathered in the present war shows the types of armor immediately needed for our overseas forces to be as follows: First, a steel helmet, universally demanded; second, a body defense, required to a limited degree. Armor for arms and legs, while produced in experimental lots, notably in France, has not been recommended for active service.

Ballistic quality.—The improvement of steel as regards its ballistic quality for helmets and armor has been undertaken, and assistance has been rendered by Prof. H. M. Howe, a leading American metallurgist, who gave practically all of his time and that of his assistants to the problem of providing a better alloy steel.

Manufacture of helmets.—Although experimental work was being done by the Equipment Division, actual orders for 400,000 steel helmets of the type used by the British Army early were placed in Great Britain. Of these 380,000 were employed in the equipment of the first of the American Expeditionary Forces, and 20,000 were brought to America, distributed among the various training camps, and used in connection with gas-mask drills. In the meantime a new alloy steel was developed, essentially similar to that used in the British helmets, but containing a higher percentage of manganese. From ingots of this special material sheets were duly rolled and heat-treated at the rolling mills. Orders were given to the American Sheet & Tin Plate Co. for a million sheets of helmet steel, and contracts were placed with 10 different pressing concerns for the forming of the helmets from the blanks which were stamped from the sheets. Corresponding contracts were placed for the lining of the helmets in which there was a departure from the British practice. Netting was employed to secure a better distribution of weight on the head of the wearer, and rubber was placed around the edge of the lining so that a relatively large dent would not reach the skull. Assembling the helmets was allotted to the Ford Motor Co., of Philadelphia, and quantity delivery of the finished helmets began at the end of November, 1917. On February 7, 1918, practically 700,000 had been shipped abroad or to storage in the United States close to the ports of embarkation.

Notwithstanding the experimental work, the original model remained standard and on July 5, 1918, new orders involving a more definite schedule of requirements were placed with 12 concerns for the pressing and with 16 concerns for the lining. By September 7,000,000 helmets were under contract and by November 11, 1918, at the time of the signing of the armistice, production was averaging a rate of 25,000 per day, with components coming along to make a probable production of 60,000 per day by January, 1919. Before orders were canceled 2,600,000 helmets had been produced in the United States.

XVIII. PROVING GROUNDS AND ARSENALS.

ABERDEEN PROVING GROUND.

Need of increased testing facilities.—Prior to the entrance of the United States into the world war all proof firing for the Ordnance Department was done at Fort Hancock, N. J., at the Sandy Hook Proving Ground, but facilities existing there becoming quite inadequate with the heavy increase in testing work incidental to our entry, it became imperative to choose a site for a new proving ground of much greater scope and extent. After a large number of possible locations had been carefully investigated the strip of land along the southern shore of the upper arm of the Chesapeake Bay, in Harford County, Md., was finally selected and acquired by the department for the establishment of the Aberdeen Proving Ground, the name being suggested by the proximity of Aberdeen, Harford County, Md., a small town on the main line of the Pennsylvania Railroad, a distance of about 4 miles westerly from the chosen site.

Topography.—The new proving ground reservation extends from Spesutie Island, in the Chesapeake Bay, on the northeast, to the Gunpowder River on the southwest, and contains some 40,000 acres of land. The extreme length of the reservation is 15 miles, with a maximum width of 4 miles, giving not only excellent sites for barracks, parade grounds, living quarters, and manufacturing, storage, and magazines, but a clear land and water range of 50,000 yards. The Gunpowder and Bush Rivers cross the reservation, the main part of the proving ground being northeast of the Bush River. The Gunpowder Neck or Peninsula is between the Bush and the Gunpowder Rivers, and there is a small portion of the proving ground southwest of the Gunpowder River. Transportation facilities are exceptionally good, inasmuch as the main lines of the Pennsylvania and Baltimore & Ohio Railroads are within a short distance, while the Chesapeake Bay offers opportunity for water shipment from docks built on the proving-ground frontage.

Buildings and roads.—A portion of the peninsula between the Gunpowder and Bush Rivers is the place used for a gas-shell filling plant. The administrative buildings and proving ground proper,

proof battery, and aviation fields are located at the north end of the reservation. The extreme northerly end of the reservation, which is somewhat higher, is used for the barracks, parade ground, and the officers' quarters, the parade ground being the central motif for the group. A water battery has been developed at a place near Mulberry Point, where the ground is also somewhat higher than the surrounding marshes. Midway between the water battery and the barracks and the administration center has been developed an aviation field which has been carefully graded, and at the southerly end has been equipped with six hangars of modern, improved construction. A concrete road, 20 feet in width, connects the water battery and the administration and barracks center, and concrete roads were laid out and built on all important road arteries throughout the post. At a point just south of the proving-ground railway, and at the head of the draw or arm of Swan Creek, has been laid out on comparatively high ground a number of barracks for housing civilian employees. The barracks are surrounded by carefully graded roads and have the benefit of water and sewerage disposition quite as carefully studied out as the water and sewerage systems for the main military development. All of this represents the best and most modern sanitary engineering.

Proving ground railroad.—A strip of land parallel to the main line of the Pennsylvania Railroad and on the easterly side thereof, at the town of Aberdeen, and opposite the Aberdeen Station, was acquired by the department and is the starting point for the proving ground railroad, which follows along the main line of the Pennsylvania, and on the easterly side thereof for a distance of about one-half mile, when it turns by easy curvature and runs on a long tangent to a point well within the reservation limits, and so on to a station near the administration center. Branches of the railroad have been run to the trench warfare battery, to Michaelsville, to the magazine, and to the water battery, and regular service, both freight and passenger, is maintained to all necessary points. The statistics of the railroad, which were carefully compiled, showed a very satisfactory condition of business during 1918, the inbound freight, because of construction, being, of course, far in excess of the outbound. The number of passengers carried for the first six months of 1918 by proving-ground trains, and work trains of the Pennsylvania Railroad running over the Aberdeen Proving Ground tracks, was 526,278. The average grade of track as developed is 1 per cent; the maximum, $1\frac{1}{2}$ per cent. There is 16.8 miles of track of all standard gauge; weight of rails, varying from $67\frac{1}{2}$ pounds to 75 pounds. So far there has been expended in ballasting the road 50,400 yards of broken rock, gravel, and slag.

Appropriations.—The original appropriation for the purchase and development of the reservation was \$7,000,000. Of this amount approximately \$3,500,000 was spent for land and (up to June 30, 1918) \$3,438,766.22 for construction work and material, and, based upon an Army of 3,000,000 men, an estimate was submitted to Congress showing \$8,480,000 additional funds as necessary for further construction.

Construction.—Approximately 17 miles of railroad was constructed, a dock 40 by 300 feet was completed, and barracks of the single-story cantonment type, housing about 4,000 troops, were built and occupied in 1918. The civilian barracks already referred to have a capacity of some 3,000 and were fully occupied. Permanent brick storehouses, a large power house, a brick instrument building, a number of semipermanent officers' quarters, and a large number of temporary officers' quarters, stock houses, and storehouses also were built, and in addition a number of magazines, constant-temperature plants, motor garages, etc. Planned and in process of construction in 1918 were such buildings as the administration building, the railway station, officers' mess building, machine shops, the telephone exchange, and telegraph offices.

Improvements.—Forests have been cleaned out, and vistas cut to permit of observation of firing on six ranges. The aviation field has been graded; the detonating ranges have been constructed; the trench-warfare range has been built, and the water battery has been established and built. Proving and testing progressed most satisfactorily at all these points during 1918, the first gun being fired on January 2. The work was greatly facilitated by the construction of concrete platforms, walks, and roadways, designed with an eye to handling heavy ammunition for use at the main and other batteries.

Water supply.—A water system for the reservation was established and some 50,000 feet of cast-iron pipe of various sizes were laid, the water being obtained by air lift from deep wells, which indicate a superabundant quantity of pure and wholesome water, the only objectionable feature of which is iron, which precipitates after contact with air and forms a reddish deposit and gives a rusty appearance. Arrangements were made, however, to eliminate this satisfactorily by means of a large mechanical tub filter plant. The water which is pumped from these wells, after having its iron content removed by aeration and mechanical filtration, passes to a suction storage reservoir which contains 300,000 gallons, and from here it is pumped into the line and into four 50,000-gallon steel tanks floating on the lines. This affords an ordinary service of water under 50 pounds pressure, but is so arranged that in case of fire the tanks are cut off automatically, and fire pumps with a capacity of 1,000 gallons per minute are cut in and maintain a pressure of 100 pounds until shut down. The system as designed is for 1,000,000 gallons per day.

Sewerage.—A very complete sewage-disposal plant was designed consisting of the usual lateral lines of vitrified pipe which feed through grease-trap connections and manhole guards into the main outfall sewer line running to a septic tank of the Doten type of sufficient size to accommodate not only the present but all reasonable future demands of the post for many years. This entire system is operated by gravity.

Service fleet.—The service department operates for the use of the range firing section, one 76-foot cruiser, one 46-foot cruiser, one 38-foot cruiser, and three launches, the large cruiser being equipped with wireless telephone.

Quartermaster's department.—The quartermaster's department is housed in a building 520 feet by 40 feet, in which it looks after the regular duties prescribed for it. A farm detail under the supervision of the quartermaster harvested in 1918 approximately 20,000 bushels of wheat, 400 tons of hay, and 1,000 tons of straw. It also harvested several thousand baskets of peaches. In 1918 it planted 118 acres of late potatoes, 7 acres of sweet corn, 5 acres of turnips, and 25,000 heads of cabbage.

Traffic department.—The traffic department handled (up to June 30, 1918) 93,900 tons of inbound freight and 1,800 tons of outbound. It carried on its own trains 205,600 passengers and handled by Pennsylvania Railroad trains in the same time over the proving-ground railroad 320,678 passengers. Of the rolling stock owned by the proving ground all except one locomotive was transferred from Sandy Hook. The trackage of the system was doubled by laying additional track near Aberdeen village, constructing a classification yard for 160 cars, and by building additional sidings; and additional freight and passenger cars were purchased.

Post exchange.—The post exchange increased its business to a total of \$40,000 per month by September 1918, and was giving very satisfactory service.

Enlisted personnel.—The enlisted personnel consisted on June 30, 1918, of 79 sergeants, 118 corporals, 5 cooks, 213 first-class and 1,180 second-class privates. It was on September 1, 1918, more than double that number.

Hospital.—A well-equipped hospital was put in operation, its personnel consisting of 10 medical officers, 6 nurses, and 54 enlisted men as orderlies. It treated 978 patients to June 30, 1918, and returned 850 to duty and transferred 54 to other hospitals up to same date.

Schools.—Two schools were maintained at the post. The ordnance engineering school gave instruction to enlisted men for the purpose of training them for commissions, and also conducted classes for officers and thoroughly trained them in the science of ordnance, and

especially in the actual testing work to be done at the proving ground. The work includes instruction in mobile artillery, artillery ammunition, instruments, trench warfare, machine guns, small arms, and aerial bombs. Instruction in military science was also carried along parallel with the ordnance work.

The railway artillery school instructed enlisted men in the operation of heavy artillery, railway mount construction, machine-shop practice, railway work, military drill, and arithmetic. Its object is to select men best qualified for the various positions and to train them in the work for which they are chosen. This is facilitated by the presence of the heavy guns, howitzers, and mortars sent here for assembly and test.

Housing.—At Aberdeen village the United States Housing Corporation has acquired a large tract of land lying near the railway station and is arranging to build thereon some 50 houses, including five community houses, all for the benefit of the civilian employees of the post. This development forms practically a self-contained village, having its own water and sewerage systems, and offers every comfort to its residents, to whom, among other advantages, will be given the opportunity of purchase of houses and lots on most favorable terms from the Government.

Savanna proving ground, near Rock Island.—North of Savanna, Ill., a tract of land of approximately 13,300 acres was purchased for use as a proving ground by Rock Island Arsenal. It is located on the Mississippi River, and is mainly high and dry ground, of a sandy nature. It is about 60 miles from the Rock Island Arsenal, and is served by two trunk lines, the Chicago, Milwaukee & St. Paul and the Chicago, Burlington & Quincy, which latter passes through the grounds; also by river transportation and several excellent wagon roads. It is located very near a town of approximately 4,000 population, affording a reasonable labor and material market. The extreme range is approximately 11 miles. The tract is from three-quarters to a mile in width at the beginning of the range and broadens out to a width of 3 miles at a range of 6 or 7 miles. This ground was purchased and equipped from an appropriation of \$1,500,000 of the subsidiary civil act approved June 12, 1917. It was originally intended to make request for further appropriations in order to equip the ground in a permanent manner, but later it was decided that, owing to its poor geographical location, nothing but temporary construction would be attempted. Temporary equipment was therefore installed. Acceptance tests can be made of 75-millimeter field-gun carriages from Rock Island Arsenal and certain other tests of carriages or ammunition may be advantageously made, but owing to the size of the grounds, it was not considered advisable to make tests of guns of larger caliber than 6 inches.

Lakehurst proving ground.—The Lakehurst Proving Ground in New Jersey, originally secured for the Ordnance Department for tests in connection with the use of poisonous gases, was taken over by the Chemical Warfare Service on July 13, 1918, by the direction of the Secretary of War. This proving ground is situated about 8 miles from Lakewood, N. J., and consists of approximately 3,000 acres of swampy ground, originally covered with undergrowth. The Pennsylvania Railroad and the Central Railroad of New Jersey both pass about 3 miles from the reservation, intersecting at Whiting Junction.

Proving grounds under control of inspection division.—The following proving grounds, discussed in the ensuing paragraphs, are under the control of the inspection division:

Erie Proving Ground.

Scituate Proving Ground.

Saybrook Proving Ground.

Sackett's Harbor Proving Ground.

Elizabethport Proving Ground.

Nitro Proving Ground.

Old Hickory Proving Ground.

Clear Spring Proving Ground.

Erie Proving Ground.—Erie Proving Ground, Ottawa County, Ohio, is located on Lake Erie, immediately adjacent and to the westward of Camp Perry and about 6 miles from the town of Port Clinton. The Lake Shore & Michigan Southern Railroad (New York Central Lines) passes within 2 miles of this proving ground and is connected thereto by a spur track. There is a macadamized road connecting with Port Clinton, which in July, 1918, was rebuilt on account of its bad condition. The proving-ground reservation is the property of the United States and consists of about 1,200 acres of land, with an extreme length of $1\frac{1}{4}$ miles and a width of 1 mile. The land is entirely level and that portion adjacent to the lake is swampy.

Erie Proving Ground is designed primarily for the testing of artillery guns, howitzers, and carriages from the caliber of 75-mm. up to and including the largest caliber of railway artillery. The capacity contemplated in July, 1918, was for proof firing 75 carriages per day. In addition to the proof work the assembly of various components of carriages and guns is made at this proving ground and the packing for overseas shipment done here. There are approximately 10 miles of railroad track and 5 miles of concrete road; a main assembly shop, 320 feet by 280 feet; a shop for railroad artillery, 100 feet by 240 feet; a secret assembly shop for 155-mm. gun recuperators (Filloux); an independent power and heating plant; a firing platform about 2,100 feet long; and all other necessary buildings, such as storehouses, warehouses, office buildings, magazines, and loading laboratories.

At Erie Proving Ground it is planned to test the greater part of the production of artillery cannon and carriages of the country. This proving ground is not adapted to tests of ammunition components, however, such as fuzes and projectiles, although, if experiments conducted at the Aberdeen Proving Ground to determine the practicability of firing projectiles for recovery into a concrete tank filled with water, showed this method of recovery is successful, tests of projectiles could be made at this proving ground by installing such a tank. The road testing of carriages is done here. The barracks and quarters provide for a garrison of 40 officers, 1,200 enlisted men, and 60 civilian clerks and stenographers. Erie Proving Ground was fairly well completed by the latter part of September, 1918.

Scituate Proving Ground.—Scituate Proving Ground is located about $1\frac{1}{2}$ miles north of Scituate, Plymouth County, on the eastern coast of Massachusetts. It is connected by a branch line with the Old Colony Division of the New York, New Haven & Hartford Railroad, which passes within a mile of the reservation. It is also connected with Boston, Mass., and with Watertown Arsenal by a macadamized road.

The reservation consists of slightly more than 100 acres of land, leased by the United States from private owners. The proving ground has its own independent power and heating plant, a shop 140 by 240 feet, and the usual office building, storehouses, warehouses, magazines, and loading laboratories.

Scituate Proving Ground is intended to proof fire the production of 240-mm. howitzer carriages from Watertown Arsenal and 155-mm. howitzer carriages from the Osgood-Bradley Car Co., Worcester, Mass., together with a corresponding number of howitzers and the 155-mm. guns, model 1918, manufactured by the Bullard Manufacturing Co., of Bridgeport, Conn. It is not adapted to the test of ammunition components, such as fuzes or projectiles, although cartridge cases, primers, or powder may be tested at this proving ground. The garrison consists of 10 officers and 130 enlisted men.

Saybrook Proving Ground.—Saybrook Proving Ground is located on Long Island Sound, about 2 miles from the town of Saybrook Junction, Middlesex County, near Cornfield Point, Conn. The reservation consists of a small tract of land about 1,200 feet long and 200 feet wide, leased by the United States from private owners. It is connected by a fair macadamized road with the town of Saybrook Junction, Conn., which is on the main line of the New York, New Haven & Hartford Railroad. It is also connected by good macadamized roads with the plant of the New Britain Machine Co., New Britain, Conn., which is distant about 35 miles.

The installation of this proving ground was entirely temporary in character and consisted merely of the necessary barracks and quarters for the garrison, a small shop and garage combined, and a small magazine and loading shed.

Saybrook Proving Ground was designed to handle anti-aircraft guns and carriages assembled by the New Britain Machine Co., New Britain, Conn. It was not adapted for testing the ammunition components except the cartridge cases and primers. It was in operation from early in the summer of 1918, the proving ground garrison consisting of 3 officers and 40 enlisted men.

Sackett's Harbor Proving Ground.—Sackett's Harbor Proving Ground, Madison Barracks, Jefferson County, N. Y., is located on Lake Ontario about 1 mile from Sackett's Harbor and about 2 miles from the post of Madison Barracks. The nearest railroad station is the Rome, Watertown & Ogdensburg Railroad at Sackett's Harbor, with which the proving ground is connected by a macadamized road, lately improved. Sackett's Harbor is connected in turn with Watertown, a distance of 12 miles, by an excellent macadamized road. The proving ground reservation consists of a very small tract of land about 200 feet square, the property of the United States, upon which there is a single building for shop and loading room.

The Sackett's Harbor Proving Ground is designed primarily to proof fire the 75-mm. carriages, model of 1916, manufactured by the New York Air Brake Co. The proving ground is not adapted for the testing of larger guns or carriages nor for the testing of ammunition components except the 75-mm. cartridge cases and primers. This proving ground was completed and in operation in midsummer 1918. The garrison consists of 1 officer and 12 enlisted men, who are quartered at the post of Madison Barracks.

Elizabethport Proving Ground.—Elizabethport Proving Ground is located at Elizabethport, Union County, N. J., about 1 mile from the plant of the Singer Manufacturing Co. and immediately adjacent to the Central Railroad of New Jersey. It is connected by a good road with the plant of the Singer Manufacturing Co. The reservation consists of a small tract of land about 800 by 1,000 feet, leased by the Singer Manufacturing Co. for the United States. Construction on this proving ground was commenced early in August, 1918.

Elizabethport Proving Ground is designed for the test of 75-mm. gun-carriage recuperators manufactured by the Singer Manufacturing Co. Firing is conducted into sand butts. The necessary buildings were built by the Singer Manufacturing Co., under contract with and for the United States. The proving ground has a capacity of 25 to 30 recuperators per day. A garrison of about 2 officers and 50 to 60 enlisted men is provided.

Nitro Proving Ground.—Nitro Proving Ground is located about 1 mile north of the Government powder plant at Nitro, Kanawha County, W. Va., with which it will be connected by a good macadamized road. This proving ground is designed for the testing of nitrocellulose powder manufactured by the powder plant for the 75-mm. gun, 155-mm. howitzer, and 155-mm. gun. It was put in operation about the end of September, 1918.

Old Hickory Proving Ground.—Old Hickory Proving Ground is located at Nashville, Tenn. It was designed and built by the Du Pont Powder Co. for the use of the United States in testing small arms and mobile artillery cannon powder manufactured by the Old Hickory powder plant.

Clear Spring Proving Ground.—Clear Spring Proving Ground is situated about 1½ miles from the village of Clear Spring and 12 miles from the town of Hagerstown, Md., with which it is connected by a macadamized road. This proving ground was designed for testing 37-mm. guns assembled by the Poole Engineering Co. at the plant of the Maryland Pressed Steel Co., Hagerstown, Md. Plans for Clear Spring Proving Ground were prepared in July, 1918.

Other proof work.—In addition to the regular proving grounds for the inspection division, mentioned above proof work was done as follows at the places named:

Camp Devens, Ayer, Mass.....	Test of trench-mortar ammunition.
Saginaw, Mich.....	Test of trench-mortar ammunition.
Texas, Md.....	Test of 37-mm. ammunition.
Fort Sheridan, Ill.....	Test of 3-inch trench mortars.

Redington Proving Ground.—Redington Proving Ground, at Redington, Pa., the property of the Bethlehem Steel Co., is situated about 4 miles from the Bethlehem Steel Co.'s plant. It is adapted for the testing of mobile artillery guns and cannon. In July, 1918, the Ordnance Department was having all mobile artillery guns and carriages manufactured by the Bethlehem Steel Co. and the Midvale Steel Co., proof fired at this proving ground, under contract with the Bethlehem Steel Co.

FRENCH PROVING GROUNDS AND LABORATORY ACTIVITIES.

Necessity of proving ground facilities.—With the establishment of an engineering division of the Ordnance Department in France and the arrival in quantity of American-made munitions there arose immediately the necessity for providing proving ground and laboratory facilities to enable this division to carry on its experimental and research work and to provide facilities for the test or retest of such matériel or lots of munitions as might be necessary.

Proving ground activities.—The work of the proving ground included proof firing of field and heavy artillery guns and carriages,

functional tests of ammunition, ballistic firing involving the taking of pressures and velocities, accuracy firing for small arms, functional tests of trench-warfare matériel, incendiary and signal equipment.

Laboratory activities.—The laboratory work included the necessary research work in connection with the investigation of defective ammunition and the development of new types, the investigation of powders, high explosives, detonating and primer compositions, and the complete metallurgical study of new or defective munitions, such as the physical properties of the various components of a new carriage under consideration for adoption or the investigation of a defective shell. One of the most important duties of the laboratory activities was the investigation and report on enemy munitions.

Cooperation with the French.—As a matter of policy, it was proposed that in general all development and research work should be conducted in conjunction with the French at their several proving grounds and laboratories, where special investigations were made, and that a proving ground should be established by the Ordnance Department adjacent to its large repair shops and depots for the proof firing of relined cannon, and of repaired carriages, and for reestablishment of charges, etc. The policy of cooperation with the French, whereby we supplemented their equipment and highly trained personnel where necessary, insured unusual research facilities which were available for both Governments. This intimate cooperation and investigation of similar technical subjects insured that we should profit mutually by our mutual experiences, and that the knowledge acquired by one would be available to the technical staffs of both Governments. The establishment of the American Expeditionary Forces' proving ground for service tests enabled it to be placed with special reference to convenience of handling matériel from our own shops and depots, and provided a convenient opportunity for such shop tests and minor experimental work as might be undertaken at our plant.

Activities under way.—In conformity with this project, the following activities were undertaken:

Bourges-Field Artillery.—Formal authority was granted for the utilization of the "Polygon" of the "Commission d'Expériences" with its well equipped 30 kilometer range, in conjunction with the French, which provided for experimental work on field and heavy artillery up to 155-millimeter, artillery ammunition of light caliber, trench-warfare matériel, special small-arms ammunition, etc. A proving ground detachment was formed, and steps were taken for the erection of necessary buildings and installation of instruments.

Gavre-Quiberon-Heavy Artillery.—Informal arrangements were made for such proof work as might later be necessary in connection with heavy artillery and railway mounts.

Versailles—Commission d'Expériences—Small arms.—Informal arrangements were made whereby such ballistic firing for small arms as might be necessary could be conducted on the special range maintained for this purpose.

St. Jean de Monts—Machine guns.—Facilities were here provided for long-range ballistic firing for machine guns under control of the Ordnance activities at this point.

Small-arms range.—A small-arms range was arranged for, to be established either at Bourges or at Poitiers.

Ordnance proving ground.—The establishment of an American ordnance proving ground in the vicinity of Mehun near the Ordnance Repair Shops was considered. This proving ground was to be for the proof of relined guns, testing of assembled and repaired gun carriages together with the establishment or verification of powder charges.

LABORATORIES.

Bourges—Ammunition and explosives.—Formal authority was received for the use of the laboratories of the École de Pyrotechnie at Bourges in cooperation with the French, in connection with the investigation of ammunition, high explosives, etc. The excellent school facilities of the École de Pyrotechnie were also extended to the Ordnance Department of the A. E. F.

Montluçon—Metallurgical research.—The kind offer of Dr. Georges Charpy to conduct for the Ordnance Department such metallurgical research work as might be required was accepted and the work was being done under the supervision of a representative of the Ordnance Department. This laboratory, that of the Compagnie de la Chatillon, Commentry et Neuves Maisons, is one of the best equipped metallurgical laboratories in France, if not in the world.

Versailles—Commission de poudre—Powder.—Informal arrangements were made with this commission for the conduct of such special investigations with respect to powder as might arise.

Purpose of the work.—It was the purpose to provide in the engineering division a service which would conduct all such experiments, research work, and tests as might be required of the several technical sections of the engineering division and other divisions of the Ordnance Department, requiring the use of proving grounds or laboratories.

ARSENALS.

General statement.—For many years prior to the war the United States Army maintained a number of arsenals distributed throughout the country whose functions were the manufacture, the repair, or the storage and supply of ordnance matériel and stores. At some of these

establishments these functions were combined, while at others manufacturing was carried on exclusively, and still others served merely as repair depots or for the storage and issue of various stores. The main manufacturing arsenals were at Watertown, Mass.; Springfield, Mass.; Watervliet, N. Y.; Picatinny, N. J.; and Rock Island, Ill. A small amount of manufacturing and repair work was done at Augusta, Ga.; Benicia, Cal.; and San Antonio, Tex., in the United States, and at Manila, in the Philippines. Repair work was carried on at Hawaii Arsenal at Honolulu and at the Panama Arsenal at Ancon, Canal Zone, while at other establishments there were storage and supply facilities as indicated in the accompanying tabulation. As will be seen in the following paragraphs, the work of these different arsenals was, and is, specialized. At Watertown Arsenal were manufactured seacoast carriages and armor-piercing projectiles; at Springfield Armory the Springfield rifle, pistols, sabers, etc.; at Watervliet, cannon both for mobile and seacoast mounts; at Frankford, artillery ammunition and small-arms ammunition and various accessories and instruments used in connection with gun carriages; at Picatinny explosives; and at Rock Island gun carriages small arms, rifles and various articles of equipment.

The repair and storage facilities of the various establishments depended in a large measure upon the needs of the various geographical departments of the Army in which they were located, and naturally at the outbreak of the war became of great importance. At certain of these arsenals or ordnance depots schools were maintained for the training of men in the enlisted Ordnance Corps and also for the instruction of officers. Later this work was rearranged and concentrated at Raritan Arsenal. A brief description is given of these establishments in the following pages, and their official designation, location, and the scope of their activities are summarized below:

THE DESIGNATIONS AND LOCATIONS OF ARSENALS.

The official designations, locations, and scope of activities of the arsenals and ordnance depots are as follows:

Designation.	Location.	Scope of activity.
Augusta Arsenal.....	Augusta, Ga.....	M R S
Benicia Arsenal.....	Benicia, Cal.....	M R S
Frankford Arsenal.....	Philadelphia, Pa.....	M
Hawaii Arsenal.....	Honolulu, Hawaii.....	R S
Manila Arsenal.....	Cavite, P. I.....	M R S
New York Arsenal.....	Governors Island, N. Y.....	S
Panama Arsenal.....	Ancon (Corozal), Canal Zone.....	R S
Picatinny Arsenal.....	Dover, N. J.....	M
Raritan Arsenal.....	Metuchen, N. J.....	M R S
Rock Island Arsenal.....	Rock Island, Ill.....	M R
San Antonio Arsenal.....	San Antonio, Tex.....	R S
Springfield Armory.....	Springfield, Mass.....	M R
Watertown Arsenal.....	Watertown, Mass.....	M
Watervliet Arsenal.....	Watervliet, N. Y.....	M

"M" signifies manufacturing; "R" signifies repair and alteration; "S" signifies storage and supply.

AUGUSTA ARSENAL, AUGUSTA, GA.

Augusta Arsenal.—The Augusta Arsenal is located about 3 miles from the business center of Augusta, Ga. It occupies a nearly rectangular plot of ground 1,900 feet by 1,600 feet, comprising about 70 acres. It is bounded on the north and west by public streets, on the east and south by private land. It has connection with the sewer, water, electric, and telephone systems of Augusta. A trolley track passes the main gate of the arsenal and connects by arsenal switch to the shops and storehouses; freight cars, not over four a day, are brought to the arsenal over this track by trolley engine. There is no direct connection with steam railway lines. In 1918 it was garrisoned by officers, and enlisted men acting as stevedores, chauffeurs, laborers, and in various administrative capacities. A separate guard is furnished.

Equipment.—The arsenal has a small foundry and forge shop, machine and carpenter shops. It manufactures cast-iron projectiles and targets for seacoast target practice, and does the repair and alteration work for the southern armament district. In 1918 a large shop for the repair of arms and equipments was established.

Storehouses.—The storehouses at the arsenal, which consist of one large storehouse and three former school buildings altered to storehouses, are used for obsolete and unserviceable stores only. All stores for issue are under the control of the supply division and are stored in the Augusta general supply ordnance depot, $3\frac{1}{2}$ miles distant from the arsenal, which has a separate barrack building for enlisted men employed at the depot, and a separate guard.

BENICIA ARSENAL, CAL.

Benicia Arsenal.—Benicia Arsenal is located about 2 miles from the town of Benicia (population 2,500), about 30 miles northeast of San Francisco, and 7 miles from Mare Island Navy Yard (which is between the arsenal and San Francisco). The main line of the Southern Pacific Railroad between Oakland and Ogden skirts the south and east sides of the arsenal, and switch tracks connect the shops and new storehouses.

Reservation.—The arsenal grounds are about 5,000 by 3,000 feet in extreme dimensions and comprise about 240 acres. The reservation is bounded on the east and south by Suisun Bay and the Straits of Carquinez (the outlet of the Sacramento River), and north and west by Benicia Barracks Reservation.

Wharfage.—There are ample wharfage facilities on Carquinez Straits, a distance of 200 yards from the railroad, where a depth of water from 13 to 25 feet is now had at low water. A further depth of 25 feet could readily be obtained by dredging.

Activities of Benicia Arsenal.—This arsenal is a depot of supply for troops in the Western Department, and to a certain extent for the Hawaiian Department. The manufactures are cast-iron projectiles for target practice, and other target material for seacoast and mobile artillery, and for small-arms target practice; the arsenal makes miscellaneous repairs and alterations of seacoast armament on the Pacific Coast, and receives and issues stores for Army, Marine Corps, State, and educational institutions. It also overhauls and repairs small arms and personal and horse equipment turned in from the service.

Storage facilities.—The remoteness of Benicia Arsenal from the principal manufactures of the East demand considerable storage facilities. New storehouses were added during 1918.

Personnel.—Being the only arsenal on the Pacific Coast, the importance of Benicia Arsenal as a distributing center was very greatly enhanced by the war, and its personnel was increased from 150 officers, enlisted men, and employees in 1917 to 228 in 1918.

FRANKFORD ARSENAL, PHILADELPHIA, PA.

Frankford Arsenal.—The Frankford Arsenal was established under the general authority contained in section 9 of the act of Congress dated February 8, 1815. The first ground acquired by the United States was in 1816.

Frankford Arsenal is located on the Delaware River, about 10 miles from the city hall, and within the city limits of Philadelphia, in the northeast portion of the city, in a section called Bridesburg. It is about 1,600 feet from north to south and varies in width from about 1,100 to 2,000 feet, comprising in all approximately 91 acres. It is bounded on the north and west by city streets, on the east by private land, and on the south by Frankford Creek and the Delaware River. Arsenal tracks to shops and storehouses connect with the New York division of the Pennsylvania Railroad, the main line of which is but a few hundred feet from the northern boundary of the arsenal reservation. It has an independent electric power plant and is also connected with the city power plants. There is an independent water-supply system from the Delaware River and also connection with the city system, and it is likewise connected with the city gas and sewer systems. During the war it was garrisoned by an adequate guard.

Product.—The principal manufactures of the arsenal are artillery ammunition, small-arms ammunition, and fire-control instruments. It manufactures artillery ammunition of calibers from 1.457 inches up to and including 6 inches. Its manufacture of small-arms ammunition includes the regular 0.30 caliber cartridge, 0.45 caliber cartridge, tracer, incendiary and armor-piercing ammunition, and ammu-

munition specially prepared for aviation service, as well as rifle and hand grenades. The total output of small-arms ammunition is about 3,000,000 rounds per week. This will be brought to over 5,000,000 per week eventually. The fire-control instruments manufactured include gun sights, quadrants, battery commander's rulers, panoramic sights, telescopic sights, etc., this being the only arsenal equipped for such manufacture, which involved optical work and assembly of a high order of precision, with accurately divided scales and circles. All gauges for the inspection of ordnance material are also made at this arsenal. Additional buildings under construction will increase the output of artillery ammunition and largely increase the output of the instrument and optical department, which was far from adequate to meet the extraordinary demands for sights, telescopes, and fire-control and other instruments that had to be met.

Activity of the arsenal.—A new plant has been erected for the manufacture of cartridge cases for artillery ammunition. These are brass cylinders containing the propellant charge of the shell or shrapnel as well as the loaded charge piece itself. Shrapnel is also still manufactured at the Frankford Arsenal, and the plant used in its making was to be extended. It was proposed to abandon the manufacture of complete rounds of other ammunition, as the development of private industries could meet this requirement.

Personnel.—The average number of employees was 3,200 in 1916, while in 1918 it was considerably over 5,000. In view of the importance of the work at this arsenal and the large amount of explosives handled the utmost efforts are made to employ adequate safety devices, and a very heavy military guard is maintained.

HAWAII ARSENAL.

Location.—In December, 1916, the funds were appropriated for the establishment of an Ordnance depot to be located at the Fort Shafter Reservation, Honolulu, Hawaii. Fort Shafter was found during the military maneuvers held in 1915 to be a secure central distributing point. It is well above sea level and not in the rain belt of the mountain valleys. It is protected by natural ridges from long-distance land firing and is out of range of modern naval guns.

Buildings.—The main buildings of this depot are arranged so as to form an equilateral triangle and consist of the following:

Supply storehouse.....	50 by 190 feet.
Four storehouses.....	50 by 100 feet.
Five magazines.....	50 by 100 feet.
Six gun sheds.....	30 by 100 feet.
Lumber shed.....	30 by 100 feet.
Machine shop.....	32 by 190 feet.
Saddler shop.....	32 by 100 feet.

The remaining buildings encompass one side of this triangle in the form of a crescent and comprise the following buildings:

Office.
 Commanding officer's quarters.
 Assistant officers' quarters.
 Noncommissioned officers' quarters.
 Barracks.
 Stable.
 Garage.

Railroad facilities.—Railroad spurs are extended from the tracks of the Oahu Railway & Land Co. to the storehouses and ammunition magazines. The Oahu Railway forms a direct connection to the wharves and to the north and west of the island.

Equipment.—The Hawaiian depot, when completed, will be equipped to perform all work of such nature as is generally required to maintain coast defense armament, as well as small-arms equipment. The general plan and arrangement of the depot is such that ample provision is made for future expansion should occasion require.

MANILA ARSENAL.

Location.—After the Spanish-American War an ordnance depot and arsenal were established on the outskirts of Manila on the site of the old Spanish arsenal or "Maestranza de Artilleria," as it is called in Spanish.

Buildings.—The depot covers an area of about 14½ acres, and originally consisted of three groups of buildings, chiefly of native architecture. The first group, near the Pasig River and just within the north wall of the city, contains the workshops and the commanding officer's quarters. The second group consists of a row of four storehouses flanked by a set of officers' quarters on one end and by the drafting room on the other. This group once served for a small-arms cartridge factory. The third group, arranged in the form of a double square or figure 8, contains the issue storehouse, leather, oil, paint, and field gun ammunition warehouses, as well as quarters for the non-commissioned staff. There are in addition to these groups several detached buildings, consisting of a machine shop, power house, and a storehouse erected in 1901.

Foundry.—The foundry as originally received contained two melting pits for bronze and a 20-inch cupola for iron. The cupola, an antiquated affair, was removed and a new one of greater capacity constructed. This cupola did excellent service until 1908, when it was supplanted by a new No. 2 Whiting cupola, shipped from the United States. At that time the machine shop was entirely rearranged, the worn-out machines being replaced by 12 new modern machine tools of American manufacture.

Blacksmith shop.—The blacksmith shop has four forges, a steam hammer, punch, and shears.

Harness shop.—The harness shop has performed an immense amount of work, principally in the repair of leather equipments. The climate is extremely trying on leather goods, which necessitates constant attention. Adjoining the harness shop is the armory, a small building, but which has proven adequate for all purposes.

Features.—The original motive power of the arsenal was a 50-horsepower English-built steam engine of the condensing type, and the steam was obtained from a 50-horsepower boiler, also of English make. Due to the peculiar construction of the buildings, no two of which are parallel, the shafting arrangement involved a number of novel problems.

A new water-distilling plant of ample capacity for the needs of the depot has been developed and a new power and lighting plant, consisting of new boilers and generator, built.

The depot is now equipped to overhaul and make repairs on field artillery and all small-arms equipment; to manufacture arm racks, ammunition boxes, hangers for 75-mm. ammunition, target frames, dummy ammunition, leggins, revolver holsters, saddlecloths, waist belts, etc.

The specially packed war reserve maintained at the Manila depot rendered valuable service during the Boxer uprising in China and enabled the depot to equip promptly the force sent to China.

As our seacoast armament on the island is increased the responsibility of this ordnance depot will be increased.

NEW YORK ARSENAL.

The New York Arsenal, located on Governors Island, New York Harbor, consists of warehouse buildings, equipped for the storage and issue of ordnance stores. Adjacent to the warehouses and other buildings are wharves to and from which supplies may be transferred by lighter from the various freight terminals. Similar lighterage can be effected to vessels at anchor or they may be loaded direct at the wharves as far as capacity permits.

PANAMA ARSENAL.

Location.—Funds for the construction of this depot were appropriated in September, 1916. The site selected was Corozal, near the Pacific end of the canal and approximately halfway between Balboa and Culebra. On one side the depot is flanked by the canal, on which there is a large unloading dock, and on the other side by the Panama Railroad. Corozal is likewise connected by highways with the interior of the Panama concession.

Dock.—The large unloading dock, erected at a cost of a quarter of a million dollars, contains a large unloading basin, and is thoroughly modern, adequate facilities being provided for handling armaments of all descriptions.

Buildings.—The buildings are of modern design, constructed to a great extent of concrete, with red tile roof and large overhanging eaves. The following is a list and brief description of the buildings:

Machine shop, 40 feet by 110 feet. Under this roof is also located the quarters for the saddlers, armorers, tool room, toilets, and offices.

Barracks sufficient to quarter 35 enlisted men.

Quarters for two officers (separate buildings) and two noncommissioned officers (one building double set).

Two reserve storehouses in one double building, divided by a fire wall 40 by 200 feet.

One current-issue storehouse, 40 by 200 feet.

One magazine for small-arms ammunition, 40 by 50 feet.

One magazine for Field Artillery ammunition, 40 by 50 feet.

One magazine for inflammable materials, 20 by 40 feet.

Oil storehouse.

Wagon shed and stable.

Quarters for machinists.

Power.—It is contemplated securing the power for operating the shops from the canal power lines.

All work of equipping the shops was of necessity delayed, owing to the conditions arising from the war. It was intended, however, to furnish the shops with all machinery necessary to repair or modify the extensive coast armament, and small arms, field guns, and mountain-battery equipments.

The entire construction work was performed by the building division of the Panama Canal force and at a greatly reduced cost over the regular private contract plan. This was entirely due to the extensive equipment and through organization then maintained on the Isthmus by the canal building division.

PICATINNY ARSENAL, N. J.

Picatinny Arsenal, N. J.—Picatinny Arsenal is located 5 miles north of Dover, N. J., in a wooded valley. Dover is 40 miles west of New York on the main line of the Delaware, Lackawanna & Western Railroad. This road has two branches from New York to the arsenal, one through Paterson and Boonton, the other through Newark and Morristown. The post office, telegraph office, and express office are at Dover, N. J.; the freight office is at Picatinny Arsenal, the Wharton & Northern Railroad being the last carrier.

The reservation is about 3 miles in length by a mile in width at the widest part, embracing 1,550 acres. The naval powder depot,

about 400 acres in extent, adjoins the southern boundary and gives additional isolation for the operation of the arsenal. The tracks of the Wharton & Northern Railroad connect with arsenal sidings to the principal storehouses and other buildings.

Product.—At the outbreak of the war about 10,000 pounds per day of smokeless powder for all calibers was being manufactured, and this output was increased. Other activities of the arsenal include an extensive laboratory for routine tests, an explosive shell loading plant, and storage for explosives, powders, and ammunition. There is also a research section.

Personnel.—The research section was increased from one officer and three or four chemists prior to the war, to six officers and about 75 chemists. This is the most important division of the arsenal and would have been increased very greatly, both in personnel and laboratory facilities, had the war continued.

The military garrison of the arsenal is about 60 officers and 1,200 enlisted men, and about 1,400 civilians are employed in the office, shops, and factory.

RARITAN ARSENAL, N. J.

Location.—Raritan Arsenal is located near Metuchen, N. J., on the Raritan River, about 3 miles above Perth Amboy. It is connected with the Pennsylvania and Lehigh Valley Railroads, and has a dock frontage on the river of 2,000 feet, from which freight can be shipped by lighter to points in New York Harbor. A channel of 12 feet depth is being constructed in the river.

Division.—The Raritan Arsenal divides itself roughly into three subdivisions—the Raritan general supply ordnance depot, under the control of the supply division; the Raritan assembling plant, under the control of the production division; and the Raritan ordnance training camp, which includes the ordnance motor instruction schools, formerly located at Rock Island Arsenal and Peoria, Ill., under the control of the administration division.

General supply ordnance depot.—The general supply ordnance depot consists of 85 standard magazines, built of tile or brick with concrete floors. These buildings are 50 by 220 feet. There are also 12 high-explosive magazines of the same type of construction, 24 by 42 feet. In addition to these there are to be constructed 95 additional magazines of the smokeless powder type, 32 by 96 feet in plan. These magazines are connected with a track system which permits the movement of material to or from the Pennsylvania or Lehigh Valley Railroads, or to and from the dock located at the south edge of the reservation on the Raritan River. Material shipped over this dock is placed in lighters and transported to lower New York Bay, where it is transferred to transports.



FIG. 205. — Assembling 75-mm. field gun carriages at Rock Island Arsenal.

Assembling plant.—The assembling plant, which later was to go into full operation and be an important feature of the arsenal, consists of seven buildings, five of which are storage warehouses and two of which are of the nature of shops. In September, 1918, this assembly plant was engaged in repairing and overhauling trucks and other mobile equipment which was driven to this point overland from the manufacturers, and from here shipped overseas. Later it was proposed to assemble in these plants certain types of tank equipment and artillery matériel.

Ordnance training camp.—The ordnance training camp is composed of buildings of the standard wooden cantonment type, sufficient for housing approximately 6,500 men. In September, 1918, these units were completely filled with organizations which were being trained as ordnance guard companies and as ordnance supply companies, for work in various ordnance establishments. This camp contains in addition to the buildings indicated, two Y. M. C. A. huts, a K. of C. building, and a post exchange.

Ordnance motor instruction schools.—In the ordnance motor instruction schools, which are housed in the main section, selected enlisted men and selected officers were trained in the handling and maintenance and repair of ordnance matériel, particularly field guns and motor equipment. This organization has a separate staff of instructors and the commanding officer is independent of the camp organization, reporting direct to the administration division regarding this work.

Organization.—The organization of the arsenal follows the outline in accordance with the provisions of G. O. 5, Office of the Chief of Ordnance, 1918. The subdivisions of the arsenal noted each have their own commanding officer, who reports, so far as the details of his work are concerned, to the division interested. For administrative purposes, the entire reservation is under control of the arsenal commander, through whom administratively the various subdivision commanders report.

ROCK ISLAND ARSENAL, ILL.

Rock Island Arsenal.—The largest United States Government arsenal is the Rock Island Arsenal, occupying an entire island in the Mississippi River between the cities of Davenport, Iowa, and Rock Island and Moline, Ill. The island is about $2\frac{1}{2}$ miles long by $\frac{1}{2}$ mile in greatest width, and includes approximately 900 acres. A dam extends across the channel adjacent to the Illinois shore, and a longitudinal wing dam extends about a mile up the main river from the east (upper) end of the island. The river at this point flows west. This arsenal was established shortly after the Civil War.

Railway facilities.—The main line of the Chicago, Rock Island & Pacific Railroad crosses the lower or western end of the island.

Branch tracks are run to the arsenal, and numerous sidings connect the shops and storehouses. In the tri-cities there are also branches of the Chicago, Milwaukee & St. Paul Railroad and Chicago, Burlington & Quincy Railroad, so that this arsenal has exceptional railway facilities. Trolley lines of the Tri-City Railway and Light Co. enter the arsenal at the southern and western end and run directly to the shops.

Power supply.—Power and light for the arsenal is furnished exclusively by electric power generated in its water-power station, augmented, when necessary, by outside purchase. There were in 1918 three generators, with a total capacity of 2,500 horsepower at 12 feet head. In addition, there was under construction a new plant, which will consist of eight generators, having a capacity of 4,000 horsepower at 12 feet head, making the total capacity of the Rock Island power plant 6,500 horsepower.

Products.—Rock Island arsenal manufactures gun carriages, limbers, caissons, battery and store wagons and other vehicles for the Field Artillery; personal and horse equipment; United States magazine rifles, model 1903 (Springfield), with appendages; target material, artillery harness, miscellaneous cloth and leather equipment; and loads time and detonating fuzes and high-explosive shell and shrapnel.

Rock Island general ordnance supply depot.—The supply depot at this arsenal is one of the largest issuing depots in the Ordnance Department. It handles no stores which are not ready for issue. On July 1, 1918, the depot occupied 13 storehouses for general storehouse purposes, or a total area of 443,180 square feet of floor space; 30 ammunition and nitrate buildings, with a floor space of 300,000 square feet; and additional storehouses were authorized and under construction. The following is a summary of receipts and issues made by the supply depot during the fiscal year ending June 30, 1918, not including raw material received for manufacturing purposes:

Increase of activity.—The increase of activity of the arsenal can be best illustrated by the increase of the number of employees. Even before the entrance of the United States into the war, there had been a considerable increase in the number of orders given the arsenal. The number of employees steadily advanced during the summer and fall of 1916 until on December 31, 1916, their total was

	Number of shipments.	Number of packages.	Weight, pounds.
Receipts.....	6,773	1,078,321	118,668,040
Issues.....	25,089	1,086,929	88,924,705
	31,862	2,165,250	207,592,745

2,906. As the volume of work increased, and new buildings were put in operation, with the plant operating 20 hours per day, the number grew further until on August 17, 1918, there were 11,601, and in the summer of 1918 this force was being increased as rapidly as suitable employees could be found. As the shortage of skilled labor became acute, every possible means was adopted for the securing of skilled mechanics, including toolmakers, harness makers, carpenters, drop forgers, etc. During the war women were being largely employed in the cloth and equipment shops and as inspectors in the armory.

New buildings and construction.—Since the beginning of the war, new buildings, additions to old buildings, and permanent construction work, such as track facilities, etc., to serve these buildings, were built to the amount of \$8,618,028. In addition thereto there was under construction (August 22, 1918) permanent work to the amount of \$1,991,400. Temporary buildings (barracks, storehouses, hospitals, laboratories, etc.) to take care of demands for the present emergency only have been constructed to the amount of \$400,981. By the spring of 1918 the shop floor space had been practically doubled over that available the year previous, and the same was true of the storage space available.

Field artillery machine shops.—In the field artillery shops, one of which was erected after the beginning of the war, Rock Island Arsenal concentrated on the more difficult lines of manufacture, such as the recuperators or recoil cylinders, in the production of which the commercial manufacturers were without experience, and which threatened to be a critical point in the manufacture of the 75-mm. field guns. Deliveries on these had begun at the time the armistice was signed.

Small-arms plant.—The armory shops at Rock Island had been closed down for more than two years up to September 5, 1916. When it was decided to place this department in operation, it was necessary that the machinery be overhauled, foremen and workmen recruited, and officers familiar with the manufacture of small arms recruited from civil life. This work was accomplished and the production in the summer of 1918 was equivalent to approximately 600 rifles per day, with a considerable quantity of spare parts in addition. By January 1, 1919, with the improvements being installed in 1918, it was believed the output could be increased to 1,000 rifles per day. The model 1903 United States rifle (Springfield) and its component parts are made in this department. Up to November 9, 1918, or just prior to the signing of the armistice, the Rock Island Arsenal had turned out 47,251 model 1903 rifles, of which all but 1,680 had been manufactured subsequent to August, 1917.

Road tests.—The island is utilized for making road and other tests of all types of artillery vehicles, caterpillar tractors, trucks, etc., and much of the experimental and development work in connection with the motor and tractor program of the United States Army was carried on. The road test of artillery vehicles consists of hauling them, loaded as they would be in service, on various kinds of roads for distances of 500 to 1,000 miles. Trucks and tractors are tested under varying conditions for specified distances, or to destruction. In many cases approximately six weeks are required properly to test a truck or tractor.

SAN ANTONIO ARSENAL, TEX.

San Antonio Arsenal, Tex.—San Antonio Arsenal is situated at San Antonio, Tex., on the Missouri, Kansas & Texas Railroad, a siding of which provides direct connection with its principal storehouses. Storehouses already up and those to be erected under appropriations made by Congress are six in number. In addition there are two magazines now up and two others to be erected presently.

Product.—This arsenal is preeminently a storage arsenal, but it is provided with a machine shop for the repairs necessary for the maintenance of mobile artillery in the Southern Department. There is also a shop for the cleaning and repair of equipment and small arms, and since \$25,000 has recently been appropriated by Congress for a new shop for this purpose it is believed that orders for the direct manufacture of headstalls, bridles, saddles, and other leather goods may be advantageously handled.

Personnel.—Prior to the outbreak of the war, the Mexican situation had brought the greater part of the Regular Army and the National Guard to the Texas border. As these troops were supplied from the San Antonio Arsenal, the personnel had already been increased greatly to take care of the enlarged activities thus entailed. The number of employees during that period, however, was altogether inadequate for the subsequent demands, and from 2 officers and 103 civilians was soon increased to 5 officers, 250 civilians, and 75 enlisted men. Additional officers were asked for, and a quota of 10 was allotted to this arsenal. The enlisted men on duty include ordnance sergeants and sergeants and corporals of ordnance, as well as privates. These enlisted men are on duty in the depot and in the arsenal office on paper work, and some of them are in the machine shop, but the major part of them take care of the necessary guard duty of the arsenal.

A stockade fence has been erected across the middle of the grounds, inside of which only identified employees or others on duty are permitted to pass. This enables the guards to center their attention on such parts of the arsenal as are most vulnerable. Flood lights along all division fences and additional street lights further aid the guard.

SPRINGFIELD ARMORY, MASS.

Because of the addition of numerous buildings, the original arsenal tract of approximately 19½ acres has become badly congested.

Springfield Armory.—Springfield Armory is located at Springfield, Mass., on the Boston & Albany, and New York, New Haven & Hartford Railroads.

Product.—The principal output of Springfield Armory is the United States rifle, caliber .30 model of 1903, known throughout the service as the "Springfield" rifle. By November, 1918, this armory was manufacturing these rifles at a rate of 8,250 per week, approximately the maximum capacity of the plant.

The plant is also equipped for the making of machine guns, pistols, sabers, bolos, bayonets, etc., but the fabrication of these articles, with the exception of bayonets, was to a great extent suspended, and the entire capacity of the armory was devoted to rifles during the latter half of 1918.

In the interval from July 1, 1917, to June 30, 1918, the following articles were manufactured in Springfield Armory, the list showing both the variety and the amount of production:

Rifles	142,697
Rifle component parts.....	39,779,500
Bolos, complete	26,767
Bolo component parts.....	172,206
Bayonets	70,134
Cavalry sabers.....	7,661
Cavalry saber parts.....	48,075
Machine guns repaired.....	274
Machine gun parts.....	119,832
Rifles cleaned and repaired.....	15,096
.22 caliber rifles cleaned and repaired.....	5,786
Arms and packing chests...	35,000

Experimental department.—The Springfield Armory maintains an experimental department, in connection with which is a small-arms proving ground. It is in this department that extensive tests are made of small arms, small-arms ammunition, and small-arms equipment. Experimental work is conducted with new inventions and various devices pertaining to small arms. A considerable portion of the work of the experimental department consists of ballistic computation and research. Complete tables of fire are being computed and compiled for use with certain types of machine guns. The theoretical values arrived at are verified by actual firing on four different ranges of which this department makes use. The engineering division of the Ordnance Office has used the experimental department extensively for tests of appliances and other experimental work

covering a wide range of articles, including new inventions either developed in the department or submitted by outside individuals.

Personnel.—The number of employees at Springfield Armory increased from 2,265 on June 1, 1917, to 5,129 on June 1, 1918.

WATERTOWN ARSENAL, MASS.

Watertown arsenal.—This arsenal is situated at Watertown, Mass., within 5 miles of the center of the city of Boston, and is served by a branch line of the Boston & Maine Railroad. Its principal products before the war were seacoast carriages, armor-piercing projectiles, target material, miscellaneous forgings and castings, and repair parts for seacoast armament. Its possibilities as a manufacturing arsenal for heavy ordnance early suggested themselves, and to the original plants for the development of the plant were added a number of other projects.

Original plant and personnel.—On April 1, 1917, the plant consisted of a machine shop, blacksmith shops, small steel foundry, press shop, testing laboratory, projectile machine shop, with necessary storehouses, etc., employing 890 civilian employees under the supervision of six officers and being policed and guarded by a detachment of 16 enlisted men.

Enlargements.—During 1916 it was decided to increase the facilities for the manufacture of seacoast carriages and armor-piercing projectiles and funds were appropriated for the new seacoast erecting shop and an addition to the projectiles machine shop and for the modification of the blacksmith shop. Plans for these projects had been completed and work was inaugurated during June of 1917. The demands brought about by the war resulted in funds being appropriated during June, 1917, which were available July 1, 1917, for the construction of a modern steel plant which would supply ordnance castings in greater quantity than had been possible in the then existing small foundry at the arsenal. In August, 1917, before these plans had been completed, it was decided to build at the arsenal a gun-forging plant, and in September to build a plant for the manufacture and erection of mobile artillery carriages. To produce steel for the gun-forging plant brought about very radical changes in the original foundry plans. Also some changes in the foundry plans were required by the fact that it was considered desirable to install melting capacity for ingots to be used in mobile artillery carriage work, such as recuperator forgings, etc. All projects were completed and the plants put in operation, the arsenal on July 1, 1918, being operated at 70 per cent capacity and up to full production by October 15, 1918. The arsenal at this time consisted of five plants, arranged as follows:

(1) *Projectile plant.*—This is composed of a hardening shop and a projectile machine shop. It performs the work of forging, machining, and heat treating of armor-piercing projectiles and high-explo-

sive shell, including the manufacture of caps and base plugs, and, in addition, forges and heat treats all high-speed tools, heat treats forgings of a miscellaneous character for gun carriages, and has a small capacity for the heat treatment of small gun forgings up to 4.7-inch caliber. Extensions of the hardening shop were early completed, and equipped with machines for taking out and finishing test specimens. A further extension of this shop was also made to provide a high-speed tool shop, and a projectile storage yard served by an overhead crane provided.

Projectile plant buildings:	Length (feet).	Breadth (feet).
Hardening shop -----	285	80
Projectile machine shop -----	280	112

(2) *Seacoast carriage plant.*—This consists of a machine shop, smith shop, old seacoast erecting shop, and a new seacoast erecting shop. It manufactures seacoast carriages, miscellaneous small forgings, and miscellaneous material for seacoast carriage repair work. It is also equipped for the machining of 240-mm. howitzer carriage recuperators, and anti-aircraft guns and carriages.

Seacoast carriage plant buildings:	Length (feet).	Breadth (feet).
Machine shop (north wing) -----	295	50
Machine shop (south wing) -----	295	50
Smith shop -----	150	55
Old seacoast erecting shop -----	275	80
New seacoast erecting shop -----	462	159
Anti-aircraft section—old foundry -----	120	50

(3) *Mobile carriage plant.*—This consists of one shop 1,010 feet long by 200 feet wide, 46 feet high, fully equipped for assembling 240-mm. howitzer carriages and for the manufacture of the cradle group and for various operations on other groups.

(4) *Gun-forging plant.*—This consists of three shops, as follows—forge shop, rough machine shop, and heat-treatment shop. It is equipped for the manufacture of gun forgings up to and including guns of 6-inch caliber and howitzers of 240-mm. caliber. To this plant are delivered the ingots for gun forgings, which are then forged, rough machined, and heat treated in this plant and shipped elsewhere for final machining and assembly. The forge shop is equipped with two 2,000-ton steam presses, one 1,000-ton press, and an 800-ton press, besides the necessary preheating and annealing furnaces which are of the latest approved design. The annealing furnaces are equipped with car bottoms and recording pyrometers. All the furnaces in this building are heated with fuel oil. The machine shop contains the various lathes, planers and millers required to machine the gun forgings as they come from the forge shop. These machine tools are all driven by individual motors and are

¹ These figures are only 50 per cent of total shop, the balance being operated by the gun-forging plant.

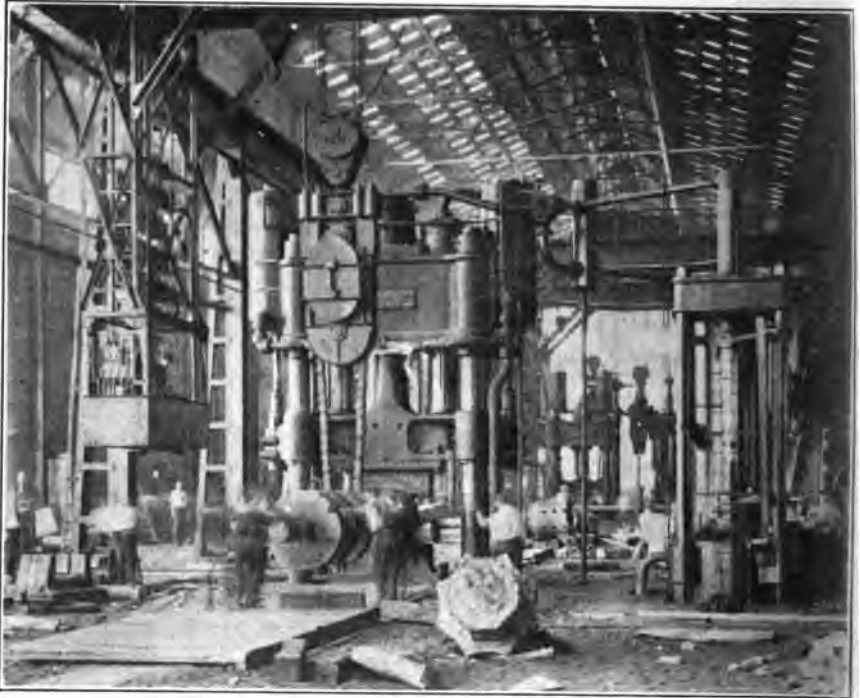

FIG. 206.—Press for gun forging at Watertown Arsenal.

supplied with cutting lubricant, which is circulated by two large centrifugal pumps from a central reservoir. The heat-treatment shop has installed in it electric heating and cooling furnaces and also gas heating and cooling furnaces, quenching pits, 750-ton straightening press, cutting off saws and sufficient lathes, drills, slotters and millers to remove the test specimens from the heat-treated forging.

(5) *Steel foundry.*—This consists of one three-bay shop equipped with open-hearth and electric furnaces; produces ingots up to 45 inches in diameter weighing 30 tons and castings for mobile and sea-coast carriages. The foundry is 510 feet long, 217 feet wide, and 76 feet high. The melting equipment consists of two 35-ton and one 15-ton open-hearth furnaces; one 2-ton and two 6-ton electric furnaces; also a steel converter and two cupolas, making a total melting capacity of 200 tons of steel a day. It is also equipped for brass melting and refining.

In addition to these five plants, there are two shops which are auxiliary in their nature and which do work for all the five plants. These are a woodworking shop and tool shop. An important feature of the arsenal is also the testing laboratory, which performs all metallurgical work and investigations in connection with the arsenal's



FIG. 207.—Electric furnace at Watertown Arsenal.

products, and conducts a large number of experiments in connection with the development of new processes, new material, and defective existing material, in which work it is in close cooperation with the engineering division of the Ordnance Office.

Power.—Steam and electric power are supplied to the arsenal from two sources:

(1) The arsenal power plant, which is equipped with six 400-horsepower automatic stoker water-tube boilers, and four 185-horsepower hand-fired boilers. Electric power is generated by one 250-kilowatt Corliss engine-driven generator; one 300-kilowatt turbo-generator, and a 750-kilowatt rotary converter fed from the Edison Electric Illuminating Co. lines in the arsenal.

(2) The central substation, which receives power from the Edison Electric Illuminating Co., of Boston, at 13,800 volts and distributes this energy as alternating current and converts it to direct current. Station has a capacity of 20,000 KVA. A large proportion of this

electrical energy furnished is used in the electric furnaces and for operating the alternate current apparatus. The equipment of the substation consists of—

One 1,000-kilowatt synchronous motor generator set.

Three 500-kilowatt synchronous motor generator set.

One 50-kilowatt synchronous motor generator set.

Three 500-kilowatt transformers.

Six transmission lines totaling 12,000 KVA.

Compressed air at 100 pounds pressure is furnished from the power station by two 1,000-cubic foot steam-driven air compressors, and from the central substation by two 2,000-cubic foot and one 1,000-cubic foot air compressors, electrically driven. The load of the arsenal on September 1 was averaging 6,000 KVA alternating current and the energy consumption about 2,800,000 kilowatt hours per month. The compressed air demand was averaging 3,000 cubic feet per minute.

Fuel and water.—Water for generation of steam and for miscellaneous purposes is furnished by the metropolitan water system. Water for manufacturing purposes is to a large extent supplied by a pumping station which takes water from the Charles River. Two motor-driven pumps of 750 gallons per minute capacity each are installed. Fuel oil for open-hearth furnaces and heating furnaces is supplied from eight storage tanks in the arsenal, aggregating 495,000 gallons capacity. An additional storage tank of 2,500,000 gallons is located on tidewater in Chelsea, enables tank steamer shipments to be unloaded direct and then transferred by the tank cars belonging to the arsenal from this point to the arsenal. In addition to the above the arsenal owns 50 tank cars of 10,000 gallons capacity each, for transportation of fuel oil. Coal is obtained by rail and is stored in a coal storage yard of 6,000 tons capacity, located near the power house.

Fire protection.—Fire protection is afforded by a 12-box automatic fire-alarm system which sounds the alarm on bells and on the power plant whistle. The fire fighting apparatus consists of an automobile fire truck and pumping engine with hose carts and other equipment.

Yard.—The arsenal yard covers about 85 acres. The various shops are connected by railroad tracks and roads, and material is transported by railroad cars and automobile trucks.

Personnel.—On September 1, 1918, there were approximately 3,700 civilian employees, 350 enlisted men, and 68 officers on duty. When the arsenal is at full capacity the total civilian personnel required is from 5,000 to 5,500.

Cost of improvements.—The cost of improvements, including those decided upon, those made prior to the war, and those since the war, approximated \$13,000,000 up to the end of hostilities.

WATERVLIET ARSENAL, N. Y.

Watervliet Arsenal.—Watervliet Arsenal is situated on the west bank of the Hudson River directly across from Troy, N. Y., and about 6 miles north of Albany, N. Y., at the upper terminal of the river passenger and freight transportation lines. It is served by the Saratoga division of the Delaware & Hudson Railroad. It occupies a plot of 106 acres in the city of Watervliet, upon which are situated all of its manufacturing buildings as well as quarters for officers and enlisted men. The arsenal has been dependent for water supply upon the municipal system of Watervliet, which consists of a drainage area terminating in a dam and reservoir situated at French Mills. A filtering plant located at this point purifies the water before it goes into the city mains. The arsenal has installed pumps on the Hudson River, from which a large volume of water can be pumped for fire protection and for manufacturing purposes, and in emergency can pump into the Watervliet city mains. The arsenal is supplied with electricity from the plants of the Adirondack Electric Light & Power Corporation, and in addition has a small water turbine fed from the Erie Canal which furnishes lighting current for the barracks and quarters.

Organization.—The arsenal is organized along the lines of a commercial manufacturing plant, all the purely military or semimilitary



FIG. 208.—Gun shop Watervliet Arsenal with 14-inch gun suspended from travelling crane.

activities being separated from those pertaining purely to manufacture. Under the commanding officer there is a works manager, who has complete charge of all phases of manufacture, including purchase of supplies, employment of labor, and the building and equipping of shop buildings, leaving the military and office divisions, such as the armament, medical, quartermaster, schools, orders, cost, finance, property, allotment, correspondence, and publicity divisions, under the control of the commanding officer through the administrative officer.

The new gun shop.—This building is 200 by 600 feet and is equipped with machinery designed to give an output of four 240-mm. howitzers and two 155-mm. guns per day.

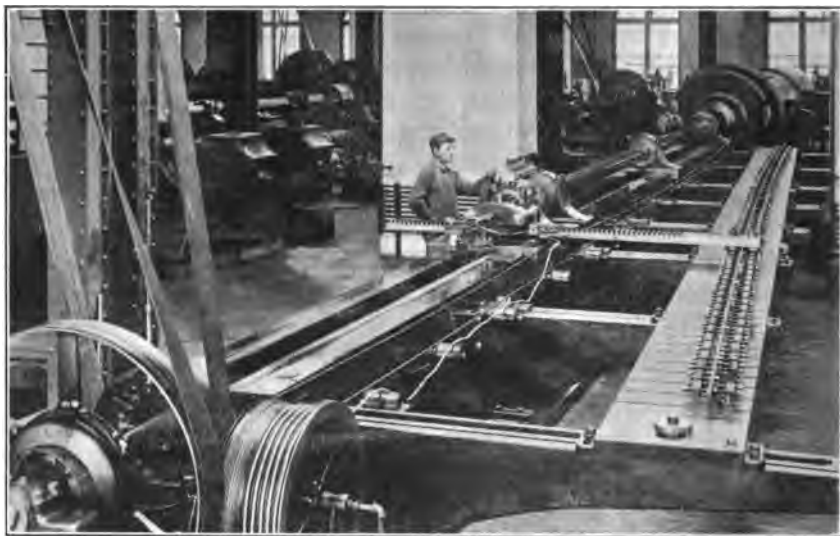

FIG. 209.—Lathe for rifling large caliber guns at Watervliet Arsenal.

The liner shop.—This building is 200 by 500 feet. It is equipped with machinery designed to prepare finished liners for shipment abroad for the relining of large-caliber guns worn out in service.

Breech mechanism shop.—This building is built on the H plan, of reinforced concrete, mushroom type, and has three wings connected by passages. The building is three stories high and has a total floor area of 140,400 square feet. It is equipped with machinery designed for the manufacture of breech mechanisms and spare parts for a number of different caliber guns and howitzers. This new building was completed, equipped, and occupied without interfering with the manufacturing operations originally started in the old gun shop from which the machinery was moved by installments.

New tool room.—This is equipped with special machinery for the manufacture of jigs and fixtures required in the manufacturing operations of the arsenal.

Pump house.—This building is built on the banks of the Hudson River on the arsenal grounds. Large electric-driven pumps are installed which draw water from the river and force it into either the arsenal or the city mains. By the installation of chlorinators in the line, purified water has been furnished the city of Watervliet in emergencies. The water from these pumps, however, is primarily intended for fire protection and industrial purposes at the arsenal, and separation is being made between the fire mains and the mains carrying water for drinking and other purposes.

Cannon relining school.—This is a school for 1,000 enlisted machinists. It has been conducted with a view to training men in the shops on various manufacturing operations pertaining to the building of cannon, and especially on those operations pertaining to the relining of guns. This school was to furnish a reservoir from which men might be drawn for service in ordnance shops abroad. During the war the officers and enlisted men in attendance were organized into Ordnance Depot companies and after about three months' training were sent overseas.

Y. M. C. A.—The Y. M. C. A. building has been provided by the war work council of that organization. The building cost \$20,000, and includes bowling alleys, billiard tables, writing and reading rooms, gymnasium, and an auditorium. This building is situated adjacent to the arsenal baseball grounds, thus offering the best facilities for athletics and physical training, both outdoor and indoor, besides many recreational features.

The general supply ordnance depot.—This depot operates under the supply division of the Ordnance Department. About 30,300 square feet of storage space is used, a new storehouse having been added to the old buildings formerly comprising the storehouses. About 283 clerks and storehouse laborers are employed under the direction of two officers.

Housing.—Local facilities for housing employees having been exhausted, the United States Housing Corporation planned the erection of a hotel on the arsenal grounds to accommodate 150 unmarried men, and providing 90 cottages to accommodate married employees. These projects involved a total expenditure of \$300,000. Many employees find accommodations in the cities of Troy and Albany, being assisted in selecting locations by the housing department of the arsenal, which maintains a register of all available rooms and apartments and has its own automobiles in which it can take the families of workmen to look over prospective locations.

Plant and personnel.—The original plant was used for the manufacture of guns of all caliber above 1 pounder, both of built-up tube and of wire-wound construction, forging being obtained from outside plants and shipped to the arsenal for machining, assembling, and final finishing. The annual output of cannon prior to the war was approximately seacoast cannon, 29; mobile artillery cannon, 21; naval guns, 10. The plant then comprised a large gun shop, having lathes of sufficient size to rifle 16-inch guns. The remainder of the plant consisted in a breech mechanism shop, a carpenter shop, and a small shop. The number of officers on duty were 4, the number of enlisted men 60, and the number of civilian employees, 422. Since the entrance of the United States into the war the plant was expanded by the addition of a new gun shop, a new liner shop, a new breech mechanism shop, a new tool room, a carpenter shop, a pump house, a welfare and cafeteria building, and cantonment to house 500 enlisted men, involving an expenditure of over \$11,000,000. This would provide for the employment of a total of about 10,000 workers, of which 4,400 were employed by October, 1918. Of this number 194 were women. The authorized military personnel at this time was 59 officers, including technical officers on duty in shops, 418 enlisted guards and general purpose troops, and 1,000 enlisted men in the cannon relining school.

XIX. GAUGES.

Gauges and interchangeability.—In the manufacture of ordnance, as in any other product the parts of which have to be assembled with others, it is necessary to make each component part identical and similar to every other corresponding part within certain specified limits, since it is obviously impossible to fit each part and at the same time secure rapid production. Every gun and every shell of the same nominal size must be interchangeable. Also, in order that parts of gun carriages, rifles, etc., may be replaced when worn or broken, the parts must be accurately alike in form and dimensions. To do this a variety of gauges must be provided to check the parts while being made. If the part being manufactured has screw threads, gauges have to be provided to test the *pitch*, *angle*, and *pitch diameters* of both the male and female threads. If a profile of the part is important, a *profile gauge* has to be provided. If the depth of a hole is an important consideration, *depth gauges* must be provided to test them. Obviously the gauges for these different purposes have a wide variety of forms and in some cases are quite complicated.

Tolerances.—Before gauges can be designed it is necessary to fix the tolerance, or slight deviations from perfections which all work must have in some degree, for the parts to be gauged. This constitutes one of the most difficult phases of the whole subject of manufacturing. Tolerances must not be made smaller than are necessary, because it increases the cost and delays production. On the other hand, they must be so small that the product as a whole will properly function when assembled. It therefore calls for an intimate knowledge of the manufacturing processes and their limitations.

Prewar conditions.—Prior to the entrance of the United States into the war quantities of munitions required by the Army were quite small and were supplied by the Government arsenals or by a few firms that by long experience had learned to make what was required. The standards maintained under prewar conditions were high. As soon as these same munitions were needed in large quantities the conditions were at once changed, and the facilities of the firms and arsenals that had heretofore made these products were totally inadequate to meet the demands. Other sources of supply, therefore, had to be found.

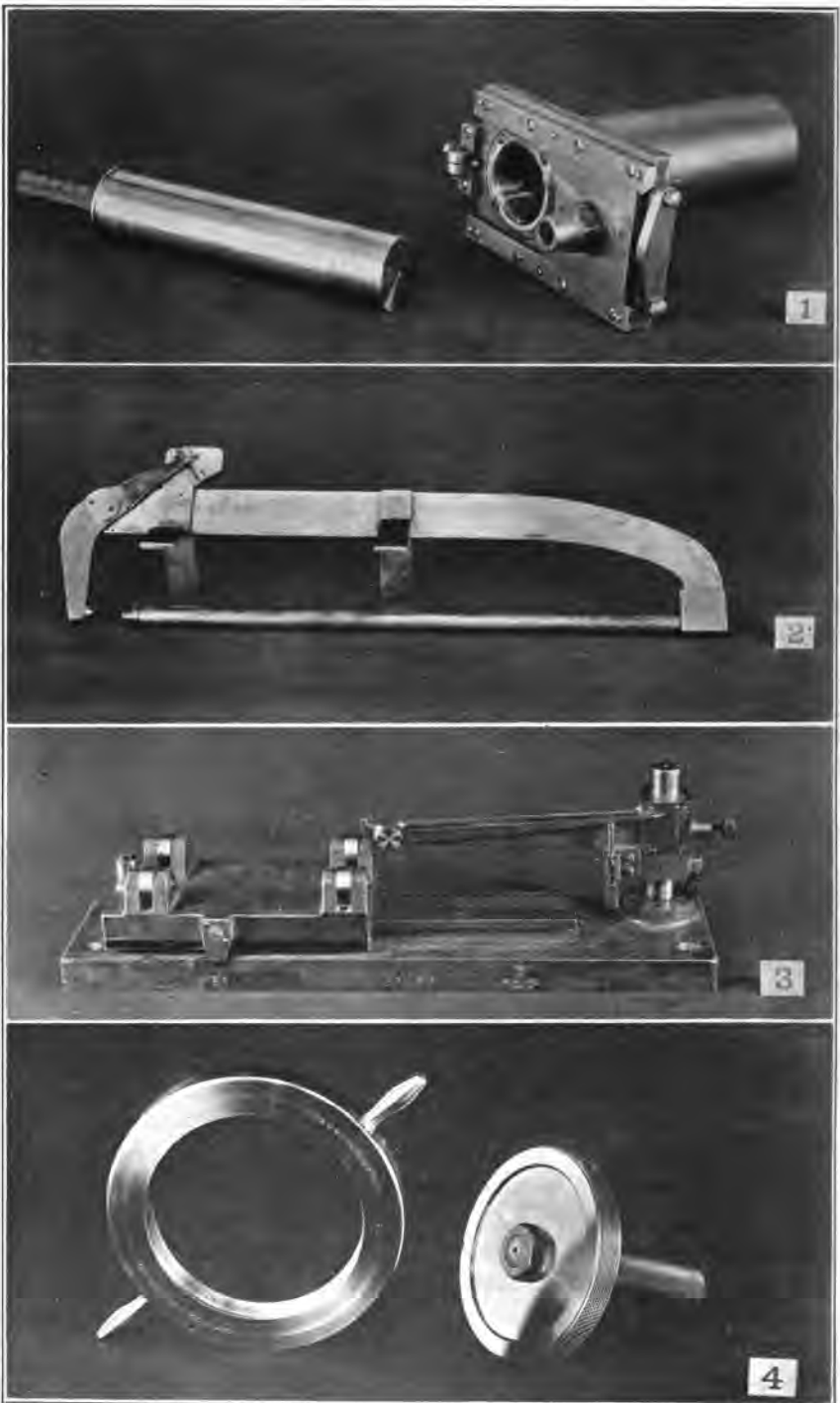

FIG. 210.—Miscellaneous types of gauges. 1. Chamber gauge and check plug for 75-mm. gun. 2. O. O. gauge for base thickness of shell. 3. Frankford Arsenal concentricity gauge. 4. Screw thread gauges, ring and plug type.

Manufacture of gauges.—Many concerns that had no previous experience in the manufacture of munitions were suddenly called upon to supply them. Whenever any of these firms undertook the manufacture of any parts the gauge question would immediately arise. It was not long before the demand far exceeded the ability of such well-known firms as the Brown & Sharp Co., Pratt & Whitney Co., Greenfield Tap & Die Co., and the Taft-Pierce Co. This demand was met to a great extent by a number of machinists and gauge makers throughout the country, who established shops for the making of gauges. But plainly these firms, lacking the experience of the older firms above cited, could not work to the same degree of accuracy, and even the latter were unable to maintain their old standards due to the fact that they could not obtain the skilled workmen employed by them before the war. These conditions made it necessary to increase the gauge makers' tolerances in order to secure the absolutely necessary gauges to proceed with the work.

Ordnance department gauge work.—Prior to the war and up to the middle of November, 1917, the gauge work for artillery ammunition and small arms was centralized at Frankford Arsenal, while cannon gauges were taken care of by the Watervliet Arsenal, and small-arms gauges by the Springfield Arsenal. On the date mentioned the work of the Frankford Arsenal was transferred to Washington, and upon the establishment of the engineering division on January 14, 1918, the gauge section was organized for the purpose of handling all gauge questions effecting ordnance matériel.

Bureau of Standards.—In conjunction with the Bureau of Standards, steps were taken as soon as war was declared with Germany to provide a central testing laboratory, where all gauges might be certified. The Bureau of Standards being by law charged with the custody of standards, and already having a splendid equipment available, the work of testing was established in that institution.

Specifications.—Specifications and tolerances for gauges were prepared and issued during the latter part of 1917 for the guidance of the gauge draftsmen and for the manufacturers of gauges. These were widely distributed to the manufacturers of gauges, as well as to the manufacturers of the components, who, in many instances, made their own working and inspection gauges, and also supplied the inspection gauges required by the Government inspectors.

Ordnance tolerances.—One of the first necessities was the establishment of thread tolerances that would meet the conditions of the enormous production required and at the same time insure the proper functioning of the parts. As the most important question to be here considered was that of the tolerances and the gauges, the subject was referred to the gauge section of the Ordnance Department. In conjunction with the Bureau of Standards and a number of manufac-

turers a systematic set of screw-thread tolerances for the United States standard screw was agreed upon in November, 1917, which proved to be entirely satisfactory for artillery ammunition and was used without change until March, 1918, at which time the tolerances on one of the dimensions was increased, without, however, disturbing the production of gauges or of components.

Classes of gauges.—Three classes of gauges are usually provided for the manufacture of ordnance and ordnance components, namely, *master gauges*, *inspection gauges*, and *working gauges*.

Master gauges.—According to American practice master gauges represent the limits beyond which the work must not vary. In other words, they represent the extreme dimensions permitted by the established tolerances. These gauges are never used to test the work, but are maintained solely for the purpose of checking the inspection gauges; consequently they wear very slowly.

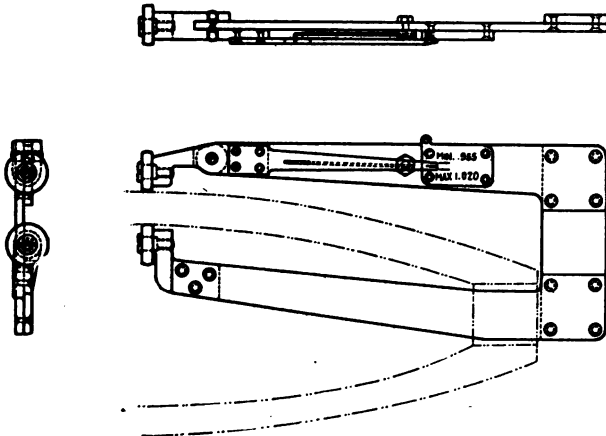

FIG. 211.—Sketch showing type of gauge used to inspect thickness of wall of shell and shrapnel.

Inspection gauges.—These are used by the inspector to test the work, to insure that it is within the specified limits or tolerances. In order to allow for wear, these gauges are dimensioned differently from the master gauges and may be used until their gauging dimensions have worn to the limiting size fixed by the corresponding master gauge. The English practice is somewhat different, and inspection gauges are allowed to wear and pass work outside the limits fixed by the tolerance.

Working gauges.—These are used by the workmen to test the work while it is being machined or, if the machinery is automatic, after the work has been finished. Like the inspection gauges, working gauges are made so as to allow for wear. The dimensions of the working gauges should be such as to insure the acceptance of the work passed by them.

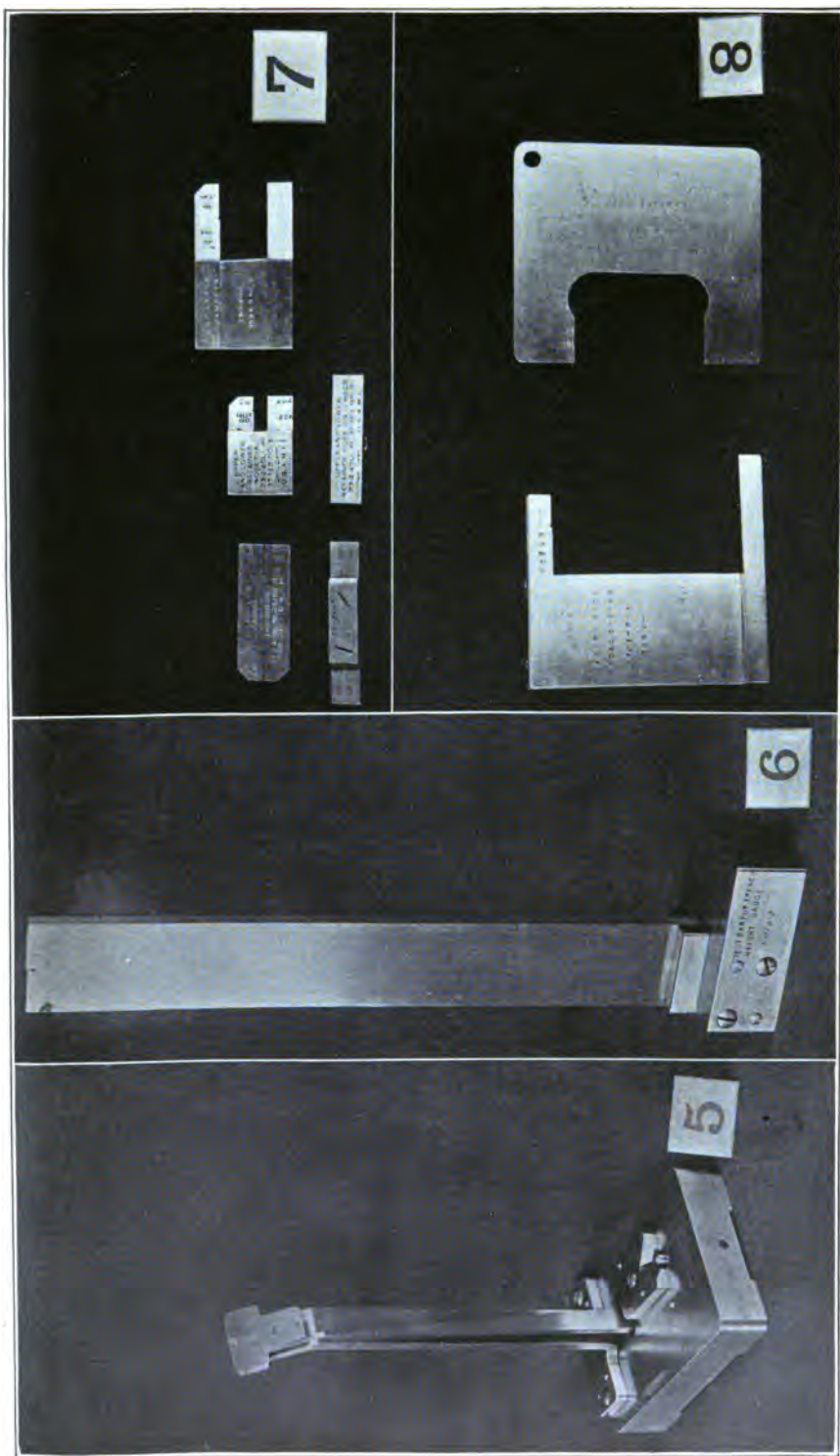

Fig. 212.—Indicator, height, and snap gauges. 5. Indicator gauge. 6. Indicator gauge. 7. Test bar for French height gauge. 7-8. Snap gauges, built up and solid.

Maximum and minimum gauges.—For every dimension gauged a maximum and minimum gauge must be provided, and the work is rejected if it is larger than the former or smaller than the latter.

Design of gauges.—The mere physical work of designing and manufacturing gauges for the varied matériel provided by the Ordnance Department for the Army is in itself a monumental task. To pro-

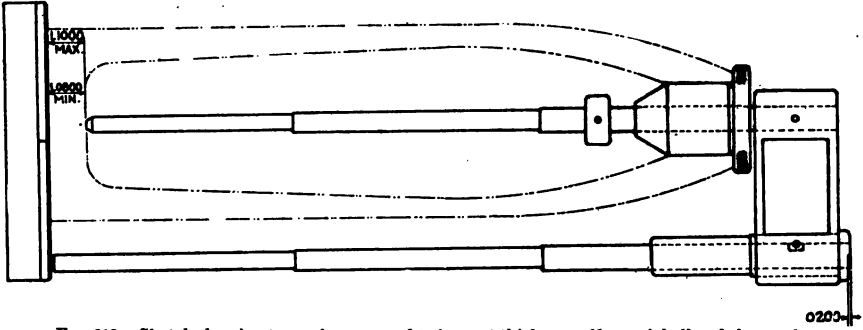

FIG. 213.—Sketch showing type of gauge used to inspect thickness of base of shell and shrapnel.

vide for the requirements of artillery ammunition alone no less than 6,000 different gauges had to be designed. The question might well be asked at this point, Why were the gauges not designed before the outbreak of the war? The answer is very simple. Practically every shell designed prior to the outbreak of the war has been modified as a result of experience in the field. Also a large number of entirely

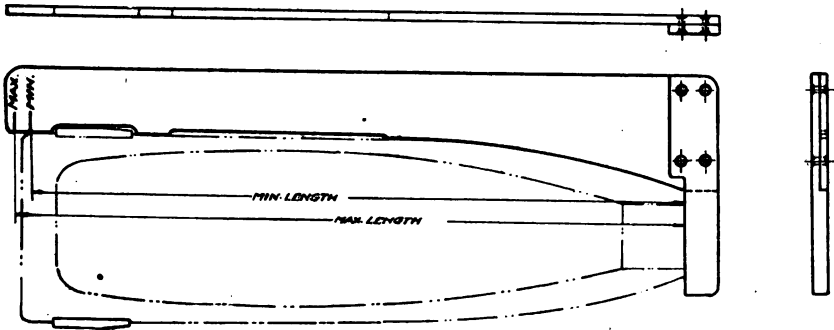

FIG. 214.—Sketch showing type of gauge used to inspect total length and profile of shell.

new shells with their respective components were developed, such as gas and anti-aircraft shells, etc., for which gauges had to be provided. Furthermore for shell adopted from our allies it was not always possible to secure useful gauges that could be reproduced.

Production and cost.—After the design of the gauges has been completed the next difficulty is in obtaining gauges by the time production begins. As a rough estimate, 10 sets of master gauges are required to supply each manufacturing plant with a set. This would

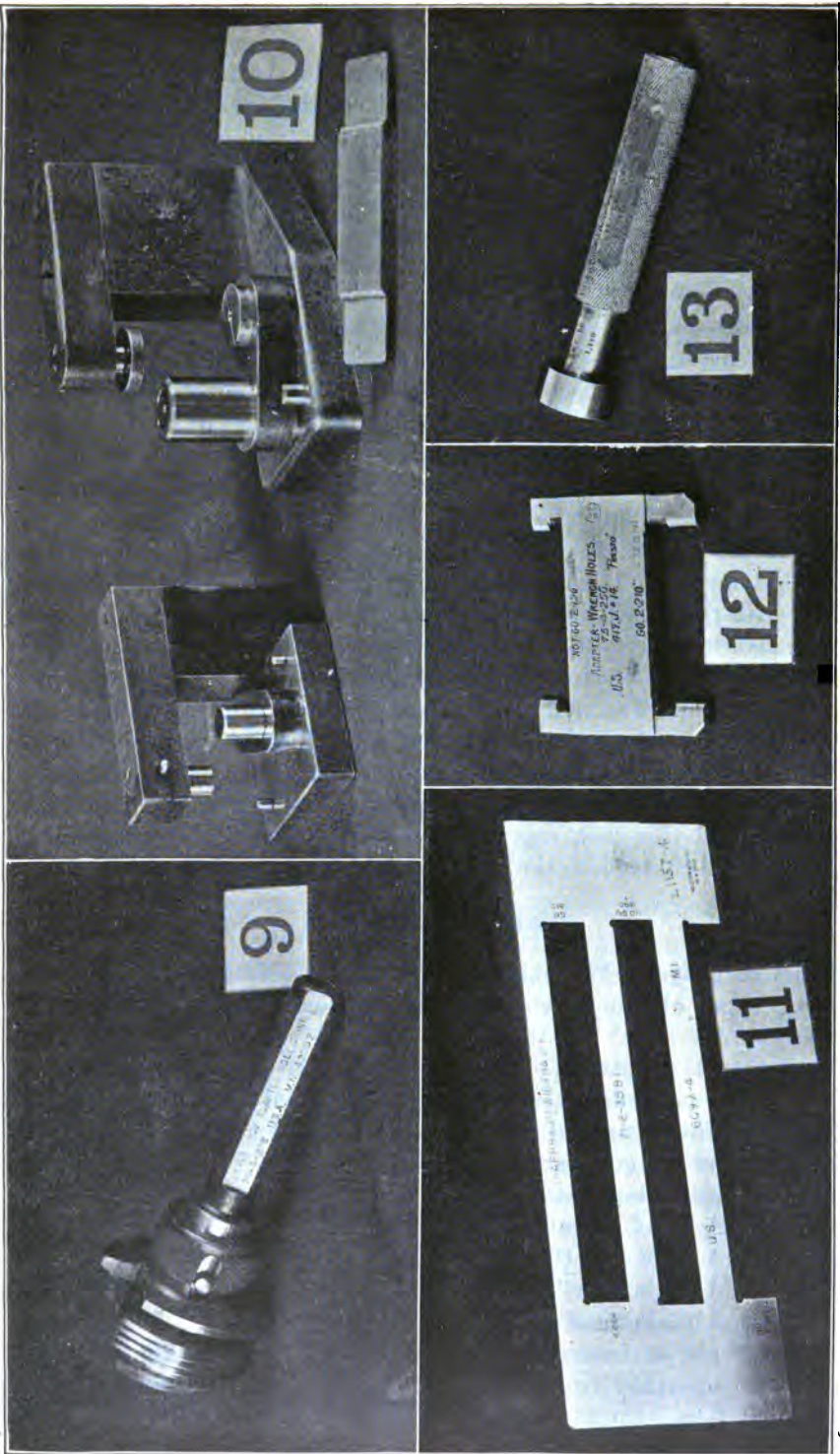

FIG. 215.—Typical gauges designed or approved by the Ordnance Office, gauge section 9. Thread gauge for adapter hole an I shell top. 10. Flush pin gauge an I check. 11. Diameter width and I diameter gauge. 12. Snap gauge for adapter wrench hole. 13. Plug gauge for hole in TNT.

mean 10 times 6,000 or 60,000 master gauges for artillery ammunition. Estimating the cost per gauge at \$20, the cost is \$1,200,000 for master gauges for artillery ammunition. Perhaps 10 times as many inspection gauges and 20 times this number of working gauges would be required by the manufacturers. Assuming that the inspection and working gauges cost one-third as much as the master gauges, the total cost of gauges for artillery ammunition alone would be \$13,000,000.

Estimates.—Gauges for cannon, for mobile gun carriages, railway, seacoast carriages, trench warfare material, machine gun small arms, motor equipment, etc., would each cost approximately the same amount, so that a conservative estimate of the amount of money spent for gauges would in round numbers be about \$91,000,000. Plainly this is a very rough estimate. The sum might easily reach twice this magnitude indeed, but would hardly fall below it.

Conference with allies.—The matter was further complicated by the fact that much of the material ordered had to be interchangeable either with the English or the French, for which tolerances were not always available. By the summer of 1918 tolerances for most of the principal components had been worked out and master gauges provided for them. The number of inspection and working gauges required was naturally greatly increased as production was speeded up.

One of the main obstacles encountered by the allies was the impossibility of securing an adequate supply of gauges of the required accuracy, and this lack was never really overcome. The entrance of the United States into the war only increased the difficulty.

TYPES OF GAUGES.

Types of gauges.—The following paragraphs describe briefly the leading types of gauges employed in the manufacture and test of ordnance.

Screw-thread gauges.—To determine whether a screw thread is within limits as to effective diameter and lead, and at the same time to insure that the desired thread form has been maintained, the following gauges are necessary:

A. To test a male thread—

1. A "go" thread ring.
2. A "not go" thread ring.
3. A plain "go" ring.
4. A plain "not go" ring.

1 and 2 are to insure that the pitch or effective diameter are within the specified limits, while 3 and 4 check the tops of the threads.

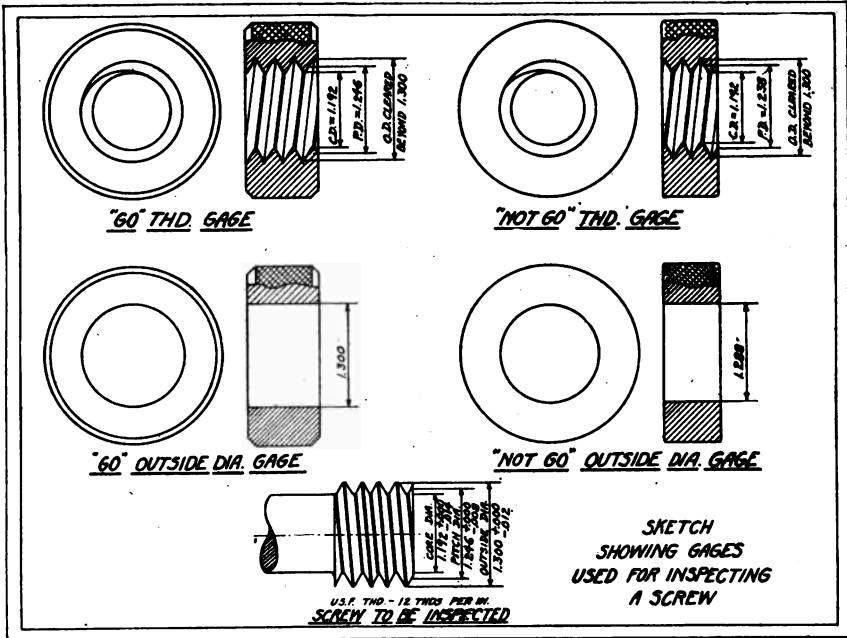

FIG. 216.—Gauges used for inspecting a screw.

B. To test a female thread—

The same number of gauges is required, the only difference being that instead of rings, thread and plain plugs are used.

Gauges made in accordance with the above plan for testing a screw are shown in the diagram above figure 216, while on the following page in a similar diagram, figure 217, are shown a corresponding set for testing a nut.

Caliper gauges.—The standard caliper gauges found in the market are carefully hardened and ground, and accurately lapped to size. By their use mistakes in the setting of calipers and variations in measurements by different workmen are in a great measure avoided. The measuring surfaces are amply large to insure accurate measurements and the maintenance of gauge sizes. As furnishing convenient and reliable standard sizes for every-day use in the workshop they are of great advantage, and their use contributes to uniformity in the production of the working parts of the machinery.

These gauges are furnished with both ends finished, one end for internal and the other for external measurements, in sizes to 3 inches. They are also furnished to these sizes with one end only finished and provided with handles, either for internal or for external measurements.

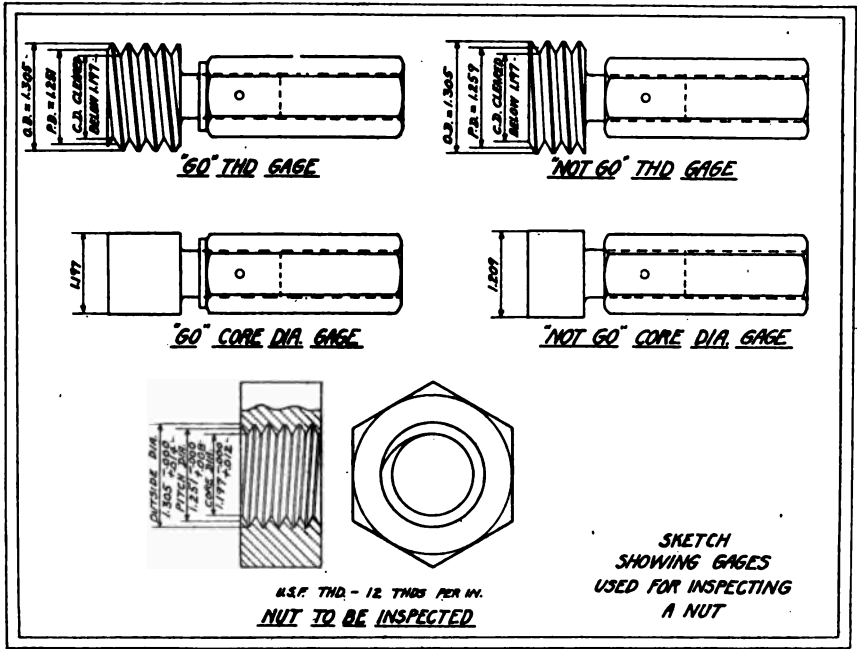

FIG. 217.—Gauges used for inspecting a nut.

Standard cylindrical gauges.—The standard cylindrical gauges are of the plug and ring form, the selection depending on whether a cylindrical part or a hole is to be tested.

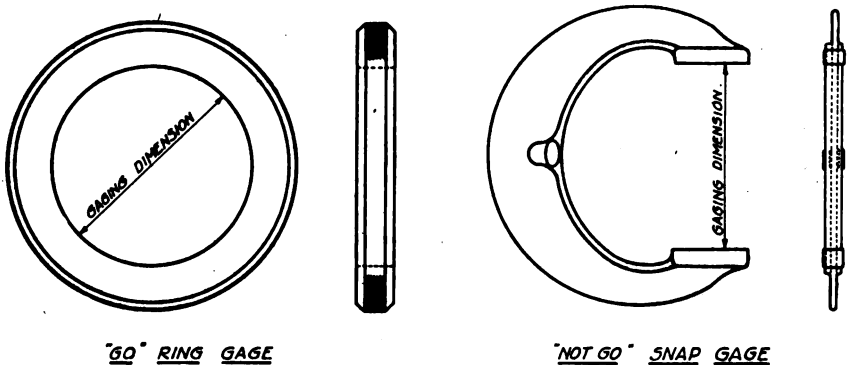

FIG. 218.—Types of ring and snap gauges.

Snap gauges.—Snap gauges are convenient, light and rigid, and intended for general shop work. With them even an ordinary operator can detect a very minute difference between two pieces of apparently the same dimension. Several types are shown in figures 212 and 215.

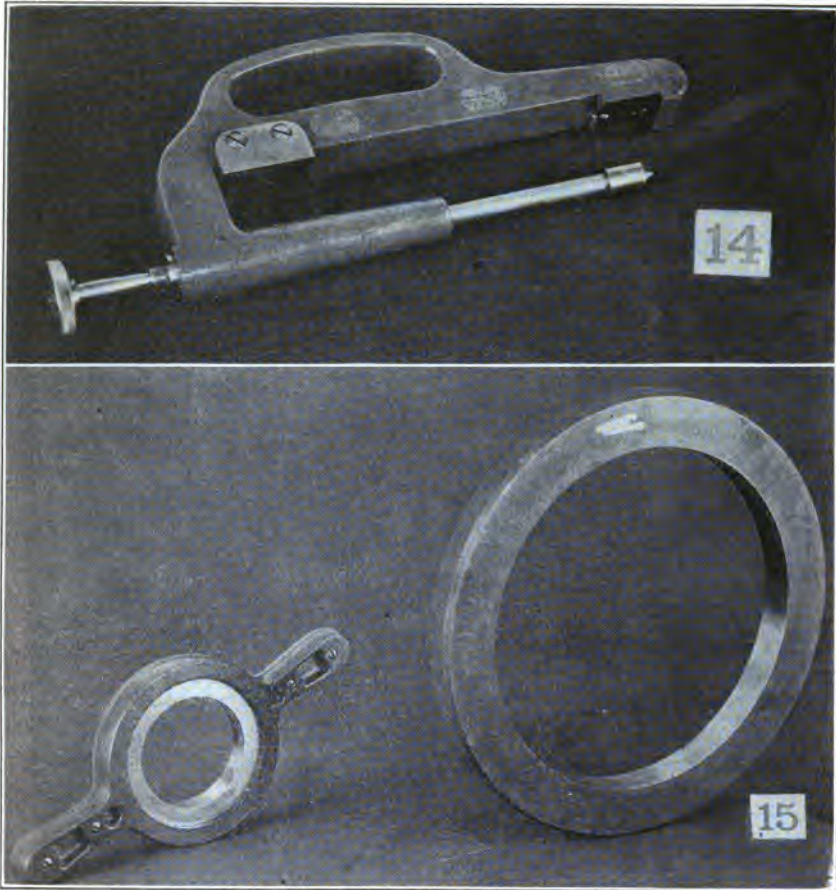

FIG. 219.—Two types of ordnance gauge. 14. Frankford Arsenal gauge for shell base thickness. 15. Ordnance department ring gauges.

Star gauges.—The star gauge was developed to meet the demand for a convenient and accurate instrument for gauging the bores and jackets of guns of all sizes. It is equally suitable in other lines of work where great accuracy is required.

Ring gauges.—In order to limit the use of the micrometer as much as possible, standard rings of the same diameters as the parts to be measured are provided. The micrometer screw which enables a quantitative determination to be made, is, therefore, only used to measure the small differences between the work to be inspected and the standard rings.

Taper gauges.—Taper gauges are similar to the plug and ring gauges of cylindrical form, with provision made for the required degree of taper.

United States standard thread system.—The exceptional merit of the United States standard thread system has long been acknowledged,



FIG. 220.—Gauges for testing holes or cavities. 16. Square taper gauge and check. 17. Cavity diameter gauge.

and the importance of its general adoption has been persistently urged by the engineering profession. Its universal adoption as the standard of all Government work in the United States and the continental European countries, also by all railroads and practically all the other manufacturing industries in the United States, is largely due to the fact that it is the only form of thread by which interchangeability in manufacturing is possible. This was appreciated by the manufacturers of ordnance in America who were called upon to adopt the various screw threads employed on foreign munitions to American conditions of manufacture.

A. S. M. E. gauges for machine screws.—The A. S. M. E. standard, so called to distinguish it from the United States standard thread, is the outcome of the efforts of the American Society of Mechanical Engineers to place the manufacture of machine screws and taps upon a more practical basis. The form of thread is the same as the United States standard.

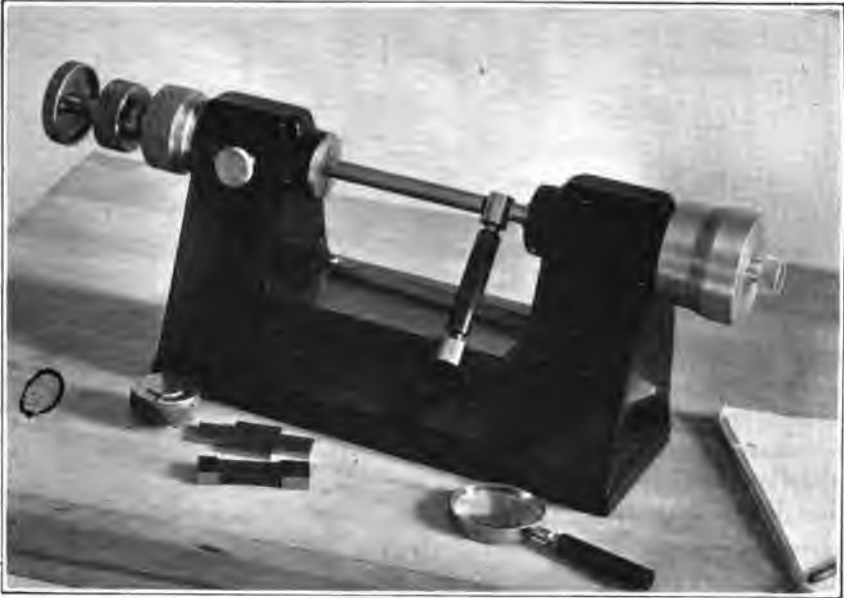

FIG. 221.—Micrometer for testing diameter of plug gauges.

Thread plug limit gauges.—The thread plug limit gauges have the minimum or “go” end made longer than the maximum or “not go” end. This not only takes care of the greater amount of wear borne by this end but also helps readily to distinguish it from the other. The gauge ends are inserted in the handle. Threaded ends when worn can be replaced, and, both limits being on the same gauge, there is no danger of their being separated and either plug misplaced.

Limit snap gauges.—The limit snap gauge is for testing the diameter of round or cylindrical surfaces, or any external diameter, within specified limits. The first, or upper, pair of contacts is set to the maximum limit. The second, or lower, pair of contacts is set to the minimum limit. The article being measured should pass the first points, but should not pass the second. To provide against wear from long-continued use, the contacts are adjustable by means of set and locking screws. Recesses back of the set screws can be filled with wax with a seal impression on same to prevent tampering.

Rapid inspection limit gauges.—The rapid inspection limit gauge is designed especially for rapid inspection of external diameters or sizes. The solid extension jaw facilitates use by guiding same to the measuring points at right angles thereto. For measuring cylindrical work while on the machine it is only necessary to invert the gauge, laying the extension jaw on the work, and sliding the gauge forward.

Concentricity gauges.—To determine whether two assembled parts of a component are not eccentric to such extent as to interfere with

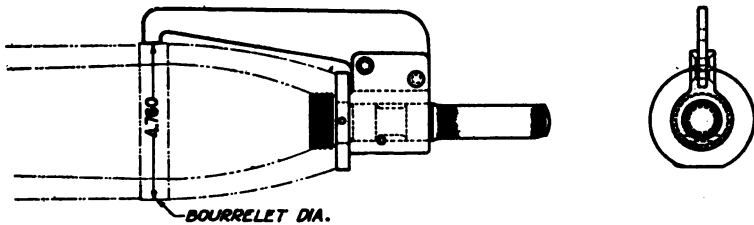

FIG. 222.—Sketch showing type of gauge used to inspect concentricity of fuze thread and bourrelet diameter in shells.

their proper functioning, they are tested with what is termed a concentricity gauge.

A good example of the need of such a gauge is the booster, the exterior thread of which must be sufficiently concentric with the body to insure its entrance into the cavity provided for it in the shell. It is obvious that if the cavity is not concentric with the thread in the nose of the shell and the body of the booster is not concentric with the outside thread on the booster, there will be interference at certain positions as the two are screwed together, provided, of course, that the eccentricity is sufficiently great. The same interference would take place between the interior of the booster and the fuze if the threads involved are not concentric within the certain required limits.

In order to take care of the inevitable lack of concentricity and to divide it between the two parts which may be made by different contractors, the following rule for computing the dimensions of such gauges has been established.

For gauge to check the inner component add 40 per cent of the clearance, viz, the space between the smallest outside component and the largest inside component to the maximum inside part permitted by the tolerance.

For gauge to check the cavity dimensions subtract 40 per cent of the clearance from the minimum dimension of the cavity.

The gauge for the inner component will be a chamber gauge, while the gauge to check the cavity will be a plug gauge.

The above distribution of clearance is entirely arbitrary and is not always adhered to. If the relative difficulty of manufacturing one component is much greater than that of the other, the distribution of the clearance between the gauges for the two components should be such as to take care of this condition.

An example of the foregoing method of computing the dimensions of concentricity gauges is shown on the following sketch. The maximum dimension of the inner component can be $1.235 + 0.005 = 1.24$. The minimum dimension of the outer component is 1.29. The difference between them is 0.05, and 40 per cent of this is 0.02.

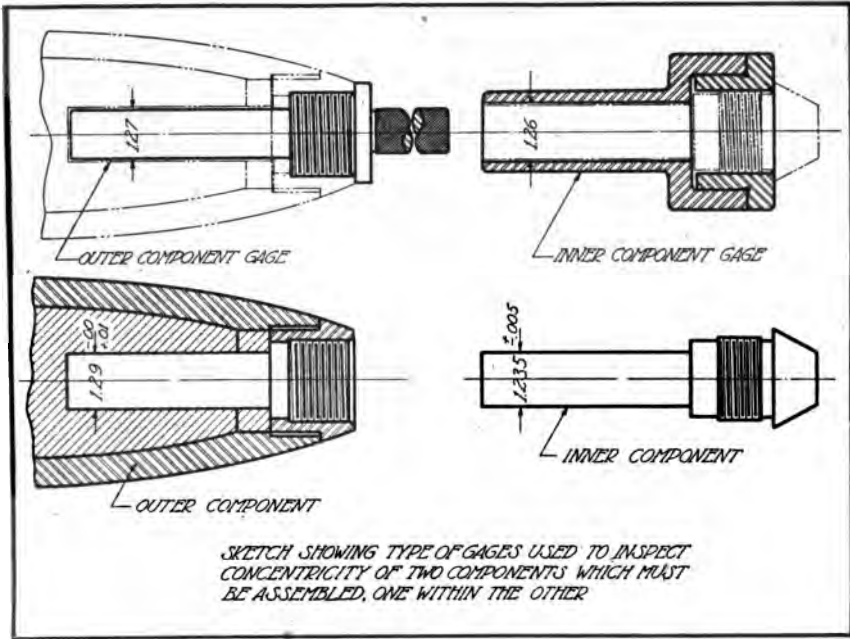

FIG. 223.—Concentricity gauges.

According to the above rule, therefore, 0.02 should be added to the maximum inside component, which is 1.24, making it 1.26 for the gauge to test the inner component, and the same quantity should be subtracted from the minimum dimension of the outside component, which is 1.29, making it 1.27, to obtain the dimension for the gauge for the outer component. The diagram above figure 223, shows the concentricity gauges for both inner and outer components of a booster casing and shell.

Commission for standardizing of screw threads.—An act (H. R. 10852) to provide for the appointment of a commission to standardize screw threads was passed by Congress July 13, 1918, and received the signature of the President.

Purpose.—The purpose of the commission was to ascertain and establish standards of screw threads for acceptance and adoption in manufacturing plants under control of the War and Navy Departments, as far as practicable, for screw threads in general use throughout the United States.

Organization.—Nine commissioners were appointed, one of whom was the director of the Bureau of Standards, who acted chairman of the commission; two commissioned officers of the Army, appointed by the Secretary of war; two commissioned officers of the Navy, appointed by the Secretary of the Navy; and four appointed by the Secretary of Commerce, two of whom were chosen from nominations made by the American Society of Mechanical Engineers and two

from nominations made by the Society of Automotive Engineers. The commission, which immediately began its labors, making its headquarters at the National Bureau of Standards, was to cease and terminate at the end of six months from the time of its appointment.

Questions to be considered.—There are mentioned herewith several items in connection with screw-thread standardization which were to be brought before the commission for consideration.

(a) Consideration as to type of thread to be used, such as United States standard form, Whitworth form, or International thread form.

(b) Establishment of dimensions and tolerances for United States standard threads; A. S. M. E. threads; and also fine pitch threads, which will result in interchangeable screws and nuts of different grades.

(c) The establishment of rules or formulas which will specify such tolerances and dimensions as to insure interchangeability and to provide for different grades of work.

DEFINITIONS.

The following are definitions of terms commonly used in gauge work:

Allowance.—Variation in dimensions to allow for different qualities of fit.

Angle diameter.—Same as pitch or effective diameter.

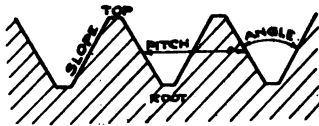

FIG. 224.—Screw thread profile.

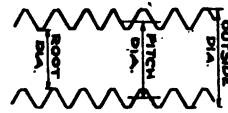

FIG. 225.—Screw thread characteristics.

Angle of thread.—The total or included angle between the sides or slopes of a thread, normal to a plane passing through the axis of the screw or nut.

Clearance.—The space between a screw and a threaded hole.

Clearance angle.—Allowance on the angles or slopes of the thread for screw threads to fit together.

Clearance, bottom.—Allowance or space at bottom of a thread to prevent a bearing at this point and to provide space for dirt.

Clearance, outside.—Allowance between outside diameter of screw and bottom tapped hole.

Core diameter.—English term for the root or bottom diameter of a screw and the small diameter of a nut. In the case of the nut it is measured between the crests of the thread. (See Root diameter.)

Crest.—English term for the top or most prominent part of a thread, whether on the screw or in the nut.

Effective diameter.—English term for pitch diameter and defined as the length of a line drawn through the axis and at right angles to it, measured between the points where the line cuts the slopes of the thread.

External diameter.—Same as full diameter or outside diameter.

Finger fit.—Where the screw fits the tapped hole so as to be just screwed in with the fingers.

Flow of thread.—The movement of metal in a screw or nut, or both, when screwed together by force, to fit in spite of an error in lead.

Flute.—The groove cut in taps and reamers to form cutting edges and to allow room for chips.

Franklin Institute thread.—The form of thread adopted by the Franklin Institute in 1864. It is a 60-degree angle thread with one-eighth of the vertical height cut from the top and filled in at the bottom. It is not confined to any special series of pitches.

Full diameter.—English term for outside diameter.

Gauge, check or checking.—Gauge for checking or testing other gauges.

Gauge, limit.—A gauge for insuring that any given dimension is within the tolerance laid down for the class of work to be produced.

Gauge, master.—A gauge which is kept as a standard, solely for comparing reference gauges.

Gauge, reference.—A gauge used by the manufacturer and by which the workman's gauge is tested. (A copy of the master gauge.)

Gauge, shop or workman's.—A gauge used by the workmen in every day practice. It is tested by or with the reference gauge.

Land.—The spaces between flutes on a tap or reamer. It includes the cutting edge and the supporting metal behind it.

Lead.—The distance a screw advances in one turn. In a single thread screw this is the same as pitch.

Lead, normal.—Correct lead.

Limits.—Two sizes expressed by positive dimensions, the larger being termed the maximum and the smaller the minimum limit.

Limit gauge.—See Gauge, limit.

Outside diameter.—Diameter at the outside of the thread. External or full diameter.

Pitch.—The distance from a given point on one thread to a similar point on the next thread, along the axis of the screw. The same as lead for a single thread. The reciprocal of threads per inch.

Pitch diameter.—Same as the effective diameter. Also defined as the diameter of a screw at a point midway of the depth of the thread. Equal to the outside diameter less the depth of one thread. This depth equals:

For V threads, $\frac{0.866}{\text{threads per inch}}$.

For United States standard, $\frac{0.6495}{\text{threads per inch}}$.

Relief.—The reduced diameter behind the cutting edge of a tap.

Root.—Bottom or smallest diameter of thread, whether in screw or nut.

Root diameter.—The smallest diameter, whether for a screw or in a nut.

Slope of thread.—The angular part which connects the large and small diameters of a thread.

Thread, modified "V."—A form of thread having a 60-degree angle and such that if carried to a sharp point it would measure to the nominal size, but with the top or bottom, or both, modified usually by being flattened, according to conditions or individual ideas.

Thread, United States standard.—The standard adopted by the United States Government, which uses the Franklin Institute form of thread, with a definite pitch for each diameter. (See Franklin Institute thread.)

Thread "V."—A form of thread having a 60-degree angle and sharp at top and bottom. Impossible in practice and always more or less modified, whether intentional or not.

Thread, Whitworth.—A thread having a 55-degree angle and a rounded top and bottom. The proportions are:

$$\text{Depth, } \frac{0.640327}{\text{threads per inch.}}$$

$$\text{Radius of top and bottom, } \frac{0.37329}{\text{threads per inch.}}$$

Thread micrometer.—A micrometer caliper with special points for measuring the pitch or angle diameter of the screw.

Threads per inch.—Number of threads in 1 inch of length.

Tolerance.—The allowable variation in size, equal to the difference between the minimum and maximum limits.

Turns per inch.—The number of turns required to advance 1 inch. Equal to the threads per inch of a single-threaded screw.

Wrench fit.—Where the screw fits the tapped hole so tightly as to require a wrench to screw into place. Used for cylinder studs in steam engines and for similar work.

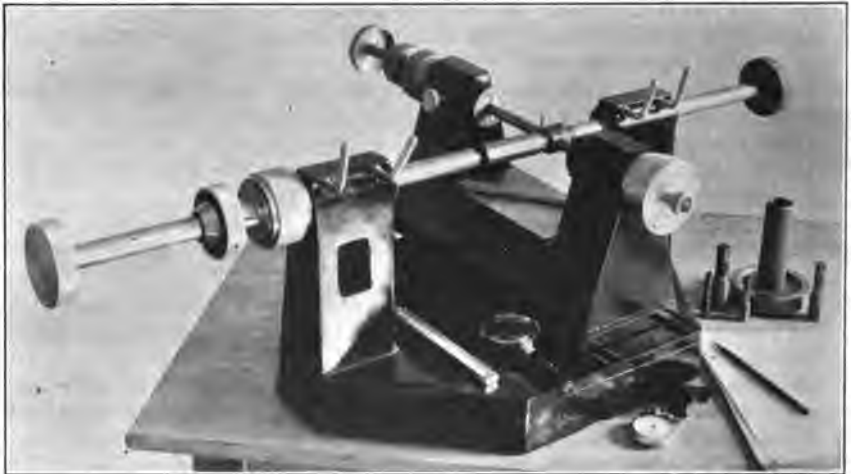

FIG. 226.—Apparatus for testing pitch diameter of screw thread gauges.

Figure 226 illustrates the method of determining the pitch or effective diameter of plug thread gauges. For this measurement three wires of such a diameter as will make the wires touch the mid-slope of the thread are used. The wires should have the same diameter within 0.00005 inch and the mean diameter of the three wires should not differ more than 0.001 inch from the size that would make contact with the thread at the mid-slope.

For making the measurements a large bench micrometer similar to that shown in the cut is very convenient, but if such a micrometer is not available the ordinary micrometer shown on page 465 will answer the purpose.

The following tables give the sizes of wires best suited to measure the effective diameters of screws of the United States standard forms, namely, angle included between the sides of the thread 60°, and both

the top and bottom of the threads flattened an amount equal to removing one-eighth the height of the thread and filling in the bottom an equal amount:

Number of threads per inch.	Diameter of best size of wire.	Number of threads per inch.	Diameter of best size of wire.
	<i>Inch.</i>		<i>Inch.</i>
80	0.0072	14	0.0412
64	.0090	13	.0444
50	.0116	12	.0481
44	.0131	11	.0525
40	.0144	10	.0577
36	.0160	9	.0642
32	.0180	8	.0722
28	.0206	7	.0825
26	.0222	6	.0962
24	.0241	5½	.1050
22	.0262	5	.1155
20	.0289	4½	.1283
18	.0321	4	.1443
16	.0361		

The formula for computing the effective diameter after the measurements have been made is as follows:

Effective diameter = measurement over wires \times H—three times the mean diameter of wires.

The values of "H" given in the following table depend upon the number of threads per inch of the screw to be measured.

Number of threads per inch.	"H."	Number of threads per inch.	"H."
	<i>Inch.</i>		<i>Inch.</i>
80	0.01083	16	0.05413
64	.01385	14	.06186
50	.01732	13	.06662
44	.01968	12	.07217
40	.02165	11	.07873
36	.02406	10	.08660
32	.02706	9	.09623
28	.03093	8	.10825
26	.03531	7	.12372
24	.03608	6	.14434
22	.03936	5	.17321
20	.04330	4	.21651
18	.04811		

XX. AMERICAN ORDNANCE BASE DEPOT IN FRANCE AND CONSTRUCTION AND MAINTENANCE DIVISION.

**OFFICE OF THE CHIEF ORDNANCE OFFICER, S. O. S.,
A. E. F.**

Original project in United States.—The provision of ordnance repair facilities for the American forces in France was the purpose contemplated by the Chief of Ordnance in Office Order No. 47, September 10, 1917, which established the division of American Ordnance Base Depot in France. Col. D. M. King was relieved from duty at Rock Island Arsenal in July, 1917, and ordered to Washington to take charge of the project and directed to proceed with the design and procurement of the necessary buildings, machinery, and equipment and to secure the personnel required for operating the various shops and establishments then proposed. It had been learned, through the French High Commission, that no existing shops or facilities would be available for the repair of ordnance matériel for the American Expeditionary Forces.

Steps were at once taken to assemble the required commissioned personnel, and, in order to facilitate the work of design and to expedite the purchase of the large amount of material and equipment required, contracts were negotiated early in August, 1917, with the firm of Stone & Webster, of Boston. They at once opened offices in the building occupied by the division of American Ordnance Base Depot in France, and the preliminary work which the undertaking involved was promptly begun.

The project, at its inception, contemplated the erection, at a point then undetermined, of a complete ordnance establishment, which would combine at one center repair and warehousing facilities, consisting of approximately 38 buildings, estimated to cost in the neighborhood of \$25,000,000 when erected and equipped. As soon as the tentative plans were completed three officers were dispatched to France (September, 1917) with instructions to submit the project to the commander in chief and to return as promptly as possible with the information required to complete that part of the work that must of necessity be done in the United States. In the meantime the procurement of the buildings, machinery, equipment, and materials was actively under way. The organization was being perfected

and the commissioned personnel was being carefully selected and assembled. On October 22, 1917, the first shipment of material was made from the United States, consisting of one steel warehouse, on the steamer *Arcadia*.

The officers who had been sent over were so urgently needed in France they were not permitted to return, and ultimately word was received that tactical considerations made it undesirable to locate the ordnance facilities at one central point, and that the tentative project in this respect was not approved. It was learned that steps were then being taken in France to secure sites for shops and depots at various points.

By the middle of February, 1918, 273 officers had been selected and assigned, more than 8,400 men of mechanical training had been recruited and enlisted by the officers of the division, as it had developed that enlisted personnel would not be available from other sources, and selected groups of both officers and men were receiving special training in the handling and care of ordnance matériel at various arsenals and schools of instruction. The work of design was practically completed, orders for approximately 90 per cent of all the buildings, machinery, equipment, etc., had been placed, and this material was reaching port well in advance of the capacity for shipment overseas. Representatives of Stone & Webster had then been in France several months to arrange for the receipt and care of material on arrival, and to prepare for the active prosecution of the construction work, which, however, they were not permitted to undertake, as all construction work was taken over by the Engineer Corps.

Col. King, accompanied by a group of 35 officers, sailed for France on February 18, 1918, with the intention of actively undertaking the erection of the shops and equipment then arriving. He left in the United States a sufficient organization to complete the work of purchase and shipment, and to follow up the delivery of the remaining material required. There had already sailed as much of the enlisted personnel as it was possible to dispatch under the American Expeditionary Forces program, and other units were organized and awaiting orders for overseas duty, their departure being governed by the priority schedule for the shipment of troops abroad.

Transfer to France.—On his arrival in France, Col. King found conditions existing which made it impossible to take active charge of the work which he had inaugurated. Soon after his departure from the United States, the division of American Ordnance Base Depot in France was abolished (March 2), and its function and personnel transferred to the control of the Supply Division, in which it continued to function as a special section.

General progress.—The original project straightway was pushed forward on an enlarged scale. Of the buildings, machinery, tools, and

equipment projected, there had been delivered to the piers on July 1, 86 per cent of the total quantity. On that date 57 per cent had been shipped overseas, and 30 per cent was at the piers awaiting shipment while, in the month of July, approximately 11 per cent of the total was shipped. All of the material which had been received in France was required for the use of the Ordnance Department, and that which was still to arrive was urgently needed. Much of it was put in service at once, and, in many cases, it provided greatly needed ordnance facilities. Similarly the operation of such ordnance facilities in many cases, was made possible only through the commissioned and enlisted personnel secured for the American Ordnance Base Depot in France project.

Construction and maintenance.—The functions of the construction and maintenance division included those for which the former division of American Ordnance Base Depot in France was organized.

This division was established by the Chief Ordnance Officer, American Expeditionary Forces, in office order No. 7, June 17, 1918, as follows:

Subject: *Construction and maintenance division.*

1. There is hereby established the construction and maintenance division of the office of the chief ordnance officer, A. E. F. (to be known as Division C). The functions of this division are:

2. Provision and maintenance of buildings and their facilities:

(a) To perform such engineering work or to represent the chief ordnance officer in dealings with other branches of the S. O. S., A. E. F., in the selection of sites, preparation of plans, and arranging for construction of ordnance facilities, such as shops, depots, etc.

(b) To represent the chief ordnance officer in all matters relating to construction of ordnance facilities, cooperating with other branches of the S. O. S., A. E. F., and providing such supervision as may be required.

(c) To follow up and report on progress of ordnance construction work, projected and under way, in France.

(d) To anticipate and plan in advance for the provision of such construction of ordnance facilities as may be needed.

(e) To provide for such periodical inspection of buildings and equipment as may be necessary to their proper maintenance and to make or cause to be made such repairs as may be necessary.

3. The determination of an installation of necessary machinery, tools, and equipment and the inspection and maintenance thereof for—

(a) General ordnance repair shop.

(b) Ordnance depot repair shop.

(c) Mobile and semipermanent ordnance repair shop attached to line organizations.

4. Operation of general ordnance repair shops.

5. Supervision of ordnance depot repair shops, including the provision and assignment of personnel.

6. Supervision of mobile and semipermanent repair shops attached to line organizations, including provision and assignment of personnel.

7. Cooperation with salvage corps in matters of repair or disposition of ordnance matériel.

8. Cooperates with the instruction section of development division in the preparation of courses of instruction. Furnishes or passes upon fitness of men selected as instructors in repair work. Furnishes shop facilities for instruction purposes.

9. Col. D. M. King, ordnance, U. S. Army, is designated as chief of this division.

10. The division will consist of the following sections:

- CA—Administration section.
- CC—Construction section.
- CD—Depot repair shop section.
- CG—General ordnance repair shop section.
- CM—Mobile repair shop section (including semipermanent shops attached to organizations).
- CS—Salvage section.

C. B. WHEELER,
Brigadier General, Ordnance, National Army,
Chief Ordnance Officer.

NOTE.—All personnel for ordnance depot or mobile repair shops will be furnished from general ordnance repair shop.

During 1918 construction work for the American Expeditionary Forces was performed by the director of construction and forestry and by French contractors working under his general direction. This division had no part in the actual work of construction, but was responsible for anticipating, planning, and effecting the arrangements for construction work, following up the progress thereof, and exercising general supervision over construction activities for the Ordnance Department in France, also the inspection, maintenance, and repair of such facilities, all as outlined in the order quoted above.

Shop and maintenance section.—The installation, operation, inspection, and maintenance of ordnance repair shops as described in the office order quoted includes:

General ordnance repair shop.—This group of shops, known as the Atelier de Mehun-sur-Yevre, is in the intermediate section for the Toul sector, and is in the advance section for the Paris sector, and is located near Mehun (Cher.). It was in the course of construction prior to the cessation of hostilities. In these shops were to be performed all serious ordnance repairs, and, when completed, they would have consisted of:

	Feet.
1 carriage assembly shop.....	240 by 500
1 carriage machine shop.....	226 by 500
1 woodworking shop.....	200 by 320
1 forge and foundry.....	160 by 245
2 gun shops, each.....	245 by 600
1 reamer shop.....	182 by 240
1 tractor shop.....	245 by 620
1 tractor shop.....	122 by 580
1 tank repair shop.....	245 by 620
1 small-arms shop.....	240 by 500

Warehouses for the storage of shop supplies, tools, etc.—The buildings machinery, equipment, etc., comprising this general ordnance repair shop were designed and ordered as part of the original project of the American Ordnance Base Depot in France. Several circumstances contributed to prevent satisfactory progress in the erection of these shops, but of chief importance was the lack of adequate construction labor and interruption to the work by the removal of construction troops to other duties elsewhere. Numerous attempts were made to cause a sufficient number of construction troops to be assigned to this project. Lack of sufficient construction material, especially stone and cement for concrete, also appreciably retarded the progress of these shops.

Advance repair shop at Is-sur-Tille.—This repair shop went into operation November, 1917, and by the following summer was performing general ordnance repair on practically all classes of ordnance matériel, except the repair of cannons and the repair of cloth, leather, and similar equipment included in class 1, G. O. 10, Headquarters American Expeditionary Forces, in which order it was directed that the repairing of such matériel should be performed by the salvage service. The repair facilities at Is-sur-Tille include a small shop for fine machine work, a machine shop for heavy repairs, a carpenter shop, a small-arms shop, optical instrument repair shop, and a small brass and gray iron foundry. In addition to repair and replacement, the Is-sur-Tille shops performed certain special manufacturing work such as the making of experimental mounts for anti-aircraft guns, metal parts for reinforcing howitzer platforms, and various other special parts and articles, as well as alterations and adaptations of a miscellaneous character. These shops provided the principal repair and replacement facilities to the Army in the Toul sector.

Railway artillery and corps repair shop at Hauséumont.—This shop was originally projected by the heavy artillery division. Its erection, installation, and operation were later turned over to the construction and maintenance division. It was in operation at the end of the summer, although not fully equipped. Primarily intended for the repair of mounts for railway artillery, the equipment was such that the general ordnance repair work for an Army corps could be performed in this shop, and its functions were rather of a general corps repair shop than a special shop for the repair of railway artillery matériel, as originally intended.

Corps repair shop at Doulaincourt.—While this shop was largely authorized to serve an O. and T. center, its geographical location made possible its utilization for general ordnance repair service of limited volume, and it therefore assumed the function of a combined corps repair shop and O. and T. center repair shop, performing general ordnance repairs of limited volume and serving the artillery

training centers in the area in which it was situated. The machinery and equipment were installed in existing buildings which were available for the purpose, and limited repairs were being performed by the early summer of 1918.

Corps repair shop at Lioussaint.—This corps repair shop was established in an existing sugar mill to serve the Paris sector. Its function was the repair of machine guns and small arms, and machinery and equipment suitable for performance of general ordnance repairs were duly installed.

Other corps shops.—Other corps shops, to perform the same general functions as those described above, were to be established as authorized. It was agreed that such shops should combine the repair activities on small arms, machine guns, and artillery matériel, in order to avoid the duplication of tools and equipment and to utilize to best advantage the limited skilled mechanical personnel.

Other functions of construction and maintenance division.—The function of this division, so far as mobile ordnance repair shops were concerned, was to supply missing or defective tool equipment, and to train the necessary personnel for such units. This work was performed at Is-sur-Tille and the various organization and training centers, the latter particularly in the case of heavy mobile repair shops.

Ordnance armament school at St. Jean Demonts.—The function of this school was to train armorers for air-service squadrons; to train ordnance small-arms and machine-gun inspectors for service with infantry divisions; and to perform experimental work on small-arms ammunition and aircraft armament matériel for the Ordnance Department. The installation of a machine shop was authorized at this school.

Ordnance aerial armament shop at Courbevois.—There was in operation at this point a small machine shop for making experimental matériel, synchronizing mechanism, and performing the general shop-work required in the armament of aircraft.

Ordnance shop at Romorantin.—This consisted of a small shop, with no machining facilities, and performing handwork in working in machine guns, mounting and synchronizing same on aircraft, work on synchronizing mechanisms, etc.

Ordnance shop at Orly Field.—This was a shop of the same character and performing the same class of work as that performed at Romorantin.

The operation of the shops at Courbevois, Romorantin, and Orly Field came under the jurisdiction of this division only in the summer of 1918, having hitherto been under the control of the aerial armament service. Certain changes in the locations of shop facilities were recommended to this division.

Tank and tractor repair shops—Chalindrey.—Authorization to establish a shop for the repair of tanks and tractors was requested. The site for same was selected at Chalindrey, and arrangements were made to proceed with the establishing of such a shop. Buildings of a special type, originally designed for the advance tractor shop of the A. O. B. D. F. were in France, and available for this project. Machinery and equipment originally procured for the advance tractor shop were also available.

Bourg.—In accordance with orders received from the chief ordnance officer, machine tools and equipment were furnished to the Tank Corps at Bourg for the installation of a tank repair shop at that place.

Small-arms corps shop.—The small-arms corps shop at Void was in the zone of the Army and not under the control of this division.

Experimental shop at Langres.—At Langres was a training school for officers of all arms of the service, and for Army candidates. This school was established by G. O. 32, G. H. Q., February 13, 1918, for the instruction of selected soldiers to fit them for commissions in the Infantry, Cavalry, Engineers, and Signal Corps. The ordnance activities at this place were considered to be under the control of the post commandant, and regarded as coming under the jurisdiction of this division.

Repair shops at O. and T. centers.—These shops were established as authorized and consisted of a standard equipment of machinery, tools, and supplies. Where existing buildings were available, they were utilized for the shop activities. If not available, suitable buildings were erected. Considerable difficulty was encountered in securing the necessary machinery, tools, and equipment for these shops, much of same having to be purchased in the European market, which was unfortunately a very limited one. It was possible to provide some of the required equipment from that originally ordered for the A. O. B. D. F. project, and requisitions for additional equipment were forwarded to the United States.

Shops of this class were established at the following places:

Libourne.—Officially designated as O. and T. Center No. 1. Artillery troops were issued 155-mm. G. P. F. guns, and the accompanying tractors and equipment. Technical instruction on guns and tractors was given at this place. The Ordnance Department maintained a very complete machine shop at Libourne, which was in operation from July 15, 1918, using as motive power a 40-horsepower Packard truck engine. The function of this shop was the repairing of 155-mm. matériel, tractors, and trucks. As there was no firing done, most of the repairs were on tractors and trucks.

Limoges.—Officially designated as O. and T. Center No. 2. Artillery troops were issued 8-inch British and 9.2-inch howitzers, and the

accompanying tractors. Technical instruction on howitzers and tractors was given. The Ordnance Department maintained a repair shop, authorized by G-4 section of the General Staff, May 2, 1918, and operating on August 1, 1918, using electric power. The function of this shop was the making of repairs to above matériel and tractors. Modifications on 8-inch British howitzers, American manufacture, also were made. As there was no firing done at this point, most of the repairs were on the tractors.

Clermont-Ferrand.—Officially designated as O. and T. Center No. 3. Artillery troops were issued 155-mm. guns and the accompanying tractors. Firing practice, as well as technical instruction on matériel and tractors, was given at this place. Shops for ordnance repair were authorized by G-4 section of the General Staff, May 2, 1918, and buildings were completed on July 31, 1918. Machinery was installed and shops made ready for operation by the 1st of September. The function of this shop was the repair of the above matériel and tractors. As this was a firing range, the work was about evenly divided between artillery matériel and tractors.

Angers.—Officially designated as O. and T. Center No. 4. Artillery troops were issued 8-inch and 9.2-inch howitzers and accompanying tractors. Technical instruction was given on the above. The Ordnance Department was to maintain a shop here as soon as the French authorities had finished the shop building. Fifty per cent of shop installation had been received and 50 per cent was in transit by September, 1918. Electric power was available at this point. This shop was authorized by G-4 section of the General Staff, May 2, 1918. The function of the shop was to be the repair of above howitzer matériel and tractors. During the autumn modifications were made on the American-manufactured 8-inch howitzers.

Coetquidan.—This was a Field Artillery training camp, where troops were issued 75-mm. gun and 155-mm. howitzer matériel. Technical instruction and firing practice were given at this place. The Ordnance Department maintained a repair shop, authorized by G-4 section of the General Staff, May 2, 1918. Fifty per cent of shop installation had been received and 50 per cent was in transit before the cessation of hostilities. When the shop was put in operation, electric power was to be used. Previously any work requiring machinery was done in French private shops. The function of the shop was the repair of the above matériel.

La Courtine.—Field Artillery training camp, where troops were issued 75-mm. guns and 155-mm. howitzers. Technical training and firing practice were given here. The Ordnance Department maintained a repair shop, authorized by G-4 section of the General Staff, May 22, 1918. Fifty per cent of shop installation had been received and 50 per cent was in transit by September, 1918. A 25-horsepower

gasoline engine was to be used for motive power. The function of this shop was the repair of above matériel, and repair of 8-inch and 9.2-inch howitzers and tractors when same were sent from Limoges to La Courtine for firing practice. Machine work was done by mobile ordnance repair shop.

Meucee.—This was a Field Artillery training camp, where troops are issued 75-mm. guns and 155-mm. howitzers. Technical instructions and firing practice were given at this place. The Ordnance Department maintained a repair shop, authorized by G-4 section of the General Staff, February 10, 1918, the buildings for which were not completed prior to the autumn of 1918. Fifty per cent of shop installation had been received and 50 per cent was in transit when hostilities ceased. A gasoline engine was to be used as motive power. The function of this shop was to have been the repair of the above matériel. Prior to its completion any work requiring machinery was done in French private shops.

Souge.—This was a Field Artillery training camp, where troops were issued 75-mm. guns and 155-mm. howitzers. Technical instruction and firing practice were given on the above, as well as firing practice for 155-mm. guns from Libourne. The Ordnance Department maintained a shop at Souge, authorized by G-4 section of the General Staff, January 31, 1918, and operating June 15, 1918. The function of this shop was the repair of the above matériel, and 155-mm. gun matériel and tractors when same were at Souge from Libourne for firing practice.

Valdahon.—This was a Field Artillery training camp, where troops were issued 75-mm. guns and 155-mm. howitzers. Technical instruction was given. The Ordnance Department maintained a repair shop at Valdahon, which was in operation June 26, 1918. The function of this shop was the repair of the above matériel.

Artillery School at Saumur.—This school was established by G. O. 45, G. H. Q., March 25, 1918. Its function was the instruction of officers and candidates for commissions from all branches of artillery. In matters pertaining to instruction and administration it was under the control of the commanding general S. O. S. The heavy artillery candidate school at Mailly was ordered transferred to and incorporated in the Saumur Artillery School by the order referred to above. The ordnance activities at this point consisted of the care and upkeep of artillery matériel used for instruction purposes, for which the facilities of the shop formerly used by the French were employed.

Construction section.—The construction section of this division had general supervision of construction of ordnance facilities, in that it was charged with anticipating, planning, and effecting the arrangements for construction work, and following up the progress thereof.

Such work was put under way for a number of ammunition and storage depots, as follows:

Villiers Le-Sec.....	Storage of ammunition, hand grenades, bombs, etc.
Mauvage.....	Grenades, storage.
Gievres.....	General ordnance storage.
Foecy.....	Ammunition storage.
Issoudun.....	Ammunition storage.
La Chappelle.....	Bombs, hand grenades, etc.
La Pallice.....	General storage.
Montoir.....	General storage.
St. Loubes.....	Ammunition storage.
St. Sulpice.....	General storage.
Donges.....	Ammunition storage.

A section for the salvage of ammunition was organized. This included the establishment of a necessary shop for re-forming cases, provision for the destruction of irreclaimable ammunition not disposed of in the zone of the Army, and the reclamation of ammunition which could be put in serviceable condition. This activity did not include the reloading of shells, which work was done by the French.

INDEX.

A.

	Page.
Abaque.....	315
Aberdeen Proving Ground.....	30, 36, 47, 419, 423
Accuracy life of artillery.....	25, 26
Adapters and boosters.....	155, 161, 171
Adapter and booster casing:	
Mark I.....	171
Mark II.....	172
Mark III.....	172
Adapter and booster packing.....	188
Adapter casting for 7-inch Navy mount.....	90
Adapter for gas shells.....	171
Adapter for high-explosive shell.....	171
Adrian, General.....	413
Aerial drop bombs (<i>see also</i> Drop bombs).....	258
Aerial drop bomb sights (<i>see also</i> Bomb sights).....	282
Aiming circle, model of 1916.....	73
Aircraft ammunition.....	345
Aircraft armament.....	248
Aircraft gun and mount, 75 mm.....	47
Aircraft machine guns, mounts, etc.....	249, 254, 308
Air Nitrates Corporation.....	212
Airplanes, types of.....	248
Breguet A2.....	274
Breguet B2.....	274
Cooper quadruple bomb carrier.....	249
Day bomber.....	248
Deliveries.....	248
Night bombers.....	248
Observation.....	248
Pursuit.....	248
Airplane flare, Mark I.....	289
Alabama Power Co.....	214
Aldis sight.....	257
Allowance in gauge work.....	468
Altimeters.....	114
Allimetre, Mle 1917.....	114
Altitude, determination of.....	114
Altitude telemeter.....	114
Amatol.....	204
American Brake Shoe & Foundry Co.....	24, 58
American Car & Foundry Co.....	378
American Cutlery Co.....	412
American Cyanamid Co.....	209

	Page.
American ordnance base depot in France.....	472, 473, 474, 476
American Sheet & Tin Plate Co.....	418
American Society of Mechanical Engineers.....	464, 467
American Society of Mechanical Engineers, gauges for machine screws.....	464
American University, Washington, D. C., Ordnance Pyrotechnic Laboratory..	291
Ammonium nitrate.....	204, 216
Ammonium picrate.....	206
Ammunition:	
Aircraft.....	345
Airplane, 37 mm.....	252
Allowance at front.....	195, 196
Allowance trench mortars, French.....	196
Artillery.....	141
British, 9.2-inch.....	118
French.....	120, 197
Supply.....	195
German.....	124, 128, 129
77 mm. guns, models of 1896 and 1916.....	128, 129
Italian, 75-mm. gun.....	137
United States.....	139
Used during the war.....	140
Program.....	141
37-mm. semiautomatic motor gun.....	37
Mark VIII tank.....	403
75-mm. field gun.....	174
4.7-inch field gun.....	49
4.7-inch howitzer.....	174
8-inch howitzer.....	174
8-inch railway gun.....	175
Car, railway.....	93
Components, packing.....	187
Consumption.....	196, 197
Delivery at front.....	195
Depots.....	193
At Atlantic ports.....	193
French Army.....	195
Fixed.....	139, 174
Gauge work.....	455
Howitzer, fuzes for.....	162
Loading.....	190
Machine-gun.....	343
Mobile artillery, United States.....	141
Packing, artillery.....	187
Reserve.....	196
Rifle, various armies.....	356
Riot shotgun.....	335
Salvage.....	481
Semifixed.....	140, 174
Separate loading.....	139, 174
Shell (<i>see also</i> Shell).....	138, 140, 151
Shrapnel (<i>see also</i> Shrapnel).....	44, 138, 155
Small-arms and machine-gun, of the armies of the world.. table facing	356

Ammunition—Continued.

Artillery—Continued.

Small-arms and machine-gun—

	Page.
United States.....	320, 343, 344
Do.....	table facing 354
Caliber .30, classification of.....	344
Service, caliber .30, model of 1906.....	343
Caliber .30, for model of 1898, Krag rifle.....	350
Caliber .30, tracer-incendiary.....	353
Caliber 7.62 mm. Russian 3-line rifle.....	352
Caliber 8 mm. French.....	353
Caliber .45, for use in pistols and revolvers.....	351
Caliber 11 mm.....	353
Boxes for.....	255
Boxes, packing.....	347
Disintegrating links for.....	255
Inspection of.....	348
Packing boxes.....	345
Waterproofing.....	343
Supply.....	195, 196
French Army.....	195
At the front.....	195
And consumption.....	196
Tractor.....	399
Train.....	95, 365, 372
Trench mortar.....	231, 234, 235, 238, 239, 242, 243, 244, 245
Ancor, O., site for nitrate plant No. 3.....	215
Angers.....	479
Angle—	
Clearance.....	468
Diameter.....	468
Gauges.....	453
Angle of—	
Site instrument.....	315
Thread.....	468
Anilite.....	201
Antiaircraft—	
Fire control.....	113
Fire-control instruments.....	114
Guns and mounts.....	108
Sights.....	112
Arcadia, S. S.....	473
Armor—	
Body.....	413, 414
Proposed types.....	414
Sentinels.....	415
Tank.....	410
Armament of tank.....	410
Armament train.....	95
Armorer's repair chest.....	354
Armorer's tool chest.....	308
Armor-piercing bullet.....	346, 347
Armory, Springfield.....	443

	Page.
Arsenals.....	429
United States.....	208, 431, 432, 433, 434, 435, 436, 437, 439, 442, 443, 444, 449
Augusta.....	431
Benicia.....	431
Frankford.....	432
Hawaii.....	433
Manila.....	434
New York.....	435
Panama.....	435
Picatinny.....	208, 436
Raritan.....	437
Rock Island.....	439
San Antonio.....	442
Watertown.....	444
Watervliet.....	449
Artillery (<i>see also</i> Field guns; Guns; Howitzers; Mortars, etc.).....	15
Accuracy life of.....	25, 26
Austro-Hungarian.....	134
British.....	116
Caterpillar mounts.....	398
Caterpillar, St. Chamond, 220 mm.....	399
European.....	117
French.....	121
United States, characteristics.....	29
Field—	
German.....	123, 124
United States (<i>see also</i> Field guns).....	29, 35
Carriage data.....	29
Fire of railway.....	88
Foot, German.....	123
General summary.....	15
German.....	123
Long-range.....	83
Heavy, mobile repair shop.....	373
Mobile.....	15, 27
Motorization of.....	29
Muzzle velocity.....	(table facing page 26), 29, 33, 122
Railway.....	88
Range table, facing page.....	26, 29, 33
Ranges, German.....	132
Repair truck.....	373, 374
Seacoast.....	15, 18, 83
School, Saumur.....	480
Supply truck.....	376
Tractors.....	387, 390
Tractor—	
2½-ton.....	390
5-ton.....	392
10-ton.....	394, 395
15-ton.....	396
20-ton.....	397
Transport in the field.....	386
Vehicles road test.....	441

	Page,
Atelier de Mehun-sur-Yevre	475
Augusta (Ga.) Arsenal	430
Austro-Hungarian artillery matériel.....	134
Automatic machine rifle, Benet-Mercie.....	305
Automobile—	
Gun mounts.....	368, 398, 399
Vehicles (<i>see also</i> Tanks; Tractors; Trucks).....	357
Automatic—	
Pistol.....	336
Grant Hammond.....	338
Rifles.....	306, 308
Berthier.....	306
Bommarito.....	316
Browning.....	298, 299
Chauchat.....	296, 306
Organization and supply.....	312
Automotive Engineers, Society of.....	468
Aviation, airplanes and aircraft armament.....	248
Signal cartridge, 35-mm., Mark I.....	291
Signal pistol.....	291
Azimuth—	
Circle of panoramic sight.....	71
Instrument, periscopic, model of 1916.....	72
Readings.....	75

B.

Bags for powder charges.....	174, 190, 192
Baldwin base detonating fuze, minor caliber, Mark I.....	163
Baldwin full automatic motor gun.....	37
Bandoleers.....	344
Bang rifle.....	316
Barlow heavy drop bomb.....	267
Bartlett Edge Tool Co.....	412
Bayonet:	
British, model 80.....	332
Model of 1905.....	333
Model of 1917.....	332
Scabbard.....	333
Weights and dimensions.....	333
Marking.....	333
Belts for cartridges.....	355
Belts, disintegrating.....	355
Belt link for machine-gun ammunition.....	302
Belt loading machines.....	308
Belt, webbing for cartridges.....	355
Bench chest, artillery supply truck.....	376
Benet, Lawrence.....	305
Benet-Mercie automatic machine rifle.....	305
Benicia Arsenal.....	430, 431
Berthier light machine rifle.....	306
Bethlehem howitzer, 6-inch and 155-mm.....	53
Bethlehem Loading Co.....	205
Bethlehem Steel Co.....	17, 21, 22, 27, 32, 53, 58, 65, 85, 427

	Page.
Bipod, machine-gun.....	310
Black powder.....	207
Blank cartridges:	
Caliber .30.....	349, 350
Caliber .45.....	351
Body armor.....	413
Bolos.....	412
Bomb carriers (<i>see also</i> Release mechanisms).....	278, 280
Bomb carrier:	
20-pound, Cooper, quadruple.....	249, 282
113-pound.....	282
230-pound.....	282
Mark V, American.....	273
Michelin, Type I.....	273, 274
Michelin, Type IV.....	273, 274, 281
Michelin Breguet, Type I.....	281
Used by the allied forces.....	278
Bombing airplanes.....	248
Bombs:	
Aerial drop (<i>see also</i> Drop bombs).....	258
Fragmentation.....	266
Incendiary.....	270
Bomb sights (<i>see also</i> Sights, bomb).....	282, 283, 284, 285
Bombs, trench mortar, European manufacture.....	231
Bommarito automatic rifle.....	316
Booster casings (<i>see also</i> Adapters and boosters).....	155, 161, 171
Boosters for gas shells.....	171
Boosters for high-explosive shell.....	171
"Bore safe" fuzes.....	153
Bore safety device.....	158, 165
Bourg.....	478
Bourges—	
Illuminating parachute flare.....	275
Laboratories, Ecole de Pyrotechnie.....	429
Small arms range.....	429
Bowden control.....	253, 254
British artillery.....	116
British Artillery Mission.....	25
Brocq Tachymetre E. M.....	114
Brown & Sharpe Co.....	455
Browning, John M.....	207, 298, 299
Browning aircraft machine gun.....	250, 299
Browning machine gun.....	296, 297, 298, 299
Brunton compass.....	314
Buckingham bullet.....	347
Buda type H. U. engine.....	362, 406
Bullard Manufacturing Co.....	425
Bullet:	
.30-caliber, United States service ammunition, model of 1906.....	343
.30-caliber, United States service ammunition, model of 1898.....	350
.45-caliber, United States service pistol and revolver ammunition.....	351
Armor-piercing—	
Model of 1918.....	347
Caliber .30, model of 1917.....	346

	Page.
Bullet—Continued.	
Buckingham.....	347
Dumdum.....	347
Incendiary.....	347, 353
Tracer.....	345, 353
Bureau of Standards, United States National.....	293, 455, 467
By-product coke ovens.....	203
C.	
Caisson:	
United States—	
3-inch and 75-mm.....	40
4.7-inch gun.....	49
German, 77-mm.....	127, 130
Calco Chemical Co.....	205
Caliper gauges.....	460
Camouflage of tractors.....	360
Camp Devens.....	427
Camp for ordnance training, Raritan Arsenal.....	439
Camp Perry.....	338
Candlepower.....	291
Cannon (<i>see also</i> Field Guns; Guns; Howitzers; Mortars; Railway guns; Trench mortars, etc.).....	15
Cannon gauges.....	455
Cannon:	
Motor.....	36, 37
Relining.....	88
Seacoast.....	33
U. S. Army, principal characteristics.....	facing 26
U. S. seacoast, characteristics of.....	33
Capper, General.....	390
Car:	
Ammunition.....	93
Gondola.....	95
Motor.....	357
Railway gun.....	90, 105
Railway gun transport.....	95
Railway, 8-inch, model of 1918, Mark I.....	91
Railway gun, model of 1918.....	90
Railway, narrow gauge, ammunition.....	95
Reconnaissance.....	370
Carburetor:	
Kingston.....	396
Schebler.....	394, 396, 397, 409
Stromberg.....	363, 368
Carnegie Steel Co.....	65
Carneys Point plant (Du Pont Co.).....	208
Carriages:	
Antiaircraft.....	108
Auto-trailer, model of 1917, for 3-inch antiaircraft gun.....	108
Field gun—	
French, 75-mm.....	43
German—	
77-mm.....	127
13-cm.....	132

Carriages—Continued.

Field gun—Continued.

	Page.
Italian, 75-mm, models of 1906 and 1911.....	137
United States—	
75-mm.....	29, 39, 43
4.7-inch.....	48
Howitzer, United States, 155-mm. Schneider.....	56
Mortar, United States, 12-inch.....	99
Railway and seacoast, British.....	117
Railway—	
United States—	
7-inch.....	89
8-inch.....	91
10-inch and 12-inch.....	97
16-inch.....	103
14-inch.....	103
Carriage data, United States field guns.....	29

Cartridge:

Bag—

Accessories.....	192
Cloth.....	191, 192
Igniter.....	192
Bags.....	190

Ball—

Caliber .30, United States service ammunition.....	343, 350
Pistol, caliber .45.....	351
Revolver, caliber .38.....	352

Belts.....

	355
--	-----

Blank—

Caliber .30, model of 1909.....	349
Caliber .30, model of 1898.....	350
Caliber .45.....	351

Case, charge.....

	174
--	-----

Case cloth.....

	191, 192
--	----------

Cases.....

German.....	128, 131
Nature and function.....	173
Manufacture of.....	433
Packing.....	187
Small-arms ammunition.....	343

Clips.....

	344
--	-----

Cloth.....

	191
--	-----

Dummies, caliber .30, model of 1898.....

	350
--	-----

Dummy—

Caliber .30.....	349
Caliber .45.....	351

French, Lebel, 8-mm.....

	353
--	-----

Gallery practice—

Caliber .30, model of 1906.....	350
Caliber .30, for model of 1898 rifle.....	350
Caliber .22.....	352

Guard, caliber .30, model of 1906.....

	349
--	-----

High-pressure test, caliber .30.....

	348
--	-----

High pressure, caliber .45.....

	351
--	-----

	Page.
Cartridge—Continued.	
Igniter cloth.....	191, 192
Incendiary, caliber .30, model of 1917.....	347
Marks, small-arms ammunition.....	344
Russian, 7.62-mm. 3-line rifle.....	352
Service—	
Caliber, .30.....	343
Caliber .45.....	351
Small-arms, supply.....	320
Tracer.....	346
Tracer, model of 1917.....	345
Test, high-pressure, caliber .30.....	348
V-B parachute, Mark I.....	288
V-B star, Mark I, for signaling.....	288
Water-proofed.....	351
Carts:	
Ammunition, for machine guns.....	311
Machine gun.....	311
Spare gun for machine guns.....	311
Casting, adapter for 7-inch Navy mount.....	90
Caterpillar:	
Artillery mount.....	398
Attachment for trucks.....	390
Gun mount, 3-ton.....	398
Mounts for 8-inch howitzer and 240-mm. howitzer.....	388
Mount, gun, 30-ton.....	399
Tractor.....	386
Cavalry saber.....	411
C. C. hydraulic gear for machine guns.....	253
Constantinesco gear for aircraft machine guns.....	253
Centers, O. and T.....	478
Chalindrey.....	478
Chamber gauge.....	454
Charge for cartridge case.....	174
Charge, propelling.....	174
Charleston Ordnance Depot.....	194
Charpy, Dr. Georges.....	429
Chassis:	
Dodge.....	372
F. W. D.....	363
Motor car, table.....	362
Motor trucks, table.....	362
Nash.....	368, 369
Tank.....	409
Truck—	
1-ton.....	362
1½-ton.....	362
2-ton.....	362
2-ton, Nash.....	362, 368
3-ton, F. W. D., Models B and B-1917.....	362, 363
3-ton, Ordnance Department.....	362, 366
White, 1-ton.....	369, 370
Trailer, table of.....	382
Chauchat rifle.....	296, 306

	Page.
Check plug.....	454
Chemical apparatus.....	287
Chests:	
Bench, Artillery Supply Truck.....	376
Repair—	
Armorer's.....	354
For small arms.....	354
Tool, armorer's.....	308
Chretien sight.....	257
Cincinnati plant (nitrate plant No. 3).....	210, 215
Cleaning outfits for small arms.....	354
Clearance in gauge work.....	468
Clearance:	
Angle.....	468
Bottom.....	468
Outside.....	468
Clear Spring Proving Ground.....	424
Clermont-Ferrand.....	479
Clinometer.....	75
Machine gun, model of 1918.....	313
Clips for cartridges.....	344
Clips for pistol and revolver ammunition.....	351
Clip loading machine for caliber .45 revolver ball cartridge.....	354
Coast Artillery.....	15, 18, 83
Antiaircraft guns.....	111
Coetquidan training camp.....	479
Colored marking of shell fuzes and grenades.....	151, 152, 170, 221
Colt double-action revolver.....	338
Colt machine gun.....	307
Colts Patent Fire Arms Manufacturing Co.....	298, 299, 303, 304, 307, 338
Commission d'Experiences.....	428
Commission for standardizing of screw threads.....	467
Compagnie de la Chatillion, Commentry et Neuves Maison.....	429
Compass:	
Brunton.....	314
Lensatic.....	314
Prismatic.....	75, 314
Concentricity gauge.....	454, 465, 466
Construction and Maintenance Division, O. C. O., A. E. F.....	474, 475, 477, 480
Construction of ordnance, problems of.....	21
Construction work for the American Expeditionary Forces.....	475
Continental motor.....	362
Control, Bowden.....	253, 254
Cooper drop bomb.....	274
Cooper quadruple bomb carrier.....	248
Corcelli's graph.....	315
Core diameter.....	468
Corps, Motor Transport of Army.....	361
Correcteur Mechanique, R. A. (Routin).....	114
Counter-battery work.....	89
Courbevois.....	477
Cracking crude petroleum.....	204
Crane, 4-ton trailer.....	380

	Page ¹
Crest of screw	468
Curtis Bay Ordnance Depot	194
Cylinder gauges	462
D.	
Darts, incendiary	273
Day bombers, airplanes	248
Days of fire	196
Dean, Maj. Bashford	414
Delaware Ordnance Depot	193
Demolition drop bombs	260
Depot, American ordnance base, A. E. F.	472
Depots:	
Ammunition, French	195, 196
Ammunition and explosive, United States	193, 194
Ammunition and storage, United States in France	481
Depth gauge	453
Destruction, fire of	89
Detonating fuzes	153, 154, 155, 156, 157, 158, 159, 160, 161, 162, 163
Detonators	125
Devens, Camp, Ayer, Mass	427
Deville, Capt. Sainte Claire, French Army	42
Diameters of screws, measurement of	470
Diaphragm for cartridge case	174
Diaphragm width and diameter gauge	459
Disintegrating belt	355
Dodge Bros.	58
Dodge chassis	372
Dodge engine	362
Doulaincourt	476
Drop bombs:	
Aerial	259, 260
Of the allies	258
Barlow, heavy	267
Chanard, incendiary	274
Cooper	274
Demolition	260
English—	
112-pound	274
230-pound	274
European	273
Fragmentation	260, 266
French, 150 pounds	274
Fuzes	276
High capacity—	
Demolition	260, 261, 262, 263, 264, 265, 266
Mark I	264
Mark I-A	265
Mark II	261
Mark III	263
Mark IV	264
Mark IV-A	265, 266
Mark V-A	265

	Page.
Drop bombs—Continued.	
Incendiary.....	260, 270
Mark I.....	270
Mark II.....	272
Mark III.....	273
115-mm., long.....	274
Safety features.....	261
Sights.....	282
United States, table of.....	259
155-mm., penetration.....	274
Drummondville plant (Canadian Explosive Co.).....	469
Dumdum bullets.....	347
Dummy cartridges:	
Caliber .30.....	349, 350
Caliber .45.....	351
Dummy hand grenade.....	221
Dummy rifle grenade.....	230
Du Pont Powder Co., E. I.....	205, 207
E.	
Ecole de Pyrotechnie.....	429
Edgewater Steel Co.....	65
Effective diameter.....	468
Eisemann magneto.....	363, 368, 394, 396, 409
Ejector, U. S. rifle.....	326
Elder, Maj.....	316
Elder periscopic attachment for rifle.....	331
Electric furnaces.....	446
Elevation quadrant.....	105
Elizabethport Proving Grounds.....	424
Emporium plant (Aetna Explosives Co.).....	208
Enfield rifle.....	319
Engine:	
Airplane, Liberty.....	399
Buda type H. U.....	406
Cadillac automobile.....	398
Gas, Panhard-Levassor.....	400
Hudson.....	406
Liberty.....	399, 405
Wisconsin.....	363
Equipment:	
Miscellaneous.....	412
Personal.....	412
Equipment repair truck.....	373
Erie Proving Ground.....	424
Estienne, Gen.....	390
Explosive "D".....	206
Explosives.....	199
Approved by Engineering Division, U. S. Ordnance Department.....	199
Manufacture of.....	202
Suitability of.....	199
Under investigation.....	199
Extension magazine for automatic pistols.....	338
External diameter.....	468

	Page.
Extractor, U. S. rifle.....	326
Eye and face shield.....	415
F.	
Face guard.....	415, 416
Field artillery:	
Austro-Hungarian.....	134
British.....	116, 117
European.....	117
French.....	120, 121, 122
German (<i>see also</i> Field guns, German).....	123
United States.....	15, 35, 83, 108
Motorization of.....	29, 30, 31, 33, 257, 260, 394
Field guns:	
Austro-Hungarian.....	134
British.....	116
75-mm.....	45
French.....	120, 121, 122
75-mm.....	42
German.....	123, 124, 125, 126, 127, 128, 129, 130, 131, 132, 133
Italian.....	135
United States.....	15, 35, 83, 108
3-inch.....	27, 39
Trailer for.....	383, 384
75-mm., model of 1916.....	17, 27, 39
Production of.....	39
75-mm., model of 1917, British.....	17, 27, 45
75-mm., model of 1897, French.....	17, 27, 42
4.7-inch.....	17, 30, 48
Motorization of.....	360, 394
155-mm., Filloux.....	18, 30, 51
5-inch seacoast.....	18, 33, 87
6-inch seacoast.....	18, 33, 87
Filloux gun, 155-mm.....	18, 30, 51
Finger fit.....	468
Fire control:	
Antiaircraft.....	113
Equipment—	
Army artillery, Engineer Corps material.....	80
Army artillery, Signal Corps material.....	80
Divisional artillery.....	77
Engineer material.....	78
Ordnance material.....	77
Signal Corps material.....	77
Railway heavy artillery.....	106
Instruments.....	71
Instruments, antiaircraft.....	113, 114
Railway artillery.....	105, 106
Instruments for machine guns.....	313
Tank.....	406
Fire of destruction.....	89
Fire of interdiction.....	89
Firing board, model of 1917.....	75
Firing platform for 8-inch railway car.....	92

Fit:	Page.
Finger.....	468
Wrench.....	470
Fixed ammunition.....	174
Flame projector.....	294, 295
Flare:	
Airplane, Mark I.....	289
Parachute, illuminating.....	275
Wing tip, Mark I.....	289
Florsheim, Dr.....	205
Flow of thread.....	469
Flush pin gauge.....	459
Flute.....	469
Follower, U. S. rifle.....	326
Ford Motor Co.....	58
Philadelphia.....	418
Ford tank.....	388
Forgings for canon.....	21, 65, 85
Forgings for 240-mm howitzer.....	65
Forgings for shell.....	140
Forging, process of.....	21
Fort Hancock, N. J.....	419
Fort Shafter.....	433
Fort Sheridan, Ill.....	427
Four-wheel drive truck.....	360, 363
Fragmentation drop bombs.....	266
Fragmentation bomb, 90-mm.....	273
Frankford Arsenal.....	160, 349, 432
Frankford Arsenal combination fuze.....	167
Franklin Institute thread.....	469
French High Commission.....	141, 158
French proving grounds.....	428
Fuel feed system, Stewart.....	396, 409
Full diameter.....	469
Fuzes for American shell and shrapnel.....	153
Fuzes:	
Aerial bomb.....	276
Antiaircraft.....	167, 168, 170
Base percussion.....	163, 164, 165
Combination time and percussion.....	167
Drop bomb.....	
Used by allied forces.....	276
Chanard.....	277
Cooper (English).....	277
Nose (English).....	277
Nose (French).....	276
Gros-Andreau, nose, 90-mm.....	276
Stokes assemblage (English).....	277
Tail (French).....	276
Frankford Arsenal.....	170
French.....	158
I. A. L.....	158
30/45 Model 1878-1881, M. 15.....	158
General consideration.....	153

Fuzes—Continued.	Page.
German.....	125, 126, 128
77-mm.....	126, 128
Detonator.....	125
Dopp. Z 1896 n/A.....	126
Light howitzer.....	125
Percussion, detonator.....	125
Shrapnel.....	126
Italian, 75-mm gun ammunition.....	136
Russian, 3 G. T. point detonating.....	156
United States—	
Ordnance Department, table.....	154
Base detonating, Marks III and V.....	165
37-mm shell.....	163
Base percussion.....	163
Minor caliber, Mark I, Baldwin type.....	164
Minor caliber, Mark II, Cartwright model.....	164
Frankford Arsenal, combination.....	170
Point detonating—	
Mark I.....	156
Mark II.....	156
Mark III.....	159
Marks III, IV, and V.....	158
Mark V.....	162
Mark IV.....	161
Marking.....	170
Packing.....	189
Safety device for.....	153, 160
Time.....	167, 168, 170
For antiaircraft shell.....	168
Waltham mechanical.....	170
Trench mortar—	
Mark VI.....	244, 245
Mark VII.....	243
Trench mortar, French allowance.....	198
Fuze setters.....	182
Antiaircraft.....	186
French bracket.....	185
U. S. bracket, model of 1916.....	182
U. S. Hand—	
Model of 1912.....	184
Model of 1913.....	185
Mark I.....	186
Furnaces, electric.....	446
F. W. D. trucks.....	360, 363, 378

G.

Gallery practice cartridge:	
Caliber .22.....	352
Caliber .30.....	350
Garnier, Maj., French Army.....	35
Gas and incendiary devices.....	294
Gas-electric locomotive for railway artillery.....	107

	Page.
Gas emplacement set.....	294
Gas shell.....	125, 128, 149
Gauges.....	453, 468
Gauges, American Society of Mechanical Engineers for machine screws.....	464
Angle.....	453
Artillery ammunition.....	455
Base thickness.....	454
Caliper.....	461
Cannon.....	455
Chamber.....	454
Check or checking.....	469
Classes.....	456
Concentricity.....	454, 465, 466
Cost of.....	458
Definitions.....	468
Depth.....	453
Design.....	458
Diameter and diaphragm width.....	459
Height.....	457
Indicator.....	457
Inspection.....	456
Interchangeability.....	453
Limit.....	465, 469
Thread plug.....	465
Manufacture of.....	455
Master.....	456, 469
Minimum and maximum.....	458
Pin, flush.....	459
Pitch.....	453
Pitch diameter.....	453
Plug.....	459
Production and cost.....	458
Profile.....	453
Reference.....	469
Ring.....	463
Ring "Go".....	460
Ring "Not go".....	460, 462
Screw threads.....	453, 454, 460
Shop or workman's.....	469
Small-arms.....	455
Snap.....	457, 459, 462, 465
Specification.....	455
Standard cylindrical.....	462
Star.....	463
Taper.....	463
Thread.....	459
Tolerance.....	453, 455
Types of.....	460
Working.....	456
Gavre-Quiberon.....	428
Gears:	
Hydraulic, for machine guns.....	253
Mechanical, for machine guns.....	253

	Page.
General Chemical Co.....	211
German artillery.....	123, 132
Gladiator, M.....	306
Gondola-car for railway gun ammunition.....	95
Goniometer.....	114
Gorham Manufacturing Co.....	332
"Go" ring gauges.....	460
Governor, simplex.....	368
Graffe, Washburne & Dunn.....	332
Grant Hammond automatic pistol.....	338
Greenfield Tap & Die Co.....	455
Grenades, hand (<i>see also</i> Hand grenades).....	217
Allowance of French.....	198
Grenade powder, Trojan.....	206
Grenade, rifle (<i>see also</i> Rifle grenades).....	227
Allowance of French.....	198
Grenades, supply of French.....	198
Grille d'observation, Mle 1917.....	114
Grommet, rope.....	187, 188
Gros-Andreau key support for 90-mm. fragmentation drop bomb.....	273
Grouzers.....	396
Guard cartridges.....	349
Guard, face.....	415, 416
Gun carriage:	
Data, United States.....	29
75-mm.—	
Model of 1916.....	39
Model of 1897 (French).....	42
Model of 1917 (British).....	45
4.7-inch gun.....	48
5-inch seacoast.....	18, 33, 87
6-inch seacoast.....	18, 33, 87, 88
6-inch howitzer.....	53
155-mm. howitzer.....	56
8-inch barbette, model of 1918.....	93
9.2-inch howitzer.....	62
240-mm. howitzer.....	65
Railway (<i>see also</i> Gun mounts, railway).....	89, 107
Gun:	
Browning.....	250, 296, 297, 298, 299
Chauchat.....	296, 306
Filloux, 155 mm.....	18, 51, 122
Hotchkiss.....	305
Lewis.....	296, 298, 300
Lewis aircraft.....	250, 300, 301
Machine (<i>see also</i> Machine guns).....	296
Gun mounts:	
Aircraft.....	47, 108
Caterpillar—	
For 8-inch howitzer.....	388
For 240-mm. howitzer.....	388, 398
3-ton.....	398
30-ton.....	399

Gun mounts—Continued.	Page.
Defined and classified	15
Railway—	
British, 9.2-inch howitzer	119
United States	88, 107
Navy, 7-inch, 40-caliber, Mark II	89
12-inch, model of 1918	103
14-inch, United States Navy	107
10-inch, models of 1888 and 1895	95, 97
12-inch, models of 1895 and 1895, MI	97
14-inch railway carriage	105
Seacoast—	
United States 5-inch	18, 33, 87
6-inch	18, 33, 87
Tractor	386
Wheeled	15
Gunner's belt	255
Gunpowder (<i>see also</i> Smokeless powder)	207
Guns	15
Accuracy life of	25, 26
Aircraft and mount, 75-mm	47
Aircraft machine	249
Antiaircraft	17, 108
75-mm. and 3-inch	30
4.7-inch	30, 48, 51, 111
4.7-inch trailer mount, model of 1918	48, 51
British	45, 116, 117
Field	15, 27, 35, 83, 108, 117
French	44, 129
75-mm.	42
105-mm. French, life	122
120-mm. French, model of 1898, life of	122
155-mm. French—	
Models of 1877–1914, life	122
Filloux, life of	122
French, 155-mm. Schneider, life of	122
German—	
77-mm. field, model of 1896 n/A	126
77-mm., model of 1916	129
77-mm. and 75-mm., materiel	129, 130
Comparison with French guns	44, 129
13-cm	131
Italian, 75-mm., models of 1906 and 1911	135
United States	17
37-mm	35
3-inch	39
4.7-inch	17, 30, 48
Motorized	48, 360
75-mm., model of 1916	17, 27, 39
75-mm., model of 1897 (French)	17, 27, 43
75-mm., British, model of 1917	17, 27, 45
155-mm., model of 1918, Filloux	18, 51

Guns—Continued.

	Page.
French—	
Characteristics of.....	120, 121
Life of.....	122
Navy and seacoast.....	120
German.....	129
Motor.....	36, 37, 251, 252
Railway, British, 9.2-inch, Marks X, XIII, and XIV.....	117
United States—	
Construction of.....	24
Cost of.....	24
Production.....	85
Manufacture.....	85
Navy Department.....	33
Range of, table facing page.....	26
Repair.....	25
Relining of.....	25
37-mm. full automatic, Puteaux.....	37
37-mm. Baldwin full automatic motor.....	37
37-mm. semiautomatic, model of 1918.....	36
Guynemer, captain, French aviator.....	36
Muzzle velocity.....	27

H.

Hagerstown, Md.....	427
Hand grenades:	
Classification.....	217
Defensive, Mark II.....	221
Dummy, Mark I.....	221
Gas, Mark II.....	224
General nature of.....	217
Incendiary, Mark I.....	226
Le Blanc.....	219
Marking.....	221
Mills.....	219
Offensive, Mark III.....	222
Packing.....	221
Phosphorus, Mark II.....	223
Testing.....	221
Thermit, Mark I.....	225
Haussimont.....	476
Hawaii Arsenal, Honolulu.....	430, 433
Heaters, machine-gun.....	256
Heavy artillery mobile repair shop.....	373
Height gauges.....	457
Helmet, sniper's.....	415
Helmets:	
Steel.....	412; 413, 416, 417, 418
Manufacture of.....	418
United States, No. 5.....	417
High-capacity drop bombs.....	260
High-pressure test cartridges:	
Caliber .30.....	348
Caliber .45.....	351
Holt landing flare.....	275

	Page.
Holt Manufacturing Co.....	398
Hotchkiss machine gun.....	305
Hotchkiss Co., St. Etienne, France.....	305
Housing, United States Housing Corporation.....	423, 451
Howe, Prof. H. M.....	418
Howitzers (see also items below).....	19
Howitzers:	
6-inch.....	58
Motorization of.....	394
155-mm.....	19, 21, 22, 24, 32, 51, 53, 55, 57, 58
Bethlehem, model of 1917.....	51
French, life of.....	122
Motorization of.....	360, 394
8-inch.....	19, 32, 33, 59, 61, 64, 68
Caterpillar mount for.....	398
Mark VI.....	19, 24, 32, 33, 59, 61
Mark VII.....	33, 59, 61
Mark VIII½.....	19, 33, 59
9.2-inch.....	19, 32, 62, 63, 64, 68
Mark I.....	32, 62, 53
220-mm, French, life of.....	122
Mark II.....	32, 63, 68
240-mm.....	19, 33, 51, 64, 65, 68
Auxiliary equipment for.....	68
Caterpillar mount for.....	388
Supply of.....	65
280-mm, Schneider.....	65
12-inch.....	33
16-inch railway mount.....	103, 104, 105
Bethlehem.....	51, 53
French, characteristics.....	120, 121, 122
German, range of.....	133
Midvale Steel Co.....	32, 90
Production.....	85
Railway mount, 16-inch.....	19, 103, 104, 105
Seacoast.....	33
Schneider—	
155-mm.....	19, 21, 22, 24, 32, 51, 53, 55, 57, 58
240-mm.....	19, 33, 51, 64, 65, 68
Source of supply.....	58
280-mm.....	65
Types.....	19
Vehicles for.....	64
Vickers—	
8-inch.....	24, 32, 33, 59, 61
9.2-inch.....	32, 62, 63
Hudson engine.....	406
Hydraulic gear, Constantinesco.....	253
I.	
Illuminometer, McBeth.....	293
Improvised carriages for seacoast guns.....	33
Incendiary and gas devices.....	294

	Page.
Incendiary bullet.....	274, 353
Incendiary darts.....	273
Incendiary drop bombs.....	270, 271, 272, 273, 274
Incendiary drop bomb, Chanard.....	274
Indicator gauge.....	457
Ingots for gun forgings.....	21
Inspection of small-arms ammunition.....	348
Instruction in ordnance care and repair.....	473
Instruction, ordnance, technical, in France.....	478, 479, 480
Interallied tank committee.....	390
Interchangeability of parts.....	453
Interdiction, fire of.....	89
International Harvester Co.....	312
Is-sur-Tille.....	476
Italian field guns.....	135

J.

Jackets for cannon.....	22
Jacks, hydraulic, for railway mounts.....	90
Jackscrew for 305-mm. Schneider railway carriage.....	97
Jazeran.....	415, 417
Jolidon pistol.....	338
Joyes, J. W., Col., U. S. A.....	211

K.

Kearney depot.....	193
Kenvil plant (Hercules Powder Co.).....	208
King, D. M., Col.....	472, 473
King Bugatti motor.....	36
Kingston carburetor.....	396
Kit, tool, for machine gun.....	308
Knapsack:	
Flame.....	294
Smoke.....	295
Knives, trench.....	412
Krag rifle, United States.....	320, 330

L.

La Courtine Training Camp.....	479
Lakehurst Proving Ground.....	190, 424
Land (of a rifle).....	69
Landing flare, Holt.....	275
Langres, repair shop at.....	478
Lead.....	469
Lead, normal.....	469
Leather saving by use of motors.....	359, 360
Le Blanc hand grenade.....	219
Lebel rifle ammunition, 8-mm.....	353
Leece-Neville electric lighting and starting system.....	370
Lensatic compass.....	314
Lewis aircraft machine gun.....	250, 300, 301
Lewis guns.....	296, 298, 300
Lewis, I. N., Col.....	300
Liberty engine.....	36, 399, 405
Liberty pistol.....	338

	Page.
Libourne.....	478
Life of guns.....	25, 26
Life of French guns.....	122
Light repair truck.....	372
Lights, position.....	288
Limber:	
3-inch, United States.....	40
4.7-inch, United States.....	49
77-mm., German.....	127, 130
Limit gauge.....	469
Limit snap gauges.....	465
Limits.....	469
Limoges.....	478
Liners, manufacture of.....	24, 450
Link belt for machine-gun ammunition.....	302, 304
Links, metallic.....	308
Lioussaint.....	477
Livens projector.....	246
Livens projector shell, Mark I.....	247
Loading ammunition.....	190
Loading and assembling plants.....	190, 191
Loads for artillery supply trucks.....	376
Lock, safety, United States rifle, model of 1917.....	326
Locomotive for railway artillery.....	107
Longeron of tank.....	406, 408
Luger pistol.....	316

M.

Machine gun:	
Accessories.....	308
Carts.....	310, 311
Heaters.....	256
Mount—	
Bipod.....	310
Browning.....	310
Organization.....	310
Production.....	298
Sights.....	256, 257, 313
Unit—	
Equipment.....	311
Motorized.....	309
Machine guns.....	249, 296, 308
Aircraft.....	249, 308
Accessories.....	254
Browning.....	250, 299
Lewis.....	250, 300
Shipping case.....	301
Indicator.....	301
Marlin.....	249, 301
Mounts.....	254
Flexible.....	302
Floor.....	254
Lewis.....	301
Single gun.....	254

Machine guns—Continued.	
Aircraft—Continued.	
Mounts—Continued.	
Synchronized for Marlin guns.....	302
Twin-gun.....	254
Synchronized, used with 37-mm. gun.....	37
caliber .30.....	249, 302, 304
11-mm.....	251
Working-in plants for.....	251
Browning, water-cooled, caliber .30.....	298
Comparative tables of.....	249, 308
Conditions at outbreak of war.....	296
Fighting.....	296
Fire-control instruments.....	313
Hotchkiss, model of 1914, caliber 8-mm.....	305
Maxim.....	303
Table of leading types.....	308
Tools.....	309
Vickers—	
Model of 1915, caliber .30.....	302
Russian.....	303
Machine rifle:	
Benet-Mercie.....	305
Berthier, light, model of 1917, caliber .30.....	306
Colt, model of 1917.....	307
Lewis—	
Caliber .303, model of 1915.....	300
Caliber .30, army type, model of 1917.....	300
Machine tools for ordnance plants.....	85
Machining cannon.....	21
Machining ordnance.....	85
Madison Barracks.....	426
Magazine:	
Extension—	
For automatic pistols.....	338
United States rifle, caliber .30, model of 1903.....	328
Lewis.....	256
United States rifle.....	326
Magneto, Eiseemann.....	363, 368, 394, 396, 397, 409
Manila Arsenal.....	434
March, Maj. Gen. P. C.....	357
Marine Corps, United States.....	51, 300, 330
Marking artillery ammunition.....	151, 152
Marking hand grenades.....	221
Marking packing boxes.....	189
Marking shell.....	151, 152
Markings, fuze.....	170
Marlin aircraft machine gun.....	249, 301
Marlin Rockwell Corporation.....	298, 299, 301
Maryland Pressed Steel Co.....	36, 427
Master gauges.....	456, 469
Matériel, ordnance, care and repair.....	372
Mauser pistol.....	338
Maxwell Motor Co.....	58

	Page.
Mays Landing.....	190
Maxim automatic machine gun.....	303
Maxim, Sir Hiram.....	303
Maximum and minimum gauges.....	458
Meade, Camp.....	331
Mehun Ordnance Proving Grounds.....	429
Mercury fulminate.....	206
Mesta Machine Co.....	58
Metallurgical research.....	429
Methyl tetryl.....	201
Metuchen, N. J.....	437
Meucoe Training Camp.....	480
Michelin illuminating parachute flare.....	275
Micrometer.....	465, 470
Sight.....	331
Thread.....	470
Midvale Steel & Ordnance Co.....	19, 21, 24, 65, 85, 327, 427
Mills hand grenade.....	219
Minimum and maximum gauges.....	458
Mobile artillery.....	15, 27, 83
Mobile ordnance repair shop.....	373
Modified thread.....	469
Montlucon, metallurgical research.....	429
Morgan plant, Perth Amboy, N. J.....	190
Mortars.....	19
French.....	121
12-inch.....	20, 89, 99
220-mm. French, models of 1881-1892, life of.....	122
Mortars and howitzers, characteristics, French.....	120
Mortars:	
German, range of.....	133
Seacoast.....	33
Trench (<i>see also</i> Trench mortars).....	230
Mosler Safe Co.....	58
Motor:	
Buda.....	362
Cannon, 37 mm.....	36, 37, 251
Car—	
Reconnaissance.....	370
Operation and function.....	370
Staff observation.....	369
Continental.....	362
Dodge.....	362
Equipment.....	357
Repairs and replacements.....	361
Repairs, shops.....	362
Guns.....	36, 37, 251, 252
King Bugatti.....	36
Liberty.....	36, 399, 405
Road tests.....	441
Traction board in France.....	366
Transport for one army corps, initial requirements.....	361
Vehicles for training troops.....	362

Motor—Continued.	Page.
Vehicles, types of United States Army Ordnance Department.....	358
White.....	362
Wisconsin.....	362, 368
Motorization of artillery.....	29
Motorization, artillery, advantages and economy of.....	357
Motorization of field artillery, 75-mm. gun.....	29, 360
Motorization of 4.7-inch guns.....	360
Motorization of 6-inch howitzers and 4.7-inch gun.....	394
Motorization of 155-mm. howitzers.....	360
Motorization equipment:	
Maintenance of.....	357
Supply of.....	357
Motorized batteries, supply truck for.....	376
Motorized machine-gun units.....	309
Mounts:	
Aircraft—	
For machine-guns (<i>see also</i> Machine-gun mounts).....	254
75-mm. gun.....	47
Antiaircraft.....	108, 111
3-inch, model of 1917 for 3-inch (15-pounder) gun, model of 1917....	110
Caterpillar.....	388, 398
Trailer, 4.7-inch, model of 1918, for antiaircraft, model of 1918.....	111
3-ton.....	398
Howitzer, 240-mm.....	398
Field gun.....	27, 29, etc.
Howitzer, 16-inch.....	19, 103, 105
Machine gun.....	254, 310
Mobile, for heavy guns.....	83
Mortar, 12-inch.....	19, 20, 99
Railway.....	18, 89, 93, 99
7-inch Navy, Mark 2, Model 3.....	89
8-inch.....	91, 93
10-inch and 12-inch gun.....	97
Schneider, 305-m. sliding.....	95
Sliding, model of 1918 for 12-inch and 14-inch guns.....	101
Sliding, model of 1918, 12-inch 50 caliber guns.....	103
For 12-inch mortars.....	99
16-inch howitzer, model of 1918.....	105
16-inch howitzer, model E.....	103
Seacoast.....	87
United States 5-inch and 6-inch.....	89
Self-propelled.....	388, 398
Tractor-propelled.....	386
Trailer for 4.7-inch antiaircraft gun.....	51
Wheeled.....	15
Munition columns, German.....	123
Muscle Shoals plant (<i>see also</i> Nitrate plant No. 2).....	209
Muscle Shoals transmission line.....	214
Musketry rule, model of 1918.....	332
Muzzle velocity:	
French guns.....	122

Muzzle velocity—Continued.

Of United States cannon:	Page.
See table facing page.....	26
Small arms.....	317
See also under separate arms and tables facing pages.....	318, 354

N.

Narrow-gauge equipment for railway artillery.....	93, 95, 99
Narrow-gauge equipment for 12-inch mortar.....	99
Nash trucks.....	360
Nash 2-ton truck.....	368
Nash chassis.....	369
National Bureau of Standards.....	293, 455, 467
Necklet.....	415
New Britain Machine Co.....	426
New York Arsenal.....	435
Night-bomber airplanes.....	248
Nitrate Division:	
Ordnance Department.....	209, 210, 211
Research Section.....	210
Nitrate plant:	
No. 1.....	209, 210
No. 2.....	209, 212, 213, 214
No. 3.....	210, 215
No. 4.....	210, 215
Nitrate plants:	
Appropriations for.....	211, 213, 214, 215
Cost of.....	211, 213, 214, 215
United States.....	209
Table of United States.....	facing 209
Nitrated ivory nut.....	202
Nitro powder plant.....	208, 427
Nitro proving grounds.....	424
Nitrostarch.....	206
Normal lead.....	469
Norman wind vane sight.....	257
"Not Go" ring gauges.....	460
Nungesser, Capt., French aviator.....	36

O.

O. and T. center:	
No. 1.....	478
No. 2.....	478
No. 3.....	479
No. 4.....	479
Observation circle, model of 1918.....	76
Old Hickory plant (Hercules Powder Co.).....	208
Old Hickory Proving Ground.....	424
Ordnance aerial armament shop, Courbevois.....	477
Ordnance armament school, St. Jean Demonts.....	477
Ordnance base depot in France.....	472
Ordnance construction.....	21
Ordnance Department motor trucks.....	365, 366

	Page.
Ordnance depot:	
Delaware.....	193
Kearney, N. J.....	193
Pig Point, Va.....	194
Charleston, S. C.....	194
Raritan.....	193
Turner Station, Md.....	194
Ordnance depots in France.....	474
Ordnance, manufacture of.....	24
Ordnance plants, private.....	21, 22, 24, 85
Ordnance proving grounds in France.....	427
Ordnance Pyrotechnic Laboratory.....	291
Ordnance repair facilities.....	472
Ordnance repair shop, A. E. F.....	475, 476
Ordnance repair vehicles.....	373
Ordnance shop, Romorantin.....	477
Ordnance training camp.....	439
Orly Field.....	477
Osgood Bradley Car Co.....	58, 425
Otis Elevator Co.....	65
Outriggers for railway mounts.....	91, 92
Outside diameter.....	469

P.

Packing artillery ammunition.....	187
Packing boxes:	
Artillery ammunition, marking.....	189
Small-arms ammunition.....	345
Packing cases for cartridges.....	346
Packing hand grenades.....	221
Panama Arsenal.....	430, 435
Panoramic telescope.....	101, 105
Parachute flare, illuminating.....	275
Penniman, Va.....	190
Periscope, battery commander's, model of 1918.....	73
Periscopic attachment for rifle.....	331
Pershing, Gen. J. J.....	83, 357
Perry, Camp.....	338
Perth Amboy, N. J.....	190
Petroelum, as source of toluol.....	204
Photometer:	
Lummer Brodhun.....	293
Sharp-Millar.....	293
Picatinny Arsenal.....	208, 430
Picric acid.....	193, 201, 205
Supply.....	205
Pig Point depot.....	194
Pistols.....	319, 335
Pistol ammunition, caliber .45.....	351
Pistol:	
Automatic—	
United States, caliber .45.....	335, 336
Extension magazine for.....	338
Grant Hammond.....	338
Operation of.....	336

	Page.
Pistol—Continued.	
Aviation signal.....	291
Jolidon.....	338
Liberty.....	338
Luger.....	316
Marking of.....	335
Mauser.....	338
Very.....	289
Pitch.....	469
Pitch diameter.....	469
Measurement of.....	470
Of gauges.....	453
Pitch gauges.....	453
Plane table.....	313
Plants:	
Nitrate.....	209
Ordnance—	
Equipment of.....	22
Private.....	21, 22, 85
Platform, firing, railway mounts.....	92, 99, 105
Plotting board.....	75
Plug check.....	454
Plug gauge.....	459
Plumb, Fayette R.....	412
Poitiers.....	429
“Polygon”.....	428
Poole Engineering & Machine Co.....	37, 427
Position lights.....	288
Powder, black.....	207
Powder charge.....	174, 175
Powder charges, loading.....	190
Powder:	
Pyrocellulose.....	174, 347
Smokeless.....	207, 349
United States Army.....	174, 207, 349
Pratt & Whitney Co.....	455
Prideaux belt link.....	302, 304
Primer:	
Composition.....	180
For small-arms ammunition.....	343
Friction.....	176
Composition.....	180
Model of 1914.....	180
“T” model, Mark IV.....	179
Packing.....	187
Percussion.....	180
Composition.....	180
20-grain.....	176, 177
21-grain, Mark II-A.....	177
49-grain.....	176
Mark I.....	178
110-grain.....	176, 177
Primers.....	175, 176
Prismatic compass.....	75, 314

	Page.
Profile gauges.....	453
Proof work in United States.....	419
Propelling charge, United States cannon, table facing page.....	26
Propelling charge for separate loading ammunition.....	192
Projectiles:	
For field guns, antiaircraft guns, howitzers used during the war, tables facing pages.....	26, 138, 140
German.....	124
Italian field gun.....	136
Marks for.....	152
United States Army principal characteristics facing pages.....	26, 138
Projector, Livens (<i>see also</i> Livens projector).....	246
Projectors, flame, knapsack type.....	294
Protractor, 12-inch semicircular, model of 1917.....	75
Proving grounds.....	419
Aberdeen.....	419, 425
American Expeditionary Forces.....	428
Elizabethport.....	426
Erie.....	424, 425
French.....	427
Lakehurst.....	424
Nitro.....	427
Old Hickory.....	427
Redington.....	427
Sacketts Harbor.....	424, 426
Sandy Hook.....	193, 419
Savanna.....	423
Saybrook.....	425, 426
Scituate.....	425
Pyrocellulose powder.....	174, 347
Pyrotechnics.....	287
Laboratory.....	291
Modern use.....	287
Nomenclature.....	292
Tests.....	292
Pyrotechnie, Ecole de.....	429
Q.	
Quadrant, elevation.....	101, 105
R.	
Ragsdale, Lieut. Col. E. J. W., United States Army.....	244
Railway and seacoast carriages, British.....	117
Railway artillery.....	88
Railway fire control.....	105
Railway artillery repair shops, A. E. F.....	476
Railway carriages for guns, howitzers, and mortars.....	18,
	89, 90, 91, 93, 95, 97, 99, 101, 103, 105
Railway gun cars, model of 1918.....	89, 90, 91, 93, 97, 101, 103
Railway mounts.....	18, 89, 90, 91, 93, 95, 97, 99, 101, 103, 105
Range finder:	
1-meter base, model of 1916.....	74
80 cm. for machine guns.....	315
Range of artillery, United States..... (table facing page 26)	27

	Page.
Range of German guns, howitzers, and mortars.....	133
Range of guns, United States 4.7-inch gun.....	30
Rapid inspection limit gauge.....	465
Raritan Arsenal.....	437
Raritan Ordnance Depot.....	193
Recoil mechanism:	
4.7-inch gun.....	48
75-mm. gun—	
United States model of 1916.....	39
Model of 1897, French.....	43
155-mm. howitzer (Schneider).....	56
Recuperators.....	39, 43, 48, 56, 65
Reconnaissance car.....	370
Reference gauge.....	469
Release mechanism (<i>see also</i> Bomb carriers).....	278, 280, 281
European.....	281
For aerial drop bombs.....	278, 280, 281
Mark I.....	280
Mark II.....	281
Mark III.....	281
Mark IV, Caproni.....	281
Mark V.....	278
Mark VI, Bristol fighter.....	281
Mark VII-B.....	
Mark VIII.....	
Mark VIII-A.....	280
Mark IX.....	281
Mark IX-A.....	281
Mark XI.....	281
Proposed.....	281
Relief (in a screw thread tap).....	469
Relining:	
Cost of.....	24
Requirements.....	25
School.....	451
Remington Arms-Union Metallic Cartridge Co.....	298, 327, 329, 335, 353
Remington riot shotgun.....	335
Renault tank.....	402
Repair—	
And cleaning outfits for small arms.....	354
Chests for small arms.....	354
Equipment, truck.....	373
Facilities, ordnance.....	472
Motor equipment.....	362
Ordnance matériel.....	372
Shop—	
Advance.....	476
Corps.....	476, 477
Doulaincourt.....	476
Lioussaint.....	477
Equipment.....	373
Langrés.....	478

Repair—Continued.

Shop—Continued.

Mobile artillery—

Equipment.....	379
Heavy.....	373, 378
Mobile ordnance.....	373
O. and T. centers.....	478, 479
Railway artillery.....	476
Small-arms corps.....	478
Tank and tractor, Chalindrey.....	478

Truck—

Artillery.....	373, 374
Light.....	372

Vehicles, ordnance.....

373

Reserve ammunition.....

196

Revolver—

Ammunition, caliber .45.....	351
Ball cartridge, caliber .38.....	352
Colts, double-action, caliber .45, model of 1917, dimensions of.....	339
Exterior ballistics.....	340

Revolvers.....

319

Marking of.....	339
-----------------	-----

Service, model of 1917.....	338
-----------------------------	-----

Smith & Wesson, double-action, model of 1917.....	338
---	-----

.. Operation of.....	340
----------------------	-----

.. Exterior Ballistics.....	341
-----------------------------	-----

Ribeyrolle.....	306
-----------------	-----

Rifles (<i>see also</i> items below and tables facing page 318).....	319
---	-----

Rifles:

Automatic.....	298, 308, 312
----------------	---------------

Bommarito.....	316
----------------	-----

Browning.....	298
---------------	-----

Chauchat, 8-mm.....	306
---------------------	-----

Organization and supply.....	312
------------------------------	-----

Bang.....	316
-----------	-----

Breech loading magazine, small caliber of various armies. tables facing page.....	318
---	-----

British contracts in United States.....	319
---	-----

Chauchat.....	296
---------------	-----

Enfield—

Pattern of 1914.....	319, 324
----------------------	----------

Production of.....	321
--------------------	-----

Interchangeability of parts.....	320
----------------------------------	-----

Krag.....	320, 321, 330
-----------	---------------

Ammunition.....	350
-----------------	-----

Magazine, table of.....	317
-------------------------	-----

Modified bang.....	316
--------------------	-----

Russian—

3-line, caliber 7.62-mm.....	328, 329
------------------------------	----------

Ammunition.....	352
-----------------	-----

Rychiger.....	316
---------------	-----

Semiautomatic.....	316
--------------------	-----

Rychiger.....	316
---------------	-----

Service, manufactured in the United States, 1917 and 1918.....	325
--	-----

	Page.
Rifles—Continued.	
Springfield, model of 1903.....	320, 441, 443
Standardization.....	320
Swiss.....	316
Telescopic sight, United States model of 1918.....	330
United States—	
Caliber .30, model of 1903, Springfield.....	320, 321, 323, 441, 443
Caliber .30, model of 1917.....	324, 326, 327
Model of 1903, magazine extension.....	328
Periscopic attachment.....	331
Sights.....	326
Rifle grenade—	
Discharger, V-B, Mark IV.....	229
Dummy.....	230
Star and parachute cartridge for V-B rifle grenade discharger.....	287
V-B, Mark I.....	229
Rifle grenades.....	227, 229, 230
Rimailho, Capt., French Army.....	42
Ring gauges.....	463
Riot shotguns.....	335
Road test for motor equipment.....	441
Rock Island Arsenal.....	323, 423, 430, 437, 439, 472
Small arms plant.....	441
Rock Island General Ordnance Supply Depot.....	440
Rocket—	
Board, model 1918.....	76
Signal, Mark I, illuminating.....	287
Signal parachute, Mark I.....	287
Signal star, Mark I.....	287
Signal supply, French.....	198
Roll, tool, for small arms.....	354
Romorantin.....	477
Root.....	469
Root diameter.....	469
Rope grommet.....	187, 188
Rule—	
12-inch.....	76
Musketry, model 1918.....	332
Zinc.....	315
Ruler, battery commander's, wooden.....	74
Russian 3-line rifle.....	328
7.62-mm ammunition.....	352
Russian Vickers machine gun.....	303
Russo-Japanese War.....	305
Rychiger semiautomatic rifle.....	316
S.	
Saber:	
Cavalry, model of 1913.....	411
Officer's.....	411
Sacketts Harbor Proving Ground.....	424
Safety devices for fuzes.....	153, 160
Saginaw, Mich.....	427
Salvage, ammunition.....	481

	Page.
San Antonio Arsenal.....	430, 442
Sandy Hook Proving Ground.....	87, 176, 193, 419
Saumur Artillery School.....	480
Savage Arms Co.....	296, 300
Savanna Proving Ground.....	423
Saybrook Proving Ground.....	424, 425
Scabbard, bayonet.....	333
Scarf ring.....	254
Schebler carburetor.....	394, 396, 397, 409
Schneider & Co.....	19, 360
Schneider howitzer:	
155-mm.....	19, 21, 22, 24, 32, 31, 53, 55, 57, 58
240-mm.....	19, 33, 51, 58, 64, 65, 68
280-mm.....	65
Schools:	
Instruction, ordnance motor.....	437
Instruction, motor, ordnance, Raritan Arsenal.....	439
Ordnance, armament, St. Jean Demonts.....	477
Relining.....	451
Scituate Proving Ground.....	424
Screw diameters, measurement of.....	470
Screw thread:	
Definitions.....	468
Gauges.....	453, 460
Ring and plug type.....	454
Measurements.....	471
Standardization.....	467, 468
Tolerances.....	456
Seacoast guns:	
Improvised carriages for.....	33
Removal of.....	83
Seacoast mounts.....	87
Self-propelled mount for 8-inch howitzer and 240-mm. howitzer.....	388
Semiautomatic rifles.....	316
Semiautomatic Rychiger.....	316
Semifixed ammunition.....	174
Semisteel shell.....	141
Separate loading ammunition.....	174
Seven Pines, Va., loading plant.....	191
Shafter, Reservation, Fort.....	433
Shaper, motor-driven, Gould & Eberhardt.....	380
Sheffield, Ala. (<i>see also</i> Nitrate Plant No. 1).....	209
Shell.....	138, 140, 151
Base fuze.....	148
" C ".....	124
Ejection bag.....	255
Ejection chute.....	255
Ejection tube.....	255
Filling.....	140, 204
French—	
Characteristics of.....	120
Navy and seacoast.....	120
Gas.....	141, 148
For Livens projector.....	246

Shell—Continued.	Page.
German.....	124
Elongated.....	124
Explosive.....	126
High-explosive, model of 1915.....	129
Semiarmor-piercing.....	125
High-explosive.....	145
Illuminating.....	149, 151
Incendiary.....	149, 246
For Livens projector.....	246
Machining.....	140
Markings, United States.....	151
Marks.....	152
Nose fuze.....	147
Packing.....	187
Point fuze.....	147
Production of.....	140
Semisteel.....	141
Smoke.....	149
Tracer.....	149
United States.....	151
Trench mortar.....	234, 238, 242
37-mm. fuzes for.....	163
Sheridan, Fort, Ill.....	427
Shipping artillery ammunition.....	187
Shop or workman's gauge.....	469
Shop:	
Ordnance, Ramorantin.....	477
Repair.....	478
Experimental, Langres.....	478
Mobile, artillery, heavy.....	373
Mobile, ordnance.....	373
Motor equipment.....	357
Small arms, corps.....	478
Tanks and tractors, Chalindrey.....	478
Shotguns:	
Repeating, riot pattern.....	335
Riot—	
Remington.....	335
Winchester.....	335
Shrapnel.....	138, 144
German.....	124, 129
Model of 1895.....	129
Packing.....	188
3.8-inch.....	145
4.7-inch.....	145
75-mm.....	44, 145
155-mm.....	145
Shrinking on jacket.....	22
Sights:	
Aldis.....	257
Antiaircraft.....	69, 112
Carriage, model of 1917.....	112
Trailer mount.....	113

Sights—Continued.	Page.
Base.....	258
Bomb.....	282
French, S. T. Aé.....	282
Mark I-A.....	283, 284
Mark I-B.....	285
Michelin.....	285
Various types.....	283
7th A. I. C.....	285
Chretien.....	257
For cannon.....	88, 103
Field guns, United States.....	69
German, for field guns.....	127, 130
Machine guns.....	256, 257, 313
5-inch, ring and bead.....	256
Micrometer, sniper's.....	331
Norman wind vane.....	257
Open, for United States field guns.....	71
Panoramic—	
Model of 1917.....	69, 105
Machine gun, model of 1918.....	313
Musket, telescopic, model of 1918.....	330
Telescopic, Winchester.....	330
Telescoping tube, winder for 1903 rifle.....	331
United States rifle.....	326
Warner objective.....	331
Signal light, Mark II, Very.....	289
Signal rockets.....	287
Supply, French.....	198
Silverford plant (Aetna Explosives Co.).....	465
Simplex governor.....	368
Singer Manufacturing Co.....	426
Sirrocco type fan.....	405
Site, angle of, instrument.....	315
Sitogoniometer, model of 1918.....	75
Sleds, artillery.....	388
Slide rule, model of 1917.....	75
Sliding railway mount.....	101
For 12-inch gun, model of 1918.....	103
Slope of thread.....	469
Small arms.....	319
(See also tables facing page 318.)	
Ammunition.....	343, 354, 356
Cleaning and repair outfits.....	354
Gauges.....	455
Plant, Rock Island Arsenal.....	441
Repair and cleaning outfit.....	354
Table of leading types.....	facing 318
Testing in France.....	429
Smith & Wesson Co.....	338
Smith & Wesson double-action revolver.....	338
Smoke knapsack.....	295
Smoke tests.....	292
Smoke torch, Mark I.....	288

	Page.
Smokeless powder.....	174, 207, 208, 349
Deterioration of.....	208
Production capacity.....	208
United States Army.....	174
Snap gauges.....	457, 459
Sniper's micrometer sight.....	331
Sniping telescopic sight.....	330
Society of Automotive Engineers.....	468
Sodatol.....	205
Souge Training Camp.....	480
Spare guns, howitzers, and mortars.....	83
Sponsons of tanks.....	402
Sponsons for tank, Mark VIII, armament.....	403
Springfield Armory.....	216, 323, 430, 443, 455
Springfield Arsenal.....	455
Springfield rifle, model of 1903.....	320
Square, zinc.....	75, 315
St. Chamond Co., gas-electric self-propelled mount.....	388
St. Chamond matériel.....	399
St. Jean Demonts.....	477
Machine gun tests.....	429
St. Louis Car Co.....	312
Staff observation car.....	369
Standardization, rifles.....	320
Standards, Bureau of.....	293, 455, 467
Standard Steel Car Co.....	65
Standard Steel Works Co.....	58
Star cartridge.....	288
Star gauges.....	463
Steel, ballistic quality.....	418
Steel helmets.....	412
Stewart vacuum fuel-fed system.....	396, 409
Stone & Webster.....	472, 473
Storage, ammunition, etc., in France.....	481
Straightedge, 24-inch.....	75
Stromberg carburetor.....	363
Supply truck, artillery.....	376
Sutere, Mr.....	306
Sutton, Lieut. F. A., R. E.....	244
Symon, Lieut. Col. W. A.....	25
Synchronization of machine guns.....	251, 252
Synchronizing gear.....	251, 252

T.

Tachyscope.....	114
Tacony Ordnance Corporation.....	65
Taft-Pierce Co.....	455
Tank—	
Ammunition.....	410
Armament.....	410
Armor.....	410
Committee, interallied.....	390

	Page.
Tanks.....	402, 403
Comparative data of.....	401
English, Mark IV and Mark V.....	403
Equivalent in artillery fire.....	402
Fighting value.....	402
Fire control.....	406
Ford.....	388
General features.....	400
Gunners and operators.....	410
Guns.....	36, 302, 402
Large.....	400
Longeron.....	408
Maneuvering ability.....	410
Mark VIII.....	403
Operation of.....	400
Personnel.....	405
Renault.....	402
6-ton, model of 1917, Renault.....	406
Small.....	402
Track.....	409
Turret.....	409, 410
Uses of.....	402
United States—	
Mark VIII, weight and crew.....	404
6-ton.....	407
6-ton, model of 1917.....	385
Taper gauges.....	463
Technical instruction.....	478, 479, 480
Telemetre d'Altitude Avec Correcteur Automatique.....	114
Telemetre de distance horizontal.....	114
Telescope:	
Battery commander's, model of 1915.....	71
Panoramic.....	101, 105
Telescopic sight rifle, United States, model of 1918.....	330
Telescopic sights.....	330
Test cartridges.....	348, 351
Tests:	
Road.....	441
Smoke.....	292
Tetranitroaniline.....	205
Tetryl.....	205
Texas, Md.....	427
Thread definitions.....	468
Thread:	
Flow of.....	469
Franklin Institute.....	469
Gauge.....	459
Micrometer.....	470
Modified.....	469
Plug limit gauges.....	465
Slope of.....	469
System, United States Standard.....	463
United States Standard.....	469

	Page.
Thread—Continued.	
"V".....	469
Whitworth.....	470
Threads, per inch.....	470
TNA (<i>see also</i> Tetranitrosaniline).....	205
TNT (<i>see also</i> Trinitrotoluol).....	201, 202
Toledo, Ohio, site for nitrate plant No. 4.....	215
Tolerance.....	453, 470
Tolerances, screw threads.....	456
Toluol.....	203
Tool chest, armorer's.....	308
Tool kit for machine guns.....	308
Tool roll for small arms.....	354
Torch, smoke, Mark I.....	288
Tourelle.....	254
Tracer cartridge.....	345, 346
Tracer-incendiary ammunition.....	353
Track-laying types of vehicles.....	386
Tracks, caterpillar.....	388
Tractor:	
Ammunition.....	399
Artillery.....	386
2½-ton, model of 1918.....	390
5-ton.....	359, 393
10-ton.....	394, 395
15-ton.....	396
20-ton.....	397
Camouflage.....	360
Caterpillar.....	386
Concealment of.....	360
Equipment.....	357
Mobility.....	359
Operation.....	390
Supply of.....	360
Track-supporting devices.....	398
Types for United States Army, Ordnance Department.....	358
United States productive capacity.....	397
Vulnerability.....	359
2½-ton high speed.....	386
Tractors.....	386, 390, 397
Trailers.....	378, 382
Antiaircraft, 3-ton.....	382
Caterpillar.....	388
For 4.7-inch antiaircraft gun.....	111
Chassis, table of.....	382
Crane, 4-ton.....	380
Field gun, 3-inch.....	382, 384
Machine gun, antiaircraft.....	382
3-ton.....	382
4-ton.....	379
4-ton shop.....	382
10-ton.....	382, 384
Trailer mount for 3-inch antiaircraft gun.....	110
Trailer mount for 4.7-inch antiaircraft gun.....	51

	Page.
Trailer special for heavy artillery mobile repair shop.....	378
Train, armament.....	95
Training Camp:	
Coetquidan.....	479
La Courtine.....	479
Meucoe.....	480
Souge.....	480
Valdahon.....	480
Training, care and repair of ordnance.....	473
Transmission, quartermaster class B.....	368
Transport of artillery.....	386
Trench knives.....	412
Trench mortar:	
3-inch Stokes.....	230, 234
4-inch Stokes.....	235
6-inch.....	235
Bed.....	239
Newton.....	235
Operation of.....	239
Propelling charge.....	239
240-mm.....	240, 242
Ammunition.....	231, 234, 235, 238, 242, 243, 244, 246
Ammunition at the front.....	196
Fuze—	
Mark VI.....	244, 245
Mark VII.....	243
Livens projector.....	246
Shell—	
3-inch Stokes.....	234
6-inch, Mark I.....	238
240-mm.....	242
Trench mortars.....	230, 231
Ammunition, French allowance.....	196
British.....	230
Tabular summary.....	231
Trench warfare Matériel.....	217
Trinitrotoluol.....	202
Tripod for fire-control instruments.....	74
Trojan grenade powder.....	206
Trojan Powder Co.....	207
Truck mount, antiaircraft, model of 1917, for 75-mm. field gun, model of 1916.	108
Trucks:	
Ammunition.....	364, 372
Attachments, caterpillar.....	390
Axles.....	368
Chassis—	
Table of types.....	362
Nash, 2-ton, Model 4017F and L.....	368
Engine, quartermaster, type B.....	394
Front drive motor, for 3-inch antiaircraft gun.....	111
F. W. D.....	360, 363, 378, 388
Chassis.....	366

Trucks—Continued.

	Page.
Four-wheel-drive—	
Interchangeable parts.....	367
Standardized.....	367
F. W. D. 3-ton.....	379
Four-wheel-drive type.....	388
3-ton, model of 1918, Ordnance Department.....	366
Interchangeability of gears.....	368
Light repair.....	373
Motor—	
United States.....	386
Table of.....	363
Ordnance Department.....	365
Narrow gauge for 12-inch mortar.....	101
12-wheel, narrow gauge.....	95
Nash.....	360
Ordnance, standardization of.....	368
Pennsylvania Railroad, standard 70-ton.....	91, 92
Railway—	
9.2 inch, Mark II, British.....	118
12-wheeled for railway gun mounts.....	97
Repair—	
Artillery.....	373, 374
Equipment.....	373
Use.....	373
Light.....	372
Schneider railway mount.....	97
Sliding railway mount, model of 1918.....	101
Standard gauge.....	92
Steering gear, quartermaster class B.....	368
Supply, Artillery.....	376
Organizations supplied.....	378
Types of loads.....	376
Table of United States motor trucks.....	362
Tests, 3-ton, model of 1918, Ordnance Department.....	367
Transport for 14-inch railway gun mount.....	105
Tullytown, Pa., loading plant.....	191
Turner Ordnance Depot.....	194
Turns per inch.....	470
Turret mount for aircraft guns.....	254
Turret of tank.....	409

U.

United States Bureau of Standards.....	293, 455, 467
United States Housing Corporation.....	423, 451
United States Marine Corps.....	300, 330
United States standard thread.....	463, 469
United States Steel Corporation.....	65

V.

Valdahon Training Camp.....	480
Vehicles:	
Artillery, road tests.....	441
German field guns.....	131
Howitzer units, 8-inch, 9.2-inch, 240-mm.....	64
Motor-driven.....	357
Repair, ordnance.....	373
Track-laying, types of.....	386

	Page.
Velie Carriage Co.....	312
Versailles:	
Commission d'Experiences, small arms.....	429
Commission de poudre—Powder investigations.....	429
Very parachute cartridge, Mark I.....	291
Very pistol.....	289
Very star cartridge, Mark I.....	291
Vickers (Ltd.).....	303
Vickers aircraft machine gun.....	249, 304
Vickers howitzer:	
8-inch.....	24, 32, 33, 59, 61
9.2-inch.....	32, 62, 63
Vickers machine gun:	
Model of 1915.....	302
Russian.....	303
11-mm.....	251, 303
Ammunition, 11-mm.....	353
Viven-Bessieres parachute cartridge, Mark I.....	288
Viven-Bessieres rifle grenade.....	229
V. B. rifle grenade star and parachute cartridge.....	287
V. B. star cartridge, Mark I.....	288
Voiturettes.....	311
Von Odkolek.....	305

W.

Waltham mechanical time fuze.....	170
Warehouses for ordnance supplies.....	476
Warner objective sight.....	331
Warrior steam power plant.....	214
Watertown, Mass.....	58, 85, 425, 430
Watervliet Arsenal.....	65, 85, 430, 444, 449, 450, 455
Webbing.....	412
Webbing belt for cartridges.....	355
Weight marking of shell.....	151, 152
Welin type of breech 9.2-inch howitzer.....	64
Western Cartridge Co.....	353
Westinghouse Co.....	298, 329
White, Lieut. Col. A. H.....	210
White motor.....	362
White truck chassis.....	369, 370
Whitworth thread.....	470
Wilmer eye and face shield.....	415
Winchester Repeating Arms Co.....	299, 327, 330, 335
Winchester riot shotgun.....	335
Winchester telescopic sight.....	330
Winder telescoping tube sight.....	331
Wing tip flare, Mark I.....	289
Wisconsin engine.....	362, 368
Woodbury, N. J., loading plant.....	191
Work, proof.....	427
Working-in plants for machine guns.....	251
Wrench fit.....	470

Z.

Zinc square.....	75, 315
------------------	---------



UNIVERSITY OF CALIFORNIA LIBRARY
BERKELEY

Return to desk from which borrowed.
This book is DUE on the last date stamped below.

21 Jul 49 En

10 May 51 BC

26 Apr 51 LC

LIBRARY USE ONLY
SEP 3 0 1985
CIRCULATION DEPT.

REC. CIR. SEP 3 0 1985

LD 21-100m-9, '48 (B399n15) 476

YC 64306



Faint, illegible text or markings, possibly a stamp or handwritten notes, located in the middle-right area of the page.

