

WAR DEPARTMENT TECHNICAL MANUAL

TM 9-1803 B

ORDNANCE MAINTENANCE

**Power Train, Body,
and Frame for
1/4-Ton 4x4 Truck**

(Willys-Overland Model MB and Ford Model GPW)

This is a reprint of TM 9-1803B, Power Train, Body, and Frame for 1/4-Ton 4x4 Truck. (Willys-Overland Model MB and Ford Model GPW). No distribution will be made to personnel possessing the original publication.

CONTENTS

WAR DEPARTMENT
Washington 25, D. C., 8 April 1944

TM 9-1803B, Ordnance Maintenance: Power Train, Body, and Frame for 1/4-ton 4 x 4 Truck (Willys-Overland Model MB and Ford Model GPW), is published for the information and guidance of all concerned.

[A.G. 300.7 (17 Nov 43)
O.O.M. 461/(TM-9) Rar. Ars. (4-15-44)]

BY ORDER OF THE SECRETARY OF WAR:

G. C. MARSHALL,
Chief of Staff.

OFFICIAL:

J. A. ULIO,
*Major General,
The Adjutant General.*

DISTRIBUTION: R 9 (4); Bn 9 (2); C 9 (5).

(For explanation of symbols, see FM 21-6.)

CONTENTS

		Paragraphs	Pages
CHAPTER	1. INTRODUCTION	1- 2	4- 6
CHAPTER	2. POWER TRAIN	3-35	7- 98
SECTION	I. Power train description.....	3	7
	II. Transmission	4- 9	7- 24
	III. Transfer case	10-15	24- 38
	IV. Propeller (drive) shafts and uni- versal joints	16-21	38- 45
	V. Front axle	22-28	45- 86
	VI. Rear axle	29-34	86- 97
	VII. Fits and tolerances.....	35	98
CHAPTER	3. BODY AND FRAME.....	36-47	99-136
SECTION	I. Springs and shock absorbers.....	36-38	99-110
	II. Steering gear and drag link.....	39-40	111-122
	III. Body	41-42	122-128
	IV. Frame	43-46	128-136
	V. Fits and tolerances.....	47	136
CHAPTER	4. SPECIAL TOOLS	48-49	137-139
REFERENCES		140-142
INDEX		143- 148

★This Technical Manual supersedes TB 1803-1, dated 8 December 1943. For supersession of Quartermaster Corps 10-series Technical Manuals, see paragraph 1 j.

TM 9-1803B

1

ORDNANCE MAINTENANCE — POWER TRAIN, BODY, AND FRAME FOR ¼-TON 4 x 4 TRUCK (WILLYS-OVERLAND MODEL MB AND FORD MODEL GPW)

CHAPTER 1

INTRODUCTION

1. SCOPE.

a. The instructions contained in this manual are for the information and guidance of personnel charged with the maintenance and repair of the power train, body, and frame of the ¼-ton 4 x 4 truck. These instructions are supplementary to field and technical manuals prepared for the using arms. This manual does not contain information which is intended primarily for the using arms, since such information is available to ordnance maintenance personnel in 100-series TM's or FM's.

b. This manual contains a description of, and procedure for, removal, disassembly, inspection, and repair of the transmission, transfer case, axles, body, and frame.

c. TM 9-803 contains operating instructions and information for the using arms.

d. TM 9-1803A contains instructions for the information and guidance of personnel charged with the maintenance and repair of the 4-cylinder engine used in these vehicles.

e. TM 9-1825B contains information for the maintenance of the Auto-Lite electrical equipment.

f. TM 9-1826A contains information for the maintenance of the Carter carburetor.

g. TM 9-1827C contains information for the maintenance of the Wagner hydraulic brake system.

h. TM 9-1828A contains information for the maintenance of the A. C. fuel pump.

i. TM 9-1829A contains information for the maintenance of the speedometer.

j. This manual includes pertinent ordnance maintenance instructions from the following Quartermaster Corps 10-series Technical Manuals. Together with TM 9-803 and TM 9-1803A, this manual supersedes them:

- (1) TM 10-1103, dated 20 August 1941.
- (2) TM 10-1207, dated 20 August 1941.
- (3) TM 10-1349, dated 3 January 1942.
- (4) TM 10-1513, Changes 1, dated 15 January 1943.

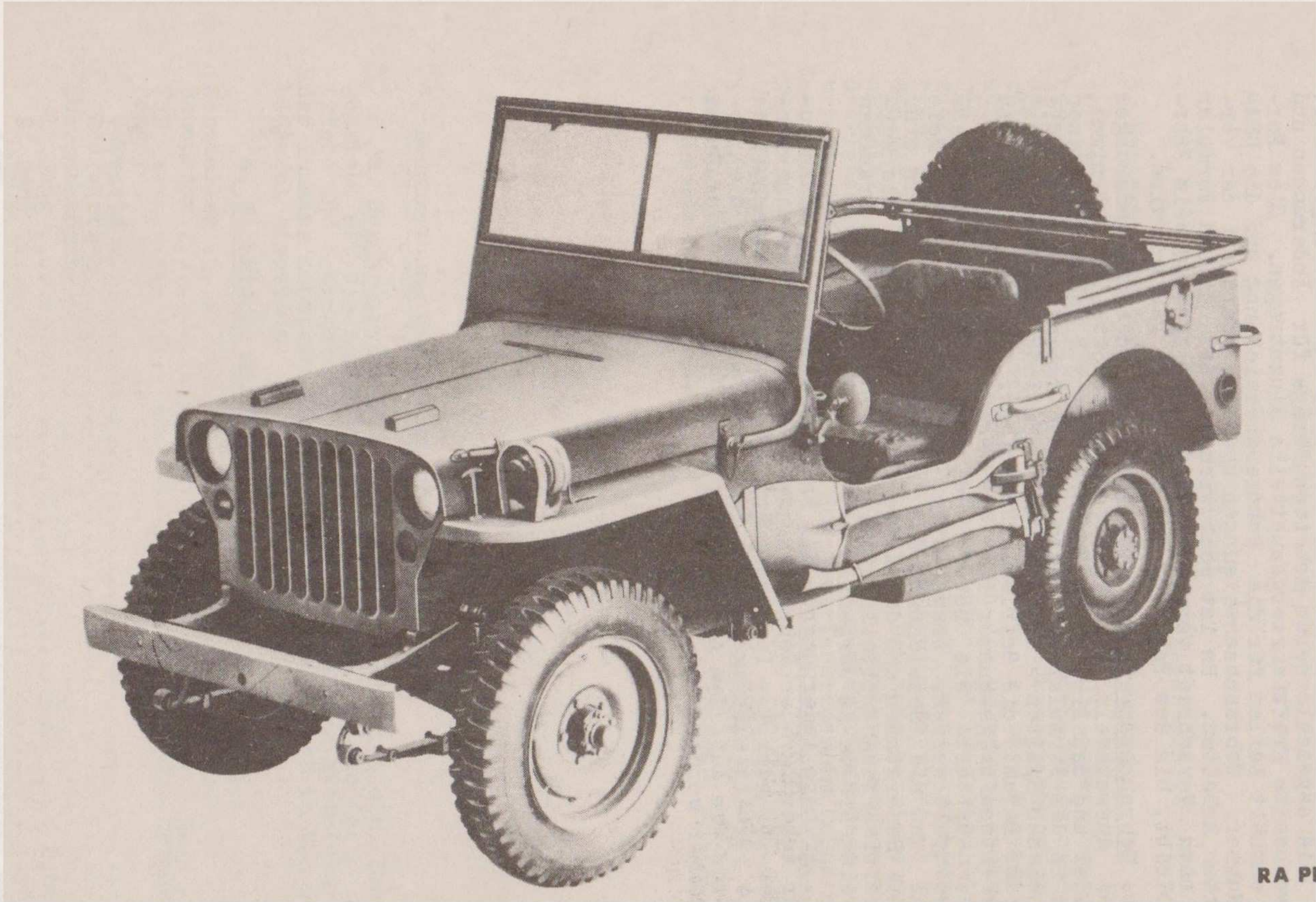

RA PD 28742

Figure 1 — 1/4-ton Truck 4 x 4 — Three-quarter Front View

INTRODUCTION

TM 9-1803B
1

**ORDNANCE MAINTENANCE — POWER TRAIN, BODY, AND FRAME FOR ¼-TON 4 x 4 TRUCK
(WILLYS-OVERLAND MODEL MB AND FORD MODEL GPW)**

2. MWO AND MAJOR UNIT ASSEMBLY REPLACEMENT RECORD.

a. **Description.** Every vehicle is supplied with a copy of AGO Form No. 478 which provides a means of keeping a record of MWO's completed or major unit assemblies replaced. This form includes spaces for the vehicle name and U. S. A. Registration Number, instructions for use, and information pertinent to the work accomplished. It is very important that this form be used as directed and that it remain with the vehicle until the vehicle is removed from service.

b. **Instructions for Use.** Personnel performing modifications or major unit assembly replacements must record clearly on the form, a description of the work completed, and must initial the form in the columns provided. When each modification is completed, record the date, hours and/or mileage, and MWO number. When major unit assemblies, such as engine, transmission, transfer case, are replaced, record the date, hours and/or mileage and nomenclature of the unit assembly. Minor repairs and minor parts and accessory replacements need not be recorded.

c. **Early Modifications.** Upon receipt of a vehicle for modification or repair, by a third or fourth echelon repair facility, maintenance personnel will record the MWO numbers of modifications applied prior to the date of AGO Form No. 478.

CHAPTER 2

POWER TRAIN

Section I

POWER TRAIN DESCRIPTION

3. POWER TRAIN DESCRIPTION.

a. The power from the engine is transmitted to the driving wheels through a transmission and a transfer case, each of which provides a means of selecting the gear reduction. The power from the transfer case is transmitted to the front and rear axles through propeller shafts equipped with universal joints. The transmission is located at the rear of the engine and is secured to the clutch housing (fig. 2). The various gears in the transmission (par. 4) are controlled by a shift lever. The transfer case is mounted directly onto the rear of the transmission. The transmission output shaft extends from the rear of the transmission into splines of the main drive gear in the transfer case. The transfer case is provided with two levers, one to select the transfer case ratio, and the other to engage or disengage the front axle (fig. 5). A hand brake drum is mounted on the rear axle output shaft. Each axle is of the spiral bevel hypoid gear full-floating type, equipped with the conventional differential.

Section II

TRANSMISSION

4. DESCRIPTION AND DATA.

a. **Description.** The transmission (fig. 3) is of the 3-speed type with synchronized second and high speed gears. The transmission and transfer case are mounted on rubber on the frame center cross-member. The gearshift lever is incorporated in the gearshift housing.

b. **Data.**

Make	Warner
Model	T84J
Type	Synchronous Mesh
Speeds:	
Forward	3
Reverse	1
Ratios:	
Low	2.665 to 1
Second	1.564 to 1

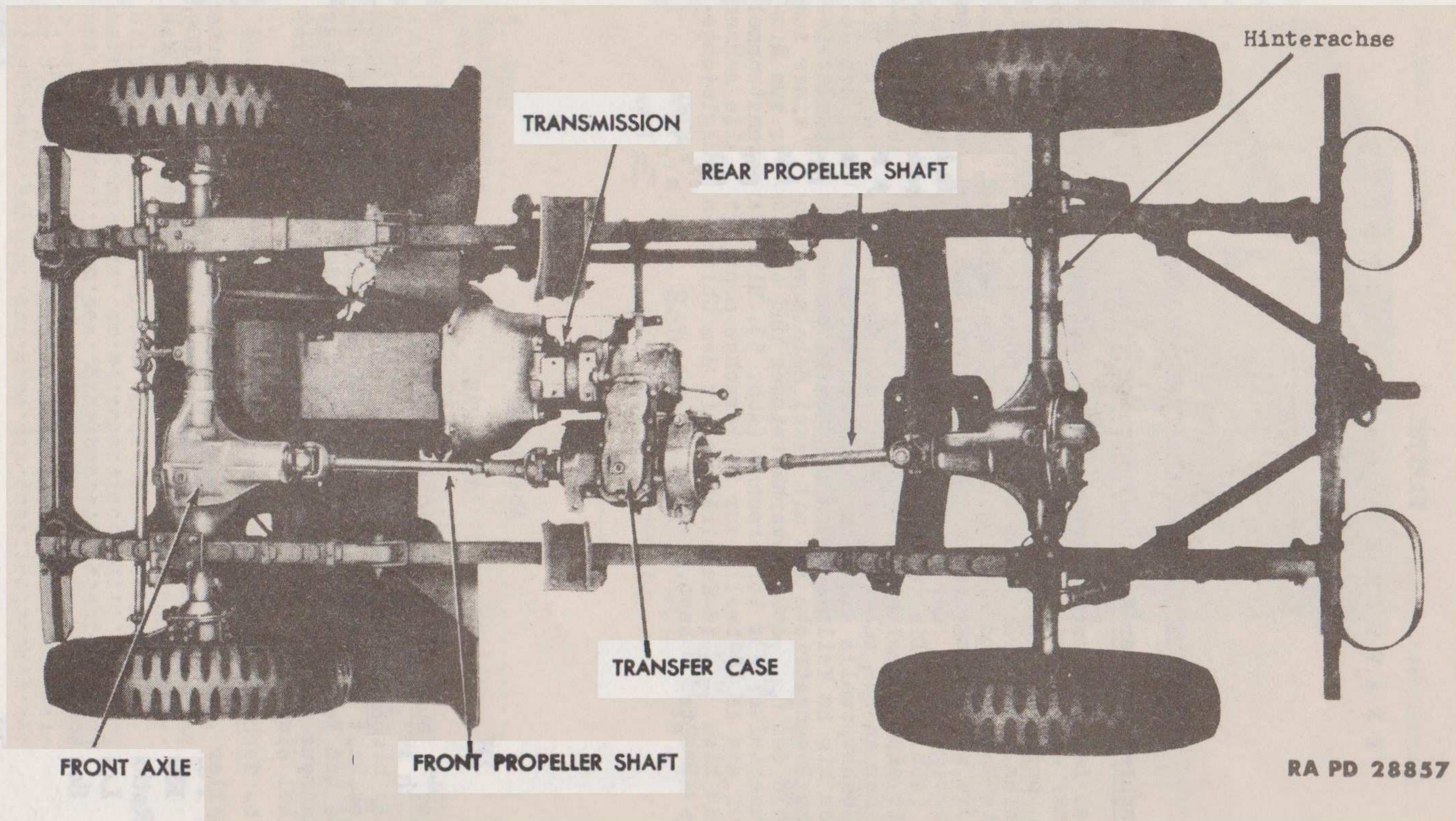

RA PD 28857

Figure 2 — Power Train

POWER TRAIN

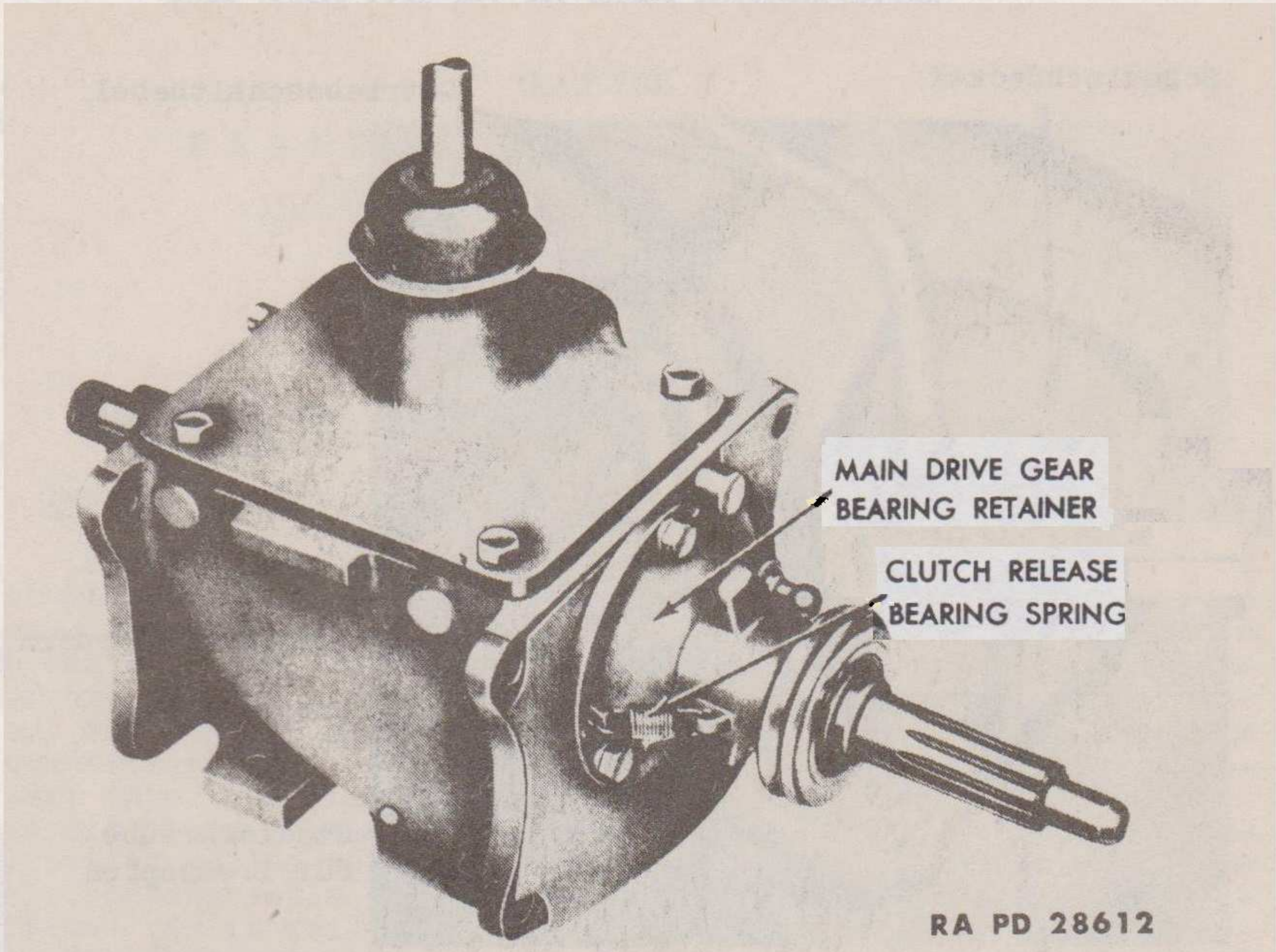

RA PD 28612

Figure 3 – Transmission – Three-quarter Front View

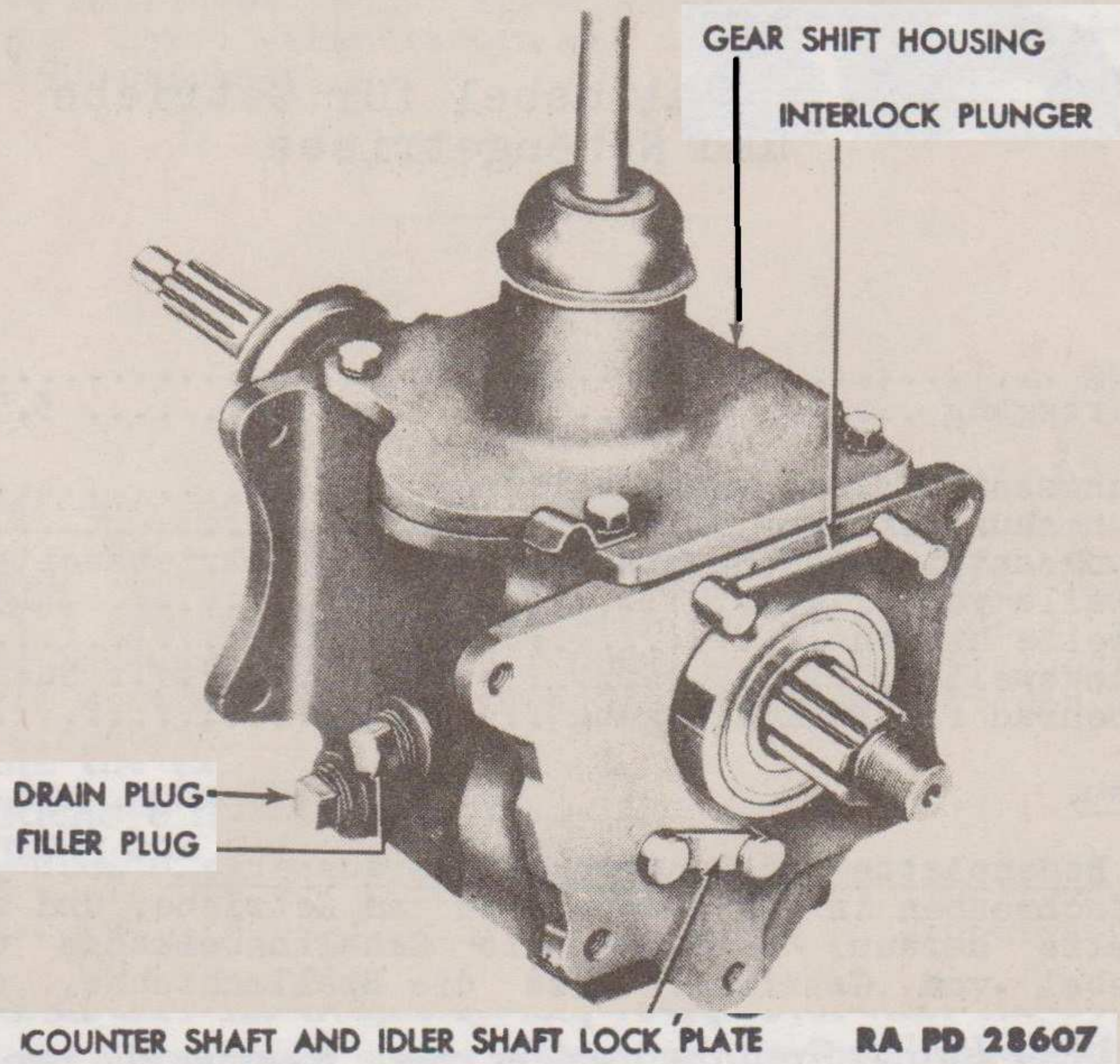

RA PD 28607

Figure 4 – Transmission – Three-quarter Rear View

ORDNANCE MAINTENANCE — POWER TRAIN, BODY, AND FRAME FOR ¼-TON 4x4 TRUCK
(WILLYS-OVERLAND MODEL MB AND FORD MODEL GPW)

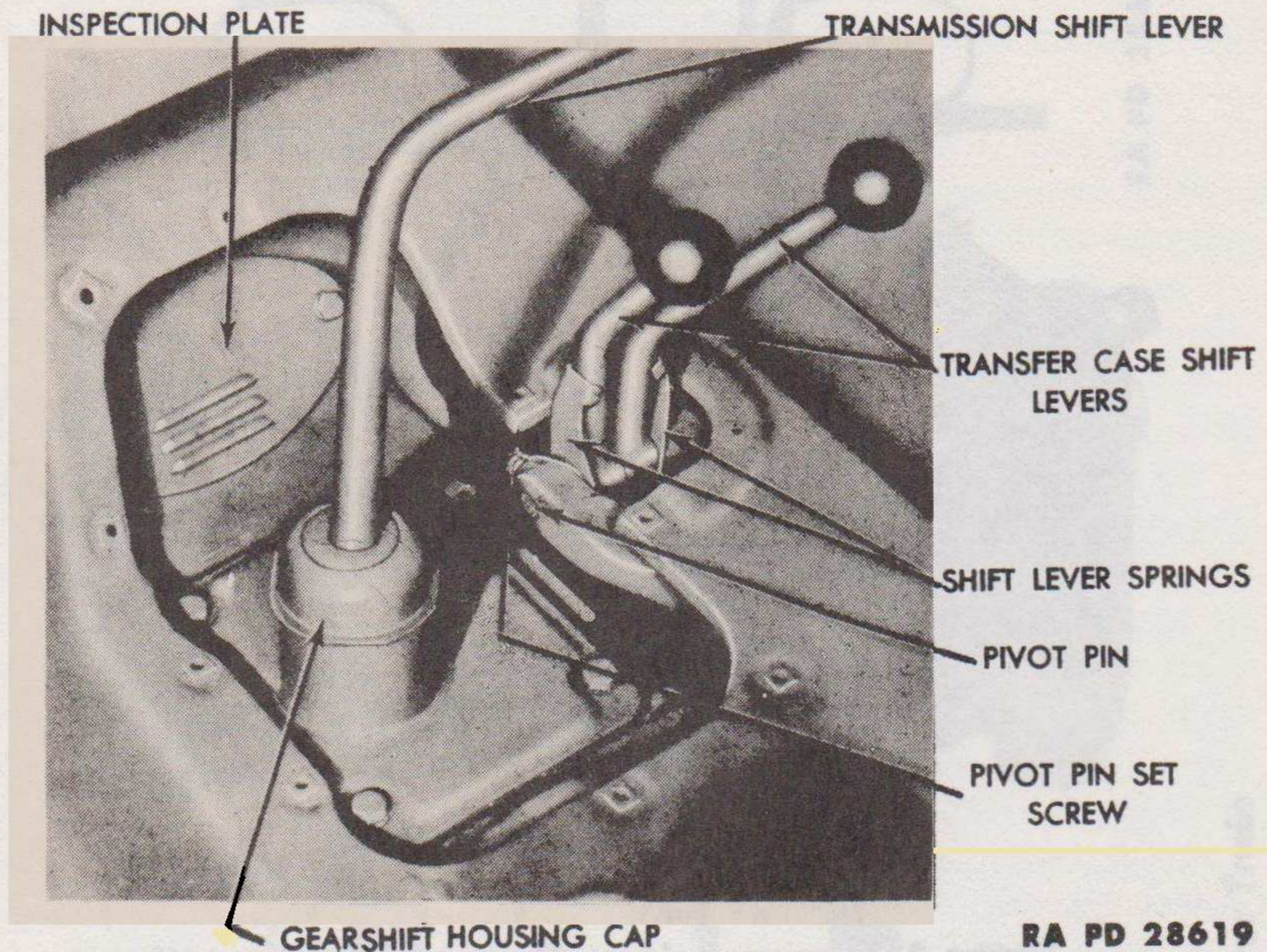

RA PD 28619

Figure 5 — Transmission and Transfer Case Shift Levers

High	1 to 1
Reverse	3.554 to 1
Bearings:	
Clutch shaft (flywheel)	Bushing
Clutch release	Ball
Clutch shaft rear (main drive gear)	Ball
Mainshaft front	13 rollers
Mainshaft rear	Ball
Countershaft gear	Bushings (2)
Reverse idle gear	Bushing

5. REMOVAL.

a. **Remove Floor Plate and Shift Lever (fig. 5).** Remove the cap screws from the floor plate at the transmission, and remove the floor plate. Remove the gearshift housing cap and remove the shift lever from the transmission. Remove the set screw that secures the shift lever pivot pin on the transfer case and, with a suitable drift, remove the shift lever pivot pin. Remove the two shift levers and shift lever springs from the transfer case. Remove the two cap screws that secure the clutch housing inspection plate and remove the inspection plate.

POWER TRAIN

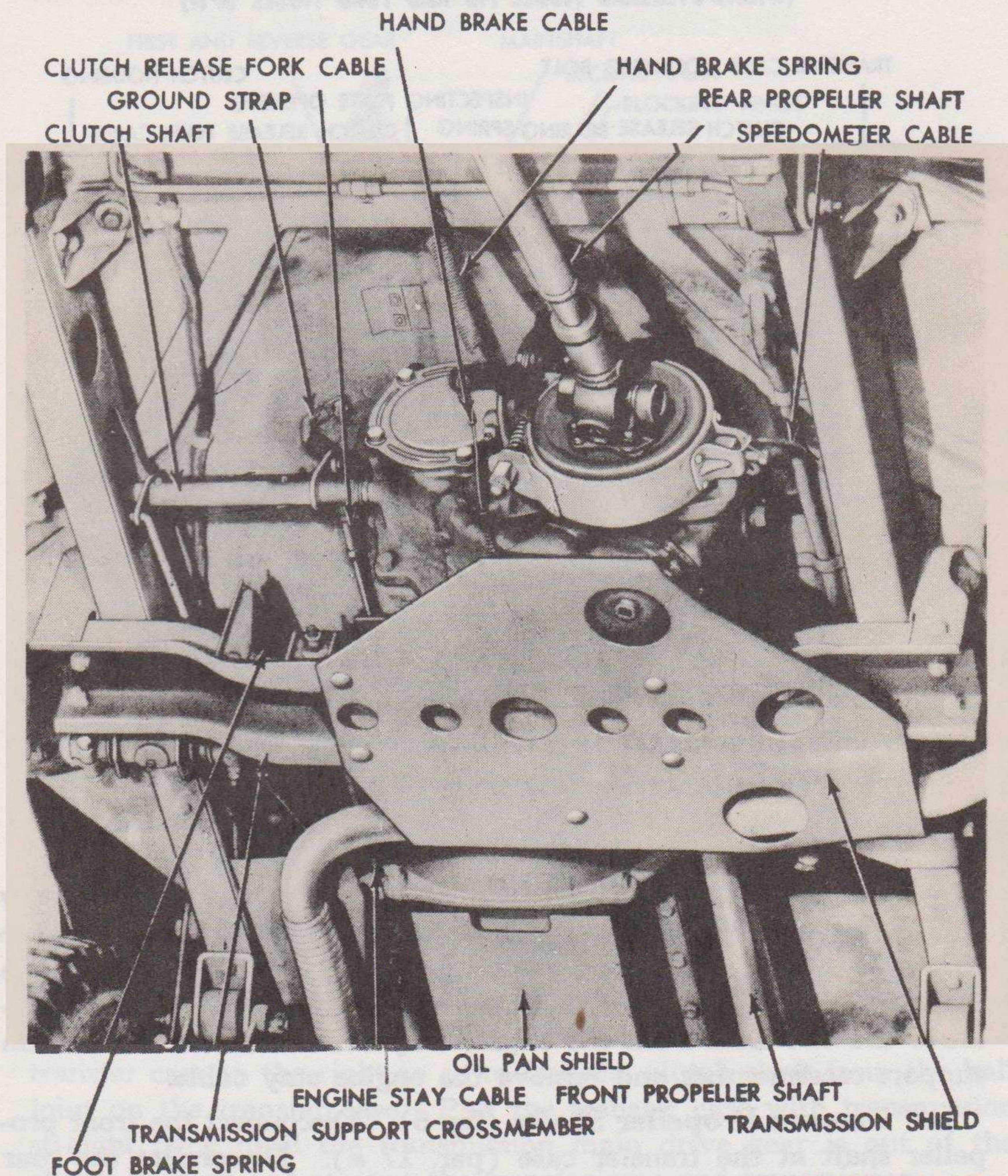

RA PD 28897

Figure 6 — Under Side of Chassis

b. **Remove Transmission Shield (fig. 6).** Remove the cap screws that secure the exhaust pipe clamp to the shield, and remove the clamp. Remove the five bolts that secure the transmission shield to the transmission support crossmember. Remove the transmission shield.

c. **Remove Brake Springs and Speedometer Cable (fig. 6).** Remove the hand brake spring. Remove the foot brake spring leading from the bottom of the brake pedal to the transmission support crossmember. Disconnect the speedometer cable at the transfer case.

ORDNANCE MAINTENANCE — POWER TRAIN, BODY, AND FRAME FOR ¼-TON 4x4 TRUCK
(WILLYS-OVERLAND MODEL MB AND FORD MODEL GPW)

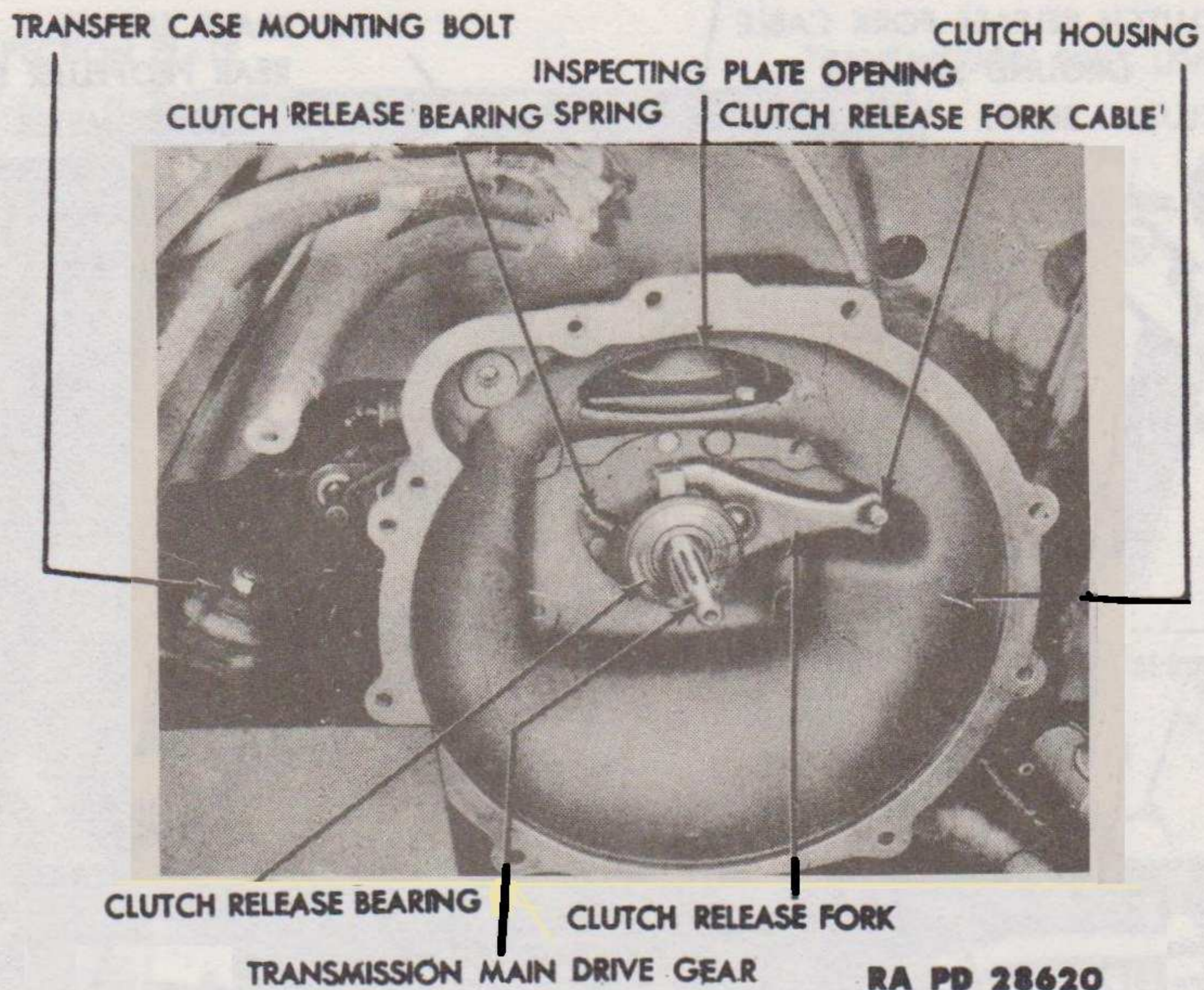

Figure 7 — Clutch Release Fork

d. **Remove Hand Brake Cable, Clutch Cable, and Engine Stay Cable** (fig. 6). Remove the clevis pin that secures the hand brake cable to the brake band. Remove the hand brake cable clamp at the transfer case. Disconnect the clutch cable at the clutch shaft. Remove the two nuts from the engine stay cable on the transmission support crossmember and remove the engine stay cable.

e. **Remove Propeller Shafts** (fig. 6). Disconnect the front propeller shaft at the transfer case (par. 17 a). Disconnect the rear propeller shaft at the transfer case (par. 17 b).

f. **Remove Ground Strap** (fig. 6). Remove the ground strap leading from the transfer case to the floor plate.

g. **Remove Clutch Release Fork** (fig. 7). Working through the inspection plate opening on the clutch housing, remove the clutch cable from the clutch release fork, and remove the clutch release fork from the clutch housing.

h. **Disconnect Radiator Hose**. Drain the coolant from the radiator. Loosen the radiator hose clamp at the radiator end, and remove the hose from the radiator.

i. **Disconnect Transmission at Clutch Housing** (fig. 6). Place a jack under the oil pan shield at the rear of the engine. Remove

POWER TRAIN

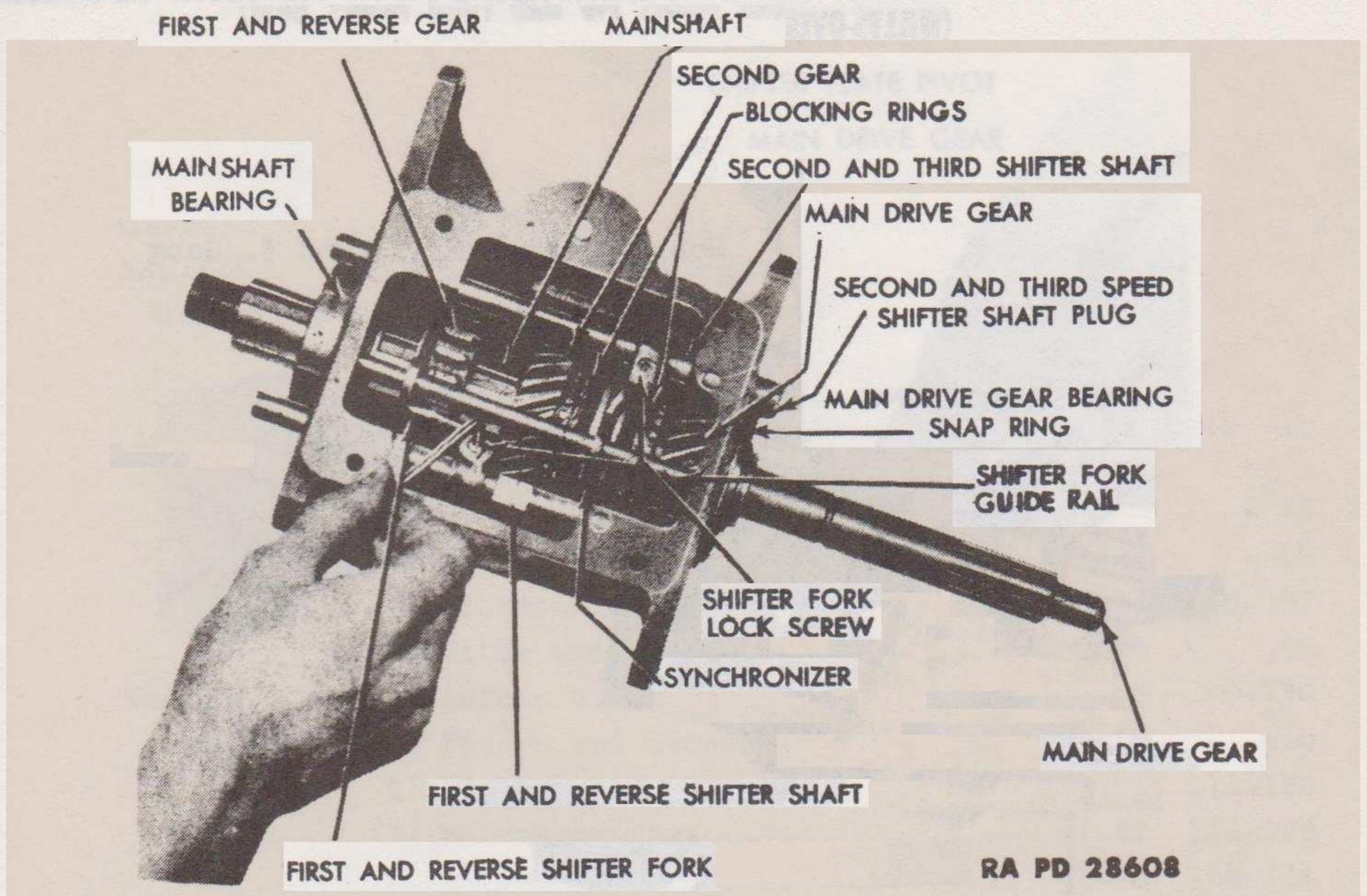

Figure 8 — Removing Shifter Fork Lock Screws

three cap screws from each side of the transmission support crossmember. Place another jack under the transmission. Remove the four bolts that secure the transmission to the clutch housing. Lower both jacks evenly until the transmission support crossmember is approximately 2 inches from the frame. Push the transmission and transfer case to the right so as to free the clutch shaft from the ball joint on the transfer case. Pull the transfer case with transmission straight back until the transmission main drive gear is out of the clutch housing and remove the transfer case and transmission.

j. **Remove Transmission Support Crossmember (fig. 6).** Remove the five mounting bolts that secure the transmission and transfer case to the transmission support crossmember. Remove the transmission support crossmember.

k. **Remove Transmission From Transfer Case (fig. 27).** Drain the oil from the transmission and transfer case. Remove the rear cover from the transfer case. Remove the castellated nut and flat washer that secure the drive gear on the transmission mainshaft and remove the drive gear and oil baffle from the transmission mainshaft, using a suitable puller, if necessary. **NOTE: Vehicles of early manufacture were not supplied with this oil baffle.**

ORDNANCE MAINTENANCE — POWER TRAIN, BODY, AND FRAME FOR ¼-TON 4x4 TRUCK
(WILLYS-OVERLAND MODEL MB AND FORD MODEL 6PW)

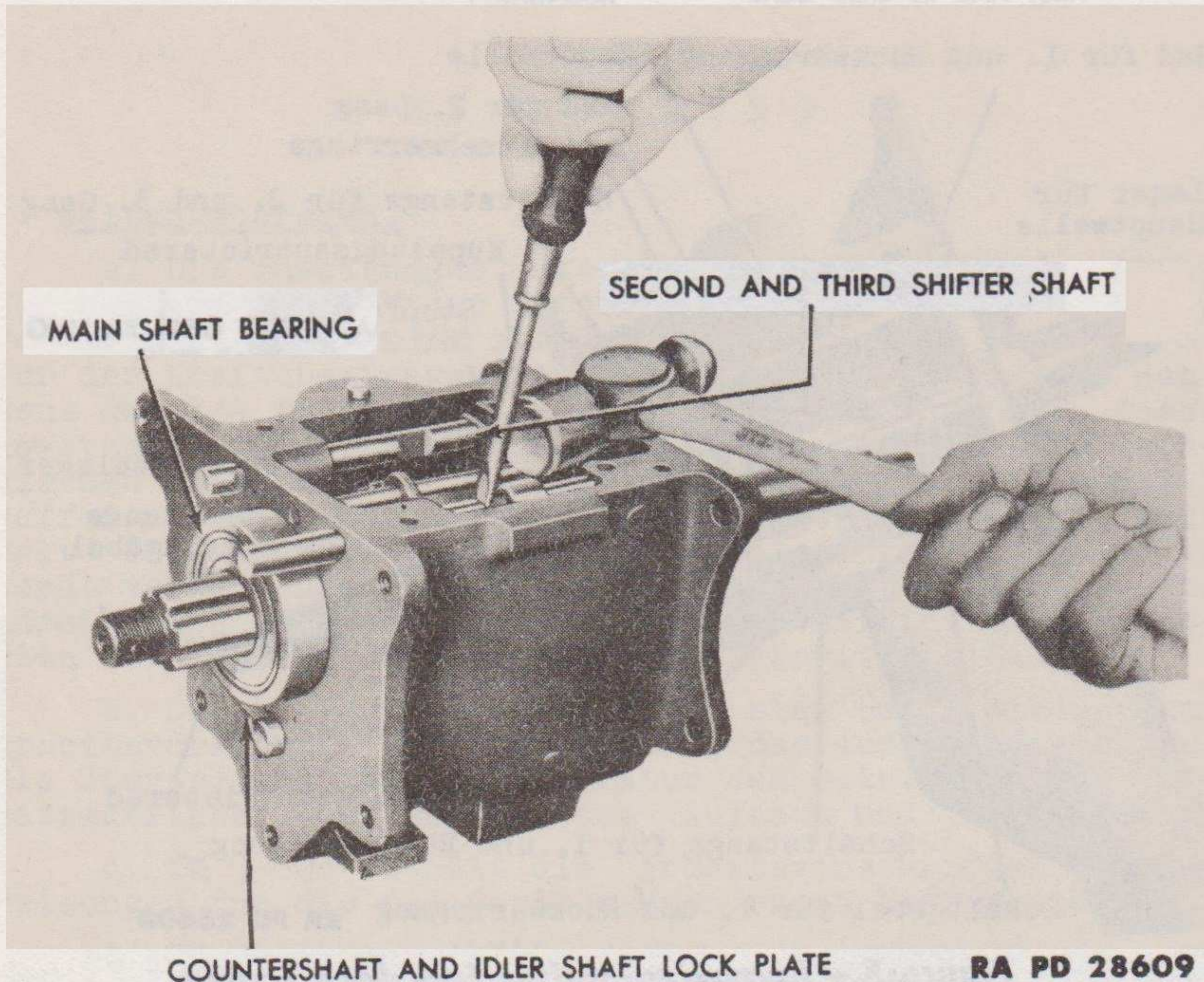

Figure 9 — Removing Shifter Shafts

6. DISASSEMBLY.

a. **Remove Gearshift Housing.** Remove the four cap screws that secure the gearshaft housing to the transmission (fig. 4). Lift the housing, shifter shaft plate, and spring washer from the transmission (fig. 17).

b. **Remove Main Drive Gear Bearing Retainer** (fig. 3). Unhook the clutch release bearing return spring and slide the bearing assembly off the bearing retainer. Remove the three cap screws from the bearing retainer. Slide the bearing retainer and cork gasket off the main drive gear.

c. **Remove Shifter Fork Guide Rail** (fig. 8). Push the shifter fork guide rail out of the transmission.

d. **Remove the Low and Reverse, and the Second and High Shifter Forks.** Remove the shifter fork lock screw from each fork (fig. 8). Tap the shifter shafts part way out of the transmission (fig. 9), being careful not to lose the interlocking ball in each shaft. Hold the shifter fork and pull the shafts from the transmission.

e. **Remove Main Drive Gear.** Tap the countershaft and idle reverse shaft lock plate out of the two shafts (fig. 4). With a long

POWER TRAIN

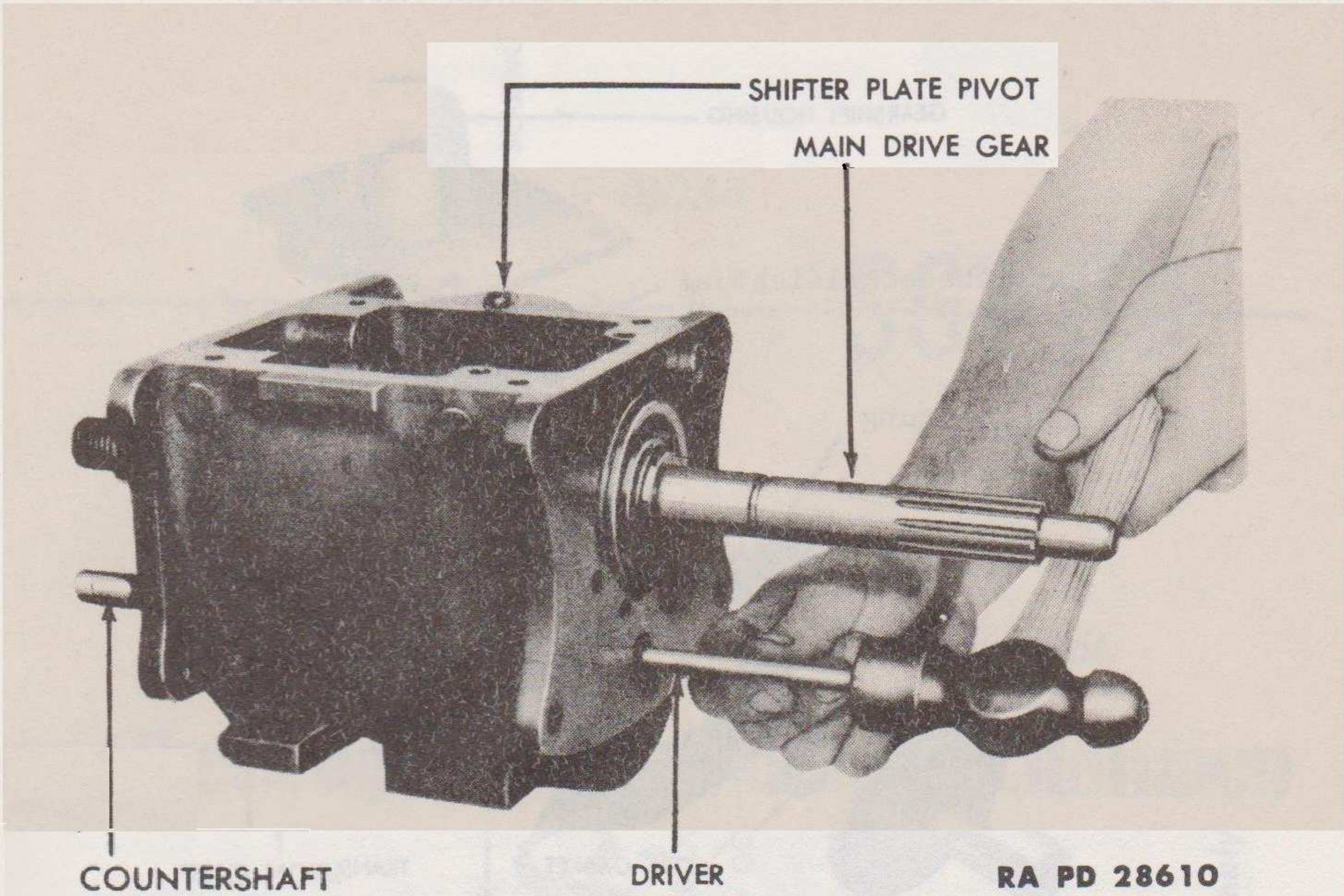

Figure 10 — Removing Countershaft

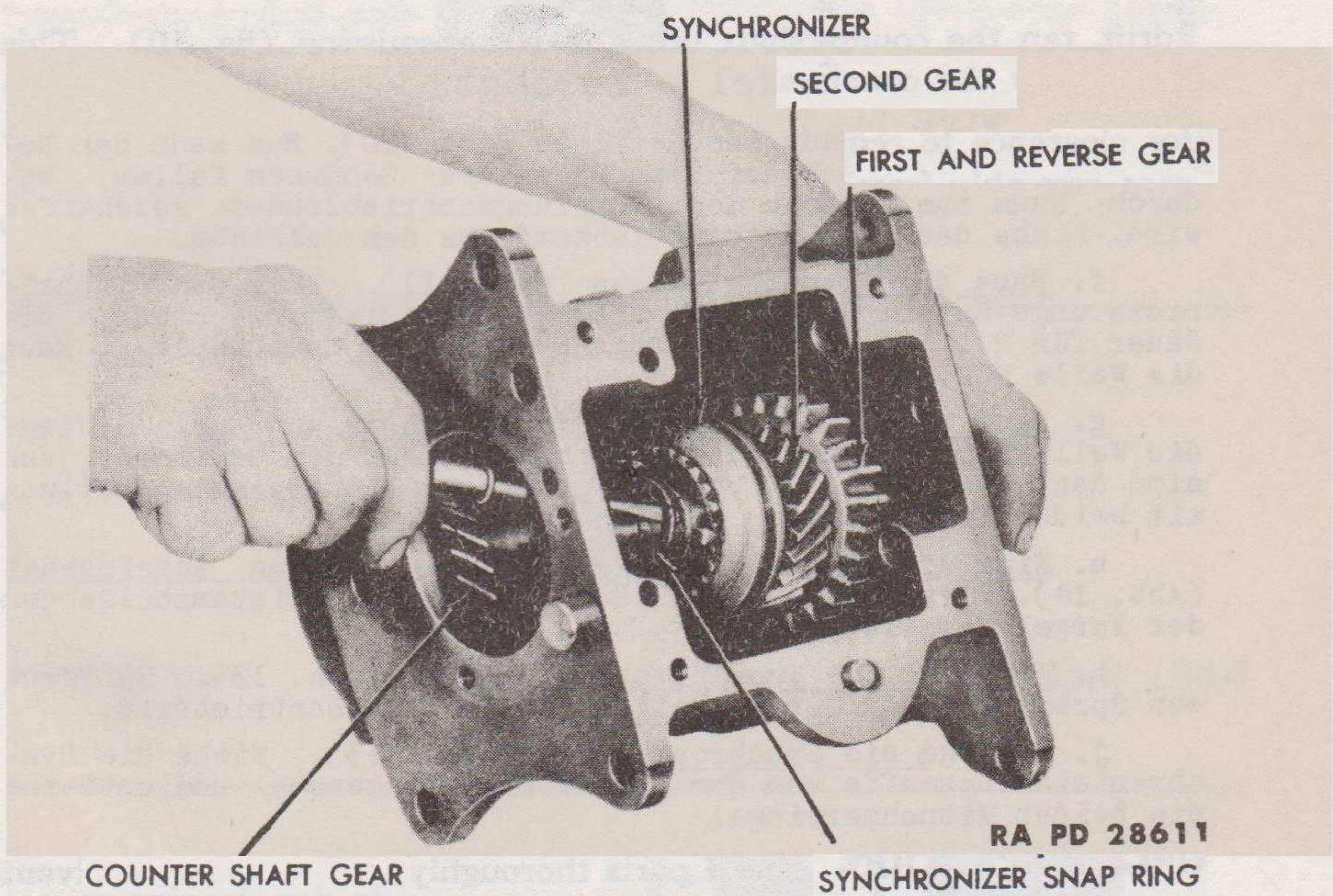

Figure 11 — Removing Synchronizer Hub Snap Ring

ORDNANCE MAINTENANCE — POWER TRAIN, BODY, AND FRAME FOR ¼-TON 4 x 4 TRUCK
(WILLYS-OVERLAND MODEL MB AND FORD MODEL GPW)

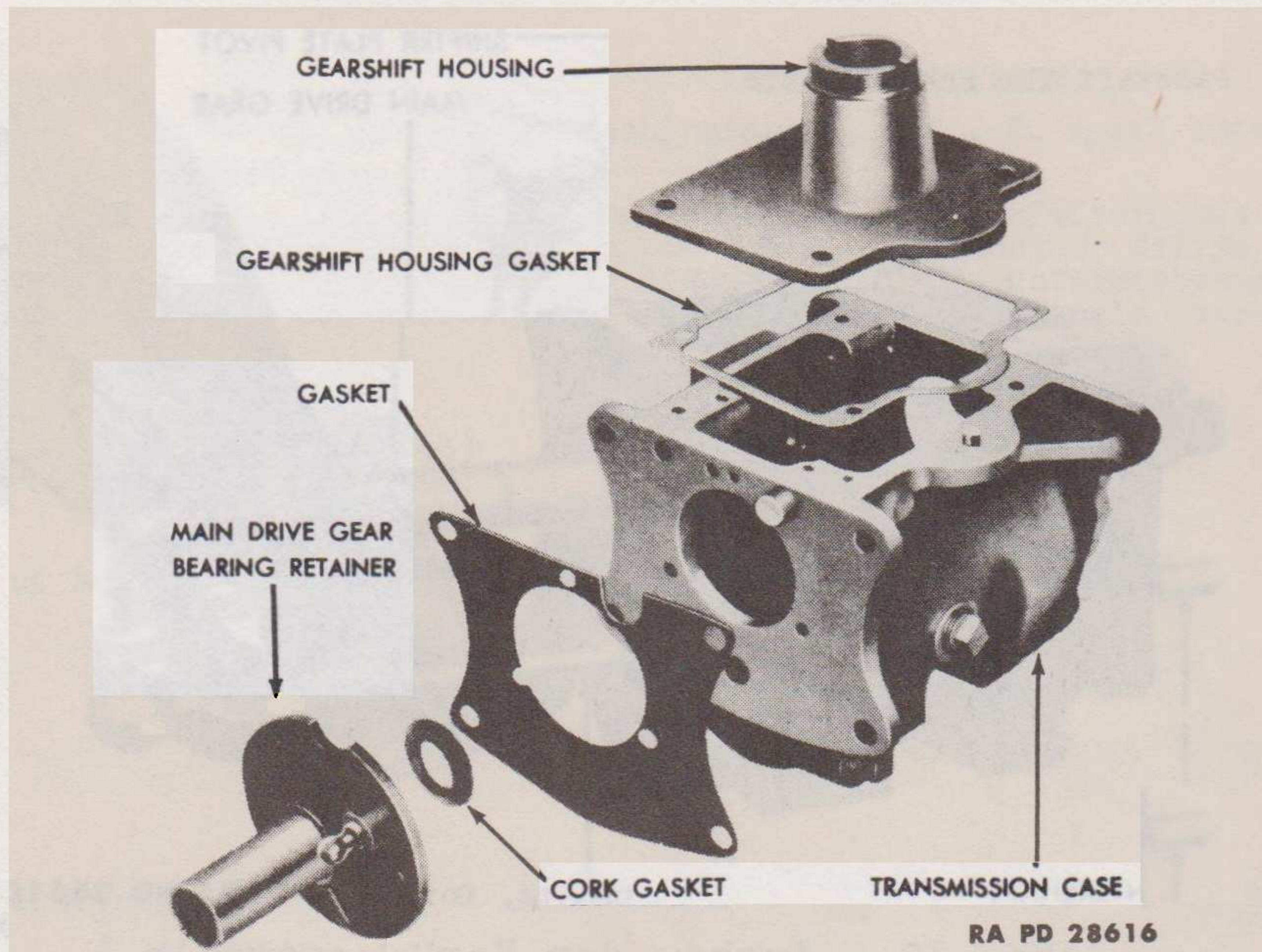

Figure 12 — Transmission Case and Gearshift Housing — Exploded View

drift, tap the countershaft out of the transmission (fig. 10). This will allow the countershaft gear to drop to the bottom of the case for clearance to remove the main drive gear. Pull the main drive gear assembly from the transmission.

f. **Remove Mainshaft** (fig. 11). Remove the synchronizer hub snap ring. Slide the synchronizer assembly, second and first and reverse gear off the mainshaft. Remove the shaft.

g. **Remove Idle Reverse Gear**. Tap the idle reverse gear shaft out of the transmission and remove the gear. Lift the countershaft gear and both thrust washers out of the transmission.

h. **Disassemble Countershaft Gear** (fig. 14). Remove the two bushings and spacer from the countershaft gear.

i. **Disassemble Main Drive Gear** (fig. 13). Remove the snap ring and the 13 rollers from the main drive gear.

j. **Disassemble Synchronizer** (fig. 13). Slide the synchronizer sleeve off the synchronizer hub and remove the two lock rings.

7. CLEANING, INSPECTION, AND REPAIR.

a. **Cleaning**. Wash all parts thoroughly in dry-cleaning solvent until all trace of old lubricant has been removed. Oil the bearings

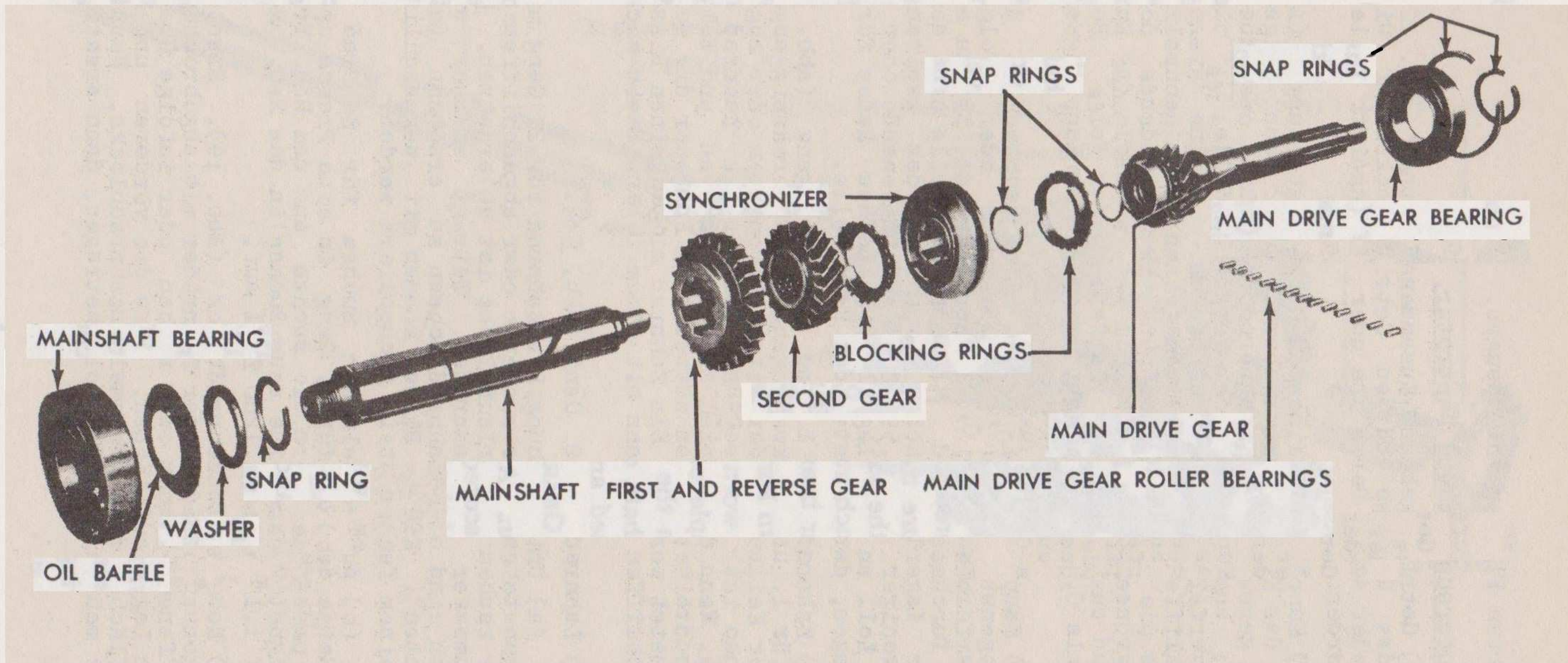

POWER TRAIN

Figure 13 — Mainshaft Assembly — Exploded View

RA PD 28618

TM 9-1803B
7

**ORDNANCE MAINTENANCE — POWER TRAIN, BODY, AND FRAME FOR ¼-TON 4x4 TRUCK
(WILLYS-OVERLAND MODEL MB AND FORD MODEL GPW)**

immediately after cleaning to prevent corrosion of the highly polished surfaces.

b. Inspection and Repair.

(1) **TRANSMISSION CASE ASSEMBLY** (fig. 12). Inspect the case and gearshaft housing for cracks or damage of any kind. Cracked or damaged units must be replaced.

(2) **MAIN DRIVE GEAR ASSEMBLY** (fig. 13). Replace the main drive gear (clutch shaft) if the following conditions are apparent: Broken teeth or excessive wear; pitted or twisted shaft; discolored bearing surfaces due to overheating. Small nicks can be honed and then polished with a fine stone. Measure the roller bearing recess in the gear end of the shaft. If more than 0.974 inch, replace the main drive gear. Measure the pilot end of the shaft. If it is less than 0.595 inch at the pilot end, replace the main drive gear.

(3) **MAINSHAFT** (fig. 13). A mainshaft excessively worn, or with pitted or discolored bearing surfaces due to overheating, must be replaced. Measure the diameter of the pilot end of the shaft and the diameter of the second speed gear bearing surface. If they are less than 0.595 inch at the pilot end, or less than 1.126 inches at the second speed gear bearing surface, replace the mainshaft.

(4) **FIRST AND REVERSE GEAR** (fig. 13). A first and reverse gear with excessively worn teeth or splines, or with broken or chipped teeth must be replaced. Slide the gear onto the mainshaft. If the backlash between the gear and the shaft exceeds 0.005 inch, either the gear or the shaft, or both, must be replaced. A gear with small nicks can be honed and then polished with a fine stone.

(5) SECOND GEAR (fig. 13).

(a) *Inspection.* A second gear with excessively worn, broken, or chipped teeth, or scored bearing surface must be replaced. Measure the inside diameter of the gear. If more than 1.129 inches the gear bushing must be replaced (step (b), below). Small nicks can be honed and then polished with a fine stone.

(b) *Second Gear Bushing Replacement.* Place the second gear in an arbor press and, with a suitable driver, press the bushing out of the gear. Use a suitable driver to press a new bushing in the gear. Ream the bushing to from 1.1275 to 1.1280 inches.

(6) **COUNTERSHAFT GEAR** (fig. 14). Replace excessively worn gears, and gears with broken or chipped teeth, or with pitted or discolored bearing surface due to overheating. Measure the front and rear bearing surfaces of the countershaft gear. If more than 0.7625 inch on either end, replace.

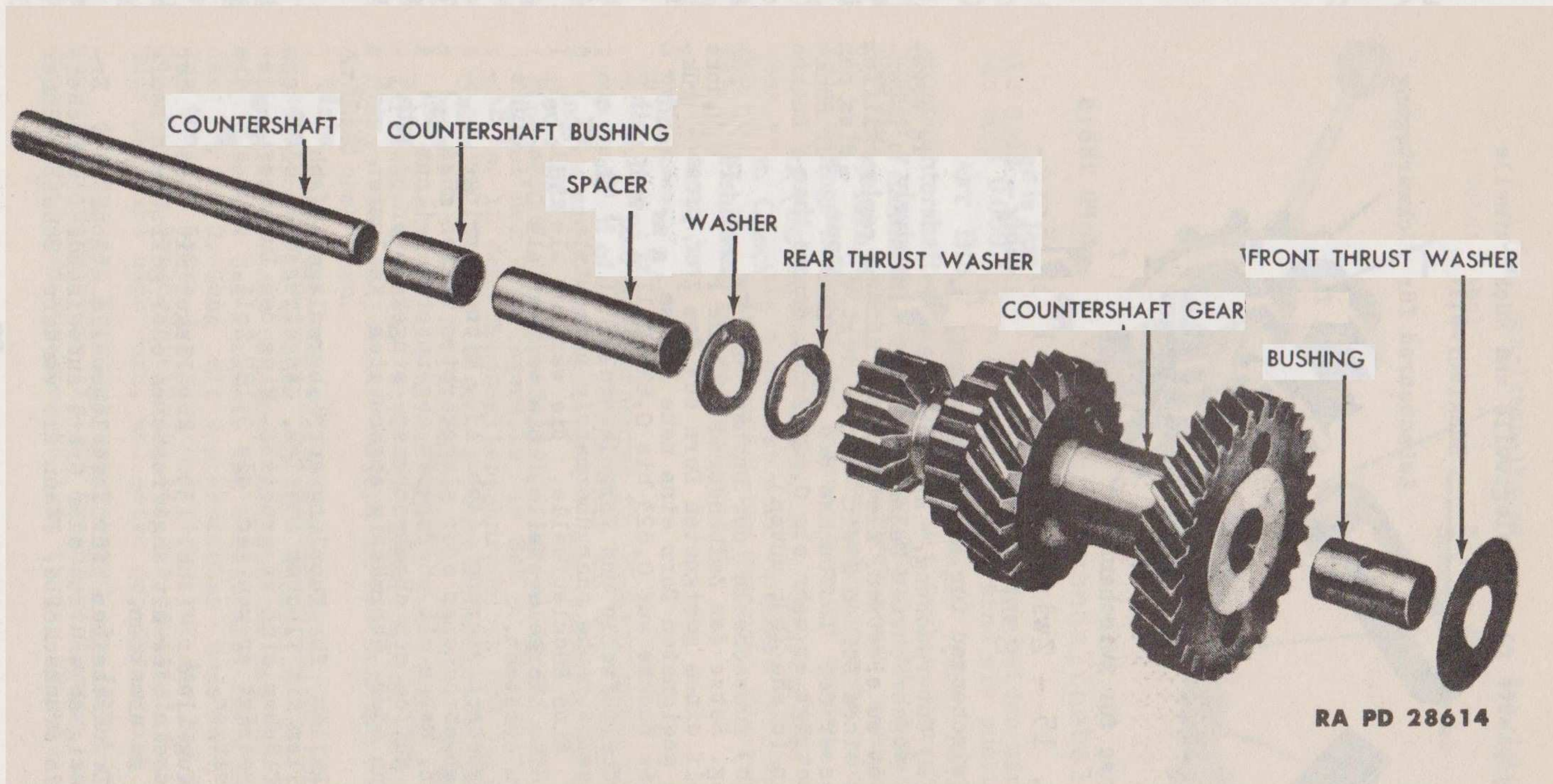

POWER TRAIN

RA PD 28614

TM 9-1803B
7

Figure 14 — Countershaft Gear Assembly — Exploded View

ORDNANCE MAINTENANCE — POWER TRAIN, BODY, AND FRAME FOR ¼-TON 4x4 TRUCK
(WILLYS-OVERLAND MODEL MB AND FORD MODEL GPW)

COUNTERSHAFT AND IDLE GEAR LOCK PLATE

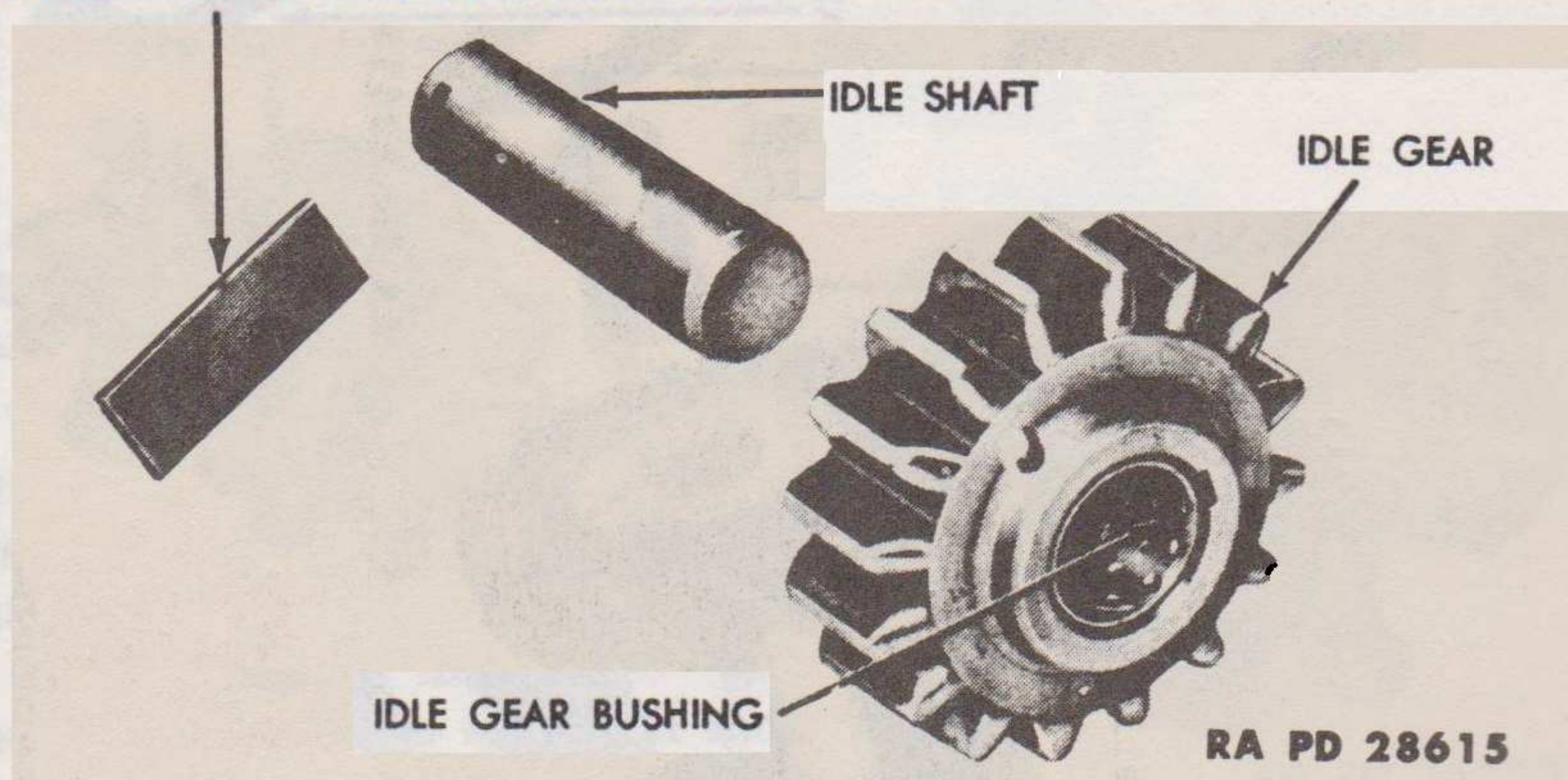

Figure 15 — Idle Gear Assembly — Exploded View

(7) IDLE GEAR (fig. 15).

(a) *Inspection.* A gear with excessively worn or broken teeth, or with a scored bearing surface must be replaced. Small nicks can be honed and then polished with a fine stone. Measure the inside diameter of the idle gear bushing. If more than 0.626 inch, the bushing must be replaced (step (b), below).

(b) *Idle Gear Bushing Replacement.* Place the idle gear in an arbor press and, with a suitable driver, press the bushing out of the gear. Use a suitable driver to press a new bushing in the idle gear. Ream the bushing to from 0.623 to 0.624 inch.

(8) IDLE GEAR SHAFT AND COUNTERSHAFT (figs. 14 and 15). Ridged, scored, or excessively worn, shafts must be replaced. An idle gear shaft measuring under 0.6185 inch or countershaft measuring under 0.7490 inch must be replaced.

(9) SYNCHRONIZER (fig. 13). Blocking rings with worn, broken, or nicked teeth, must be discarded. Hubs with excessively worn splines must be replaced. Sleeves with broken, nicked, or worn teeth, or excessively worn splines, must be replaced.

(10) MAIN DRIVE GEAR BEARING ROLLERS (fig. 13). Needle bearing rollers with flat spots, pitted, or discolored surfaces must be replaced. Measure the diameter of each roller. If less than 0.187 inch, the rollers must be replaced.

(11) BALL BEARINGS (fig. 13). Ball bearings with loose or discolored balls, or with pitted or cracked races must be replaced.

(12) COUNTERSHAFT THRUST WASHERS (fig. 14). Replace excessively worn or ridged thrust washers. Measure each thrust wash-

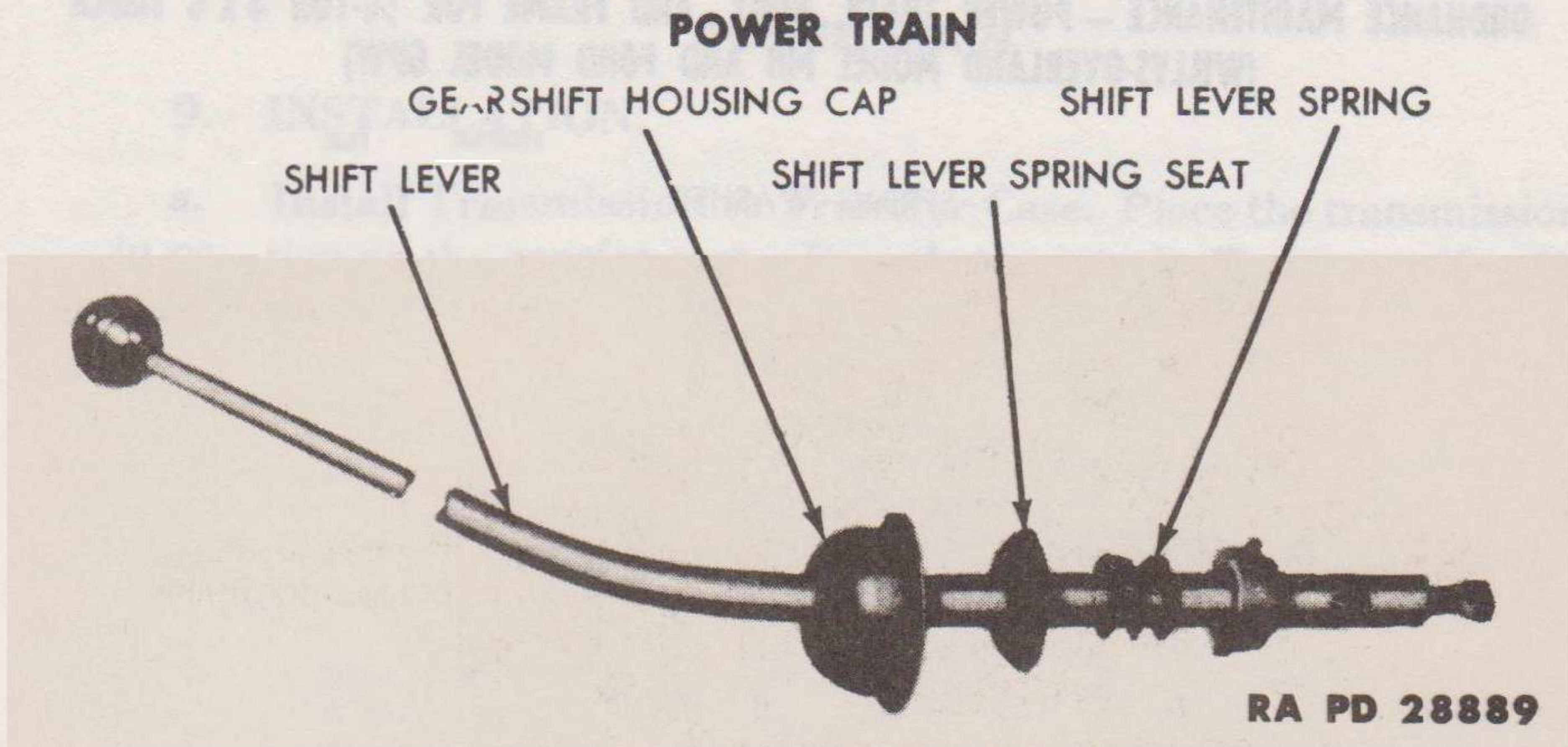

Figure 16 — Transmission Shift Lever

er. If the front washer is less than 0.029 inch, or if either of the rear washers are less than 0.060 inch, they must be replaced.

(13) **COUNTERSHAFT BUSHINGS** (fig. 14). Excessively worn, scored, or ridged countershaft bushings must be replaced. Measure the inside and outside diameter of the bushings. If the outside diameter is less than 0.759 inch, or if the inside diameter is more than 0.6225 inch, the bushings must be replaced.

(14) **SHIFT LEVER** (fig. 16). Replace the shift lever if it is excessively worn or bent. Check the gearshift housing cap for stripped threads. Replace the shift lever spring, if it is cracked.

8. ASSEMBLY.

a. **Install Idle Gear.** Hold the idle gear (fig. 15) in place in the case with the cone end of the hub toward the front, and push the idle gear shaft into the case.

b. **Install Countershaft Gear** (fig. 14). Dip the countershaft bearings into SAE 90 oil. Slide the spacer into the countershaft gear and install a bushing in each end of the countershaft gear. Coat the front thrust washer, rear thrust washer, and steel washer with a light film of grease to hold them in place while installing the gear. Lay the countershaft gear in the case with the large gear toward the front.

c. **Install Mainshaft Assembly** (fig. 13). Insert the mainshaft in the case through the opening in the rear of the case. Slide the first and reverse gear onto the shaft, with the shifter fork channel toward the rear. Slide the second gear onto the mainshaft with the tapered end of the gear toward the front. Install a blocking ring onto the second gear. Slide the synchronizer onto the mainshaft with the long end of the hub toward the front and install the snap ring.

d. **Install Main Drive Gear Assembly** (fig. 13). Place the other blocking ring in the synchronizer and install the main drive gear assembly in the case.

POWER TRAIN

9. INSTALLATION.

a. **Install Transmission to Transfer Case.** Place the transmission in position on the transfer case. Be sure the interlock plunger (fig. 4) is in position between the two shifter shafts on the transmission. Install the bolts that secure the transmission to the transfer case. Slide the oil baffle and mainshaft gear on the transmission mainshaft through the rear cover opening on the transfer case. (The oil baffle was not supplied on vehicles of early manufacture. If grease is found to have been leaking from the transfer case into the transmission on vehicles without this baffle, reverse the rear mainshaft bearing (fig. 13) so that the open side of the bearing faces the front of the transmission. Leave the oil baffle in front of the bearing in its original position. Install another oil baffle at the rear of the bearing.) Install the flat washer and nut that secure the mainshaft gear to the transmission mainshaft. Install a new gasket and the rear cover on the transfer case (fig. 27).

b. **Place Transmission in Position on Vehicle.** Place a jack under the transmission and raise the transmission and transfer case up until the shaft of the main drive gear is lined up with the splines in the clutch disk.

c. **Install Transmission Main Drive Gear to Clutch Housing.** Insert the shaft of the main drive gear into the clutch splines carefully, do not use force. Slide the transmission in flush with the clutch housing. Install the four bolts that secure the transmission to the clutch housing.

d. **Install Clutch Shaft to Transfer Case (fig. 6).** Push the transfer case to the right until the clutch shaft has enough clearance to enter the ball joint on the transfer case.

e. **Install Transmission Support Crossmember (fig. 6).** Place the transmission support crossmember in position on the transmission. Install the four bolts that secure the crossmember to the transmission. Raise the transmission up with a jack until the crossmember is flush with the frame. With a long nosed drift, line up the holes on the crossmember with the holes in the frame. Install the three nuts and bolts on each end of the crossmember and remove the jack. Install the transfer case mounting bolt.

f. **Install Clutch Release Fork (fig. 7).** Working through the inspection plate opening on the clutch housing, insert the clutch release fork in the clutch housing. Place the release fork behind the clutch release bearing. Slide the clutch release fork cable in the slot on the opposite end of the clutch release fork. Install the clutch release fork cable to the clutch shaft at the transfer case.

**ORDNANCE MAINTENANCE — POWER TRAIN, BODY, AND FRAME FOR ¼-TON 4 x 4 TRUCK
(WILLYS-OVERLAND MODEL MB AND FORD MODEL GPW)**

g. Install Hand Brake Cable (fig. 6). Install the hand brake cable to the brake band at the transfer case. Install the hand brake spring leading from the brake band linkage to the body floor plate. Install the clamp that secures the hand brake cable to the transfer case.

h. Install Engine Stay Cable and Ground Strap (fig. 6). Install the engine stay cable leading from the engine rear plate to the transmission support crossmember. Install the ground strap leading from the transmission to the floor plate.

i. Install Propeller Shafts and Speedometer Cable (fig. 6). Install the rear propeller shaft to the transfer case (par. 21 a). Install the front propeller shaft to the transfer case (par. 21 b). Install the speedometer cable to the transfer case.

j. Install Transmission Shield (fig. 6). Install the five nuts and bolts that secure the shield to the transmission support crossmember. Install the clamp that secures the exhaust pipe to the shield.

k. Lubricate and Adjust Clutch. Fill both the transmission and transfer case to proper oil level with specified oil. Adjust the clutch pedal free travel (refer to TM 9-803).

Section III

TRANSFER CASE

10. DESCRIPTION AND DATA.

a. Description. The transfer case (figs. 28 and 29) is located at the rear of the transmission. The transfer case is essentially a 2-speed transmission, which provides two gear ratios and a means of distributing the power from the transmission to the two axles.

b. Data.

Make Spicer
Model 18
Mounting Unit with transmission
Shift lever Floor
Ratio:
High 1 to 1
Low 1.97 to 1

POWER TRAIN

Bearings:

Transmission mainshaft	Ball
Idle gear	2 rollers
Output shaft	Taper rollers
Front axle clutch shaft front bearing.....	Ball
Rear pilot in output shaft.....	Bronze bushing

11. REMOVAL.

a. **Remove Transmission Shield (fig. 6).** Remove the two cap screws that secure the exhaust pipe clamp to the shield. Remove the exhaust pipe clamp. Remove the five bolts that secure the transmission shield to the transmission support crossmember and remove the shield.

b. **Remove Hand Brake Cable and Clutch Cable (fig. 6).** Remove the hand brake spring at the transfer case. Remove the clevis pin that secures the hand brake cable at the brake on the transfer case. Remove the hand brake cable clamp on the transmission. Remove the clevis pin from the clutch cable at the transmission support crossmember.

c. **Remove Mounting Bolt and Rear Cover (figs. 7 and 27).** Remove the mounting bolt that secures the transfer case to the transmission support crossmember at the right side of the transfer case. Remove the five cap screws that secure the rear cover to the transfer case.

d. **Remove Rear Propeller Shaft (fig. 7).** Disconnect the rear propeller shaft at the transfer case (par. 17 b).

e. **Remove Mainshaft Gear (fig. 27).** Through the opening at the rear of the transfer case, remove the castellated nut that secures the mainshaft gear to the transmission mainshaft. Remove the flat washer mainshaft gear and oil retainer.

f. **Remove Transfer Case.** Place a jack under the transfer case. Remove the five cap screws that secure the transfer case to the transmission. Move the transfer case straight back until the transmission mainshaft is out of the transfer case. Remove the transfer case.

12. DISASSEMBLY.

a. **Remove Brake Band and Drum Assembly (fig. 28).** Remove the two anchor screws from the brake band. Remove the brake band adjusting nut and adjusting screw. Remove the clevis pin from the hand brake linkage. Remove the brake band assembly. Remove the castellated nut that secures the universal joint flange to the output shaft. Install puller 41-P-2912 on the universal joint flange and remove the flange and brake drum (fig. 18). *NOTE: The puller illustrated in figure 18 is similar to puller 41-P-2912.*

ORDNANCE MAINTENANCE — POWER TRAIN, BODY, AND FRAME FOR ¼-TON 4 x 4 TRUCK
(WILLYS-OVERLAND MODEL MB AND FORD MODEL GPW)

UNIVERSAL JOINT REAR

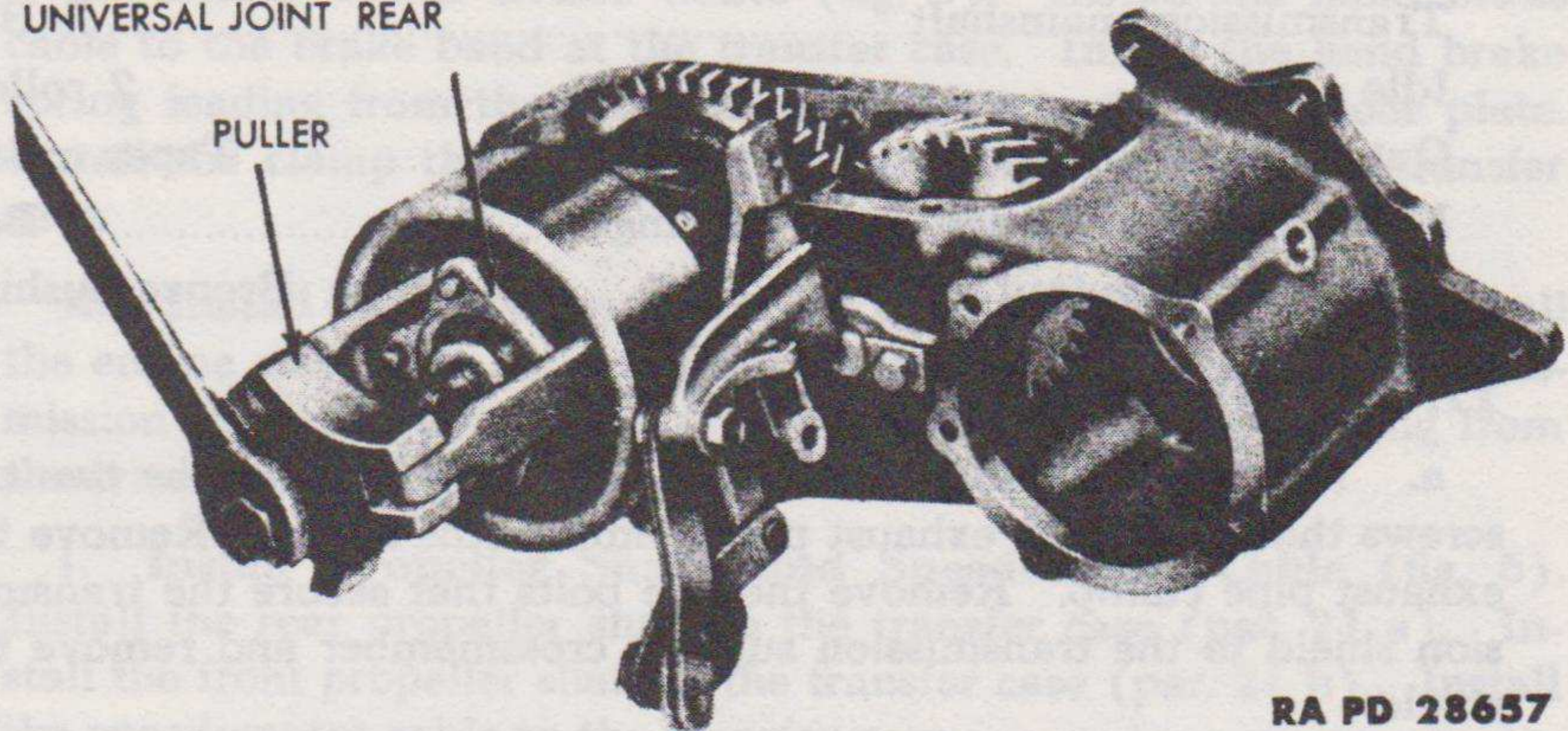

RA PD 28657

**Figure 18 — Removing Rear Universal Joint Flange
With Puller Similar to Puller 41-P-2912**

b. Remove Rear Output Shaft Bearing Cap (fig. 26). Remove the four cap screws that secure the rear output shaft bearing cap to the transfer case housing. Remove the rear output shaft bearing cap. Remove the rear bearing cap shims. Remove the speedometer drive gear from the output shaft.

c. Remove Intermediate Gear and Bottom Cover (figs. 25 and 27). Remove the 10 cap screws that secure the bottom cover to the transfer case and remove the bottom cover. Remove the cap screw that secures the lock plate. Remove the lock plate. With a suitable driver, remove the intermediate gear shaft. Remove the intermediate gear, thrust washers, and roller bearings through the bottom of the transfer case.

d. Remove Shifter Shaft and Front Output Shaft Bearing (fig. 29). Shift front axle drive to the engaged position. Remove the poppet plug, spring, and ball on both sides of the output shaft bearing cap. Remove the five cap screws that secure the front output shaft bearing cap to the transfer case. Remove the front output shaft bearing cap as an assembly with the universal joint flange, clutch shaft, bearing, clutch gear, shifter fork, and shifter rod. Be careful not to lose the interlock in the front bearing cap.

e. Remove Output Shaft (fig. 19). Insert a screwdriver between the snap ring and output shaft bearing and pry the output shaft bearing away from the snap ring. Remove the snap ring from the groove in the output shaft. Pull the output shaft out from the rear of the housing. The output shaft bearing, snap ring thrust washer, output shaft sliding gear, and output shaft gear can now be removed through the bottom of the transfer case.

POWER TRAIN

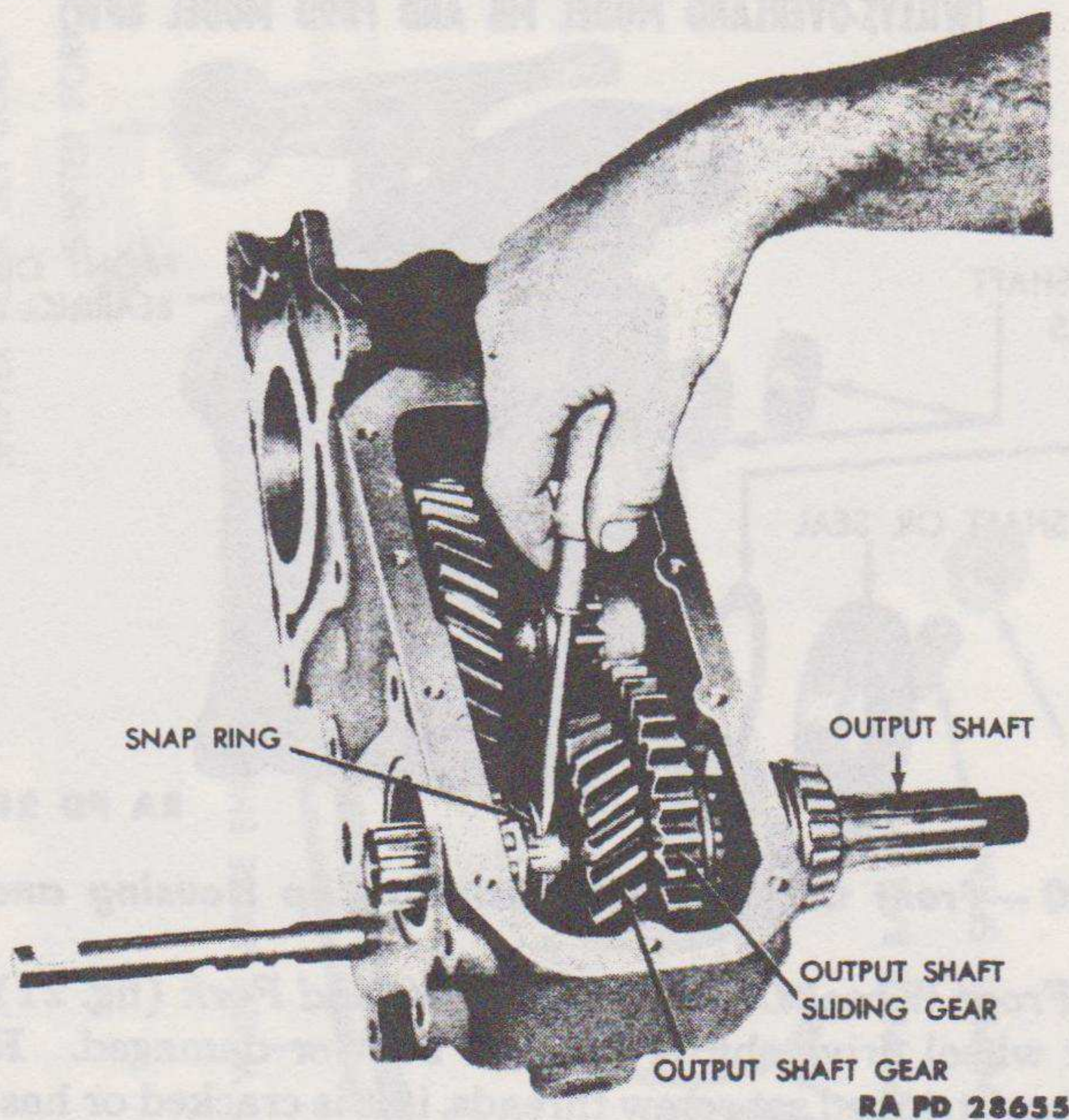

Figure 19 — Removing Snap Ring From Output Shaft

f. **Disassemble Front Output Shaft Bearing Cap** (fig. 21). Remove the set screw that secures the shifter fork to the front wheel drive shifter shaft. Slide the shifter shaft out of the shifter fork. Remove the shifter fork and clutch gear from the bearing cap. Remove the snap ring that secures the output shaft bearing and remove the output shaft bearing from the bearing cap.

13. CLEANING, INSPECTION, AND REPAIR.

a. **Cleaning.** Cleaning all parts thoroughly in dry-cleaning solvent. Clean the bearings by rotating them while immersed in dry-cleaning solvent until all trace of lubricant has been removed. Oil the bearings immediately to prevent corrosion of the highly polished surface.

b. **Inspection.**

(1) **TRANSFER CASE ASSEMBLY** (fig. 27). Inspect the transfer case housing for cracks or damage of any kind. Inspect the bottom and rear cover for bent or damaged condition. Replace the gaskets on the bottom and rear covers.

(2) **FRONT OUTPUT SHAFT BEARING CAP ASSEMBLY** (fig. 21).

(a) **Front Output Shaft Bearing Cap Housing** (fig. 20). Replace the front bearing cap, if it is cracked or damaged. Shifter shaft and output shaft oil seals must be replaced (subpar. c, below).

ORDNANCE MAINTENANCE — POWER TRAIN, BODY, AND FRAME FOR ¼-TON 4 x 4 TRUCK
(WILLYS-OVERLAND MODEL MB AND FORD MODEL GPW)

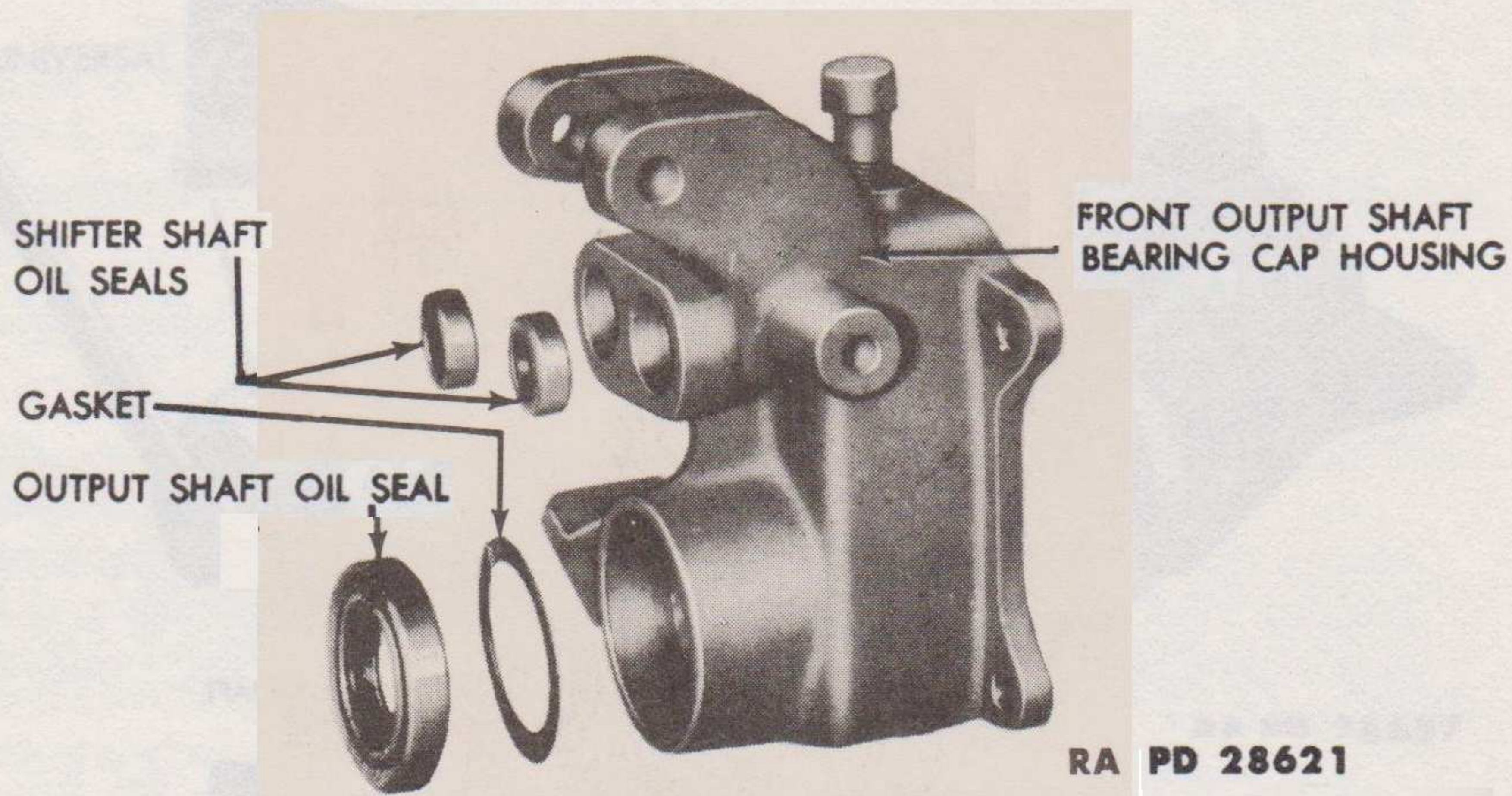

Figure 20 — Front Output Shaft Bearing Cap Housing and Oil Seals

(b) *Front Wheel Drive Shifter Shaft and Fork* (fig. 21). Replace the front wheel drive shifter shaft, if bent or damaged. Replace the fork if it has stripped set screw threads, if it is cracked or has bent forks.

(c) *Clutch Shaft and Gear* (fig. 21). Replace the clutch shaft if the splines or gear teeth are chipped or worn, if the gear has any teeth missing. Check the diameter of the pilot end of the clutch shaft. If the diameter is less than 0.625 inch, replace the clutch shaft. Replace the clutch gear, if it is worn or has any broken teeth.

(d) *Output Shaft Bearing* (fig. 21). Ball bearings with loose or discolored balls or with pitted or cracked races must be replaced.

(3) **INTERMEDIATE GEAR ASSEMBLY** (fig. 25). Replace the intermediate gear if excessively worn, or if any teeth are damaged. Check the thickness of the thrust washers. If the thrust washers are less than 0.093 inch in thickness, replace them. Check the diameter of the intermediate gear shaft. If the diameter is less than 0.750 inch, replace the intermediate gear shaft. Replace the roller bearing, if the rollers are scored or have flat spots.

(4) **REAR OUTPUT SHAFT BEARING CAP ASSEMBLY** (fig. 26). Replace the output shaft bearing cap if cracked or damaged. Replace the speedometer drive gear if it is worn or has damaged teeth. Replace the oil seal in the output shaft bearing cap housing (subpar. c, below). Replace the brake drum if it is worn or bent. Replace the universal joint rear flange, if the splines are worn. Replace the dust shield on the flange if bent.

(5) **OUTPUT SHAFT ASSEMBLY** (fig. 24). Replace the output shaft if the splines are worn. Small nicks can be removed by honing and then polishing with a fine stone. Measure the inside diameter of

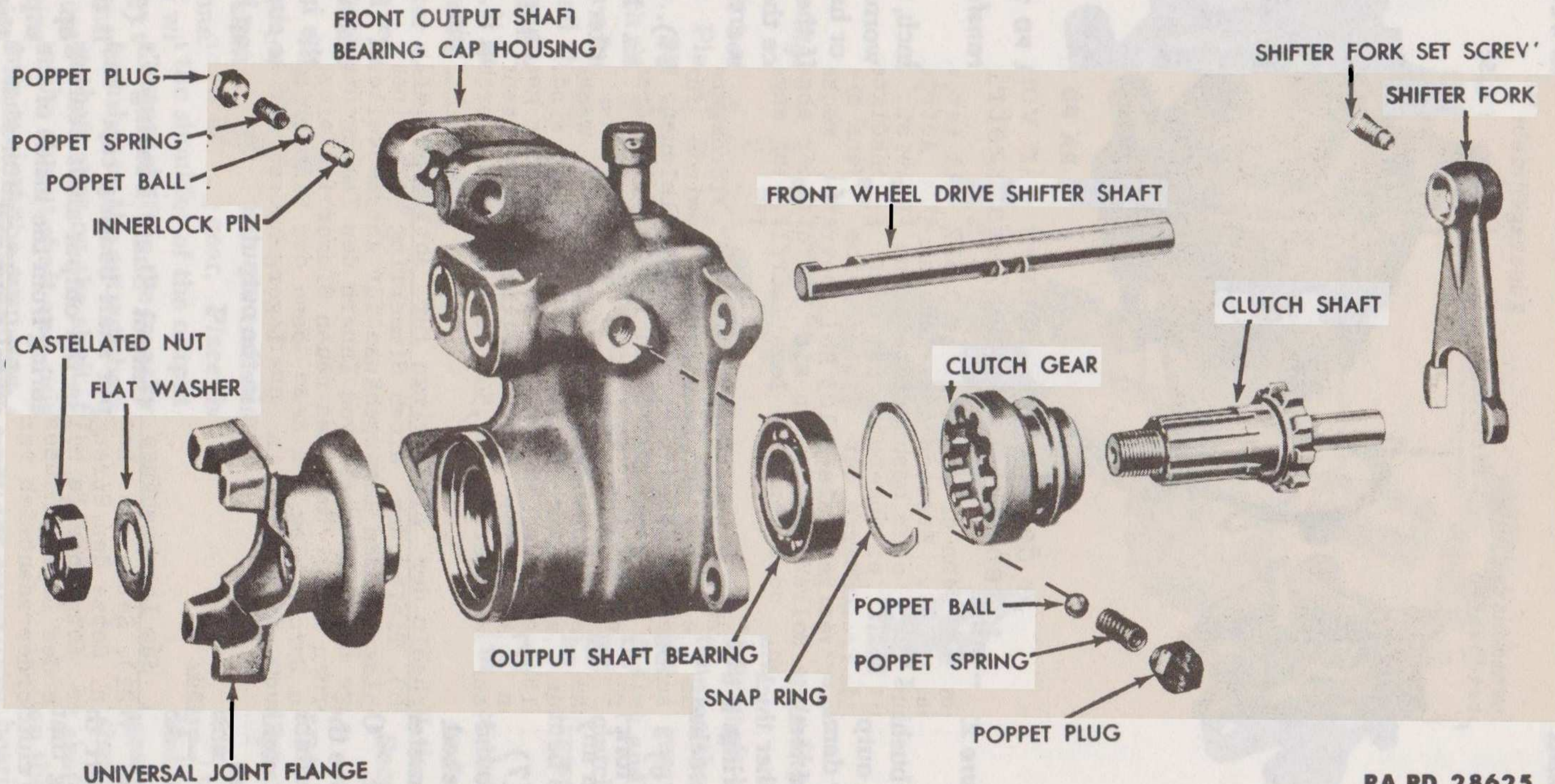

RA PD 28625

Figure 21 — Front Output Shaft Bearing Cap — Exploded View

ORDNANCE MAINTENANCE — POWER TRAIN, BODY, AND FRAME FOR ¼-TON 4 x 4 TRUCK
(WILLYS-OVERLAND MODEL MB AND FORD MODEL GPW)

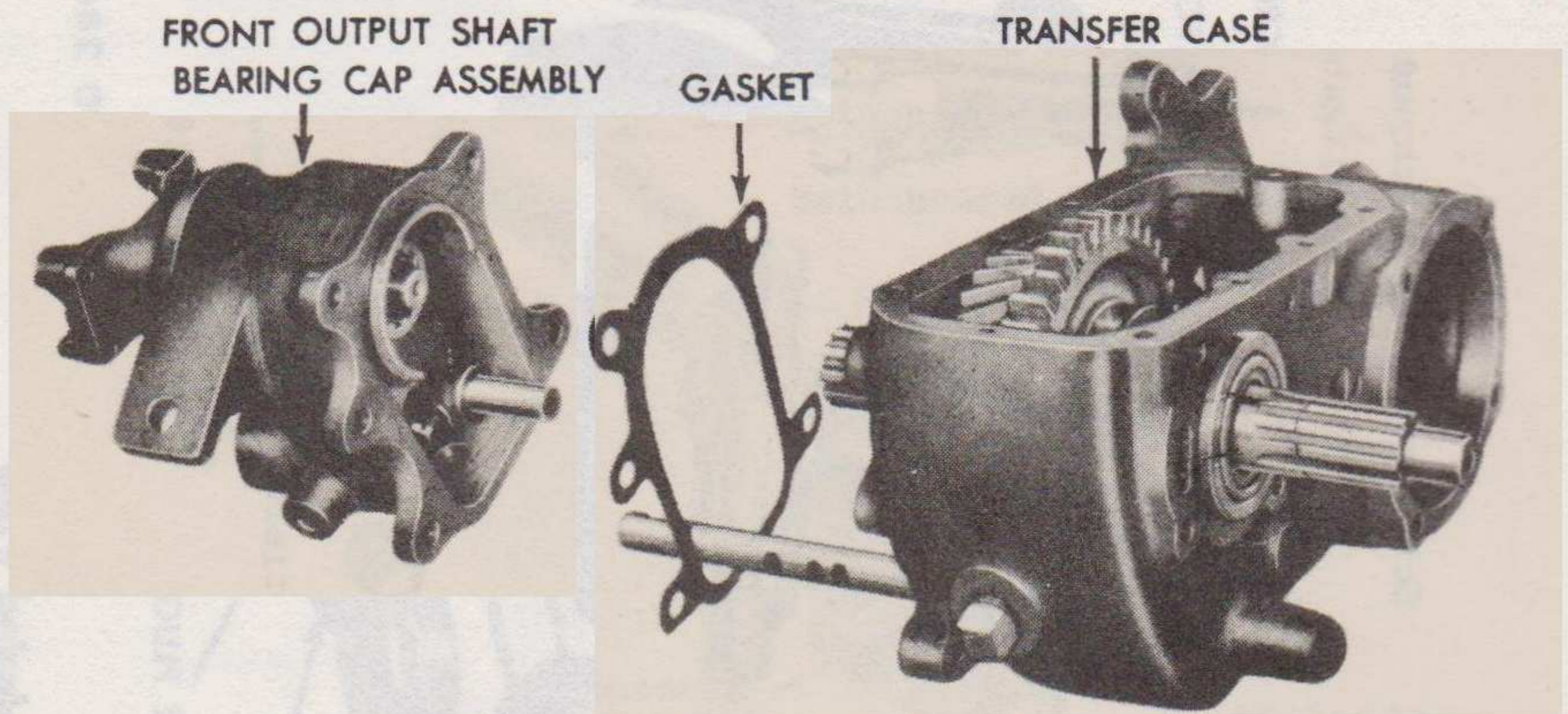

RA PD 28623

Figure 22 — Installing Front Output Shaft Bearing Cap to Transfer Case

the bushing in the output shaft. If it is greater than 0.627 inch, replace the output shaft. Replace the output shaft gear if it is worn or has any damaged teeth. Replace the sliding gear, if it is worn or has damaged teeth. Measure the thickness of the thrust washer. If the thrust washer thickness is less than 0.103 inch, replace it. Replace the roller bearings if they are scored or have flat spots, or if the races are nicked or cracked.

(6) **UNDER DRIVE SHIFTER FORK ASSEMBLY** (fig. 24). Check the fork for stripped set screw threads, cracked or bent forks. Replace if in any of these conditions. Replace the under drive shifter shaft if it is bent.

(7) **SHIFT LEVER ASSEMBLY** (fig. 29). Replace the shift levers if found bent or damaged. Replace the shift lever spring if bent or cracked. Measure the diameter of the shift lever pivot pin. If the diameter is less than 0.500 inch, replace the pivot pin.

c. **Output Shaft Bearing Cap Oil Seal Replacement** (fig. 20). Drive the old oil seal out of the output shaft bearing cap housing, using a suitable driver. Drive the oil seals out, working from the inside of the cap housing. To install a new oil seal, use a driver the size of the oil seal and drive the new seal in the output shaft bearing cap housing.

14. ASSEMBLY.

a. **Assemble the Front Output Shaft Bearing Cap** (fig. 21). Insert the bearing in the output shaft bearing cap. Install the snap ring that secures the bearing in the output shaft bearing cap. Insert the clutch shaft through the bearing from the inside of the output shaft bearing cap. Insert the front wheel drive shifter shaft in the output

POWER TRAIN

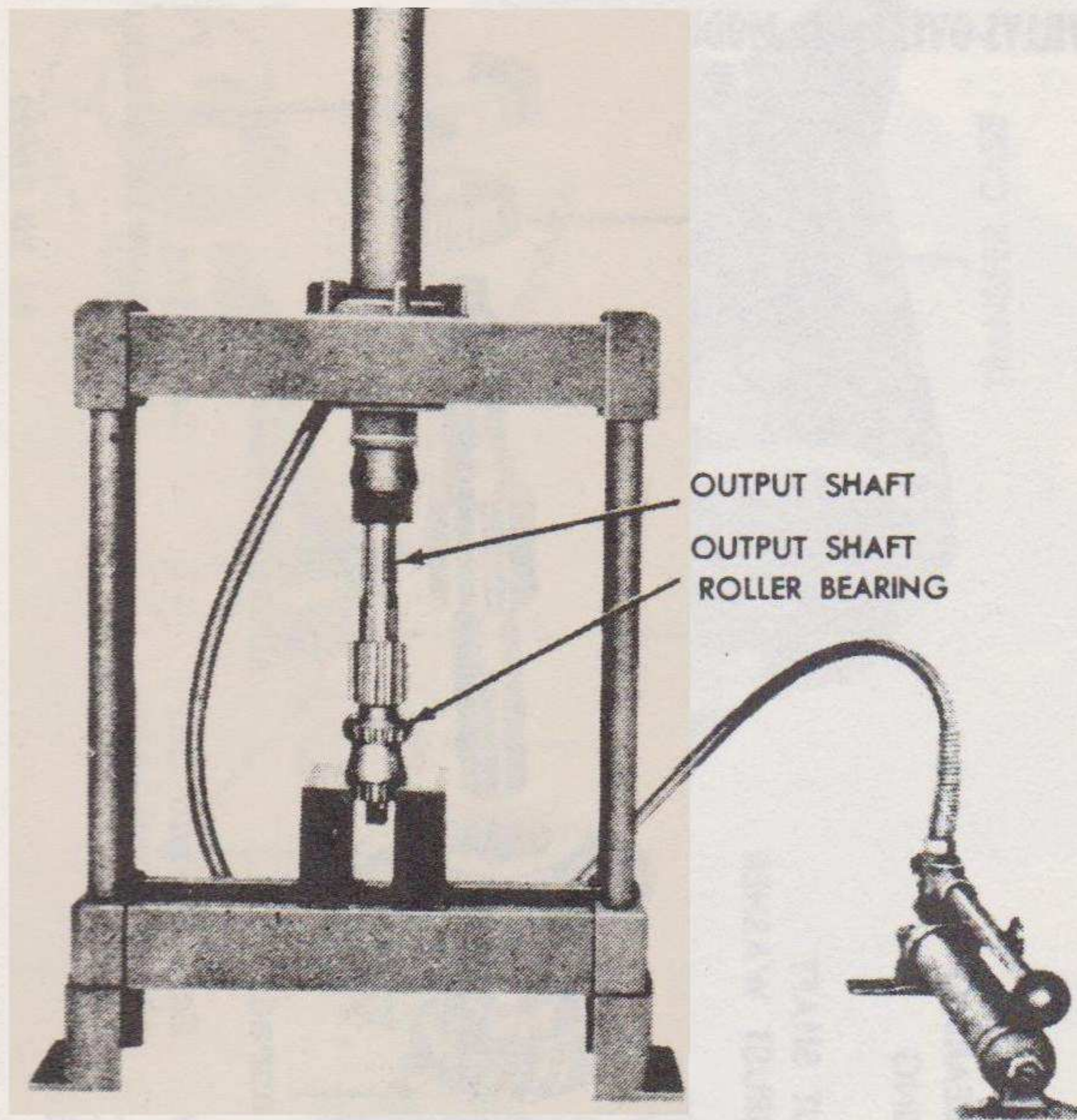
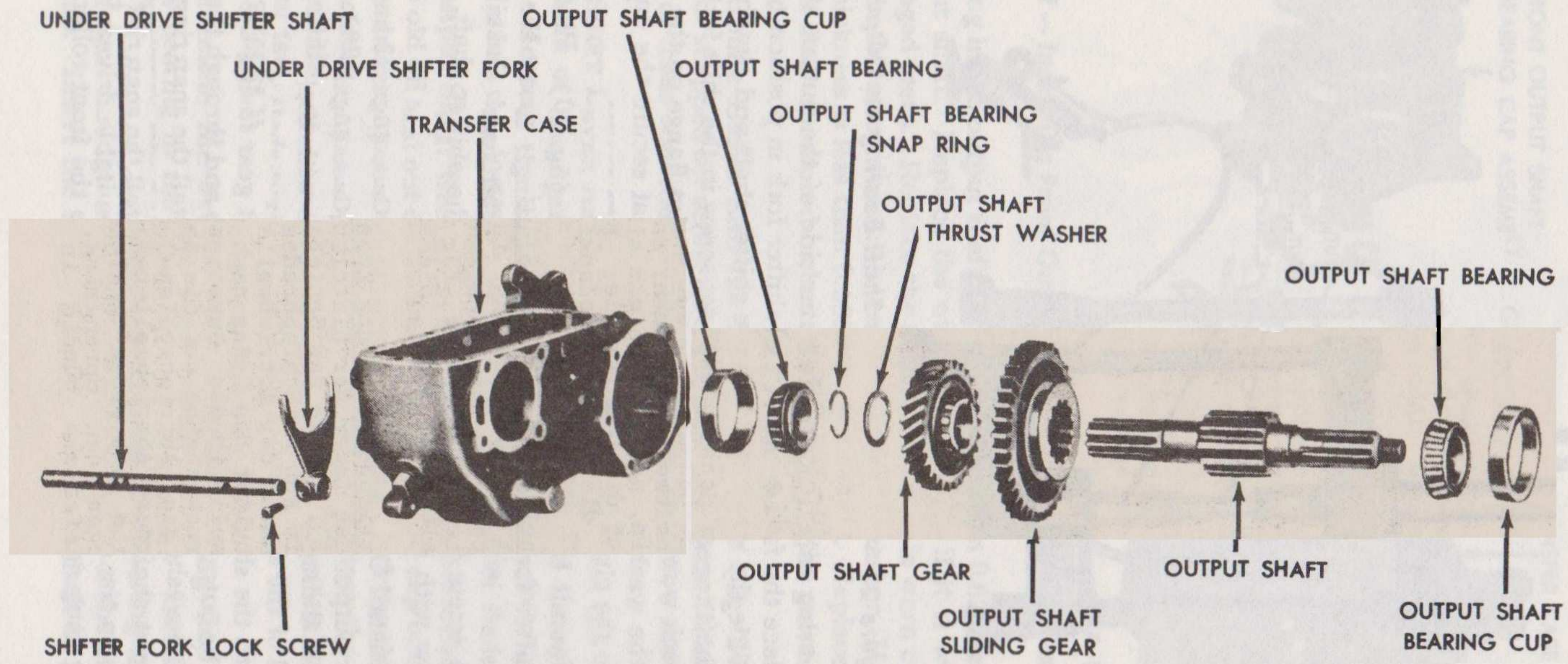

Figure 23 – Pressing Output Shaft Bearing on Output Shaft

shaft bearing cap through the outer side of the output shaft bearing cap. Place the front wheel drive shifter fork in position on the clutch gear. Slide the shifter fork on the shifter shaft and clutch gear on the clutch shaft together. Install the set screw in the shift fork and secure with a lock wire. Install the universal joint flange on the clutch shaft. Install the washer and castellated nut that secure the universal joint flange to the clutch shaft.

b. Install Under Drive Shifter Fork (fig. 20). Place the under drive shifter fork in the transfer case housing. Insert the under drive shifter shaft in the transfer case and shifter fork. Install the shifter fork set screw that secures the fork to the shifter shaft. Secure the set screw with lock wire.

c. Install Output Shaft in Transfer Case (figs. 23 and 24). Press the rear output shaft bearing on the output shaft (fig. 23). Set the output shaft sliding gear in the transfer case with the shifter fork in the channel of the sliding gear. Place the output shaft gear in the transfer case with the shoulder of the output shaft gear facing the sliding gear. Insert the output shaft in the transfer case and through the gears. Slide the thrust washer on the output shaft. Install the snap ring that secures the output shaft gear on the shaft. Slide the front output shaft roller bearing on the output shaft and, using a suitable driver, tap the roller bearing snug against the snap ring. Tap the front roller bearing cup



RA PD 28622

Figure 24 —Output Shaft — Exploded View