

# TM9-2854

US Army  
WAR DEPARTMENT TECHNICAL MANUAL

4 ba  
6113  
12  
TM9: 2854  
1945  
INSTRUCTION GUIDE

ORDNANCE

PACKAGING AND

SHIPPING

(Posts, Camps, and Stations)

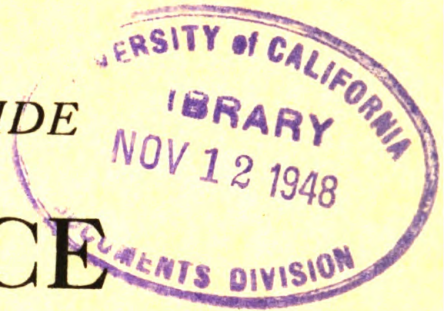

UNCLASSIFIED  
WD CIR 168  
BY  
1948

**RESTRICTED. DISSEMINATION OF RESTRICTED MATTER.**  
No person is entitled solely by virtue of his grade or position to knowledge or possession of classified matter. Such matter is entrusted only to those individuals whose official duties require such knowledge or possession. (See also paragraph 23b, AR 380-5, 15 March 1944.)

WAR DEPARTMENT

•

17 FEBRUARY 1945

THE UNIVERSITY OF CALIFORNIA  
LIBRARY

THE UNIVERSITY OF CALIFORNIA  
LIBRARY

*INSTRUCTION GUIDE*

ORDNANCE  
PACKAGING AND  
SHIPPING  
(Posts, Camps, and Stations)



WAR DEPARTMENT

17 FEBRUARY 1945

---

**RESTRICTED. DISSEMINATION OF RESTRICTED MATTER.**

No person is entitled solely by virtue of his grade or position to knowledge or possession of classified matter. Such matter is entrusted only to those individuals whose official duties require such knowledge or possession.

(See also paragraph 23b, AR 380-5, 15 March 1944.)

---

WAR DEPARTMENT  
Washington 25, D. C., 17 February 1945

TM 9-2854, Instruction Guide: Ordnance Packaging and Shipping (Posts, Camps, and Stations), is published for the information and guidance of all concerned.

[ A.G. 300.7 (29 Mar 43)  
O.O. 300.7/3407 ]

BY ORDER OF THE SECRETARY OF WAR:

G. C. MARSHALL,  
*Chief of Staff.*

OFFICIAL:

J. A. ULIO,  
*Major General,  
The Adjutant General.*

DISTRIBUTION: AAF (10); AGF (10); ASF (2); S Div ASF (1); Dept (10); AAF Comds (2); Arm & Sv Bd (2); Tech Sv (2); SvC (10); PC&S (1); PE (Ord O) (5); PE, Sub PE & Cargo PE (Continental, Canada & Alaska) (6); Port Agencies (1); Dist O, 9 (5); 55 (1); Dist Br O, 9 (3); Reg O, 9 (3); Establishment, 9 (5); Decentralized Sub-O, 9 (3); TZ (1); Gen & Sp Sv Sch (10); USMA (2); A (10); CHQ (10); D (2); AF (2); T/O & E 9-57 (3); 9-377 (3).

(For explanation of symbols, see FM 21-6.)

# CONTENTS

U113

•2

TM9:2854

★ 1945 ★

	Paragraphs	Pages
CHAPTER 1. INTRODUCTION .....	1- 2	1
CHAPTER 2. PREPARATION FOR PACKING .....	3-10	2- 18
SECTION I. Cleaning and preservation .....	3- 6	2- 8
II. Inner packaging .....	7-10	8- 18
CHAPTER 3. EXTERIOR SHIPPING CONTAINERS....	11-37	19- 96
SECTION I. Choice of exterior containers .....	11-13	19- 21
II. Tools and materials for construction of containers .....	14-16	22- 25
III. Nailed wood boxes .....	17- 22	26- 60
IV. Open type nailed wood crates .....	23-25	60- 71
V. Fully sheathed, nailed wood crates	26-35	71- 89
VI. Skid units .....	36-37	89- 96
CHAPTER 4. IDENTIFICATION AND MARKING .....	38-44	97-100
SECTION I. Requirements for identification .....	38-42	97- 99
II. Marking .....	43-44	100
CHAPTER 5. CAR AND TRUCK LOADING .....	45-61	101-145
SECTION I. Loading box cars .....	45-56	101-119
II. Loading flat cars and gondola cars..	57-58	120-144
III. Loading trucks .....	59-61	144-145
CHAPTER 6. APPENDIX .....	62-65	146-157
SECTION I. Tools and materials .....	62	146-153
II. References .....	63-65	154-157
INDEX .....		158-161

M609705

**INSTRUCTION GUIDE — ORDNANCE PACKAGING AND SHIPPING (POSTS, CAMPS, AND STATIONS)**



NOTE — HANDLING WITH HOOK  
PROTECTS COATING ON  
OPERATING SURFACES  
OF GEAR.

RA PD 88983

**Figure 1 — Method of Dipping and Removing Gear From Bath of Heated Corrosion-preventive Compound**

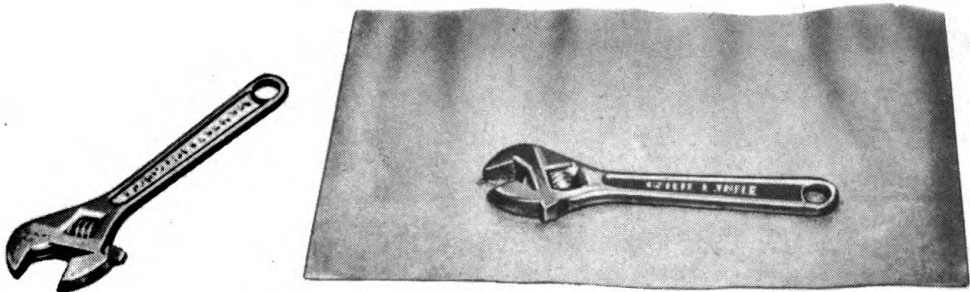

WRENCH AFTER CLEANING  
AND DRYING

WRENCH COATED WITH RUST PREVENTIVE  
COMPOUND (HEAVY) AND PLACED ON SHEET  
OF GRADE A GREASEPROOF PAPER



WRENCH WRAPPED IN GREASEPROOF  
PAPER IDENTIFICATION LABEL IS HELD  
IN PLACE WITH TRANSPARENT TAPE  
THAT ADHERES TO ITS OWN BACKING.

RA PD 88984

**Figure 2 — Method I Packaging Applied to a Wrench**

# RESTRICTED

## CHAPTER 1

### INTRODUCTION

#### 1. PURPOSE AND SCOPE.

a. **Purpose.** This manual is published for the information and guidance of all concerned. It presents simplified instructions for use in packaging and shipping ordnance general supplies at posts, camps, and stations, where available equipment and materials may be more limited than at industrial plants, manufacturing arsenals, and depots. These instructions have been especially prepared so as to require as few materials as possible, and to outline operations that can be performed with hand tools and equipment. They are intended to provide for adaptation of procedures to meet different field conditions. They are not to be used at installations other than posts, camps, and stations, without authorization from the Office of the Chief of Ordnance. The instructions and illustrations included herein are designed to be more easily understood than the packaging specifications used at manufacturing facilities, and to be complete enough so that very few references to other publications will be necessary.

b. **Scope.** The instructions in this manual include cleaning and the application of corrosion preventives to materiel in preparation for packing, methods of inner packaging, construction of exterior shipping containers and skid units, identification and marking, and freight car and truck loading. The methods and procedures set forth in this manual are supplementary to those instructions for using troops concerning specific materiel, which are published in storage and shipment sections of 100-series TM's and in Ordnance Storage and Shipment Charts (SB 9-OSSC's). This manual covers preparation of materiel for both domestic and overseas shipment.

#### 2. PREPARATION OF UNBOXED ORDNANCE MATERIEL FOR SHIPMENT.

a. The preparation of unboxed ordnance materiel, such as vehicles and wheeled artillery, for both domestic and overseas shipment is covered in War Department Supply Bulletin 9-4. *NOTE: TM 9-2854 should be used where U. S. Army Specification 100-14 (latest revision) is referred to in SB 9-4 for the packing and waterproofing of small arms weapons at posts, camps, and stations.*

## CHAPTER 2

**PREPARATION FOR PACKING**

## Section I

**CLEANING AND PRESERVATION****3. NEED FOR PRESERVATION.**

a. **General.** Materiel can become immobilized from corrosion or moisture damage in a relatively short time while in transit or storage, if not properly protected. Cleaning, application of corrosion preventives, and protection from rainfall and spray are therefore essential.

b. **Export Shipment.** Materiel shipped overseas must be prepared to withstand the effects of the following conditions:

- (1) A wide range of temperatures and varying humidity.
- (2) Intermittent contact with sea water when deckloaded.
- (3) High temperature and humidity in closed ship holds.
- (4) Uncertainty of length of transit period.
- (5) Indefinite exposure to weather in open storage.

c. **Domestic Shipment.** Materiel shipped within the continental limits of the United States may be subjected to rainfall, dampness, rapid changes of temperature, open storage, etc., and a considerable period of time may elapse before it is again lubricated and placed in service. Parts and assemblies under such conditions often become unserviceable because of corrosion, unless proper precautions have been taken. Corrosion, once started on a highly finished part, is difficult to stop.

**4. CLEANING METHODS.**

a. **General.** Almost any type of dirt or foreign matter on unpainted metal surfaces may promote corrosion; this is true whether or not grease or oil covers the foreign matter. Acids, such as in perspiration from hands, and alkalis are especially corrosive. All unpainted surfaces to which a corrosion preventive is to be applied must first be cleaned. Either dry-cleaning solvent or soap solution may be used.

**b. Solvent Method.**

(1) Clean unpainted metal areas of parts or assemblies with dry-cleaning solvent, applied with a clean brush or cloth. Repeat applications with clean solvent until all traces of foreign matter are removed.



## CLEANING AND PRESERVATION

(2) To protect hands from inflammation, use rubber gloves or hand-protective creams. (Solvent is toxic to some persons.)

(3) Take precautions against fire.

(4) Avoid getting solvent on rubber materials.

(5) Dry surfaces thoroughly with clean, dry cloths or with dry compressed air. (To test air for moisture, allow it to blow on a polished finished metal surface at room temperature and watch for condensation.)

(6) After cleaning and drying, do not touch the surfaces with bare hands. Use clean canvas, cloth, or rubber gloves.

### c. Soap Solution Method.

(1) Prepare soap solution as follows: Add shavings of castile soap or issue soap to water, in the proportion of 1 pound of soap to 4 gallons of water. Heat the water until the soap is dissolved, stirring the water slowly to prevent foaming.

(2) Apply soap solution by vigorously brushing or scrubbing the surfaces thoroughly until all traces of foreign matter are removed.

(3) Rinse surfaces thoroughly with clean, hot water to remove soap, and immediately dry as specified in subparagraph b (5), above.

### d. Cleaning Gun Bores After Firing.

(1) Swab the gun bore immediately after firing, while the tube is still hot, and daily thereafter on the following 3 days, with rifle bore cleaner. Clean the bore thoroughly; then dry with clean burlap or wiping cloths. Oil the bore as prescribed in appropriate Technical Manuals, unless a corrosion preventive is to be applied immediately (par. 6).

(2) The cleaning process must be repeated daily for 3 days or more, or until there is no longer evidence of sweating. A clean bore is indicated by uniform gray appearance. (Rifle bore cleaner has limited rust-preventive qualities, and may be left in the bore between cleanings instead of using oil if experience shows that it provides adequate rust prevention during the 24-hour period.)

*NOTE: Amendments to applicable Technical Manuals will include the cleaning procedure described in the foregoing paragraphs.*

### e. Removing Rust.

(1) Painted or coated surfaces that have become checked, chipped, pitted, or rusted should be cleaned with aluminum-oxide abrasive cloth, or a buffing wheel, where wear of the parts cleaned will not affect the functioning of the mechanism. The surface is then ready for the next step in painting.

(2) Finished surfaces that show stains or evidence of rusting should be cleaned with crocus cloth, followed with dry-cleaning solvent or soap solution.

**INSTRUCTION GUIDE — ORDNANCE PACKAGING AND SHIPPING (POSTS, CAMPS, AND STATIONS)****5. PAINTING.**

a. **Application of Primer.** Apply a liberal coating of rust-inhibitive synthetic primer over the entire area of the cleaned bare surfaces to be repainted, by brushing or spraying. The primer will brush satisfactorily as received or after the addition of not more than 5 percent by volume of synthetic enamel thinner. For spraying, the primer may be thinned with not more than 15 percent by volume of thinner. Allow to dry thoroughly.

b. **Sanding.** Sand the primed surfaces with flint paper (No. 2/0) and wipe all particles of dust from surfaces.

c. **Application of Enamel.** Apply coat of O. D. lusterless synthetic enamel and allow to dry thoroughly.

**6. APPLICATION OF CORROSION PREVENTIVES.**

a. **Time of Application and Care Required.** On metal surfaces that are not to be painted, a corrosion-preventive compound or oil should be applied immediately after the surface is cleaned and dried. Care should be exercised in application to insure a complete, unbroken film on the surfaces needing protection, and in subsequent handling to avoid breaking this film on or near critical surfaces before the part is wrapped in greaseproof material or the film hardens.

b. **Selection of Corrosion Preventive.** No one corrosion-preventive compound will suffice for all types of parts and assemblies, or for all conditions of climate and storage. Ordinary lubricating oil or grease, or straight mineral type compounds are not satisfactory as corrosion preventives. The approved corrosion preventives described in the following paragraphs are made up chiefly of greases or oils and contain special corrosion inhibitors. They should never be applied to any natural rubber compound, insulated electric wires, or interior parts of artillery, fire control instruments, or electrical assemblies, such as motors or generators. The selection of a corrosion preventive depends on the following factors:

- (1) Nature and function of the part to be coated.
- (2) Type of exposure and degree of corrosion prevention required.
- (3) Nature of wrapping and packaging, if any, to be used over the corrosion preventive.
- (4) Ease, or necessity, of removal of corrosion preventive from the part before use.
- (5) Availability of corrosion preventive.
- (6) Difficulty of application.

c. **Description of Corrosion Preventives and Guide for Use.**

- (1) **RUST-PREVENTIVE COMPOUND (HEAVY).**

## CLEANING AND PRESERVATION

(a) *Description.* This compound is an almost hard, thick-film grease type. It may be used on any parts or assemblies which can be properly coated, and where the compound may be satisfactorily removed before the material is put into operation. Removal is generally time-consuming. This compound is especially useful on highly finished operating parts, where one or more of the following conditions is expected:

1. Long-term storage.
2. Impact or abrasion resistance of corrosion-preventive film due to lack of sufficient protective wrapping.
3. Exposure to temperatures up to 150° F.

(b) *Application.* Heat the compound until it becomes liquid and apply by dipping, spraying, or brushing. The dripping method is illustrated in figure 1. Do not dilute with solvents and use as a cold dip.

(c) *Examples.* Examples of parts suitable for the application of rust-preventive compound (heavy) are:

- Bolts, nuts, washers, and other standard hardware items.
- Braces, brackets.
- Bushings, sleeves (except oilless).
- Camshafts, crankshafts (without lubricating holes).
- Clamps (keep compound off rubber hose).
- Clips (wiring, brake, and gasoline line).
- Covers (rocker arm and head).
- Cylinder blocks without fitted pistons, cylinder heads (except oil-holes).
- Gears (unassembled).
- Gun breeches (exterior surfaces only).
- Oil cups (exteriors and covers).
- Plates, solid shafts, solid rods.
- Pulleys.
- Recoil slides (heavy artillery).
- Shims.
- Springs, of 21-gage wire or larger, or diameter greater than  $\frac{1}{32}$  inch.
- Valves.
- Yokes (tie rod).

### (2) RUST-PREVENTIVE COMPOUND (LIGHT).

(a) *Description.* This compound is a soft, thick-film type with the consistency of a light grease. It may be used on any parts or assemblies which can be properly coated, and where the compound may be satisfactorily removed later. This compound is useful on highly finished operating parts where corrosion-preventive periods of approximately 1 year may be necessary at temperatures under 120° F, and where wrapping and packaging are sufficient to protect the film from abrasion and pressure damage.

## INSTRUCTION GUIDE — ORDNANCE PACKAGING AND SHIPPING (POSTS, CAMPS, AND STATIONS)

(b) *Application.* Heat the compound until it becomes liquid and apply by dipping, spraying, or brushing. Do not dilute with solvents and use as a cold dip. The dipping method is illustrated in figure 1.

(c) *Examples.* Examples of parts and assemblies suitable for the application of rust-preventive compound (light) are:

Bolts, nuts, washers, and other standard hardware items.  
 Breech mechanisms (interior, after disassembly).  
 Bushings, sleeves (except oilless).  
 Camshafts, crankshafts (without lubricating holes).  
 Clamps (keep compound off rubber hose).  
 Clips (wiring, brake, and gasoline line).  
 Cylinder blocks with fitted pistons (except oilholes).  
 Electric motors, generators, etc. (exposed ends of shafts only).  
 Extractors.  
 Fittings, tees, elbows.  
 Gaskets (metal).  
 Gears (unassembled, precision type).  
 Gun parts and mounts (subcaliber).  
 Gun tubes (except for extremely hot climate).  
 Machine guns.  
 Pins (dowel and piston).  
 Pistons.  
 Projectors, pyrotechnic (all parts).  
 Propeller shafts (slip joint and bearings).  
 Rivets.  
 Rods, shafts (solid).  
 Shims.  
 Small arms.  
 Spare parts (small arms).  
 Springs, locking rings.  
 Supports.  
 Thermostats (bimetal).  
 Valves.  
 Yokes (tie rod).

(3) RUST-PREVENTIVE COMPOUND (THIN-FILM).

(a) *Description.* This is a thin-film type of compound containing up to 60 percent solvent, which gradually hardens to a waxy, tough film after application, as the solvent evaporates. It may be used on parts or assemblies that do not have highly finished working surfaces requiring complete removal of the compound before being put into operation. It should not be used on inaccessible parts, such as gun bores, because manual rubbing is usually required in addition to a solvent to remove it. It is especially useful on tools. The film develops resistance to abrasion and direct moisture and, therefore, is suitable for use where there will be little or no wrapping or packaging.

**CLEANING AND PRESERVATION**

(b) *Application.* Apply without heating, by dipping, spraying, brushing, or flooding on parts, assemblies, or portions thereof. Brushing is the least satisfactory of these methods. Do not dilute further with solvents, unless the compound becomes too thick for application.

(c) *Examples.* Examples of parts suitable for the application of rust-preventive compound (thin-film) are:

Bogey rims.

Bolts, nuts, washers, and other standard hardware items.

Boxes (metal).

Braces, brackets.

Brake shoes, clutch-driven members (metal parts only).

Cables (steel).

Chains.

Clamps (keep off rubber hose).

Clips (wiring, brake, and gasoline line).

Covers, housings, plates.

Fire extinguishers (unpainted surfaces).

Flywheels.

Fuel tanks (exterior, if not painted).

Gaskets (combined metal and asbestos, but not cylinder-head gaskets).

Gun tubes (exterior surface only).

Mufflers.

Pans (drain).

Pipes (exhaust, tail, or any steel pipe).

Pulleys.

Radiator shells (exterior).

Rivets.

Springs (large coil, volute, and leaf).

Tank tracks (all-metal).

Tools (except precision type with inaccessible surfaces).

Tripods (light gun).

Tubing (close ends before applying).

Wheels (keep off bearings and tires).

(4) **PRESERVATIVE LUBRICATING OIL (MEDIUM).**

(a) *Description.* This is a nonhardening, thin-film lubricating material, about the same in viscosity as engine oil SAE 30. It is especially useful on internal working surfaces of assemblies which will probably not be disassembled and cleaned before being put into operation, and which have sufficient wrapping and packaging for protection against direct moisture during shipment and storage.

(b) *Application.* Apply without heating, by dipping, spraying, fogging, brushing, or flooding on parts, assemblies, or portions thereof. Brushing is the least satisfactory of these methods. When dipping, hold the materiel at such angles that trapped air bubbles cannot keep portions of the interior surfaces from being coated with the oil.

**INSTRUCTION GUIDE — ORDNANCE PACKAGING AND SHIPPING (POSTS, CAMPS, AND STATIONS)**

(c) *Examples.* Examples of parts and assemblies suitable for the application of preservative lubricating oil (medium) are:

Air cleaners.

Artillery and generator (not engine) lubricant for conditions of high temperature and humidity.

Automatic mechanisms (oil-filled).

Connecting rods (with drilled lubricating holes).

Covers (timing case with oil seals).

Cylinder block oilholes (close afterward to keep out grease type corrosion preventive).

Filters (oil and fuel).

Fuel tanks (interior; use fine spray or fog).

Gear assemblies (enclosed).

Ignition parts (breaker plates, weights, cams, rotors).

Locks, catches.

Nozzles.

Oil seals.

Pins, screws (in a part or assembly).

Piston rings.

Pump assemblies.

Repair kits (carburetor, water pump, master cylinder, wheel cylinder—bare metal only).

Shafts (hollow or drilled).

Springs (small precision).

Windshield wipers (metal parts only).

---

**Section II****INNER PACKAGING****7. GENERAL.**

a. The proper choice and application of a wrapper or inner package is fully as important as proper cleaning and coating with a corrosion preventive. If the inner wrapping is carelessly or incorrectly applied, all previous efforts to prevent corrosion are wasted.

**8. GREASEPROOF AND WATERPROOF MATERIALS.****a. Greaseproof Materials.**

(1) **GENERAL.** The purpose of greaseproof wrapping paper is to keep the corrosion-preventive film on the part. Greaseproof material is designed not to absorb oils or greases, and to be noncorrosive. It prevents the surface of the part from coming in contact with other materials which might absorb the oil or otherwise promote corrosion. The selected wrapping material must be strong enough in relation to

## INNER PACKAGING

the weight and shape of the wrapped piece, to resist tearing or puncturing.

(2) **GRADES.** Greaseproof wrapping material is furnished in different grades as follows:

(a) *Grade A.* This greaseproof, acid-free, noncorrosive, and wax-free material is identified by being colored red or having red markings. It is used as a noncorrosive wrapping, chiefly over machined or polished surfaces. It does not provide a waterproof wrap.

(b) *Grade C.* This greaseproof, acid-free, noncorrosive, moldable, and sealable material is identified by being colored green or having green markings on the greaseproof side. It is used as a noncorrosive wrapping that can be molded around a machined or polished part and suitably sealed. A film of wax is used on one or both sides of the sheet. Lighter types of grade C are usually composed of single or double plies of paper. In the heavy-duty types, one of the laminations is usually cloth or similar material. The sheet is water-resistant and, when suitably sealed at all edges, folds, and seams will form a waterproof wrap (par. 9 d). Grade C material is also valuable as a cushioning wrap, used in one to three thicknesses on sharp edges, corners, or protrusions of parts and assemblies, to protect adjacent layers of greaseproof and waterproof wrapping from being cut or punctured. **NOTE:** *Whenever a laminated wrapper is used, the greaseproof side must be placed next to the part or assembly.*

(3) **TYPES.** Both grade A and grade C greaseproof wrapping paper are furnished in different types as follows: type I has high bursting and tearing strength and type II has medium bursting and tearing strength.

(4) **GREASEPROOF, WATERPROOF BAGS.** Greaseproof, waterproof bags are furnished in different types. Type I has high bursting and tearing strength and type II has medium bursting and tearing strength. Both types have inside surfaces that are noncorrosive and resistant to grease, and outer surfaces resistant to water penetration. These bags may be sealed by heat, or by taping with nonhygroscopic adhesive tape. When properly sealed, greaseproof, waterproof bags will meet the requirements for Method I-A inner packages as defined in paragraph 9 d. The use of greaseproof, waterproof bags for either Method I or I-A packages for small, light parts are, in many cases, more efficient and faster than wrapping the parts.

### b. Waterproof Papers.

(1) **GENERAL.** Waterproof barrier wrapping paper is used as a protective wrapper or box lining to resist the passage of water into the space enclosed by the paper. It is important that all seams, closures, and joints be made in such manner as to give protection equal to that of the paper itself. Joints should be sealed with asphalt

## INSTRUCTION GUIDE — ORDNANCE PACKAGING AND SHIPPING (POSTS, CAMPS, AND STATIONS)

or other suitable waterproof adhesive. Waterproof wrapping of an irregularly shaped object can be effected by securing all joints with the adhesive and tying the paper securely with cord. The purpose is to shed water, but the wrapping or box lining is not intended to be airtight or to exclude moisture vapor in the air. The type of paper to be used will depend on the requirements for strength, stretchability, and flexibility.

(2) **TYPES.** Waterproof barrier wrapping paper is supplied in various types and constructions. The various types of paper are intended for different uses, as follows:

(a) *Interior Wrap Use.* These papers consist of two sheets of light paper cemented together with asphalt. They are intended for protection of light parts, or sections of parts, against penetration of water. (The parts will be packed in boxes or fully sheathed crates.) These papers are designated type C-1 or A-1.

(b) *Interior Shroud Use.* This paper is reinforced with cords or strands of fiber imbedded in the asphalt between the two outer plies of paper. It is intended for covering the top and sides of items in crates, to shed water. This paper may also be used as an interior wrap, where a strong but not very flexible material is needed. It is also acceptable as a case liner (step (c), below). This paper is designated type E-2.

(c) *Case-liner Use.* This paper consists either of two sheets of heavy paper or three sheets of light paper, cemented together with asphalt. They are designed either to have high strength or to be stretchable, so as not to be easily torn. They are intended for use as waterproof linings for boxes. Application of waterproof linings is described in paragraph 21. Case-liner papers, if of sufficient strength, may be acceptable also for interior shrouds. Some of these papers have one side specially treated with asphalt, resins, waxes, or wax blends to give resistance to abrasion when either dry or wet. This treated side must be on the outside of a box liner or shroud, partly to take advantage of the treatment and partly because the adhesive used for seams and closures may not make a strong bond on the treated side. These papers are designated type H-1, H-2, H-3, L-2, or M.

**NOTE:** *Waterproof papers specially made for use on crate tops, sides, and ends are described in paragraph 30.*

## 9. METHODS OF INNER PACKAGING.

### a. Definition of Methods.

(1) Method I is an unsealed wrap. This method is used where it is definitely known that the corrosion preventive alone is sufficient protection for the part if the preventive is kept in place. The wrap-



## INNER PACKAGING

ping keeps the corrosion preventive from being rubbed off or absorbed by the dunnage or blocking, or from flowing off in hot weather, and provides some protection against mechanical damage to the part. It does not prevent the entrance of moisture vapor in the air or corrosive gas but, being unsealed, it also permits easy escape of condensed vapor or water that may enter. That is, the inside of the package may become damp, but it can dry out again. The contents will become wet if the package is placed in water.

(2) Method I-A is a sealed wrap. A corrosion preventive is always used on the parts, unless they are completely protected by highly corrosion-resistant plating or painting, or are composed of non-metallic materials, such as cork, fiber, rubber, or plastic. The parts are wrapped in grade C greaseproof wrapping material, and the wrapper is sealed. The sealed wrapper resists the entrance of water even if placed in water for a short time. See paragraph 8 a (4) for information on the use of greaseproof, waterproof bags for Method I-A packaging.

**b. Choice of Method.** The method chosen for packaging will be dependent upon the following conditions:

(1) The corrosion preventive applied to the part. Very large, heavy parts which can be sufficiently protected by the application of a viscous type corrosion preventive (rust-preventive compound (heavy) ) or a hard-drying type corrosion preventive (rust-preventive compound (thin-film) ) may not need wrapping. Parts that are coated with these corrosion preventives but need protection to keep the coating in place may be wrapped by Method I. Parts that have nonprecision or noncritical surfaces and are coated with rust-preventive compound (light) may also be wrapped by Method I. Pistons, small and medium sized precision type gears, or similar parts which are protected by a coating of rust-preventive compound (light) or preservative lubricating oil (medium) should be wrapped by Method I-A. The Method I-A wrapper should completely inclose the part or assembly and should conform to its contour as closely as possible, without squeezing or scraping the corrosion preventives completely from any area. Because the light, soft types of corrosion preventives are more easily removed when putting the part into use, it is often advisable to use them and wrap by Method I-A. All wrappers in contact with parts must be noncorrosive material. Method I-A wrapping is also used on items that cannot be treated with a corrosion preventive, such as cork or fiber gaskets, electric switches, and other small electrical assemblies.

(2) The distance and the methods of transportation and the climatic conditions must be considered. Parts being packaged for overseas shipment and those which may be subjected to extended periods of outdoor storage before being put into use need to be

**INSTRUCTION GUIDE — ORDNANCE PACKAGING AND SHIPPING (POSTS, CAMPS, AND STATIONS)**

wrapped by Method I-A if entrance of water, grit, or salt air would damage them.

(3) The size and shape of the part to be packed may determine the materials and wrapping method to be used. Sharp projections on parts need to be carefully cushioned to prevent puncturing of the greaseproof wrapping. A sealed waterproof wrap that is punctured while in transit is poorer protection than an unsealed wrap, as it does not permit evaporation of water that may enter through cuts in the wrapper.

(4) Availability of materials and equipment may determine the choice of packaging method.

c. **Application of Method I.** Examples of typical items suitable for Method I packaging are included in the lists given in paragraph 6 c (1) (c) and (3) (c). Method I packaging applied to a tool is illustrated in figure 2.

(1) Clean and dry the part as described in paragraph 4.

(2) Apply the corrosion preventive as specified in paragraph 6, using the type prescribed for the part.

(3) As soon as the corrosion preventive is set, and with as little handling as possible to avoid damage to the coating, wrap in greaseproof wrapping paper, grade A. Select the type of grade A paper that is strong enough to resist puncturing and tearing, depending on the weight and shape of the part to be packed. Use noncorrosive padding on sharp points and edges (par. 10).

(4) The closing edge of the wrapper may be secured in place by folding, taping, tying, or stapling.

(5) Large parts, sufficiently protected by a hard type corrosion preventive, may not need to be completely inclosed by the Method I wrapping, but just enough to prevent contact with the dunnage or blocking.

(6) Small parts or assemblies coated with corrosion preventive may be placed in close-fitting bags or cartons, provided that the interior surfaces of the bags or cartons are greaseproof and noncorrosive. Bags or cartons may be closed by folding, taping, tying, stapling, or similar means.

(7) The wrapped part should be placed in a box of the proper dimensions and strength, and lined with waterproof paper (see ch. 3).

d. **Application of Method I-A.** Examples of typical items suitable for Method I-A packaging are included in the lists given in paragraph 6 c (2) (c) and (4) (c).

(1) Clean and dry the parts and assemblies as described in paragraph 4.

## INNER PACKAGING

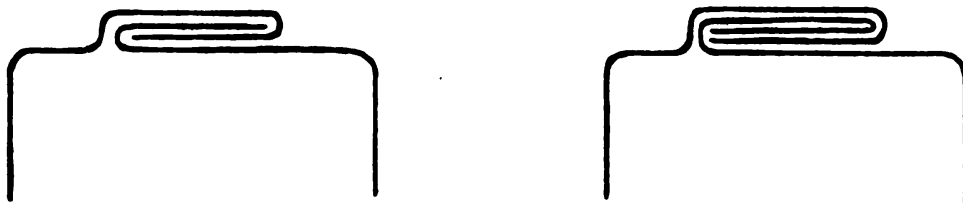

RA PD 88985

**Figure 3 – Two Methods of Making Lock-seams in Wrapping**

(2) Apply the corrosion preventive as specified in paragraph 6. The corrosion preventive must give adequate protection against moisture vapor that may enter the package, and also against moisture condensation from the air within the package. (The entire wrapping should include as little air space as possible.)

(3) Inclose the part or assembly in grade C greaseproof wrapping paper. It is water-resistant, can be wrapped closely to the various shaped parts, is noncorrosive, and is also good for cushioning. The type selected depends on the weight and shape of the part being wrapped. Be sure to place the greaseproof (colored) side next to the part or assembly if laminated material is used. Where two parallel edges of the wrapper are joined, a lock-seam fold should be made (fig. 3). Wrapping a precision type gear is illustrated in figure 4. A flat wrap would be used for a gear with a small inside hole. See paragraph 8 a (4) for information on the use of greaseproof, water-proof bags for Method I-A packaging.

(4) Seal the package against water by dipping in dip coating sealing compound. This wax or waxlike compound requires use of a dip tank (fig. 5), heated indirectly by steam or electrical heat to a temperature of 160° F to 200° F. A preliminary test should be made to determine the most satisfactory temperature for the compound and the grade C material being used. The compound should be hot enough to produce a coating thickness of not over  $\frac{1}{16}$  inch, but not hot enough to cause delamination (separation of plies) of the grade C material. The heat should be directed from the sides, as well as the bottom of the tank so that the wax is of equal temperature in all parts of the tank. Overheating will destroy the protective qualities of the compound. Packages should usually be dip-coated in two stages with an overlap at the center (fig. 5). The first half of the package should be dipped no longer than 10 seconds. As soon as the coating is set, dip the other half, dipping not longer than 5 seconds. The second dip must be of shorter duration than the first in order not to heat the included air and cause bubbles in the coating. The overlap of the coating should be about 1 inch. Between dips,

INSTRUCTION GUIDE — ORDNANCE PACKAGING AND SHIPPING (POSTS, CAMPS, AND STATIONS)

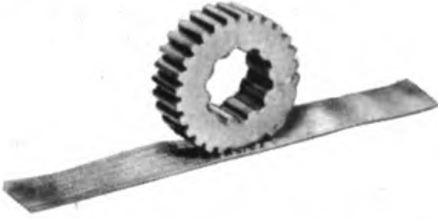

GEAR COATED WITH RUST PREVENTIVE COMPOUND (LIGHT) AND PLACED ON STRIP OF GRADE C GREASEPROOF WRAPPING PAPER.



GEAR ENCIRCLED WITH GRADE C STRIP TO CUSHION OUTSIDE EDGES.



STRIP EDGES CRIMPED DOWN



GEAR WITH EDGES CUSHIONED, PLACED ON SHEET OF GRADE C GREASEPROOF WRAPPING PAPER.



WRAPPING BEGUN, WITH EDGES JOINED IN LOCK-SEAM.



ONE END OF CYLINDER MOLDED TO INSIDE OF GEAR, THIS BEING REPEATED WITH OTHER END.

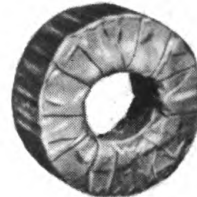

GEAR WITH COMPLETED WRAP "DOUGHNUT"

RA PD 88986

Figure 4 — Applying Method I-A Packaging to a Precision Type Gear

### INNER PACKAGING

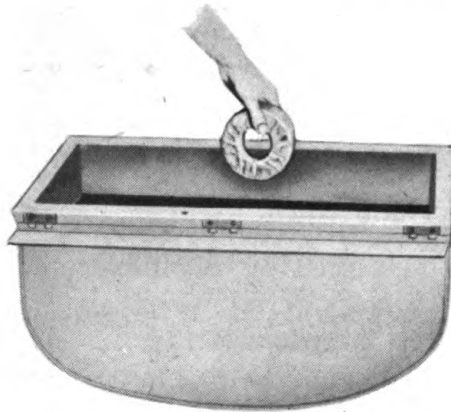

TANK INDIRECTLY HEATED BY STEAM OR ELECTRICAL HEAT TO A TEMPERATURE OF 160° TO 200° F.

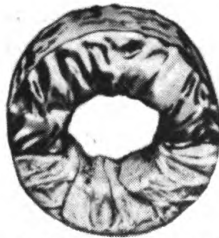

AFTER FIRST DIP IN SEALER, HALF OF ITEM COATED.



AFTER SECOND DIP OTHER HALF COATED WITH OVERLAP AT CENTER.

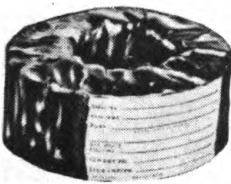

IDENTIFICATION LABEL ATTACHED TO WRAPPED SEALED GEAR.

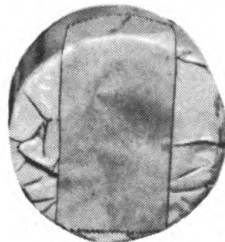

OVERWRAP WITH KRAFT PAPER AND GUMMED TAPE.

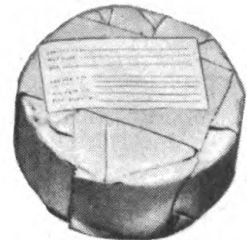

SECOND LABEL ATTACHED TO OVERWRAP.

RA PD 88987

**Figure 5 — Applying Method I-A Dip-coat Sealing, Labels, and Overwraps to the Wrapped Precision Type Gear**

**INSTRUCTION GUIDE — ORDNANCE PACKAGING AND SHIPPING (POSTS, CAMPS, AND STATIONS)**

and during the final setting, the packages should be placed on wax paper or grade A greaseproof pads. Packages must not be dipped in water to cool the wax coating. Care should be taken not to cause any breaks in the coating. For some large assemblies, dip-coat sealing may not be practical because of the relatively small size of the tank instead of dip coating such items, brush the seams and folds of the grade C wrapper with heated sealing compound.

(5) A label should be placed on the dip-coated package, the package overwrapped with kraft paper, waxed paper, or equivalent, and an outer label affixed to the package (fig. 5). For a description of labels and methods of attaching them to the package, see paragraph 41 b (1). The kraft wrapper is to keep packages from adhering to each other, and to prevent damaging the coating when the package is handled.

(6) The wrapped or bagged part should be properly boxed for shipment in a box lined with waterproof paper. This provides the required "double" water barrier for Method I-A packaging; that is, the sealed wrapper and the waterproof box liner.

*NOTE: If suitable grade C material and dip-sealing compound or greaseproof, waterproof bags are not available and it is, therefore, impossible to make Method I-A packages as described above, waterproof inner packages can be made by using waterproof paper (type C-1) to overwrap parts wrapped in grade A greaseproof paper and sealing all seams with rubber base waterproof cement.*

## **10. CUSHIONING MATERIALS.**

### **a. General.**

(1) Cushioning materials are used for four main purposes:

(a) To prevent or minimize damage to parts or assemblies caused by sudden impacts in handling or shipment, by absorbing part of the shock.

(b) To prevent damage to several articles packed in the same shipping container, caused by striking or rubbing one another.

(c) To fill small voids in shipping containers, thus preventing packed articles of relatively light weight from moving in various directions and perhaps breaking the container by thrusts from the inside.

(d) To prevent puncture or tearing of wrappings, interior packing cartons, linings, shrouds, etc.

(2) For the last-named purpose, the cushioning may be either inside or outside the wrapping or lining, depending on the location of the points of contact likely to cause puncture or tearing. The use of grade C, type I greaseproof material as a cushion on protrusions and edges has been described in paragraph 8 a (2) (b). No other

## INNER PACKAGING

cushioning material, unless it meets greaseproof requirements, should be directly in contact with any surface that can be damaged by corrosion. All cushioning materials must be *dry* when used in packing. For use around, under, and over articles in a closed box, the quantity of cushioning material should be sufficient to make a reasonably tight pack so that shifting of the articles in transportation is minimized. Thickness of cushioning necessary on each face depends on the fragility of the articles. Watches, control panels, and other delicate instruments need maximum cushioning.

**b. Materials Generally Available.** Practically all materials generally available for cushioning are water-absorbent. Parts that are susceptible to corrosion, therefore, should always be separated from the cushioning material by waterproof paper or by grade C wrapping. These precautions must be observed in using materials for cushioning, as follows:

(1) **CORRUGATED PAPER (FLEXIBLE SINGLE-FACE).** Flexible single-face corrugated paper is made with specially indented corrugations which permit the material to be folded in any direction and into any shape. It is useful as a cushioning wrapper. Articles wrapped with this corrugated paper must be placed in a waterproof-lined shipping box.

(2) **EXCELSIOR.** Excelsior is often used for cushioning purposes, in thicknesses of 1 to 3 inches. Its cushioning value is not as greatly affected by water or dampness as paper or paper-like products which tend to "pack down" and lose most of their cushioning value on becoming damp. Loose excelsior should be pressed into place firmly in the pack, as it will settle somewhat after a time. Loose excelsior should not be used where there is a possibility that damage to a machine part will be caused by entrance of wood particles or dust. For the packing of such parts, excelsior should be used only in the form of pads, completely wrapped with strong paper and sealed. **NOTE:** *Excelsior is not an item of issue.*

(3) **SHREDDED PAPERS.** Use of shredded papers should be limited to the packing of articles of very light weight. Shredded plain paper should never be used except inside containers that are waterproof-lined or are otherwise designed to keep out water. Shredded waxed paper is much more resistant to moisture than plain paper. **NOTE:** *These materials are not items of issue.*

(4) Creped cellulose wadding, kraft-backed, may be used for cushioning against shock and protecting polished surfaces from abrasion. It can be used to cushion small articles by wrapping the whole piece in the wadding and placing it in a box. It is especially suitable for fragile and valuable items. The kraft paper backing on the wadding is designed to provide some water resistance, but as in the case

**INSTRUCTION GUIDE — ORDNANCE PACKAGING AND SHIPPING (POSTS, CAMPS, AND STATIONS)**

of shredded paper, this wadding should never be used except inside containers that are waterproof-lined or are otherwise designed to keep out water.

(5) **SAWDUST AND SHAVINGS.** Use of sawdust and shavings should be limited to the packing of articles that cannot be damaged by dust, dirt, or moisture. They may be used inside a box, around an inner container which holds a liquid, when an absorbent is required in the event of leakage from the inner container. **NOTE:** *These materials are not items of issue.*

(6) **SALVAGED CLOTH.** If no other suitable cushioning material is available, salvaged wool or cotton cloth (usually several thicknesses) may be used as a substitute. Cloth is not suitable where any extended period of storage will be involved, because mildew, mold, etc. will cause its deterioration. Precautions should be taken to keep polished or operating surfaces of materiel from direct contact with the cloth, and to prevent moisture from reaching the cloth, because several layers saturated with moisture will remain damp indefinitely. Slow evaporation of this moisture would keep the interior of a container damp for a long period and cause corrosion of the materiel.

(7) **FELT.** Felt is supplied in rolls of various widths, and in various thicknesses. It may be cut conveniently into pads of any desired size, with shears. It is especially suitable for padding sections of blocks or braces which will be in contact with greaseproof or waterproof wrappers. Small tacks may be used to attach the felt, but they should be located so as to avoid punctures or tears in the wrapper through contact with the tack heads. In general, the same precautions should be taken in using felt as in using salvaged cloth (step (6), above). **NOTE:** *Felt is not an item of issue.*

(8) **SALVAGED FIBERBOARD.** Corrugated fiberboard or solid fiberboard salvaged from fiberboard (paperboard) shipping boxes or packing cartons may be used for cushioning and space-filling purposes, or as separators between layers of articles in a box. The corrugated fiberboard has more cushioning effect than the solid fiberboard, but lacks the flexibility of the single-face corrugated paper previously described. Different kinds and grades of fiberboard vary in stiffness and strength. Fiberboard identified with the "V" mark has considerable water resistance. Pieces of fiberboard can be used just inside a waterproof lining to protect it from puncture by the contents. The fiberboard must be dry.

(9) **HAY AND STRAW.** Hay and straw shall *not* be used for cushioning or space-filling purposes. **NOTE:** *Hay and straw are not regularly issued.*



CHAPTER 3  
**EXTERIOR SHIPPING CONTAINERS**

---

Section I

**CHOICE OF EXTERIOR CONTAINERS**

**11. TYPES OF SHIPPING CONTAINERS.**

a. **General.** Information on the construction and use of different types of containers included in this chapter are as follows:

(1) **NAILED WOOD BOX.** A nailed wood box is a fully closed container that consists essentially of boards nailed together at the edges of its six faces.

(2) **CRATE.** A crate may also be fully closed or sheathed, but it consists of a frame to which the sheathing boards are fastened.

(3) **OPEN TYPE CRATE.** An open type crate may have no sheathing boards, or may be partly sheathed.

(4) **SKID UNIT.** A skid unit is a base to which an item is fastened for convenience in handling and transporting it.

(5) **BUNDLE.** A bundle may consist of a number of like items that are not likely to be damaged during shipment. The bundle may be tied together with metal bands, wires, or by similar means. One end of a bundle may be protected by a box that is open on one side, as shown in figure 6. Bundles are not discussed in any other section of this manual. Many other types of shipping containers, specially suited to certain classes of commodities, are in use, but they are outside the scope of this publication.

**12. FACTORS GOVERNING CHOICE OF SHIPPING CONTAINER.**

a. Factors which may govern the choice of the type of shipping container to be used include the following:

(1) Degree of protection required by the item.

(2) Kind of corrosion prevention and inner packaging applied to the item (ch. 2).

(3) Weight and size of item or items to be placed in container.

(4) Modes of transportation to be used (truck, railway, ship, etc.).

(5) Availability of materials for making containers.

(6) Time available for preparation of shipment.

b. The most appropriate type of shipping container can be determined, therefore, by considering the facts of a given situation. In

INSTRUCTION GUIDE — ORDNANCE PACKAGING AND SHIPPING (POSTS, CAMPS, AND STATIONS)

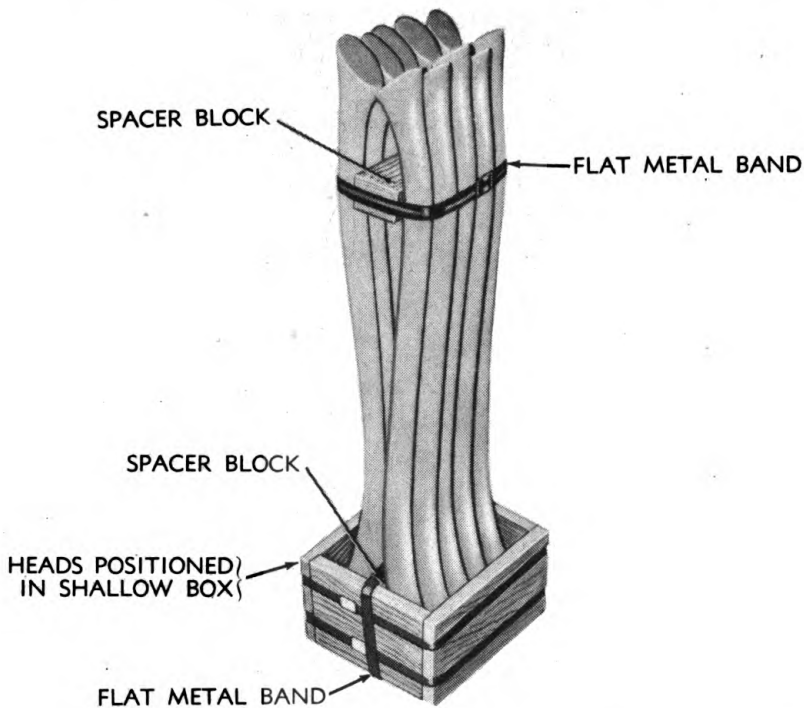

RA PD 88988

**Figure 6 — Method of Bundling Ten Axes Protected by a Box Open on One Side**

most instances a suitable shipping container can easily be chosen according to the nature and function of the items to be packed.

c. Materiel to be packaged will be segregated by types so that like items will be packed together. Items of a fragile nature will be cushioned individually and blocked securely. Reference is made to paragraph 10 for information on cushioning materials, and paragraph 20 for interior bracing and blocking with boxes. Ordinarily, heavy rugged items such as anvils will not be packaged with fragile items such as hydrometers. If it is necessary to pack heavy items with relatively light items in one container, the heavy items will be separated by sufficient blocking and cushioning material to prevent contact between the two types of items. Whenever possible, items allocated to only one SNL group shall be packed in one container. In shipping to depots, serviceable and unserviceable items shall not be packed in the same container.

### 13. GUIDE TO CHOICE OF SHIPPING CONTAINER.

a. **Nailed Wood Boxes.** Boxes are used for articles of comparatively small size and weight that need good protection. Nailed wood boxes may be used for loads up to 1,000 pounds.

**CHOICE OF EXTERIOR CONTAINERS**

**b. Crates.** Crates are used for large articles or those weighing more than 1,000 pounds, and also for fragile machines, items of about 200-pound, or greater, weight that require much bracing and blocking inside the container, and items that require bolting to the container base.

**c. Open Crates.** Open crates are used for items that require comparatively little or no protection, to facilitate handling and stacking.

**d. Skid Units.** Skid units are used for shipping large or heavy items constructed so as not to be easily damaged by shocks or exposure to weather. Such items are fastened to skid units or bases for convenience and safety in moving, lifting, and loading them on cars and trucks. A more detailed guide to choice of a shipping container is given in table 1.

**TABLE 1 — GUIDE TO CHOICE OF SHIPPING CONTAINER**

CLASS OF ARTICLE	Nailed Wood Box	Sheathed Crate	Open Crate	Skid Unit	Bundle
Artillery tubes, recoil mechanisms				X	
Structural parts—metal or wood			X	X	X
Major items, machine assemblies or subassemblies	X	X	X	X	
Small arms weapons	X				
Tools and machine parts	X	X			
Pipes and rods—long pieces			X	X	X
Metal rods and sheets	X		X	X	X
Bulk materials—solid	X				
Loose materials not liable to damage during transportation					X
Hardware and fittings	X				
Wire and cable	X				X
Furniture—office and field	X	X	X		
Office machinery	X	X			
Kitchen and sanitary equipment	X	X	X		
Instruments, radio equipment, etc.	X	X			
Textiles	X				X
Cordage	X				X
Liquids—in small containers	X				
Fluxes and compounds	X				

Section II

**TOOLS AND MATERIALS FOR CONSTRUCTION  
OF CONTAINERS**

**14. SOURCES.**

a. Tools and materials shall be requisitioned through regular supply channels in accordance with latest Supply Bulletins or other directives. See appendix for further information.

**15. TOOLS REQUIRED.**

a. The following tools are required for construction of nailed wood boxes, crates, and skid units:

Braces and bits.

Chisels.

Hammers.

Hand saws, crosscut.

Hand saws, rip.

Miter box (may be improvised if not otherwise available).

Nail puller.

Planes.

Rasps, half-round.

Screwdrivers.

Squares.

Tensioning and sealing tools for metal band or wire strapping.

Vise.

**16. MATERIALS.**

a. **General.** Materials required are listed in the appendix.

b. **Lumber.**

(1) **WOOD GROUPS.** Woods commonly used in box, crate, and skid unit construction are divided into four groups. Woods in any one group are similar in the properties important for box, crate, and skid unit design. From group I to group IV the woods generally increase in nail-holding ability, strength, hardness, and weight, but also increase in tendency to split at nails. With the harder woods (higher-numbered groups), therefore, thickness of boards can be reduced, and smaller nails should be used. The woods are grouped as follows:

## TOOLS AND MATERIALS FOR CONSTRUCTION OF CONTAINERS

### Group I

Aspen (popple)	Cucumbertree	Pine, ponderosa
Baldcypress	Fir, alpine	Pine, red (Norway)
Basswood	Fir, balsam	Pine, sugar
Buckeye	Fir, noble	Pine, white
Butternut	Fir, white	Redwood
Cedar	Magnolia	Spruce
Chestnut	Pine, jack	Willow
Cottonwood	Pine, lodgepole	Yellow poplar

### Group II

Douglas fir	Larch (tamarack)	Pine, southern yellow
Hemlock	Pine, North Carolina	

### Group III

Ash, black	Elm, white	Sycamore
Ash, pumpkin	Maple, soft	Tupelo, water
Blackgum	Sweetgum (redgum)	

### Group IV

Ash, white	Elm, rock	Maple, hard
Beech	Hackberry	Oak
Birch	Hickory	

(2) **SURFACING OF LUMBER.** Lumber for boxes and crates should be surfaced (planed) on at least one side. The smooth side of the lumber should be on the outside of the container to permit legible marking. Skid units may be made of unsurfaced lumber.

(3) **SEASONING OF LUMBER.** The importance of obtaining well-seasoned lumber (12 to 18 percent moisture content) and of keeping lumber dry until it is made up into shipping containers cannot be overemphasized. Green or wet lumber shrinks considerably when it dries, opening large cracks between boards, loosening joints, loosening straps and other reinforcements, and losing a great deal of its ability to hold nails. Many rough-handling tests of boxes have shown that, taking the strength of a box made of thoroughly air-dried lumber and immediately tested as 100 percent, the strength of a box made of green lumber and kept in dry storage 45 days averaged 24 percent; after storage for a year 15 percent. Alternate wetting and drying has a similar effect, but this effect is much less severe if the lumber originally has a moisture content of 12 to 18 percent. The loss in strength is mainly due to loosening of the nails. Keep in mind, therefore, that a box or crate may seem amply strong immediately after it is nailed together, but may not be strong enough after very few weeks or months. A wood container is no stronger than its nailed joints.

(4) **DEFECTS.** Do not use boards containing knots that extend across more than one-third the width of the board (fig. 7), knots that

INSTRUCTION GUIDE — ORDNANCE PACKAGING AND SHIPPING (POSTS, CAMPS, AND STATIONS)  
SPIKE KNOT

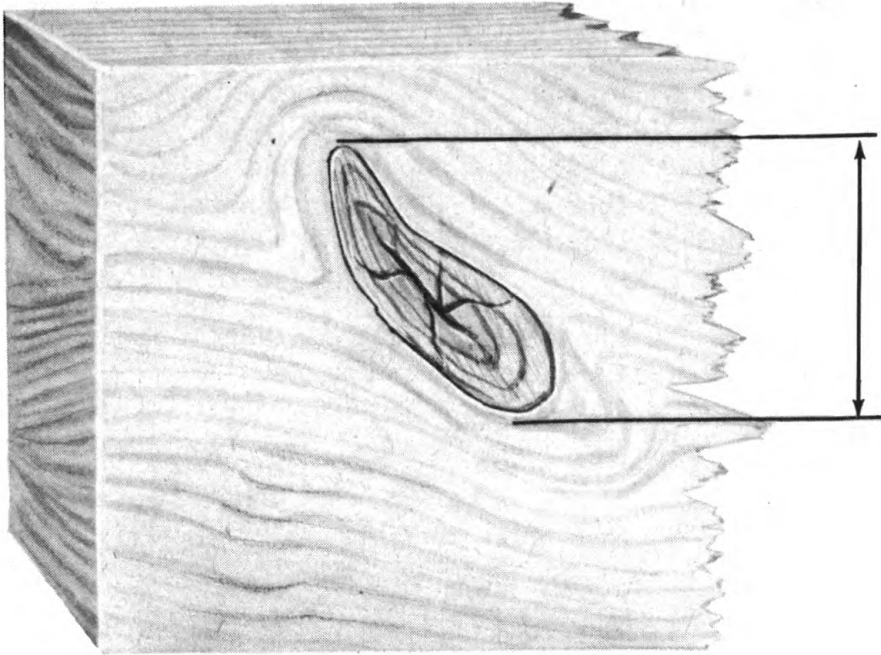

ROUND KNOT

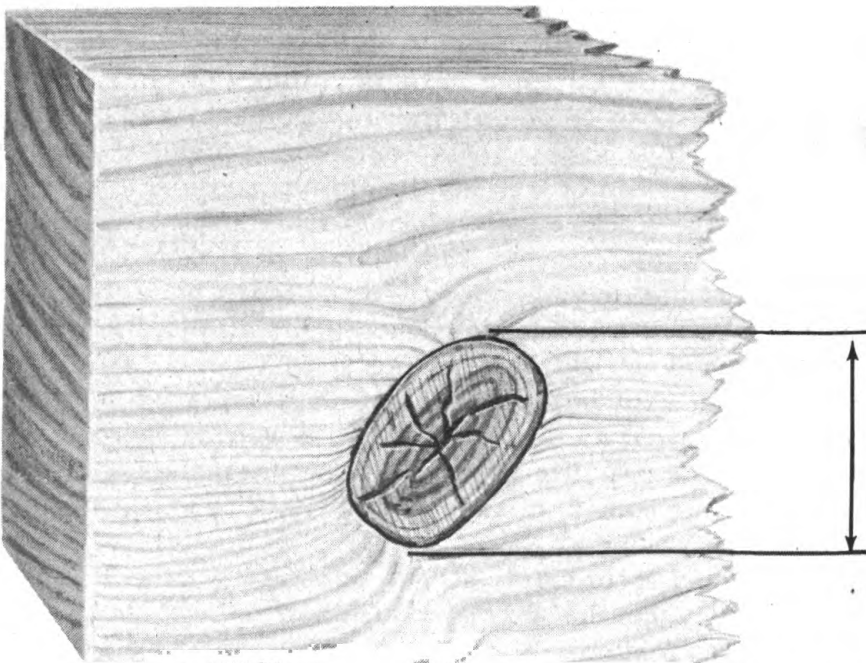

RA PD 88989

**Figure 7 — Method of Measuring Knots**

TOOLS AND MATERIALS FOR CONSTRUCTION OF CONTAINERS

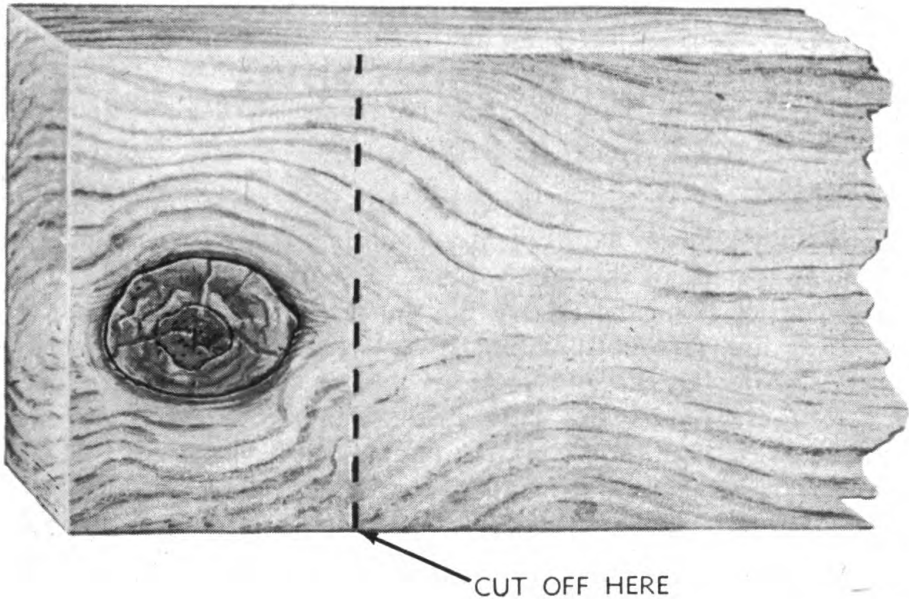

RA PD 88990

**Figure 8 – Knot That Would Interfere With Nailing Board**

interfere with nailing (fig. 8), or large knotholes or loose knots. Do not use badly cross-grained boards (grain deviating more than 1 inch in 8 or 10 inches of length).

**c. Nails.**

(1) **KIND.** Cement-coated nails are preferred because they frequently have 50 to 100 percent more holding power than smooth bright nails.

(2) **LENGTH.** The lengths of cement-coated nails (coolers, sinkers, or corkers) are given in the following tabulation:

Size of Nail* (penny)	Length (inches)
two .....	1
three .....	1 <sup>1</sup> / <sub>8</sub>
four .....	1 <sup>3</sup> / <sub>8</sub>
five .....	1 <sup>5</sup> / <sub>8</sub>
six .....	1 <sup>7</sup> / <sub>8</sub>
seven .....	2 <sup>1</sup> / <sub>8</sub>
eight .....	2 <sup>3</sup> / <sub>8</sub>
nine .....	2 <sup>5</sup> / <sub>8</sub>
ten .....	2 <sup>7</sup> / <sub>8</sub>
twelve .....	3 <sup>1</sup> / <sub>8</sub>
sixteen .....	3 <sup>1</sup> / <sub>4</sub>
twenty .....	3 <sup>3</sup> / <sub>4</sub> (corkers 3 <sup>7</sup> / <sub>8</sub> )

\*Bright common and box nails of most sizes are 1/8 inch longer, penny size for penny size, than cement-coated nails.

## Section III

## NAILED WOOD BOXES

## 17. STYLES OF BOXES.

a. **General.** Boxes of styles 2, 4, and 5, most commonly used for ordnance general supplies and equipment, are shown in figure 9. The arrangement of the parts should be carefully studied. The top and bottom of a box should overlap the sides, as illustrated in figure 9. The sides, top, and bottom must overlap the ends, since a box with the ends nailed to the end grain of the boards in the sides, top, and bottom would have very little strength. In the ends and sides of a box, boards of different widths should preferably be used and so arranged that the joints between boards are offset from each other at the vertical (side-end) edges, to avoid having a line of weakness around the box. The procedure in making up a cleated box usually is as follows:

(1) Nail the cleats to the end boards, clinching nails (clinched points to be on inside of box), thus completing the end panels.

(2) Nail sides to end panels.

(3) Nail the bottom to the end panels and sometimes to the sides. **NOTE:** *If the sides are less than  $\frac{3}{4}$  inch in thickness, neither the top nor the bottom shall be nailed to the sides.* The box is then ready for loading, and fastening of the top.

b. **Style 2 Box.** The style 2 box, with both vertical and horizontal cleats on the ends (fig. 9), has a stronger construction than style 4 or style 5, and may be used for loads up to 1,000 pounds. The cleats form convenient handholds. As there are cleats along all four edges of each end, two rows of nails can be used in fastening side, top, and bottom boards at the joints where they overlap the end boards and cleats. (This staggering of nails is possible also with uncleated ends of very thick lumber; e.g.,  $1\frac{3}{8}$  inches or more.) Since a board shrinks far more crosswise than it does lengthwise, the vertical cleats should be cut slightly shorter than the inside depth of the box, so that their ends will be about  $\frac{1}{16}$  inch from the inside surfaces of the top and bottom. (Otherwise, shrinkage may leave the cleats protruding from the top and bottom edges of the ends, so as to cause splits in the top and bottom boards or loosen the nails fastening them.)

c. **Style 4 Box.** The style 4 box, with two vertical cleats on the outside of each end (fig. 9), may be used for loads up to 400 pounds, and is slightly easier to construct than style 2. Cleats may be used as handholds if a side is turned upward. The cleats must be positioned across the end boards; in this way they strengthen the end against splitting. Top and bottom boards overlap the ends, but not



**NAILED WOOD BOXES**

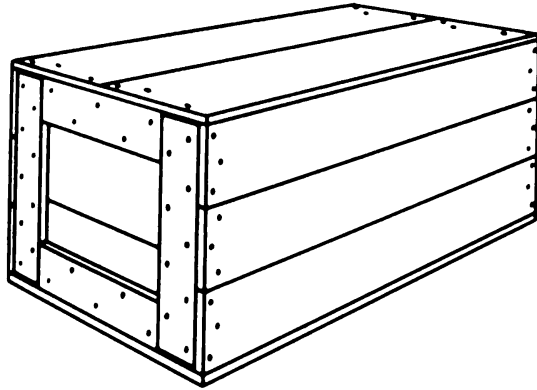

STYLE 2

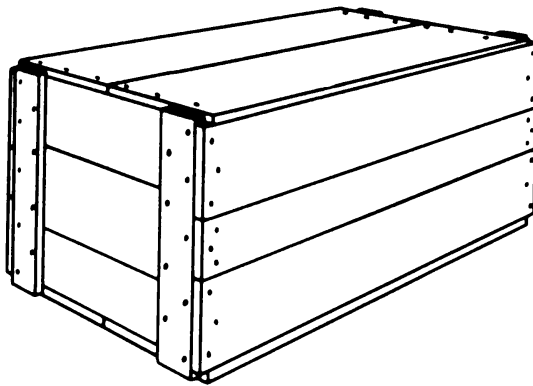

STYLE 4

ALTERNATE FORMS  
OF CLEATS

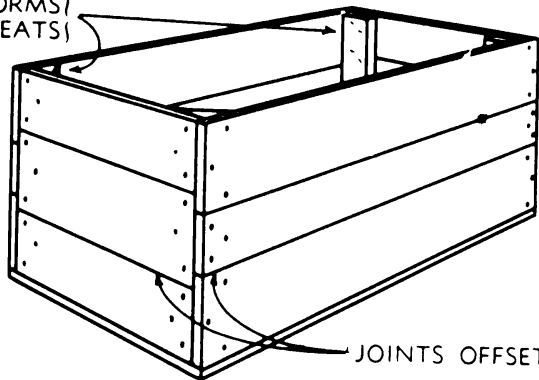

STYLE 5

RA PD 27096

**Figure 9 – Three Approved Styles of Nailed Wood Boxes**

RA PD 88991

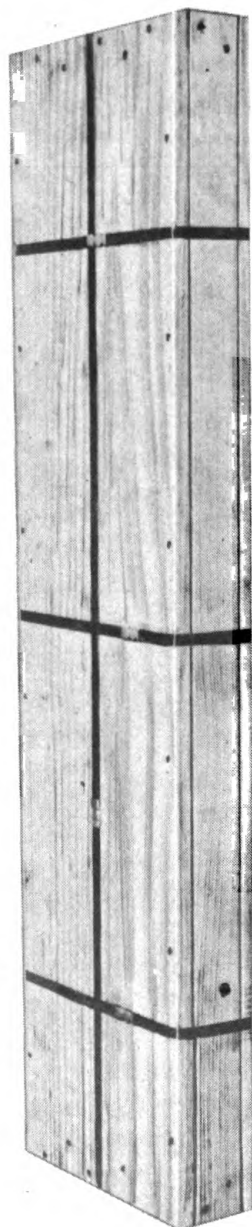

METHOD OF APPLYING METAL STRAPS

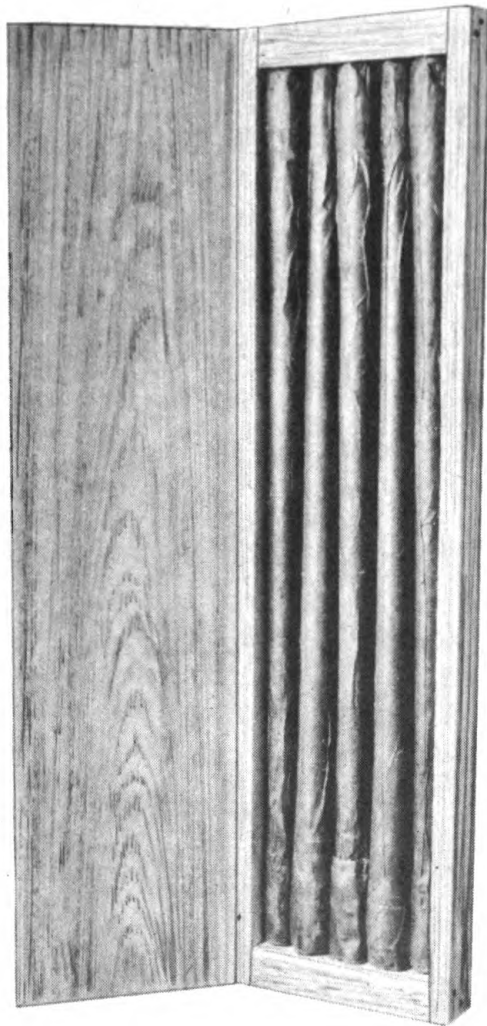

SHALLOW STYLE 1 BOX FOR GUN BARRELS

*Figure 10 — Style 1 Box*

## NAILED WOOD BOXES

the cleats. Cleats should be cut slightly shorter than the outside height of the box, so that their ends will be about  $\frac{1}{8}$  inch from the outside surfaces of the top and bottom. This reduces the possibility of pulling them off in handling.

d. **Style 5 Box.** The style 5 box differs from style 4 only in that the cleats are placed inside the ends (fig. 9), thus slightly reducing the over-all length. Efficient use of style 5 depends on the contents having such a shape that room is left in the corners of the box for the cleats. The cleats must be positioned across the end boards. The load limit for style 5 boxes is 400 pounds.

e. **Style 1 Box.** The style 1 box, having no cleats on the ends, is not generally used for shipping military supplies, as this style box is much weaker than other styles of boxes with average dimensions. If the box depth required is less than about 5 inches, however, ordinary cleats on the ends are likely to split. These extremely shallow boxes can be made serviceable by using uncleated ends  $1\frac{3}{8}$  to  $1\frac{5}{8}$  inches thick (fig. 10) and by staggering the nailing into the ends. It is desirable to use an additional strap on such boxes, placed lengthwise, over the ends, top, and bottom (fig. 10).

## 18. BOARDS AND CLEATS FOR BOXES.

a. **Dimensions of Boxes.** Inside dimensions of a box will usually be determined by the dimensions of the item or items to be packed, and their weight per cubic foot. Unless the item itself has greater dimensions, it is good practice to keep box dimensions within the following approximate limits: length 36 inches, width 18 inches, and depth 15 inches. A convenient size is 24 inches by 12 inches by 12 inches. If possible, avoid making boxes that are either extremely long and narrow or cubical, as such boxes are not easily handled, stowed, and stacked.

(1) **EXAMPLES OF TIME-SAVING BOX SIZES.** Time and labor can be saved by using boxes that can be made from lumber of standard widths, without ripping any boards for the ends, sides, top, or bottom. Lumber as it is bought dressed or surfaced is always slightly less in dimensions than the nominal size by which it is known. Thus a nominal 2 by 4, dressed, is actually  $1\frac{5}{8}$  by  $3\frac{5}{8}$  inches. Dressed 1-inch lumber may be actually  $\frac{3}{4}$ ,  $1\frac{3}{16}$ , or  $2\frac{5}{32}$  inch thick. The following tabulation shows the actual width, U. S. standard dressed, of some nominal widths:

INSTRUCTION GUIDE — ORDNANCE PACKAGING AND SHIPPING (POSTS, CAMPS, AND STATIONS)

Nominal width (Inches)	Actual width (Inches)
4	3 <sup>5</sup> / <sub>8</sub>
5	4 <sup>5</sup> / <sub>8</sub>
6	5 <sup>5</sup> / <sub>8</sub>
7	6 <sup>5</sup> / <sub>8</sub>
8	7 <sup>1</sup> / <sub>2</sub>
9	8 <sup>1</sup> / <sub>2</sub>
10	9 <sup>1</sup> / <sub>2</sub>
12	11 <sup>1</sup> / <sub>2</sub>

NOTE: Some convenient sizes of boxes, style 2 or 4, that can be made from these standard widths of lumber with an actual thickness of <sup>3</sup>/<sub>4</sub> inch are shown below:

INSIDE DIMENSIONS			BOARDS (NOMINAL SIZE) USED IN EACH	
Length	Width	Depth	Top and Bottom	End and Side
Inches	Inches	Inches		
14	10	9 <sup>1</sup> / <sub>4</sub>	One 1 x 12	Two 1 x 5
18	13 <sup>1</sup> / <sub>2</sub>	11 <sup>1</sup> / <sub>4</sub>	Two 1 x 8	Two 1 x 6
22	11 <sup>5</sup> / <sub>8</sub>	13 <sup>3</sup> / <sub>8</sub>	One 1 x 6; one 1 x 8	One 1 x 6; one 1 x 8
24	13 <sup>1</sup> / <sub>2</sub>	15	Two 1 x 8	Two 1 x 8
30	15 <sup>1</sup> / <sub>2</sub>	13 <sup>3</sup> / <sub>4</sub>	Two 1 x 9	Two 1 x 7
36	17 <sup>1</sup> / <sub>2</sub>	15	Two 1 x 10	Two 1 x 8

Cleats for these boxes can be made by ripping nominal 1 x 6's, giving a cleat width of 2<sup>3</sup>/<sub>4</sub> inches (allowing <sup>1</sup>/<sub>8</sub> inch for the saw cut).

(2) EXAMPLE OF BILL OF MATERIAL. The box with inside length of 24 inches, mentioned in the preceding paragraph, is taken as an example. For a style 2 box of these dimensions, the parts required and the cutting sizes would be as follows:

BILL OF MATERIAL

QUANTITY REQUIRED	PART NAME	ACTUAL SIZE (INCHES)			NOTES
		Length	Width	Thickness	
2	Ends	13 <sup>1</sup> / <sub>2</sub>	15	<sup>3</sup> / <sub>4</sub>	4 pieces 7 <sup>1</sup> / <sub>2</sub> in. wide (nominal 1 x 8)
4	Cleats (vertical)	14 <sup>7</sup> / <sub>8</sub>	2 <sup>3</sup> / <sub>4</sub>	<sup>3</sup> / <sub>4</sub>	1 x 6 ripped in two
4	Cleats (horizontal)	8	2 <sup>3</sup> / <sub>4</sub>	<sup>3</sup> / <sub>4</sub>	1 x 6 ripped in two
2	Sides	27	15	<sup>3</sup> / <sub>4</sub>	4 pieces 7 <sup>1</sup> / <sub>2</sub> in. wide (nominal 1 x 8)
2	Top and bottom	27	15	<sup>3</sup> / <sub>4</sub>	4 pieces 7 <sup>1</sup> / <sub>2</sub> in. wide (nominal 1 x 8)

This box requires 16.9 board feet of lumber (figured as from 4/4 nominal size) and, if made of well-seasoned group I wood, weighs about 34 pounds. It should carry up to 200 pounds safely. For nailing cleats to ends, use fivepenny nails spaced 1<sup>1</sup>/<sub>2</sub> inches; for nailing sides, top, and bottom to ends and cleats, use eightpenny nails spaced 2<sup>1</sup>/<sub>2</sub> inches; for nailing top and bottom to sides use sevenpenny nails spaced 6 to 8 inches (these nail sizes assume use of group I wood; see tables 5, 6, and 7).

**NAILED WOOD BOXES**

b. **Sizes of Boards and Cleats.** Table 2 is a guide for the selection of thicknesses of sides, tops, bottoms, ends, and thickness and width of cleats. As shown in the table, ends and cleats should be thicker than sides, tops, and bottoms for maximum serviceability of boxes. Table 3 shows the maximum permissible number of boards in any face of a box, according to the width of that face. This provides a guide for determining the width of boards to be used in any box. No board should be less than 2½ inches wide, although cleats may be as narrow as 2¼ inches, for boxes carrying up to 100 pounds.

**TABLE 2 — MINIMUM THICKNESS OF ENDS, SIDES, TOPS, AND BOTTOMS, AND DIMENSIONS OF CLEATS, STYLE 2, 4, OR 5 BOXES (GROUPS I AND II WOODS)**

WEIGHT OF CONTENTS (POUNDS)	STYLE OF BOX	SIDES, TOP, AND BOTTOM (THICKNESS)	ENDS (THICKNESS)	CLEATS	
				Thickness	Width
		Inches	Inches	Inches	Inches
Up to 100	4 or 5	½	¾	¾	2¼
	2	½	⅝	⅝	2¼
101 to 400	4, 5, or 2	¾	1 1/16	1 1/16	3¼
401 to 800	2	1 1/8	1 1/16	1 1/16	3¼
801 to 1000	2	1 1/8	1 5/8	1 5/8	4 1/8

**TABLE 3 — MAXIMUM NUMBER OF BOARDS PER FACE**

WIDTH OF SIDE, TOP, BOTTOM, OR END (INCHES)	MAXIMUM NUMBER OF BOARDS
Under 4	1
4 to 7	2
7 to 10	3
10 and over	(Note)

Note: One board for each 3 inches of width. Each board shall be at least 2½ inches wide.

c. **Resawing Lumber to Desired Thickness.** At posts where resaw equipment is available, but only very few thicknesses of lumber can be obtained, it may be worth while if time permits to have the lumber resawed to desired thicknesses. The following tabulation suggests some economical practices in resawing.

Finished Thickness (inch)	Original Thickness (Inches) and Times Sawed
½	1 1/16 resawed once
⅝	1 5/16 resawed once
¾	2 3/8 resawed twice

**INSTRUCTION GUIDE — ORDNANCE PACKAGING AND SHIPPING (POSTS, CAMPS, AND STATIONS)**

**d. Cutting Sizes.** Procedure in determining the lengths of various pieces in the box will depend on the style of box selected (par. 17). For a style 2 box, length of boards in the ends will equal the inside width of the box; length of boards in the sides, tops, and bottoms will equal the inside length of the box plus twice the thickness of the end and cleat. (For cleat lengths, see paragraph 17.) For a style 4 box, length of end and side boards will be figured the same as for style 2, but length of top and bottom boards will equal the inside length of box plus twice the thickness of the end boards only. For a style 5 box, which has cleats on the inside, lengths of boards are figured as if the box had no cleats.

**e. Additional Cleats.** Boxes of exceptionally large dimensions require additional cleats (battens) to give extra support to the box faces. Additional cleats should be nailed to the ends, or to the sides, tops, and bottoms of boxes when the unsupported span exceeds that given in table 4 for the thickness of the part involved. Additional cleats applied to ends should be spaced at equal intervals between the regular cleats. Additional cleats applied to sides, tops, and bottoms should be positioned across the grain of the principal boards, and placed inside the box whenever the contents permit. If placed inside, they should be cut 1/4 inch shorter than the inside width of the box face to which they are applied. If placed outside, not less than two sets of additional cleats should be used, so that the box will rest level, and solidly.

**TABLE 4 — REQUIREMENTS FOR ADDITIONAL CLEATS**

THICKNESS OF END, SIDE, TOP, OR BOTTOM		ADDITIONAL CLEAT REQUIRED IF UNSUPPORTED SPAN EXCEEDS —
Groups I and II Woods	Groups III and IV Woods	
Inches 3/8 and 7/16	Inches 5/16 and 3/8	Inches 23
1/2	7/16	30
5/8	1/2	38
3/4	5/8	45
25/32	11/16	47
13/16	3/4	50
11/16	7/8	64

NAILED WOOD BOXES

19. NAILING OF BOXES.

a. **General Rules.** Placement of nails in styles 2 and 4 boxes is illustrated in figure 11. Nailing for style 4 can easily be adapted to style 5 boxes. Arranging nails alternately in two rows is known as the staggering arrangement. Nails fastening cleats to ends must be staggered in two rows, and must be long enough so that about  $\frac{1}{4}$  inch of the points can be clinched on the inside of the box. In nailing a cleat over 2 inches wide, the rows of nails should be  $\frac{1}{2}$  inch from the cleat's two sides edges, respectively. Each board in a side, top, or bottom *must* have at least two nails in each nailing end. No nail should be placed less than  $\frac{1}{2}$  inch from an edge of the board holding the nailhead. To help prevent driving nails slanted so that they cause splits, or the points are exposed (shiners), the edge of the box being nailed should be placed so as to point toward the workman, as shown in figure 12. (Use of a template (fig. 12) helps to keep the box "squared up" while it is being assembled.) Overdriving, that is, driving the nailhead below the surface of the board, seriously weakens the box. Nails should be driven so that heads are as nearly flush as possible. Nails hold much better if driven into the side grain of the wood than if driven into the end grain (end of a board). When nails in the staggered arrangement are driven into the side grain of a cleat and the end grain of an end, the greater number of nails should be driven into the cleat (side grain), as shown in figure 9.

b. **Size of Nail.** The correct size of nail to use depends on the thickness of the piece of wood holding the point. Table 5 shows the size of cement-coated nails for fastening sides, top, and bottom to ends and cleats of different thicknesses. If the prescribed size of nail is not available, use the next smaller size and reduce the spacing of the nails specified in the next subparagraph by  $\frac{1}{2}$  inch. For fastening cleats to ends, nails must be long enough so that about  $\frac{1}{4}$  inch of the points can be clinched, as previously stated. This rule applies also to nails fastening additional cleats to sides, top, and bottom. Table 6 shows the size of nails for fastening top and bottom to sides, when required.

TABLE 5 — SIZE OF CEMENT-COATED NAILS FOR FASTENING SIDES, TOP, AND BOTTOM TO ENDS AND CLEATS

THICKNESS OF ENDS AND CLEATS	SIZE OF NAILS FOR EACH GROUP OF WOODS			
	Group I	Group II	Group III	Group IV
Inches	Penny	Penny	Penny	Penny
$\frac{5}{8}$	seven	six	five	four
$\frac{3}{4}$ to $\frac{13}{16}$	eight	seven	six	five
$\frac{7}{8}$	nine	eight	seven	seven
1 to $1\frac{1}{16}$ <sup>1</sup>	nine	nine	eight	eight

<sup>1</sup>For thicknesses over  $1\frac{1}{16}$  inches, use nail size given in last column of table 9.

INSTRUCTION GUIDE — ORDNANCE PACKAGING AND SHIPPING (POSTS, CAMPS, AND STATIONS)

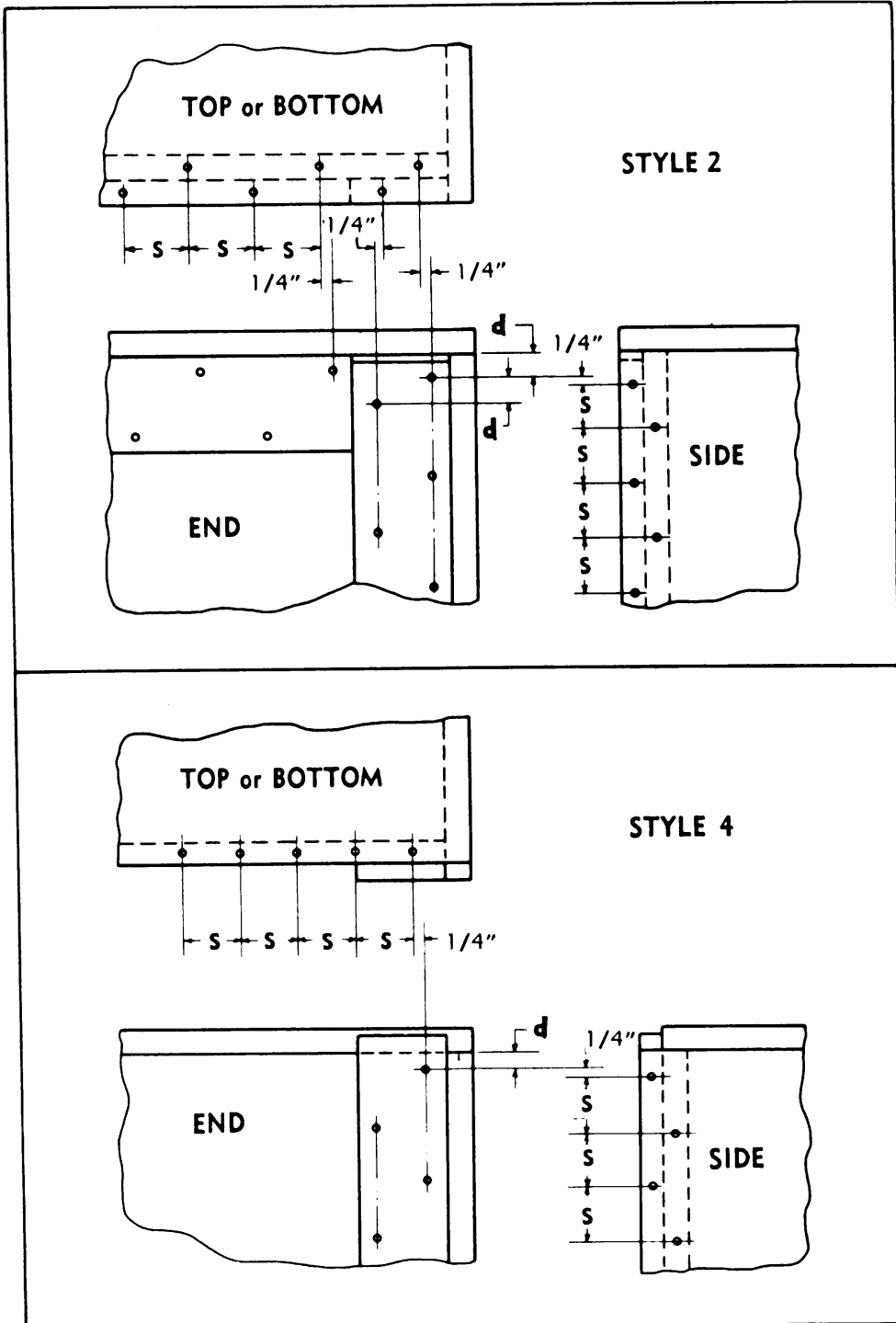

S = spacing given in table 6.

d = 5/8 inch when thickness of end and cleats is 5/8 inch or less.

d = 3/4 inch for all thicker lumber.

RA PD 88992

Figure 11 — Nailing Details for Styles 2 and 4 Boxes



**NAILED WOOD BOXES**



— TEMPLATE ON BENCH KEEPS BOX "SQUARED UP" DURING ASSEMBLY.

RA PD 88993

**Figure 12 — Correct Position of Box for Nailing**

**TABLE 6 — SIZE OF CEMENT-COATED NAILS FOR FASTENING TOP AND BOTTOM TO SIDES**

THICKNESS OF SIDE	SIZE OF NAIL		
	Group I Wood	Group II Wood	Groups III and IV Woods
Inches	Penny	Penny	Penny
Under $\frac{3}{4}$	None	None	None
$\frac{3}{4}$ to $\frac{7}{8}$	seven	six	five
$\frac{1}{2}$ to $1\frac{1}{8}$	eight	seven	—

Note: Space nails 6 to 8 inches apart. No nail to be less than 4 inches from end of box.

**c. Spacing of Nails.**

(1) The spacing of nails fastening top and bottom to sides is usually 6 to 8 inches, and none of these nails should be less than 4 inches from the end of the box.

(2) Table 7 shows the average spacing of nails for nailing to ends and cleats, and nailing cleats to ends. These spacings may be increased or decreased as much as 50 percent, to make adjustments for widths of boards or other factors. At least two nails should be driven through each cleat into each board to which it is fastened. Table 7

**INSTRUCTION GUIDE — ORDNANCE PACKAGING AND SHIPPING (POSTS, CAMPS, AND STATIONS)**

should be used together with the nailing diagram (fig. 11). To determine the number of nails to drive, divide the width of the part by the spacing given in table 7, and count any resulting fraction of  $\frac{1}{2}$  or over as 1. Example: 10-inch width divided by 1.75 equals 5.7; use six nails spaced not more than  $1\frac{3}{4}$  inches apart. Reminder: At least two nails must be driven through each board at each nailing point.

**TABLE 7 — AVERAGE SPACING OF NAILS FOR NAILING TO ENDS AND CLEATS**

SIZE OF NAIL	SPACING WHEN DRIVEN INTO CLEATS AND SIDE GRAIN OF END	SPACING WHEN DRIVEN INTO CLEATS AND END GRAIN OF END (USE ALSO IN NAILING CLEATS TO ENDS)
	Inches	Inches
Fourpenny	$1\frac{1}{2}$	$1\frac{1}{4}$
Fivepenny	$1\frac{3}{4}$	$1\frac{1}{2}$
Sixpenny	2	$1\frac{3}{4}$
Sevenpenny	$2\frac{1}{4}$	2
Eightpenny	$2\frac{1}{2}$	$2\frac{1}{4}$
Ninepenny	$2\frac{3}{4}$	$2\frac{1}{2}$
Tenpenny	3	$2\frac{3}{4}$
Twelvepenny	$3\frac{1}{2}$	3
Sixteenpenny	4	$3\frac{1}{2}$
Twentypenny	$4\frac{1}{2}$	4

Note: If the desired size of nail is not available, use one size smaller and reduce the spacing  $\frac{1}{2}$  inch.

**20. INTERIOR BRACING AND BLOCKING.**

**a. Application.**

(1) Articles that do not completely fill the shipping container should be braced, blocked, or fastened, or otherwise protected to prevent moving or shifting inside the container, and if necessary according to the nature of the article, to prevent abrasion by rubbing of one article against another (par. 10). Bracing should also be provided where projections of heavy contents bear against the box, to distribute the load across the face of the box. A rule of good packing is to make a reasonably tight pack to prevent shaking and shifting of the items during transportation, unless the item, such as a very delicate instrument, is purposely "floated" in the package by means of thick layers of cushioning material on all sides, or by similar means. Good bracing makes the article practically a part of the box itself. It is accomplished by use of wood or metal members fastened to the shipping box. Bracing may be effected in many different ways, crosswise, lengthwise, both directions, and by cutting out portions of braces or supports to fit around a part of a machine or other assembly. Bracing should always be applied to a part or parts of an article that

**NAILED WOOD BOXES**



BLOCKING IN POSITION

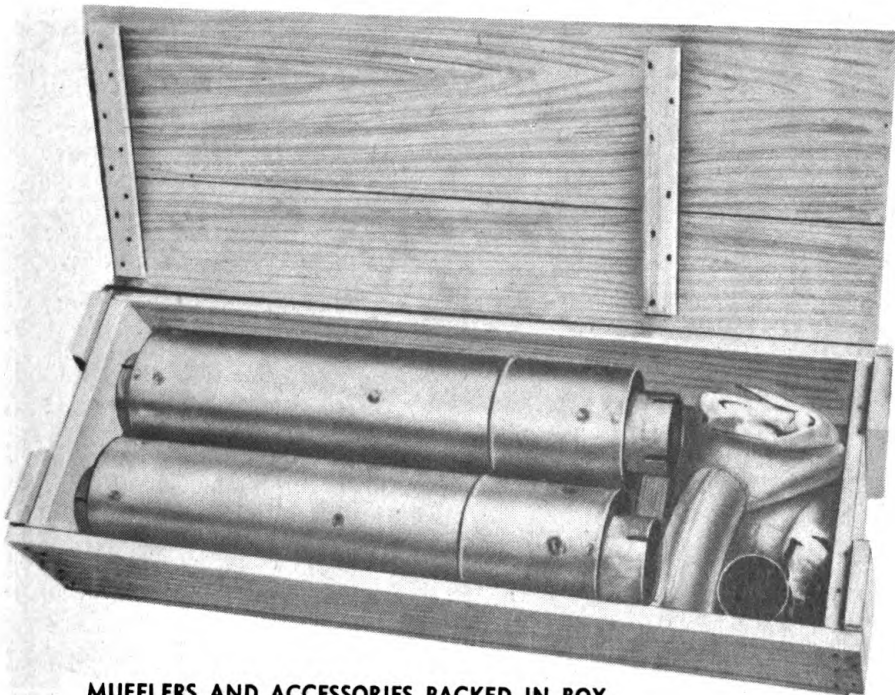

MUFFLERS AND ACCESSORIES PACKED IN BOX

RA PD 88994

**Figure 13 – Packing Box for Two Mufflers and Accessories**

**INSTRUCTION GUIDE — ORDNANCE PACKAGING AND SHIPPING (POSTS, CAMPS, AND STATIONS)**

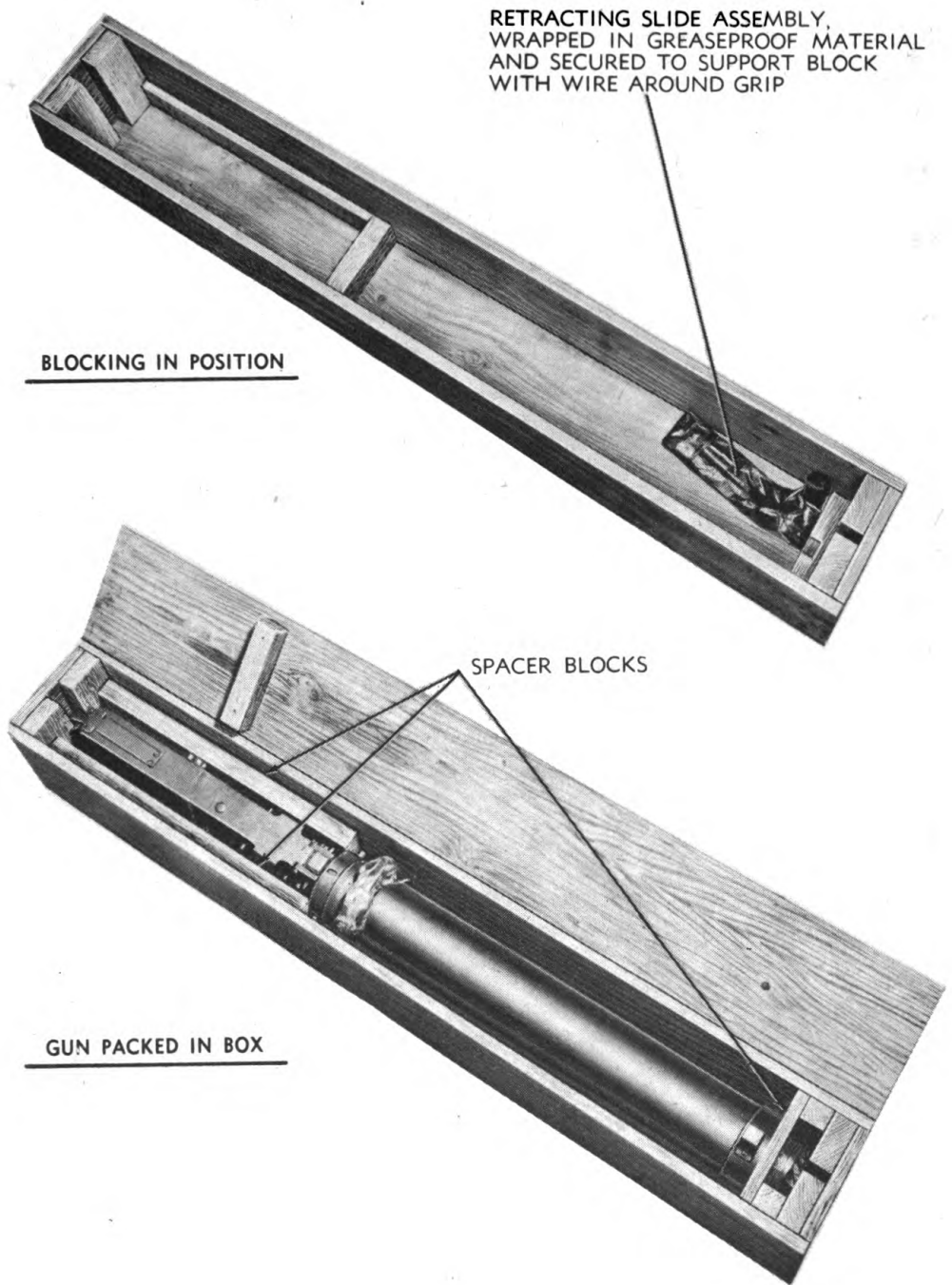

RA PD 88995

**Figure 14 — Packing Box for Cal. .50 Machine Gun M2,  
Water-cooled, Flexible**

## NAILED WOOD BOXES

cannot be damaged by hard impacts received in shipment. Braces, for example, may bear against machine bases, heavy housings, or heavy mounting lugs or brackets. If a machine or other item has holes for mounting bolts in its base, use them in bolting to thick, strong wood members which are part of the base of the container or are securely fastened to it.

(2) It is not ordinarily practical to support an item at more than two points along its length, and, in the case of a wide item, at more than two points across its width. Any possible advantage of three- or four-point suspension is lost when the container is bent or distorted in handling, or because of warping and shrinking of wood pieces.

(3) Examples of bracing and blocking are shown in figures 13 to 28. In most of the illustrations, the waterproof lining has been omitted to make the illustration clearer. Some of these bracing and blocking systems may be more complex than the types used at posts and camps, but they should be carefully studied to obtain a knowledge of the general techniques and methods.

(4) If proper bracing or blocking of articles, such as rifles weighing not more than about 10 pounds, is too difficult to accomplish, an alternative procedure is to wrap metal parts of the article (after cleaning and preservation) carefully in greaseproof wrapping, grade C, using two thicknesses throughout. Cushion projections with kraft-backed cellulose wadding, wrap spirally with a strip (3 inches wide) of type B-2 creped waterproof paper, and pack tightly in the shipping box (4 to 12 in a box). This procedure is illustrated in figures 29 and 30.

### b. General Rules.

(1) A brace or support fastened to the face of a container by nailing into its end grain will *not* carry any appreciable load. Nail the end of the brace to the edge of a cleat, and nail the cleat to the inside face of the container. For a medium or heavy load, the cleat should bear directly against the end of the container, or should be braced with horizontal cleats extending to the end of the container, as shown in figure 22. Another method is to form a socket for the end of the brace by nailing three or four cleats to the inside of the container (fig. 31). Nail into a wide face of any piece of lumber, or into its edge, *not* into its end grain.

(2) Pieces that have notches cut out of them, or are for other reasons likely to split when vertical or horizontal loads are applied to them, can be reinforced by fastening small cleats ( $\frac{3}{4}$  inch or more in thickness) to the weak piece, positioned across its grain and as near to the point of weakness as possible. Use several nails, staggered, with the points clinched in the thicker of the two pieces, but avoid using nails that are larger than necessary to provide for clinching. (Excessively large nails will cause splitting of the wood.)

INSTRUCTION GUIDE — ORDNANCE PACKAGING AND SHIPPING (POSTS, CAMPS, AND STATIONS)

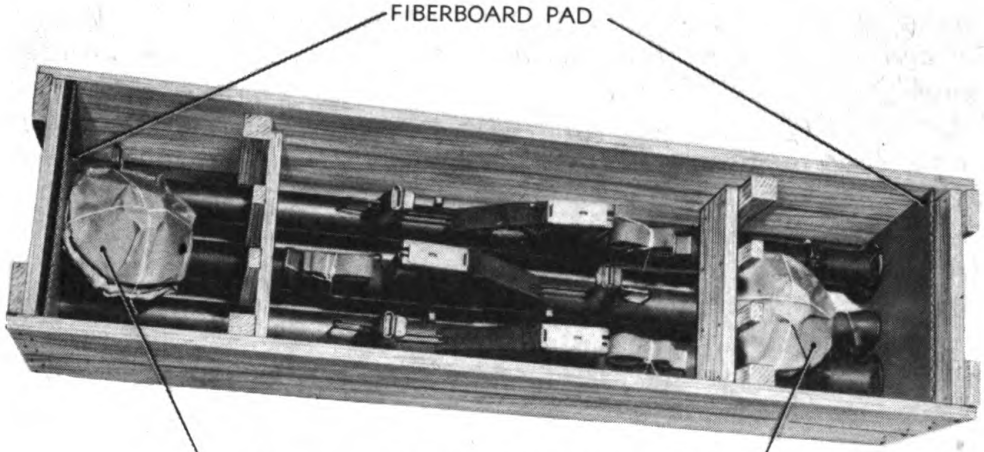

BATTERIES AND FLASH DEFLECTOR SCREENS  
ARE WRAPPED SEPARATELY AND PLACED  
ON BOTTOM LAYER OF LAUNCHERS

BOTTOM LAYER OF LAUNCHER IN POSITION

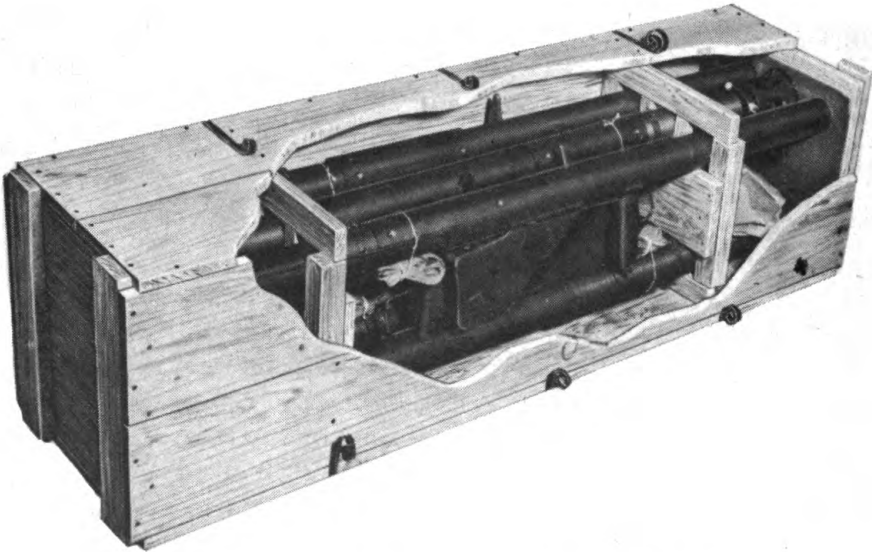

TOP AND SIDE CUT-AWAY TO SHOW  
COMPLETELY PACKED BOX

RA PD 88996

**Figure 15 — Packing Box for 2.36-in. A.T. Rocket Launcher M1A1**

**NAILED WOOD BOXES**

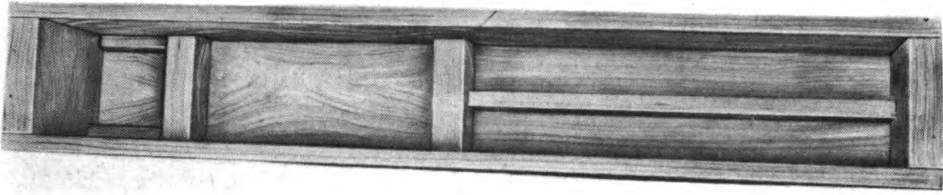

BLOCKING IN POSITION

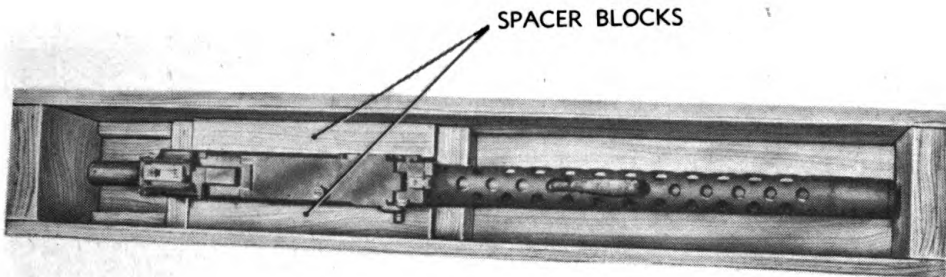

MACHINE GUN PACKED IN BOX

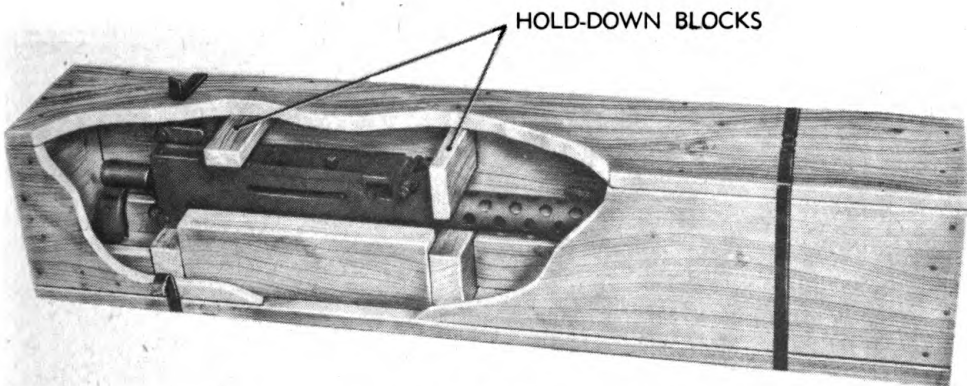

TOP AND SIDE PARTIALLY CUT-AWAY TO SHOW HOLD-DOWN BLOCKS

RA PD 88997

**Figure 16 – Packing Box for Cal. .30 Machine Gun M1919A4, Flexible**

(3) Side, end, top, or bottom boards should *not* be grooved on the inside to hold the ends of braces, supports, or hold-downs in position; the grooves weaken the container too much. Instead, nail two cleats vertically, parallel to each other, to form the necessary groove (figure 26). This bracing can be strengthened further by using additional pieces placed horizontally, with their ends against the parallel cleats.

INSTRUCTION GUIDE — ORDNANCE PACKAGING AND SHIPPING (POSTS, CAMPS, AND STATIONS)

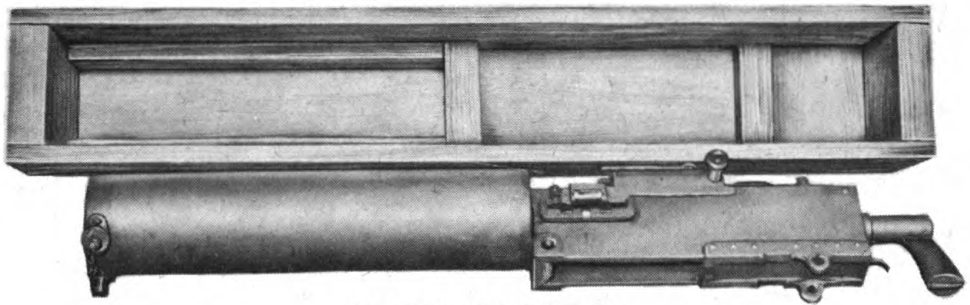

BLOCKING IN POSITION

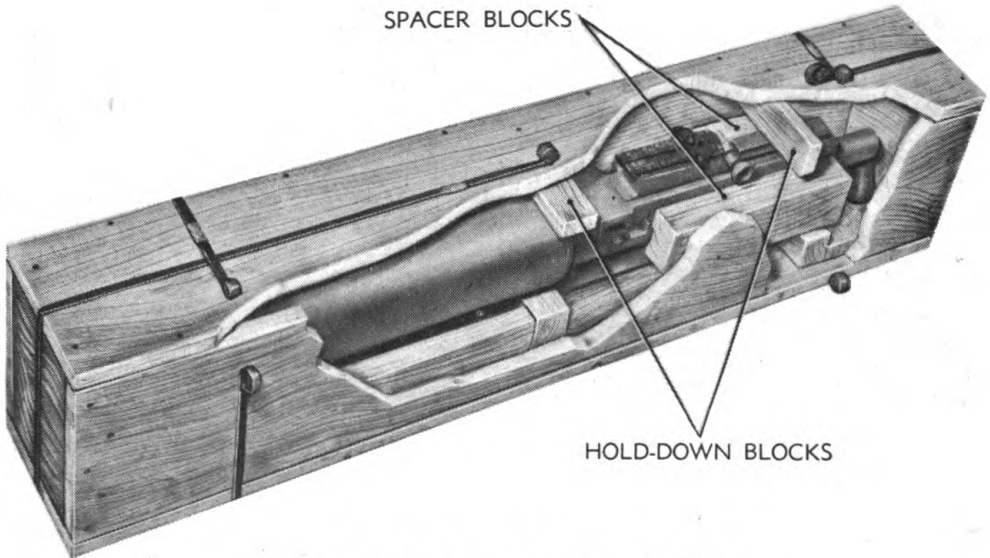

TOP AND SIDE PARTIALLY CUT-AWAY TO SHOW  
POSITION OF SPACER AND HOLD-DOWN BLOCKS

RA PD 88998

**Figure 17 — Packing Box for Cal. .30 Machine Gun M1917A1**

(4) Whenever practicable, arrange braces and blocks so that the more concentrated thrusts or loads will come against the end grain of the pieces. Wood is 15 to 20 times stronger in the direction of its grain than across its grain. Wood, also, shrinks and swells much less along the grain than across the grain.

(5) In nailing two pieces of different thicknesses together, drive the nail first through the thinner piece, so that the point is held by the thicker piece.



**NAILED WOOD BOXES**

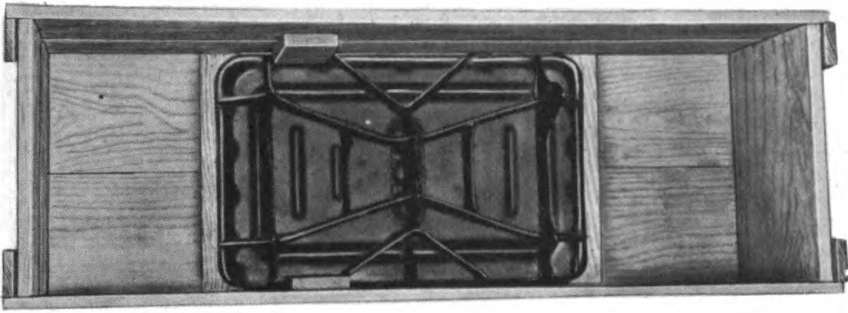

STEP I

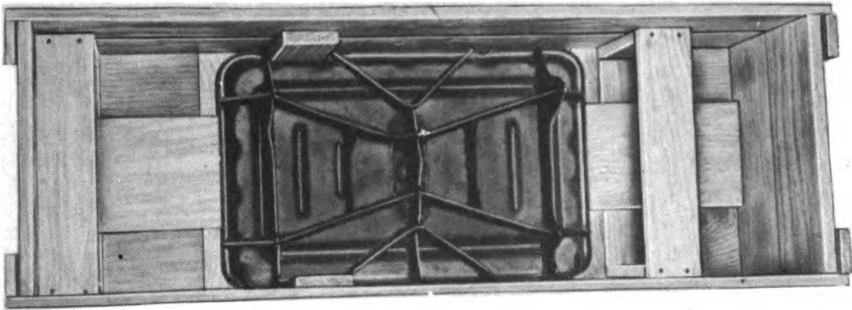

STEP II

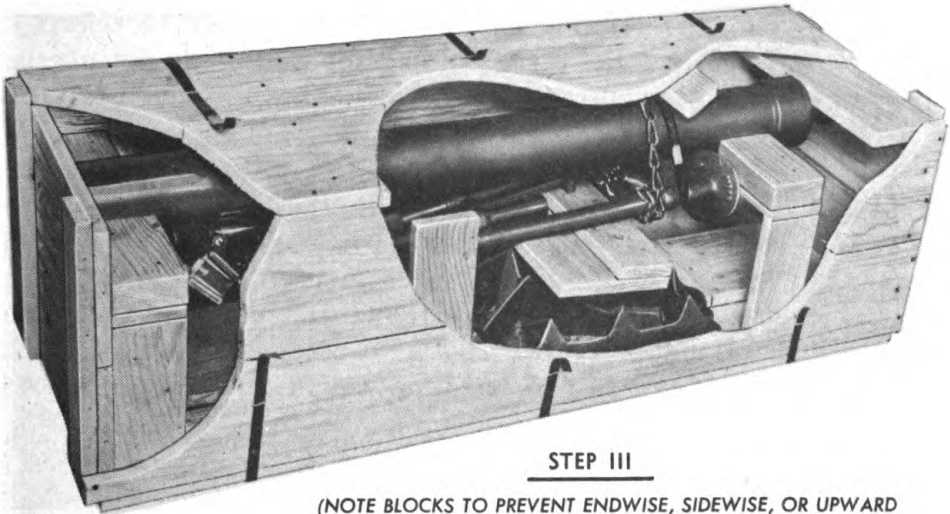

STEP III

(NOTE BLOCKS TO PREVENT ENDWISE, SIDEWISE, OR UPWARD MOVEMENT OF TUBE.)

RA PD 88999

**Figure 18 — Packing Box for 81-mm Mortar and Mount M1**

INSTRUCTION GUIDE — ORDNANCE PACKAGING AND SHIPPING (POSTS, CAMPS, AND STATIONS)

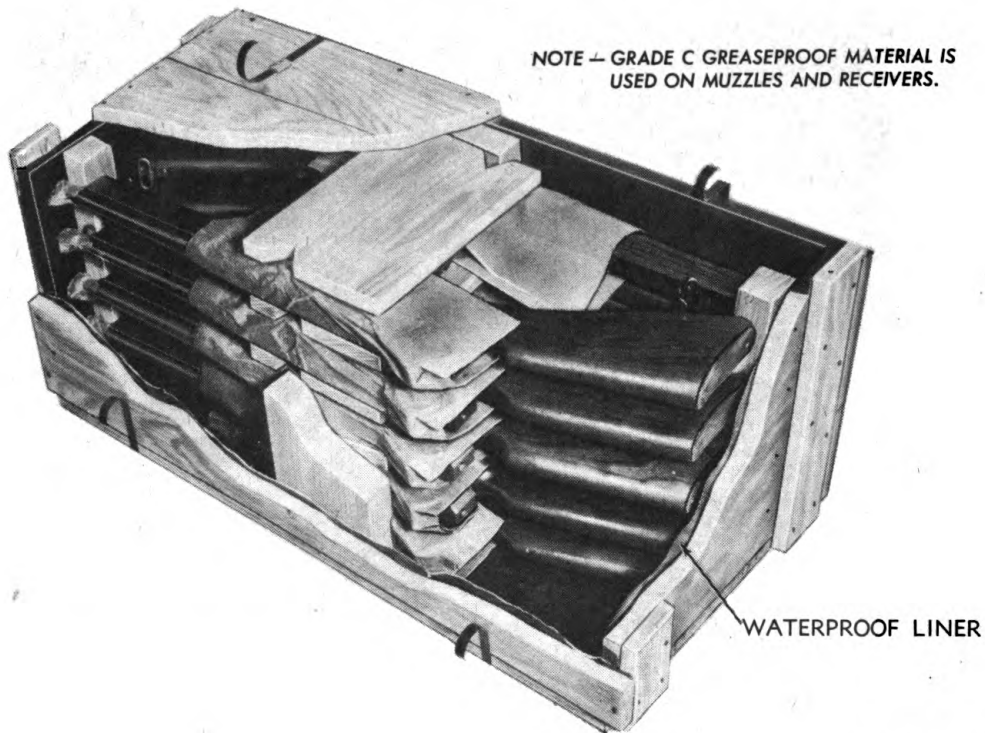

RA PD 89000

**Figure 19 — Packing Box for 10 Thompson Submachine Guns M1A1**

(6) For selecting nail sizes to be used in bracing and blocking other than clinched fastenings, the rule of thumb is to use a nail three times as long as the thickness of the piece (up to  $\frac{7}{8}$  inch) holding the head. Nails for greater thicknesses of lumber should be selected for good penetration into the piece holding the point, but not overlarge. Sizes of nails for various thicknesses of lumber are given in table 9.

(7) Carriage bolts (with rounded heads and square shanks near the heads) may be used for securing an item to the base of a container, or securing support blocks to a container base. Nuts should be inside the container. Large washers should be used under nuts at points of contact with wood, so that nuts will not cut into or pull through the wood. After nuts are tightened, paint the bolt threads with asphalt or unthinned lead paint to prevent nuts from working loose. Bolting an assembly or medium weight to the bottom of a box is illustrated in figure 32.

## 21. WATERPROOF LININGS.

a. **Application.** Boxes and other closed containers for overseas shipment of items likely to damage from water or moisture shall be lined with waterproof paper (type L-2 or equivalent) or with a waterproof bag liner made of the same paper, unless the contents

## NAILED WOOD BOXES

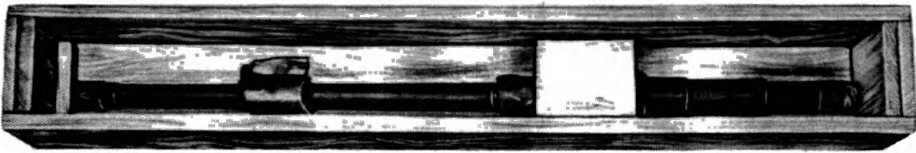

### STEP I

ENDS AND MIDDLE OF BARREL ARE WRAPPED WITH GRASEPROOF MATERIAL THE BLOCK OVER THE BARREL IS NAILED TO TWO SUPPORT BLOCKS RESTING ON THE BOTTOM OF THE BOX.

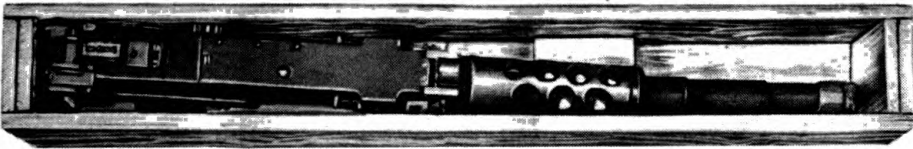

### STEP II

RECEIVER, WITH BARREL GUARD ATTACHED, RESTING ON CUSHION ON BARREL, AND ON BLOCKING.

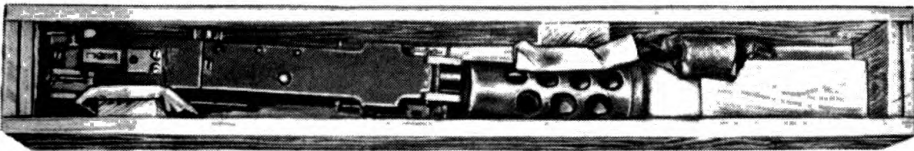

### STEP III

RECEIVER AND BARREL BRACED WITH THREE ADDITIONAL BLOCKS. GREASEPROOF MATERIAL SEPARATES METAL FROM WOOD. BARREL CARRIER PACKED NEAR RIGHT END OF BOX.

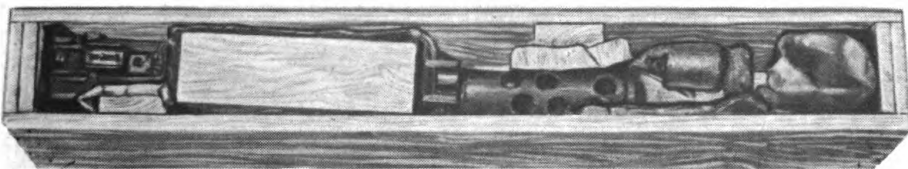

### STEP IV

BACK PLATE AND RETRACTING SLIDE ASSEMBLY, WRAPPED IN GREASEPROOF MATERIAL, PACKED AT RIGHT END OF BOX AND BLOCK PLACED OVER RECEIVER BEFORE NAILING ON THE TOP

RA PD 89001

**Figure 20 — Packing Box for Cal. .50 Machine Gun M2,  
Heavy Barrel, Flexible**

INSTRUCTION GUIDE — ORDNANCE PACKAGING AND SHIPPING (POSTS, CAMPS, AND STATIONS)

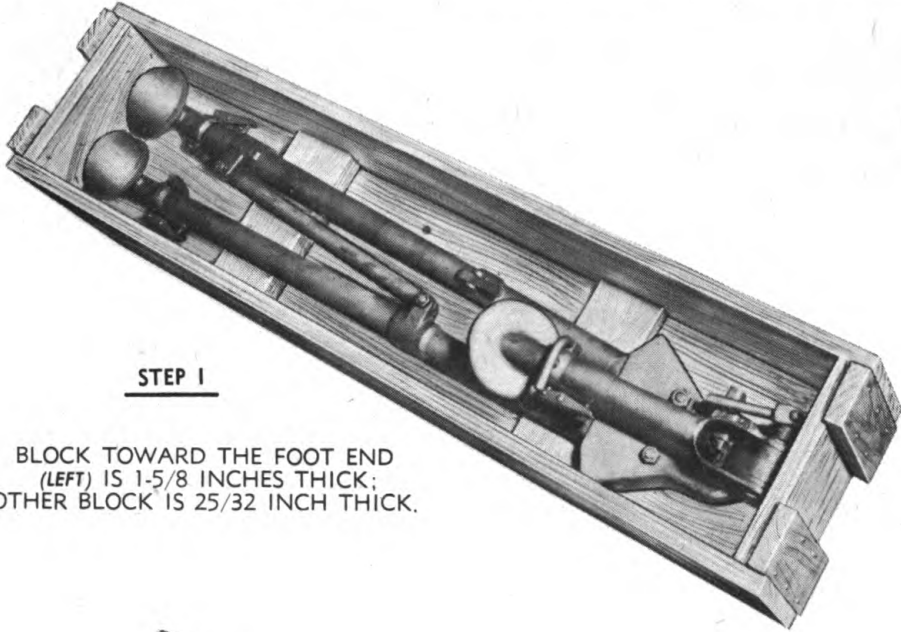

STEP I

BLOCK TOWARD THE FOOT END  
(LEFT) IS 1-5/8 INCHES THICK;  
OTHER BLOCK IS 25/32 INCH THICK.

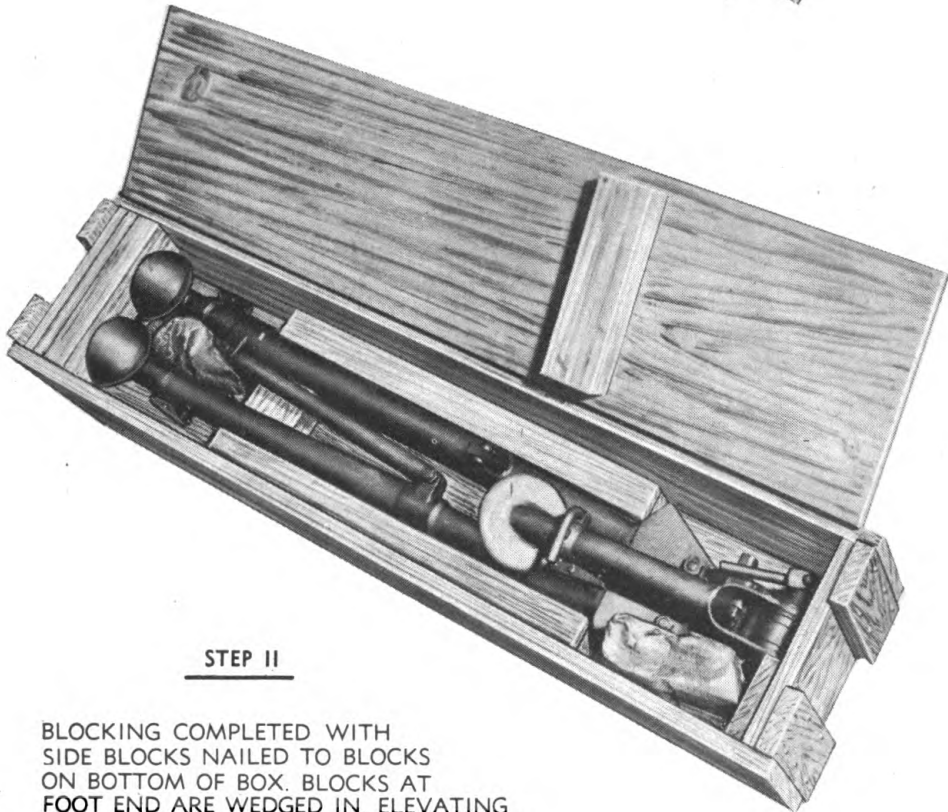

STEP II

BLOCKING COMPLETED WITH  
SIDE BLOCKS NAILED TO BLOCKS  
ON BOTTOM OF BOX. BLOCKS AT  
FOOT END ARE WEDGED IN. ELEVATING  
MECHANISM AND PINTLE ARE WRAPPED  
IN GREASEPROOF PAPER, THEN CORRUGATED  
PAPER, AND PACKED IN AVAILABLE SPACES.

RA PD 89002

**Figure 21 — Packing Box for Cal. .50 Machine Gun Tripod Mount M3**

NAILED WOOD BOXES

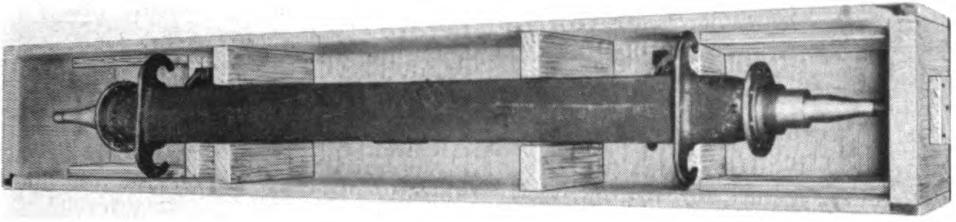

NOTE BRACING TO PREVENT ENDS OF AXLE  
FROM PUNCTURING ENDS OF BOX.

RA PD 89003

**Figure 22 — Packing Box for Axle (Welded) for 105-mm,  
Howitzer Carriage M2**

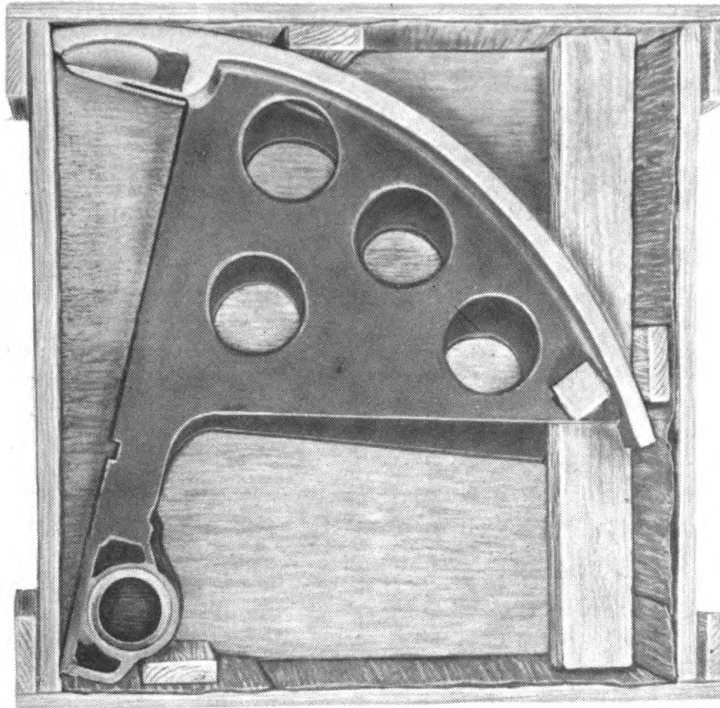

RA PD 89004

**Figure 23 — Packing Box for Left Elevating Arc and Right Elevating Arc  
for 105-mm Howitzer Carriage M2**

themselves are completely treated with rust-preventive compound (thin-film) or completely inclosed in waterproof wrappings so as to give thorough protection from rainfall and spray. (If it is necessary to brace or block such treated or wrapped articles within the con-

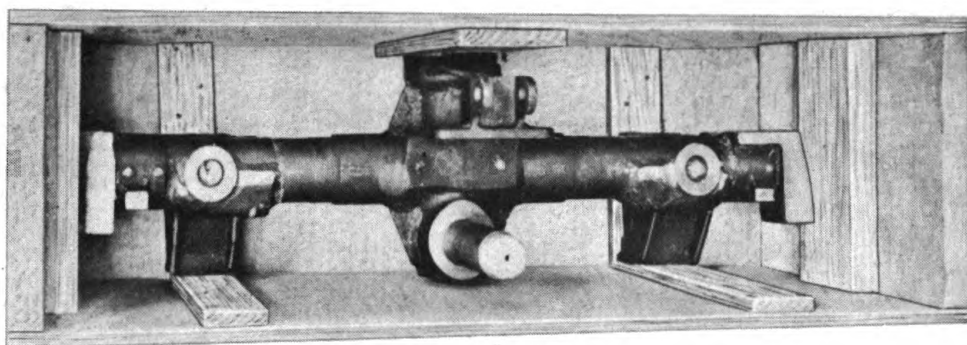

RA PD 89005

**Figure 24 — Packing Box for Equalizing Support for  
105-mm Howitzer Carriage M2**

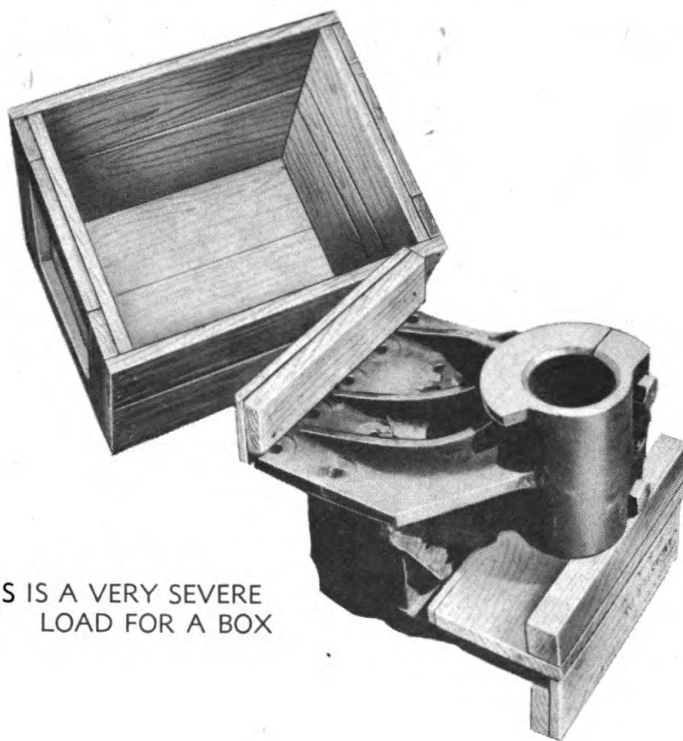

THIS IS A VERY SEVERE  
LOAD FOR A BOX

RA PD 89006

**Figure 25 — Packing Box for Track Idler Wheel Bracket for  
Medium Tank M4A4**

tainer, cushioning must be provided at the points of contact with braces or blocks to prevent puncture or abrasion of the rust-preventive film or waterproof wrapping.) Lining of the panels with flat sheets of paper is generally less effective than using bags. Bags are

**NAILED WOOD BOXES**

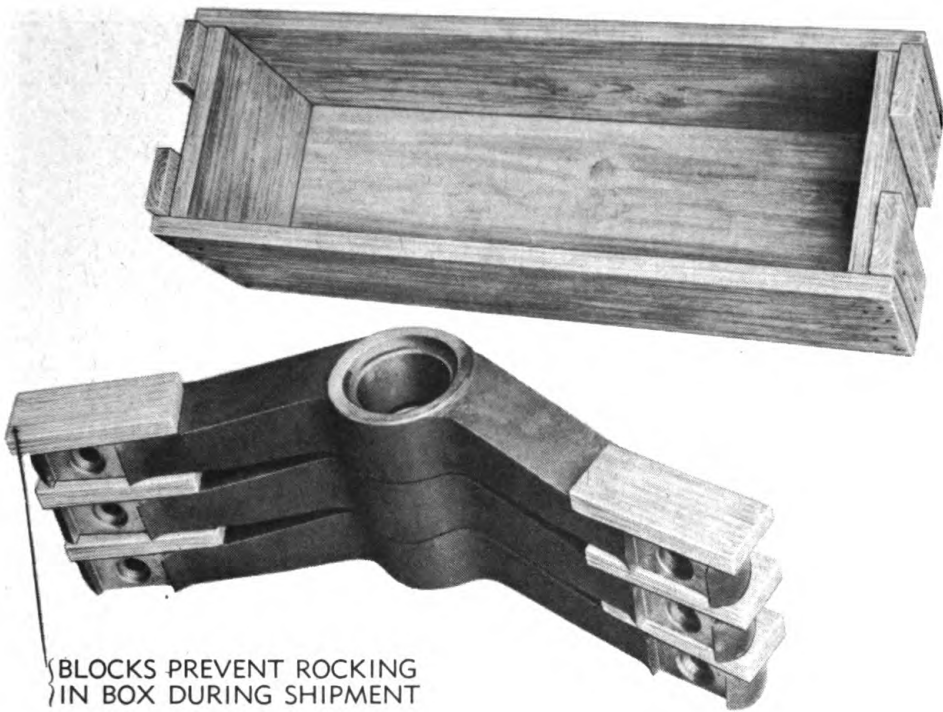

RA PD 89007

**Figure 26 — Packing Box for Three Bogie Arms**

not practical, however, for containers that have interior cleats or blocking nailed to the sides, ends, or bottom, or for extremely large containers.

**b. Panel Linings.** Linings should preferably be left free and slightly loose within the box (fig. 19), to avoid the tearing strains caused by distortion of the box in handling. Where necessary, they may be attached to the panels with rubber base waterproof cement at as few points as possible. Following is a suggested procedure for preparing and applying panel linings. Dimensions of all linings should be slightly "over" rather than "under."

(1) Cut two linings for ends, about 3 to 5 inches larger in both length and width than the end panels, to allow the paper to overlap all four edges of the panels where sides, top, and bottom will be nailed to the end panels.

(2) Cut two linings for sides the same length as the side panels, but with enough extra width to allow for overlapping the top and bottom edges of the side panels.

(3) Cut linings for the top and bottom. Dimensions: length = length of top and bottom boards; width = outside width of box.

**INSTRUCTION GUIDE — ORDNANCE PACKAGING AND SHIPPING (POSTS, CAMPS, AND STATIONS)**

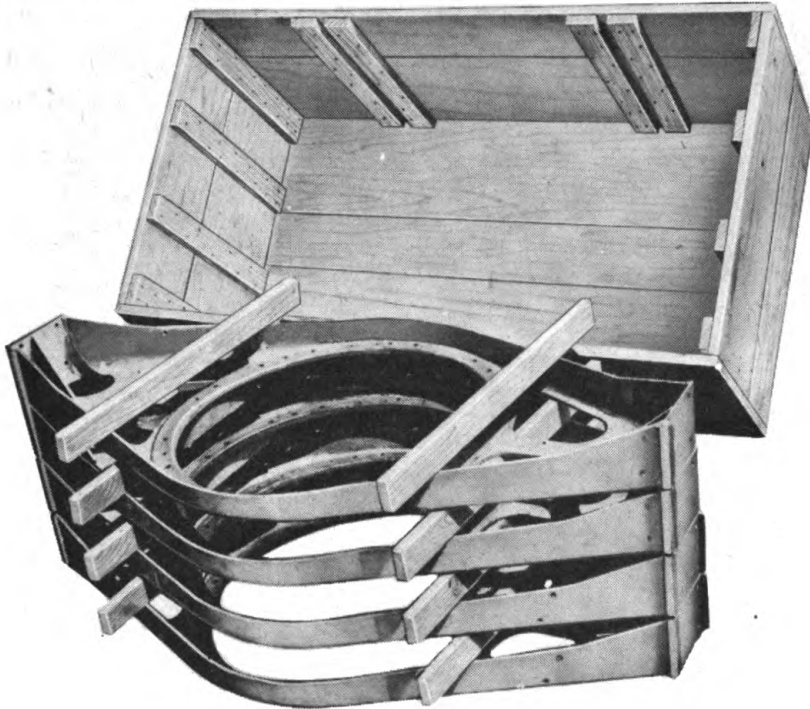

**STEP I**

CLEATS AND SPACER BLOCKS IN POSITION.

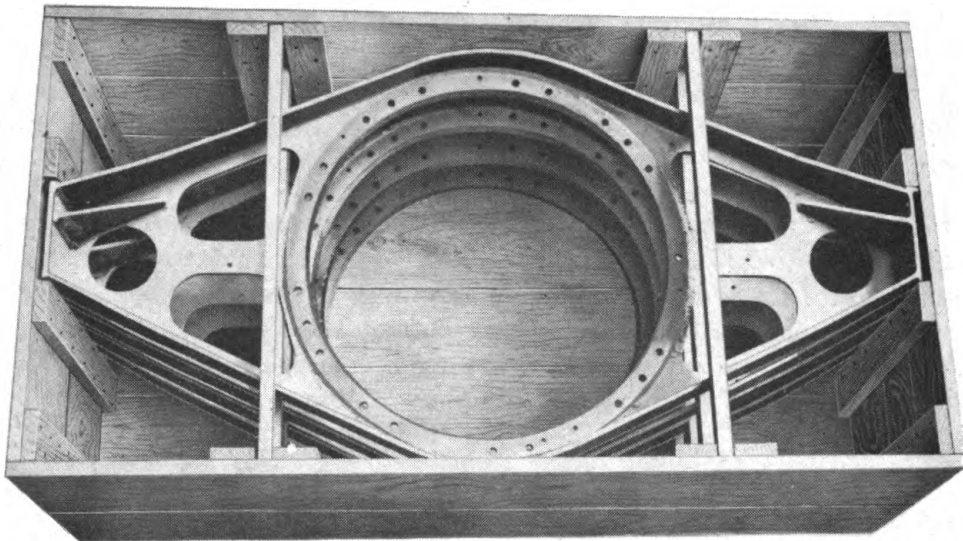

**STEP II**

MOUNTS IN POSITION IN BOX. CLEATS AND SPACER BLOCKS HOLD MOUNTS SECURELY IN PLACE AND DISTRIBUTE LOAD OVER TOP AND BOTTOM.

RA PD 89008

**Figure 27 — Packing Box (Style 5) for Four Radial Engine Tank Mounts**



NAILED WOOD BOXES

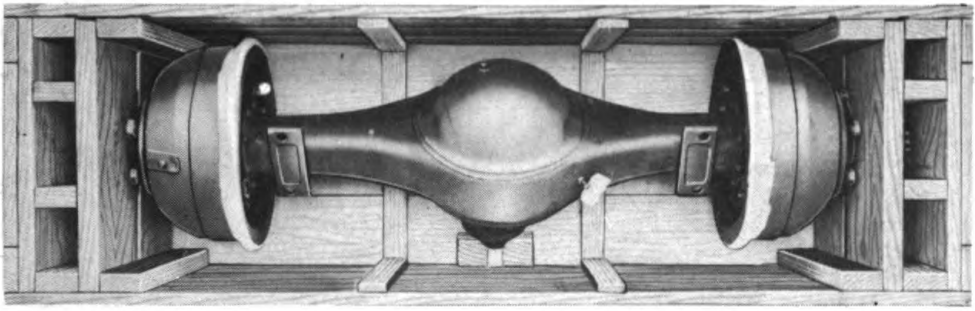

HUBS EXTEND THROUGH HOLES IN TRANSVERSE BLOCKS.  
NOTE SEALING OF BRAKE DRUMS WITH WATER PROOF TAPE.

RA PD 89009

**Figure 28 — Packing Box for Rear Axle for Half Track**

(4) Make up each side of the box as a panel, using cleats across the boards. Lining must be placed against inside face of panel, usually under the cleats that are needed for blocking or reinforcing. (Ends are always made up as panels before assembly of the box.)

(5) Secure overlaps of linings to top and bottom edges of the side panels with a few daubs of rubber base waterproof cement.

(6) Apply linings to end panels, securing the overlaps to edges with daubs of adhesive. Do not stretch paper tightly.

(7) Coat the paper overlying a side edge of each end panel with rubber base waterproof cement, and nail the lined side panel to these edges. This forms a sealed joint between the linings of adjacent panels. Follow same procedure for other side of box.

(8) Coat the paper overlying the bottom edges of the end and side panels with rubber base waterproof cement, using extra care at the box corners. Apply the bottom lining paper, pressing it to the cement at all edges, and nail on the bottom. Trim off any projecting edges of paper.

(9) After the box is packed, follow the same procedure as given in step (8), above, for lining, sealing, and closing the top.

**c. Bag Linings.** Bag linings made to fit inside a box should be large enough so that the pressure of the contents is carried by the box, not the bag. Directions and illustrations for a method of making bag linings of waterproof paper are given in figures 33 and 33A. The height of the finished bag should be sufficient to permit a 3-inch overlap at the top joint. For best results, any void spaces in the box should be filled with dry packing material so that the load is level with the top edges of the box, and the cover will maintain a slight pressure on the top seam and folds of the bag. The closed bag

**INSTRUCTION GUIDE — ORDNANCE PACKAGING AND SHIPPING (POSTS, CAMPS, AND STATIONS)**

REAR SIGHT, TOP OF RECEIVER,  
AND OPERATING SLIDE HANDLE  
CUSHIONED WITH CREPED  
CELLULOSE WADDING

METAL PARTS WRAPPED  
IN GRADE C GREASEPROOF  
MATERIAL



**STEP I**  
**METHOD OF WRAPPING CARBINE FOR SIMPLIFIED PACK**

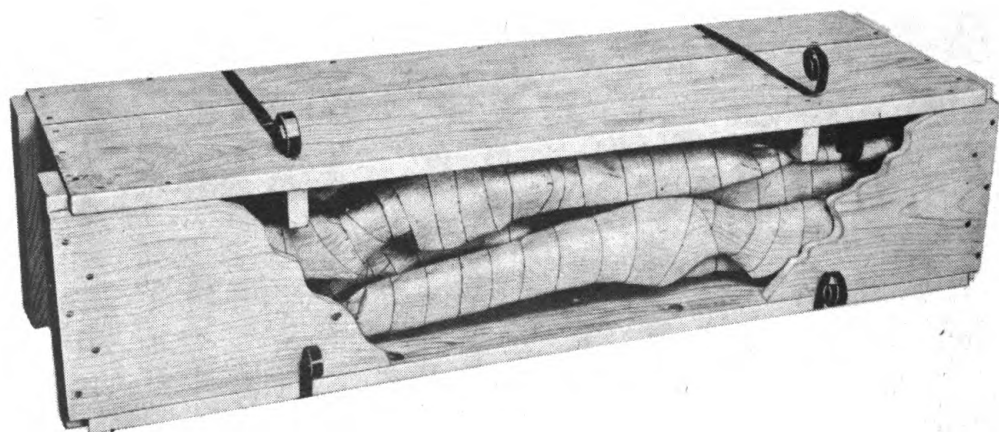

ALTERNATE CARBINES ARE REVERSED IN DIRECTION.  
NOTE TWO HOLD-DOWN BLOCKS ATTACHED TO BOX TOP.  
PACK MUST BE TIGHT.

**STEP II**  
**TEN WRAPPED CARBINES PACKED IN BOX** RA PD 89010

**Figure 29 — Method of Wrapping and Packing 10 Cal. .30 Carbines M1 for Simplified Pack**

### NAILED WOOD BOXES

REAR SIGHT AND TOP RECEIVER CUSHIONED WITH CREPED CELLULOSE WADDING.

BOLT AND ALL OTHER METAL PARTS WRAPPED IN GRADE C GREASEPROOF MATERIAL; BOLT THEN TAPED TO STOCK

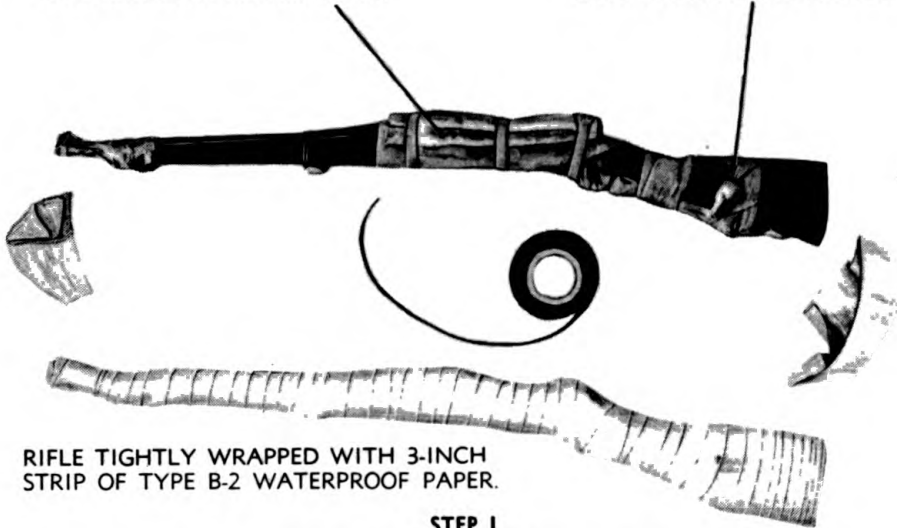

RIFLE TIGHTLY WRAPPED WITH 3-INCH STRIP OF TYPE B-2 WATERPROOF PAPER.

#### STEP I

#### METHOD OF WRAPPING RIFLE FOR SIMPLIFIED PACK

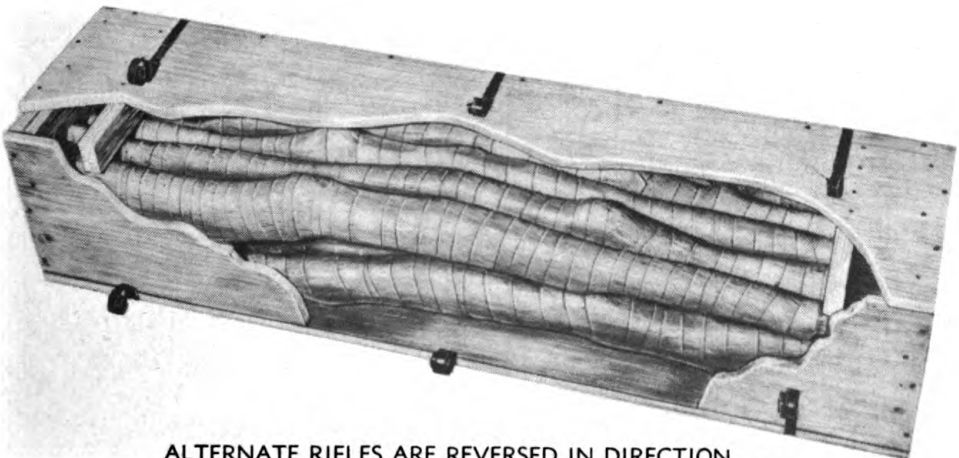

ALTERNATE RIFLES ARE REVERSED IN DIRECTION. NOTE TWO HOLD-DOWN BLOCKS ATTACHED TO TOP OF BOX. PACK MUST BE TIGHT.

#### STEP II

#### TEN WRAPPED RIFLES PACKED IN BOX

RA PD 89011

**Figure 30 — Method of Wrapping and Packing 10 Cal. .30 Rifles M1903A3 for Simplified Pack**

RA PD 89012

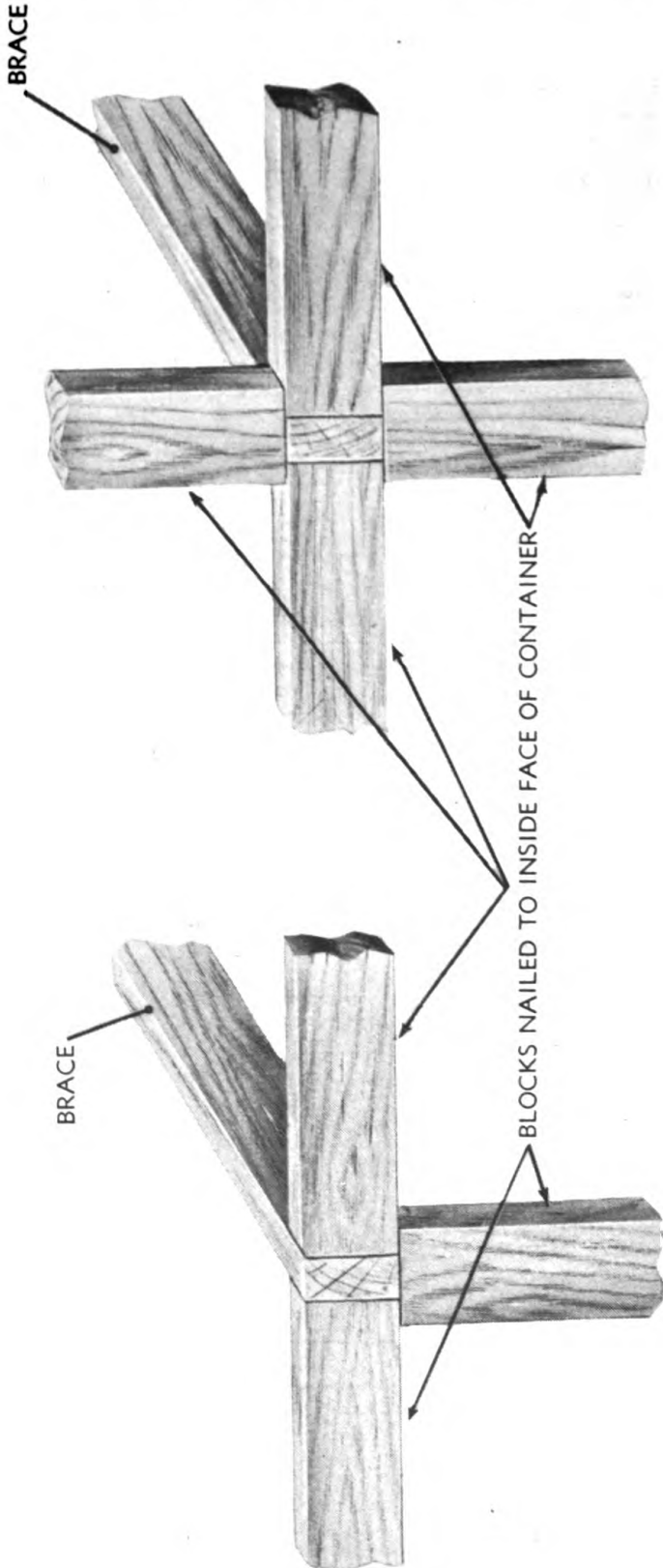
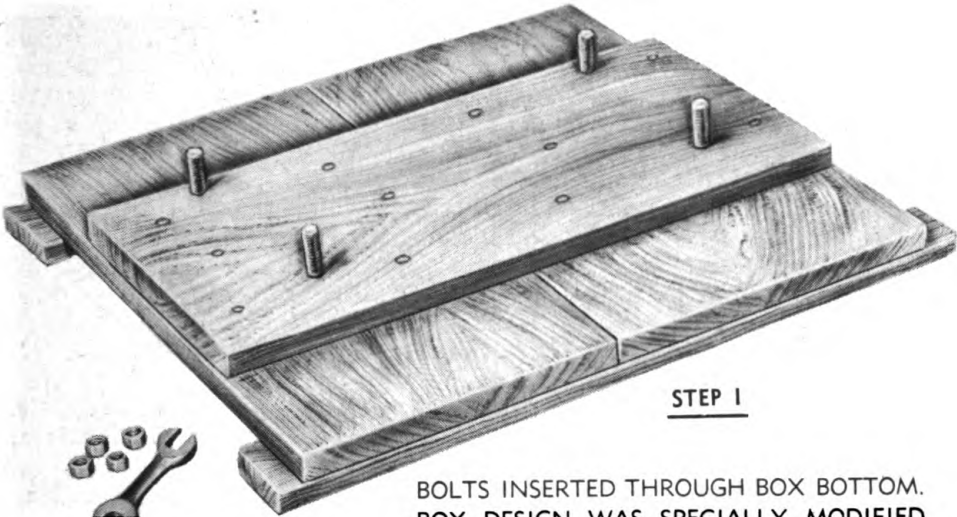

Figure 31 — Socket Forms of Fastening for Interior Braces

**NAILED WOOD BOXES**



STEP I

BOLTS INSERTED THROUGH BOX BOTTOM.  
BOX DESIGN WAS SPECIALLY MODIFIED  
TO PROVIDE CLEATS ON BOTTOM

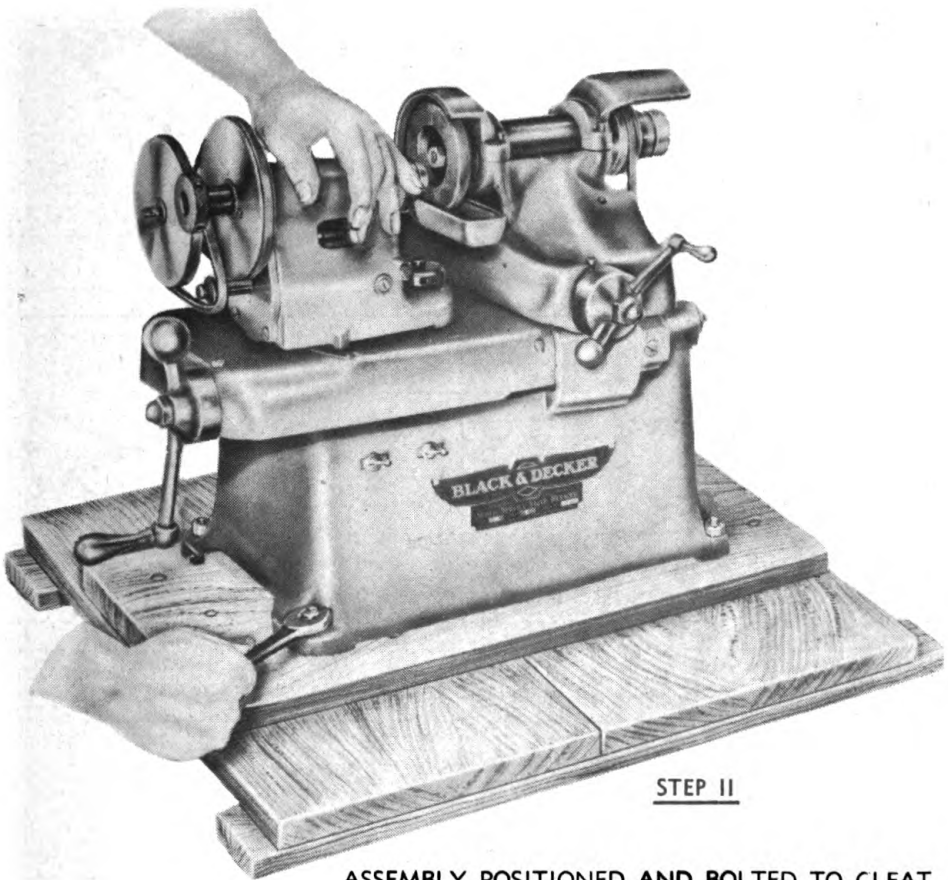

STEP II

ASSEMBLY POSITIONED AND BOLTED TO CLEAT

**Figure 32 — Bolting an Assembly of Medium Weight to the  
Bottom of a Box**

RA PD 89013

**INSTRUCTION GUIDE — ORDNANCE PACKAGING AND SHIPPING (POSTS, CAMPS, AND STATIONS)**

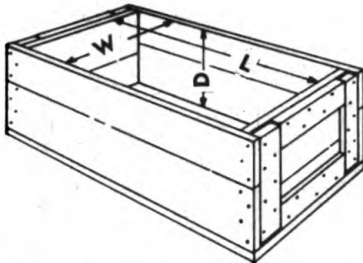

MEASURE THE INSIDE DIMENSIONS OF THE BOX IN INCHES.

①

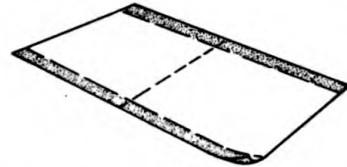

UNFOLD THE SHEET AND APPLY WATERPROOF ADHESIVE TO BOTH 2-INCH MARGINS.

④

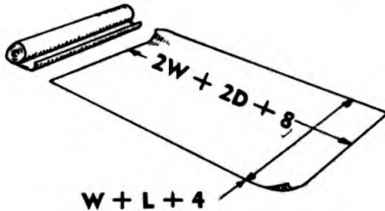

CUT A SHEET OF WATERPROOF PAPER TO THE FOLLOWING SIZE:  
 LENGTH =  $2W + 2D + 8$   
 WIDTH =  $W + L + 4$

②

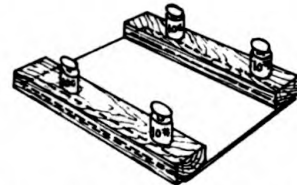

REFOLD THE SHEET AT ALL CREASES AND APPLY A PRESSURE OF 10 TO 20 POUNDS PER LINEAR FOOT TO THE MARGINS WHILE THE ADHESIVE SETS.

⑤

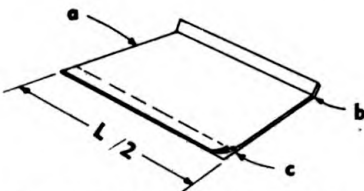

FOLD AND CREASE THE SHEET AT **a**, THE MIDDLE OF THE LENGTH. CREASE THE SHEET 2 INCHES FROM EACH SIDE EDGE AT **b** AND **c**.

③

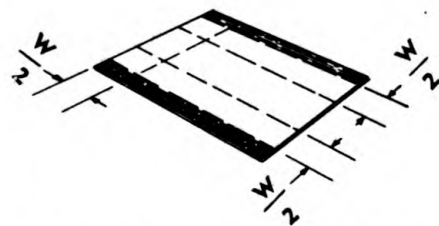

CREASE THE SHEET AT DISTANCE  $1/2$  WIDTH OF BOX, FROM EACH OF THE 3 CREASES MADE IN STEP 3.

⑥

RA PD 89014

**Figure 33 — Method of Making Waterproof Liner for a Box**

NAILED WOOD BOXES

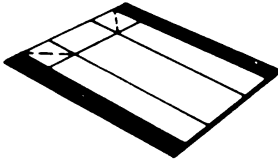

CREASE AT DOTTED LINES.

7

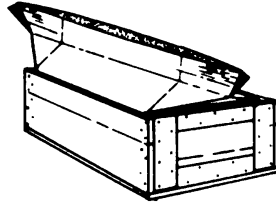

MAKE LOCK FOLD IN BAG AS IN STEP 11b. REOPEN TOP, AND APPLY ADHESIVE TO INSIDE OF EDGES. WHILE HOLDING BAG AGAINST LOAD TO EXCLUDE AIR, PRESS EDGES TOGETHER TO MAKE A WATERPROOF SEAM.

10

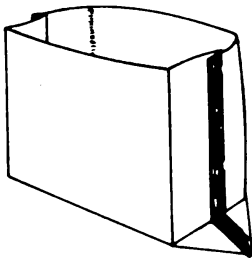

OPEN THE BAG.

8

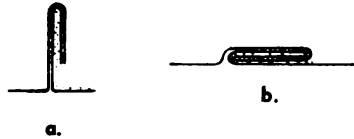

COAT ONE SIDE OF BAG TOP WITH ADHESIVE AND MAKE A FOLD AS SHOWN IN a. PRESS THE FOLD FLAT AGAINST CONTENTS OF BOX AS SHOWN IN b.

11

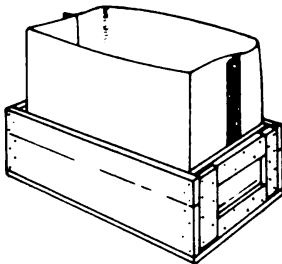

FOLD UP THE BOTTOM EARS; THEN PLACE BAG IN BOX AND PACK WITH CONTENTS.

9

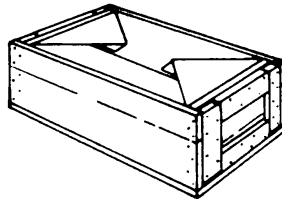

FOLD DOWN THE TOP EARS OF THE BAG. BOX IS NOW READY TO BE CLOSED.

12

RA PD 89014A

Figure 33A — Method of Making Waterproof Liner for a Box — Cont.



**RA PD 89015**

***Figure 34 — Tightening Flat Metal Strapping on Box***



NAILED WOOD BOXES

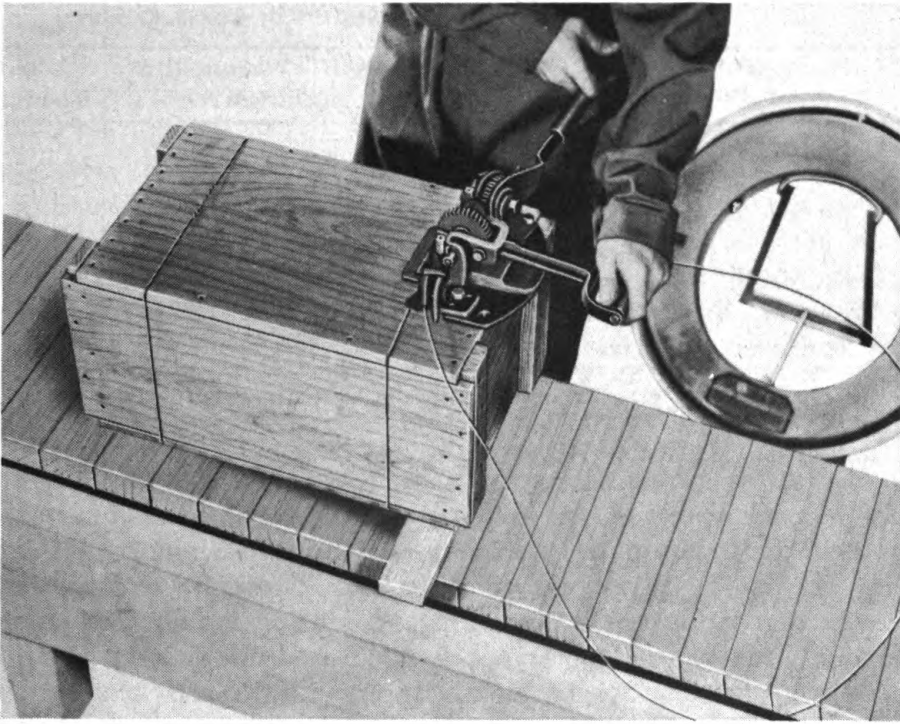

RA PD 89016

**Figure 35 — Tightening and Sealing Round Wire Strapping on Box**

should be somewhat slack at the top. All seams and joints must be made as waterproof as the bag material itself.

**22. STRAPPING.**

**a. Application.** Strapping in the form of flat metal bands or round wires shall be applied to all boxes used as exterior shipping containers. Strapping helps to keep side, top, and bottom boards from being forced loose by the weight of the contents in handling, and to prevent splitting and breaking of these boards. Straps should not be applied while boxes are damp or wet, because they will become loose as the wood dries and shrinks. It is important to place the straps carefully at right angles to the edges of a box, and to draw them tight enough to sink into the wood (group I or II wood) about  $\frac{1}{8}$  to  $\frac{1}{4}$  inch at the edges (figs. 34 and 35). If these instructions are not followed, the straps will probably become loose, and therefore of little value, as the box is handled.

**b. Number and Size of Straps.** The number and dimensions of straps to be used, depending on the gross weight and the length of the box, are shown in table 8.

**INSTRUCTION GUIDE — ORDNANCE PACKAGING AND SHIPPING (POSTS, CAMPS, AND STATIONS)**

**TABLE 8 — MINIMUM SIZE AND NUMBER OF STRAPS (FLAT BANDS OR ROUND WIRES)  
FOR VARIOUS WEIGHTS AND LENGTHS OF BOXES**

GROSS WEIGHT AND LENGTH OF BOX	NUMBER OF STRAPS	DIMENSIONS OF FLAT BANDS	GAGE OF ROUND WIRE
		Inches	No.
Up to 125 lb, not over 18 in.	1	$\frac{1}{2}$ x 0.020	13
125 to 250 lb, not over 48 in.	2	$\frac{5}{8}$ x 0.020	13
250 to 600 lb, not over 48 in.	2	$\frac{3}{4}$ x 0.023	12
250 to 600 lb, not over 72 in.	3	$\frac{3}{4}$ x 0.020	12
600 to 1,000 lb, not over 72 in.	3	$\frac{3}{4}$ x 0.023	12
Over 72 in.	Note	$\frac{3}{4}$ x 0.023	12

Note: One additional strap for each 24 inches in added length. Total number of straps may be obtained by dividing length of box (in inches) by 24, and counting any resulting fraction as 1.

c. **Position.** A single strap should be placed around the sides, top, and bottom of the box, midway of the length. If two straps are required, they should be placed one-sixth of the length of the box from each end. Any intermediate straps should be equally spaced between the end straps. For a long, slender or shallow box carrying a load of great weight per cubic foot, an additional strap should be placed lengthwise, around the ends, top, and bottom. Straps crossing this strap should be applied last, so as to pass over it, as shown in figure 10.

---

**Section IV**

**OPEN TYPE NAILED WOOD CRATES**

**23. PREPARATION OF ITEM FOR CRATING.**

a. **Disassembly.** Disassembly of the item will simplify the job of crating it and, in addition, provide better protection. Gross weight of crates can be kept within reasonable limits by disassembling very heavy items and packing the major items in two or more crates or boxes which must then be set-marked. The extent of disassembly should not be to a point that will unnecessarily expose delicate parts, or require special tools or equipment for reassembly. Accessories and disassembled parts may be packed in small boxes and the boxes secured firmly to the floor of the crate containing the major item, if the total weight is not excessive.

b. **Preservation of Exposed Surfaces.** All exposed surfaces of items to be crated shall be treated to prevent damage by corrosion in accordance with paragraphs 4, 5, and 6. Protection of rust-preventive film and of greaseproof or waterproof wrappings at points of contact with braces and blocks in a crate must be provided by means of cushioning with felt, salvaged cloth, or similar material.

## OPEN TYPE NAILED WOOD CRATES

## 24. OPEN CRATES FOR LOADS NOT OVER 2,000 POUNDS GROSS.

a. **General.** Open crates described in this section are suitable for domestic or overseas shipment of a limited class of items not requiring the degree of protection from weather and handling afforded by a closed box or crate. They may be used for items that are designed to be used in the open and are sufficiently protected from moisture and dirt by housings, hoods, or other covers that have only a few small openings which can be effectively sealed with waterproof paper or nonhygroscopic adhesive tape. Open crates should *not* be used for delicate assemblies such as fire control directors, because effective cushioning cannot be provided in an open crate. The sizes of wood members and other construction details shown in this section are designed so that the crate can support a load of 400 pounds per square foot of top area (stacked on top of the crate) where this load is carried to the sides by use of dunnage in stacking, or in stowing aboard ship. Crates made according to this design must not exceed 8 feet in length, 4 feet in width, or 5 feet 6 inches in height, all outside dimensions. (For construction of larger crates, see section V of this chapter.) Lighter members should not be used for any crate containing a serviceable item, regardless of the gross weight, because of the top-loading factor and because lighter members do not permit adequate fastenings. For many of the smaller items weighing 500 pounds or less, it will be better to build a box than to construct an open crate.

b. **Construction.** All lumber dimensions refer to nominal size.

(1) **BASE OF CRATE** (Fig. 36). In determining the dimensions of the base, consideration should be given to securing the item within the crate so as to prevent its shifting, and allowing sufficient space in the crate for any protruding parts. Clearance between the item and the sides, ends, and top of the crate usually will be necessary for protection against damage due to slight distortion of the crate during handling. In such instances, provision should, if possible, be made for securely bolting the item to the outer skids or strapping it to the upper pieces of the skids (steps (a) and (6), below).

(a) **Skids.** Each outer skid is made of a 2 by 6 and a 2 by 4 nailed together flatwise, the outer edges to be flush. The 2 by 4 is made 16½ inches shorter than the 2 by 6 if cross members are 2 by 8, or 12¾ inches shorter if cross members are 2 by 6. Bottom end edges of skids should be beveled at 45 degrees, to one-half of their depth. Twelvepenny nails, spaced 6 inches apart in staggered rows, are used for nailing the pieces together. The center skid is a 2 by 4 spaced equally between the outer skids, unless a different position is more convenient for securing the item. If the item has holes for bolts in its mounting and does not extend laterally much beyond the

INSTRUCTION GUIDE — ORDNANCE PACKAGING AND SHIPPING (POSTS, CAMPS, AND STATIONS)

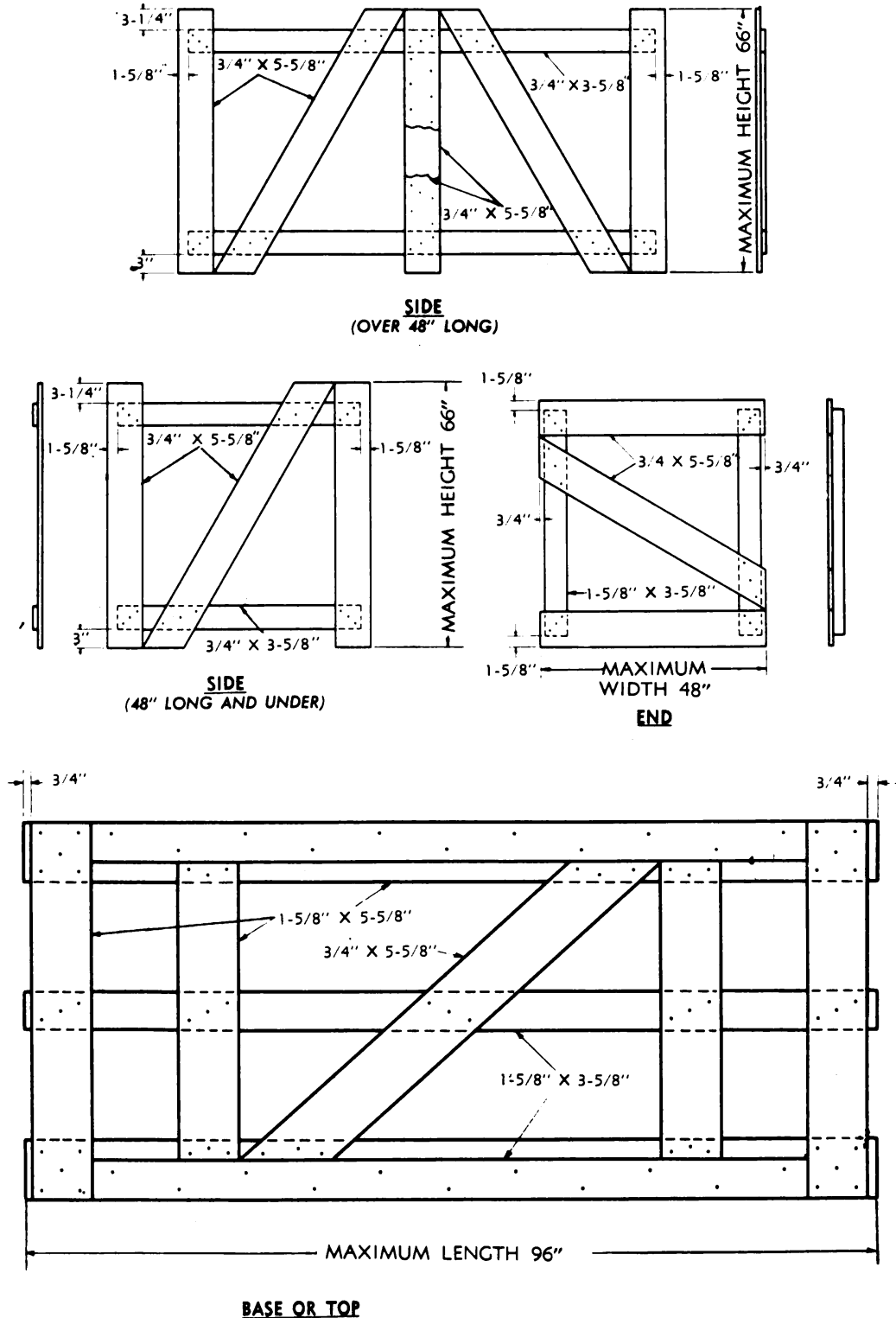

RA PD 89017  
**Figure 36 — Base or Top, Side, and End of Open Crate for Gross Load Up to 2,000 Pounds**

## OPEN TYPE NAILED WOOD CRATES

bolt holes, it is advisable to bolt through the outer skids. A bolt should be at least 1 inch from the edge of a skid piece. It may be necessary to use wider skids to effect this type of attachment to skids (example: 2 by 8 combined with 2 by 6). Notches, not over  $\frac{1}{8}$  deep, may be made at the surface of contact between the 2 by 4 and 2 by 6 to allow passage of bands or wires used to secure the item to the base.

(b) *Cross Members.* For loads of 1,500 to 2,000 pounds gross and widths of 3 to 4 feet, cross members in the base must be 2-inch by 8-inch lumber. For loads under 1,500 pounds or widths less than 3 feet, cross members may be 2-inch by 6-inch lumber. The end cross members extend to the outer edges of the skids, as shown in figure 36. Intermediate cross members, which are cut to fit between the upper pieces of the skids, may be placed according to the bearing area of the load, and more cross members may be added to suit the load, especially when the load does not bear on the end cross members. The area of support for the load should be made as large as possible, except for a light load. If the length of crate does not exceed 4 feet, the intermediate cross members may be omitted. In longer crates, they must be used. Cross members are nailed to skids at each point of contact with at least three twelvepenny nails, spaced 2 inches apart and staggered. End cross members are nailed to each outer skid with five twelvepenny nails, arranged as shown in figure 36.

(c) *Diagonal Member.* This member is essential for a strong base. A 1 by 6 is miter-cut to fit between skids and cross members as shown in figure 36. It is nailed to the skids with three sevenpenny nails, staggered, at each point of contact.

(2) **TOP OF CRATE** (fig. 36). The top is constructed similarly to the base, but the intermediate cross members may be placed differently for convenience in attaching hold-down blocks. The diagonal is to be placed so that it will be crosswise of the diagonal in the base when the crate is assembled.

(3) **SIDES OF CRATE** (fig. 36). Sides are made of 1 by 4 lengthwise members and 1 by 6 vertical members and diagonals. Bottom lengthwise members are placed so as to rest on the skids when the crate is assembled. Top lengthwise members will help to support the top of the crate. A 1 by 6, cut to fit between upper and lower lengthwise members, is nailed to the full-length center strut with six sixpenny nails per foot of length, staggered in two rows and clinched. At all points of intersection of members, three sixpenny nails are driven in staggered arrangement and clinched. If the outside length of the crate is not more than 4 feet, the center strut may be omitted and a single diagonal used. Single diagonals on opposite sides should run crosswise of each other, thus the two sides are identical.

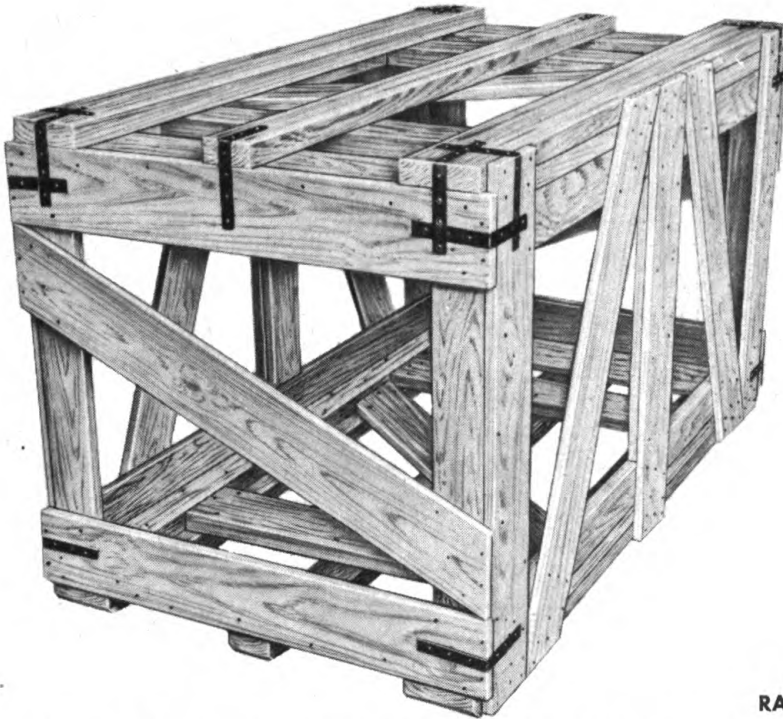

RA PD 89243

**Figure 37 — Open Crate Assembled and Corners Reinforced With Nailed Straps**

(4) **ENDS OF CRATE** (fig. 36). Each end is made of 2 by 4 vertical members and 1 by 6 horizontal members and diagonal, fastened together with three ninepenny or tenpenny nails, clinched, at each intersection. The vertical 2 by 4's are set in  $\frac{3}{4}$  inch from the ends of the horizontal members, so that the ends of the crate overlap the sides when it is assembled. The two ends are identical, so that the diagonals run in opposite directions in the assembled crate.

(5) **ADDITIONAL REINFORCING IN LARGE CRATES.** In large crates the diagonals are so long that they need additional reinforcing members to prevent breakage due to impacts in handling. If the unsupported span of any edge members (that is, the distance between boards to which they are fastened) is more than 30 inches, additional reinforcing members must be used. These will be placed on the inside of a crate face, so as to back up or reinforce each diagonal at its center. Additional members will usually be vertical in the ends of a crate and horizontal in the sides, as shown in figure 38. In a crate with center struts in the sides, two 1 by 6 pieces must then be used on the inside of each strut. These must be cut to fit snugly between the edge members and the additional member. Each addi-

OPEN TYPE NAILED WOOD CRATES

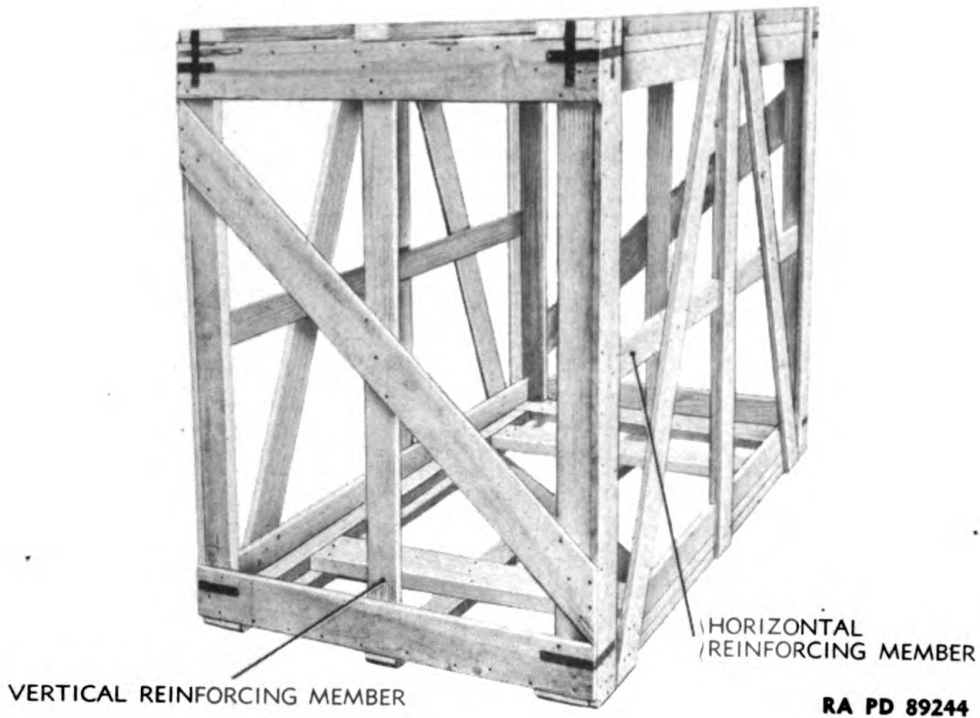

RA PD 89244

**Figure 38 — Reinforcing Large Open Crates for Gross Loads Up to 2,000 Pounds**

tional member is fastened at each intersection with three sixpenny nails driven in staggered arrangement and clinched.

(6) **BLOCKING AND BRACING.** Nature of the item may necessitate use of several interior blocks and braces designed to prevent any lengthwise, sidewise, or vertical movement of the item within the crate, as an alternate or supplement to the bolting or strapping mentioned previously in step (1), above. If the item is, for example, a machine with very strong base or legs that rest directly on the cross members and skids, movement lengthwise or crosswise of the crate can be prevented by 2 by 4 blocks bearing against the base or legs, and nailed securely to all possible skids and cross members. These blocks should be made as long as possible to permit strong fastening, and for maximum effectiveness should be bolted to skids. To prevent damage to a machine or other assembly caused by whipping action in the starting and stopping of motion during shipment, or caused by tipping the crate sidewise or endwise in handling, the machine must be braced also at or above its center of gravity with braces fastened preferably to nominal 2-inch members of the crate, as described in paragraph 20 b (1) to (7). Sizes of nails (based

INSTRUCTION GUIDE — ORDNANCE PACKAGING AND SHIPPING (POSTS, CAMPS, AND STATIONS)

on use of group II wood) for fastening blocks and braces are shown in table 9.

TABLE 9 — SIZE OF CEMENT-COATED NAILS (SINKERS OR CORKERS) FOR FASTENING BLOCKS AND BRACES IN CRATES, AND OTHER GENERAL USE

ACTUAL THICKNESS OF LUMBER (INCHES)		SIZE OF NAIL	
Against Nail Head	Holding Nail Point	Both Pieces Flat <sup>1</sup>	Nailing to Edge
1/2	1/2 to 5/8	Penny four	Penny six
1/2 to 5/8	3/4 and over	five	seven
3/4	3/4 and over	six	seven to nine
1 1/8 to 7/8	1 1/8 and over	seven	eight or nine
1	1 and over	eight	ten
1 1/8 to 1 1/4	1 1/8 and over	nine	twelve
1 3/8 to 1 1/2	1 3/8 and over	ten	twelve
1 5/8	1 5/8 and over	twelve	sixteen
1 3/4	1 3/4 and over	sixteen	—
1 7/8 to 2	1 7/8 and over	twenty <sup>2</sup>	—
2 1/8 to 2 1/4	2 1/8 and over	thirty <sup>2</sup>	—
3	3 and over	sixty <sup>2</sup>	—
Over 3	—	Bolt	—

<sup>1</sup>Nail size permits good clinching with the specified lumber thicknesses up to and including 1 1/4 inches. Table is based on use of group II woods.

<sup>2</sup>Before driving nails, drill holes with diameter 75 percent of nail diameter.

(7) ASSEMBLY OF CRATE (figs. 36 and 37). Parts of the crate are assembled on the base; one convenient order is side, end, side, end, top. The crate should be merely “tacked” together until it has been squared up, and the best possible fit at the joints obtained. Correct nailing in assembling is especially important. Each vertical and diagonal member of the sides is nailed to each nominal 2-inch lengthwise member in the base and top with three sevenpenny nails, or six nails in each end of a side member. Nails must be staggered. Sides are nailed to 2- by 4-inch members in the ends, and ends are nailed to crosswise members in top and base, using sevenpenny nails, 6 inches apart, staggered as much as practical. Horizontal and diagonal members in ends are nailed to vertical members in the sides with sevenpenny nails, two in each end of a board. If sevenpenny nails are not available, eightpenny cement-coated sinkers may be substituted.

(8) REINFORCEMENT OF CORNERS. Nailed strapping is used to reinforce the corners and straighten the ends of the crate (fig. 37). Three pieces, each about 11 inches long, are required at each top corner, and one piece at each bottom corner. Prepunched annealed band, 1 by 0.028 inch, is the most convenient for the purpose, but flat band, 1 1/4 by 0.035 inches, not prepunched, may be used. Strapping is fastened with sixpenny nails, spaced about 1 1/2 inches apart.



OPEN TYPE NAILED WOOD CRATES

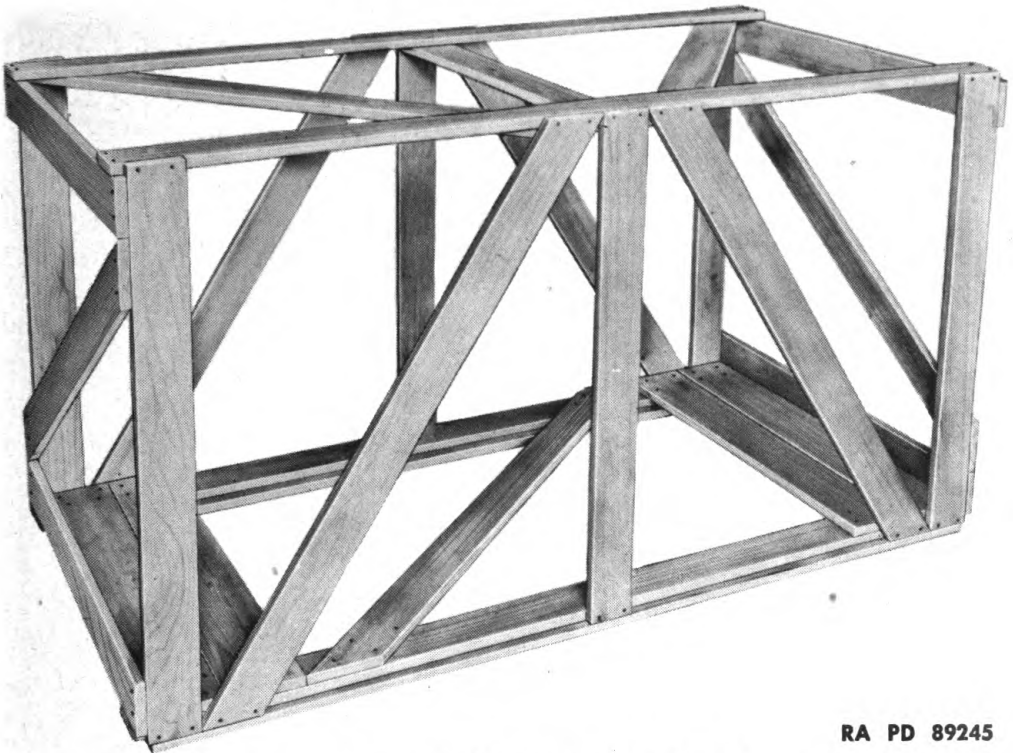

RA PD 89245

**Figure 39 — Three-way-corner Style Open Crate for Domestic Shipment of Loads Up to 200 Pounds**

c. **Weatherproofing.** Some crated items will need protection from rain. If a canvas or tarpaulin cover is furnished with the item, it should be secured in place before the crate is assembled. A substitute is a shroud of type E-2 waterproof paper, or equivalent, applied over the top and sides of the item. Asphalt adhesive should be used at the seams of the paper. The shape of the shroud at the top should insure quick run-off of water. The shroud should be well tied to the item with cord. Means of air circulation must be provided at the bottom of the item to prevent excessive condensation of moisture within the shroud. Such a shroud will not withstand exposure to high wind, as when the crate is deck-loaded on a ship or carried on a flat car. If a hold-down or other blocks in the crate contact the fabric or paper shroud, they should be well padded with felt or cloth to prevent puncture of the shroud.

**25. OPEN CRATES FOR LOADS NOT OVER 200 POUNDS.**

a. **General.** Light crates described in this paragraph are for domestic shipment only, and cannot be used for items to be shipped overseas. They, likewise cannot be used for serviceable items shipped to depots, because the depot may ship the item on an overseas requi-

INSTRUCTION GUIDE — ORDNANCE PACKAGING AND SHIPPING (POSTS, CAMPS, AND STATIONS)

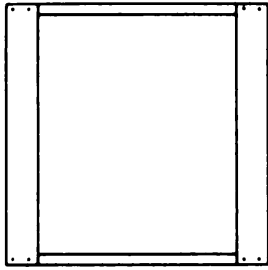

STRENGTH OF CRATE 100 UNITS

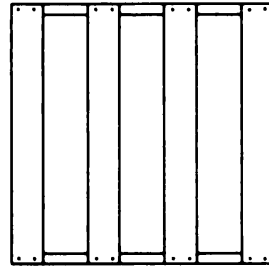

STRENGTH OF CRATE 120 UNITS

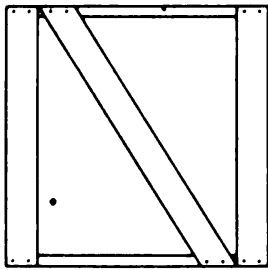

STRENGTH OF CRATE 400 UNITS

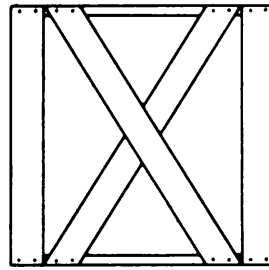

STRENGTH OF CRATE 700 UNITS

RA PD 89246

**Figure 40 — Comparative Strength of Three-way-corner Crates Having All Six Faces Constructed as Shown**

sition, leaving it in the same light crate to save man-hours. These crates are not intended to withstand appreciable stacking loads, lifting by their tops, or other common hazards of overseas handling. They can be handled with fork lifts, double slings placed under the crate, or platform slings. They can be used for domestic shipment of items of awkward shape to be handled and stowed uncrated, or items that need the kind of protection usually given furniture in domestic shipment by rail. (Example: Air compressor, unserviceable, being shipped to a depot or facility for overhaul.) These crates should be used only for items weighing about 200 pounds net, or less, and must not exceed 40 inches in length, 30 inches in width, or 30 inches in height.

**b. Construction.** An example of a light crate, three-way-corner style, is shown in figure 39. It is constructed entirely of nominal 1-inch lumber, group I wood. The crate shown was made large to clarify the details of construction; ordinarily a crate carrying 200 pounds or less would be much smaller. All pieces of lumber in this crate are nominal 4-inch width, except the bottom skids and load-bearing cross members, which are nominal 6-inch width. The base,

OPEN TYPE NAILED WOOD CRATES

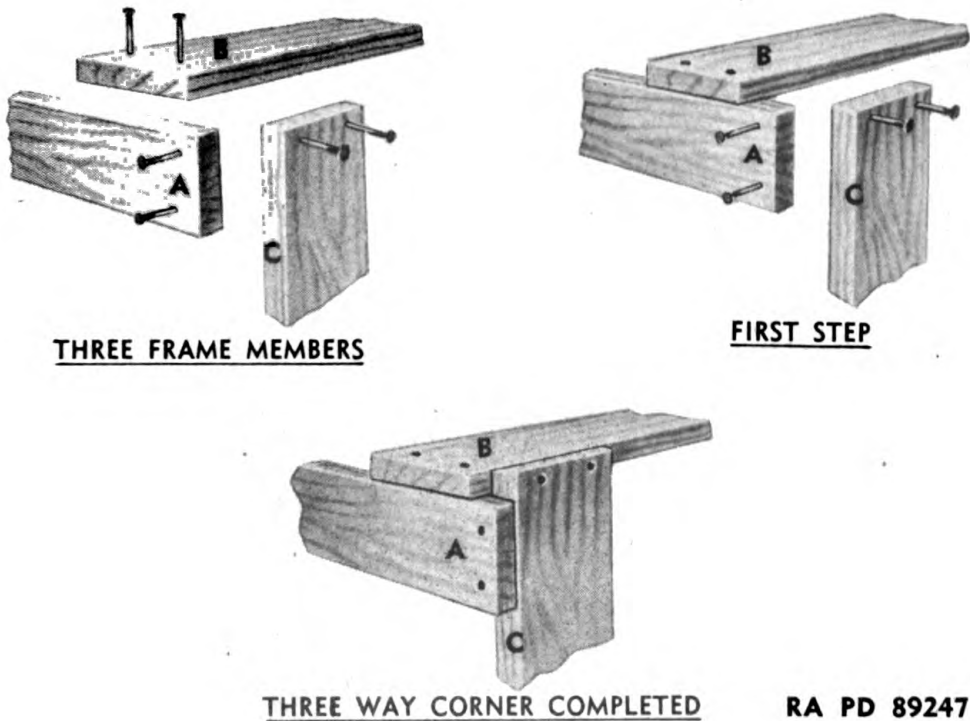

Figure 41 — Assembly of a Three-way Corner

top, and ends of the crate should be built as sections before the crate is assembled.

(1) **BASE OF CRATE.** Each skid is made of a 1 by 6 and a 1 by 4 nailed together flatwise with fivepenny common or sixpenny cement-coated nails, spaced 3 inches apart, staggered and clinched. The 1 by 4 is set in  $\frac{3}{4}$  inch from the outer edge of the 1 by 6, so that vertical members and side diagonals will rest on the 1 by 6 in the assembled crate. The 1 by 4 extends  $\frac{3}{4}$  inch beyond the 1 by 6 at each end, to form three-way corners in the assembled crate. Load-bearing cross members and diagonal brace are nailed to the skids with sevenpenny cement-coated nails, four at each intersection, staggered.

(2) **TOP OF CRATE.** The top edge members are nailed to the center top strut and top diagonals with fivepenny common or sixpenny cement-coated nails, four at each intersection, clinched.

(3) **ENDS OF CRATE.** The end edge members and end diagonals are nailed to vertical edge members with eightpenny cement-coated nails, two at each joint.

(4) **USE OF DIAGONAL BRACES.** The angles formed by diagonal braces should be not less than 30 degrees or more than 60 degrees.

**INSTRUCTION GUIDE — ORDNANCE PACKAGING AND SHIPPING (POSTS, CAMPS, AND STATIONS)**

If any face of a crate is nearly square, therefore, only one diagonal brace need be used. Diagonal braces are far more effective than parallel braces, as indicated in figure 40 which describes the comparative strength of different constructions. Use of crossed or X-braces, which give very high strength, is usually not practical unless they are made of thin lumber or are relatively long, because of the need to spring the ends of the outer brace in order to nail them. Crossed braces should be fastened to each other with two clinched nails at the point of intersection. The load itself occasionally will be solid and strong enough to prevent diagonal distortion of the crate, so that diagonals may be omitted from one or more faces.

**(5) ASSEMBLING CRATE.**

(a) *Assembly of Three-way Corners.* The assembly of a three-way corner is illustrated in figure 41. The three edge members joined together may be of different widths, but all should be of the same thickness. There are a number of methods of forming three-way corners, the essential feature of all methods being that each member is fastened in two directions, and all nails are driven through one member into the side grain of another member. Starting nails through the first member before assembly will usually save time.

(b) *Nailing.* Sizes of nails to be used are shown in table 9. The correct number of nails for fastening the end of a board to the edge of another board will usually be two for nominal 3- or 4-inch width, three for nominal 5- or 6-inch width, etc., but must depend somewhat on good judgment. Excessive nailing will probably cause splits in the edges of the boards into which nails are driven, thus destroying the strength of the joint. When two or more nails are required, consider the board composed of the same number of equal-width sections as there are nails, and drive a nail through the middle of each width. Nails should be driven in a staggered arrangement whenever practicable. (This paragraph applies to construction of all parts of the crate.)

(c) *Strengthening a Light Crate.* The strength of a light crate can be increased about two-thirds by doubling the thickness of the crate edge members at the place where diagonals are nailed to their edges. This may be accomplished by fastening blocks inside the edge members at such places with clinched nails. The number of nails driven through the diagonals into side grain can then be doubled, and effectiveness of the diagonals is increased accordingly. Joints between edge members or edge members and struts can be reinforced similarly.

(6) **REINFORCEMENT OF CORNERS.** Use of straps around the girth of a three-way-corner crate is not practical, because the strap will not overlies frame members at all points, and will be readily snagged off. (Other styles of crates may permit effective use of

## FULLY SHEATHED, NAILED WOOD CRATES

girth straps.) Each three-way corner should be reinforced with three nailed straps, as described in paragraph 24 b (8) and shown in figure 37. Length of pieces may be slightly shorter than that specified, because of use of thinner lumber in the crate.

(7) **BLOCKING AND BRACING.** For instructions on blocking and bracing the contents, refer to paragraphs 20 and 24 b (6).

c. **Weatherproofing.** For instructions on weatherproofing, see paragraph 24 c.

---

### Section V

## FULLY SHEATHED, NAILED WOOD CRATES

### 26. GENERAL.

a. **Description.** Fully sheathed crates are often known as boxes but, unlike a box, a crate is made by constructing a frame and applying sheathing to the frame if a closed container is desired. The frame members are made capable of withstanding the loads and side pressures to which the crate is subjected in handling and shipment, and the weight of other containers or articles placed upon it. The sheathing adds some reinforcement. Whenever possible, sheathing is nailed to the frame members before the crate is assembled.

b. **Purpose of Design of the Base.** The design of the base specified herein is intended to support the weight of the contents, and largely disregards the reinforcing effect of the side structures. This provides an extra margin of safety, and also permits the base to be used in skidding the article from one location to another before the side, end, and top panels of the crate are assembled.

c. **Purpose of Design of the Top.** The design of the top is intended to provide support for a stacked nonrigid load distributed over the area of the top. The top is intended also to resist the side-wise pressure caused by lifting the crate with grabhooks or with slings without spreaders.

d. **Purpose of Design of Sides and Ends.** The design of sides and ends is intended to provide support for heavy loads stacked upon the crate in storage or on shipboard, where this load is rigid or is carried to the edges of the top by adequate dunnage. The sides and ends are intended to resist crushing caused by grabhook or sling lifting, or pushing with a tractor.

e. **Exception.** If the nature of the items is such that they cannot be damaged through distortion of the crate, and these items are solid and strong enough to sustain a heavy superimposed load, frame members (par. 27) may be omitted, to the extent that the contents can and do act as a substitute for the frame members.

## INSTRUCTION GUIDE — ORDNANCE PACKAGING AND SHIPPING (POSTS, CAMPS, AND STATIONS)

**f. Application.** Fully sheathed crates described herein are for loads up to 2,000 pounds, and for contents not over 8 feet wide or 7 feet high. Specifications for sheathed crates carrying over 2,000 pounds, or larger than the dimensions stated, are given in U. S. Army Specification 100-14 (latest revision). Fully sheathed crates constructed as specified herein may be used for either overseas or domestic shipment.

**g. Preparation of Items for Crating.** Steps in the preparation of an item for crating are described in paragraph 23.

**27. DEFINITIONS.**

**a. Frame Members.** Frame members are those parts which form the main structure of the crate and upon which the strength and rigidity of the crate chiefly depend. Frame members include the following parts, illustrated in figures 43 to 46 inclusive:

(1) **EDGE MEMBERS.** Edge members are the frame members at the upper and lower edges of the side and end panels. They must be of sufficient size and strength to permit adequate fastening of the various parts.

(2) **STRUTS.** Vertical struts are frame members positioned between and at right angles to upper and lower edge members of a side or end. The struts at the end of a panel are usually known as corner posts.

(3) **DIAGONAL BRACES.** Diagonal braces are those frame members positioned between parallel frame members and placed as nearly as practicable at angles of 45 degrees to the edge members. Diagonal braces are necessary to insure a high measure of rigidity in the crate.

(4) **SKIDS.** Skids are members attached lengthwise at the bottom of the crate to support the load and for convenience in moving the crate.

**b. Sheathing.** Sheathing consists of the covering boards which enclose the crate. When used on the top of a crate, it is known as top sheathing. When used on the sides and ends, it is known as side sheathing.

**c. Floor Boards.** Boards placed across the skids and fastened to them are known as floor boards. If any part of the contents rests directly on these boards, the boards are known as load-bearing floor boards.

**d. Top Cleats.** Top cleats are fastened underneath the sheathing of the top, and run lengthwise of the crate. They are used to reduce the unsupported span of the top sheathing which runs crosswise of the crate, and also to strengthen the top in the lengthwise direction.

## FULLY SHEATHED, NAILED WOOD CRATES

**e. Top Joists.** Top joists are members extending across the top, fastened to its under side. They are used to support loads stacked on top of the crate and to prevent crushing when slings or grabhooks are used. If any area of the top is completely supported by the contents, top joists are not required in that area.

**f. Top Joist Supports.** Ends of the top joists are supported by horizontal boards, known as top joist supports, nailed to the upper frame members and adjacent members of the sides.

**g. End Floor Members.** End floor members, placed across each end of the base and bolted to the skids, are used to provide for a strong fastening of the lower edges of the end panels to the base of the crate.

## 28. PRELIMINARY PROCEDURE FOR DESIGN.

**a. Arrangement of Contents.** The first step, after the exact nature and degree of disassembly of the contents is determined, is to plan the arrangement of the pack to afford the best protection to delicate parts and to reduce the total cubic displacement or volume of the crate as much as possible. Fragile articles, such as radiators, instrument panels, or protruding parts of machine tools, need more protection from contact with inner faces of the crate, resulting from crate distortion, than substantial objects such as axle hubs or heavy castings. Distribution of weight over the base of the crate should be made as even as possible. Consideration should also be given to the blocking, bracing, and tie-downs needed.

**b. Measurement of Contents.** Measure the over-all length, width, and height of the contents of the crate, including bracing, blocking, and any necessary padding between the articles and the bracing. Add to these dimensions sufficient clearance between the items and the members of the crate to give the contents proper protection. At least 1 inch of clearance must be allowed between the top members of the crate and the contents, when the contents require any protection against loads, impact forces, or abrasion. The total of each of these measurements will be the inside dimensions of the crate, between the frame members (length and width) and between the floor boards and top joists (height). *NOTE: It may be possible to allow parts of the contents to extend between the top joists. The crate width may need to be increased to provide clearance between the top joist supports and the contents.*

**c. Estimating Weight of Crate.** The approximate weight of the crate may be obtained as follows: The inside dimensions are estimated (subpar. b, above) to the nearest foot or one-half foot. The length, width, and height in feet are multiplied and the result is multiplied by 4. The width and height are multiplied and the result

**INSTRUCTION GUIDE — ORDNANCE PACKAGING AND SHIPPING (POSTS, CAMPS, AND STATIONS)**

multiplied by 10. The sum of these results will be the approximate weight of the crate.

(1) Example: Estimate the weight of a crate 92 inches long, 44 inches wide, and 62 inches high (inside dimensions).

$$\begin{array}{r} 4(7.5 \times 3.5 \times 5) = 525 \\ 10(3.5 \times 5) \quad = 175 \\ \hline 700 \end{array}$$

(2) The estimated weight of the crate (tare weight) is 700 pounds. The estimated gross weight or gross load is obtained by adding to this quantity the weight of the contents.

**29. SECURING CONTENTS WITHIN THE CRATE.**

a. **General.** The contents of a fully sheathed crate will generally need to be held securely in position, to avoid damage due to contact with the inner faces of the crate or to the striking of one part of the contents against another part. The method of securing the item or items will depend on such factors as the weight and construction of the item, and whether it has strong parts or surfaces against which blocks and braces can be applied. If the contents include boxes containing detached parts or subassemblies of the major item, the boxes must be effectively fastened to one or more inner faces of the crate. This may be done by using a combination of blocks and hold-down braces against the box or, if the box is not too heavy, by strapping it to the crate base and side or end, fastening each strap end to a crate frame member with two or three nails. Annealed (soft) steel strap is much better than high-tensile (hard) strap for this purpose. Round wire is also satisfactory.

b. **Bolting to Base.** The contents should be bolted to the base if possible. The size and number of the bolts will be determined by the size and number of the available bolt holes. Bolts should pass through skids wherever possible. A bolt should be at least 1 inch in from the edge of a skid. Additional instructions on bolting are given in paragraph 20 b (7). For some top-heavy items, bolting to the base (fig. 42) is not sufficient without also blocking the item at a point above its center of gravity.

c. **Blocking and Bracing.** Application of blocking and bracing in sheathed crates should follow the same rules and principles as those given for blocking and bracing in boxes and open type crates, in paragraphs 20 b (1) to (7) and 24 b (6) (figs. 13 to 28, and 31).

**30. WEATHERPROOFING.**

a. **General.** There are several alternate methods of weatherproofing, and the choice will depend on the materials available and the nature of the crate contents.



FULLY SHEATHED, NAILED WOOD CRATES

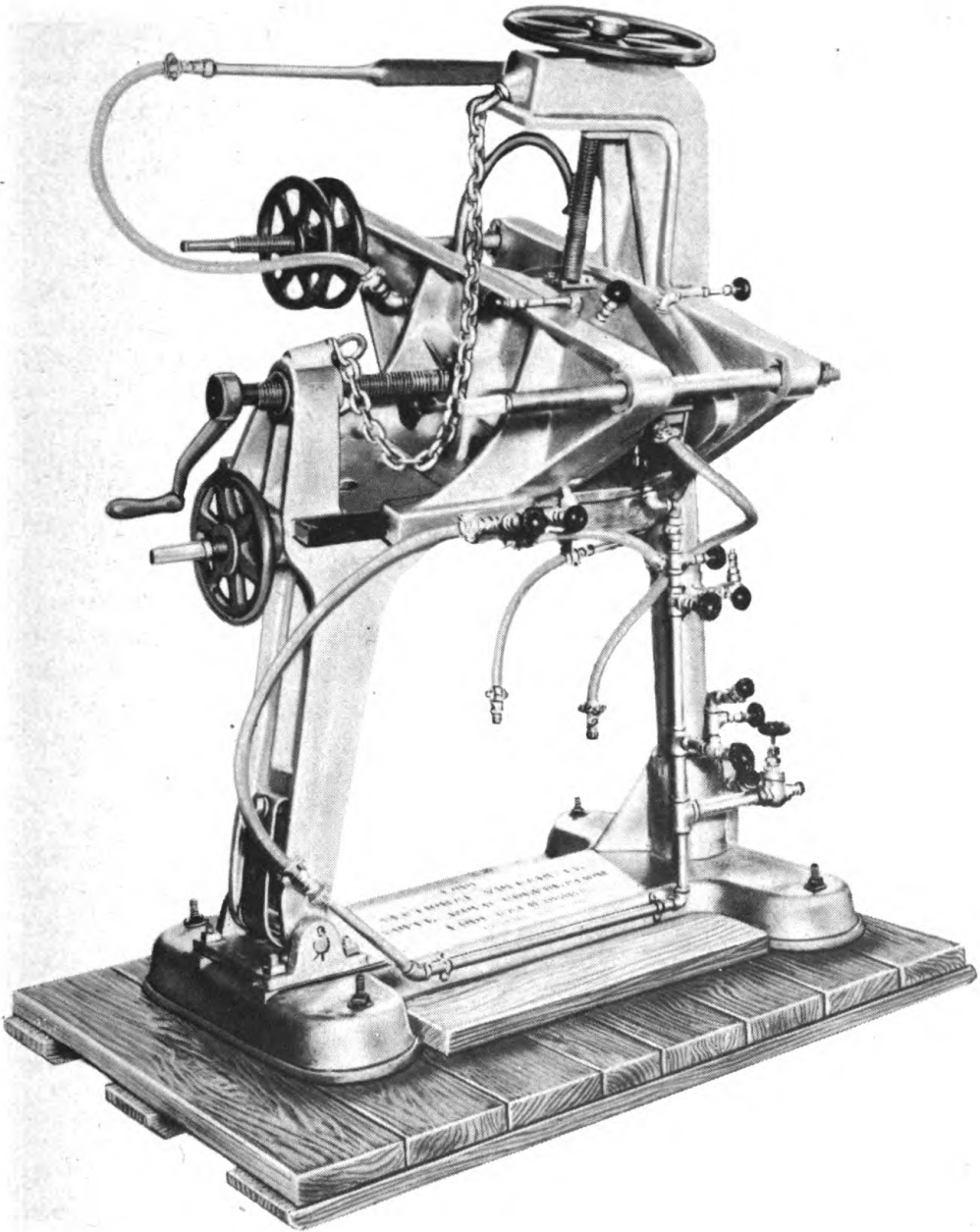

NOTE — NAILED BLOCKS 2-INCH THICK ARE PLACED AGAINST MACHINE BASE TO STRENGTHEN FASTENING. THIS TOP-HEAVY MACHINE SHOULD BE WELL BRACED INSIDE THE CRATE.

RA PD 89248

**Figure 42 — Machine Bolted to 2-inch Floor Boards on Crate Base**

**INSTRUCTION GUIDE — ORDNANCE PACKAGING AND SHIPPING (POSTS, CAMPS, AND STATIONS)**

(1) The simplest and most satisfactory method will usually be to use an interior shroud. An interior shroud, however, may not be practical if the item is too awkward in shape, if there are several items packed in the same crate, if clearances are too narrow, or if much bracing is required. Braces will have a tendency to cut or puncture a shroud and, to avoid this, must be very carefully padded.

(2) A second method is to spread bituminous crate topcoating material over the top, and line the sides and ends of the crate with waterproof paper placed between the frame members and the sheathing.

(3) If the specified topcoating material is not available, the top of the crate may be double-sheathed and the waterproof paper placed between the layers of the sheathing. The sides and ends of the crate are lined as in method in step (2), above. Following are more detailed instructions for the application of weatherproofing.

**b. Interior Shrouds.** An interior shroud of tarpaulin or waterproof paper may be sufficient protection against rain and snow. Waterproof paper of type E-2 or equivalent should be used. Details of application are given in paragraph 24 c.

**c. Crate Topcoating.** The top of the crate may be made watertight, similar to a good roof, by the following procedures:

(1) Apply a coat of bituminous crate topcoating material not less than  $\frac{1}{16}$  inch thick over the entire area of the top after the crate is assembled. The material resembles thick liquid asphalt, and is applied cold. Directions for thinning the mixture with solvent and instructions on application procedure are usually shown on the topcoating material container label.

(2) Cover the bituminous material with a layer of waterproof paper, type E-1, or as a second choice type E-2. The paper should overlap the sides and ends of the crate about 3 inches, and the overlaps should be cemented with rubber base waterproof cement and tacked down with galvanized roofing nails spaced 6 to 8 inches apart. The paper protects the bituminous material until it is hardened, and the fibers of the paper gradually imbed themselves in the material, thus strengthening it against abrasion and cracking.

(3) If the top sheathing is a single layer of ordinary butt-joined (square-edged) lumber, the bituminous material will drip through the cracks formed when the boards shrink, especially in hot weather. To protect the contents from this dripping, the under side of the top should be lined with waterproof paper, placed between the sheathing and the top cleats. Any available standard waterproof paper is satisfactory for this purpose.

**d. Lining of Double-sheathed Tops.** If double sheathing is used, waterproof paper of the crate-top cover or case-liner type (in

FULLY SHEATHED, NAILED WOOD CRATES

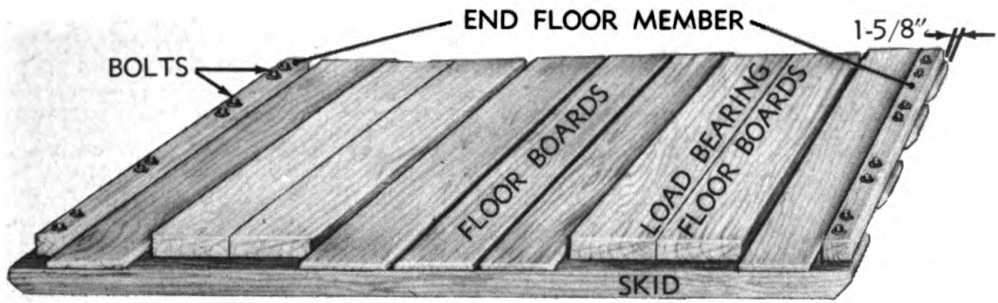

FLOOR BOARDS SPACED 3/8 IN. APART TO ALLOW FOR DRAINAGE

RA PD 89249

Figure 43 — Base of Fully Sheathed Crate

order of preference, type E-1, L-2, E-2, or C-2) should be placed between the layers of sheathing. Joints in the paper should be cemented with rubber base waterproof cement. The two layers of sheathing should be nailed to each other with sixpenny nails, clinched.

e. **Lining Side and End Panels.** A suitable type of waterproof paper must be placed between the side and end sheathing and the frame members (unless a shroud is used over the contents). Examples of suitable papers are, in order of preference, types C-2, L-2, E-1, and E-2. Joints in the paper should be under vertical struts.

f. **Ventilation in End Panels.** A cluster of 1/2-inch holes must be bored in each end panel, through the sheathing just below the upper frame member. The holes must be bored upward from the outside at an angle of 45 degrees, to keep out the rain. The number of holes required in each end varies with the size of the crate, but should not be less than nine. Care should be taken that the holes are clean and free of any obstruction.

### 31. CONSTRUCTION OF BASE.

a. **General.** The general construction of a crate base is shown in figure 43.

b. **Skids.**

(1) Skids in crate bases must be placed flatwise; that is, the depth of the skid must not be greater than its width.

(2) Skids must not be more than 48 inches apart; therefore, a crate 8 feet wide requires at least three skids.

(3) Having estimated the gross load or total weight of contents and crate (par. 28 c), select the skids to be used from table 10. This table permits some choice of sizes according to the lumber available, but the skids shown are the minimum for the loads.

INSTRUCTION GUIDE — ORDNANCE PACKAGING AND SHIPPING (POSTS, CAMPS, AND STATIONS)

TABLE 10 — NUMBER AND SIZE OF SKIDS FOR SHEATHED CRATES ACCORDING TO LOAD AND GROUP OF WOOD USED

SKIDS, NUMBER AND NOMINAL SIZE (INCHES)	MAXIMUM GROSS LOADS FOR SKIDS OF EACH GROUP OF WOODS		
	Group I	Groups II and III	Group IV
	Pounds	Pounds	Pounds
Two 2 x 3	375	500	550
Two 2 x 4	525	650	750
Three 2 x 3	575	700	800
Four 2 x 3 } Three 2 x 4 }	775	950	1,100
Two 2 x 6	825	1,000	1,150
Four 2 x 4	1,050	1,250	1,500
Three 2 x 6	1,225	1,500	1,725
Two 3 x 4	1,375	1,650	1,950
Three 3 x 4	2,075	2,500	2,925
Two 4 x 4	2,650	3,200	3,700

Note 1: All skids, unless square in cross section (4 x 4), must be placed flatwise; that is, skid width must at least equal skid depth.

Note 2: Table is based on vertical strut spacing of 48 inches.

(4) Bottom end edges of the skids should be beveled at 45 degrees to one-half of their depth.

c. End Floor Members.

(1) End floor members shall be nominal 2 by 4's placed flatwise, or nominal 4 by 4's. The length of the end floor members will be the same as the estimated inside width of the crate (par. 28 b), but the remainder of the base must be 3¼ inches wider than this length, as shown in figure 43, to allow the lower edge members of the side panels to rest on the base and against the ends of the end floor members (twice the thickness of edge members, 1⅝ inches, equals 3¼ inches).

(2) End floor members must be bolted to the skids at each intersection, as shown in figure 43. Since the lower edge member of the end panel, a nominal 2 by 4, will rest on the end floor member, the bolts must be placed at least 1⅝ inches from the outer edge of the end floor member. Bolts must be not less than ⅜ inch in diameter, and holes of the same diameter must be bored for them. Heads of the bolts must be at the bottom of the skids. Carriage or step bolts, having rounded heads and square shanks near the heads, should be used. Large standard cut washers should be used under the nuts. After nuts are tightened, the bolt threads above them should be upset or painted with asphalt to prevent the nuts from working loose.

(3) End floor members must be set in from the ends of the skids a distance equal to the thickness of the sheathing to be used on the end panels.

## FULLY SHEATHED, NAILED WOOD CRATES

### d. Floor Boards.

(1) Load-bearing floor boards usually should be nominal 2-inch boards. If the crate will be handled with fork-lift trucks, 2-inch floor boards should be used for a distance of 36 inches from each end. If a heavy load bears on a very small area, the required thickness of the floor board must be determined from table 15, as if the floor boards were skids. Total width of floor boards bearing the load is to be substituted for total width of skids shown in the table.

(2) If a considerable number of adjacent floor boards will carry no load or a very light load, nominal 1-inch lumber should be used for these boards. The thicker floor boards must then be cut short like the end floor members, or as an alternate may be notched to provide even support for the lower edge members of the side panels.

(3) If the total width of nominal 2-inch or thicker floor boards is over 18 inches in any one area, and there are nominal 1-inch floor boards in other areas of the base, then filler strips nominally 2 inches wide must be placed adjacent to the ends of the load-bearing floor boards to level up with the nominal 1-inch floor boards. This will provide even support for the lower edge members of the side panels.

(4) Floor boards must be spaced  $\frac{3}{8}$  inch apart for drainage and ventilation. This is especially important near the ends of the crate, where water is likely to collect.

(5) Floor boards must be securely fastened to all skids. Nails should be staggered to avoid splitting the skids or floor boards. Sizes of nails to be used are shown in table 9. For filler strips, sixpenny nails, spaced 10 inches apart, are sufficient.

## 32. CONSTRUCTION OF TOP.

### a. Sheathing.

(1) Sheathing should be nominal 1-inch lumber, which is usually dressed to  $\frac{3}{4}$ -inch thickness. If the wood is group IV,  $\frac{5}{8}$ -inch thickness is sufficient. Boards must be not less than  $3\frac{1}{2}$  inches wide.

(2) Tongue-and-grooved lumber should be used for top sheathing if available. If neither tongue-and-grooved lumber nor bituminous crate topcoating material is available, the top should be double-sheathed with butt-joined (square-edged) lumber, one layer running lengthwise and the other crosswise of the crate. If single sheathing is used, it must run crosswise of the crate.

### b. Top Cleats.

(1) Top cleats are not necessary if double sheathing is used.

(2) Top cleats should be nominally 1 inch in thickness, and at least nominally 6 inches in width.

(3) The top cleats must run lengthwise of the crate, and must be spaced not more than 18 inches apart, center to center.

**INSTRUCTION GUIDE — ORDNANCE PACKAGING AND SHIPPING (POSTS, CAMPS, AND STATIONS)**

(4) The distance between the outer edges of the outside top cleats must be such that the top cleats will fit against the upper edge members of the side panels. The length of the top cleats, similarly, must be such that the cleats will fit against the upper edge members of the end panels.

(5) Sheathing should be nailed to the top cleats with sixpenny nails, in two rows  $\frac{3}{4}$  inch from the edges of the top cleats. The nails should be about 6 inches apart in each row and staggered between rows.

**c. Top Joists.**

(1) If any area of the top is completely and adequately supported by the contents, top joists are not required in that area.

(2) Top joists shall run crosswise of the top, and shall be cut accurately to length so that their ends fit against the upper edge members of the side panels.

(3) The size and spacing of the top joists shall be determined from table 11. The table permits a choice in the size and spacing, which will depend on the lumber available and perhaps the arrangement of the contents. If the actual inside width of the crate is not the same as one of the widths shown, use the joists for the next greater width. For the narrower crates, it will generally be more convenient and will reduce crate height to place the joists flatwise.

**TABLE 11 — NOMINAL SIZE AND SPACING (IN INCHES) OF TOP JOISTS**

INSIDE WIDTH OF CRATE (INCHES)	SIZE AND POSITION OF TOP JOISTS	MAXIMUM SPACING OF JOISTS, CENTER TO CENTER
36	2 x 4 flat	26
36	2 x 4 on edge	40
48	2 x 4 on edge	32
48	2 x 4 combined with 1 x 4 on edge	41
48	2 x 6 flat	23
60	2 x 4 on edge	23
60	2 x 4 combined with 1 x 4 on edge	32
60	2 x 6 on edge	37
72	2 x 4 on edge	15
72	2 x 6 on edge	30
72	2 x 6 combined with 1 x 6 on edge	41
84	2 x 6 on edge	25
84	2 x 6 combined with 1 x 6 on edge	32
84	2 x 8 on edge	34
84	2 x 8 combined with 1 x 8 on edge	41
96	2 x 6 on edge	21
96	2 x 8 on edge	27
96	2 x 8 combined with 1 x 8 on edge	34

FULLY SHEATHED, NAILED WOOD CRATES

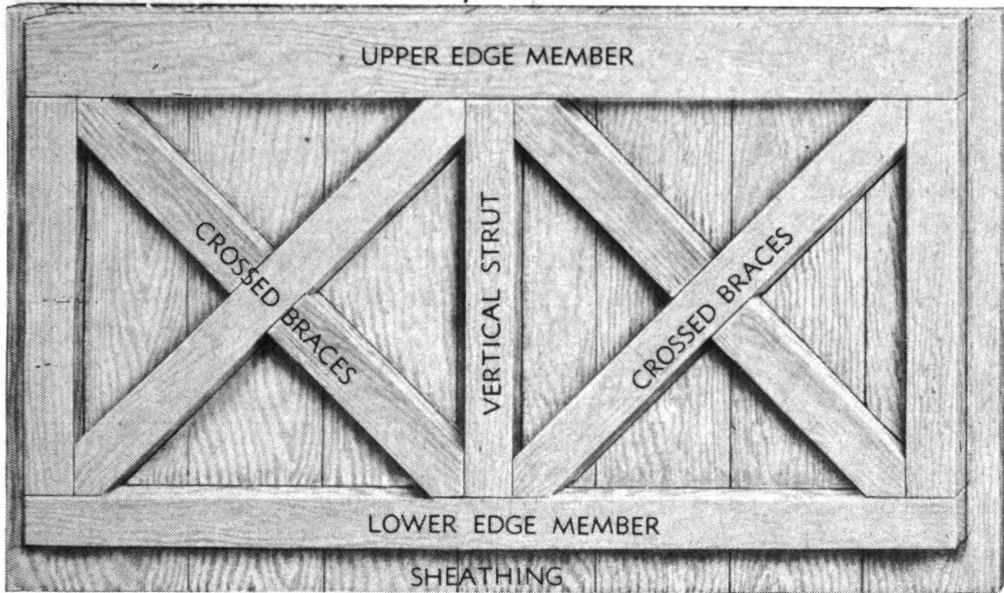

RA PD 89250

**Figure 44 – Side of Fully Sheathed Crate**

(4) If two pieces combined are used, they should be nailed together flatwise with sevenpenny cement-coated nails, the nailheads in the thinner piece. The nails should be 1 inch from the edges, with two rows of nails in nominal 4-inch and 6-inch pieces and three rows of nails in nominal 8-inch pieces. Nails should be 18 inches apart in each row and staggered between rows.

(5) In fastening top joists (on edge) to the remainder of the top, sixteenpenny nails should be driven through the sheathing, through the top cleats (if used), and into the top joists. Use two nails at each intersection of top cleats and top joists. If no top cleats are used, the nails should be spaced about 8 inches apart. If the top joists are flatwise, twelvepenny nails are adequate and the nails should be staggered.

### 33. CONSTRUCTION OF SIDES AND ENDS.

a. **General.** The general construction of side panels is shown in figure 44. Construction of end panels is similar.

b. **Sheathing.** Side and end sheathing should be nominal 1-inch lumber, butt-joined (square-edged), and boards must be not less than 3½ inches wide. Not more than 10 percent of the boards should be of minimum width, nor should narrow boards be placed adjacent to each other. Sheathing must be applied vertically. Side sheathing should extend to ¼ inch from the bottom of the skids. The sheath-

## INSTRUCTION GUIDE — ORDNANCE PACKAGING AND SHIPPING (POSTS, CAMPS, AND STATIONS)

ing boards at either end of each panel must be not less than  $5\frac{1}{2}$  inches wide.

c. **Height.** Usually the necessary height of the sides and ends cannot be determined until the size and position of the top joists are known (par. 32 c). The outside height of the crate will be the thickness of the skids, plus thickness of the load-bearing floor boards, plus height of contents with allowance for clearance, plus depth of top joists, plus thickness of top cleats and top sheathing. From this total the length of the side sheathing is figured as follows: Subtract the thickness of the top sheathing, since it will overlap the side sheathing, and also subtract  $\frac{1}{4}$  inch since the ends of the sheathing boards should be  $\frac{1}{4}$  inch from the bottom of the skids. The sheathing boards on the end panels rest on the skids so that, in figuring length of end sheathing, the full depth of the skids instead of  $\frac{1}{4}$  inch must be subtracted.

d. **Vertical Struts.**

(1) **SPACING OF STRUTS.** Struts should be spaced uniformly so that the angle of the diagonal braces will be as near 45 degrees as possible, but shall not be spaced more than 48 inches center to center. For crates not over 48 inches long, the end struts or corner posts may be sufficient, if the height is such that a satisfactory angle for the diagonal braces will result. If, however, the length of the crate is more than  $1\frac{1}{2}$  times the height, an intermediate strut should be used on each side panel. Similarly, if the width of the crate is more than  $1\frac{1}{2}$  times the height, an intermediate strut should be used on each end panel.

(2) **SIZE OF STRUTS.**

(a) To determine the size of struts required, it is necessary first to determine whether the length of the struts is more or less than 40 inches. The struts are positioned between the upper and lower edge members. Hence, if there is doubt as to the length of struts, it can be estimated as the distance from the floor boards to the top sheathing, minus  $3\frac{5}{8}$  inches (width of lower edge member), and minus 5 inches (approximate width of upper edge member).

(b) The size of lumber for struts is based on the distance between struts, length of struts, and width of the crate, and is obtained by referring to tables 12 and 13. If the measurements are not the same as those shown in the tables, use the next greater measurement shown. After obtaining the top load supported per strut from table 12, find in table 13 the load for the length of strut which is equal to or greater than the top load supported. The size of strut required is shown at the top of the same column in table 13. Depending on the lumber sizes available, larger struts than the minimum required may be used.



FULLY SHEATHED, NAILED WOOD CRATES

NOTE: *If the strut length and crate width are such that the sheathing alone is sufficient to support the top load, as shown by table 12, the vertical struts should be either 1 3/8 by 3 5/8 inches or nominal 2 by 4.*

TABLE 12 — TOP LOAD SUPPORTED BY EACH VERTICAL STRUT

SPAN BETWEEN VERTICAL STRUTS (CENTER TO CENTER)	WIDTH OF CRATE (INCHES)							
	54	60	66	72	78	84	90	96
	Pounds	Pounds	Pounds	Pounds	Pounds	Pounds	Pounds	Pounds
	Length of Strut 40 Inches or Less							
24	Sheathing is sufficient to support top load				192	408	600	792
30					240	510	750	990
36					288	612	900	1,188
42					336	714	1,050	1,386
48					384	816	1,200	1,584
	Length of Strut Over 40 Inches							
24	600	816	1,008	1,200	1,392	1,608	1,800	1,992
30	750	1,020	1,260	1,500	1,740	2,010	2,250	2,490
36	900	1,224	1,512	1,800	2,088	2,412	2,700	2,988
42	1,050	1,428	1,764	2,100	2,436	2,814	3,150	3,486
48	1,200	1,632	2,016	2,400	2,784	3,216	3,600	3,984

TABLE 13 — SIZE OF VERTICAL STRUT AS DETERMINED BY LOAD SUPPORTED (SEE TABLE 12)

LENGTH OF STRUT	SIZE OF STRUT (INCHES)				
	1 3/8 x 3 5/8 (ACTUAL)	2 x 4 (NOMINAL)	2 x 6 (NOMINAL)	2 x 8 (NOMINAL)	3 x 4 (NOMINAL)
Inches	Pounds	Pounds	Pounds	Pounds	Pounds
24	7,160				
30	4,580	7,570			
36	3,185	5,260			
42	2,340	3,865			
48	1,790	2,965	4,595		
54	1,413	2,335	3,625	4,835	
60	1,146	1,892	2,970	3,915	
66	944	1,565	2,428	3,240	
72	796	1,315	2,080	2,720	5,540

e. Diagonal Braces.

(1) No diagonal braces are required if the vertical struts are less than 18 inches long.

(2) If the vertical struts are 18 to 35 inches long, single or crossed diagonal braces must be used in all spaces between struts, as shown in figure 44. Crossed diagonals are preferred.

INSTRUCTION GUIDE — ORDNANCE PACKAGING AND SHIPPING (POSTS, CAMPS, AND STATIONS)

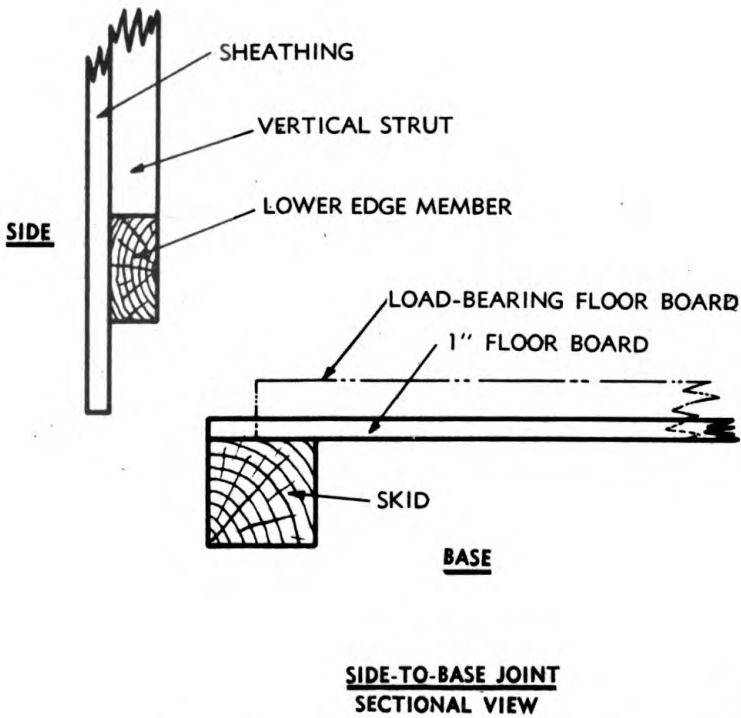
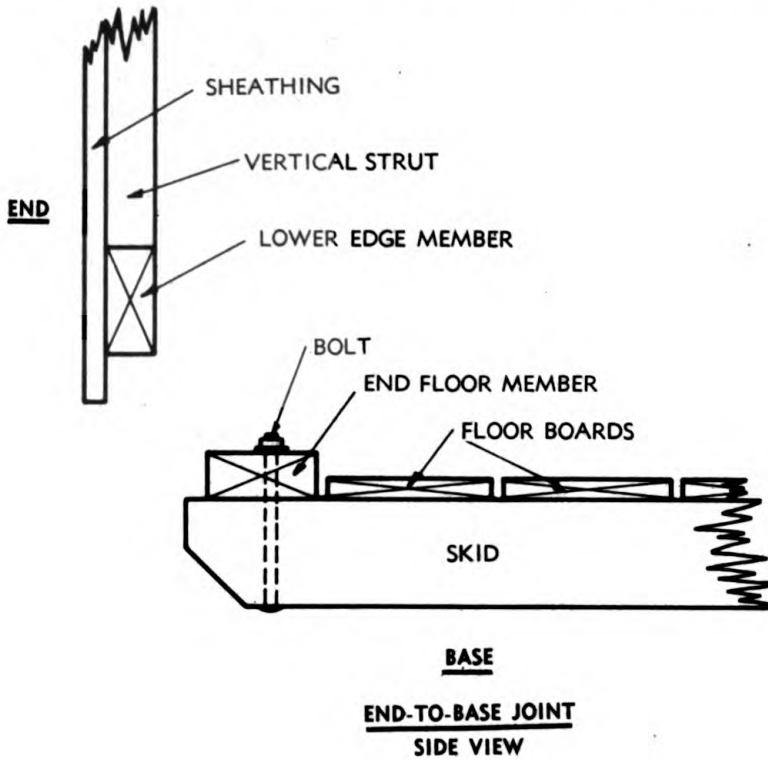

RA PD 89251

Figure 45 — Details of Crate Joints

**FULLY SHEATHED, NAILED WOOD CRATES**

(3) If the vertical struts are 36 or more inches in length, crossed diagonal braces (X-braces) must be used in all spaces between struts.

(4) Diagonal braces should be of nominal 4-inch width, and must be the same thickness as the vertical struts, up to nominally 2 inches.

(5) If crossed diagonals are used, one diagonal must be a continuous piece and the other diagonal of the pair must be formed of two pieces.

(6) Ends of diagonals extending to corners formed by the frame members must be double miter-cut to fit accurately in the corners.

(7) If the end struts of a side panel are not backed up by diagonal braces, they must be reinforced with corner blocks, nailed to the upper and lower frame members, respectively. The purpose of these blocks is to prevent the struts from being dislocated by impacts or pressure on the end of the crate.

**f. Lower Edge Members.**

(1) Lower edge members should be nominal 2 by 4's.

(2) Lower edge members of end panels will rest on end floor members and, as shown in figure 45, must be spaced a distance equal to the thickness of the end floor member, from the end of the sheathing boards.

(3) Lower edge members of side panels will rest on floor boards and, as shown in figure 45, must be spaced a distance equal to the floor board thickness plus the skid thickness less 1/4 inch, from the ends of the sheathing boards.

**g. Upper Edge Members.**

(1) Upper edge members are not rigidly supported throughout their length as are the lower edge members and, therefore, are often required to be stronger, to carry the weight of the stacked loads. The required size of upper edge members is shown in table 14, with the exception that the width of upper edge members of side panels must be at least as great as the depth (width of lumber) of the top joists. This may require a greater width than that shown in the table.

**TABLE 14 — NOMINAL SIZE (IN INCHES) OF UPPER EDGE MEMBERS**

SPAN BETWEEN VERTICAL STRUTS (CENTER TO CENTER)	WIDTH OF CRATE (INCHES)										
	0-42	48	54	60	66	72	78	84	90	96	
0-48	2 x 4	2 x 4	Length of Vertical Strut 40 Inches or Less				2 x 6	2 x 6	2 x 6	2 x 6	
			2 x 4	2 x 4	2 x 4	2 x 4	2 x 6	2 x 6	2 x 6	2 x 6	
0-30	2 x 4	2 x 4	Length of Vertical Strut Over 40 Inches							2 x 6	2 x 6
36	2 x 4	2 x 4	2 x 4	2 x 4	2 x 4	2 x 4	2 x 6	2 x 6	2 x 6	2 x 8	
42	2 x 4	2 x 4	2 x 4	2 x 6	2 x 6	2 x 6	2 x 8	2 x 8	2 x 8	2 x 8	
48	2 x 4	2 x 4	2 x 4	2 x 6	2 x 6	2 x 8	2 x 8	2 x 8	2 x 8	2 x 8	

Note: Width of top edge members must be at least as great as depth of top joists, regardless of sizes shown in this table.

INSTRUCTION GUIDE — ORDNANCE PACKAGING AND SHIPPING (POSTS, CAMPS, AND STATIONS)

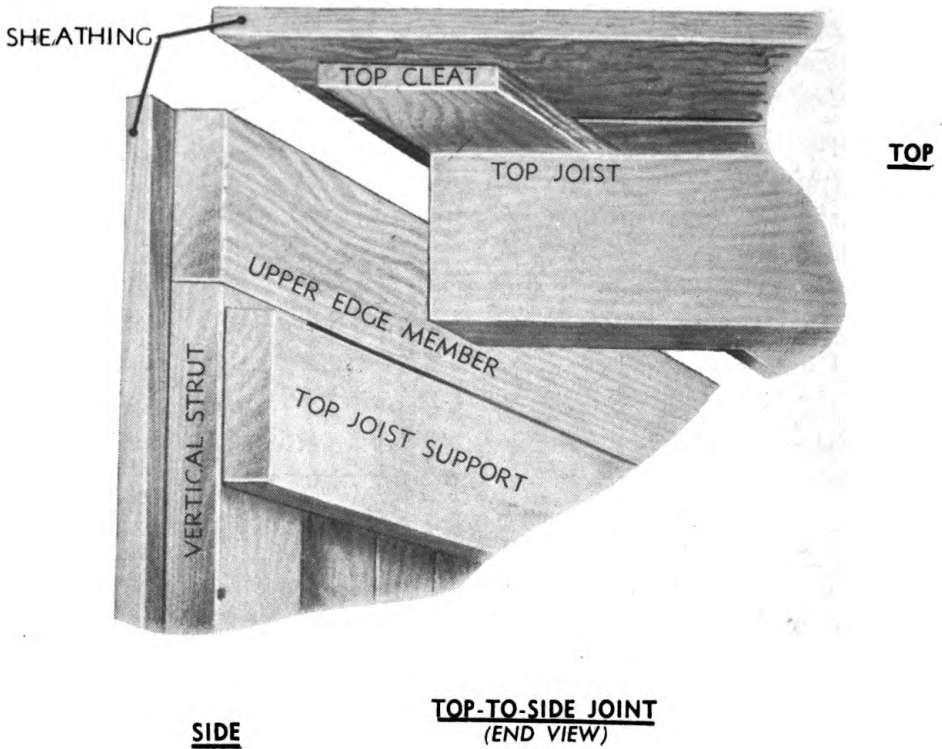
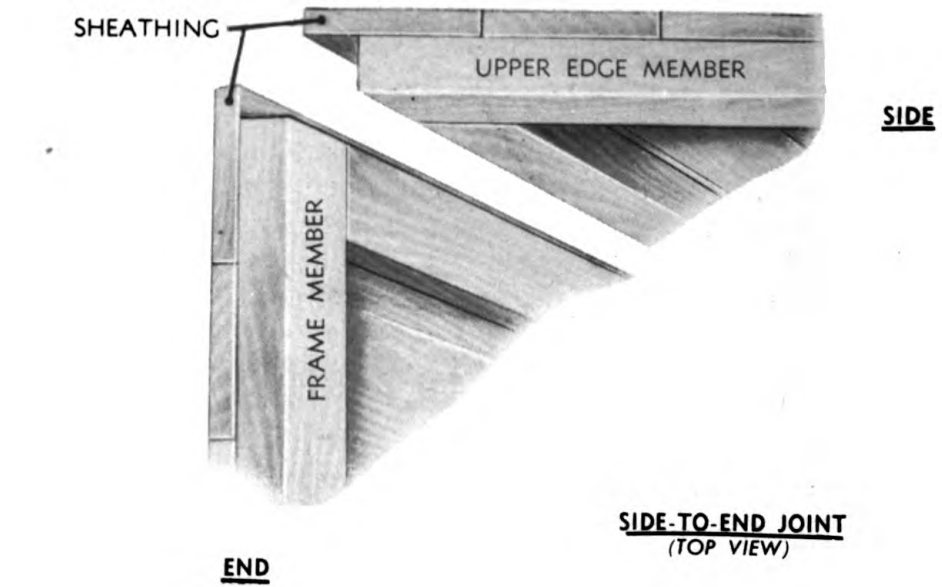

RA PD 89252

Figure 46 — Details of Crate Joints

## FULLY SHEATHED, NAILED WOOD CRATES

(2) Upper edge members of end panels need not be larger than 2 by 6.

(3) The top edges of the upper edge members will be flush with the ends of the sheathing boards.

**h. Nailing of Sheathing.** Sheathing must be nailed to all frame members in a panel, including edge members, vertical struts, and diagonal braces, with ninepenny or tenpenny nails. The nails must be clinched in the frame members. When nailing into horizontal and diagonal frame members nominally 4 to 6 inches wide, arrange nails in three rows and stagger them between rows. At each intersection, there should be three nails per sheathing board up to 6 inches wide, and four nails per board over 6 inches wide. When nailing into horizontal frame members nominally 8 inches wide, use four rows of nails, with four nails per board 6 inches wide and five nails per board over 6 inches wide. When nailing into vertical struts nominally 4 to 6 inches wide, use two rows of nails, 6 inches apart in each row and staggered between rows. Nails should be not less than  $\frac{3}{4}$  inch from the edge of any board or frame member.

**i. Top Joist Supports.** Top joist supports must be nominal 2 by 6's. They must be fastened to the side panels at a distance from the upper edge equal to the thickness of the top cleats (if used) plus the depth of the top joints, as shown in figure 46. Use twelpenny cement-coated nails, three at each intersection with vertical struts and two at each intersection with diagonal braces. If the top joist support overlaps the upper edge member at least  $1\frac{1}{2}$  inches, one row of nails spaced 12 inches apart should also be driven through the support into the edge member.

### 34. ASSEMBLING CRATE.

**a. Fastening Sides and Ends to Base.** When a crate is lifted with grabhooks, the nails fastening the sides and ends to the base must carry the entire weight of the contents and base. It is especially important, therefore, that this nailing be correctly done. Nails fastening side and end sheathing to skids and end floor members should be placed not less than  $\frac{1}{2}$  inch from the end of a sheathing board, and should be staggered as much as practicable. Two nails should be driven through each nominal 4-inch sheathing board, three nails through each 6-inch board, and four nails through each 8-inch board. For nailing into nominal 2-inch depth skids and end floor members, use tenpenny cement-coated nails. For nailing into nominal 3-inch or 4-inch depth skids, use twelpenny cement-coated nails.

#### **b. Fastening Ends to Sides.**

(1) Nail through end sheathing and end frame members into side frame members, using twentypenny cement-coated nails, spaced about 12 inches apart and staggered slightly.

**INSTRUCTION GUIDE — ORDNANCE PACKAGING AND SHIPPING (POSTS, CAMPS, AND STATIONS)**

(2) Nail side sheathing to end frame members, using sevenpenny or eightpenny cement-coated nails, spaced about 6 inches apart and staggered.

(3) Nail end sheathing to the edges of side sheathing, using sevenpenny or sixpenny cement-coated nails, spaced about 6 inches apart.

**c. Fastening Top to Sides and Ends.**

(1) Nail ends of top sheathing boards to upper edge members of sides with tenpenny cement-coated nails, staggered as much as practicable. Two nails should be driven through each nominal 4-inch board, three nails through each 6-inch board, and four nails through each 8-inch board.

(2) Nail top sheathing to upper edge members of ends with tenpenny cement-coated nails, spaced .6 inches apart and staggered slightly.

(3) Nail through side sheathing and upper frame members of sides into ends of top joists with twentypenny nails. Use two nails for the end of a nominal 4-inch joist, three nails for a nominal 6-inch joist, and four nails for a nominal 8-inch joist. (If joists are placed flatwise, this nailing is not necessary, as the nails fastening the joists to the top are sufficient to hold them in position.) Before the top is fastened, the position of the top joists must be marked on the sides so that these nails can be located properly.

(4) An alternate method of assembling the top joists is to omit fastening them to the top until the crate is assembled. By this method the top joists are separately placed on the top joist supports and fastened to the sides as specified in step (3), above. The location of the two edges of each top joist should then be marked on the sides, and the marks extended to lines across the top after the top is in place, for convenience in nailing through the top sheathing into the top joists (par. 32 c (5)).

**35. REINFORCING CRATE.**

a. Crate corners must be reinforced before crate topcoating material is applied (par. 30). Each top corner should be reinforced with three pieces of strapping, each about 11 inches long, fastened as shown in figure 37, over frame members. One strap should be applied over side and end at each bottom corner of the crate (fig. 37). In addition, the vertical edges of the crate and the horizontal edges around the top should be reinforced with single straps at intervals

## SKID UNITS

of about 48 inches. Each strap should be fastened with six nails, three in each panel, spaced about  $1\frac{1}{2}$  inches apart. Prepunched annealed band, 1 to  $1\frac{1}{4}$  inches wide and 0.028 inch thick, or standard corner irons, 1 by 0.0625 inch, may be used. If neither of these is available,  $1\frac{1}{4}$ - by 0.035-inch high-tensile flat band may be substituted.

---

### Section VI

## SKID UNITS

### 36. GENERAL.

a. When shipment is made of a large machine part, such as a base casting having no exposed highly finished surfaces and so constructed as not to be easily damaged by shocks or exposure to weather, complete crating will usually be unnecessary. In such instances much time and lumber can be saved by constructing skid units instead of complete crates or boxes.

(1) Examples of items that can be shipped on skid units either overseas or within the continental limits of the United States are:

Artillery tubes.

Rough castings.

(2) Examples of items that can be shipped on skid units within the continental United States only are:

Artillery recoil mechanisms.

Engine-driven compressors and generators.

Final drive assemblies for tanks.

Machine tools.

(3) If a part of an item on a skid unit needs protection, it may be possible to secure a kind of box or nailed wood housing over that part. On some items it will be desirable to use shrouds as described in paragraph 24 c. In constructing skid units it is necessary to use special care in regard to fastenings, since there are relatively few fastenings and all of the strains imposed by handling and shipment must be resisted by these few fastenings. Lumber or timbers should be selected so that large knots or other weak sections do not occur at or near a fastening point, nor approximately in the center of an unsupported span.

**INSTRUCTION GUIDE — ORDNANCE PACKAGING AND SHIPPING (POSTS, CAMPS, AND STATIONS)**

**37. CONSTRUCTION OF SKID UNIT.**

a. **Over-all Dimensions.** The over-all dimensions of a skid unit should be figured similarly to the dimensions of the base for a crate (par. 28 b). An item that is top-heavy or has a high center of gravity needs a relatively larger skid unit to prevent its tipping over and, thereby, endangering the handlers. Consideration should be given to the need for space to apply adequate end and side blocking to prevent slippage of the item on the skid unit. If the item is heavy, back-up cleats similar to those used in carloading (ch. 5) may be needed to reinforce the blocking.

b. **Number of Skids.** If the over-all width of the skid unit is more than 4 feet, at least three skids must be used. If the over-all width is more than 8 feet, at least four skids must be used. Skids must not be spaced more than 4 feet apart, center to center. Proper fastening of the item to the skid unit (subpar. g below), should also be considered in determining the number and spacing of the skids.

c. **Size of Skids.**

(1) Depth and width of skids is determined by referring to table 15 which permits a choice of skid sizes according to sizes of lumber or timber available. The widths shown in table 15 refer to the total of widths of all skids, measured horizontally, when the skids are in position as parts of the skid unit. If a small depth of skid is used, the width of skids is made greater as indicated by the table, to provide the necessary strength to carry the load. If the actual load to be carried is not shown in the table, use the skid sizes shown for the next greater load.

(2) Sizes shown in table 15 are for wood group II or III (par. 16 b). If the wood is group I, the width of skids must be increased one-fifth; if the wood is group IV, the width may be reduced one-seventh.

(3) To save lumber, skids larger than 4 by 4 should be placed on their narrow faces, but the depth of a skid must not be more than  $1\frac{1}{2}$  times its width. (Example: A 4 x 6 skid can be placed on the 4-inch face, but a 4 by 8 skid cannot be placed on the 4-inch face because its depth would then be 2 times its width and there would be danger of its tipping over.)



SKID UNITS

TABLE 15 — TOTAL WIDTH OF SKIDS REQUIRED FOR SKID UNITS (GROUP II OR III WOOD)

LOAD (POUNDS)	NOMINAL DEPTH OF SKIDS	TOTAL ACTUAL WIDTH OF SKIDS FOR EACH LENGTH OF SKIDS							
		2 FT	3 FT	4 FT	5 FT	6 FT	8 FT	10 FT	12 FT
	Inches	Inches	Inches	Inches	Inches	Inches	Inches	Inches	Inches
1,000	2	6	9	12	14	18	24	—	—
	3	3	4	5	6	7	9	11	13
	4	2	2	3	3	4	6	7	8
2,000	2	12	18	23	29	—	—	—	—
	3	5	7	9	11	13	18	22	26
	4	3	4	5	6	7	10	12	14
3,000	3	7	10	14	17	20	26	33	—
	4	4	6	7	9	11	14	17	21
	6	—	—	—	4	5	6	7	9
4,000	3	9	14	18	22	26	35	—	—
	4	5	7	10	12	14	20	23	28
	6	—	—	4	5	6	8	10	12
5,000	4	6	9	11	15	18	22	29	—
	6	3	4	5	6	8	10	12	15
	8	—	—	—	—	—	—	7	8
6,000	4	7	11	14	18	21	28	—	—
	6	3	5	6	7	9	12	15	17
	8	—	—	—	—	—	—	8	10
7,000	4	8	12	16	20	24	32	—	—
	6	4	6	7	9	10	14	17	20
	8	—	—	—	—	—	8	10	12
8,000	4	9	14	19	23	28	—	—	—
	6	4	5	8	10	12	15	19	23
	8	—	—	—	—	7	9	11	13
9,000	4	11	16	21	26	31	—	—	—
	6	5	7	9	11	13	17	22	26
	8	—	—	—	—	8	10	12	15
10,000	4	12	17	23	29	—	—	—	—
	6	5	7	10	12	15	19	24	29
	8	—	—	—	7	8	11	14	16
12,000	4	14	21	28	—	—	—	—	—
	6	6	9	12	15	17	23	29	34
	8	—	—	7	8	10	13	16	20
14,000	4	16	24	32	—	—	—	—	—
	6	7	10	14	17	20	27	34	—
	8	—	—	8	10	12	15	19	23
16,000	4	19	28	—	—	—	—	—	—
	6	8	12	15	19	23	31	—	—
	8	—	7	9	11	13	17	22	26
18,000	4	21	31	—	—	—	—	—	—
	6	9	13	17	22	26	34	—	—
	8	—	8	10	12	15	20	24	29
20,000	4	23	35	—	—	—	—	—	—
	6	10	15	19	24	29	38	—	—
	8	—	8	11	14	16	22	27	32

Notes:

1. Skids of group I wood must be one-fifth wider; skids of group IV wood may be one-seventh narrower.
2. Skids larger than 4 by 4 should be placed on narrow faces (to save lumber), but the depth of a skid not be more than 1½ times its width.
3. Width shown refers to actual width, not nominal width.
4. Some of the smaller total widths shown must be increased to give practical skids. These widths, however, may be applied directly in using this table for load-bearing cross members.

## INSTRUCTION GUIDE — ORDNANCE PACKAGING AND SHIPPING (POSTS, CAMPS, AND STATIONS)

(4) **EXAMPLE OF USE OF SKID TABLE.** Assume that the load to be carried is 3,700 pounds, the necessary width of the skid unit is 5 feet, and the necessary length of skids is 8 feet. A width of 5 feet requires that at least three skids be used. In table 15, refer to the load 4,000 pounds (next greater than 3,700 pounds) in the first column and read across to the column for a length of 8 feet. Three different total widths that could be used are shown as follows: 35 inches for skids of 3-inch depth, 20 inches for skids of 4-inch depth, and 8 inches for skids of 6-inch depth. (Depths are shown in the second column of the table.) If skids of 6-inch depth are used, each of the three required must be at least 4 inches (actually  $3\frac{5}{8}$  inches) wide, as stated in step (3), above. Since  $3 \times 3\frac{5}{8} = 10\frac{7}{8}$ , which exceeds the required total width of 8 inches, the three 4 by 6 skids would have more than adequate strength. If skids of 4-inch depth are used, the requirement of 20-inch total width can be met with three skids each nominally 8 inches wide ( $3 \times 7\frac{1}{2} = 22\frac{1}{2}$ ) or six skids each nominally 4 inches wide ( $6 \times 3\frac{5}{8} = 21\frac{3}{4}$ ). Of the choices, the three 4 by 6 skids or the three 4 by 8 skids appear to require the least labor, and the 4 by 6 skids resting on 4-inch faces use the least lumber. The method chosen for fastening the item to the base, however, may make the use of four or five skids of 3-inch or 4-inch depth more practical. Dimensions of these skids would be figured in the manner already described.

(5) Sizes of skids for lengths greater than 12 feet may be obtained by multiplication of the figures shown. Example: Assume that the load is 5,000 pounds, the depth of skid material available is nominally 6 inches, and the length of skids is 16 feet. For skids one-half as long, that is, 8 feet, the total width required is 10 inches. For the 16-foot skids, twice that total width, or 20 inches, will be required. This requirement can be met by using four nominal 6 by 6 skids or three nominal 6 by 8 (actually  $5\frac{5}{8}$ - by  $7\frac{1}{2}$ -inch skids), or other combinations of numbers and sizes.

**d. End Cross Members.** The cross member at each end of the skid unit is intended to tie the skids together securely, and should be not less than the same width and thickness as one of the skids. For example, if three 4 by 6 skids are required, the end cross members also should be at least 4 by 6. Frequently these cross members can also serve as cross blocks, in contact with the ends of the base of the item. A modification of this method is to use cross blocks fitted tightly between the item and the end cross members, so that the latter serve the purpose of back-up blocks. End cross members must be fastened to skids with two bolts at each intersection. *NOTE: Before fastening, make sure that all skids are exactly parallel.* Carriage or step bolts, having rounded heads and square shanks near the heads, should be used. Holes bored for the bolts must be of the

## SKID UNITS

same diameter as the bolts. Heads of the bolts must be at the bottom of the skids. Large standard cut washers should be used under the nuts. After nuts are tightened, the bolt threads above the nuts should be upset or painted with asphalt or unthinned lead paint to prevent the nuts from working loose. Lag screws should *not* be used in place of bolts. Following is a guide for selection of bolt sizes:

Depth of Skids and End Cross Members (Inches)	Diameter of Bolts (Inch)
1 <sup>5</sup> / <sub>8</sub> to 2 <sup>5</sup> / <sub>8</sub>	3/8
Over 2 <sup>5</sup> / <sub>8</sub> to 3 <sup>1</sup> / <sub>2</sub>	1/2
Over 3 <sup>5</sup> / <sub>8</sub> to 6	5/8
Over 6 to 8	3/4

### e. Load-bearing Cross Members.

(1) Determine the required thickness of load-bearing cross members from table 15, as if the floor boards were skids. The width of floor boards for a load-bearing area is to be substituted for the total width of skids shown in the table. Use the load shown in the first column of the table which is equal to or greater than the estimated weight of load resting on that load-bearing area. (The load will not always be divided equally between two or more load-bearing areas, and the portion of the load to be carried on one area must then be estimated.) The length of the cross members should be considered as the greatest distance between two adjacent skids.

(2) Example: Determine the size of load-bearing cross members where the greatest distance between skids is 3 feet, and where the item weighs 4,000 pounds, three-fourths of which weight is estimated to bear on one load-bearing area which measures 7<sup>1</sup>/<sub>2</sub> inches lengthwise of the skid unit. In table 15, refer to the load 3,000 pounds (three-fourths of 4,000 pounds) in the first column and read across to the fourth column, for 3 feet. In the latter column two widths, 10 inches and 6 inches, are shown. The actual load-bearing width, as previously stated, is only 7<sup>1</sup>/<sub>2</sub> inches and to use the depth required for a width of 10 inches would probably not give sufficient depth or thickness of load-bearing members. The width of 6 inches, therefore, should be used in determining adequate depth. From the number 6 in the fourth column, follow the same horizontal line back to the second column, which shows a nominal depth of 4 inches required. A nominal 4 by 8, dressed to 3<sup>5</sup>/<sub>8</sub> by 7<sup>1</sup>/<sub>2</sub> inches, will meet the requirements for this load-bearing area. If group I wood is used, members are required to be one-fifth wider than the values shown in the table, but in this instance the actual width, 7<sup>1</sup>/<sub>2</sub> inches, is one-fourth greater than the width shown, 6 inches; therefore, a 4 by 8 of wood of any group is satisfactory. For the load-bearing cross members

INSTRUCTION GUIDE — ORDNANCE PACKAGING AND SHIPPING (POSTS, CAMPS, AND STATIONS)

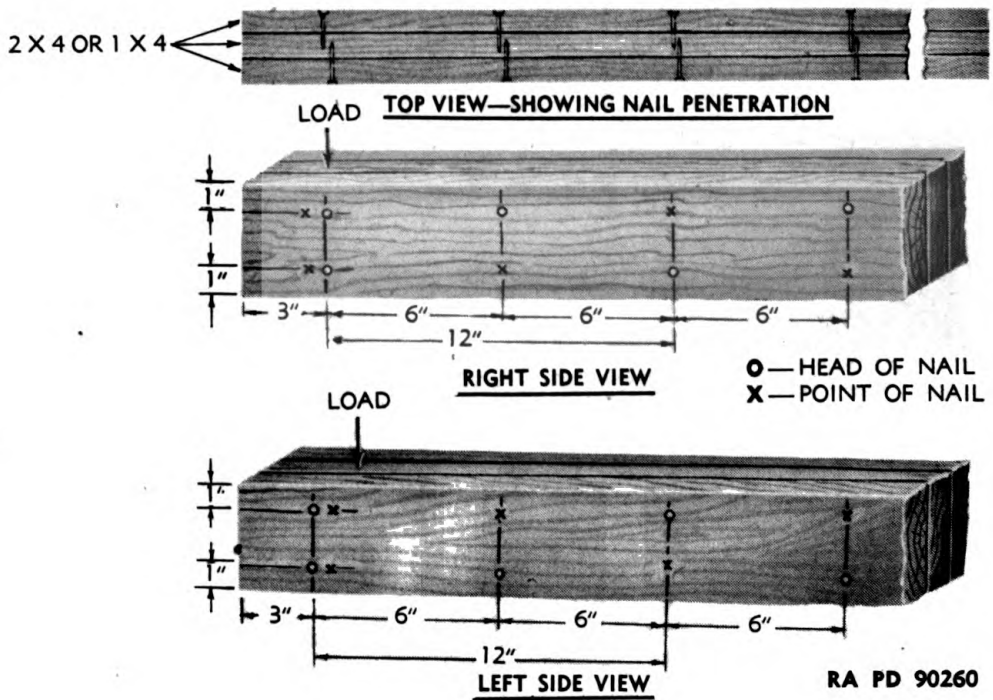

**Figure 47 — Method of Fabricating Skid of 4-inch Depth From Full-length Pieces of 2 by 4 Lumber**

carrying the remaining 1,000 pounds of the item's weight, minimum thickness is determined similarly.

(3) The actual width of load-bearing cross members selected should not be much greater than the same dimension of the load resting on them. If the load rests on only part of the width of a board, the board may split and thus become inadequate in strength. It, therefore, will usually be better to increase the thickness instead of the width of boards, to meet the requirements of table 15.

(4) If lumber thicker than 2 inches is not available for load-bearing cross members, and a 4-inch depth, for example, is required, the cross members can be fabricated using several 2 by 4's on edge, nailed together, as described in detail in subparagraph h, below.

(5) Load-bearing cross members shall be fastened to each skid. If the cross members are not over 3 inches thick, nails of the size indicated by table 9 shall be used. The nails should be placed approximately 2 inches apart in staggered patterns to avoid splitting the wood. If the load-bearing cross members are over 3 inches thick, lag screws or, preferably, through-bolts must be used instead of nails. Being of larger diameter, the lag screws or bolts should be spaced

SKID UNITS

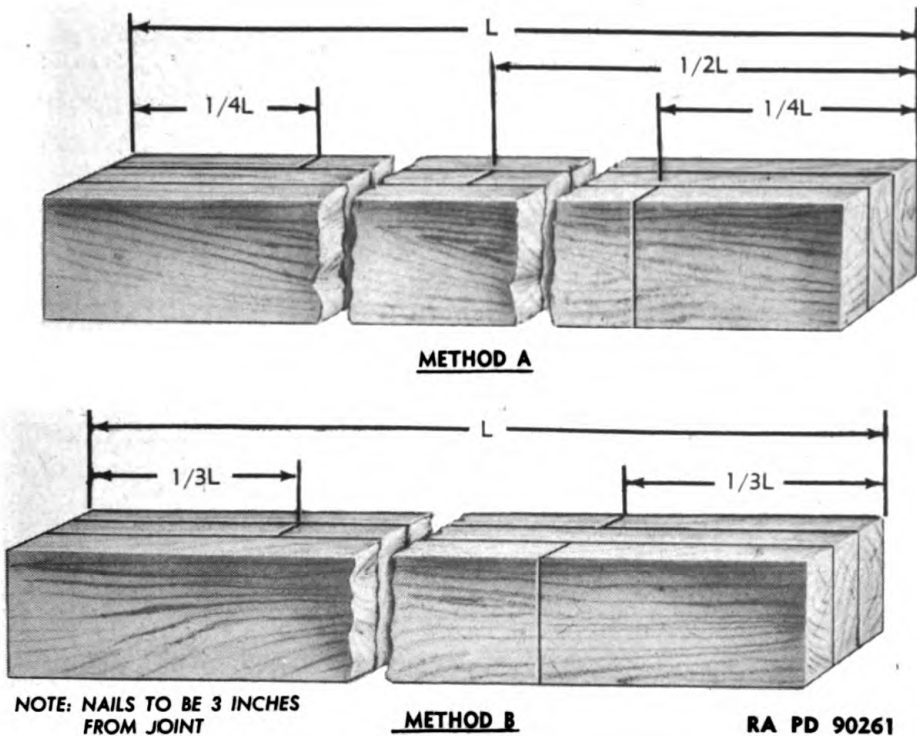

**Figure 48 — Methods of Fabricating Skid From Pieces of Lumber Shorter Than Full Length**

about 3 inches apart. Lag screws must be turned in with a wrench, not driven with a hammer, and care exercised to avoid turning them too many revolutions and thus destroying the threads cut in the wood. Holes should be drilled for either large nails or lag screws. These should be 75 percent of the diameter of the nail if the wood is soft, or 90 percent of the diameter of the nail if the wood is very hard (group IV, such as oak). For lag screws, the holes should be 75 to 80 percent of the diameter of the screw.

**f. Diagonal Braces.**

(1) If the item has a very strong, heavy base that cannot be broken or damaged when subjected to twisting and distorting strains in handling and shipment, diagonal bracing will not be needed in the skid unit. In this case the item itself acts as a diagonal brace. An example of such an item is a pedestal or column-base type of machine tool. For other kinds of items, such as leg, end-frame, or side-frame types of machines, or long, narrow items such as artillery tubes which do not tend to afford diagonal bracing to the skid unit, diagonal braces should be used if possible. One diagonal brace is more effective in adding rigidity than several crosspieces.

**INSTRUCTION GUIDE — ORDNANCE PACKAGING AND SHIPPING (POSTS, CAMPS, AND STATIONS)**

(2) The diagonal brace or braces should be nominal 1 by 6 as a minimum for light loads and small skid units. Lumber of larger cross section is needed for heavier loads and larger skid units. Diagonals should be applied at as near an angle of 45 degrees to the skids as possible. Depending on the space available, diagonals may be used singly, in the form of an X, or in the form of a V. Diagonals must be nailed to each skid with at least three nails of the size shown in table 9, well staggered. X-diagonals should be nailed to each other at the point of intersection with two nails, clinched.

**g. Fastening of Item to Skid Unit.** Holes in the base of a machine or similar item must be utilized for fastening to the skid unit. If there are four or more holes in the base, the item shall be bolted to the skid unit with not less than four bolts. Lag screws must *not* be used for this purpose. Standard carriage bolts or step bolts shall be used, and the bolt diameter shall be determined by the diameter of the holes in the base of the item. The bolts must pass through as many of the skids as possible and not through the cross members only. Application of the bolts should be as previously described in subparagraph d, above. If the item has no base with bolt holes, it may be secured with heavy wire attached to the end cross members. Flat bands may also be used, attached to the end cross members or fastened to the skids by means of anchor plates. Another possible method is to use vertical tie rods, extending through the outside skids and through two or more 2 by 4's, or larger, crosspieces resting on substantial parts of the top of the item. A combination of these methods of fastening may be the most practical and effective.

**h. Fabricating Large Skids From 2-inch Lumber.** If lumber or timber of the size required for skids is not available, the skids can be fabricated or built up from 2-inch lumber, as illustrated in figures 47 and 48. To build up skids of greater width, fasten three pieces together as shown in the sketches; then nail additional pieces on alternate sides. Use sixteenpenny nails in fastening 2-inch pieces together; use eightpenny nails in case 1-inch lumber is employed. The effective width of skids can also be increased by nailing 2 by 4's to 4 by 4's, etc. For built-up skids of nominal 6-inch depth, use the same nail spacing as that shown in figure 47, but add another row of nails at the center. When the built-up skids are in use, the 2-inch pieces should always be on edge.

CHAPTER 4  
IDENTIFICATION AND MARKING

---

Section I

REQUIREMENTS FOR IDENTIFICATION

38. DIFFERENCE BETWEEN IDENTIFICATION AND MARKING.

a. "Identification" refers to description of the contents of a package; "marking" refers to information placed on a shipping container or package so that it will go to the proper destination, so that the shipment will be kept together and not mixed with other shipments, and for the guidance of handlers en route.

39. NEED FOR IDENTIFICATION.

a. No matter how well a package or shipping container may be made, it is of little value at destination if the contents are not known or cannot be identified. A part is of no value unless its name or number and the assembly to which it belongs can be determined. Correct identification of contents will eliminate the useless breaking open of shipping boxes and inner packages for determining what is inside. Lack of correct identification will cause enormous waste of time and material. Identification must be given on the shipping document in exactly the same form as it is given on the container or the item itself. (Shipping documents should be prepared in accordance with ASF Manual M403 and ASF Manual M401.)

40. INFORMATION TO BE INCLUDED.

a. The following items of information are required for proper identification:

(1) FOR MAJOR ITEMS.

(a) Quantity.

(b) Exact name of item, including model or type number (ordnance nomenclature).

(2) FOR PARTS.

(a) Quantity.

(b) Exact name of part, including model or type number (ordnance nomenclature).

(c) Name of major item to which part belongs.

(d) SNL group number (example: SNL B-28, for carbine parts).

**INSTRUCTION GUIDE — ORDNANCE PACKAGING AND SHIPPING (POSTS, CAMPS, AND STATIONS)**

(e) Item stock number or ordnance drawing number (if available).

(f) Name of manufacturer and manufacturer's part number (if available).

**41. IDENTIFICATION ON THE ITEM OR THE INNER PACKAGE.**

**a. General.** If an inner package, such as a wrapper, envelope, or carton, encloses the item or items so that exact names, numbers, and quantity cannot be determined without opening the package, proper identification should be placed on the inner package. Many major items and large subassemblies will not be completely enclosed in a package or wrapper, and it will be more practical to attach the identifying label or tag directly to the materiel rather than the package. The numbers given on the housing or cover plate of a subassembly may be misleading, as such numbers may apply to the housing or cover plate only, not the subassembly as a whole. As much as possible of the information listed in paragraph 40 should be placed on the item in such instances. Some major items, however, have the ordnance nomenclature printed plainly on a name plate or embossed on some conspicuous part of the assembly. This eliminates any need to attach a label or tag to the item itself.

**b. Application.**

(1) **LABELS.** The identification should be typed or written in waterproof ink. The label should be attached with waterproof glue and covered with a waterproof protective lacquer. If the inner package is a Method I-A sealed wrap, an alternative procedure is to place the label directly on the film of dip-coating sealing compound, while it is still warm, then cover just the edges of the label with heated compound (fig. 5), using a brush. The label will adhere well to the warm compound. A duplicate label should be attached to the overwrapping of kraft paper (fig. 5). If the label is not gummed, its edges may be secured with gummed paper tape, or the identification may be typewritten directly on the tape before its application to the overwrap.

(2) **ENVELOPES.** Identification may be typewritten directly on small envelopes, or hand-lettered thereon in waterproof ink.

(3) **TAGS.** Tags may be cloth, waterproof paper, or other suitable material, and should be attached with annealed wire through a substantial eyelet. The wire should not be used where it can cut through



## REQUIREMENTS FOR IDENTIFICATION

waterproof and greaseproof wrappers. After the identification has been typewritten or hand-lettered on a paper tag, the tag can be waterproofed with a thin film of dip-coating sealing compound, thoroughly heated.

(4) **STENCILING OR LETTERING.** For stenciling or lettering directly on the item or on a container (wood or metal), stencil paint, black or white, should be used.

### 42. IDENTIFICATION ON SHIPPING CONTAINER.

**a. For Overseas Shipment.** For instructions pertaining to identification on shipping containers for overseas movement, refer to POM, AG 370.5 (latest edition). Identification is to be placed on all items shipped, whether they are unboxed vehicles or other major items, or are in bundles, bags, boxes, or crates.

#### **b. For Domestic Shipment.**

(1) Old markings on shipping containers must be planed, scraped, or sanded off, or effectively painted over with special obliterating paint.

(2) Identification should be stenciled or lettered in characters at least  $\frac{1}{2}$  inch high, using stencil paint, black or white.

(3) Identification must be placed on both ends of the container near the top, or if the ends are too small, on both sides of the container near the top.

(4) If the shipping box or other shipping package contains one item or identical items, the quantity, exact name (ordnance nomenclature), and SNL group number must be included in the identification.

(5) If the shipping box contains more than one kind of item, only a brief description of the contents, such as "Spare parts for Carbine, cal. .30, M1" should be placed on the shipping box.

(6) If the shipping box contains more than one kind of item and is shipped LCL (less than carload lot) or LTL (less than truckload lot), two packing lists giving items of information listed in paragraph 40 are required. One packing list is placed inside the box in a conspicuous place. The other packing list is placed in a waterproof envelope and tacked to the outside of the box, between the cleats on the end or in the most protected location.

**NOTE:** *For convenience in identification and to save the time of those who unpack the container at its destination, items belonging to more than one SNL group or to more than one service should not be packed in the same container. If possible, parts or subassemblies belonging to only one major item should be packed in the same container.*

**Section II**

**MARKING**

**43. MARKING FOR OVERSEAS SHIPMENT.**

**a. General.**

(1) For instructions on marking for overseas shipment, refer to POM, AG 370.5 (latest edition). At least one surface of a container must be free of all markings, other than service color triangles or bands, when it arrives overseas.

(2) For explanation of difference between identification and marking, see paragraph 38.

**44. MARKING FOR DOMESTIC SHIPMENT.**

**a. Information To Be Included.** In addition to the information required for identification (par. 40), the only necessary markings are as follows:

(1) Gross weight.

(2) Consignor in LCL or LTL shipment only.

(3) Consignee LCL or LTC shipment only.

(4) Special markings. (Occasionally special markings will be prescribed. Following are examples of special markings.)

(a) "Delicate. Handle with extreme care."

(b) "Other side up;" or arrows indicating which surface should be up, with the word "UP."

(c) "Sling here," with line indicating center of gravity, for heavy and awkwardly shaped containers.

**b. Application of Marking.**

(1) **PROCEDURE OF MATERIALS.** The instructions given in paragraph 42 b (1) and (2) should be followed for markings. The name and address of consignor and consignee may be written on a label in characters not less than  $\frac{1}{8}$  inch high. The label should be securely attached to the face of the container, and covered with waterproof lacquer.

(2) **LOCATION.** The gross weight, consignor, and consignee should be placed on one side of the container near the top. In general, marking should be confined to the upper two-thirds of the surface of a container.

## CHAPTER 5

### CAR AND TRUCK LOADING

---

#### Section I

#### LOADING BOX CARS

#### 45. GENERAL RULES.

a. **General.** The following rules have been abstracted from the latest issues of pamphlets published by the Operating-Transportation Division, Association of American Railroads, describing safe methods of loading closed cars, and must be observed. Some of these instructions are presented in amplified form for the benefit of personnel who may not be especially familiar with various car-loading procedures.

b. **Preventing Shifting of Load.** Load *must* be so secured that it will not come in contact with side doors or roll or shift crosswise in transit. Unless the snubbing method (par. 56) is used, shifting lengthwise must be prevented. Consideration should be given to the force which the load exerts against bracing or blocking when a car moving at 10 miles per hour comes to a sudden stop. With the lighter types of loads, upward shifting of the load needs to be prevented by top bracing. Loads of a character requiring protection to prevent rolling out at doorway or coming in contact with the door while in transit must have the prescribed stripping across the door opening.

#### c. Load Limits and Distribution of Load.

(1) Cars should be loaded as heavily as possible up to but not exceeding 100 percent of the load limit (not "capacity") as stenciled on the car. Load must be so placed in the car that there will not be more weight on one side of the car than the other. One truck (set of four wheels) must not carry more than one-half of the maximum allowable load for the car. When the load is in small units or in bulk, it should be so placed that the weight will be evenly distributed over the car floor and, if in stacks or piles, the height of the stacks or piles should be kept even or equal so that a general distribution of weight is obtained. Heavy loads must not be placed in two diagonally opposite corners, but should be centered at either end to avoid dangerous weaving of the car in motion.

(2) Because car sills should bear a distributed load and not be overloaded at any point, the percent of stenciled load limits, as shown in figure 49 and in the following tabulation, must not be exceeded for loads located between truck centers (centers over each group of four wheels) measured lengthwise of the car, except when the car owner

INSTRUCTION GUIDE — ORDNANCE PACKAGING AND SHIPPING (POSTS, CAMPS, AND STATIONS)

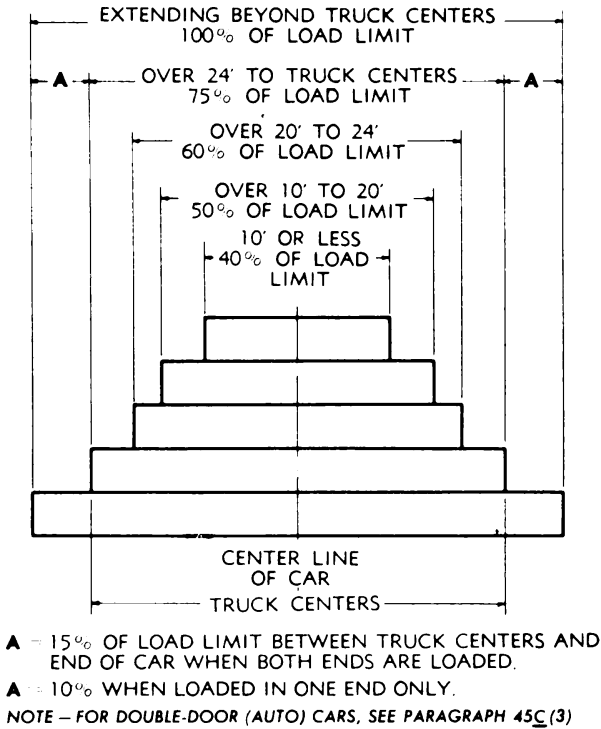

RA PD 90262

Figure 49 — Maximum Permissible Weights To Be Loaded on Indicated Sections of Railroad Car Floor Length

designates otherwise by note in the Official Equipment Register, or by stenciling on the car:

Length of Item or Items Loaded (Feet)	Maximum Weight, Portion of Load Limit (Percent)
10 or less .....	40
Over 10 to 20 .....	50
Over 20 to 24 .....	60
Over 24 to truck centers .....	75
Extending beyond both truck centers .....	100

NOTE: Materiel loaded between truck centers and ends of car **MUST** not exceed 30 percent of the stenciled load limit (i.e. 15 percent each end) when both ends of the car are loaded, or 10 percent when only one end of the car is loaded.

(3) For cars with double doors (auto-box), the weight of the load must be limited to 50 percent of the stenciled load limit over a space of not less than 20 feet for a nominal 40-foot inside length car and 25 feet for a nominal 50-foot inside length car.

(4) If the load is heavier than the limit permitted for the length that the load occupies, the weight must be distributed over a greater

## LOADING BOX CARS

length by placing suitable timbers under the load. For example, an item 18 feet long and weighing more than 50 percent and less than 60 percent of the load limit would need timbers under it extending the length of the load-bearing area to over 20 feet. When crosswise bearing timbers are used on loads exceeding 10 feet in length, the outside crosswise timbers must cover the minimum length for the weight of the load as specified in the above tabulation. If the load is made up of small, heavy units, it must be distributed over the required space even though its size would permit stacking in a much smaller space.

**d. Bracing and Blocking of Machines.** Machines and other items having a high center of gravity or a narrow base must be braced above the center of gravity to prevent them from tipping over in transit. Cross braces secured to the car walls with pocket cleats (par. 50) may be used on two sides of the materiel to prevent tipping lengthwise of the car, and pieces nailed from cross brace to cross brace to prevent tipping sidewise. Diagonal braces may be used instead, but they occupy more car space than cross car braces. If diagonals are used, they should extend from the car floor to points above the center of gravity of the item, and each diagonal must have a back-up cleat nailed to the floor. Minimize bowing of diagonals by use of knee braces. To prevent shifting of a machine at the base, floor blocking will also be needed (par. 49).

**e. Mixed Shipments.**

(1) In mixed carload shipments, the various types of containers must be segregated, with heavy objects such as drums and barrels in the ends of the car, followed by pails if in the shipment, and cartons or wood cases in the center of the car. Some form of protection must be placed between the various types of containers. Use a gate similar to that shown in figure 50, with face boards nailed to both sides.

(2) If a load consists of wooden and of fiberboard containers, the wooden cases should be loaded in one end of the car and the fiberboard in the other. If there are only a few fiberboard boxes, they should be placed in the doorway area and the necessary doorway protection applied.

(3) Containers of any type should be placed on their largest faces so that their position is as stable as possible, unless there are markings or other indications (such as skids) showing that a certain face should be downward.

## 46. CARS.

**a.** Cars ready for loading should be clean, have sound roofs, floors, sides, and end walls, and be free from protruding nails or other projections. Any projecting nails or blocking that may have been left

INSTRUCTION GUIDE — ORDNANCE PACKAGING AND SHIPPING (POSTS, CAMPS, AND STATIONS)

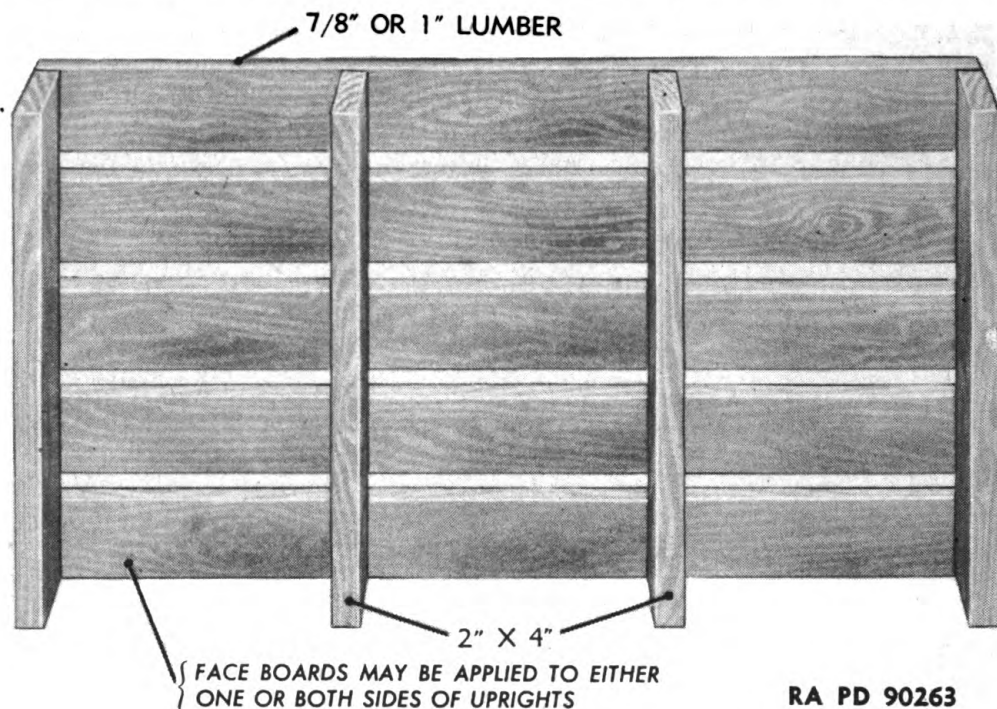

Figure 50 — Bulkhead or Gate for Heavy Loads

from previous loads must be removed. Freight loaded in vehicle cars with end doors must be securely protected against end shifting, and loaded in such a manner that it will not come in contact with end doors. If lift trucks or other trucks are used in loading, temporary steel plates should be used, especially near the car door to prevent heavy loads from breaking through the car floor.

#### 47. LUMBER FOR BRACING AND BLOCKING.

a. Refer to paragraph 16 for pertinent information for the selection and care of lumber. Always select the best materials available for cross car bracing and diagonals.

#### 48. NAILS AND NAILING.

a. For general rules of nailing, refer to paragraph 19. **NOTE:** *The use of cement-coated nails is prescribed as they have greater holding power than common nails.*

b. **Size of Nails.** Nails should be long enough to give the necessary holding power. If possible, about two-thirds of the length of the nail should enter the timber holding the point of the nail. Standard lengths of nails are given in table 16. For nailing a block nominally 2 inches thick to a car floor or other 2-inch lumber, use thirtypenny or twentypenny cement-coated nails. For fastening a block nominally

**LOADING BOX CARS**

4 inches thick, predrill holes and use sixtypenny nails, spaced 6 inches apart and staggered; however, it is better to build up blocks with 2-inch material. If nails of the best size are not available, use the next smaller size and use more nails. The diameter of the nails should be such that they will not cause splitting. If splitting occurs, use thinner nails, or blunt the points.

**TABLE 16 — LENGTHS OF NAILS USED FOR BRACING AND BLOCKING IN FREIGHT CARS**

SIZE OF NAIL	KIND OF NAIL	
	Common	Cement-coated Sinkers <sup>1</sup>
<b>Penny</b>	<b>Inches</b>	<b>Inches</b>
twenty	4	3¾
thirty	4½	4¼
forty	5	4¾
fifty	5½	5¼
sixty	6	5¾

<sup>1</sup>Cement-coated corks are 1/8 inch longer than the corresponding size of cement-coated sinkers.

**c. Number of Nails.** The strength increases directly with the number of nails used if the wood is not split. Balanced nailing is important. The proper balance is reached when there is equal likelihood of the wood failing, or the nails breaking off or pulling out of the brace or the car structure. The number required to obtain full strength of the timber depends on the quality of the brace and arrangement of the cleat. A dry 2 x 6 timber placed on its edge against the load requires three to six twentypenny nails in the lengthwise member of the pocket cleat at each end. Complete balance comes with the use of six nails, and with at least three of them driven through the cleat into a side stanchion or upright in the car wall.

**d. Method of Nailing.** Refer to paragraphs 19 and 20 b.

(1) As the lining of cars is only ¾ to 7/8 of an inch thick, it has little holding power for large nails. Blocking on side walls should therefore be so nailed that several of the nails are driven into the heavy uprights.

(2) Avoid toenailing whenever possible. Do not nail on a slant as shown in figure 51.

(3) To facilitate the driving of nails in hardwood and to increase holding power, a hole approximately 75 percent of the diameter of the nail should first be drilled in the material.

(4) Whenever possible, drive the nails so that the direction of the force to be resisted will be at right angles to the nails. Nails are much more likely to be pulled out if the direction of force is parallel to the nails.

INSTRUCTION GUIDE — ORDNANCE PACKAGING AND SHIPPING (POSTS, CAMPS, AND STATIONS)

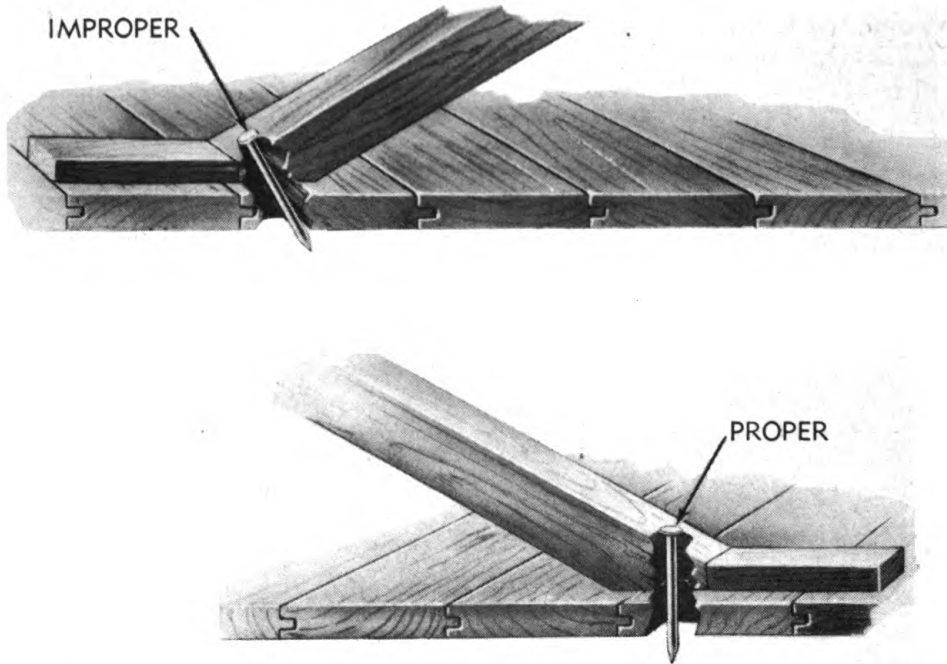

RA PD 90264

**Figure 51 — Proper and Improper Methods of Nailing Diagonal Brace to Car Floor**

(5) Bolts are best for securing heavy bracing material, though it is usually impractical to put bolts through the car floor. If bolts are passed through the floor, they must pass also through a 2-inch group IV wood sleeper under the car floor boards, at right angles to them and in contact with at least three floor boards. Lag screws are not permitted. See paragraph 20 b (7) for method of applying bolts.

**49. FLOOR BLOCKING.**

a. **Application.** All floor blocking must be securely nailed, and backed with cleats at least 12 inches in length (fig. 52). Nails should be driven straight. Avoid application of blocking on weakened parts of car floors.

b. **Blocking Skids.** Crosswise floor blocking for shipments on skids must be of the same thickness as skid members. Back-up cleats, preferably built up to the same thickness as the floor blocking, must be placed in line with the skids. If the skid is 4 inches thick, the blocking should be made of two pieces of full 2-inch lumber, the first piece nailed to the floor and the second nailed to the first. Such blocking is stronger than a single piece of 4-inch blocking. Extra nails should be driven into the blocking opposite each skid. Excessive mitering or beveling of skids will result in a tendency of the skids to ride over the floor blocking. A hold-down cleat fastened over both



LOADING BOX CARS

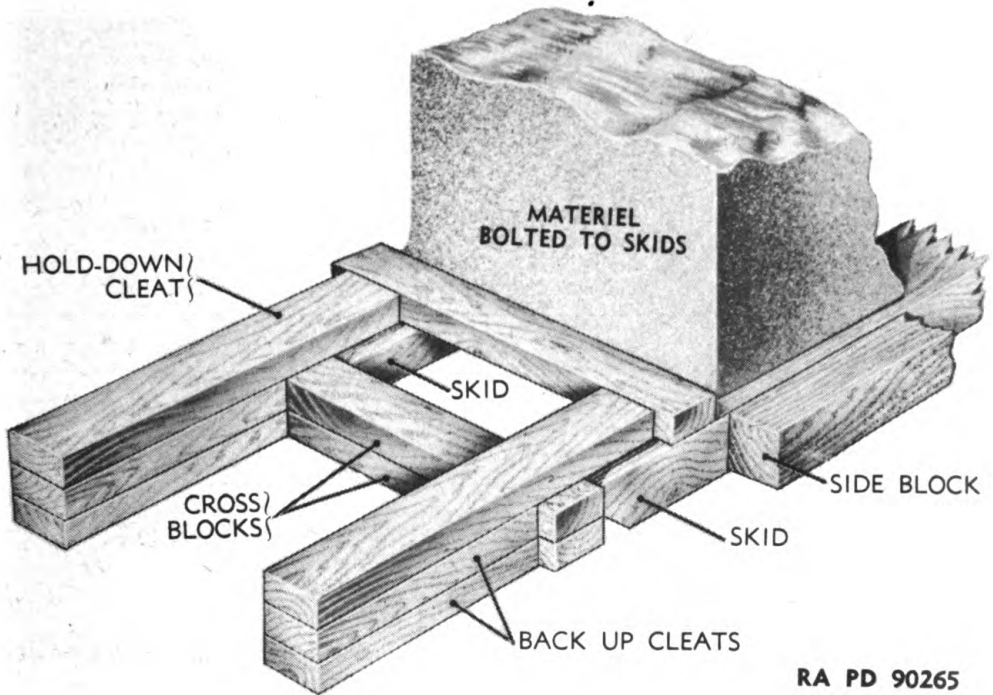

RA PD 90265

**Figure 52 — End and Side Blocking of Load on Skids**

the blocking and the skid helps to prevent riding of the skids over the blocking (fig. 52).

c. **Side Blocking.** To prevent the load from shifting sidewise, side blocking should also be used (fig. 52).

**50. CROSS BRACING.**

a. **General.** All cross car bracing must be of such dimension as will adequately hold the load. For heavy loads, cross braces should be at least 4 by 4. The force exerted lengthwise of the car is greater near the top of the lading than near the bottom.

**b. Use of Cross Braces.**

(1) Where possible, the cross board should be affixed with the narrow face against the load to obtain the maximum strength of the piece. Where there is a possibility of damage to the lading due to the concentrated pressure under the narrow face of the bracing, protection may be given the commodity by adding a buffer crosspiece to form a T-brace, or upright buffer pieces as shown in figure 53.

(2) It is very important that cross car bracing be placed against the strongest part of the lading, and not in contact with thin materials

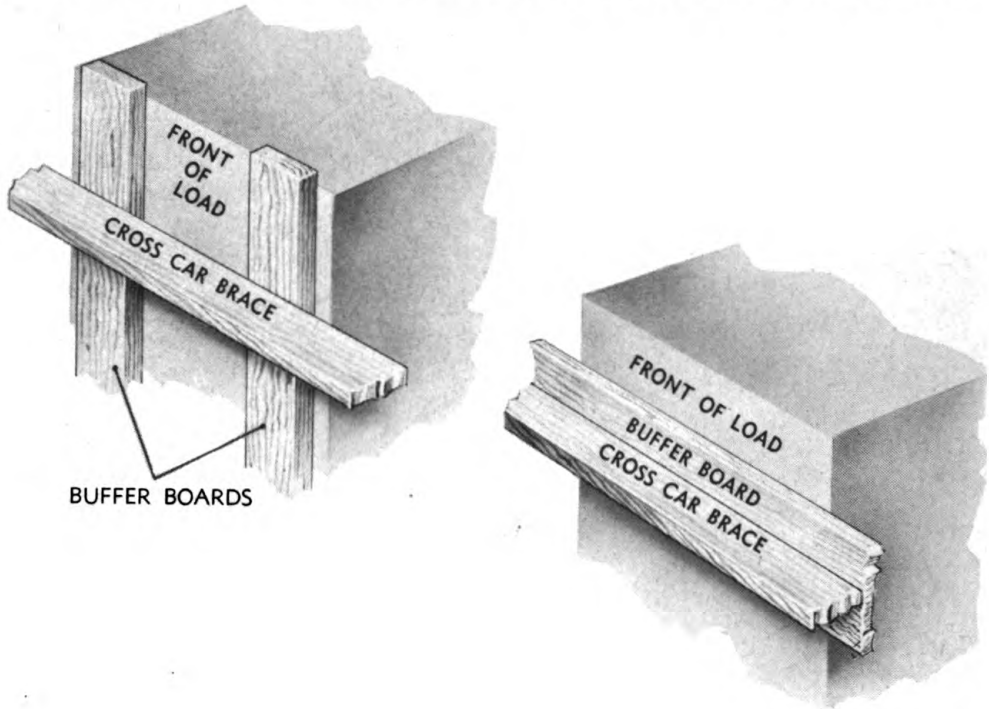

RA PD 90266

**Figure 53 — Cross Car Bracing With Horizontal or Vertical Buffers for Protection of Load**

in the ends of boxes or similar packages, or the middle of a layer of cans or drums. A sufficient number of upright or cross buffer boards must be placed between the lading and the bracing.

(3) All bracing affixed to car walls must be secured in pocket cleats of at least 2 by 4 material (A, fig. 54). It is important that the center cleat be of such length as to reach an upright stanchion in the car wall, and at least three nails must be driven through the cleat into the stanchion. Reinforcement as shown in B, figure 54, must first be nailed securely to the walls of single-sheathed cars before pocket cleats are nailed in position. The reinforcing boards should reach an upright.

## 51. K-BRACES AND DIAGONAL BRACES TO FLOOR.

a. **K-braces.** Cross car bracing holding heavy loads must be reinforced by diagonals running from the cross brace to car walls or floor. A K-brace fastened to the car walls is shown in figure 55. Diagonals must be affixed to the car walls about 2 inches higher than the level at which the opposite ends are secured to the cross brace, at an angle of not less than 45 degrees with the load. Length of the center or butting cleat applied to the cross brace depends on the concentration of the load against the brace. If the load bears against the full length

LOADING BOX CARS

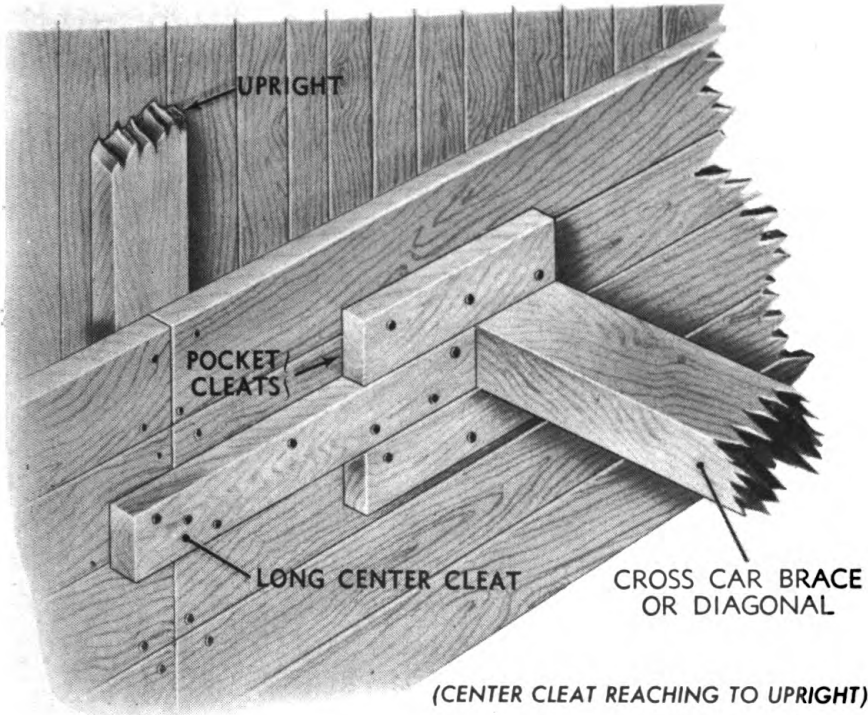

A

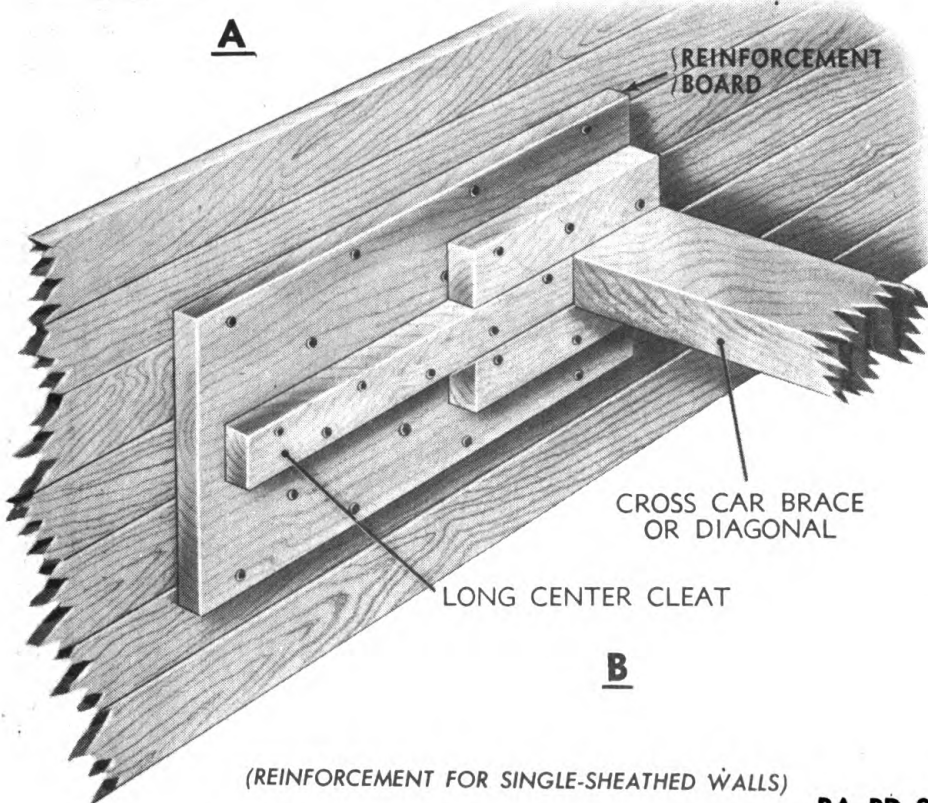

B

RA PD 90267

**Figure 54 — Applications of Pocket Cleats on Car Wall To Hold Bracing**

INSTRUCTION GUIDE — ORDNANCE PACKAGING AND SHIPPING (POSTS, CAMPS, AND STATIONS)

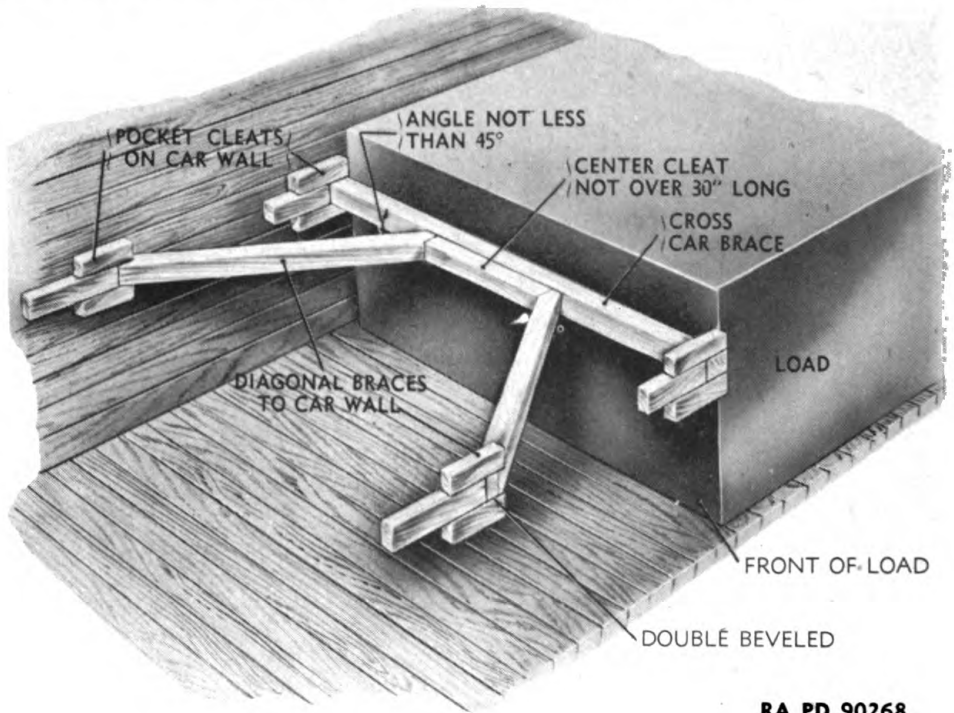

Figure 55 — K-brace for Cross Car Bracing

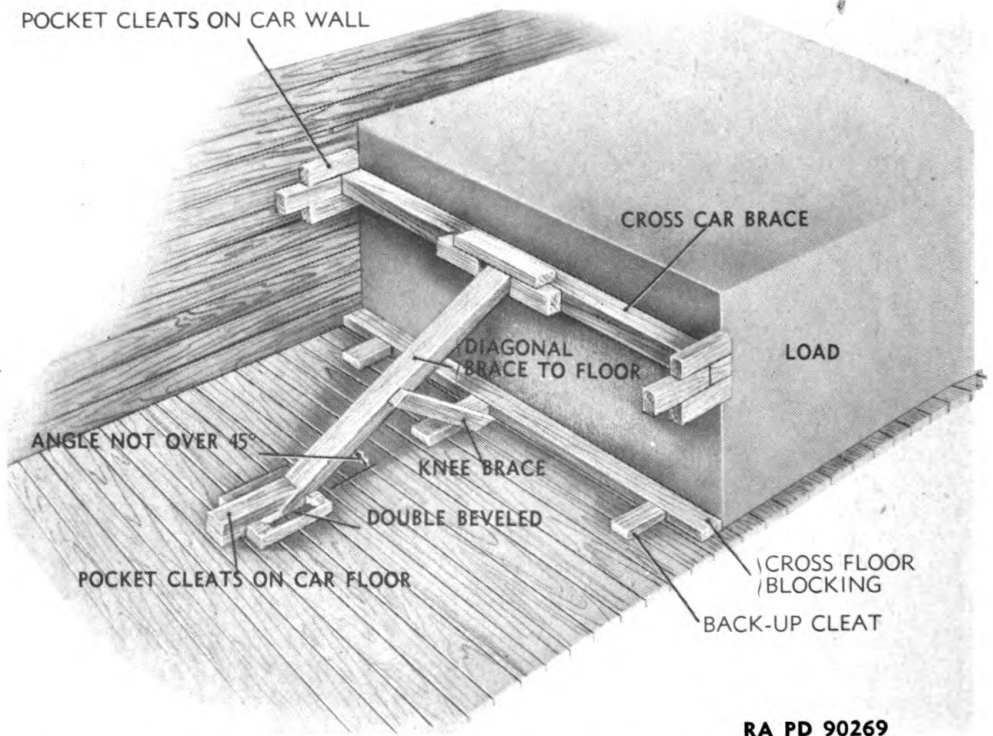

Figure 56 — Cross Car Brace With Diagonal to Floor and Knee Brace

## LOADING BOX CARS

of the cross brace, the cleat must be about 30 inches in length. The length of the cleat otherwise will depend upon the width of the load, but should not exceed 30 inches. K-braces are also often used to hold back the second and third layers of lading or an incomplete top layer.

**b. Diagonal Braces.** A similar form of reinforcement of the cross bracing is provided for in the use of diagonal bracing to the car floor (fig. 56). This bracing must not be applied at an angle greater than 45 degrees with the car floor, whether applied to the cross bracing or to the lading. It is preferable to affix floor diagonals in line with the center of weight of the load. The following tabulation gives the length of braces required so that the angle will not exceed 45 degrees.

Point of Application of Diagonal to Cross Car Brace or Load, Height Above Car Floor		Minimum Length of Diagonal to Floor	
(Feet)	(Inches)	(Feet)	(Inches)
1	0	1	6
1	6	2	3
2	0	3	0
2	6	3	6
3	0	4	3
3	6	5	0
4	0	5	9
4	6	6	6
5	0	7	3
5	6	7	9
6	0	8	6

NOTE: *Bowing action of floor diagonals can be minimized by the use of a knee brace (fig. 56).*

**c. Adaptation of the K-brace and Floor Diagonals for Heavy Loads.** An additional cross car brace may be placed near the bottom of the load and both cross braces reinforced by diagonals to the walls or floor, fastened to one or two strong uprights applied at the center of the cross braces. For heavy loads, all diagonals should be at least 2 by 6.

## 52. BULKHEADS OR GATES, AND CRIB BRACING.

**a.** When lading is in small containers or in bulk, bulkheads or gates are necessary protection (fig. 50). The distance between the stringers in the gate will vary with the weight of the load and the

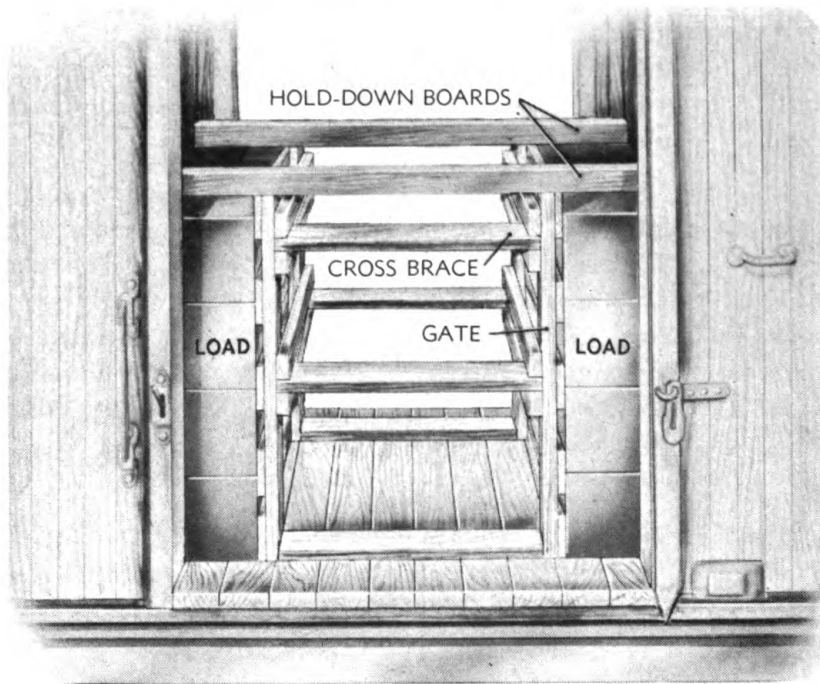

RA PD 90270

Figure 57 — Crib Bracing of Gates or Bulkheads

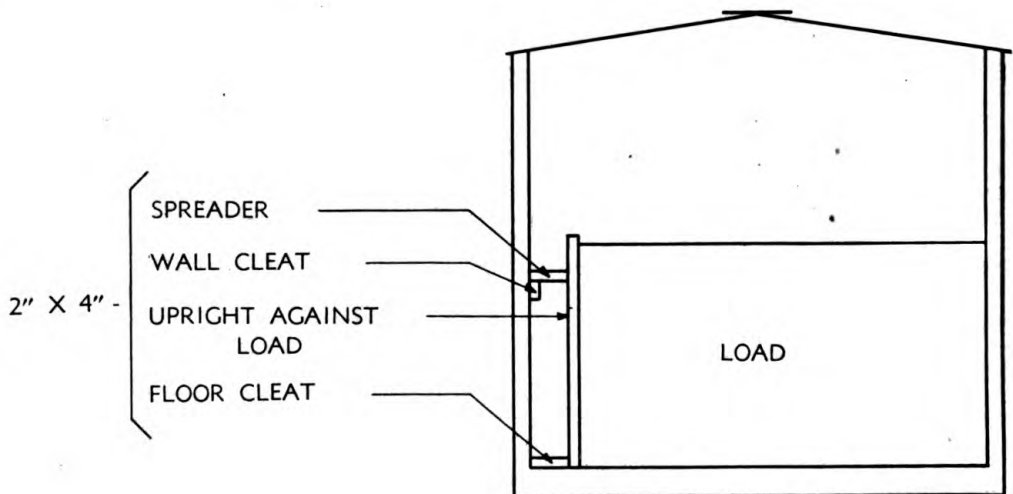

RA PD 90271

Figure 58 — Side Bracing of Load

## LOADING BOX CARS

size of the containers. If the load is in relatively weak containers such as metal drums or paperboard boxes, it should be divided into units lengthwise of the car, using double-faced bulkheads secured to car walls with cleats nailed to car uprights. This will prevent crushing of the containers by the accumulated force of the entire load or entire layer of containers, acting lengthwise of the car. If the load almost fills the car, the bulkheads or gates at the doorway can be braced by crib bracing (fig. 57). If the cross members of the crib bracing are over 3 feet in length, a center upright fastened to a floor block and to these members must be used to give added strength. Diagonal braces between the gates are necessary if the load is heavy, or bears unevenly against the gates. Upward movement of all bulkheads must be prevented by hold-downs nailed to the car wall and in contact with the top of the bulkhead (fig. 57).

### 53. SIDE BRACING.

a. Where the load does not occupy the full width of the car, leaving a total space of more than 18 inches measured across the car, sidewise movement of the load should be prevented by side bracing as shown in figure 58. Unless the load occupies nearly the full width of the car, it should be centered and braced on both sides.

### 54. TOP BRACING.

a. Top bracing may be applied in the same manner as cross bracing, using pocket-cleated cross braces, K-braces, or diagonal braces (fig. 59). The success of the bracing used to prevent upward movement in the lading depends upon the security of the pocket cleats nailed to car walls. The braces should not be tied to the roof. The greatest upward thrust occurs at the center of the car, which buckles upward slightly but suddenly when an impact force is exerted against both ends, as in coupling cars.

### 55. DOORWAY PROTECTION.

a. **Rough Freight.** Cars containing rough freight of such a nature that it cannot be damaged by contact with the ends of doorway boards (but must be prevented from rolling out at doorway) can be protected by nailing boards across the door to the inside of the doorposts. Nailing boards on the outside of doorposts is not permitted.

b. **All Other Freight.** All other freight likely to damage by contact with the ends of boards applied on the inside of doorposts such as boxes, cartons, and similar containers, requires that doorway protection boards be set in flush with the doorpost and car lining. Size and strength of the material to be used will depend on the weight and pressure of the load. The spacing of the boards will depend on the

**INSTRUCTION GUIDE — ORDNANCE PACKAGING AND SHIPPING (POSTS, CAMPS, AND STATIONS)**

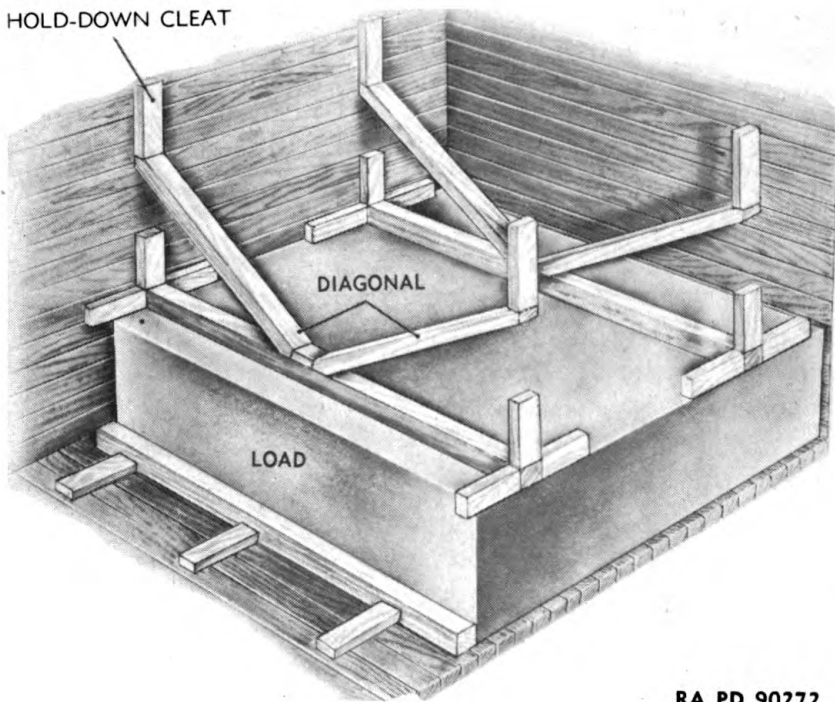

RA PD 90272

**Figure 59 — Top Bracing**

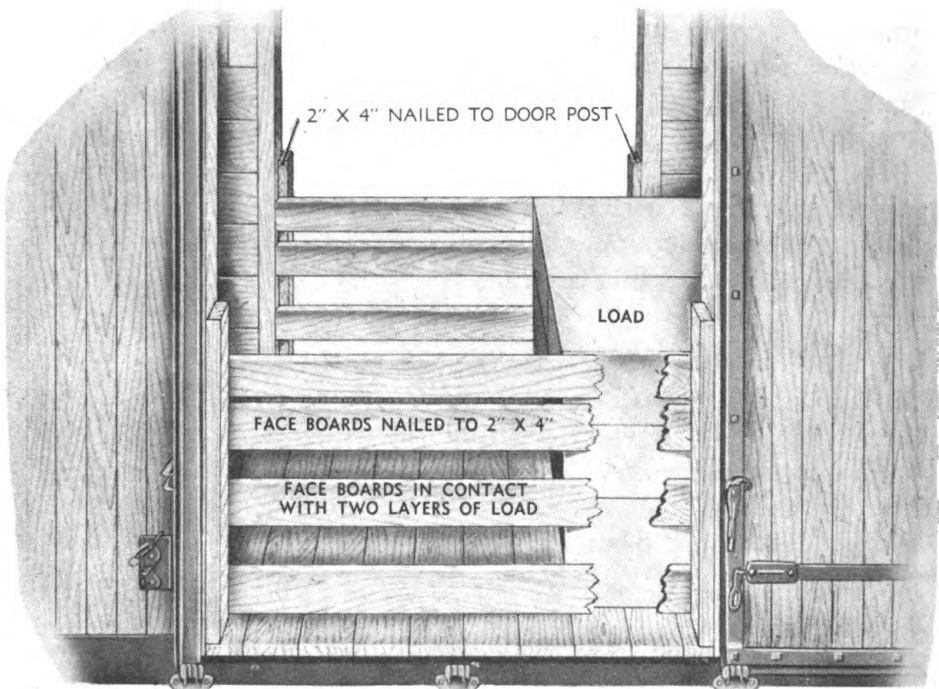

RA PD 90273

**Figure 60 — Flush Doorway Protection for Cars With Wood Doorposts**



**LOADING BOX CARS**

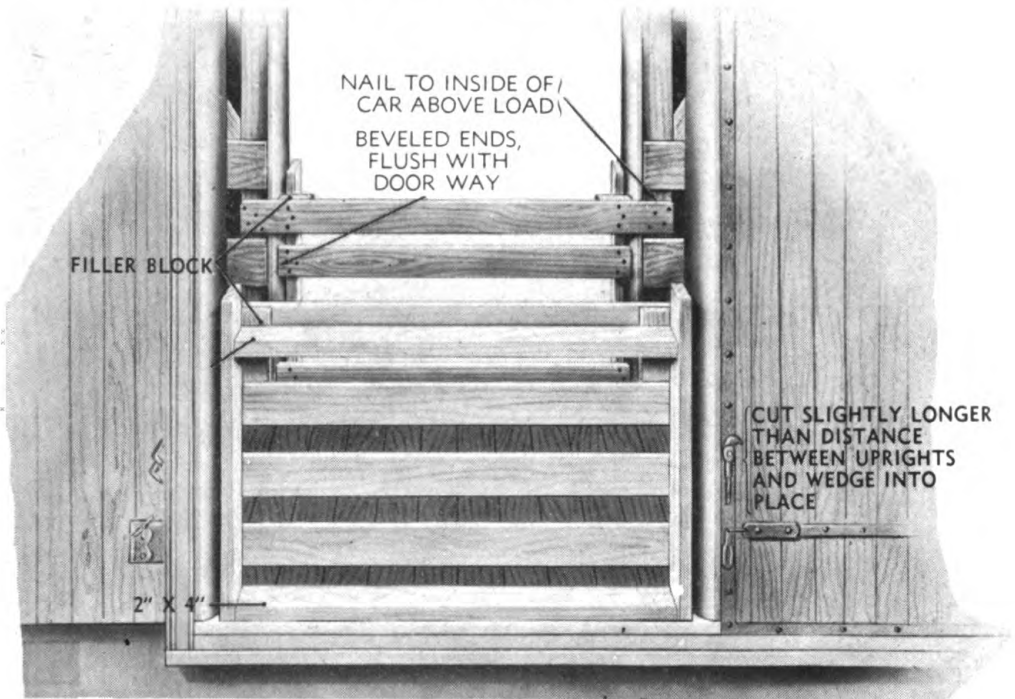

RA PD 90274

**Figure 61 — Doorway Protection in Cars With Steel Thresholds and Rounded Steel Doorposts**

size of the containers behind the protection. Each board, except top and bottom, should be in contact with two layers of containers (fig. 60). Vertical face members are as effective as horizontal members.

(1) **WOOD DOORPOSTS.** In cars with wood doorposts, the protection can be nailed directly to the car timbers. The boards must be flush with the doorposts (fig. 60).

(2) **STEEL DOORPOSTS.** A method of applying protection to a door with a steel threshold and rounded steel doorposts is shown in figure 61. As timbers cannot be nailed to the steel doorposts, the 2 by 4 floor and top strips must be cut slightly longer than the width of the doorway, and wedged tightly into place. The protection is fastened to the car by the strip across the top, which should be higher than the load, and is nailed to the car walls on either side of the door. Filler blocks are placed between the uprights and the top strip. Cross strips in contact with round steel corners are beveled for a flush fit.

**56. SNUBBING METHOD.**

a. **General.** The use of antiskid plates or lag screws in place of wood bracing or blocking is a very effective and economical method of loading, and is especially adaptable to leg type machines, *except*

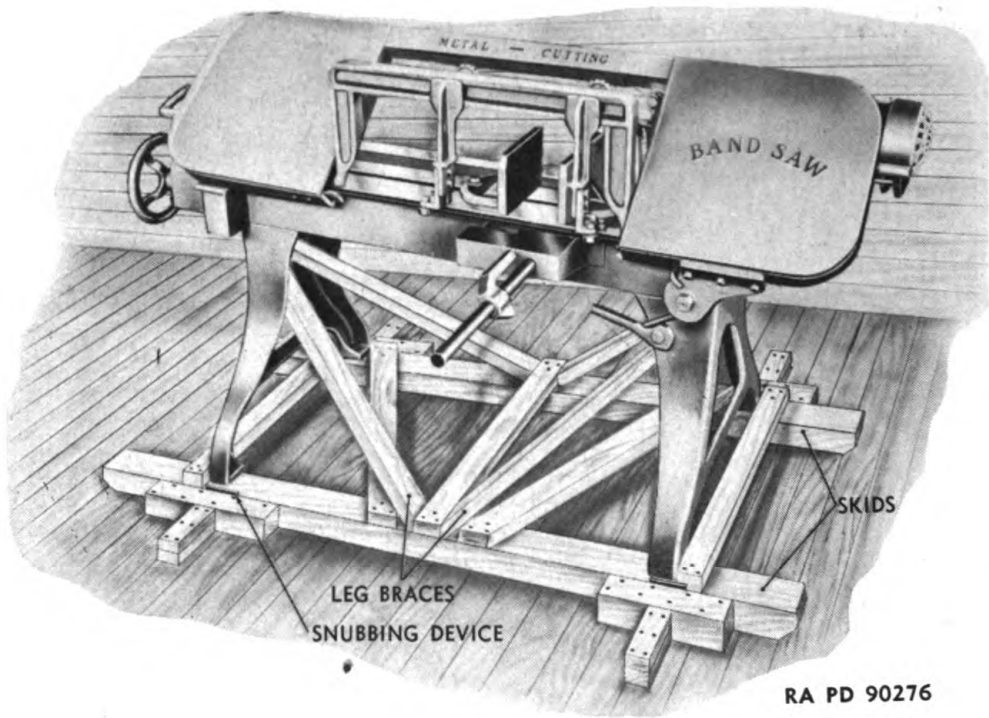

**Figure 62 — Application of Snubbing Devices to Machine on Skids**

*top-heavy machines.* The application of snubbing permits limited shifting of the lading, lengthwise of the car, thereby lessening the shocks ordinarily transmitted to the body of the machine and likewise acting against a vertical rise of the machine. The hazard of leg breakage is reduced to a minimum. Leg type machines on skids must be provided with independent diagonal braces from the skids to the legs (fig. 62).

**NOTE:** *Skids must be parallel for snubbing devices to be effective.*

**b. Application.** The prescribed number of antiskid (perforated) plates or lag screws to be applied as snubbing devices is shown in table 17.

**TABLE 17 — NUMBER OF SNUBBING DEVICES REQUIRED IN CARLOADING ARTICLES ON SKIDS OR IN CRATES (SEMIFLOATING LOAD)**

GROSS WEIGHT OF ARTICLE (Pounds)	NUMBER OF 6-HOLE PERFORATED PLATES PER SKID	NUMBER OF LAG SCREWS PER SKID (1/2-inch Penetration)
1,000 to 2,000	2	2
2,000 to 5,000	2	3
5,000 to 10,000	3	4
10,000 to 15,000	5	5

**LOADING BOX CARS**

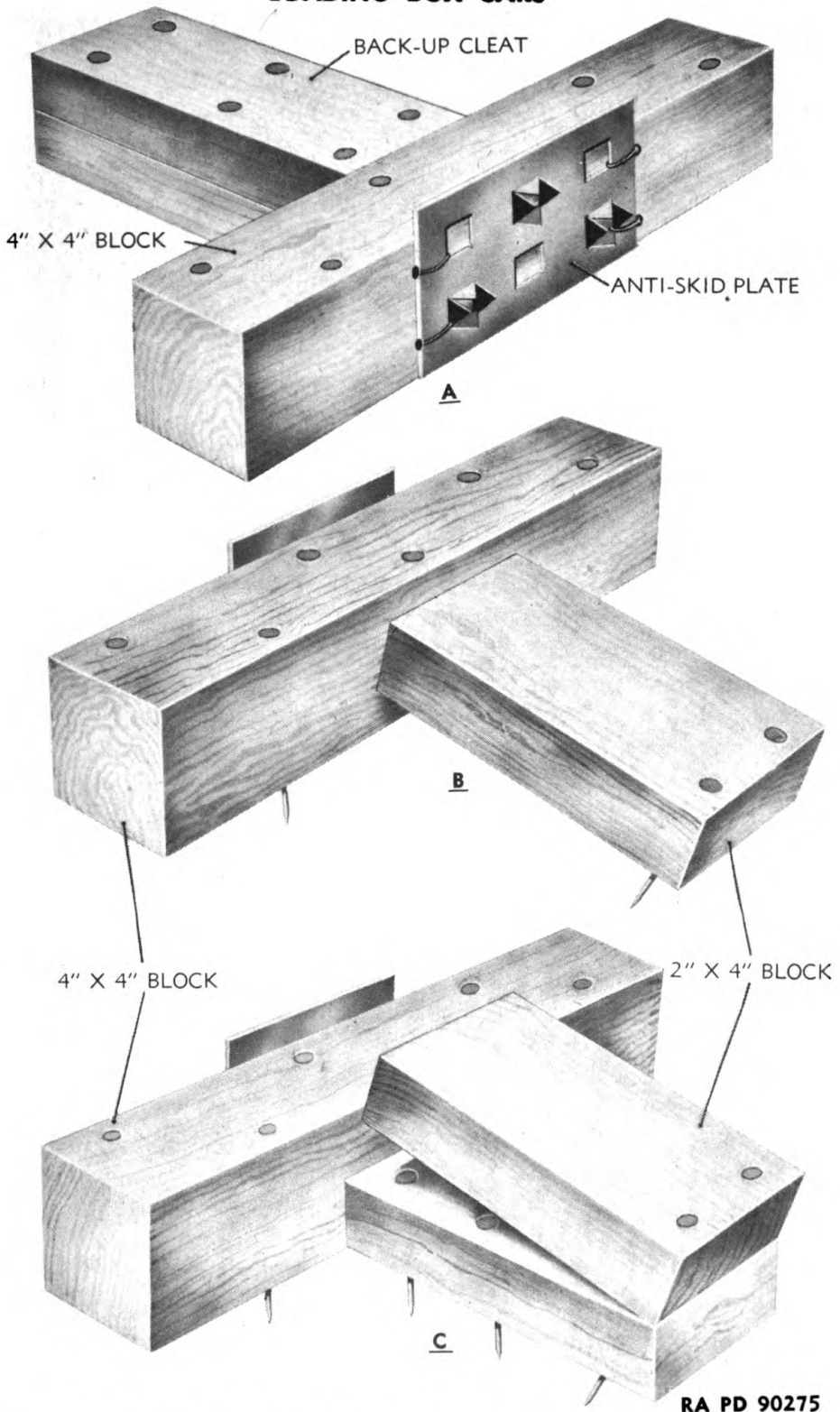

**Figure 63 — Antiskid Plate Nailed to 4- by 4-inch Blocks With Back-up Cleats**

## INSTRUCTION GUIDE — ORDNANCE PACKAGING AND SHIPPING (POSTS, CAMPS, AND STATIONS)

## (1) ANTISKID (PERFORATED) PLATES.

(a) Fasten the antiskid plate to a wood block 4 by 4, at least 18 inches long, by driving the points on one side into the block as far as possible (see A, fig. 63). If convenient, several plates may be placed on the same block if the block is long enough to allow at least 18 inches between plates.

(b) Spike the plate securely to the block with heavy nails driven through perforations, and bend over the heads of nails to hold the plate (A, fig. 63).

(c) Using a sledge hammer, force the block tight against the side of the skid, driving the points of the perforated plate into the skid as far as possible.

(d) Nail the block securely to the car floor, using at least six sixtypenny nails. Holes slightly less than the diameter of the nails should first be bored through the block to insure straight driving of the nails into the car floor.

(e) Reinforce each block with at least two cleats, each not less than 2 by 4 by 8 inches. Place cleats directly back of each plate as shown in A, figure 63. The first cleat must be placed against the block with the outer edge nailed to the floor (B, fig. 63). Placing a small temporary block under the raised end of the cleat will facilitate this operation. Drive this cleat down in place to force the plate block tighter against the skid, and nail securely to the car floor. The second or top cleat should be applied in the same manner (C, fig. 63).

(f) When there is not enough space between the sides of the car and the skids to drive the antiskid plates and blocks, or when crate sheathing or other members interfere with their application, antiskid plates may be fastened directly to the bottom of the skids or container. Guide blocks placed closely along the sides of the skids or container are needed to keep motion of the item in one line. Lag screws may be used against the sides of skids (step (2), below), but not against crate or box sheathing, when there is not enough space to apply antiskid plates properly.

(g) An alternative method is to fasten the antiskid plates to the side of the skid instead of to a block. The lower edge of the plate should be flush with the floor. Longer nails will be needed and greater care taken to avoid splitting when nailing through crate sheathing into the skid, as the sheathing will have a number of nails already in it. Use of plates with points all in one direction will also help avoid splitting of the sheathing. Long 4 by 4 blocks are then driven against the plate points and fastened to the car floor as previously described.

(2) LAG SCREWS. Lag screws may be used in place of antiskid plates as a snubbing device. The screw point acts in a similar way to the point on the antiskid plate. The prescribed size of screw for

### LOADING BOX CARS

this purpose is 6 inches in length and  $\frac{1}{2}$  inch in diameter. The square head of the lag screw can be turned into the skid with a wrench.

(a) Use 4- by 4-inch blocks at least 18 inches long. Several screws may be used in the same block, or one long block for each skid may be used, allowing 18 inches between lag screws.

(b) Drill a  $\frac{7}{16}$ -inch hole through the center of the block for each  $\frac{1}{2}$ -inch lag screw.

(c) Turn the lag screw through the hole until the point is flush with the inside surface of the block. Soap or other lubricant may be put on the screw to make it easier to turn. Do not drive the screw with a hammer.

(d) Place the block, with the screw point flush with the inside surface, tight against the skid, and nail the block to the car floor with no less than six sixtynenny nails.

(e) Reinforce the block in place with two back-up cleats for each screw, placed at equal distances on each side of the screw and nailed securely to the car floor.

(f) Measure the portion of the lag screw protruding from the block, and turn the lag screw into the skid with a wrench until  $\frac{1}{2}$  inch of penetration is obtained.

**c. Location of Snubbing Devices.** The placing of the antiskid plates or lag screws along the length of the skid depends upon the number of plates or lag screws required according to weight of the item (table 17) and the length of the skids. The following general rules cover the essentials. Figure 62 shows a machine snubbed with two pairs of snubbing devices.

(1) The plate or lag screw must be at least 30 inches from the end of the skid or block against which it acts, to permit sufficient movement without sliding away from the snubber.

(2) When two plates or lag screws are used on the same skid, they should be placed at approximately the same distance (not less than 30 inches) from the two ends of the skids respectively (fig. 62).

(3) When three or more plates or lag screws are used on each skid, the intermediate plates or lag screws should be spaced equally between the end plates or lag screws.

(4) When the thickness of the skid members is less than 4 inches, boards at least 2 by 4 inches in size must first be nailed flatwise to the side of each skid, and the points of antiskid plates or lag screws applied to these boards.

Section II

**LOADING FLAT CARS AND GONDOLA CARS**

**57. LOADING RULES FOR RAIL SHIPMENT.**

**a. General.**

(1) All ordnance materiel shipped by rail by the using arms must be prepared for shipment in accordance with applicable instructions given in the pertinent SB 9-OSSC's or 100-series TM's. The importance of this preparation cannot be overstressed, as extreme care must be exercised to prevent damage, corrosion, and deterioration during this period.

(2) The hazards connected with high-speed multiple-track railroads, tunnels, electrical conductors, and the necessity for the protection of human life and property must be borne in mind in the loading of materiel, and every effort should be made to properly and safely secure the materiel before offering to the railroads for movement. The following rules apply to the rail shipment of all major items of ordnance transported in complete troop trains accompanied by military personnel or in regular train service not accompanied by military personnel.

**b. Inspection of Railroad Cars.** Railroad cars must be inspected to see that they are suitable to safely carry loads to destination. Cars should have good sound floors, and all loose nails or other projections, not an integral part of the car, should be removed. Nails, bolts, etc., necessary in car construction, when loose, should be made tight rather than removed.

**c. Brake Wheel Clearance** (fig. 64). The load should clear the brake wheel as much as possible, but must not be less than 4 inches below nor less than 6 inches above, in back and on both sides of the brake wheel.

**d. Maximum Load Weights.** In determining the maximum weight of load, the following shall govern, except where load weight limit has been reduced by the car owner.

Marked Capacity of Car	Total Weight of Car and Load	Load Weight (Deduct Lt. Wt. of Car)
(Pounds)	(Pounds)	(Pounds)
40,000	66,000	66,000
60,000	103,000	103,000
80,000	136,000	136,000
100,000	169,000	169,000
140,000	210,000	210,000
200,000	251,000	251,000

**LOADING FLAT CARS AND GONDOLA CARS**

**EXAMPLE**

	<b>Pounds</b>
Capacity of car .....	100,000
Total weight of car and load .....	169,000
*Light weight of car (to be subtracted) .....	37,000
Permissible weight of load .....	132,000

**e. Load Distribution.** Refer to paragraph 45 c.

**f. Loading Trailers.** Trailers used for handling bulldozers, etc., over highways, must not be placed on railroad cars with such equipment loaded thereon. These items should be removed, placed on car floor, and blocked in accordance with specifications.

**g. Clearing Limits.** The height and width of the load must be within the clearance limits of the railroad over which it is to be moved. Army and railroad officials must check on clearances prior to each move.

**h. Handling.**

(1) Railroad cars loaded in accordance with loading instructions given herein must not be handled in hump switching.

(2) Railroad cars must not be cut off while in motion and must be coupled carefully and all unnecessary shocks avoided.

**i. Rotating Parts of Materiel.** Turrets must be positively locked to prevent rotating in transit. Traversing gun barrels, including those in turrets, must be secured with 4 strands, No. 8 gage black annealed wire, or wires of equivalent strength, or steel strapping by looping wire or strapping around gun barrel about midway between muzzle and breech, and attaching to lifting lugs or other available parts of the vehicle (fig. 76). Twist-tie wires with rod or bolt, and seal steel strapping.

**j. Brakes.** After loading on railroad car, hand brakes must be applied on materiel so equipped.

**k. Use of Idler Cars.** Idler cars are used when load projects beyond the end sill of the carrying car. The following rules govern the use of idler cars:

(1) Clearance of 4 inches must be maintained below the overhanging portion of load and any part of the idler car.

(2) The space on the idler car may be utilized for loading, provided the ends of such materiel are located not less than two feet from the ends of the overhanging portions of the load.

(3) The uncoupling mechanism must be made inoperative, but not disconnected, on all couplers underneath the load.

---

\*This marking is stenciled on each side of car as "LT. WT."

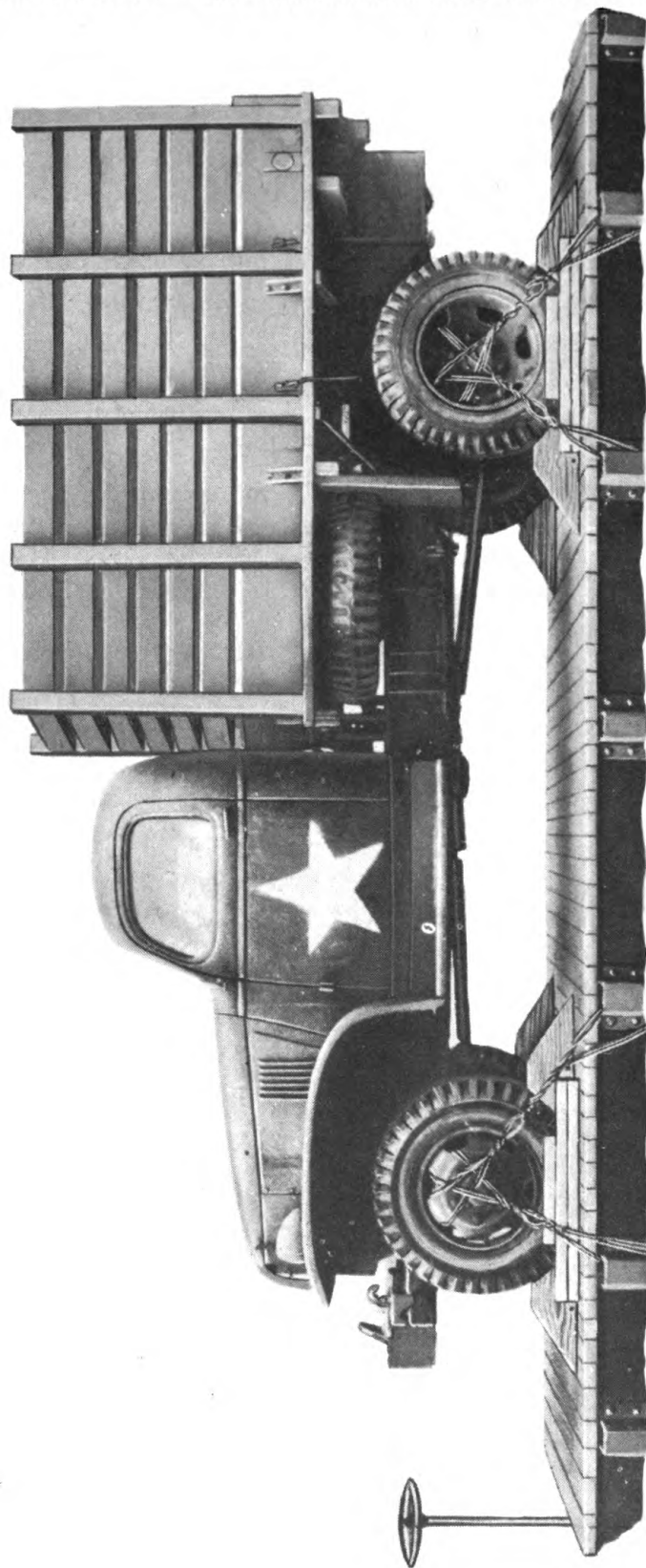

**"A" BRAKE WHEEL CLEARANCE**

LOAD SHOULD CLEAR THE BRAKE WHEEL AS MUCH AS POSSIBLE, BUT MUST NOT BE LESS THAN 4 INCHES BELOW, NOR LESS THAN 6 INCHES ABOVE, IN BACK AND ON BOTH SIDES OF THE BRAKE WHEEL.

RA PD 90454

**Figure 64 — Brake Wheel Clearance**



LOADING FLAT CARS AND GONDOLA CARS

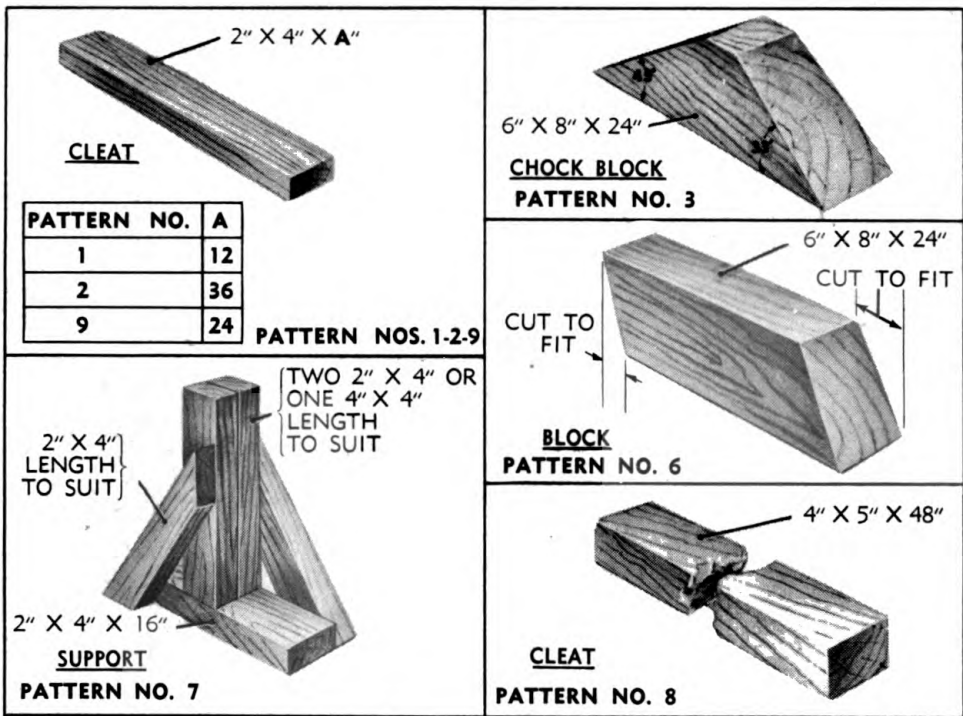

RA PD 90279

Figure 65 - Blocking Pattern Details

I. Materials Used for Blocking Vehicles on Railroad Cars.

- (1) Stakes, braces, blocks, cleats, and wedges must be of sound, straight-grained wood.
- (2) Wire for securing loads must be No. 8 gage black annealed or wires of equivalent strength.
- (3) Steel strapping shall be 1 inch, No. 14 B. W. gage hot rolled steel.

58. METHOD OF BLOCKING MATERIEL ON RAILROAD CAR.

a. General. The examples of blocking ordnance materiel described in this section are in accordance with the latest accepted methods and are the minimum requirements as prescribed by the Association of American Railroads. Additional blocking may be added at the discretion of the officer in charge. The blocking of items for which specific examples are not given must conform as nearly as possible to the method shown for an item having similar characteristics. For further details of blocking major items of ordnance, refer to the pertinent SB 9-OSSC or 100-series TM.

(Continued on page 144)

**STRUCTION GUIDE — ORDNANCE PACKAGING AND SHIPPING (POSTS, CAMPS, AND STATIONS)**

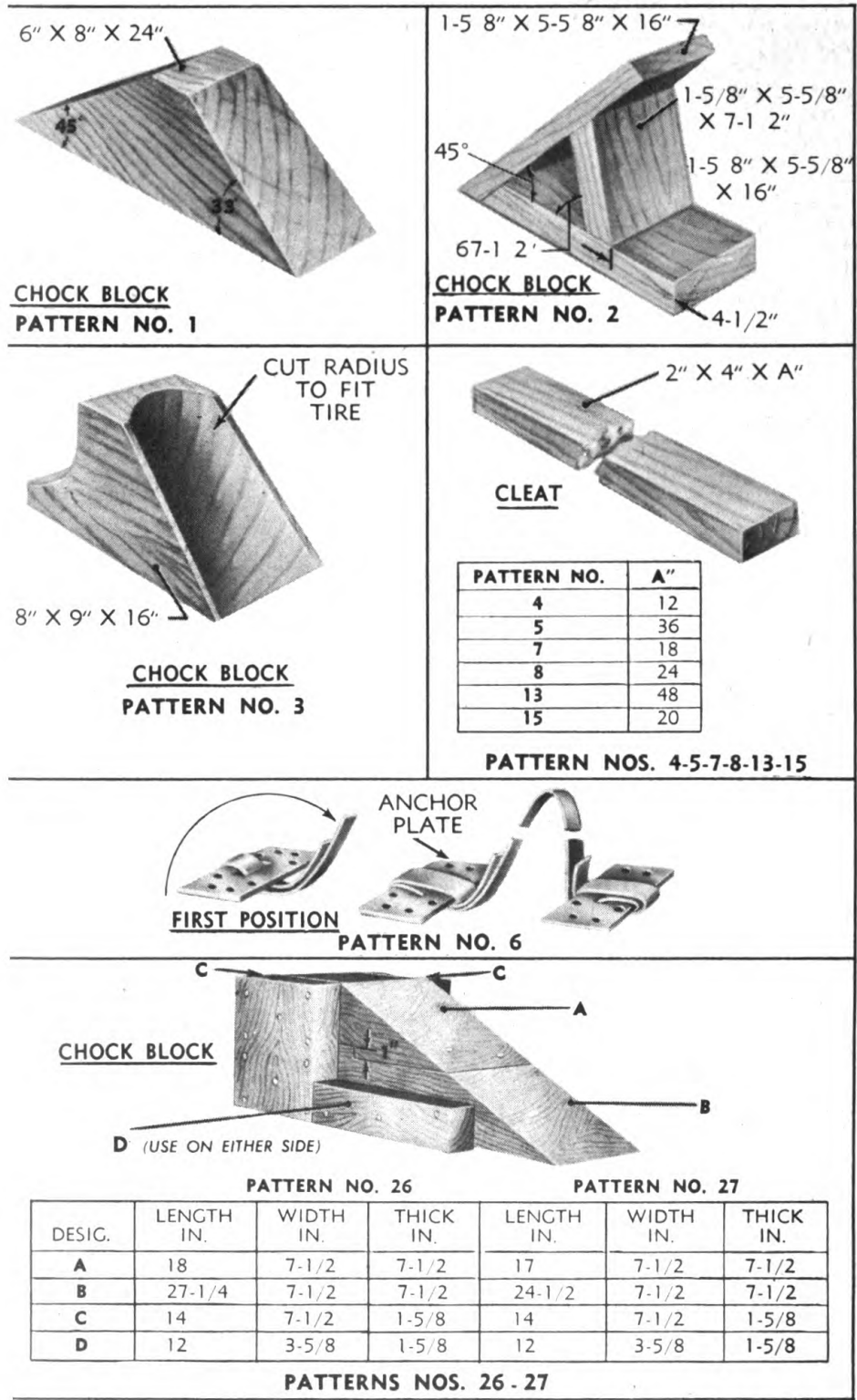

RA PD 90405

**Figure 66 — Blocking Pattern Details**

**LOADING FLAT CARS AND GONDOLA CARS**

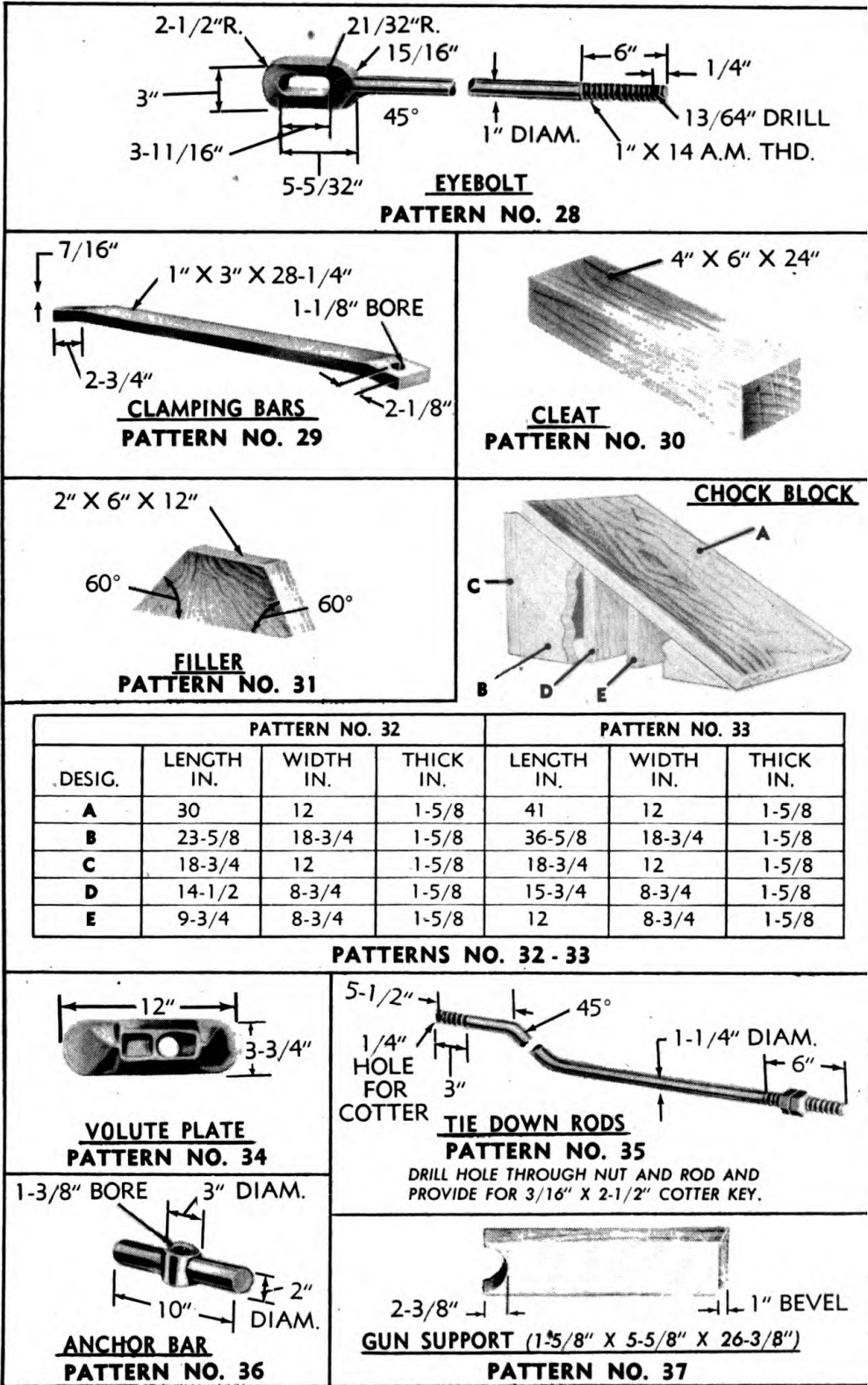
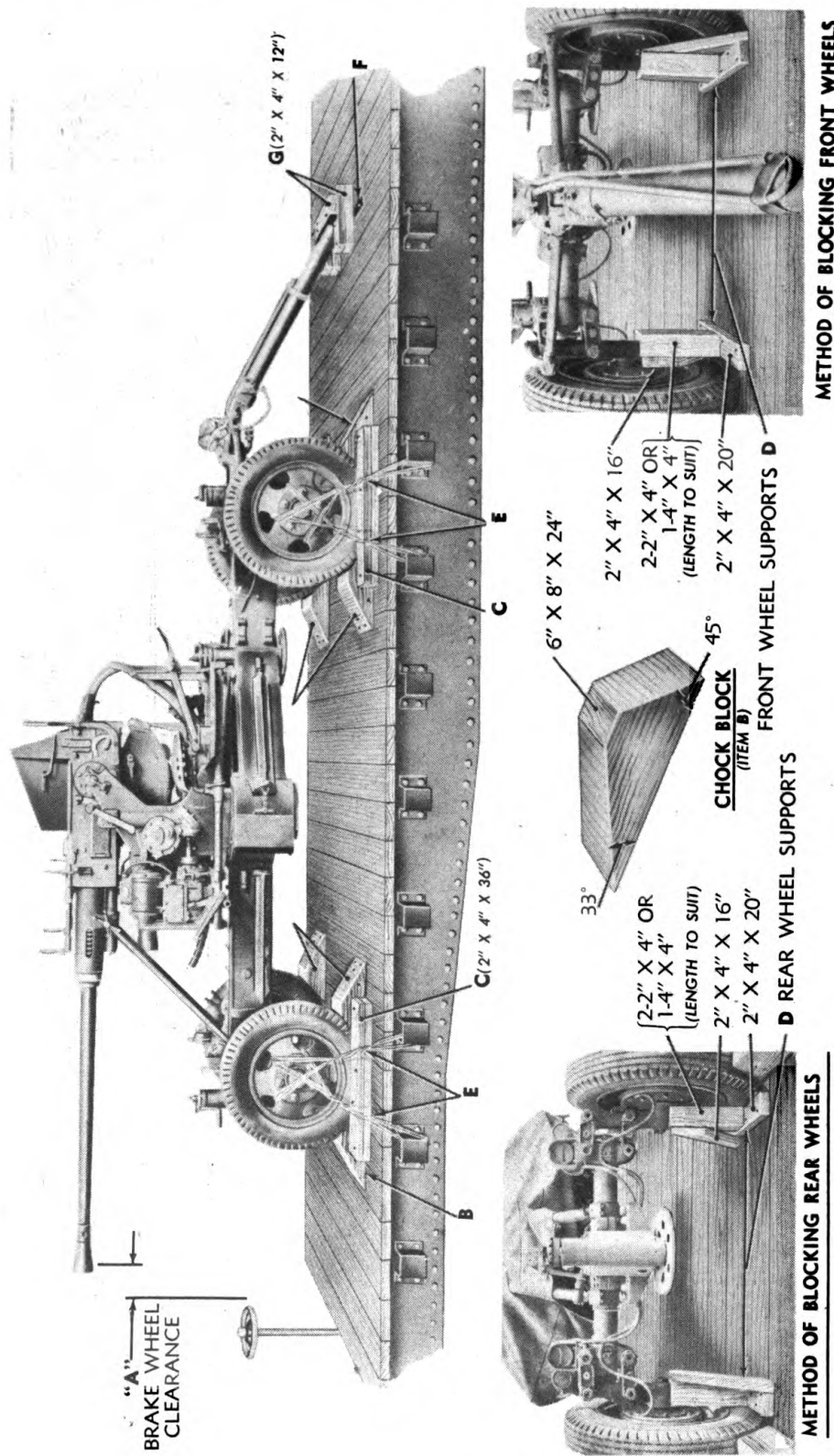

Figure 67 - Blocking Pattern Details

RA PD 90406

INSTRUCTION GUIDE — ORDNANCE PACKAGING AND SHIPPING (POSTS, CAMPS, AND STATIONS)



RA PD 82284

Figure 68 — Method of Blocking 40-mm Automatic Gun M1 and AA Carriages M2 and M2A1 on Railroad Car

LOADING FLAT CARS AND GONDOLA CARS

BLOCKING INSTRUCTIONS		
Item	Pat. No.	Qty. Req.
A	—	—
BRAKE WHEEL CLEARANCE (fig. 64).		
B	3 Fig. 65	8
CHOCK BLOCKS (6 x 8 x 24 in.). Position blocks with 45-degree portion against front and rear of each wheel. Nail heel of blocks to car floor with three forty-penny cement-coated nails, and toenail outside portion to car floor with two forty-penny cement-coated nails before items C are applied.		
C	2 Fig. 65	8
SIDE CLEATS (2 x 4 x 36 in.). Position two cleats at the outside face of each wheel. Nail lower piece to car floor with four thirty-penny cement-coated nails, and top piece to the one below and the car floor with four thirty-penny cement-coated nails.		
D	—	4
WHEEL SUPPORTS. (Length to be 1/4 inch longer than the distance between cross head and car floor to partially relieve weight from tires.) Position front supports under cross head with diagonal cleat facing toward the inside face of wheel. Position rear supports under cross head with diagonal cleat facing toward the center of the car. Nail each support base to car floor with six forty-penny cement-coated nails.		
E	—	8
WHEEL STRAPPING. Position wheels so that openings are even near the top of the wheel. Secure each wheel with two pieces of No. 8 gage black annealed wire consisting of four strands, two wrappings, each wire to pass through two openings in each wheel (top and adjacent hole) and be attached to stake pocket. (Wires shall cross each other at center of wheel.) With rod or bolt, twist-tie ends of wire enough to remove slack. If gondola or box cars are used, apply strapping in similar fashion and attach to car floor by use of blocking or anchor plates.		
F	—	1
DRAWBAR STRAPPING. Position lunette flat on car floor and pass steel strapping through lunette and secure to car floor with two eight-penny cement-coated nails on each side of lunette.		
G	1 Fig. 65	5
CLEATS (2 x 4 x 12 in.). Position two cleats lengthwise of car against each side of lunette on top of strapping, item F. Nail lower cleats to car floor with three thirty-penny cement-coated nails and top cleats to the lower cleats and car floor with three thirty-penny cement-coated nails. Position one cleat crosswise of car on top of lengthwise cleats and lunette. Nail each end with two forty-penny cement-coated nails.		

INSTRUCTION GUIDE — ORDNANCE PACKAGING AND SHIPPING (POSTS, CAMPS, AND STATIONS)

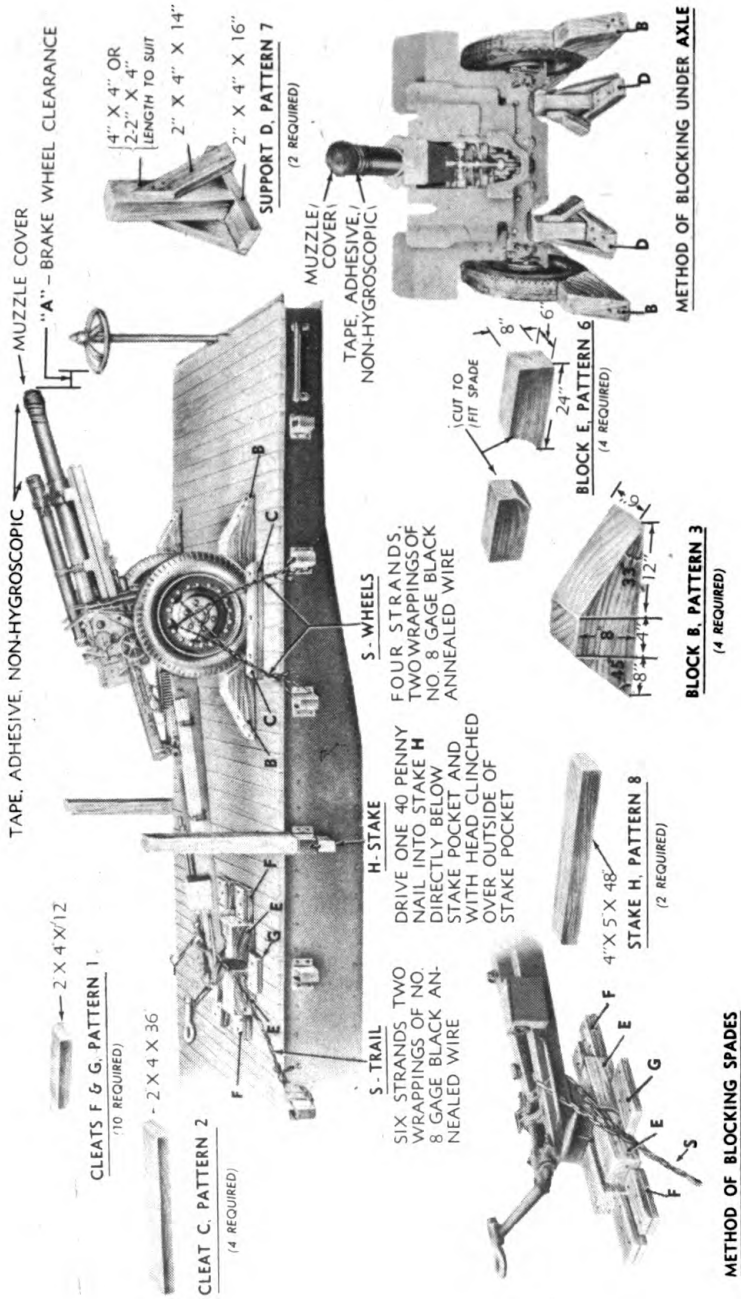

RA PD 85635

Figure 69 — Method of Blocking 105-mm Howitzer Carriage M2A2 on Railroad Car

LOADING FLAT CARS AND GONDOLA CARS

BLOCKING INSTRUCTIONS		
Item	Part No.	Qty. Req.
A	—	—
	BRAKE WHEEL CLEARANCE (fig. 64).	
B	3 Fig. 65	4
	CHOCK BLOCKS (6 x 8 x 24 in.). Position blocks with the 45-degree portion against the front and rear of each wheel. Nail heel of the blocks to the car floor with three forty-penny cement-coated nails, and toenail outside portion to car floor with two forty-penny cement-coated nails before items C are applied.	
C	2 Fig. 65	4
	SIDE CLEATS (2 x 4 x 36 in.). Position two cleats C against the outside face of each wheel. Nail lower piece to car floor with four thirty-penny cement-coated nails, and top piece to the one below and car floor with four thirty-penny cement-coated nails.	
D	7 Fig. 65	2
	WHEEL SUPPORTS. (Length to be 1/4 inch longer than the distance between the axle and car floor to partially relieve weight from the tires.) Place support D under the axle near the inside face of each wheel. Nail each support to the car floor with six forty-penny cement-coated nails.	
E	6 Fig. 65	4
	CHOCK BLOCKS (6 x 8 x 24 in.). Place one block E against the front and rear of each spade. Toenail blocks to car floor with six forty-penny cement-coated nails. Blocks shall be cut to fit contour of spades.	
F	1 Fig. 65	8
	CLEATS (2 x 4 x 12 in.). Place two cleats F against each block E. Nail lower piece to car floor with three thirty-penny cement-coated nails, and top piece to the one below and car floor with three thirty-penny cement-coated nails.	
G	1 Fig. 65	2
	CLEATS (2 x 4 x 12 in.). Place one cleat G against each side of spade and nail to car floor with three forty-penny cement-coated nails.	
H	8 Fig. 65	2
	STAKES (4 x 5 x 48 in.). Locate in stake pocket of car one-third the distance from the end of trail to the center of the wheels, stake to extend 4 inches below pocket. Drive one forty-penny cement-coated nail into each stake H directly below stake pocket clinched over outside of pocket.	
S	—	4
	*WHEEL STRAPPING. Position wheels so that openings are even near the top of the wheel. Secure each wheel with two pieces of No. 8 gage black annealed wire consisting of four strands, two wrappings, each wire to pass through two openings in each wheel (top and adjacent hole) and be attached to stake pocket. (Wires shall cross each other at center of wheel.) With rod or bolt, twist-tie ends of each wire enough to remove slack.	
S	—	2
	*TRAIL STRAPPING. Secure each trail of the carriage using six strands, two wrappings, of No. 8 gage black annealed wire looped around and over the top of rear end of trail and secured to stake pockets on both sides of the car. With rod or bolt, twist-tie both sides of trail.	

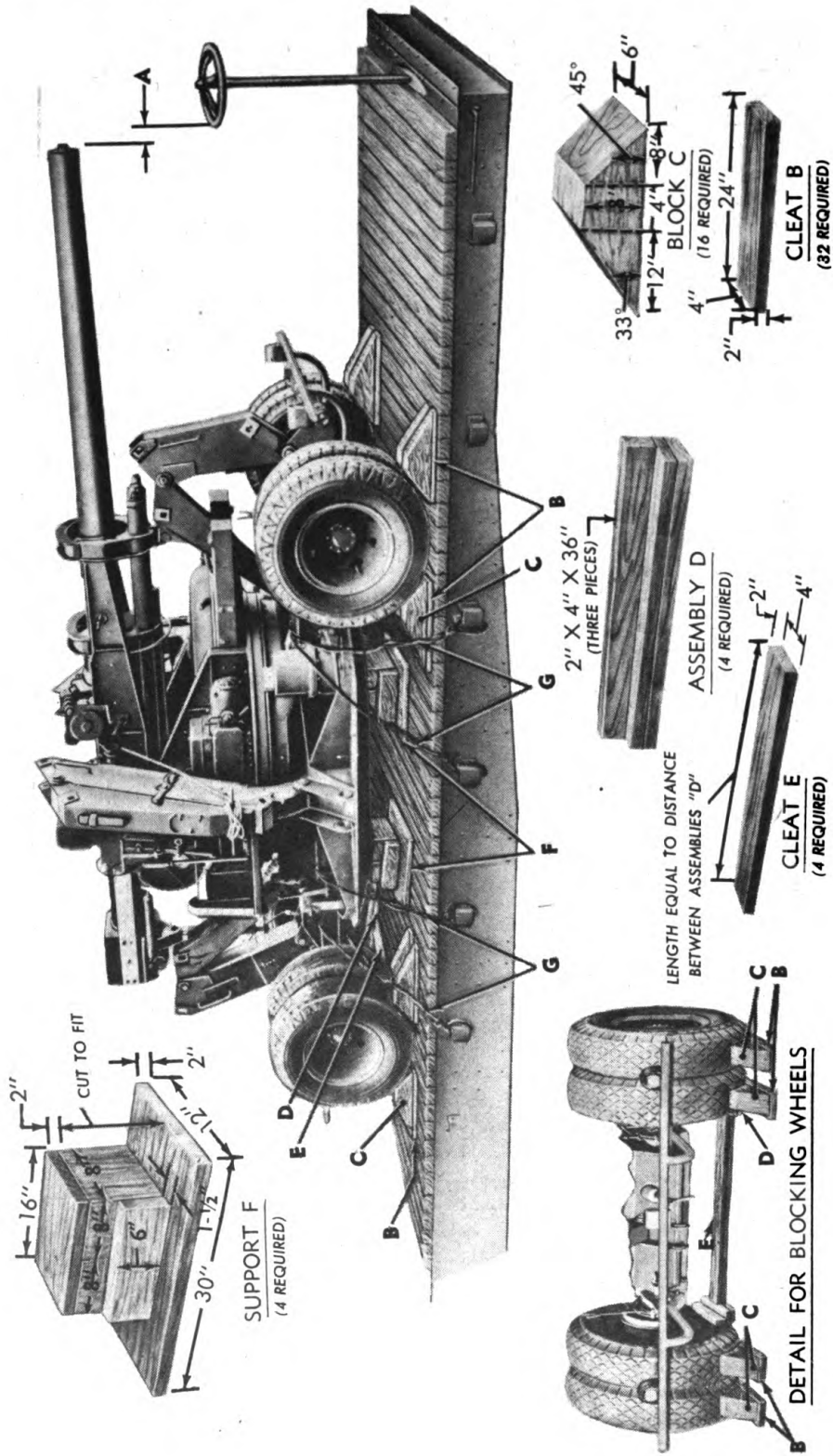

RA PD 85615

Figure 70 — Method of Blocking 120-mm Gun M1 and AA Mount M1 on Railroad Car



LOADING FLAT CARS AND GONDOLA CARS

		BLOCKING INSTRUCTIONS
Item	Pat. No.	Qty. Req.
A	—	—
<b>BRAKE WHEEL CLEARANCE (fig. 64).</b>		
B	9 Fig. 65	32
CLEATS (2 x 4 x 24 in.). Nail two pieces, side by side, to the base of each block C with four forty-penny cement-coated nails in each cleat.		
C	3 Fig. 65	16
CHOCK BLOCKS (6 x 8 x 24 in.). Position the 45-degree portion of block against the front and rear of each wheel. Nail the heel of block C through cleats B to the car floor with three sixty-penny cement-coated nails, and toenail outside portion of blocks to the car floor with two sixty-penny cement-coated nails.		
D	2 Fig. 65	12
WHEEL CLEATS (2 x 4 x 36 in.). Each assembly consists of three pieces as follows: Nail one wide surface of the intermediate piece to one of the edges of the top pieces with five twenty-penny cement-coated nails. Nail the bottom piece to the other wide surface of the intermediate piece with five twenty-penny cement-coated nails, one side of the assembly to be flush. Position one assembly against the inside of each set of dual tires, and nail to the car floor with four sixty-penny cement-coated nails.		
E	—	4
LATERAL CLEATS (2 x 4 in., length equal to distance between wheel cleats D). Two pieces are joined to form an assembly as follows: Nail the lower piece to the car floor with four forty-penny cement-coated nails, and the top piece to the one below with four forty-penny cement-coated nails. (One assembly is positioned at center line of front wheels and one assembly at center line of rear wheels between wheel cleats D.)		
F	—	4
SUPPORTS. Position under bed of mount to partially relieve weight on tires. Cut height to fit snugly between the car floor and bed of mount. Nail each support to car floor with ten forty-penny cement-coated nails.		
G	—	4
STRAPPING. Using No. 8 gage black annealed wire, eight strands, secure mount at the frame by passing wire around frame and attaching at the nearest stake pocket of the car. Bring ends of wire together, and twist taut with rod or bolt.		
—	—	—
DRAWBAR. Secure drawbar that has been removed from mount to the car floor, using 1 1/4-inch flat steel strapping or No. 8 gage black annealed wire. Attach strapping to the car floor by means of anchor plates or wood blocking.		

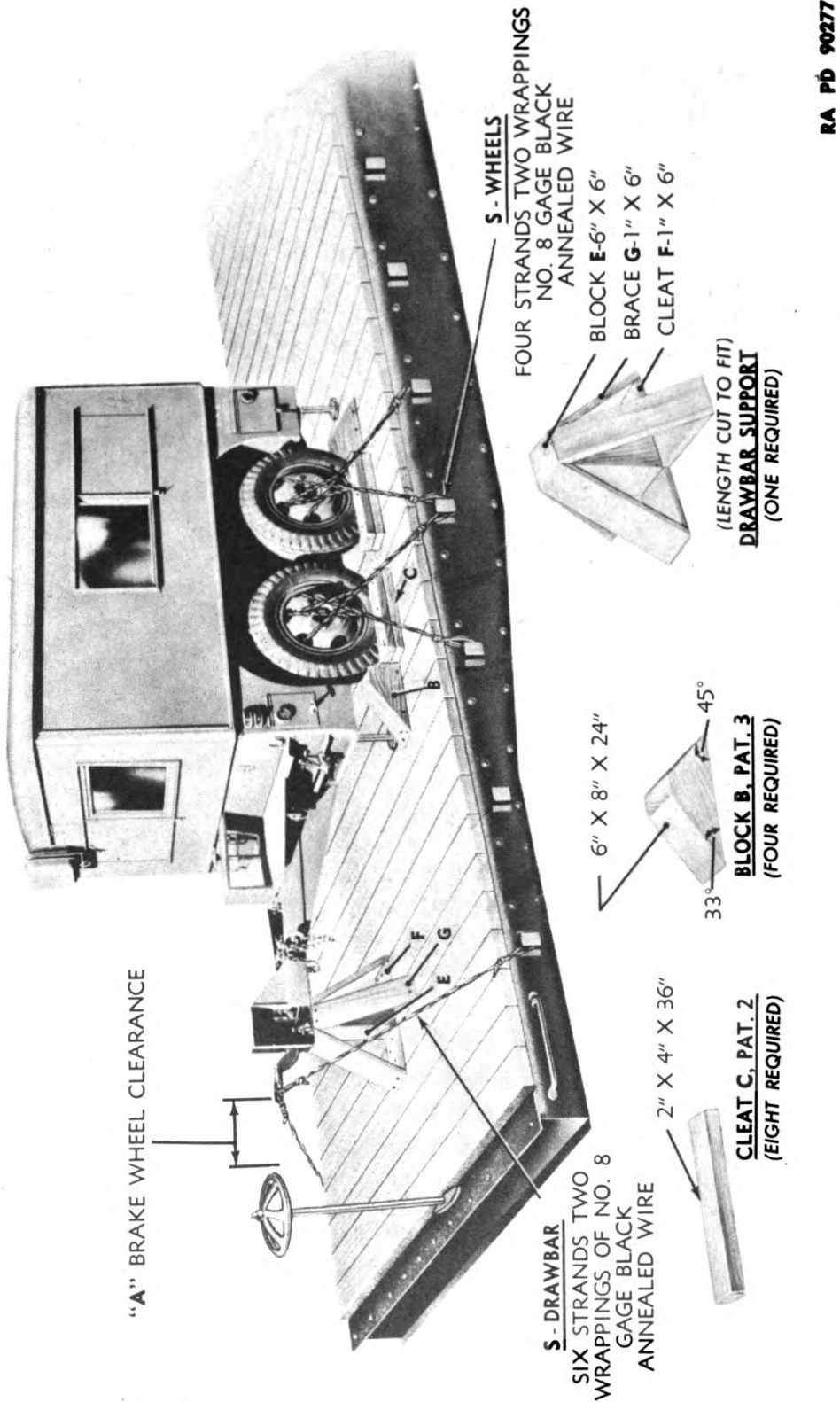
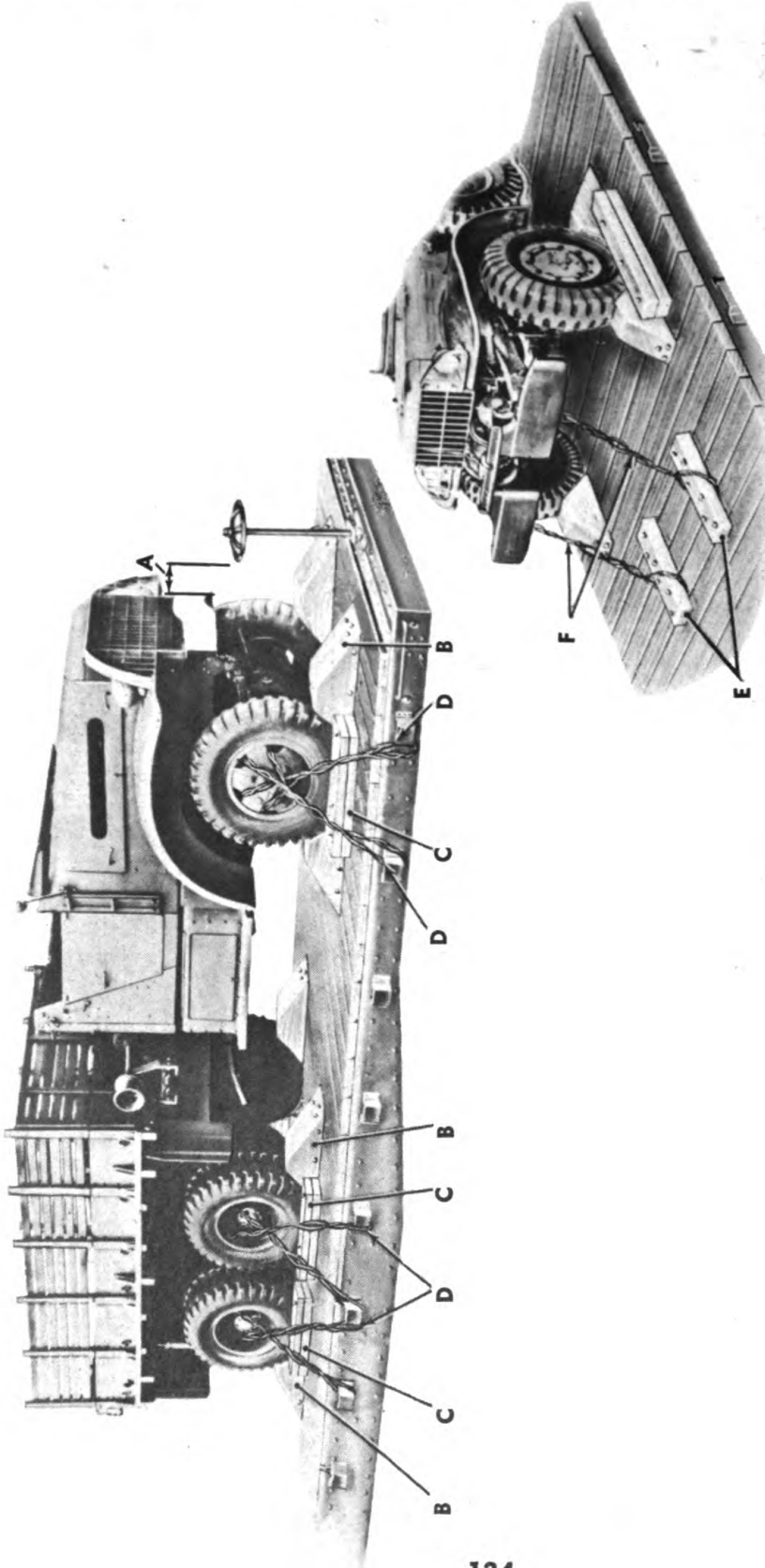

Figure 71 — Method of Blocking Director Trailer M14 on Railroad Car

LOADING FLAT CARS AND GONDOLA CARS

BLOCKING INSTRUCTIONS		
Item	Pat. No.	Qty. Req.
A	—	—
BRAKE WHEEL CLEARANCE (fig. 64).		
B	3 Fig. 65	4
CHOCK BLOCKS (6 x 8 x 24 in.). Position one block B to the front of each front wheel and one to the rear of each rear wheel. Position the 45-degree portion of the block next to the wheel. Nail the heel of the block to the car floor with three forty-penny cement-coated nails, and toenail outside portion of blocks to car floor with two forty-penny cement-coated nails before cleats C are applied.		
C	2 Fig. 65	8
SIDE CLEATS (2 x 4 x 36 in.). Position two cleats at the outside face of each wheel. Nail lower piece to car floor with four thirty-penny cement-coated nails, and top piece to the one below and the car floor with four thirty-penny cement-coated nails.		
DRAWBAR SUPPORT		
E	—	1
BLOCK (6 x 6 in., length cut to fit). Place one block E under tongue of unit in center, and toenail to car floor, using forty-penny cement-coated nails.		
F	—	4
CLEATS (1 x 6 in., length cut to fit). Locate on floor against four sides of block E. Nail to floor, using four twenty-penny cement-coated nails in each cleat.		
G	—	4
BRACES (1 x 6 in., length cut to fit). Cut braces long enough to extend from floor to top of block E. Toenail to block E using three twenty-penny cement-coated nails, and to cleats F and car floor with three twenty-penny cement-coated nails in each end.		
S	—	4
*WHEEL STRAPPING. Position wheels so that openings are even near the top of the wheel. Secure each wheel with two pieces of No. 8 gage black annealed wire consisting of four strands, two wrappings, each wire to pass through two openings in each wheel (top and adjacent hole) and be attached to stake pocket. (Wires shall cross each other at center of wheel.) With rod or bolt, twist-tie ends of wire enough to remove slack.		
S	—	2
*DRAWBAR STRAPPING. Secure drawbar at stake pockets on each side of car by looping wire, six strands of No. 8 gage black annealed, around lunette. Use separate wires to each side. Twist wire taut with rod or bolt.		
—	—	—
*SUPPORT LEGS. Position trailer chassis support legs at the four corners of the unit.		

\*When gondola or box cars are used, strapping should be applied in similar fashion, and attached to car floor by use of blocking or anchor plates.



STRAPPING FOR SOLID DISC STEEL WHEELS

RA PD 90453

**Figure 72 — Method of Blocking 6-wheel Trucks (Single or Dual Wheels) on Railroad Car for Complete Troop Train Movement**

LOADING FLAT CARS AND GONDOLA CARS

BLOCKING INSTRUCTIONS		
Item	Pat. No.	Qty. Req.
A	—	—
BRAKE WHEEL CLEARANCE (fig. 64).		
B*	3 Fig. 65	8
<p>CHOCK BLOCKS (6 x 8 x 24 in.). Locate blocks with 45-degree portion against front and rear of front wheels, in front of outside intermediate wheels and in back of outside rear wheels. Nail heel of block to car floor with three forty-penny cement-coated nails and toenail one side of blocks with two forty-penny cement-coated nails before cleats C are applied.</p>		
C*	2 Fig. 65	12
<p>SIDE CLEATS (2 x 4 x 36 in.). Locate two cleats against the outside face of each wheel. Nail lower cleat to car floor with three forty-penny cement-coated nails, and the top cleat to the lower cleat and car floor with three forty-penny cement-coated nails in each cleat.</p>		
D	—	6
<p>STRAPPING. Pass four strands of No. 8 gage black annealed wire, or wires of equivalent strength, through spokes or holes in disk wheels and through stake pockets. Bring both ends of wire together and twist taut with rod or bolt just enough to take up slack. (NOTE: When gondola or box cars are used, apply strapping in similar fashion, and attach to the floor by use of blocking or anchor plates. If units have solid disk steel wheels without holes, tie down over top of front and rear bumper brackets with items E and F for gondola or box cars, and to stake pockets for flat cars.</p>		
ALTERNATE METHOD OF STRAPPING		
E	2 Fig. 65	4
<p>CLEATS (2 x 4 x 36 in.). Nail to car floor, lengthwise of car, with six forty-penny cement-coated nails.</p>		
F	—	4
<p>STRAPPING. Pass four strands of No. 8 gage black annealed wire, or wires of equivalent strength, underneath items E and over top of bumper bracket. After car springs have been compressed as much as possible, bring both ends of wire together and twist taut with rod or bolt just enough to take up slack.</p>		

\*Must also be used for alternate method of strapping.

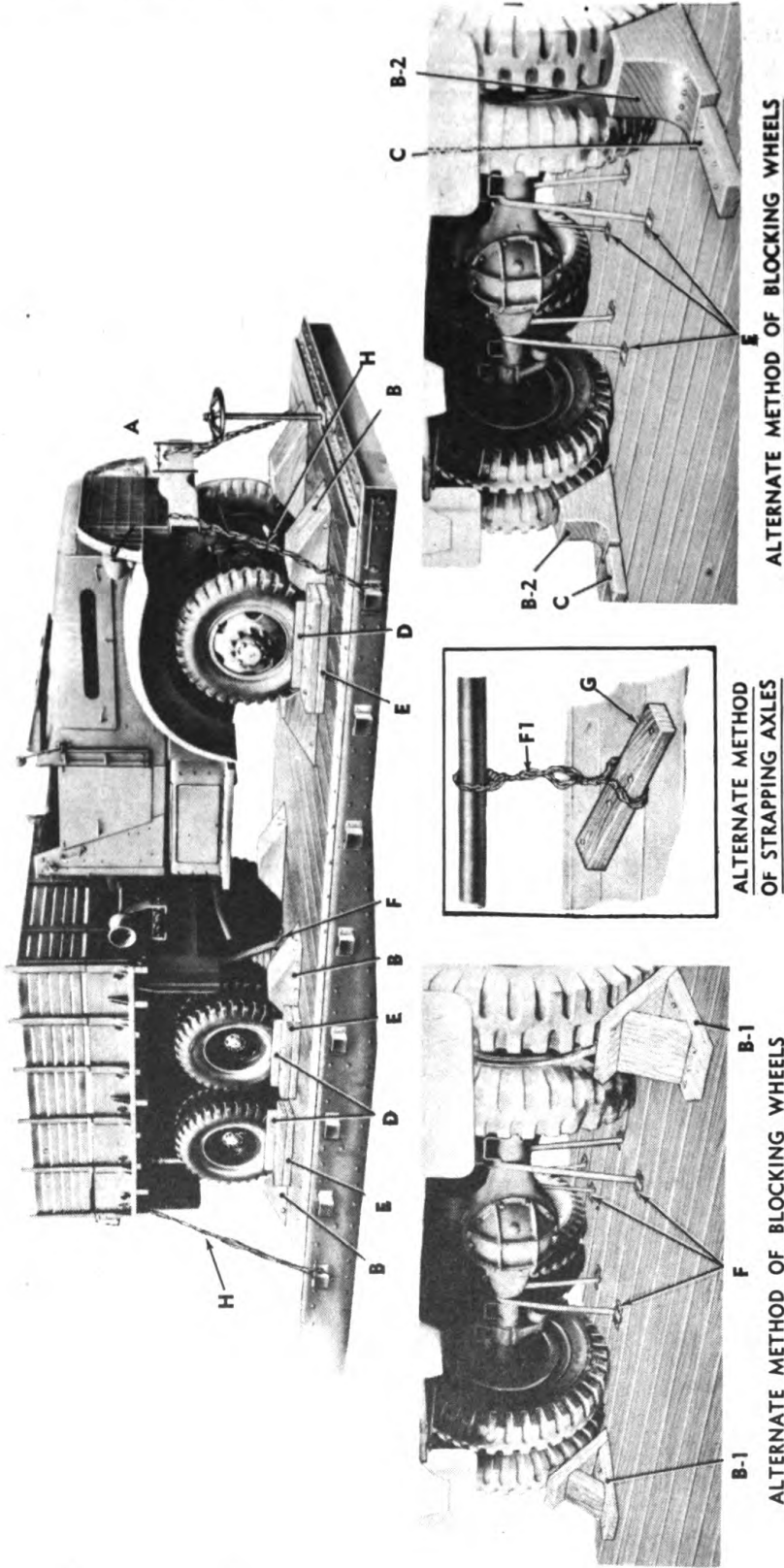

RA PD 90452

**Figure 73 — Method of Blocking 6-wheel Trucks (Single or Dual Wheels) on Railroad Car for Regular Freight Train Service**

LOADING FLAT CARS AND GONDOLA CARS

BLOCKING INSTRUCTIONS		
Item	Pat. No.	Qty. Req.
A	—	—
BRAKE WHEEL CLEARANCE (fig. 64).		
B	1 Fig. 66	8
CHOCK BLOCKS (6 x 8 x 24 in.). Locate blocks with 45-degree portion against front and rear of front wheels, in front of outside intermediate wheels and in back of outside rear wheels, before cushioning material, items D, and side cleats E are applied. Nail heel of block to car floor with three forty-penny cement-coated nails and toenail one side of blocks to car floor with two forty-penny cement-coated nails.		
D*	—	6
CUSHIONING MATERIAL. Place suitable cushioning material, such as waterproof paper, burlap, etc., under bottom portion of cleats E, top portion to extend 2 inches above cleats E.		
E*	5 Fig. 66	12
SIDE GLEATS (2 x 4 x 36 in.). Locate two cleats against the outside face of each wheel. Place suitable cushioning material, item D, in position. Nail lower cleat to car floor with four thirty-penny cement-coated nails, and top cleat to the lower cleat and car floor with four thirty-penny cement-coated nails in each cleat.		
F	6 Fig. 66	6
AXLE STRAPPING. Locate two 1-inch No. 14 B.W. gage hot rolled steel banding wires over each axle and secure to car floor with anchor plates, pattern No. 6. Nail anchor plates to car floor with eight twenty-penny cement-coated nails.		
H*	—	4
BUMPER OR END-TIE-DOWN STRAPPING. (Not required for units loaded in gondola or box cars.) Attach four strands, No. 8 gage black annealed wire, or wires of equivalent strength, to each corner of vehicle and nearest stake pocket. Bring both ends of wires together and twist taut with rod or bolt just enough to take up slack.		
ALTERNATE METHOD OF BLOCKING		
B-1	2 Fig. 66	8
CHOCK BLOCKS. Pattern No. 2 may be substituted at each location for chock blocks, pattern No. 1. Nail each block to car floor at rear of support brace with three twenty-penny cement-coated nails and toenail at front of support brace to car floor with one thirty-penny cement-coated nail at each side.		
B-2	3 Fig. 66	8
CHOCK BLOCKS. Pattern No. 3 may be substituted at each location for chock blocks, pattern No. 1. Nail each block to car floor at rear of block with four twenty-penny cement-coated nails before cleats C are applied.		
C	4 Fig. 66	8
CLEAT (2 x 4 x 12 in.). (Not required when patterns No. 1 and No. 2 are used.) Locate cleats against block lengthwise of car, and nail to car floor with four thirty-penny cement-coated nails.		
F-1	—	6
AXLE STRAPPING. Four strands of No. 8 gage black annealed wire, or wires of equivalent strength, may be substituted for steel banding. Pass wires over axle, underneath and around cleats G. After cleats G have been nailed to car floor, bring both ends of wires together and twist taut with rod or bolt just enough to take up slack.		

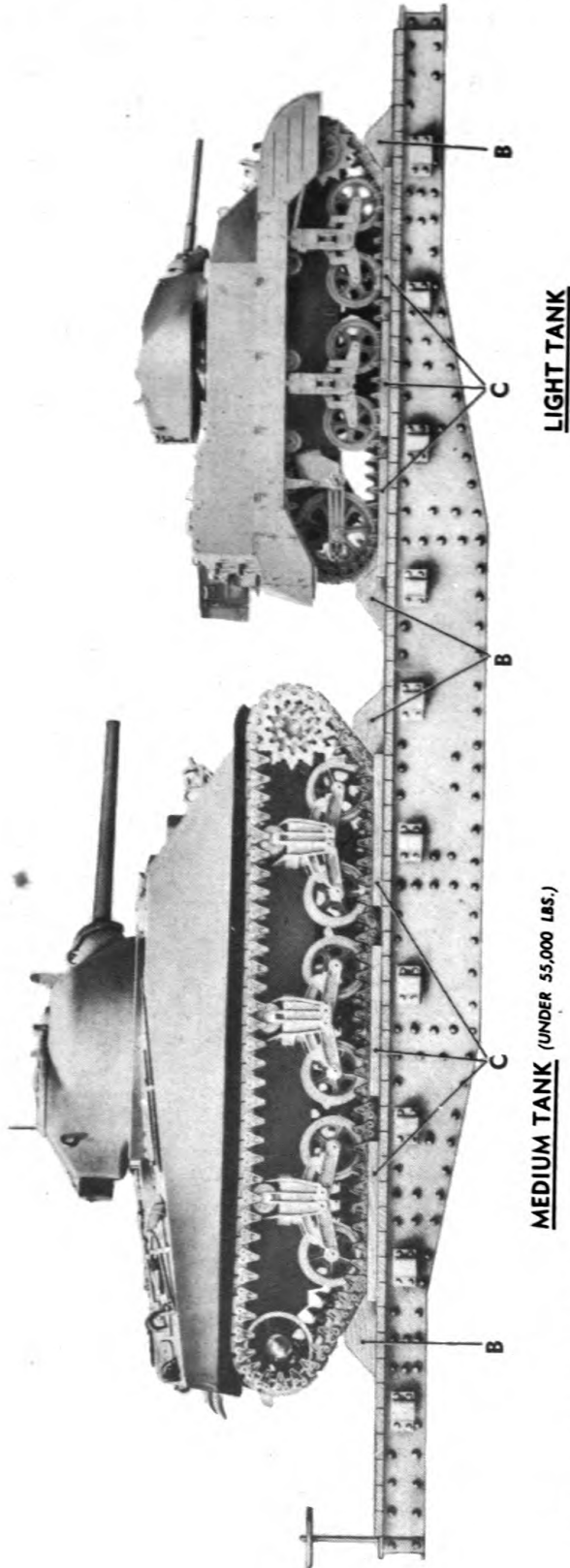

MEDIUM TANK (UNDER 55,000 LBS.)

LIGHT TANK

NOTE: LONGITUDINAL CENTER LINE OF TANK OR PRIME MOVER MUST BE DIRECTLY OVER LONGITUDINAL CENTER LINE OF CAR.

RA PD 27057

**Figure 74 — Method of Blocking Light and Medium Tanks on Railroad Car for Complete Troop Train Movement**



LOADING FLAT CARS AND GONDOLA CARS

Item	Pat. No.	Qty. Req.	BLOCKING INSTRUCTIONS
A	—	—	BRAKE WHEEL CLEARANCE (fig. 64).
B	3 Fig. 65	4	CHOCK BLOCKS (6 x 8 x 24 in.) Locate block with 33-degree portion against crawler tread. Nail heel of block to car floor with five fortypenny cement-coated nails and toenail one side of blocks to car floor with two fortypenny cement-coated nails.
C	2 Fig. 65	6	SIDE CLEATS (2 x 4 x 36 in.). May be applied either inside or outside of crawler tread. Nail each cleat to car floor with three fortypenny cement-coated nails.

RA PD 27073

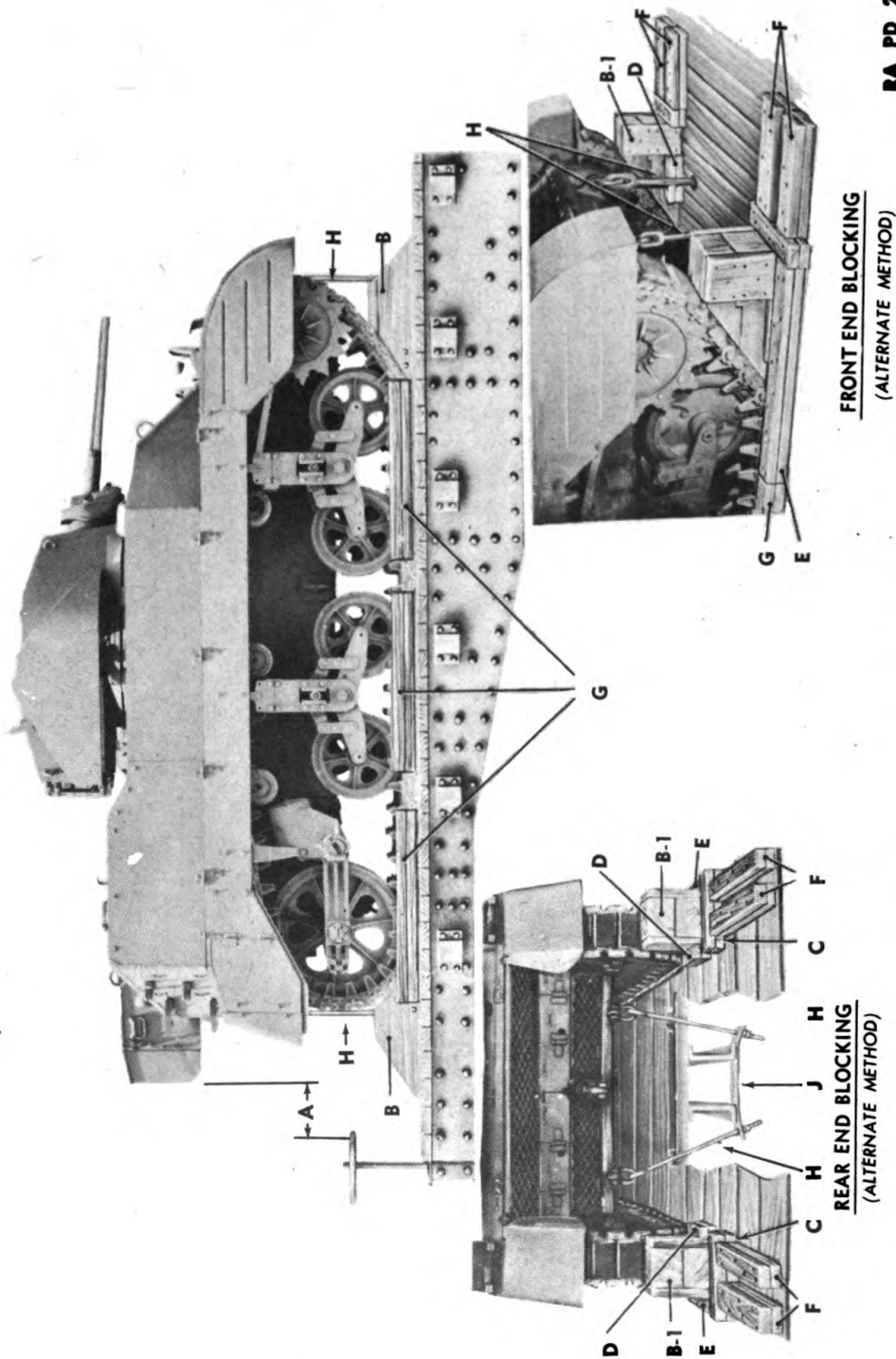

Figure 75 — Method of Blocking Light Tanks on Railroad Car for Regular Freight Train Service

LOADING FLAT CARS AND GONDOLA CARS

		BLOCKING INSTRUCTIONS
Item	Pat. No.	Qty. Req.
A	—	—
BRAKE WHEEL CLEARANCE (fig. 64).		
B	1 Fig. 66	4
CHOCK BLOCKS (6 x 8 x 24 in.). Locate block with 33-degree portion against crawler tread at front end, and 45-degree portion against crawler tread at rear end. Nail heel of block to car floor with five forty-penny cement-coated nails and toenail one side of blocks to car floor with two forty-penny cement-coated nails.		
G*	13 Fig. 66	12
WHEEL CLEATS (2 x 4 x 48 in.). Locate two cleats each against either the inside or outside of bogie wheels and idler wheel. Nail lower cleat to car floor with eight thirty-penny cement-coated nails, and top cleat to the lower cleat and car floor with twelve thirty-penny cement-coated nails.		
H*	28 Fig. 67	4
EYEBOLTS (length to suit). Insert eyebolts through holes in the car floor and attach the eye of the bolts to front and rear lifting devices. Attach to clamping bars, items J, with flat steel standard washers and tighten with 1-inch hexagon nuts and jam nuts. Insert cotter pins.		
J*	29 Fig. 67	2
CLAMPING BARS. Locate under center sills and secure with items H.		
ALTERNATE METHOD OF BLOCKING		
B-1	26 (front) and 27 (rear) Fig. 66	2 ea.
CHOCK BLOCKS. Substitute, if desired, in place of chock blocks B, pattern No. 1, two blocks each of patterns No. 26 and No. 27. Locate at front end of crawler, chock blocks pattern No. 26; and at rear end of crawler, chock blocks pattern No. 27. Toenail each block to car floor with four thirty-penny cement-coated nails.		
C	7 Fig. 66	8
CLEATS (2 x 4 x 18 in.). Locate two cleats each against rear of items B-1, patterns No. 26 and 27, crosswise of car. Nail lower cleat to car floor with four thirty-penny cement-coated nails, and top cleat to the lower cleat and car floor with six thirty-penny cement-coated nails.		
D	4 Fig. 66	8
CLEATS (2 x 4 x 12 in.). Locate two cleats each against inside face of items B-1, patterns No. 26 and 27. Nail lower cleat to car floor with three thirty-penny cement-coated nails, and top cleat to the lower cleat and car floor with four thirty-penny cement-coated nails.		
E	13 Fig. 66	8
CLEATS (2 x 4 x 48 in.). Locate two cleats each against outside face of items B-1, patterns No. 26 and 27. Nail lower cleat to car floor with eight thirty-penny cement-coated nails, and top cleat to the lower cleat and car floor with twelve thirty-penny cement-coated nails.		
F	7 Fig. 66	16
CLEATS (2 x 4 x 18 in.). Locate four cleats each lengthwise of car against rear of crosswise cleat C, pattern No. 7. Nail lower cleat to car floor with four thirty-penny cement-coated nails, and top cleat to the lower cleat and car floor with six thirty-penny cement-coated nails.		

\*Must also be used for alternate method of blocking.

INSTRUCTION GUIDE — ORDNANCE PACKAGING AND SHIPPING (POSTS, CAMPS, AND STATIONS)

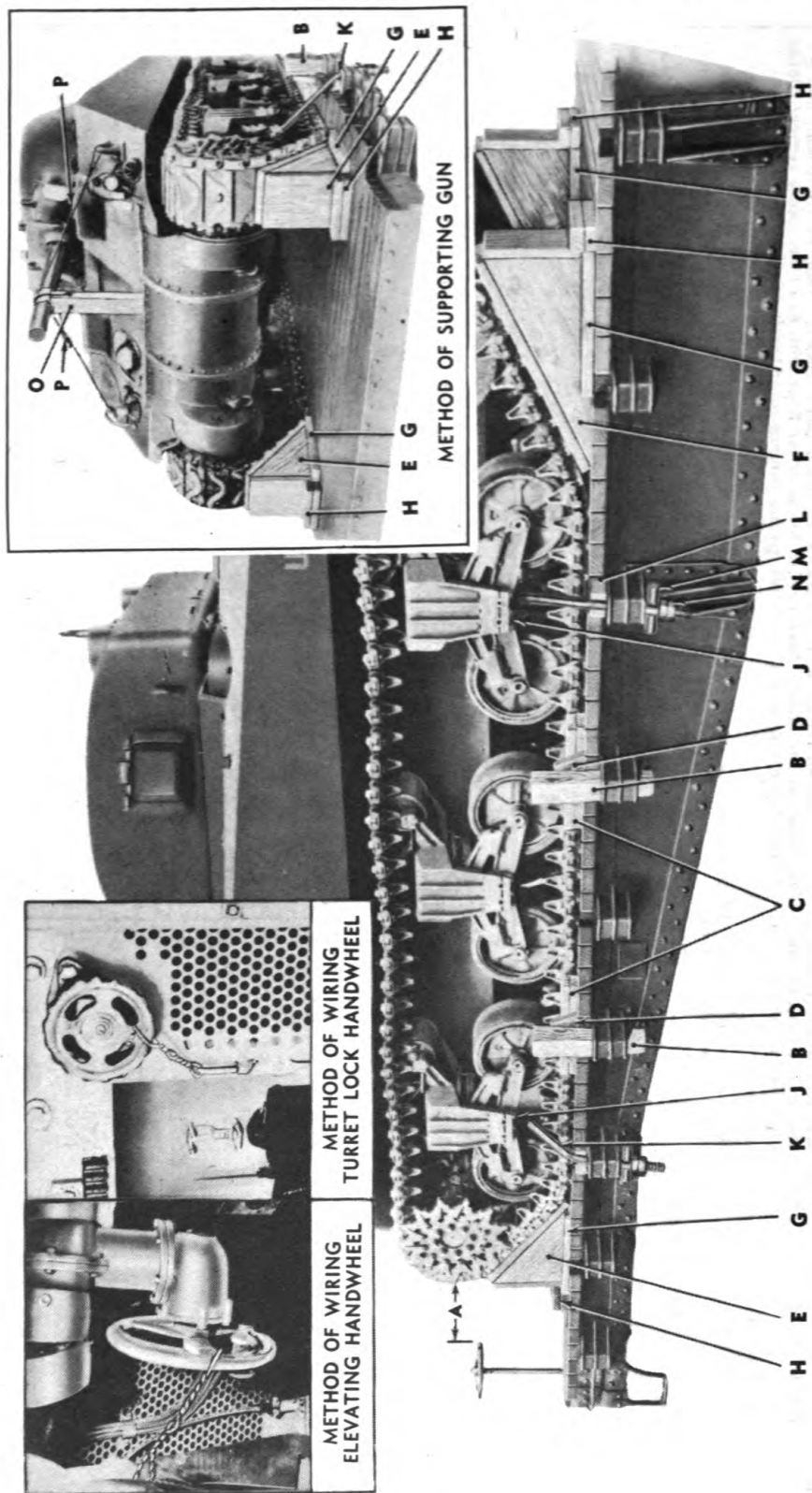

RA PD 90451

Figure 76 — Method of Blocking Medium Tanks on Railroad Car for Regular Freight Train Service

LOADING FLAT CARS AND GONDOLA CARS

BLOCKING INSTRUCTIONS		
Item	Part No.	Qty. Req.
A	—	—
	BRAKE WHEEL CLEARANCE (fig. 64).	
B	30 Fig. 67	4
	SIDE STAKES (4 x 6 x 24 in.). Locate two stakes on both sides of tank, one in first stake pocket to right of tank, and one to left of stake pocket nearest center of tank. Side stakes must extend at least 2 inches below stake pocket and 8 inches above car floor. Drive one forty-penny cement-coated nail directly into stake below and with head clinched over outside of stake pocket.	
C	8 Fig. 66	8
	SIDE CLEATS (2 x 4 x 24 in.). Locate two cleats each against crawler treads with centers opposite stakes B. Nail lower cleat to car floor with six twenty-penny cement-coated nails and the top cleat to the lower cleat with five twenty-penny cement-coated nails.	
D	31 Fig. 67	As required
	FILLER CLEAT (2 x 6 x 12 in.). Center between stakes B and cleats C and nail to car floor with one twenty-penny cement-coated nail in each end. Use sufficient cleats to completely fill space between items B and C.	
E	32 Fig. 67	2
	CHOCK BLOCKS — FRONT END. Locate chock blocks under crawlers at front end of tank.	
F	33 Fig. 67	2
	CHOCK BLOCKS — REAR END. Locate chock blocks under crawlers at rear end of tank.	
G	15 Fig. 66	8
	BRACE BLOCKS (2 x 4 x 20 in.). Locate one brace block against each side of chock blocks E and F and nail each to car floor with six twenty-penny cement-coated nails.	
H	4 Fig. 66	8
	BRACE BLOCKS (2 x 4 x 12 in.). Locate two brace blocks each against ends of chock blocks E and F. Nail each lower block to car floor with four twenty-penny cement-coated nails, and top block to lower block with three twenty-penny cement-coated nails.	
J	34 Fig. 67	4
	VOLUTE PLATES. Locate volute plates in bracket of bogie assembly.	
K	35 Fig. 67	4
	TIE-DOWN RODS. Insert through hole in volute plate J, stake pocket, and anchor bar M. Apply nut and cotter to top end of rod, above volute plate J. Apply 1 1/4-inch standard hexagon nut N below anchor bar M. Install lock nut and tighten. Heating of rods is prohibited. (Due to construction of tank, tie-down rods, when properly tightened at originating point, may be found slightly loose in transit. When so found, they should not be disturbed enroute.)	
L	—	4
	WEDGES (3 1/2 x 4 x 4 in., cut to fit). The wedges are driven into the stake pockets behind the bogie wheel tie-down rods K.	
M	36 Fig. 67	4
	ANCHOR BARS. Apply to item K below stake pocket.	
N	—	4
	1 1/4-INCH STANDARD HEXAGON NUTS. Secure with lock nut or nut lock. When common nut is used as lock nut, threads need not be nicked.	
O	37 Fig. 67	1
	GUN SUPPORT. (Wrap gun barrel with nonhygroscopic adhesive tape before applying gun support.) Apply to top of tank under turret gun barrel, and secure with one piece of 3/4-inch band of high tensile strength placed over gun barrel and nailed to each side of support with two sixty-penny cement-coated nails. Not required when gun is secured with built-in gun support.	
P	—	2
	GUN BARREL. (Wrap gun barrel with nonhygroscopic adhesive tape before applying banding.) Apply two 3/4-inch bands of high tensile strength, one each side of gun barrel. Bands should be sealed about 18 inches from gun barrel and 12 inches from top lifting rings with two seals at each point of attachment. (Turret gun should be in straight-forward position, and turret lock handwheel and elevating mechanism handwheel must be wired to prevent rotating.)	

**INSTRUCTION GUIDE — ORDNANCE PACKAGING AND SHIPPING (POSTS, CAMPS, AND STATIONS)**

*(Continued from page 123)*

b. Specific examples for blocking the following major items are given in this section.

- (1) 40-mm Automatic Gun M1 and AA Carriages M2 and M2A1 (fig. 68).
- (2) 105-mm Howitzer Carriage M2A2 (fig. 69).
- (3) 120-mm Gun M1 and AA Mount M1 (fig. 70).
- (4) Director Trailer M14 (fig. 71).
- (5) 6-wheel trucks (single or dual wheels).
  - (a) Blocking for complete troop train movement (fig. 72).
  - (b) Blocking for regular freight train service (fig. 73).
- (6) Light tanks.
  - (a) Blocking for complete troop train movement (fig. 74).
  - (b) Blocking for regular freight train service (fig. 75).
- (7) Medium tanks.
  - (a) Blocking for complete troop train movement (fig. 74).
  - (b) Blocking for regular freight train service (fig. 76).

c. Patterns used for blocking materiel shown in the blocking examples are given in figures 65, 66, and 67.

---

**Section III**

**LOADING TRUCKS**

**59. GENERAL RULES.**

a. **Loading.** Army trucks must not be loaded beyond the maximum permissible weight as indicated by the appropriate Technical Manual. The essential principle of truck loading is to distribute the load as evenly over the truck bed as possible, both side to side and end to end.

b. **Balancing the Load.** An unbalanced load will make the truck "handle" and steer badly, and will injure tires. After the truck is loaded, check to see whether the truck is parallel with the ground. If an unbalanced condition is shown, correct it by shifting or rearranging the load. If the load consists of a number of containers, these should be piled or placed so that they will not change position in transit. Sacks, for example, should be laid flat and, if necessary, piled in pyramid fashion. Drums should ordinarily be placed upright, and the heads protected with lumber (dunnage) if other articles are loaded

## LOADING TRUCKS

on top of them. (For further details on loading procedure, refer to TM 21-300.)

### 60. PROTECTION OF TAIL GATE.

a. If the load includes long pieces such as lumber or pipe so that the tail gate must be left down, dunnage about 4 inches in height should first be placed across the truck bed near the rear. This will protect the tail gate and also prevent the load from working toward the rear.

### 61. CROSS-COUNTRY OPERATION.

a. **Securing the Load.** It is not usually necessary to secure the load if operation is over good roads. For operation over rough ground, however, shifting and bouncing of the load may be prevented by tying it securely with heavy wire, flat metal bands, or any other available material of sufficient strength. Ties should pass around the sides and over the top of items loaded. Care should be taken that the ends are securely fastened. The possibility that ties will become cut or chafed through at certain points should be considered, and protection provided at these points. An example of lashing a load is given in TM 21-300.

**CHAPTER 6**

**APPENDIX**

**Section I**

**TOOLS AND MATERIALS**

**62. TOOLS AND MATERIALS.**

a. The tools and materials listed below have been mentioned in the text and are required to do a complete job on all types of packaging, packing, and carloading prescribed in this Technical Manual. This list should be used as a guide in requisitioning tools and materials. Requisitions should be processed through regular channels, in accordance with the latest Supply Bulletins, catalogs, circulars, or other applicable publications.

Item	Use
ADHESIVE, stickum, 1 qt.	Applying stencils only (optional use).
BAR, wrecking, gooseneck, 24 in.	Removing old blocking in freight cars.
BIT, auger, single-twist, solid-center, set, complete, consisting of 1/4-, 5/16-, 3/8-, 1/2-, 5/8-, 3/4-, 7/8-, and 1-in. diameter	Boring holes for bolts (with brace); and for drainage and ventilation in sheathed crates (if no electric drill is available).
BIT, expansive, screw-adjusting, 7/8 to 3 in.	Boring large holes in blocking, etc., (with brace).
BIT, screwdriver, 3/8 in.	Turning screws (with brace).
BOLT, carriage, rd-hd., sq-nk, S., w/nuts	Fastening article to base of container; fastening thick wood members together.
BOLT, lag, sq-hd., S., 1/2 x 6 in., 5/8 x 10 in.	Also called lag screws. Fastening thick floor boards; snubbing device in carloading.
BOX, mitre, adjustable, w/o saw	Making angle cuts.
BRACE, ratchet, 12 in.	Boring holes for lag screws and bolts.
BRUSH, chassis and running gear	Cleaning with solvent or soap solution.
BRUSH, glue, round	Applying adhesive.
BRUSH, grease, bristled (3/8 x 3/4 x 5 1/4 in.)	Brush application of rust-preventive compounds.



TOOLS AND MATERIALS

Item	Use
BRUSH, marking, bristle, No. 2 ( $1\frac{1}{64}$ in.)	Marking for shipment.
BRUSH, paint, metal bound, flat (medium grade), No. 1 (3 in.)	Applying paint or enamel; cleaning with dry-cleaning solvent.
BRUSH, scrubbing, floor, hand	Removing heavy accumulations of dirt from materiel.
BRUSH, stencil, No. 1 ( $1\frac{3}{16}$ in.) 5 $\frac{1}{8}$ in. long	Marking with stencils.
BRUSH, varnish, flat (double x thickness), No. 2	Applying varnish or lacquer.
CEMENT, adhesive, rubber base	Making seams and joints in waterproof paper linings and shrouds.
CEMENT, waterproof	Securing labels.
CHISEL, woodworkers', handled, socket-firmer (type A), 1 in.	Fitting blocks and braces.
CLEANER, rifle bore (1 qt.) (U.S.A. Spec. 2-117)	Cleaning rifle and artillery bores.
CLOTH, abrasive, aluminum-oxide, sheet 9 x 11, 2/0-100. lgr. (Fed. Spec. P-C-451)	Removing rust or other imperfections from noncritical surfaces.
CLOTH, crocus (Navy 42-C-5)	Removing rust from critical surfaces and highly finished parts.
CLOTH, salvaged	Cushioning material.
CLOTH, wiping, cotton, Class A, Type II, 5 lb. 100 lb.	Drying cleaned parts or wiping off grease.
COMPOUND, rust-preventive, heavy (U.S.A. Spec. 2-82C), 5 lb. 100 lb.	See paragraph 6.
COMPOUND, rust-preventive, light (U.S.A. Spec. 2-84B), 5 lb. 25 lb.	See paragraph 6.
COMPOUND, rust-preventive, thin-film (Ord. Dept. Tentative Spec. AXS-673), 1 gal. 5 gal.	See paragraph 6.

INSTRUCTION GUIDE — ORDNANCE PACKAGING AND SHIPPING (POSTS, CAMPS, AND STATIONS)

Item	Use
COMPOUND, sealing, dip-coating (order by lb.) (Ord. Dept. Tentative Spec. AXS-1015)	Dip-coating inner packages for storage or shipment.
DRILL, breast, plain, 1/8 to 1/2 in. (for straight, square, or taper square bit stock shanks —Type A)	If no electric drill is available.
DRILL, twist, straight-shank, H.S.S. 1/16 to 1/2 in. by 64ths, set, complete	With electric drill if available, drilling holes for nails, lag screws, bolts, and for drainage and ventilation in sheathed crates.
ENAMEL, synthetic, lusterless, O.D. (U.S.A. Spec. 3-173), 1 gal. 5 gal.	Final or top coat of enamel.
ENVELOPE, waterproof, heavy oil paper, metal fastening, metal eyelet, 4 1/4 x 5 3/4 in.	Enclosing packing lists.
GLOVE, canvas (or cotton)	For wear while handling cleaned parts.
GLOVE, rubber, synthetic	For wear while working in solvent.
HAMMER, carpenters', claw, bell-faced, 16 oz. 20 oz.	
INK, stencil, for fountain brush, (U.S.A. Spec. 36-2)	Waterproof ink for lettering labels.
IRON, corner, crate, 1 x 0.0625 in.	Reinforcing corners, etc., of crates (substitute: prepunched annealed strap).
LABEL, paper, 4 x 6	For attachment to packages. Any good grade of white paper may be used.
LACQUER, clear, 1 pt. 1 gal.	Waterproof protective covering for labels.
LUMBER, nominal 1-in. and 2-in.; dimension and timber stock if available	Construction containers; carloading.
NAIL, galvanized roofing (Fed. Spec. FF-N-101)	Securing waterproof paper placed on tops of crates.

TOOLS AND MATERIALS

Item	Use
<p>NAIL, wire, steel, bright common, standard (Fed. Spec. FF-N-101), 20d 30d 40d 60d</p>	<p>To be used if cement coated nails are not available.</p>
<p>NAIL, wire, steel, cement-coated sinker (Fed. Spec. FF-N-101), 4d 6d 7d 8d 9d 10d 12d 16d</p>	<p>Nailing boxes, crates, skid units, blocking, and bracing. If sinkers are not available, corkers may be used.</p>
<p>OIL, lubricating, preservative, medium (Ord. Dept. Tentative Spec. AXS-674), 1 qt. 5 gal. 55 gal.</p>	<p>See paragraph 6.</p>
<p>PAINT, lacquer, markings, obliterating, 1 gal.</p>	<p>Covering old markings.</p>
<p>PAINT, stencil (U.S.A. Spec. 3-179) black, 1 qt.; white (paste) 1 qt.</p>	<p>Marking boxes and crates.</p>
<p>PAPER, corrugated, single-faced, flexible (48 in. roll)</p>	<p>Cushioning parts or projections when packing.</p>
<p>PAPER, flint, Class B, No. 2/0 (Fed. Spec. P-P-111), 1 gr.</p>	<p>Sandpapering primed surfaces before applying enamel.</p>
<p>PAPER, kraft, overwrapping</p>	<p>Overwrapping dip-coated packages. Waxed paper or glassene may be used.</p>
<p>PAPER, shredded, waxed</p>	<p>For cushioning.</p>
<p>PAPER, stencil, board (oiled), 20 x 24 in., 24 x 36 in.</p>	<p>Marking shipments in quantity.</p>

**INSTRUCTION GUIDE — ORDNANCE PACKAGING AND SHIPPING (POSTS, CAMPS, AND STATIONS)**

Item	Use
PAPER, wrapping, greaseproof, Grade A (U.S.A. Spec. 100-15), Type I Type II Grade C (U.S.A. 100-15), Type I Type II	Covering preserved surfaces to keep the preservative (corrosion preventive) on the part. See paragraphs 7 and 8.
PAPER, wrapping, waterproof barrier (Ord. Dept. Tentative Spec. AXS-1246), Type B-1 Type C-1 Type E-1 Type E-2  Type H-3 Type L-2	See paragraphs 8, 9, 10, 21, and 30.  Stretchable, used for spiral wraps. Interior packaging wrapping. Crate top covers. Shrouds, case liners, or crate top covers. High grade case liners. Regular case liners.
PLANE, jack, iron, 11½ in.	Planing blocks and braces to exact size; removing old markings.
PLATE, anchor, strapping, 4 x 2 x 0.125 in.	Making tie-downs with steel bands (optional use).
PLATE, antiskid (perforated)	To make snubbing devices in carloading.
PRIMER, synthetic, rust-inhibitive (U.S.A. Spec. 3-171), Grade II, 1 gal. 5 gal.	Priming coat on metals under synthetic enamels.
PROTECTOR, packing list, fiber	Protecting packing list on exterior of container.
PULLER, nail, 18 in.	Pulling nails when disassembling boxes or crates.
RASP, wood, half-round, 10 in.	Fitting blocks, braces, etc.
SAW, hand, crosscut, 10 points per in., 26 in.	Fitting blocks, braces, etc.
SAW, hand, rip, 5½ points per in., 26 in.	Cutting lumber across grain.
SAW, mitre-box, 20 in. (or available substitute)	Making angle cuts.

TOOLS AND MATERIALS

Item	Use
SAWDUST, shavings	Occasionally may be used for cushioning or space filling (par. 10).
SCREWDRIVER, comm., normal-duty, 3-in. blade 6-in. blade	
SEAL, box, strapping, universal type, 1/2 in. 5/8 in. 3/4 in. 1 1/4 in.	Fastening ends of flat steel strapping.
SHEARS, office trimmers, straight, 10 in.	Cutting paper, tape, felt, or cellulose cushioning, etc.
SLEDGE, blacksmiths' double-face, 10 lb.	Applying antiskid plates.
SOLVENT, dry-cleaning (Standard solvent) (also called SOLVENT, petroleum distillate) (Fed. Spec. P.S. 661a.), 1 gal. 5 gal. 55 gal.	Cleaning metal parts of assemblies. (First, Second, and Third Service Commands procure from Jersey City Quartermaster Depot.)
SPRAY GUN	Spraying rust-preventive compound.
SQUARE, standard, 18 x 24 in. 12 x 8 in. 8 x 6 in.	Measuring and marking for saw cuts.
STEEL PLATES	Protection of box car floor against traffic of heavy loads.
STRAP, annealed, prepunched, 1 to 1 1/4 x 0.028 in.	Reinforcing crate corners and edges. Securing items inside crates.
STRAPPING, flat steel, 1/2 x 0.020 in. 5/8 x 0.020 in. 3/4 x 0.020 in. 3/4 x 0.023 in. 1 1/4 x 0.035 in. 2 x 0.050 in.	Reinforcing boxes and crates. Round wire may be used instead.

**INSTRUCTION GUIDE — ORDNANCE PACKAGING AND SHIPPING (POSTS, CAMPS, AND STATIONS)**

Item	Use
<b>TACKS</b> , wire, iron or steel, 7/16-in. length 9/16-in. length 1 1/16-in. length	Fastening felt or cloth cushioning, labels, and packing lists.
<b>TAGS</b> , paper, No. 2, with wire strings, No. 6, 5 1/4 x 2 5/8, each	Identification or shipping information on items where labels cannot be readily attached.
<b>TANK</b> , cleaner, 24 x 36 in., with safety lid	Immersion cleaning with solvent.
<b>TANK</b> , heating	Heating heavy or light rust-preventive compounds, dip-coat sealing compound.
<b>TAPE</b> , adhesive, nonhygroscopic, 2 in. x 60 yd. 4 in. x 60 yd.	Gun muzzle covers; sealing other apertures in materiel (where required). Formerly called nonhygroscopic tape.
<b>TAPE</b> , kraft, gummed, 2 1/2 in.	Sealing kraft wrappings; fastening edges of labels or for use directly as substitute labels with typing or lettering on the tape.
<b>TAPE</b> , transparent, 2 in. x 60 yd.	Fastening labels (optional use).
<b>THINNER</b> , enamel, synthetic (U.S.A. Spec. 3-176), 1/2 pt. 1 gal. 5 gal.	To thin synthetic enamel or primer if too thick.
<b>TOOL</b> , tensioning and sealing	To apply the flat strap or round wire being used (tools not interchangeable).
<b>TOPCOATING</b> , crate, bituminous, (AXS 1231)	Waterproofing tops of sheathed crates (par. 30).
<b>TWINE</b> , jute, baling, sacking, or wrapping, type C, 3 ply	Tying small packages; securing shrouds.
<b>WISE</b> , woodworkers'	To hold material for planing, etc.
<b>WADDING</b> , creped cellulose, kraft-backed, 30 ply-24 in.	Cushioning small or fragile articles.
<b>WASHER</b> , plain, S., U.S.A. std.	Under nuts against wood.

**TOOLS AND MATERIALS**

Item	Use
WASTE, cotton, white, 1 lb. 5 lb.	General wiping and cleaning (where lint will do no harm).
WIRE, steel, carbon, low, an- nealed, black, 0.032	Attaching tags.
WIRE, strapping, 13 gage 12 gage	Optional use as substitute for flat strap.
WRENCH, adjustable, single-end, 18 in.	Turning nuts and lag screws.

Section II

REFERENCES

63. PUBLICATIONS INDEXES.

The following publications indexes should be consulted frequently for latest changes or revisions of references given in this section and for new publications relating to materiel covered in this manual:

- a. Ordnance supply catalog index (index to SNL's) ASF Cat.  
ORD 2 OPSI
- b. Major items and combinations, and pertinent publications ..... SB 9-1
- c. List of publications for training (listing CCBPS's, FM's, FT's, MTP's, TB's, TM's, TR's, TC's, and WDLO's) ..... FM 21-6
- d. List of training films, film strips, and film bulletins ..... FM 21-7
- e. Military training aids (listing graphic training aids, models, devices, and displays) ..... FM 21-8
- f. List of administrative and supply publications (listing MR's, RR's, SB's, WDMWO's, and WDP's) ..... WD Pamphlet 12-6

64. STANDARD NOMENCLATURE LISTS.

- a. Cleaning, preserving and lubricating materials; recoil fluids, special oils, and miscellaneous related items ..... ORD 5  
SNL K-1
- b. **Hardware, Tools, and Related Items.**
  - Abrasion and compression tools (hand grinders, hand presses, sharpening stones, etc.) ..... ORD 5  
SNL J-1
  - Cutting, boring, and tweezer tools (saws, shears, planes, files, rasps, chisels, bits, reamers (hand), pliers, pincers, etc.) ..... ORD 5  
SNL J-2
  - Miscellaneous hardware ..... ORD 5  
SNL H-2
  - Standard hardware ..... ORD 5  
SNL H-1



REFERENCES

65. EXPLANATORY PUBLICATIONS.

a. **Cleaning, Preserving Materials, etc.**

Catalog of approved packaging instructions for major items and spare parts for ordnance general supplies .....	PS No. 1000
Cleaning, preserving, sealing, lubricating and related materials issued for ordnance materiel .....	TM 9-850
Corrosion prevention processing and packaging .....	ASF Manual M406
Preparation of ordnance materiel for deep water fording .....	TM 9-2853
Preparation of overseas movement.....	AG 370.5
Preparation of unboxed ordnance materiel for shipment .....	SB 9-4
Preservation of ordnance materiel not in regular use .....	SB 9-28
Protection of ordnance materiel in open storage .....	SB 9-47
Rust-preventive materials .....	SB 9-31

b. **General.**

Basic maintenance manual .....	TM 37-250
Carpentry .....	TM 5-226
Decontamination .....	TM 3-220
Defense against chemical attack.....	TM 21-40
Dictionary of United States Army Terms.....	TM 20-205
Distribution and issue of ordnance general supplies .....	SB 9-3
Inspection of ordnance materiel.....	TM 9-1100
Maintenance and care of pneumatic tires and rubber treads .....	TM 31-200
Standard artillery and fire control materiel.....	TM 9-2300
Stevedoring .....	TM 55-310
Water transportation .....	TM 10-380
Welding—theory and application .....	TM 9-2852

c. **Methods and Procedures.**

Bill of lading procedure .....	ASF Manual M404
Driver selection and training .....	TM 21-300
Duplicating methods and forms .....	ASF Manual M405

**INSTRUCTION GUIDE — ORDNANCE PACKAGING AND SHIPPING (POSTS, CAMPS, AND STATIONS)**

- Standard operating procedure for movement of equipment and supplies to ports of embarkation, Canada, and Mexico ..... **TM 38-415**  
**ASF Manual M403**
- Station supply procedure ..... **M403**
- War Department shipping document ..... **ASF Manual M401**
- d. Packaging and Packing Specifications.**
  - Army-Navy general specification for packaging and packing for overseas shipment (latest revision) ..... **USA No. 100-14**
  - Engines and vehicles, storage and shipment, preparation for ..... **AXS-836**
  - General packaging instructions for small arms spare parts ..... **PS 100**
  - Ordnance packaging instructions for cleaning, preserving, wrapping and packaging of tools and equipment ..... **PS 502**
  - Ordnance packaging instructions for preservation of corrosion on boxed vehicles ..... **PS 504**
  - Packaging and packing of machine tools and extra parts for overseas shipment ..... **PS 300**
  - Packaging for overseas shipment: Tires, tubes, and flaps for vehicles ..... **USA No. 100-18**
- e. Shipment and Storage.**
  - Compressed gas cylinder ..... **AR 850-60**
  - Depot operations: Storage ..... **ASF Manual M402**
  - Loading of commodities on open top and in box cars, published by Association of American Railroads, Special Supplements No. 1 and No. 2 .....
  - Requisitioning and marking supplies for overseas shipment (marking directive) ..... **AG 400.161**
  - Stock control manual for posts, camps, and stations ..... **TM 38-220**
  - Storage and shipment of rubber tires, tubes and camelback ..... **SB 9-43**
  - Transportation corps—overseas movement of organizations, casuals, and individuals of Army transports ..... **AR 55-390**

**REFERENCES**

- Transportation corps—transported by commercial means; general ..... AR 55-105
- Transportation of public property (except animals) and remains ..... AR 55-155
- f. Storage and Shipment Charts.**
- Ordnance storage and shipment chart..... SB 9-OSSC-A
- Ordnance storage and shipment chart..... SB 9-OSSC-B
- Ordnance storage and shipment chart..... SB 9-OSSC-C
- Ordnance storage and shipment chart..... SB 9-OSSC-G



INDEX

<b>C — Contd.</b>	<b>Page</b>	<b>E</b>	<b>Page</b>
Corrosion preventives .....	4	Edge members	
Corrugated paper .....	17	construction .....	85
Crates, open		definition .....	72
assembly .....	66, 70	table 14 .....	85
blocking and bracing.....	65	End floor members	
construction		construction .....	78
base and skids.....	61, 69	definition .....	73
cross members, diagonal mem- bers, top, and sides.....	63, 69	Excelsior, use for cushioning.....	17
ends .....	64, 69	Eyebolts, blocking data .....	141
description .....	19		
general discussion of crates for loads		<b>F</b>	
not over 200 pounds.....	67	Felt, use as cushioning material.....	18
not over 2,000 pounds.....	61	Fiberboard, salvaged .....	18
guide to choice of.....	21	Floor boards	
reinforcement of corners.....	66, 70	definition .....	72
size of nails used for blocking and bracing .....	66	used in construction of base.....	79
weatherproofing .....	67	Frame members, definition.....	72
Crates, sheathed			
application, and definitions of parts .....	72	<b>G</b>	
arrangement, measurement, and weight of contents.....	73	Greaseproof materials .....	8
assembling .....	87	Gun barrel, blocking data.....	143
construction		Gun bores .....	3
base .....	77	Gun support, blocking data.....	143
sides and ends.....	81		
top .....	79	<b>H</b>	
general discussion .....	71	Hay, use as cushioning material.....	18
lining of side and end panels.....	77	Hexagon nuts, blocking data.....	143
reinforcing .....	88		
securing contents .....	74	<b>I</b>	
selection of bolt sizes.....	93	Identification and marking	
topcoating and lining of double- sheathed tops .....	76	application .....	98
ventilation of end panels.....	77	definition of terms.....	97
weatherproofing .....	76	on item or inner package.....	98
Cross members .....	92, 93	on shipping container.....	99
Cushioning material .....	16, 137	Idler cars, use .....	121
		Inner packaging (See Packaging)	
<b>D</b>		Inspection of railroad cars.....	120
Diagonal members .....	63		
Drawbar, strapping data..	127, 131, 133	<b>J</b>	
		Joists, top	
		construction	
		joist .....	80
		joist supports .....	87
		description of joists and supports	73
		nominal size and spacing of joists (table 11) .....	80

INSTRUCTION GUIDE — ORDNANCE PACKAGING AND SHIPPING (POSTS, CAMPS, AND STATIONS)

L	Page	P	Page
Lag screws, application.....	118	Packaging	
Linings		general discussion .....	8, 10
application of waterproof.....	44	methods .....	10, 12
preparation		Packing, preparation for.....	2
bag linings .....	51	Painting .....	4
panel linings .....	49	Paper, shredded	
Load (for rail shipment)		used as cushioning material.....	17
limits and distribution of.....	101	(See also Waterproof paper and	
maximum load weights.....	120	Corrugated paper)	
Loading rules for rail shipment....	120	Preservatives .....	2
Lubricating oil, preservative			
description and application.....	7	<b>R</b>	
examples .....	8	Rail shipment, loading rules.....	120
Lumber		Rotating parts .....	121
for bracing and blocking.....	104	Rust, removal .....	3
resawing for nailed boxes.....	31	Rust-preventive compound	
surfacing and seasoning.....	23	application and examples	
<b>M</b>		heavy .....	4
Marking		light .....	6
general marking for shipment....	100	thin-film .....	7
(See also Identification and		description	
marking)		heavy .....	4
Materials		light .....	5
cushioning .....	16	thin-film .....	6
description of greaseproof and			
waterproof .....	8	<b>S</b>	
list of tools and materials.....	149	Sawdust and shavings, use in pack-	
		ing .....	18
<b>N</b>		Sheathing	
Nails		definition .....	72
kind used in construction of con-		nailing .....	87
tainers .....	25	Shipment	
size and general rules for nailing	104	cleaning and preservation of ma-	
sizes of cement-coated nails used		teriel for export and domes-	
for fastening		tic shipment .....	2
blocks and braces in open		loading rules for rail shipment....	120
crates .....	66	preparation of unboxed ordnance	
sides and tops.....	33	material .....	1
tops and bottoms to sides.....	35	Shroud .....	67
spacing in construction of nailed		Skid units	
wood boxes .....	35	construction	
tabulated data		skids .....	77
average spacing of nails for		units .....	90
nailing to ends and cleats..	36	definition .....	19
construction of containers.....	25		
lengths of nails used for brac-			
ing and blocking in freight			
car .....	105		

INDEX

S — Contd.	Page	T	Page
Skid units — Contd.		Tail gate (truck), protection.....	145
fabricating of large skids from		Tie-down rods .....	143
2-inch lumber .....	96	Tools and materials.....	146
general discussion .....	89	Trail, strapping data.....	129
guide to choice of.....	21	Trailers, loading .....	121
tabulated data		Trucks	
number and size.....	78	cross country operation and pro-	
width .....	91	tection of tailgate.....	145
Snubbing method of securing load		loading .....	144
description .....	115		
number of snubbing devices re-		<b>V</b>	
quired .....	116	Volute plates .....	143
Strapping			
application, number, and size of		<b>W</b>	
straps .....	59	Wadding, crepe cellulose.....	17, 152
blocking data .....	127-143	Waterproof materials .....	9
tabulated data .....	60	Waterproof paper	
Straw, use as cushioning material	18	application to shipping contain-	
Struts		ers .....	44
definition .....	72	types and uses.....	10
spacing and size of vertical.....	82	Wedges, blocking data.....	143
tabulated data .....	83	Wheel supports .....	127, 129, 131











