

Farymann Diesel

Operator's manual

**Diesel engine
Series 15W / 18W**

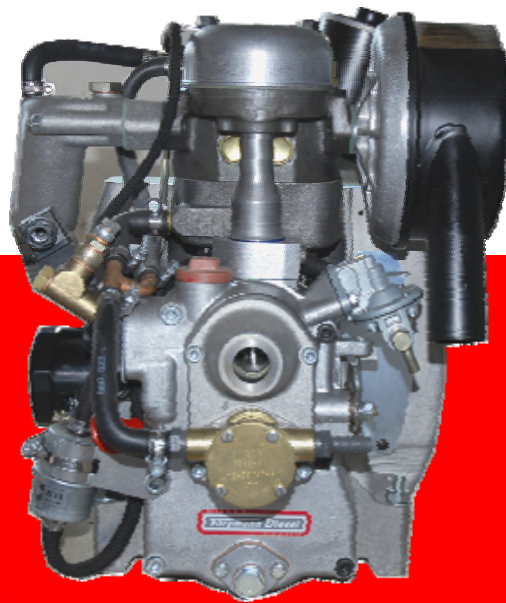

Doc-ID: Grea-8247

Read the operating instructions before starting work!

© Greaves-Farymann Diesel GmbH
Industriestraße 19
68623 Lampertheim
Germany
Tel.: +49 (0) 62 06 / 5 07 - 0
Fax: +49 (0) 62 06 / 5 07 - 111

E-Mail: info@farymann.de
Internet: www.farymann.de

Release:

Created by:
Kothes!
Technische Kommunikation GmbH & Co. KG
www.kothes.de

1	General	7
1.1	Information about this manual	7
1.2	Explanation of the symbols.....	8
1.3	Limitation of liability.....	9
1.4	Copyright.....	10
1.5	Warranty terms	10
1.6	Customer service.....	10
2	Safety	11
2.1	Customer's responsibility.....	11
2.2	Personnel requirements.....	13
2.2.1	Qualifications	13
2.3	Appropriate use	14
2.4	Personal protective equipment	15
2.5	Specific dangers	16
2.6	Safety devices.....	20
2.7	Behaviour in the case of danger and accidents.....	20
2.8	Environmental protection	21
3	Technical data	22
3.1	Technical specifications	22
3.2	Applications.....	22
3.3	Standard configuration.....	23
3.4	Options.....	23
3.5	Engine type plate	24
3.6	Engine type code	24
3.7	Engine data.....	25
3.8	Performance data	26
3.9	Dimensions and weight.....	27
3.10	Temperatures.....	27
3.11	Pressures.....	28
3.12	Operating materials	28
3.13	Engine oil specification	29



Table of contents

4	Structure and function.....	30
4.1	Overview	30
4.2	Electrical System.....	33
4.2.1	Alternator (option)	33
4.2.2	Alternator regulator (option).....	34
4.2.3	Operating conditions.....	34
4.2.4	Dangers and cause of failure.....	35
4.2.5	Batteries.....	36
4.3	Cooling system.....	37
4.3.1	Open cooling water circuit with direct sea water cooling without thermostat	37
4.3.2	Open cooling water circuit with direct sea water cooling with thermostat	37
4.3.3	Closed cooling water circuit with radiator and thermostat.....	38
4.4	Galvanic corrosion (electrolysis) on engines for marine generators applications.....	38
5	Transport, packing and storage	39
5.1	Safety notes for transport.....	39
5.2	Transport inspection.....	39
5.3	Packing	40
5.4	Transport.....	40
6	Installation and commissioning	42
6.1	Safety	42
6.2	Installation	42
6.2.1	Mounting the flywheel.....	42
6.2.2	Attaching stub shaft (option).....	44
6.2.3	Attaching speed controller	45
6.3	Initial commissioning	46
6.4	Filling with engine oil	47
6.4.1	Venting the fuel system for engines with fuel feed pump (option).....	49

7	Operation	50
7.1	Safety	50
7.2	Preparing for start	54
7.3	Manual start	55
7.4	Starting with electric starter	61
7.5	Operation	62
7.6	Switching off.....	64
7.6.1	Engine without electric starter	65
7.6.2	Engine with electric starter	65
7.7	Decommissioning	66
8	Maintenance	68
8.1	Safety.....	68
8.2	Maintenance plan	70
8.3	Cleaning the intake area.....	73
8.4	Checking threaded connections	74
8.5	Changing engine oil.....	75
8.5.1	Version with oil drain plug	75
8.5.2	Version with oil drain valve.....	76
8.5.3	Removing and installing oil strainer	78
8.6	Changing oil filter (for D/W crankcase version)	79
8.7	Fuel system.....	81
8.7.1	Replacing fuel filter	81
8.7.2	Replacing fuel filter (with thread).....	82
8.7.3	Replacing fuel filter (standard)	84
8.8	Replacing air filter	86
8.8.1	Dry type air cleaner (standard engine).....	87
8.8.2	Dry type air cleaner (oval flange)	89
8.8.3	Oil bath air cleaner (standard engine).....	90
8.9	Adjusting valve clearance	92
8.9.1	Engines with visible flywheel and O.T. marking.....	93
8.9.2	Engines with covered flywheel (without visible O.T. marking)	97



Table of contents

8.10	Cooling water diagram (standard).....	101
8.11	Cooling water diagram (with water-cooled exhaust manifold)	102
8.12	Replacing neoprene impeller of the cooling water pump	103
8.13	Removing, installing and checking thermostat	107
8.14	Checking the cooling system for leaks.....	110
8.14.1	Engines with radiator (and e.g. electric water pump).....	110
8.14.2	Engines with direct sea water cooling	110
8.14.3	Checking the cooling water hoses and hose clamps.....	111
8.14.4	Precautions in the case of engine overheating.....	111
8.15	Checking level of the coolant (for engines with radiator)	112
8.15.1	Replacing coolant (for engines with radiator)	113
9	Faults.....	114
9.1	Safety	114
9.2	Troubleshooting chart	117
9.2.1	Engine does not start.....	117
9.2.2	Engine starts, however runs irregularly or stops	119
9.2.3	Bad engine performance	120
9.2.4	Operating behaviour not faultless.....	121
9.3	Startup after eliminating fault	124
10	Replacement Parts List.....	125
10.1	Spare parts.....	125
10.2	Ordering spare parts	125
11	Service history.....	129
11.1	Proof of purchase.....	129
11.2	Handover and servicing history.....	130
12	Index	134
	Notes	136

1 General

1.1 Information about this manual

This manual makes safe and efficient use of the engine possible.

The manual is an integral part of the machine and must be kept in the immediate vicinity of the machine and accessible at any time for the personnel. The personnel must have carefully read and understood this manual before starting all work. The basic prerequisite for safe working is compliance with all the safety and handling instructions stated in this manual.

Furthermore, the local accident prevention regulations and general safety conditions for the application of the machine are also applicable.

Illustrations in this manual are provided for basic understanding and can be different from the actual version of the engine for the machine.

General

1.2 Explanation of the symbols

Safety information

Safety information in this manual is identified using symbols. The safety information is introduced using signal words which express the scale of the hazard.

Always comply with the safety instructions and act cautiously in order to avoid accidents, injuries to persons and damage to property.



DANGER!

... points out a directly dangerous situation which results in death or severe injuries if it is not avoided.



WARNING!

... points out a potentially dangerous situation which can result in death or severe injuries if it is not avoided.



CAUTION!

... points out a potentially dangerous situation which can result in minor or slight injuries if it is not avoided.



CAUTION!

... points out a potentially dangerous situation which can result in damage to property if it is not avoided.

Tips and recommendations



NOTE!

... highlights useful tips and recommendations and information for efficient and trouble-free operation.

1.3 Limitation of liability

All information and instructions for use in this manual have been compiled taking account of the applicable standards and regulations, the latest state of technology and our many years of expertise and experience.

The manufacturer accepts no liability for damage due to:

- Non-observance of the instructions
- Improper use
- Use of untrained personnel
- Unauthorised modifications
- Technical changes
- Use of non-original spare parts

The actual scope of delivery can be different from the explanations and illustrations stated here for special versions, the use of additional ordered options or due to the latest technical changes.

The agreed obligations in the supply contract, the general terms and conditions and the delivery conditions of the manufacturer and the applicable legal regulations in force at the time of the conclusion of the contract are applicable.

We reserve the right to make technical modifications in order to improve usability.



General

1.4 Copyright

This manual is protected by copyright law and exclusively to be used for internal purposes.

Passing this manual on to third parties, duplication of any kind – even in form of excerpts – as well as the use and/or disclosure of the contents without the written consent of the manufacturer is not permitted, except for internal purposes.

Violations oblige to compensation. The right for further claims remains reserved.

1.5 Warranty terms

The warranty terms are provided in the manufacturer's terms and conditions.

1.6 Customer service

Our customer service is pleased to provide further technical information. Please refer to our website (www.farymann.de) or telephone us on +49 (0)6206/507-0 for a list of our sales and service partners.

Furthermore, our employees are always interested in new information and experience arising from use and which can be valuable for the improvement of our products.

2 Safety

This paragraph provides an overview of all important safety aspects for optimal protection of personnel as well as safe and trouble-free operation.

Disregarding this manual and safety regulations specified therein may result in considerable danger.

2.1 Customer's responsibility

The system is used commercially. The owner of the machine is thus subject to the legal obligations for health and safety at work.

As well as the operational safety instructions in this operator's manual, the applicable safety, accident prevention and environmental regulations for the application must also be complied with. The following particularly apply:

- The owner must inform himself about the applicable health and safety conditions and also determine hazards arising from the special operating conditions at the usage location of the machine in a risk analysis. He must implement this in the form of operating instructions for the operation of the machine.
- During the complete usage time of the machine, the owner must check whether the operating instructions created by him correspond with the current status of the regulations and must adapt these if necessary.
- The owner must clearly regulate and specify the responsibilities for installation, operation, maintenance and cleaning.
- The owner must ensure that all employees involved with the machine have read and understood the operating instructions. He must also train the personnel and inform them about the dangers at regular intervals.
- The owner must provide the necessary protective equipment for the personnel.

The owner is also responsible that the machine is always in proper working condition. Therefore, strictly observe the following:

- The owner must ensure that the maintenance intervals specified in this manual are complied with.
- The owner must arrange for all safety equipment to be checked regularly for functionality and completeness.
- The owner must ensure that antifreeze is filled for engines with radiators.
- Explosive and easily flammable substances must always be kept away from the engine as the engine can become very hot during operation.
- Do not touch rotating parts while the engine is running.



Safety

- Only fill with fuel when the engine is switched off. Do not fill in the vicinity of naked flames or ignitable sparks, do not smoke and do not spill any fuel.
- This operator's manual must be kept in the immediate vicinity of the engine and must be accessible at any time to all persons working on and with the engine.
- The engine must only be operated if it is in proper working condition. The engine must be checked for intactness before every start-up.
- In the case of doubt, always contact the nearest Greaves Farymann Diesel service partner before starting the engine.
- Only regular maintenance in accordance with the information in this operator's manual maintains the operational readiness of the engine.
- Only perform maintenance and cleaning work when the engine is switched off.
- Strictly observe all the information in the operator's manual.
- Observe all warning and information signs on the engine and keep these in legible condition. If a warning or information sign should be lost or difficult to read, always request a replacement from the nearest **Greaves Farymann Diesel service partner**.

2.2 Personnel requirements

2.2.1 Qualifications

**WARNING!****Danger of injury for unqualified personnel!**

Improper handling can result in severe personal injury and/or material damage.

Therefore:

- Have all jobs carried out by qualified personnel only.

The following qualifications are specified for different areas of activity listed in the manual.

■ **Trained person**

has been instructed by the owner about the tasks assigned to him and possible dangers in the case of improper behaviour.

■ **Technical personnel**

are persons who on the basis of their professional training by Greaves Farymann Diesel GmbH, experience and knowledge of the relevant conditions can perform the work assigned to them using the operating and repair instructions and can recognise and avoid possible dangers themselves.

Only persons who are expected to perform their tasks reliably are permitted as personnel. Persons whose reaction capability is impaired, e.g. through drugs, alcohol or medication are not permitted.

- When selecting the personnel, the stipulations regarding age and occupation applying at the location must be observed.



Safety

2.3 Appropriate use

The system is designed and constructed exclusively for the intended purpose described here.

The engine is provided exclusively for the intended purpose which has been specified and tested by the manufacturer of the equipment in which the engine is installed. Any other use is considered to be improper. Greaves Farymann Diesel GmbH accepts no liability for any dangers and damage resulting from this. The risk is borne solely by the user.

The installation must be made so that all applicable safety regulations for the operation of diesel engines are complied with.

Proper use also includes compliance with all the information in this operator's manual.

Any use beyond the intended use and/or other types of use is considered misuse and can result in dangerous situations.



WARNING!
Danger due to misuse!

Misuse can result in dangerous situations.

Refrain particularly from the following uses of the system:

- Operation of the engine **while it is not in the installed condition.**
- Operation of the engine without sufficient safety devices.
- Operation of the engine with non-approved fuels.

Any types of claims for damage arising from improper use are excluded.

2.4 Personal protective equipment

Wearing of personal protective equipment is required when working to minimize the health hazards.

- Always wear the protective equipment that is necessary for the respective task when working.
- Follow the instructions on personal protective equipment that are posted in the work area.

Wear generally

Generally wear for all kind of work:



Protective clothing

is close fitting, with low resistance to tearing, with narrow sleeves and without protruding parts. It mainly provides protection against being entangled by moving machine parts.

Do not wear any rings and other jewellery.



Safety boots

to protect against heavy parts falling down or slipping on slippery ground.

Personal protective equipment for special tasks

When performing special tasks it is necessary to wear personal protective equipment. This personal protective equipment will be separately specified in the chapters of this manual. This special protective equipment is explained below.



Ear defenders

to protect against hearing damage.



Hard hat

to protect against parts and materials falling down and flying around.



Protective gloves

to protect the hand against friction, graze, punctures or deep cuts as well as contact with hot surfaces.



Safety goggles

to protect the eyes against parts flying around or squirts of fluids.



Safety

2.5 Specific dangers

The following section lists the residual risks that have been determined by the risk assessment.

- Heed the safety instructions listed here, and the warnings in subsequent chapters of this manual, to reduce health hazards and to avoid dangerous situations.

Rotating parts



WARNING!

Risk of injury due to rotating parts

Rotating parts can cause severe injuries.

Therefore:

- Do not reach into or work on rotating parts during operation.
- Do not open or remove covers during operation.
- Pay attention to the run-on time after switching off the engine.
Ensure there are no parts still moving or the engine is not running before opening the covers.
- Wear close-fitting work clothing.

Substances harmful to health**WARNING!****Danger of poisoning and danger of skin rashes and allergies!**

Fuels, antifreeze and lubricants contain substances harmful to health and can result in severe poisoning and skin rashes or allergies.

Therefore:

- Observe the safety data sheet of the manufacturer of fuels, antifreeze and lubricants.
- Avoid spilling fuels and fog formation.
- In the case of inhalation, bring affected person into the open air immediately. Contact a doctor.
- Contact doctor immediately in the case of swallowing. Rinse mouth thoroughly with water.
- Avoid skin and eye contact:
 - Apply suitable skin protection cream before working on tanks, piping or supply equipment.
 - Wear protective gloves made of plastic or rubber during the work.
- In the case of contact with the skin or eyes, rinse immediately with a lot of water. Contact a doctor.
- Dispose of contamination in the working area properly and in accordance with environmental regulations. Fuels, antifreeze and lubricants must not get into the sewer system.
- Do not eat, drink or smoke when working.



Safety

Highly flammable materials



WARNING!

Fire hazard by highly flammable materials!

Highly flammable materials, liquids or gases may catch fire causing serious and even fatal injuries.

Therefore:

- Do not smoke within the danger zone and the immediate vicinity. Avoid using open flames or ignition sources.
- Keep a fire extinguisher ready.
- Report suspicious materials, liquids or gases immediately to the person in charge.
- Suspend any work activities in case of fire. Leave the danger zone until the all clear signal is given.

Hot operating materials



WARNING!

Risk of burns due to hot operating materials!

Operating materials can reach high temperatures during operation and cause burns in the case of contact.

Therefore:

- Check whether operating materials are hot before handling them. If necessary, let them cool down to the ambient temperature.

Hot surfaces of the engine components



CAUTION!

Risk of burns due to hot surfaces of the engine components!

Contact with hot surfaces can cause burns.

Therefore:

- Always wear protective clothing and protective gloves for all work in the vicinity of hot parts.
- Ensure that all parts have cooled down to the ambient temperature before all work.

Antifreeze (for engines with radiators and, e.g. electric water pump)



WARNING!
Danger of poisoning and danger of skin rashes and allergies!

Antifreeze contains substances harmful to health and can result in severe poisoning and skin rashes or allergies.

Therefore:

- Observe the safety data sheet of the antifreeze manufacturer.
- Wear rubber gloves when handling antifreeze.
- Never mix different types of antifreeze.
- Contact a doctor immediately in the case of swallowing. Rinse mouth thoroughly with water.
- Avoid skin and eye contact:
 - Wear protective gloves made of plastic or rubber during the work.
- Collect coolant drained from the engine in a suitable container and dispose of in accordance with the environmental regulations.

Safety

2.6 Safety devices



WARNING!

Risk of injury due to non-functional safety devices!

Safety is only ensured if the safety devices are intact.

Therefore:

- Check whether the safety devices are functional and correctly installed before starting work.
- Never deactivate safety devices.



NOTE!

See the Chapter "Design and function" for detailed information about the position of the safety devices.

2.7 Behaviour in the case of danger and accidents

Preventive measures

- Always be prepared for accidents or fire.
- Keep first aid equipment (first aid kit, blankets etc.) and fire extinguishers ready to hand.
- Familiarise personnel with accident reporting, first aid and rescue equipment.
- Keep access routes clear for rescue vehicles.

Actions in the case of accidents

- Operate the EMERGENCY STOP button on the machine (if present) immediately.
- Initiate first aid actions.
- Rescue people from the danger zone.
- Inform the responsible person at the usage location.
- Notify the rescue services.
- Keep access routes clear for rescue vehicles.

2.8 Environmental protection

**CAUTION!****Danger to the environment due to mishandling!**

Significant environmental damage can occur, particularly for incorrect disposal, if environmentally hazardous operating materials are mishandled.

Therefore:

- Always observe the instructions mentioned below.
- Take immediate action if environmentally hazardous materials reach the environment. Inform the responsible local authorities about the damage in the case of doubt.

Lubricants, fuels

The following environmentally hazardous substances are used:

Fuels, coolants and lubricants such as, e.g. diesel fuel, antifreeze and engine oil contain toxic substances. They must not reach the environment. The disposal must be performed by a specialist disposal company.

Technical data

3 Technical data

3.1 Technical specifications

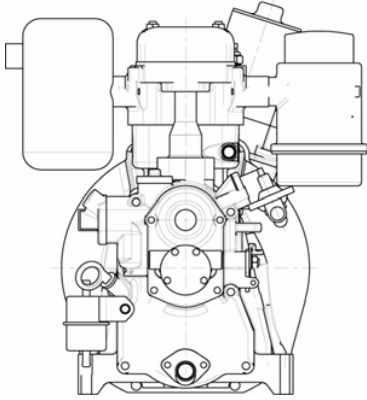

Fig. 1

Single-cylinder, four-stroke diesel engine, water-cooled, with the following characteristics:

- Direct injection (Bosch injection system)
- Power take-off at the flywheel
- Safe manual start with starting handle or electric starter
- Automatic decompression and automatic starting quantity
- Self-venting fuel system
- Mechanical speed governor
- Oil forced-feed lubrication system with gear pump, oil filter (option) for increased operational reliability
- Exhaust silencer
- Dry type air filter or oil bath filter
- Cooling water pump (neoprene impeller pump)
- Fuel feed pump and fuel filter
- Crankcase of high tensile light alloy
- Plain bearings on conrod and crankshaft on the control side
- Roller bearing on output side
- Engine mounting points integrally cast on the crankcase
- Environmentally friendly due to internal crankcase venting and valve stem seals

3.2 Applications

The engine series 15W /18W is suitable, for example, for the following applications:

- Generators (marine and industrial applications)
- Vehicle cooling systems
- Special applications (according to customer requirements)

3.3 Standard configuration

The engine is delivered with the following standard configuration:

- Fuel filter
- Dry type air cleaner or oil bath air cleaner
- Fuel feed pump
- Coolant thermostat (opening temperature 50 °C or 70 °C)
- Cooling water pump (neoprene impeller pump)
- Exhaust silencer
- Crank handle (rigid)

3.4 Options

The engine is available with the following options:

- Crankcase with oil filter (version D/W crankcase)
- Dry type air cleaner (various versions)
- Water-cooled exhaust manifold
- Electric water pump (12 V or 24 V)
- Starter (12 V or 24 V)
- Solenoid valve open or closed with zero current (12 V or 24 V)
- Alternator (12 V or 24 V)
- Oil pressure switch
- Temperature switch
- Stub shafts (various versions)
- Bell housings (various versions)
- Crank handle RD (limited kickback)



Technical data

3.5 Engine type plate

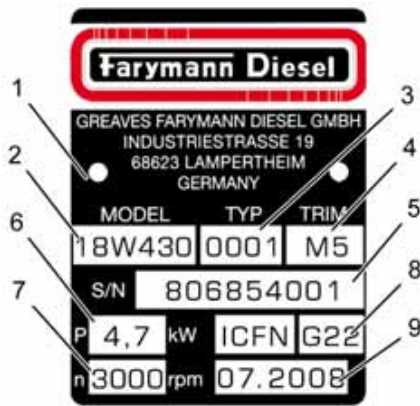

Fig. 2: Example of the engine type plate

There is an engine type plate on the engine with the following information:

- 1 Manufacturer
- 2 Series
- 3 Type number
- 4 Version of the speed governor
- 5 Serial number
- 6 Power
- 7 Speed
- 8 Emissions code
- 9 Date of manufacture (e.g. 07/2008 = July 2008)

3.6 Engine type code

The engine type code is a 12-digit code in addition to the serial number e.g. **18W 430.0001 M5**

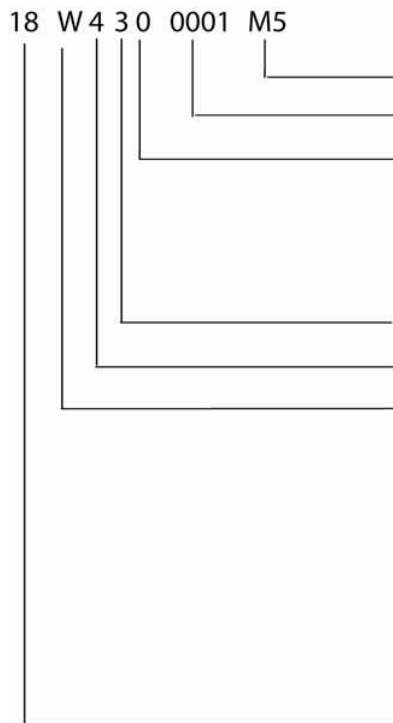

Fig. 3

Trim No. = speed governor version

Type No. = engine version

Start 0 = crank handle

5 = electric start

6 = alternator without starter

7 = alternator with starter

Bearings 3 = roller bearing on the flywheel side

Crankshaft 4 = horizontal position

Basic engine design A = vertical cylinder, anticlockwise rotation (old version)

B = vertical cylinder, clockwise rotation (new version)

D = vertical cylinder, anticlockwise rotation (new version)

E/F = horizontal cylinder, anticlockwise rotation

W = water-cooled cylinder, anticlockwise rotation

Displacement = in cubic inches (approx.)

3.7 Engine data

Description	Value
Type	Vertical single-cylinder diesel engine
Design	Vertical
Cylinders	1
Operating method	Four-stroke
Combustion method	Direct injection
Rotation direction	Anticlockwise (as seen from output or flywheel side)
Type of cooling	Water-cooled
Valve control	Overhead valves with push rods and rocker arms
Valves	Two-valve technology
Valve clearance (cold engine) Intake valve Exhaust valve	0.2 mm 0.2 mm
Type of starting all engines Option	Manual starting with crank handle Starter (12 V or 24 V)
Required battery capacity	36 Ah (12 V) 72 Ah (2 batteries a = 12 V) for 24 V
Permitted operating inclined position (permanent)	15° longitudinal 15° lateral



Technical data

3.8 Performance data

Description	Value 15W	Value 18W
Max. power (at 3600 rpm)	IFN-ISO* 4.3 kW ICFN-ISO* 3.9 kW	IFN-ISO* 5.2 kW ICFN-ISO* 4.7 kW
Max. speed	3600 rpm	
Max. torque	13.0 Nm (2500 rpm)	15.3 Nm (2500 rpm)
Bore	82 mm	
Stroke	55 mm	
Displacement	290 cm ³	
Mean piston speed	6.6 m/s (3600 rpm)	
Compression ratio	20:1	

*** IFN-ISO**

Blocked performance for intermittent load.

*** ICFN-ISO**

Power for constant speed and constant load. Contact the manufacturer for continuous use outside the stated performance limit.

Power reduction

Reduction approx. 1% for each 100 m height and approx. 2% for each 5 °C over 20 °C. Performance guaranteed with 5 % deviation for the run-in engine with standard air filter and exhaust silencer.

3.9 Dimensions and weight

Description	Value
Overall length	374 mm
Overall height	422 mm
Overall width	401 mm
Dry weight: standard engine with air filter and exhaust silencer	39 kg

3.10 Temperatures

Description	Value
Max. permissible air intake temperature	50 °C
Max. permissible exhaust temperature	580 °C
Max. permissible cooling air temperature	50 °C
Max. permissible fuel temperature	70 °C
Max. permissible engine oil temperature	130 °C
Max. permissible cooling water temperature	90 °C



Technical data

3.11 Pressures

Description	Value
Injector setting - nozzle opening pressure	200 bar
Oil pressure (max.)	5 bar
Intake vacuum	permitted 2 kPa
Exhaust gas back pressure	permitted 5 kPa

3.12 Operating materials

Description	Value
Fuel	Diesel EN 590 DIN 51601-OK BS 2869 A1/A2 ASTM D 975-1D/D2
Engine oil	Multigrade oil SAE 10W40 mineral oil API (CD or higher)
Max. engine oil filling quantity (version with oil filter)	approx. 1.2 litres
Max. engine oil filling quantity (version with oil strainer)	approx. 1.1 litres
Engine oil refill quantity bottom – top mark (oil dipstick)	
Standard engine	approx. 0.3 litres
Engine oil consumption	1.0 g/kWh
Coolant requirement for direct cooling	7 – 8 l/min

3.13 Engine oil specification

The engine oil quality has a significant influence on the lifetime, performance and thus also the cost-effectiveness of the engine.

The ambient temperature at the installation location or application of the engine is crucial for the selection of the correct viscosity class.

Too high viscosity can result in starting difficulties; too low viscosity can endanger the lubrication effect and result in high lubrication oil consumption. The viscosity is classified according to SAE.

Basically, use multigrade oils.

Depending on the lubrication oil temperature, we recommend the following common viscosity classes.

Viscosity classes according to ambient temperature

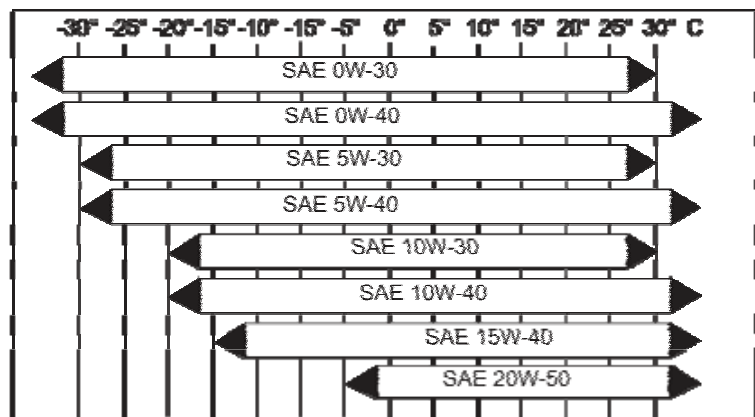

Fig. 4

Structure and function

4 Structure and function

4.1 Overview



NOTE!

The engine shown in the pictures 5 and 6 is the D/W crankcase version.

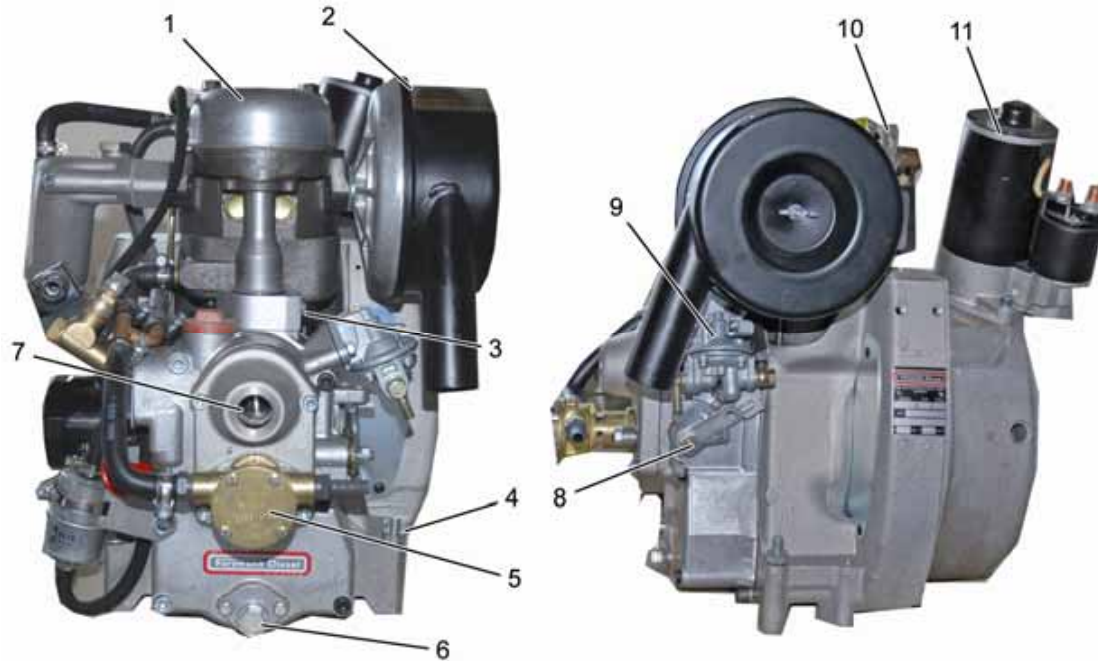

Fig. 5: Front view

- 1 Valve cover
- 2 Dry type air cleaner (oval flange / option)
- 3 Decompression unit
- 4 Engine mounting point
- 5 Cooling water pump (neoprene impeller pump)
- 6 Oil drain plug

Left view

- 7 Starting handle support bearing
- 8 Speed adjusting lever
- 9 Fuel feed pump
- 10 Lifting eye for transport
- 11 Starter



NOTE!

The engine with D/W crankcase has an oil filter.

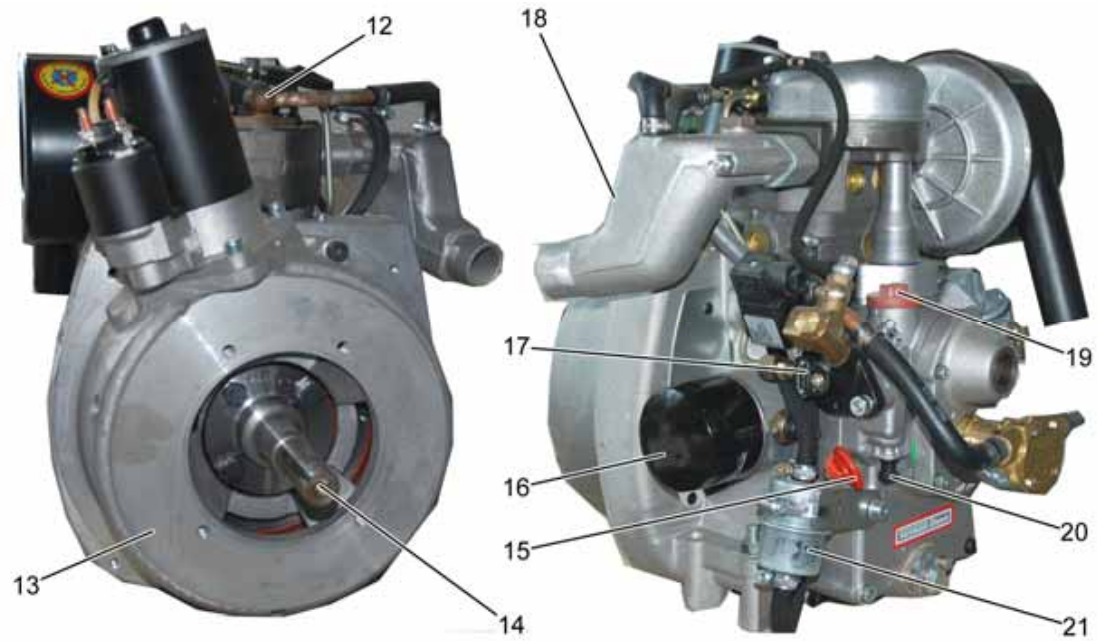

Fig. 6: Output side

- 12 Thermostat housing
- 13 Bell housing (option)
- 14 Stub shaft (option)
- 15 Oil dipstick
- 16 Oil filter (D/W crankcase)

Right view

- 17 Injection pump
- 18 Water-cooled exhaust manifold (option)
- 19 Oil filler cap
- 20 Excess fuel device
- 21 Fuel filter (standard)

Structure and function



NOTE!

The engine shown in pictures 7 and 8 is the standard engine.

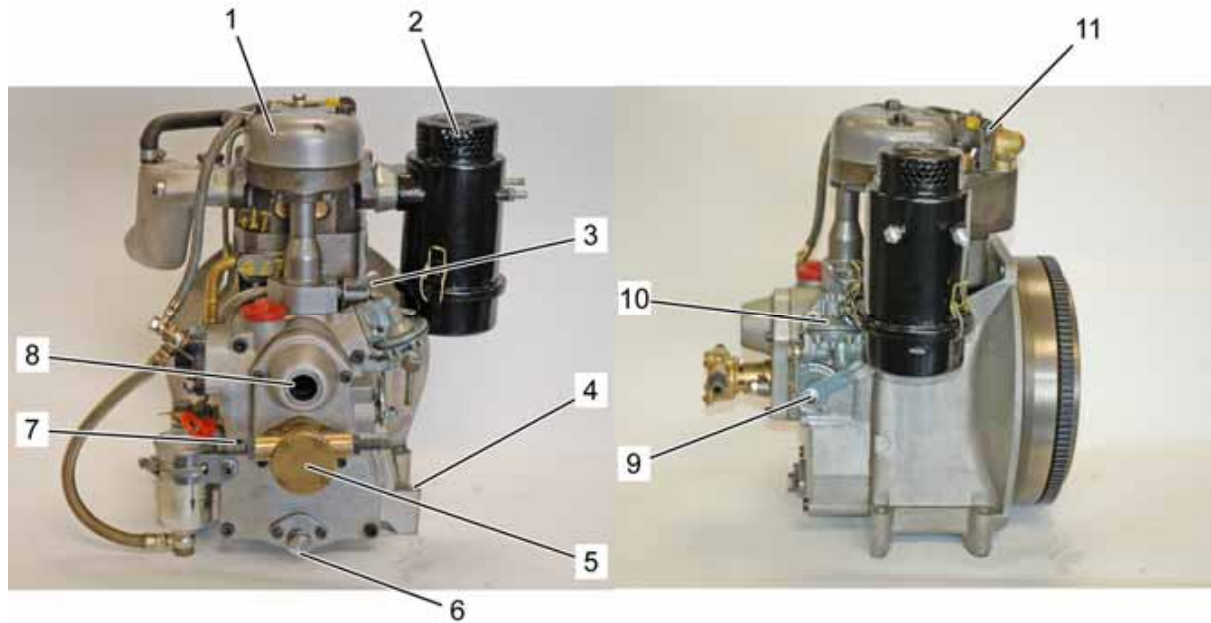

Fig. 7: Front view

- 1 Valve cover
- 2 Oil bath air cleaner
- 3 Decompression unit
- 4 Engine mounting point
- 5 Cooling water pump (neoprene impeller pump)
- 6 Oil drain plug

Left view

- 7 Excess fuel device
- 8 Starting handle support bearing
- 9 Speed adjusting lever
- 10 Fuel feed pump
- 11 Lifting eye for transport



NOTE!

The standard engine 15W / 18W has an oil strainer and no oil filter.

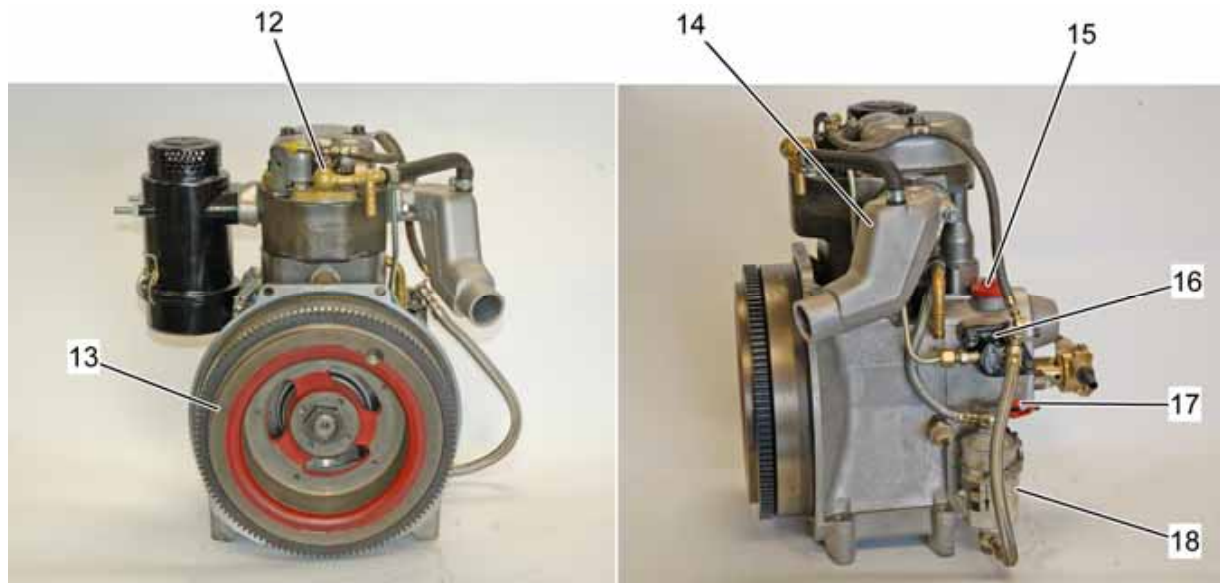

Fig. 8: Output side

Right view

- 12 Thermostat housing
- 13 Flywheel
- 14 Water-cooled exhaust manifold (option)
- 15 Oil filler cap

- 16 Injection pump
- 17 Oil dipstick
- 18 Fuel filter

4.2 Electrical System

4.2.1 Alternator (option)

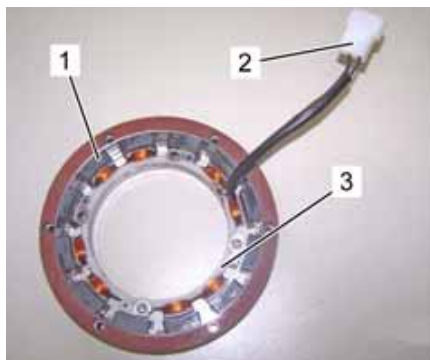

Fig. 9: Example: Alternator

The permanent magnets on the magnet carrier (1) on the flywheel side induce an alternating current proportional to speed in the coils of the stator (3).



NOTE!

The connector at cable (2) on the alternator can be one of various versions.

Structure and function

4.2.2 Alternator regulator (option)



Fig. 10: Example: Alternator regulator

The alternating current is rectified in the alternator regulator (Fig. 10) and constantly regulated to approx. 14.2-14.5 V.

- 2 x yellow (alternator coils input, can be connected either way)
- 1 x red (charging current output)
- 1 x brown (charge indicator, connecting terminal 15 ignition switch)
- Earth connection is made using mounting surface.

4.2.3 Operating conditions

- Permitted operating temperatures -20 °C to 70 °C (measured on the alternator regulator surface).
- There must be an intact earth connection between alternator regulator and engine and between alternator regulator and external attachment (no painted mounting surfaces).

4.2.4 Dangers and cause of failure

Dangers	Cause of failure
Battery terminals incorrectly connected	Damage to the charging circuit
Defective battery or complete discharge	Destruction of the alternator regulator
Disconnection of the battery when the engine is running	Immediate destruction of the alternator regulator
External start with jump leads for defective or completely discharged battery	Destruction of the alternator regulator
Manual starting with disconnected battery	Destruction of the alternator regulator
Interruption of the earth connection of the alternator regulator to the engine	Destruction of the alternator regulator

Welding work

WARNING!
Material damage due to welding work on the machine!

Welding work on the machine can cause high material damage.

Therefore:

- **always disconnect the negative pole of the battery in advance.**
- **disconnect the plug connection to the alternator regulator.**



Structure and function

4.2.5 Batteries

Observe the following safety factors:

- Batteries produce explosive gases.
- Keep away from naked flames and other ignition sources. Do not smoke.
- Do not lay any tools on the battery.
- Always disconnect the negative pole of the battery before performing work on the electrical system.
- Do not mix up the + (plus) and - (minus) poles of the battery.
- Connect the plus cable first and the minus cable afterwards when installing the battery.
- Disconnect the minus cable first and the plus cable afterwards when removing the battery.
- Always avoid short-circuits and earth contact of live cables.
- In the case of faults in the electrical system, first check the cable connections for good contact.
- Replace defective indicator lamps immediately.
- Do not remove the ignition key during operation.
- Do not disconnect the battery while the engine is running (occurring voltage peaks can destroy electronic components, e.g. the alternator regulator).
- **Do not spray parts of the electrical system during engine cleaning with a water jet or high pressure jet.**
- Always disconnect the minus terminal of the battery and disconnect the plug connection to the alternator regulator for welding work.

Batteries



WARNING!
Risk of injury due to incorrect handling of batteries!

Batteries must be handled with particular caution.

Therefore:

- Never expose batteries to high temperatures. There is a risk of explosion.
- Escaping liquid due to incorrect use can result in skin rashes. Avoid contact with the liquid. Always rinse with a lot of water in the case of contact with the liquid. If the liquid gets into the eyes, rinse immediately with water and contact a doctor immediately.

4.3 Cooling system

4.3.1 Open cooling water circuit with direct sea water cooling without thermostat



Fig. 11

Among other things, the engine is designed for direct sea water cooling. The cooling water is circulated using an impeller pump (1). The pump is driven by the camshaft via gear wheels. With this type of sea water cooling, the required cooling water quantity which is delivered by the impeller pump is limited so that operation without thermostat and without bypass line is possible.

4.3.2 Open cooling water circuit with direct sea water cooling with thermostat

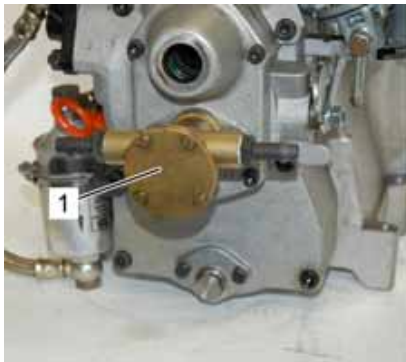

Fig. 12

The cooling water is also circulated here using an impeller pump (1). The temperature of the cooling water circulating around the cylinder and cylinder head is regulated by a thermostat in the cylinder head. The cooling water thermostat is set to a maximum temperature.

There are two versions of cooling water thermostats:

- Cooling water thermostat for use with "salt water".
 - Opening temperature of the thermostat 50 °C.
- Cooling water thermostat for use with "fresh water".
 - Opening temperature of the thermostat 70 °C.

The opening temperature prevents the separation and deposit of salt crystals from the sea water in the cooling water area of the engine



Structure and function

4.3.3 Closed cooling water circuit with radiator and thermostat

With this type of cooling, for example, a radiator, an electric water pump and a thermostat with an opening temperature of 70 °C are used.



NOTE!

A neoprene impeller pump cannot be used here.

4.4 Galvanic corrosion (electrolysis) on engines for marine generators applications

It can happen with applications of marine generators that very strong corrosion which damages these parts can occur at different parts of the engine.

This is usually a galvanic decomposition process (electrolytically caused corrosion) where the cause is outside the affected application (for marine electricity generation applications). External influences become effective due to electrical voltage.

As aluminium as a material reacts very sensitively to these influences, this problem should be paid a lot of attention to in advance so that damage can be detected in good time or the conditions or causes can be established in good time and preferably rectified.

However, the effectiveness of this process also depends on various other conditions. For example, one precondition for this decomposition process is a high salt content of the water (electrolyte) with simultaneous high water temperature (see the operating manual of the generator manufacturer).

5 Transport, packing and storage

5.1 Safety notes for transport

Improper transport

**CAUTION!****Damage due to improper transport!**

Significant damage to property and injuries to persons can occur in the case of improper transport.

Therefore:

- Proceed carefully when unloading the packages and on delivery and internal transport and observe the signs and notices on the packing.
- Only use the attachment points provided.
- Do not remove packing until just before the installation.

5.2 Transport inspection

Check the delivery immediately on receipt for completeness and transport damage.

If externally detectable transport damage is found, proceed as follows:

- Do not accept the delivery, or only with reservation.
- Record the extent of transport damage in the transport documents or on the delivery note of the forwarding agent.
- Start complaints procedure.

**NOTE!**

Claim any damage as soon as it is detected. Compensation claims can only be submitted within the applicable complaints periods.

Transport, packing and storage

5.3 Packing

Concerning packing

The individual packages have been packed to match the transport conditions that can be expected. Only environmentally friendly materials were used for packing.

The packing has the function of protecting the individual components against damage, corrosion, etc., until they are finally assembled. The packing material must therefore not be damaged and should only be removed just before assembly takes place.

Handling packing materials

If there is no returns agreement for the packing, separate materials according to type and size and direct to further use or recycling.



CAUTION!

Environmental damage caused by incorrect waste disposal!

Packing materials are valuable raw materials and can continue to be used in many cases or sensibly reconditioned and recycled.

Therefore:

- Dispose of packing materials environmentally.
- Follow the locally valid waste disposal regulations. If necessary employ a special waste disposal company to dispose of packing material.

5.4 Transport

Transport of the engine with the crane



Fig. 13: Transport with the crane

The engine has one lifting eye (Fig. 13/1) and can be transported directly with a crane under the following conditions:

- Crane and lifting gear must be designed for the weight of the engine.
- Only lift and transport the engine in the normal position (engine mounting points at the bottom).
- The operator must wear a safety helmet, safety shoes and protective gloves and must be authorised to operate the crane.

Attaching:

1. Attach ropes, belts or chains according to Fig. 13.
2. Ensure that the engine is attached straight.
3. Do not start the transport until then.

Storage of the engine

Store new engines under the following conditions:

- Do not store outdoors.
- Store dry and dust-free.
- Do not expose to any aggressive media.
- Protect against direct sunlight.
- Avoid mechanical vibrations.
- Storage temperature: 15 to 35 °C.
- Relative humidity: max. 60 %.
- In the case of storage for longer than 3 months, check the general condition of all parts and the packing regularly. If required, refresh or renew the anti-corrosion protection.

Storage of the engines up to 12 months is possible under the above conditions.

**CAUTION!
Damage due to improper storage!**

Parts of the engine can corrode and become non-functional in the case of **too high relative humidity or air containing salt**.

Therefore:

- In the case of storage for longer than 6 months, contact the nearest Greaves Farymann Diesel service partner in order to agree suitable precautions.

6 Installation and commissioning

6.1 Safety

Personnel

- Installation and commissioning may be executed only by specially trained personnel.
- All work on the electrical system must be performed by a qualified electrician.

6.2 Installation

6.2.1 Mounting the flywheel

- Must only be performed by a specialist.
- Additional protective equipment required:
 - Safety footwear
- Special tool needed:
 - Torque wrench

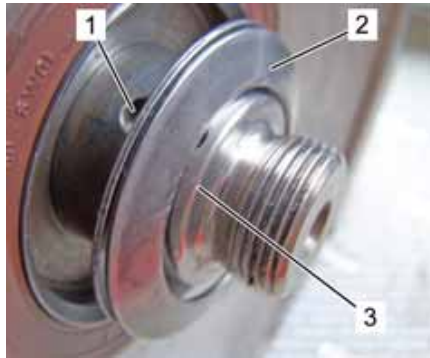

Fig. 14



NOTE!

Always check the flywheel nut with a **torque wrench set for 216 to 226 Nm** before every installation in or attachment to the machine.

1. Install engine on suitable mounting.
2. Turn engine slowly with the crank handle until the keyway (1) in the crankshaft (3) faces upwards.



NOTE!

This position makes installation of the flywheel easier.

3. Place both plate washers (2) on the crankshaft (3).



NOTE!

The flat sides of the plate washers face each other.



Fig. 15

4. Install key (4) into the keyway of the crankshaft and ensure that this sits correctly.



Fig. 16

5. Install the flywheel (5) ensuring that it is not twisted during the installation.



NOTE!

In the case of improper installation of the flywheel, the magnets of the magnet carrier (e.g. for engines with alternator) can be damaged. The alternator does not function correctly if the magnets are damaged.

6. After the installation of the flywheel, check without fail that the key (arrow) is seated in the keyway of the crankshaft before screwing on the flywheel nut.



NOTE!

In the case of improper mounting of the flywheel, the key can fall out of the crankshaft keyway. This results in the flywheel not being properly fixed. Due to the missing key, the flywheel nut can slacken when starting the engine. This results in the crankshaft and the flywheel being severely damaged.

Installation and commissioning

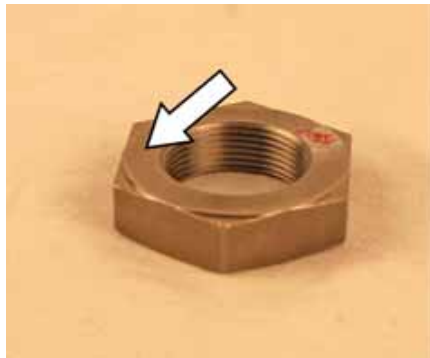

Fig. 17

7. Screw on the flywheel nut as far as possible by hand.



NOTE!

In doing so, ensure that the machined flat side (arrow) of the flywheel nut is facing the crankshaft.

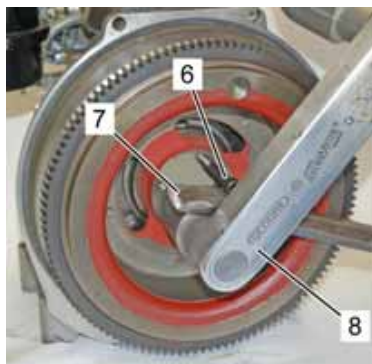

Fig. 18

8. Screw two bolts (6) into the thread provided on the flywheel.
9. Fix the flywheel with a suitable lever (e.g. tyre lever) (7).
10. Tighten the flywheel nut with a torque wrench (8) to **216 – 226 Nm**.
11. Turn the flywheel by hand and examine for unobstructed movement (must not jam).

6.2.2 Attaching stub shaft (option)

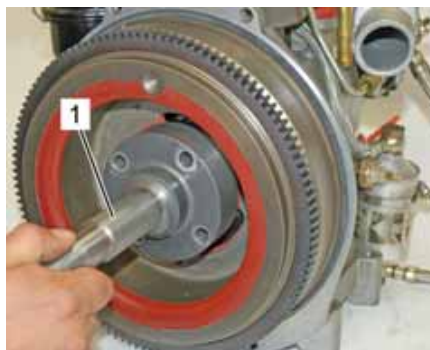

Fig. 19: Example: Stub shaft

Example: Not all applications need a stub shaft.

12. Attach stub shaft (1) to the flywheel.



NOTE!

Depending on the type of installation, the stub shaft can be different from that shown in the picture.

6.2.3 Attaching speed controller

**NOTE!**

Depending on the version and installation position of the engine, the speed controller can be installed differently by the device manufacturer.

Depending on the version and installation position of the engine, different versions for the speed controller can be attached (e.g. rods, Bowden cables, manual, electric, etc.).

Example: Speed controller with Bowden cable

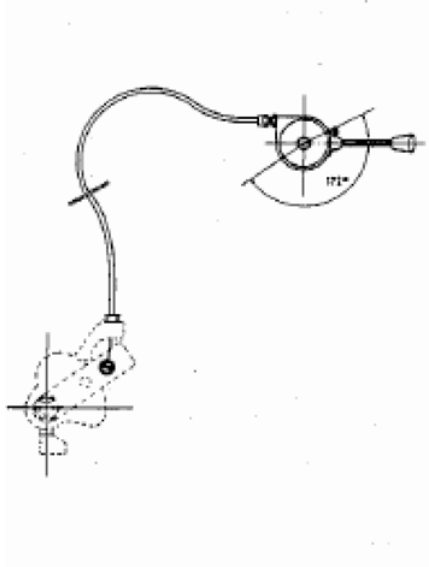

Fig. 20



Installation and commissioning

6.3 Initial commissioning



CAUTION! **Engine damage due to missing operating materials!**

The engine is delivered without operating materials. Operation without all required operating materials can destroy the engine.

Therefore:

- Fill with engine oil and **diesel fuel** before first use.
- Only use operating materials which are specified in the technical data.
- Observe the filling quantities.
- Before first use or after a long decommissioning (more than 6 months), operate the engine after starting for approx. 1 minute at low speed and without load.

Due to this action, an optimum lubrication of all bearings is achieved and a lack of lubrication is avoided.



CAUTION! **Engine damage due to cold start aids!**

The use of cold starting aid results in engine damage.

Therefore:

- **Never use cold starting aids.**



NOTE!

The 15W / 18W engine is supplied without fuel tank. Due to the design, no fuel tank is included in the scope of delivery of the 15W / 18W engine.

6.4 Filling with engine oil

**CAUTION!****Engine damage due to incorrect oil quantity!**

Too high or too low an engine oil level can result in damage to the engine.

Therefore:

- Never exceed the maximum level.
Never drop below the minimum level.
- The engine must stand up straight for checking the oil level.



Fig. 21

1. Release oil filler cap (1) e.g. with a 13mm jaw spanner and screw off by hand.



Fig. 22

2. Fill engine oil into the filling opening (2).

Installation and commissioning

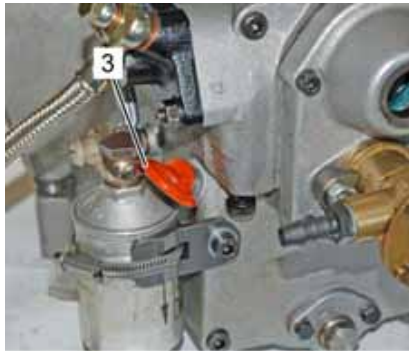

Fig. 23

3. Pull out oil dipstick (3) and clean the bottom end with a clean and fluff-free cloth.
4. Replace the oil dipstick (3) and pull it out again.

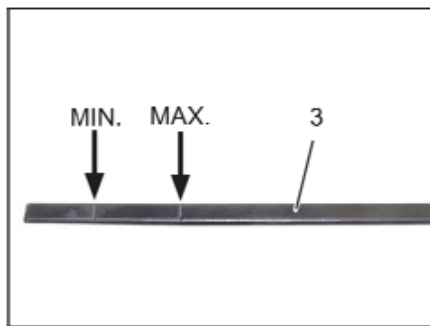

Fig. 24

5. Check the oil level quantity. The oil level should be just under the Max. marking.
6. Fill with engine oil if needed.



Fig. 25

7. **Only tighten** the oil filler cap (1) **by hand** (risk of breakage).

6.4.1 Venting the fuel system for engines with fuel feed pump (option)

NOTE!

The engine has a self-venting fuel system. In the case of the fuel tank running empty, faultless operation after refilling is ensured by the self-venting.

The venting can be accelerated using the lever (1) on the fuel feed pump (2).

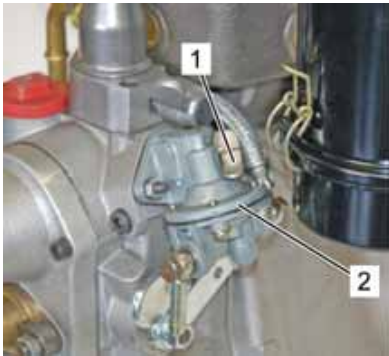

Fig. 26

8. Using the lever (1) on the fuel feed pump (2), pump by hand until the counter pressure becomes noticeable. This builds up the primary pressure in the fuel system and accelerates the venting.

NOTE!

The 15W / 18W engine is supplied without fuel tank. Due to the design, no fuel tank is included in the scope of delivery of the 15W / 18W engine.

Operation

7 Operation

7.1 Safety

Improper operation

**WARNING!****Risk of injury due to improper operation!**

Improper operation can result in severe personal injuries or material damage.

Therefore:

- Perform all the operating steps in accordance with the information in this operator's manual.
- Ensure that all covers and safety devices are installed and in proper working condition before starting the work.
- Never deactivate safety devices during operation.
- Ensure tidiness and cleanliness in the working area. Loose components and tools lying around or on top of each other cause accidents.

Rotating parts

**WARNING!****Risk of injury due to rotating parts**

Rotating parts can cause severe injuries.

Therefore:

- Do not reach into or work on rotating parts during operation.
- Do not open covers during operation.
- Note the run-on time of 10 to 20 seconds of the engine:
Ensure there are no parts still moving and the engine is not running before opening the covers.
- Wear close-fitting clothing in the danger zone.

Exhaust gases**WARNING!****Danger of poisoning due to exhaust gases!**

There is a danger of poisoning by odourless carbon monoxide of the exhaust gases are inhaled.

Therefore:

- Never inhale the exhaust gases.
- Only operate the engine in well-ventilated areas.

Hot surfaces of the engine components**CAUTION!****Risk of burns due to hot surfaces of the engine components!**

The engine can become very hot during operation. Contact with the exhaust system and the engine can cause burns.

Therefore:

- Never touch the engine during operation.
- Ensure that all parts have cooled down to the ambient temperature before all work.

Engine oil and fuel**WARNING!****Danger of fire due to fuel and engine oil!**

Oil and fuel vapours can ignite on contact with ignition sources.

Therefore:

- No naked flames during work on the engine.
- Do not smoke.
- Remove oil and fuel residues from the engine and floor.

Operation



CAUTION!
Danger of poisoning due to fuel, antifreeze and engine oil!

Contact with engine oil, antifreeze and fuel can result in damage to health.

Therefore:

- Avoid skin contact with engine oil, fuel and antifreeze.
- Remove oil, fuel and antifreeze splashes from the skin immediately.
- Do not inhale oil and fuel vapours.

Antifreeze (for engines with radiator and, e.g. electric water pump)



WARNING!
Danger of poisoning and danger of skin rashes and allergies!

Antifreeze contains substances harmful to health and can result in severe poisoning and skin rashes or allergies.

Therefore:

- Observe the safety data sheet of the antifreeze manufacturer.
- Wear rubber gloves when handling antifreeze.
- Never mix different types of antifreeze.
- Contact a doctor immediately in the case of swallowing. Rinse mouth thoroughly with water.
- Avoid skin and eye contact:
 - Wear protective gloves made of plastic or rubber during the work.
- Collect coolant drained from the engine in a suitable container and dispose of in accordance with the environmental regulations.

Personal protective equipment

Wear the following protective equipment for all operation work:

- Protective clothing
- Safety footwear

**NOTE!**

Protective equipment which must be worn for certain work is specially pointed out in the warnings of this chapter.

The engine must be switched off as quickly as possible in dangerous situations.

Emergency shutdown

Proceed as follow in the case of danger:

1. Switch off the engine immediately.
2. Inform the responsible person at the usage location.
3. Rescue people from the danger zone, initiate First Aid actions.
4. Switch off the main switch on the machine (if present) and secure it against being switched on again.
5. Keep access routes clear for rescue vehicles.
6. If required for the severity of the emergency, inform the responsible authorities.
7. Assign specialist personnel to the fault rectification.

After the rescue actions**WARNING!****Risk of fatal injury due to premature restarting!**

There is a risk of fatal injury for all persons in the danger zone when the machine is restarted.

Therefore:

- Ensure there are no persons in the danger zone before restarting.
8. Before restarting, ensure that all safety devices are installed and functional.



Operation

7.2 Preparing for start

Checks

Carry out the following checks in order to avoid damage to the engine:

- Check engine oil level, refill with engine oil if necessary.
- Check fuel level, refill with **diesel fuel** if necessary.
- Check cooling water level, refill if necessary.
- Check air filter for soiling, clean if necessary or replace air filter element.
- Check engine mounting.
- Check machine for completeness of the safety equipment.
- Check engine and machine for missing covers.
- Check engine for damaged oil and fuel lines.
- Check engine for damaged electrical cables and insulation.
- Check engine and cooling system for leaks.
- Ensure sufficient supply air for combustion.

Setting cold start / warm start



CAUTION!

Engine damage due to cold start aids!

The use of cold starting aid results in engine damage.

Therefore:

- **Never use cold starting aids.**

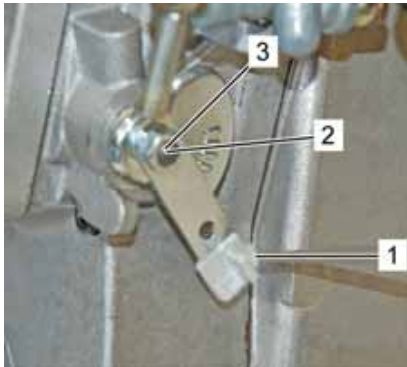

Fig. 27

The speed can be controlled using the speed adjustment lever.

The following positions are possible:

- 1 Stop – Engine off
- 2 Partial load range
- 3 Cold start and full load

7.3 Manual start



NOTE!

In the case of outdoor temperatures below 5 °C, the engine must be rotated to the speed adjustment "max" position.

Put the speed adjustment lever into the increased idle speed position in the case of a cold engine.

If the engine does not start, the starting speed is too low. Constant and accelerated turning the starting handle supports the engine starting.

Manual start

The engine is equipped with an automatic decompression and an excess fuel device for a safe manual start.

Operation

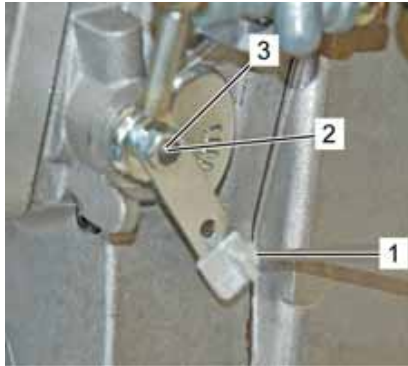

Fig. 28

1. If the engine is cold, put the speed adjustment lever (3) in the increased idle speed position.

If the engine is warm, put the speed adjustment lever into position (2) (depending on the application).



Fig. 29: Example: automatic decompression with star knob

2. Turn decompression button to the right (clockwise) to the starting position (1).

- 1 Starting position
- 2 Neutral position
- 3 Operating position

■ **Starting position:** The automatic decompression operates for the manual starting of the engine with the crank handle. If the decompression unit's pin has moved to the operating position, the decompression has finished. The compression begins and the engine starts.

■ **Neutral position:** In the neutral position the compression is switched off. By turning the engine with the crank handle all bearings are provided with engine oil (e.g. following repair or before commencement of cold start at extremely low temperatures).

■ **Operating position:** In the operating position the decompression is switched off and the engine is under compression.

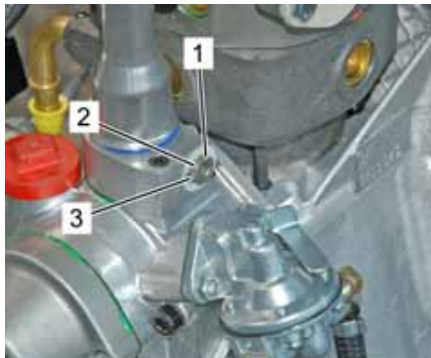

Fig. 30: Example: automatic decompression with lever



NOTE!

Never use the automatic decompression to switch off the engine.



- 1 Starting position
- 2 Neutral position
- 3 Operating position

Fig. 31: Example: automatic decompression



The automatic decompression (Fig. 31) is adjusted on the starting handle (Fig. 33) with the adjusting spanner.

Fig. 32: Example: Adjusting the automatic decompression on the starting handle with the adjusting spanner

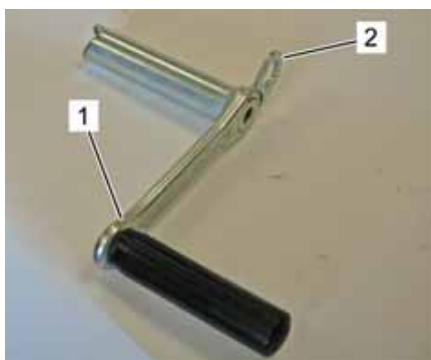

Starting handle (1) with adjusting spanner (2).

Fig. 33: Adjusting spanner on the starting handle

Operation

Excess fuel device



NOTE!

The excess fuel device (1) must be pulled out for cold starting.



Fig. 34: Excess fuel device

All engines are equipped with an excess fuel device (1) to make starting them easier.

A lever limits the injection pump control shaft's path. If the starting excess button (1) is pulled out when starting the lever allows a longer path for the control shaft.

As soon as the engine has reached the maximum speed permitted by the governor the mechanical speed governor pushes the control shaft to stop and the starting excess button returns to its starting position.

Therefore it is important that the engine is started without load and can reach its maximum speed. Otherwise the starting excess button does not return to its starting position and the engine is overloaded.



NOTE!

When starting the engine when warm (operating temperature) do not pull out the excess fuel device.

Manual start

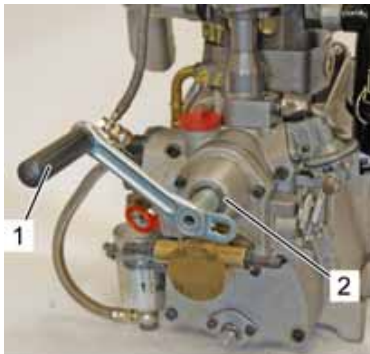

Fig. 35

1. Turn decompression knob to the right (clockwise) to the starting position (Fig. 29/1).
2. Put the speed adjustment lever in the increased idle speed position (Fig. 28/3).
3. Pull out excess fuel device for cold start (Fig. 34/1).
4. Insert the crank handle (1) in the starting handle support bearing (2) and turn slowly anticlockwise until the crank is engaged.

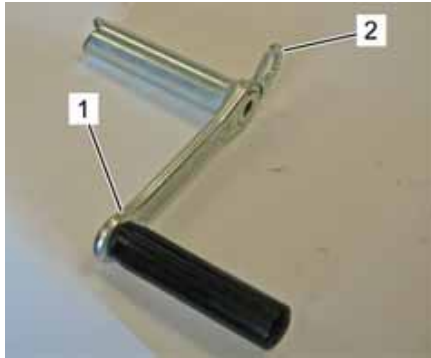

Fig. 36: Starting handle (rigid version)



NOTE!

In the case of engines with cooling water pump (neoprene impeller pump), manual starting with an RD crank handle (limited kickback crank handle) is not possible due to the design. Only the "rigid version" shown as an example in picture 36 can be used.



Fig. 37: RD crank handle



NOTE!

Due to the design, the RD (limited kickback) crank handle shown in picture 37 cannot be used for engines with a cooling water pump (neoprene impeller pump).

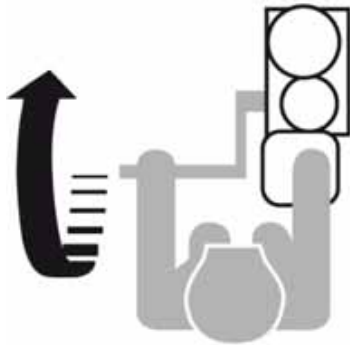

Fig. 38

5. Erect on the right in front of the engine and ensure a secure position.

Operation

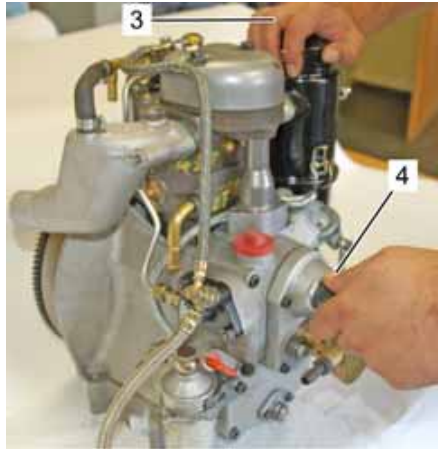

Fig. 39

6. Support the air filter with your right hand (3).



CAUTION!

Risk of injury due to rotating crank handle!

There is a risk of injury when starting the engine by hand.

Therefore:

- **Do not encircle the handle with your thumb.**

7. Hold crank handle with your left hand and thumb on top (4) and turn to the left (anticlockwise); in doing so increase the speed continuously.

Turning further and faster with the crank handle supports starting the engine.



NOTE!

The automatic decompression operates for the manual starting of the engine. If the pin has moved to the operating position (Fig. 29/3), the decompression is finished. The compression begins and the engine starts.

8. Absolutely continue turning after the first compression until the crank handle is overtaken by the running engine and disengaged.



NOTE!

If the engine does not start, repeat the starting procedure (continuous cranking at a steadily increasing speed will help starting) and increase the speed.



NOTE!

When starting the engine when warm (operating temperature) do not pull out the excess fuel device.

7.4 Starting with electric starter



NOTE!

For engines with an electric starter the automatic compression does not need to be activated. The engine is started with e.g. a key switch.



CAUTION!

Damage due to starting while the engine is running!

Incorrect operation of the starter can damage it.

Therefore:

- Only operate the starter when the engine is not running.
- Do not operate the starter for longer than 10 to 20 seconds and release the key when the engine is running.
- Wait approx. 30 seconds before repeating starting.



CAUTION!

Engine damage due to cold start aids!

The use of cold starting aid results in engine damage.

Therefore:

- **Never use cold starting aids.**

The engine in the version with a starter is started using a key switch (see e.g. operating instructions of the device manufacturer).

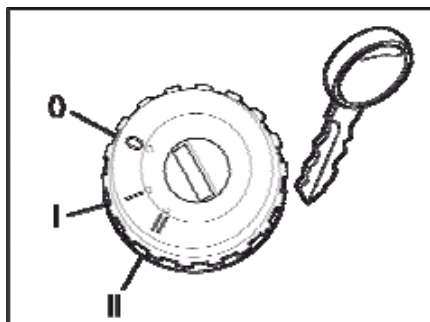

Fig. 40: Example: Key switch

Example of the key switch positions:

- 0 Electrical system switched off. Key can be removed.
- I Electrical system switched on.
Operating position
- II Electrical system switched on.
Starting position

Operation

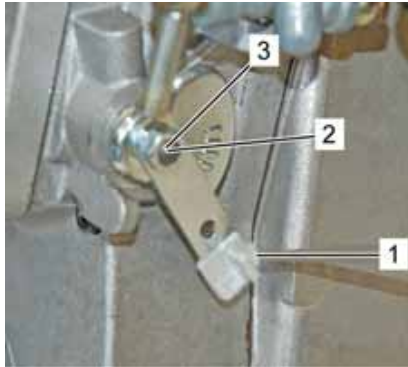

Fig. 41

Starting engine

1. If the engine is cold, put the speed adjustment lever in the increased idle speed position (3).

If the engine is warm, put the speed adjustment lever in the position (2) (depending on the application of the engine).

2. Turn key e.g. to position I. Any existing indicator lamps from the machine must light afterwards (e.g. oil check, battery charge check, etc.).
3. Press in the key, turn as far as position II and release immediately after the engine starts.



NOTE!

If the engine does not start, the battery voltage can be too low. Charge the battery or replace it if necessary.

7.5 Operation



CAUTION!

Engine damage due to incorrect operation!

The lifetime of the engine can be reduced due to incorrect operation.

Therefore:

- Strictly observe the following instructions for first use, normal operation and continuous operation.



CAUTION!

Engine damage due to cold start aids!

The use of cold starting aid results in engine damage.

Therefore:

- **Never use cold starting aids.**

First use

WARNING!
Risk of injury due to leaking fuel!

Fuel escaping from the injection system can penetrate the skin and eyes due to the high pressure and cause severe injuries.

Therefore:

- Wear safety goggles during first use and check the fuel system for leak tightness.
- If fuel escapes, switch off the engine and contact the nearest Greaves Farymann Diesel service partner.

- Let the engine warm up for approx. 5 minutes after starting. Increase load slowly.
- **After the first 25 operating hours, carry out the following work in accordance with the maintenance work:**
 - Change the engine oil and replace oil filter (see Chapter 8.6 Changing engine oil and oil filter).
 - Arrange for the valve clearance to be checked by the nearest Greaves Farymann Diesel service partner (see Chapter 8.10 Adjusting valve clearance).

Note!

Replace oil filter (engines with D / W crankcase).

Normal operation

- Let the engine warm up for approx. 5 minutes after starting. Increase load slowly.
- Do not let the engine idle longer than 30 minutes and do not operate without load (longer idling of the engine can result in excessive carbonisation on the piston and cylinder barrel).

Continuous operation

- Let the engine warm up for approx. 5 minutes after starting. Increase load slowly.
- Check the engine oil level every 15 hours during continuous operation and refill with engine oil if necessary (see Chapter Filling engine oil).
For this purpose:
 - Switch off the engine
 - Wait 5 minutes so that the oil can flow back from all bearings into the oil sump or additional oil sump (for engines with additional oil sump).
 - Check engine oil level and correct if necessary.
 - Start the engine again.



Operation

7.6 Switching off



CAUTION!

Risk of injury due to engine run-on!

After switching off, the engine runs on for approx. 10 to 20 seconds.

Therefore:

- Wait until the engine is at a standstill before starting all work.



CAUTION!

Engine damage due to premature switching off!

Switching off under load can reduce the lifetime of the engine.

Therefore:

- During full load operation, let the engine idle for approx. 5 minutes without load before switching off.

7.6.1 Engine without electric starter

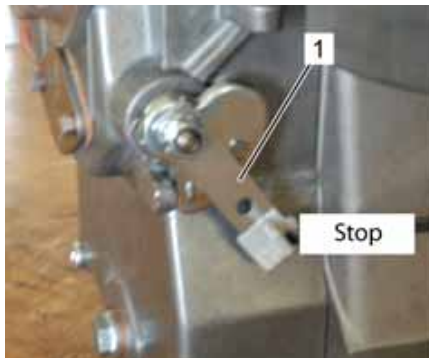

Fig. 42

- Put the speed adjustment lever (1) in the STOP position and hold it there until the engine comes to a complete standstill after approx. 10 to 20 seconds.



NOTE!

Never turn off the engine with the automatic decompression at full load. Before turning off first let the engine run for approx. 5 minutes in idle mode and then pull the speed adjustment lever to the stop position (Fig. 42/1) and hold it there until the engine stops after approx. 10 to 20 seconds.

7.6.2 Engine with electric starter

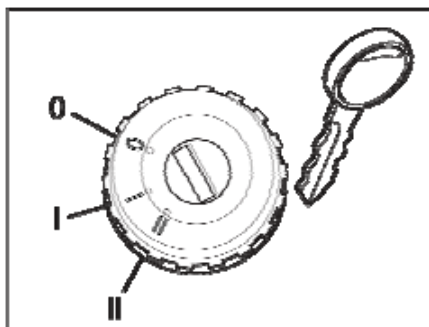

Fig. 43: Example of key switch



NOTE!

See e.g. operating instructions of the device manufacturer.

1. Turn the key switch to the position "0". The engine comes to a standstill after approx. 10 to 20 seconds.
2. Remove key.



Operation

7.7 Decommissioning

Decommissioning and preservation

The following preservation protects the engine during decommissioning (e.g. winter break) for 3 months.

1. Perform thorough external cleaning of the engine.
2. Drain engine oil and fill engine with approx. 1.0 litre of corrosion protection oil.
3. Detach fuel line from the fuel tank (on the machine side) to the fuel feed pump. Fill a suitable container with approx. 0.5 litre mixture of nine parts of diesel fuel and one part of corrosion protection oil. Afterwards, connect a short suction line to the fuel feed pump and insert in the container so that the fuel feed pump can intake the mixture.
4. Put the speed adjustment lever in full load position. Turn the automatic decompression to the neutral position and rotate the engine slowly for approx. 20 revolutions with the crankhandle.
5. Drain the cooling system of the engine by detaching the cooling water pump (neoprene impeller pump) cover.
6. Seal inlet and exhaust openings with textile adhesive tape.
7. Store the engine in a dry place and protected against the effects of weather.

Storing for longer than 3 months

Repeat the following work every 2 months in the case of longer storage.

1. Remove adhesive tape from the inlet and exhaust openings.
2. Put the speed adjustment lever at full load, turn the automatic decompression to the neutral position and slowly rotate the engine with the starting handle for approx. 20 revolutions.
3. Seal inlet and exhaust openings with textile adhesive tape.
4. Store the engine in a dry place and protected against the effects of weather.

Restarting

Perform the following work for restarting the engine:

1. Perform thorough external cleaning of the engine.
2. Remove textile adhesive tape from the inlet and exhaust openings.
3. Drain corrosion protection oil from the engine into a suitable container and dispose of in accordance with the environmental regulations.
4. Fill engine with engine oil (see Chapter 6.4 "Filling engine oil) and replace oil filter (engine with D/W crankcase).
5. Connect fuel supply hose to fuel feed pump and tighten hose clamp.
6. Fill the fuel tank on the machine side with diesel fuel.
7. Filling cooling system.
8. Start engine and check the cooling and fuel system for leaks.

Maintenance

8 Maintenance

8.1 Safety

Maintenance work not carried out correctly



WARNING!

Risk of injury due to incorrectly carried out maintenance work!

Improper maintenance can result in severe personal injuries or material damage.

Therefore:

- Always undertake maintenance work when the engine is switched off.
- Ensure there is sufficient installation clearance before starting work.
- Ensure tidiness and cleanliness at the workplace. Loose components and tools lying around or on top of each other are sources of accidents.
- Only perform maintenance work using commercially available tools and special tools. Incorrect or damaged tools can result in injuries.

Engine oil and fuel



WARNING!

Danger of fire due to fuel and engine oil!

Oil and fuel vapours can ignite on contact with ignition sources.

Therefore:

- No naked flames during work on the engine.
- Do not smoke.
- Remove oil and fuel residues from the engine and floor.

**CAUTION!**
Danger of poisoning due to fuel, antifreeze and engine oil!

Contact with engine oil, antifreeze and fuel can result in damage to health.

Therefore:

- Avoid skin contact with engine oil, fuel and antifreeze.
- Remove oil and fuel splashes and antifreeze from the skin immediately.
- Do not inhale oil and fuel vapours.

Personnel

- The maintenance work described here can be performed by the operator unless otherwise indicated.
- Other maintenance work must only be performed by specially trained qualified personnel or by specialist workshops (Greaves Farymann Diesel service partners). This particularly applies to work on the valve adjustment, diesel injection system and for the engine repair.

Personal protective equipment

Wear the following protective equipment for all maintenance work:

- Protective clothing
- Safety footwear

**NOTE!**

Protective equipment which must be worn for certain work is specially pointed out in the warnings of this chapter.



Maintenance



NOTE!

Independent repair and adjustment work on the engine beyond a very limited scope is forbidden for safety reasons.

Improper work on components relevant for safety endangers you and others.

This particularly applies to work on the valve adjustment, diesel injection system and for the engine repair.

Do not tighten cylinder head nuts!

In the case of use where there is an excessive occurrence of dust, shorten the maintenance intervals by at least half.

In the case of low operating time, the engine oil and oil filter (engines with D/W crankcase) must be replaced at least every 12 months irrespective of the actual operating hours.

Only use original Greaves Farymann Diesel spare parts.

8.2 Maintenance plan

The various tasks are listed in the maintenance plan.

The maintenance intervals must be complied with as follows:

- daily before every start-up
- after 25 operating hours
- every 250 operating hours
- every 500 operating hours



NOTE!

The maintenance interval for 500 operating hours includes all the work for the interval of 250 operating hours.

Maintenance table

Components Component group	Work to be performed	Daily before every start-up	After 25 operating hours	Every 250 operating hours	Every 500 operating hours
Engine oil	Check oil level, refill with engine oil if necessary	X			
Engine oil (version with oil strainer)	Replace engine oil at least every 12 months		X	X	
Change engine oil and oil filter (D/W crankcase version)	Replace engine oil and oil filter at least every 12 months		X	X	
Oil strainer	Remove oil strainer and clean, replace if necessary				X
Suction area	Check area for intake air, clean if necessary	X	X	X	
Dry type air cleaner	Clean air filter element and air filter case			X	
	Replace air filter element and clean air filter case				X
Oil bath air cleaner	Check oil contamination and oil level, several times a day in the case of a high occurrence of dust; if necessary fill oil up to marking or change it	X			
	Change the oil bath air cleaner's oil			X	
Neoprene impeller	Check neoprene impeller			X	
Valve adjustment	Using Greaves Farymann Diesel service partner: Check valve clearance, adjust if necessary (cold engine)		X	X	
Threaded connections	Check for tightness, tighten if necessary (cylinder head nuts must not be tightened)		X	X	



Maintenance

Components Component group	Work to be performed	Daily before every start-up	After 25 operating hours	Every 250 operating hours	Every 500 operating hours
Exhaust system	Check for leaks, arrange repair by a Greaves Farymann Diesel service partner if necessary			X	
Fuel filter	Replace				X
Fuel hoses	Check, replace if necessary and in any case at least every 4 years by a Greaves Farymann Diesel service partner	X			
Electric cables	Check for damage, replace by a Greaves Farymann Diesel service partner if necessary	X			
Cooling water hoses and hose clamps	Check, replace if necessary and in any case at least every 2 years by a Greaves Farymann Diesel service partner	X			
Thermostat	Replace thermostat	Recommendation: after 2000 operating hours			
Coolant	Replace coolant (engines with closed cooling water circuit / with radiator and e.g. electric water pump)	Recommendation: every 2 years			
Engine	Outside cleaning with engine cleaner	as required			

Maintenance for special conditions

CAUTION!
Reduced maintenance intervals in the case of special conditions!

Additional maintenance is necessary in the case of special operating conditions in order to maintain the lifetime of the engine.

Therefore:

- Observe the following points.

■ Excessive occurrence of dust

In the case of use where there is an excessive occurrence of dust, shorten the maintenance intervals by at least half.

■ Low operating time

In the case of low operating time, the engine oil and oil filter (for the D/W crankcase version) must be replaced at least every 12 months irrespective of the actual operating hours.

8.3 Cleaning the intake area

CAUTION!
Engine damage due to dust in the intake area!

Dust in the combustion chamber can result in premature engine wear and reduced engine performance.

Therefore:

- Keep the area for the intake air free of dust and contamination.

- Clean dust and contamination in the intake area (1) with a suitable clean and dry cloth.



Fig. 44



Maintenance

8.4 Checking threaded connections



CAUTION!

Damage due to too high tightening torque!

Bolts tightened too much can break off and the thread can be damaged.

Therefore:

- Only check and tighten threaded connections with appropriate commercially available tools and respective special tools.
- Do not exceed the tightening torques stated here.



CAUTION!

Cylinder head nuts must not be tightened!

Therefore:

- Do not tighten cylinder head nuts without authorisation.
- Arrange for work on the cylinder head to be carried out by a Greaves Farymann Diesel service partner.

Tightening torques

Threaded connection relevant for safety	Tightening torque Nm
High pressure line of the injection nozzle holder	25
Mounting of the fuel filter	10
Wing nut of sealing cap of the air filter case	After cleaning or replacing the air filter only tighten the wing nut of the air filter case by hand.
Exhaust silencer bolts	10
Oil filter (for engines with D/W crankcase)	Only tighten oil filter by hand.
Valve cover	8 – 12
Oil drain plug	12
Oil strainer bolts	3 – 4
Thermostat housing bolts	10

8.5 Changing engine oil

NOTE!

Only change engine oil when the engine is at a standstill and at operating temperature. Always replace engine oil and oil filter together.

8.5.1 Version with oil drain plug

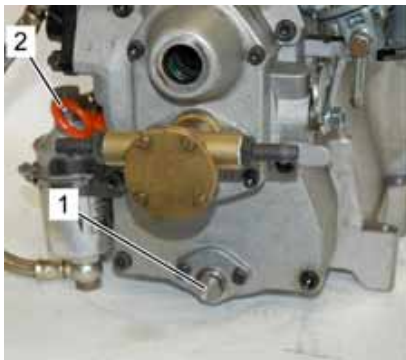

Fig. 45

1. Switch off the engine
2. Slacken oil drain plug (1) (e.g. with a ring spanner SW 13).
3. Place a suitable container underneath.
4. Screw out oil drain plug by hand.
Caution: Engine oil can be hot.
5. Collect old oil in a suitable container and dispose of in accordance with the environmental regulations.

Maintenance



Fig. 46

6. Check oil drain plug (1) for damage and replace if necessary.
7. Always replace the copper seal (2).
8. Screw in oil drain plug by hand and tighten with e.g. ring spanner SW 13.

Tightening torque: 12 Nm

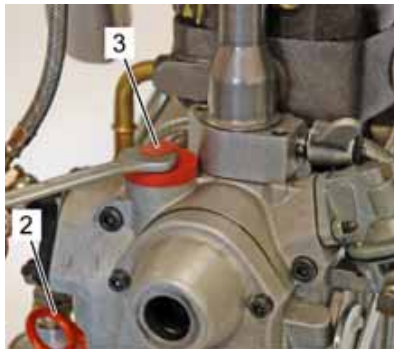

Fig. 47

9. Release oil filler cap (3) e.g. with a flat wrench (wrench size: 13 mm) and screw off by hand.
10. Fill with engine oil.
11. Pull out oil dipstick (2) and clean the bottom end with a clean and fluff-free cloth.
12. Replace the oil dipstick (2) and pull it out again.
13. Check the oil level quantity. The oil level should be just under the Max. marking.
14. Only tighten the oil filler cap (3) by hand (risk of breakage).
15. Start engine and check for leaks.

8.5.2 Version with oil drain valve

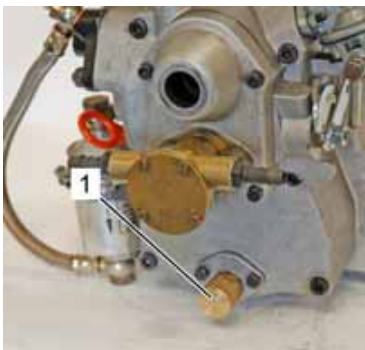

Fig. 48

1. Switch off the engine.
2. Screw off the sealing cap (1) by hand.

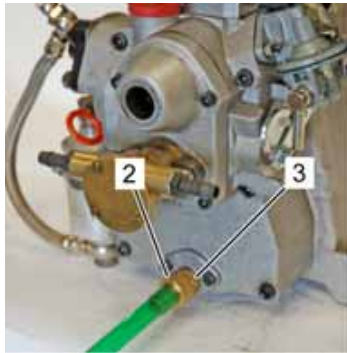

Fig. 49

3. Screw special oil drain hose (2) onto the oil drain valve (3). This opens the quick-release coupling.
4. Collect old oil in a suitable container and dispose of in accordance with the environmental regulations.
5. Unscrew and remove the oil drain hose (2).

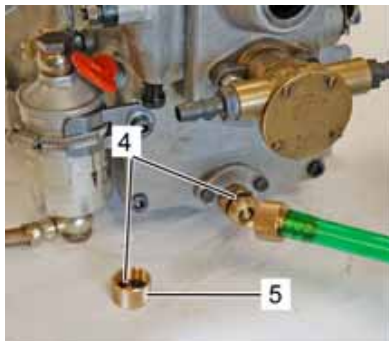

Fig. 50

6. Check O-rings (4) for damage and replace oil drain valve (Fig. 49/3) if necessary.
7. Tighten the sealing cap (5) by hand.



Fig. 51

8. Release oil filler cap (3) e.g. with a flat wrench (wrench size: 13 mm) and screw off by hand.
9. Fill with engine oil.
10. Pull out oil dipstick (Fig. 47/2) and clean the bottom end with a clean and fluff-free cloth.
11. Replace the oil dipstick (Fig. 47/2) and pull it out again.
12. Check the oil level quantity. The oil level should be just under the Max. marking.
13. Only tighten the oil filler cap (3) by hand (risk of breakage).
14. Start engine and check for leaks.



NOTE!

Always replace engine oil and oil filter together (for engines with D/W crankcase).

Maintenance

8.5.3 Removing and installing oil strainer

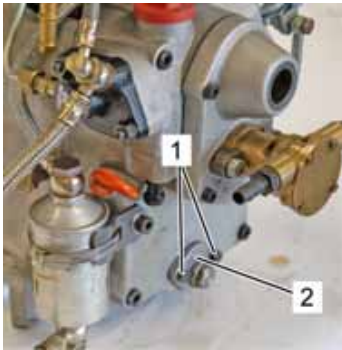

Fig. 52

1. Place a suitable container underneath.
2. Drain engine oil (see Chapter 8.5.1).
3. Unscrew both bolts (1).
4. Remove oil strainer housing (2).
5. Collect old oil in a suitable container and dispose of in accordance with the environmental regulations.
6. Clean oil strainer with cold cleaning agent or diesel.



NOTE!

If the oil strainer is deformed or damaged, it must absolutely be replaced.



Fig. 53

7. Install cleaned or new oil strainer (4) with new gasket (3) carefully.
8. Screw in both bolts (5) with new copper seals (6) and tighten.

Tightening torque: 3 – 4 Nm

9. Screw in oil drain plug (7) with new copper seal (8) and tighten with ring spanner SW 13.

Tightening torque: 12 Nm



Fig. 54

10. Release oil filler cap (9) e.g. with a flat wrench (wrench size: 13 mm) and screw off by hand.
11. Fill with engine oil.
12. Pull out oil dipstick (Fig. 47/2) and clean the bottom end with a clean and fluff-free cloth.
13. Replace the oil dipstick (Fig. 47/2) and pull it out again.
14. Check the oil level quantity. The oil level should be just under the Max. marking.
15. Only tighten the oil filler cap (9) **by hand** (risk of breakage).
16. Start engine and check for leaks.

8.6 Changing oil filter (for D/W crankcase version)



NOTE!

Always replace engine oil and oil filter together.
Changing engine oil (see Chapter 8.5.)



Fig. 55

1. Slacken oil filter (3) with an oil filter wrench (1) and e.g. a ring spanner 27 (2) off and unscrew and remove by hand.



NOTE!

The oil filter can be hot.

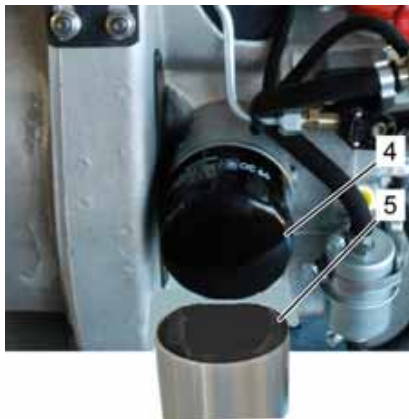

Fig. 56

2. Collect the engine oil from the oil filter (4) and oil filter case in a suitable container (5) and dispose of in accordance with the environmental regulations.

Maintenance

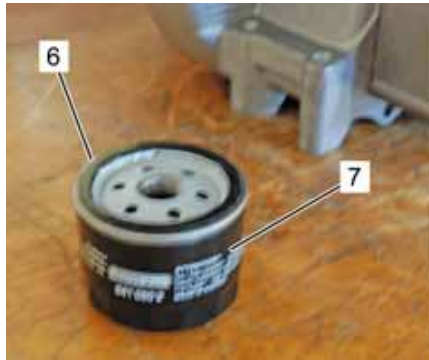

Fig. 57

3. Clean the sealing surface on the oil filter case.
4. Use new oil filter (7) and wet seal (6) with clean engine oil.

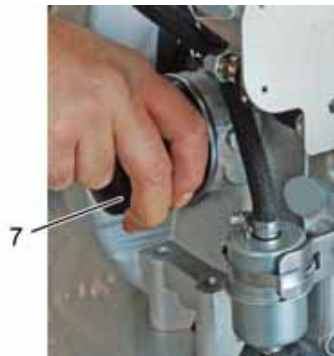

Fig. 58

5. Tighten the oil filter (7) **only by hand**.
6. Fill with engine oil.
7. Start engine and check for leaks.

8.7 Fuel system

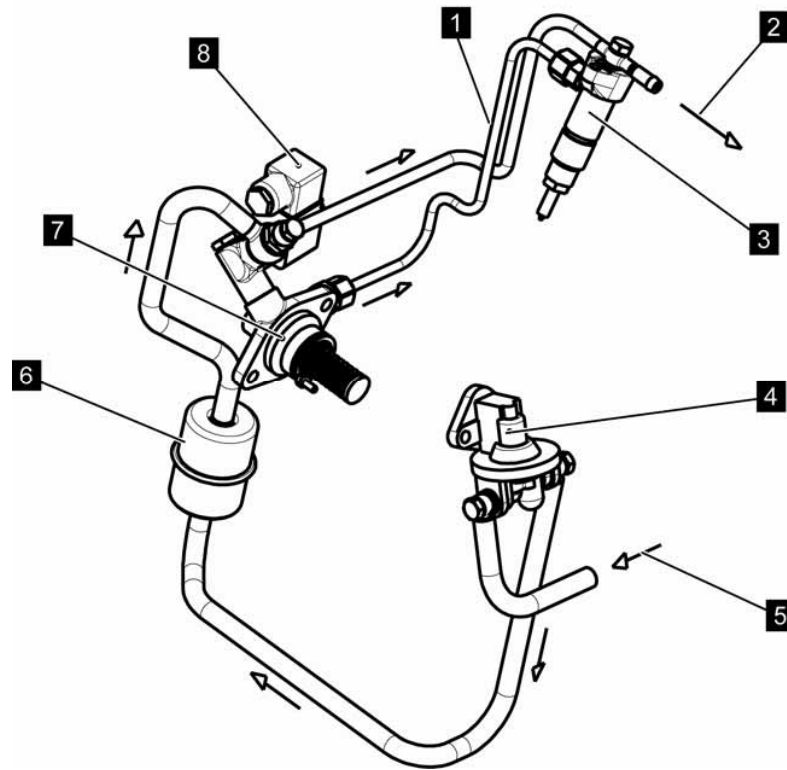

Fig. 59: Fuel system

- | | |
|--|--|
| 1 Fuel pressure line | 5 Connection for fuel line to the fuel tank (feed) |
| 2 Connection for fuel line to the fuel tank (return) | 6 Fuel filter (standard) |
| 3 Injection nozzle holder | 7 Injection pump |
| 4 Fuel feed pump | 8 Electric solenoid valve (option) |

8.7.1 Replacing fuel filter



Fig. 60: Fuel filter with thread

There are two versions of the fuel filter:

- Fuel filter (1) with thread version (option): With this version, the fuel lines are screwed on to the fuel filter.

Maintenance



Fig. 61: Fuel filter (standard)

- Fuel filter (2) version (standard): With this version, the fuel lines are fixed using hose clamps.

8.7.2 Replacing fuel filter (with thread)



Fig. 62

1. Switch off the engine
2. Disconnect fuel line (1) using special fuel line disconnecting tool (2).

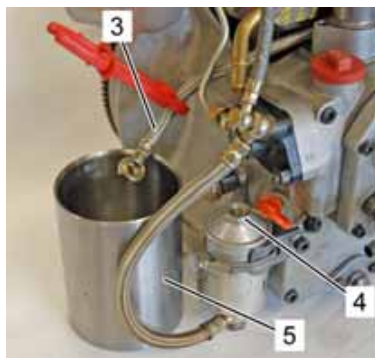

Fig. 63

3. Unscrew fuel line (3) from the fuel filter (4).
4. Collect the fuel from the fuel line (3) in a suitable container (5) and dispose of in accordance with the environmental regulations.

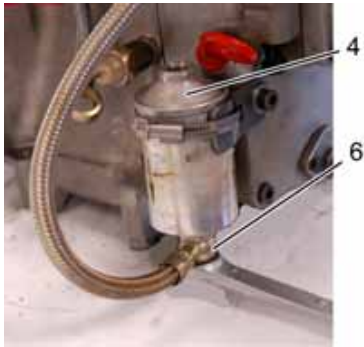

Fig. 64

5. Detach fuel line (6) from the fuel filter (4).



Fig. 65

5. Undo hose clamp (7) and remove fuel filter (4).



Fig. 66

6. Collect the fuel from the fuel line (6) in a suitable container (5) and dispose of in accordance with the environmental regulations.

Maintenance

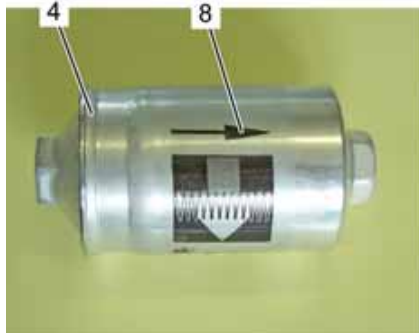

Fig. 67: Fuel filter with thread

Fuel filter with thread (option)

6. Install new fuel filter (4) and pay attention to the flow direction. The arrow (8) must point in the direction of the injection pump.



Fig. 68

7. Check banjo bolts (9) for damage and replace copper seals (10).
8. Assembly is in the reverse order to the dismantling.
9. Start engine and check the fuel system for leaks.

8.7.3 Replacing fuel filter (standard)

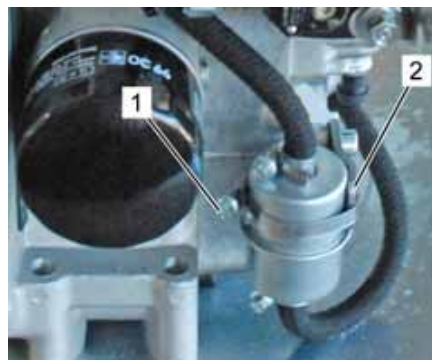

Fig. 69

1. Switch off the engine.
2. Undo hose clamp (1) on the mounting (2) of the fuel filter.



Fig. 70

3. Disconnect fuel line (2) using special fuel line disconnecting tool (3).

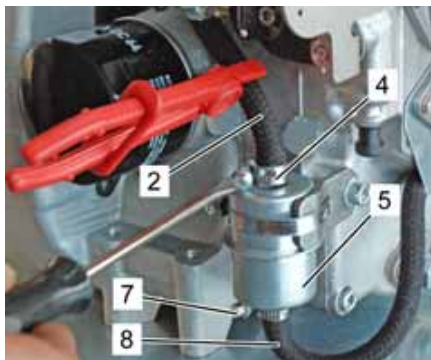

Fig. 71

4. Undo hose clamp (4) and pull off the fuel line (2) from the fuel filter (5).



Fig. 72

5. Collect the fuel from the fuel line (2) and from the fuel filter (5) in a suitable container (6) and dispose of in accordance with the environmental regulations.
6. Undo hose clamp (Fig. 71/7) and pull off the fuel line (Fig. 71/8) from the fuel filter (Fig. 71/5).

Maintenance

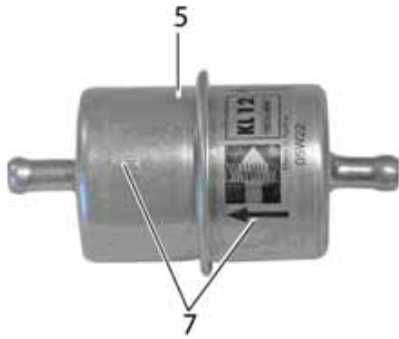

Fig. 73

7. Install new fuel filter (5) and pay attention to the flow direction. The arrow (7) must point in the direction of the injection pump. Assembly is in the reverse order to the dismantling.



Fig. 74

8. Tighten screw (1) of the hose clamp on the mounting.
8. Start engine and check the fuel system for leaks.

8.8 Replacing air filter



CAUTION!

Engine damage due to use of non-original air filter!

Unfiltered air can result in rough engine running and engine damage. A dusty air filter reduces the engine power and increases the fuel consumption.

Therefore:

- Do not operate the engine without the air filter.
- Clean or replace air filter according to the maintenance plan.

8.8.1 Dry type air cleaner (standard engine)



Fig. 75

1. Switch off the engine
2. Unscrew and remove the wing nut (1).
3. Release sealing clips (2) and remove air filter case (3).



Fig. 76

4. Remove air filter element (4).



Fig. 77

5. Remove air filter cover (5) with air filter pot (6) and centring ring (7).

Maintenance



Fig. 78

6. Thoroughly clean intake area (Fig. 78/8), air filter cover (Fig. 77/5) and air filter pot (Fig. 77/6) as well as centring ring (Fig. 77/7).



NOTE!

When removing the air filter and when cleaning the air filter case, always ensure that no dirt gets into the intake tract.

7. After cleaning assemble the centring ring, air filter pot and air filter cover. While doing this only tighten the wing nut (Fig. 75/1) by hand.



Fig. 79

8. Install new air filter element (4).



Fig. 80

9. Position air filter case (3) straight, in the process pay attention to correct seating, and close sealing clips (2).

8.8.2 Dry type air cleaner (oval flange)

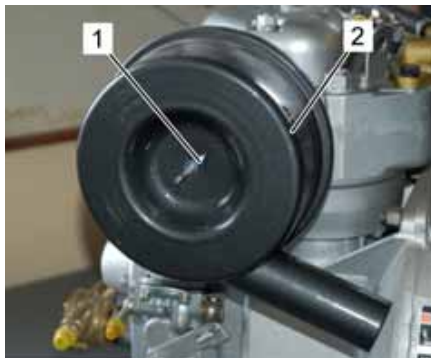

Fig. 81

1. Switch off the engine.
2. Unscrew and remove the wing nut (1).
3. Remove air filter cover (2).



Fig. 82

4. Remove air filter element (3).



Fig. 83

5. Clean suction area (Fig. 83/4) and air filter cover (Fig. 81/2) thoroughly.



NOTE!

When removing the air filter and when cleaning the air filter case, always ensure that no dirt gets into the intake tract.

Maintenance

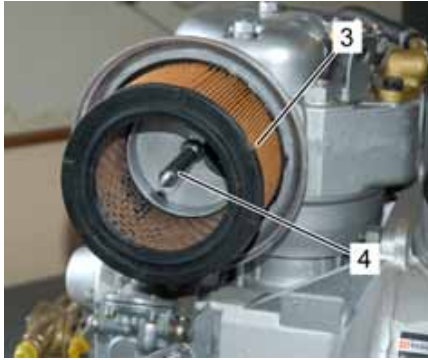

Fig. 84

6. Install new air filter element (3); in doing so, ensure that the spacer sleeve (4) is also installed.

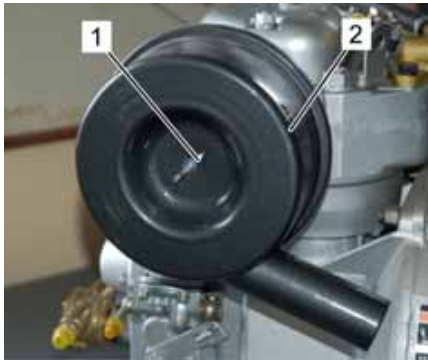

Fig. 85

7. Position air filter case (2) straight, in the process pay attention to correct seating, and fasten with the wing nut (1).

8.8.3 Oil bath air cleaner (standard engine)



Fig. 86



NOTE!

Check oil contamination and oil level several times a day in the case of a high occurrence of dust, if necessary fill oil up to marking or change it (see maintenance plan).

1. Open fasteners (2) and remove oil container (1).
2. Remove contaminated oil and sludge from oil container. Collect old oil and dispose of it in accordance with environmental regulations.
3. Clean the oil container thoroughly.



Fig. 87

4. Check filter material (3) depending on occurrence of dust. In the case of severe contamination, remove filter and wash out in diesel fuel or replace complete oil bath air cleaner.



NOTE!

Before assembly of the filter, let the diesel fuel drip off sufficiently or wipe off.



NOTE!

Do not pull out the filter material (3) from the filter case. The filter must be completely dry before fitting.



Fig. 88

5. Fill oil container up to marking (4) with engine oil (use oil in accordance with the viscosity classes on page 29).
6. Fix oil container to the filter, whilst doing so make sure the filter sits correctly, and close both fasteners.

Maintenance

8.9 Adjusting valve clearance

Safety



WARNING!

Risk of injury due to starting the engine!

The engine can be accidentally started when adjusting the valve clearance and thereby cause severe injuries.

Therefore:

- Disconnect the high pressure line on the injection nozzle holder before starting work.

Personnel

This work must only be carried out by trained specialist personnel. In the absence of the required qualifications, arrange for the work to be carried out by a Greaves Farymann Diesel service partner.

Prerequisites

Only check and adjust the valve clearance when the engine is cold (less than 35 °C).

Settings

Exhaust valve 0.2 mm
Intake valve 0.2 mm

8.9.1 Engines with visible flywheel and O.T. marking

Preparations



Fig. 89

1. Switch off engine and let it cool down to the ambient temperature.
2. Unscrew the nuts (1) on the valve cover (2) and remove bracket (3) for fuel line and plastic seals, valve cover and valve cover gasket.

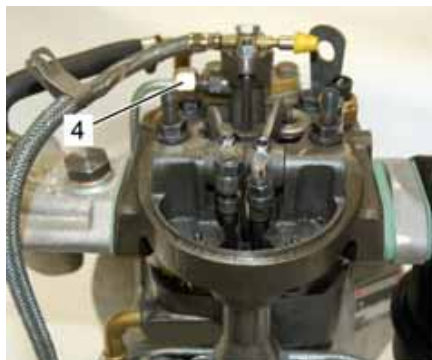

Fig. 90

3. Detach the high pressure line (4) on the injection nozzle holder in order to prevent accidental starting of the engine.



Fig. 91

4. Turn automatic decompression to operating position (5), pin faces forward (9 o'clock position).



NOTE!

The decompression must be turned off at the valve adjustment (operating position: pin faces forward: 9 o'clock position), only in this way is a correct adjustment of the valves guaranteed.

Maintenance

Adjusting inlet valve - exhaust valve



Fig. 92

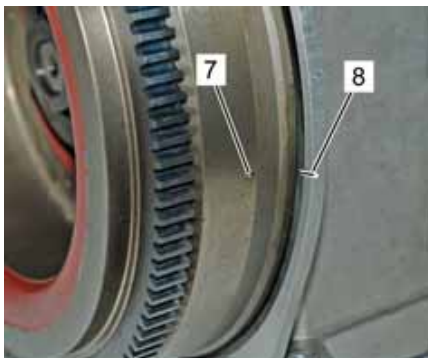

Fig. 93

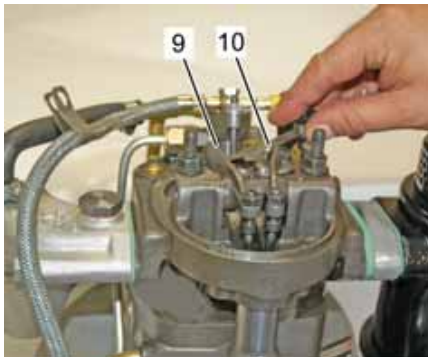

Fig. 94

5. Insert crank handle (6) in the starting handle support bearing and slowly turn the crankshaft in the engine rotation direction (anticlockwise) until the end of the compression stroke or

until the O.T. marking (7) on the flywheel corresponds to the crankcase marking (8).

In this position both valves (inlet and exhaust valves) are closed (max. clearance between rocker arm and valve stem).

Exhaust valve setting

6. Slide a feeler gauge (10) with thickness 0.2 mm between rocker arm (9) and the exhaust valve stem and check the valve clearance of the exhaust valve. The feeler gauge must be able to be pulled through between the valve and the cam follower without noticeable resistance (drag).

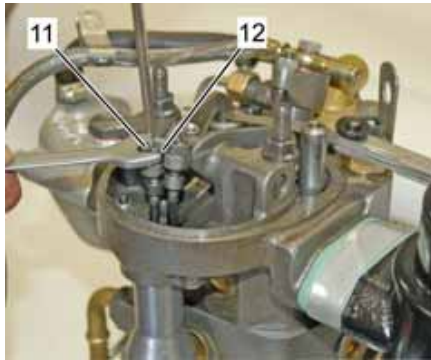

Fig. 95

7. If the clearance is too large or too small, undo the lock nut (12) and adjust the clearance with the adjusting screw (11). The feeler gauge must be able to be pulled through without noticeable resistance (drag).
8. Hold the adjusting screw in place with a screwdriver and tighten the lock nut.
9. Check the valve clearance again.



Fig. 96

Inlet valve setting

10. Setting the inlet valve is carried out in exactly the same way as for the exhaust valve (see Fig. 94 and 95).

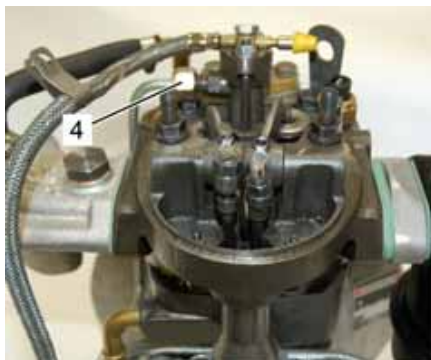

Fig. 97

11. Tighten the high pressure line (4) on the injection nozzle holder.

Tightening torque 25 Nm

Maintenance

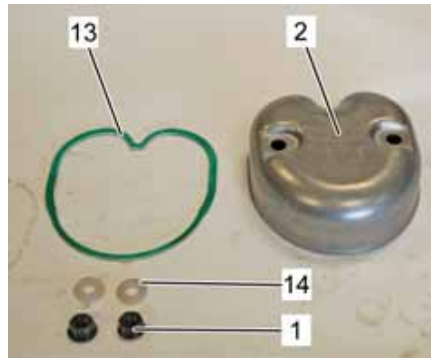

Fig. 98

12. Replace valve cover gasket (13).



Fig. 99

13. Install valve cover (2) using two new plastic seals (14).

14. Mounting bracket (3) of the fuel line.

15. Tighten both nuts (1) of the valve cover (2).

Tightening torque 8–12 Nm



NOTE!

Always replace the valve cover gasket and the two plastic seals under the nuts of the valve cover.

8.9.2 Engines with covered flywheel (without visible O.T. marking)

Preparations



Fig. 100

1. Switch off engine and let it cool down to the ambient temperature.
2. Unscrew both nuts (1) on the valve cover (2) and remove bracket (3) for fuel line and plastic seals, valve cover and valve cover gasket.



Fig. 101

3. Detach the high pressure line (4) on the injection nozzle holder in order to prevent accidental starting of the engine.



Fig. 102

4. Turn automatic decompression to operating position (5). Pin faces forward (9 o'clock position).

NOTE!

The decompression must be turned off at the valve adjustment (operating position: pin faces forward: 9 o'clock position), only in this way is a correct adjustment of the valves guaranteed.

Maintenance

Adjusting exhaust valve



Fig. 103

5. Insert crank handle (6) into the starting handle support bearing and slowly turn the crankshaft in the engine rotation direction (anticlockwise) until the inlet valve's spring is pushed down completely (inlet valve is now fully open).

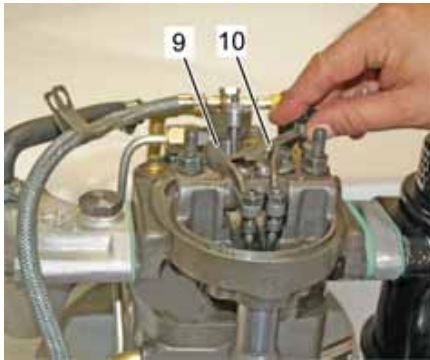

Fig. 104

6. Slide a feeler gauge (10) with thickness 0.2 mm between rocker arm (9) and the exhaust valve stem and check the valve clearance of the exhaust valve. The feeler gauge must be able to be pulled through without noticeable resistance (drag).

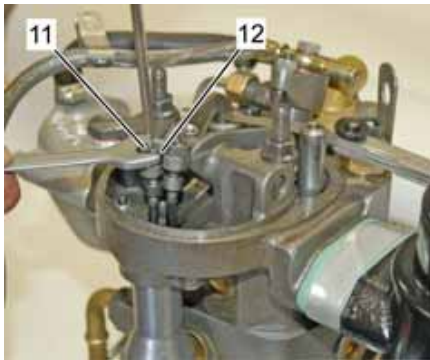

Fig. 105

7. If the clearance is too large or too small, undo the lock nut (12) and adjust the clearance with the adjusting screw (11). The feeler gauge must be able to be pulled through without noticeable resistance (drag).
8. Hold the adjusting screw in place with a screwdriver and tighten the lock nut.
9. Check the valve clearance again.

Adjusting intake valve



Fig. 106

10. Insert crank handle (6) into the starting handle support bearing and slowly turn the crankshaft in the engine rotation direction (anticlockwise) until the exhaust valve's spring is pushed down completely (exhaust valve is now fully open).



Fig. 107

11. Slide a feeler gauge (10) with thickness 0.2 mm between rocker arm (9) and the inlet valve stem and check the valve clearance of the inlet valve. The feeler gauge must be able to be pulled through without noticeable resistance (drag).



Fig. 108

12. If the clearance is too large or too small, undo the lock nut (11) and adjust the clearance with the adjusting screw (12). The feeler gauge must be able to be pulled through without noticeable resistance (drag).
13. Hold the adjusting screw in place with a screwdriver and tighten the lock nut.
14. Check the valve clearance again.

Maintenance

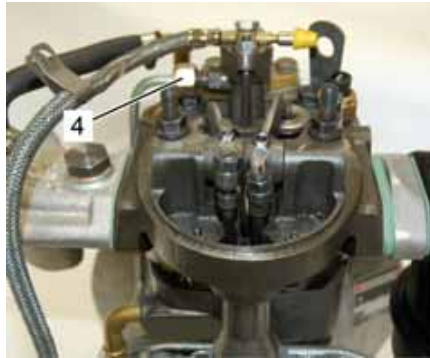

15. Tighten the high pressure line (4) on the injection nozzle holder.

Tightening torque 25 Nm

Fig. 109

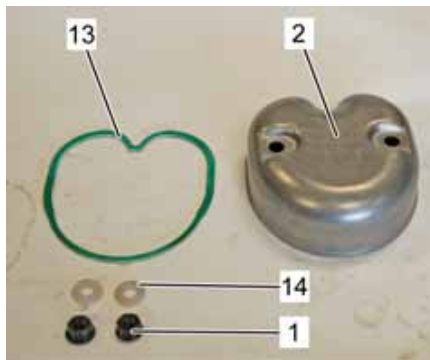

16. Replace valve cover gasket (13).

Fig. 110



17. Install valve cover (2) using two new plastic seals (14).
18. Mounting bracket (3) of the fuel line.
19. Tighten both nuts (1) of the valve cover (2).

Tightening torque 8–12 Nm



NOTE!

Always replace the valve cover gasket and the two plastic seals under the nuts of the valve cover.

Fig. 111

8.10 Cooling water diagram (standard)

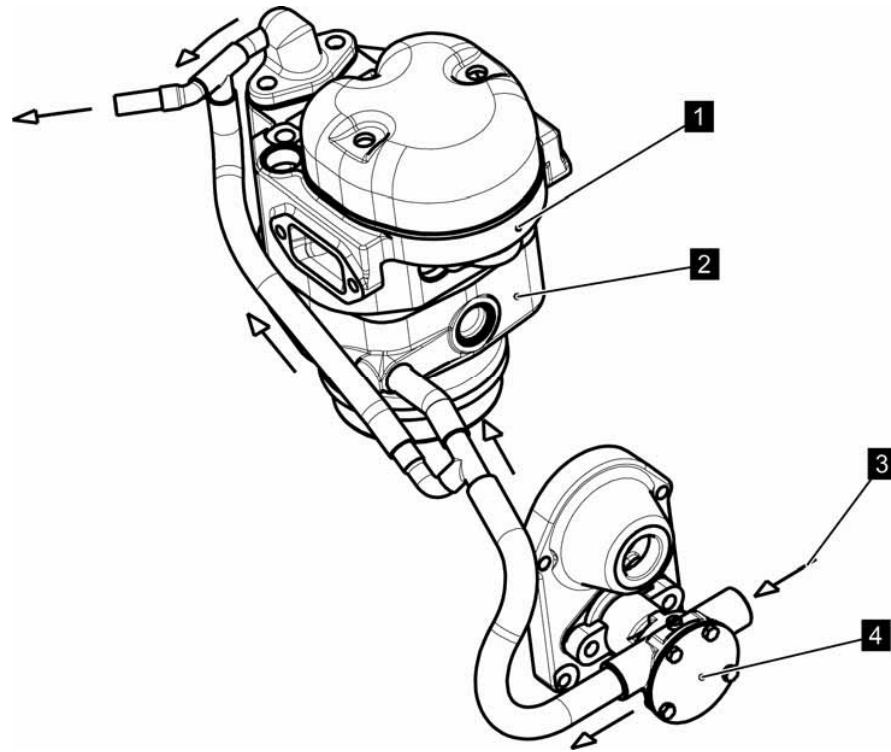

Fig. 112: Cooling water diagram (standard)

- 1 Cylinder head
- 2 Cylinder

- 3 Cooling water flow direction
- 4 Cooling water pump (neoprene impeller pump)

Maintenance

8.11 Cooling water diagram (with water-cooled exhaust manifold)

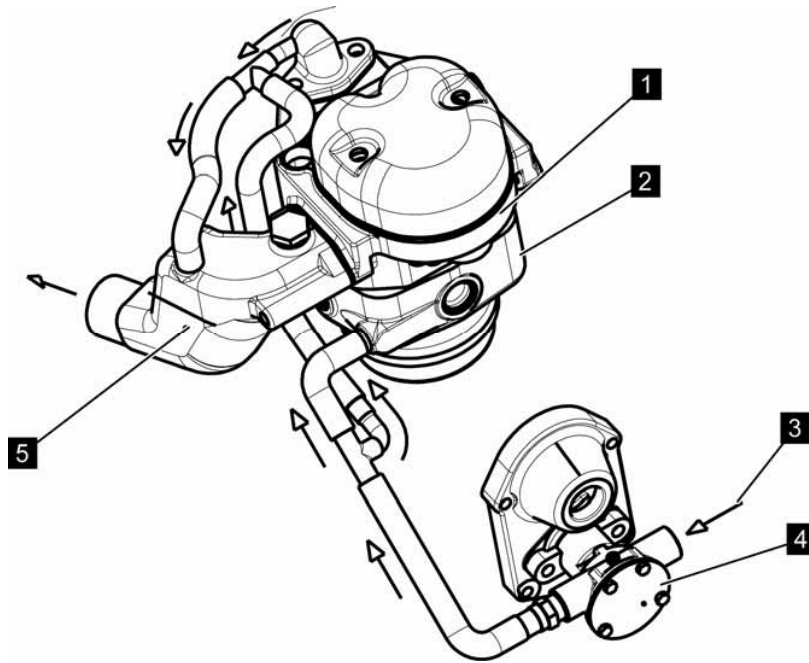

Fig. 113: Cooling water diagram

- | | | | |
|---|------------------------------|---|---|
| 1 | Cylinder head | 4 | Cooling water pump (neoprene impeller pump) |
| 2 | Cylinder | 5 | Water-cooled exhaust manifold |
| 3 | Cooling water flow direction | | |

8.12 Replacing neoprene impeller of the cooling water pump



NOTE!

The neoprene impeller of the cooling water pump must be considered as a wearing part. The service life of the neoprene impeller can be extremely different and depends solely on the operating conditions.



Fig. 114

1. Switch off engine and let it cool down to the ambient temperature.
2. Place suitable container under the cooling water pump.
3. Mark cooling water pump, e.g. with a touch-up stick (see arrow).

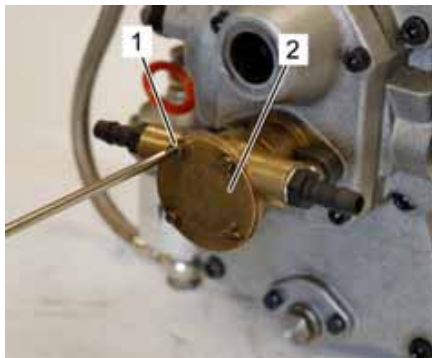

Fig. 115

4. Unscrew the 4 bolts (1) on the cooling water pump cover (2).
5. Collect water in a suitable container and dispose of in accordance with the environmental regulations.
6. Remove cooling water pump cover (2) with gasket.

Maintenance

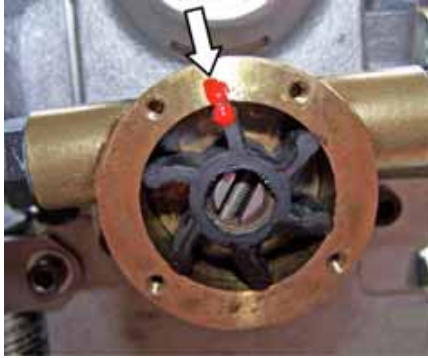

Fig. 116

7. Mark neoprene impeller for the case (see arrow).



NOTE!

It is ensured by the marking that the neoprene impeller is inserted in the correct position in the event of reinstallation.

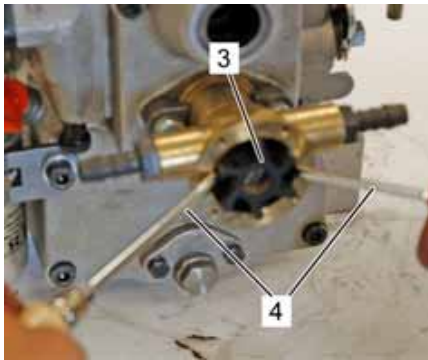

Fig. 117

8. Carefully remove the neoprene impeller (3) using two screwdrivers (4).

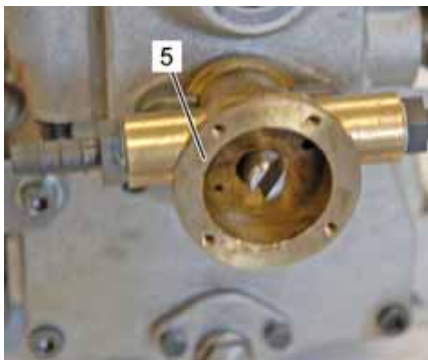

Fig. 118

9. Remove calcium deposits and gasket residues from the cooling water pump case (5).



Fig. 119

10. Check cooling water pump case (5) and neoprene impeller (3) for damage; replace if necessary.



NOTE!

Coat the neoprene impeller with some Vaseline® before installing in the water pump case.

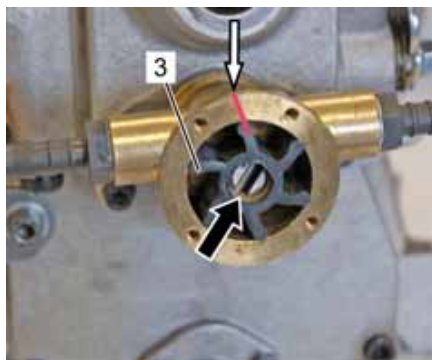

Fig. 120

11. Insert neoprene impeller (3) in the recess of the pump shaft (see black arrow); in doing so, ensure that it is fixed properly.



NOTE!

If the "old" neoprene impeller is reused, place this on the previously applied marking (see arrow).

Maintenance

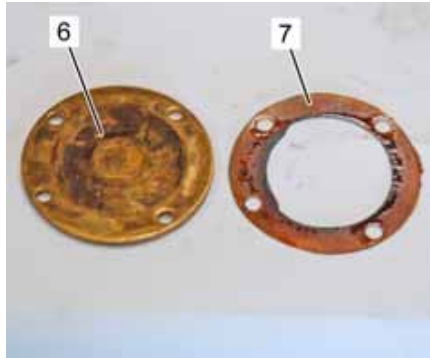

Fig. 121

12. Clean the sealing surface of the cooling water pump cover (6).
13. Use new gasket (7).

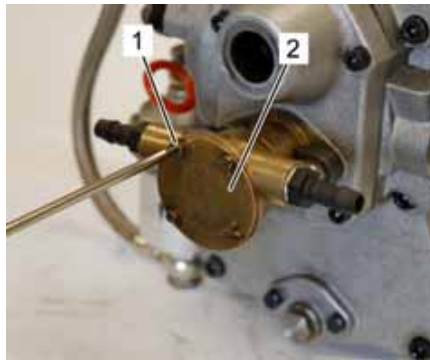

Fig. 122

14. Replace cooling water pump cover (2), screw in all screws (1) and tighten with a screwdriver.
15. Fill with water.
16. Start engine and check cooling system for leaks.



NOTE!

Never operate the neoprene impeller pump without sea water (never let it run "dry"). Even very short dry running can result in destruction of the impeller.



NOTE!

If there is a danger of frost during the process of decommissioning, remove water from the cooling system by undoing the screws (1) of the cooling water pump cover (2).

8.13 Removing, installing and checking thermostat

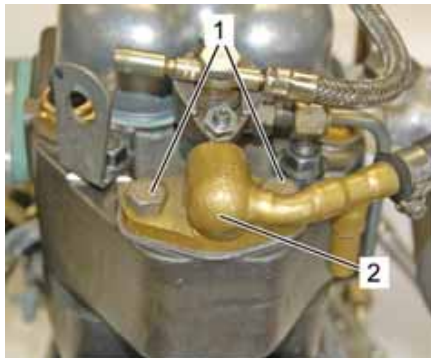

Fig. 123

1. Switch off engine and let it cool down to the ambient temperature.
2. Drain coolant and collect in a suitable container.
3. Unscrew both bolts (1).
4. Remove thermostat housing (2) with gasket.



Fig. 124

5. Remove thermostat (3).

Functional check



Fig. 125

6. Fill a container with water.
7. Attach thermostat (3) to a wire (4) and submerge in the water.
8. Heat the water slowly using, for example, a submersible heater.

Maintenance



Fig. 126

9. Measure the water temperature with a suitable temperature measuring instrument.
10. The thermostat must be completely open at 50 °C water temperature (for the salt water version) or at 70 °C water temperature (for the fresh water version).



Fig. 127

Example: Thermostat completely opened (see arrow).



Fig. 128

Example: Thermostat closed (see arrow).

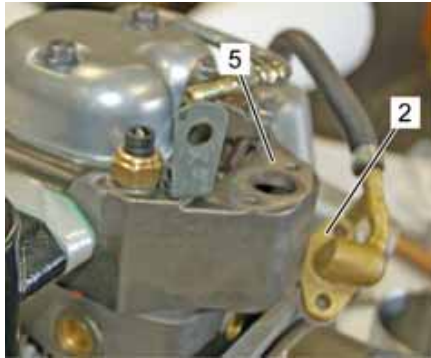

Fig. 129

11. Remove deposits and gasket residues on the cylinder head (5) and on the thermostat housing (2); in doing so, ensure that no dirt gets into the water channel in the cylinder head.



Fig. 130

12. Install thermostat (3).



NOTE!

Ensure when installing the thermostat that the small bore hole (see arrow) is not covered or closed and that the split pin is in the hole.

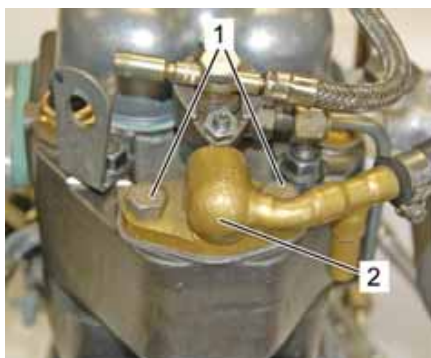

Fig. 131

13. Replace thermostat housing (2) with new gasket.
14. Screw in and tighten both bolts (1).

Tightening torque 10 Nm

15. Fill with coolant (for engines with radiator) or water (for engines with neoprene impeller pump).
16. Start engine and check cooling system for leaks.

Maintenance

8.14 Checking the cooling system for leaks

8.14.1 Engines with radiator (and e.g. electric water pump)

Hot operating materials



WARNING!

Risk of burns due to hot operating materials!

Operating materials can reach high temperatures during operation and cause burns in the case of contact.

Therefore:

- Never open the radiator cap at operating temperature.
- Let the cooling water cool down to the ambient temperature and open the radiator cap slowly so that the pressure can escape.

In the case of engine overheating or loss of cooling fluid in the cooling circuit (e.g. radiator, water pump and cooling water hoses), switch off the engine immediately and make the following checks:

- Checking the cooling system for leaks.
- Checking thermostat ⇒ Chapter 8.12.
- Check electric water pump (e.g. pay attention to running noises).

If the cause of the error cannot be determined, contact your nearest Greaves Farymann Diesel service partner or call us.

8.14.2 Engines with direct sea water cooling

In the case of engine overheating or leaks in the sea water cooling circuit (e.g. impeller pump and cooling water hoses), switch off the engine immediately and make the following checks:

- Checking the cooling system for leaks.
- Checking cooling water pump impeller ⇒ Chapter 8.11.
- Checking thermostat ⇒ Chapter 8.12.

If the cause of the error cannot be determined, contact your nearest Greaves Farymann Diesel service partner or call us.

8.14.3 Checking the cooling water hoses and hose clamps

Check the cooling water hoses daily. If a cooling water hose is damaged or sea water / coolant discharges, this can result in overheating of the engine. This can also result in severe skin burns / scalding.

- Check the cooling water hoses daily in order to avoid damage to the engine and cooling system.
- If a hose clamp of the cooling water hoses has loosened itself and cooling water discharges, the hose clamp must be tightened or replaced if necessary.
- If cooling water hoses are frayed, swollen, hardened or damaged, the cooling water hoses and the hose clamps must be replaced immediately.
- Cooling water hoses and hose clamps must be replaced at least every 2 years.

8.14.4 Precautions in the case of engine overheating

If the engine overheats during operation and the cooling liquid temperature rises to near or even above boiling point, the following actions must be performed immediately.

- Switch off the engine immediately in the unloaded condition.
- Immediately leave the area around the engine or the machine and maintain a safety distance.
- Never remove covers or other parts on the engine as there is a danger that "hot" cooling water can discharge and thus result in skin burns / scalding.
- If hot steam discharges, leave the immediate danger area immediately and maintain a safety distance.
- When the engine has cooled down to the ambient temperature and there is no more danger of burns or scalding, investigate the cause of the overheating in accordance with the operating manual.
- If the cause of the error cannot be determined, contact your nearest Greaves Farymann Diesel service partner or call us.



CAUTION!
The use of radiator sealants is basically not permitted.

Maintenance

8.15 Checking level of the coolant (for engines with radiator)

Hot operating materials

**WARNING!****Risk of burns due to hot operating materials!**

Operating materials can reach high temperatures during operation and cause burns / scalding in the case of contact.

Therefore:

- Never open the radiator cap at operating temperature.
- Let the cooling water cool down to the ambient temperature and open the radiator cap slowly so that the pressure can escape.

Antifreeze (for engines with radiator and, e.g. electric water pump)

**WARNING!****Danger of poisoning and danger of skin rashes and allergies!**

Antifreeze contains substances harmful to health and can result in severe poisoning and skin rashes or allergies.

Therefore:

- Observe the safety data sheet of the antifreeze manufacturer.
- Wear rubber gloves when handling antifreeze.
- Never mix different types of antifreeze.
- Contact a doctor immediately in the case of swallowing. Rinse mouth thoroughly with water.
- Avoid skin and eye contact:
 - Wear protective gloves made of plastic or rubber during the work.
- Collect coolant drained from the engine in a container and dispose of in accordance with the environmental regulations.

Determine coolant level by visual inspection and coolant if necessary (the coolant level should be up to the bottom edge of the radiator filler neck (see also the operating manual of the device manufacturer).

Do not start work on the cooling system until the engine and the cooling system are cooled down to the ambient temperature.

Never open the radiator cap at operating temperature. Do not open the radiator cap until the cooling water has cooled down to the ambient temperature. Opening the radiator cap at operating temperature can result in severe skin burns / scalding.

If the radiator cap is loose or not mounted properly, the engine can overheat due to loss of coolant. This can result in engine damage.

8.15.1 Replacing coolant (for engines with radiator)

If the cooling water freezes, the engine and cooling system (e.g. radiator) can be severely damaged. If the outside temperature falls below 0 °C, the cooling water must be drained or mixed with antifreeze. It is recommended to replace the coolant (antifreeze / water) every 2 years (see also the operating manual of the device manufacturer).



Faults

9 Faults

Possible causes of faults and the work for rectifying them are described in the following chapter.

In the case of increasingly occurring faults, reduce the maintenance intervals in accordance with the actual load.

In the case of faults which cannot be rectified using the following information, contact the nearest Greaves Farymann Diesel service partner or the manufacturer.

9.1 Safety

Personnel

- The work described here for fault clearance can be performed by the operator unless otherwise indicated.
- Some work must only be performed by a Greaves Farymann Diesel service partner; this is specially pointed out in the description of the individual faults.

Personal protective equipment

Wear the following protective equipment for all maintenance work:

- Protective clothing
- Safety footwear



NOTE!

Protective equipment which must be worn for certain work is specially pointed out in the warnings of this chapter.

Improper fault clearance**WARNING!****Risk of injury due to improper fault clearance!**

Improper fault clearance can result in severe personal injuries or material damage.

Therefore:

- Ensure there is sufficient installation clearance before starting work.
- Ensure tidiness and cleanliness at the workplace! Loose components and tools lying around or on top of each other cause accidents.
- If parts have been removed, pay attention to correct assembly, reinstall all fixing elements and comply with the tightening torques for threaded connections.

Engine oil and fuel**WARNING!****Danger of fire due to fuel and engine oil!**

Oil and fuel vapours can ignite on contact with ignition sources.

Therefore:

- No naked flames during work on the engine.
- Do not smoke.
- Remove oil and fuel residues from the engine and floor.

**CAUTION!****Danger of poisoning due to fuel and engine oil!**

Contact with engine oil and fuel can result in damage to health.

Therefore:

- Avoid skin contact with engine oil and fuel.
- Remove oil and fuel splashes from the skin immediately.
- Do not inhale oil and fuel vapours.



Faults

Antifreeze (for engines with radiator and, e.g. electric water pump)



WARNING!
Danger of poisoning and danger of skin rashes and allergies!

Antifreeze contains substances harmful to health and can result in severe poisoning and skin rashes or allergies.

Therefore:

- Observe the safety data sheet of the antifreeze manufacturer.
- Wear rubber gloves when handling antifreeze.
- Never mix different types of antifreeze.
- Contact a doctor immediately in the case of swallowing. Rinse mouth thoroughly with water.
- Avoid skin and eye contact:
 - Wear protective gloves made of plastic or rubber during the work.
- Collect coolant drained from the engine in a container and dispose of in accordance with the environmental regulations.

Procedure for faults

The basic rule is:

1. Stop the engine immediately in the case of faults which represent an immediate danger for persons or property.
2. Determine the cause of the fault.
3. Inform the responsible person at the usage location about the fault.
4. Arrange for rectification by a Greaves Farymann Diesel service partner or yourself depending on the type of the fault.



NOTE!

The fault table listed below gives information about who is authorised for rectification of the fault.

9.2 Troubleshooting chart

9.2.1 Engine does not start

Error	Possible cause	Troubleshooting	Clearance by
If the injection noise (chattering) cannot be heard	No fuel in the tank	Filling with fuel	Operator
	Speed adjusting lever is in the Stop position	Put speed adjusting lever in the "full load" position	Operator
	Ventilation in the fuel filler cap blocked	Replace fuel filler cap	Operator
	Fuel line interrupted	Check fuel lines	Operator
	Fuel filter blocked	Replace fuel filter	Operator
Failure of the fuel system; turn engine by hand and pay attention to the typical "chatter" of the injection nozzle.	Fuel line broken or leaky connection	Replace fuel line or tighten connection	Operator
	Vapour bubble formation caused by too hot fuel	Let fuel cool down	Operator
	Paraffin precipitation in the fuel (for low external temperature approx. -10 °C)	Drain and flush fuel system, replace fuel filter, use winter fuel	Skilled employee
	Defective injection nozzle	Check injection nozzle, replace if necessary	Skilled employee
If the injection noise (chattering) can be heard	Petrol instead of diesel in the tank	Drain tank and fuel system and arrange for engine to be checked by a Greaves Farymann Diesel service partner (petrol in the tank results in engine damage)	Skilled employee
	Air intake tract blocked	Check intake area of the air filter case and air filter cartridge	Operator
	Incorrect valve clearance	Adjust valve clearance	Skilled employee



Faults

Error	Possible cause	Troubleshooting	Clearance by
Compression too low	Decompression unit defective	Check decompression unit, replace if necessary	Skilled employee
	Leaky valves	Check valves, repair or replace	Skilled employee
	Leaky cylinder head / cylinder head gasket	Replace cylinder head gasket	Skilled employee
	Sticking piston rings	Check piston rings, replace if necessary and check piston ring grooves	Skilled employee
	Piston and cylinder worn	Overhaul engine (change piston and cylinder)	Skilled employee
	Starting load too high	Reduce load	Operator
Engine can only be turned with difficulty	Engine oil too viscous	Change engine oil, use correct viscosity	Operator
	Main bearing or piston "seized"	Overhaul engine	Skilled employee

9.2.2 Engine starts, however runs irregularly or stops

Error	Possible cause	Troubleshooting	Clearance by
Bad fuel supply	Fuel filter blocked	Replace fuel filter	Operator
	Fuel line interrupted	Check fuel line	Operator
	Leaky fuel line	Check fuel line, tighten connection	Operator
	Water in the fuel	Drain tank and fuel system, flush with diesel and refill and check injection system	Skilled employee
	Defective injection nozzle	Check injection nozzle, repair or replace	Skilled employee
	Injection pump defective	Check injection pump, repair or replace	Skilled employee
Bad compression	Incorrect valve clearance	Adjust valve clearance	Skilled employee
	Worn valves	Replace cylinder head	Skilled employee
	Sticking piston rings	Check piston rings, replace if necessary and check piston ring grooves	Skilled employee
	Piston and cylinder worn	Overhaul engine (change piston and cylinder)	Skilled employee
Defective intake system	Intake area blocked	Check intake area of the air filter case and air filter cartridge	Operator
Defective exhaust system	Exhaust blocked	Check exhaust, clean or replace	Operator



Faults

9.2.3 Bad engine performance

Error	Possible cause	Troubleshooting	Clearance by
Operating conditions	Engine overloaded	Reduce load; troubleshooting at machine	Operator
	Performance reduction due to increased intake temperature	Improve operating conditions	Operator
Bad fuel supply	Fuel filter blocked	Replace fuel filter	Operator
	Seal under the injection nozzle missing or there are too many seals installed	Install seal or correct the number of seals, check injection nozzle holder	Skilled employee
	Defective injection nozzle	Check injection nozzle, replace if necessary	Skilled employee
	Injection pump defective	Check injection pump, repair or replace	Skilled employee
Incorrect adjustment	Incorrect valve clearance	Adjust valve clearance	Skilled employee
	Incorrect end of delivery	Adjust end of delivery	Skilled employee
	Incorrect valve timing	Check sprocket adjustment markings	Skilled employee
	Piston incorrectly installed (marking on piston head not pointing in the direction of the flywheel side)	Install piston correctly	Skilled employee

9.2.4 Operating behaviour not faultless

Error	Possible cause	Troubleshooting	Clearance by
Overheating (engine becomes too hot)	Engine overloaded	Reduce load	Operator
	Cooling air inlet blocked	Clear blockage	Operator
	Cooling air supply blocked	Improve cooling air supply, check engine installation	Operator
	Oil level in the crankcase too high	Correct oil level	Operator
	Defective injection nozzle	Check injection nozzle, repair or replace	Skilled employee
	Insufficient coolant level	Fill with coolant	Operator
	Coolant thermostat defective	Check coolant thermostat, replace if necessary	Operator
	Impeller of the neoprene impeller pump defective	Replace impeller	Operator
	Loss of cooling water	Check the cooling system for leaks	Operator
	Temperature switch or temperature sensor defective	Check temperature switch or temperature sensor, replace if necessary	Skilled employee
	Cylinder head gasket or cylinder head defective	Check cylinder head gasket and cylinder head, replace if necessary	Skilled employee
	End of delivery of the injection pump incorrectly adjusted	Check and adjust end of delivery	Skilled employee
Knocking noises	Carbon deposit on piston head	Remove carbon deposits on piston, replace piston and cylinder if necessary	Skilled employee
	Injection nozzle needle sticks / jams	Replace injection nozzle	Skilled employee
	Incorrect end of delivery Incorrect begin of delivery	Check and adjust begin of delivery / end of delivery	Skilled employee
	Broken piston rings	Replace piston rings, check piston and cylinder	Skilled employee



Faults

Error	Possible cause	Troubleshooting	Clearance by
Knocking noises	Piston and cylinder worn	Overhaul engine (change piston and cylinder)	Skilled employee
	Main bearing, connecting rod bearing worn	Overhaul engine	Skilled employee
	Loose flywheel	Check flywheel and crankshaft for damage, overhaul engine if necessary	Skilled employee
	Petrol mixture in the tank	Drain tank and fuel system, flush with diesel, fill with new fuel and check engine, arrange overhaul if necessary	Skilled employee
Strong speed fluctuations	Overheating	See: Overheating	
	Air in the fuel system	Check fuel system for leaks	Operator
	Speed governor jammed or defective	Check speed governor, replace if necessary	Skilled employee
	Fuel filter blocked	Replace fuel filter	Operator
	Adjusting lever jammed or defective	Check adjusting lever, replace if necessary	Skilled employee
Engine stops suddenly	Empty tank	Filling with fuel	Operator
	Ventilation in the fuel filler cap blocked	Replace fuel filler cap	Operator
	Vapour bubble formation caused by too hot fuel	Let fuel cool down	Operator
	Defective injection nozzle	Check injection nozzle, repair or replace	Skilled employee
	Fuel line broken	Replace fuel line	Skilled employee
	"Piston seizure"	Overhaul engine (change piston and cylinder)	Skilled employee
	Crankshaft bearings "seized" or worn	Overhaul engine	Skilled employee

Error	Possible cause	Troubleshooting	Clearance by
Engine emits blue smoke	Oil level too high	Correct oil level	Operator
	Crankcase ventilation valve defective	Replace crankcase ventilation valve	Skilled employee
	Valve stem seal on intake valve guide defective	Replace valve stem seal	Skilled employee
	Worn valves, valve guides	Replace cylinder head	Skilled employee
	Piston and cylinder worn	Replace piston and cylinder	Skilled employee
Engine emits white smoke	End of delivery too late	Check and adjust end of delivery	Skilled employee
	Injection nozzle worn	Replace injection nozzle	Skilled employee
Coolant temperature warning lamp lights (if present)	Coolant level too low	Check and correct coolant level	Operator
	Coolant temperature switch defective	Replace coolant temperature switch	Skilled employee
	Coolant thermostat defective	Check coolant thermostat, replace if necessary	Operator
	Impeller of the neoprene impeller pump defective	Replace impeller of the neoprene impeller pump	Operator
Oil pressure warning lamp lights (if present)	Oil level too low	Correct oil level	Operator
	Oil pressure switch defective	Replace oil pressure switch	Skilled employee
Oil pressure too low	Pressure relief valve defective	Check pressure relief valve, clean, replace if necessary	Skilled employee
	Bearing seat in pressure relief valve dirty	Check pressure relief valve, clean, replace if necessary	Skilled employee
	Oil filter blocked	Replace oil filter and engine oil	Operator
	Oil pump defective	Replace oil pump, overhaul engine if necessary	Skilled employee



Faults

Error	Possible cause	Troubleshooting	Clearance by
Cold start problems	Speed adjusting lever is not at the maximum position	Set speed adjusting lever to the maximum position (increased speed)	Operator
	Engine oil too viscous	Change engine oil, use correct viscosity	Operator
	Paraffin precipitation in the fuel	Drain and flush fuel system, replace fuel filter, use winter fuel	Skilled employee
	Starting speed too low	Check battery, replace if necessary	Operator

9.3 Startup after eliminating fault

After rectifying the fault, carry out the following steps for restarting:

1. Ensure there are no persons in the danger zone.
2. Start engine and check the engine for correct functioning.

10 Replacement Parts List

10.1 Spare parts

WARNING!

Risk to safety due to use of non-original spare parts!

Defective and non-original spare parts can adversely affect the safety and result in damage and malfunctions or total failure of the engine.

Therefore:

- **Only use original spare parts from the manufacturer.**

Spare parts can be ordered from the nearest Greaves Farymann Diesel service partner.

Please refer to our website (www.farymann.de) or telephone us on +49 (0)6206/507-0 for a list of our sales and service partners.

10.2 Ordering spare parts

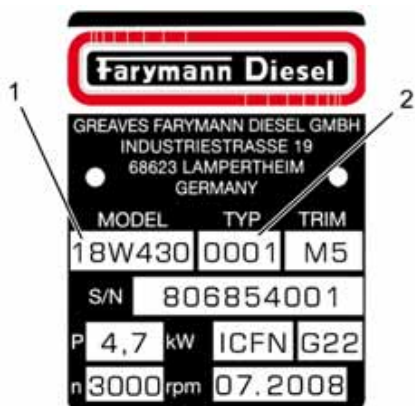

Fig. 132

Always state the following when ordering spare parts:

- 1 MODEL, e.g. 18W 430 (see type plate)
- 2 TYPE, e.g. 0001 (see type plate)

Spare parts orders without this information cannot be processed.

Spare parts can be ordered from the nearest Greaves Farymann Diesel service partner.



Replacement Parts List

Wearing parts for maintenance work

Order number	Description	Quantity
541.052.2	Air filter element (dry type air cleaner)	1
555.129.1	Sealing clip	2
514.093.2	Wing nut	1
541.059.2	Air filter cover	1
541.058.2	Air filter pot	1
541.057.2	Guide-blade disc rim	1
541.056.2	Centring ring	1
512.158.2	M6 stud	1
741.138.5	Complete oil bath air cleaner	1
541.065.2	Air filter element (filter element for the version with oval flange)	1
541.038.2	Fuel filter (standard)	1
541.069.2	Fuel filter (with thread)	1
890.74.18	Copper sealing ring A14x18x1.5 (for fuel filter with thread)	4
770.142.4	Valve cover gasket	1
890.08.15	Plastic seals 8.0x17x2	2
E734.032.8	Oil strainer, complete	1
770.168.4	Gasket for oil strainer	1
890.74.04	Copper sealing ring A6x10x1.5 (for the bolts on the oil strainer)	2
890.30.03	Oil drain plug	1
890.74.25	Copper sealing ring A17x23x1.5 (for oil drain plug)	1
541.050.2	Oil filter (D/W crankcase version)	1
239.012.2	Oil drain valve with sealing cap	1
955.131.1	Oil drain hose	1



Replacement Parts List

Order number	Description	Quantity
555.003.2	Cooling water thermostat 50 °C (salt water)	1
555.006.2	Cooling water thermostat 70 (fresh water)	1
890.07.03	Split pin for thermostat	1
770.108.4	Thermostat housing gasket	1
538.219.2	Neoprene impeller for cooling water pump with gasket	1



Replacement Parts List

Special tools

Order number	Description	
748.115.6	Fuel line disconnecting tool	
748.173.2 (for engines with D/W crankcase)	Oil filter wrench (dismantling the oil filter)	

Special tools can be ordered from the nearest Greaves Farymann Diesel service partner.

11 Service history

11.1 Proof of purchase

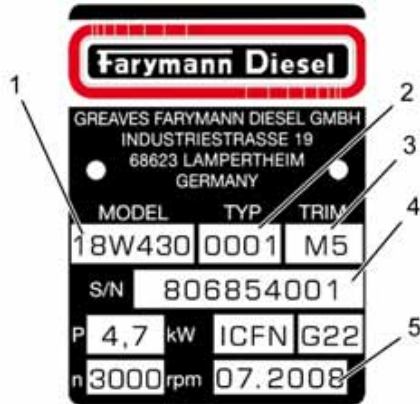

Fig. 133

Using the type plate, copy the following information on to the proof of purchase and arrange confirmation.

There is a type plate on the engine with the following information:

- 1 Model
- 2 Type number
- 3 Version of the speed governor
- 4 Serial number
- 5 Date of manufacture

Description	Please fill in:
1 Model	
2 Type number	
3 TRIM	
4 Serial number (S/N)	
5 Date of manufacture	
Date of purchase	
by	Dealer stamp



Service history

11.2 Handover and servicing history

Arrange maintenance work during the warranty period and afterwards to be carried out by one of our authorised Greaves Farymann Diesel sales and service partners.

Comply with the maintenance intervals and have the following evidence of maintenance confirmed by the specialist workshop.

The maintenance intervals must not be exceeded by more than 10% or maximum 25 operating hours.

Engine, equipment
installation and handover
Dealer stamp:

Hours

Date

after 25 operating hours /
1 month
Dealer stamp:

Hours

Date

after 250 operating hours /
6 months
Dealer stamp:

Hours

Date

after 500 operating hours /
12 months
Dealer stamp:

Hours

Date

after 750 operating hours /
18 months
Dealer stamp:

Hours

Date

after 1000 operating hours /
24 months
Dealer stamp:

Hours

Date

after 1250 operating hours /
30 months
Dealer stamp:

Hours

Date

after 1500 operating hours /
36 months
Dealer stamp:

Hours

Date

after 1750 operating hours /
42 months
Dealer stamp:

Hours

Date



Service history

after 2000 operating hours /
48 months
Dealer stamp:

Hours

Date

after 2250 operating hours /
54 months
Dealer stamp:

Hours

Date

after 2500 operating hours /
60 months
Dealer stamp:

Hours

Date

after 2750 operating hours /
66 months
Dealer stamp:

Hours

Date

after 3000 operating hours /
72 months
Dealer stamp:

Hours

Date

after 3250 operating hours /
78 months
Dealer stamp:

Hours

Date

after 3500 operating hours /
84 months
Dealer stamp:

Hours

Date

after 3750 operating hours /
90 months
Dealer stamp:

Hours

Date

after 4000 operating hours /
96 months
Dealer stamp:

Hours

Date



Service history

after 4250 operating hours /
102 months
Dealer stamp:

Hours

Date

after 4500 operating hours /
108 months
Dealer stamp:

Hours

Date

after 4750 operating hours /
114 months
Dealer stamp:

Hours

Date

after 5000 operating hours /
120 months
Dealer stamp:

Hours

Date

after 5250 operating hours /
126 months
Dealer stamp:

Hours

Date

after 5500 operating hours /
132 months
Dealer stamp:

Hours

Date

after 5750 operating hours /
138 months
Dealer stamp:

Hours

Date

after 6000 operating hours /
144 months
Dealer stamp:

Hours

Date

after 6250 operating hours /
150 months
Dealer stamp:

Hours

Date

after 6500 operating hours /
156 months
Dealer stamp:

Hours

Date

after 6750 operating hours /
162 months
Dealer stamp:

Hours

Date

after 7000 operating hours /
168 months
Dealer stamp:

Hours

Date

after 7250 operating hours /
174 months
Dealer stamp:

Hours

Date

after 7500 operating hours /
180 months
Dealer stamp:

Hours

Date

after 7750 operating hours /
186 months
Dealer stamp:

Hours

Date

after 8000 operating hours /
192 months
Dealer stamp:

Hours

Date

after 8250 operating hours /
198 months
Dealer stamp:

Hours

Date

after 8500 operating hours /
204 months
Dealer stamp:

Hours

Date



NOTE!

Further service histories can be ordered from the nearest Greaves Farymann Diesel sales and service partner. Refer to our website for a list of our sales partners.



Index

12 Index

A		Environmental protection	21
Accident	20	Exhaust gases.....	51
Adjusting valve clearance	92	F	
Applications.....	22	Faults	114
Appropriate use.....	14	Fire	20
Attachment points	40	First aid	20
B		Fuel system.....	81
Batteries.....	36	Fuels	21
C		H	
Checking level of the coolant.....	112	Hard hat	15
Checking the cooling system for leaks	110	I	
Checking threaded connections	74	Installation	42
Cleaning the intake area.....	73	Instruction.....	13
Cold start.....	55	L	
Cold starting aids	46, 55, 61, 62	Liability	9
Commissioning	46	Lubricants.....	21
Cooling system	37	M	
Copyright.....	10	Maintenance.....	68
Customer service.....	10	Maintenance plan.....	70
D		Manual start	55
Danger zone	20	Misuse.....	14
Dangers and cause of failure.....	35	O	
Decommissioning.....	66	Oil bath air cleaner	90
Dimensions	27	Operating conditions	34
E		Operating materials.....	18, 28, 110, 112
Ear defenders	15	Operation	50, 62
Electrical System	33	Options.....	23
EMERGENCY STOP	53	Overview	30
Engine data.....	25	Owner.....	11
Engine oil		P	
changing.....	75	Packing	39, 40
filling	47	Parts	
Specification.....	29	rotating.....	50
Engine type code	24	Personal protective equipment	15
Engine type plate	24	Personnel	13

commissioning	42	Spare parts	125
Faults	114	Ordering	125
installation	42	Standard configuration.....	23
Maintenance	69	Starting with electric starter	61
Pressures.....	27	Storage	39, 41
Protective equipment.....	15	Surfaces, hot.....	18, 51
Faults	114	Switching off	64
Installation.....	69	Symbols	
Operation	53	in the operator's manual.....	8
Protective gloves	15	T	
R		Technical data	22
Replacement parts	125	Technical personnel.....	13
Replacement parts list.....	125	Temperatures	27
Replacing air filter.....	86	Transport.....	39, 40
Replacing fuel filter	81	Crane.....	40
Replacing oil filter	79	Inspection.....	39
Risk of fire.....	18	Troubleshooting	
S		Chart.....	117
Safety		U	
general	11	Usage.....	14
Safety boots.....	15	W	
Safety devices	20	Warm start	55
Safety goggles.....	15	Warranty	10
Service.....	10	Weight.....	27
Service history	129		



Notes

Notes



Art. 903.01.44 08.08