

**B-GL-317-015/FP-001
(CFP317(15))**

**WEAPONS
VOLUME 15
GROUND SURVEILLANCE RADAR
AN/PPS 15 (V) 2**

OPI: FMCHQ

78-11-08

ISSUED ON AUTHORITY OF THE CHIEF OF THE DEFENCE STAFF

LIST OF EFFECTIVE PAGES

Insert latest changed pages; dispose of superseded pages in accordance with applicable orders.

NOTE - On a changed page, the portion of the text affected by the latest change is indicated by a vertical line in the margin of the page. Changes to illustrations are indicated by miniature pointing hands, or black vertical lines.

Total number of pages in this publication is 170 consisting of the following:

Page No.	Change No.
Cover.....	0
Title Page	0
A.....	0
i to xi	0
1-1 to 1-8	0
1A-1 to 1A-6	0
2-1 to 2-15	0
3-1 to 3-16	0
4-1 to 4-30	0
4A-1 to 4A-6	0
4B-1	0
5-1 to 5-13	0
6-1 to 6-15	0
7-1 to 7-8	0
7A-1 to 7A-10	0
7B-1 to 7B-10	0
8-1 to 8-19	0
9-1 to 9-3	0

Zero in Change No. column indicates an original page.

FOREWORD

1. B-OT-317-015/FP-001, Weapons, Volume 15, Ground Surveillance Radar, AN/PPS-15(V)2 is issued on authority of the Chief of the Defence Staff.
2. This publication is effective on receipt.
3. Suggestions for changes shall be forwarded through normal channels to Mobile Command Headquarters, Attention SO Doc Coord.

TABLE OF CONTENTS

CHAPTER 1 - DESCRIPTION, CHARACTERISTICS, AND CAPABILITIES

SECTION 1 - GENERAL

- 101 Introduction
- 102 Function

SECTION 2 - CHARACTERISTICS, CAPABILITIES, AND LIMITATION

- 103 Characteristics and Capabilities
- 104 Technical Characteristics
- 105 Limitations

ANNEX A - DATA TABLES

CHAPTER 2 - BASIC RADAR PRINCIPLES

SECTION 1 - GENERAL

- 201 Definitions
- 202 Introduction
- 203 Radar
- 204 Applications of Radar

SECTION 2 - PRINCIPLES

- 205 Radar Components
- 206 Basic Theory

SECTION 3 - COMPONENTS AND FUNCTIONS

- 207 Introduction
- 208 Receiver/Transmitter Group
- 209 Antenna Drive Assembly
- 210 Tripod Radar Mount
- 211 Case Carrying
- 212 Case Transport
- 213 Electrical Headset
- 214 External Power Cable Assembly
- 215 Remote Control Cable Assembly
- 216 Adapter, Pintle-mount (MX-9426/PPS-15)

CHAPTER 3 - THEORY OF OPERATIONS

SECTION 1 - GENERAL

301 Introduction

SECTION 2 - ELECTRICAL AND ELECTRONIC THEORY

302 System Functioning
303 Power Sub-system
304 Transmitter Sub-system
305 Receiver Sub-system
306 Antenna Positioning Sub-system
307 The Indicating Sub-system

SECTION 3 - THEORY OF MECHANICAL OPERATION

308 General
309 Antenna Drive Assembly

CHAPTER 4 - PREPARATION FOR USE

SECTION 1 - GENERAL

401 Handling

SECTION 2 - INSTALLATION INSTRUCTIONS

402 General
403 Sighting and Site Selection
404 Multiple Radar Interference
405 External Power Operation
406 Setting Up for Remote Control Operation
407 Tripod Mounted (Local) Position
408 Tripod Mounted (Remote) Position
409 Hand-held Position

SECTION 3 - INITIAL ADJUSTMENT PROCEDURES

410 Azimuth Orientation Adjustment
411 Levelling Adjustment
412 Scan Centre Adjustment
413 Elevation Adjustment
414 Alarm Sensitivity Adjustment

SECTION 4 - MOVEMENT TO A NEW SITE

- 415 General
- 416 Disassembly and Packing
- 417 Use of C2 Rucksack Frame
- 418 Preparation for Backpacking Through Water
- 419 Packing the Radar Set in the Transport Case

ANNEXES

- A COMPONENT CHECK LIST
- B RANGE TECHNICAL CHARACTERISTICS

CHAPTER 5 - LOCATION OF CONTROLS AND INDICATIONS

- 501 General

CHAPTER 6 - OPERATION UNDER SPECIFIC CONDITIONS

SECTION 1 - OPERATING PROCEDURES

- 601 General
- 602 Audible Indications
- 603 Operating Positions
- 604 Modes of Operation

SECTION 2 - OPERATING UNDER NORMAL CONDITIONS

- 605 General
- 606 Preliminary Starting Procedures
- 607 Terrestrial Surveillance Application
- 608 Target Tracking Application
- 609 Fixed Point Observation Application
- 610 Standby Procedure
- 611 Shutdown Procedure

SECTION 3 - OPERATION UNDER EMERGENCY CONDITIONS

- 612 General
- 613 Partial Operation After Equipment Failure
- 614 Operation Through Electronic Counter Measures

SECTION 4 - OPERATION UNDER UNUSUAL CONDITIONS

- 615 Operation in Rain, Sleet, and Snow
- 616 Operation in Tropical Climates

- 617 Operation in Arctic Climates
- 618 Operation in Desert Areas

CHAPTER 7 MAINTENANCE INSTRUCTIONS

SECTION 1 - DEFINITIONS

- 701 Maintenance Definitions

SECTION 2 - PREVENTIVE MAINTENANCE

- 702 General
- 703 Operator Preventive Maintenance Checks and Services
- 704 Preventive Maintenance Intervals
- 705 Organizational Preventive Maintenance
- 706 Preventive Maintenance Intervals
- 707 Service Requirements Before, During, and After Operation

SECTION 3 - TROUBLESHOOTING

- 708 General
- 709 Operator Troubleshooting

ANNEXES

- A OPERATOR PREVENTIVE MAINTENANCE CHECKS AND SERVICES
- B OPERATOR TROUBLESHOOTING

CHAPTER 8 - TACTICAL EMPLOYMENT

SECTION 1 - INTRODUCTION

- 801 General
- 802 Surveillance Card

SECTION 2 - PLANNING

- 803 General
- 804 Enemy Situation
- 805 Friendly Situation
- 806 Control
- 807 Maintenance
- 808 Weather

SECTION 3 - SITING CONSIDERATIONS

- 809 General
- 810 Line of Sight
- 811 Camouflage
- 812 Orientation and Fixation
- 813 Integrated Surveillance Plan
- 814 Alternate Positions
- 815 Overlapping Areas of Covering
- 816 Operator Protection
- 817 Communications
- 818 Determining Angle of Elevation/Slant Range
- 819 Defensive Employment
- 820 Offensive Employment
- 821 Reconnaissance

SECTION 4 - DESTRUCTION TO PREVENT ENEMY CAPTURE

- 822 Destruction of the AN/PPS-15(V)2

CHAPTER 9 - ELECTRONIC WARFARE

SECTION 1 - DEFINITIONS

- 901 Electronic Warfare
- 902 Electronic Countermeasures
- 903 Electronic Counter Countermeasures

SECTION 2 - ELECTRONIC COUNTERMEASURES REPORTING AND RECORDING AND ELECTRONIC COUNTERMEASURES PROCEDURES

- 904 Countermeasures Reporting and Recording
- 905 Electronic Counter Countermeasures Procedures

LIST OF FIGURES

FIGURE	TITLE
1-1	The AN/PPS-15(V)2 Ground Surveillance Radar
1A-1	Radar Set, AN-PPS-15(V)2
2-1	The Basic System
2-2	Control Indicator, C-9353/PPS(V)
2-3	Antenna Assembly, AS-2906/PPS-15(V)
2-4	Antenna Drive Assembly, AB-1205/PPS-15
2-5	Tripod, Radar, MT-4800/PPS-15(V)
2-6	Case, Carrying, CY-7339/PPS-15(V)
2-7	Case, Transport, CY-7338/PPS-15(V)
2-8	Headset, Electrical, H-251/U
2-9	External Power Cable Assembly W2
2-10	Remote Control Cable Assembly W3
3-1	Radar Set AN/PPS-15(V)2, Simplified System Block Diagram
3-2	Power Sub-system, Block Diagram
3-3	Transmitter Sub-system, Block Diagram
3-4	Receiver Sub-system, Block Diagram
3-5	Antenna Positioning Sub-system, Block Diagram
3-6	Indicating Sub-system (Block Diagram)
3-7	Antenna Drive Assembly - Mechanical Schematic Diagram
4-1	Radar Set, AN/PPS-15(V)2, Components Packed in Transport Case CY-7338/PPS-15(V)
4-2	Radar Set AN/PPS-15 (V)2, Components Packed in Carrying Case CY-7339/PPS-15(V)
4-3	Radar Set, AN/PPS-15 (V)2, Interconnection Diagram
4-4	Radar Set AN/PPS-15(V)2, Tripod Mounted Local Operation Position
4-5	Tripod Installation
4-6	Battery Installation
4-7	Receiver/Transmitter Group, Installation for Local Operation
4-8	Antenna Drive Assembly, Installation
4-9	Receiver/Transmitter Group Installation
4-10	Radar Set AN/PPS(V)2, Tripod Mounted Remote Operating Position
4-11	Receiver/Transmitter Group, Installation for Remote Operation
4-12	Radar Set AN/PPS-15(V)2, Installation, Hand-held Position
4-13	Azimuth Orientation Adjustment
4-14	Receiver/Transmitter Group, Controls, and Indicators
4-15	Antenna Drive Assembly, Controls Indicators and Connectors
4-16	Radar Set, AN/PPS-15 (V)2, Packed in Carrying Case and Attached to the G2 Rucksack Frame
5-1	Receiver Transmitter Group Controls Indicators and Connectors
5-2	Antenna Drive Assembly, Controls Indicators and Connectors
5-3	Radar Tripod, Controls
8-1	Surveillance Card

- 8-2 Proper Siting of PPS-15 Radar
- 8-3 Proper and Improper Siting of PPS-15 Radar
- 8-4 Range and Vertical Angle
- 8-5 Corner Reflector
- 8-6 Adaptor, Pintle-mount

LIST OF TABLES

TABLE	TITLE
1A-1	Radar Set AN/PPS-15(V)2 Component Data
1A-2	Total Space Requirements
1A-3	Power Requirements
1A-4	Transmitter Technical Characteristics
1A-5	Azimuth Technical Data
1A-6	Elevation Technical Data
1A-7	Receiver Indication Technical Data
4A-1	Visual Component Inspection Check List
5-1	Receiver Transmitter Group, Indicators Control and Connectors
5-2	Antenna Drive AB-1205/PPS-15(V), Indicators, Controls and Connectors
5-3	Radar Tripod MT-3800/PPS-15(V), Controls
6-1	Radar Set AN/PPS-15(V)2, Application of Operating Positions
6-2	Target Audio Sounds
6-3	Modes of Operation Display
7-1	Organizational Preventive Maintenance Checks and Services
7-2	Operators Daily Servicing Schedule
8-1	Slant Range Factors

CHAPTER 1

DESCRIPTION, CHARACTERISTICS, AND CAPABILITIES

SECTION 1 - GENERAL

101. Introduction

1. This publication sets forth information which will familiarize the user in the field as well as the Radar Technician with the lightweight battlefield surveillance radar, AN/PPS-15(V)2 shown in figure 1-1.
2. The radar set AN/PPS-15(V)2, supplements but does not replace the radar set AN/PPS-4 (CFP 317(16), Ground Surveillance Radar AN/PPS-4 refers).

102. Function

1. General. Radar set, AN/PPS-15(V)2, is a battery-powered, solid state, coherent doppler, line-of-sight, very short range ground surveillance radar. The radar set is used to detect and locate moving personnel and vehicles (targets) under various conditions of terrain, visibility, and weather. Target detection and identification are accomplished by operator's recognition of characteristic sounds in the electrical headset. An alarm lamp and speaker provide automatic visual and audible indications when a moving target is detected. Indicators provide digital bearing and range information. The following paragraphs in this chapter describe the various uses and capabilities. This chapter, Annex A, provides the data necessary for the operational and unit level maintenance.
2. Terrestrial Search and Scanning. The radar set can be operated as a hand-held radar, or it may be mounted on a tripod for local or remote operation. The radar set can be rotated manually and electrically through 6 400 mils (360E) in azimuth and manually from -600 mils (-34E) to +400 mils (+23E) in elevation when mounted on the tripod. Automatic bearing scanning is provided, with two bearing scanning widths 800 mils (45E) and 1600 mils (90E), available for selection by the operator. Detected moving objects will produce an audible sound in the headset and audible and visual alarms from the automatic alarm circuits.

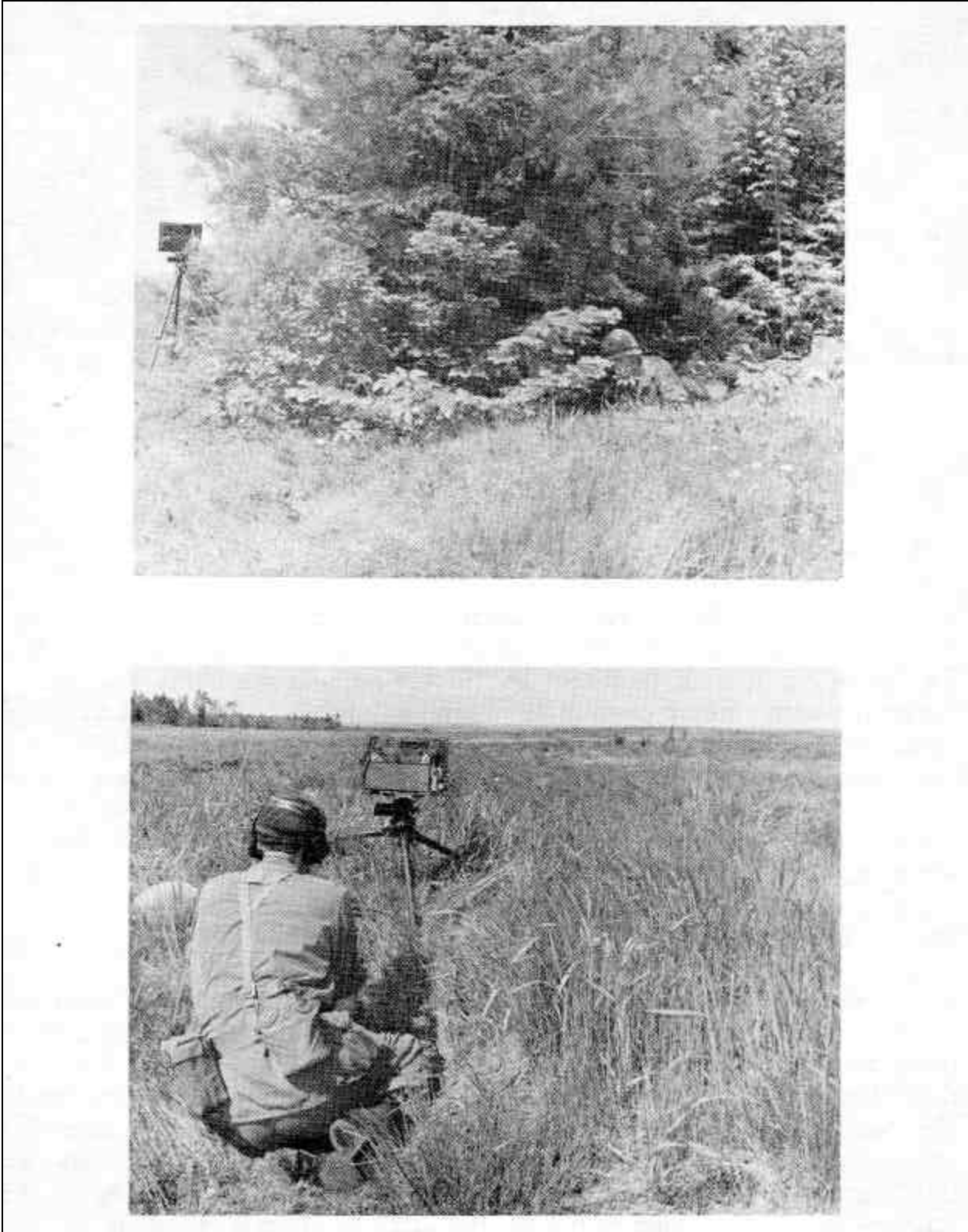

Figure 1-1 The AN/PPS-15(V)2 Ground Surveillance Radar

3. Target Tracking. Once a target has been detected, the radar set can be used to track it. The target is tracked in bearing by positioning the antenna assembly in azimuth and elevation to maintain maximum tone in the headset and maximum number of dots on the peaking indicator. Tracking the target provides information about its location, direction, and speed.
4. Fire Control. The radar set can also be used for the control of indirect fire. The operator can provide range within 20 m (21.9 yards) and bearing within 10 mils (0.56E) of any designated target when tracking has been established.
5. Target Presentation. Target information is presented by the AN/PPS15(V)2, radar set by both visual and audible indications. The prime method of target indication is provided by the target audio in the operator's headset. Variations in the sounds heard in the headset provide an indication of the size and type of target(s) detected. Visual indications of range and azimuth are provided by digital indicators. In addition, a peaking indicator provides visual indication of signal strength which enables the operator to determine when the radar set antenna is oriented directly at the target. Alarm circuits also provide audible and visual indications of target detection as a tone from the alarm speaker and a blinking alarm indicator lamp. Only moving targets can be detected. Examples of moving targets are a man standing still but moving his arms, a man walking or running, and a moving vehicle. In any case, the target must have motion.
6. External Power Sources. The radar may be operated from a vehicle battery by using an external power cable which is provided for power connection to any external 24-volt DC source such as a vehicle or battery.
7. Self-test. The power circuits of the radar set can be tested before, during, or after operation without tools or test equipment. By holding momentarily the status switch on the BAT/XMTR test position, a digital voltage reading can be observed on the AZ-MILS (bat volts) indicator and dots will be illuminated on the peaking XMTR test indicator. The voltage output of the internal dry cell battery, or the regulator output of the external power cable (if being used), will be reflected by the reading on the AZ-MILS (bat volts) indicator. The number of dots indicated on the peaking (XMTR test) indicator reflects the status of the radar set transmitter power output.

SECTION 2 - CHARACTERISTICS, CAPABILITIES, AND LIMITATIONS

103. Characteristics and Capabilities

1. General. Radar set AN/PPS-15(V)2 is an advanced day or night, all-weather, lightweight ground surveillance radar set. It is capable of detecting, locating, and identifying moving targets such as personnel, vehicles, and boats under conditions of limited or no visibility. Once the presence of a moving target is established, the range and bearing to the target are easily determined. It can be used for reconnaissance by infantry and armoured companies and for combat surveillance and target acquisition. Its light weight and simplicity of operation allow it to accurately locate infiltrating elements in a variety of situations. Target detection and identification are accomplished by the operator's recognition of characteristic sounds in the headset. The radar is virtually silent during operation. The complete radar set may be easily transported by one man.
2. Portability. The radar set can be unpacked and set up, or taken down and back-packed by one man. The equipment, packed in its carrying case, can be packed in a transport case for vehicular transportation or for storage purposes. The carrying case with equipment packed inside can also be readily attached to a pack frame for back-packing. Operating power from an internal dry battery makes the radar set truly portable for field missions. In addition, the radar set can be air dropped.
3. Detection. The radar is capable of detecting a single moving person at a maximum reliable range of 1500 m when the velocity of the individual relative to the radar is .8 KPH (1/2 MPH) or greater. Detection of groups may be expected at ranges in excess of 1500 m. The radar is capable of detecting a 1/2 ton moving vehicle at a maximum reliable range of 3 000 m when the velocity of the vehicle relative to the radar is between .8 KPH and 56 KPH (1/2 and 35 MPH).
4. Location. The location of the target in bearing and elevation is determined by manual manipulation of the radar until the loudest target response is heard in the headset. Target location in range is determined by manually directing the radar set until the loudest target response is heard and the maximum amount of data is observed on the peaking indicator (XMTR test). The actual location of the target is read from the manual range control, the digital bearing, and the elevation scale.
5. Search. There are two search modes available to the operator of the AN/PPS-15(V)2. One mode is automatic, the other manual. When a target is detected in the automatic search mode, the operator then switches to manual search to more accurately determine the target's bearing. In more detail, the two modes are:
 - a. Automatic Search. In the automatic mode, the radar provides motor-driven bearing scanning with sector widths of 1600 or 800 mils about a scan centre which may be adjusted t 3 200 mils.

- b. Manual Search. In manual search, the operator may position the radar by hand for a search of arc extending from 0 to 6 400 mils.

104. Technical Characteristics

1. General

a. Range

Personnel	50 to 1500 m
Vehicles	50 to 3 000 m
Accuracy	∇ 10 m
Resolution	35 m (distance in range that two
.....	targets must be separated to allow operator to
.....	ascertain that two different targets are present)

b. Scanning Arc

Coverage	0 to 6 400 mils
.....	(clockwise and counterclockwise)
Accuracy	10 mils
Resolution	100 mils (minimum lateral
.....	separation between two targets permitting the
.....	operator to identify two different targets)

c. Elevation

Manual Coverage	400 to 600 mils
-----------------------	-----------------

d. Component Data

- (1) Operational Weight. The total weight of the AN/PPS-15(V)2 system when transported in a back-pack configuration is 12 kg (26.2 pounds).
- (2) Other data is contained in the Data Tables, in this chapter, Annex A.

2. Electronic Data

a. Transmission and Output

Operating frequency	10.3 GHz (Nom)
Transmitter output	45 milliwatts

b. Antenna

Radiating element	Slotted array waveguide
Gain	28 db
Beam width	Horizontal 100 mils
.....	Vertical 180 mils

c. Indicating System

Battery test	digital readout in volts
Transmitter output	light emitting diodes
Bearing (Az) indicator	digital readout in mils
Range indicator	visual digital readout in metres
Elevation indicator	elevation angle readout in mils
Headsets	aural detection and identification

d. Power Sources

Types	Internal - batteries, BA 4386/PRC-25
.....	External - 24-volt vehicle batteries
Life	Internal - 16 hours at 21EC (70E F)
.....	External Depending on battery
.....	rating and condition

105. Limitations

1. Terrain. The AN/PPS-15(V)2 is limited to line-of-sight operations. It will not penetrate very dense foliage, buildings, walls, or hills. It will, however, penetrate glass and dry canvas.
2. Wind. Since the radar is designed to detect moving targets, the effect of wind which causes the movement of high grass, vegetation, and branches, produces some problems in target detection. In average to dense terrain, winds above 20 to 25 knots (23 to 29 MPH) will cause an increasing background noise which may cause some masking of target signatures. In this case, and in open terrain, the limitation is one of operator proficiency. Targets have been detected by skilled operators in moderately open terrain during winds above 30 to 35 knots (35 to 40 MPH).
3. Rain. A light to moderate rain has very little effect on the radar's performance. A heavy rain will cause a reduction in range. Snow has an effect similar to rain, and a heavy wet snowfall will effect the greatest reduction in range.
4. Temperature. The battery life is greatly reduced during temperatures near or below freezing. However, if arrangements are made to keep the battery warm, operation and battery life are not affected by similar low temperatures.

5. Handling Care. Since the radar is an electronic device, care and caution should be exercised when transporting or handling the system.

6. Operator Proficiency. Due to the aural type of presentation, the operator's proficiency may be reduced if he is required to operate the radar using earphones for a period greater than 45 minutes in each 2-hour interval. After an initial training period, operator efficiency can be improved by periodic listening time practices on controlled targets.

7. Target Movement. The radar is designed to detect targets which are moving with a velocity varying between 1 and 56 KPH (1/2 and 35 MPH). Targets approaching or going away from the radar are easily detected. Targets moving at right angles to the radar can be detected but not as readily as those moving at angles other than right angles.

(106 to 199 not allocated)

DATA TABLES

Data Tables

Tables 1A-1 through 1A-8 provide ready reference to data necessary for the operational and unit level of maintenance. Components are illustrated in figure 1A-1.

Component	Quantity	Length (cm)	Width (cm)	Height (cm)	Weight (kg)
Adapter, Pintle-mount, MX-9426/PPS-15	1	10 (4")	11 (4.5")	19 (7.5")	1.4 (3 lbs)
Antenna Assembly, AS 2906/PPS-15(V)	1	36 (14")	7 (2.7")	25 (9.8")	1.8 (3.9 lbs)
Battery Dry, BA- 4386/PRC-25	2	24 (9.5")	9 (15")	5.4 (2.1")	1.4 (3 lbs)
Cable Assembly, External Power, W2	1		6.4 (2.5")	3.3 (1.3")	1.3 (2.8 lbs)
Cable Assembly, Remote, W3	1		2.5 (1")	2.5 (1")	1.6 (3.5 lbs)
Case, Carrying, CY- 7339/PPS-15(V)	1	71 (28")	41 (16")	18 (7")	1.7 (3.6 lbs)
Case, Transport, CY- 7338/PPS-15(V)	1	94 (37")	56 (22")	30 (12")	17.8 (39.25 lbs)
Drive, Antenna, AB- 1205/PPS-15(V)	1	19 (7.5")	14.5 (5.7")	1.1 (4.4")	1.1 (2.4 lbs)
Headset, Electrical, H- 25/U	2	20 (8")	10 (4")	14 (5.5")	.3 (0.7 lbs)
Indicator, Control, C- 9353/PPS-15(V)	1	36 (14")	10 (4")	24 (9.6")	1.7 (3.7 lbs)
Tripod, Radar, MT-PPS- 15(V) with legs extended -	1				
			152 (60") max	23 (9") min	2,1 (4.67 lbs)
with legs retracted and - folded for storage			11.8	7.1	2.1

			(4.6") min	(28") max	(4.67 lbs)
Sling, Type 1, MIL-S-1698	1	82 (32.25") adjustable to 138 cm (54.5")	4.4 (1.75")	.08 (.031")	.09 (.1875 lbs)
Humidity Indicator MS 20003-3	1	-	-	-	-
Dessicant, type 1, size 8 Per MIL-D-3464	-	-	-	-	-

Table 1A-1 Radar Set AN/PPS-15(V)2 Component Data



LEGEND

- | | | | |
|----|--|-----|---|
| 1. | Case, Carrying CY-7339/
PPS-15(V) | 7. | Control Indicator, C-9353/
PPS-15(V) |
| 2. | Case, Transport CY-7338/
PPS-15-(V) | 8. | Headsets, Electrical H-251/U |
| 3. | Tripod, Radar MT-4800/
PPS-15(V) | 9. | Cable Assembly External
Power, W2 |
| 4. | Battery, Dry BA-4386/
PRC-25 | 10. | Cable Assembly, Remote
Control (9 metre), W3 |
| 5. | Sling, Type 1 MIL-S-1698 | 11. | Antenna Assembly AS-2906/
PPS-15(V) |
| 6. | Drive, Antenna AB-1205/
PPS-15(V) | 12. | Pintle Mount Adaptor |

Figure 1A-1 Radar Set, AN-PPS-15(V)2

Equipment	Bulk (cubic metres)	Area (square metres)		Height (metres)	
		Min	Max	Min	Max
Radar set AN/PPS-15(V) 2, packed in carrying case CY-7339/PPS-15(V)	.05	.28	N/A	N/A	N/A
Radar set AN/PPS-15 (V)2, packed in transport case CY- 7338/PPS-15(V)	.2	.46	N/A	N/A	N/A
Radar set, AN/PPS-15 (V)2, tripod mounted, local operating position	N/A	.5	1.5	.8 (2.66')	1.2 (3.92')

Table 1A-2 Total Space Requirements

Power Source	DC Voltage	Battery Life	Duty Cycle
Normal power - Battery, dry, BA-4386/PRC-25	14.0	More than 12 hours at 40EF (4.4EC)	Continuous
Optional external power - (battery, vehicle motor, generator)	24 + 6 - 4 24 + 6 - 4	N/A N/A	Continuous Continuous

Table 1A-3 Power Requirements

Characteristics	Technical Data
Nominal transmitted frequency	10.3 GHz
Transmitter tuning range	10.197 to 10.403 GHz
Average transmitter power ¹	45 milliwatts
Horizontal Beam width	100 mils max
Vertical Beam width	1180 mils max

¹Radiated Power approx equal to 36 milliwatts due to antenna loss

Table 1A-4 Transmitter Technical Characteristics

Manual Coverage	Automatic Scan Width	Automatic Scan Rate	Scan Centre
mils	mils	mils/sec	mils
6 400	800 ∇ 100 1600 ∇ 200	90 ∇ 9	Any azimuth 0 to 6400
Accuracy (Probable Error)	Resolution		Determination
Mils 10	Mils 100		Display Headset audio; digital numerical readout

Table 1A-5 Azimuth Technical Data

Manual Coverage (mils)	Determination
+400 to -600	Calibrated elevation scale

Table 1A-6 Elevation Technical Data

	Type of Indication	
	Audible	Visual
Headset	Target detection and identification	N/A
Alarm speaker	Target Detection	N/A
ALARM lamp	N/A	Blinking red alarm lamp on target detection
AZ-MILS (bat volts) indicator	N/A	Digital numeric readout
Range meters indicator	N/A	Digital numeric readout
Peaking (XMTR test) indicator	N/A	Lightbar dot display

Table 1A-7 Receiver Indication Technical Data

CHAPTER 2

BASIC RADAR PRINCIPLES

SECTION 1 - GENERAL

201. Definitions

Radar is an application of radio principles by means of which it is possible to detect the presence of objects, to determine their direction and range, and to identify the nature of the object.

202. Introduction

1. Early warning systems have been in use for many years. For example, smoke signals, signal fires, drums, listening with one's ear to the ground or a railway track for sounds of distant movement, and many others, are examples of simple techniques to obtain early warning.
2. Defences on the modern battlefield require systems that will:
 - a. see farther than the human eye;
 - b. see through darkness, snow, rain, fog, smoke, and blinding sun;
 - c. indicate the direction and range to a target;
 - d. direct counter fire onto the target; and
 - e. perform more complex tasks.

203. Radar

1. Radar was originally developed to detect the approach of enemy aircraft and ships.
2. The term radar is derived from Radio Detection and Ranging.

204. Applications of Radar

1. The first real trial for radar came during the Battle of Britain.
2. During World War 2, radar was used in the following ways:
 - a. Land Operations. Radar was used to detect and locate aircraft and missiles, and to provide laying information for guns in anti-aircraft units. To a limited extent, the use of radar was extended to battlefield surveillance and to locate enemy mortar positions.

- b. Maritime Operations. Radar was used in ships to give early warning of hostile ships and aircraft, and to assist in fire control.
- c. Air Operations. Radar was used for early warning to scramble fighters, to vector bombers, to do blind bombing, and assist in all-weather navigation.

SECTION 2 - PRINCIPLES

205. Radar Components

1. A simple radar system consists of three main components:
 - a. the transmitter;
 - b. the receiver; and
 - c. the indicator.

The principle of operation of the system is shown in figure 2-1.

2. The transmitter sends out a signal and part of the signal may hit a target and bounce or be reflected back to the radar receiver.

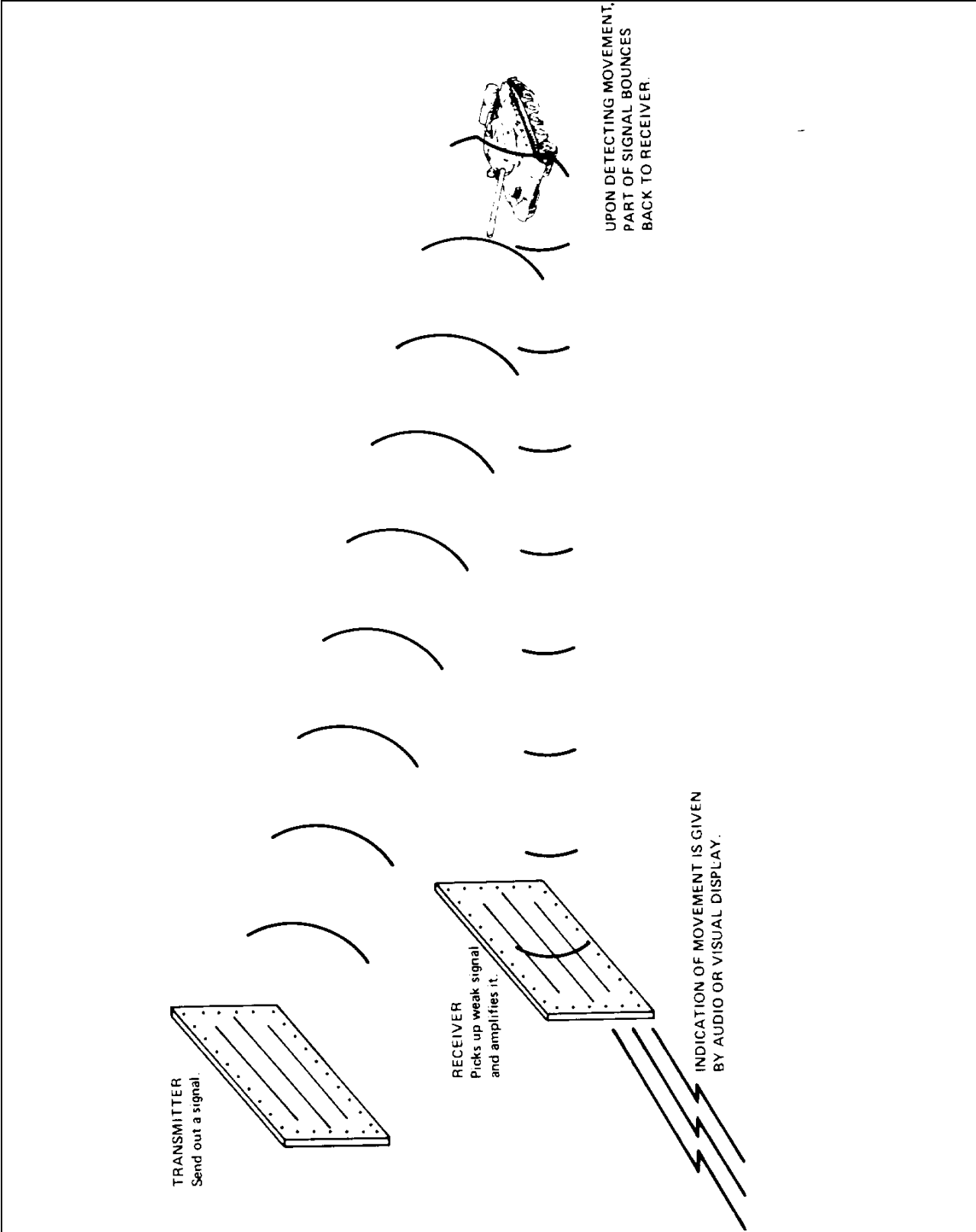

Figure 2-1 The Basic System

3. The receiver picks up the returning signal, amplifies it, and sends it to the indicator.
4. The indicator indicates the range to the target by measuring the time it takes for the signal to travel to the target and return.

206. Basic Theory

1. Radar signals travel at a constant speed (approximately 300 million m per second) and in straight lines.
2. Knowing the speed of these signals, it is possible to design equipment to measure the time radar pulses, take to travel to the target and return, and convert this information into range.
3. At a speed of 300 million metres per second, the radar signals travel 300 m in 1 microsecond ($1/1,000,000$ sec).
4. Similar to the way in which a flashlight focuses light into a beam, radar antennae focus radar energy into a beam thereby giving the radar directional capabilities.

SECTION 3 - COMPONENTS AND FUNCTIONS

207. Introduction

1. This section describes the radar set AN/PPS-15(V)2. The radar set is a portable solid state, battery-powered, ground surveillance doppler radar used to detect moving personnel and vehicles at very short range. The radar set consists of an electrically and mechanically connected receiver/transmitter group, antenna drive mechanism, power and special purpose cables, and a tripod. A carrying case and a transport case are provided for transportation and storage. Components are illustrated in Chap 1, Annex A.

208. Receiver/Transmitter Group

1. General Unit. The control indicator and the antenna assembly are electrically and mechanically interconnected to form the receiver/transmitter group. The term local is used when the receiver/transmitter group (consisting of the antenna and control indicator) are mechanically connected as a single unit. The term remote is used when the control indicator is physically separated from the antenna assembly and the two units are electrically connected together using the remote control cable assembly. All modes of operation can be performed in either the local or remote configuration.

2. Control Indicator

- a. Description. The control indicator is shown in figure 2-2. The control indicator contains controls and indicators, cable connectors, battery compartment, and the majority of the electronic circuitry. The battery compartment is separately sealed against hydrogen gas leakage that might be emitted from the battery. The battery cover assembly is secured to the control indicator with two trunk-type latches, and the control indicator is mechanically secured to the antenna assembly by three trunk-type latches. The control indicator is provided with two-way pressure relief valves to prevent damage when being transported at altitudes up to 15 240 m above sea level. The battery compartment relief valve on the control indicator maintains low pressure differences to exhaust hydrogen gas given off by the battery. A means for attaching a suspension strap to the control indicator is also provided.
- b. Function. The control indicator provides the means for alignment and adjustment of the radar set, the facility to identify and monitor targets, and the capability to self-test and to allow other maintenance tests to be conducted. The control indicator also provides the space for the installation of the dry battery and a connector for termination of the external power cable when external power is used.

3. Antenna Assembly

- a. Description. The antenna assembly is shown in figure 2-3. The antenna assembly contains the antenna array, transmitter, an antenna duplexer assembly to separate transmit and receive signals, two electronic printed circuit cards, and connectors. A compass support located on the top surface of the antenna is equipped with alignment pins. The antenna assembly is positioned on the antenna drive cradle of the antenna drive assembly, using two guide pins in the antenna drive assembly mounting brackets, and is locked in place by means of two quarter-turn fasteners on the antenna drive assembly.

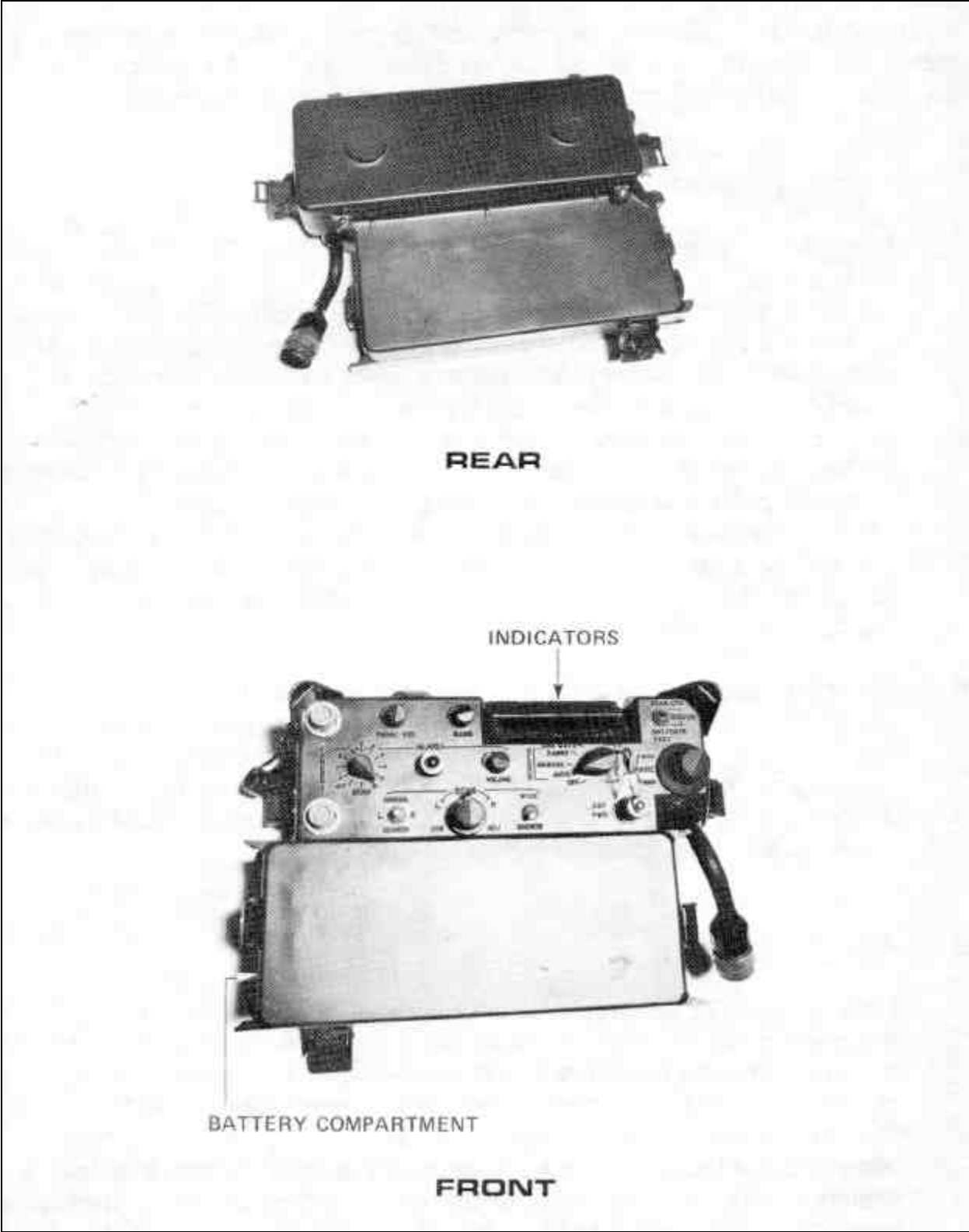

Figure 2-2 Control Indicator, C-9353/PPS(V)

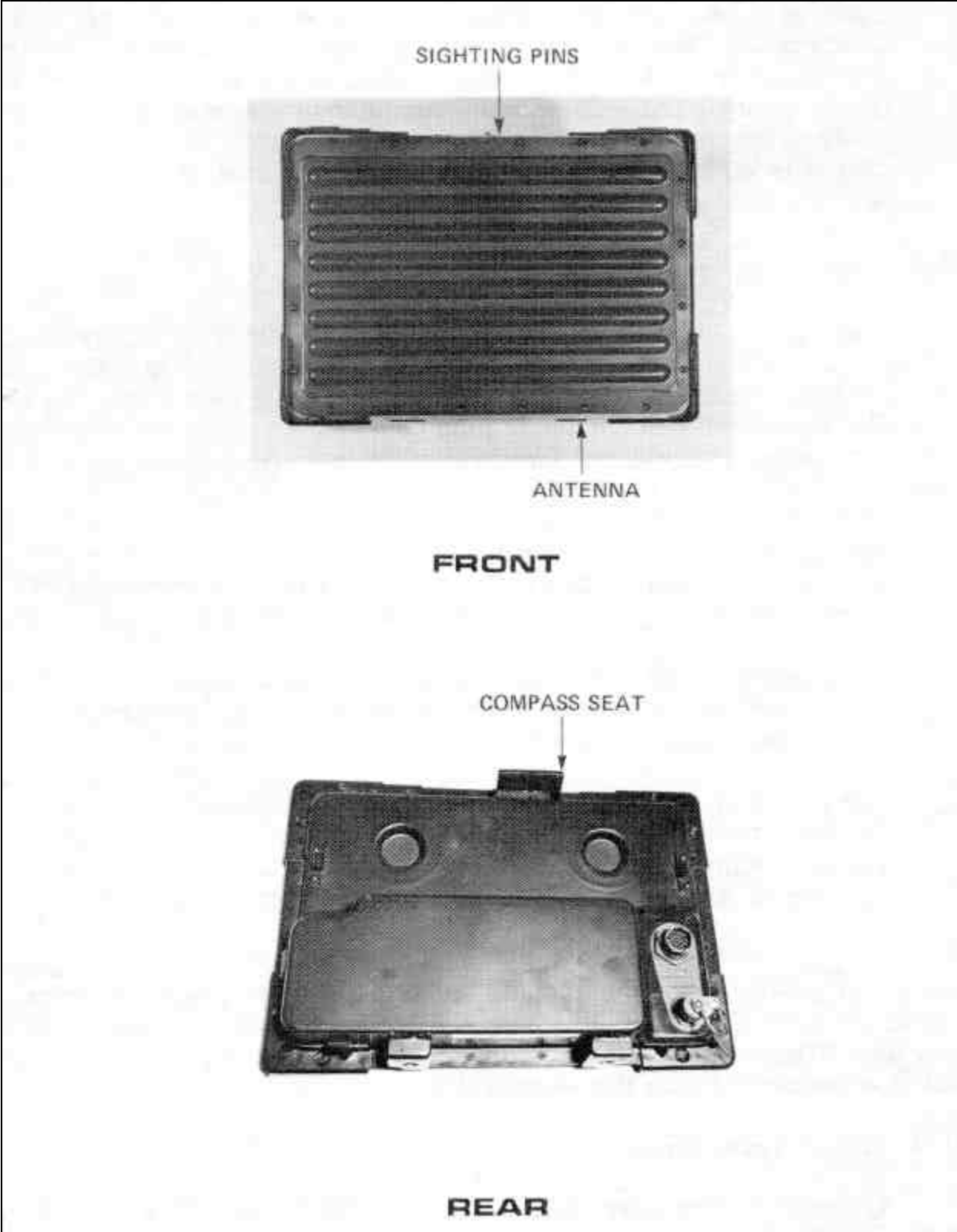

Figure 2-3 Antenna Assembly, AS-2906/PPS-15(V)

- b. Function. The antenna assembly contains electronic circuitry that generates the transmitted signals used to detect moving targets, and an antenna array used to emit these signals into the atmosphere and to receive return signals. In addition, the antenna assembly contains circuitry to strengthen the received signal to a level suitable for use by the control indicator. The antenna assembly is also used to visually align and orient the radar set.

209. Antenna Drive Assembly

1. Description. The antenna drive assembly (AB-1205/PPS-15(N)) shown in figure 2-4, is comprised of a base, housing, cradle, drive motor, elevation dial, elevation control, elevation dial lamp, antenna drive cable and connector 3P1, illuminated bubble level, illumination switch, and azimuth (bearing) zero reference blades. The principal functions of the main components are as follows:

- a. Cradle. The receiver/transmitter group mounts on the cradle and is secured by two quarter-turn fasteners. Quarter-turn fasteners are used to allow quick assembly or disassembly of the radar set.
- b. Illumination Switch. The illumination switch is a momentary contact push-button switch, used to control illumination of the bubble level and the elevation dial.
- c. Cable. Electrical connection to the receiver/transmitter group is provided through the antenna drive assembly cable. The cable is provided with a captive knurled sleeve on connector plug 3P1 to secure the plug to its mating connector receptacle on the antenna assembly.

2. Function. The antenna drive supports the receiver/transmitter group on the tripod, provides drive for scanning, and provides bearing location information to the control indicator. Elevation angular control and indication are also provided. Manual slewing for the purpose of mechanically zeroing the radar set is accomplished with the antenna drive.

210. Tripod Radar Mount

1. Description. The radar tripod mount (MT-4800/PPS-15(V)) is shown in figure 2-5. The tripod supports the radar set for remote or local position operation. The latching knob (see figure 2-5) in the centre of the tripod head is used to attach the antenna drive to the radar tripod. In addition, the latching knob provides a means of attaching tie-down straps for use under high wind conditions. Tripod design includes two-section, variable-length legs, and a head which allows for differing angles between the legs. These features allow the tripod to be set up on sloping terrain. They also allow the height of the antenna to be varied from a minimum of 81 cm (32 inches) (measured to the centre of the antenna) to a maximum of 114 cm (47 inches). The base of each leg is similar in design to the base of a ski pole, with a spike for ice and other hard surfaces, and a pad to prevent sinking into sand or mud. The spike and general construction provide a continuous electrical path to act as a ground for the receiver/transmitter group.

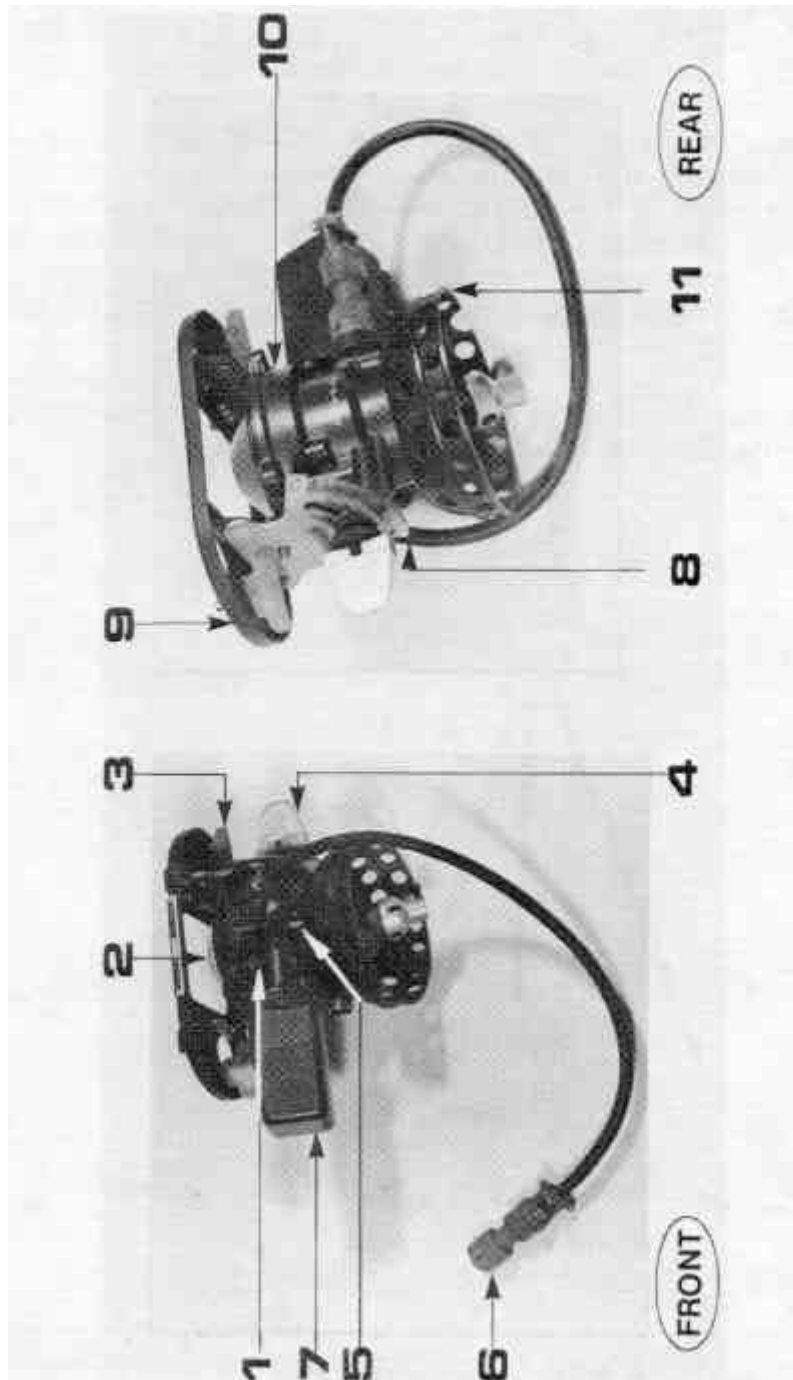

- | | | |
|-------------------------------------|----------------------------------|-------------|
| 1. Illumination Switch Assembly | 5. Azimuth Reference Zero Blades | 9. Cradle |
| 2. Bubble Level | 6. 3P1 Connector | 10. Housing |
| 3. Quarter Turn Fastener (Unlocked) | 7. Drive Motor | 11. Base |
| 4. Elevation Control (Unlocked) | 8. Elevation Dial | |

Figure 2-4 Antenna Drive Assembly, AB-1205/PPS-15

2. Function. The radar tripod supports the receiver/transmitter group and antenna drive for either local or remote position operations.

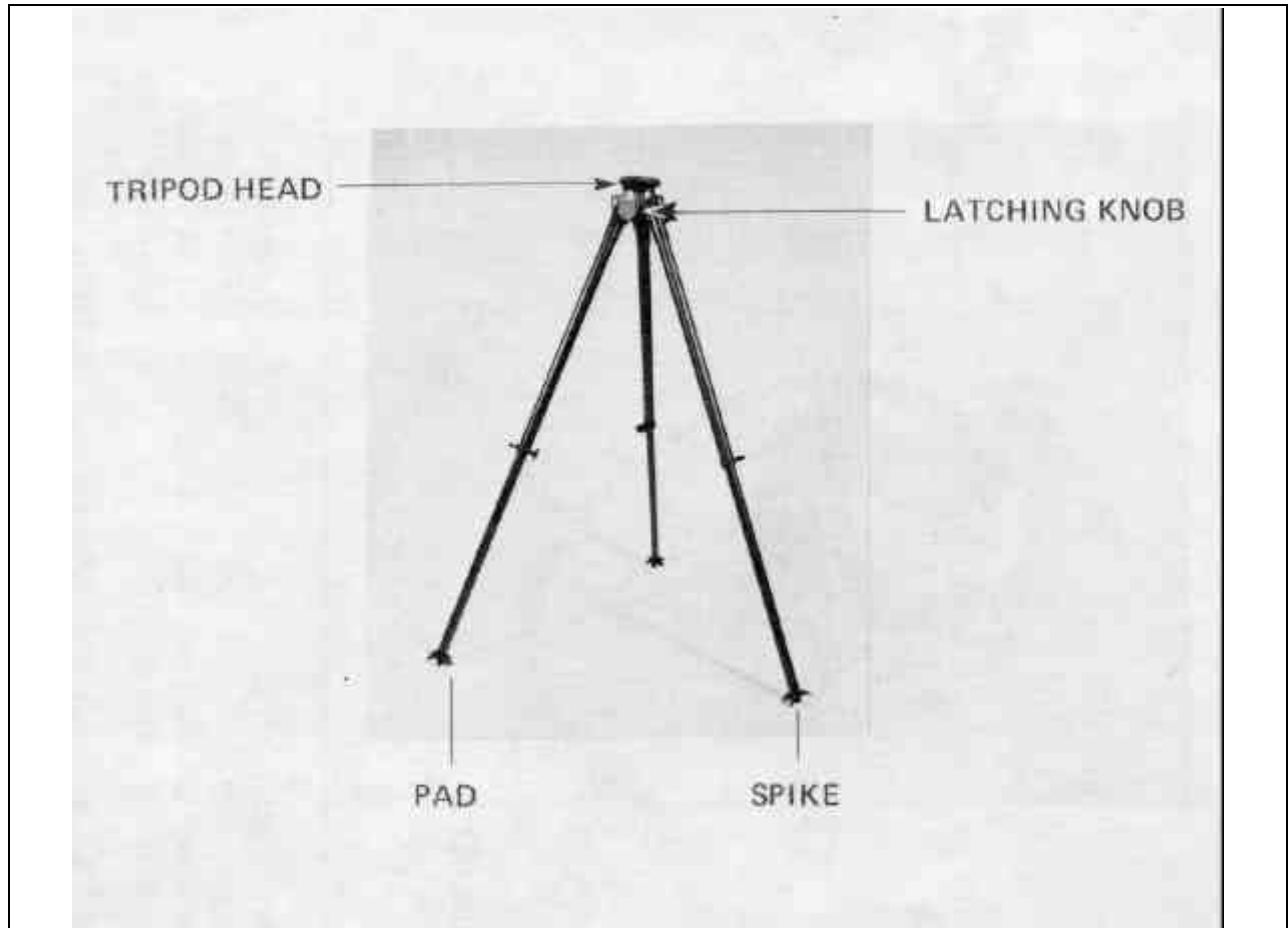

Figure 2-5 Tripod, Radar, MT-4800/PPS-15(V)



Figure 2-6 Case, Carrying, CY-7339/PPS-15(V)

211. Case Carrying

1. Description. The carrying case (CY-7339, PPS-15(V)) shown in figure 2-6, is a splash-proof canvas case designed for backpacking the radar set. It is designed for maximum comfort. Wide straps and minimum profile provide for ease of carrying through vegetation and jungle. It can also be mounted on a pack frame.
2. Function. The carrying case is a portable backpack used to store and transport the complete radar set, including the tripod, cables, and operating battery.

212. Case Transport

1. Description. The transport case (CY-7338/PPS-15(V)), is shown in figure 2-7. It is a protective enclosure used to house the radar set during transit and storage. Additional space is provided for storage of ancillary equipment not provided with this system. Shock protection for the radar set packed in the carrying case is provided by polyurethane compression pad in the lid of the case. Protection from the elements is provided by watertight tongue and groove gaskets on the case and lid. The removable lid is secured by four trunk-type latches. A swivel mounted ball-type handle is provided on one side of the transport case to enable carrying by one man. Two bail handles on each end of the transport case are also provided.

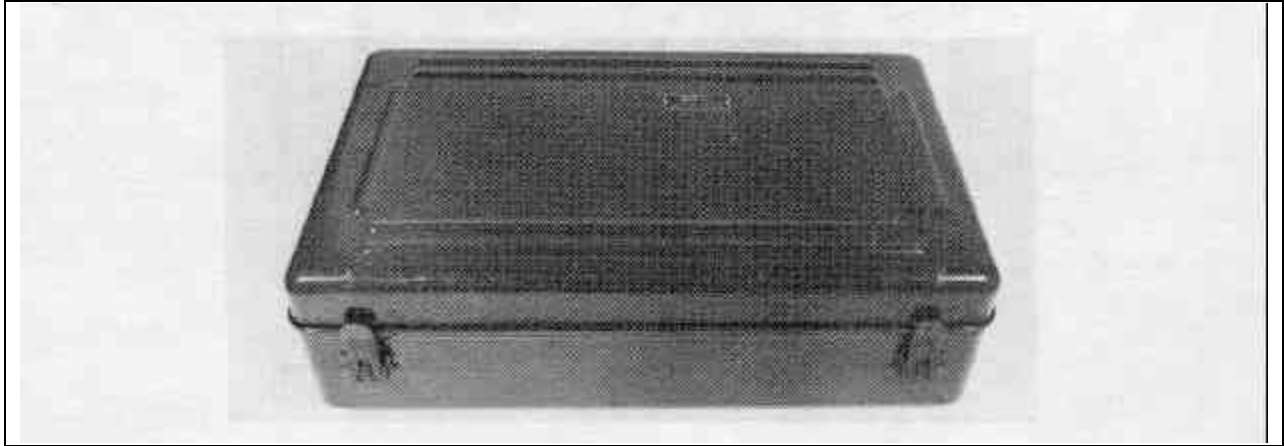

Figure 2-7 Case, Transport, CY-7338/PPS-15(V)

2. Function. The transport case is a protective container designed to house to radar set during transit or storage.

213. Electrical Headset

1. Description. The electrical headset (H-251/V) is shown in figure 2-8. Two 500 ohm impedance headsets are provided. Both headsets are identical and are equipped with a coil cord and plug. The headset connector plugs are equipped with a captive knurled sleeve to secure the plug to its mating connector receptacle on the control indicator.

2. Function. The two headsets are provided to monitor moving target returns. Both headsets are identical and are interchangeable.



Figure 2-8 Headset, Electrical, H-251/U

214. External Power Cable Assembly

1. Description. The external power cable assembly (W2) shown in figure 29, is 10 in (10.94 yards) long. It is equipped with an electrical connector plug P3 on one end and with one red and one black insulated aligator clip (P1 and P2 respectively) on the other end. An electronic voltage regulator subassembly is positioned approximately 1 m from the P1 and P2 end of the cable. The P3 connector plug is equipped with a quarter-turn fastener for securing the cable to its mating connector receptacle on the control indicator.

2. Function. The W2 power is a 10-metre cable provided to permit connection of the radar set to any available external 24-volt DC battery or 24-volt DC power source. The cable assembly regulates the external power source voltage to the radar set.

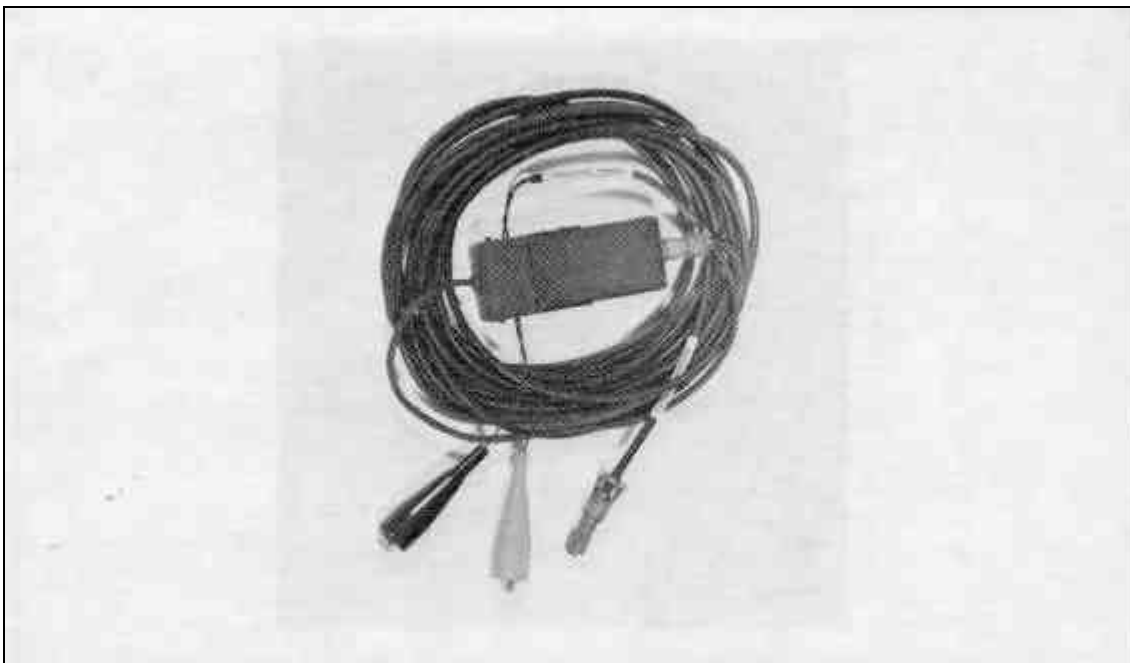

Figure 2-9 External Power Cable Assembly W2

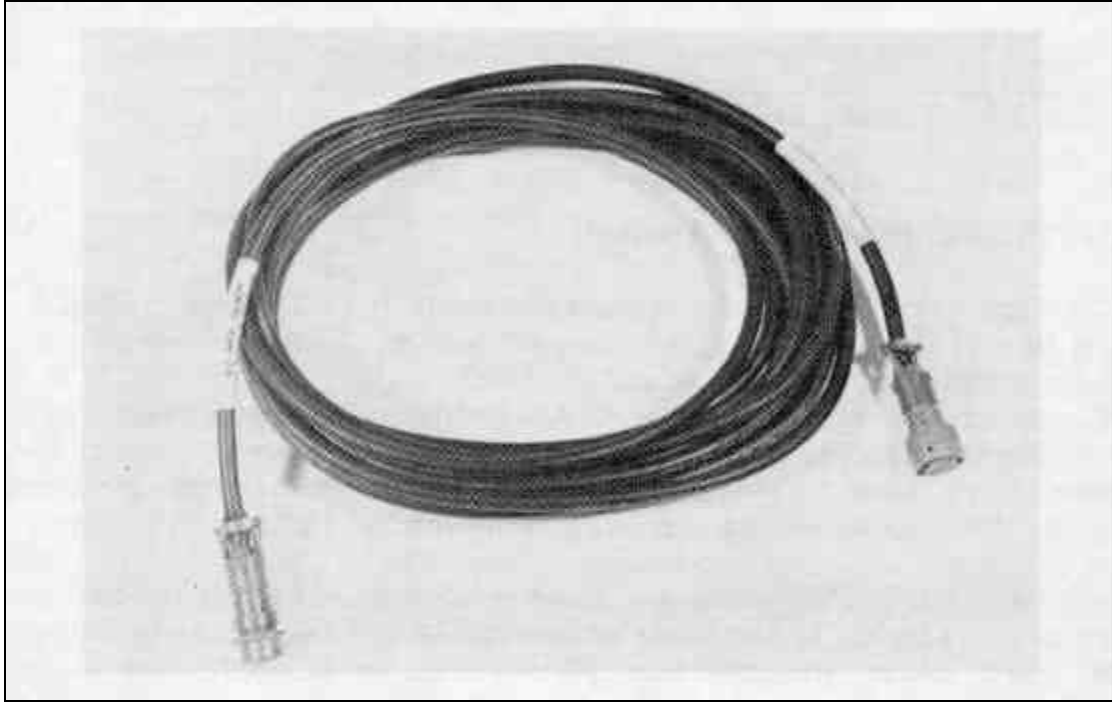

Figure 2-10 Remote Control Cable Assembly W3

215. Remote Control Cable Assembly

1. Description. The remote control cable assembly W3 (see figure 2-10) is 9 m (9.8 yards) long. The cable is equipped with a P1 and P2 connector plugs. The P1 connector plug is equipped with a captive knurled sleeve to secure the plug to its mating connector receptacle on the antenna assembly. The P2 connector is a male plug and is secure to its mating connector plug on the control indicator signal cable by a quarter-turn fastener.
2. Function. The cable is used to allow remote operation of the radar set. The cable provides the means for interconnecting the control indicator to the antenna assembly when remote operation is desired, and permits locating the control indicator up to 9 m from the antenna assembly without sacrificing any of the functions of the radar set.

216. Adapter, Pintle-Mount (MX-9426/PPS-15)

1. Description. The pintle-mount adapter (MX-9426/PPS-15) shown in Chap 8 (see figure 8-6), connects with a .50 calibre machine-gun pintle and with the antenna drive. The knob attaches the antenna drive to the pintle-mount adapter while the hand-screws provide the means for levelling and orienting the radar set.

2. Function. The pintle-mount adapter is used when operating the radar set from a stationary vehicle. The adapter provides the radar set with the same quick-disconnect mounting and levelling mechanism as the tripod assembly and provides an additional leveling adjustment to permit rough adjustment leveling when the vehicle is parked on slopes up to 530 mils (30 degrees).

(217 to 299 not allocated)

CHAPTER 3

THEORY OF OPERATION

SECTION 1 - GENERAL

301. Introduction

The AN/PPS-15(V)2 radar set is a battery powered, solid state very short range ground surveillance radar, limited to line-of-sight operation. The radar set can detect, locate, and recognize fast and slowly moving vehicles and personnel under varying conditions of terrain, visibility, and weather. The radar set provides both audible and visual alarm indications of probable targets, and provides digital readouts for range and bearing. To provide these indications, the radar system uses PFM/CW (pulse-frequency-modulated/continuous wave) techniques to produce a phase modulated waveform at X-band frequencies and generates characteristic doppler frequencies between 15 and 1050 Hz for moving targets with crossing speeds between .8 and 56 KPH (0.5 and 35 MPH). These doppler frequencies are amplified and used for audible detection of targets in the operator's headset and a tone in the alarm speaker. Target detection is also visually provided as a blinking alarm indication. The radar set also provides bearing and range indications of a selected target as a digital readout displayed on the control indicator.

SECTION 2 - ELECTRICAL AND ELECTRONIC THEORY

302. System Functioning

1. Electrical operation of the radar set can best be explained by separating the circuitry into six major sub-systems. Figure 3-1 is a block diagram of the radar set, showing the interconnections between each of the six sub-systems and identifies the portions of each sub-systems that are contained in the control indicator, antenna assembly, and antenna drive assembly. A comprehensive block diagram analysis of the major sub-systems is provided in this section.

2. The functions and an analysis of major interconnections between the six sub-systems are as follows:

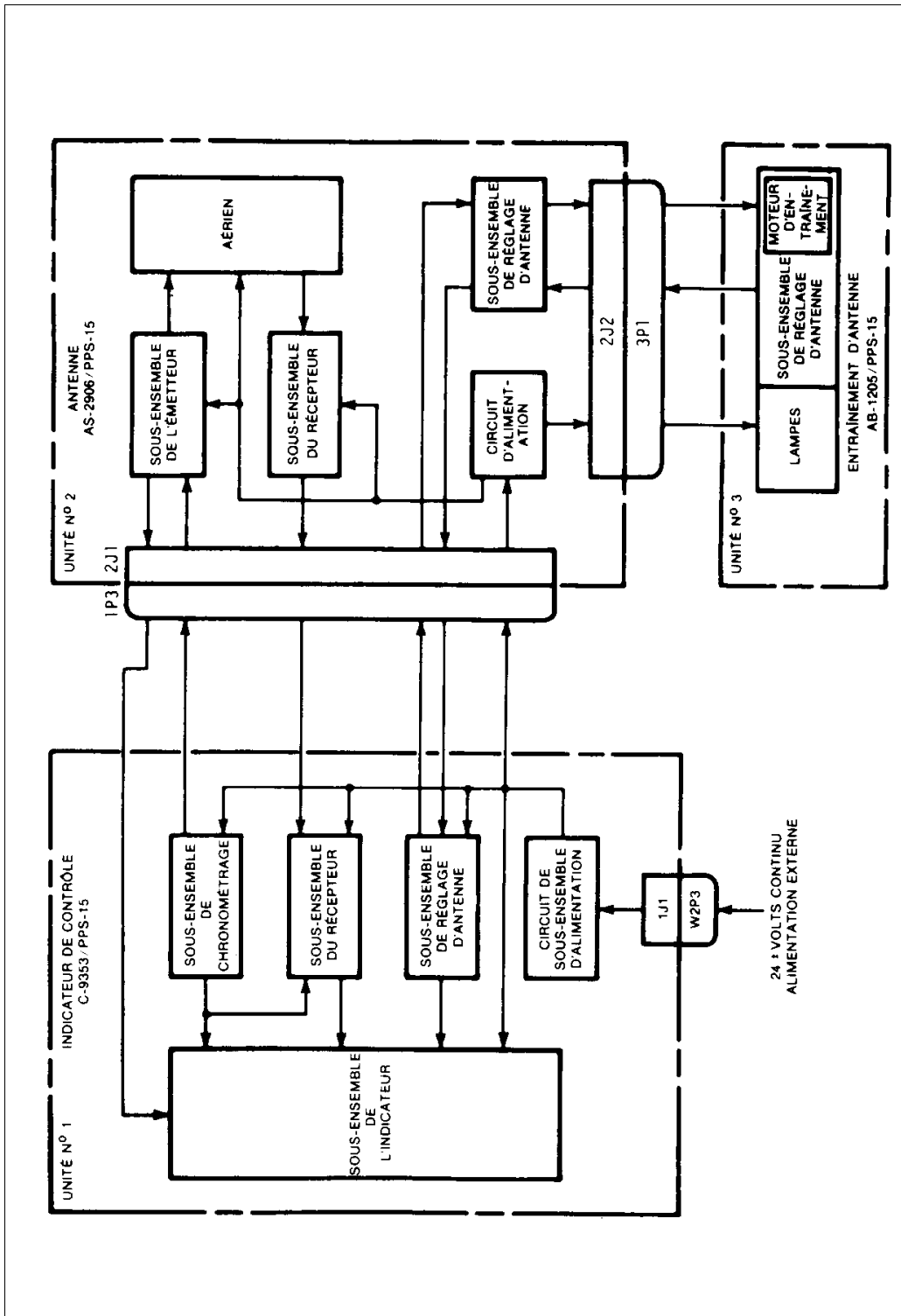

Figure 3-1 Radar Set AN/PPS-15(V)2, Simplified System Block Diagram

- a. Power Sub-system. Portions of the power system are contained in all three major units. The prime function of the power system is to generate and regulate the required DC voltage and distribute power to all units and circuitry requiring voltage inputs.
- b. Transmitter Sub-system. The transmitter sub-system is contained in the antenna assembly. The function of the transmitter sub-system is to generate the X-band RF frequencies required for transmission. Inputs from the timing sub-system are used to modulate the transmitted signal. A sample of the transmitted signal is supplied to the indicator subsystem to provide an indication of transmitted power under test conditions.
- c. Receiver Sub-system. Portions of the receiver sub-system are contained in the antenna assembly and in the control indicator. The function of the receiver is to amplify reflected radio frequency RF energy from targets, de-modulate and detect the received signals to eliminate reflections from stationary targets, and to develop doppler audio frequency signals for moving targets. Outputs of the receiver sub-system are supplied to the indicator sub-system to provide audible and visual indications of target data.
- d. Antenna Positioning Sub-system. Portions of the antenna positioning sub-system are contained in all three major units. One function of the component is to provide for automatic or manual scanning control of the antenna. The other function is to provide an analog voltage signal from the antenna positioning circuitry in the antenna drive assembly to the control indicator. The voltage level reflected by this signal indicates the degree of rotation of the antenna from a zero bearing reference point. This signal is used by the control indicator antenna positioning circuits to control the automatic scanning function, and by the indicating circuits to provide a digital readout of the antenna bearing position from the zero reference point.
- e. Indicating Sub-system. This sub-system is contained entirely in the control indicator, and functions to provide audible and visual indications of target data. A secondary function of the indicating sub-system is to provide test indications for use in checkout and troubleshooting of the radar set. Inputs to the indicator sub-system are received from each of the other five.
- f. Timing Sub-system. The timing sub-system provides pulses of frequency and time duration needed for synchronization of the indicator, receiver, and transmitter sub-systems. De-modulation processing for ranging information is also provided by the timing sub-system. Timing and subsystem support of the other radar sub-systems is shown in figure 3-1.

303. Power Sub-system

1. General. To operate properly, the radar set requires (12(\pm 2) volts DC power input. This voltage is normally supplied by the internal battery BA4386/PRC-25. However, external power cable W3 may also be used to apply voltage from a 20 to 30 volt DC external battery or generator source. Cable W2 contains a voltage regulator circuit internal to the cable that regulates the external voltage to 12 (\pm 0.6) volts DC. Figure 3-2 shows the power sub-system and power distribution.

2. Electrical Theory. Power is applied from the battery or external power cable to the power regulator circuits through the mode switch which functions as the power on/off switch. The power regulator circuits change the battery voltage to the different voltage values needed in the system and distribute these voltages to the control indicator logic circuits, the antenna assembly circuits, and the antenna drive light circuits. The light circuits in the antenna drive assembly consist of a push-button switch and two lamps to illuminate the elevation dial and bubble level.

304. Transmitter Sub-system

1. General. The transmitter sub-system is contained entirely in the antenna assembly. The CW X-band output of the transmitter is pulse frequency modulated by 100 nanosecond (1 second $\times 10^{-9}$) wide timing pulses occurring at a 37.5 kHz repetition rate to provide the pulse frequency modulation/continuous wave (PFM/CW) transmitted output from the radar set.

2. Electronic Functioning. Figure 3-3 shows two inputs from the control indicator to the transmitter sub-system. DC power from the control indicator power sub-system circuits is applied to the transmitter oscillator, to enable X-band frequency oscillation. One hundred nanosecond wide timing pulses from the timing sub-system are fed to the transmitter modulator regulator and the output applied to the transmitter oscillator and combined to generate the FM/CW output pulses. The output of the transmitter oscillator is then emitted by the antenna array. A portion of the transmitted signal is provided to the input of the monitor circuits. The signal is amplified by the monitor circuits and routed to the control indicator for indicator use (XMTR) test.

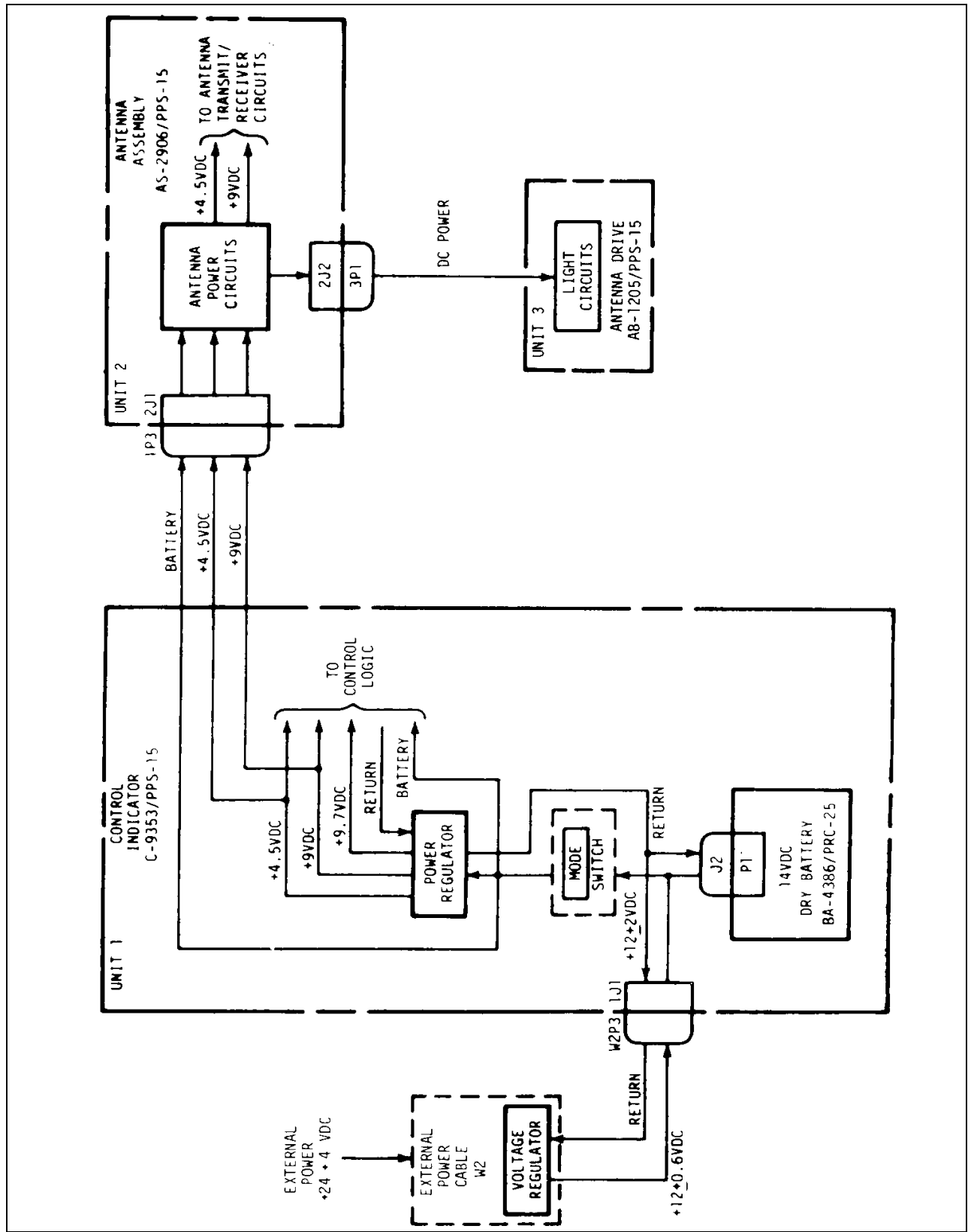

Figure 3-2 Power Sub-system, Block Diagram

305. Receiver Sub-system

1. General. The receiver sub-system functions to detect targets and to provide characteristic doppler frequencies between 15 and 1050 Hz for inputs to the radar indicating sub-system. The receiver sub-system is shown in figure 3-4. The front end (mixer and pre-amplifier) of the receiver is located in the antenna assembly. The rest of the receiver processing circuits are located in the control indicator. As shown in figure 3-4, the output of the pre-amplifier is simultaneously applied to two circuits that operate independently to provide the operator with information needed to detect, identify, track, and determine target range.
2. Front End Circuit. Signals returning to the antenna are fed into the mixer where they are mixed with continuous wave (CW) frequencies generated by the transmitter oscillator. The mixer output is then applied to the pre-amplifier input and the mixed signal is increased in strength to a usable level. The strengthened signal appearing at the output of the pre-amplifier is simultaneously applied to the narrow band all-range intermediate frequency (IF) amplifier and the wide band discrete range video amplifier inputs.
3. All-range Circuit. The output signal from the antenna pre-amplifier is applied to the all-range IF amplifier where it is filtered and amplified. The IF amplifier output is applied to the demodulator which removes the carrier component of the signal and blanks out reflected frequencies from stationary targets. The demodulated doppler audio frequency signals are supplied to the automatic alarm input and to the amplifier circuits and doppler filter. The filtered and amplified audio frequency signal output is then applied to the indicator sub-system for further processing.

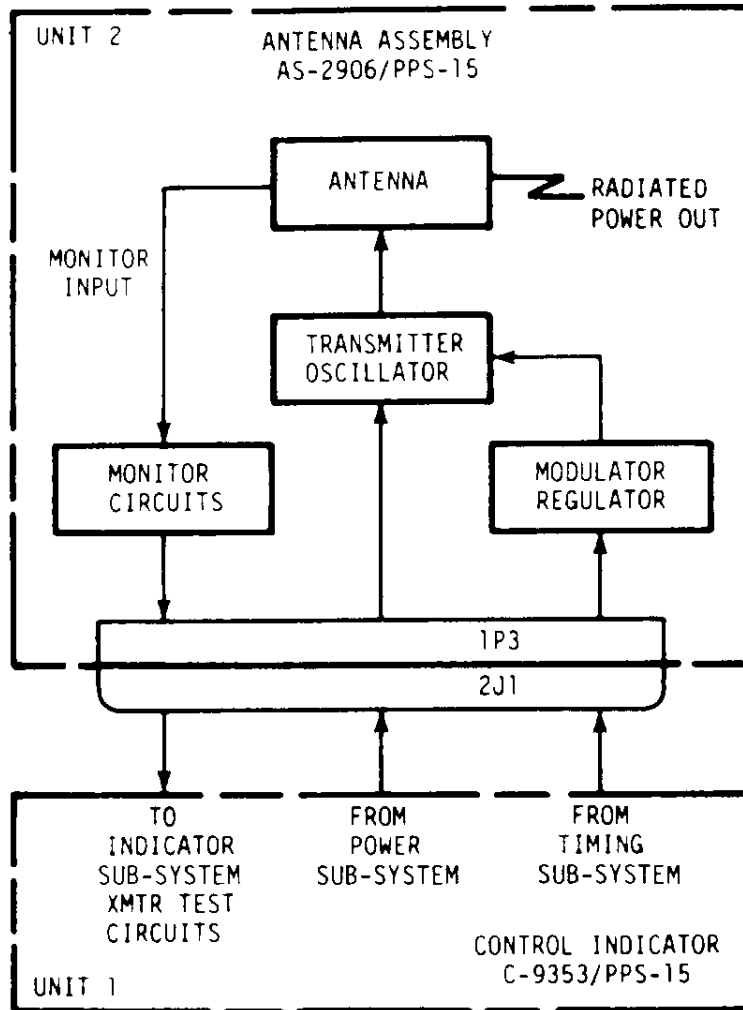

Figure 3-3 Transmitter Sub-system, Block Diagram

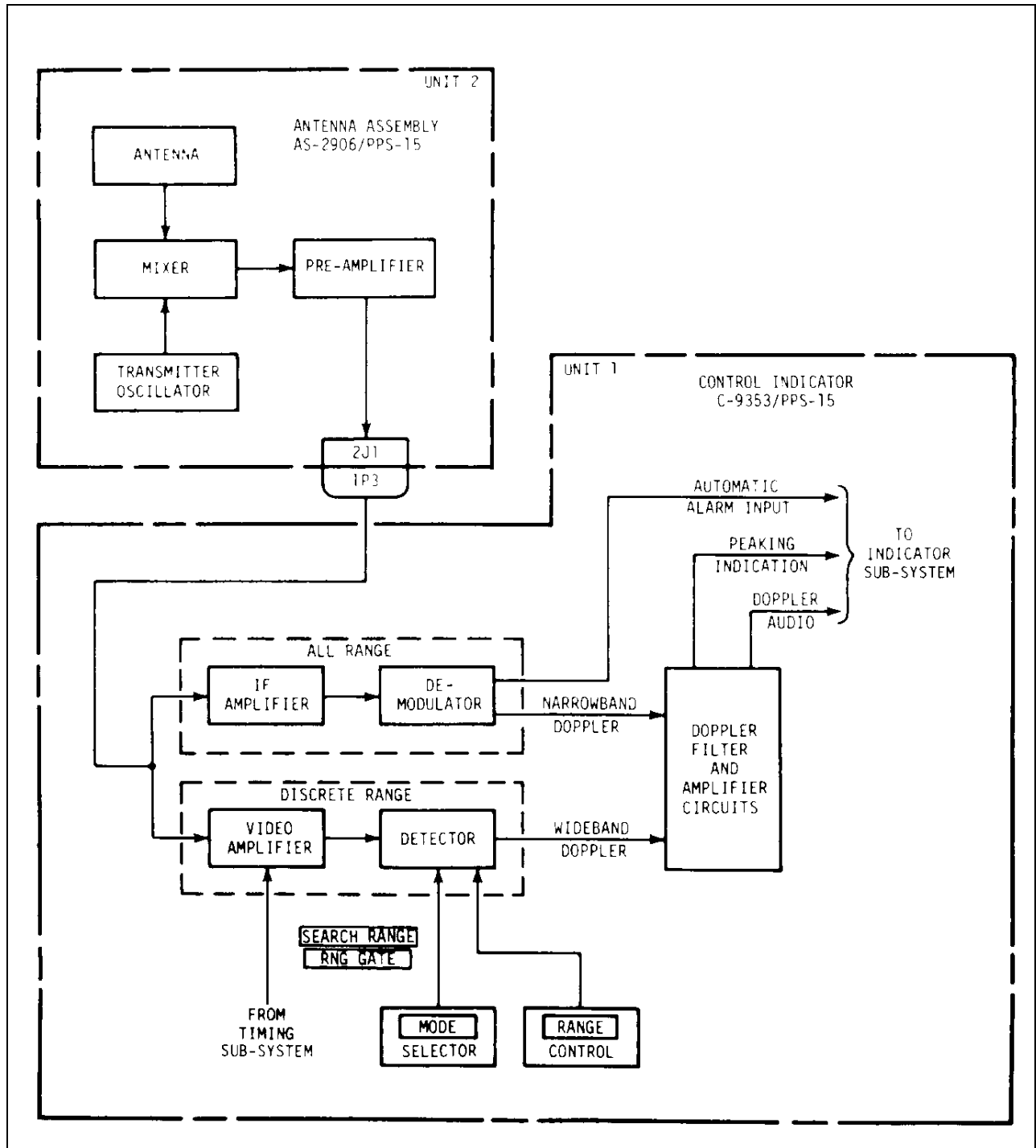

Figure 3-4 Receiver Sub-system, Block Diagram

4. Discrete Range Circuits. The mode selector switch enables power to be applied to the discrete range circuits only in the SEARCH-RANGE and RNG GATE positions. As a result, the range circuitry of the radar set operates only in these two modes. The video amplifier in the discrete range circuits receives the identical input from the antenna assembly pre-amplifier as that received by the all-range circuits discussed in art 302-2c. This signal is amplified and detected to provide a wide band doppler audio frequency for moving targets to match the doppler signal output of the all-range circuits and to prevent target distortion at short ranges. The wide band doppler output signal from the discrete range detector is controlled by a 25-nanosecond wide-gate pulse. The position of this gate pulse is controlled by adjustment of the range control on the control indicator front panel. As a result, the discrete range doppler output is generated only when the range gate is on the target and the range is shown by the digital range meter indicator.

5. Doppler Filter and Amplifier Circuit. The doppler outputs from the all-range demodulator and the discrete range detector are applied to the doppler filter and amplifier circuits. Identical circuits are used to filter out high frequency components remaining in the signals. The wide band audio frequency doppler signal is then multiplied by the all-range narrow band doppler signal and the product of these two signals is applied to the indicator sub-system to drive the peaking indicator. Amplified audio signals are also applied to the indicator sub-system to provide audible target information.

306. Antenna Positioning Sub-system

1. General. The antenna positioning sub-system (see figure 3-5) consists of antenna drive, antenna assembly, and control indicator circuitry. A reversible DC permanent magnet drive motor and bearing positioning potentiometer are located in the antenna drive. Motor drive control circuitry is provided by the antenna assembly. The rest of the antenna positioning circuitry is located in the control indicator.

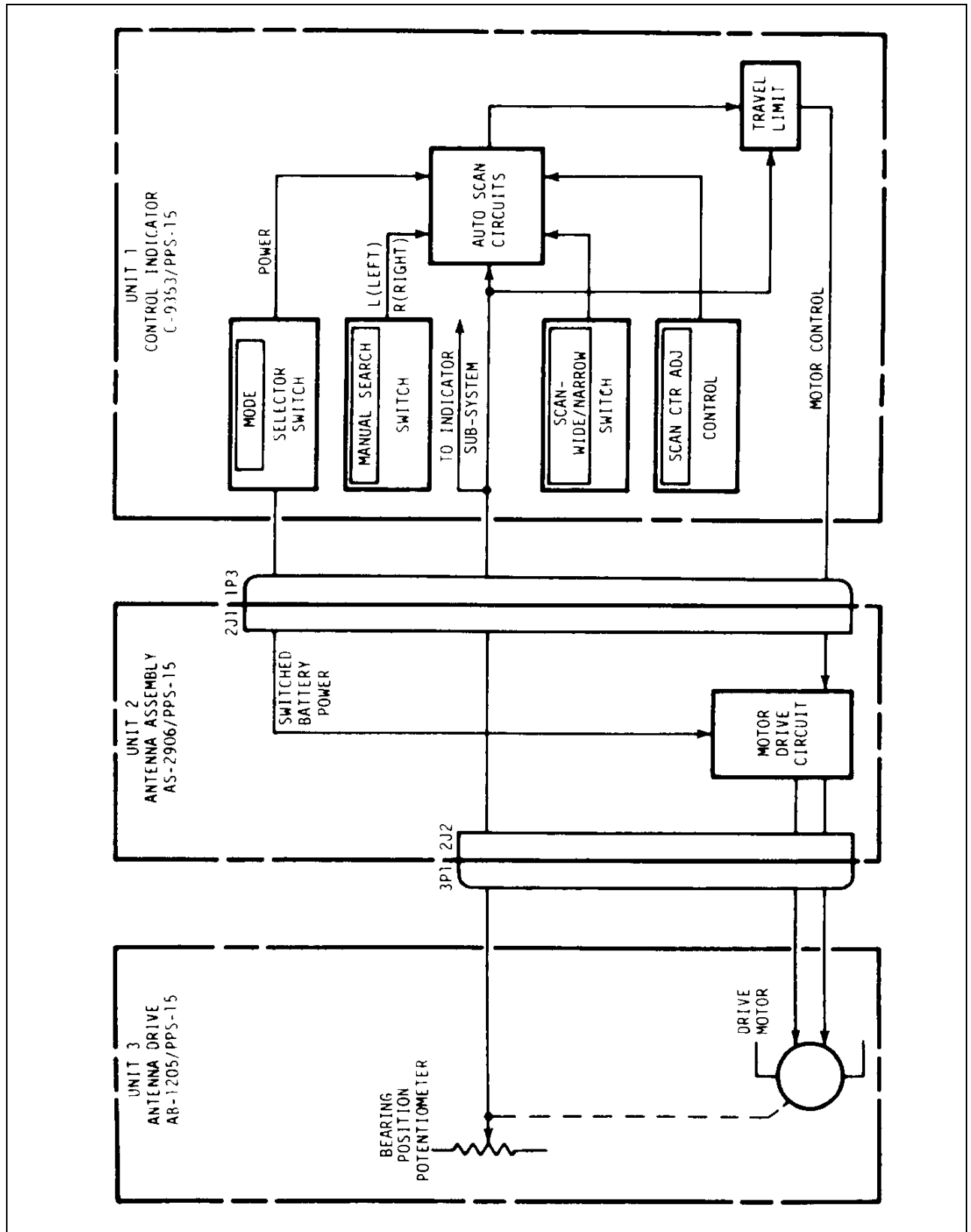

Figure 3-5 Antenna Positioning Sub-system, Block Diagram

2. Electrical Theory. Antenna movement resulting from drive motor rotation can be achieved by two methods depending on the setting of the control indicator mode selector switch. With the mode selector switch in the SEARCH-MANUAL, SEARCH-RANGE, and RNG GATE positions, antenna drive motor rotation is manually initiated by placing the control indicator scan-manual search switch into either the L (left) or R (right) positions. When the mode selector switch is in the SEARCH-AUTO position, continuous automatic scanning occurs over either a 1600 mils (90E) or 800 mils (45') arc depending on the position of the SCAN WIDE/NARROW switch. In the automatic scanning mode, the drive motor power and polarity are controlled by the SCAN-CTR ADJ control setting, SCAN-WIDE/NARROW switch position, and the signal voltage level feeding back from the antenna drive hearing positioning potentiometer.

3. Automatic Scan Circuits. As the antenna scans, the position of the antenna causes a change in the resistance of the azimuth position potentiometer. This results in a change in the voltage applied to the control indicator auto scan circuits amplifier. The amplifier output is then routed to the azimuth digital display logic circuit. The scan position signal is added to the SCAN-CENTRE ADJ control signal and the sum is applied as input to the auto scan circuits sector scan amplifier. The output voltage of the sector scan amplifier is applied to the travel limit circuit where it is identified as a positive or negative voltage. The antenna scan width is controlled by the SCAN-WIDE/NARROW switch. A scan width of 1 600 (∇ 200) mils or 800 (∇ 100) mils is available for selection. The output of the travel limit circuit is applied to the drive motor through the antenna assembly motor drive circuit and causes the antenna to scan in one direction. The changing voltage generated from the azimuth position potentiometer will cause a change in the summed voltage applied to the input of the auto scan circuits sector scan amplifier. The output of the amplifier as seen by the travel limit circuit recognizes the change and generates a change in the voltage polarity on the motor control signal fed to the motor drive circuit. This change causes the motor to turn in the opposite direction.

4. Manual Search Circuits. In the SEARCH-MANUAL, SEARCH RANGE, and RNG GATE modes of operation, the antenna is in a fixed position (not scanning). When the SCAN-MANUAL SEARCH switch is turned to L or R, a positive or negative voltage is applied to the input of the auto scan circuits. When the SCAN-MANUAL SEARCH switch is turned in an opposite direction (left-to-right or right-to-left) the polarity will be recognized and will result in scanning in the opposite direction. When the SCAN-MANUAL SEARCH switch is returned to the neutral position, the antenna will stop scanning. Data signals from the SCAN-WIDE/NARROW switch and the SCAN-CTR ADJ control are inhibited during manual operation.

5. Azimuth Positioning Potentiometer. As the antenna drive assembly scans in either the automatic or manual modes of operation, a variable voltage indicating the physical position of the antenna is fed back to the control indicator through the antenna assembly. In the manual positions of the mode selector switch, this signal is supplied to the indicating sub-system for presentation of a digital display in mils on the AZ-MILS (bat volts) indicator. In the SEARCH-AUTO mode, the signal is provided to the auto scan circuits to control the limits of scanning. Circuitry in the indicating subsystem inhibits the display on the AZ-MILS (bat volts) indicator when in the SEARCH-AUTO mode.

307. The Indicating Sub-system

1. The Indicating Sub-system Block Diagram Analysis. The indicating subsystem shown on figure 3-6 consists of components contained in the control indicator. Inputs for presentation by the indicating sub-system are received from the other sub-systems in the radar set and displayed in a manner determined by the control indicator front panel controls. The indicating subsystem provides audible and visual target detection. Of the two methods, the audible indications emitted from the electrical headsets is the primary method used for detection.

2. Audible Target Indication. Audio signals from the receiver subsystem circuits are switched through the mode selector switch and applied to the phone vol control. The variable amplitude output of the phone vol control is then applied to the headset amplifier circuits and the audio output of the amplifier is applied to both phone connectors on the control indicator. The phone vol control adjusts the level of the target audio doppler signal heard in the headsets. The mode selector applies the proper audio doppler signal dependent on mode of operation.

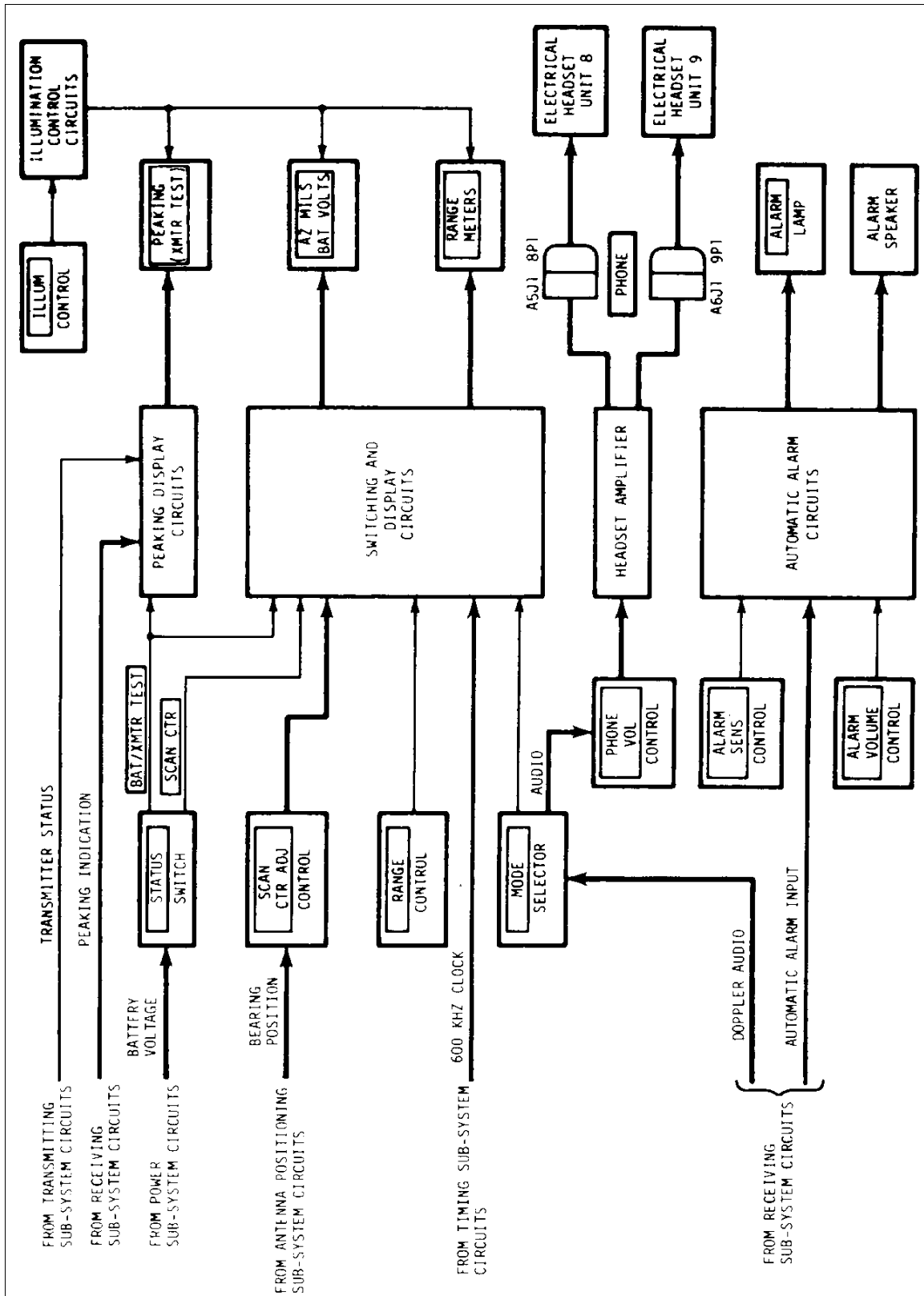

Figure 3-6 Indicating Sub-system (Block Diagram)

3. Visual Target Indication. Visual target information is displayed on the control indicator peaking (XMTR test), AZ-MILS (bat volts), and range meters indicators. Data actually displayed is selectively switched through the use of the mode selector and status switch on the control indicator front panel. Timing for enabling the displays is provided by the 600 kHz clock signal from the timing sub-system. The selective switching and resultant display on the indicators can best be explained in tabular form. Refer to table 6-3 for displays provided for each of the 12 possible combinations of mode selector and status switch settings.

4. Alarm Circuitry. In all modes of operation, the automatic alarm circuits provide visual and audible indications of moving targets. A signal from the receiver sub-system is applied to the automatic alarm circuits to activate the alarm when a moving target is detected. The alarm sens control provides an adjustable threshold level for the doppler signal to overcome background interference from clutter (swaying branches and waving grasses). When a target is detected, the outputs of the automatic alarm circuits cause the alarm lamp to blink and the alarm speaker to produce an audible tone. The alarm volume control provides adjustable audio level for the speaker or it can turn the speaker off.

5. Illumination Control Circuits. The illum control adjusts the intensity of the digital display indicators from very low (for night time use) to bright (for daytime operation).

SECTION 3 - THEORY OF MECHANICAL OPERATION

308. General

The antenna drive system is unique in that the drive motor is secured to the antenna drive housing on which the radar set is installed and the entire assembly is driven in a scanning motion around a stationary shaft. Refer to figure 3-7 for the mechanical schematic diagram of the antenna drive unit.

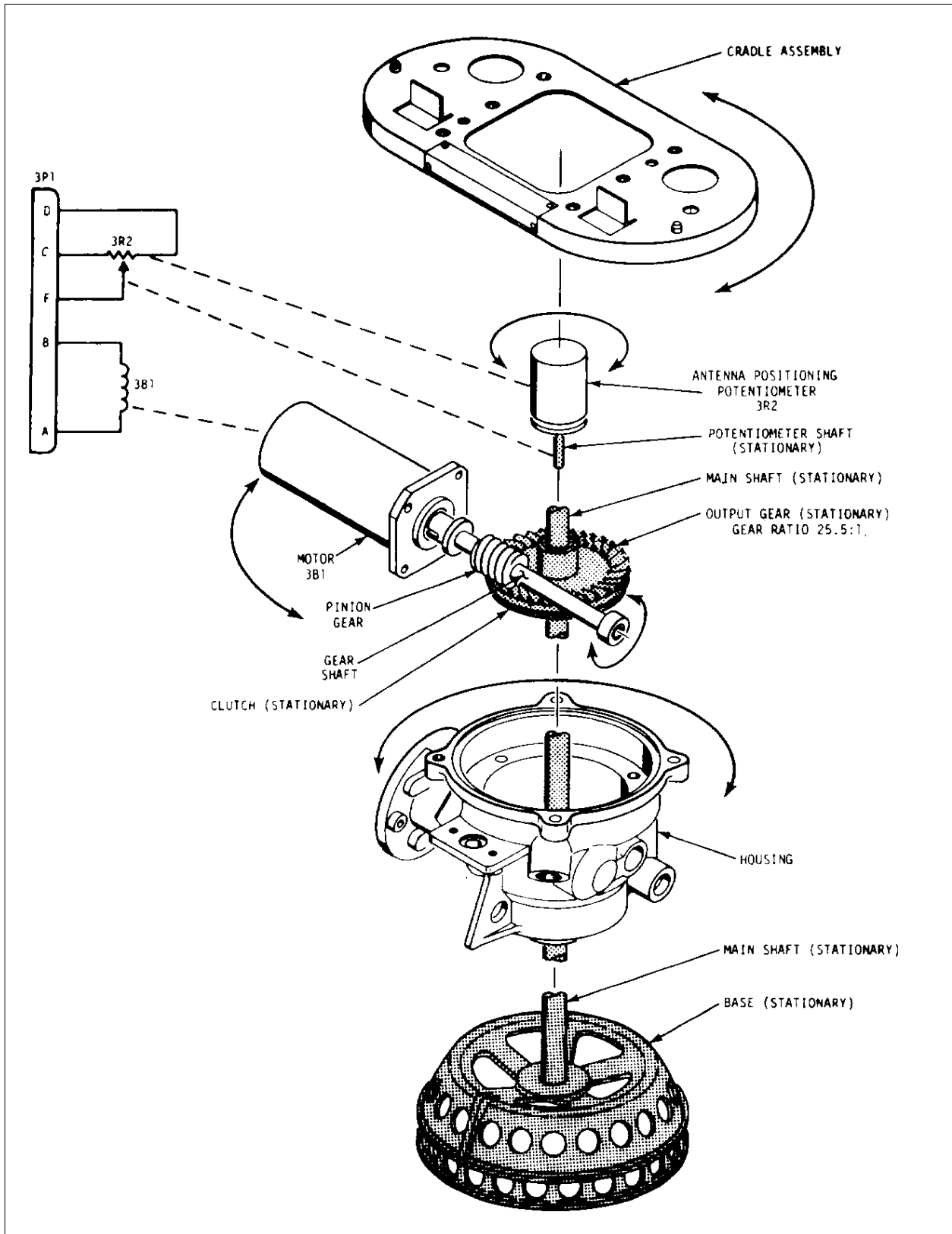

Figure 3-7 Antenna Drive Assembly - Mechanical Schematic Diagram

309. Antenna Drive Assembly

1. Introduction. Three major sub-assemblies of the antenna drive assembly are related to the mechanical functioning of antenna positioning: the antenna drive assembly base, housing, and cradle. The stationary parts of the antenna drive assembly consist of the base (which is secured to the tripod), the main shaft, the clutch, and the potentiometer shaft. In addition, the output gear is normally stationary as a result of clutch tension. The rotating parts of the antenna drive assembly as shown in figure 3-7 consist of the housing, the drive motor, the pinion gear, and its shaft, the potentiometer housing, and the cradle assembly. Both the main shaft and the pinion gear shaft are supported by the housing with bearings on each end of the shafts.

2. Scan Motion. The rotary motion of the antenna housing is provided by the gear set consisting of the motor-driven pinion gear and stationary output gear. When power is applied to the drive motor, the pinion gear will rotate. Since the output gear is stationary, the drive motor and housing rotates around the output gear. Reversing the current to the drive motor permits reversing the direction of rotation of the housing. Thus, periodic reversing of drive motor current results in the scanning motion of the radar set attached to the cradle.

3. Clutch Operation. The stationary states of the output gear is achieved through tension from the clutch which is secured to the main shaft. In this way, it is possible to manually turn the radar set attached to the cradle assembly which in turn causes rotation of the housing. Manual rotation of the radar set causes the clutch to slip and prevents damage to the gear set and drive motor.

4. Antenna Position Potentiometer. A DC voltage is applied between pins C and D of the 3P1 connector plug. The housing of the potentiometer 3R2 is connected to the antenna drive housing and the potentiometer shaft is connected to the main shaft. Therefore, a variable voltage indication is present at pin F of the 3P1 connector to provide an indication of the azimuth setting of the radar set.

(310 to 399 not allocated)

CHAPTER 4

PREPARATION FOR USE

SECTION 1 - GENERAL

401. Handling

1. Handling Instructions. One man can easily pick up and carry the radar set when packed in its shipping container. Normal caution should be taken when transporting the set to its location for unpacking.
2. Inspection. The following inspection procedure will be followed on receipt of the equipment (see figure I and figure 2):
 - a. Inspect the transport case to assure that no damage has occurred during previous use or storage.
 - b. Unpack the equipment in accordance with para 3.
 - c. Verify that batteries are unused by inspecting the paper seal covering the battery connector. If the seal is either broken or missing, obtain a new battery. Do not discard batteries until a check has been made to determine if they have been discharged beyond a usable state.

Note: The battery can be checked by placing it in an operational radar set and performing sequence 5 in table 7-1.

- d. As each assembly is removed from the carrying case, inspect it for dents or broken structural components. Then, using the table in this chapter, Annex A, inspect each of the listed components. Ensure that all switches and controls are accounted for and that control knobs are not missing and control shafts are not bent. Control indicators are to be inspected to determine if they have been damaged. Inspect all connectors and plugs for broken or bent pins. All cables should be free from abrasions and cuts which may expose cable conductors. Ensure that no assembly screws or other hardware are missing, and that the equipment is free of dust and corrosion.
3. Unpacking. To unpack the equipment, proceed as follows;
 - a. Open the four latches that secure the cover of the transport case and remove the cover (see figure 4-1).
 - b. Remove the battery from the transport case.
 - c. Remove the packed carrying case from the transport case.

- d. Refer to figure 4-2 and unpack the radar set as follows -
- (1) Unfasten the two straps securing the carrying case weather cap and turn the cap back to gain access to the stored components.
 - (2) Remove the receiver/transmitter group by lifting the unit out of the carrying case.
 - (3) Remove both headsets from the top of the carrying case. The: headsets are stored in the same compartment, one above the other.
 - (4) Remove the tripod by carefully pulling it from its compartment.
 - (5) Lay the carrying case on its back, unzip the compartment on the lower front surface of the carrying case, and fold back the flap.
 - (6) Remove the antenna drive assembly from its storage compartment.
 - (7) Remove the sling.
 - (8) Remove the battery.

SECTION 2 - INSTALLATION INSTRUCTIONS

402. General

Without the aid of tools, an experienced operator can assemble and mount the radar set on the tripod and be ready for adjustment and alignment within two minutes after removing the set from the carrying case.

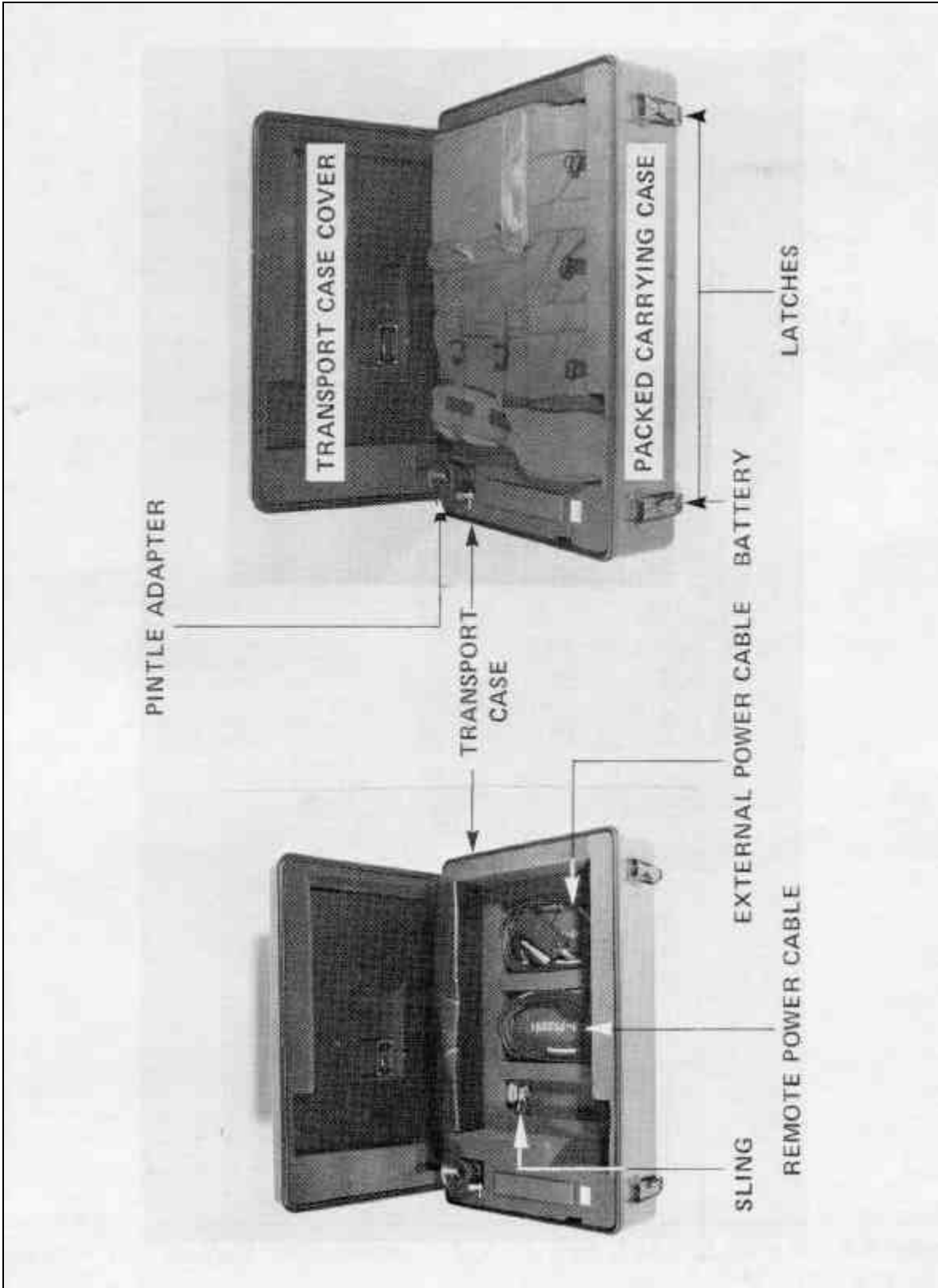

Figure 4-1 Radar Set, AN/PPS-15(V)2, Components Packed in Transport Case CY-7338/PPS-15(V)

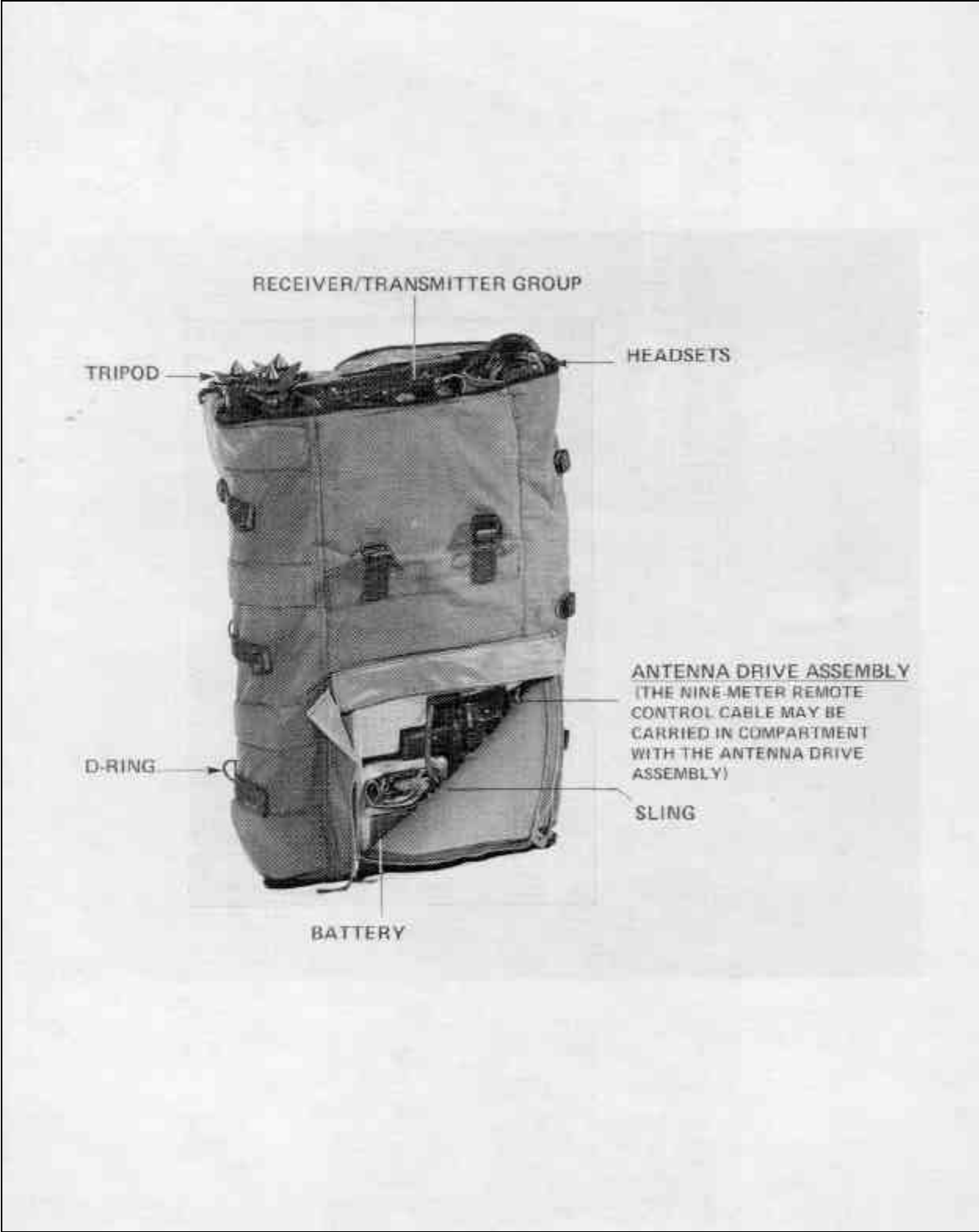

Figure 4-2 Radar Set AN/PPS-15(V)2, Components Packed in Carrying Case CY-7339/PPS-15(V)

403. Sighting and Site Selection

1. Sighting. The radar set AN/PPS-15(V)2 is limited to line-of-sight operations. Its signals will not penetrate foliage, buildings, walls, or hills but they will penetrate glass and dry canvas. The ideal radar site should be as high as possible above the area of interest to overcome (radio frequency) (RF) multipath phenomena and to obtain the best performance. Ranges over water, snow, desert, marsh, and other types of terrain are listed in this chapter, Annex B. Further information on line of sight and other siting considerations can be found in chapter 8.

404. Multiple Radar Interference

In certain tactical situations, it may be necessary to use the AN/PPS-15(V)2 radar sets in pairs. If it becomes necessary to operate two radar sets close to each other, the operating frequency of one might have to be changed slightly to prevent interference with the other to obtain the best performance. This slight frequency change can be achieved by re-tuning the transmitter. Transmitter re-tuning is not normally required and should be done only if set-to-set interference becomes a problem, and then only on direction from higher authority.

405. External Power Operation

1. The radar set may be operated using an external 24-volt battery or a 24-volt (DC) generator. Figure 4-3 illustrates the proper cables to be used and the connections required.
2. To operate the radar set using an external 24-volt (DC) power source, the following steps must be performed:
 - a. Turn the mode selector on the control indicator to the OFF position.
 - b. Remove battery, if installed (see figure 4-6, steps 1 and 2).

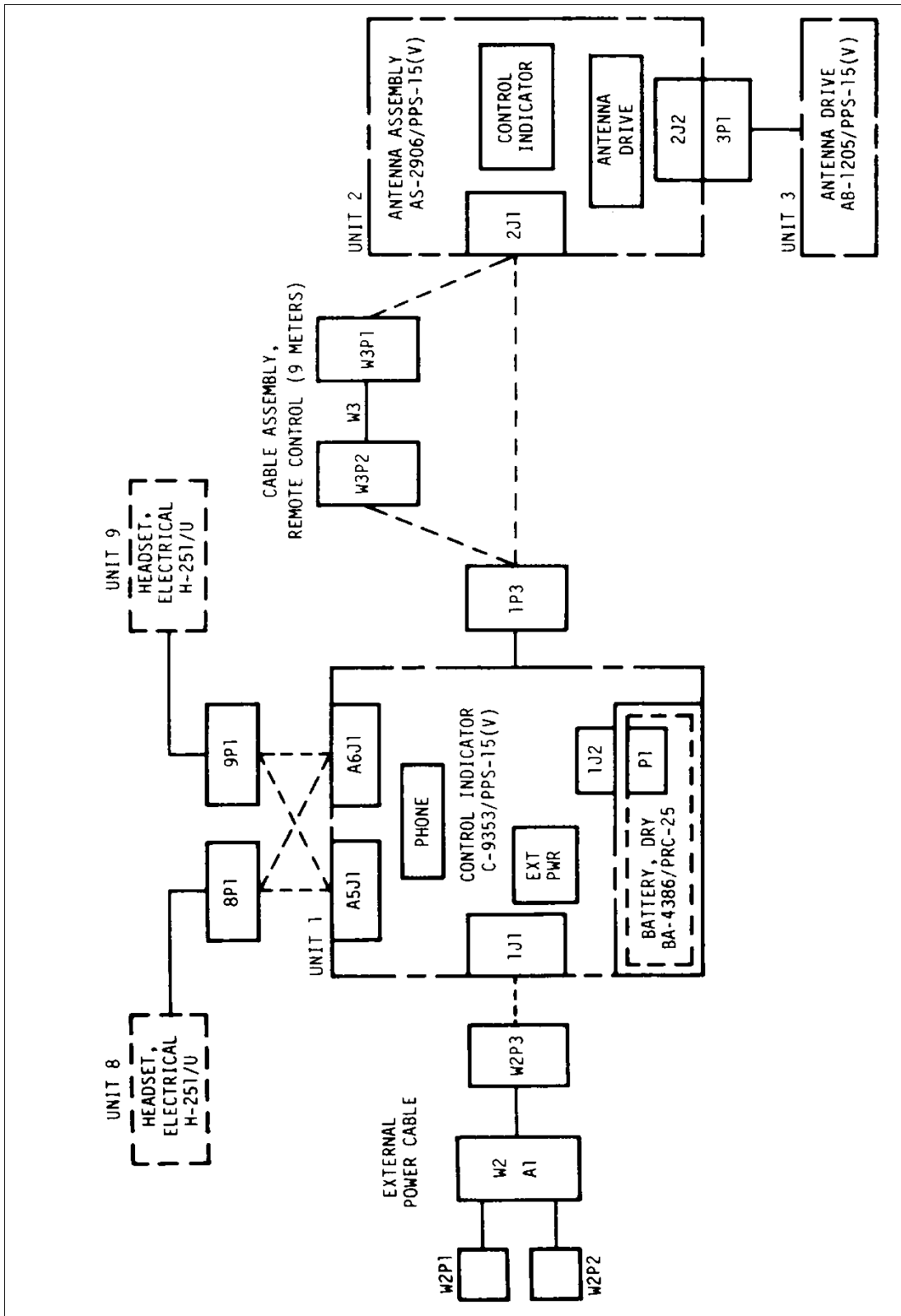

Figure 4-3 Radar Set, AN/PPS-15(V)2, Interconnection Diagram

- c. Connect the external power cable assembly W3 connector plug P3 to the EXT PWR connector receptacle J1 on the control indicator.
- d. Connect the red insulated alligator clip, P1 on the power cable to the positive battery or generator terminal and the black insulated alligator clip, P2 to the negative battery or generator terminal.

Note: A diode bridge in the external power cable assembly allows the radar set to operate properly with either alligator clip connected to the positive battery post or generator terminal of the external power source.

406. Setting Up For Remote Control Operation

1. The radar set can be operated from the local position or from a remote position.
2. To operate the radar set from the remote control position, using either the self-contained dry battery BA-4386/PRC-25 or an external battery or generator, the following steps must be performed:
 - a. Remove the control indicator from the antenna assembly by disconnecting the cable from the control indicator connector J1 on the antenna assembly and by releasing the three latches which mechanically secure the control indicator to the antenna assembly. (Refer to figure 4-11).
 - b. Connect the remote control cable assembly W3 connector plug P1 to the antenna assembly control indicator connector J1, and connect the remote control cable assembly connector plug P2 to the control indicator cable connector plug P3.

407. Tripod Mounted (Local) Position

1. To install the radar set on the tripod for local operation as shown in figure 4-4, perform the following:

CAUTION

A tiedown ring is provided on the tripod latching knob. It is necessary to use this tiedown ring under high wind conditions of more than 24 X-PH (15 MPH) to stabilize the radar set. Tiedown material is not included as part of the AN/PPS-15(V)2 radar set.

- a. Set up the tripod using the sequence of steps in figure 4-5.
- b. Install battery in the battery compartment using the sequence optional procedures for using external power source.
- c. Assemble, or verify the assembly of the control indicator and the antenna assembly to the local receiver/transmitter group configuration, using the steps shown in figure 4-7.

- d. Mount the antenna drive assembly on the tripod in the sequence shown in figure 4-8.
- e. Install the receiver/transmitter group on the antenna drive assembly and attach the headset in the sequence shown in figure 4-9.

408. Tripod Mounted (Remote) Position

- 1. The installation of the radar set on the tripod for remote position operation, as shown in figure 4-10, is performed as follows:
 - a. Set up the tripod in the sequence shown in figure 4-5.
 - b. Install the battery in the control indicator in the sequence shown in figure 4-6. Refer to art 405/2 outlining procedures for the optional use of an external power source.
 - c. Prepare the receiver/transmitter group for remote operation in the sequence shown in figure 4-11.
 - d. Mount the antenna drive assembly on the tripod in the sequence shown in figure 4-8.
 - e. Install the receiver/transmitter group on the antenna drive assembly and attach the headsets in the sequence shown in figure 4-9.

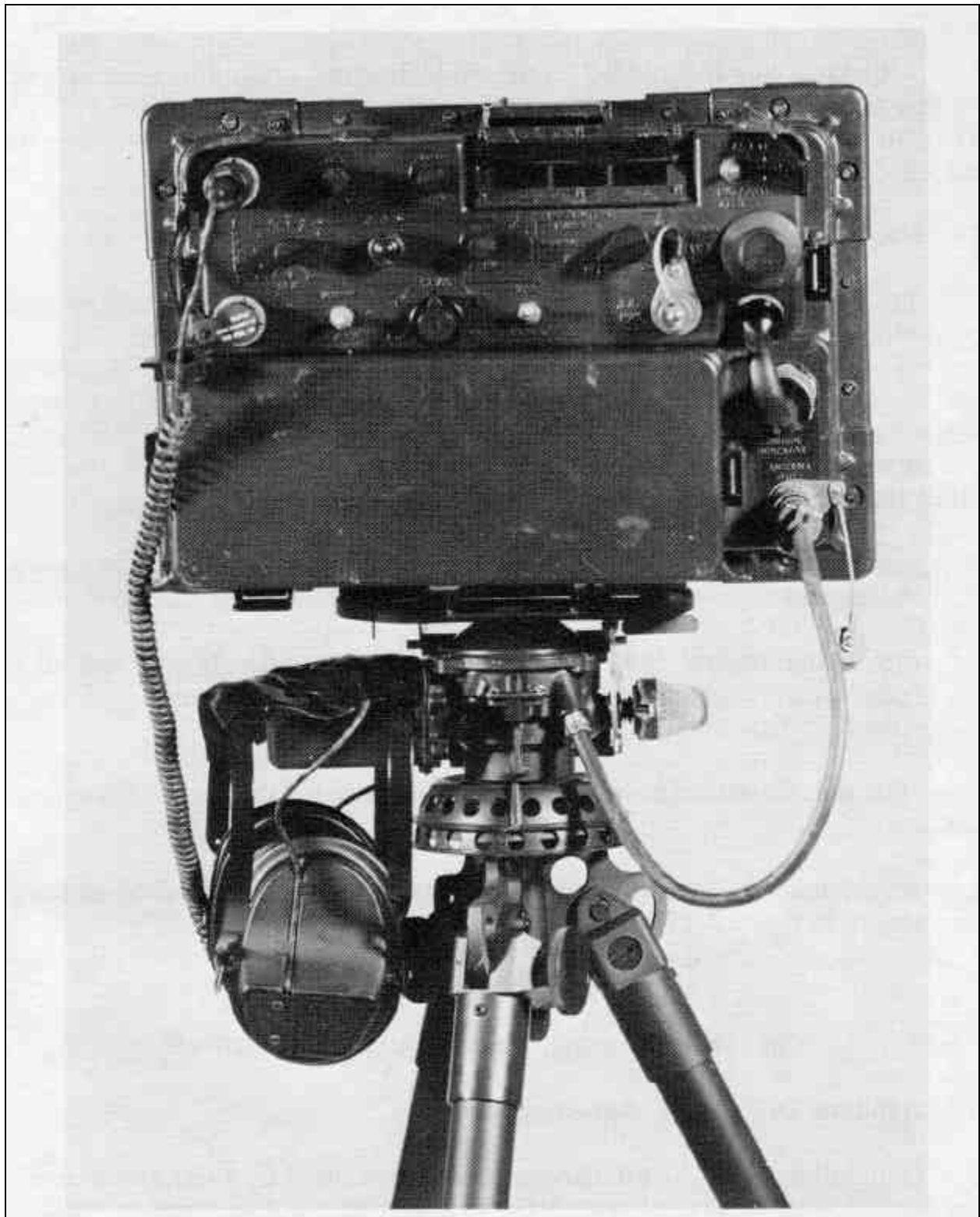

Figure 4-4 Radar Set AN/PPS-15(V)2, Tripod Mounted Local Operation Position

CAUTION

A tiedown ring is provided on the tripod latching knob. It is necessary to use this tiedown ring under high wind conditions of more than 24 KPH (15 MPH) to stabilize the radar set antenna. Tiedown material is not included as part of AN/PPS-15A radar set.

409. Hand-Held Position

1. To operate the radar from the hand-held position, only the receiver/transmitter group is needed. The operator uses the sling supplied with the radar set to support and position the receiver/transmitter group in front of him. Surveillance is performed by manually pointing the antenna to the desired azimuth and elevation. Since the antenna drive is not used for this method of operation, azimuth readout will not be observed on the control indicator. To install the radar set for hand-held operation, perform the following,:

- a. Install battery in the control indicator using the sequence of steps shown in figure 4-6.
- b. Install the control indicator and the antenna assembly in the local receiver/transmitter group configuration using the sequence of steps shown in figure 4-12.

Note: The use of external power is not recommended for this method of operation.

- c. Install the sling and connect the headsets using the sequence of steps shown in figure 4-12.

SECTION 3 - INITIAL ADJUSTMENT PROCEDURES

410. Azimuth Orientation Adjustment

1. General. Azimuth is a horizontal angle measured in a clockwise direction with 0 usually aligned with NORTH. The azimuth orientation/adjustment for the two methods of tripod operation (local and remote) are identical. The radar set may be oriented in azimuth using a compass and the radar antenna sighting pins to adjust to magnetic north. The sighting pins and a stationary (fixed) object of the known azimuth may also be used for orientation.



STEP 1. POSITION LEG ANGLE

Loosen the three leg locks (1). Adjust angle of legs so there is approximately 2 to 3 feet separation between them. Tighten the three leg locks.

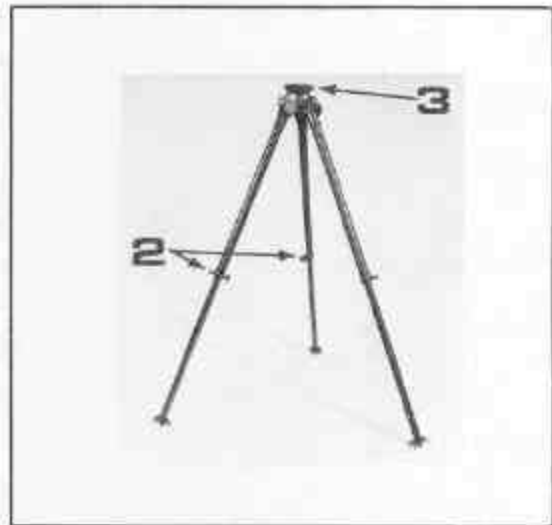

STEP 2. ADJUST LEG LENGTH

Loosen the three leg extension locks (2). Fully extend the leg to be placed in the lowest ground position and tighten the lock. Extend the other two legs as required to provide maximum support for the radar set when mounted on the tripod head (3).



STEP 3. LEVEL THE TRIPOD HEAD

Visually check the tripod head (3) to assure the head is level. If not: loosen the three leg locks (1). Position the tripod head (3) until it is approximately level. Tighten the three leg locks.



STEP 4. TIE DOWN THE TRIPOD
(REQUIRED ONLY UNDER
HIGH WIND CONDITIONS)

Obtain ropes or straps and fasten one end to the tie-down ring (4) if necessary. Secure the other end of the straps or ropes to stakes or other fixed objects.

Figure 4-5 Tripod Installation

Figure 4-5 Tripod Installation

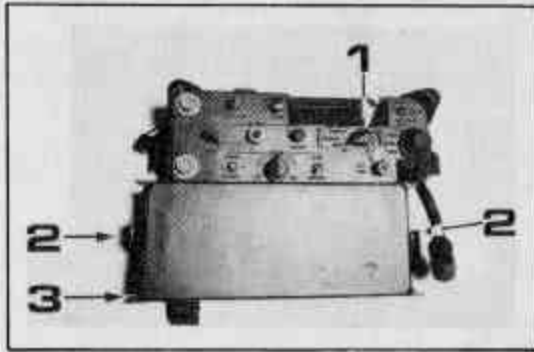

STEP 1. REMOVE BATTERY COMPARTMENT COVER

Turn MODE selector switch (1) to off. Unfasten latches (2). Remove battery compartment cover (3).

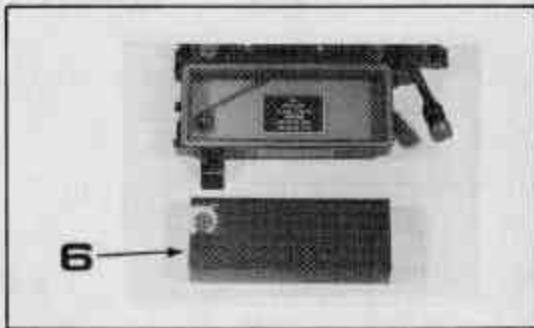

STEP 3. REMOVE SEAL FROM BATTERY

Remove the paper seal (6) covering the battery connector.

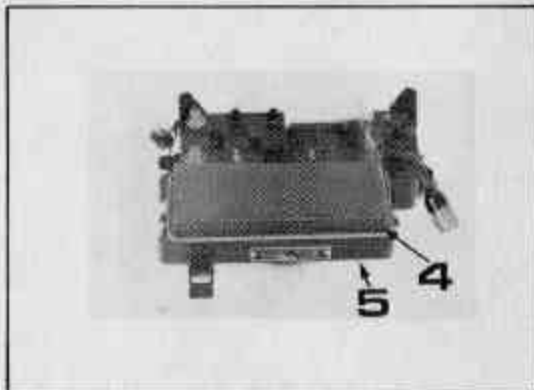

STEP 5. INSTALL BATTERY

Place battery (4) into battery compartment (5). Press on battery to mate the connectors.

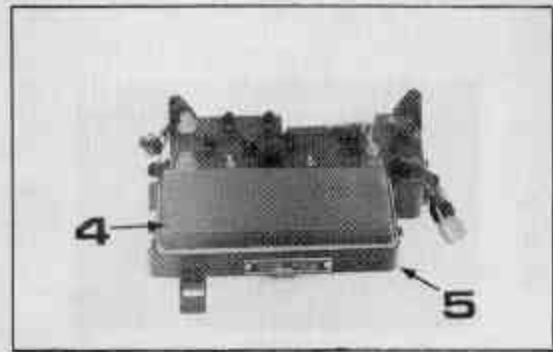

STEP 2. REMOVE DISCHARGED BATTERY (WHEN APPLICABLE)

Grasp battery (4) and lift from battery compartment (5).

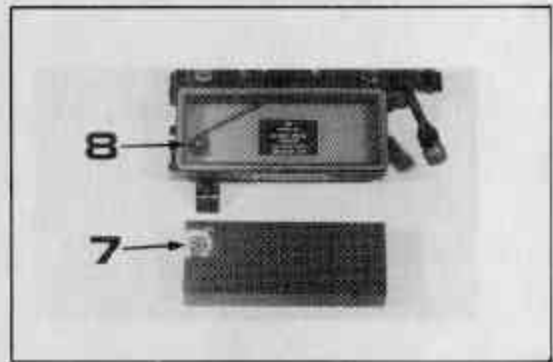

STEP 4. ORIENT CONNECTORS

Orient battery so battery connector (7) will mate with control indicator battery connector (8).

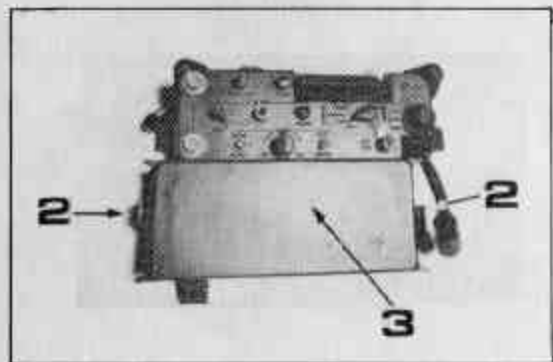

STEP 6. REPLACE BATTERY COMPARTMENT COVER

Position battery compartment cover (3) in place. Fasten the two latches (2).

Figure 4-6 Battery Installation

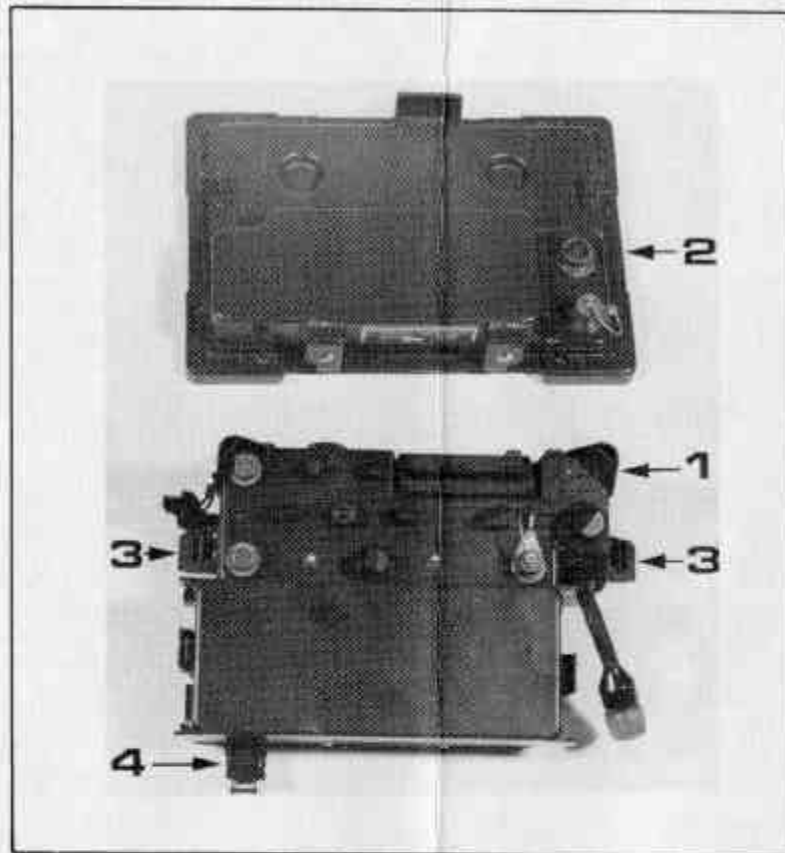

**STEP 1. MATE RECEIVER/
TRANSMITTER GROUP**

Position the control indicator (1) against the antenna assembly (2). Fasten the two latches (3). Fasten the latch (4).

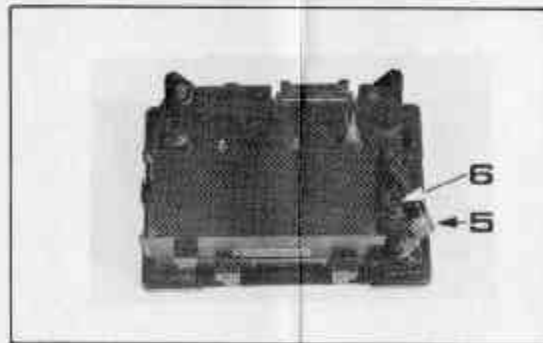

**STEP 2. CONNECT CONTROL
INDICATOR CABLE**

Connect the control indicator cable connector plug (5) to the antenna assembly CONTROL INDICATOR connector receptacle (6).

Figure 4-7 Receiver/transmitter Group, Installation for Local Operation



STEP 1. OBSERVE METHOD OF FASTENING

Note that the threads on the tripod center latching knob (1) mate with the threaded swivel type adapter assembly (2) in the base (3) of the antenna drive assembly (4).

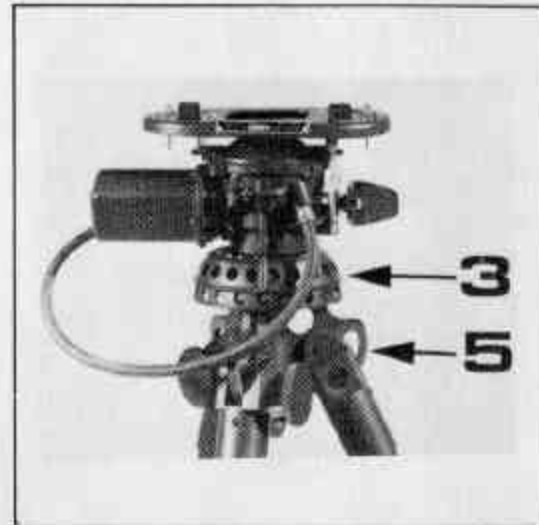

STEP 2. MOUNT ANTENNA DRIVE ASSEMBLY ON THE TRIPOD

Place the antenna drive assembly base (3) on the tripod head (5). Turn the tripod center latching knob (1) in a clockwise direction until the threads on the latch are securely engaged with the threaded adapter in the antenna drive assembly base (as shown by (1) and (2) in step (1)). Do not tighten. Level the antenna drive assembly as shown in step 3.

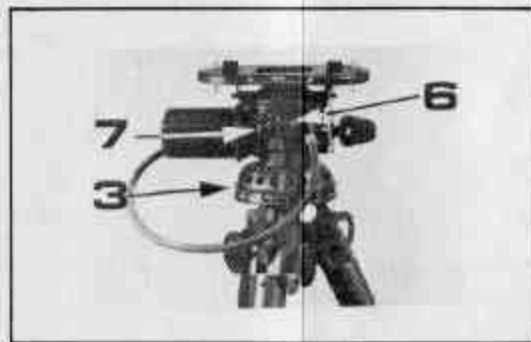

STEP 3. LEVEL THE ANTENNA DRIVE ASSEMBLY

Position the antenna base (3) on the tripod head to place the bubble on the level indicator (6) in the center of the ring. If installing the radar set at night, press and hold switch (7) to illuminate level indicator (6). Tighten the tripod center latching knob (1).

Figure 4-8 Antenna Drive Assembly, Installation

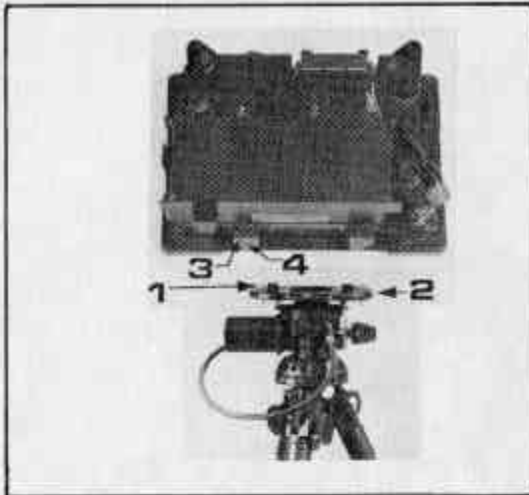

STEP 1. ORIENT ALIGNMENT PINS

Orient alignment pins (1) on the antenna drive assembly cradle (2) with the alignment holes (3) on the bottom of the antenna mounting brackets (4).

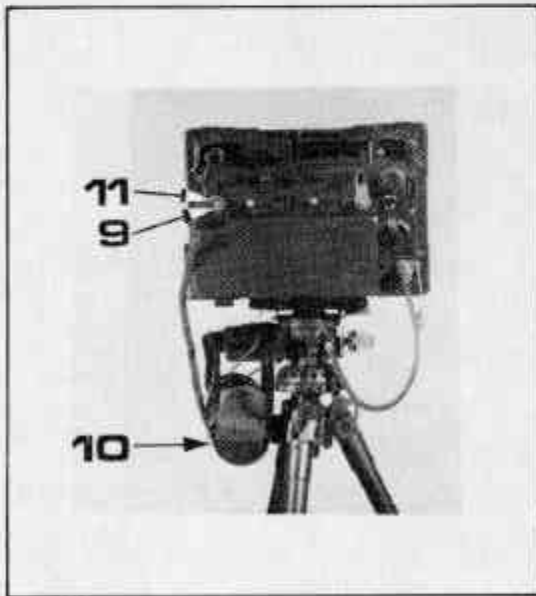

STEP 3. CONNECT HEADSETS

Secure the connector plugs (9) on the two headsets (10) to the two PHONE connector receptacles (11) on the control indicator. If it is desired to use only one headset, the plug may be connected to either PHONE receptacle.



STEP 2. SECURE ANTENNA DRIVE ASSEMBLY TO THE ANTENNA ASSEMBLY

Turn the two fasteners (5 and 6) on the antenna drive assembly cradle to the "open" position as shown by (6). Mate the antenna drive assembly and the antenna assembly. Turn the two fasteners (5 and 6) on the antenna drive assembly cradle to the locked position as shown by (5). Connect the antenna drive assembly cable connector plug (7) to the ANTENNA DRIVE connector receptacle (8), on the antenna assembly.

Figure 4-9 Receiver/transmitter Group Installation

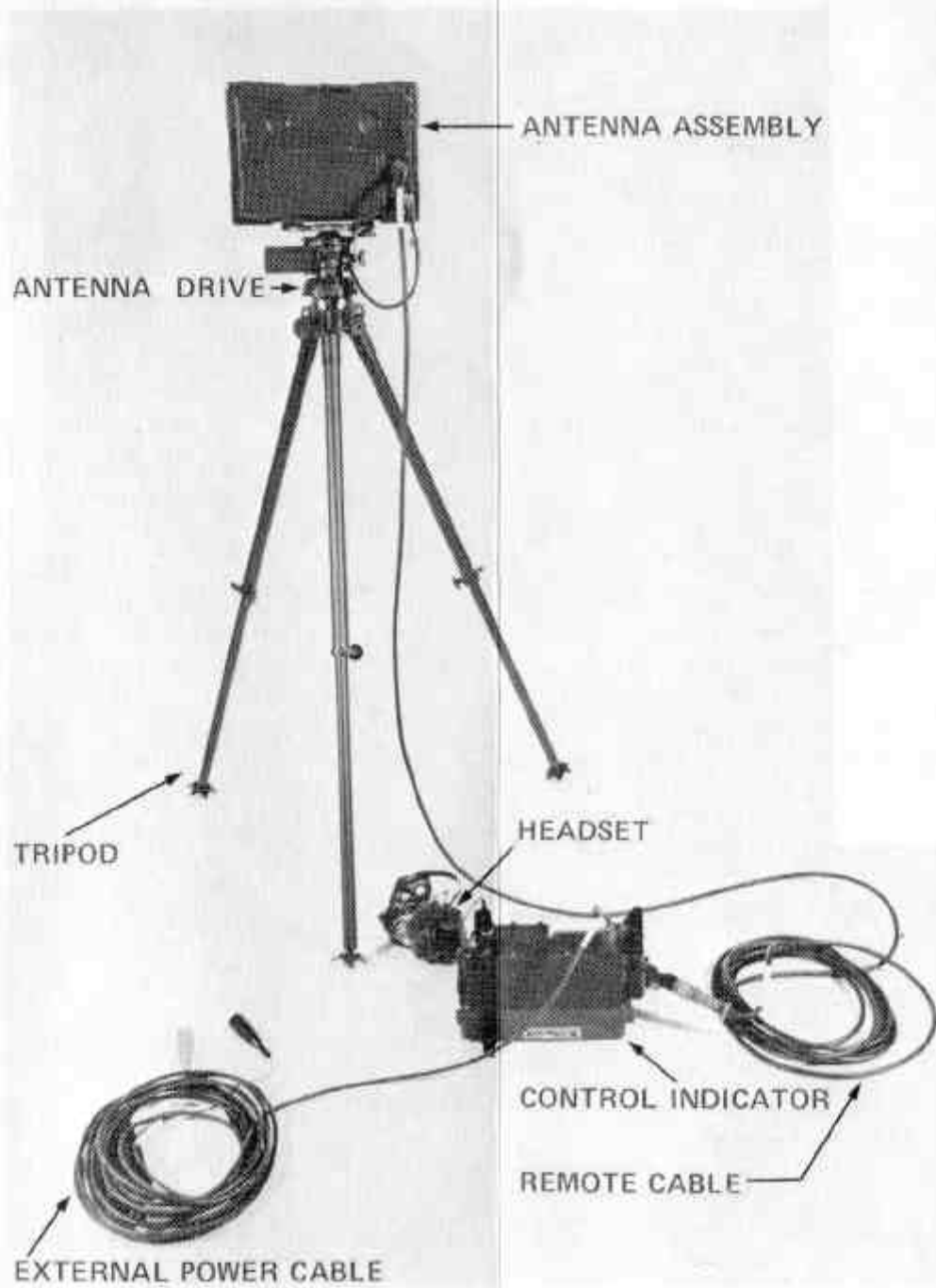

Figure 4-10 Radar Set AN/PPS 15(V)2, Tripod Mounted Remote Operating Position

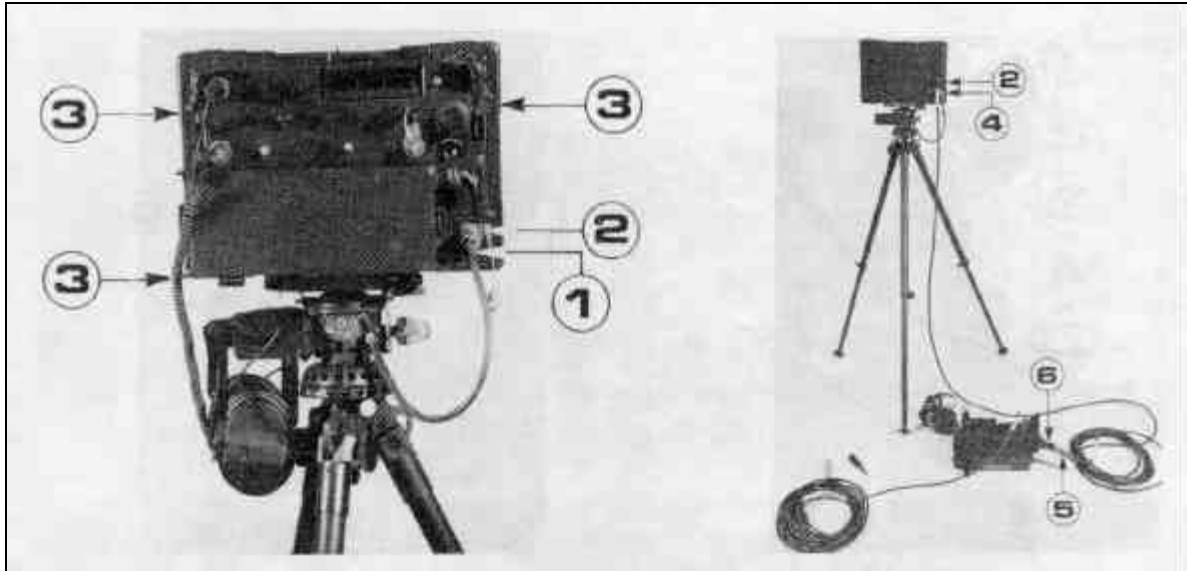

Figure 4-11 Receiver/transmitter Group, Installation for Remote Operation

STEP 1. SEPARATE RECEIVER/ TRANSMITTER GROUP

Disconnect the control indicator plug (1) from the antenna assembly CONTROL INDICATOR connector receptable (2). Unfasten the three latches (3) securing the antenna to the control. Separate the two units.

STEP 2. INSTALL REMOTE CONTROL CABLE

Connect the remote control cable female connector plug (4) to the antenna assembly CONTROL INDICATOR connector receptable (2). Connect the remote control cable male connector plug (5) to the control indicator cable female connector plug (6).

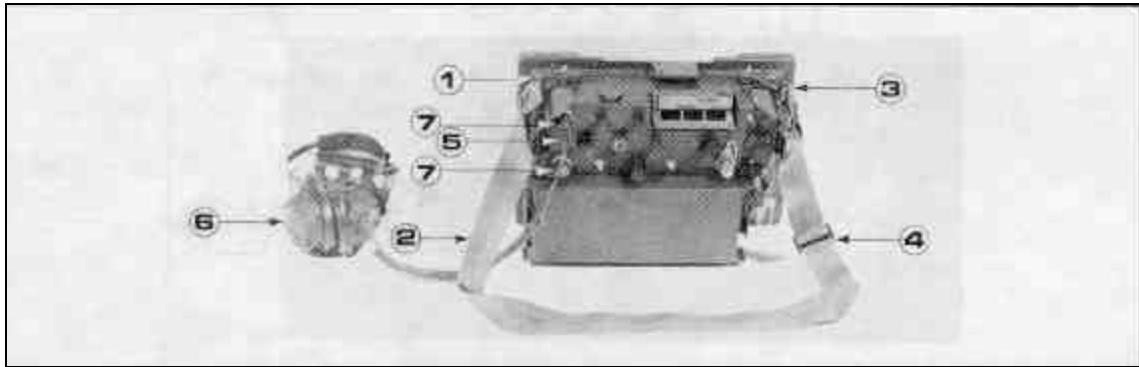

Figure 4-12 Radar Set AN/PPS-15(V)2, Installation, Hand-held Position

STEP 1. INSTALL SLING

Connect the snaps (1) on each end of the sling (2) to the rings (3) on the top of receiver/transmitter group. Sling length may be adjusted to operators comfort by buckle (4).

STEP 2. CONNECT HEADSETS

Connect the connector plugs (5) on the headset (6) to either PHONE connector receptacle (7) on the control indicator. If it is desired to use two headsets, connect the second headset to the other receptacle.

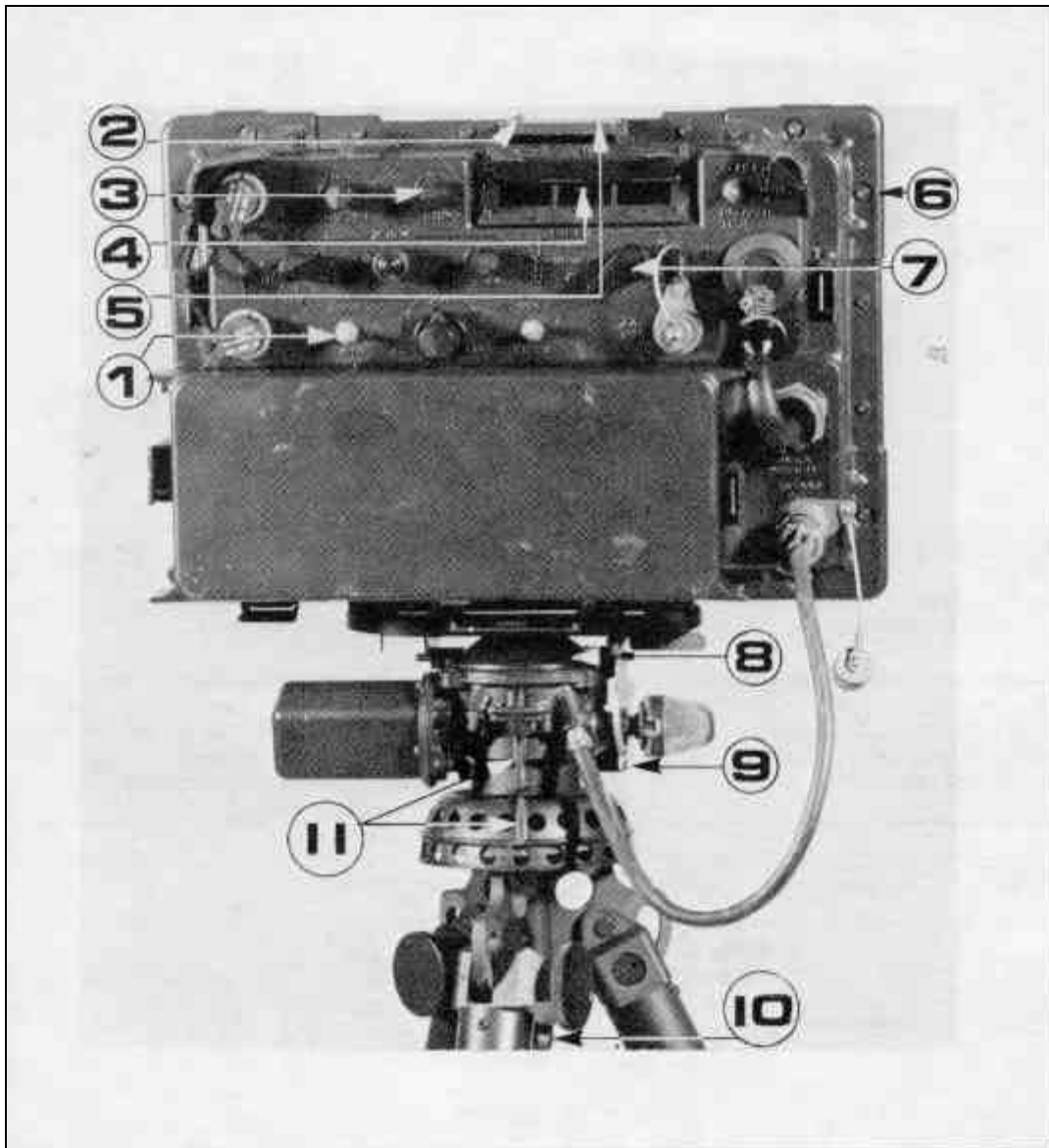

- | | | | |
|----|---------------|-----|--------------------------|
| 1. | Manual Search | 7. | Mode Switch |
| 2. | Sighting Pins | 8. | Bubble Level |
| 3. | Illum | 9. | Antenna Drive |
| 4. | Az-Mils | 10. | Center Latching Knob |
| 5. | Compass Seat | 11. | Azimuth Reference Blades |
| 6. | Antenna | | |

Figure 4-13 Azimuth Orientation Adjustment

2. Procedure When Using the Compass

- a. Place a compass on the antenna assembly along-side the sighting pins (see figure 4-13).
- b. Grasp the antenna and manually turn the antenna until the zero reference blades (see figure 4-13) on the antenna drive assembly are aligned.
- c. Grasp the receiver/transmitter group to prevent it from falling and loosen the centre latching knob (see figure 4-13) on the tripod.
- d. Keeping the receiver/transmitter group in a level condition, rotate the radar set on the ball joint between the tripod and antenna drive assembly for a magnetic north sighting. Use the compass in conjunction with the sighting pins. The compass needle, which always points north, will be parallel with a line envisioned between the two sighting pins when the north position is reached.
- e. Verify that the zero reference blades are still aligned. Then, while holding the radar set level and observing the bubble level, tighten the centre latching knob on the tripod.

3. Procedure for Using a Fixed Object

- a. Perform the preliminary starting procedures described in art 606.
- b. Position the mode selector switch (see figure 4-13) on the control indicator to the SEARCH-MANUAL position.
- c. Rotate the illum control (see figure 4-13) on the control indicator in a clockwise direction until a display can be seen on the AZ-MILS indicator.
- d. Select a fixed object of known azimuth to the radar set site and determine the azimuth of the target in mils.
- e. Using the SCAN MANUAL SEARCH switch (see figure 4-13) on the control indicator, rotate the radar set with the drive motor until the AZ-MILS indicator (see figure 4-13) displays the reading in mils as determined in sub-para d.

Note: Normally, the radar set will not be directed toward the selected target after completion of this step.

- f. Loosen the centre latching knob on the radar tripod (see figure 4-13) while holding the receiver/transmitter group to prevent it from falling.
- g. Rotate the radar set on the ball joint between the tripod and the antenna drive assembly and align the radar set with the selected target, using the sighting pins.

- h. Verify that the AZ-MILS indicator still shows the mils indication established in subpara e; then, while holding the radar set level and observing the bubble level, tighten the centre latching knob on the tripod.

411. Levelling Adjustment

It is necessary that the antenna drive assembly be level to permit the radar set to provide accurate target information. The levelling adjustment is performed as part of the installation procedure outlined in arts 406 and 407 for tripod-mounted close-coupled and remote operation. Any movement of the radar set on the tripod or any movement of the tripod will affect the levelling. Therefore, the level adjustment should be checked immediately prior to operation of the radar set and readjusted if necessary. Procedures for making this adjustment are outlined in figure 4-8, step 3. Since the tripod and the antenna drive assembly are not used in hand-held operation, this adjustment is not performed. However, it is necessary that the operator maintain the radar set as level as possible when operating from the hand-held position.

412. Scan Centre Adjustment

1. General. Scan centre adjustment is required when the radar set is initially installed. When a new sector is to be automatically scanned, the scan centre must be in the automatic mode of operation (SEARCH-AUTO) which is used only in the terrestrial surveillance application described in art 607.

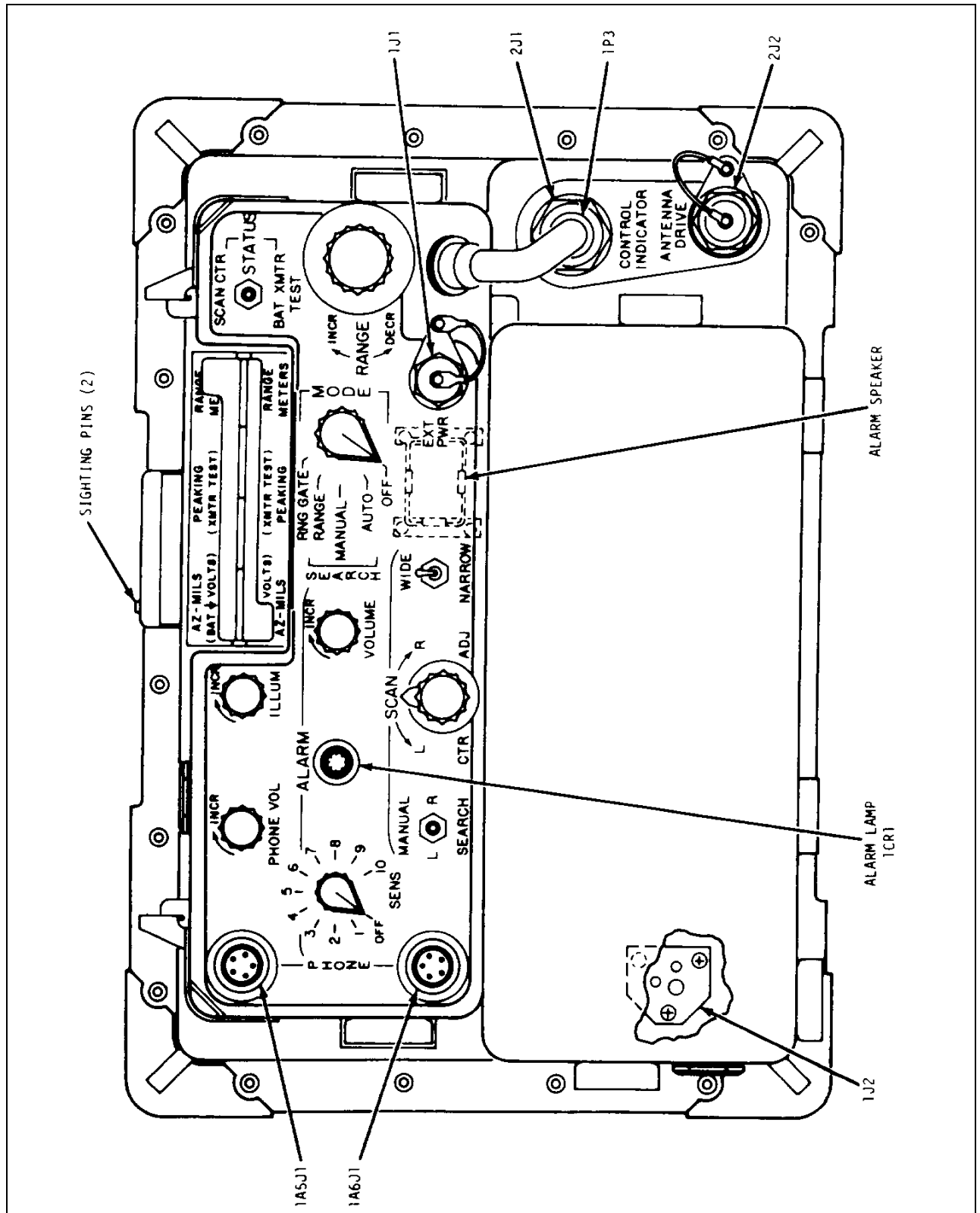

Figure 4-14 Receiver/Transmitter Group, Controls, and Indicators

2. Procedure

- a. Verify the azimuth zero direction established by the azimuth orientation adjustment (see art 409).

Note: Refer to figure 4-14 for identification of controls and indicators.

- b. Rotate the mode selector switch to the SEARCH-MANUAL position.
- c. Press the SCAN-MANUAL SEARCH switch to the L or the R position and allow the radar set to scan until the centre of the desired scanning sector is perpendicular to the flat surface of the antenna: then release the SCAN-MANUAL SEARCH switch. Note the reading displayed on the AZ-MILS (bat volts) indicator.

Note: If the antenna reaches the mechanical stop before the centre of the desired scan sector is reached, press the SCAN-MANUAL search switch in the opposite direction and permit the radar to scan until the desired scan is reached.

- d. Loosen the locking knob on the SCAN-CTR-ADJ control. Rotate the SCAN-CTR-ADJ control until the reading on the AZ-MILS (bat test) indicator is equal to the (-0005 mils) of the azimuth reading noted in subpara c. Release the status switch and tighten the locking knob on the SCAN-CTR-ADJ control.
- e. Check the adjustment by rotating the mode select switch to SEARCH-AUTO and confirm that the radar set automatically scans art 800- or 1 600-mil sector about the newly adjusted scan centre point.

413. Elevation Adjustment

1. General. To provide maximum signal strength, the flat surface of the antenna must be at nearly right angles to the target area. To accomplish this, the elevation adjustment must be made during the initial setting up of the radar set, and at any time the scanned sector is changed to a new sector where the slope of the terrain differs. While the procedures which follow pertain to tripod-mounted operation, elevation must also be considered in the hand-held position. The operator must physically maintain the proper elevation by directing the radar set towards the target area.

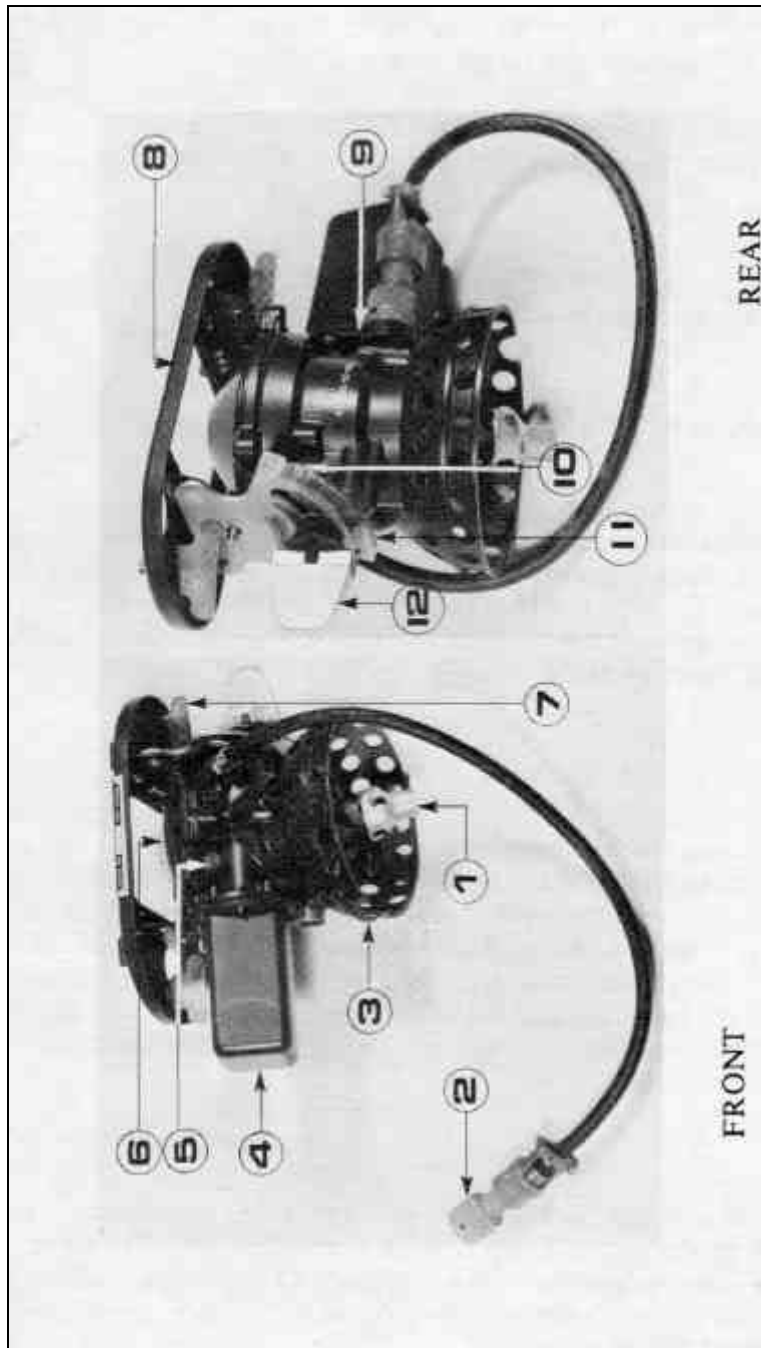

- | | | |
|---------------------|-----------------|--|
| 1. Adapter Assembly | 5. Light Switch | 9. Dummy Receptacle |
| 2. 3P1 | 6. Bubble Level | 10. Elevation Dial Index |
| 3. Base | 7. Antenna Lock | 11. Elevation Dial Assembly |
| 4. Drive Motor | 8. Cradle | 12. Elevation Control/Dial Lock Unlocked |

Figure 4-15 Antenna Drive Assembly, Controls Indicators, and Connectors

2. Procedure. Refer to figure 4-15 for identification of elevation control knob, elevation dial, and elevation dial index. AU other control are identified in figure 4-14:
 - a. Verify that the radar set is level (see figure 4-8).
 - b. Turn the mode selector to the SEARCH-MANUAL position.
 - c. Identify the point where radar surveillance is to be made, or if a large area is to be scanned, identify a point of average elevation within the scan area. Press the SCAN-MANUAL SEARCH switch to L or R to rotate the radar set until the antenna azimuth is pointing directly at the selected point, then release the switch.
 - d. Loosen the latching mechanism on the elevation control knob. While using using the sighting pins on the top of the antenna, rotate the elevation control knob until the sighting pins are aligned with the selected point in the area to be observed. An optional method of setting the elevation (when it is possible to determine the elevation in mils of the target area with respect to the radar set site) is to use the calibrated elevation dial on the antenna drive assembly. In this case, the elevation dial index points to the correct elevation.
 - e. To check the elevation adjustment (or to make a fine adjustment while on target and operating the equipment as outlined in arts 607 through 609), turn the mode selector switch to RNG GATE and turn the elevation control until the maximum number of dots is displayed on the peaking (XMTR test) indicator.

414. Alarm Sensitivity Adjustment

1. General. When the radar set detects a moving target, the alarm lamp will blink and the alarm loudspeaker will produce a tone. However, false target information can be provided from stationary objects such as grass and foliage when there is sufficient wind to cause them to sway. The function of the alarm sensitivity adjustment is to eliminate these false target alarms but retain as much sensitivity as possible to detect actual moving targets. Normally, the alarm sensitivity adjustment will be required at the initial start of operation and at any time during operation that the sector under surveillance is changed, or any time a change in climatic conditions (such as change in wind speed or rain) occurs during operation.
2. Procedure. Refer to figure 4-14 for location of controls and indicators. As a preliminary procedure to performing the adjustment, operate the radar set in one of the applications outlined in arts 607 through 609.
 - a. If performing terrestrial surveillance as outlined para 607, set the mode selector to the SEARCH-AUTO position. If using the radar set for target tracking or fixed-point observation as outlined in arts 608 and 609, turn the mode selector switch to the SEARCH-MANUAL position.

- b. Verify that there are no moving objects within the beam of the radar's transmitted RF signal (if in SEARCH-AUTO mode, observe only the portion(s) of the scan sector which do not have any moving targets). Then rotate the alarm sens control fully clockwise to 10.
- c. With the alarm sens control set to 10, its maximum sensitivity point, it is probable that the alarm lamp will blink and the alarm loudspeaker will produce a tone. Adjust the control for the desired listening level.
- d. Slowly rotate the alarm sens control in a counterclockwise direction to decrease sensitivity until the alarm indications stop. This step provides a coarse adjustment of the alarm sensitivity.
- e. Maximum sensitivity can be obtained by noting the setting of the alarm sens control made in the preceding step and then turning the alarm sens control clockwise until an alarm condition occurs. Note the setting of the alarm sens control and set the alarm sens at a point between the two noted positions.
- f. To check the alarm circuitry simulate a target by waving your hand in front of the antenna. While waving your hand, the lamp should blink and the alarm tone should be heard. As soon as the hand-waving is stopped, the alarm lamp should extinguish and the alarm speaker should be silent.

SECTION 4 - MOVEMENT TO A NEW SITE

415. General

The radar set, AN/PPS-15(V)2, can be disassembled and packed in the carrying case (item CY-7339/PPS-15(V)) for backpack transport, or the packed carrying case can be attached to a packframe for transport by one man. In addition, the packed carrying case may be placed in a parachutist's container for airdrop. For vehicular movement or limited storage, the packed carrying case is placed in a transport case (item CY-7338/PPS-15(V)), and the lid secured to guard against damage.

416. Disassembly and Packing

1. Use the following step-by-step procedure to disassemble the equipment from either the local or remote operation positions and to pack the equipment in the carrying case for movement. When the equipment is being operated from the hand-held position, the tripod, antenna drive assembly, and cables will normally have already been packed in the carrying case. Therefore, the following steps relating to these items do not apply (refer to figures 4-7 and 4-9 for identification of units and points of disassembly and to figure 4-2 for proper placement of units and components in the carrying case):

- a. Turn the mode selector switch to the OFF position.
- b. If the radar set is being operated from an external power source, disconnect the external power cable from the external power source and from the EXT PWR connector on the control indicator.
- c. Disconnect the headset(s) from the control indicator phone connectors and store the headsets in the carrying case.
- d. If the radar set is being operated from the remote position, perform the following -
 - (1) Disconnect the remote control cable from the antenna assembly control indicator connector J1 and from the control indicator connector plug P3.
 - (2) Secure the control indicator to the antenna assembly by fastening the three latches on the control indicator.
 - (3) Connect the control indicator cable connector plug P3 to the antenna assembly control indicator connector receptacle J1.
 - (4) Secure dust covers to the unused connectors.
- e. Disconnect the antenna drive assembly cable connector plug PI from the antenna assembly antenna drive connector receptacle J2. Connect the plug to the dummy connector on the antenna drive assembly.

- f. Loosen the two quarter-turn fasteners securing the receiver/transmitter group to the antenna drive assembly. Remove the receiver/transmitter group and store it in the carrying case.
- g. Loosen the centre latching knob on the underside of the tripod hub and remove the antenna drive assembly. Store the antenna drive assembly in the carrying case.
- h. Store the tripod in the carrying case as follows-
 - (1) Remove any tiedown ropes or straps that may have been used.
 - (2) Loosen the three latches securing the legs to the tripod hub and fold the legs together. Tighten the latches.
 - (3) Always place the tripod with the head pointing down into the carrying case.
- j. Store the cable in the carrying case front pocket.
- k. Store the carrying strap in the carrying case front pocket.
- m. Close the carrying case front pocket.
- n. Close the carrying case weather cap and fasten the two straps.

417. Use of C2 Rucksack Frame

- 1. After the radar set has been packed in the carrying case, it may be attached to the C2 rucksack frame. Refer to figure 4-16 and follow these step-by-step procedures to secure the radar set carrying case to the rucksack frame:
 - a. Lay the carrying case flat with the shoulder straps facing up.
 - b. Position the rucksack frame on the backpack as shown in figure 4-16.
 - c. Using the straps provided with the rucksack, secure one strap to the centre cross brace of the rucksack frame.
 - d. Lay the strap on top of the vertical rucksack frame brace and run the strap through the middle D-ring on the carrying case.
 - e. Run the strap over the top of the vertical brace and under the middle cross brace, then through the top D-ring on the carrying case.
 - f. Run the strap over the top and around the vertical cross brace, then down and around the under side of the middle cross brace and up to the top cross brace of the packframe.

- g. Take up the slack in the strap until the packframe is snug attached to the top cross brace of the backpack.
- h. Since each side of the packframe is identically secured, repeat the above steps for the other side.

418. Preparation For Backpacking Through Water

No special precaution is required for fording a body of water, if the radar set is packed in either the carrying case or transport case.

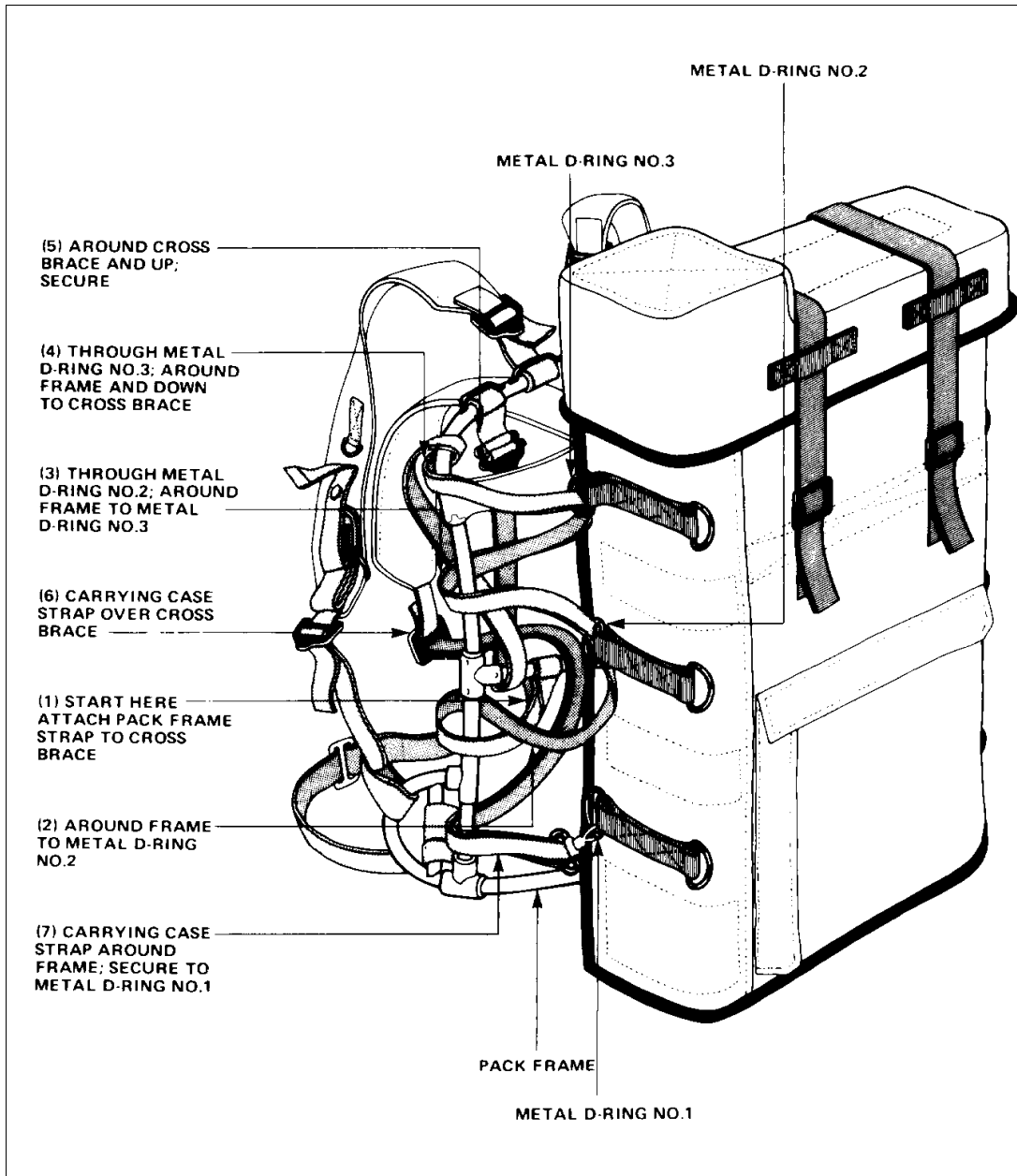

NOTE: Bracketed numbers are steps for attaching carrying case to rucksack frame and should be performed in sequence.

Figure 4-16 Radar Set, AN/PPS-15(V)2, Packed in Carrying Case and Attached to the C2 Rucksack Frame

419. Packing The Radar Set In The Transport Case

1. If movement involves transport by vehicle, place the radar set in its transport case using the following procedures:
 - a. Disassemble and pack the radar set in the carrying case as outlined in art 415.
 - b. Unlatch the four latches on the transport case and remove the cover as shown in figure 4-2.
 - c. Remove the remote control cable and external power cable from temporary storage in the carrying case.
 - d. Place the remote control cable and external power cable in the compartments in the bottom of the transport case. Close the flap to cover the cables.
 - e. Place the spare battery in its compartment in the transport case.
 - f. Place the packed carrying case in the transport case.
 - g. Place the Ed on the transport case and secure it with the four latches.

(420 to 499 not allocated)

	Contr ol Indica tor	5-1		X								
	Anten na Drive	5-1		X								
3.	Lamp s											
	Alarm	5-1	X									
	Elevat ion	5-2			X							
4.	Cable s	-	X		X		X		X	X		
5.	Screw s	-	X	X	X							
6.	Latch es	2-2	X			X						X
7.	Seal, batter y conne ctor P1					X						
8.	Anten na face	2-3		X								
9.	Elevat ion dial	5-2			X							
10.	Bubbl e level	5-2			X							
11.	Azim uth zero refere nce blades	5-2			X							
12.	Align ment pins	2-4			X							
13.	Quart er turn fasten	2-4			X							

	Illumi nation	5-2		X								
28.	Contr ols											
	Range	5-1	X									
	Scan- Ctr Adj	5-1	X									
	Alarm Sens	5-1	X									
	Phone Vol	5-1	X									
	Alarm Volu me	5-1	X									
	Illum	5-1	X									
	Elevat ion	5-2			X							
29.	Indica tors											
	Peaki ng (XMT R TEST)	5-1	X									
	AZ- MILS (Bat Volts)	5-1	X									
	Range Meter s	5-1	X									

Table 4A-1 Visual Component Inspection Check List

RANGE TECHNICAL CHARACTERISTICS

Type of Target	Target size (square metres)	Velocity in KPH (radial)		Range in metres		Accuracy probable error (metres)	Resolution between separate targets (metres)	Determination
		Min	Max	Min	Max			
Walking target	0.5	.8 (0.5 mph)	56 (35 mph)	50	1500	20	35	Headset audio; digital numeric readout
Crawling target	0.05	(0.5 mph)	(35 mph)	50	500	20	35	Headset audio; digital numeric readout
Vehicle	10.0	.8 (0.5 mph)	56 (35 mph)	50	3000	20	35	Headset audio; digital numeric readout

CHAPTER 5

LOCATION OF CONTROLS AND INDICATIONS

501. General

This chapter describes the controls that are used to align the radar set. Figures 5-1 through 5-3 are furnished to provide ready references for location of each control connector and indicator. Tables 5-1 through 5-3 identify and outline the functions of all connectors, controls, and indicators needed for installation, alignment, and operation of the radar set.

Serial	Control or Indicator (See Figure 5-1)	Type	Function
(a)	(b)	(c)	(d)
1	MODE selector	5-position rotary switch	<p>Turns system off or on (by selection of one of four operational modes)</p> <ul style="list-style-type: none"> a. OFF position removes power from the system. b. SEARCH-AUTO position applies power to the system and provides continuous scan operation. Targets at all ranges are detected. c. SEARCH-MANUAL position applies power to the system and conditions the radar set for manual scanning operations. Targets at all ranges are detected. d. SEARCH-RANGE position applies power to the system and provides simultaneous all-ranges visual target data. e. RNG GATE position applies power to the system and provides discrete (fine range) measurements. <p style="text-align: center;">Note</p> <p style="text-align: center;">Only targets at the range displayed by the RANGE METRES indicator are detected.</p>
2	RANGE control	Variable resistor	Varies the DC voltage applied to the RANGE METRES indicator circuit, providing a display from 50 to 3000 metres, when the MODE selector is in the SEARCH-RANGE or RNG GATE position.
3	SCAN-WIDE/ NARROW switch	Two-position toggle switch	Selects either WIDE (1600 ∇ 200 mils) or NARROW (800 ∇ 100 mils) automatic scan width.
4	SCAN-MANUAL SEARCH switch	Three-position, spring-loaded, toggle	Provides manual selection of antenna scan direction (L-left or R-right) by controlling polarity of input signal to the

		switch	motor drive circuit. Centre position of switch is "off".
5	SCAN-CTR ADJ	Variable resistor	Permits the scan centre to be set to all relative positions in the full 6 400 mil circle by varying the voltage applied to the scan control circuits. A lock is provided to secure the selected position. The scan centre control position is indicated on the AZ-MILS (BAT VOLTS) indicator when the STATUS switch is set at SCAN-CTR (scan-centre).
6	STATUS switch	Three-position, spring-loaded, toggle switch. Centre position is operate position.	Selects either SCAN-CTR or BAT/XMTR TEST (battery/transmitter test) status. The BAT/XMTR TEST position activates battery test circuits, display voltage and indicates operational condition of the radar set. The SCAN-CTR switch position enables displays the scan centre control setting on the AZ MILS (BAT VOLTS) indicator. Centre position of the switch is operate.
7	ALARM-SENS	Variable resistor	Energizes automatic alarm circuitry and provides sensitivity control for the threshold level of the automatic alarm circuits under varying wind conditions.
8	ALARM-VOLUME control	Variable resistor	Varies the voltage applied to the audible alarm circuits to control alarm speaker output volume, or to deactivate it.
9	ALARM speaker	Loudspeaker	Provides an audible tone alarm upon detection of target.
10	ALARM lamp indicator	Light emitting diode	Provides visual alarm indication upon detection of targets.
11	PHONE VOL control	Variable resistor	Varies voltage to control audio output level to the headsets.
12	ILLUM control	Variable resistor	Controls illumination of the AZ-MILS (BAT VOLTS), PEAKING (SMTR TEST) and RANGE METRES indicators from "off" to "full brightness".
13	AZ-MILS (BAT VOLTS)	Light emitting diode	Electronic digital numeric readout displays antenna azimuth in mils when STATUS switch is in centre (operate position). With STATUS switch in BAT/XMTR TEST position, indicates condition of internal or external power sources in volts. With STATUS switch in SCAN-CTR

			position indicates setting of SCAN-CRT-ADJ control in mils.
14	RANGE METRES indicator	Light emitting diode 4-digit indicator	Displays digital indication of target range in metres when the MODE selector is in the SEARCH-RANGE or RNG GATE positions.
15	PEAKING (XMTR TEST) indicator	Light emitting diode bar indicator	Bar display provides visual indication of ranging circuit outputs when range gate is positioned on target and the MODE selector is in SEARCH-RANGE or RNG GATE. With STATUS switch in BAT/XMTR TEST position provides dots to indicate go no-go condition of transmitter.
16	PHONE connectors	Connector, receptacle	Provides connections for the two headset cable connector plugs to pass audio doppler signals from receiver/transmitter group to headset.
17	EXT PWR connector Control indicator cable connector	Connector, receptacle Connector, plug	Used to connect external power cable W2 to an external power source. Provides cable connection between the control indicator and the antenna assembly.
18	CONTROL INDICATOR	Connector, receptacle	Provides cable connection on the antenna assembly for the control indicator connector plug.
19	ANTENNA DRIVE connector	Connector, receptacle	Provides cable connection on the antenna assembly for the antenna drive connector plug.

Table 5-1 Receiver Transmitter Group, Indicators, Controls, and Connectors

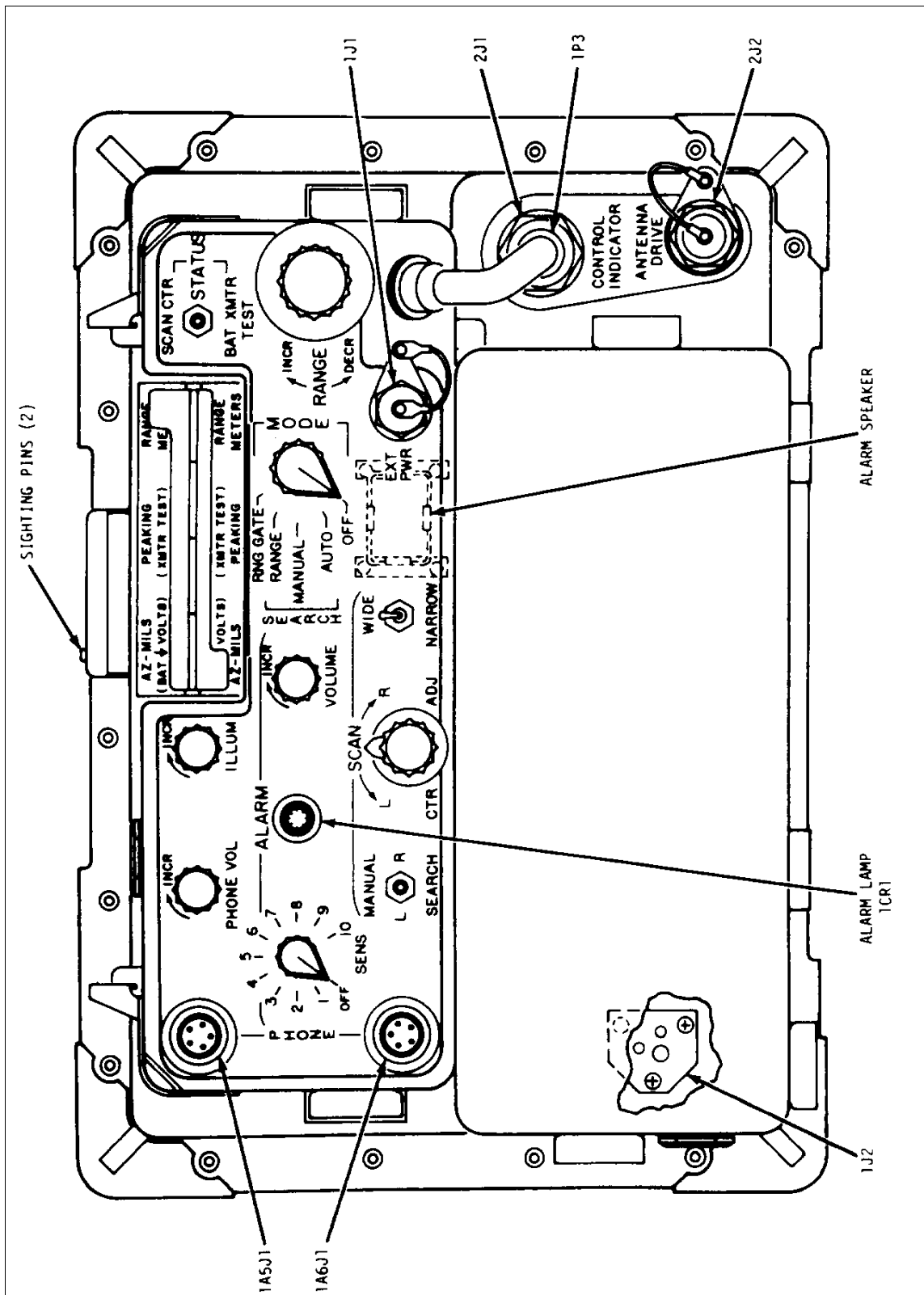

Figure 5-1 Receiver Transmitter Group Controls Indicators and Connectors

Serial	Control or Indicator (See Figure 5-2)	Type	Function
(a)	(b)	(c)	(d)
1	Illumination switch	Spring-loaded, momentary-on push button switch	Used to energize light emitting diodes to illuminate ELEVATION dial and bubble level.
2	Bubble level indicator	Circular centred bubble level	Indicates level condition of the radar set.
3	Azimuth zero reference blades	Vertical bars	Used to mechanically zero the radar set in azimuth for tripod operation.
4	ELEVATION control	Geared control	Used to manually adjust the radar set in elevation. Contains a locking device to maintain selected elevation.
5	ELEVATION dial	Curved scale graduated in mils x 100	Scale and pointer indicates elevation and angle of target from -600 (∇50) mils (-33.75E) to 400 50 mils (-27.50E).
6	Antenna drive connector	Connector plug	Used to provide electrical connection between the antenna drive and the antenna assembly.

Table 5-2 Antenna Drive AB-1205/PPS-15(V), indicators, Controls, and Connectors

Serial	Control or Indicator (See Figure 5-3)	Type	Function
(a)	(b)	(c)	(d)
1	Centre latching knob	Spring loaded, threaded stud	Secures the antenna drive assembly to the radar tripod.
2	Upper leg lock knobs (3 each)	Threaded stud and clamp	When unlocked allows the tripod legs to be spread to the desired angle. When locked secures the tripod legs.
3	Lower leg lock knobs (3 each)	Threaded stud and clamp	When unlocked allows the lower leg sections to be extended to the desired length. When locked secures the lower leg sections in place.

Table 5-3 Radar Tripod MT-3800/PPS-15(V), Controls

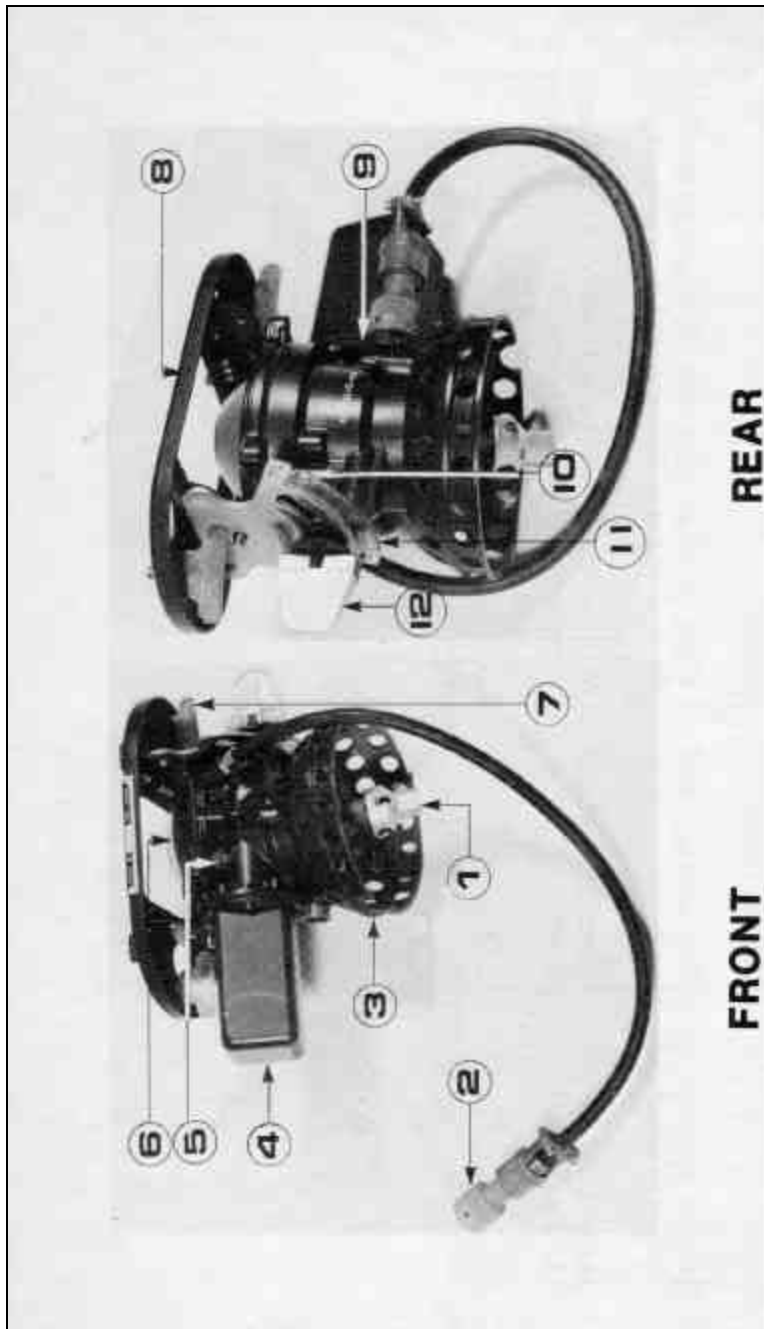

- | | | |
|---------------------|-----------------|--|
| 1. Adapter Assembly | 5. Light Switch | 9. Dummy Receptacle |
| 2. 3P1 | 6. Bubble Level | 10. Elevation Dial Index |
| 3. Base | 7. Antenna Lock | 11. Elevation Dial Assembly |
| 4. Drive Motor | 8. Cradle | 12. Elevation Control/Dial Lock (Unlocked) |

Figure 5-2 Antenna Drive Assembly, Controls, Indicators, and Connectors

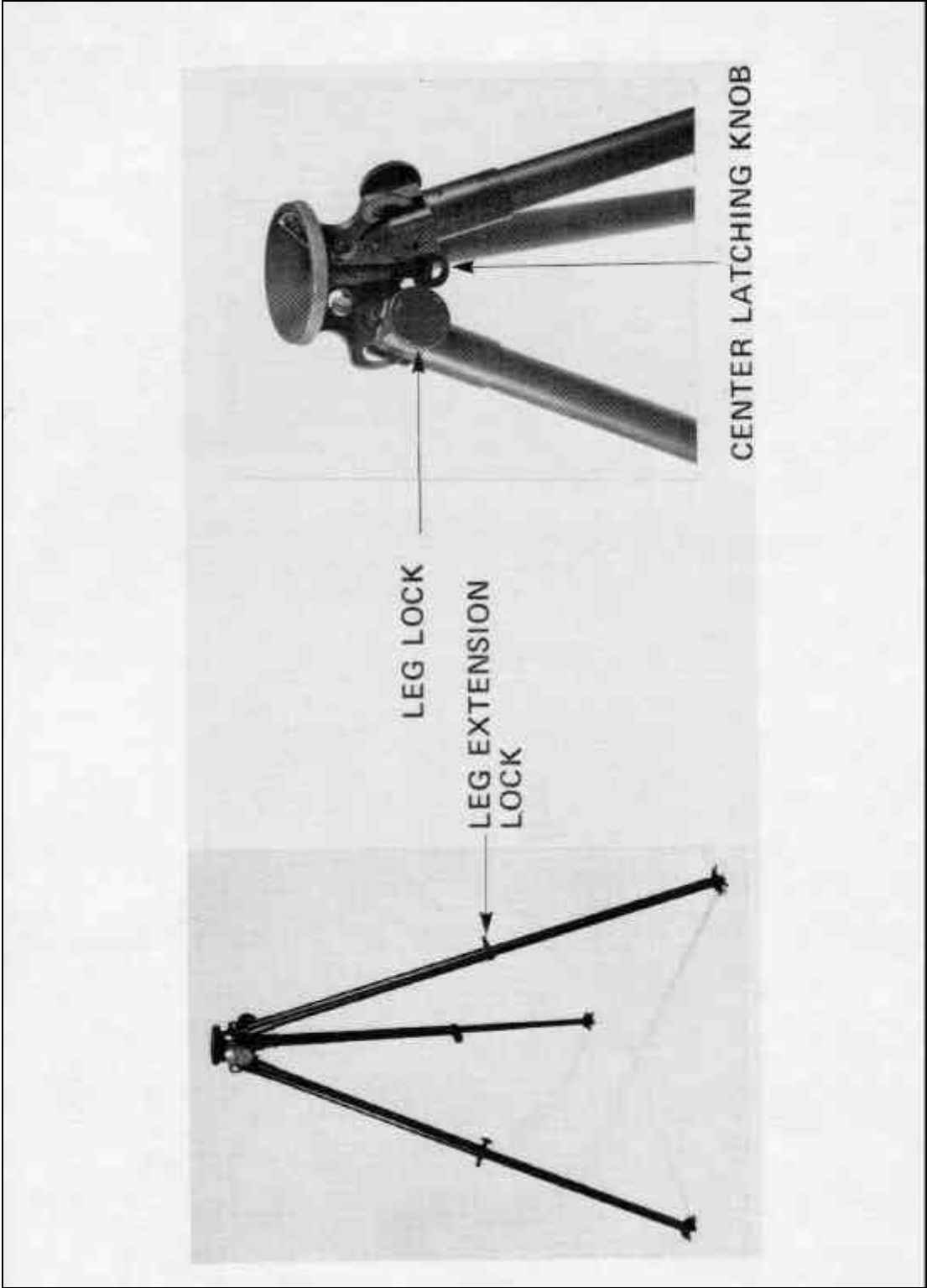

Figure 5-3 Radar Tripod, Controls

CHAPTER 6

OPERATION UNDER SPECIFIC CONDITIONS

SECTION 1 - OPERATING PROCEDURES

601. General

1. The instructions in this section are for the information and guidance of the personnel responsible for the operation of the radar set.

2. It is essential that the operator know how to accomplish every functional operation of the radar set. Radar set AN/PPS-15(V)2 may be used in three different applications: for terrestrial surveillance to detect moving targets by scanning a large area; for fixed-point observation to detect any movement in a small specific area; and for target tracking to determine range and direction of a specific target. Operating procedures for these different applications are provided in this chapter, Sect 2. Since nearly every mission presents a different problem, the operator may have to vary the given procedures to fit the specific assignment. Therefore, supplemental operational data outlined in this chapter, Sect 1, provides pertinent information relating to all applications and must be clearly understood. The supplemental data describes the differences between the three operating positions, and the four major modes of operation of the radar set. Table 6-1 summarizes the relationship between applications, operating positions, and modes of operation. In addition, the table lists the prime controls used by the operator to pinpoint a target for each of the various combinations. Art 602 provides information for the operator to aid in identifying the type of target by interpretation of the various audible signals received.

602. Audible Indications

A moving target detected by the radar set will produce an audible signal in the headphones. Fixed targets will not produce audible or visual signals. The audible signals in the headsets resulting from moving targets will differ from general background noise and will differ from each other dependent on the type of target. Target noise is characterized by continuous or pulsating rather than random sounds. Table 6-2 lists some of the sounds that may be heard and their general characteristics, to aid in interpreting the type of target being detected.

Application	Normal Operating Position	Normal Mode of Operation	Controls Used for Target Location
Terrestrial surveillance (art 607)	Tripod-mounted, local or remote	SEARCH-AUTO SEARCH-MANUAL SEARCH-RANGE or RNG GATE	None SCAN-MANUAL SEARCH switch SCAN-MANUAL SEARCH switch and RANGE: control
	Handheld	SEARCH-RANGE or RNG GATE	RANGE control with manual positioning for azimuth and elevation
Fixed-point observation (art 609)	Tripod-mounted, local or remote	RNG GATE	SCAN-MANUAL SEARCH switch and RANGE: control used for initial location of fixed point
Target tracking (art 608)	Tripod-mounted local or remote	SEARCH-RANGE or RNG GATE	SCAN-MANUAL SEARCH switch RANGE control
	Handheld	SEARCH-RANGE or RNG GATE	RANGE control with manual positioning for azimuth and elevation

Table 6-1 Radar Set AN/PPS-15(V)2, Application of Operating Positions

603. Operating Positions

1. General. The radar set can be operated from either tripod-mounted local, tripod-mounted remote, or hand-held positions.
2. Tripod-Mounted Local Operation. In the local position (see figure 4-4) the antenna assembly and the control indicator are electrically and mechanically joined together to form a single operating assembly, referred to as the receiver/transmitter group. The radar set can be operated from either standing or kneeling positions, depending on the tripod adjustment. The local position is ordinarily used when equipment and operator protective cover is available in the same immediate area.

Sound	Interpretation
--------------	-----------------------

Hissing (rushing)	Normal receiver tones. Indicates receiver is, operating.
Random rumbling (low pitched)	Foliage or grass moving in the wind.
Even whine or rumble with synchronized overtones (changing pitch together)	Tracked vehicle such as a tank. The even, low tone is produced by the motion of the tank and the overtone is generated by the motion of the tank treads.
Even rumbling (varying pitch) with synchronized overtones	Slowly moving vehicle. The even rumbling is produced by the body of the vehicle, and the wheels produce the overtones.
Even whine (varying pitch) with synchronized overtones	Rapidly moving vehicle. The even whine is produced by the body of the vehicle, and the wheels produce the overtones.
Periodic rumbling (low-pitched sounds; resemble snoring)	A moving person. The periodic part of the sound is created by the intermittent motion of the person's legs or arms.

Table 6-2 Target Audio Sounds

3. Tripod-Mounted Remote Operation. In remote operation (see figure 4-10) the control indicator is physically removed from the antenna assembly and electronically connected to it by means of remote control cable assembly W3. Remote control cable W3 is 9 metres long and is used when not enough cover is available at the equipment location for both the operator and the radar set. Although the control indicator is located away from the antenna assembly, the operator has all controls and displays for complete operation of the radar set at his disposal. To change from the local to the remote operating positions, perform the procedures outlined in figure 4-1.

4. Hand-held Operation. In the hand-held operating position (see figure 4-12) the receiver/transmitter group is normally positioned in front of the operator by the sling. In this position, the operator must manually control azimuth and elevation by pointing the radar set towards the area under surveillance. Since the antenna drive unit is not used in this operating position, a digital readout of the azimuth will not be displayed on the AZ-MILS (bat volts) indicator. Therefore the operator must rely on his sense of direction and estimate the target azimuth. The hand-held position is normally used under operational conditions when it is impractical to set up the tripod, or it can be used when tripod or antenna drive assemblies are defective.

604. Modes of Operation

1. General. In addition to the power OFF position, the mode selector switch is positioned to control the four different modes of operation available to the radar set operator. Tables 6-1 and 6-3 summarize the effect of the different modes of operation on the application of the different operating procedures, and on the affect of target data displayed on the digital display indicators. Specific characteristics of each mode are outlined in this article.
2. Search-Auto Mode. The SEARCH-AUTO mode is used for sector surveillance, with continuous scanning occuring automatically about a preselected scan centre azimuth point determined by the positioning of the SCAN-CTR ADJ switch. Scan sector widths are controlled by the position of the scan-wide narrow switch. The NARROW position of this switch permits scanning of 350 to 450 mils on either side of the setting of the SCAN-CTR ADJ control to give a 700 to 900 mil scan sector width. The WIDE position permits scanning of a sector width of 1 400 to 1 800 mils. When operating in this mode, the radar circuitry enables detection of all targets within the surveillance area regardless of range.
3. Search-Manual Mode. The search-manual mode is used to locate targets in any desired azimuth by pressing the scan-manual search switch to L or R, to electrically control the scanning motion of the radar set. The radar circuitry enables detection of all targets within the transmitted radio frequency signal beam regardless of range of target(s).

Switch and position							DISPLAY		
MODE				STATUS			RANGE METERS	PEAKING (XMTR TEST)	AZ-MILS (BAT VOLTS)
RNG GATE	SEARCH			SCAN CTR	Operate - center position	BAT/X MTR TEST			
	RANGE	MANUAL	AUTO						
			X	X			***	***	All positions SCAN CTR ADJ control setting
		X		X			***	***	
	X			X			** RANGE control setting	Range PEAKING	
X				X					
			X		X		***	***	***
		X			X		***	***	* Antenna azimuth position
	X				X		** RANGE control setting	Range PEAKING	
X					X				
			X			X	***	(XMTR TEST)	(BAT VOLTS)
		X				X	***		
	X					X	** RANGE control setting		
X						X			

* BLANKED IN THE HAND-HELD POSITION.

** ACTUAL TARGET RANGE DETERMINED BY ADJUSTING THE RANGE CONTROL UNTIL MAXIMUM VOLUME OF TARGET SIGNAL IS HEARD IN THE HEADSET AND MAXIMUM NUMBER OF DOTS ARE DISPLAYED ON THE PEAKING INDICATOR.

*** BLANKED

Table 6-3 Modes of Operation Display

4. Search-Range Mode. The search-range mode is used to locate and determine the range of selected targets. Scanning of the radar set for azimuth indication is electrically controlled by means of the scan-manual search switch. In this mode of operation, the all-range target audio detection capability is combined with the fine (discrete) range video capability of the range gate circuitry. Audio target data is generated for all targets present within the beam of the transmitted radio frequency signal regardless of range; digits and dots are displayed on the range metres and peaking (XMTR test) indicators for each specific target, as long as multiple targets are separated by at least 35 in. Operation of the range control enables determination of target range.

5. RNG Gate Mode. The RNG Gate mode of operation (discrete range operation) may be used for surveillance of a single point such as a road junction. It is also used to determine the precise range of targets detected in the other modes of operation. In this mode of operation, audio and visual target data is provided only when a target is within 20 m of the range displayed on the range metres indicator when the range control is adjusted for maximum dot display on the peaking (XMTR test) indicator.

SECTION 2 - OPERATING UNDER NORMAL CONDITIONS

605. General

Because of the portability and utilization of the AN/PPS-15(V)2 radar set, the operator is responsible for unpacking, inspecting, installation, testing and adjustments, operation, disassembly, and repacking the equipment for storage. The sequential step-by-step procedures in this section provide reference notations to the requirements identified in other sections of this manual in addition to the actual operating instructions.

606. Preliminary Starting Procedures

1. Perform the following procedures to install and check the radar set to verify the equipment is ready for operation:
 - a. Unpack. Unpack the equipment:
 - b. Inspect and Clean. Perform the operator's service requirements outlined in art 707.
 - c. Install. Assemble and set-up the radar set for the desired method of operation as outlined in arts 402 through 408.
 - d. Initial Mechanical Adjustments. Adjust the radar set for azimuth orientation and levelling as outlined in arts 409 and 410.
 - e. Initial Control Settings. Referring to figures 5-1 and 5-2 position each control to the following setting indicated:

CONTROL

SETTING

MODE.....	OFF
PHONE VOL.....	Maximum (ccw)
ILLUM.....	Maximum (ccw)
ALARM SENS.....	OFF
ALARM lamp lens.....	Open (ccw)
ALARM - VOLUME.....	Maximum (ccw)
SCAN - MANUAL/SEARCH.....	Centre (normal.) position
STATUS.....	Centre (normal) position
SCAN - CTR ADJ.....	Mid-position
SCAN - WIDE/NARROW.....	WIDE
RANGE.....	Maximum (ccw)
ELEVATION dial.....	Zero

Note: ccw = counter clockwise

- f. Testing. Verify the equipment is properly operating by performing the operator preventive maintenance checks and services as outlined in table 7-1.

9. Operational Adjustments. The scan centre, elevation, and alarm sensitivity controls are used in making operational adjustments. These adjustments are included as part of the tests outlined in table 7-1. However, they may be required to be changed during operation, depending on the application of the radar set as indicated in art 607 through 609. If it becomes necessary to readjust these controls, refer to arts 409 through 413 for detailed instructions.

607. Terrestrial Surveillance Application

1. Terrestrial surveillance is the continuous observation of a ground area to detect moving targets (vehicles or personnel) and is a prime function of the radar set. This type of operation is used under varying conditions of terrain, visibility, and weather conditions. The specified maximum range at which small moving targets (personnel) can be detected is 1 500 m (1640 yards) and for a crawling man is 500 m (547 yards). The detection range for large moving targets is in excess of 3 000 m (3281 yards). Terrestrial surveillance operation is conducted as outlined in the following paragraphs.

2. After performing the preliminary starting procedures (see art 608), rotate the mode selector switch (see figure 5-2) to the SEARCH-AUTO position and the radar will automatically scan about the preselected scan centre.

3. Set the scan-wide/narrow switch at NARROW (700 to 900 mils) or WIDE (1 400 to 1 800 mils) to select radar scan sector width.

4. When a target is detected (audible and/or visual indication), stop the scan by setting the mode selector to SEARCH-MANUAL, and maximize the target audio doppler signal heard in the headset by using the scan-manual search switch to electronically slew the radar set in azimuth. Observe the AZ-MILS (bat volts) indicator reading to determine target azimuth.
5. Set the mode selector switch to SEARCH-RANGE and observe the peaking (XMTR test) indicator, while adjusting the range control for the maximum number of dots displayed and the loudest audio doppler signal in the headset.
6. When the dots on the peaking (XMTR test) indicator are maximized, turn the mode selector switch to the RNG gate position for the final determination of target range. If the target audio doppler signal is still present in the electrical headset, and the peaking (XMTR test) display is still maximized, the target is located within 20 m (22 yards) of the range reading indicated on the range metres indicator. If necessary, turn the range control until this condition exists.

608. Target Tracking Application

1. Once a target has been detected and located, it may be tracked to obtain continuous azimuth and range information.
2. Set the mode selector switch to SEARCH-RANGE, and rotate the radar using the scan-manual search switch as necessary to maintain the target audio doppler signal in the headset and maximum peaking (XMTR test) indicator display.
3. When the audio doppler signal starts to fade even though the azimuth angle has been maximized, rotate the range control slightly to shift the range gate either higher or lower in range. If the signal is completely lost, reverse the direction of rotation.
4. Tracking should normally be done in the RNG GATE position, but if the target is moving rapidly, it may be necessary to use the SEARCH-RANGE position to follow the movement of the target.

609. Fixed Point Observation Application

1. Initial detection of a target can also be achieved by monitoring a fixed point.
2. After performing the preliminary starting procedures (see art 608) turn the mode selector switch (see figure 5-2) to the RNG GATE position.
3. Operate the SEARCH-MANUAL switch on the control indicator to direct the radar set toward the point to be observed. Then rotate the range control to select the range segment (35-metre range gate width) in which the fixed point is located.

4. If a target moves in or into the area being observed, the audio doppler signal will be heard in the headset and the peaking (XMTR test) indicator will display dots. In addition, the alarm speaker sounds and the alarm lamp blinks.

610. Standby Procedure

Whenever it is desired to place an operational radar set on standby, rotate the mode selector switch to the OFF position to conserve battery power.

611. Shutdown Procedure

1. To shut down the AN/PPS-15(V)2 radar set, perform the following:
 - a. Turn the mode selector switch to the OFF position to remove power.
 - b. Prepare the radar set for limited storage and shipment or prepare the radar set for movement to a new site as outlined in arts 414 through 418.

SECTION 3 - OPERATION UNDER EMERGENCY CONDITIONS

612. General

Emergency conditions is defined as operating the radar set with reduced capability. Intelligent information can still be produced by the radar set, even though some of the electronic circuits in major assemblies do not function properly, or the circuits or mechanical components that provide motion to the radar set do not work. In any case, all or some information will be produced by the radar set.

613. Partial Operation After Equipment Failure

1. The AN/PPS-15(V)2 radar set may be operated under emergency conditions when specific parts of the radar set are defective. Examples of this partial operation are outlined in the following subparagraphs:

- a. Antenna Drive Failure. If the antenna drive AB-1205/PPS-15 fails, limited operation can be maintained by grasping the antenna and manually turning it to direct the radar set towards the target ;area. The receiver/transmitter group can also be removed from the antenna drive and used in hand-held operation (see art 408).
- b. Remote Control Cable Failure. If remote control cable W3 should fail, full operation of the radar set is possible from the tripod mounted local configuration (see art 406).
- c. All Available Batteries Are Discharged. If usable batteries are not available, the full operational capability of the radar set is possible by using the remote power cable assembly connected to any 24 (+ 6 or - 4) volt DC power source (See art 405).

614. Operation Through Electronic Counter Measures

Electronic counter measures are attempts to electronically interfere with successful operation of the radar set. In case of electronic counter measures, follow the procedures given in local standard operating procedures for reporting, recording, and avoiding them.

SECTION 4 - OPERATION UNDER UNUSUAL CONDITIONS

615. Operation In Rain, Sleet, and Snow

1. Shelter the radar set if possible from rain, sleet, and snow. The radar set is watertight, but water, sleet, and snow on the indicator windows will obscure displayed information. A tarpaulin or poncho rigged over the receiver/transmitter group is a worthwhile precaution against rainstorms. Do not allow wet tarpaulin or poncho to hang in front of the antenna because return target signals will be distorted.
2. The electrical headsets are submersible. However, to avoid damage hang them on the tripod or the antenna drive when they are not in use.
3. Moisture will not affect the operation of the antenna or other parts of the radar set, but wipe them as dry as possible before packing the radar set components in carrying case CY-7339/PPS-15(V), or placing them in transport case CY-7338/PPS-15(V). After returning from a mission in the rain, clean and dry the equipment as soon as possible.
4. Rain, sleet, and snow with high wind conditions increase the rushing noise (higher pitched) in the electrical headsets in the area of the storm. The higher the wind condition, the more intense the noise in the headsets. Storms and high winds tend to obscure targets. The more dense the precipitation, the more obscure the targets. When operating the radar set during a storm and high wind condition, the operator must be especially alert for target indications. Also, the alarm-sens control will have to be set at a reduced level for the high prevailing wind conditions. During periods of high winds and heavy rain, snow, or sleet it is possible that only large targets may be detected, thus reducing the security provided by the radar set.

616. Operation in Tropical Climates

1. The combination of great heat, high humidity, heavy rainfall, and rapid growth of fungi (mold) in the tropics creates operating problems not encountered in temperate climates. The growths must be cleaned off before they increase to a size that may interfere with mechanical functions of the radar set or visibility of the indicators. After being in direct sunlight, the metal parts of the radar set may become hot enough to cause skin burns if touched. The high humidity hastens rusting and corrosion, therefore, touch-up paint must be applied promptly on the equipment when the paint has been scratched or scraped to bare metal.
2. If possible, shade both the radar set and the operator.
3. Avoid moving the radar set quickly from a very warm place to a much cooler place, as the warm moist air may condense on the indicator windows and obscure the readings displayed on the indicators.

617. Operation In Arctic Climates

1. The radar set can operate at environmental temperatures as low as minus 45EC (-50EF) (excluding internal battery operation). At lower environmental temperatures, the equipment must be sheltered (in a tent, for example) and kept at or above minus 45EC (-50EF) by space heaters or by some other means. The operator should wear gloves to prevent his fingers from touching the cold metal of the radar set. At temperatures below -7EC (20EF) it is advisable for the operator to remove the dry battery BA-4386/PRC-25 from the battery compartment and operate from an external power source using external power cable W2. When not in use, the dry battery should be stored in the same manner. Body heat will improve the efficiency and extend the useful life of the batteries under these low temperature conditions.
2. Shelter both the radar set and the operator from the cold and wind. The alarm-sens control should be set at an optimum level for the existing weather conditions. Range and resolution losses insignificant when the AN/PPS-15(V)2 radar set is operated from inside a dry tent. Keep drifting snow below the level of the antenna.
3. Avoid moving the radar set from a warmed area (such as a heated building) to a very cold area. Warmed moist air inside the control indicator may condense on indicator windows and form frost. The stresses induced by sudden extreme changes in temperature may impose severe structural strains on the cases and the assemblies inside them and may damage or shorten the useful life of the equipment.
4. Remove any ice or snow from the antenna (front) side of the receiver/transmitter group. Remove ice from the radome by very gently tapping and scraping with a non-metallic object because radomes are relatively thin. Heavy icing can seriously reduce operating effectiveness by reducing transmission efficiency. Keep the antenna drive mechanism free of ice or snow to prevent loss of drive, or possible damage when elevation or azimuth rotation is attempted.

618. Operation in Desert Areas

1. The chief hazards in desert operation are sand, dust, and high temperature. Dust cannot get into the antenna azimuth drive and elevation mechanisms, but wind-blown sand can permanently scar the indicator windows, and make it necessary to replace them.
2. Shade both the radar set and the operator.
3. Wipe sand and dust off the antenna (front) side of the receiver/transmitter group. Cover the equipment when it is set up but not in use. Take any other practicable measures to keep sand and dust from settling on the equipment.

(619 to 699 not allocated)

CHAPTER 7

MAINTENANCE INSTRUCTIONS

SECTION 1 - DEFINITIONS

701. Maintenance Definitions

1. General. Maintenance is the action taken to retain material in, or restore material to, a serviceable condition. Maintenance of the AN/PPS-15(V)2 radar set shall include the following areas, as defined:
 - a. Service. To clean, to preserve, and when necessary, replace the internal battery or external power supply.
 - b. Adjust. To regulate periodically, to prevent malfunction.
 - c. Inspect. To verify serviceability and to detect imminent mechanical failure by scrutiny.
 - d. Test. To verify serviceability and to detect imminent mechanical or electrical failure by use of special equipment such as gauges, meters, etc.
 - e. Replace. To substitute serviceable assemblies, subassemblies, and parts for unserviceable components.
 - f. Inspection and Repair Only as Necessary. Inspection and repair only as necessary is a technique which determines the minimum repairs necessary to restore equipment, components, or assemblies to prescribed maintenance serviceability standards by utilizing all available diagnostic equipment and test procedures and by minimizing disassembly and parts replacement. It is applicable to all categories of maintenance. It is further defined as-
 - (1) Repair. To restore that which is unserviceable to a serviceable condition by adjusting or replacing damaged or unserviceable parts, components, or assemblies.
 - (2) Overhaul. To restore an item to completely serviceable condition by inspecting, disassembling its assemblies and sub-assemblies as necessary, replacing parts, and performing necessary boring, grinding, or machining operation, followed by reassembly and final inspection. Maximum utilization of diagnostic and test equipment is combined with a minimum disassembly of the item during the overhaul process.

SECTION 2 - PREVENTIVE MAINTENANCE

702. General

Preventive maintenance is the systematic care inspection and servicing of the radar set to maintain it in a serviceable condition, prevent breakdowns, and to assure maximum operational capability. The operator and organizational preventive maintenance checks and services charts (tables 7-1 and 7-2 respectively) are designed to help maintain the radar set in a serviceable condition. They indicate what items should be checked, procedures for making the check, and performance standards that are required. Refer to the troubleshooting data outlined in art 709 for isolation of trouble and corrective action if the radar set fails to meet performance standards.

Note: The sequential procedures outlined in tables 7-1 and 7-2 are based on a radar set installed for remote controlled operation. If the radar set is being operated from the local position or in the handheld position, ignore those steps checking for operation of components or circuitry not being used.

703. Operator Preventive Maintenance Checks and Services

Preventive maintenance checks and services to be performed by the operator are in this chapter, Annex A. The procedures assume the equipment has been installed for operation and the pre-operational adjustments outlined in Chap 4 have been completed.

704. Preventive Maintenance Intervals

1. Daily. When the radar set is installed and remains in the same operation location for periods of longer than one day, the operator preventive maintenance checks and services should be performed daily.
2. Before Operation. When the radar set is initially set up for operation the operator preventive maintenance checks and services should be performed as a part of the operator's services outlined in art 707.
3. After Operation. Unless prevented by operational conditions, perform the checks and services outlined in art 707 immediately prior to disassembly of the radar set and packing for storage. In any case, perform the procedures as soon as practicable after operation.

705. Organizational Preventive Maintenance

Organizational preventive maintenance is the systematic care and inspection of equipment to maintain it in serviceable condition and to prevent breakdowns. It includes the replacement of parts or units that inspection and tests indicate are faulty, or would probably fail before the next scheduled inspection.

706. Preventive Maintenance Intervals

The unit preventive maintenance checks and services outlined in table 7-1 should be performed at quarterly intervals for all operational radar sets and for radar sets in limited and short term storage. Limited storage is defined as periods of less than two weeks. Short term storage is defined as periods of more than two weeks, but less than three months.

707. Service Requirements Before, During, and After Operation

1. General. To ensure that the equipment is ready for operation at au times, it must be inspected systematically before, during, and after operation, so that defects may be discovered and corrected before they result in serious damage or failure. The necessary preventive maintenance services will be performed before operation. Defects discovered during operation of the unit will be noted and corrected as soon as practicable after operation has ceased. After operation, servicing shall be performed by the operator after every operating period. During operation, servicing will be performed at intervals based on the normal operation of the equipment. The interval may be reduced to compensate for abnormal conditions. Defects or unsatisfactory operating characteristics beyond the authority of the operator to correct must be reported at the earliest opportunity to the unit maintenance section. Servicing requiring accomplishment by the operator are outlined in table 2.

Sequence	Items to be inspected
1	Completion and General Condition. Inspect and service the equipment in accordance with art 707.
2	Publications. Inspect all applicable publications to assure that they are current, complete, and serviceable.
3	Modifications. Determine if new equipment modifications have been published, and if all modifications to the equipment have been accomplished.
4	Equipment Tests. Perform the sequence of checks listed in Appendix A, sequences 1b through 17a.
NOTE: When performing sequence 13 of Annex A, place a target at a measured distance of 100 metres or more, to determine that the range control as used in sequences 14 and 15 will adjust to the measured distance, and is accurate within 20 meters.	

Table 7-1 Organizational Preventive Maintenance Checks and Services

2. Cleaning. The exterior surfaces of the radar set should be clean and free of dust, dirt, grease, and fungus. Clean surfaces as follows:

a. Dust and Loose Dirt. Remove dust and loose dirt with a clean soft cloth.

b. Grease, Fungus, and Imbedded Dirt. Remove grease, fungus, and imbedded dirt as follows -

(1) Dampen (do not soak) a cloth with trichloroethane (see Note 1).

(2) Wipe off grease, fungus, or imbedded dirt with a damp cloth.

(3) Wipe the component dry with a clean cloth.

c. Plugs and Connectors. Remove dust or dirt from plugs and connectors with a soft-bristle brush.

d. Knobs and Indicators. Clean knobs, glass window, and indicators as follows -

(1) Dampen a cloth with water (use detergent or mild soap if available).

(2) Wipe dirt off all control knobs and windows with the damp cloth.

(3) Wipe dry with a clean cloth.

e. Rain. Rain will not damage the radar set; however, dry the equipment, carrying case, and transport case before packing.

Notes: 1. The fumes of trichloroethane cleaning compound are toxic. Provide thorough ventilation whenever used. Do not use near an open flame. Trichloroethane is not flammable, but exposure of the fumes to an open flame or hot metal forms highly toxic phosgene gas.

2. Do not press on glass windows of indicators, as they may become damaged.

SECTION 3 - TROUBLESHOOTING

708. General

Troubleshooting is the process of locating a trouble in order that correct repairs and adjustments can be made. Troubleshooting by the operator is preventive in nature since proper action at the first warning can prevent complete failure and extensive damage. The most valuable aids in troubleshooting are the audible and visual indications provided by the radar set. Any variation from the normal conditions displayed by the indicators or heard in the headset provides a warning that trouble may be present. The operator is responsible for accurately reporting trouble symptoms so that the responsible maintenance personnel can diagnose, isolate, and correct the trouble with the least possible delay.

709. Operator Troubleshooting

Operator troubleshooting with the radar set consists of accomplishing the preventive maintenance checks and services outlined in this chapter, Appendix A and noting any abnormal indication or failure to meet the performance standard. When an abnormal condition is encountered, the operator should note the problem and the sequence number in Appendix A and then turn to the corresponding sequence number in Appendix B, Operator Troubleshooting, to check the probable causes and possible remedies listed. The symptoms cited in the troubleshooting chart may also be noted during normal operation as well as during performance of the preventive maintenance checks.

Services Interval				Procedure
Before Operation	During Operation	After Operation	Appx A Sequence Number	
(a)	(b)	(c)	(d)	(e)
X	X	X	1a	Visual INSPECTION. Check each assembly to ensure no damage has occurred. Check to ensure that all controls, indicators, switches, and Cables are present and not damaged. Check cabling for secure connection.
X			1b	INSTALL. Assemble radar set for the desired operating position (arts 402 through 408).
X	X		1c	AZIMUTH ORIENTATION ADJUSTMENT. Check the radar set for azimuth zero orientation (art 409).
X	X		1d	LEVELLING ADJUSTMENT. Verify that the radar antenna drive assembly is maintained in a level condition (art 410).
X	X	X	1a	CLEANLINESS. Check the radar set for cleanliness.
X		X	2	DRIVE CLUTCH. Verify that the clutch has maintained its proper adjustment.
X	X	X	2-17 (as applicable)	PREVENTIVE MAINTENANCE CHECKS AND SERVICES. Perform the maintenance checkout procedures outlined in art 703. For troubleshooting refer to Chap 7, Sect 3.
X	X	X	5	BATTERY VOLTAGE. Check the battery to assure that it has not discharged beyond a usable state. Check battery voltage. If necessary replace battery as outlined in figure 4-6.

		X	-	PREPARATION FOR STORAGE. Disassemble and pack the radar set.
--	--	---	---	--

Table 7-2 Operators Daily Servicing Schedule

(710-799 not allocated)

OPERATOR PREVENTIVE MAINTENANCE

CHECKS AND SERVICES

Ser	Item to be Checked	Procedure	Performance Standard
(a)	(b)	(c)	(d)
1	Radar Set AN/PPS 15(V)2	<p>a. Inspect and service the equipment in accordance with art 707.</p> <p>b. Assemble the set in accordance with arts 402 through 408.</p> <p>c. Adjust the equipment as outlined in art 409.</p>	<p>a. No switches, controls, or assembly hardware is missing or damaged, and all switches and controls move freely.</p> <p>b. Radar set is properly installed for tripod mounted close-coupled, remote, or hand-held operating position with or without external power.</p>
2	Drive clutch	Grasp the sides of the antenna and physically turn the antenna left and then right about 4 800 mils (270E) in each direction then back to alignment of the azimuth reference zero blades.	Radar moves easily with very little drag.
Note: 1 Not applicable in hand-held position.			
3	ELEVATION control	Turn the elevation control to the maximum position in both directions, then turn it until the vertical plane of the antenna is perpendicular to the ground plane slope of the ground.	Radar operates up and down from +4 to -6 mils x 100 as indicated on the elevation scale.
4	Bubble level and ELEVATION lamps and switch (Note 1)	Turn the mode selector to SEARCH-MANUAL. Press and hold the illumination switch on the antenna drive.	Bubble level and elevation lamps light.

5	Battery or remote power/transmitter power illum control/display indicator circuits.	a. Turn the mode selector to RNG GATE. Push and hold the status switch to BAT/XMTR test. Turn the illum control slowly to INCR. Adjust illum control for desired light intensity.	a. AZ-MILS (bat volts) indicator displays at least 10.00 (volts). b. Peaking (XMTR test) indicator displays five dots or mor. c. Range meters indicator displays light intensity.
6	Receiver/phone volume circuits	a. Put the headset on and turn the phone vol control slowly to INCR, then back for desired listening level.	a. Hissing sound is heard in the headset indicating the receiver circuits are operative. b. Phone vol control adjusts the level of hissing (background noise).
7	Alarm sensing circuits	a. Remove the headset. Turn the mode selector to SEARCH-MANUAL. Turn the alarm-sens control fully clockwise to INCR. b. Turn the alarm sens control counter clockwise until alarm speaker is silenced and alarm stops blinking.	a. Waving hand or other object in front of antenna causes the alarm speaker to sound and the alarm lamp to blink. (Shading of lamp by hand is required in bright light to see blinking.) b. Alarm-sens control varies the alarm sensitivity level (threshold).
8	Alarm volume	a. Turn the alarm volume control slowly and fully to INCR while waving your hand in front of the antenna. Observe the alarm speaker and alarm lamps. b. Turn the alarm-volume control fully counter clockwise. Wave your hand in front of the antenna. Observe the alarm speaker and alarm lamp. Adjust the alm-volume control for the desired speaker output while waving your hand in front of the antenna.	a. Alarm is heard from the speaker and in creases in strength as control is turned toward INCR. Alarm lamp blinks. b. Alarm speaker is silent but alarm lamp blinks.

9	Phone volume control circuits	<p>a. Put the headset on. Wave your hand in front of the antenna. Observe the sound in the headset.</p> <p>b. Turn the phone vol control to the desired listening level.</p>	<p>a. Target noise simulated by the handwaving is heard in the headset.</p> <p>b. Loudness is adjustable by turning the phone vol control.</p>
10	Automatic scan circuitry	<p>a. Turn the mode selector to SEARCH-AUTO and observe the antenna.</p>	<p>a. Antenna continually scans a 1 400 to 900 mil arc.</p>
11	Scanning adjustment circuitry	<p>a. Set the mode selector to SEARCH-MANUAL. Unlock the SCAN-CTR ADJ control and turn it fully clockwise to R. Press and hold the status switch to SCAN CTR and observe the AZ-MILS (bat volts) indicator.</p> <p>b. While still holding the status switch to SCAN-CTR, turn the SCAN-CTR ADJ control full ccw to L and observe AZ-MILS (bat-volts) indicator.</p>	<p>a. Antenna stops scanning; AZ-MILS (bat volts) indicator displays more than 3 200 (mils).</p> <p>b. AZ-MILS (bat volts) indicator displays less than 3 200 (mils). Release the status switch.</p>
12	Scan centre adjustment	<p>a. Determine the sector to be placed under surveillance. Press the scan-manual search switch in the direction of the sector selected (L left, R right) and release the switch when the face of the antenna is in the centre of the sector. See Note 1.</p> <p>b. Note the azimuth displayed on the AZ-MILS (bat volts) indicator. Press the status switch to SCAN-CTR</p>	<p>a. Antenna scans in the desired direction and stops when the scan-manual search switch is released. See Note 2.</p> <p>b. Pressing the status switch displays the scan centre. Adjusting the SCAN-CTR ADJ controls to the same azimuth noted before adjustment</p>

		<p>and adjust the control until AZ-MILS (bat volts) indicator displays the noted azimuth ∇ 0005. Release the switch and lock the control.</p> <p>c. Turn the mode selector to SEARCH-AUTO and observe the radar set.</p>	<p>conditions the radar to automatically scan about the new centre.</p> <p>c. Radar set continually scans about the new scan centre.</p>
13	Azimuth circuitry	<p>a. Turn the mode selector the SEARCH-MANUAL. Select a target at 100 m or more in the sector under surveillance. Press the scan-manual search to L or R until the strongest target return signal is heard in the headset. Release the switch and observe the display on the AZ-MILS (bat volts) indicator.</p>	<p>a. Radar scans electrically and stops when the switch is released. Target signal return is heard in the headset and target azimuth is displayed on the AZ-MILS (bat volts) indicator.</p>
14	Range circuitry	<p>a. Turn the mode selector to SEARCH-RANGE. Track the target by pressing the scan-manual search switch in the position (L or R) that will keep the target centred in the antenna, or physically turn the antenna if operating from the hand-held position. Turn the elevation control in a direction that will present the loudest target signal in the headset. Observe the peaking (XMTR test) indicator and adjust the range control for the maximum number of dots. Observe the range meters indicator.</p>	<p>a. Radar set is adjusted for course target range displayed on the range meters indicator.</p>
15	Discrete range circuitry	Turn the mode selector to	Discrete target range has been

		RNG gate and observe the target range displayed on the range-meters indicator. Turn the range control until the maximum number of dots is displayed on the peaking (XMTR test) indicator and observe the range meters display again (See Note 3.)	achieved and target range is displayed (within t 20 m) on the range-meters indicator. Maximum target audio is heard in the headset.
16	Azimuth positioning potentiometer circuitry	Press the scan-manual search switch to L or R and scan until the azimuth reference zero blades are aligned. Observe the AZ-MILS (bat volts) indicator.	AZ-MILS (bat volts) indicator displays 0000, 0005, or 6395.
17	Standby	Turn the mode selector to OFF. Listen to the sound in the headsets.	No background (hissing) is heard in the headset. All power source voltage has been removed from the active circuits.

Notes: 1. In bright light shade the bubble level and elevation dial.

2. If the radar reaches the electrical stop before reaching the centre of the sector to be scanned, press the SCAN-MANUAL SEARCH switch to the opposite direction and continue scanning until the centre of the desired scan sector is reached, then release the switch.

3. Antenna will stop when it reaches the electrical stop. When the switch is released and pressed in the opposite direction, the antenna will start scanning in the opposite direction.

4. It may be necessary to keep manual track in azimuth and to readjust the elevation and range controls to maintain maximum audio in the headset and the maximum number of dots on display.

Not applicable in the hand-held position

OPERATOR TROUBLESHOOTING

Ser	Symptom	Probable Cause	Possible Remedy
(a)	(b)	(c)	(d)
1	<p>Switches, controls, or assembly hardware is missing or damaged.</p> <p>b. Radar set is not oriented to magnetic north.</p> <p>c. Radar set is not level.</p>	<p>1. Equipment has been improperly packed,dropped,or scavenged.</p> <p>b. Radar tripod may have been jarred from its original position.</p> <p>c. Radar set may have been jarred from its originally set position, or if set up on soft dirt, may have settled.</p>	<p>1. Replace damaged or missing items (unit level).</p> <p>b. Re-orient the radar set as described in art. 409.</p> <p>c. Relevel the radar set as described in art. 410.</p>
2	Radar set is difficult to physically turn or cannot be physically turned when installed on the tripod.	Clutch is not properly adjusted, or is faulty.	Replace antenna drive AB-1205/PPS-15(V).
3	Radar will not operate up and down from 4 to -6 X 100 when the elevation control is turned.	Elevation scale may be bent.	Same as 2.
4	Bubble level and elevation dial lamps do not light when illumination control is pressed.	<p>1. Mode selector switch is turned to OFF.</p> <p>2. Internal battery may be discharged.</p> <p>3. External power source may be less than 20 volts DC.</p> <p>4. External power cable W2 connections may not be making good contact.</p>	<p>1. Turn the mode selector to SEARCH-OFF.MANUAL.</p> <p>2. Replace the internal</p> <p>3. Replace the external power source.</p> <p>4. Check connections at both ends of the external power cable. If the connections are making good contact, replace the cable.</p>

5	<p>With mode selector in RNG GATE and status switch to BAT/XMTR test:</p> <p>a. AZ-MILS (bat volts) indicator displays less than 10.00 (volts).</p> <p>b. Peaking (XMTR test) indicator displays less than five dots.</p> <p>c. Range meters indicator shows less than four digits or no digits.</p> <p>d. Illum control does not vary the display light intensity.</p>	<p>1. Same as 4.</p> <p>b. Transmitter may be faulty.</p> <p>c. Range circuitry may be faulty.</p> <p>d. Illum control may be faulty.</p>	<p>1. Same as 4.</p> <p>1. Replace antenna assembly AS-2906/PPS-15(V) (Note 2).</p> <p>c. Replace control indicator C-9353/PPS-15(V) (Note 2).</p> <p>d. Replace control indicator C-9353/PPS-15(V) (Note 2).</p>
6	<p>No hissing sound is heard in the headset.</p> <p>b. Phone vol control will not adjust the noise level heard in the headset.</p>	<p>a. Preamplifier may be faulty.</p> <p>b. Receiver circuitry may be faulty.</p> <p>b. Phone vol control may be faulty.</p>	<p>a. Replace antenna assembly AS-2906/PPS-15(V) (Note 2).</p> <p>b. Replace control indicator C-9353/PPS-15(V) (Note 2).</p> <p>1. Replace control indicator C-9353/PPS-15(V) (Note 2).</p>
7	<p>With mode selector in SEARCH-MANUAL.</p> <p>a. Waving hand or other object in front of antenna does not cause the alarm speaker to sound or the alarm lamp to blink when alarm-sens control is turned fully counter clockwise.</p> <p>b. Alarm speaker sounds and alarm lamp blinks when the alarm-sens control is turned fully ccw.</p>	<p>1. If five dots or more are displayed on the peaking (XMTR test) indicator when the status switch is pressed to BAT/XMTR test, the alarm sensing circuitry is faulty. See sequence 5.</p> <p>1. Alarm-sens control is faulty.</p>	<p>1. Replace control indicator C-9353/PPS-15(V) (Note 2).</p> <p>1. Replace control indicator C-9353/PPS-15(V) (Note 2).</p>

8	<p>Alarm speaker does not sound and alarm lamp does not blink when alarm volume control is turned fully to INCR and hand is waved in front of the antenna.</p> <p>a. No target noise is heard in the headset when the hand is waved in front of the antenna.</p> <p>b. Phone vol control does not adjust the target noise level heard in the headset.</p>	<ol style="list-style-type: none"> 1. Alarm lamp lens shutter may be closed. 2. Alarm lamp may be faulty. 3. Alarm circuitry may be faulty. <ol style="list-style-type: none"> 1. Headphones or phone connectors may be faulty. 2. Amplifier circuitry may be faulty, <ol style="list-style-type: none"> 1. Phone vol control is faulty. 	<ol style="list-style-type: none"> 1. Turn the alarm lens shutter fully counter clockwise. 2. Replace the alarm lamp. 3. Replace control indicator C-9353/PPS-15(V) (Note 2). <ol style="list-style-type: none"> 1. Check each headset with each phone connector. If target noise is heard in one headset, replace the faulty one. If no target noise is heard in either headset, replace control indicator C-9353/PPS-15(V) (Note 2). 2. Replace control indicator C-9353/PPS-15(V) (Note 2). <ol style="list-style-type: none"> 1. Replace control indicator C-9353/PPS-15(V) (Note 2).
10	<p>a. Radar set does not continuously scan a 1 400 to 1 800 mil arc when the mode selector is in SEARCH-AUTO and the scan-wide/narrow switch is set to WIDE.</p> <p>b. Radar set does not continually scan a 700 to 900 mil arc when the mode selector is in</p>	<ol style="list-style-type: none"> 1. Scan-wide/Narrow switch or antenna drive may be faulty. <ol style="list-style-type: none"> 1. Scan-wide/Narrow switch may be set to WIDE. 2. Scan-wide/Narrow 	<ol style="list-style-type: none"> 2. Recheck cable connections between the antenna drive and antenna assembly, and the cable connections between the antenna assembly and control indicator. If problem still exists, replace the radar set (Note 2). <ol style="list-style-type: none"> 1. Push scan-wide/Narrow switch down to NARROW. 2. Recheck cable

		switch or antenna drive may be faulty.	connections between the antenna drive and the cable connections between the antenna assembly and control (Note 2).
11	<p>a. Less than 3 200 (mils) is displayed on the AZ-MILS (bat volts) indicator when the mode selector is in SEARCH-MANUAL and the Scan-CTR ADJ control is turned fully to R.</p> <p>b. More than 3 200 (mils) is displayed on the AZ-MILS (bat volts) indicator when the mode selector is in SEARCH-MANUAL and the Scan-CTR ADJ control is turned fully to L.</p>	<p>1. The Scan-CTR ADJ control or scan circuitry may be faulty.</p> <p>1. Same as 11a-1.</p>	<p>1. Replace control indicator C-9353/PPS-15(V) (Note 2).</p> <p>1. Same as 11a-1.</p>
12	<p>a. Antenna does not scan to left (or right) when the mode selector is in SEARCH-MANUAL and the Scan-manual Search switch is pressed to L (left) or R (right).</p> <p>b. Scan-CTR ADJ control will not adjust to a new scan centre when turned to L or R (See Note 1).</p> <p>c. Radar set does not scan about a new scan centre when the mode selector is in SEARCH-AUTO.</p>	<p>1. Antenna has reached the stop limit.</p> <p>1. Scan-CTR control or scan circuitry is defective.</p> <p>1. Scan circuitry is defective.</p>	<p>1. Press the Scan-manual Search switch to the opposite position L (left) or R (right), and scan until the desired scan sector is reached.</p> <p>2. Same as 10a-2.</p> <p>1. Same as 11a-1.</p> <p>1. Same as 10a-2.</p>
13	<p>a. No target return signal is heard in the headset when manually tracking a target.</p> <p>b. Azimuth of target at 100 m or more is not displayed on the AZ-MILS (bat volts)</p>	<p>1. Same as 9a-1.</p> <p>2. Same as 9a-2.</p> <p>1. Azimuth display circuitry is defective.</p>	<p>1. Same as 9a-1.</p> <p>2. Same as 9a-2.</p> <p>1. Replace control indicator C-9353/PPS-15(V) (Note 2).</p>

	indicator when tracking in the manual search mode of operation from the tripod mounted close-coupled or remote positions.		
14	<p>Mode selector is in SEARCH-RANGE and azimuth and elevation are properly adjusted on target.</p> <p>a. Not able to adjust the range control for range display on the Range Meters indicator.</p> <p>b. Not able to adjust the range control for maximum dot display on the Peaking (XMTR Test) indicator range display on the range meters indicator.</p>	<p>1. Range control or range circuitry is faulty.</p> <p>1. Same as 14a-1.</p>	<p>Replace control indicator C-9353./PPS-15(V) (Note 2).</p> <p>1. Same as 14a-1.</p>
15	<p>With mode selector in RNG Gate and azimuth and elevation properly adjusted.</p> <p>a. Unable to obtain discrete target range display on the range meters indicator.</p> <p>b. Unable to hear target return signal in the headset when range control is turned in either direction.</p>	<p>1. Range control may not be adjusted.</p> <p>2. Same as 14a-1.</p> <p>1. Same as 14a-1.</p>	<p>1. Adjust the range control.</p> <p>2. Same as 14a-1.</p> <p>1. Same as 14a-1.</p>
16	<p>a. 0000, 0005, or 6395 is not displayed on the AZ-MILS (bat volts) indicator when the azimuth reference zero blades aligned.</p>	<p>1. Azimuth positioning potentiometer or circuitry is faulty.</p>	<p>1. Replace antenna drive AB-1205/PPS-15(V) (Note 2).</p>
17	<p>a. Background noise (hissing) is heard in the headset when the mode selector is turned OFF.</p>	<p>1. Mode selector switch is faulty.</p>	<p>1. Remove the internal battery or disconnect the external power cable from the control indicator. Remove both if both power sources are being</p>

			used together. Replace control indicator C-9353/PPS-15(V) (Note 2).
--	--	--	---

- Notes: 1. Determination is made by pressing the status switch to SCAN CTR and observing the display on the AZ-MILS (bat volts) indicator.
2. Repair to be accomplished by higher echelon maintenance, eg, unit level or above.

CHAPTER 8

TACTICAL EMPLOYMENT

SECTION 1 - INTRODUCTION

801. General

1. The principal function of the radar set AN/PPS-15 is to assist in the detection of enemy personnel and vehicle movement during periods of reduced visibility. Early location of such ground targets will be of significant assistance in eliminating surprise attacks by allowing additional time to react to any enemy threat. The radar, when used in conjunction with other sensors, detection or observation techniques, provides an additional means for collecting information about the enemy. It does not replace other reconnaissance agencies or means.
2. The radar set AN/PPS-15(V)2 supplements but does not replace the radar set AN/PPS-4. The characteristics and operation of the latter are described in CFP 317(16).

802. Surveillance Card

1. The surveillance card is a diagram of the important features as seen from the radar's viewpoint. A sample surveillance card is shown in figure 8-1.
2. In many cases, it will be desirable to produce a surveillance card as an aide mémoire to the crew or detachment regarding its tasks and search priorities. (Often a suitably marked map will serve the purpose adequately.)
3. A surveillance card should reflect the following:
 - a. grid reference and elevation of the radar site;
 - b. grid reference and elevation of any alternate site(s);
 - c. description of task;
 - d. bearing to target area;
 - e. range to target area;
 - f. elevation setting to target area; and
 - g. dead ground that cannot be scanned by the radar.
4. The use of a surveillance card does not preclude the use of a range card by the radar operator in a defensive position. A description of the range card and its use is contained in CFP 317(4).

SECTION 2 - PLANNING

803. General

Comprehensive planning is essential in arriving at appropriate decisions as to how, when, and where to employ surveillance radars. Regardless of the type of unit, or its assigned mission, consideration of certain factors will enable the commander to obtain maximum effectiveness from his radars.

804. Enemy Situation

1. Strengths and Dispositions. The commander must consider an probable locations of his enemy, in what strength he is capable of operating, and for what length of time.
2. Firepower. Enemy direct and indirect firepower capabilities must be considered by the commander in his decisions regarding the radar employment and emplacement.
3. Enemy Electronic Countermeasures. Enemy electronic countermeasures (ECM) capability may effect the employment of surveillance radars; conversely, the lack of enemy ECM employment will permit maximum information to be obtained from employed radars. ECM may reduce the amount of detailed information that the radar should obtain but the mere presence of enemy ECM is a valuable indication of enemy activity in an area. The enemy would not bother to employ ECM if he did not have reason to consider that area important. Employment of AN/PPS-15s in pairs may tend to reduce enemy ECM effectiveness, since each radar operates at a slightly different frequency.

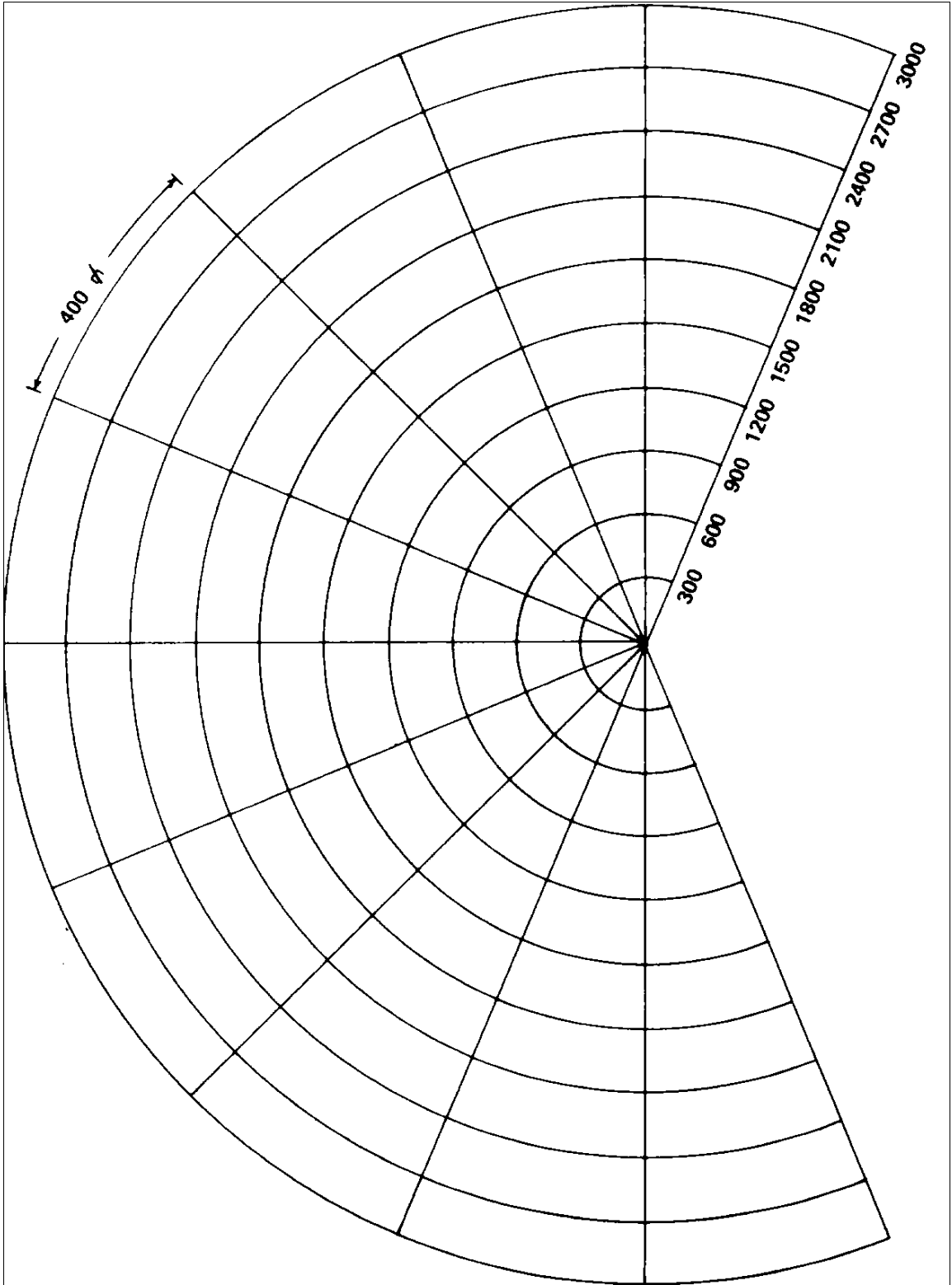

Figure 8-1 (Sheet 2 of 2) Surveillance Card

805. Friendly Situation

1. Mission. The unit's assigned mission must be carefully considered by the commander in making his decision in regard to the employment of the AN/PPS-15.
2. Own Strengths and Dispositions. The commander must consider the location of the elements of his unit, especially relative to each other, and to known and probable enemy locations. The characteristics of the area of operations and relative firepower must also be considered. He may then employ radar surveillance to add to the security coverage of those portions of his unit's position which may be thinly manned.
3. Availability of Trained Operators. A minimum of three trained operators are required for all-night operation of one radar.
4. Patrol Activity. The commander must consider the number, timings, route, type, and size of all friendly patrols operating in his area of responsibility to ensure the minimum number of false alarms.
5. Adjacent Units. The activities and operations of adjacent units must be known and considered in surveillance planning.

806. Control

Overall control of AN/PPS-15 radars must be precisely and carefully assigned. Reporting procedures must be planned so that the maximum amount of information is made available to the commander. Use of the radars in connection with operation of other sensors must be studied and planned.

807. Maintenance

1. The surveillance plan must include consideration of any maintenance factors which might affect the performance of the radars:
 - a. preventive maintenance;
 - b. battery supply;
 - c. repair and replacement; and
 - d. maintenance of supporting surveillance devices.

808. Weather

The effects of weather on the performance capabilities of the radar and the individual capabilities of the operators must be considered. High winds, heavy rains, and extreme cold will affect the surveillance plan.

SECTION 3 - SITING CONSIDERATIONS

809. General

The factors of terrain and the radar characteristics bear heavily on selection of proper sites for radar operation to assure optimum coverage. Siting is equally important whether the operation is one of reconnaissance, ambush, or an anti-ambush.

810. Line of Sight

1. The antenna unit of the AN/PPS-15 should be sited so as to have a direct line of sight to the area to be searched. Remember that only those targets visible by eye or through binoculars during good conditions will be detectable by radar at night or during conditions of poor visibility.
2. As shown in figure 8-2, radar are properly sited on high ground to cover a likely avenue of approach of enemy troops and vehicles. Proper siting provides good overlapping coverage.
3. Proper and improper sitings are depicted in figure 8-3. Although all radars are properly sited on high ground, only R2 is capable of providing the desired surveillance of the road. Ra is masked by a hill and Rc is masked by dense foliage preventing proper surveillance of the desired areas. In addition, Rc is being operated singly without overlapping coverage from another radar. if the sector of search of Ra were displaced approximately 350 mils to the right, Ra would not be masked and overlapping coverage would exist with Rb.

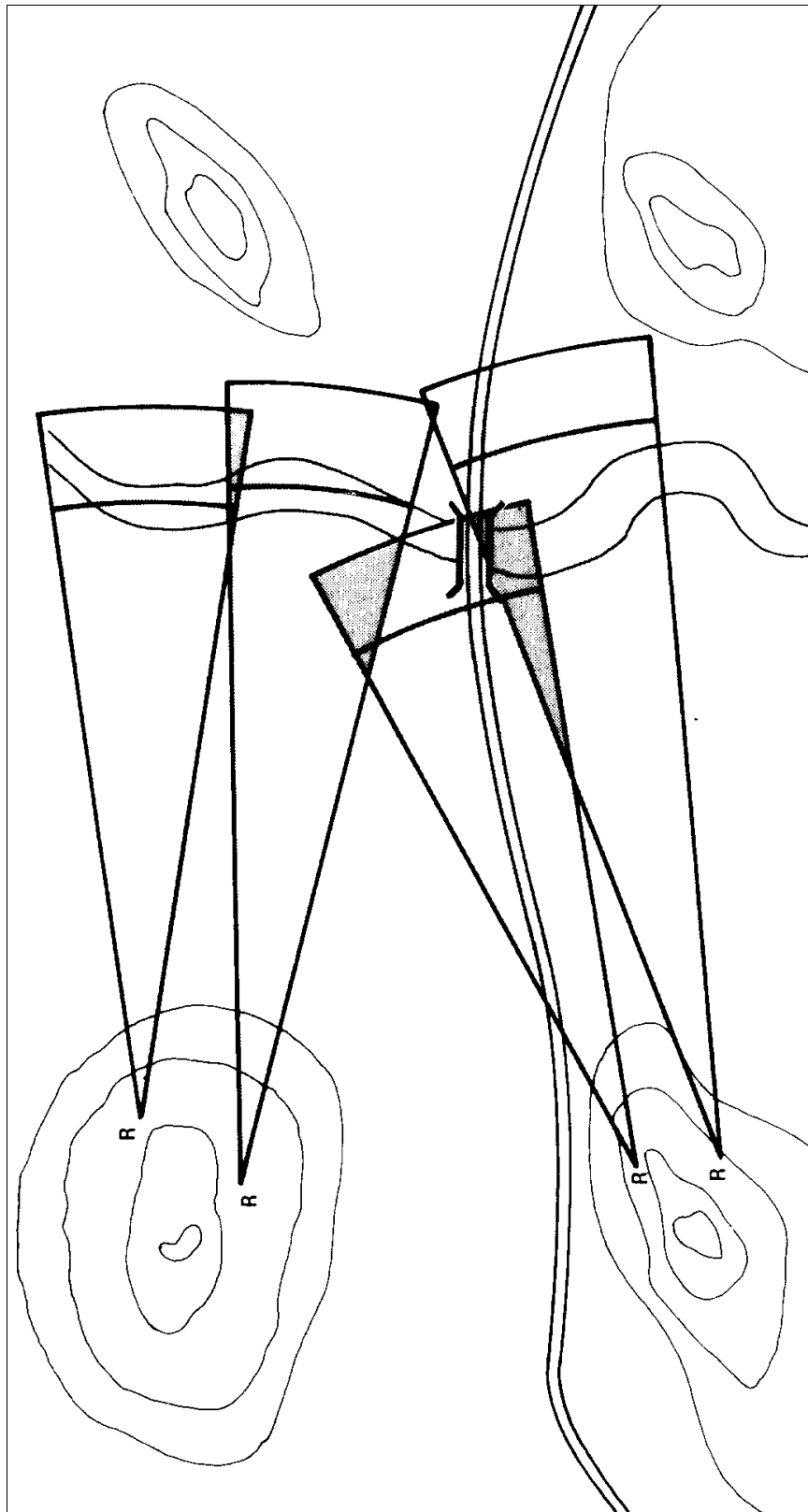

Figure 8-2 Proper Siting of PPS-15 Radar

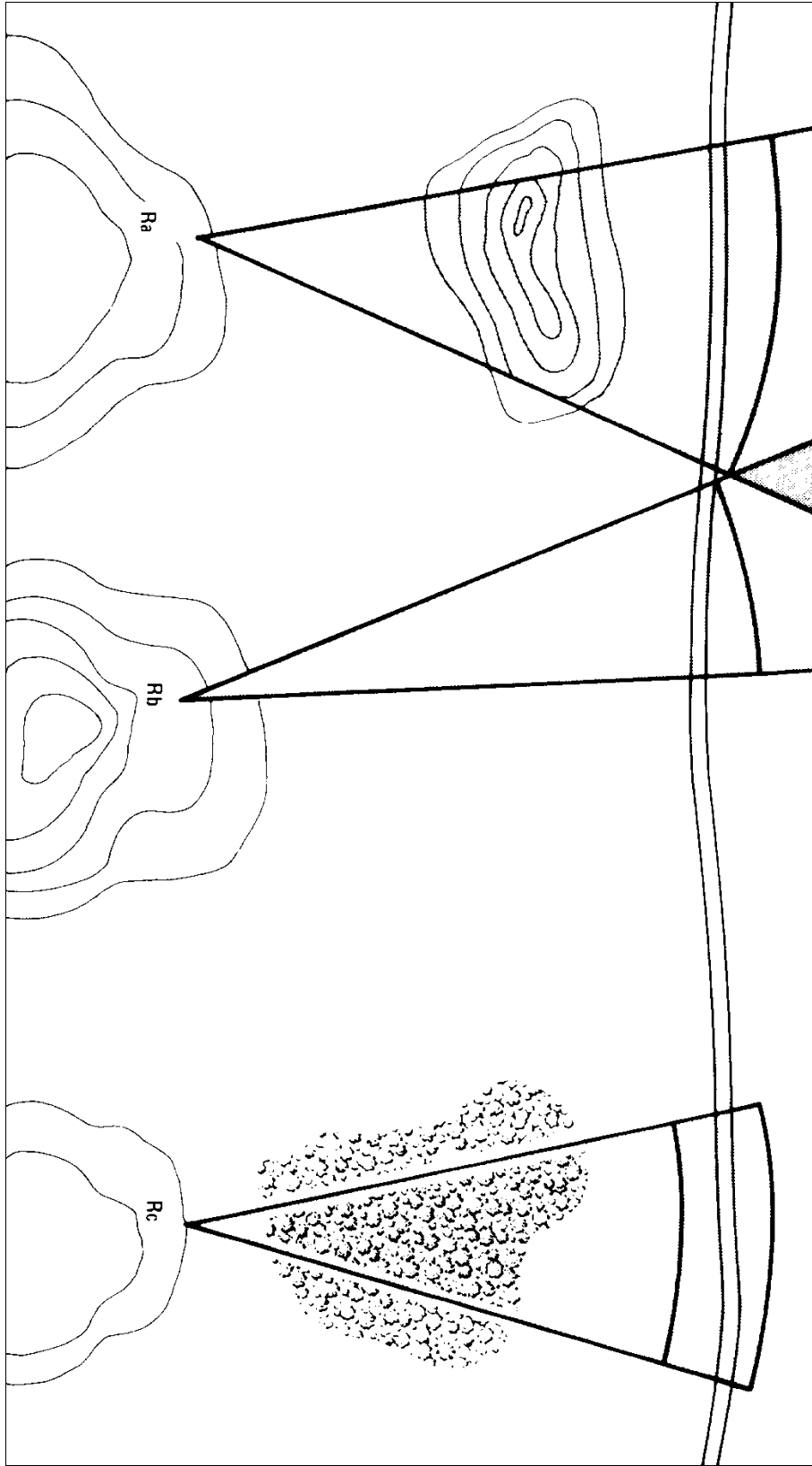

Figure 8-3 Proper and Improper Siting of PPS-15 Radar

811. Camouflage

It will generally be necessary to camouflage the radar. The antenna unit should never be placed on the sky-line or in any other position easily visible to the enemy. Remember the AN/PPS-15 will not penetrate foliage, buildings, walls, or hills, but will penetrate glass and dry canvas.

812. Orientation and Fixation

When carrying out surveillance over an area, accurate information will be produced only when orientation and fixation are accurate. Orientation and fixing should be done during daylight and under conditions of good visibility for greatest accuracy.

813. Integrated Surveillance Plan

1. General. The surveillance plan must ensure that all radars are fully coordinated with other information gathering means. The radar should be used for the establishment of an electronic fence at long range to obtain early detection of enemy movement.
2. AN/PPS-4 Radar. With a range of 8 000 m for large targets and 1 500 m for small targets, the PPS-4 radar can still be effectively employed, especially at the longer ranges, in a surveillance plan. For further reference, CFP 317(16), Ground Surveillance Radar AN/PPS-4A should be consulted.
3. Night Observation Devices/Infrared Devices. These devices may well be used in close proximity to radar. When a possible target is detected during the night by the radar, the Night Observation Devices (NOD) and infrared devices (IR) can be given the bearing and range to the target and can observe that area for positive identification and verification of enemy movement.
4. Other Detection Means. The radar should when possible be sited to support any of the following:
 - a. patrols;
 - b. listening posts; and
 - c. observation posts.

814. Alternate Positions

The radar is detectable by the enemy. Alternate positions will generally be necessary. When choosing these, a position should be selected which is in defilade to enemy observation but still permits coverage of the assigned tasks.

815. Overlapping Areas of Covering

It is desirable to employ AN/PPS-15 radars to ensure adequate coverage of areas entailing a degree of overlap in search patterns. Ideally, the radar sets should be sited in pairs, or in such numbers as are required to guarantee adequate and overlapping coverage of sectors. Areas which are masked from the radars beacon such as reverse slopes, gullies, woods may have to be dealt with by other means, eg, standing patrols, outposts, sensor devices, etc.

816. Operator Protection

The siting of the radars should also take into consideration the amount and type of cover available to the operator within the 9-metre remote capability. Maximum protective cover should be utilized.

817. Communications

1. Where the radar is sited to provide information for an overall surveillance plan, it will be necessary to consider communications when siting. A suitable site will be one which:
 - a. ensures that communications link can be established; and
 - b. guarantees absence of interference with, or from other radars, radios or external power sources.

818. Determining Angle of Elevation/Slant Range

1. In normal situations, the radar will be sited on high ground overlooking the area under surveillance. This type of siting is desirable to provide optimum sector coverage.
2. There are, of course, occasions when this type of siting is not necessary, eg, when looking across the floor of a valley into the hills beyond.
3. Care should be taken to determine the proportions of range and elevation alterations necessary when very steep vertical angles are involved. The map will show only horizontal ranges which will not be suitable when working at large vertical angles.
4. To determine the angle of elevation, it is necessary to have the following information:
 - a. Horizontal Range. The horizontal range is the distance in metres (measured on a map) from the radar site to the target.
 - b. Height Difference. The difference in height between the radar and the target (this information can be obtained by reading the contour lines on the map) in metres.
5. Calculating the Angle of Elevation Formula. The following formula is useful for the purpose of calculating the angle of elevation where:

- a. HD = Difference in height (metres);
- b. S = Subtention (metres); and
- c. Angle of Elevation (mils) = H/S

NOTE: Subtention - At 1 000 m an angle of 1 mil subtends an arc of 1 m.

6. Assuming that the height (or width) of an object at the target range of 2 000 metres is 1 mil, the following example illustrates the formula's use:

Angle of Elevation (Mils)	Factor (Mils)	Angle of Elevation (Mils)	Factor	Angle of Elevation (Mils)	Factor	Angle of Elevation	Factor
100	1.005	280	1.039	460	1.111	640	1.238
120	1.007	300	1.045	480	1.121	660	1.256
140	1.009	320	1.051	500	1.134	680	1.276
160	1.012	340	1.058	520	1.145	700	1.296
180	1.015	360	1.065	540	1.160	720	1.317
200	1.020	380	1.074	560	1.173	740	1.339
220	1.024	400	1.082	580	1.186	760	1.362
240	1.028	420	1.091	600	1.203	780	1.383
260	1.033	440	1.100	620	1.220	800	1.414

Table 8-1 Slant Range Factors

- a. HD = 880 m;
- b. S = 2 m; and
- c. Angle of Elevation = $880/2 = 440$ mils.

7. Calculation of Slant Range. Once the angle of elevation has been determined, there then only remains to find the slant range. This is done by multiplying the known horizontal by the slant range factor appropriate to the known angle of elevation. Using the information already supplied in the example in para 6 of this article and assuming that the horizontal range is 2 000 m, the slant range can be found by means of a formula as follows:

$$\text{Slant Range} = \text{Horizontal Range} \times \text{Slant Range Factor}$$

From table 8-1 the slant range factor for the angle of elevation of 440 mils is 1.100. Continuing with our example:

$$SR = 2000 \times 1.100 = 2\ 200\ m$$

Slant range and Angle of Elevation are graphically illustrated in figure 8-4.

819. Defensive Employment

1. General. The most productive employment of the AN/PPS-15 will be found in defensive situations. The fact that it is more portable and its silent operation can be exploited to maximum advantage by units in the defense. The following factors should be considered when siting the PPS-15 in a defensive position:

- a. Surveillance of Enemy Avenues of Approach. The AN/PPS-15 will frequently be employed as a means of keeping likely enemy avenues of approach under surveillance.
- b. Route Surveillance. The radar can provide information on enemy traffic density and direction of movement when used to scan movement routes.
- c. Patrol Coordination. Utilization of the AN/PPS-15 provides a means of control and coordination of patrols out to the limit of the radar's range. Undesired engagements with enemy forces or accidental meetings between friendly units and patrols operating in their proximity may be avoided by using radar as a means of coordination.
- d. Coordination Illumination. The radar can provide precise range and bearing to allow illumination of moving targets.
- e. Control of Fire. The AN/PPS-15 can acquire targets for night fire missions and can track the advancing or retreating enemy to permit accurate shifting of fire.

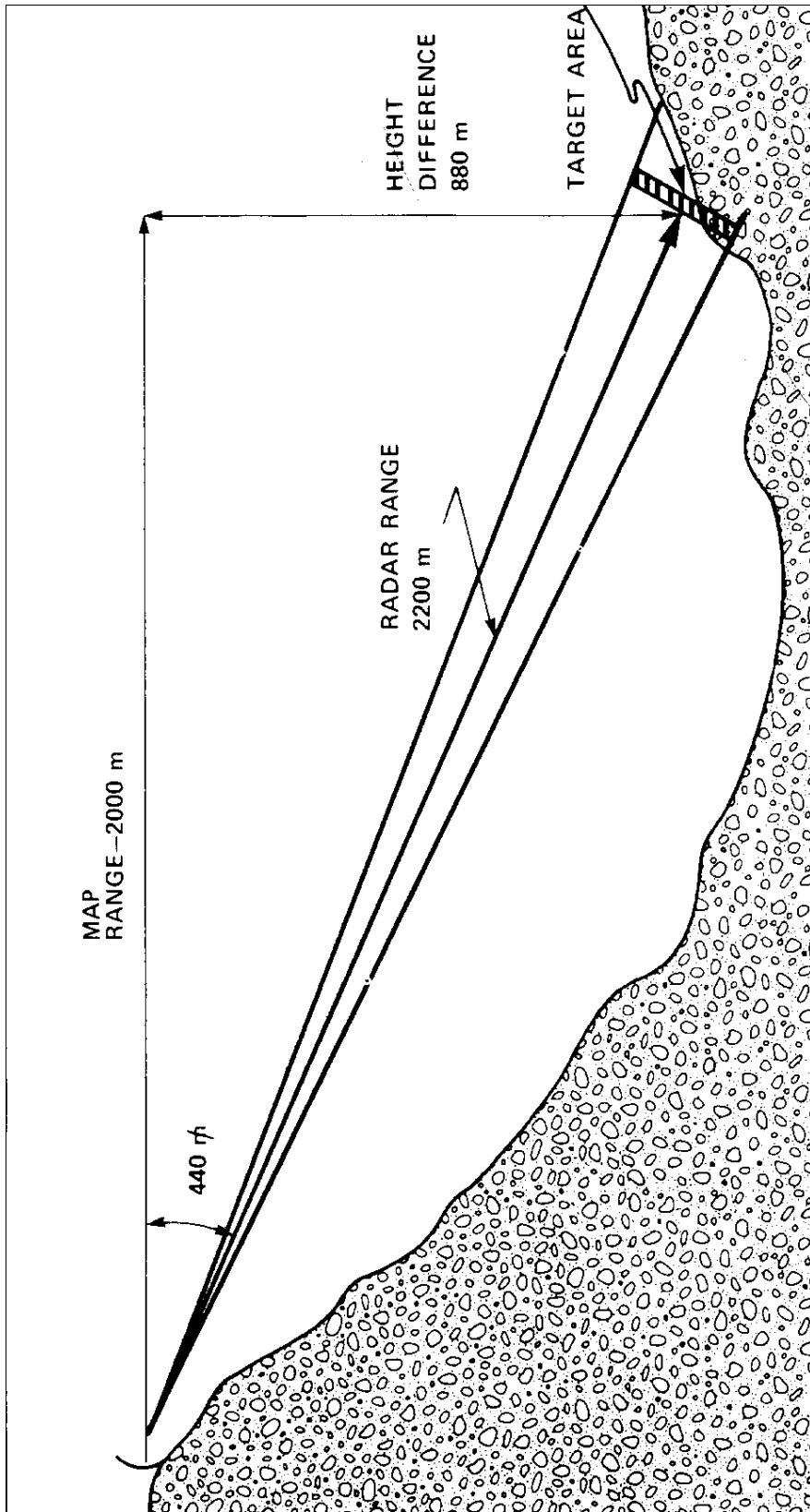
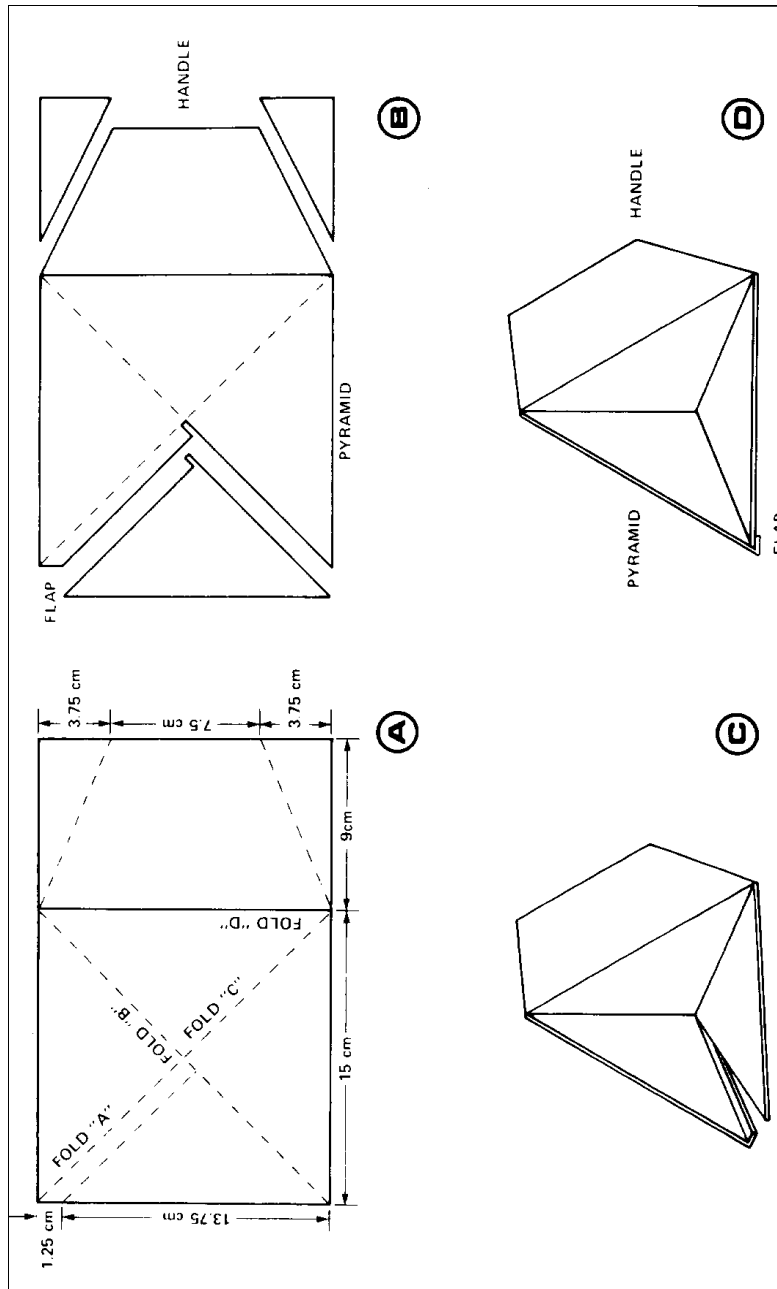

Figure 8-4 Range and Vertical Angle

- f. Naval Defense. Movement of watercraft on rivers or in coastal areas can be detected.
- g. Perimeter Security of Fixed Installations. The AN/PPS-15 may be used to enhance the security of fixed installations.
- h. Area Scan. The radar can be used to detect the presence of intruders in such areas as ammunition dumps, fuel depots, or equipment staging areas.
- j. Hasty Defense Security. The AN/PPS-15 can be utilized to establish security for a hasty night defensive position just as readily as for a deliberate defensive position.

820. Offensive Employment

- 1. General. The surveillance radar AN/PPS-4 was generally considered as a defensive surveillance device but with a limited capability for assistance in offensive operations. The light weight of the AN/PPS-15 and its remote control capability combine to give the radar a role in offensive operations. Some uses for the PPS-15 in these operations are as follows:
 - a. Night Attack Coordination. The radar can serve as an accurate means of determining the location of deployed units during the night attack. Enemy activity in the objective area can also be determined. Small corner reflectors (see figure 8-5) or even an empty can, may be used as an identification means by simply waving it toward the radar in a prearranged signal sequence.
 - b. Raid Objective Surveillance. The AN/PPS-15 may be used to determine sentry or guard motion and timing by surveillance of the objective.
 - c. Flank Screening. The radar can be employed as a surveillance means on the unprotected flank of a unit advancing at night. By leapfrogging radar sets, constant surveillance can be maintained and the possibility of being surprised by an attack from the flank can be reduced.



- A. 1 – Cut a piece of light gauge sheet metal to 15 cm x 24 cm
 2 – Scribe all lines except fold D on the bottom surface of the sheet metal as shown above.
 3 – Scribe the line for fold D on top surface as shown above.
- B. 1 – Cut the pieces as shown above.
 2 – Bend the flap up to 120° along fold A.
- C. Bend fold C and then B to form a pyramid.
- D. Fabricated corner reflector.

Figure 8-5 Corner Reflector

- d. Ambush Detection. The AN/PPS-15 radar provides a means of detecting the establishment of an ambush by the enemy. The enemy force can be tracked as it moves into its planned ambush position. Even when the ambush position has been occupied, it is likely that there will be tell tale movement which will reveal the position. It must be remembered, however, that the radar cannot detect personnel standing still.
- e. Preparation of an Ambush. The AN/PPS-15 can play an important role in the preparation of an ambush. It can detect moving enemy forces at sufficient range to permit the alerting of all members of the ambush team and re-adjustment of the position. Because of its silent operation, the radar can be used to track the enemy close to the ambush site.

821. Reconnaissance

- 1. General. Because of its light weight and portability when carried in its backpack, the AN/PPS-15 can be easily carried by reconnaissance elements. The AN/PPS-15 can also be mounted on the pintle of the armoured personnel carrier and the Lynx for vehicle operation by using the pintle adapter. (See figure 8-6). Tasks which can be performed include:
 - a. Patrol Base Security. A reconnaissance patrol commander may, in unusual cases, use the AN/PPS-15 to enhance the security of his patrol in the same manner that a larger unit commander would use it to protect his defensive positions.
 - b. Movement Count. The radar can be used in reconnaissance to conduct a count of enemy movements, or activities, from positions well away from areas subject to search by enemy patrols.



Figure 8-6 Adapter, Pindle-mount

- c. Screening. Reconnaissance elements can use the AN/PPS-15 to assist them in conducting screening operations for larger forces.

SECTION 4 - DESTRUCTION TO PREVENT ENEMY CAPTURE

822. Destruction of the AN/PPS-15(V)2

1. General. When capture or abandonment of the radar set AN/PPS-15(V)2 to an enemy is imminent, the responsible unit commander must make the decision to either destroy the equipment or to render it inoperative.
2. Destruction by Mechanical Means. Destruction of the radar set is readily accomplished with a hammer, pick, or any other tool available, or if no tools are available, using a heavy stone:
 - a. Smash in and distort the physical shape of the antenna.
 - b. Hit the top of the drive motor to break it off or bend the drive shaft.
 - c. Remove the control indicator and smash all the controls, switches, and the indicator.
 - d. Bend the elevation control and indicator.
 - e. Remove the battery from the battery compartment and smash it.
 - f. Cut up the cables.
 - g. Bend or break all equipment controls and cable connectors.
 - h. Distort the terminals inside the battery case beyond use.
 - j. Remove the antenna drive from the tripod and bend each leg.
 - k. When time permits, disassemble and scatter all removable components.

(823 to 899 not allocated)

CHAPTER 9

ELECTRONIC WARFARE

SECTION 1 - DEFINITIONS

901. Electronic Warfare

Electronic warfare (EW) may be defined as the division of the military use of electronics involving actions taken to prevent or reduce an enemy's effective use of radiated electromagnetic energy and also actions taken to ensure our own effective use of radiated electromagnetic energy.

902. Electronic Countermeasures

1. Electronic counter measures may be defined as the major sub-division of electronic warfare involving actions taken to prevent or reduce the effectiveness of enemy equipment and tactics employing electromagnetic radiations and to exploit the enemy's use of such radiation. ECM is considered in two categories:

- a. Passive. Passive ECM is the examination or analysis of electromagnetic radiations to determine, for the purpose of electronic countermeasures' use, the existence, origin, and pertinent characteristics of those electromagnetic radiations which the enemy may be using.
- b. Active. Active ECM is the impairment of enemy electronic detection, control, or communication devices and systems through deliberate jamming or deception -
 - (1) Jamming. Electronic jamming is the deliberate radiation, re-radiation, or reflection of electro-magnetic signals, with the object of hampering the use of electronic devices by the enemy.
 - (2) Deception. Electronic deception is the deliberate radiation, re-radiation, alteration, absorption, or reflection of electromagnetic radiations in a manner intended to mislead an enemy in the interpretation of data received by his electronic equipment or to present false indications to electronic systems.

903. Electronic Counter Countermeasures

Electronic counter countermeasures is the major subdivision of EW involving actions taken to ensure our own effective use of electromagnetic radiations despite the enemy's use of countermeasures.

SECTION 2 - ELECTRONIC COUNTERMEASURES REPORTING AND RECORDING AND ELECTRONIC COUNTER COUNTERMEASURES PROCEDURES

904. Countermeasures Reporting and Recording

1. Immediate reporting of countermeasures and accurate, complete recording of countermeasures reception for additional reports, are important responsibilities of the radar operator. Countermeasures usually indicate an impending enemy action.
2. Local standing operating procedures should be followed in reporting and recording countermeasures. Generally for effective reporting, the radar operator must determine as quickly as possible and report on the following
 - a. The time and duration of the interference.
 - b. The strength of a jamming signal, eg, strong, medium, or weak, depending on how seriously it hampers operation and over how large an area it is effective.
 - c. As accurately as possible, the bearing and elevation of the origin of a jamming signal and also the ranges of deception signals.
 - d. In general, all data regarding the countermeasure signals and the extent to which they impair the successful completion of the radar mission.

905. Electronic Counter Countermeasures Procedures

1. The operator must expect to receive countermeasures and must be ready at all times, to employ all the electronic counter countermeasures as laid out in unit standing operating procedure to successfully accomplish the mission.
2. With equipment such as radar set AN/PPS-15(V)2, the operator's best defence against electronic countermeasures is a thorough knowledge of, and familiarity with, all the various target sounds he might encounter.
3. If electronic countermeasures are encountered, the operator must:
 - a. not turn off the radar set (it is an indication to the enemy that his ECM is effective);
 - b. keep calm; and
 - c. react quickly and decisively, by employing electronic counter countermeasures immediately and accurately.

(906 to 999 not allocated)