

**MIL-HDBK-162A  
VOLUME 1 OF 2  
15 DECEMBER 1965**

**DEPARTMENT OF THE ARMY TECHNICAL MANUAL**

**TM 11-487C-1**

**MILITARY STANDARDIZATION HANDBOOK  
UNITED STATES  
RADAR EQUIPMENT**

**FSC MISC**

**\*TM 11-487C,1**

HEADQUARTERS  
DEPARTMENT OF THE ARMY  
WASHINGTON, D. C., *15 December 1960*

TM 11-487C-1/MIL-HDBK-162A, Volume 1, is issued for the use of all concerned.

---

**'This manual supersedes TM 11-487C (MIL-HDBK-162), 13 February 1961.**



**DEPARTMENT OF DEFENSE  
WASHINGTON 25, D.C.**

MIL-HDBK-162A  
United States Radar Equipment  
15 December 1965

1. This standardization handbook has been approved by the Department of Defense and is mandatory for use by all Departments and Agencies of the Department of Defense.

2. This publication was approved on 15 December 1965 for printing and inclusion in the military standardization handbook series.

3. This handbook is designed to supplement department manuals and directives and is intended for use in the standardization to the greatest extent possible, of the design, development, procurement, and application of military radar equipment.

4. Every effort has been made to reflect the latest data and information on radar equipment of current interest to each of the Departments of the Department of Defense. This handbook is to be reviewed and supplemented, periodically, to insure its completeness and currency. Users of this document are encouraged to report any errors discovered and any recommendations for changes or inclusions to Cataloging Office, New Item Entry Control Division (Manual), Communications Branch, Attn: SGEBF, Wright-Patterson Air Force Base, Ohio 45433.

Custodian:  
Army--Electronics Command - EL  
Navy--Bureau of Ships  
Air Force - 85

Preparing Activity:  
Air Force - 85  
Project Number Misc - 0282



TABLE OF CONTENTS  
VOLUME 1

SECTION 3 - SHIPBORNE (Cont'd)		SECTION 3 - SHIPBORNE (Cont'd)	
Type	Page	Type	Page
AN/BPA .....	AN/BPA-4: 1	SA .....	SA: 1
AN/BPS .....	AN/BPS-4: 1	SB .....	SB-440/SP: 1
AN/CPT .....	AN/CPT-2: 1	SC .....	SC: 1
AN/SPA .....	AN/SPA-4: 1	SD .....	SD: 1
AN/SPG .....	AN/SPG-TIO: 1	SF .....	SF: 1
AN/SPN .....	AN/SPN-T1: 1	SG .....	SG-a: 1
AN/SPQ .....	AN/SPQ-7: 1	SJ .....	SJ: 1
AN/SPS .....	AN/SPS-TJ: 1	SN .....	SN-148/SPA: 1
AN/SSA .....	AN/SSA-16(XN-2): 1	SO .....	SO: 1
AN/SSQ .....	AN/SSQ-4: 1	SP .....	SP: 1
AN/UPA .....	AN/UPA-4: 1	SR .....	SR: 1
AN/UPN .....	AN/UPN-7: 1	SS .....	SS: 1
AN/UPX .....	AN/UPX-1: 1	ST .....	ST: 1
AN/WPN .....	AN/WPN-1: 1	SU .....	SU: 1
AN/WSA .....	AN/WSA-1: 1	SV .....	SV: 1
AS .....	AN/45A/APR-6: 1	SX .....	SX: 1
AT .....	AT-1090/B: 1	VC .....	VC: 1
BL .....	BL-1: 1	VE .....	VE: 1
BN .....	BN-1: 1	VF .....	VF: 1
C .....	C-2456/P: 1	VG .....	VG: 1
CP .....	CP-87/U: 1	VH .....	VH: 1
CV .....	CV-95A/U: 1	VJ .....	VJ: 1
CXBR .....	CXBR-1: 1	VK .....	VK: 1
CXKA .....	CXKA: 1	VL .....	VL: 1
CY .....	CY-1913/U: 1	YJ .....	YF-2: 1
F .....	F-20/UPR: 1	23AFL .....	23AFL: 1
IP .....	IP-99/SP: 1	23AGU .....	23AGU: 1
KY .....	KY-71/UPX: 1	46ACQ .....	46ACQ-1: 1
MK 8 MOD 2 .....	MK 8 MOD 2: 1	50ACU .....	50ACU: 1
MK 12 MOD 1 .....	MK 12 MOD 1: 1	55ACU .....	55ACD: 1
MU .....	MU: 1	55ADP .....	55ADP: 1
MX .....	MX-969/SPA-4A: 1	55AHP .....	55AHP-1: 1
O .....	O-329/SP: 1	66ACG .....	66ACG: 1
OA .....	OA-266/SSA: 1	66AHQ .....	66AHQ: 1
OBJ .....	OBJ: 1	APPENDIX A .....	1A-1
OCJ .....	OCJ: 1	APPENDIX B .....	B-1
OCZ .....	OCZ: 1	INDEX OF ITEMS BY NAME .....	i-1
PU .....	PU-155/SP: 1		
R .....	R-223/SPR: 1		

## INTRODUCTION

### 1. PURPOSE

MIL-HDBK-162A is intended to provide, in concise and convenient form, factual data to familiarize maintenance and engineering personnel and government contractors with the characteristics and physical make-up of radar equipments use within the Department of Defense. In the case of government contractors, sufficient information is provided for determination that an item of equipment is suitable or unsuitable for a contemplated application, usually without recourse to supplemental detailed data. If detailed data is required to consider possible modification of the item, the item description will readily reflect availability of publications for requisition through proper channels.

### 2. SCOPE

This publication contains technical and functional descriptions, logistical information, installation considerations, and reference data for radar equipments used in the Department of Defense. Ground, airborne, and shipborne equipments are included.

### 3. ARRANGEMENT OF CONTENTS

MIL-HDBK-162A is a two-volume publication. Volume 1 contains descriptions of unclassified radar equipments, while Volume 2 contains descriptions only of those equipments classified "CONFIDENTIAL." Each volume is divided into three major sections - Ground Radar, Airborne Radar, and Shipborne Radar. Within each section, equipments are listed alphanumerically, according to type designation.

Equipments are designated by one of the five nomenclature systems used in this handbook. Although the majority of the equipments are designated according to the Joint Electronics Type Designation System (JETDS), the following systems are also used: (Appendix A contains detailed explanations of each of these systems).

- a. Signal Corps Nomenclature System
- b. Navy Model Letter System
- c. Navy Type Designation System
- d. Navy Experimental Model Letter System

### 4. GLOSSARY OF ABBREVIATIONS

Appendix B is a glossary of the abbreviations used in this publication. Abbreviations are listed alphabetically, letter-by-letter, without regard to punctuation or the number of words contained in the abbreviated phrase.

### 5. DETAILS OF CONTENT

Descriptions of individual equipments are presented in a standard format. The first page of each description includes an illustration (if available) and all information, needed for general identification of the equipment. More detailed information appears on a second and, succeeding pages. The nomenclature at the top of each page indicates the specific equipment described on that page. Parentheses attached to the type designation indicate that the description applies to more than one model of the equipment. If only specific models of an equipment are covered by a description, the type designation for each is listed at the top of the page.

Cognizant Service is defined as that service responsible for procuring the equipment and/or applying for its nomenclature.

FSN is the abbreviation of Federal Stock Number, the number assigned to an equipment for supply cataloging. The FSN is a combination of the Federal Supply Classification number and the Federal Item Identification Number.

If available, a photograph of each equipment is included. For some of the complex equipments,

stylized drawings are used. Minor accessories are deleted from most of the photographs, and, in some, not all major components are shown.

Data is included for only the major operating components. The topics covered are:

- (1) Functional Description
- (2) Relation to Similar Equipment
- (3) Technical Description
- (4) Installation Considerations
- (5) Reference Data and Literature

In addition, a table, listing principal components with dimensions and weights, is included.

## 6. STATUS OF EQUIPMENT CLASSIFICATION

Each department of the Department of Defense uses its own status of equipment classification.

a. U. S. Army Equipment Classification System. The following terms are used by the U. S. Army to describe the status of Army equipment.

(1) Standard A (Std-A) designates items which are preferred for operational requirements. Both complete and end items and necessary repair parts and components may be procured.

(2) Standard B (Std-B) designates items which are acceptable to fill operational requirements. Repair parts and components to support end items already in the system may be procured. Complete end items will not be procured without program approval by the Deputy Chief of Staff for Logistics.

(3) Standard C (Std-C) designates items which are only marginally accepted for operation requirements, and will be phased out of the system as stocks of more acceptable items become adequate to meet requirements. End items in stock may be maintained to the extent permitted by repair parts and components already on hand or by cannibalization. No procurement of repair parts or complete overhaul programs in this category will be effected without program approval by the Deputy Chief of Staff for Logistics.

(4) Obsolete type (Obs) designates an item or assemblage which has been declared unsuitable for military (Army) use. Obsolete

items will not be issued and will be disposed of at the earliest practicable date by the chief of the responsible agency in accordance with the existing instructions, except in those special cases where they are to be retained for special requirements outside of the established Army supply program. Where the development and procurement status of the new types make such action desirable, the chief of the responsible development agency will recommend reclassification of former types through the technical committee.

b. U. S. Navy Equipment Classification System. The following terms are used by the U. S. Navy to describe the status of its equipment.

(1) Standard(Std). The most advanced and satisfactory articles adopted, and those which are preferred for procurement.

(2) Limited standard (Ltd Std). Articles which do not have satisfactory military characteristics as standard articles, but are usable substitutes for standard articles. Complete major units will not be procured, but component parts and accessories and complementary articles, even though they may be limited standard articles, may be procured if necessary and economical, to maintain the complete major units in serviceable condition throughout a reasonable life expectancy.

(3) Substitute standard(Sub Std). Articles which do not have as satisfactory military characteristics as standard articles and, when necessary, may be procured to supplement the supply for standard articles.

(4) Planned standard (P Std). Those articles under evaluation which have been indicated by the Ship Characteristics Board for installation through the Ship Improvement Guide on new construction and conversion projects. Approval for service use prior to installation is required for articles in this category.

(5) Obsolescent (Obsoles). Those articles which do not have satisfactory military characteristics. Complete units, component parts, accessories, and complementary articles normally will not be procured for the specific purpose of maintaining this equipment; however, spare parts common to other equipment in the supply established may be used for their maintenance.

(6) Obsolete (Obs). Those articles that have been declared unsuitable for their original military purpose. Disposal of obsolete articles will, in all cases, be expedited.

## TABLE OF CONTENTS

## VOLUME 2

Paragraph	Page	SECTION 2 - AIRBORNE (Cont'd)
<b>INTRODUCTION</b>		Type <span style="float: right;">Page</span>
1 Purpose .....	vii	AN/APW.....AN/APW-11: 1
2 Scope .....	vii	AN/APX.....AN/APX-34(): 1
3 Arrangement of Contents.....	vii	AN/ASB.....AN/ASB-1: 1
4 Glossary of Abbreviations.....	vii	AN/DPN.....AN/DPN-37: 1
5 Details of Content .....	vii	CP.....CP-376A/APA-127: 1
6 Status of Equipment		E.....E-34: 1
Classification .....	viii	KY.....KY-145/DPW: 1
7 Currency of Information.....	ix	
8 Nonavailable Data.....	ix	
9 Changes. ....	ix	
<b>SECTION 1 - GROUND</b>		<b>SECTION 3 - SHIPBORNE</b>
Type		AN/BPA.....AN/BPA-2: 1
AN/FPS.....AN/FPS-7: 1		AN/BPQ.....AN/BPQ-1: 1
AN/GKA.....AN/GKA-1: 1		AN/BPS.....AN/BPS-1: 1
AN/GPA.....AN/GPA-37: 1		AN/SPA.....AN/SPA-7: 1
AN/GPS.....AN/GPS-4: 1		AN/SPG.....AN/SPG-34: 1
AN/GSS.....AN/GSS-1: 1		AN/SPN.....AN/SPN-12: 1
AN/KPQ.....AN/KPQ-1: 1		AN/SPQ.....AN/SPQ-2: 1
AN/MPN.....AN/MPN-17: 1		AN/SPS.....AN/SPS-2: 1
AN/MPQ.....AN/MPQ-25: 1		AN/SPW.....AN/SPW-2: 1
AN/MPS.....AN/MPS-21: 1		AN/SPX.....AN/SPX-2(XN-21): 1
AN/MSQ.....AN/NSQ-4: 1		AN/SSA.....AN/SSA-7: 1
AN/TPA.....AN/TPA-12: 1		AN/UPA.....AN/UPA-3: 1
AN/TPN.....AN/TPN-7: 1		AN/WPA.....AN/WPA-1: 1
AN/TPQ.....AN/TPQ-7: 1		AS.....AS/468/B: 1
ANA PS.....AN/TPS-22: 1		C.....C-1918(XN-I)/SPS-18: 1
AN/TPX.....AN/TPX-19: 1		CP.....CP-98(XN-1)/UPW.: 1
AN/UPS.....AN/UPS-1: 1		CV.....CV-1054(XN-I)/SPS-32: 1
AN/UPX.....AN/UPX-14: 1		CXRX.....CXRX: 1
AS.....AS-606/U: 1		IP.....P-199(XN-1)/SP: 1
OA.....OA-1162/TXQ-1: 1		MK 25 MOD 3.....MK 25 MOD 3: 1
T18.....T18: 1		MK 34 MOD 17.....MK 34 MOD 17: 1
		MK 35 MOD 2.....MK 35 MOD 2: 1
		OA.....OA-1213/WPQ: 1
		P.....P-14X: 1
		PO.....PO: 1
		SB.....SB-990(XN-1)/SP: 1
		SM.....SM-117/BPQ-2: 1
		SV.....SV-3: 1
		YQ.....YQ: 1
		APPENDIX A.....2A-1
		APPENDIX B.....2B-1
		INDEX OF ITEMS BY NAME.....i-
<b>SECTION 2 - AIRBORNE</b>		
AN/APA.....AN/APA-69: 1		
AN/APG.....AN/APG-51: 1		
AN/APN.....AN/APN-134: 1		
AN/APQ.....AN/APQ-50: 1		
AN/APR.....AN/APR-9: 1		
AN/APS.....AN/APS-27: 1		

c. U. S. Air Force Equipment Classification System. The following terms are used by the U. S. Air Force to describe the status of its equipment.

(1) Standard (Std). An item that meets an established need and is considered suitable for Air Force use.

(2) Alternate standard (Alt Std). An item that may not be so satisfactory as a standard item, but which is a usable alternate for procurement in quantity in place of the standard item when the standard item cannot be procured in quantities to satisfy Air Force needs.

(3) Limited standard (Ltd Std). An item in stock that is not as satisfactory as either standard or alternate standard items but which is usable in place thereof. Limited standard items may be used until stocks are exhausted. Limited standard end items will not be procured. Additional parts and components may be procured when necessary to maintain the item in serviceable condition.

(4) Tentative standard (Tent Std). An item that appears promising enough operationally to warrant the risk of initiating production of limited quantities prior to the completion of development or prior to completion of testing.

(5) Obsolete (Obs). An item that no longer meets Air Force needs.

(6) Development (Dev). Any new or significantly redesigned item undergoing development or testing and which has not been re-released as a satisfactory prototype for procurement in quantity for limited or general Air Force use. This classification is not normally assigned to commercial items or to items developed and tested by other Government agencies when being considered for use by the Air Force.

d. "Used By" Status Designation. Certain items of equipment are not assigned any of the equipment classifications defined in paragraphs a through c. These certain items of equipment are designated as "Used By" the particular service involved.

## 7. CURRENCY OF INFORMATION

Information in this publication is current as of the date on the first page of each equipment description.

## 8. NONAVAILABLE DATA

Space is provided for the insertion of data which was not available during the preparation of this publication.

## 9. CHANGES

Changes will be made as required to add information about current equipment. Reports of errors and omissions should be submitted through departmental custodians.

**SECTION 1**

**GROUND RADAR EQUIPMENT**



DATE: 1 July 1964

ITEM NAME: VIDEO AMPLIFIER

COGNIZANT SERVICE: USN

TYPE: AM-229/UP

FEDERAL STOCK NUMBER:

	USA	USN	USAF	USMC
STATUS OR TYPE CLASSIFICATION				
Mfg (s) Name or Code Number: National Electrical Machine Shops Inc, Silver Spring, Md				

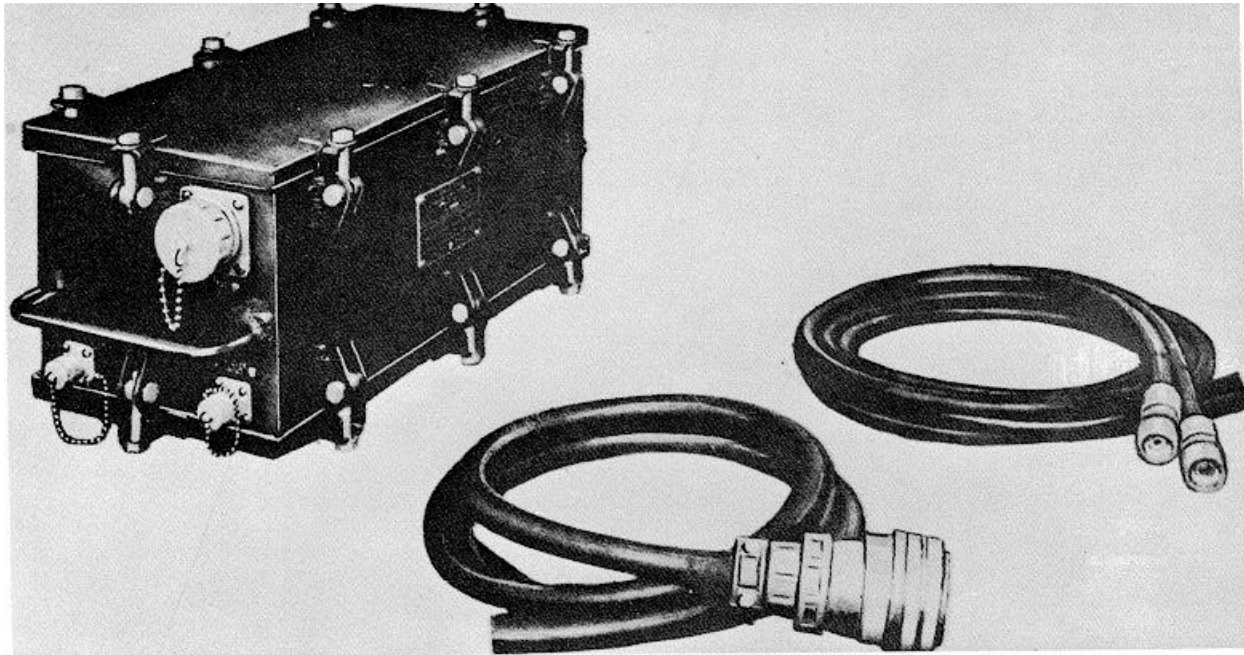

### FUNCTIONAL DESCRIPTION

The AM-229/UP is a repeater unit for video signals and trigger pulses. It is designed to be used when it is desired to transmit radar data to a remote repeater at a distance in excess of the maximum distance ordinarily

allowed. Since the video and trigger voltage outputs of the various radar equipments vary considerably, the distance at which the use of the video amplifier AM-229/UP is necessary must be determined by trial. For most equipments, except Radar Set AN/CPS-5, this distance will be around 750 ft. Since the

AM-229/UP: 1

**ITEM NAME:** VIDEO AMPLIFIER

**TYPE:** AM-229/UP

video voltage output of the AN/CPS-5 is not sufficient to operate a remote repeater such as the VE-1 Radar Repeating Equipment a video amplifier must ordinarily be used regard-less of the distance involved.

Video Output Signal: 2v peak amplitude  
Output Trigger Signal: 40v peak amplitude  
Video Channel Bandwidth  
    Within 1 db: From 1000 cycles to 4 me  
    Within 3 db: From 60 cycles to 6 mc  
Signal Input and Output Impedance: 75 ohms  
Power Source Required: 115v, 60 cps, 60w max

**RELATION TO SIMILAR EQUIPMENT**

None.

**TECHNICAL DESCRIPTION**

Video Input Signal: 0.5 to 2.0v

**INSTALLATION CONSIDERATIONS**

Not available.

**PRINCIPAL COMPONENTS AND PHYSICAL DATA**

<b>COMPONENTS</b>	<b>QTY</b>	<b>OVERALL DIMENSIONS (Inches)</b>	<b>UNIT WT. (Pounds)</b>
Video Amplifier AM-229/UP	1	8-5/32 x 9-25/64 x 18-21/64	32.5
Adapter Cable: c/o 6 ft lg RG-8/U Cable with UG-21/U plug at one end	2		
Adapter Cable: c/o 6 ft lg MC OS-7 Cable with AN3106-28-1P Plug at one end	1		
Technical Manual NAVSHIPS 91256	2		0.5
Box Equipment Spare Parts	1		

**REFERENCE DATA AND LITERATURE**

Technical Manuals:  
NAVSHIPS 91256 for Video Amplifier  
AM-229/UP.

**AM-229/UP: 2**

DATE: 1 April 1964  
COGNIZANT SERVICE: USAF

ITEM NAME: TRIGGER-VIDEO AMPLIFIER  
TYPE: AM-1379/FPS

FEDERAL STOCK NUMBER: 5840-345-8674

	USA	USN	USAF	USMC
STATUS OR TYPE CLASSIFICATION Std				
Mfg(s) Name or Code Number: General Electric Company				

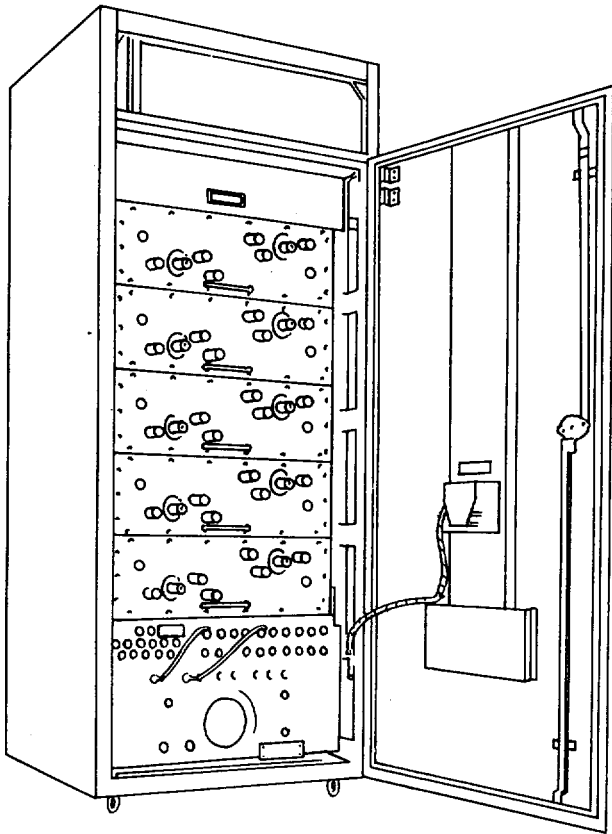

### FUNCTIONAL DESCRIPTION

Trigger-Video Amplifier AM-1379/FPS is a fully duplexed, general purpose, long-line equipment generally used in radar applications for amplification or isolation purposes. Trigger-Video Amplifier AM-1379/FPS accepts trigger, video, and antenna bearing information from a single, duplexed, air search radar equipment or from each of two air search radar installations designated as Radar 1

and Radar 2. Trigger pulses from both radar sets are amplified and shaped in this equipment; video information from either (but not both) radar set is only amplified. Antenna bearing information from either (but not both) radar set is directly routed to the output lines. An oscilloscope is included as part of this equipment to monitor all input and out-put signals.

### RELATION TO SIMILAR EQUIPMENT

None.

### TECHNICAL DESCRIPTION

Input Impedance: 50, 72, 93, or 220, 000 ohms

Output Impedance: 50 ohms

Video Channel Data:

Number of Channels - 5 (duplex)

Bandwidth - 100 cps to 4 mc

Gain - 40 db (variable)

Output Pulse Amplitude - 4. 5v, positive (max)

Trigger-Channel Data:

Number of Channels - 6

Input Trigger Pulse - amplitude, 15 to 55v, positive; duration, 1 to 8  $\mu$ sec; rise time, 0. 5  $\mu$ sec (max)

Output Trigger Pulse - amplitude, 25v, positive; duration, 1 to 3  $\mu$ sec; rise time, 0. 15  $\mu$ sec (max)

Power Requirements: 120 vac, 60 cps, 2 kva

Duty Cycle: Continuous

### INSTALLATION CONSIDERATIONS

Siting:

Mounting: Floor-mounted

Cabling Requirements: Control, signal, and power cables are fabricated locally

Related Equipment: Coordinate Data Transmitter AN/FST-1 and AN/FST-2

AM-1379/FPS

**PRINCIPAL COMPONENTS AND PHYSICAL DATA**

<b>COMPONENT</b>	<b>QTY</b>	<b>HEIGHT (Inches)</b>	<b>WIDTH (Inches)</b>	<b>DEPTH (Inches)</b>	<b>UNIT WT. (Pounds)</b>
Amplifier AM-1379/FPS	1	72	28	28	960

**REFERENCE DATA AND LITERATURE**

Technical Orders:  
31P6-2FPS-501

**AM-1379/FPS: 2**

DATE: 1 April 1964

ITEM NAME: DELAY LINE SET

COGNIZANT SERVICE: USAF

TYPE: AM-1796/FPS

FEDERAL STOCK NUMBER: 5840-628-1122

	USA	USN	USAF	USMC
STATUS OR TYPE CLASSIFICATION			Std	
Mfg(s) Name or Code Number: Hallicrafters Company				

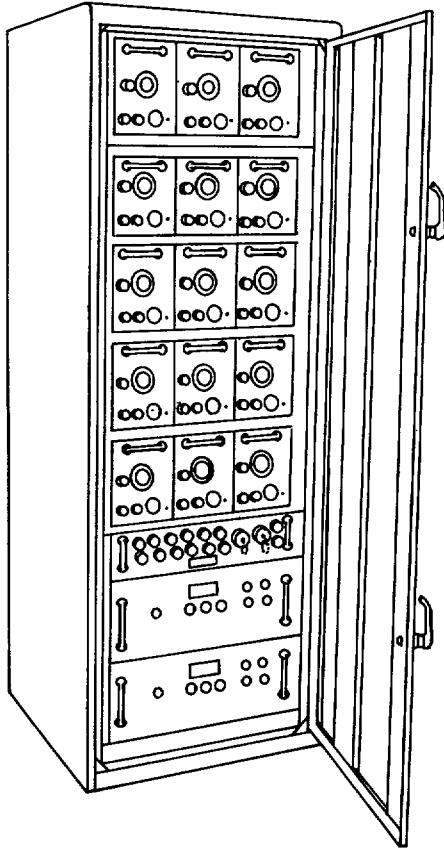

### FUNCTIONAL DESCRIPTION

Delay Line Set AM-1796/FPS is a dual-channel equipment used for synchronizing the zero-range return of duplex radar and IFF equipment. The AM-1796/FPS also supplies synchronization pulses to Coordinate Data Transmitting Set AN/FST-2. This synchronizing function is accomplished by a number of delay lines and blocking oscillators comprising Delay Line Set AM-1796/FPS. Delay Line Set AM-1796/FPS provides two delay channels, designated as a duplex. Delay Line Set AM-1796/FPS(XD-1) provides one delay channel, designated as a simplex.

### RELATION TO SIMILAR EQUIPMENT

None.

### TECHNICAL DESCRIPTION

Input Pulses: 15 to 90v, positive  
 Delay Range: 0 to 53. 2  $\mu$ sec in 0. 1  $\mu$ sec increments at operating points  
 Number of Vacuum Tubes: 58 (plus 6 in spare units)  
 Number of Silicon Rectifiers: 16  
 Input Impedance: All greater than 10, 000 ohms  
 Pulse Power Output (Triggering); +40,+30, and -10v into nom 50 ohm load  
 Delay Lines: Two 35-,sec delay lines, tapped to supply delays of 5, 7. 5, 10, 20, 30, 32. 5, and 35- $\mu$ secs; two 15-, $\mu$ sec delay lines, tapped to supply delays of 0. 3, 6, 9, 12, and 15  $\mu$ sec; 15 variable delay lines, variable from 0 to 3.2  $\mu$ secs in increments of 0.1  $\mu$ sec  
 Pulse Repeater Modules (Generator, Pulse 0-538/FPS): 4 available for each channel, used with any variable delay module to supply any auxiliary output  
 Temperature Requirements: Operating, -29 to 54 deg C; non-operating, -54 to +71 deg C  
 Barometric Pressure: Operating, sea level to approximately 10, 000 ft; non-operating, sea level to approximately 40, 000 ft  
 Cooling Method: Air convection

AM-1796/FPS

Power Requirements: 115 vac, 60 cps, 1-ph,  
290w

Mounting: Located within electrical equipment  
cabinet

Cabling Requirement:

Related Equipment:

Sage Computer AN/FSQ-7

Coordinate Data Transmitting Set AN/FST-2

**INSTALLATION CONSIDERATIONS**

Siting: Physically located at Sage radar sites

**PRINCIPAL COMPONENTS AND PHYSICAL DATA**

COMPONENT	QTY	HEIGHT (Inches)	WIDTH (Inches)	DEPTH (Inches)	UNIT WT. (Pounds)
Delay Line Set AM-1796/FPS	1	78-1/2	28	28	1000
Power Cable	1			25 ft	2. 56
Spare Parts Group	1				
Coaxial Cable with Connectors BNC RG- 58C/U	4			54 ft	1.37
Coaxial Cable with Connectors BNC RG- 58C/U	2			10	.062
51 Ohm Termination	6				.031
69 Ohm Termination	6				.031

**REFERENCE DATA AND LITERATURE**

Technical Orders:  
31P1-2FPS-111

31P1-2FPS-122

31P1-2FPS-123

31P1-2FPS-124

Specification:  
MIL-D-9774

**AM-1796/FPS: 2**

DATE: 1 July 1964

ITEM NAME: RADIO SET

COGNIZANT SERVICE: USN

TYPE: AN/CPN-3

FEDERAL STOCK NUMBER: F5895-665-2465 W/S

	USA	USN	USAF	USMC
STATUS OR TYPE CLASSIFICATION				
Mfg(s) Name or Code Number: Philco Corporation, Philadelphia, Pennsylvania				

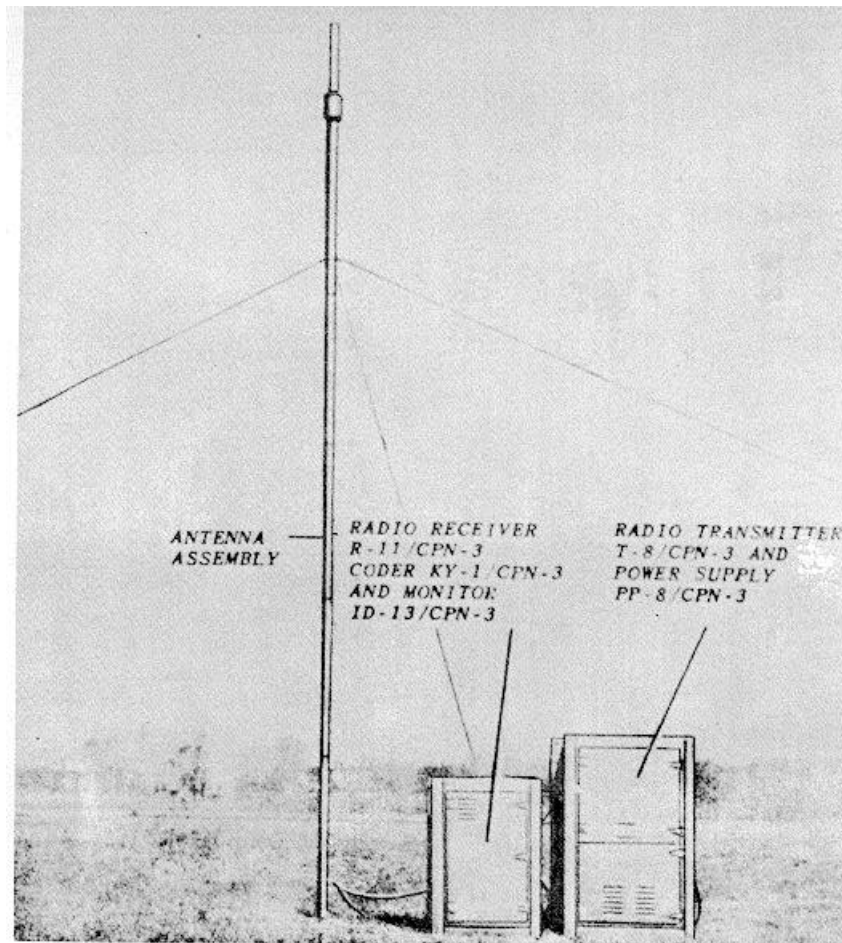

### FUNCTIONAL DESCRIPTION

The AN/CPN-3 is a ground radar beacon which responds automatically to beacon interrogating pulses from radar equipment on aircraft seeking the beacon position. The radio set is non-directional, receiving over a wide

super-high frequency band, and transmitting at a preset frequency near this band. It transmits coded signals which identify the beacon to the interrogating aircraft. These signals, transmitted after a delay of 4  $\mu$ sec, consists of six or less time spaced pulses which appear on the aircraft indicator screen.

AN/CPN-3: 1

**ITEM NAME:** RADIO SET

**TYPE:** AN/CPN-3

The first pulse locates the beacon in azimuth and range, the others form the code which identifies it.

Range: 150 mi under favorable conditions  
Operating Power: 100 to 130v, 50 to 70 cps, 15 amp, or 200 to 260v, 50 to 70 cps, 7.5 amp  
Power Factor: 0.9

**RELATION TO SIMILAR EQUIPMENT**

None.

**INSTALLATION CONSIDERATIONS**

**TECHNICAL DESCRIPTION**

Frequency

Receiver: 3267 to 3333 mc, respon 66 mc wide

Transmitter: Fixed, 3256 mc

Operating Temperature: -30 deg to plus 50 deg C

Related Equipment: (Required but not Supplied) (1) Radar Test Set AN/CPN-1, (1) Synchroscope TS-143/CPM-1, (1) Test Set AN/CPM-1, (1) Multimeter I-239, (1) Test Equipment MK-14/GPM, (1) Precision-Volt-Ohmmeter 884-P, (1) Signal Generator and Attenuator LZ, (1) Wattmeter TS-125/ AP (1) Fluxmeter TS-15A/AP, (1) Headset, (1) Standard Oscilloscope.

**PRINCIPAL COMPONENTS AND PHYSICAL DATA**

<b>COMPONENT</b>	<b>QTY</b>	<b>OVERALL DIMENSIONS (Inches)</b>	<b>UNIT WT. (Pounds)</b>
Antenna Support AB-2/CPN-3	1	300 lg	127
Mast Head AS-9/CPN-3	1	43 lg	26
Case CY-11/CPN-3	1	23-5/8 x 24 x 46	
Case CY-9/CPN-3	1	23-5/8 x 24 x 46	
Chest CY-12/CPN-3	1	30 x 37 x 57	188.7
Chest CY-10/CPN-3	1	21 x 30 x 44	135
Coder KY-1/CPN-3	1	8 x 13 x 19	40
Coder KY-1A/CPN-3	1	8 x 13 x 19	40
Cord CX-9/CPN-3	1	360 lg	
Cord, Power CD-772	1	300 lg	
Cord CX-10/CPN-3	1	360 lg	
Cord CX-800-A	1	60 lg	0.625
Cord CD-800-A	1	84 lg	0.875
Interconnecting Cable CX-17/CPN-3Cord	1 2	84 lg 14 lg	
Cord CD-800-A	1	20 lg	
Ground Pin Assy MX-38/CPN-3	1		
Monitor ID-13/CPN-3	1	8 x 13 x 19	30
Radio Receiver R-11/CPN-3 or R-11A/CPN-3	1	8 x 13 x 19	52.5
Power Supply PP-8/CPN-3 or PP-BA/CPN-3	1		
Shorting Rod	1		

**AN/CPN-3: 2**



ITEM NAME: RADIO SET

TYPE: AN/CPN-3

COMPONENT	QTY	PRINCIPAL COMPONENTS AND PHYSICAL DATA	
		OVERALL DIMENSIONS (Inches)	UNIT WT. (Pounds)
Radio Transmitter T-8/CPN-3	2	6-1/2 x 14 x 20	
Case CY-19/CPN-3	1	4-3/4 x 10-1/2 x 17-5/8	
Allen Setscrew Wrench 6, 8, 10	5		
Wrench	1		
Pilot Light Tool	1		
Case CY-39/CPN-3	1	1-11/16 x 3 x 5-1/2	
Oil Can	1		
Fuse 30 amp	2		
Fuse 3 amp	10		
Fuse 3 amp	6		
Fuse 15 amp	2		

#### REFERENCE DATA AND LITERATURE

Technical Manual for Radio Set AN/CPN-3.

AN/CPN-3: 3

DATE: 1 April 1964

ITEM NAME: RADAR SET

COGNIZANT SERVICE: USAF

TYPE: AN/CPN-4, -4A\*, -4B\*\*

USA LINE ITEM NUMBER: 634384

FEDERAL STOCK NUMBER: 5840-538-7840, 5840-505-0928\*, 5840-505-1853\*\*

	USA	USN	USAF	USMC
STATUS OR TYPE CLASSIFICATION			LS, LS**	
Mfg(s) Name or Code Number: Gilfillan Brothers				

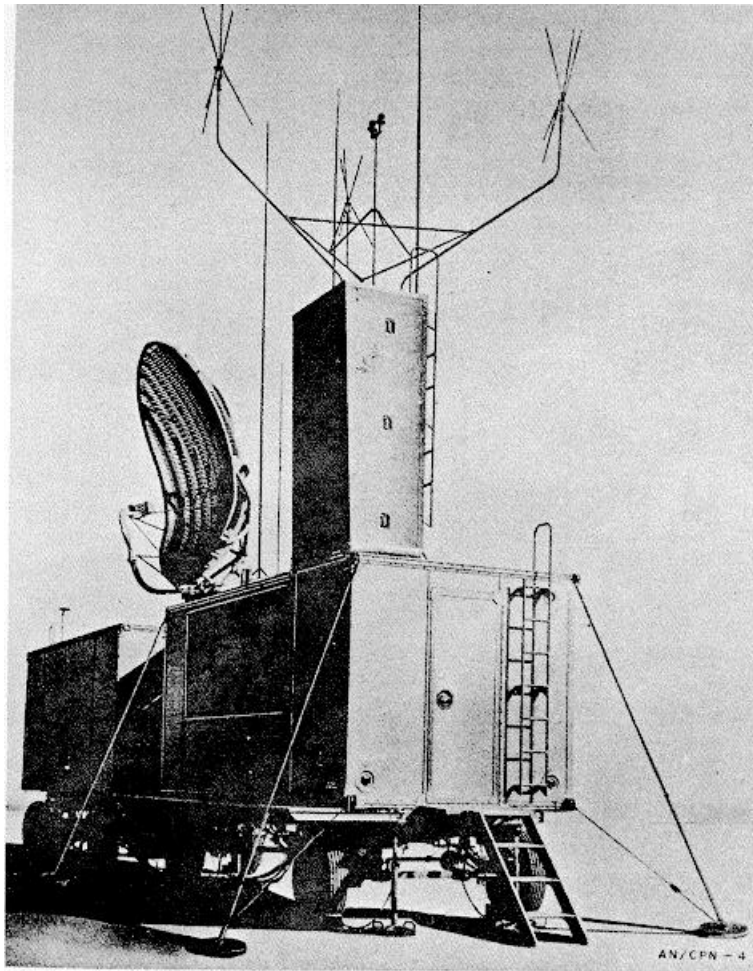

**FUNCTIONAL DESCRIPTION**

The AN/CPN-4, 4A, 4B is a self-contained, mobile GCA radar equipment that is designed to function as an air traffic control center for landing aircraft during periods of reduced visibility. To accomplish this

purpose, the AN/CPN-4, 4A, 4B incorporates three major systems: (1) a search radar for initially locating aircraft within a 30-mile radius of the equipment; (2) a precision radar system for tracking aircraft down the glide path during the final landing field approach; and (3) a

**ITEM NAME:** RADAR SET

**TYPE:** AN/CPN-4, -4A, -4B

radio-telephone communications system for the necessary two-way, aircraft-to-ground communications. Two special features of the search and precision systems are: (1) MTI that functions with either or both systems to eliminate or greatly reduce signals derived from stationary targets and (2) instantaneous direction finding equipment that functions with the search system to locate aircraft communicating with the GCA station by radio.

In addition to the three major systems, all necessary equipment and power supplies necessary to permit the functioning of the AN/CPN-4, 4A, 4B, as a completely independent unit are provided.

**RELATION TO SIMILAR EQUIPMENT**

Radar Set AN/CPN-4, 4A, 4B are similar to and interchangeable as a whole, with each other, the difference being only in the type of Communication Equipment used.

**TECHNICAL DESCRIPTION**

Search System

Frequency: 2780 to 2820 mc  
Wavelength: 10 cm band (S)  
Range: 18 naut mi at 2000 ft,  
28 naut mi at 6000 ft  
36 naut mi at 10,000 ft  
Azimuth Coverage: 360 deg  
Elevation Coverage:  
0.5 to 45 deg from O to 8000 ft  
Azimuth Accuracy: 1 deg if target range is over 10% of sweep range  
Range Accuracy: 4% of true range provided target range is over 20% of sweep range  
Resolution Accuracy:  
Range - 500 ft separation of targets or 1% of sweep range, whichever is greater  
Azimuth - 3.3 deg if target range is over 30% of sweep range  
Pulse Repetition Frequency: 1500 pps plus or minus 2%  
Antenna Scan: 360 deg cw mechanical scan  
Scan Speed: 20 plus or minus 2 rpm  
Peak Power Output: 600 kw (min) Pulse Width: 0.5  $\mu$ sec plus 20% or -10% (at 50% of peak current amplitude)  
IF. Bandwidth (Normal and MTI):  
4.5 plus or minus 1 mc between half power points  
Sensitivity (Normal and MTI): 95 dbm Display: 12-in. PPI Calibration Marks:  
2-mi intervals on 5- and 10-mi range  
5-mi intervals on 20- and 30-mi range  
Angel Marks: -50, O, and plus 15 deg to indicate outline of precision azimuth coverage with respect to runway parallel

Direction Finding System

Indicates bearings of target in communication with radar set with delay of less than 35 ms.

Precision System

Frequency: 900 to 9160 mc  
Range: At least 8 naut mi  
Antenna Scan: 2 to 22 deg with respect to normal-to-array  
Indicator Maps: -5 to plus 15 deg with respect to runway parallel  
Elevation Coverage  
Antenna Scan: 2 to 9 deg with respect to normal-to-array  
Indicator Maps: -1 to plus 6 deg with respect to ground line  
Accuracy  
Azimuth: 0.6% of range plus 10% of deviation from optimum approach path  
Elevation: 0.3% of range plus 10% deviation from glide path  
Range: 2% of true range provided range of target is over 2% of sweep range  
Resolution:  
Range - 200 ft target separation  
Azimuth - 1.1 deg target separation  
Elevation - 0.6 deg target separation  
Detectable Deviation From Glide Path: 25 ft at 1-mi range  
Pulse Repetition Frequency:  
Normal - transmitter, 1833 or 5500 pps; indicator - 1833 pps  
MTI - transmitter, 5500 pps; indicator - 1833 pps  
Azimuth Coverage: 2 to 22 deg electrical scan toward elevation antenna compartment from normal-to-array (-5 to plus 15 deg with respect to runway parallel line)  
Antenna Elevation: 2 to 9 deg electrical scan upward from normal-to-array (-1 to plus 6 deg with respect to ground line)  
Modulator Pulse Width: 0.18  $\mu$ sec plus or minus 10% at approx 90% of peak voltage pulse amplitude  
IF. Bandwidth (Normal and MTI): 12 plus or minus 1 mc between half power points  
Sensitivity (Normal and MTI): 90 dbm  
Display: Azimuth and elevation expanded displays combined on 12-in. CRT; elevation on upper half, azimuth on lower half; sector limiting to prevent overlapping  
Sweeps: Logarithmic time-base sweeps, 8-5/16 in. long (may be linear by modification). Log sweep at 1 mi has 3 times the sensitivity of a linear sweep at 1 mi (operating on a 10-mi range). The same expansion at 1 mi will occur for the 6- and 8-mi ranges.  
Range Marks:  
Ranges - Adjustable for any range between 6 and 10 naut mi  
Calibration - 1-mi intervals adjustable for a variable delay between O and 55  $\mu$ sec (O to 4.5 naut mi) with respect to the time-base sweep origin

Communications System

AN/CPN-4  
HF: AN/ART-13

**ITEM NAME:** RADAR SET  
**TYPE:** AN/CPN-4, -4A, -4B

HF: AN/ARR-15  
VHF: AN/ARC-3  
UHF: AN/ARC-27

VHF: AN/ARC-3  
UHF: AN/ARC-27

**AN/CPN-4A**

HF: AN/ART-13  
HF: AN/ARR-15  
VHF: AN/ARC-1  
UHF: AN/ARC-27

**INSTALLATION CONSIDERATIONS**

Siting: Requires unobstructed field in close proximity to landing facilities being serviced.

**AN/CPN-4B**

HF: Collins 18S-4 Transceiver

**PRINCIPAL COMPONENTS AND PHYSICAL DATA**

<b>COMPONENTS</b>	<b>QTY.</b>	<b>HEIGHT (Inches)</b>	<b>WIDTH (Inches)</b>	<b>DEPTH (Inches)</b>	<b>UNIT WT. (Pounds)</b>
Indicator Group OA-230/GPN	3				
Antenna Group OA-234/GPN	1				
Comparator Power Supply Group OA-245/GPN	1				
Indicator Control Group OA-271/GPN	1				
Communications Operations Group OA-267/GPN	3				
Antenna Group OA-235/GPN	1				
Comparator Power Supply Group OA-244/GPN	1				
Radar Group OA-279/GPN	1				
Radar Set Group OA-257/GPN	1				
Transmitter Group OA-243/GPN	1				
Indicator Group OA-231/GPN	3				
Radar Set Group OA-262/GPN	1				
Power Supply Synchronizer Group OA-254/GPN	1				
Amplifier-Power Supply Group OA-261/GPN	1				
Communications Operations Group OA-278/GPN	3				
Air Conditioner HD-78/G	1				
Engine Generators PU-211/G	2				
Direction Finder Group OA-277/GPN	1				
Antenna AT-310/GPN	3				
Antenna AT-285/GPN	4				
Antenna AT-282/GPN	1				
Antenna AT-197/GR	3				

**AN/CPN-4: 3**

**ITEM NAME:** RADAR SET

**TYPE:** AN/CPN-4, -4A, -4B

**PRINCIPAL COMPONENTS AND PHYSICAL DATA**

<b>COMPONENTS</b>	<b>QTY.</b>	<b>HEIGHT (Inches)</b>	<b>WIDTH (Inches)</b>	<b>DEPTH (Inches)</b>	<b>UNIT WT. (Pounds)</b>
Antenna AT-283/GPN	1				
Transmitter Group OA-243/GPN	1				
Dynamotor-Power Distribution Group OA-251/GPN	1				
Power Supply PP-655/GPN	1				
Electrical Synchronizer SN-87/GPN	1				
Radar Set Group OA-259/GPN	1				
Pulse Generator O-150/GPN	1				
Radar Transmitter T-289/GPN	1				
Pulse Generator TD-57/GPN	1				
Power Supply PP-634/GPN	1				
Pulse Generator TD-58/GPN	1				
Power Supply PP-654/GPN	1				
Power Supply PP-653/GPN	1				
Amplifier Oscillator Group OA-253/GPN	1				
Radar Set Group OA-258/GPN	1				
Amplifier Assembly AM-514/GPN	1				
Radar Set Group OA-279/GPN	1				
Motor Generator PU-220/GPN	1				
Voltage Regulator Assembly CN-145/GPN	1				
Voltage Regulator Switchboard SB-195/GPN	1				
Antenna System AS-439/GRD	1				
Antenna System AS-440/GRD	1				
Receiver Group OA-94/GRD	2				
Radio Set SCR-536-F	2				
Radio Set AN/ART-13 (not used with 4B)	1				
Radio Set AN/ARR-15 (not used with 4B)	1				
Radio Set AN/ARC-3 (not used with 4A)	1				

**AN/CPN-4: 4**

**ITEM NAME:** RADAR SET

**TYPE:** AN/CPN-4, -4A, -4B

**PRINCIPAL COMPONENTS AND PHYSICAL DATA**

<b>COMPONENTS</b>	<b>QTY.</b>	<b>HEIGHT</b> (Inches)	<b>WIDTH</b> (Inches)	<b>DEPTH</b> (Inches)	<b>UNIT WT.</b> (Pounds)
Radio Set AN/ARC-27	1				
Radio Set 18S-4 (Collins) (used with 4B only)	1				
Radio Set AN/ARC-1 (used only with 4A)	1				
Antenna Assembly AS-112/TRC	1				
Antenna Group OA-234/GPN	1				
Antenna Group OA-373/GPN	1				

**REFERENCE DATA AND LITERATURE**

TECHNICAL ORDERS:  
31P5-2CN4- Series

**AN/CPN-4: 5**

DATE: 1 July 1964  
COGNIZANT SERVICE: USN

ITEM NAME: RADAR BEACON  
TYPE: AN/CPN-6

FEDERAL STOCK NUMBER: F5895-665-3691 (shipboard)  
F5895-665-3690 (shore base)

	USA	USN	USAF	USMC
STATUS OR TYPE CLASSIFICATION		Ltd Std		
Mfg(s) Name or Code Number: Galvin Manufacturing Corporation				

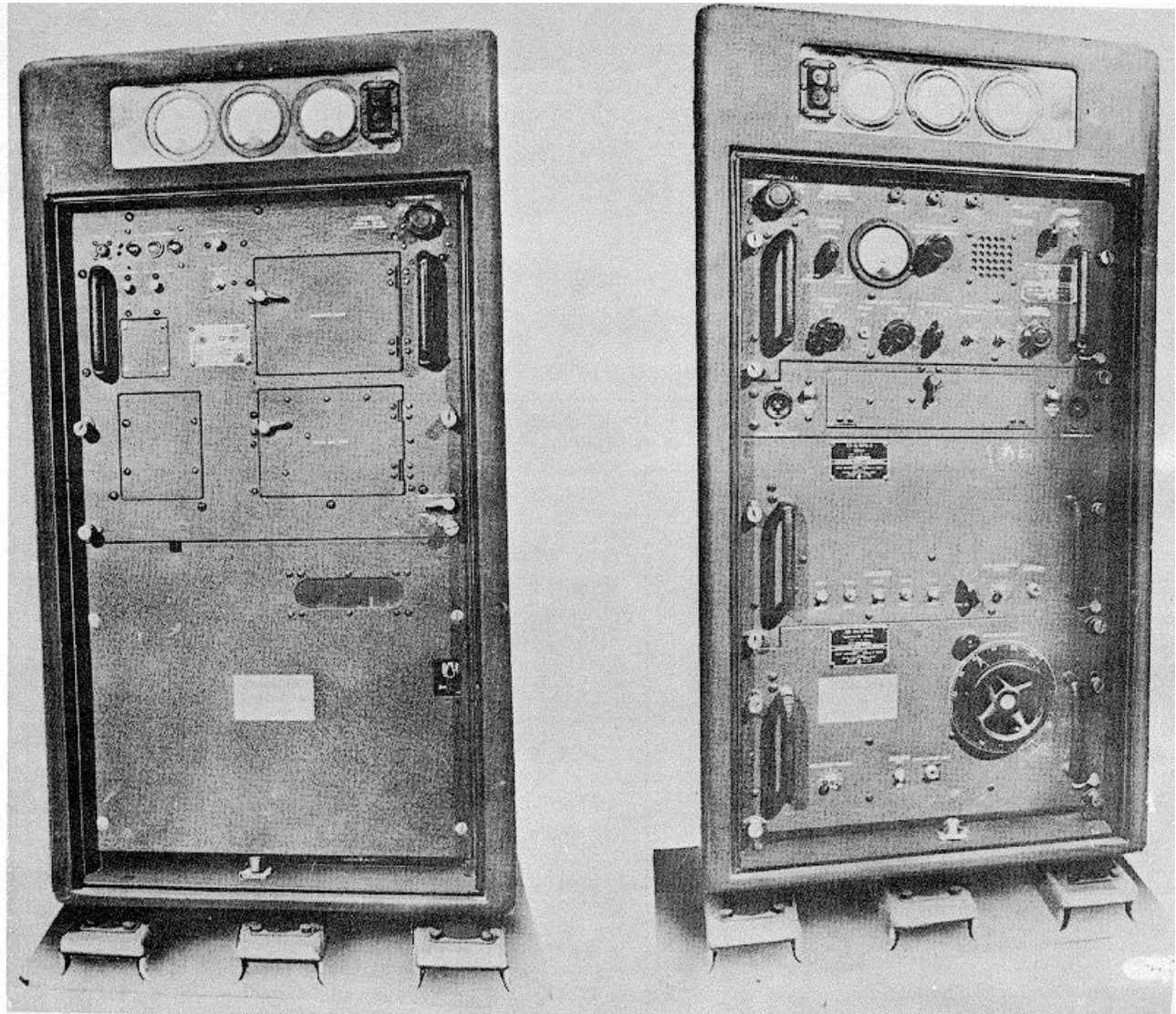

AN/CPN-6: 1

AN/CPN-6

**FUNCTIONAL DESCRIPTION**

The AN/CPN-6 is a heavy microwave radar beacon that is used primarily as a navigational aid for aircraft equipped with suitable interrogating equipment. The signal is coded so that the particular beacon can be identified by reference to a chart or beacon list, enabling the aircraft radar operator to obtain both bearing and range to the beacon. The AN/CPN-6 transmits only when interrogated by a special radar pulse.

**RELATION TO SIMILAR EQUIPMENT**

None.

**TECHNICAL DESCRIPTION**

Frequency: Transmitter, 9310 \*3 mc; receiver, 9320 to 9430 mc  
 Peak Power Output: 40 kw  
 Emission: Coded pulse  
 Coder Pulse Combinations: 2 to 6 pulses  
 Coder Pulse Delay Time: 15 or 35 ,µsec between pulses  
 Possible Codes: 56  
 Pulse Width: 0. 5 µsec

Receiver Type: Superheterodyne  
 Reception: Accepts 2- to 5-µsec pulses  
 Range: 100 naut mi  
 Altitude: Continuous operation up to 7500 ft  
 Ambient Temperature: -40 to +50 deg C (-40 to +122 deg F)  
 Humidity: 95% max  
 Power Requirements: 115v, 50 to 70 cps, 1-ph; or 230v, 50 to 70 cps, 1-ph with autotransformer, or 5 kva generator  
 Antenna Type: 2 linear arrays  
 Polarization: Horizontal  
 Horizontal Beam Width: Uniform to 3 db  
 Vertical Beam Width (At 1/2 Power Points): Shore use, 5 deg; shipboard use, 30 deg  
 Feed: Coaxial line

**INSTALLATION CONSIDERATIONS**

Siting: The AN/CPN-6 is designed for ground, ship, or truck installation.  
 Mounting:  
 Cabling Requirements:  
 Related Equipments: The AN/CPN-6 is designed to operate with airborne radar equipments ASD, AN/APS-3, AN/APS-4, AN/APS-6, AN/APS-10, AN/APS-15, AN/APS-31, AN/APS-32, AN/APQ-13, and 717T3.

**PRINCIPAL COMPONENTS AND PHYSICAL DATA**

COMPONENT	QTY	HEIGHT (Inches)	WIDTH (Inches)	DEPTH (Inches)	UNIT WT. (Pounds)
Receiver Cabinet CY-170/CPN-6	1	51-3/8	27-1/2	20-1/4	470
Receiver R-88/CPN-6	1	19-3/8	15-1/4	10-1/2	45
IF Strip AM-45/CPN-6	1	14-1/2	4-1/4	3-3/4	
Discriminator Strip F-12/CPN-6	1	12-1/2	5-1/4	5-1/4	
Coder KY-6/CPN-6 or KY-6A/CPN-6	1	19-3/8	15-1/4	10-1/2	57
Modulator Driver AM-44/CPN-6	1	19-3/8	15-1/4	10-1/2	74
Technical Manual NAVSHIPS 900838	2	11	8-1/2	1	1.7
Technical Manual NAVSHIPS 900771	2	11	8-1/2	3/8	0.5
Transmitter Cabinet CY-169/CPN-6	1	51-3/8	27-1/2	20-1/4	534
Transmitter Modulator T-79/CPN-6	1	19-1/2	16-7/8	14-1/8	115
Transmitter Power Supply PP-93/CPN-6	1	18	16-3/4	11-1/4	143



AN/CPN-6

**PRINCIPAL COMPONENTS AND PHYSICAL DATA (cont'd)**

<b>COMPONENT</b>	<b>QTY</b>	<b>HEIGHT (Inches)</b>	<b>WIDTH (Inches)</b>	<b>DEPTH (Inches)</b>	<b>UNIT WT. (Pounds)</b>
Antenna AS-119/CPN-6	1 65	25	14	243	
Antenna Mast Assembly AB-42/CPN-6	1				258
Autotransformer MX-202/CPN-6	1	12	10	7-1/2	70
Antenna Assembly AS-118/CPN-6	1	62	22-1/4	14-1/2	
Antenna Yard Arm Assembly	1				
Dummy Load Antenna TS-108A/AP					

**REFERENCE DATA AND LITERATURE**

Technical Manual:  
NAVSHIPS 900838  
NAVSHIPS 900771

DATE: 1 May 1964

ITEM NAME: RADAR SET

COGNIZANT SERVICE: USAF

TYPE: AN/CPN-18, \*AN/CPN-18A  
\*\*AN/CPN-18C, \*\*\*AN/CPN-18D

FEDERAL STOCK NUMBER: 5840-538-7833 \*\*5840-685-8903  
\*5840-505-0995 \*\*\*No FSN Available

	USA	USN	USAF	USMC
STATUS OR TYPE CLASSIFICATION			LS, *AS, ** & *** None Assigned	
Mfg(s) Name or Code Number: Bendix Radio				

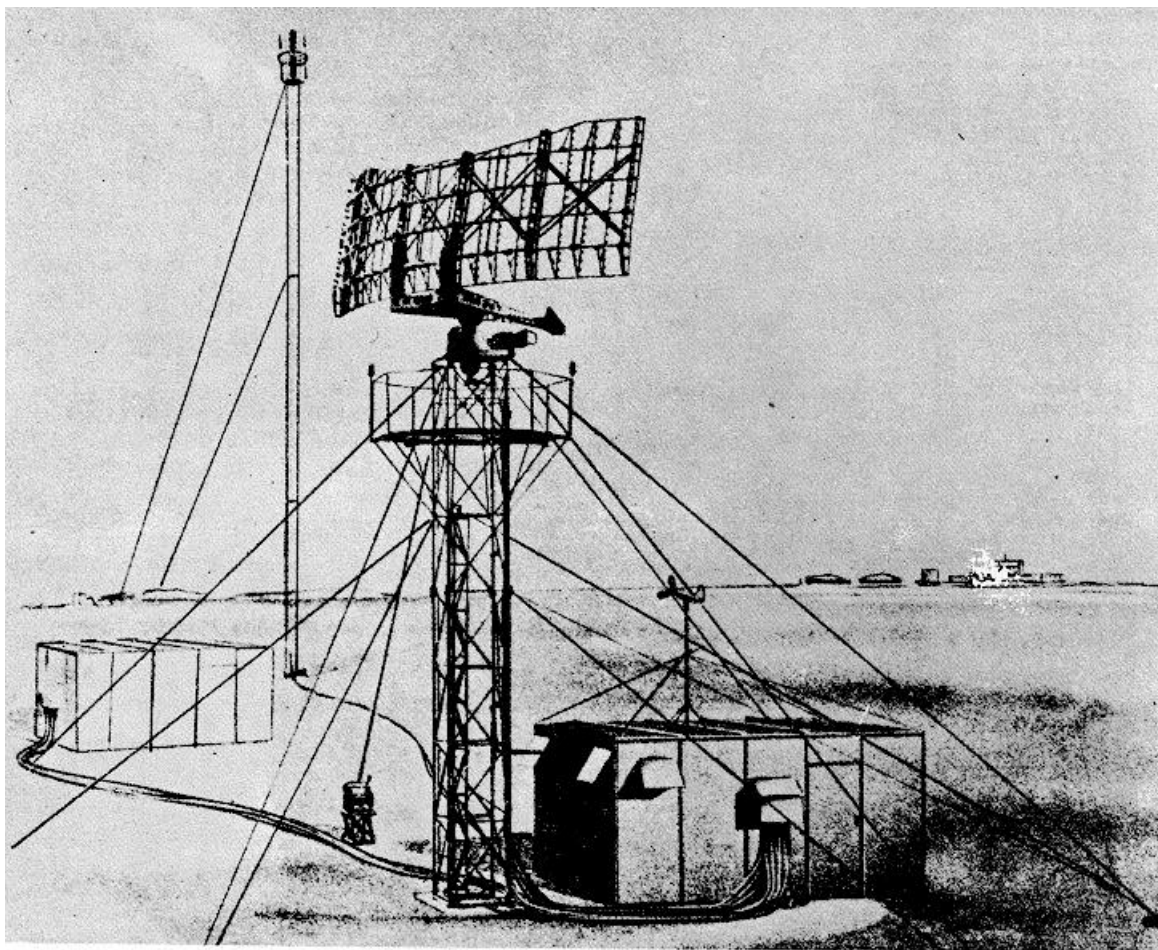

**FUNCTIONAL DESCRIPTION**

Radar. Set AN/CPN-18, 18A, 18C, 18D is a S-band medium range radar portion of an Air Traffic Control System. The radar set detects and locates aircraft targets within 53 nautical miles (61.5 statute miles) of an

air terminal and displays the target information for air traffic control personnel to permit them to direct and control the aircraft (via radio communications equipment that is not part of this radar). In association with auxiliary equipment, the radar set is also capable of identifying

**ITEM NAME:** RADAR SET

**TYPE:** AN/CPN-18, AN/CPN-18A, AN/CPN-18C, AN/CPN-18D

certain aircraft within the radar coverage area and of tracking these aircraft at distances too great to permit tracking them with the radar system alone.

**RELATION TO SIMILAR EQUIPMENT**

Radar Set AN/CPN-18D is similar to and one-way interchangeable with AN/CPN-18, 18A, 18C. Differs in that AN/CPN-18D is modified per T.O. 31P5-2CPN18-539.

Radar Set AN/CPN-18C is similar to and functionally interchangeable with AN/CPN-18A. Differs in that Indicator Group OA-348/CPN-18A is replaced by Indicator Group OA-2238/CPN-18C and range is increased to 200 miles. AN/CPN-18C is a composite of AN/CPN-18 and AN/CPN-18A.

Radar Set AN/CPN-18 is similar to AN/CPN-4 and AN/MPN-11 differs in that AN/CPN-18 does not include the precision portion of equipment and is not trailer mounted.

**TECHNICAL DESCRIPTION**

Frequency: 2700 - 2900 mc  
Pulse Width: 0.5 usec (1.0 usec in modified sets)  
Pulse Repetition Rate: 1500 pps (900 pps in modified sets)  
Transmitter Peak Power Output: 500 kw min  
Receiver Sensitivity: 95 dbm min  
Receiver Noise Figure: 9.5 db max  
Receiver Outputs: Normal video and MTI video  
Range: 53 naut mi (70 naut mi for modified sets)

Accuracy  
Range: 2 pet  
Azimuth: 2 deg  
Resolution  
Range: 1000 ft  
Azimuth: 1.5 to 3.0 deg  
Antenna Polarization: Linear or circular  
Antenna Rotation: 10 rpm clockwise only  
Power Requirements: 120v ac, 60 cps, 3 ph, 10.4 kw supplied from commercial or 15 kw generators.

**INSTALLATION CONSIDERATIONS**

Siting: The site must be large enough to accommodate the operations shelter, power shelter, tower and winch. The foundation for the operations building and the foundation for the tower must be on the same level. The area must have adequate water sanitation and good drainage. The ground must be high enough above the average terrain to prevent excessive ground clutter. Recommended Plot Size is: 90 x 130 feet.

Mounting: All equipment is mounted within the operations shelter and power shelter with the exception of the antenna which is mounted on the tower.

Cabling Requirements: No special power or cabling considerations are applicable to Radar Set AN/CPN-18, 18A, 18C, 18D.

Related Equipments: Electronic Mapping Groups AN/GPA-5 or Video Mapping Group AN/GPA-30, Interference Blanker Group AN/GPA-28, Radar Identification Set AN/GPX-9.

**PRINCIPAL COMPONENTS AND PHYSICAL DATA**

COMPONENT	QTY	HEIGHT (Inches)	WIDTH (Inches)	DEPTH (Inches)	UNIT WT.
Operations Shelter S-63/CPN-18	1	96	156	192	
Power Shelter S-64/CPN-18	1	96	156	192	
Modulator Group OA-170/CPN-18	1	32	22	23-3/4	350
Modulator Power Supply Group OA-223/CPN-18	1	40	28	28-3/4	700
Transmitter Group OA-181/CPN-18	1	40	22	23-3/4	400
Rotary Coupler CU-237/CPN-18	1	6-13/16	8-3/4	11-1/4	
Rotary Coupler CU-237/CPN-18	1	7-1/2	7-1/2	8-5/8	
Radar Set Group OA-703/CPN-18	1				
Antenna Reflector AT-260B/CPN-18	1	96	240		

ITEM NAME: RADAR SET

TYPE: AN/CPN-18, AN/CPN-18A, AN/CPN-18C, AN/CPN-18D

PRINCIPAL COMPONENTS AND PHYSICAL DATA

COMPONENT	QTY	HEIGHT (Inches)	WIDTH (Inches)	DEPTH (Inches)	UNIT WT.
Antenna Pedestal AB-181/CPN-18	1				
Antenna Tower AB-182/CPN-18	1	360	108	36	
Receiver Group OA-207/CPN-18	1	480	264	23-3/4	265
Amplifier-Power Supply Group OA-171/CPN-18	2	32	22	23-3/4	400
Comparator-Indicator Group OA-222/CPN-18	1	40	22	23-3/4	425
Standby Receiver and Amplifier Group	1	40	22	23-3/4	265
Amplifier-Power Supply Group OA-169/CPN-18	1	32	22	23-3/4	325
Standby Cancellor and Spare RF Group	1	32	22	23-3/4	400
Amplifier-Power Supply Group OA-349/CPN-18A	1	40	22	23-3/4	320
Direction Finder Group OA-182/CPN-18	1	43-1/2	15	23-3/4	200
Receiver Control C-716/CPN-18		5-1/2	19	11-3/4	50
Indicator Group OA-348/CPN-18A or OA-348/CPN-18 or OA-2238/CPN-18C	5	43-1/2	27	36-3/4	600
Voltage Regulator CN-131/CPN-18	1	26-1/4	32	16	500
Controller C-707/CPN-18	1	20-1/2	14	5	40
Battery Box CY-836/CPN-18	1	38-1/2	77	25	600
Distribution Panel SB-118/CPN-18	1	30	24	10-1/2	300
Distribution Panel SB-117/CPN-18 or SB-238/CPN-18A	1	41	24	12-1/2	300
Air Heater HD-72/CPN-18 and HD73 or HD-73A/CPN-18	3	28	24	20	150
Table FN-40/P	1	36	20-1/4	36-1/4	40
Bench FN-46/P		34-1/2	31	54	
Case CY-897/CPN-18	1	40	22	23-3/4	
Pack MT808 and MT-809/CPN-18	2	40	22	23-3/4	150

REFERENCE DATA AND LITERATURE

TECHNICAL ORDERS:  
31P5-2CPN18- Series

AN/CPN-18: 3

DATE: 1 July 1964

ITEM NAME: RADAR SET

COGNIZANT SERVICE: USAF

TYPE: AN/CPS-6B

FEDERAL STOCK NUMBER: 5840-249-6610

	USA	USN	USAF	USMC
STATUS OR TYPE CLASSIFICATION			Std	
Mfg(s) Name or Code Number: General Electric Company				

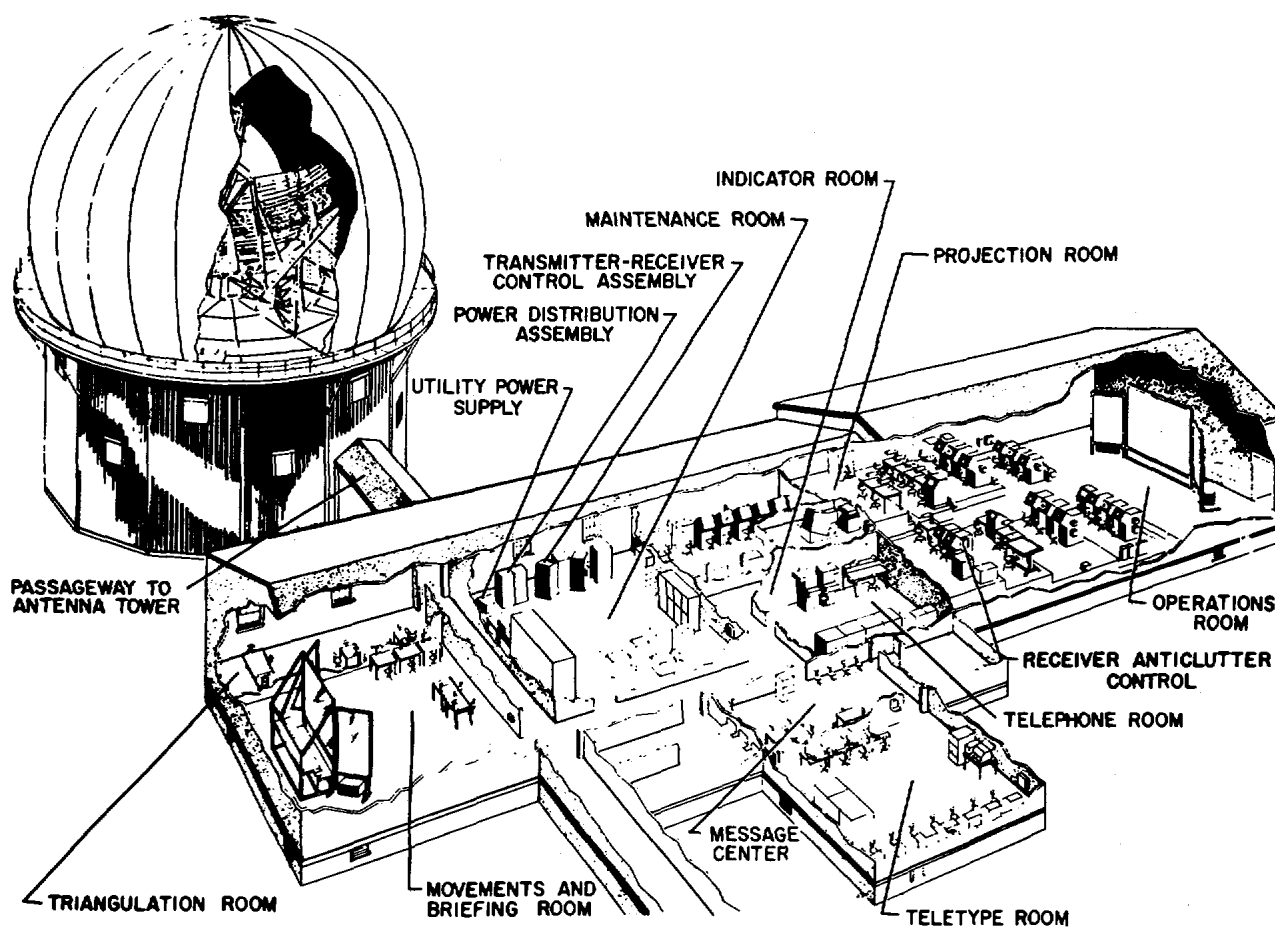

### FUNCTIONAL DESCRIPTION

Radar Set AN/CPS-6B is a fixed station, air transportable, high power, long range search and height finding radar set that is used for aircraft early warning and ground controlled intercept applications. The set has a maximum range of 265 naut mi and a height finding capability of 40,000 ft. Facilities are provided for use of advance filter techniques that eliminate the time lag inherent in passing plots through a filter room. This

equipment has provisions for operational use of video mapping, direction finding, and identification equipment. Terminal facilities are also provided for voice, code or telegraph, and radio or wire communications. AN/CPS-6B is equipped with MTI and many remote operating facilities.

### RELATION TO SIMILAR EQUIPMENT

AN/CPS-6B is similar to AN/FPS-10, differing only in the number of indicators used and in the

**ITEM NAME:** RADAR SET  
**TYPE:** AN/CPS-6B

telephone system. The AN/FPS-10 has fewer indicators and the telephone system is not included as part of the set, but is Government furnished.

**TECHNICAL DESCRIPTION**

Frequency: 2700 to 3019 mc (in six freq bands, one for each transmitter)  
Power Output: 900 kw, peak (each of five transmitters), 2 megw, peak (EW transmitter)  
RF Power Source: Type 5586 and 5657 tunable magnetron, and QK-254 magnetron (EW)  
Pulse Width: 1 usec at 600 pps; 1 or 2 usec at 300 pps  
EW Transmitter - 2 usec  
Pulse Repetition Rate: 600 or 300 pps  
EW Transmitter - 300 pps  
Range (B-17 or B-29 Type Target):  
Height Finding - 120 mi  
EW (V-Beam) - 150 mi  
EW (S-Beam) - 240 mi  
Vertical Coverage: 40,000 ft in altitude, 0 to 24 deg angular  
Horizontal Coverage: 360 deg continuous rotation  
Antenna Speed of Rotation: 0 to 15 rpm (continuously variable)  
Resolution:  
Range - 0.17 mi  
EW Channel - 0.85 deg  
Azimuth - plus or minus 1 deg  
EW Channel - 0.85 deg  
Elevation - 1 deg  
System Accuracy:  
Range - 0.87 mi  
EW Channel - 0.5 mi  
Azimuth - 1 deg

EW Channel - 0.5 deg  
Elevation - plus or minus 500 ft (relative); plus or minus 1000 ft (absolute)  
Beam Width:  
Vertical Beam Antenna - horizontal - 1 deg; vertical - 2.2 deg (lower beam), 4.2 deg (middle beam), 21 deg (upper beam)  
Slant Beam Antenna - horizontal - 0.8 deg; vertical - 7.7 deg (lower beam), 24 deg (upper beam)  
Receiver Bandwidth: 2 mc  
IF. Frequency: 30 mc  
Indicator Type and Quantity:  
PPI scopes - Ten 12-in.  
B-scopes - Five 12-in.  
RHI scopes - Four 12-in.  
Indicator Ranges: 0 to 50, 0 to 100, and 0 to 200 naut mi  
Range-Marks: 10- and 50-mi intervals  
Angle Marks: 10-deg intervals and 30-deg marks, intensified.  
Power Requirements: 120/208v ac, 60 cps, 3 ph, 4-wire, 120 kva

**INSTALLATION CONSIDERATIONS:**

Siting: For optimum performance use the highest available location, with ample space for erection of operations building, power building and arctic tower.

**Mounting:**

Antenna Group is mounted in Arctic Tower AB-451/CPS-6B  
Indicator and Control Group is installed in the operations building.  
Power units are housed in the power building.

**PRINCIPAL COMPONENTS AND PHYSICAL DATA**

COMPONENT	QTY	HEIGHT (Inches)	WIDTH (Inches)	DEPTH (Inches)	UNIT WT.
Antenna Assembly AS-451/CPS-6B (includes Arctic Tower and Bid)	1	684	720		
Radar Set Group OA-345/CPS-6B	1	60	51-1/2	31	
Receiver-Transmitter Group OA-126/CPS-6B	2	59	45	24	
Receiver-Transmitter Group OA-127/CPS-6B	2	59	45	24	
Receiver Transmitter Group OA-128/CPS-6B	1	59	45	45	24
Radar Modulator MD-98/CPS-6B	1	43	34	34	824

**AN/CPS-6B: 2**

PRINCIPAL COMPONENTS AND PHYSICAL DATA(cont'd)

COMPONENT	QTY	HEIGHT (Inches)	WIDTH (Inches)	DEPTH (Inches)	UNIT WT. (Pounds)
Radar Modulator, MD-99/CPS-6B	1	43	34	34	710
Relay Assembly, RE-76/CPS-6B	1	60	36	12	
Motor Generator, PU-178/CPS-6B	1	19	24	54	
Motor Generator,PU-179/CPS-6B	1	14-3/8	13-3/8	25-5/8	
Control Power Supply Group OA- 103/CPS-6B	1	72	24	24	377
Power Supply, PP-415/CPS-6B	1	30	29	40	
Indicator Group, OA-97/CPS-6B	5	42	21	43	394
Indicator Group, OA-98/CPS-6B	4	42	21	43	500
Indicator Group, OA-99/CPS-6B	10	42	21	43	
Indicator Group, OA-100/CPS-6B	1	42	21	43	362
Blanker-Indicator Group OA- 101/CPS-6B	1	72	24	24	352
Antenna Control Group OA- 110/CPS-6B	1	42	40	30	
Calibrator Generator Group OA-96/CPS- 6B	1	72	24	24	219
Mixer-Blanker,MX-918/CPS-6B	1	72	24	24	259
Moving Target Indicator Group OA- 121/CPS- 6B	1	72	24	24	
Control Monitor Group OA-331/CPS-6B	1	72	24	24	
Power Supply, PP-415/CPS-6B	1	30	29	40	
Power Control Group OA- 122/CPS-6B	1	72	24	24	291
Plotting Board, PT-105/CPS-6B	2	114	46	108	
Plotting Table, PT-104/CPS-6B	2	38	36-1/2	34	
Radome Pressure Control Unit	1				
Telephone System	1				
Diesel Power Unit (GFE)	3				

Volume 1  
Section 1

**MIL-HDBK-162A**  
15 December 1965

**ITEM NAME:** RADAR SET

**TYPE:** AN/CPS-6B

**REFERENCE DATA AND LITERATURE**

Technical Orders:

31P6-2CPS6- Series

See also 31P6-2FPS8- Series

**AN/CPS-6B: 4**



DATE: 1 July 1964

ITEM NAME: RADAR SET

COGNIZANT SERVICE: USA

TYPE: AN/CPS-9

LINE ITEM NUMBER: 634383

FEDERAL STOCK NUMBER: 5840- 503-1088

	USA	USN	USAF	USMC
STATUS OR TYPE CLASSIFICATION	Std -C			
Mfg(s) Name or Code Number: Raytheon Mfg. Co.				

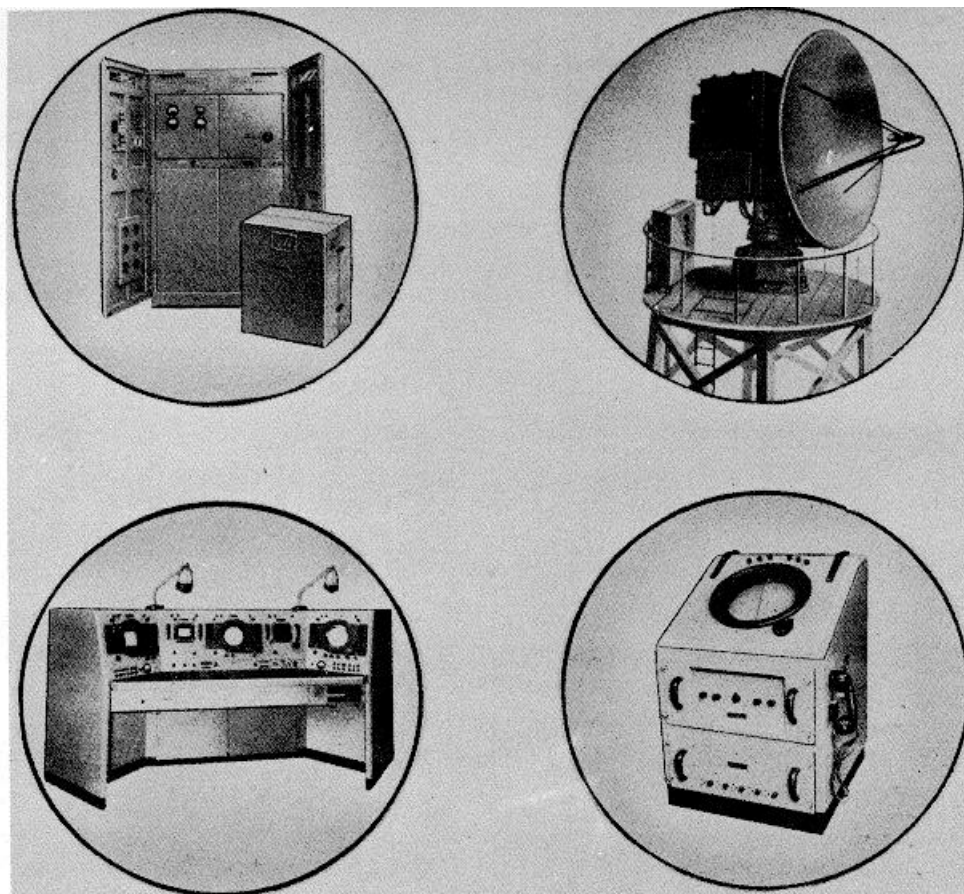

### FUNCTIONAL DESCRIPTION

Radar Set AN/CPS-9 is an air-transportable storm detection ground radar used for locating and plotting precipitation areas within a radius of approximately 250 statute miles.

Range and azimuth of approaching storms are displayed on a main PPI scope. An off-center PPI permits enlarging a selected area for detailed study.

A third PPI scope, up to one-half mile from the main operating console, duplicates the main PPI display. The RHI scope provides height readings of storm clouds.

### RELATION TO SIMILAR EQUIPMENT

None.

AN/CPS-9: 1

**ITEM NAME:** RADAR SET  
**TYPE:** AN/CPS-9

**TECHNICAL DESCRIPTION**

Frequency: 9317 plus or minus 87 mc  
Range, Max: 250 statute mi  
Range, Min: 1/2 statute mi  
Peak Power Output: 250 kw min (short pulse); 225 kw min (long pulse)  
Average Power: 115 w (short pulse); 230 w (long pulse)  
Operating Voltages and Power Requirements:  
110 to 120v, 50 to 60 cps, 7.8 kva;  
PF - 90%  
220 to 240v, 50 to 60 cps, 1-ph, 3-wire,  
7.8 kva; PF - 90%  
191 to 208v, 50 to 60 cps, 3-ph, 4-wire,  
7.8 kva; PF - 90%  
Type of Presentation:  
Standard RHI, 7-in. CRT; A/R unit, 5-in.  
CRT; Standard PPI, 7-in. CRT; Standard or off-center PPI, 7-in. CRT; Standard PPI, 12-in. CRT  
Duty Cycle: 0.0005 (short pulse);

0.0009 (long pulse)  
Accuracy of Maximum Range: 0.2%  
Range Resolution: 246 ft (short pulse) 2,460 ft (long pulse)  
Pulse Repetition Rate: 931 pps (short pulse); 186 pps (long pulse)  
Pulse Width: 0.5 usec (short pulse); 5.0 usec (long pulse)  
Antenna Data  
Type Reflector: Parabolic  
Reflector Feed: Horn type  
Beam Width: Approx 1 deg between half-power points in horizontal and vertical  
Attenuation: 20 db for back and side lobes

**INSTALLATION CONSIDERATIONS**

Antenna Tower: 16-ft square platform at top to support 1750 lb plus wind loading.

**PRINCIPAL COMPONENTS AND PHYSICAL DATA**

<b>COMPONENT</b>	<b>QTY</b>	<b>HEIGHT (Inches)</b>	<b>WIDTH (Inches)</b>	<b>DEPTH (Inches)</b>	<b>UNIT WT.</b>
Antenna Control C-515/CPS-9	1	25	14-3/8	21-1/4	100
Antenna Assembly	1	109-3/4	8-1/2	92-3/4	712
Azimuth and Range Indicator IP-25/CPS-9	1	37	30-1/4	25-7/16	250
Radar Modulator MD-91/CPS-9	1	74-1/2	29-7/8	41	1150
Radar Receiver-Transmitter RT-150/CPS-9	1	49-1/2	20-1/4	31-1/2	538
Radar Set Console OA-83/CPS-9	1	50-1/8	43-3/4	110-1/4	1035

**SHIPPING DATA**

<b>COMPONENT</b>	<b>BOXES (NR.)</b>	<b>OVERALL DIMENSIONS (Inches)</b>	<b>UNIT WT. (Pounds)</b>
Electrical Equipment Cabinet CY-1313/CPS-9	1	58 x 62 x 124	1620
Range and Height Indicator IP-28/CPS-9	1	27 x 29 x 35	177
Adapter Kit MX-949A/U			
Oscilloscope AN/USM-24	1	19 x 22 x 25	112
Test Set TS-147/UP	1	16 x 19 x 25	74
Electrical Dummy Load DA-64/UP	1	18 x 18 x 26	75
Flexible Hose	1	24 x 24 x 36	76

**AN/CPS-9: 2**

ITEM NAME: RADAR SET  
TYPE: AN/CPS-9

**SHIPPING DATA**

<b>COMPONENT</b>	<b>BOXES (NR.)</b>	<b>OVERALL DIMENSIONS (Inches)</b>	<b>UNIT WT. (Pounds)</b>
Set of Accessories for Console	1	15 x 19 x 30	63
Set of Misc. Accessories and Tools	1	21 x 24x 31	155
Cable W1504	1	18 x 21 x 33	116
Ladder	1	13 x 25 x 54	72
Terminal Box J-279/CPS-9 & J-280/CPS-9 w/Misc. Accessories and Cable (2) Handset Headset (3) Telephone Handset Assy	1	21 x 24 x 31	132
Power Transformers TF-117/CPS-9	1	13 x 15 x 26	128
Reel Coaxial Cable	1	18 x 31 x 31	288
Reel Multiconductor Cable	6	23 x 39 x 39	563
Reel Multiconductor Cable	1	16 x 33 x 33	162
Equipment Spares	1	14 x 15 x 24	57

**REFERENCE DATA AND LITERATURE**

Specifications:  
MIL-R-10846(SigC)

Technical Manuals:  
TM 11-1304  
TM 11-1504

**AN/CPS-9: 3**

DATE: 1 July 1964

ITEM NAME: CONTROL-MONITOR GROUP

COGNIZANT SERVICE: USN

TYPE: AN/FPA-I(XN-1)

FEDERAL STOCK NUMBER:

	USA	USN	USAF	USMC
STATUS OR TYPE CLASSIFICATION	Used By	Used By		
Mfg(s) Name or Code Number: Melpar Incorporated (76394)				

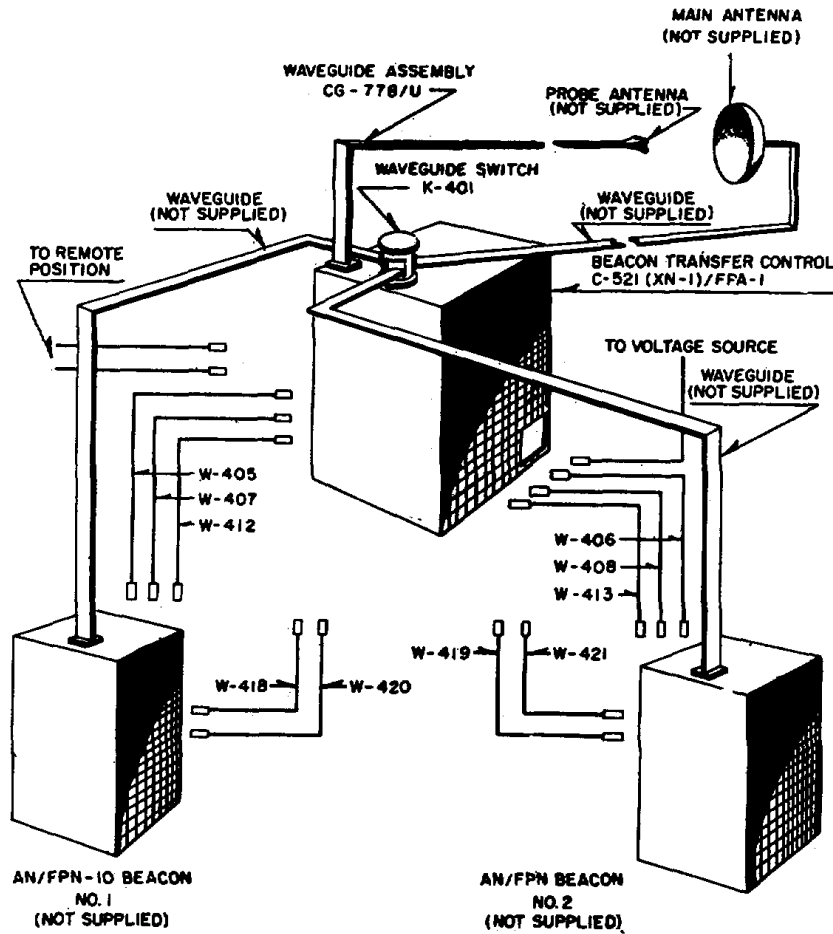

### FUNCTIONAL DESCRIPTION

The Control-Monitor Group AN/FPA-I(XN-1) is designed for operation in an isolated and unattended position in conjunction with two (2) AN/FPN-10 Radar Beacons. It periodically monitors the performance of

one beacon, the active beacon, and in the event of failure or reduced performance of that beacon, it transfers operation from the active beacon to the other beacon, the standby beacon, and at the same time, activates an alarm at a remote station.

**ITEM NAME:** CONTROL-MONITOR GROUP

**TYPE:** AN/FPA-1(XN-1)

**RELATION TO SIMILAR EQUIPMENT**

The AN/FPA-1(XN-1) has been specifically designed for operation with Radar Beacon AN/FPN-10 in the X-band; however, it can be made to operate with other radar beacons.

**TECHNICAL DESCRIPTION**

Operating Frequency Range: 8500 to 9600 mc

Power Requirement Data

Operating Power Requirements: 115v ac, 120v ac, 208v ac, or 230v ac plus or minus 10%; 60 cps, single ph; 750w

Full Load Current: 5.7 amps from a 115v ac source

Input Power: 520w

Power Factor: 79%

**INSTALLATION CONSIDERATIONS**

Related Equipment: (Required but not

Supplied) (2) Radar Beacon AN/FPN-10; (1) Main Antenna (w/AN/FPN-10); (1) Probe Antenna (9285 to 9335 mc); (1) Test Set TS-120/UP; (1) Spectrum Analyzer TS-148/UP; (1) Oscilloscope TS-239A/UP; (1) 8-Conductor Cable (AN-3106A-18-1S plug and AN-3057-10 clamp on one end to mate w/J-409); (1) 2-Conductor Cable (AN-3106A-18- 4P plug and AN-3057-10 clamp on one end to mate w/J-410); (1) Power Cable (AN-3106B-16-9S plug and AN-3057-8 clamp on one end to mate w/J-403); (1) Technical Manual for Radar Beacon AN/FPN-10.

<b>COMPONENT</b>	<b>BOXES (NR.)</b>	<b>OVERALL DIMENSIONS (Inches)</b>	<b>UNIT WT. (Pounds)</b>
Beacon Transfer Control C-521(XN-1)/FPA-1	1	25.6 x 35.9 x 54	484
Cabinet, Electrical Equipment CY-1026(XN-1)/FPA-1	1	25.6 x 35.9 x 54	216
Pulse Generator 0-154(XN-1)/FPA-1	1	16.6 x 22 x 31.4	153
Electronic Control Amplifier AM-526(XN-1)/FPA-1	1	13.5 x 22 x 31.2	115
Waveguide Assy CG-778/U	1		
Waveguide RG-51/U (10 ft)	9	120 lg	
Waveguide RG-51/U (5 ft)	1	60 lg	
Waveguide RG-51/U (3 ft)	1	36 lg	
Waveguide RG-51/U (2 ft)	1	24 lg	
Waveguide RG-51/U (1 ft)	1	12 lg	
Waveguide RG-51/U (7 ft)	1	84 lg	

**REFERENCE DATA AND LITERATURE**

Technical Manuals:  
NAVSHIPS 91804

**AN/FPA-1(XN-1): 2**

ITEM NAME: RADAR SET  
TYPE: AN/FPN-1A

PRINCIPAL COMPONENTS AND PHYSICAL DATA (Cont.)

COMPONENT	BOXES (NR.)	OVERALL DIMENSIONS (Inches)	UNIT WT. (Pounds)
Generator G-23/U	1		
Battery Part No. 19065	2	10-1/4 x 11-1/4 x 23	146
Motor Generator PU-147(XN-1)/U	1	13-1/2 x 14 x 33-1/2	178
Radar Receiver R-176/GPN-2	4	8-3/4 x 19 x 22-1/4	60
Distribution Panel Board SB-75/FPN-1A	1	17-1/4 x 19 x 20-1/2	75
Distribution Panel Board SB-76/FPN-1A	1	19 x 21 x 26-1/2	122
Distribution Panel Board SB-77/FPN-1A	1	17-1/2 x 19 x 20-1/2	69
Distribution Panel Board SB-78/FPN-1A	1	8 x 9 x 34-1/2	10
Telephone Switchboard SB-79/FPN-1A	1	3-1/2 x 7 x 18-1/2	5
Synchronizer SN-49/FPN-1A	4	10-1/2 x 18 x 19	36
Transmitter-Modulator T-149/GPN-2	1	19 x 22-1/4 x 22-1/4	115
Transmitter-Modulator T-190/FPN-1A	3	19 x 22-1/4 x 22-1/4	99
Antenna Drive TG-1/FPN-1A	1	7 x 12-1/2 x 20	35-1/2
Antenna Drive TG-2/FPN-1A	1	7 x 12-1/2 x 20	35-1/2
Synchronizer TS-504/GPN-2	5	8-3/4 x 19 x 22-1/4	50
Trailer V-31/FPN-1A	1	96 x 125 x 237	19000

REFERENCE DATA AND LITERATURE

Technical Manuals:  
NAVSHIPS 900664

AN/FPN-1A: 5

**DATE:** 1 September 1965

**ITEM NAME:** RADAR SET GROUP

**COGNIZANT SERVICE:** USAF

**TYPE:** AN/FPA-18

**FEDERAL STOCK NUMBER:**

	USA	USN	USAF	USMC
STATUS OR TYPE CLASSIFICATION				
Mfg(s) Name or Code Number: General Electric Co., Syracuse, New York				

Illustration not Available.

**FUNCTIONAL DESCRIPTION**

Radar Set Group AN/FPA-18 provides Radar Set AN/FPS-6 with AJ features.

**RELATION TO SIMILAR EQUIPMENT**

None.

**AN/FPA-18: 1**

**ITEM NAME:** RADAR SET GROUP

**TYPE:** AN/FPA-18

**TECHNICAL DESCRIPTION**

Not available.

**INSTALLATION CONSIDERATIONS**

Related Equipment: The AN/FPA-18 is used with but not part of AN/FPS-6.

**PRINCIPAL COMPONENTS AND PHYSICAL DATA**

<b>COMPONENT</b>	<b>BOXES (NR.)</b>	<b>OVERALL DIMENSIONS (Inches)</b>	<b>UNIT WT. (Pounds)</b>
Receiver Group OA-3878/FPA-18	1		
Control-Power Supply Group OA-3877/FPA-18	1		
Receiver Group OA-3450/FPS-6	1		
Antenna AT-1078/FPS-6			
Intermediate Frequency Amplifier AM-2712/FPS-6	1		
Amplifier-Control AM-2711/FPS-6	1		
Band Pass Filter F-463/FPS-6	1		
Interconnecting Box J-1190/FPS-6	1		
Radar Signal Distribution Panel SB-1164/FPS-6	1		

**REFERENCE DATA AND LITERATURE**

Unclassified Nomenclature card dated 23 Feb 62 for AN/FPA-18.

**AN/FPA-18: 2**



DATE: 15 September 1964

ITEM NAME: DISPLAY SET, STATUS

COGNIZANT SERVICE: USAF

TYPE: AN/FPA-20

FEDERAL STOCK NUMBER: 5840-976-4313

	USA	USN	USAF	USMC
STATUS OR TYPE CLASSIFICATION		STD		
Mfg(s) Name or Code Number: Radio Corporation of America				

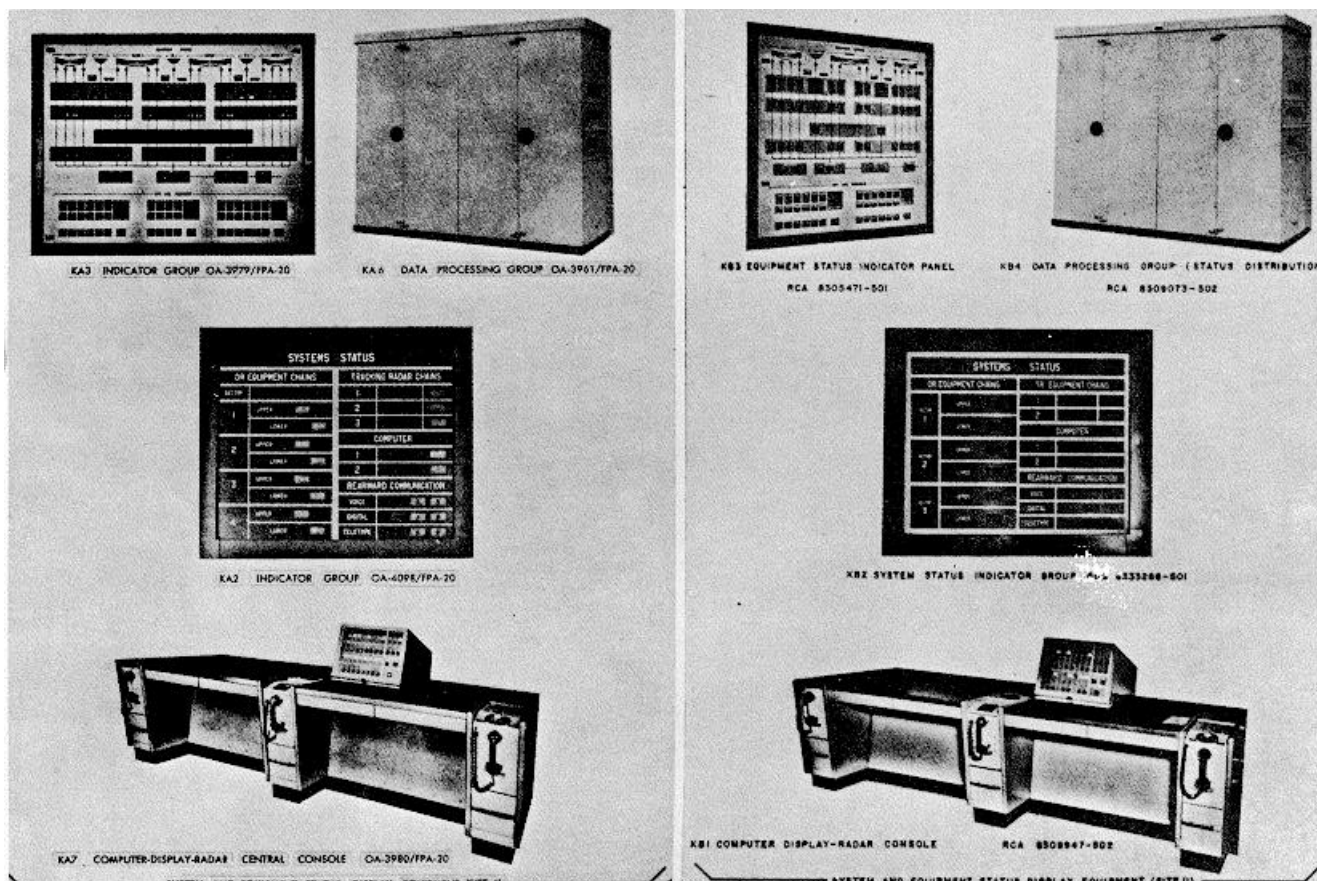

### FUNCTIONAL DESCRIPTION

The AN/FPA-20 is used at BMEWS Sites one and two. The purpose of this equipment at both sites is to display the status of major equipment subsystems, to display the assignment of major equipment, to display

system models and parameters, and to provide a means for manually inserting system status summary reports. The Control Monitor Group included at Site 1 is to establish and control the antenna parameters of any combination of three Tracking Radars; monitor, evaluate, and report.

**ITEM NAME:** DISPLAY SET, STATUS  
**TYPE:** AN/FPA-20

the presence of electromagnetic disturbances, man-made (ecm) or natural (usually aurora borealis), utilizing the scan capabilities of the Tracking Radar; and control the effects of electromagnetic disturbances upon radar reception during Tracking Radar scan mode operation.

Voltage: 120v, 3 ph  
Frequency: 60 cps  
Primary dc Power Requirements:  
Voltage: 26v

**RELATION TO SIMILAR EQUIPMENT:**

None.

**INSTALLATION CONSIDERATIONS**

Siting: Installed at BMEWS site 1 and 2.

**TECHNICAL DESCRIPTION**

Primary ac Power Requirements:

Related Equipments: used with but not part of AN/FPS-49, AN/FPS-49A, and AN/FPS-50(V)

**PRINCIPAL COMPONENTS AND PHYSICAL DATA**

COMPONENT	QTY	HEIGHT (Inches)	WIDTH (Inches)	DEPTH (Inches)	UNIT WT.
EQUIPMENT AT SITE 1:					
Data Analysis Console OA-3980/FPA-20	1				
Control Monitor Group OA-6047/FPA-20	1				
Equipment Status Panel OA-3979/FPA-20	1	107	7	102	715
EQUIPMENT AT SITE 2:					
Equipment Status Panel RCA 8305471-501	1	107	7	78	1030
Maintenance Control Console	1	39	46	103	
EQUIPMENT AT SITES 1 AND 2:					
Signal Data Comparator Group OA-3961/FPA-20	2	87	36	105	
System Status Panel OA-4098/FPA-20	2	55	9	43	275

**REFERENCE DATA AND LITERATURE**

TECHNICAL ORDERS  
31P1-2GPA50 Series

DATE: 15 September 1964  
COGNIZANT SERVICE: USAF

ITEM NAME: DISPLAY SET. STATUS  
TYPE: AN/FPA-21

FEDERAL STOCK NUMBER: 5840-976-4312

	USA	USN	USAF	USMC
STATUS OR TYPE CLASSIFICATION			STD	
Mfg(s) Name or Code Number: Radio Corporation of America				

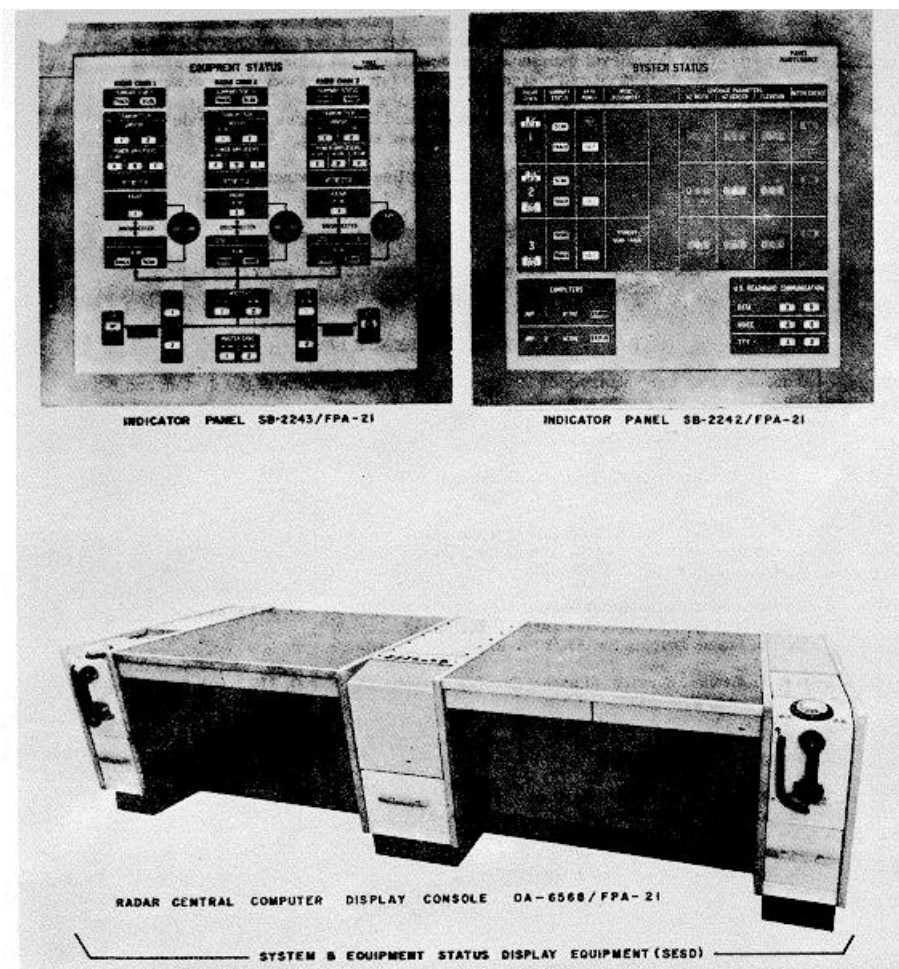

**FUNCTIONAL DESCRIPTION**

The AN/FPA-21 is used at BMEWS Site 3. The purpose of this equipment is to display the status of major equipment subsystems, to display the assignment of major equipments, to display system modes and

parameters, and to provide a means for manually inserting system status summary reports. The Control Monitor Group included at Site 3 is to establish and control the antenna scan parameters of any combination of three Tracking Radars; monitor, evaluate, and report the presence of electromagnetic disturbances,

**ITEM NAME:** DISPLAY SET, STATUS

**TYPE:** AN/FPA-21

man-made (ecm) or natural (usually aurora borealis) utilizing the scan capabilities of the Tracking Radar; and control the effects of electromagnetic disturbances upon radar reception during Tracking Radar scan mode operations.

**RELATION TO SIMILAR EQUIPMENT**

None.

**TECHNICAL DESCRIPTION**

Primary Power: 120v, 60 cps

**INSTALLATION CONSIDERATIONS**

Siting: Installed at BMEWS Site 3.

Related Equipments: AN/FPA-21 is used with but not part of AN/FPS-49, AN/FPS-49A, AN/FPS-50(V).

**PRINCIPAL COMPONENTS AND PHYSICAL DATA**

<b>COMPONENT</b>	<b>QTY</b>	<b>HEIGHT (Inches)</b>	<b>WIDTH (Inches)</b>	<b>DEPTH (Inches)</b>	<b>UNIT WT.</b>
Indicator Panel SB-2243/FPA-21	1	73	50	8	570
Indicator Panel SB-2242/FPA-21	1	73	50	8	570
Radar Central Computer	1				
Display Console OA-6568/FPA-21	1				
Control-Monitor Group OA-4258/FPA-21	1				

**REFERENCE DATA AND LITERATURE**

TECHNICAL ORDER:  
31P1-2FPA21 Series

**AN/FPA-21: 2**

DATE: 1 July 1964  
COGNIZANT SERVICE: USN

ITEM NAME: RADAR SET  
TYPE: AN/FPN-1(XN-2)

FEDERAL STOCK NUMBER:

	USA	USN	USAF	USMC
STATUS OR TYPE CLASSIFICATION Used By Used By				
Mfg(s) Name or Code Number: Bendix Radio Div. of Bendix Aviation Corporation (06845)				

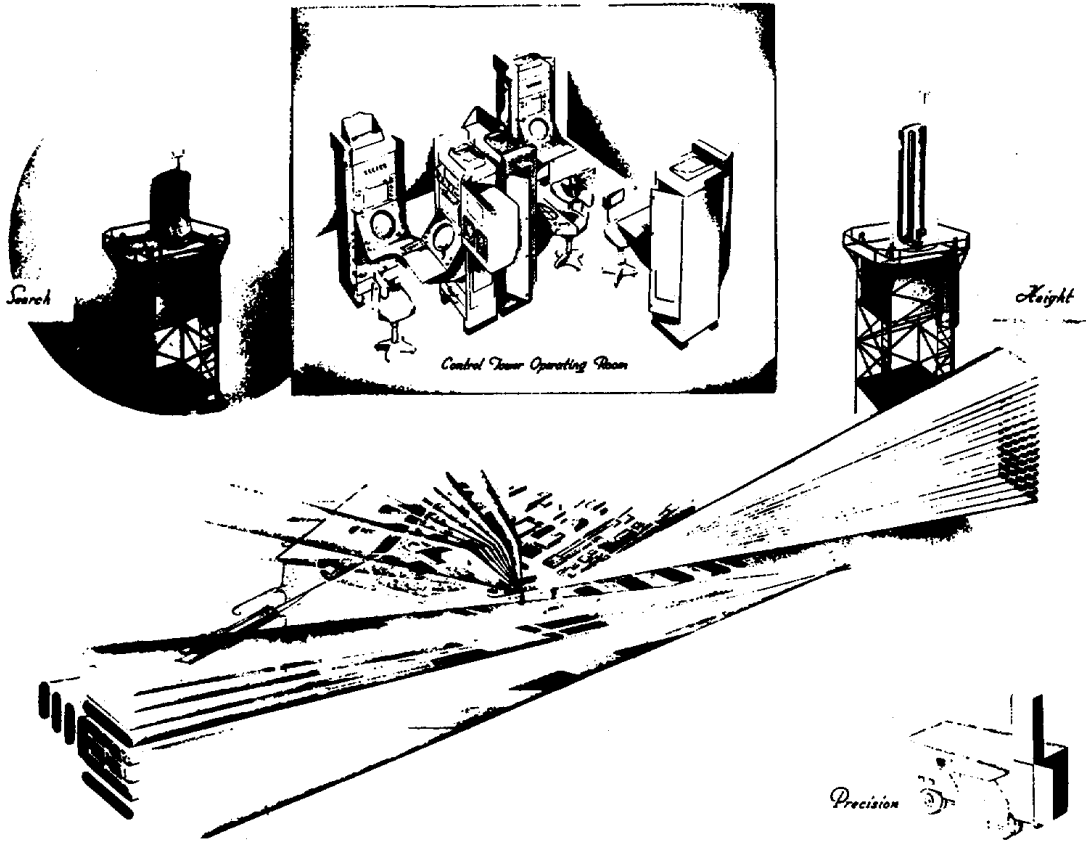

**FUNCTIONAL DESCRIPTION**

The Radar Set AN/FPN-1(XN-2) is designed as a fixed ground radar system for airport surveillance, height finding, and for guiding aircraft for safe approach to the airport runway under all conditions of visibility.

Accurate and continuous information regarding the location of incoming aircraft with respect to the predetermined glide path is presented to the operators in the form of azimuth range and elevation data by the radar portion of the equipment. This

AN/FPN-1(XN-2): 1

**ITEM NAME:** RADAR SET  
**TYPE:** AN/FPN-1(XN-2)

information is translated by the radar set to lateral and vertical deviation from the selected glide path, and the pilot of the incoming aircraft is instructed verbally as to corrections he must make to keep on the glide path.

Through these instructions the pilot is guided to a height of 75 feet or less above the runway and to within 50 ft of the runway's center line, enabling him to touch down under visual control in the usual manner.

**RELATION TO SIMILAR EQUIPMENT**

None

**TECHNICAL DESCRIPTION**

**Radar Operating Frequencies**

- Search System: 2880 plus or minus 20 mc
- Height Finder System: 9150 plus or minus 10 mc
- Precision Azimuth System: 9040 plus or minus 10 mc
- Precision Elevation System: 9010 plus or minus 10 mc

**Communications Operating Frequencies**

- Transmitting (hf): 2 to 18 mc
- Receiving (hf): 1.5 to 9.0 mc
- Transmitting (vhf): 100 to 156 mc
- Receiving (vhf): 100 to 156 mc

**Power Output**

- Radar**
  - Search System: 150 kw min
  - Height Finder System: 35 kw min
  - Precision Azimuth System: 35 kw min
  - Precision Elevation System: 35 kw min

**Communications**

- Band (vhf): 8w
- Band (hf): 100w

**Magnetron Tube Currents**

- Search System: 25 ma
- Height Finding System: 12.5 ma
- Precision Azimuth System: 12.5 ma
- Precision Elevation System: 12.5 ma

**Range Limits**

- Search System: 30, 20, 10 and 6 naut mi
- Height Finder System: 20 naut mi slant range, 12,000 ft altitude

Precision Azimuth and Elevation: 6 naut mi  
Pulse Data

- Pulse Repetition Frequency: 2000 pps
- Pulse Duration: 0.5 usec

**Antenna Beam Dimensions**

Search Antenna: Coscant squared pattern, with nose of beam 2.75 deg above horizontal adjustable for 2 deg to 10 deg.  
Coverage 5000 ft altitude. Azimuth width of beam 5 deg max.

**Height Finder Antenna**

- Azimuth: 4 deg wide
- Elevation: 0.6 deg high

**Precision Azimuth Antenna**

- Azimuth: 1.2 deg wide
- Elevation: 2 deg high

**Precision Elevation Antenna**

- Azimuth: 3.6 deg wide
- Elevation: 0.6 deg high

**Scanning Ranges and Rates**

- Search Antenna: 360 deg at 30 rpm
- Height Finder Antenna: 20 deg in elevation at 1/2 cycle (1 sweep) per sec.  
360 deg controlled rotation at 5.75 rpm
- Precision Azimuth Antenna: 20 deg electrical scan in azimuth at 1 cycle (2 sweeps) per sec, 7 deg mechanical tilt in elevation.

**Radar Bandwidths (All systems)**

- Intermediate Frequency: 4.0 mc
- Video Frequency: 1.75 mc

Operating Power Requirements: 115v ac, 60 cps, single ph, 40 kw.

**INSTALLATION CONSIDERATIONS**

Related Equipment: (Required but not Supplied) (1) Wattmeter "S" Band TS125/AP; (1) Signal Generator "S" Band TS-14/AP(LAD); (1) Echo Box "S" Band TS-270/UP; (2) Wattmeter "X" Band TS36/AP; (2) Signal Generator "X" Band TS-191/UP; (2) Echo Box "X" Band TS218/UP; (3) Fluxmeter TS-15A/AP; (4) Tube Tester OCL; (4) Volt ohmmeter OCR; (1) Megger OCW; (4) Cap and Resistance Bridge CLB60007; (3) Crystal Rectifier Test Set TS-268/U; (4) Oscilloscope TS34A/AP; (1) Test Set (Communications) IE-35A; (3) Voltage Divider TS-89/AP; (3) Vacuum Tube Voltmeter Model 62.

**PRINCIPAL COMPONENTS AND PHYSICAL DATA**

COMPONENTS	QTY	OVERALL DIMENSIONS (Inches)	UNIT WT. (Pounds)
Antenna Mount AB-104/GPN-2	1	32 x 46-1/2 x 54	375
Antenna Mounting AB-136(XN-1)/FPN-1	1	18 x 26 x 50	548
Antenna Tower AB-138(XN-1)/FPN-1	1	230 x 230 x 706	25000
Antenna Tower AB-139(XN-1)/FPN-1	1	230 x 230 x 706	25000
Preamplifier AM-29/MPN-1A	6	3 x 4 x 7-3/4	3

**AN/FPN-1(XN-2): 2**

ITEM NAME: RADAR SET  
TYPE: AN/FPN-1(XN-2)

PRINCIPAL COMPONENTS AND PHYSICAL DATA (Cont.)

COMPONENTS	QTY	OVERALL DIMENSIONS (Inches)	UNIT WT. (Pounds)
Mounting Rack MT-577(XN-1)/FPN-1	1	16-1/2 x 22-1/2 x 64-1/4	66
Mounting Rack MT-578(XN-1)/FPN-1	1	16-1/2 x 22-1/2 x 64-1/4	66
Mounting Rack MT-579(XN-1)/FPN-1	2	14-1/2 x 19-1/2 x 23-1/2	25-1/2
Mounting Rack MT-580(XN-1)/FPN-1	1	29 x 40 x 82	265
Mounting Rack MT-581(XN-1)/FPN-1	1	21 x 22-1/2 x 65-1/2	70
Mounting Rack MT-582(XN-1)/FPN-1	1	20 x 29 x 39	48
Hydr. Lev. System MX-100/MPN-1A	1		
Obstruction Light MX-808/U	2		
Obstruction Light MX-816/U	1		
Motor-Gearcase PD-6(XN-1)/FPN-1	1	11 x 12 x 24	94
Power Supply PP-291(XN-1)/FPN-1	4	17-1/2 x 19 x 22-1/2	115
Power Supply PP-292(XN-1)/FPN-1	1	10-1/2 x 19- x 20-1/2	68
Power Supply PP-293(XN-1)/FPN-1	3	10-1/2 x 16 x 19	44
Power Supply PP-302(XN-1)/FPN-1	1	10-5/8 x 18 x 19	70
Motor Generator PU-133/U	1	11-1/2 x 20 x 41	425
Generator G-23/U	1		
Battery 19065	2	10-1/4 x 11-1/4 x 23	146
Motor Generator PU-147(XN-1)/U	1	13-1/2 x 14 x 33-1/2	178
Radar Receiver R-176/GPN-2	4	8-3/4 x 19 x 22-1/4	60
Distribution Panelboard SB-75(XN-1)/FPN-1	1	17-1/4 x 19 x 20-1/2	75
Distribution Panelboard SB-76(XN-1)/FPN-1	1	19 x 21 x 26-1/2	122
Distribution Panelboard SB-77(XN-1)/FPN-1	1	17-1/2 x 19 x 20-1/2	69
Distribution Panelboard SB-78(XN-1)/FPN-1	1	8 x 9 x 34-1/2	10
Telephone Switchboard SB-79(XN-1)/FPN-1	1	3-1/2 x 7 x 18-1/2	5
Synchronizer SN-49(XN-1)/FPN-1	4	10-1/2 x 18 x 19	36
Transmitter-Modulator T-149/GPN-2	1	19 x 22-1/4 x 22-1/4	115
Transmitter-Modulator T-190(XN-1)/FPN-1	3	19 x 22-1/4 x 22-1/2	99
Antenna Drive TG-i(XN-1)/FPN-1	1	7 x 12-1/2 x 20	35-1/2
Antenna Drive TG-2(XN-1)/FPN-1	1	7 x 12-1/2 x 20	35-1/2
Synchroscope TS-504/GPN-2	5	8-3/4 x 19 x 22-1/4	50

AN/FPN-1(XN-2): 5

Volume 1  
Section 1

**MIL-HDBK-162A**  
15 December 1965

**ITEM NAME:** RADAR SET  
**TYPE:** AN/FPN-1(XN-2)

**PRINCIPAL COMPONENTS AND PHYSICAL DATA (Cont.)**

<b>COMPONENTS</b>	<b>QTY</b>	<b>OVERALL DIMENSIONS (Inches)</b>	<b>UNIT WT. (Pounds)</b>
Trailer V-31(XN-1)/FPN-1	1	96 x 125 x 237	19000

**REFERENCE DATA AND LITERATURE**

Technical Manuals  
NAVSHIPS 900664

**AN/FPN-1(XN-2): 6**



ITEM NAME: RADAR SET  
TYPE: AN/FPN-1(XN-2)

PRINCIPAL COMPONENTS AND PHYSICAL DATA (Cont.)

COMPONENTS	QTY	OVERALL DIMENSIONS (Inches)	UNIT WT. (Pounds)
Servo Amplifier AM-138/GPN-2	2	10-5/8 x 14-1/2 x 19	35-1/2
Electronic Control Amplifier AM-206(XN-i)/FPN-1	1	10-1/2 x 19 x 20-1/2	40
A.F. Amplifier AM-207(XN-I)/FPN-1	1	5-1/8 x 14-1/4 x 19	8
Video Amplifier AM-208(XN-I)/FPN-1	2	8-3/4 x 16 x 19	28
Antenna Assy AS-78/MPN-1A	2	180 lg	20
Antenna Assy AS-317/GPN-2	1	5-1/2 x 12 x 55	32
Antenna Assy AS-338/GPN-2	2	4 dia x 16 lg	4
Antenna Assy AS-379(XN-i)/FPN-1	1	8-1/4 x 11 x 173	100
Antenna Assy AS-380(XN-i)/FPN-1	1	6-1/2 x 8-1/2 x 100	65
Antenna Assy AS-381(XN-i)/FPN-1	1	8-1/4 x 11 x 173	100
Azimuth Reflector AT-44/MPN-1A	1	28 x 49 x 102	150
Elevation Reflector AT-45/MPN-IA	2	14 x 27 x 74	150
		14 x 27 x 94	
Antenna Reflector AT-109/U	1	26-1/4 x 62-1/2 x 101	198
Power Control C-444(XN-1)/U	1	10 x 11 x 16	
Power Control C-445(XN-i)/FPN-1	1	10-5/8 x 17 x 19	16
Power Control C-446(XN-i)/FPN-1	1	10-1/2 x 17-3/4 x 19	15
Search Control C-447(XN-I)/FPN-1	1	11 x 18-1/2 x 19	20
Azimuth-Elevation Control C-448(XN-i)/FPN-1	2	7 x 19-1/8 x 21	10-1/2
Radio Set Control C-449(XN-i)/FPN-1	1	5 x 6-1/2 x 14	6-1/2
Intercommunication Control C-447(XN-1)/FPN-1	1	7 x 8-1/2 x 13	6
Power Control C-458(XN-I)/FPN-1	1	3-1/4 x 5-1/2 x 8	1-1/2
Voltage Regulator CN-74(XN-1)/U	4	8 x 10 x 24	
Angle Coupling Capacitor CU-29/MPN-1A	3	4 x 5 x 5-1/2	4
Angle Coupler CU-144(XN-1)/FPN-1	3	5-1/4 x 8 x 12-1/2	12-1/4
Radome CW-175(XN-i)/FPN-1	1	72 dia x 210	350
Case CY-599(XN-I)/FPN-1	2	11-1/4 x 15 x 19	20
Filter F-54/GPN-2	1	5-1/4 x 14 x 19	23-1/2
Position Deviation Indicator ID-233(XN-1)/FPN-1	1	10 x 21 x 26-1/4	28

AN/FPN-I(XN-2): 3

**ITEM NAME:** RADAR SET  
**TYPE:** AN/FPN-1(XN-2)

**PRINCIPAL COMPONENTS AND PHYSICAL DATA (Cont.)**

<b>COMPONENTS</b>	<b>QTY</b>	<b>OVERALL DIMENSIONS (Inches)</b>	<b>UNIT WT. (Pounds)</b>
Range-Azimuth Indicator IP-5(XN-1)/FPN-1	2	19 x 26 x 33-1/4	165
Elevation Deviation Indicator IP-6(XN-1)/FPN-1	1	19 x 32 x 33-1/4	171
Azimuth Deviation Indicator IP-7(XN-1)/FPN-1	1	19 x 32 x 33-1/4	171
Range-Height Indicator IP-8(XN-1)/FPN-1	1	19 x 33-1/4 x 37-3/4	182
Connector Panel J-244(XN-1)/FPN-1	3	3-1/2 x 4 x 58	10
Terminal Box J-245(XN-1)/FPN-1	2	11 x 17 x 25-1/2	27
Connector Panel J-246(XN-1)/FPN-1	1	4 x 5 x 49	18
Connector Panel J-247(XN-1)/FPN-1	1	3-3/4 x 5-1/2 x 64	8
Connector Panel J-248(XN-1)/FPN-1	1	4 x 4 x 57	10
Terminal Box J-249(XN-1)/FPN-1	2	11 x 22-1/2 x 26	36
Terminal Box J-250(XN-1)/FPN-1	2	11 x 21-1/4 x 26	32
Terminal Box J-251(XN-1)/FPN-1	1	10-1/2 x 36-1/4 x 37-1/4	72
Terminal Box J-252(XN-1)/FPN-1	4	12 x 15 x 23-3/4	22-1/2
Terminal Box J-253(XN-1)/FPN-1	4	3-1/2 x 4-1/2 x 22	8
Connector Panel J-254(XN-1)/FPN-1	1	4 x 8 x 43	8
Connector Panel J-255(XN-1)/FPN-1	1	4 x 7-1/2 x 52-1/2	8
Connector Panel J-256(XN-1)/FPN-1	1	3-1/2 x 4 x 43-1/4	8
Terminal Box J-257(XN-1)/FPN-1	1	3 x 15-1/2 x 17	11
Terminal Box J-258(XN-1)/FPN-1	1	6-3/4 x 15-1/4 x 16-1/4	13
Terminal Box J-259(XN-1)/FPN-1	3	2-3/4 x 8-1/2 x 16-1/4	7
Connector Panel J-260(XN-1)/FPN-1	1	3-3/4 x 5-1/2 x 64	8
Connector Panel J-261(XN-1)/FPN-1	1	4 x 5 x 49	6
Connector Panel J-262(XN-1)/FPN-1	1	4 x 5 x 49	6-1/2
Connector Panel J-264(XN-1)/FPN-1	1	5-1/4 x 14-1/4 x 34-1/4	8
Mounting Rack MT-483/GPN-2	2	16-1/2 x 22-1/2 x 64-1/4	66
Mounting Rack MT-572(XN-1)/FPN-1	3	22-1/2 x 22-1/2 x 65-1/2	70
Mounting Rack MT-573(XN-1)/FPN-1	2	21-1/2 x 23 x 49-3/4	65
Mounting Rack MT-574(XN-1)/FPN-1	1	22 x 23 x 61-1/4	60
Mounting Rack MT-575(XN-1)/FPN-1	1	16-1/2 x 22-1/2 x 64-1/4	66
Mounting Rack MT-576(XN-1)/FPN-1	4	16-3/4 x 17-1/4 x 50-1/2	

**AN/FPN-1(XN-2): 4**

DATE: 1 July 1964

ITEM NAME: RADAR SET

COGNIZANT SERVICE: USN

TYPE: AN/FPN-1A

FEDERAL STOCK NUMBER:

	USA	USN	USAF	USMC
STATUS OR TYPE CLASSIFICATION	Used By	Used By		
Mfg(s) Name or Code Number: Bendix Radio Division of Bendix Aviation Corp. (86270)				

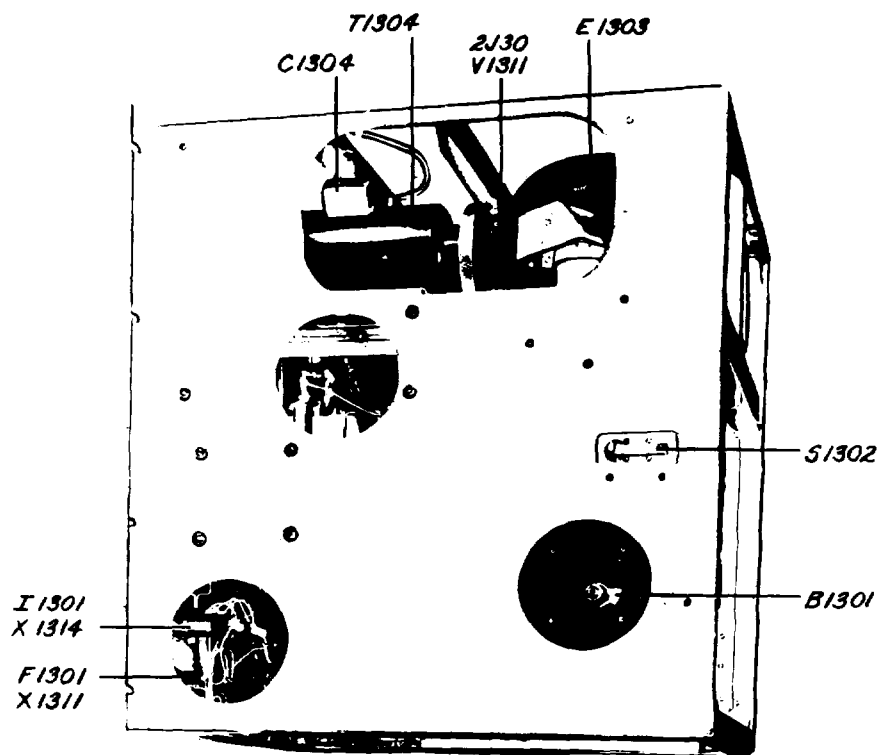

**FUNCTIONAL DESCRIPTION**

The AN/FPN-1A Radar Set is a fixed ground radar system for airport surveillance, height finding, and for

guiding aircraft for safe approach to airport runway under all conditions of visibility.

AN/FPN-IA: 1

**ITEM NAME:** RADAR SET  
**TYPE:** AN/FPN-1A

**RELATION TO SIMILAR EQUIPMENT**

The AN/FPN-1A is similar to the AN/FPN-1 except for component parts.

**TECHNICAL DESCRIPTION**

Operating Frequencies Radar  
 Search System: 2880 mc  
 Height Finder System: 9150 mc  
 Precision Azimuth System: 9040 mc  
 Precision Elevation System: 9010 mc  
 Operating Frequencies Communications  
 Transmitting (hf): 2 to 18 mc  
 Receiving (hf): 1.5 to 9 mc  
 Transmitting (vhf): 100 to 156 mc  
 Receiving (vhf): 100 to 156 mc  
 Pulse Data

Pulse Repetition Frequency: 2000 pps  
 Pulse Duration: 0.5 usec  
 Duty Cycle: 0.001  
 Range Limits  
 Search System: 30, 20, 10 and 6 naut mi  
 Height Finder System: 20 naut mi slant range, 12, 000 ft altitude  
 Precision Azimuth and Elevation: 6 naut mi  
 Radar Bandwidths (All Systems)  
 Intermediate Frequency: 4.0 mc  
 Video Frequency: 1.75 mc  
 Operating Power Requirements: 115v ac, 60 cps, single ph, 40 kw

**INSTALLATION CONSIDERATIONS**

Siting: Fixed station.

**PRINCIPAL COMPONENTS AND PHYSICAL DATA**

COMPONENTS	QTY	OVERALL DIMENSIONS (Inches)	UNIT WT. (Pounds)
Antenna Mount AB-104/GPN-2	1	32 x 46-1/2 x 54	375
Antenna Mount AB-136/FPN-1A	1	18 x 28 x 50	548
Antenna Tower AB-138, /FPN-1A	1	330 x 330 x 804	25000
Antenna Tower AB-139/FPN-1A	1	330 x 330 x 804	25000
Preamplifier AM-29/MPN-1A	6	3 x 4 x 7-3/4	3
Servo Amplifier AM-138/GPN-2	2	10-5/8 x 14-1/2 x 19	35-1/2
Electronic Control Amplifier AM-206/FPN-1A	1	10-1/2 x 19 x 20-1/2	40
A.F. Amplifier AM-207/FPN-1A	1	5-1/8 x 14-1/4 x 19	8
Video Amplifier AM-20B/FPN-1A	2	B-3/4 x 16 x 19	28
Antenna Assy AS-76/MPN-1A	2	20	
Antenna Assy AS-317/GPN-2	1	5-1/2 x 12 x 55	32
Antenna Assy AS-338/GPN-2	2	4 dia x 16	4
Antenna Assy AS-379/FPN-1A	1	8-1/4 x 11 x 173	100
Antenna Assy AS-380/FPN-1A	1	6-1/2 x 8-1/2 x 100	65
Antenna Assy AS-3b1/FPN-1A	1	8-1/4 x 11 x 173	100
Azimuth Reflector AT-44/MPN-1A	1	28 x 49 x 102	150
Elevation Reflector AT-45/MPN-1A	2		150
Antenna Reflector AT-109/U	1	26-1/4 x 62-1/2 x 101	198
Power Control C-444(XN-1)/U	4	10 x 11 x 16	
Power Control C-145/FPN-1A	1	10-5/8 x 17 x 19	16

**AN/FPN-1A: 2**

ITEM NAME: RADAR SET

TYPE: AN/FPN-1A

PRINCIPAL COMPONENTS AND PHYSICAL DATA (Cont.)

COMPONENTS	QTY	OVERALL DIMENSIONS (Inches)	UNIT WT. (Pounds)
Power Control C-446/FPN-1A	1	10-1/2 x 17-3/4 x 19	15
Search Control C-447/FPN-1A	1	11 x 18-1/2 x 19	20
Azimuth-Elevation Control C-448/FPN-1A	2	7 x 19-1/8 x 21	10-1/2
Radio Set Control C-449/FPN-1A	1	5 x 6 -1/2 x 14	6-1/2
Intercommunication Control C-457/FPN-1A	1	7 x 8-1/2 x 13	6
Power Control C-458/FPN-1A	1	3-1/4 x 5-1/2 x 8 1-1/2	
Voltage Regulator CN-74(XN-1)/U	4	8 x 10 x 24	
Angle Coupling Capacitor CU-29/MPN-1A	3	4 x 5 x 5-1/2	4
Angle Coupler CU-144/FPN-1A	3	5-1/4 x 8 x 12-1/2	12-1/4
Radome CW-175/FPN-1A	1	72 dia x 210	350
Case CY-599/FPN-1A	2	11-1/4 x 15 x 19	20
Filter F-54/GPN-2	1	5-1/4 x 14 x 19	23-1/2
Position Deviation Indicator ID-233/FPN-1A	1	10 x 21 x 26-1/4	28
Range-Azimuth Indicator IP-5/FPN-1A	2	19 x 26 x 33-1/4	165
Elevation Deviation Indicator IP-6/FPN-1A	1	19 x 32 x 33-1/4	171
Azimuth Deviation Indicator IP-7/FPN-1A	1	19 x 32 x 33-1/4	171
Range Height Indicator IP-8/FPN-1A	1	19 x 33-1/4 x 37-3/4	182
Connector Panel J-244/FPN-1A	3	3-1/2 x 4 x 58	10
Terminal Box J-245/FPN-1A	2	11 x 17 x 25-1/2	27
Connector Panel J-246/FPN-1A	1	4 x 5 x 49	18
Connector Panel J-247/FPN-1A	1	3-3/4 x 5-1/2 x 64	8
Connector Panel J-248/FPN-1A	1	4 x 4 x 57	10
Terminal Box J-249/FPN-1A	2	11 x 22-1/2 x 26	36
Terminal Box J-250/FPN-1A	2	11 x 21-1/4 x 26	32
Terminal Box J-251/FPN-1A	1	10-1/2 x 36-1/4 x 37-1/4	72
Terminal Box J-252/FPN-1A	4	12 x 15 x 23-3/4	22-1/2
Terminal Box J-253/FPN-1A	4	3-1/2 x 4-1/2 x 22	8
Connector Panel J-254/FPN-1A	1	4 x 8 x 43	8

AN/FPN-1A: 3

**ITEM NAME:** RADAR SET

**TYPE:** AN/FPN-1A

<b>COMPONENTS</b>	<b>QTY</b>	<b>OVERALL DIMENSIONS (Inches)</b>	<b>UNIT WT. (Pounds)</b>
Connector Panel J-255/FPN-1A	1	4 x 7-1/2 x 52-1/2	8
Connector Panel J-256/FPN-1A	1	3-1/2 x 4 x 43-1/4	8
Terminal Box J-257/FPN-1A	1	3 x 15-1/2 x 17	11
Terminal Box J-25B/FPN-1A	1	6-3/4 x 15-1/4 x 16-1/4	13
Terminal Box J-259/FPN-1A	1	2-3/4 x 8-1/2 x 16-1/4	7
Connector Panel J-260/FPN-1A	1	3-3/4 x 5-1/2 x 64	B
Connector Panel J-261/FPN-1A	1	4 x 5 x 49	6
Connector Panel J-262/FPN-1A	1	4 x 5 x 49	6-1/2
Connector Panel J-264/FPN-1A	1	5-1/4 x 14-1/4 x 34-1/4	8
Mounting Rack MT-483/GPN-2	2	16-1/2 x 22-1/2 x 64-1/4	66
Mounting Rack MT-572/FPN-1A	3	21-1/2 x 22-1/2 x 65-1/2	70
Mounting Rack MT-573/FPN-1A	2	21-1/2 x 23 x 49-3/4	65
Mounting Rack MT-574/FPN-1A	1	22 x 23 x 61-1/4	60
Mounting Rack MT-575/FPN-1A	1	16-1/2 x 22-1/2 x 64-1/4	66
Mounting Rack MT-576/FPN-1A	4	16-3/4 x 17-1/4 x 50-1/2	
Mounting Rack MT-577/FPN-1A	1	16-1/2 x 22-1/2 x 64-1/4	66
Mounting Rack MT-57B/FPN-1A	1	16-1/2 x 22-1/2 x 6-1-1/4	66
Mounting Rack MT-579/FPN-1A	1	14-1/2 x 19-1/2 x 23-1/2	25-1/2
Mounting Rack MT-580/FPN-1A	1	29 x -0 x 82	265
Mounting Rack MT-581/FPN-1A	1	21 x 22-1/2 x 65-1/2	70
Mounting Rack MT-582/FPN-1A	1	20 x 29 x 39	48
Hydraulic Lever System	1		
Obstruction Light MX-808/U	2		
Obstruction Light MX-816/U	1		
Motor Gearcase PD-6/FPN-1A	1	11 x 12 x 2, 1	95
Power Supply PP-291/FPN-1A	4	17-1/2 x 19 x 22-1/2	115
Power Supply PP-292/FPN-1A	1	0-1/2 x 19 x 20-1/2	63
Power Supply PP-293/FPN-1A	3	10-1/2 x 16 x 19	11
Power Supply PP-302/FPN-1A	1	10-5/8 x 18 x 19	70
Motor Generator PU-133/U	1	11-1/2 x 20 x 11	125
includes:			
Motor PD-3/U	1		

**AN/FPN-1A: 4**

DATE: 1 July 1964

ITEM NAME: RADAR BEACON

COGNIZANT SERVICE: USN

TYPE: AN/FPN-10(XN-1)

FEDERAL STOCK NUMBER:

	USA	USN	USAF	USMC
STATUS OR TYPE CLASSIFICATION	Used By	Used By		
Mfg(s) Name or Code Number: Raytheon Manufacturing Company (49956)				

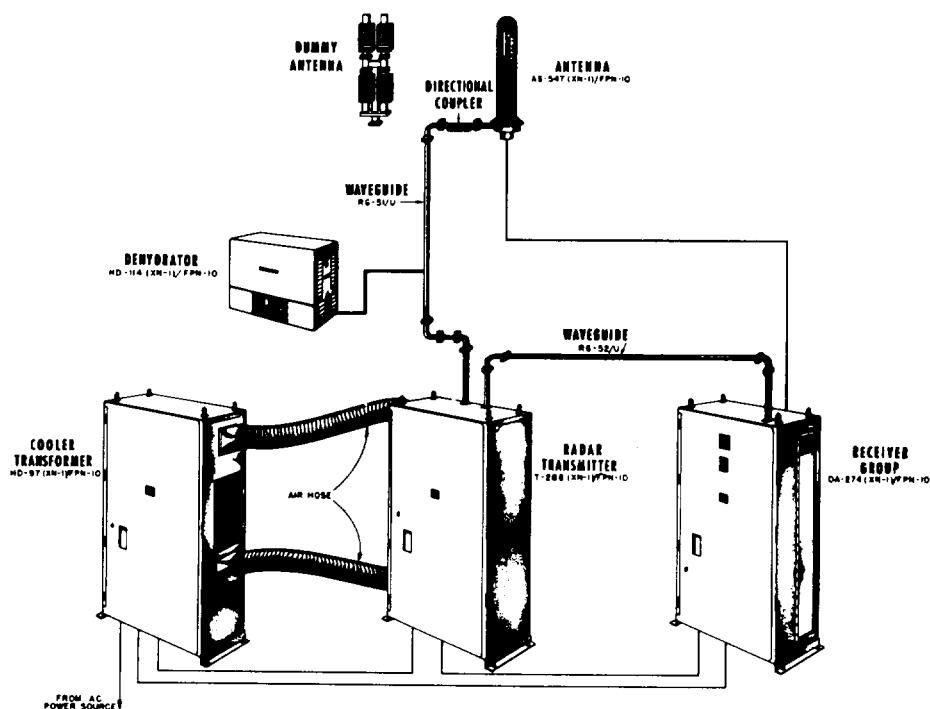

**FUNCTIONAL DESCRIPTION**

The Radar Beacon AN/FPN-10(XN-1) is a land-based radar navigational aid which automatically gives an identification letter (in Morse code) and range and azimuth information to interrogating aircraft equipped

with suitable Xs-band radar equipment. It is designed to be capable of operating unattended for a 30-day period.

The AN/FPN-10(XN-1) is capable of being interrogated by any radar set have a transmitted pulse-width of 2.0 to 2.7 microseconds and transmitted frequency of 9335 to

AN/FPN-10(XN-1): 1

**ITEM NAME:** RADAR BEACON

**TYPE:** AN/FPN-10(XN-1)

9415 megacycles. Upon being interrogated, the beacon replies by transmitting a Morse code letter on a frequency of 9310 mc. The transmitted code letter will appear on the interrogating radar set at the bearing of the beacon and at a range that is approximately 570 yards greater than the distance between the interrogating radar and the beacon.

**RELATION TO SIMILAR EQUIPMENT**

None.

**TECHNICAL DESCRIPTION**

Type of Signal Transmitted: Morse Code pulse signal.  
Frequency Range: 9335 to 9415 mc  
Transmitting Morse Code Frequency: 9310 mc  
Transmitted Pulse-Width: 2.0 to 2.7 usec  
1g  
Operating Power Requirements: 200v, 220v or 440v ac, 60 cps, 3 ph, 17 kva

**INSTALLATION CONSIDERATIONS**

Siting: Fixed ground.

**PRINCIPAL COMPONENTS AND PHYSICAL DATA**

<b>COMPONENTS</b>	<b>QTY</b>	<b>OVERALL DIMENSIONS (Inches)</b>	<b>UNIT WT. (Pounds)</b>
Radar Receiver R-403(XN-1)/FPN-10	1	3 x 22 x 28	
Radar Transmitter T-288(XN-1)/FPN-10	11	24-3/4 x 35-3/4 x 53-1/2	150
Antenna AS-547(XN-1)/FPN-10	1	7-3/8 dia x 28 lg	
Cabinet CY-1001(XN-1)/FPN-10	1	24-3/4 x 35-3/4 x 53-1/2	
Transformer Cooler HD-97(XN-1)/FPN-10		23-1/2 x 35-1/2 x 53-1/2	900
Dehydrator HD-114(XN-1)/FPN-10	1	8 x 13 x 22	
Beacon Coder KY-72(XN-1)/FPN-10	1	11-1/2 x 16 x 22	20
A.F. Monitor LS-178(XN-1)/FPN-10	1	11-1/2 x 16 x 21-5/8	
Receiver Group OA-274(XN-1)/FPN-10	1	24-3/4 x 35-3/4 x 53-1/2	850
Power Supply PP-670(XN-1)/FPN-10	1	11 x 21 x 27	

**REFERENCE DATA AND LITERATURE**

Technical Manuals:  
NAVSHIPS 92148

**AN/FPN-10(XN-1): 2**



DATE: 1 May 1964

ITEM NAME: RADAR BEACON

COGNIZANT SERVICE: USAF

TYPE: AN/FPN-13

FEDERAL STOCK NUMBER: 5895-538-2269-EG

	USA	USN	USAF	USMC
STATUS OR TYPE CLASSIFICATION			STD	
Mfg(s) Name or Code Number: Webster - Chicago Corporation				

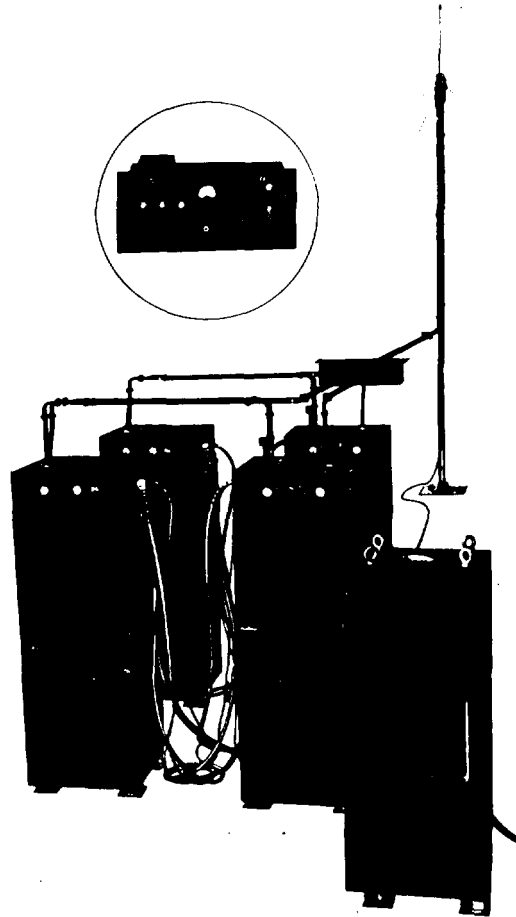

**FUNCTIONAL DESCRIPTION**

Radar Beacon AN/FPN-13 is a micro-wave transponder type radar beacon, designed to operate unattended in a fixed sheltered installation as a navigational aid to aircraft. It may be triggered by any

airborne interrogator capable of originating a triggered pulse satisfying the frequency and pulse width requirements of the beacon. When triggered, the beacon transmits a group of coded pulses, which when interpreted, will identify the beacon and enable the aircraft to establish its relative

**AN/FPN-13: 1**

**ITEM NAME:** RADAR BEACON

**TYPE:** AN/FPN-13

position. The beacon can also be operated remotely through telephone lines up to a distance of 15 miles.

minus 5 cycle, 15 kva

Range: 175 mi

**RELATION TO SIMILAR EQUIPMENT**

AN/FPN-13 was designed to replace AN/CPN-8.

**INSTALLATION CONSIDERATIONS**

**Siting:** Siting area should contain an adequate shelter for the beacon set. The terrain must be such that the antenna is not obstructed by prominent objects or buildings. Consideration must be given to availability of power.

**Mounting:** All equipment should be floor-mounted within a shelter approximately 15 ft by 10 ft by 7 ft high, except for the antenna, which should be mounted close to the shelter.

**Cabling Requirements:** The Cable System consists of all interconnecting cable assemblies required for the operation of the equipment, with exception of the field telephone wire required for remote operation and the cable to the radar suppressor unit.

**TECHNICAL DESCRIPTION**

Frequency:

Receiver - 9335 to 9415 mc (X-band)  
Transmitter - 9310 plus or minus 0.75 mc

Pulse Width:

Receiver - Accepts only pulse 2.35 plus or minus 0.15 usec wide  
Transmitter - Replies with pulses 0.5 usec wide

Transmitter Power Output: 5 kw min peak power pulses.

Voltage and Power Requirements: 115 plus or minus 10v, 3 ph, 4-wire 60 plus or

**PRINCIPAL COMPONENTS AND PHYSICAL DATA**

<b>COMPONENT</b>	<b>QTY</b>	<b>HEIGHT (Inches)</b>	<b>WIDTH (Inches)</b>	<b>DEPTH (Inches)</b>	<b>UNIT WT. (Pounds)</b>
Receiver Group OA-21B/FPN-13	2	72	23-1/2	24	750
Transmitter Group OA-219/FPN-13	2	72	23-1/2	24	1150
Radar Set Control Group OA-577/FPN-13	1	59-1/8	18-5/16	21-5/16	550
Waveguide Switch SA-361/FPN-13	1	6-3/4	22-1/2	9-23/32	32
Control Monitor C-78B/FPN-13	1	8-3/4	19	11	33
Antenna AS-454/FPN-13	1				24
Antenna Mast AB-42/CPN-6	1				130
Waveguide Components Kit RK-202/CPN-6	1				140
Waveguide System	1				13
Cable System	1				193

**REFERENCE DATA AND LITERATURE**

TECHNICAL ORDERS:

31P5-2FPN13- Series      Specification MIL-R-9531A(USAF)

DATE: 1 May 1964

ITEM NAME: RADAR SET

COGNIZANT SERVICE: USAF

TYPE: AN/FPN-16

FEDERAL STOCK NUMBER:

	USA	USN	USAF	USMC
STATUS OR TYPE CLASSIFICATION			STD	
Mfg(s) Name or Code Number. Gilfillan Brothers, Incorporated				

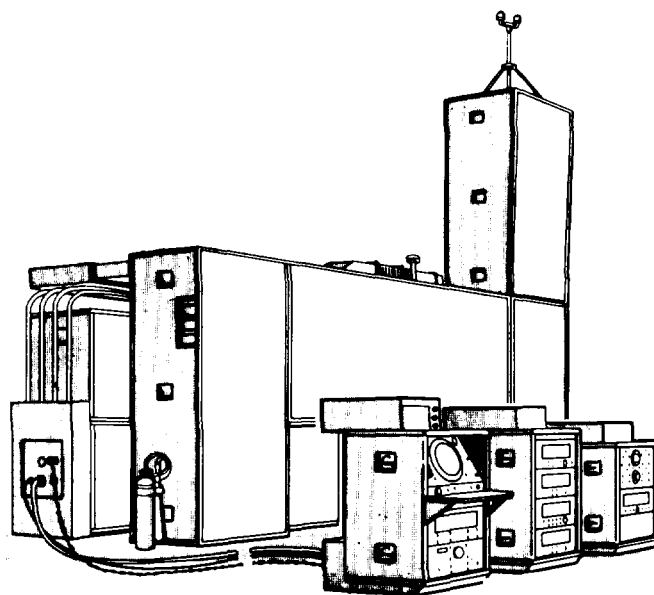
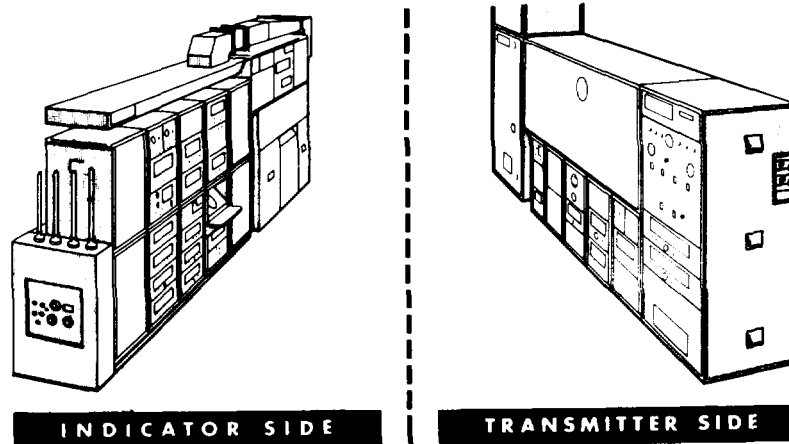

**FUNCTIONAL DESCRIPTION**

The AN/FPN-16 is a precision GCA (Ground Controlled Approach) radar equipment. It may be used as an independent precision radar system to monitor aircraft final approaches, but is primarily designed to

function as an integral part of a complete GCA system which incorporates (in addition to the AN/FPN-16) radio communications and search radar facilities. The purpose of the equipment is to present aircraft altitude, range, and flight course information for use by the Control Center in directing

**ITEM NAME:** RADAR SET

**TYPE:** AN/FPN-16

the approach and landing of aircraft during periods of reduced visibility.

**RELATION TO SIMILAR EQUIPMENT**

Radar Set AN/FPN-16 is similar to AN/CPN-4 and AN/MPN-11, differs in that AN/FPN-16 does not include the search portion of equipment and is not trailer-mounted.

**TECHNICAL DESCRIPTION**

Frequency: 9000 to 9160 mc  
Wave Length: 3-cm band (X)  
Range: At least 8 naut mi (9.2 statute mi)  
Coverage:  
    Azimuth - Antenna Scan, -2 to 22 deg  
            Indicator Maps, -5 to plus  
            15 deg  
    Elevation - Antenna Scan, -2 to 9 deg  
            Indicator Maps, -1 to plus  
            6 deg  
System Accuracies:  
    Azimuth - 0.6 pct  
    Elevation - 0.3 pct  
    Range - 2 pct  
Resolution:  
    Range - 200 ft, target separation  
    Azimuth - 1.1 pct target separation

Elevation - 0.6 deg target separation  
Pulse Repetition Frequency:  
    Transmitter Normal - 1883 pps  
    Transmitter MTI - 5500 pps  
Antenna Scan Speed: 1 cps  
Transmitter Output: 45 kw  
Pulse Width: 0.18 usec  
Voltage and Power Requirements: 120/208v,  
    4-wire, 3 ph, 60 cycle, 19.3 kw

**INSTALLATION CONSIDERATIONS**

Siting: Requires an unobstructed field in close proximity to the landing facility and sufficient space for installation of equipment shelter.  
  
Mounting: All equipment is mounted and installed in Shelter S-59/FPN-16.  
  
Cabling Requirements: The primary power cable should be run through an underground duct to a transformer vault. Cables between AN/FPN-16 and RAPCON Center or other remote sites must not be longer than 10, 000 ft. An underground duct system must be used within 300 ft of the radar antenna.  
  
Related Equipments: Search Radar AN/CPN-18, Communication Equipment.

**PRINCIPAL COMPONENTS AND PHYSICAL DATA**

<b>COMPONENT</b>	<b>QTY</b>	<b>HEIGHT (Inches)</b>	<b>WIDTH (Inches)</b>	<b>DEPTH (Inches)</b>	<b>UNIT WT. (Pounds)</b>
Antenna Group OA-2B1/GPN (Upper Elevation Antenna)	1	40	52	110	1140
Antenna Group OA-281/GPN (Lower Elevation Antenna)	1	36	52	91	1105
Antenna Group OA-280/GPN	1	36	52	125	1664
Antenna AS-520/GPN with Sensitive Switch SA-232/GPN	1	172	10	10	280
Radar Set Group OA-257B/GPN	1	22	24	32	410
Transmitter Group OA-243B/GPN	1	22	24	32	410
Synchroscope Set OA-283/GPN	1	22	24	32	462
Radar Set Group OA-256/GPN	1	22	24	32	362
Power Supply-Synchronizer Group OA-255/GPN	1	22	24	32	423
Power Supply Set OA-282A/GPN (Power Distribution Assembly)	1	36	28	39	1209
Equipment Assembly - Storage and Test No. 1	1	40	22	24	275

ITEM NAME: RADAR SET

TYPE: AN/FPN-16

PRINCIPAL COMPONENTS AND PHYSICAL DATA

COMPONENT	QTY	HEIGHT (Inches)	WIDTH (Inches)	DEPTH (Inches)	UNIT WT. (Pounds)
Equipment Assembly - Storage and Test No. 2	1	22	24	32	240
Amplifier - Power Supply Group OA-260/GPN		22	24	32	434
Equipment Assembly - Spare Unit Storage No. 2	1	40	22	24	560
Indicator Control Group OA-272/GPN	1	22	24	32	298
Comparator - Power Supply Group OA-246A/GPN	1	40	22	24	505
Equipment Assembly - Spare Unit Storage No. 3	1	22	24	32	350
Indicator Group OA-230A/GPN	1	40	22	24	565
Equipment Assembly - Storage and Test No. 3	1	40	22	24	268
Equipment Assembly (spare- transmitter)	1	22	24	32	405
Indicator Group OA-230A/GPN (Remoting)	1	40	22	24	663
Amplifier Group OA-239/GPN (Remoting)	1	40	22	24	777
Synchroscope Set OA-283/GPN (Remoting)	1	22	24	32	473
Heater and Ventilation Unit	1	32	27	65	820
Heater and Ventilation Unit	1	6	8	33	55
Air Conditioner HD-79A/G	1	56	27	63	2303
Transmission Line (crated)	1	10	18	150-1/2	150
Transmitter Cable and Duct Assembly	1	33	46	166	1467
Outer Hot-Air Duct Assembly	1	35	25	97	345
Shelter Cabling Assy (crated)	1	22-1/4	22	41	170
Voltage Regulator CN-146/GPN	1	11-1/2	27	48	373
Motor, Heater and Ventilation Blower	1	8	11	17	135
Target RR-33/G (crated)	12	29-1/2	46	110	809
Operators Seat Assy (crated)	1	24	21	24	67
Table Assembly, portable		38-1/8	36-1/8	25-1/8	115
Tool Chest No. 1 (crated)	1	13	15-1/2	82	270

AN/FPN-16: 3

**ITEM NAME:** RADAR SET

**TYPE:** AN/FPN-16

**PRINCIPAL COMPONENTS AND PHYSICAL DATA**

<b>COMPONENT</b>	<b>QTY</b>	<b>HEIGHT (Inches)</b>	<b>WIDTH (Inches)</b>	<b>DEPTH (Inches)</b>	<b>UNIT WT. (Pounds)</b>
Tool Chest No. 2 (crated)	1	16	13-1/2	102	140
Miscellaneous Test Equipment (crated)	1	19-1/4	30-1/4	43-1/4	267

**REFERENCE DATA AND LITERATURE**

TECHNICAL ORDERS:  
31P5-2FPN16- Series

**AN/FPN-16: 4**

DATE: 1 July 1964

ITEM NAME: RADAR SET

COGNIZANT SERVICE: USN

TYPE: AN/FPN-28, AN/FPN-28A

FEDERAL STOCK NUMBER:

	USA	USN	USAF	USMC
STATUS OR TYPE CLASSIFICATION				
Mfg(s) Name or Code Number: Bendix Radio Div., Bendix Aviation Corp., Towson, Maryland				

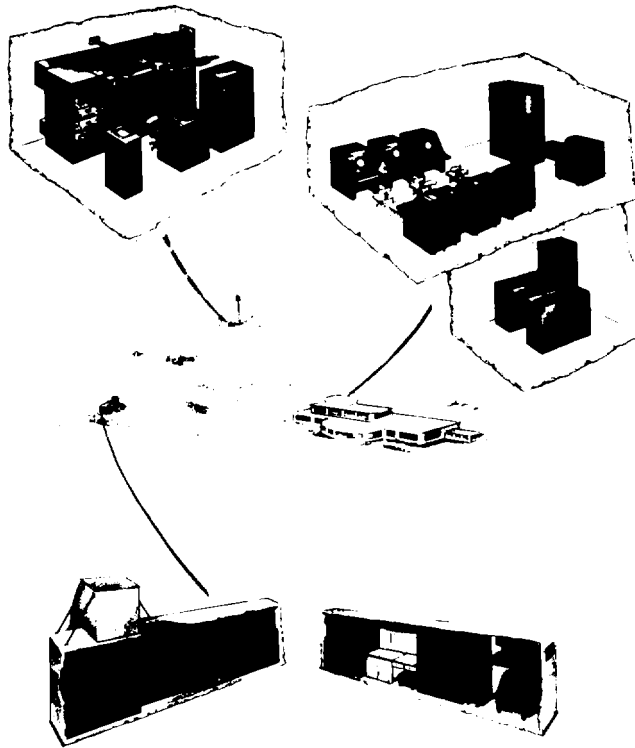

### FUNCTIONAL DESCRIPTION

Radar Sets AN/FPN-28 and AN/FPN-28A are ground-controlled approach radar systems consisting of a search and a precision systems.

The search system is designed to detect aircraft up to a maximum range of 50 miles and furnish precise information for directing the movement of the aircraft in azimuth to a predetermined point in space. From this point, the aircraft can be directed along a predetermined glide path to a point within 50 feet above an airport

AN/FPN-28: 1

**ITEM NAME: RADAR SET**

**TYPE: AN/FPN-28, AN/FPN-28A**

runway through the facilities of the precision system of the radar set.

The precision approach system is designed to provide precise information for directing the movement of aircraft in azimuth and elevation along a predetermined glide path to a point above an airport runway from which a landing can be completed under normal visual means and under all conditions approaching minimum visibility.

**RELATION TO SIMILAR EQUIPMENT**

None.

**TECHNICAL DESCRIPTION**

**Frequency Range**

Search System (S-Band): 2775 to 2900 mc

Precision System (X-Band): 9000 to 9180 mc

**Communications Systems**

HF: 2000 to 18, 100 kc (AN/ART-13 and AN/ARR-15).

VHF: 100 to 156 mc (AN/ARC-1).

UHF: 225 to 399.9 mc (AN/ARC-27).

**Type of Frequency Control**

Search System: afc (motor-driven freq control of Search Stalo).

Precision System: No true freq control necessary.

**Peak Power Output**

Search Transmitter: 500 kw

Precision Transmitter: 25 kw

**Communications System**

HF: 31 to 90w (depending on freq AN/ART-13).

VHF: 8w (AN/ARC-1).

UHF: 10w (AN/ARC-27).

**Pulse Repetition Frequency**

Search System: 1200 per sec

Precision System: 2400 per sec

**Pulse Width**

Search System: 0.8 usec

Precision System: 0.5 usec

**Duty Cycle**

Search System: 0.00096

Precision System: 0.0012

**Magnetron Tube Currents**

Search System: 32 to 34 ma

Precision System: 10 ma

**Range Limits**

Search System: 50 naut mi

Precision System: 10 naut mi

**Radial Blind Speeds**

Search System: 124 knots

Precision System: 77 knots

**Available Glide Path Angles**

Precision Elevation System: plus 2 deg to plus 5 deg

**Touch-Down Point Location Limits**

Minimum: 2500 ft

Maximum: 7500 ft

**Typical Hard Stand Construction for Precision Trailer**

Length: 80 ft

Width: 40 ft

Material: Concrete. Load rating 9000 lbs per wheel.

**Search System Resolution**

Azimuth Resolution: 4.0 deg

Range Resolution: 1% of sweep range or 650 ft, whichever is greater.

**Precision System Resolution**

Azimuth Resolution: 1.2 deg

Range Resolution: 400 ft

Elevation Resolution: 0.55 deg

Range Resolution: 400 ft

**Type Receivers: Superheterodyne (search and precision systems).**

**Intermediate Frequencies**

Search and Precision Systems: 30 mc

**Receiver Output**

Search and Precision Systems: plus 2v (video amplitude precision and search).

**Antennas**

**Beam Pattern Dimensions**

Search Antenna: Cosecant Squared pattern to 25 deg in elevation. Beam width is 2.2 deg in azimuth.

Azimuth Antenna: Modified Beavertail pattern to give 4 deg coverage in elevation. Beam width is 57 minutes in azimuth.

Elevation Antenna: Cosecant Squared pattern to 10 deg in azimuth. Beam width is 33 minutes in elevation.

**Scanning Rates**

Search Antenna: 15 rpm and 30 rpm

Azimuth and Elevation Antennas: Two looks per sec.

**Scanning Ranges**

Search Antennas: 360 deg

Azimuth Antenna: 20 deg in azimuth

Elevation Antenna: 7 deg in elevation.

**Power Requirements**

Search Site: 12 kva (approx)

Control Tower: 10 kva (approx)

Precision Trailer: Approx 18 kva plus 23 kva for floor heaters.

**INSTALLATION CONSIDERATIONS**

Not available.



ITEM NAME: RADAR SET

TYPE: AN/FPN-28, AN/FPN-28A

PRINCIPAL COMPONENTS AND PHYSICAL DATA

COMPONENTS	QTY	OVERALL DIMENSIONS (Inches)	UNIT WT. (Pounds)
Antenna Pedestal AB-390/FPN-28	1	15-1/4 x 35 x 38-7/32	
Antenna Pedestal AB-391/FPN-28	1	15-7/8 x 37-53/64 x 42-33/64	
Antenna Pedestal AB-392/FPN-28	1	31 dia x 30	
Mast AB-442/FPN-28	1		
Electronic Control Amplifier AM-414/MPN-5	4	6-13/16 x 7 x 13-31/64	
Electronic Control Amplifier AM-415/MPN-5	2	9.13 x 16.20 x 24.39	
R.F. Amplifier AM-416/MPN-5	4		
Amplifier-Speaker AM-445/U	1		
Direct Current Amplifier AM-1148/FPN-28	1		
Direct Current Amplifier AM-1149/FPN-28	1		
Trigger Video Amplifier AM-1159/FPN-28	4		
Trigger Video Amplifier AM-1160/FPN-2B	4		
Antenna AS-390/SRC	1		
Antenna Assembly AS-394A/U	1		
Antenna AS-512/MR	1		
Antenna AS-762/MPN-5	1		
Antenna AS-763/MPN-5	1		
Antenna AS-764/MPN-5	1		
Antenna AS-765/MPN-5	1		
Antenna Reflector AT-262/MPN-5	1		
Antenna Reflector AT-263/MPN-5	1		
Antenna Reflector AT-265/MPN-5	1		
Antenna Horn AT-268/MPN-5	1		
Waveguide Horn AT-776/FPN-28	1		
Waveguide Horn AT-777/FPN-28	1		
Antenna Horn AT-411/MPN-5	1		
Control Panel C-724/MPN-5	3		
Control Panel C-781/U	1		
Interphone Control C-1305/MPN-5	1		
Indicator Control C-1555/FPN-28	4		
Remote Switching Control C-1613/FPN-28	1		
Selector Control C-1776/FPN-28	1		

AN/FPN-28: 3

**ITEM NAME:** RADAR SET

**TYPE:** AN/FPN-28, AN/FPN-28A

**PRINCIPAL COMPONENTS AND PHYSICAL DATA**

<b>COMPONENTS</b>	<b>QTY</b>	<b>OVERALL DIMENSIONS (Inches)</b>	<b>UNIT WT. (Pounds)</b>
Power Supply Control C-1883/FPN-28	1		
R.F. Cable Assembly CG-762/U	3	600 lg	
Waveguide Assembly CG-794/MPN-5	1		
Waveguide Assembly CG-795/MPN-5	1		
Waveguide Assembly CG-1366/FPN-28	1		
Signal Comparator CM-53A/MPN-5	2		
**Voltage Regulator CN-342/FPN-28A	9		
Directional Coupler CU-387/FPN-28	2		
Directional Coupler CU-388/FPN-28	3		
Duplexer CU-438/FPN-28	2		
Coupler-Switch Assy CU-440/FPN-28	1		
Frequency Converter CV-131/CPN-18	2		
Signal Data Converter CV-351/FPN-28	2		
Signal Data Converter CV-352/FPN-28	2		
Radome CW-305/MPN-5	1		
Radome CW-306/MPN-5	1		
Electrical Power Cable Assy CX-3204/U	1	300 lg	
Electrical Power Cable Assy CX-3263/U	3	600 lg	
Electrical Power Cable Assy CX-3264/U	1	600 lg	
Electrical Power Cable Assy CX-3265/U	1	600 lg	
Electrical Power Cable Assy CX-3266/U	5	600 lg	
Electrical Power Cable Assy CX-3689/FPN-28	5		
Electrical Power Cable Assy CX-3690/FPN-28	2		
Electrical Power Cable Assy CX-3691/FPN-28	4		
Electrical Equipment Cabinet CY-1546/FPN-28	1		
Electrical Equipment Cabinet CY-1547/FPN-28	1	22.90 x 27.44 x 73.62	
Electrical Equipment Cabinet CY-1548/FPN-28	1		
Electrical Equipment Cabinet CY-1549/FPN-28	1		

**AN/FPN-28: 4**

ITEM NAME: RADAR SET

TYPE: AN/FPN-28, AN/FPN-28A

PRINCIPAL COMPONENTS AND PHYSICAL DATA

COMPONENTS	QTY	OVERALL DIMENSIONS (Inches)	UNIT WT. (Pounds)
Electrical Equipment Cabinet CY-1550/FPN-28	1	17 x 52.23 x 52.93	
Electrical Equipment Cabinet CY-1551/FPN-28	1	26.88 x 77 x 85.12	
Electrical Equipment Cabinet CY-1552/FPN-28	1	25 x 27.10 x 90.50	
Electrical Equipment Cabinet CY-1553/FPN-28	1	25.18 x 27.25 x 89.12	
Electrical Equipment Cabinet CY-1554/FPN-28	1		
Electrical Equipment Cabinet CY-1555/FPN-28	4	19.10 x 19.10 x 52.02	
Battery Box CY-1556/FPN-28	1		
Electrical Equipment Cabinet CY-1654/FPN-28	1		
Electrical Equipment Cabinet CY-1655/FPN-28	1		
Electrical Equipment Cabinet CY-1707/FPN-28	1	25.12 x 27.84 x 89.09	
Power Supply Case CY-1703/FPN-28	1		
Electrical Equipment Cabinet CY-1883/FPN-28	1		
Dummy Load, Electrical DA-96/U	1		
Dummy Load, Electrical DA-97/U	1		
Filter, Bandpass F-250/FPN-28	2		
Filter, Bandpass F-251/FPN-28	2		
Tuned Cavity FR-89/FPN-28	2		
Tuned Cavity FR-90/FPN-28	1		
Tuned Cavity FR-107/FPN-28	1		
Electrical Space Heater HD-211/FPN-28	1		
Annunciator ID-513/FPN-28	1		
Azimuth and Range Indicator IP-309/FPN-28	4		
Azimuth and Elevation Indicator IP-310/FPN-28	4		
Interconnecting Box J-745/FPN-28	1		
Interconnecting Box J-746/FPN-28	1		
Distribution Box J-747/FPN-28	1		

AN/FPN-28: 5

**ITEM NAME:** RADAR SET

**TYPE:** AN/FPN-28, AN/FPN-28A

**PRINCIPAL COMPONENTS AND PHYSICAL DATA**

<b>COMPONENTS</b>	<b>QTY</b>	<b>OVERALL DIMENSIONS (Inches)</b>	<b>UNIT WT. (Pounds)</b>
Distribution Box J-748/FPN-28	1	3.96 x 20.76 x 23.19	
Lifting Jack MX-1121/M	2		
Lifting Jack MX-1122/M	2		
Electrical Connector Assy MX-1894/FPN-28	1		
Oscillator, Radio Frequency O-328/FPN-28	2		
Oscilloscope Group OA-741/FPN-28	1		
Comparator-Indicator Group OA-807/FPN-28	1		
Amplifier-Power Supply Group OA-823/FPN-28	1		
Amplifier-Power Supply Group OA-824/FPN-28	1		
Amplifier-Power Supply Group OA-825/FPN-28	1		
Amplifier-Power Supply Group OA-826/FPN-28	1		
Receiver-Transmitter Group OA-828/FPN-28	1		
Radar Receiver-Transmitter Group OA-829/FPN-28	1		
**Electrical Power Switching Group OA-933/FPN-28A	1		
Communications Central OA-1070/FPN-28	1		
Oscilloscope OS-18A/MPN-5	3	9.89 x 18.41 x 22.89	
Gearcase Motor PD-33A/MPN-5	1		
Gearcase Motor PD-34/MPN-5	1		
Power Supply PP-568/MPN-5	2	9.51 x 20.76 x 26.72	
Power Supply PP-569A/MPN-5	2	25.5 x 26.75 x 36	
Power Supply PP-579/MPN-5	4	10 x 16.5 x 26.25	
Power Supply PP-646/MPN-5	3	9.89 x 15.23 x 24.38	
Power Supply PP-896/MPN-5	4	9-7/8 x 14 x 25-3/4	
Power Supply PP-897A/MPN-5	4	9.88 x 17.85 x 25.88	
Power Supply PP-898/MPN-5	2	22.88 x 24.68 x 27.12	
Power Supply PP-1229/FPN-28	2	8.74 x 9.44 x 22.00	
Power Supply PP-1230/FPN-28	6	9.88 x 24.78 x 26.72	
Power Supply Assy PP-1264/FPN-28	1		

**AN/FPN-28: 6**

ITEM NAME: RADAR SET

TYPE: AN/FPN-28, AN/FPN-28A

PRINCIPAL COMPONENTS AND PHYSICAL DATA

COMPONENTS	QTY	OVERALL DIMENSIONS (Inches)	UNIT WT. (Pounds)
Power Supply Assy PP-1265/FPN-28	1		
Power Supply Assy PP-1269/FPN-28	1		
Power Supply Assy PP-1270/FPN-28	1		
Power Supply PP-1459/FPN-28	1	15.06 x 15/31 x 26.14	
Radar Receiver R-364A/MPN-5	3		
Radar Receiver-Signal Comparator R-402A/MPN-5	2		
Relay Unit RE-87/U	2		
Targets RR-34/U	22		
Waveguide Switch SA-373/FPN-28	1		
Waveguide Switch SA-374/FPN-28	2		
**Power Switchboard SB-443/FPN-28A	3		
**Power Switchboard SB-444/FPN-28A	1		
**Power Switchboard SB-445/FPN-28A	1		
**Power Switchboard SB-446/FPN-28A	1		
Intercommunication Panel SB-630/FPN-28	1		
Pulse Generator SG-75/MPN-5	2	7.53 x 11.68 x 12.96	
Radar Transmitter T-261A/MPN-5	3	17-1/16 x 24-3/8 x 33-7/8	
Radar Transmitter T-561/FPN-28	2	25.56 x 26.87 x 33.62	
Electro-Mechanical Rotary Actuator TG-24/MPN-5	2		
Waveguide Tuner TN-234/FPN-28	2		
Echo Box TS-488/UP	1		
Relay Test Set TS-887/FPN-28	1		
Converter Alignment Set TS-915/FPN-28	1		
Electrical Connector Assy U-159/FPN-28	1		
Trailer V-III/FPN-28	1		
*Voltage Regulator CN-133/MPN-5	1		
*Voltage Regulator CN-257/U	2		
*Electrical Power Switching Group OA-827/FPN-28	1		
*Power Switchboard SB-425/FPN-28	1		
*Power Switchboard SB-426/FPN-28	1		

AN/FPN-23: 7

**ITEM NAME:** RADAR SET

**TYPE:** AN/FPN-28, AN/FPN-28A

**PRINCIPAL COMPONENTS AND PHYSICAL DATA**

<b>COMPONENTS</b>	<b>QTY</b>	<b>OVERALL DIMENSIONS (Inches)</b>	<b>UNIT WT. (Pounds)</b>
*Power Switchboard SB-427/FPN-28		1	
Webster Teletalk		5	
Receiver-Transmitter RT-178/ARC-27		1	
Radio Transmitter-Receiver RT-18/ARC-1		1	
Transmitter T-47/ART-13		1	
Receiver R-105/ARR-15		1	
Dynamotor DY-17/ART-13		1	

**NOTE:**            \*AN/FPN-28 only  
                     \*\*AN/FPN-28A only

**REFERENCE DATA AND LITERATURE**

Technical Manuals:  
NAVHIPS 92633(A)

**AN/FPN-28: 8**

DATE: 1 July 1964

ITEM NAME: RADAR SET

COGNIZANT SERVICE: USN

TYPE: AN/FPN-29(XN-1)

FEDERAL STOCK NUMBER:

	USA	USN	USAF	USMC
STATUS OR TYPE CLASSIFICATION Used By		Used By		
Mfg(s) Name or Code Number: Raytheon Manufacturing Company (49956)				

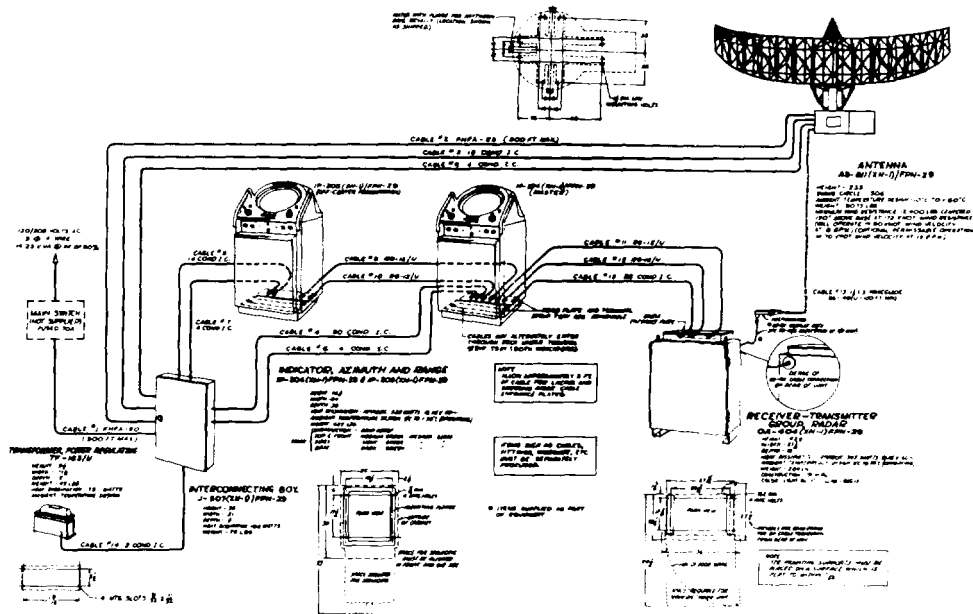

**FUNCTIONAL DESCRIPTION**

The Radar Set AN/FPN-29(XN-1) is so designed that the Master Indicator IP-204 (XN-1)/FPN-29 and the Off-Center Indicator IP-205(XN-1)/FPN-29 can be conveniently arranged in the operating room with

Cabinet CY-1211(XN-1)/FPN-29 (Receiver-Transmitter) operated remotely by the controls of the Master Indicator. R-F connection between the cabinet and the antenna is made by the use of waveguide.

**AN/FPN-29(XN-1): 1**

**ITEM NAME:** RADAR SET

**TYPE:** AN/FPN-29(XN-1)

**RELATION TO SIMILAR EQUIPMENT**

None.

20 mi  
Range Accuracy: Within 50 yds or 1% of range mark position (fixed & movable), whichever is greater.  
Range Resolution: Plus or minus 50 yds  
Bearing Resolution: 0.35 deg  
Ambient Temperature: 0 deg C to plus 50 deg C (plus 32 deg F to 122 deg F)  
Relative Humidity: Up to 95%  
Noise Factor: 12 db  
Operating Power Requirements: 220v ac, 60 cps, 3 ph, 14.25 kva

**TECHNICAL DESCRIPTION**

Type of Receiver: Superheterodyne  
Type of Presentation: PPI  
Operating Frequency: 3010 to 3120 mc  
Peak R-F Power Output: 22.5 kw max  
Pulse Repetition Rate: 800 and 1600 pps  
Pulse Duration: 0.2 and 0.6 usec plus or minus 10%.  
Minimum Range: 50 yds or less  
Range Scales  
Master Indicator: 1, 2, 4, 8, 20, 40 mi  
Off-Center Indicator: 1, 2, 4, 8, 10,

**INSTALLATION CONSIDERATIONS**

Not available.

**PRINCIPAL COMPONENTS AND PHYSICAL DATA**

<b>COMPONENTS</b>	<b>QTY</b>	<b>OVERALL DIMENSIONS (Inches)</b>	<b>UNIT WT. (Pounds)</b>
Antenna AS-611(XN-i)/FPN-29	1	234 h x 504 dia	9075
Receiver-Transmitter Group Radar OA-404(XN-1)/FPN-29 consists of:	2		
Cabinet CY-1211(XN-1)/FPN-29	1	23-1/2 x 30 x 40	200
Transmitter-Radar T-367(XN-1)/FPN-29	1	16 x 26 x 31	
Receiver, Radar R-514(XN-1)/FPN-29	1	5 x 8-1/2 x 18	
Indicator, Azimuth and Range IP-205(XN-1)/FPN-29	1	24 x 30 x 46-1/2	
Indicator, Azimuth and Range IP-204(XN-1)/FPN-29	1	24 x 30 x 46-1/2	
Interconnecting Box J-507(XN-1)/FPN-29	1	6 x 30 x 36	
Transformer, Power Regulating TF-163/U	1	5 x 9-1/8 x 12-3/8	

**REFERENCE DATA AND LITERATURE**

Technical Manuals:  
NAVSHIPS 91675

**AN/FPN-29(XN-1): 2**



DATE: 15 September 1964

ITEM NAME: RADAR SET

COGNIZANT SERVICE: USAF

TYPE: AN/FPN-47

FEDERAL STOCK NUMBER: No Stock Number Assigned

	USA	USN	USAF	USMC
STATUS OR TYPE CLASSIFICATION			STD	
Mfg(s) Name or Code Number: Texas Instruments Incorporated				

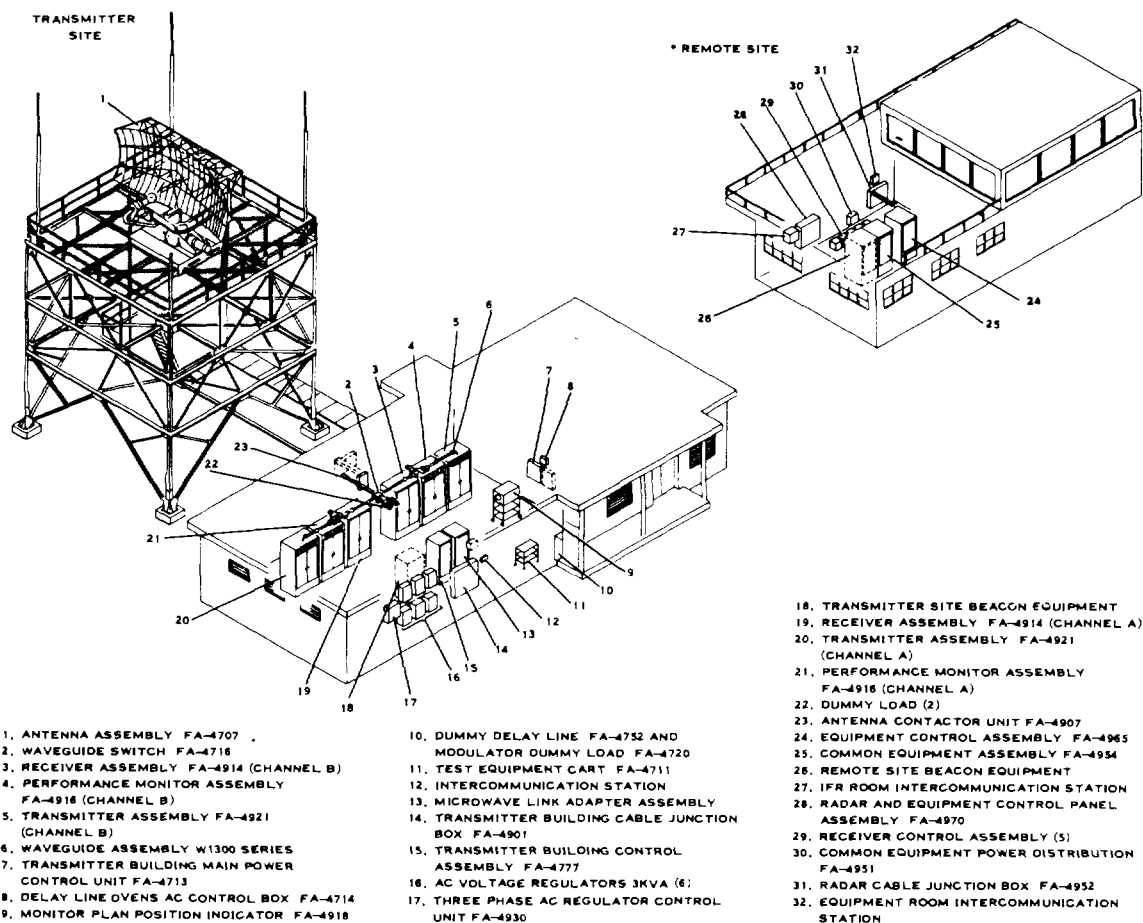

1. ANTENNA ASSEMBLY FA-4707
2. WAVEGUIDE SWITCH FA-4716
3. RECEIVER ASSEMBLY FA-4914 (CHANNEL B)
4. PERFORMANCE MONITOR ASSEMBLY FA-4916 (CHANNEL B)
5. TRANSMITTER ASSEMBLY FA-4921 (CHANNEL B)
6. WAVEGUIDE ASSEMBLY W1300 SERIES
7. TRANSMITTER BUILDING MAIN POWER CONTROL UNIT FA-4713
8. DELAY LINE OVENS AC CONTROL BOX FA-4714
9. MONITOR PLAN POSITION INDICATOR FA-4918

10. DUMMY DELAY LINE FA-4752 AND MODULATOR DUMMY LOAD FA-4720
11. TEST EQUIPMENT CART FA-4711
12. INTERCOMMUNICATION STATION
13. MICROWAVE LINK ADAPTER ASSEMBLY
14. TRANSMITTER BUILDING CABLE JUNCTION BOX FA-4901
15. TRANSMITTER BUILDING CONTROL ASSEMBLY FA-4777
16. AC VOLTAGE REGULATORS 3KVA (6)
17. THREE PHASE AC REGULATOR CONTROL UNIT FA-4930

18. TRANSMITTER SITE BEACON EQUIPMENT
19. RECEIVER ASSEMBLY FA-4914 (CHANNEL A)
20. TRANSMITTER ASSEMBLY FA-4921 (CHANNEL A)
21. PERFORMANCE MONITOR ASSEMBLY FA-4916 (CHANNEL A)
22. DUMMY LOAD (2)
23. ANTENNA CONTACTOR UNIT FA-4907
24. EQUIPMENT CONTROL ASSEMBLY FA-4965
25. COMMON EQUIPMENT ASSEMBLY FA-4954
26. REMOTE SITE BEACON EQUIPMENT
27. IFR ROOM INTERCOMMUNICATION STATION
28. RADAR AND EQUIPMENT CONTROL PANEL ASSEMBLY FA-4970
29. RECEIVER CONTROL ASSEMBLY (5)
30. COMMON EQUIPMENT POWER DISTRIBUTION FA-4951
31. RADAR CABLE JUNCTION BOX FA-4952
32. EQUIPMENT ROOM INTERCOMMUNICATION STATION

\* NOTE: SHOWS ONLY EQUIPMENT SUPPLIED DOES NOT REPRESENT ACTUAL LAYOUT

## FUNCTIONAL DESCRIPTION

Radar Set AN/FPN-47 and Airport Surveillance Radar Model ASR-5 are installed at USAF bases as a part of 431-L Air Traffic Control Systems. The transmitter site equipment of both radar sets is identical;

however, the radar sets are used with different indicator groups. AN/FPN-47 is used with Indicator Group OA-4754/FPN-47 and ASR-5 is used with Indicator Groups of Radar Set AN/CPN-18B. The radar sets detect aircraft within 60 nautical miles of their ground-based location and provide radar

AN/FPN-47: 1

**ITEM NAME:** RADAR SET  
**TYPE:** AN/FPN-47

video containing range and azimuth information to the Indicator Groups. Provisions are also included for processing and remoting beacon video from GFE equipment. The equipment is designed for continuous operation and, except for the antenna, is dual channeled.

**RELATION TO SIMILAR EQUIPMENT**

None.

**TECHNICAL DESCRIPTION**

Duty: continuous, unattended

Primary Power Requirements: power factor

0.7, three ph (4-wire), 60 cps, 120v line to neutral, 208v line to line, 50 amps per ph, 10.27 kw

Range: 60 naut mi

Antenna Pattern: fan-shaped beam from minus 3 to plus 30 deg in elevation and 1-1/2 deg in azimuth

Rate of Scanning: 15 rpm

Frequency Range: 2700 to 2900 mc, continuously var.

Frequency Control: automatic freq control

of stable local oscillator (stalo)

Nominal Power Output:

400 w avg power at prf of 1200 pps

390 w avg power at prf of 1170 pps

380 w avg power at prf of 1140 pps

Peak Power Output: 425 kw at duty factor of 0.001

Pulse Repetition Frequency: 1200 pps, 1170 pps, 1140 pps, or 900 pps with respective pulse periods of 833, 855, 877, or 1111 usec

Modulation (input to magnetron): 25 kv pulse, 0.833 usec wide at 70 pct amplitude point.

Receiver Characteristics: type, superhetrodyne, intermediate freq, 30 mc, noise figure, max 4 db relative to theoretical source, bandwidth, normal if. 2.1 to 2.7 mc, normal video 2mc MTI if. 4 to 5 mc, MTI video 2 mc, sensitivity (below 1 mw), norm min of 109 db, MTI min of 107 db.

Antenna Electrical Characteristics:

VSWR1.4 to 1 at net avg power.

Power Handling 1250 kw peak at 0.002 duty cycle.

Power Gain min of 34 db over isotropic source.

**PRINCIPAL COMPONENTS AND PHYSICAL DATA**

COMPONENT	QTY	HEIGHT (Inches)	WIDTH (Inches)	DEPTH (Inches)	UNIT WT. (Pounds)
Antenna Assembly FA-4707	1				2700
Transmitter Assembly FA-4921	2				990
Performance Monitor FA-4916	2				760
Receiver Assembly FA-4914	2				520
Transmitter Building Control Assembly FA-4777	1				260
Equipment Control Assembly FA-4965	1				320
Common Equipment Assembly FA-4954	1				330
Microwave Link Adapter Assembly	1				250
Waveguide Switch FA-4716	1				
Waveguide Assembly W1300 Series	1				
Transmitter Building Main Power Control Unit FA-4713	1				
Delay Line Ovens AC Control Box FA-4714	1				
Monitor Plan Position Indicator FA-4918	1				
Dummy Delay Line FA-4752	1				
Modulator Dummy Load FA-4720	1				
Microwave Link Adapter Assembly	1				
Transmitter Building Cable Junction Box FA-4901	1				
Transmitter Building Control Assembly FA-4777	1				
AC Voltage Regulators 3 kva	6				
Three Phase AC Regulator Control Unit FA-4930	1				

ITEM NAME: RADAR SET

TYPE: AN/FPN-47

**PRINCIPAL COMPONENTS AND PHYSICAL DATA**

<b>COMPONENT</b>	<b>QTY</b>	<b>HEIGHT (Inches)</b>	<b>WIDTH (Inches)</b>	<b>DEPTH (Inches)</b>	<b>UNIT WT.</b>
Transmitter Site Beacon Equipment	1				
Dummy Load	2				
Antenna Contractor Unit FA-4907	1				
Remote Site Beacon Equipment	1				
IFR Room Intercommunication Station	1				
Radar and Equipment Control Panel Assembly FA-4970	1				
Receiver Control Assembly	5				
Common Equipment Power Distribution FA-4951	1				
Radar Cable Junction Box FA-4952	1				
Equipment Room Intercommunication Station	1				

**REFERENCE DATA AND LITERATURE**

TECHNICAL ORDERS:  
31P5-2FPN47-2 Series

**AN/FPN-47: 3**

**DATE:** 15 January 1964

**ITEM NAME:** MISSILE RANGE INSTRUMENTATION  
SET

**COGNIZANT SERVICE:** USAF

**TYPE:** AN/FPQ-6

**FEDERAL STOCK NUMBER:**

	USA	USN	USAF	USMC
STATUS OR TYPE CLASSIFICATION Tent. Std				
Mfgs) Name or Code Number: Radio Corporation of America, Moorestown, New Jersey				

**No Illustration Available.**

**FUNCTIONAL DESCRIPTION**

The Missile Range Instrumentation Set is a fixed station long-range precision tracking set to be used for tracking intercontinental ballistic missiles for range safety and range user's trajectory

measurement data. It will also be used for tracking during staging and parking orbit (trilateration) of a synchronous satellite, The operational objective is to provide a fixed station radar capable of skin tracking a square meter target to ranges in excess of 300 nautical miles

**AN/FPQ-6: 1**

**ITEM NAME:** MISSILE RANGE INSTRUMENTATION SET

**TYPE:** AN/FPQ-6

with a precision of 0.1 mile in angle and 1.5 to 3 yds in the range coordinate, and capable of tracking transponder equipped target ranges up to 30,000 nautical miles, depending on the characteristics of the vehicle beacon and antenna system. This is approximately seven times the tracking performance capability of currently available missile range C-band instrumentation radar sets. The fixed station system will generally be operated on a Chain Radar Range supplied with Communication capabilities, real time data transmission, and reception of remote target designation data for initial acquisition.

The AMR Advanced Instrumentation Radar, AN/FPQ-6, will be used to provide precise space position data on ballistic missiles and space vehicles.

**RELATION TO SIMILAR EQUIPMENT**

The AN/FPQ-6 is similar to AN/TPQ-18 and AN/SPQ-7. The AN/FPQ-6 is a modified AN/FPS-16.

**TECHNICAL DESCRIPTION**

Power Requirements:  
208 or 120v ac, 60 cps, 3 ph, 4-wire,  
225 kva  
Frequency data:  
Transmitter; 5400 - 5900 mc  
Receiver; 5400 - 5900 mc

**INSTALLATION CONSIDERATIONS**

Siting: Fixed Installation.

**PRINCIPAL COMPONENTS AND PHYSICAL DATA**

COMPONENT	QTY	HEIGHT (Inches)	WIDTH (Inches)	DEPTH (Inches)	UNIT WT.
AN/FPS-16 (less standard range group, standard antenna group, standard transmitter, standard boresight tower, and standard antenna pedestal).	1				
5000 N. M. Digital Range Group					
30 foot Parabolic Hydraulic Driven Antenna Group					
Low Noise Receiver Group					
High Power Tuneable Transmitter					
Acquisition and Control Console Group					
Boresight Tower (150 feet) and Equipment Group					
Real Time Digital Data Corrector Group					

**REFERENCE DATA AND LITERATURE**

Nomenclature Card and AF Form 01 for AN/FPQ-6.

DATE: 1 April 1964

ITEM NAME: RADAR SET

COGNIZANT SERVICE: USAF

TYPE: AN/FPS-3,-3A \*

5840-248-9160

FEDERAL STOCK NUMBER: 5840-505-0996 \*

	USA	USN	USAF	USMC
STATUS OR TYPE CLASSIFICATION			*Std LS	
Mfg(s) Name or Code Number: Bendix Radio Division of Bendix Aviation Corporation				

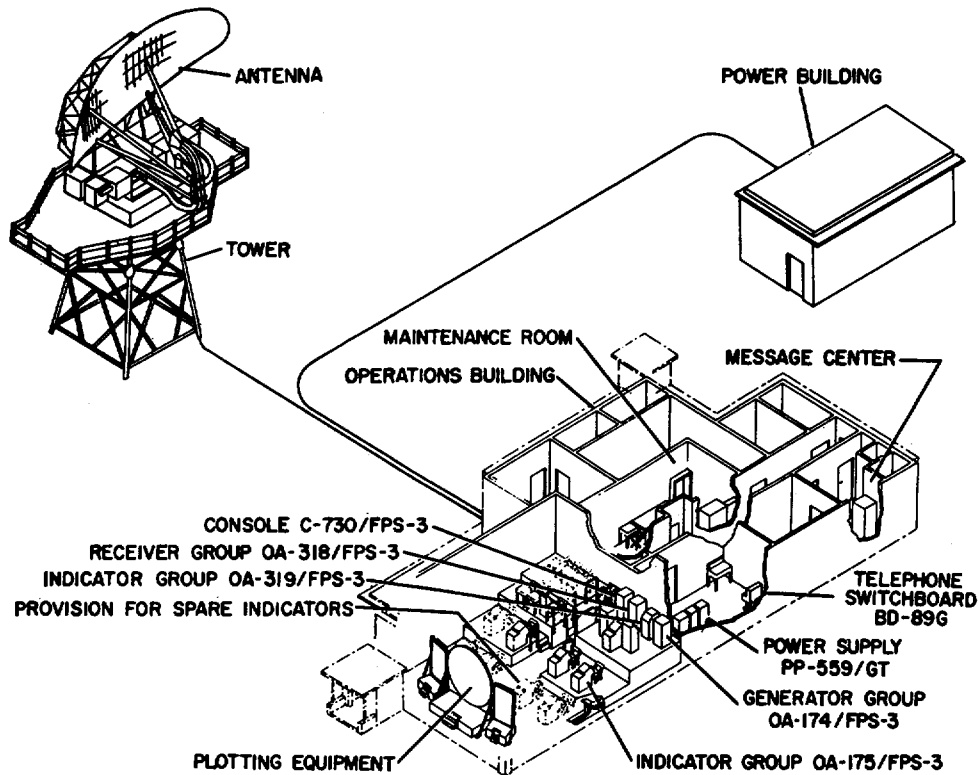

**FUNCTIONAL DESCRIPTION**

Radar Set AN/FPS-3, -3A is a fixed-system, long range radar equipped with MTI and normally employed as part of an aircraft early warning network. The AN/FPS-3, -3A is capable of detecting heavy bomber type air

craft at a range of 300 mi and a height of approximately 40,000 ft. At shorter ranges, aircraft at altitudes up to 60,000 ft can be readily detected. The equipment may be operated in temperatures ranging from -67 deg F to plus 140 deg F with humidity up to 100 percent, and at altitudes from sea level

**ITEM NAME:** RADAR SET

**TYPE:** AN/FPS-3, -3A

to 7000 ft above. For GCI applications, the equipment is used in conjunction with a height finding radar set. Power for operation, if not from a commercial source, is obtained from two 100-kv diesel driven generators and a spare. The AN/FPS-3, -3A also supplies power to associated height-finder, beacon, identification, and video-mapping equipment, although these equipments are not part of the AN/FPS-3, -3A.

**RELATION TO SIMILAR EQUIPMENT**

Radar Set AN/MPS-7 is the mobile version of the AN/FPS-3, -3A. Radar Set AN/FPS-3A is similar to and interchangeable with AN/FPS-3. Differs in that AN/FPS-3A uses Transmitter Group OA-398/FPS-3 and improved components.

**TECHNICAL DESCRIPTION**

Frequency: 1220 to 1365 mc  
 Power Output: 650 kw, peak (each transmitter)  
 RF Power Source: Type 5J26 tunable magnetron  
 Pulse Width: 3 or 6 usec  
 Pulse Repetition Rate: 200 or 400 pps (MTI available on 403 pps only)  
 Vertical Coverage: Up to 60,000 ft, 15 deg angular  
 Horizontal Coverage: 360 deg  
 Antenna Tilt: -0.5 to plus 6.5 deg  
 Antenna Scanning Rate: 3.3, 5, 6.6, or 10 rpm  
 Range Resolution: 0.5 mi

Azimuth Resolution: 1.3 deg  
 Range Accuracy: plus or minus 1 mi  
 Azimuth Accuracy: plus or minus 1 deg  
 Horizontal Beam Width: 1.3 deg  
 Vertical Beam Width: 0 to 3 deg lower, 3 to 15 deg upper  
 Receiver Bandwidth: 0.4 mc  
 IF. Frequency: 30 mc  
 Indicator Type and Quantity: 4 to 12 PPI's  
 Indicator Ranges: 50, 150, 325 mi  
 Range Marks: 10- and 50-mi intervals  
 Range: 325 naut mi

**INSTALLATION CONSIDERATIONS**

**Siting:** The power shelter should not be located near the antenna or operations shelter, as the noise and vibration makes operation difficult. The distance separating the antenna tower and the operations shelter is limited to the length of interconnecting cables. The antenna should be located at least 500 feet from vhf communication equipment and more if possible from uhf equipment to minimize interference.

**Mounting:** Antenna group is mounted on Temperate Tower AB-178/FPS-3 or AB196/FPS-3 or on Arctic Tower AB-199/ FPS-3. Remaining components, with the exception of the power units, are housed in the operations building.

**Related Equipments:** Video Mapping Group AN/GPA-30, Identification Set AN/GPX-7, 7A and Height-Finders AN/FPS-6, 6A, 6B or AN/IPS-10D.

**PRINCIPAL COMPONENTS AND PHYSICAL DATA**

COMPONENT	QTY	HEIGHT (Inches)	WIDTH (Inches)	DEPTH (Inches)	UNIT WT.
Antenna Reflector AT-251/FPS-3	1	480	230	156	
Pedestal AB-180/FPS-3	1	63	66	108	
Antenna Support AB-179/FPS-3	1	160	89	101	
Antenna Horn AS-488/FPS-3	1	96	60	138	
Transmitter Group OA-398/FPS-3	2	42	39	43	600
Oscilloscope OA-17/FPS-3	1				
Receiver Group OA-176/FPS-3 or OA-318/FPS-3	1	59	27	28	450
Indicator Group OA-175/FPS-3	0 to 12	44	24	45	412
Indicator Group OA-188/FPS-3 or OA-319/FPS-3	1	48	21	26	
Radar Control Group OA-179/FPS-3	1	60	23	26	

ITEM NAME: RADAR SET  
TYPE: AN/FPS-3, -3A

**PRINCIPAL COMPONENTS AND PHYSICAL DATA**

<b>COMPONENT</b>	<b>QTY</b>	<b>HEIGHT (Inches)</b>	<b>WIDTH (Inches)</b>	<b>DEPTH (Inches)</b>	<b>UNIT WT.</b>
Generator Group OA-174/FPS-3	1				
Display-Plotting Board Group OA-289A/G or OA-327/G	1	21-1/4	15-1/4	10-1/8	
Telephone Central Group AN/GTA-3	1				
Towers AB-178/FPS-3 or AB-196/FPS-3 (Temperate) or AB-199/FPS-3 or AB-199A/FPS-3A (Arctic)	1	300	264	480	14000

**REFERENCE DATA AND LITERATURE**

Technical Orders:  
31P6-2FPS3- Series  
See also 31W1-2GTA3- Series

**AN/FPS-3: 3**



DATE: 1 April 1964

ITEM NAME: RADAR SET

COGNIZANT SERVICE: USAF

TYPE: AN/FPS-4

FEDERAL STOCK NUMBER: 5840-505-1852

	USA	USN	USAF	USMC
STATUS OR TYPE CLASSIFICATION		LS		
Mfg(s) Name or Code Number: Radio Corporation of America				

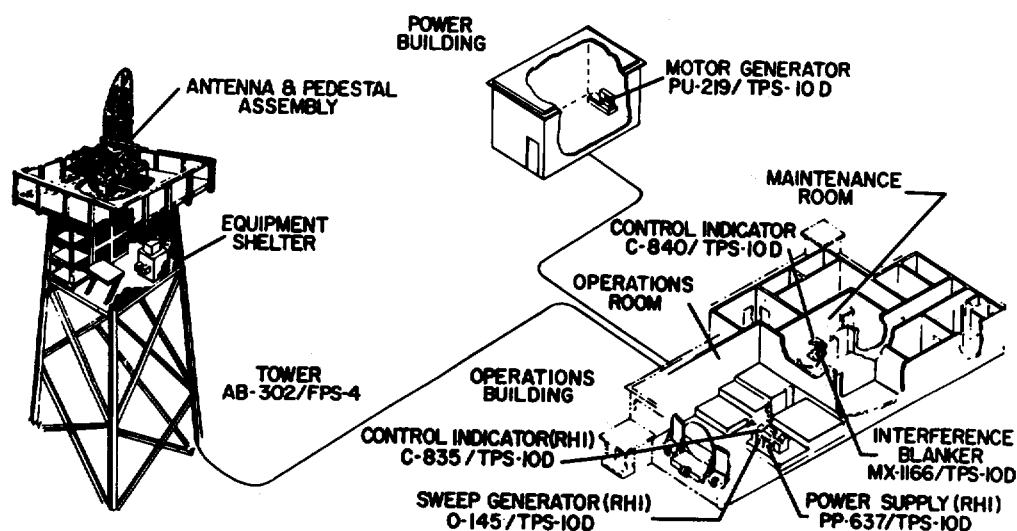

### FUNCTIONAL DESCRIPTION

Radar Set AN/FPS-4 is a fixed-station, lightweight, medium range radar designed for aircraft height finding. This radar set is especially adaptable to installation in mountainous terrain because of the

extremely narrow beam characteristics of its antenna. The set has a maximum presentable range coverage of 120 mi and a height finding capability of -5000 to plus 60,000 ft with reference to the horizontal reference line. The AN/FPS-4 has provisions for operating the antenna solely from the tower.

AN/FPS-4: 1

**ITEM NAME:** RADAR SET  
**TYPE:** AN/FPS-4

**RELATION TO SIMILAR EQUIPMENT**

Radar Set AN/MPS-8 is the mobile version, and Radar Set AN/TPS-10D is the transportable version of Radar Set AN/FPS-4. The AN/MPS-8, AN/TPS-10D and AN/FPS-4 are functionally interchangeable.

**TECHNICAL DESCRIPTION**

Frequency: 9230 to 9404 mc  
Power Output: 250 kw, peak  
RF Power Source: Type JAN-6002 magnetron  
Pulse Width: 0.5 or 2.0 usec  
Pulse Repetition Rate: 539 pps  
Range: 120 mi  
Vertical Coverage: -5000 to plus 60,000 ft, -2 to plus 23 deg angular  
Horizontal Coverage: 360 deg  
Antenna Speed of Rotation: 1/3 rpm, automatic; 0 to 6 rpm, manual  
Antenna Vertical Scanning Rate: 60 cpm, automatic; 30 cpm, manual  
Resolution: 0.7 mi in range (120-mi position) or 0.43 mi in range (60-mi position); 2.3 deg in azimuth; 0.8 deg in elevation  
System Accuracy:  
Range - 1 mi at 100 mi, absolute; 0.5 mi at 100 mi, relative  
Azimuth - 2 deg, absolute; 0.5 deg, relative  
Elevation - plus 1000 ft, absolute; plus 500 ft, relative  
Beam Width:  
Horizontal - 2.05 deg  
Vertical - 0.755 deg  
Receiver Bandwidth: 3 mc  
IF. Frequency: 30 mc  
Indicator Type and Quantity: One RHI and

provisions for an additional RHI  
Indicator Range: 60 or 120 mi  
Range Marks: 5-mi intervals (60-mi position), 10-mi intervals (120-mi position)  
Power Requirements: 120-208v ac, 60 cps, 3-ph, 4-wire, 12 kw

**INSTALLATION CONSIDERATIONS**

**Siting:** The set is capable of detecting targets at low angles. In order to make the best use of the low-angle coverage, and to eliminate blind spots caused by peaks, the radar set should be located at the highest practicable point.

**Mounting:** Antenna Group is installed in either Temperate Tower AB-302/FPS-4 or Arctic Tower AB-343/FPS-4. Indicator and control group are installed in operations building. Motor-generator is installed in power building.

**Cabling Requirements:** No specific order need be followed for connecting the assault and tower mounted radar set cables. Each cable connector has an associated marker whose numbers correspond to the number of the mating connector on the unit to which it attaches.

Be careful when installing cabling near rotating machinery. Make sure there is no danger of cables or connector caps being caught.

**Related Equipments:** The AN/FPS-8 is the AN/FPS-4's associated search radar set.

**PRINCIPAL COMPONENTS AND PHYSICAL DATA**

COMPONENT	QTY	HEIGHT (Inches)	WIDTH (Inches)	DEPTH (Inches)	UNIT WT.
Radar Receiver-Transmitter RT-208/TPS-10D	1	27-1/8	27-5/8	32-1/2	215
Power Supply PP-636/TPS-10D	1	22-1/4	23-1/2	21-3/4	85
Radar Modulator MD-140/TPS-10D	1	22	24	43-1/4	185
Power Supply PP-635/TPS-10D	1	22	23-3/4	30-3/4	210
Electronic Control Amplifier AM-493/TPS-10D	1	32-3/4	35	49-1/2	450
Manifold Dehydrator Type B-1 HD-147/TPS-10D	1	19-3/4	28	22	230
Antenna Group OA-375/TPS-10D	1	157	63-1/4 (radius)		
Antenna Pedestal AB-226/TPS-10D	1				
Control Indicator C-835/TPS-10D	1	27-1/4	22	44	200

**AN/FPS-4: 2**

ITEM NAME: RADAR SET  
TYPE: AN/FPS-4

**PRINCIPAL COMPONENTS AND PHYSICAL DATA**

<b>COMPONENT</b>	<b>QTY</b>	<b>HEIGHT (Inches)</b>	<b>WIDTH (Inches)</b>	<b>DEPTH (Inches)</b>	<b>UNIT WT.</b>
Sweep Generator 0-145/TPS-1OD	1	21	21-3/4	34	147
Power Supply PP-637/TPS-1OD	1	22	23-3/4	30-3/4	210
Antenna Control C-841/TPS-1OD	1	7-7/8	14-1/4	16	18
Control Indicator C-840/TPS-1OD	1	18-1/2	21-1/2	20-3/4	97
Motor-Generator PU-219/TPS-1OD	1	31-1/4	59-1/2	22-3/8	950

**REFERENCE DATA AND LITERATURE**

Technical Orders:  
31P3-2FPS4- Series

**AN/FPS-4: 3**

DATE: 1 April 1964

ITEM NAME: RADAR SET

COGNIZANT SERVICE: USAF

TYPE: AN/FPS-6

USA LINE ITEM NUMBER: 634398

FEDERAL STOCK NUMBER: 5840-505-0921

	USA	USN	USAF	USMC
STATUS OR TYPE CLASSIFICATION	Std-A		Ltd Std	
Mfg(s) Name or Code Number: General Electric Company				

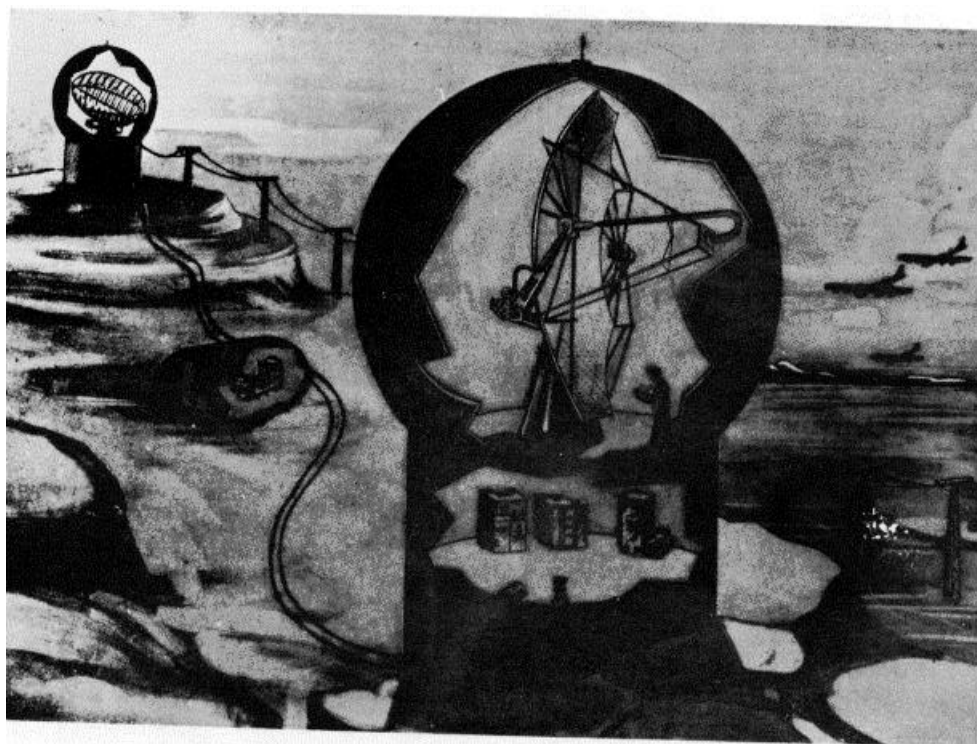

### FUNCTIONAL DESCRIPTION

Radar Set AN/FPS-6 is a long range, high power, air transportable, height finding radar that has a maximum range of 200 nautical miles and a height finding capability of 75,000 feet for targets within the elevation

angle limit of minus 2 to plus 32 degrees. The AN/FPS-6 is normally used in conjunction with a search radar of comparable range capability and derives its power from the same source that supplies the search radar. Radar Set AN/FPS-6 uses Radar Set Group OA270/FPS-6 for visual display of height

AN/FPS-6: 1

**ITEM NAME:** RADAR SET

**TYPE:** AN/FPS-6

information.

**RELATION TO SIMILAR EQUIPMENT**

AN/FPS-6 is similar to and one way interchangeable with Radar Sets AN/FPS-6A and 6B. Radar Set AN/FPS-6A differs in that Indicator Group OA-929/FPS-6A is used in place of Radar Set Group OA-270/FPS-6 which provides increased height findings, accuracy and reliability. Radar Set AN/FPS-6B differs also in that Indicator Group OA-929/FPS-6A is used along with improved components and a variable nod feature which incorporated into the antenna. AN/MPS-14 is the mobile version of AN/FPS-6.

**TECHNICAL DESCRIPTION**

- Frequency: 2700 to 2900 mc
- Power Output: 5 megw, peak
- Power Source (rf): Type QK-338 magnetron (fixed, tunable)
- Pulse Width: 2 to 3 usec
- Pulse Repetition Rate: 300 to 400 pps
- Range: 200 naut mi
- Vertical Coverage: minus 5000 to plus 60,000 ft; minus 2 to plus 32 deg angular
- Horizontal Coverage: 360 deg
- Antenna Speed of Rotation: In a 180-deg pointscan, the avg slewing rate is 7-1/2 rpm
- Antenna Vertical Scanning Rate: 20 or 30 cpm
- Range Resolution: 3/8 mi or 0.5 pct
- Azimuth Resolution: 3.2 deg
- Elevation Resolution: 0.90 deg
- Range Accuracy: plus or minus 1 pct
- Azimuth Accuracy: 0.5 deg
- Elevation Accuracy: 1000 ft
- Horizontal Beam Width: 3.2 deg
- Vertical Beam Width: 0.85 deg

- Receiver Band Width: 1 mc
- Frequency (if.): 30 mc
- Type of Presentation: Two 12-1/2 in. RHI scopes
- Indicator Ranges:
  - Azimuth: 0 to 110 mi; 90 to 200 mi;
  - 50-mi sector scan that can be started at any range between 0 and 150 mi
- Height: minus 5000 to plus 60,000 ft, minus 5000 to plus 20,000 ft, 15,000 to 35,000 ft and 35,000 to 60,000 ft
- Range Marks: 10-mi intervals, accentuated at 50-mi intervals
- Height Marks: 20,000, 40,000 and 60,000 ft
- Elevation Angle Marks: 5-deg intervals from 0 to 30 deg
- Power Requirements: 120/208v, 60 cps, 3-ph, 4-wire, 50 kva

**INSTALLATION CONSIDERATIONS**

- Siting: Tower AB-258/FPS-6 (temperate) requires a level area of 30 feet in diameter. Tower AB-259/FPS--6 (arctic) requires a level area of 70 feet in diameter.
- Mounting: Antenna Group is installed in either Temperate Tower AB-258/FPS-6 or Arctic Tower AB-259/FPS-6. Indicator Group is installed in the operations building which contains the associated search radar.
- Interference Considerations: Absolute minimum of 100 feet distance must be maintained between the AN/FPS-6 and associated radar or other high power radiating equipment.
- Related Equipments: Radar Set AN/FPS-6 can be used with AN/FPS-3, 3A, AN/FPS- 20, 20A, AN/FST-2

**PRINCIPAL COMPONENTS AND PHYSICAL DATA**

COMPONENT	QTY	HEIGHT (Inches)	WIDTH (Inches)	DEPTH (Inches)	UNIT WT.
Motor-Generator PU-293 or 293A/U	1	18	16	44-5/8	
Antenna Equipment	1				
Antenna Control C-1050/FPS-6	4	18	7-1/2	13	50
Antenna Control C-1048/FPS-6	1	7	6	9-1/2	25
Radar Set Group OA-320/FPS-6	1	48	24	42	1200
Heat Exchanger HD-188/FPS-6	1	21-3/8	34-1/4	30-1/2	300
Terminal Box J-470/FPS-6 (crated)	1	7-1/4	22-1/2	57	130 (crated)

**AN/FPS-6: 2**

ITEM NAME: RADAR SET  
TYPE: AN/FPS-6

**PRINCIPAL COMPONENTS AND PHYSICAL DATA**

<b>COMPONENT</b>	<b>QTY</b>	<b>HEIGHT (Inches)</b>	<b>WIDTH (Inches)</b>	<b>DEPTH (Inches)</b>	<b>UNIT WT.</b>
Transmitter T-338/FPS-6	1	31	31	37	800
Modulator Group OA-329/FPS-6	1	60	40	34	1200
Power Supply PP-783/FPS-6 (crated)	1	27-1/2	48	61	1155 (crated)
Voltage Regulator CN-93/CPS-6B (crated)	1	45-1/2	21-1/2	22-1/2	425 (crated)
Dehydrator HD-187/FPS-6	1	26	26	34	300
Radar Set Group OA-270/FPS-6	2	42	32	25	700
Indicator Height ID-331/FPS-6	4	11	14-1/2	6	35
Radar Set Group OA-357/FPS-6	1	48	22	44	750
Antenna Control C-1049/FPS-6	1	8	7	11-1/2	25
Radome-Tower Group AN/GPA-89	1				

**REFERENCE DATA AND LITERATURE**

Technical Orders:  
31P3-2-FPS-6 Series  
See also 31p6-2-CPS-6 Series

**AN/FPS-6: 3**

DATE: 1 April 1964  
COGNIZANT SERVICE: USAF

ITEM NAME: RADAR SET  
TYPE: AN/FPS-6A

FEDERAL STOCK NUMBER: 5840-561-9160

	USA	USN	USAF	USMC
STATUS OR TYPE CLASSIFICATION			LS	
Mfg(s) Name or Code Number: General Electric Company, Syracuse, New York				

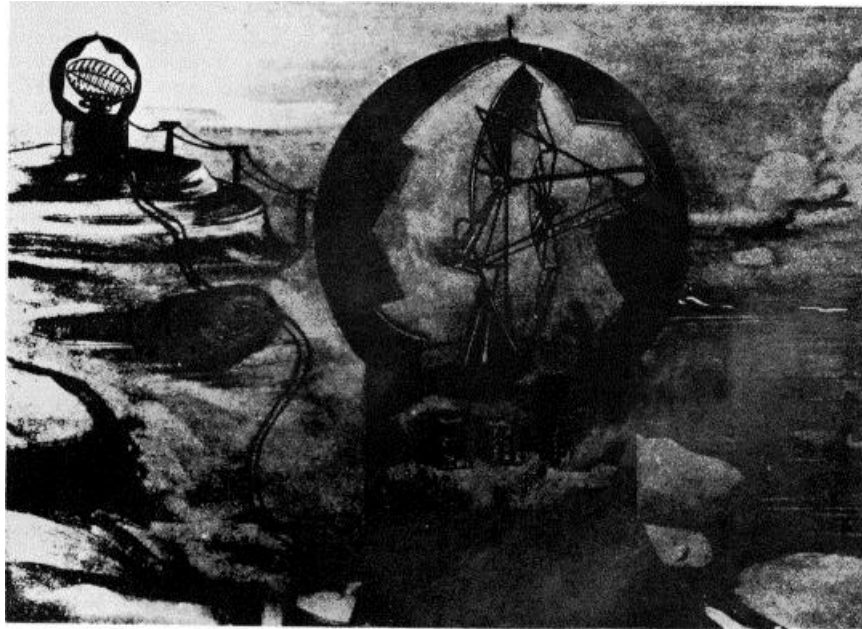

**FUNCTIONAL DESCRIPTION**

Radar Set AN/FPS-6A is an air transportable, high power, long range, height finding radar that has a maximum slant range of 300 nautical miles and a height finding / capability of up to 100,000 feet for targets

within the elevation limit of minus 2 and plus 32 degrees. The AN/FPS-6A is normally used in conjunction with a Search Radar of comparable range capability and derives its power from the same source that supplies the Search Radar. Radar Set AN/FPS-6A uses Indicator Group OA-929/FPS-6A for visual

**AN/FPS-6A: 1**

**ITEM NAME:** RADAR SET  
**TYPE:** AN/FPS-6A

height information.

**RELATION TO SIMILAR EQUIPMENT**

AN/FPS-6A is similar to and one way interchangeable with AN/FPS-6. Differs in that Indicator Group OA-929/FPS-6A is used in place of Radar Set Group OA-270/FPS-6 which provides increased height findings, accuracy and reliability. AN/FPS-6B is similar to and one way interchangeable with AN/FPS-6, 6A; differs in that improved components are used and variable antenna nod features are incorporated. AN/MPS-14 is similar to AN/FPS-6A; differs in that AN/MPS-14 is a mobile version.

Vertical Beamwidth: 0.85 deg  
Frequency (if.): 30 mc  
Type of Presentation: RHI scopes  
Indicator Ranges:  
Azimuth: 0 to 100 mi; 0 to 200 mi  
Height: 5000 to 75,000 ft - 5000 to 25,000 ft - 20,000 to 50,000 ft - 45,000 to 75,000 ft  
Range Marks: 10, 20, 50 mi  
Height Marks: 10,000 ft intervals  
Elevation Angle Marks: 5 deg intervals  
Power Requirements: 120/208, 3 ph, 60 cycle, 4-wire, 50 kva

**TECHNICAL DESCRIPTION**

Receiver Frequency: 2730 to 2930 mc  
Transceiver Frequency: 2700 to 2900 mc  
Power Output: 5 megw, peak  
Power Source (rf): Type QK338A magnetron  
Pulse Width: 2 to 3 usec  
Pulse Repetition Rate: 300 to 400 pps  
Range: 300 naut mi  
Vertical Coverage: minus 2 to plus 32 deg angular  
Horizontal Coverage: 360 deg  
Antenna Vertical Scanning Range: 20 or 30 cpm  
Range Resolution: plus or minus V pct  
Azimuth Resolution: 3.2 deg  
Elevation Resolution: 0.90 deg  
Range Accuracy: plus or minus 1 pct  
Elevation Accuracy: 1000 ft  
Horizontal Beam Width: 3.2 deg

**INSTALLATION CONSIDERATIONS**

Siting: Tower AB-258/FPS-6 (temperate) requires a level area of 30 feet in diameter while Tower AB-259/FPS-6 (arctic) requires a level area of 70 feet in diameter.  
Mounting: Antenna Group is installed in either Temperate Tower AB-258/FPS-6 or Arctic Tower AB-259/FPS-6. Indicator Group is installed in the operations building which contains the associated search radar.  
Interference Considerations: Absolute minimum of 100 feet distance must be maintained between AN/FPS-6A on associated or other radar equipments.  
Related Equipments: Radar Set AN/FPS-6A can be used with Radars AN/FPS-3, 3A, AN/FPS-20, 20A, AN/FST-2

**PRINCIPAL COMPONENTS AND PHYSICAL DATA**

COMPONENT	QTY	HEIGHT (Inches)	WIDTH (Inches)	DEPTH (Inches)	UNIT WT.
Antenna Group OA-2035/FPS-6A					
Motor Generator PU-293 or 293A	1	18	16	44-5/8	
Blanker, Interference MX-1739A	1	11	15	12	49
Antenna Control C-1050/FPS-6	1	18	7-1/2	13	50
Control Group Assy OA-2036/FPS-6A	1	48	24	42	1200
Ferrite Isolator CU-492 or CU-492A/FPS-6A	1	14 15-1/4	24 18-3/4	24 30	90 70 (crated)
Heat Exchanger HD-188/FPS-6 (crated 2 boxes)	1	21-3/8	34-1/4	30-1/2	300
Heat Exchanger HD-289/FPS-6A	1	18-1/8	30	19	360 (crated)



ITEM NAME: RADAR SET  
TYPE: AN/FPS-6A

PRINCIPAL COMPONENTS AND PHYSICAL DATA

COMPONENT	QTY	HEIGHT (Inches)	WIDTH (Inches)	DEPTH (Inches)	UNIT WT.
Terminal Box J-470/FPS-6	1	7-1/4	22-1/2	57	130 (crated)
Transmitter T-338A/FPS-6A	1	44	41	52	1110 (crated)
Modulator Group OA-329A/FPS-6A	1	70	44	42	1535 (crated)
Power Supply PP-783/FPS-6	1	27-1/2	48	61	1155 (crated)
Voltage Regulator CN-93/CPS-6B	1	45-1/2	21-1/2	22-1/2	425 (crated)
Indicator Group OA-1385/GPA-40 (c/o 3 crated items)	1 1 1	45-1/2 27 19-3/4	33-1/2 13-1/2 14-1/2	26 14 16-1/2	320 60 65
Dehydrator HD-187/FPS-6	1	26	26	34	300
Indicator Group OA-1040/GPA (crated)	1	21	21	27-1/2	150
Indicator Group OA-929/FPS-6A (crated)	2	37	36	42-1/2	500
Indicator ID-331/FPS-6	4	11	14-1/2	6	35
Radar Set Group OA-2037/FPS-6 (crated)	1	59	34	51	1100
Control Antenna C-1830/GPS	1	45	26	33-1/2	320 (crated)
Control Antenna C-1049/FPS-6	1	8	7	11-1/2	25
Radome-Tower Group AN/GPA-89	1				

REFERENCE DATA AND LITERATURE

TECHNICAL ORDERS:  
31P3-2FPS6- Series  
See also 31P6-2CPS6- Series

AN/FPS-6A: 3

DATE: 15 April 1964

ITEM NAME: RADAR SET

COGNIZANT SERVICE: USAF

TYPE: AN/FPS-6B

FEDERAL STOCK NUMBER: 5840-679-3304

	USA	USN	USAF	USMC
STATUS OR TYPE CLASSIFICATION			Ltd Std	
Mfg(s) Name or Code Number: General Electric Company				

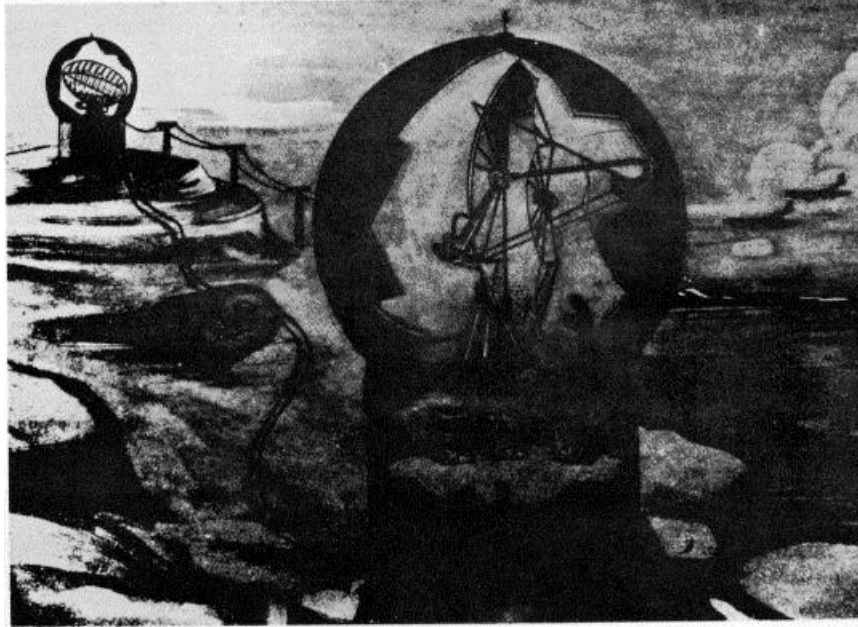

#### FUNCTIONAL DESCRIPTION

Radar Set AN/FPS-6B is an air transportable, high power, long range, fixed height finding radar that has a maximum slant range of 300 nautical miles and a height finding capability of 100,000

feet for miles, targets within the elevation limit of minus 2 degrees and plus 32 degrees. The AN/FPS-6B is normally used with a search radar of comparable range capability and derives its power from the same source that supplies the search radar.

AN/FPS-6B: 1

**ITEM NAME:** RADAR SET

**TYPE:** AN/FPS-6B

**RELATION TO SIMILAR EQUIPMENT**

AN/FPS-6B is similar to and one-way interchangeable with Radar Sets AN/FPS-6 and AN/FPS-6A. Radar Set AN/FPS-6 differs in maximum slant range and height, type of indicators used and does not have the variable nod feature of the AN/FPS-6B. AN/FPS-6B differs from the AN/FPS-6A mainly in improved components and the incorporated variable nod feature. AN/MPS-14 is similar to AN/FPS-6B, differs in the mobile version of AN/FPS-6B.

**TECHNICAL DESCRIPTION**

Frequency: 2700 to 2900 mc  
Power Output: 5 megw, peak  
Power Source, rf: Type QK-338A magnetron  
Pulse Width: 2 to 3 usec  
Pulse Repetition Rate: 300 to 400 pps  
Range: 300 naut mi  
Vertical Coverage: Minus 2 to plus 32 deg angular  
Horizontal Coverage: 360 deg  
Antenna Vertical Scanning Rate: 20 or 30 cpm  
Range Resolution: Plus or minus V pct  
Azimuth Resolution: 3.2 deg  
Elevation Resolution: 0.90 deg  
Range Accuracy: Plus or minus 1 pct  
Elevation Accuracy: 1000 ft  
Horizontal Beam Width: 3.2 deg  
Receiver Bandwidth: 0.85 deg  
Frequency, if.: 30 mc  
Type of Presentation: RHI scopes

**Indicator Ranges:**

Azimuth - 0 to 100 mi, 0 to 200 mi  
Height - 5000 to 75,000 ft  
5000 to 25,000 ft  
20,000 to 50,000 ft  
45,000 to 75,000 ft

Range Marks: 10, 20, 50 mi  
Height Marks: 10,000 ft intervals  
Elevation Angle Marks: 5 deg intervals  
Power Requirements: 120/208v, 3 ph, 60 cycle, 4-wire, 50 kva

**INSTALLATION CONSIDERATIONS**

**Siting:** Tower AB-258/FPS-6 (temperate) requires a level area of 30 feet in diameter while Tower AB-259/FPS-6 (arctic) requires a level area of 70 feet in diameter.

**Mounting:** Antenna Group is installed in either Temperate Tower AB-258/FPS-6 or Arctic Tower AB-259/FPS-6. Indicator Group is installed in the operations building which contains the associated search radar.

**Interference Considerations:** Absolute minimum of 100 feet distance must be maintained between AN/FPS-6A on associated or other radar equipments.

**Related Equipments:** Radar Set AN/FPS-6B can be used with Radar Sets AN/FPS-3, 3A, AN/FPS-20, 20A, AN/FST-2.

**PRINCIPAL COMPONENTS AND PHYSICAL DATA**

COMPONENT	QTY	HEIGHT (Inches)	WIDTH (Inches)	DEPTH (Inches)	UNIT WT.
Motor-Generator PU-293/G or PU-293A/G	1	18	16	44-5/8	
Antenna Group OA-2040/FPS-6B	1				
Blanker MX-1739A/FPS-6	1	11	15	12	49
Antenna Control C-1050/FPS-6	1	18	7-1/2	13	50
Radar Set Group OA-2036/FPS-6B	1	48	24	42	1200
Ferrite Isolator CU-492/FPS-6A or CU-492A/FPS-6A	1	14	24	24	90 (crated)
		15-1/4	18-3/4	30	70 (crated)
Heat Exchanger HD-188/FPS-6	1	21-3/8	34-1/4	30-1/2	300
Heat Exchanger HD-289/FPS-6A	1	18-1/8	30	19	360 (crated)
Terminal Box J-910/FPS-6B	1	7-1/4	22-1/2	57	130 (crated)
Transmitter T-338A/FPS-6A	1	44	41	52	1110 (crated)

**AN/FPS-6B: 2**

ITEM NAME: RADAR SET  
TYPE: AN/FPS-6B

**PRINCIPAL COMPONENTS AND PHYSICAL DATA**

<b>COMPONENT</b>	<b>QTY</b>	<b>HEIGHT (Inches)</b>	<b>WIDTH (Inches)</b>	<b>DEPTH (Inches)</b>	<b>UNIT WT.</b>
Modulator Group OA-329A/FPS-6A	1	70	44	42	1535 (crated)
Power Supply PP-783/FPS-6	1	27-1/2	48	61	1155 (crated)
Voltage Regulator CN-93/CPS-6B	1	45-1/2	21-1/2	22-1/2	425 (crated)
Indicator Group OA-1385/GPA-40 (c/o 3 crated items)	1 1	45-1/2 27	33-1/2 13-1/2	26 14	320 60
Dehydrator HD-187/FPS-6	1	19-3/4	14-1/2	16-1/2	65
Indicator Group OA-1040/GPA	1	26	26	34	300
Indicator Group OA-929/FPS-6A	2	21	21	27-1/2	150 (crated)
Indicator Height ID-331/FPS-6	4	37	36	42-1/2	500 (crated)
Antenna Control C-1830/GPS	1	11	14-1/2	6	35
Antenna Control C-1049/FPS-6	1	45	26	33-1/2	320 (crated)
Radome-Tower Group AN/GPA-89	1	8	7	11-1/2	25

**REFERENCE DATA AND LITERATURE**

TECHNICAL ORDERS:  
31P3-2FPS6- Series  
Also see 31P6-2CPS6- Series

**AN/FPS-6B: 3**

DATE: 1 April 1964  
COGNIZANT SERVICE: USAF

ITEM NAME: RADAR SET  
TYPE: AN/FPS-8

FEDERAL STOCK NUMBER: 5840-505-1848

	USA	USN	USAF	USMC
STATUS OR TYPE CLASSIFICATION			Std	
Mfg(s) Name or Code Number: General Electric Company, Syracuse, New York				

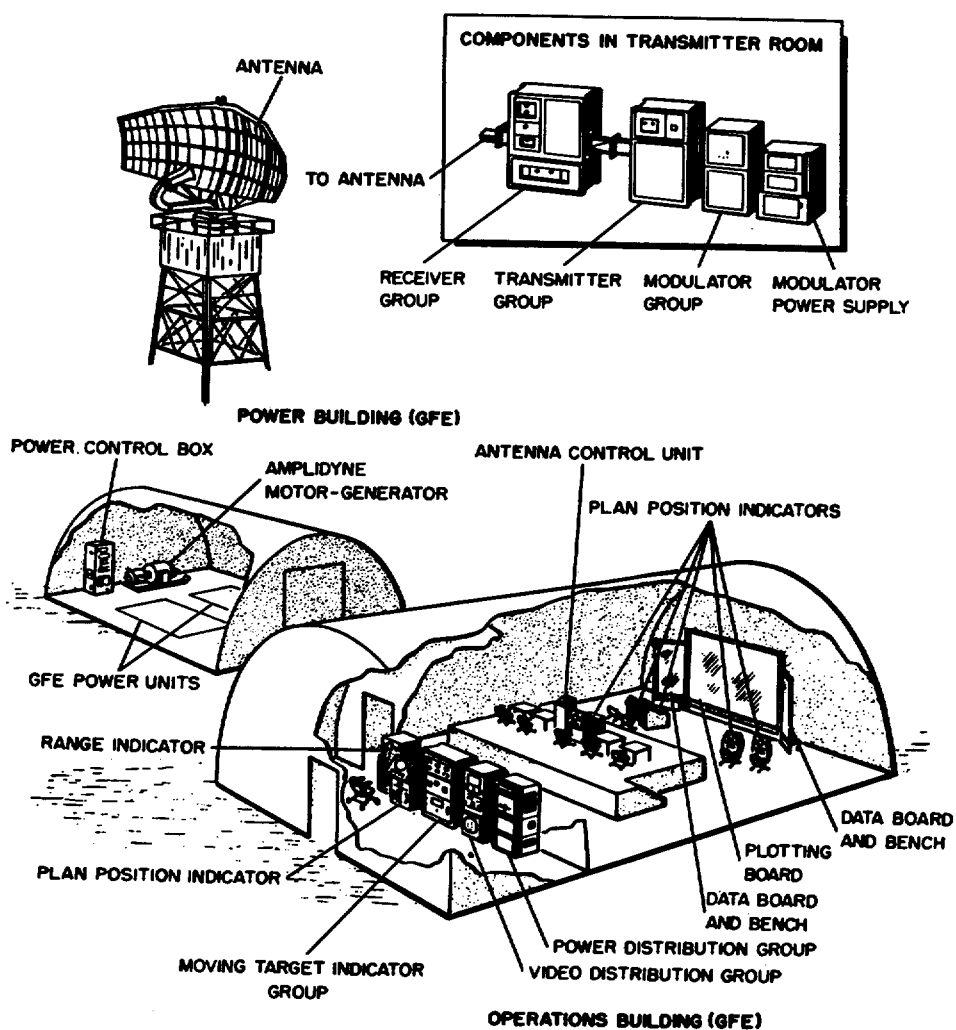

## FUNCTIONAL DESCRIPTION

Radar Set AN/FPS-8 is an air-transportable, fixed-station, long range radar used as an early warning set and featuring coherent video cancellation type moving target indication. This set is capable of detecting

aircraft at ranges up to 40,000 ft, and in any direction in azimuth. The antenna can be scanned back and forth through any sector at any degree in azimuth. In addition, Radar Set AN/FPS-8 provides: power and video connections for a video mapping unit; power, video, and antenna connections for

**ITEM NAME:** RADAR SET

**TYPE:** AN/FPS-8

identification equipment; power for telephone communications equipment; and power and trigger for a height finding radar set when the set is used in a ground controlled intercept system.

**RELATION TO SIMILAR EQUIPMENT**

Radar Set AN/MPS-11 is essentially a mobile version of Radar Set AN/FPS-8 with identical purpose, capabilities, and limitations. Differs only in mounting facilities.

**TECHNICAL DESCRIPTION**

Frequency: 1280 to 1350 mc  
 Wave Length in Free Space: 22.2 to 23.4 cm  
 Power Output: 1 megw, peak  
 RF Power Source: Type JAN-QK-358 tunable magnetron  
 Pulse Width: 3 usec  
 Pulse Repetition Rate: 360 pps  
 Duty Cycle: 0.00108  
 Range: 160 naut mi without delay, 220 naut mi with delay  
 Horizontal Coverage: 360 deg continuous, either direction  
 Antenna Speed of Rotation: 0 to 10 rpm  
 Resolution: plus or minus 1/2 deg in azimuth  
 System Accuracy:  
     Range - 0.5 mi  
     Azimuth - 0.5 deg  
 Beam Width:  
     Horizontal - 2.5 deg

Vertical - 9 deg  
 Receiver Bandwidth: 0.6 mc  
 IF. Frequency: 30 mc  
 Indicator Type and Quantity: Two to six 12-in. PPI scopes, one 5-in. "A" scope  
 Indicator Ranges: 0 to 50, 0 to 100, and 0 to 160 mi  
 Range Marks: 10-mi intervals, accentuated at 50-mi intervals  
 Angle Marks: 10-deg intervals, every third mark accentuated  
 Power Requirements: 120/208v ac, 60 cps, 3-ph, 4-wire, 20 kw

**INSTALLATION CONSIDERATIONS**

**Siting:** It is normally desirable to site tower AB-937/FPS-8 on the highest available location due to the relative importance of extending low angle coverage for optimum early warning performance.

When AN/FPS-8 is to be located in close proximity to other radar sets, a minimum of 100 feet distance must be maintained between antennas to prevent crystal burnout.

**Mounting:** Antenna Group is installed in Arctic Tower AB-313/FPS-8 or Temperate Tower AB-397/FPS-8. Indicator and control group is installed in operations building. Power group is installed in power building.

**Related Equipment:** Interrogator Set AN/GPX-18, Video Mapping Equipment.

**PRINCIPAL COMPONENTS AND PHYSICAL DATA**

COMPONENT	QTY	HEIGHT (Inches)	WIDTH (Inches)	DEPTH (Inches)	UNIT WT.
Antenna Group OA-405/FPS-8	1	200	300	72 (length)	2429
Receiver Group OA-417/FPS-8	1	50-1/2	33-1/8	27	540
Transmitter Group OA-413/FPS-8	1	57-9/16	32	24	578
Modulator Group OA-414/FPS-8	1	55-1/3	24	24-1/4	578
Power Supply Group OA-412/FPS-8	1	54	30	28	1160
Switching Group Electrical Power OA-415/FPS-8	1	61-1/2	25	32	760
Radar Set Group OA-381/FPS-8'	1	40-3/4	33-3/8	26-5/8	150
Radar Set Group OA-416/FPS-8	1	63-9/16	24	29	570
Control, Antenna C-1133/FPS-8	1	30	15	15	
Indicator, Range IP-209/FPS-8	1	21	28-11/16	15	150
Indicator Group OA-99A/CPS	2 to 6	419			

ITEM NAME: RADAR SET  
AN/FPS-8

COMPONENT	PRINCIPAL COMPONENTS AND PHYSICAL DATA				UNIT WT.
	QTY	HEIGHT (Inches)	WIDTH (Inches)	DEPTH (Inches)	
Radome-Tower Group AN/GPA-89	1				ea

**REFERENCE DATA AND LITERATURE**

Technical Orders:  
31P6-2FPS8- Series  
See also 31P6-2CPS6- Series

**AN/FPS-8: 3**

DATE: 1 April 1964  
COGNIZANT SERVICE: USAF

ITEM NAME: RADAR SET  
TYPE: AN/FPS-10

FEDERAL STOCK NUMBER: 5840-505-0994

	USA	USN	USAF	USMC
STATUS OR TYPE CLASSIFICATION			Std	
Mfg(s) Name or Code Number: General Electric Company				

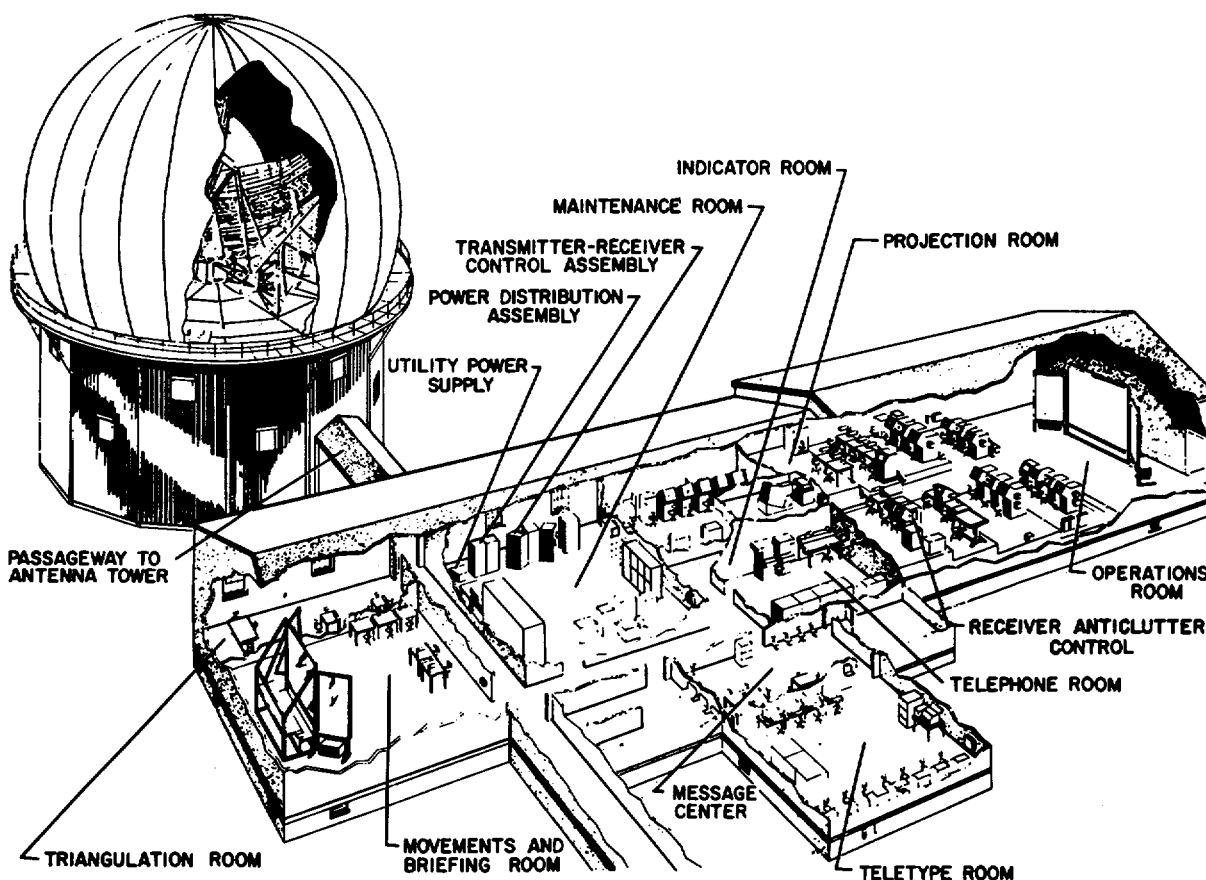

### FUNCTIONAL DESCRIPTION

Radar Set AN/FPS-10 is a fixed-station, airtransportable, high-power, long-range search and height-finding radar that is used for aircraft early warning and GCI applications. This radar set has a maximum range of 265 naut mi and a height-finding capability of 40,000 ft. Facilities are provided for use of advance filter techniques that eliminate the time lag inherent in passing plots through a filter room. The AN/FPS10 has provisions for optional use of video mapping, direction finding, and identification equipment.

Terminal facilities are also provided for voice, code or teletype, and radio-or wire communications. This radar set is equipped with moving target indication and many remote operating facilities.

### RELATION TO SIMILAR EQUIPMENT

Radar Set AN/FPS-10 is similar to Radar Set AN/CPS-6B, differing only in the number of indicators used in the absence of B-scan indicators,



**ITEM NAME:** RADAR SET

**TYPE:** AN/FPS-10

and in the telephone system. The AN/CPS-6 has more indicators, and its telephone system is supplied as part of the equipment.

**TECHNICAL DESCRIPTION**

Frequency: 2700 to 3019 mc (6 freq bands)

Power Output: 900 kw, peak (each of 5 transmitters), 2 megw, peak (EW transmitter)

Beam Width (Vertical Beam Antenna):

Horizontal - 1 deg

Vertical - 2.2 deg (lower beam), 4.2 deg, (middle beam), 21 deg, (upper beam)

Beam Width (Slant Beam Antenna):

Horizontal - 0.8 deg

Vertical - 7.7 deg (lower beam), 24 deg (upper beam)

Receiver Bandwidth: 2.0 mc

IF. Frequency: 30 mc

Indicator Type and Quantity:

PPI scopes - Seven 12-in.

RHI scopes - Two 12-in.

Indicator Ranges: 0 to 50, 0 to 100, and 0 to 200 naut mi

Range Marks: 1,0-mi intervals

Angle Marks: 10 deg and 30 deg intensified

Power Requirements: 120-208v ac, 60 cps, 3-ph, 4-wire, 100 kw

RF Power Source: Type 5586 and 5657 tunable magnetrons, and QK-254 magnetron (EW)

Pulse Width: 1 usec at 600 pps, 1 or 2 usec at 300 pps, EW Transmitter - 2 usec

Pulse Repetition Rate: 600 or 300 pps

EW Transmitter - 300 pps only

Range (B-17 or B-29 Type Target):

Height Finder - 120 naut mi

EW (V-beam) - 150 naut mi

EW (S-beam) - 240 naut mi

Vertical Coverage: 40,000 ft altitude, 0 to 24 deg angular

Horizontal Coverage: 360 deg continuous rotation

Antenna Speed of Rotation: 2 to 15 rpm (continuously variable)

Resolution:

Range - 0.17 mi, EW Channel - 0.34 mi

Azimuth - plus or minus 1.0 deg, EW Channel - 0.85 deg

Elevation - 1 deg

System Accuracy:

Range - 0.87 mi, EW Channel - 0.5 mi

Azimuth - 1 deg, EW Channel - 0.5 deg

Elevation - plus or minus 500 ft (relative; plus or minus 1000 ft (absolute):

**INSTALLATION CONSIDERATIONS**

Siting: For optimum performance use the highest available location, with ample space for erection of operations building, power building and Arctic tower.

Mounting: Antenna group is mounted in Arctic Tower AB-451/CPS-6B. Indicator and control group is installed in the operations building. Power units are housed in the power building.

Cabling Requirements: Cable ducts or troughs situated below the floor level with sectional covers are provided throughout the buildings and tower. Heavier cables should be put into the ducts first and the coaxial and high voltage pulse cables last. Cables lengths have ample slack at both ends. Short cables can be run directly from unit to unit outside the ducts.

**PRINCIPAL COMPONENTS AND PHYSICAL DATA**

COMPONENT	QTY	HEIGHT (Inches)	WIDTH (Inches)	DEPTH (Inches)	UNIT WT.
Antenna Assembly AS-451/CPS-6B (includes Arctic Tower and bldg)	1	684	720		
Radar Set Group OA-345/CPS-6B	1	60	51-1/2	31	
Receiver-Transmitter Group OA-126/CPS-6B	2	59	45	24	
Receiver-Transmitter Group OA-127/CPS-6B	2	59	45	24	
Receiver-Transmitter Group OA-128/CPS-6B	1	59	45	24	
Radar Modulator MD-98/CPS-6B	1	43	34	34	824
Radar Modulator MD-99/CPS-6B	1	43	34	34	710
Relay Assembly RE-76/CPS-6B	1	60	36	12	

**AN/FPS-10: 2**

**PRINCIPAL COMPONENTS AND PHYSICAL DATA (cont'd)**

COMPONENT	QTY	HEIGHT (Inches)	WIDTH (Inches)	DEPTH (Inches)	UNIT WT.
Motor-Generator, PU-178/CPS-6B	1	19	24	54	
Motor-Generator, PU-179/CPS-6B	1	14-3/8	13-3/8	25-5/8	
Power Supply, PP-415/CPS-6B	1	30	29	40	
Control Power Supply Group OA- 103/CPS-6B	1	72	24	24	377
Indicator Group, OA-98/CPS-6B	2	42	21	43	500
Indicator Group, OA-99/CPS-6B	7	42	21	43	
Indicator Group, OA-100/CPS-6B	1	42	21	43	362
Blanker-Indicator Group OA- 101/CPS-6B	1	72	24	24	352
Antenna Control Group OA- 110/CPS- 6B	1	42	40	30	
Calibrator Generator Group OA-96/CPS- 6B	1	72	24	24	219
Mixer-Blanker, MX-918/CPS-6B	1	72	24	24	259
Moving Target Indicator Group OA- 121/CPS- 6B	1	72	24	24	
Power Supply, PP-415/CPS-6B	1	30	29	40	
Power Control Group OA- 122/CPS-6B	1	72	24	24	291
Plotting Table, PT-105/CPS-6B 2					
Plotting Board, PT-104/CPS-6B		38	36-1/2	34	
Radome Pressure Control Unit	1				
Diesel Power Unit (GFE)					

**REFERENCE DATA AND LITERATURE**

Technical Orders:  
31P6-2CPS6- Series  
See also 31P6-2FPS8 Series

DATE: 1 April 1964  
COGNIZANT SERVICE: USAF

ITEM NAME: RADAR SET  
TYPE: AN/FPS-14

FEDERAL STOCK NUMBER: 5840-342-3089

	USA	USN	USAF	USMC
STATUS OR TYPE CLASSIFICATION			AS	
Mfg(s) Name or Code Number: Bendix Radio Division of Bendix Aviation Corp.				

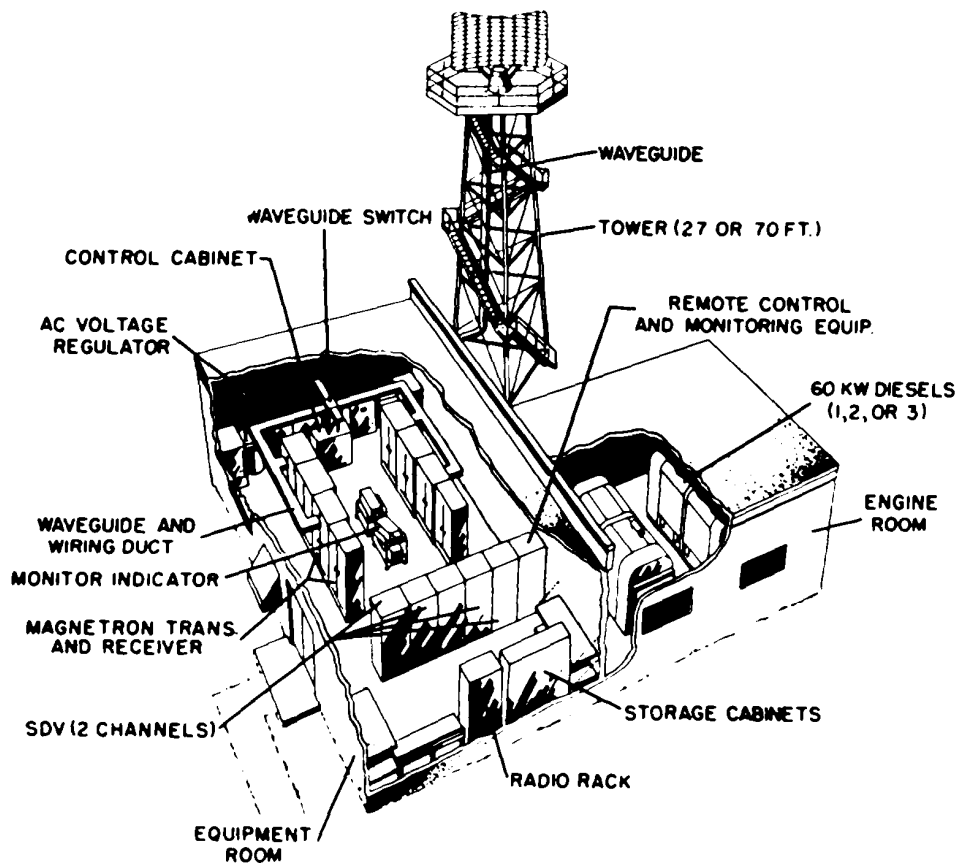

## FUNCTIONAL DESCRIPTION

Radar Set AN/FPS-14 is a fixed-station, medium power search radar used specifically for low altitude coverage (gap filler radar). It is capable of detecting type F-86 aircraft at altitudes up to 15, 000 feet, at angles of elevation up to 30 degrees, and at ranges up to 30 miles. This set is composed of two identical transmitting and receiving channels,

one of which is a standby channel that is automatically placed in operation when the normal operating channel develops a fault. Either vertical or circular polarization of the radiated energy of the AN/FPS-14 is possible, and is controlled by a switch in the control cabinet. The visual display is enhanced by moving target indication. This set also has provisions for accommodating slow scanning rate video equipment to permit the transmission of radar data to and from a remote site.

Volume 1  
 Section 1  
**ITEM NAME:** RADAR SET  
**TYPE:** AN/FPS-14

**MIL-HDBK-162A**  
 15 December 1965

**RELATION TO SIMILAR EQUIPMENT**

Similar to Radar Set AN/FPS-18. Differs in that AN/FPS-18 use a Klystron in place of a magnetron and has twice the power output.

(monitor)  
 Indicator Ranges: 10, 0, and 70 mi  
 Range Marks: 2-mi intervals on i()-ml sweep, or 10-mi intervals on ,()- or 70-mi sweep  
 Power Requirements: 120/2(K)v ac, 60 cps, 3-ph, 4-wire

**TECHNICAL DESCRIPTION**

Frequency: 2700 to 2900 mc  
 Peak Power Output: 460 kw  
 RF Power Source: Type 4J31--4J35 (fixed) magnetron or type 5586 (tunable) magnetron  
 Pulse Width: 1 usec  
 Pulse Repetition Rate: 891 to 909 pps (determined by MTI delay line)  
 Range: 70 naut mi  
 Vertical Coverage: 0.5 deg to 30 deg angular (F-i6 aircraft at any aspect)  
 Horizontal Coverage: 360 deg  
 Antenna Speed of Rotation: 5.33 rpm  
 Range Resolution: 1/9 mi  
 Azimuth Resolution: 1.4 deg  
 Range Accuracy: plus or minus 1 pct  
 Azimuth Accuracy: plus or minus 1 deg  
 Horizontal Beam Width: 1.4 plus or minus 0.1 deg  
 Vertical Beam Width: 30 deg  
 Receiver Bandwidth: 2 plus or minus 0.25 mc  
 IF. Frequency: 30 mc  
 Type of Presentation: One 12-in. PPI

**INSTALLATION CONSIDERATIONS**

Siting: Requires approximately one-half acre of land in a high, clear area with an unobstructed view of the horizon.  
 Mounting: The Antenna Group is mounted on a triangular steel tower of 28, 40, 54 or 70 ft high, depending on requirement. The remaining equipment is mounted in the Equipment and Generator building.  
 Cabling Requirements: Almost all connections between various equipments are made by prefabricated Cable harnesses. Several Cables must be fabricated from bulk supplies by the installation activity.  
 Related Equipment: Associated Search Radar AN/FPS- 20, 20A, Coordinate Data Transmitter AN/FST-1, Control Monitor Set AN/FSW-1 and Monitor, Coordinate Data OA-917/FST-1.

**PRINCIPAL COMPONENTS AND PHYSICAL DATA**

COMPONENT	QTY	HEIGHT (Inches)	WIDTH (Inches)	DEPTH (Inches)	UNIT WT.
Antenna Group OA-897/FPS-14	1				1668
Transmitter Group OA-864/FPS-14	2	84	48	31	1543
Receiver Group OA-898/FPS-14	2	84	40	27	720
Control Monitor Group OA-896/FPS-14	1	53	40	27	408
Directional Coupler CU-453/FPS-14	2	7-3/4	5-1/4	24-1/2	32
Waveguide Switch SA-436/FPS-14	1	11-3/4	13-1/4	13-1/4	53
Waveguide Tuner TN-243/FPS-14	2				
Dummy Load DA-961/FPS-28	1	5	6-1/4	21-1/2	31
Voltage Regulator CN-325/FPS-14	2	40-1/2	24-1/2	17-1/2	390
Test and Maintenance Table FN-83/FPS-14	1				
Indicator Group OA-1166/FPS-14	1	40	18-1/2	30-1/2	213

**AN/FPS-14: 2**

**MIL-HDBK- 162A**  
15 December 1965

Volume 1  
Section 1

**ITEM NAME:** RADAR SET  
**TYPE::** AN/FPS-14

**REFERENCE DATA AND LITERATURE**

Technical Orders:  
31P6-2FPS14- Series

**AN/FPS-14: 3**

DATE: 1 April 1964  
 COGNIZANT SERVICE: USAF

ITEM NAME: RADAR SET  
 TYPE:: AN/FPS-14

USA LINE ITEM NUMBER: 631396  
 FEDERAL STOCK NUMBER:

	USA	USN	USAF	USMC
STATUS OR TYPE CLASSIFICATION	Std-B	Std	Std	
Mfg(s) Name or Code Number. Radio Corporation of America, Camden, New Jersey				

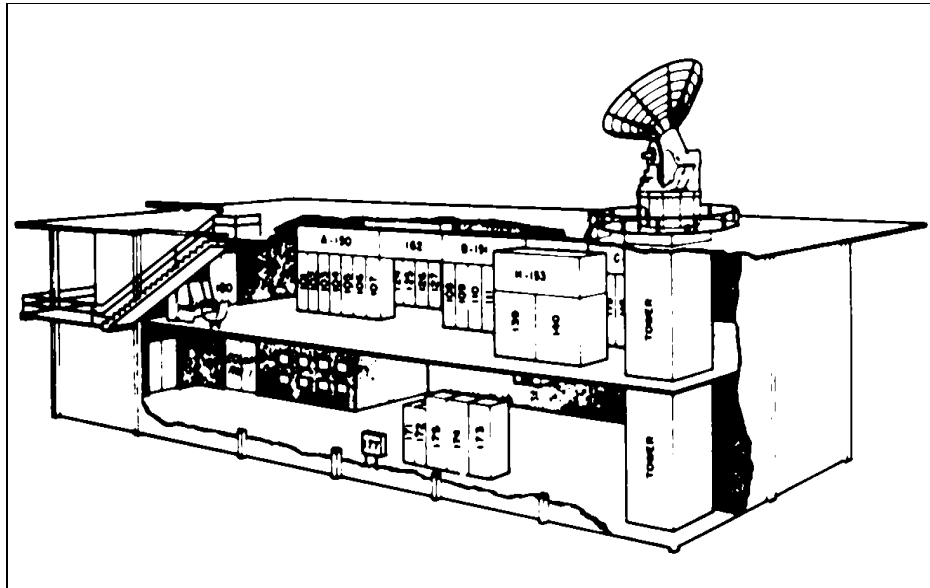

**FUNCTIONAL DESCRIPTION**

The Radar Set AN/FPS-16 is specifically designed to be installed at guided missile test centers for monitoring the flight paths of missiles during tests. It is capable of acquiring and tracking missiles,

with or without beacons, and of providing highly accurate trajectory data for evaluating performance and for maintaining range safety. The radar can be installed as a single system or as one of a chain of radars along the flight path to insure sufficient tracking throughout the entire.

**ITEM NAME:** RADAR SET  
**TYPE:** AN/FPS-16

missile flight. The accuracy of Radar Set AN/FPS-16 is such that the position data obtained from point-source targets has azimuth and elevation angular errors of less than 0.1 mil rms and range errors of less than 5 yards with a signal-to-noise ratio of 20 decibels or greater.

**RELATION TO SIMILAR EQUIPMENT**  
None.

**TECHNICAL DESCRIPTION**

Type of Presentation: Dual-trace CRT,  
A/R and R type displays.

**Transmitter Data**

Nominal Power: 1 megw peak (fixed-freq magnetron); 250 kw peak (tunable magnetron).

**Frequency**

Fixed: 5480 plus or minus 30 mc  
Tunable: 5450 to 5825 mc

Pulse Repetition Frequency (Internal):  
341, 366, 394, 467, 569, 682, 732, 853,  
1024, 1280, 1364 or 1707 pps.

Pulse Width: 0.25, 0.50, 1.0 usec  
Code Groups: 5 pulses max, within 0.001  
duty cycle limitation of transmitter.

**Radar Receiver Data**

Noise Figure: 11 db  
Intermediate Frequency: 30 mc  
Bandwidth: 8 mc  
Narrow Bandwidth: 2 mc  
Dynamic Range of Gain Control: 93 db

**Gate Width**

Tracking: 0.5 usec, 0.75 usec, 1.25 usec  
Acquisition: 1.0 usec, 1.25 usec, 1.75

**usec**

**Coverage**

Range: 500 to 400,000 yds  
Azimuth: 360 deg continuous  
Elevation: minus 10 to plus 190 deg

**Servo Bandwidth**

Range: 1 to 10 cps (var)  
Angle: 0.25 to 5 cps (var)

Operating Power Requirements: 115v ac,  
60 cps, 50 kva, 3 ph.

**INSTALLATION CONSIDERATIONS**

Not available.

**PRINCIPAL COMPONENTS AND PHYSICAL DATA**

<b>COMPONENTS</b>	<b>QTY</b>	<b>OVERALL DIMENSIONS (Inches)</b>	<b>UNIT WT. (Pounds)</b>
Amplifier Electronic Control 1 3.1 x 3.7 x 10.4 6 AM-1751/FPS-16			
Tuning Drive TG-55/FPS-16	1	3.1 x 3.i x 10	3
Control Electrical Frequency C-2278/FPS-16	1	3.7 x 4.7 x 19.2	6
Control Amplifier C-2276/FPS-16	1	3.7 x 1.7 x 17.2 5	
Air Conditioner	1	32 x 56 x 73	1500
Air Conditioner	1	18 x 72 x 76	1500
Amplifier Filament Supply	13	3.7 x 3.7 x 5	1
Angle Compensation Amplifier (Azimuth Elevation)	2	B.2 x 15.5 x 19.5	24
Angle Control Unit AM-1760/FPS-16	1	d.2 x 15.5 x 19.5	20
Angle Error Amplifier (Azimuth & Elevation)	2	8.2 x 13.7 x 19.5	21
Angle Servo Preamplifier (Azimuth Servo Elevation Servo)	2	2.5 x 6 x 1d.7	10
Angle Summing Amplifier (Azimuth Elevation)	2	12.2 x 15.5 x 19.5	24
Azimuth Driver Amplifier AM-1759/FPS-16	1	8.2 x 13.7 x 19.5	21

**AN/FPS-16: 2**

ITEM NAME: RADAR SET  
TYPE:: AN/FPS-16

PRINCIPAL COMPONENTS AND PHYSICAL DATA

COMPONENTS	QTY	OVERALL DIMENSIONS (Inches)	UNIT WT. (Pounds)
Beacon Range-Gate (Generator OA-1605/FPS-16	1	8.2 x 11.7 x 1 9.5	21
Blanking Amplifier Module	1	1.5 x 7.6 x 9.7	1
Coarse Digital Encoder	3	3 dia x 5.1	2
Communications & Power Programmer Unit	1	10 x 11.5 x 19.5	15
Commutator	1	8.2 x 10 x 19.5	14
Composite & 10,000 Yard Intensity) Gates Module	1	1.5 x 7.6 x 9.7	1
Composite & 2000 Yard Sweep Amplifier Module	1.	1.5 x 7.6 x 9.7	1
Composite Sweep Generator	1	11.2 x 13.5 x 19.5	18
Condensing Unit (Air Cooled Refrigeration)	1	58 x 66 x 106	3500
Contacto Panel	1	7.7 x 12 x 19.5	29
Contacto Panel (Range Pedestal and Angle Servo)	1	7.7 x 12 x 19.5	29
Control Monitor	1	9.5 x 10 x 10.5	18
DC Filament Supply)	1	6.5 x 7.8 x 19.5	25
DC Sequencing Panel	1	7.7 x 8.7 x 19.5	15
Dehydrator Pressurizer HD-296/FPS-16	1	26 x 26 x 34	300
Digital DC Bleeder	1	6 x 8.5 x 19.5	10
Discriminator Range-Gate Generator	1	8.2 x 11.7 x 19.5	20
Elevation Driver-Amplifier	1	8.2 x 13.7 x 19.5	20
Converter, Digital-To-Digital CV-610 FPS- 16	2	8.2 x 9 x 14.2	25
Converter, Digital-To-Digital CV-610 FPS- 16	1	13 x 13.5 x 19.5	50
Equalizer & Switching Unit	1	8.2 x 15.5 x 19.5	24
Error Distribution Unit	1	8.2 x 15.2 x 19.5	50
Excitation Amplifier	1	11.2 x 15.5 x 19.5	24
External Phase Compensator	1	8.2 x 15.5 x 19 5	
Failure Indicator	1	5.2 x 6 x 19.5	15
Fine Digital Encoder (Optical Encoder)	3	4 dia x 7.5	5
Function Selector	1	8.2 x 15.2 x 19.5	50
Gated Error Detector (Comparator Signal) (CM-105/FPS-16	2	1.7 x 1.7 x 19.2	6

AN/FPS-16: 3



ITEM NAME: RADAR SET  
TYPE:: AN/FPS-16

PRINCIPAL COMPONENTS AND PHYSICAL DATA

COMPONENTS	QTY	OVERALL DIMENSIONS (Inches)	UNIT WT. (Pounds)
Gate Generator Module	1	1.5 x 7.6 x 9	1
Comparator Signal CM-104/FPS-16	2	3.7 x 4.7 x 19.2	6
I.F. Amplifier AM-1750/FPS-16	3	3.6 x 3.7 x 9.6	3
I.F. Amplifier AM-1752/FPS-16	3	4.1 x 4.7 x 13.4	5
Instrumentation Patch Panel	1	8.5 x 15.7 x 19	15
Instrument Servo Amplifier	5	8.2 x 8.5 x 19.2	13
KRT High-Voltage Power Supply (Radar Monitor, Range Indicator)	2	B.5 x 16.7 x 19.7	60
Line Regulator	1	15.2 x 15.7 x 19.5	350
Local Designation Synchro	1	8 x 12.3 x 19	15
Oscillator Power Supply O-50H/FPS-16	1	8.2 x 9.7 x 15	25
I.F. Amplifier AM-1753/FPS-16	4	3.7 x 4.7 x 17.5	5
Meter Panel (Digital)	1	5 x 7.7 x 19.5	12
Meter Panel (Range)	1	5 x 7.7 x 19.5	12
Meter Panel (Angle)	1	5 x 7.7 x 19.5	12
Meter Panel (Pedestal)	1	5 x 7.7 x 19.5	12
Attenuator Dummy Load CM-450/FPS-16	1		
Mixer Stage Frequency CV-607/FPS-16	1	80	
Mode Switching Unit	1	7.25 x 19.5 x 31	50
Monitor & Status Panel	1	17 x 24 x 30	100)
Noise Figure & Power Monitor	1	9 x 11 x 19.5	20
I.F. Amplifier AM-1754/FPS-16	1	3.7 x 4.7 x 14.2	4
Pedestal Voltage Interlock Panel	1	6.7 x 7.7 x 19.5	5
PRF & Systems Switching Unit	1	7.2 x 19.5 x :11	5)
PRF Generator No. 1	1	8.2 x 12 x 19.5	16
PRF Generator No. 2	1	8.2 x 12 x 19.5	16
Pulse Generator	1	8 x 10.2 x 15.2	16
Radar Control Panel	1	17 x 24 x 30	200
Range-Delay Trigger Generator	1	B.2 x 10 x 19.5	15
Range Designation Controller	1	6.5 x 8.2 x 19.5	10
Range discriminator No. 1	1	8.2 x 15.5 x 19.5	15.5
Range Discriminator No. 2	1	8.2 x 15.5 x 19.5	21

AN/FPS-16: 4

ITEM NAME: RADAR SET  
TYPE:: AN/FPS-16

PRINCIPAL COMPONENTS AND PHYSICAL DATA

COMPONENTS	QTY	OVERALL DIMENSIONS (Inches)	UNIT WT. (Pounds)
Range Equalizer	1	4.7 x 8.2 x 19.5	10
Range-Gate Time Modulator	1	8.2 x 15 x 19.5	22
Range-Gate Trigger Delay Unit	1	6.5 x 8.2 x 19.5	20
Converter Gate Assy MX-2259/FPS-16	1	16 x 19 x 19.5	70
Range Indicator	1	24 x 25 x 31	180
Range Notch Amplifier Module	1	1.5 x 7.6 x 9.7	1
Range Servo Amplifier	1	8.2 x 8.2 x 19.5	18
Range Servo Controller	1	8.2 x 12 x 19.5	17
Range Sweep & Positioner	1	8.2 x 11 x 19.5	18
Range-Trigger Generator No. 1	1	8.2 x 12 x 19.5	25
Range-Trigger Generator No. 2	1	8.2 x 13 x 19.5	23
Range Velocity Controller	1	6.5 x 8.2 x 19.5	9
Receiver Range-Gate Generator	1	8.2 x 10 x 19.5	18
Reference Driver	1	8.2 x 12 x 19.5	17
Reference Oscillator	1	8.2 x 15.5 x 19.5	17
Reference Trigger Generator	1	8.2 x 11.5 x 19.5	20
Reference Voltage Divider	1	3.2 x 4 x 19.5	8
Running Time Unit	1	6 x 10.4 x 19.5	10
Scan Generator	1	8.2 x 15.5 x 19.5	31
STC Unit (Control Amplifier) C-2277/FPS-16	1	6.7 x 8.3 x 19.5	12
Servo Junction Box	1	8 x 20 x 30	50
Servo Power Supply	1	7.7 x 15.7 x 19.5	50
Slip-Ring Assy	1	17 x 24 dia	90
Sweep Generator Module	1	1.5 x 7.6 x 9.7	1
Synchronization Unit No. 1	1	8.2 x 13.5 x 19.5	19
Synchronization Unit No. 2	1	8.2 x 15.2 x 19.5	23
I.F. Amplifier AM-1755/FPS-16	1	3.7 x 4.7 x 13.2	4
Video Amplifier Module	1	1.5 x 7.6 x 9.7	1
Video Amplifier Module	1	1.5 x 7.6 x 9.7	1
Video Distribution Unit	1	8.2 x 15.2 x 19.5	25
Dummy Load (120v Divider)	1	3.2 x 4 x 19.5	10

ITEM NAME: RADAR SET  
TYPE:: AN/FPS-14

PRINCIPAL COMPONENTS AND PHYSICAL DATA

COMPONENTS	QTY	OVERALL DIMENSIONS (Inches)	UNIT WT. (Pounds)
Module (Plus 120v Driver)	1	1.5 x 5.5 x 7.5	1
Module (Plus 120v Preamplifier)	1	1.5 x 5.5 x 7.5	1
Power Supply Unit (120v)	5	7.7 x 15.7 x 19.5	73
Regulating Amplifier Module (Plus 150v)	1	1.5 x 4.5 x 9.2	1
Dummy Load (150v Divider)	3	3.2 x 4 x 19.5	10
Module (Plus or Minus 150v Divider)	7	1.5 x 5.5 x 7.5	1
Module (Minus 150v Divider)	1	1.5 x 5.5 x 7.5	1
Plus 150v High-Current Power Supply Unit	2	7.7 x 15.7 x 19.5	75
Plus or Minus 150v Power Supply PP-1824/FPS-16	13	7.7 x 15.7 x 19.5	75
Plus or Minus 150 Preamplifier Module	7	1.5 x 5.5 x 7.5	1
Minus 150v Preamplifier (Self- Referenced Module)	1	1.5 x 5.5 x 7.5	1
2000 yd Gate Generator Module	1	1.5 x 7.6 x 9.7	1
2000 yd Intensity Gate & Pipper Module	1	1.5 x 7.6 x 9.7	1
26v dc Power Supply PP-1826/FPS-16	1	18.4 x 18.4 x 31	240
Plus 300v Regulating Amplifier Module (High-Current Power Supply)	1	1.5 x 4.5 x 9.2	1
300v Divider (Dummy Load)	2	3.2 x 4 x 19.5	10
Minus :300v Driver Module	2	1.5 x 5.5 x 7.5	1
Minus :350v Driver Module	1	1	
Plus 300v Divider Module	1	1.5 x 5.5 x 7.5	1
Plus 300v High Current Power Supply Unit	2	7.7 x 15.7 x 19.5	80
Plus 300v Preamplifier Module	1	1.5 x 5.5 x 7.5	1
Minus 300v Preamplifier Module	2	1.5 x 5.5 x 7.5	1
Minus 350v Preamplifier Module	1	1.5 x 5.5 x 7.5	1
Power Supply PP 1825-/FPS-16	11	7.7 x 15.7 x 19.5	78
Plus 300v Rectifier Module	1	2.5 x 1.7 x 7.7	1.5
Motor Generator PU-397/FPS-16	1	16-.5 x 21 x 26	567
Motor Generator PU-397A/FPS-16	1	16-.5 x 21 x 26	Approx 567
Plus 50v, Plus 15v, Minus 15v & Minus 75v rectifier Unit			

**ITEM NAME:** RADAR SET  
**TYPE::** AN/FPS-16

**PRINCIPAL COMPONENTS AND PHYSICAL DATA**

<b>COMPONENTS</b>	<b>QTY</b>	<b>OVERALL DIMENSIONS (Inches)</b>	<b>UNIT WT. (Pounds)</b>
400 cycle Regulator	1		
400 cycle Regulator Control Unit	1		
400 cycle Voltage Regulator	1	11.5 x 15 x 18.2	

**REFERENCE DATA AND LITERATURE**

Technical Manuals:  
NAVAER 16-30FPS16-501

DATE: 1 April 1964  
 COGNIZANT SERVICE: USAF

ITEM NAME: RADAR SET  
 TYPE:: AN/FPS-16(V)

**FEDERAL STOCK NUMBER**

	USA	USN	USAF	USMC
STATUS OR TYPE CLASSIFICATION	Used by	Used by		
Mfg(s) Name or Code Number: Radio Corporation of America (77522)				

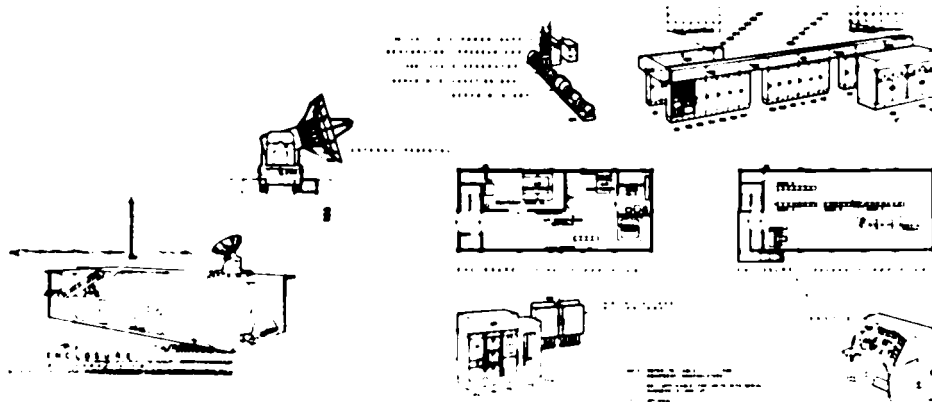

**FUNCTIONAL DESCRIPTION**

The Radar Set AN/FPS-16(V) is designed specifically for installation at guided missile test centers for the purpose of obtaining highly accurate trajectory data of missiles during tests. It is capable

of acquiring and accurately tracking missiles (with or without beacons), nose cones, boosters, tankage assemblies, instrument packages, and debris, and of providing trajectory data of these objects for real time or future evaluation of performance. The data obtained from the radar on the

**AN/FPS 16(V): I**

**ITEM NAME:** RADAR SET  
**TYPE:** AN/FPS-16(V)

position of these targets may be used to maintain range safety. The radar can be installed as a single system or as one of a chain of radars along the flight path to ensure sufficient tracking throughout the entire missile flight. Radar Set AN/ FPS-16(V) is capable of tracking earth orbiting satellites. The accuracy of Radar Set AN/FPS-16(V) is such that the position data obtained from point-source targets has azimuth and elevation angular errors of less than 0.1 mil rms and range errors of less than 5 yards rms, with a signal-to noise ratio of 20 decibels (db) or greater.

### RELATION TO SIMILAR EQUIPMENT

None.

### TECHNICAL DESCRIPTION

#### Transmitter Data

##### Power Output

Fixed-Frequency Magnetron: 1 megw plus or minus 2 db, peak.

Tunable Magnetron: 250 kw plus or minus 2 db, peak.

Dynamic Range (Gain Control): 20 db

#### Frequency

Fixed-Frequency Magnetron: 5480 plus or minus 30 mc

Tunable Magnetron: 5.150 to 5825 mc  
PRF (Internal): 311, 366, 394, 467, 569, 682, 732, c53, 102.1, 1280, 1364, and 1707 pps.

Pulse Widths: 0.25 plus or minus 0.05; 0.5 plus or minus 0.08; and 1.0 plus or minus 0.1 usec

#### Receiver Data

Noise Figure: 11 db

Intermediate Frequency: 30 mc

Wide Bandwidth: 8 mc

Narrow Bandwidth: 1.B mc

Dynamic Range of Gain Control: 73 db

#### Gate Width

Tracking: 0.5; 0.75; and 1.25 usec

Acquisition: 1.0; 1.25; and 1.75 usec

#### Servo Bandwidth

Range: 1 to 10 cps (var)

Angle: 0.25 to 5 cps (var)

#### Radar Inputs

##### Digital Data Read Pulse

Termination Impedance (Radar Integral): 75 ohms.

Pulse Amplitude: 10v min; 75v max

Pulse Duration: 0.2 usec min; 1.0 usec max.

Pulse Rise Time: Approx 0.1 usec

Data Read Rate: 100 pps max

##### Digital Data Shift Pulse

Termination Impedance (Radar Internal): 75 ohms.

Pulse Amplitude: 10v max; 75v min

Pulse Duration: 0.2 usec min; 1.0 usec max

Pulse Rise Time: 0.1 usec approx

Data Shift Time Rate: 100 kc, nom max  
Time Spacing Between Read Pulse and First Shift Pulse: 500 usec min

Angle Sine-Cosine Precision Potentiometer

Voltage: plus or minus 125 and -125v max to terminals.

Range Precision Potentiometer Voltage: 350v max to terminals.

Angle and Range Designation Data

Synchro Excitation (Internal and External): 120v, 60 cps

Type I Synchro System Calibration:

Azimuth: 360 deg revolution

Elevation: 360 deg revolution

Range: 1,296,000 yds revolution and 72,000 yds revolution.

Type II Synchro System Calibration

Azimuth: 6.100 mils revolution

Elevation: 100 mils revolution

Range: 1,000,000 yds revolution and 50,000 yds revolution

#### Beacon Code Triggers

Termination Impedance (Radar Internal): 75 ohms.

Pulse Amplitude: 10v min; 75v max

Pulse Duration: 0.2 usec min; 1.0 usec max

Pulse Rise Time: 0.1 usec approx

Pulse Timing and Spacing

4-Pulse Code: Greater than 0.8 usec from leading edge to leading edge.

5-Pulse Code: Spaced 1.0 usec min; between first four-pulses and 8 usec min, between fourth and fifth pulses.

#### 82-kc Sine Wave

Termination Impedance: 600 ohms

Pulse Amplitude: 1 mw plus or minus 2 db

Frequency: 1 cycle equals 2000 yd range.

#### 341-cps Sine Wave

Pulse Amplitude: 1 mw plus or minus 2 db

#### External Pretrigger

Termination Impedance (Radar Internal): 75 ohms.

Pulse Amplitude: plus 10v min; 75v max

Pulse Duration: 0.2 usec min; 1.0 usec max.

Pulse Rise Time: 0.1 usec approx

Pulse-to-Pulse Time Jitter: 0.005 max

#### Radar Outputs

Termination Impedance: 75 ohms

Pulse Amplitude: 25v min

Pulse Duration: 1.0 usec

Pulse Rise Time: 0.1 usec max

Data Read Rate: 100 pps, max

Data Shift Rate: 100 kc max

Angle and Range Synchro Data

Type I Synchro Data Output Calibration

Azimuth Coarse: 360 deg per revolution.

Azimuth Fine: 10 deg per revolution.

Elevation Coarse: 360 deg per revolution.

Elevation Fine: 10 deg per revolution

Range Coarse: 1,296,000 yds per revolution.

Range Medium: 72,000 yds per revolution.

Range Fine: 2000 yds per revolution.

**ITEM NAME:** RADAR SET  
**TYPE::** AN/FPS-16(V)

Type II Synchro Data Output Calibration  
Azimuth Coarse: 6400 mils per revolution.  
Azimuth Fine: 400 mils per revolution  
Elevation Coarse: 6,100 mils per revolution.  
Elevation Fine: 400 mils per revolution.  
Range Coarse: 1,000,000 yds per revolution.  
Range Medium: 50,000 yds per revolution.  
Range Fine: 2000 yds per revolution.

Angle and Range Synchro Voltage  
Type I Synchro Voltage Calibration  
Range Coarse: 1,296,000 yds per revolution.  
Range Medium: 72,000 yds per revolution.

Type II Synchro Voltage Calibration  
Azimuth Coarse: 6400 mils per revolution.  
Azimuth Fine: 400 mils per revolution.  
Elevation Coarse: 6400 mils per revolution.

Elevation Fine: 400 mils per revolution.  
Range Coarse: 1,000,000 yds per revolution.  
Range Medium: 50,000 yds per revolution.  
Radar Set AN/FPS-16(V) Coverage  
Range: 500 to -100,000 yds  
Azimuth: 360 deg continuous.  
Elevation: minus 10 deg to plus 190 deg  
Types of Presentation  
Range Indicator: Dual-trace cathode-ray tube, A/R and R type displays.  
Radar Monitor: Single-trace cathode-ray tube, A-type display.  
Type of Emission: Pulse type.  
Number of Bands: 2 bands.  
Operating Power Requirements: 2W0 & 120v ac plus or minus 15%, 60 cps, 3 ph.

**INSTALLATION CONSIDERATIONS**

Not available.

**PRINCIPAL COMPONENTS AND PHYSICAL DATA**

COMPONENTS	QTY	OVERALL DIMENSIONS (Inches)	UNIT WT. (Pounds)
Console, Radar Set C-2279/FPS-16	*	53 x 57 x 84	1500
Switchboard, Power 5B-780/FPS-16	*	18 x 22 x 72	243
Recorder, Signal Data RO-72/FPS-16	*	18 x 22 x 72	243
Converter-Power Supply Group OA-1612/FPS-16	*	18 x 22 x 72	243
Monitor-Synchronizer Group OA-1597/FPS-16	*	18 x 22 x 72	243
Programmer, Electronic Command Signal TD-199/FPS-16	*	18 x 22 x 72	243
Converter, Signal Data CV-60b/FPS-16	*	18 x 22 x 72	243
Coordinate Data Storage Group OA-159t8/FPS-16	*	18 x 22 x 72	243
Amplifier Power Supply AM-1747/FPS-16	*	18 x 22 x 72	243
Power Supply Assy PP-1816/FPS-16	*	18 x 22 x 72	243
Relay Assy RE-33i/FPS-16	*	18x 22 x 72	243
Control, Transmitter C-2269/FPS-16	*	18 x 22 x 72	243
Distribution Box J-874/FPS-16	*	18 x 22 x 72	243
Distribution Box J-t75/FPS-16	*	18 x 22 x 72	243
Amplifier Power Supply AM-1756/FPS-16	*	16 x 22 x 72	243
Power Supply Assy PP-1821/FPS-16	*	18 x 22 x 72	243

**AN/FPS-16(V): 3**

ITEM NAME: RADAR SET  
TYPE:: AN/FPS-14

PRINCIPAL COMPONENTS AND PHYSICAL DATA

COMPONENTS	QTY	OVERALL DIMENSIONS (Inches)	UNIT WT. (Pounds)
Power Supply Assy PP-1822/FPS-16	*	18 x 22 x 72	213
Amplifier Assy AM-1757/FPS-16	*	18 x 22 x 72	243
Amplifier Assy AM-1756/FPS-16	*	18 x 22 x 72	243
Amplifier Assy AM-1759/FPS-16	*	18 x 22 x 72	213
Amplifier Power Supply AM-1760/FPS-16	*	18 x 22 x 72	243
Electronic Timing Group OA-1605/FPS-16	*	18 x 22 x 72	243
Range Computer Group OA-1606/FPS-16	*	18 x 22 x 72	243
Range Computer Group OA-1607/FPS-16	*	18 x 22 x 72	243
Range Computer Group OA-1608/FPS-16	*	18 x 22 x 72	243
Range Computer Group OA-1609/FPS-16	*	18 x 22 x 72	243
Power Supply Assy PP-1U23/FPS-16	*	18 x 22 x 72	243
Range Computer Group OA-1610/FPS-16	*	18 x 22 x 72	243
Motor-Generator PU-398/FPS-16	*	18 x 18 x 72	1100
Antenna Group OA-1613/FPS-16 and Antenna Pedestal AB-5-17/FPS-16	*	96 x 132 x 132	11000
Receiver Group, Radar OA-1611/FPS-16	*	21 x 42 x 53	850
Antenna AS-903/FPS-16	*	121 w x 144 dia	
Modulator, Radar MD-313A/FPS-16	*	13 x 64 x 00	1600
Transmitter, Radar T-6.1 t/FPS-16	*	13 x 6.1 x 80	2100
Power Supply PP-1826/FPS-16	*	14 x 36 x 90	1200
Power Supply	.	14 x 36 x 90	1700
Circuit Breaker Box J-b76/FPS-16	*	18 x 22 x 72	800
Voltage Regulator CN-.449/FPS-16	*	18 x 22 x 72	1000
Circuit Breaker Box J-877/FPS-16	*	18 x 22 x 72	1000
Dehydrator Pressurizer HD-296/FPS-16	*	26 x 26 x 3,1	300
26v dc Power Supply PP-1826/FPS-16	*	18.1 x 1b.1 x 31	240
Motor-Generator Pt-397 FPS-16	*	16.5 x 21 x 26	567
Motor-Generator Pt-397A FPS-16	*	16.5 x 21 x 26	567
Amplifier Electronic Control AM-1751/FPS-16	1	3.1 x 3.7 x 10.4	6
Driver, Tuning TG-55/FPS-16	1	3.1 x 3.4 x 10	3
Control Electrical Frequency C-2278/FPS-16	1	3.7 x 1.7 x 19.2	6

AN/FPS-16(V): 4



ITEM NAME: RADAR SET  
TYPE:: AN/FPS-14

PRINCIPAL COMPONENTS AND PHYSICAL DATA

COMPONENTS	QTY	OVERALL DIMENSIONS (Inches)	UNIT WT. (Pounds)
Agastat Chassis	2	4.5 x 7.18 x 27.28	
Control Amplifier C-2276/FPS-16	1	3.7 x 1.7 x 17.2 5	
Air Conditioner	1	32 x 56 x 73	1500
Air Conditioner	1	48 x 72 x 76	1500
Amplifier Filament Supply	17	3.7 x 3.7 x 5	1
AND Gate Module	28	1.5 x 7.6 x 9.7	1
Angle Compensation Amplifier	3	8.2 x 15.5 x 19.5	24
Angle Control Unit	1	8.2 x 15.5 x 19.5	20
Angle Error Amplifier	2	8.2 x 13.7 x 19.5	21
Angle Servo Preamplifier	2	2.5 x 6 x 18.7	10
Angle Summing Amplifier	2	12.2 x 15.5 x 19.5	24
Azimuth Driver Amplifier	1	b.2 x 13.7 x 19.5	21
Beacon-Range-Gate Generator	1	8.2 x 11.7 x 19.5	21
Beam Switch Counter Module	1	1.5 x 7.6 x 9.7	1
Blanking Amplifier Module	1	1.5 x 7.6 x 9.7	1
Coarse Digital Encoder	3	3 x 5.1 dia	2
Cathode Follower Module	8	1.5 x 7.6 x 9.7	1
Communication & Power Programmer Unit	1	10 x 11.5 x 19.5	15
Comutator		18.2 x 10 x 19.5	14
Composite & 10,000 Yd Intensity Gates Module		1 1.5 x 7.6 x 9.7	1
Composite & 2000 Yd Sweep Amplifier Module	1	1.5 x 7.6 x 9.7	1
Composite Sweep Generator	1	8.2 x 13.5 x 19.5	18
Condensing Unit (Air Cooled Refrigeration)	1	58 x 66 x 106	3500
Contacto Panel (Digital)	1	7.7 x 12 x 19.5	29
Contacto Panel (Range, Pedestal & Angle Servo)	3	7.7 x 12 x 19.5	29
Control Monitor	1	9.5 x 10 x 10.5	18
CRT High-Voltage Power Supply	2	8.5 x 16.7 x 19.7	60
DC Filament Supply	1	6.5 x 7.8 x 19.5	25
Dehydrator-Pressurizer HD-296/FPS-16	1	26 x 26 x 34	300
DC Sequencing Panel	1	7.7 x b.7 x 19.5	15

AN/FPS-16(V): 5

ITEM NAME: RADAR SET  
TYPE:: AN/FPS-16(v)

## PRINCIPAL COMPONENTS AND PHYSICAL DATA (Cont.)

COMPONENTS	QTY	OVERALL DIMENSIONS (Inches)	UNIT WT. (Pounds)
Delay Line Module	2	1.5 x 7.6 x 9.7	1
Digital DC Bleeder	1	6 x 6.5 x 19.5	10
Discriminator Range-Gate Generator	1	8.2 x 13.7 x 19.5	20
Elevation Driver Amplifier	1	8.2 x 13.7 x 19.5	20
Encoder Core Driver Module	1	1.5 x 7.6 x 9.7	1
Converter Digital-To-Digital CV-610/FPS-16	2	t.2 x 9 x 1.1.2	25
Converter Digital-To-Digital 1 CV-610/FPS-16	1	13 x 13.5 x 19.5	50
Encoder Trigger & Line Driver Module	2	1.5 x 7.6 x 9.7	1
Encoder Trigger Module	1	1.5 x 7.6 x 9.7	1
Equalizer & Switching Unit	2	6.2 x 15.5 x 19.5	29
Error Distribution Unit	1	d.2 x 15.2 x 19.5	50
Excitation Amplifier	1	(3.2 x 15.5 x 19.5	21
External Phase Compensator	1	6.2 x 10 x 19.5	9
Failure Indicator	1	5.2 x 6 x 19.5	15
Fine Digital Encoder (Optical Encoder)	3	4 x 7.5 dia	5
Function Selector	1	t3.2 x 15.2 x 19.5	50
Gate Generator Module	1	1.5 x 7.6 x 9.7	1
Comparator Signal CM-105/FPS-16	2	3.7 x 1.7 x 19.2	6
Comparator Signal CM-104I/FPS-16	2	3.7 x 4.7 x 19.2	6
Amplifier I.F. AM-1750/FPS-16	3	3.6 x 3.7 x 9.6	3
Amplifier I.F. AM-1752/FPS-16	3	1.1 x 1.7 x 13.1	5
Instrument Servo Amplifier	6	8.2 x 8.5 x 19.2	13
Instrument Patch Panel	1	8.5 x 15.7 x 19	15
Inverter Amplifier Module	9	1.5 x 7.6 x 9.7	1
Level Amplifier Module	2	1.5 x 7.6 x 9.7	1
Line Driver (Pulse Driver) Module	6	1.5 x 7.6 x 9.7	1
Line Regulator	1	15.2 x 15.7 x 19.5	350
Local Designation Synchros	1	8 x 12.3 x 19	15
Oscillator Power Supply O-508/FPS-16	1	8.2 x 9.7 x 15	25
Logic Bistable Multivibrator	21	1.5 x 7.6 x 9.7	1
I.F. Amplifier AM-1753/FPS-16	4	3.7 x 1.7 x 17.5	5

AN/FPS-16(V): 6

ITEM NAME: RADAR SET  
TYPE:: AN/FPS-16(V)

PRINCIPAL COMPONENTS AND PHYSICAL DATA

COMPONENTS	QTY	OVERALL DIMENSIONS (Inches)	UNIT WT. (Pounds)
Meter Panel (Digital)	1	5 x 7.7 x 19.5	12
Meter Panel (Range)	1	5 x 7.7 x 19.5	12
Meter Panel (Angle)	1	5 x 7.7 x 19.5	12
Meter Panel (Pedestal)	1	5 x 7.7 x 19.5	12
Attenuator Dummy Load CM-,150/FPS-16	1		
Mixer Stage Frequency CV-607/FPS-16	1		3
Mode Switching Unit	1	7.25 x 19.5 x 31	50
Monitor & Status Panel	1	17 x 24 x 30	100
Noise Figure & Power Monitor	1	9 x 14 x 19.5	20
Noise Generator Power Supply	1	2 x 3.9 x 1:3.61	
I.F. Amplifier AM-1751/FPS-16	1	1.7 x 1.7 x 1.1.2	4
OR Gate Module	5	1.5 x 7.6 x 9.7	1
Over Voltage Control Panel	1	1.7 x 7.5 x 19.5	6
PRF & Systems Switching Unit	1	7.2 x 19.5 x 31	50
PRF Generator No. 1	1	8.2 x 12 x 19.5	16
PRF Generator No. 2	1	8.2 x 12 x 19.5	16
Pulse Generator	1	8 x 10.2 x 15.2	18
Pulse Sharper A	24	1.5 x 7.6 x 9.7	1
Pulse Sharper B	1	1.5 x 7.6 x 9.7	1
Radar Control Panel	1	17 x 21 x 30	200
Range-Delay Trigger Generator	1	t.2 x 10 x 19.5	15
Range Designation Controller	1	6.5 x t.2 x 19.5	10
Range Discriminator No. 1	1	8.2 x 15.5 x 19.5	15-1/2
Range Discriminator No. 2	1	8.2 x 15.5 x 19.5	21
Range Equalizer	1	4.7 x 13.2 x 19.5	10
Range-Gate Timer Modulator	1	8.2 x 15 x 19.5	22
Range-Gate Trigger Delay Unit	1	6.5 x t3.2 x 19.5	20
Range Gear Assy MX-2259/FPS-16	1	16 x 19 x 19.5	70
Range Indicator	1	24 x 25 x 31	180
Range Notch Amplifier Module	1	1.5 x 7.6 x 9.7	1
Range Servo Amplifier	1	1.2 x 8.2 x 19.5	18
Range Servo Controller	1	8.2 x 12 x 19.5	17

AN/FPS-16(V): 7

PRINCIPAL COMPONENTS AND PHYSICAL DATA

COMPONENTS	QTY	OVERALL DIMENSIONS (Inches)	UNIT WT. (Pounds)
Range Sweep & Positioner	1	8.2 x 11 x 19.5	18
Range-Trigger Generator No. 1	1	8.2 x 12 x 19.5	25
Range-Trigger Generator No. 2	1	8.2 x 13 x 19.5	23
Range Velocity) Controller	1	6.5 x 8.2 x 19.5	9
Receiver Range-Gate Generator	1	8.2 x 10 x 19.5	18
reference Driver	1	8.2 x 12 x 19.5	17
Reference Oscillator	1	8.2 x 15.5 x 19.5	20
Reference Voltage Divider	2	3.2 x 4 x 19.5	8
Relay Chassis	1	1.5 x 9.12 x 17.5	
Relay Driver Module	5.1	1.5 x 7.6 x 9.7	1
R.F. Monitor Panel	1	9.5 x 10 x 10.5	18
Running Time Unit	1	6 x 10.1 x 19.5	10
Scan Generator	1	8.2 x 15.5 x 19.5	31
Servo Junction Box	1	8 x 20 x 30	50
Servo Power Supply	1	7.7 x 15.7 x 19.5	50
Shift Register Driver Module	B	1.5 x 7.6 x 9.7	1
Shift Register Driver Module	7	1.5 x 7.6 x 9.7	1
Pedestal Slip Ring Assy	1	17 x 21 dia	90
Control Amplifier C-2277/FPS-16	1	6.7 x b.3 x 19.5	12
Sweep Generator Module	1	1.5 x 7.6 x 9.7	1
Synchronization Unit #1	1	8.2 x 13.5 x 19.5	19
Synchronization Unit #2	1	8.2 x 15.2 x 19.5	23
Timing Generator Module	1	1.5, x 7.6 x 9.7	1
I.F. Amplifier AM-1755/FPS-16	1	3.7 x 1.7 x 13.2	4
Video Amplifier Module	1	1.5 x 7.6 x 1).7	1
Video Amplifier Module	1	1.5 x 7.6 x 9.7	1
Video Distribution Unit	1	8.2 x 15.2 x 19.5	25
1 & 60 Cycle Generator Module	1	1.5 x 7.6 x 9.7	1
5-Bit Shift Register Module	1	1.5 x 7.6 x 9.7	1
5/1 Bit Shift Register Module	2	1.5 x 7.6 x 9.7	1
6-Bit Shift Register Module	1	4 x 7.6 x 9.7	1
8-Bit Shift Register Module	8	1.5 x 7.6 x 9.7	1

AN/FPS-16(V): B

ITEM NAME: RADAR SET  
TYPE:: AN/FPS-16(V)

PRINCIPAL COMPONENTS AND PHYSICAL DATA

COMPONENTS	QTY	OVERALL DIMENSIONS (Inches)	UNIT WT. (Pounds)
Plus or Minus 15v Rectifier Unit	1	8.2 x 15.5 x 19.5	75
26v dc Power Supply PP-1826/FPS-16	1	18.4 x 18.4 x 31	240
Plus 50 & Minus 75v Rectifier Unit	1	8.2 x 15.5 x 19.5	75
Dummy Load	1	3.2 x 4 x 19.5	10
Plus 120v Driver Module	1	1.5 x 5.5 x 7.5	1
Plus 120v Preamplifier Module	1	1.5 x 5.5 x 7.5	1
120v Power Supply Unit	5	7.7 x 15.7 x 19.5	78
150v Divider Dummy Load	1	3.2 x 4 x 19.5	10
Plus or Minus 150v Driver Module	8	1.5 x 5.5 x 7.5	1
Minus 150v Driver Module	1	1.5 x 5.5 x 7.5	1
Plus 150v High Current Power Supply Unit	4	7.7 x 15.7 x 19.5	75
Power Supply PP-1824/FPS-16	11	7.7 x 15.7 x 19.5	78
Plus or Minus 150v Preamplifier Module	8	1.5 x 5.5 x 7.5	1
Minus 150v Preamplifier Module	1	1.5 x 5.5 x 7.5	1
Plus or Minus 150v Rectifier Module	2	1.5 x 5.5 x 7.5	1
Plus 150v Regulating Amplifier Module	2	1.5 x 4.5 x 9.2	1
300v Divider Dummy Load	1	3.2 x 4 x 19.5	10
Plus or Minus 300v Driver Module	7	1.5 x 5.5 x 7.5	1
Plus or Minus 300v High Current Power Supply Unit	2	7.7 x 15.7 x 19.5	80
Power Supply PP-1825/FPS-16	12	7.7 x 15.7 x 19.5	78
Plus or Minus 300v Preamplifier Module	7	1.5 x 5.5 x 7.5	1
Plus or Minus 300v Rectifier Module	1	2.5 x 4.7 x 7.7	1-1/2
Plus or Minus 300v Regulating Amplifier Module	1	1.5 x 4.5 x 9.2	1
Minus 350v Driver Module	1	1.5 x 5.5 x 7.5	1
Minus 350v Preamplifier Module	1	1.5 x 5.5 x 7.5	1
Motor-Generator PU-397/FPS-16	1	16.5 x 21 x 26	567
Motor-Generator PU-397A/FPS-16	1	16.5 x 21 x 26	
400-cycle Regulator	1		
400-cycle Regulator Control Unit	1		
400-cycle Voltage Regulator	1	11.5 x 15 x 18.2	

Volume 1  
Section 1

**MIL-HDBK-162A**  
15 December 1965

**ITEM NAME:** RADAR SET  
**TYPE:** AN/FPS-16(V)

**PRINCIPAL COMPONENTS AND PHYSICAL DATA**

<b>COMPONENTS</b>	<b>QTY</b>	<b>OVERALL DIMENSIONS (Inches)</b>	<b>UNIT WT. (Pounds)</b>
2000 Yard Gate Generator Module	1	1.5 x 7.6 x 9.7	1
2000 Yard Intensity Gate & Pipper Module	1	1.5 x 7.6 x 9.7	1

**NOTE:**

\*Indicates that Quantity is variable.

**REFERENCE DATA AND LITERATURE**

Technical Manuals:  
NAVWEPS 16-30FPS-16-501-1

DATE: 1 April 1964  
COGNIZANT SERVICE: USAF

ITEM NAME: RADAR SET  
TYPE:: AN/FPS-1A\*\*

FEDERAL STOCK NUMBER: \*5840-505-0435  
\*\*5840-646-9897

	USA	USN	USAF	USMC
STATUS OR TYPE CLASSIFICATION			Std*, **	
Mfg(s) Name or Code Number: Bendix Radio Division of Bendix Aviation Corporation				

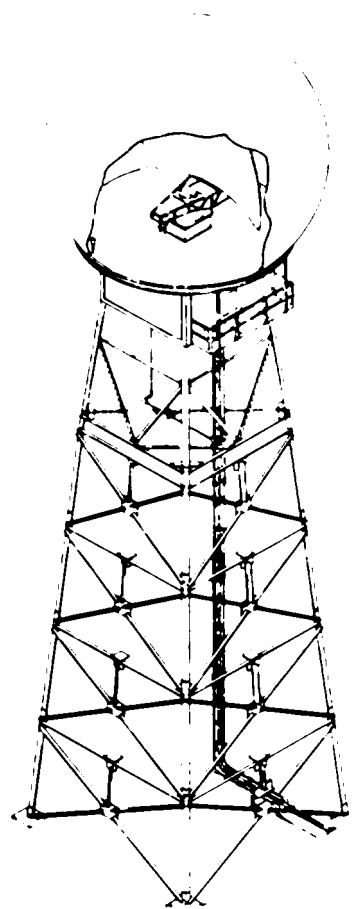

**FUNCTIONAL DESCRIPTION**

Radar Sets AN/FPS-18 and AN/FPS-18A are used for search. They are medium-power, short range sets. They contain a coherent klystron power-amplifier transmitter for more reliable moving target indication..

The antenna-feed assembly of the AN/FPS-18 and AN/FPS-18A provides vertical and circular polarization. A remote control selects either type. The AN/FPS-18 and AN/FPS-18A detects F-86 aircraft in line of sight as high as 17000 feet and as far away as 35 nautical miles.

**ITEM NAME:** RADAR SET  
**TYPE:** AN/FPS-18, AN/FPS-18A.

Search is limited from 0.5 to 30 degrees above the horizontal reference line. The sets have identical dual-channel transmitters and receivers which operate automatically. If one channel fails, the other channel is automatically interchanged with the defective one.

Vertical Beam Width: 30 deg approx Receiver  
Bandwidth: 1.0 to 1.5 mc IF. Frequency: 30 mc  
Indicator: One 7-in. maintenance PPI Indicator  
Ranges: 10 mi range with 2 mi range marks; 50 mi range with 10 mi range marks; 48 mi range slowed down video without range marks.

**RELATION TO SIMILAR EQUIPMENT**

The AN/FPS-18A is identical to Radar Set AN/FPS-18, with the exception that it permits use of an additional type tower which requires a new type of waveguide, wiring harnesses, conduit cables and miscellaneous hardware.

Duty Cycle: 0.0012 Average Power Output: 1200 watts  
Receiver Noise Figure: 8 to 10 db Operating Voltages and Power Requirements: 120/208v ac, 60 cps, 3-ph, 4-wire, 60 kw max **INSTALLATION CONSIDERATIONS**  
Siting: Needs about one half acre of high, clear land with an unobstructed view of the horizon.

**TECHNICAL DESCRIPTION**

Frequency: 2700 to 2900 mc (tunable)  
Peak Power Output: 1 megawatt  
RF Power Source: V87-B or V87-C klystron  
Pulse Width: 1 usec  
Pulse Repetition Rate: 1200 pps (nom)  
Range Max: 50 naut mi  
Horizontal Coverage: 360 deg  
Rotation Speed of Antenna: 5.33 rpm(nom)  
Horizontal Beam Width: 1.4 deg

Mounting: All components except the antenna group are mounted on the floor.

Cabling Requirements: Prefabricated harness furnished.

Related Equipment: Coordinate Data Transmitter Set AN/FST-1, Control Monitor Set AN/FSW-1 and Coordinate Monitor OA-947/FST-1 when AN/FPS-18 is installed as a remote gap-filler facility.

COMPONENT	QTY	HEIGHT (Inches)	WIDTH (Inches)	DEPTH (Inches)	UNIT WT. (Pounds)
Antenna Group OA-897A/FPS-14	1				2918
Transmitter Group OA-1140/FPS-18	2	84	56	35-1/2	1805
Power Supply PP-1497/FPS-18	2	84	44	34-1/8	1745
Electron Tube Liquid Cooler MX-2010/FPS-18 605	2	46	30		56
Receiver Group QA-1231/FPS-18	2	84	40	24	844
Indicator Group QA-1339/FPS-18	1	40	18-1/2	30-1/2	213
Control Monitor C-2097/FPS-18	1	53-1/8	10	27	485
Motor Generator PU-366/FPS-18	1				2000
Voltage Regulator CN-385/FPS-18	2	40--1/2	24	20-7/8	495
Directional Coupler CU-453/FPS-14	2	7-3/4	5-1/4	24-1/2	32
Waveguide Switch SA-436/FPS-14	1	11-3/4	13-1/4	13-1/4	34
Dummy Load DA-114/FPS-14	1	5	6-1/4	31-1/2	31
Mobile Test Cart FN-83/FPS-14	2	24	38-1/2	32	62

**AN/FPS-18: 2**



ITEM NAME: RADAR SET  
TYPE:: AN/FPS-14

COMPONENT	QTY	HEIGHT (Inches)	WIDTH (Inches)	DEPTH (Inches)	UNIT WT. (Pounds)
Alarm Monitor Group OA-1441/FPS-18 Transmitting Set, Radar AN/FPT-6(v) *Tower AB-637/FPS **Tower AB-665/FPS Radome CW-413/FPS	2	84	26	26	390

NOTE: \* Used on AN/FPS-18 only  
\*\* Used on AN/FPS-18A only.

REFERENCE DATA AND LITERATURE

Technical Orders:  
31P6-2FSPS18- Series

DATE: 15 December 1964  
 COGNIZANT SERVICE: USAF

ITEM NAME: RADAR SET  
 TYPE:: AN/FPS-19

FEDERAL STOCK NUMBER: 5840-342-3086

	USA	USN	USAF	USMC
STATUS OR TYPE CLASSIFICATION			Std	
Mfg(s) Name or Code Number. Raytheon Mfg. Company				

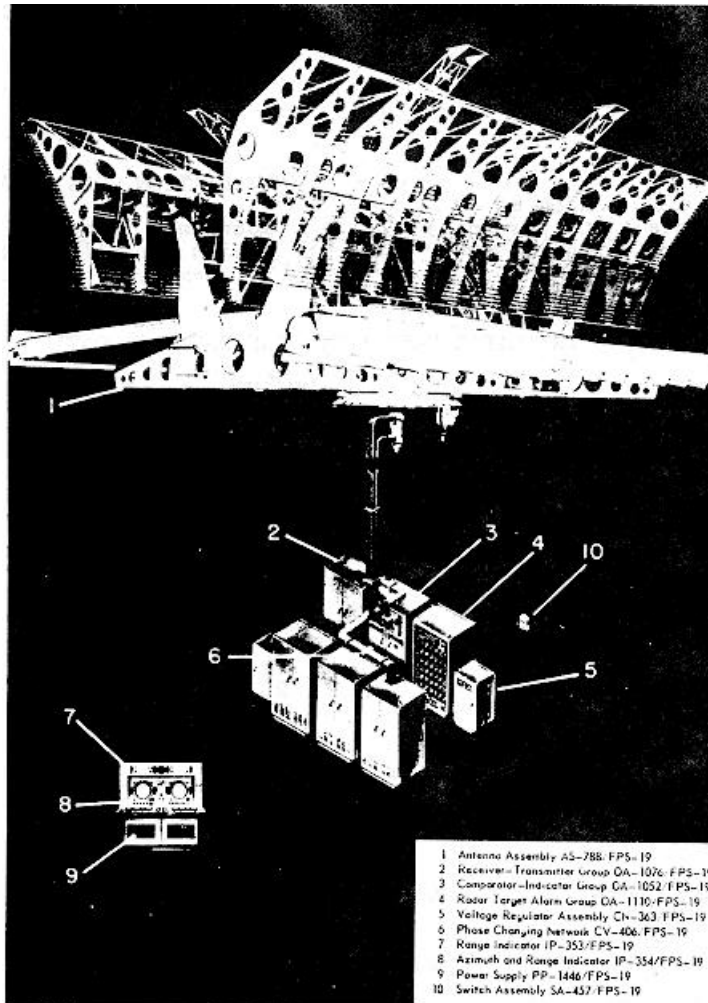

**FUNCTIONAL DESCRIPTION**

Radar Set AN/FPS-19 is an early warning L-band, long-range, dual antenna search radar designed for a fixed installation where a high degree of reliability and ease of maintenance is desired. Dual radars

operate into a single antenna pedestal to obtain a high degree of target detection. The two radars operate simultaneously. Each uses one of a pair of reflectors mounted back-to-back. Each may be used as a normal radar or as a moving target indicator. Two

**ITEM NAME:** RADAR SET  
**TYPE:** AN/FPS-14

automatic radar target alarm groups furnish visual alarm signals to the radars. An alarm appears when a moving target is within the range limits of the guarded bands. Thirty-six channels are guarded in a total of six bands. Each band can be set at any range between 20 and 120 miles. Either a cosecant-squared or a pencil-beam antenna pattern is used. The AN/FPS-19 is designed to operate when the antenna is covered by one-eighth of an inch of ice. In this condition it searches to a maximum altitude of 8000 feet. The AN/FPS-19 operates when winds are as high as 40 miles per hour.

**RELATION TO SIMILAR EQUIPMENT** None.

**TECHNICAL DESCRIPTION**

Frequency Range: 1220 - - 1350 mc  
Pulse Repetition Ratio: 400 pps (nom)  
Average  
Output Power: 0 to .0 kw  
Intermediate Frequency: 30 mc

Receiver Noise Figure: 5 to 15 db  
Antenna  
Rotation: 360 deg continuously  
Beam Pattern: Cosecant-squared for normal operation; pencil for emergency  
Standing Wave Ratio: 1.1 to 2.6  
Reflectors elevation angles  
Normal Mode  
Upper Beam: 6-1/2 deg  
Lower Beam: 2 deg  
Manual Mode  
Upper Beam: -2 to plus 18 deg  
Lower Beam: -2 to plus 18 deg  
Rotation Speeds: 3.3, 5, 6.6, and 10rpm  
Operating Voltages and Power Requirements:  
208v ac, 60 cps, 3-ph, 4-wire, 60 kw  
Sweep Ranges:  
A Type: 0-20, 0-40, 0-80, 0-160 naut mi  
PPI Type: 0-20, 0-40, 0-80, 0-160 naut mi

**INSTALLATION CONSIDERATIONS**

Mounting: Requires a rigid superstructure with a platform to support the antenna assembly (not supplied)

**PRINCIPAL COMPONENT AND PHYSICAL DATA**

COMPONENT	QTY	HEIGHT (Inches)	WIDTH (Inches)	DEPTH (Inches)	UNIT WT. (Pounds)
Antenna Assembly AS-788/FPS-19	1	108	432	48	
Voltage Regulator Assembly CN-363/FPS-19	2	45-5/8	24-1/8	25-1/4	
Phase Changing Network 2 CV-406/FPS-19					
Range Indicator IP-353/FPS-19	2	7-5/8	20	25	
Range and Azimuth Indicator IP-354/FPS-19	2	20	19-5/8	27	
Comparator-Indicator Group 2 72 40 30 OA-1052/FPS-19					
Receiver-Transmitter Group 2 72 40 30 OA-1076/FPS-19					
Radar Target Alarm Group 2 72 40 30 OA-1110/FPS-19					
Power Supply PP-1446/FPS-19	2	11	11-1/4	18	
Switch Assembly SA-457/FPS-19	1	10-1/2	7	4-1/2	

**REFERENCE DATA AND LITERATURE**

Technical Orders:  
31P6-2FPS19- Series

DATE: 1S December 1964      ITEM NAME: RADAR SET

COGNIZANT SERVICE: USAFTYPE: AN/FPS-30

FEDERAL STOCK NUMBER: 5840-588-9674

	USA	USN	USAF	USMC
STATUS OR TYPE CLASSIFICATION			Std	
Mfg(s) Name or Code Number: Bendix Radio Division of the Bendix Corp., Baltimore 4, Maryland				

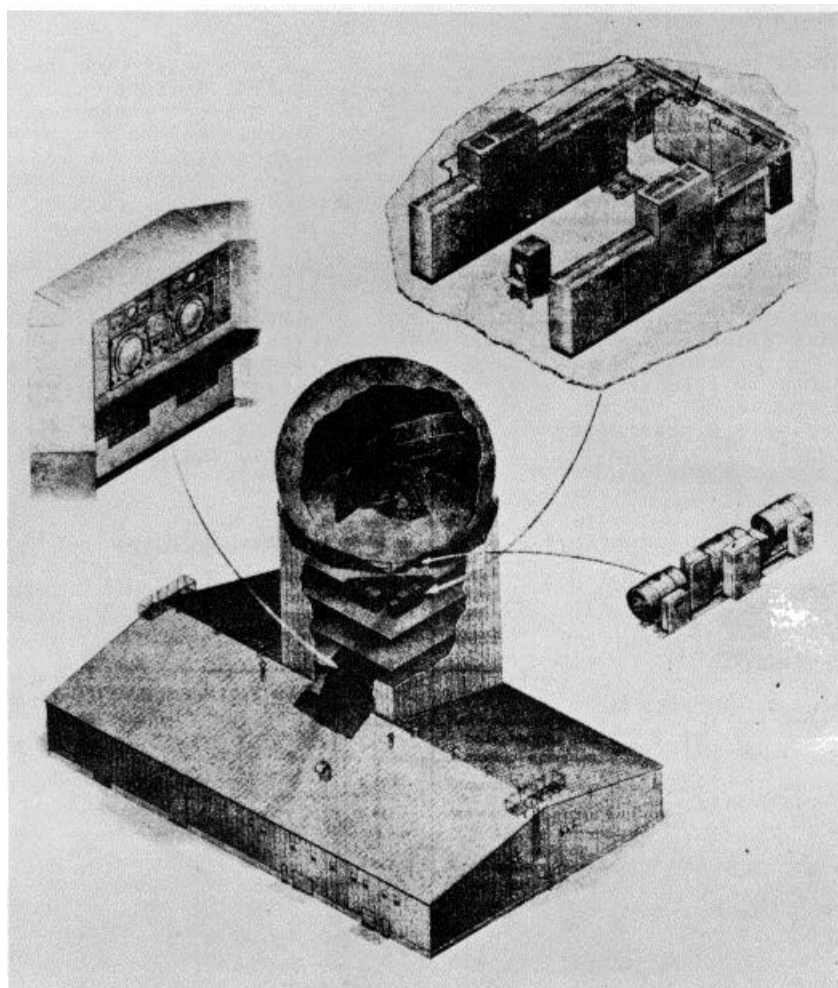

**FUNCTIONAL DESCRIPTION**

Radar Set AN/FPS-30 is a high-power, long-range, L-band search radar system. It is capable of detecting, locating, and identifying any conventional high

performance aircraft. For continuous operation and extended reliability two complete radar transmitter and receiver systems are included in this radar set.

**AN/FPS-30: 1**

**ITEM NAME:** RADAR SET  
**TYPE:** AN/FPS-30

**RELATION TO SIMILAR EQUIPMENT**

None.

**TECHNICAL DESCRIPTION**

Frequency Range: 570 to 630 mc (var)  
Pulse Repetition Rate: 385 pps  
Pulse Repetition Interval: 2595 usec  
Pulse Duration:  
    52 usec (norm operation)  
    4 usec  
    Variable from 4 to 52 usec  
Pulse Compression  
Peak Power Output:  
    400 kw with 4 usec pulse width  
    200 kw with 52 usec pulse width  
Average Power Output:  
    4 kw with 52 usec pulse width  
    616 w with 4 usec pulse width  
Duty Cycle:  
    0.020 with 52 usec pulse width  
    0.00154 with 4 usec pulse width  
Range: 200 naut mi  
Altitude: 145,000 ft  
Elevation Angle: 0 - 30 deg  
Azimuth Angle: 0 - 360 deg  
Range Accuracy: plus or minus 2 naut mi  
Beacon Identification Frequency Range:  
    990 to 1040 mc - transmit  
    1080 to 1130 mc - receive  
Intermediate Frequency: 30 mc  
Minimum Discernible Signal Band:  
    Wide-Band Mode - 110.5 dbm  
    Narrow-Band Mode - 124 dbm

Noise Figure: 6.5 db  
Resolution:  
Min of 675 yds between targets in  
    slant range direction in 4 usec mode.  
Min of 2 degrees between targets in  
    azimuth.  
Sweep Ranges: 0 - 30, 0 - 50, 0 - 100,  
    0 - max naut mi  
Azimuth Accuracy: plus or minus 0.5 deg

**INSTALLATION CONSIDERATIONS**

Siting: Of primary importance in select-  
ing a site is it's height above the  
surrounding terrain.  
Mounting: Both Channels of the AN/FPS-30 are housed  
on the same floor in the building and each cabinet is  
shielded to prevent interference from an external source  
or interference within the system. The radar equipment  
is located on the mezzanine floor at the icecape site,  
and on the sixth floor at the coastal site.

Cabling Requirements: The difference in the position of  
the radar equipment on the respective floors at each site  
and the distance from the antenna equipment, requires  
different lengths of RF transmission lines, RF and power  
cables and cable conduits.

Related Equipment: Radar Set Console AN/FPS-19  
(Modified).

**PRINCIPAL COMPONENTS AND PHYSICAL DATA**

<b>COMPONENT</b>	<b>QTY</b>	<b>HEIGHT (Inches)</b>	<b>WIDTH (Inches)</b>	<b>DEPTH (Inches)</b>	<b>UNIT WT.</b>
Antenna Reflector AS-1063/FPS-30	1				
Waveguide Horn AT-932/FPS-30	1				
Antenna Pedestal AB-627/FPS-30	1				
Radio Frequency Rotary Coupler CU-777/FPS-30	1				
Voltage Regulator CN-569/FPS-30	2				
Monitor-Power Distribution Group OA-2523/FPS-30	1	84	48	36.84	700
Coder Interrogator Set 2 KY-274/GPX	2				
Video Decoder KY-275/GPX	2				
Power Supply PP-2191/GPX	2				
Radar Recognition Set RT-264/UPX-6	2				

**AN/FPS-30: 2**

ITEM NAME: RADAR SET  
 TYPE: AN/FPS-30

**PRINCIPAL COMPONENTS AND PHYSICAL DATA**

COMPONENT	QTY	HEIGHT (Inches)	WIDTH (Inches)	DEPTH (Inches)	UNIT WT.
Control-Monitor Group OA-2522/FPS-30	1	84	48	36.84	600
Camera-Indicator Group OA-2524/FPS-30	1	64	51	36.84	300
Power Supply PP-2497/FPS-30	1	84	54	36.84	2200
Power Supply Group OA-2521/FPS-30	1	84	54	36.84	3310
Radio Frequency Amplifier AM-2367/FPS-30	1	120	72	36.84	5600
Radar Set Group OA-2520/FPS-30	1	84	54	36.84	1300
Indicator Group OA-2525/FPS-30	1				
Coaxial-to-Waveguide Adapter UG-1341/FPS-30	2				
Duplexer CU-778/FPS-30	2				
Directional Coupler CU-790/FPS-30	2				
Electrical Dummy Load OA-224/FPS-30	1				
Low Pass Filter F-455/FPS-30	1				
Azimuth-Range Indicator IP-521/FPS-30	2				
Range Indicator IP-529/FPS-30	2				
Power Supply PP-2428/FPS-30	2				
Antenna Control C-3013/FPS-30	1				
Control-Indicator C-3104/FPS-30	1				
Coder-Decoder Control C-3117/GPA-97	1				
Motor-Generator PU-470/FPS-30	1				
Radio Frequency Transmission Line					
Radio Frequency Cable Assembly					

REFERENCE DATA AND LITERATURE  
 Technical Orders:  
 31P6-2FPS30- Series

DATE: 1 July 1964 ITEM NAME: RADAR SET

COGNIZANT SERVICE: USA TYPE: AN/FPS-36

LINE ITEM NUMBER: 631397

FEDERAL STOCK NUMBER: 5840-562-8903

	USA	USN	USAF	USMC
STATUS OH TYPE CLASSIFICATION	Std-A			
Mfg(s) Name or Code Number. Raytheon Mfg. Company, Waltham, Massachusetts				

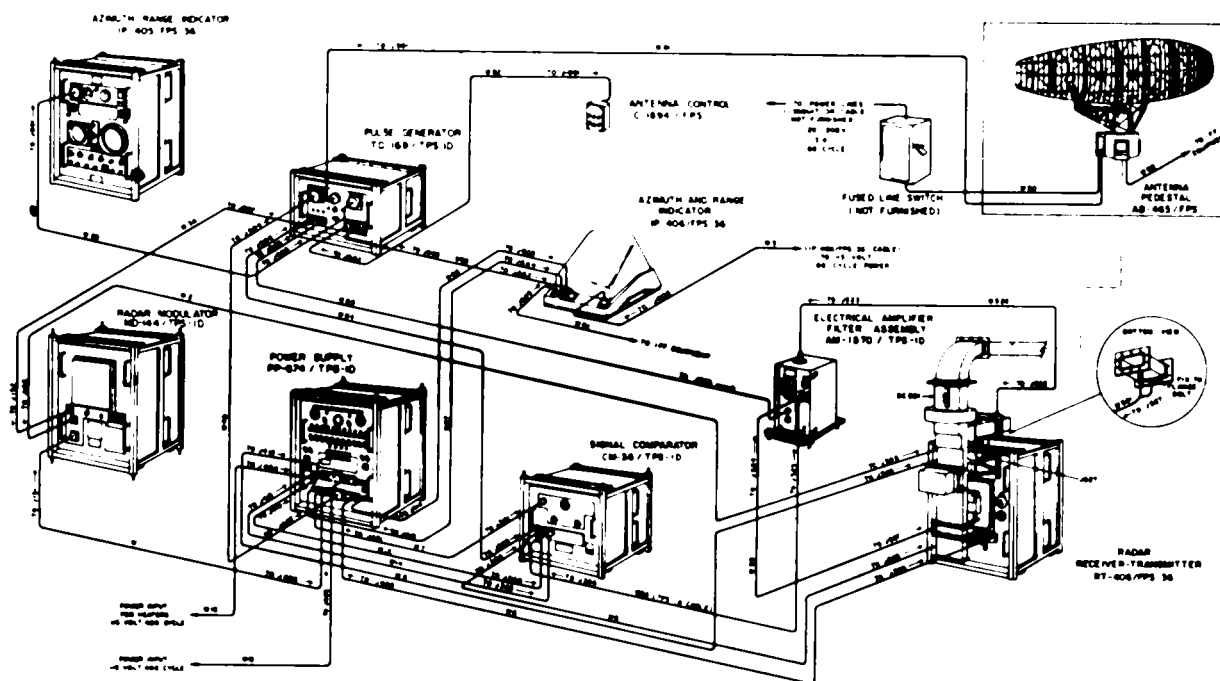

**FUNCTIONAL DESCRIPTION**

Radar Set AN/FPS-36 is a fixed-position, high-power search radar used for detecting aircraft within a range of 200 nautical miles in any azimuth direction. The AN/FPS-36 equipment consists of Radio Set AN/TPS-1D modified with Modification Kit MK-304/TPS-

1D. This modification improves the operation of the AN/TPS-1D, and increases the maximum operational range from 160 to 200 nautical miles. The AN/FPS-36 features a MTI system. When switched from normal radar operation, the clutter of return echo

**ITEM NAME: RADAR SET**  
**TYPE: AN/FPS-36**

from fixed objects is reduced or removed from the radar indicators. This feature aids the operator in the detection of moving targets.

**RELATION TO SIMILAR EQUIPMENT**

The AN/FPS-36 is a modified Radio Set AN/TPS-ID that has been modified with Electronic Equipment Modification Kit MK-304/TPS-ID

**TECHNICAL DESCRIPTION**

Frequency: 1220 to 1350 mc  
Wavelength: 24.6 to 22.2 cm  
Range, Max: 200 naut mi  
Range, Min: 300 yd  
Peak Power Output: 500 kw  
Operating Voltages and Power Requirements:  
115v plus or minus 5%, 400 cps plus or minus 4%, 7.5 kw; 120/200v ac plus or minus 5%, 60 cps plus or minus 4%, 4-wire, 3-ph, 27 kw, (includes 5 kw system power and 2.5 kw heater power)  
Type of Presentation: 7-in. PPI, 10-in. PPI, 5-in. A-scope  
Duty Cycle: 0.001 (For prr of 400 pps)  
RF Power Source: Type Magnetron 5J26  
Azimuth Scan: 360 deg cw at 6 rpm  
Antenna Gain: 34 db along axis of max radiation  
Range Accuracy: 3% of range plus 1 naut mi (at max range)  
Pulse Repetition Rate: 325 plus or minus 10 pps on 200-mi range. On other ranges adjustable from 360 to 400 pps in normal operation; fixed 400 pulses per second in MIT operation and normal operation.  
Pulse Width: 2 usec  
Horizontal Beam Width: 1.4 plus or minus 0.2 deg at half-power points  
Vertical Beam Width: 6.2 plus or minus 0.5 deg at half-power points  
Reflector Feed: Waveguide horn at reflector focal points  
Vertical Beam Position: 2.5 deg above the

horizontal  
IFF Reflector Feed: Dipole radiator at reflector focal point  
IFF Horizontal Beam Width: 1.6 plus or minus 3 deg at half-power points  
IFF Vertical Beam Width: 6.2 plus or minus 5 deg at half-power points  
Peak RF Power Handling Capacity: 2 megw at .001 duty cycle  
Azimuth Position Synchros: 24-speed, 400 cps type 31TX4, and i-speed, 60 cps type 5HG  
RF Input Connection: L-band Waveguide Flange UG-418A/U  
IF Frequency: 60 mc  
IF Bandwidth: 1 mc  
Receiver Noise Figure: 11.7 db (nom)  
Heat Dissipation (Approx):  
Radar Modulator - 800w  
Indicator - 150w  
Remote Indicator - 160w  
Signal Comparator - 160w  
Power Supply - 350w  
Receiver-Transmitter-1300w  
Antenna Group - 27 kw  
Special Features: Antijamming circuit that limits width of echo pulse that receiver will pass.

**INSTALLATION CONSIDERATIONS:**

Siting: An ideal operating site is one that provides maximum range detection capabilities in all directions with a minimum of ground clutter, shadow areas, and ghost images. The radar site should be located at an elevated position and the line-of-sight path from the radar to all points on the horizon should be level or slanting slightly downward.  
Mounting: Antenna and antenna components are installed on a reinforced concrete foundation. A weatherproof shelter is necessary for the protection of installed radar operating components. This shelter must be located not more than 20 ft from the antenna.

**PRINCIPAL COMPONENTS AND PHYSICAL DATA**

COMPONENT	QTY	HEIGHT (Inches)	WIDTH (Inches)	DEPTH (Inches)	UNIT WT.
Antenna Pedestal AB-465/FPS	1	99	111	94	7430
Antenna AS-847/FPS	1	194	480	205	1322
Radar Receiver-Transmitter RT-406/FPS-36	1	29	24-1/4	24	335
Radar Modulator 1 29 24-1/4 24 350 MD-144/TPS-ID					
Power Supply PP-674/TPS-ID	1	29	24-1/4	24	242

**AN/FPS-36: 2**



**MIL-HDBK- 162A**  
15 December 1965

Volume 1  
Section 1

**ITEM NAME:** RADAR SET  
**TYPE:** AN/FPS-36

**PRINCIPAL COMPONENTS AND PHYSICAL DATA**

<b>COMPONENT</b>	<b>QTY</b>	<b>HEIGHT (Inches)</b>	<b>WIDTH (Inches)</b>	<b>DEPTH (Inches)</b>	<b>UNIT WT.</b>
Antenna Control C-1894/FPS	1	5-5/16	4-1/16	2-5/8	4
Azimuth-Range Indicator IP-405/FPS-36	1	29	24-1/4	24	213
Azimuth-Range Indicator IP-406/FPS-36	1	17-3/4	17-3/4	28	93
Signal Comparator CM-36/TPS-1D	1	29	24-1/4	24	208
Pulse Generator TD-169/TPS-1D	1	15-3/16	24	24	77
Electrical Amplifier-Filter Assembly AM-1570/TPS-ID	1	17	8-1/2	12	11

**REFERENCE DATA AND LITERATURE**

Technical Manuals:  
TB 11-1167-2  
TM 11-5840-201-10  
TM 11-5840-201-20  
TM 11-5840-201-35/1

**DATE:** 1 July 1964

**ITEM NAME:** RADAR SET

**COGNIZANT SERVICE:** USN

**TYPE:** AN/FPS-37

**FEDERAL STOCK NUMBER:**

	USA	USN	USAF	USMC
STATUS OR TYPE CLASSIFICATION				

Mfg(s) Name or Code Number General Electric Company, Syracuse, New York

Illustration not Available

#### FUNCTIONAL DESCRIPTION

Radar Set AN/FPS-37 is a fixed, ground, dual-channel (one operating and one standby), remotely operated, air traffic control, surveillance radar set. The high gain antenna has provisions for either linear or

circular polarization of the radiated energy. The operations center has remote control facilities and selection of PPI presentation at various locations.

**ITEM NAME:** RADAR SET  
**TYPE:** AN/FPS-37

**RELATION TO SIMILAR EQUIPMENT**

Radar Set AN/FPS-37 is similar to Radar Set AN/FPS-b, except for high gain antennas, MTI equipment, and provisions for dual-channel and remote control operation.

Pulse Repetition Rate: 360 pps  
Pulse Duration: 3 usec  
Horizontal Beam Width: 1.3 deg  
Vertical Beam Width: 5 deg  
Emissions Type: PO  
Power Requirements: 120 to 200v ac  
60 cps, 3-ph, 4-wire

**TECHNICAL DESCRIPTION**

Frequency: 1280 to 1350 mc  
Power Output: 1 megw

**INSTALLATION CONSIDERATIONS**

Not available.

**PRINCIPAL COMPONENTS AND PHYSICAL DATA**

COMPONENT	QTY	HEIGHT (Inches)	WIDTH (Inches)	DEPTH (Inches)	UNIT WT.
Radar Set Control Group OA-2312/FPS-37	1		17.25	17.25	
Switch, Waveguide SA-644/FPS-37	1	14.18	17-1/4	17-1/4	
Dummy Load, Electrical DA-180/FPS-33	1	9.00	39.932	5.55	
Modulator Group OA-414A/FPS-8	1				
Power Supply Group OA-412A/FPS-B	1		4.50	3.75	
Coupler, Directional CU-319/FPS-B	1	1.50	4-1/2	14.69	
Interconnecting Box J-1062/FPS-37	1	20.00	34.3	14.69	
Radar Set, Control Group OA-2333/FPS-37	1				
Control Antenna C-2870/FPS-37	1	10.00	6.00	7.00	
Moving Target Indicator Group OA-2332/FPS-37	2				
Transmitter Group OA-416A/FPS-8	2				
Receiver Group OA-417A/FPS-8	2				

**REFERENCE DATA AND LITERATURE**

Technical Manuals:  
NAVSHIP 9300

Specifications:  
MIL-R-9569A  
822B-097

**AN/FPS-37: 2**

**DATE:** 1 July 1964

**ITEM NAME:** RADAR METEOROLOGICAL SET

**COGNIZANT SERVICE:** USN

**TYPE:** AN/FPS-41(XN-1)

**FEDERAL STOCK NUMBER:**

	USA	USN	USAF	USMC
STATUS OR TYPE CLASSIFICATION				

Mfg(s) Name or Code Number. Raytheon Manufacturing Company, Waltham, Mass.

Illustration not Available.

**FUNCTIONAL DESCRIPTION**

The AN/FPS-41(XN-1) is an all-purpose weather radar system for use in the detection of precipitations and associated meteorological phenomena.

**NOTE:** Conical beam and ISO-Echo circuitry incorporated to facilitate meteorological application.

**ITEM NAME:** RADAR METEOROLOGICAL SET

**TYPE:** AN/FPS-41(XN-1)

**RELATION TO SIMILAR EQUIPMENT**

None.

Receiver Frequency Range: 2700 to 3300 mc

Operating Power Requirement: 208 to 220v, 50 to 60  
cps, 3 ph

**TECHNICAL DESCRIPTION**

Transmitter Frequency Range: 2700 to 3300  
mc

**INSTALLATION CONSIDERATIONS**

Not available.

**PRINCIPAL COMPONENTS AND PHYSICAL DATA**

Not Available.

**REFERENCE DATA AND LITERATURE**

Nomenclature Card AN/FPS-41(XN-1) Radar Set,  
Meteorological.

**DATE:** 15 January 1965

**ITEM NAME:** METEOROLOGICAL SET RADAR

**COGNIZANT SERVICE:** USAF

**TYPE:** AN/FPS-77(V)

**FEDERAL STOCK NUMBER:** 6660-874-8532

	USA	USN	USAF	USMC
STATUS OR TYPE CLASSIFICATION			Tent. Std	
Mfg(s) Name or Code Number	Lear Siegler Inc., Long Island City, New York			

No Illustration Available.

**FUNCTIONAL DESCRIPTION**

Meteorological Set, Radar AN/FPS-77(V) is intended for use in locating, detecting, and displaying meteorological phenomena associated with precipitation areas within a 200 nautical mile range.

It is further intended that the AN/FPS-77(V) will serve as a gap-filler type radar when installed in the storm detecting radar network in conjunction with the long-range weather Radar Set, AN/CPS-9.

**AN/FPS-77(V): 1**

**ITEM NAME:** METEOROLOGICAL SET RADAR

**TYPE:** AN/FPS-77(V)

**RELATION TO SIMILAR EQUIPMENT**

The AN/FPS-77(V) replaces the AN/FPS-68. The AN/FPS-77(V) will differ from the AN/ FPS-68 in several distinct areas. The AN/FPS-77(V) has several built-in test facilities. The main PPI has been changed from a dark viewing phosphor tube to a daylight indicator utilizing a storage tube. The remote indicator has likewise been changed to the daylight indicator design. A camera has been added for photographing the main PPI, the RHI, and the A/R scopes of the main console. The range markers have been changed from a countdown circuit design. The elevation drive system for the antenna (and the RHI scope) has been provided with an elevation sector scan feature. The RT-639/FPS-77(V) unit has been changed from a table-mounted design, which proved very cumbersome in maintenance and servicing, to a floor-mounted design employing pull-out chassis construction. Front and back access to the RT639/FPS-77(V) has been provided. The servo

amplifiers associated with the antenna drive system have been removed from the antenna pedestal and are now mounted in the RT-639/ FPS-77(V) shelter for ease of maintenance. The solid state circuitry which proved to be highly temperature sensitive has been replaced by electron tubes. The modular construction concept has been retained but with additional test provisions to aid in trouble-shooting.

**TECHNICAL DESCRIPTION**

Power Requirements:

115v ac, 60 cycles, single ph

Frequency:

Transmitter; 5450 to 5650 mc, single band, single channel.

Receiver; 5450 to 5650 mc, single band, single channel.

**INSTALLATION CONSIDERATIONS**

Siting: Fixed installation.

**PRINCIPAL COMPONENTS AND PHYSICAL DATA**

COMPONENT	QTY	HEIGHT (Inches)	WIDTH (Inches)	DEPTH (Inches)	UNIT WT.
Antenna Group OA-3493/FPS-77(V) (Fixed Component)	1				
Console Group, Meteorological Set, Radar OA-3491/FPS-77(V) (Fixed Component)	1				
Indicator Group OA-3492/FPS-77(V) (Variable Component)	1				
Radome CW-603/FPS-77(V) (Variable Component)	1	120	72		
Receiver-Transmitter, Radar RT-639/FPS-77(V) (Fixed Com)ponent	1	24	36	48	
Tower AB-703/FPS-77(V) (Variable Component)	1	840	198		
Tower Section AB-704/FPS-77(V) (Variable Component)	1	360	252		

**REFERENCE DATA AND LITERATURE**

Nomenclature Card and AF Form B1 for AN/FPS-77(V)

DATE: 15 February 1965  
COGNIZANT SERVICE: USAF

ITEM NAME: RADAR SET  
TYPE: AN/FPS-78

FEDERAL STOCK NUMBER: 5840-875-0226

	USA	USN	USAF	USMC
STATUS OR TYPE CLASSIFICATION		Used By		
Mfg(s) Name or Code Number: General Electric Co., Defense Electronics Div., Syracuse, N.Y.				



**FUNCTIONAL DESCRIPTION**

Radar Set AN/FPS-78 determines the presence and location of unknown airborne objects.

**RELATION TO SIMILAR EQUIPMENT**

None.

**AN/FPS-78: 1**



**ITEM NAME:** RADAR SET  
**TYPE:** AN/FPS-78

**TECHNICAL DESCRIPTION**

Frequency Data  
Transmitter: 186 to 207 mc, 4 channels  
Receiver: 175 to 215 mc, 7 channels  
Power Requirements  
Input: 2400v ac, 3-ph, 60 cycles, 1000  
kva

208v ac, 3-ph, 60 cycles

**INSTALLATION CONSIDERATIONS**

Not available.

**PRINCIPAL COMPONENTS AND PHYSICAL DATA**

<b>COMPONENT</b>	<b>QTY</b>	<b>HEIGHT (Inches)</b>	<b>WIDTH (Inches)</b>	<b>DEPTH (Inches)</b>	<b>UNIT WT.</b>
Transmitters	2				
Receivers	2				
Monitor Control Console (Tracker)	1				
Automatic Digital Data Processor	1				
60 Foot Tracking Antenna	1				
Air Conditioning System	1				

**REFERENCE DATA AND LITERATURE**

Nomenclature Card dated 18 October 1961.

**DATE:** 1 March 1965

**ITEM NAME:** RADAR SET

**COGNIZANT SERVICE:** USAF

**TYPE:** AN,/FPS-79

	USA	USN	USAF	USMC
STATUS OR TYPE CLASSIFICATION				
Mfg(s) Name or Code Number:				

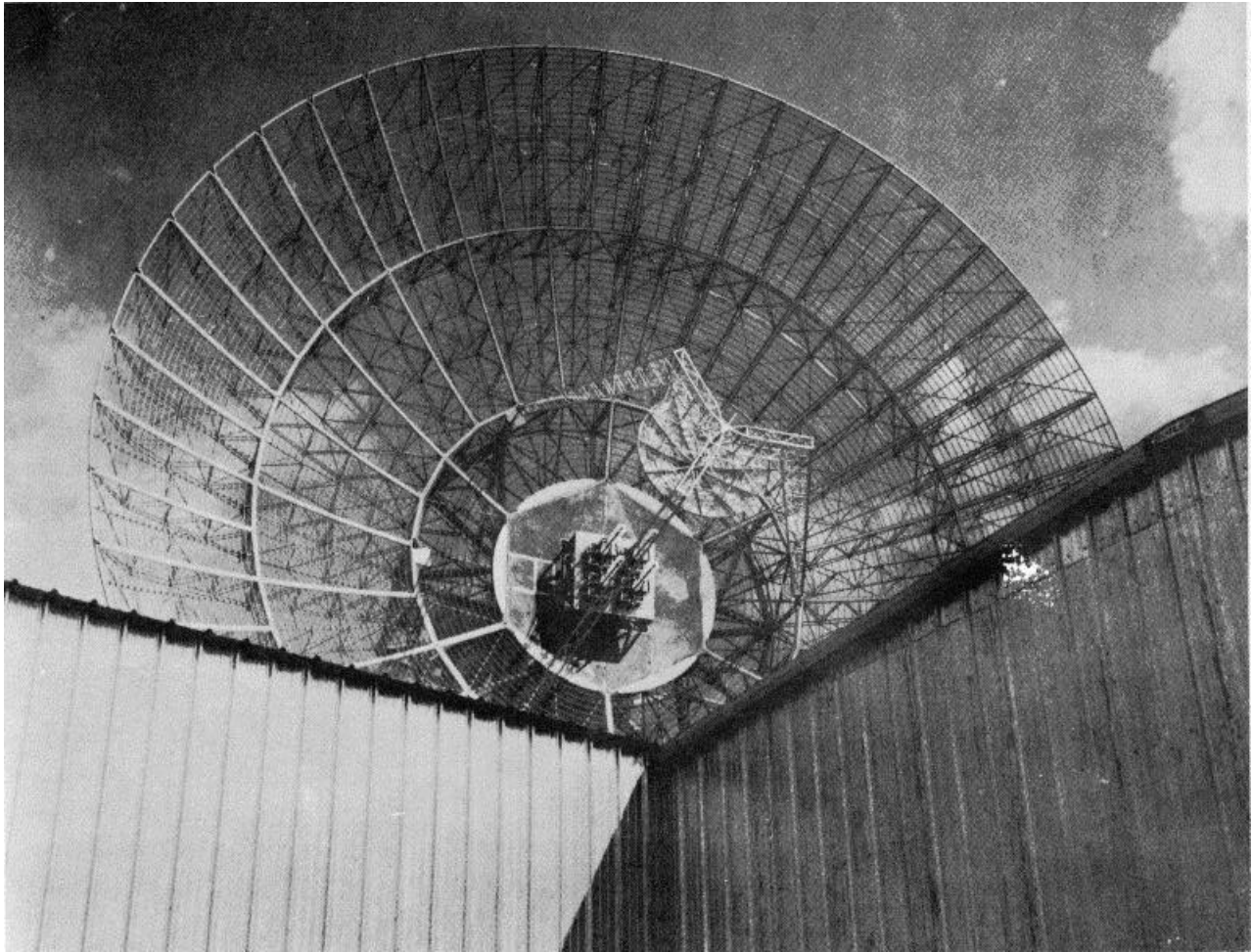

**FUNCTIONAL DESCRIPTION**

Radar Set AN/FPS-79 is used for tracking all types of

orbiting vehicles for determination of orbital path

**AN/FPS-79: 1**

**ITEM NAME:** RADAR SET  
**TYPE:** AN/FPS-79

**RELATION TO SIMILAR EQUIPMENT**

None.

**INSTALLATION CONSIDERATIONS**

Siting: Fixed installation; specific use.

**TECHNICAL DESCRIPTION**

Not Available.

**PRINCIPAL COMPONENTS AND PHYSICAL DATA**

<b>COMPONENT</b>	<b>QTY</b>	<b>HEIGHT (Inches)</b>	<b>WIDTH (Inches)</b>	<b>DEPTH (Inches)</b>	<b>UNIT WT.</b>
Transmitter Group					
Modulator Group					
Power Supply Group					
Receiver Group					
Antenna Group					
Antenna					
Pedestal					

**REFERENCE DATA AND LITERATURE**

Unclassified Nomenclature card for AN/FPS-79 dated 2 Jan 62.

**DATE:** 1 September 1965  
**COGNIZANT SERVICE:** USAF

**ITEM NAME:** RADAR SET  
**TYPE:** AN/FPS-85

**FEDERAL STOCK NUMBER:**

	USA	USN	USAF	USMC
STATUS OR TYPE CLASSIFICATION				
Mfg(s) Name or Code Number. Bendix Radio Division of Bendix Corporation, Towson, Maryland				

Illustration not Available.

**FUNCTIONAL DESCRIPTION**

Radar Set AN/FPS-d5 is designed for the long range detection and tracking of satellites. The radar beam is formed and scanned electronically.

**RELATION TO SIMILAR EQUIPMENT**

The AN/FPS-B5 is not interchangeable with any existing like item in ; r Force use.

**AN/FPS-85: 1**

**ITEM NAME:** RADAR SET  
**TYPE:** AN/FPS-85

**TECHNICAL DESCRIPTION**

Frequency Data

Transmitter: 120 to ,150 mc, 1 band

Receiver: 120 to 150 mc, 1 band

Operating Power Requirements: ac, 4160,  
120/208v,60 cyc, 3-ph

**INSTALLATION CONSIDERATIONS**

Not available.

**PRINCIPAL COMPONENTS AND PHYSICAL DATA**

<b>COMPONENT</b>	<b>QTY</b>	<b>HEIGHT (Inches)</b>	<b>WIDTH (Inches)</b>	<b>DEPTH (Inches)</b>	<b>UNIT WT.</b>
Antenna Group	1				
Receiver Group	1				
Transmitter Group	1				
Beam Forming Network	1				
Control and Programmer (Group	1				
Indicator Group	1				
Tracking Group	1				
Data Processing and Recording (Group)	1				
Power Supply Set	1				

**REFERENCE DATA AND LITERATURE**

Unclassified AFSC Form 81 for AN/FPS-85 dated :31 Aug 64.

**DATE:** 15 January 1965

**ITEM NAME:** RADAR SET

**COGNIZANT SERVICE:** USAF

**TYPE:** AN/FPS-89

**FEDERAL STOCK NUMBER:** 5840-966-7034

	USA	USN	USAF	USMC
STATUS OR TYPE CLASSIFICATION			Std	
Mfg(s) Name or Code Number: General Electric Company, Syracuse, New York				

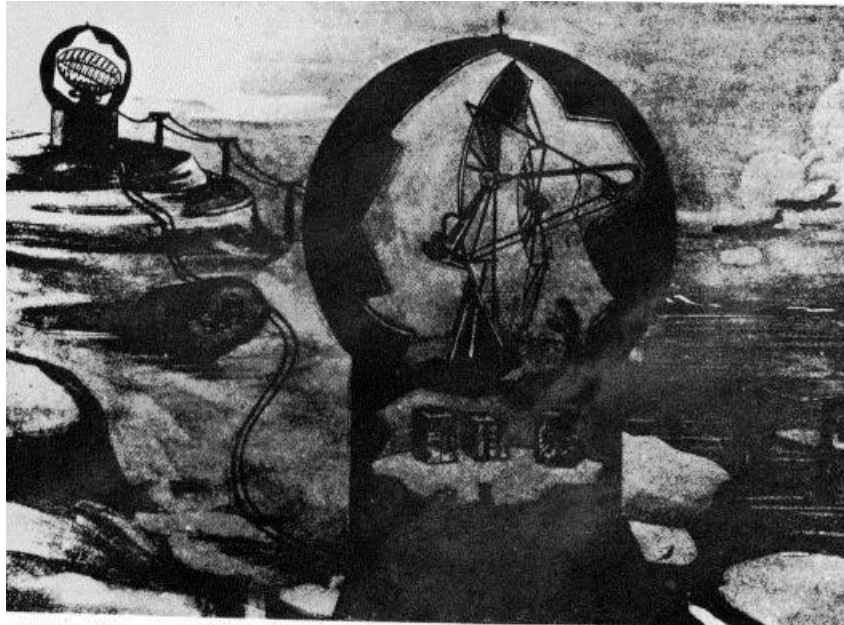

**FUNCTIONAL DESCRIPTION**

Radar Set AN/FPS-89 is a high power long-range height finding radar. The AN/FPS-89 is normally used in conjunction with a

search radar of comparable range capability, and derives its power from the same source that supplies the search radar.

**AN/FPS-89: 1**

**ITEM NAME:** RADAR SET

**TYPE:** ,AN./FPS-89

**RELATION TO SIMILAR EQUIPMENT**

AN/FPS-b9 is basically an AN/FPS-6B with Ferrite Circulator added and variable nod angle control features removed.

Receiver; 2700 to 2900 mc freq range, band, single channel  
Operating Power Requirements:  
input; 120/208v ac, 60 cps, 3-ph

**TECHNICAL DESCRIPTION:**

Frequency Data:  
Transmitter; 2700 to 2900 mc freq range,  
1 band, single channel

**INSTALLATION CONSIDERATIONS**

Related Equipment: Used with, but not part of MX-1739A/FPS, C-1050/FPS-6, ID-331/FPS-6, OA-1040/GPS

**PRINCIPAL COMPONENTS AND PHYSICAL DATA**

COMPONENT	QTY	HEIGHT (Inches)	WIDTH (Inches)	DEPTH (Inches)	UNIT WT.
Radar Set Control Group OA-203B/FPS-6B	1				
Radar Set Group OA-2039/FPS-6B	1				
Antenna Group OA-2035/FPS-6A	1				
Transmitter, Radar T-33BA/FPS-6	1				
Cooler, Liquid Electron Tube HD- 11/FPS-6	1				
Dehydrator Desiccant Electric HD-187A/tPS-6:N	1				
Amplifier-Regulator Group OA-329A/FPS-6	1				
Power Supply PP-7b3/FPS-6	1				
Regulator, Voltage CN-93/C PS-6B	1				
Terminal Box J-910/FPS-6B	1				
Indicator Group OA-929/FPS-6A	1				
Control, Antenna C-1830/GPS	1				
Radio Frequency Reflection CU-492A /FPS-6A	1				
Control, Antenna C-1049/FPS-6	1				
Telephone Set TA-1/PT	1				
Adapter Base MX-1597/GP	1				

**REFERENCE DATA AND LITERATURE**

Nomenclature Card dated 5 December 1962

DATE: 15 December 1964

ITEM NAME: RADAR SET

COGNIZANT SERVICE: USAF

TYPE: \*AN/FPS-90, \*eAN/FPS-507

FEDERAL STOCK NUMBER: \*5840-983-1786

	USA	USN	USAF	USMC
STATUS OR TYPE CLASSIFICATION			*Used By	
			**Used By	
Mfg(s) Name or Code Number. *General Electric Co., **Canadian Marconi				

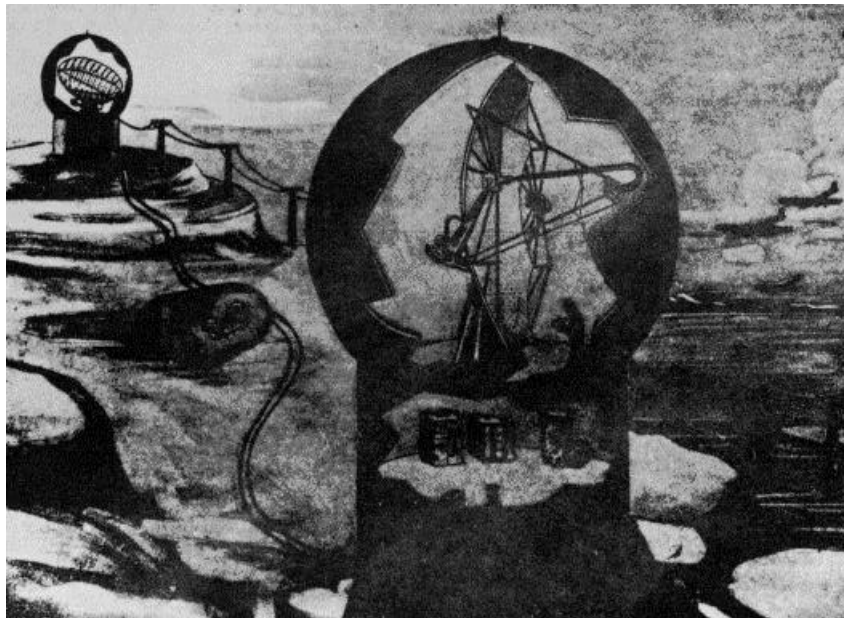

**FUNCTIONAL DESCRIPTION**

Radar Set AN/FPS-90 and AN/FPS-507 are long range, high power, air transportable, height finding radar.

These Radar Sets normally are used in conjunction with a search radar of comparable range capability and derives its power from the same source that supplies the search radar.



**ITEM NAME:** RADAR SET  
**TYPE:** AN/FPS-90, AN/FPS-507

**RELATION TO SIMILAR EQUIPMENT**

Radar Set AN/FPS-90 has been assigned to Radar Sets AN/FPS-6( ) which have had the mechanical variable-nod mechanism removed from the antenna. The variable-nod controls remain in place, but are not used. Radar Set AN/FPS-507 performs the same functions as Radar Set AN/FPS-6B but performs them with greater reliability due to the substitution of Radar Transmitter T-5030/FPS-507. The reliability of the transmitter is due essential to the employment of Canadian Marconi type 7182 magnetron. Also, units of Radar Set AN/FPS-6B are modified to produce Radar Set AN/FPS-507.

**TECHNICAL DESCRIPTION**

Frequency: fixed frequency within the 2700 to 2900 mc band  
Power Output: 5 megw  
RF Power Source:  
Type QK-33cA magnetron on the AN/FPS-90  
Type 7182 magnetron on the AN/FPS-507  
Pulse Width:  
2 to 3 usec on the AN/FPS-900  
3.8 plus or minus 0.3 usec on the AN/FPS-507  
Pulse Repetition Rate: 300 to .100 pps  
Range: 100 naut mi  
Vertical Coverage: -2 to plus 32 deg angular  
Horizontal Coverage: 360 deg  
Antenna Vertical Scanning Rate: 20 or  
Range Resolution: plus or minus 1/2 pct Azimuth  
Resolution: 3.2 deg

Elevation Resolution: 0.90 deg  
Range Accuracy: plus or minus 1 pct  
Elevation Accuracy: 1000 ft  
Vertical Beamwidth: 0.85 deg  
IF. Frequency: 30 mc  
Type of Presentation: RHI scopes  
Indicator Ranges:  
Azimuth - 0 to 100 mi, 0 to 200 mi  
Height - 5000 to 75,000 ft, 5000 to 25,000 ft, 20,000 to 50,000 ft, 45,000 to 75,000 ft  
Range Marks - 10, 20, 50 mi  
Height Marks - 10,000 ft intervals  
Elevation Angle Marks - 5 deg intervals  
Power Requirements: 120/2003, 3 ph, 60 cycle, 4-wire, 50 kva

**INSTALLATION CONSIDERATIONS**

Sitting: Tower AB-2513/FPS-6 (temperate) requires a level area of 30 feet in diameter, while Tower AB-259/FPS-6 (arctic) requires a level area of 70 feet in diameter.  
Mounting: Antenna Group is installed in either temperate Tower AB-25B/FPS-6 or Arctic Tower AB-259/FPS-6. Indicator Group is installed in the operations building which contains the associated search radar.  
Related Equipment: Radar Sets AN/FPS-90 and AN/FPS-507 can be used with Radar Sets AN/FPS-3, AN/FPS-3A, AN/FPS-20, and AN/FPS-20A. Also Coordinate Data Transmitting Set AN/FST-2 is used with the AN/FPS-900 and AN/FPS-507.

**PRINCIPAL COMPONENTS AND PHYSICAL DATA**

COMPONENT	QTY	HEIGHT (Inches)	WIDTH (Inches)	DEPTH (Inches)	UNIT WT.
Motor Generator PU-293/G or PU-293A /G	1	18	16	44-5/8	
*Antenna Group OA-15-10/FPS-90	1				
**Antenna Group OA-2010/FPS-6B	1				
*Support, Antenna Reflector AB-776/FPS -90	1				
**Support, Antenna Reflector AB-580/FPS-6B	1				
Reflector, Antenna AT-873/FPS-6B	1				
Horn, Antenna AT-137/FPS-6					
Support, Antenna AB-284/FPS-6	1				
Coupler, Rotary Transmission Line UG-950/FPS -6	1				
Adapter, Base MX-1547/GP	1				
Coupler, Rotary Transmission Line UG-960/FPS-6	1				
Waveguide					
Base, Antenna AB-285/FPS-6	1				
Control, Antenna C-1055 FPS-6	1				
Blanker, Interference MX-1739A/FPS-6	1	11	15	12	49

**ITEM NAME:** RADAR SET  
**TYPE:** AN/FPS-90, AN/FPS-507

**PRINCIPAL COMPONENTS AND PHYSICAL DATA**

<b>COMPONENT</b>	<b>QTY</b>	<b>HEIGHT (Inches)</b>	<b>WIDTH (Inches)</b>	<b>DEPTH (Inches)</b>	<b>UNIT WT.</b>
Control, Antenna C-1050/FPS-6	4	18	7-1/2	13	50
Radar Set Group OA-2036/FPS-6B	1	48	24	42	1200
Isolator, RF Reflection CU-492/FPS-6A or CU-492A/FPS-6A	1	14	24	24	90 (crated) 70 (crated)
Cooler, Liquid, Electron Tube HD-188/FPS-6	1	21-3/8	34-1/4	30-1/2	300
Cooler, Liquid, R-F Isolator HD-289/FPS-6A	1	18-1/8	30	19	360 (crated)
Terminal Box J-910/FPS-6B	1	7-1/4	22-1/2	57	130 (crated)
*Transmitter, Radar T-33BA/FPS-6A	1	44	41	52	1110 (crated)
**Transmitter, Radar T-5030/FPS-507	1				
Modulator Group OA-329A/FPS-6A	1	70	44	42	1535 (crated)
Power Supply PP-783/FPS-6	1	27-1/2	48	61	1155 (crated)
Voltage Regulator CN-93/CPS-6B	1	45-1/2	21-1/2	22-1/2	425 (crated)
Indicator Group OA-1385/GPA-40 (c/o 3 crated items)	1 1	45-1/2 27	33-1/2 13-1/2	26 14	320 60
Dehydrator, Desiccant, Electric HD-187/FPS-6	1	19-3/4	14-1/2	16-1/2	65 300
Indicator Group OA-1040/GPA	1	21	21	27-1/2	150 (crated)
Indicator Group OA-929/FPS-6A	2	37	36	42-1/2	500 (crated)
Indicator, Height ID-331/FPS-6	4	11	14-1/2	6	35
Radar Set Group OA-2039/FPS-6B	1				
Control, Antenna C-1830/GPS	1	45	26	33-1/2	320 (crated)
Amplifier, Trigger AM-654/FPS-6	1				
Control, Antenna C-1049/FPS-6	1	8	7	11-1/2	25
*Used on AN/FPS-90					
**Used on AN/FPS-507					

**REFERENCE DATA AND LITERATURE**

Technical Orders:  
31P3-2FPS6- Series

**AN/FPS-90: 3**

**DATE:** 1 March 1965

**ITEM NAME:** RADAR SET

**COGNIZANT SERVICE:** USAF

**TYPE:** \*AN/FPS-93, \*\*AN/FPS-93A

**FEDERAL STOCK NUMBER:**

	USA	USN	USAF	USMC
STATUS OR TYPE CLASSIFICATION			*Ltd Std **Std	
Mfg(s) Name or Code Number. See Note 1				

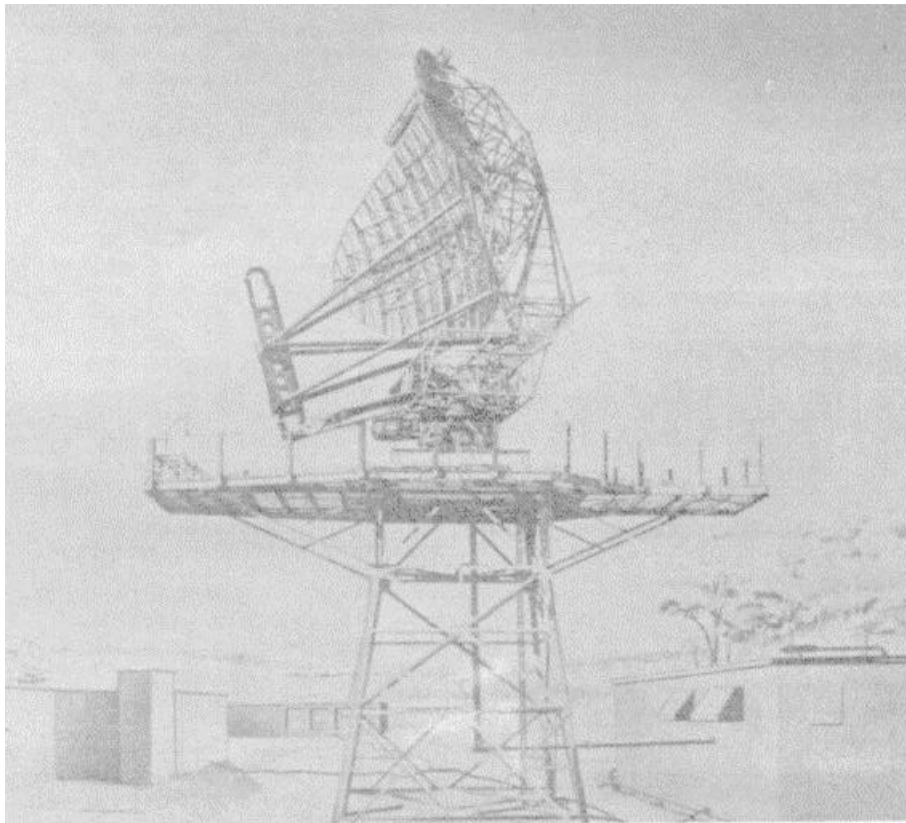

**FUNCTIONAL DESCRIPTION**

Radar Sets AN/FPS-87 and AN/FPS-87A modified by the incorporation of Modification Kit, Electronic Equipment MK-747/FPS become

Radar Sets AN/FPS-93 and AN/FPS-98A respectively, for improved long range tracking in range, azimuth and search.

**AN/FPS-93: 1**

**ITEM NAME:** RADAR SET  
**TYPE:** AN/FPS-93, AN/FPS-93A

**RELATION TO SIMILAR EQUIPMENT**

The AN/FPS-93A is one-way interchangeable with AN/FPS-93. The AN/FPS-20A is the basic building block of the AN/FPS-93A.

Receives: 1250 to 1350 mc

Bands: One  
Channels: Two  
Operating Power Requirements: 120/200v,  
ac, 60 cycle, 3-ph

**TECHNICAL DESCRIPTION**

Frequency Data  
Transmits: 1250 to 1350 mc

**INSTALLATION CONSIDERATIONS**

Not available.

**PRINCIPAL COMPONENTS AND PHYSICAL DATA**

<b>COMPONENT</b>	<b>QTY</b>	<b>HEIGHT (Inches)</b>	<b>WIDTH (Inches)</b>	<b>DEPTH (Inches)</b>	<b>UNIT WT.</b>
*Radar Set AN/FPS-87	1				
**Radar Set AN/FPS-87A	1				
Modification Kit, Electronic Equipment MK-747/FPS	1				

**NOTE:** \*For AN/FPS-93 only.  
\*\*For AN/FPS-93A only.

**REFERENCE DATA AND LITERATURE**

- Unclassified Nomenclature Card for AN/FPS-93  
dated 13 September 1963.
- Unclassified Nomenclature Card for AN/FPS-93A  
dated 13 September 1963.
- Unclassified AFSC Form 81 for AN/FPS-93A  
dated 12 October 1964.

**Note 1. WK-747/FPS: Raytheon Company, Lexington, Massachusetts.**  
**AN/FPS-87 or -87A: Bendix Corporation, Baltimore, Maryland.**

**DATE:** 1 September 1965

**ITEM NAME:** RADAR SET

**COGNIZANT SERVICE:** USAF

**TYPE:** AN/FPS-100, AN/FPS-IOOA

**FEDERAL STOCK NUMBER:**

	USA	USN	USAF	USMC
STATUS OR TYPE CLASSIFICATION				
Mfg(s) Name or (2nd Number: Bendix Corporation, Towson, Maryland				

Illustration not Available.

**FUNCTIONAL DESCRIPTION**

Fixed, ground, hi-power search radar.

**RELATION TO SIMILAR EQUIPMENT**

The AN/FPS-100 is similar to AN/FPS-20

because of the addition of the Amplifier-Control Group OA-7091/FPS and modification to other units and also additional new equipment. The AN/FPS-100 is a modified Radar Set AN/FPS-20.

The AN 'PS-100A is one-way interchangeable with AN 'FPS-100, differs mechanically, due to out)put poser.

**ITEM NAME:** RADAR SET

**TYPE:** AN/FPS-100, AN/FPS-100A

**TECHNICAL DESCRIPTION**

**INSTALLATION CONSIDERATIONS**

Frequency Data

Transmitter: 1250 to 1350 mc, 1 band,  
1 channel

Receiver: 1250 to 1350 mc, I band,  
1 channel

Operating Power Requirements: 208v ac,  
60 cps, 3-ph

Not available.

**PRINCIPAL COMPONENTS AND PHYSICAL DATA**

<b>COMPONENT</b>	<b>QTY</b>	<b>HEIGHT (Inches)</b>	<b>WIDTH (Inches)</b>	<b>DEPTH (Inches)</b>	<b>UNIT WT. (Pounds)</b>
Interconnecting Box J-724/GPS	1				
Motor Starter SA-365/FPS-3A	1				
Radio Frequency Rotary Coupler CU-512/FPS-20	1				
Antenna Pedestal AB-.III/FPS-20	1				
Fixed Attenuator CN-496/FPS-20A	1				
Direct Current Power Filter F-297/FPS-20	4				
Power Supply Subassembly 4 PP-1054/FPS-20					
Step-up Power Transformer 4 TF-190/FPS-20					
Power Supply PP-1301/GPS	4				
*Power Supply PP-1409/FPS-20	2				
Pulse Generator 0-228/GPS	8				
*Pulse Generator 0-339/FPS-20A	2				
Radar Modulator MD-212/FPS-20	4				
*Radar Modulator MD-260/FPS-20A	2				
Voltage Regulator CN-323/FPS-20	6				
Radar Set Control C-1736/FPS-20	2				
*Radar Set Control C-1934/FPS-20A	2				
Pulse Generator TD-BI/MPS-7	2				
Radio Frequency Amplifier AM-1348/FPS-20	2				
*Radio Frequency Amplifier AM-1654/FPS-20A	2				
Power Supply PP-1356/FPS-20	4				

**AN/FPS-100: 2**

ITEM NAME: RADAR SET

TYPE: AN/FPS-100, AN/FPS-100A

PRINCIPAL COMPONENTS AND PHYSICAL DATA (Continued)

COMPONENT	QTY	HEIGHT (Inches)	WIDTH (Inches)	DEPTH (Inches)	UNIT WT. (Pounds)
Radio Frequency Amplifier AM--1402/FPS-2U	2				
Radar Modulator MD-276/FPS-20	2				
Amplifier-Mixer AM 1317/FPS-20	2				
Power Supply PP-1378/FPS-20	2				
Power Supply PP-1377/FPS-20	2				
Interconnecting Box J-951/FPS-20A	1				
Switch Box SA-476/FPS-20	2				
Power Driven Rotary Pump HD-231/FPS-20	2				
Electron Tube Liquid Cooler HD-230/FPS-20	2				
Power Driven Rotary Compressor HD-246/FPS-20	2				
Radiometer IM-9()/PD	6				
Directional Coupler CU-516/FPS-20	2				
Monitor-Oscillator Group OA-955/FPS-20	2				
Waveguide Arc-Over Detector TS-1146/FPS-20A	2				
Directional Coupler CU-649/FPS-20A	2				
Electrical Dummy Load DA-126/FPS-20	1				
Waveguide Switch SA-448/FPS-20	1				
Power Supply Group OA-954/GPS	3				
Electrical Equipment Cabinet CY-1876/GPS	2				
Voltage Regulator CN-345/GPS	3				
Receiver Group OA-1077/FPS-20	2				
Receiver Group OA-8903/FPS-20	2				
Sound Measuring Set TS-2168/FPS-100	1				
Amplifier-Control Group OA-1517/FPS-20	2				

Volume 1  
Section 1

**MIL-HDBK-162A**  
15 December 1965

**ITEM NAME:** RADAR SET

**TYPE:** AN/FPS-100, AN/FPS-100A

**PRINCIPAL COMPONENTS AND PHYSICAL DATA (Continued)**

<b>COMPONENT</b>	<b>QTY</b>	<b>HEIGHT (Inches)</b>	<b>WIDTH (Inches)</b>	<b>DEPTH (Inches)</b>	<b>UNIT WT. (Pounds)</b>
Distribution Box J-855/FPS-20	2				
Electrical Bell and Indicator Light BZ-34/FPS-3A	1				
Alarm-Monitor BZ-37/MPS-7	1				
General Purpose Table FU-55/P	2				
Power Distribution Panel SB-873/FPS-20A	1				
Interconnecting Box J-590/FPS-3A	1				
Interconnecting Box J-513/MPS-7	1				
Frequency Mixer Stage 1 CV-592/FPS-20					
Antenna Reflector AT-1072/FPS-67A	1				
Antenna Boom AB-693/FPS-67A	1				
Waveguide Horn AT-1073/FPS-67A	1				
Antenna Feed Polarizer MX-3603/FPS-67A	1				
Antenna Feed Polarizer Control C-3829/FPS-67A	1				
Polarizer Antenna Feed Control C-3628/FPS-67A	1				
Electrical Dummy Load DA-281/FPS-67A	1				
Display-Plotting Board Group OA-1541/FPS-20A	1				
Electrical Special Purpose Cable Assy CX-10117/U (-ft-in.)	1				
Electrical Power Cable Assy CX-10116/U(-ft-in.)	1				
Radio Frequency Indicator ID-810/FPS-20	1				
Power Distribution Panel SB-2375/FPS-100	1				
Duplexer CU-1395/FPS-100	2				
Electrical Equipment Cabinet CY-453,1/FPS-10 0	1				



ITEM NAME: RADAR SET

TYPE: AN/FPS-100, AN/FPS-100A

PRINCIPAL COMPONENTS AND PHYSICAL DATA (Continued)

COMPONENT	QTY	HEIGHT (Inches)	WIDTH (Inches)	DEPTH (Inches)	UNIT WT. (Pounds)
Radar Set Performance Indicator ID-66BA/FPS-20A	1				
Radar Set Group OA-7090/FPS-100	1				
Amplifier-Control Group OA-7091/FPS-100Op	1				
*Power Distribution Panel SB-2376A/FPS-100A (Supplied to contractor as GFE)	1				
*Power Distribution Panel SB-2376/FPS-100 A (Supplied to contractor as GFE)	1				

NOTE: \*Included only with AN/FPS-100A.

REFERENCE DATA AND LITERATURE

Nomenclature card dated 23 Apr 64 for AN/FPS-100 and -100A.

**DATE:** 15 December 1964

**ITEM NAME:** RADAR SET

**COGNIZANT SERVICE:** USAF

**TYPE:** A N/FPS-507

**FEDERAL STOCK NUMBER:**

	USA	USN	USAF	USMC
STATUS OR TYPE CLASSIFICATION			Used By	
Mfg(s) Name or Code Number Canadian Marconi				

Description for Radar Set AN/FPS-507 is found on Radar Set AN/FPS-90 data sheet, pages AN/FPS-90: 1 through AN/FPS-90: 3.

**DATE:** 15 September 196,1

**ITEM NAME:** CONTROL-MONITOR GROUP

**COGNIZANT SERVICE:** USAF

**TYPE:** AN/FSA-4

**FEDERAL STOCK NUMBER:** 5895-505-0578-EG

	USA	USN	USAF	USMC
STATTS OR TYPE CLASSIFICATION			LS	
Mfg(s) Name or (Code Number: Wickes				

Illustration not Available.

**FUNCTIONAL DESCRIPTION**

Control-Monitor Group AN/FSA-, is installed in a Radar Air Traffic Control (RATC) Center-Control room to provide communications facilities for Radar and other operational personnel. The facilities provided

by the AN/FSA-4 equipment are the control of 30 remotely-located radio telephone transmitters, the monitoring control of 30 remotely located communications receivers, and direct communication between RATC Center Control Room and 14 telephone substations.

**AN/FSA-4: 1**

**ITEM NAME:** CONTROL-MONITOR GROUP

**TYPE:** AN/FSA-4

**RELATION TO SIMILAR EQUIPMENT**

The AN/FSA-4 is interchangeable with the AN/FSA-4A. The difference is the AN/FSA-4A has a lockout feature and an automatic visual identification of incoming signals.

**TECHNICAL DESCRIPTION**

Input is 117v, 60 cps

**INSTALLATION CONSIDERATIONS**

Siting: Equipment is installed in Control Center Building.  
Mounting: Consoles are bolted to the floor.

**PRINCIPAL COMPONENTS AND PHYSICAL DATA**

COMPONENT	QTY	HEIGHT (Inches)	WIDTH (Inches)	DEPTH (Inches)	UNIT WT. (Pounds)
Communications Control Console OA-444/FSA-4	6	43-1/81-	21-9/32	41-3/4	199
Communications Control Console OA-445/FSA-4	1	43-1/8	21-9/32	41-3/4	200
Communications Control Console OA-467/FSA-4	1	43-1/8	21-9/32	41-3/4	127
Communications Control Console OA-468/FSA-4	1	43-1/8	21-9/32	41-3/4	115
Communications Control Console OA-469/FSA-4	2	43-1/B	21-9/32	41-3/4	93
Power Supply Group 1 OA-451/FSA-4	76	22	21-7/16	669	
Interconnecting Group OA-447/FSA-4	1	76	22	38	354.5
Telephone Main Distribution Facilities Group OA-448/FSA-4	1	76	22	38	459.5
Interconnecting Group OA-449/FSA-4	1	76	22	38	319.5
Receiver-Transmitter Control Group OA-450/FSA-4	2	76	22	38	518.5
Transmitter Control Group OA-526/FSA-4	1	76	22	38	604.5
Control Monitor C-1191/FSA-4	3	14	19	12-15/16	137.5
Wiring Harness CX-2228/FSA-4	2	10-1/2	19	6	16.5

**REFERENCE DATA AND LITERATURE**

Technical Orders  
31S1-2FSA4- Series

DATE: 15 September 1964

ITEM NAME: CONTROL-MONITOR GROUP

COGNIZANT SERVICE: USAF

TYPE: AN/FSA-4A

FEDERAL STOCK NUMBER: 5895-505-0878-EG

	USA	USN	USAF	USMC
STATUS OR TYPE CLASSIFICATION			STD	
Mfg(s) Name or Code Number. Federal Television Corporation				

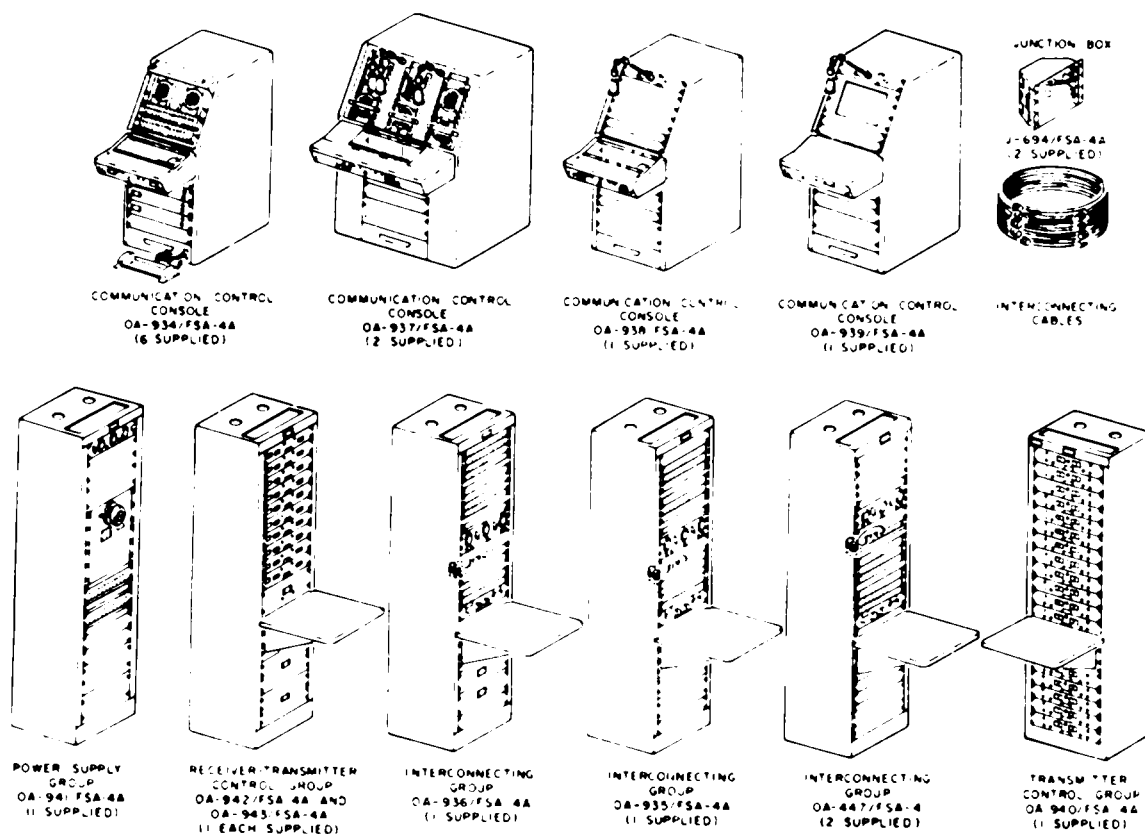

### FUNCTIONAL DESCRIPTION

Control-Monitor Group AN/FSA-4A is installed in a Radar Air Planning Control (RAPCON) Center Control room to provide communications facilities for Radar and other operational personnel. The equip-

ment provides local facilities for initiating Audio signals to be transmitted, local facilities for monitoring audio signals from 30 remotely located communications Receivers, and Controlling Circuits for audio-signals from local and remote keying sources to 30 remotely located radio-telephone

**ITEM NAME:** CONTROL-MONITOR GROUP

**TYPE:** AN/FSA--1A

transmitters.

ph, :3718 w

**RELATION TO SIMILAR EQUIPMENT**

The AN/FSA-4A is interchangeable with the AN/FSA-4, the difference is the AN/FSA-4A has a lockout feature and an automatic visual identification of incoming signals.

**INSTALLATION CONSIDERATIONS**

Siting: Equipment is installed in Control Center Building.

Mounting: Consoles are bolted to the floor.

**TECHNICAL DESCRIPTION**

Input is 117v, 60 cps, single or three

**PRINCIPAL COMPONENTS AND PHYSICAL DATA**

<b>COMPONENT</b>	<b>QTY</b>	<b>HEIGHT (Inches)</b>	<b>WIDTH (Inches)</b>	<b>DEPTH (Inches)</b>	<b>UNIT WT. (Pounds)</b>
Communications Control Console OR -93-1/FSA-4A	6	43-1/8	21-9/32	45	199
Communications Control Console OA-937/FSA-1A	2	43-1/8	31-27/32	45	
Communications Control Console OA-938/FSA-4A	1	43-1/8	21-9/32	45	
Communications Control Console OA-9:39/FSA-.1A	1	43-1/8	21-9/32	45	93
Interconnecting Group OA-447/FSA- 1	2	76	22	38	354 .5
Interconnecting Group OA -935/FSA-. 1A	1	76	22	38	459.5
Interconnecting Group OA -936 /FSA-. 1A	1	76	22	38	319.5
Receiver-Transmitter Control Group OA-9-12/FSA-.1A	1	76	22	38	518.5
Receiver-Transmitter Control Group OA-9.13/FSA-.1A	1	76	22	38	518.5
Power Supply Group OA -941/FSA-.1A	1	76	22	21	
Transmitter Control Group OA-940/FSA- 1A	1	76	22	38	604.5

**REFERENCE DATA AND LITERATURE**

**TECHNICAL ORDERS:**

31S1-2FSA4 - Series

**DATE:** 1 February 1965

**ITEM NAME:** SYNCHRONIZER GROUP

**COGNIZANT SERVICE:** USAF

**TYPE:** AN/FSA-24

**FEDERAL STOCK NUMBER:** 5895-708-9327-EG

	USA	USN	USAF	USMC
STATUS OR TYPE CLASSIFICATION			Used By	
Mfg(s) Name or Code Number. Radio Corporation of America, Moorestown, New Jersey				

Illustration not Available.

**FUNCTIONAL DESCRIPTION**

Synchronizer Group (H) supplies basic synchronizing trigger to the Tracker Radar System and the Checkout and Monitoring System. All synchronizer outputs are monitored continuously for failure indica-

tion. Generates pulses for system. Special Features for AN/FSA-24 are a simplex unit in an 1/1 Cabinet which generates pulses for the system; unit is used in the engineering model only.

**AN/FSA-24: 1**

**ITEM NAME.** SYNCHRONIZER GROUP

**TYPE:** AN/FSA-24

**RELATION TO SIMILAR EQUIPMENT**

None.

**INSTALLATION CONSIDERATIONS**

Related Equipment: AN/FSA-24 is used with, but not part of, AN/FPS-49, AN/FPS-50(V), which are part of BMEWS

**TECHNICAL DESCRIPTION**

Not available.

**PRINCIPAL COMPONENTS AND PHYSICAL DATA**

<b>COMPONENT</b>	<b>QTY</b>	<b>HEIGHT (Inches)</b>	<b>WIDTH (Inches)</b>	<b>DEPTH (Inches)</b>	<b>UNIT WT. (Pounds)</b>
Voltage Divider MD-462	2				
Comparator, Voltage MD-485	2				
Power Supply MD-367	2				
Relay Assy P/N 8305107-501	1				
Calibrator, Voltage P/N 8601984-501	1				
Comparator, Signal MD-276	1				
Multivibrator, Bistable MD-25	3				
Detector, Radio Frequency M3-400	1				
Gate, Electronic, Digital MD-173	1				
Power Supply MD-168	2				
Converter, Digital to Analog MD-361	1				
Comparator, Signal MD-166	6				
Gate, Electronic, Digital MD-17.1	3				
Gate, Electronic, Digital MD-1	2				
Semiconductor Device Assy Diode MD-20	1				
Amplifier Trigger Pulse MD-275	1				
Gate, Electronic, Digital MD-11	1				
Selector Unit, Signal P/N 8305885-501	1				
Power Supply P/N 8305107-501	1				
Amplifier, Audio Frequency MD-252	1				
Power Supply P/N 8305864-501	1				
Amplifier, Audio Frequency MD-258	1				



**ITEM NAME** SYNCHRONIZER GROUP

**TYPE:** AN/FSA-24

**PRINCIPAL COMPONENTS AND PHYSICAL DATA (Cont.)**

<b>COMPONENT</b>	<b>QTY</b>	<b>HEIGHT (Inches)</b>	<b>WIDTH (Inches)</b>	<b>DEPTH (Inches)</b>	<b>UNIT WT. (Pounds)</b>
Power Supply P/N t305833-501	1				
Amplifier, Audio Frequency MD-253	1				
Power Supply P/N 8305846-501	1				
Amplifier, Audio Frequency MD-256	1				
Oscillator, RF P/N 860.1071-501	1				
Module, Electronic MD-137	1				
Module, Electronic MD-127	2				
Module, Electronic MD-130	9				
Module, Electronic MD-135	4				
Module, Electronic MD-132	1				
Module, Electronic MD-219	2				
Amplifier, dc MD-308	10				
Module, Electronic MD-308	3				
Module, Electronic MD 12t;	3				
Distribution Box P/N d303(111-501	1				
Power Supply P/N t305-55-501	3				
Power Supply P/N d307729 501	2				
Power Supply P/N t0530,30.5-501	1				
Power Supply P/N j60(1772-501	1				
Capacitor Transformer Assy P/N t606107-501	1				
Panel Indicator P/N 8605122 505	1				
Panel, Power Distribution P/N 8305172-501	1				
Cabinet, Electrical Equipment PIN 8306552-501	1				

**REFERENCE DATA AND LITERATURE**

Nomenclature Card for AN/FSA-21 dated 26 August 1961.

**DATE:** 1 March 1965

**ITEM NAME:** SYNCHRONIZER GROUP

**COGNIZANT SERVICE:** USAF

**TYPE:** AN/FSA-27

**FEDERAL STOCK NUMBER:** 5840-829-4841

	USA	USN	USAF	USMC
STATUS OR TYPE CLASSIFICATION			Std	
Mfg(s) Name or Code Number: Radio Corporation of America, Moorestown, New Jersey				

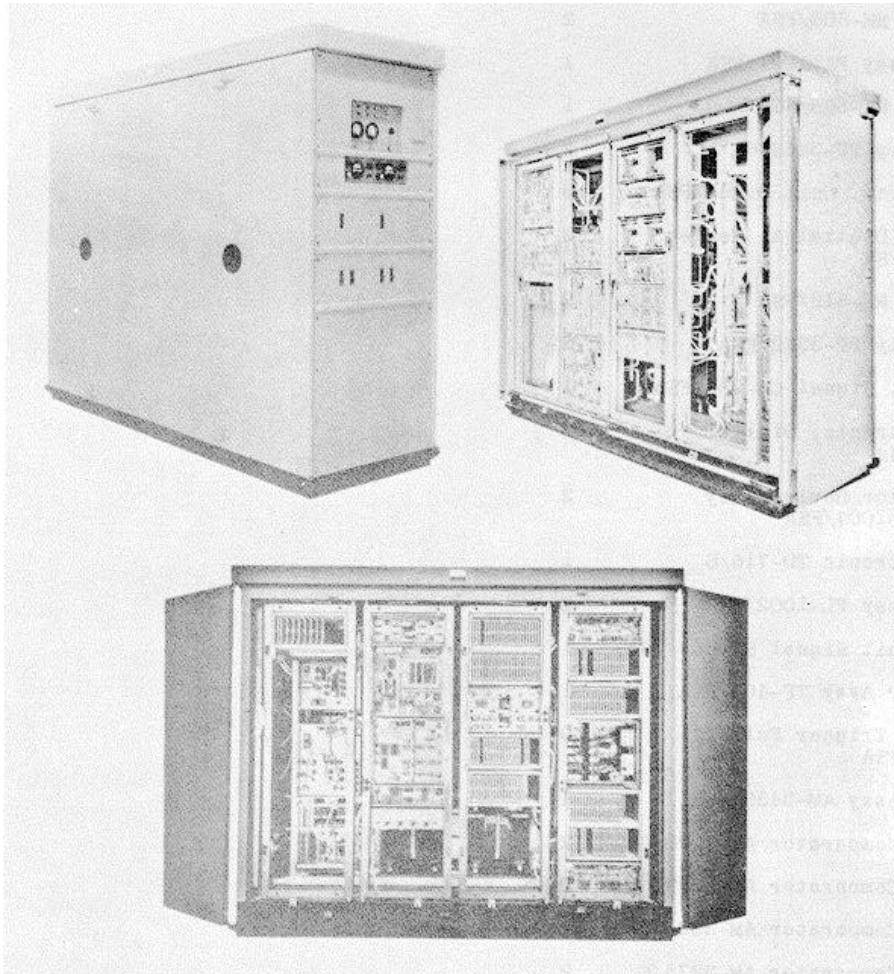

**FUNCTIONAL DESCRIPTION**

The Synchronizer Group supplies the basic synchronizing trigger to the radar systems.

**RELATION TO SIMILAR EQUIPMENT**

None.

**AN/FSA-27: 1**

**ITEM NAME:** SYNCHRONIZER GROUP

**TYPE:** AN/FSA-27

**TECHNICAL DESCRIPTION**

Not available.

BMEWS Site 1.  
Related Equipment: AN/FSA-27 is part of BMEWS Site 1 (4741 system) used with, but not part of AN/FPS-49, AN/FPS-50(V) AN/FSQ-28.

**INSTALLATION CONSIDERATIONS**

Siting: The AN/FSA-27 is installed at

**PRINCIPAL COMPONENTS AND PHYSICAL DATA**

<b>COMPONENT</b>	<b>QTY</b>	<b>HEIGHT (Inches)</b>	<b>WIDTH (Inches)</b>	<b>DEPTH (Inches)</b>	<b>UNIT WT. (Pounds)</b>
Relay Assy RE-5t8/FSA	2				
Resistor Assy PL-1001/FSA	1				
Relay Assy RE-596/FSA	1				
Power Supply PP-3B63/G	2				
Multivibrator, Unit O-963/FSA	8				
Converter, Digital to Analog CV-1299/FSA	2				
Relay Assy RE-613/FSA	2				
Power Supply PP-33-12/FSA	2				
Comparator, Signal CM-236/FSA	1				
Gate, Electronic, Digital TD-555/FSA	12				
Semiconductor Device Assy Diode PL-1004/FSA	2				
Gate, Electronic TD-716/G	1				
Resistor Assy PL-1002/FSA	2				
Selector Unit Signal SA-864/FSA	1				
Transformer Assy TF-,103/FSA	1				
Amplifier, Trigger Pulse AM--3345/FSA	20				
Amplifier Assy AM-3435/FSA	4				
Amplifier-Comparator AM-3298/G	2				
Amplifier-Comparator AM-3299/G	2				
Amplifier-Comparator AM-3300/G	2				
Amplifier-Comparator AM-3373/G	2				
Amplifier-Gate Multivibrator AM-3372/FSA	2				
Amplifier -Gate Multivibrator AM 3573/FSA	18				
Amplifier-Gate Multivibrator AM-3574/FSA	6				

ITEM NAME: SYNCHRONIZER GROUP

TYPE: AN/FSA-27

PRINCIPAL COMPONENTS AND PIFYSICAL DATA

COMPONENT	QTY	HEIGHT (Inches)	WIDTH (Inches)	DEPTH (Inches)	UNIT WT. (Pounds)
Amplifier- Generator-Multi- vibrator AM-3434/FSA	2				
Amplifier-Multivibrator AM-3436/FSA	4				
Amplifier-Multivibrator AM-3437/FSA	8				
Cabinet, Electrical Equipment P/N 8335720-501 RCA	1				
Capacitor Assy PL-1005/FSA	2				
Comparator, Signal CM-23B/FSA	19				
Converter, Digital to Analog CV-1305/FSA	1				
Comparator, Signal CM-244/FSA	4				
Comparator, Voltage CM-237/FSA	2				
Converter, Waveform CV-1306/FSA	1				
Converter, Signal Data CV-1719/FSA-27	1				
Electronic Switch SA-Ht69/F	2				
Gate, Electronic Digital TD-554/FSA	13				
Gate, Electronic Digital TD-585/F	1				
Multivibrator Unit 0-988/G	1				
Network, Voltage Dividing PL-1003/FSA	2				
Oscillator, Radio Frequency 0-960/FSA	2				
Panel, Indicator SB-1639/FSA	1				
Panel, Power Distribution SB-1614/FSA	1				
Power Supply PP-3343/FSA	6				
Power Supply PP-3344/FSA	1				
Power Supply PP-3341ti/FSA	2				
Power Supply PP-3349/FSA	1				
Power Supply PP-3350/FSA	2				
Power Supply PP-3400/FSA	3				
Power Supply PP-35(6)/FSA	2				

**ITEM NAME:** SYNCHRONIZER GROUP

**TYPE:** AN/FSA-27

**PRINCIPAL COMPONENTS AND PHYSICAL DATA (Cont.)**

<b>COMPONENT</b>	<b>QTY</b>	<b>HEIGHT (Inches)</b>	<b>WIDTH (Inches)</b>	<b>DEPTH (Inches)</b>	<b>UNIT WT. (Pounds)</b>
Power Supply PP-3861/G	3				
Power Supply PP-3u62/G	1				

**REFERENCE DATA AND LITERATURE**

Nomenclature Card for AN/FSA-27 dated 16 October 1963.

DATE: 1 March 1965

ITEM NAME: SYNCBIRONIZER GROUP

COGNIZANT SERVICE: USAF

TYPE: AN/FSA-28

FEDERAL STOCK NUMBER: 5840-829-4840

	USA	USN	USAF	USMC
STATUS Oil TYPE CLASSIFICATION			Std	
Mfg(s) Name or (Code Number. Radio Corporation of America, Moorestown, New Jersey				

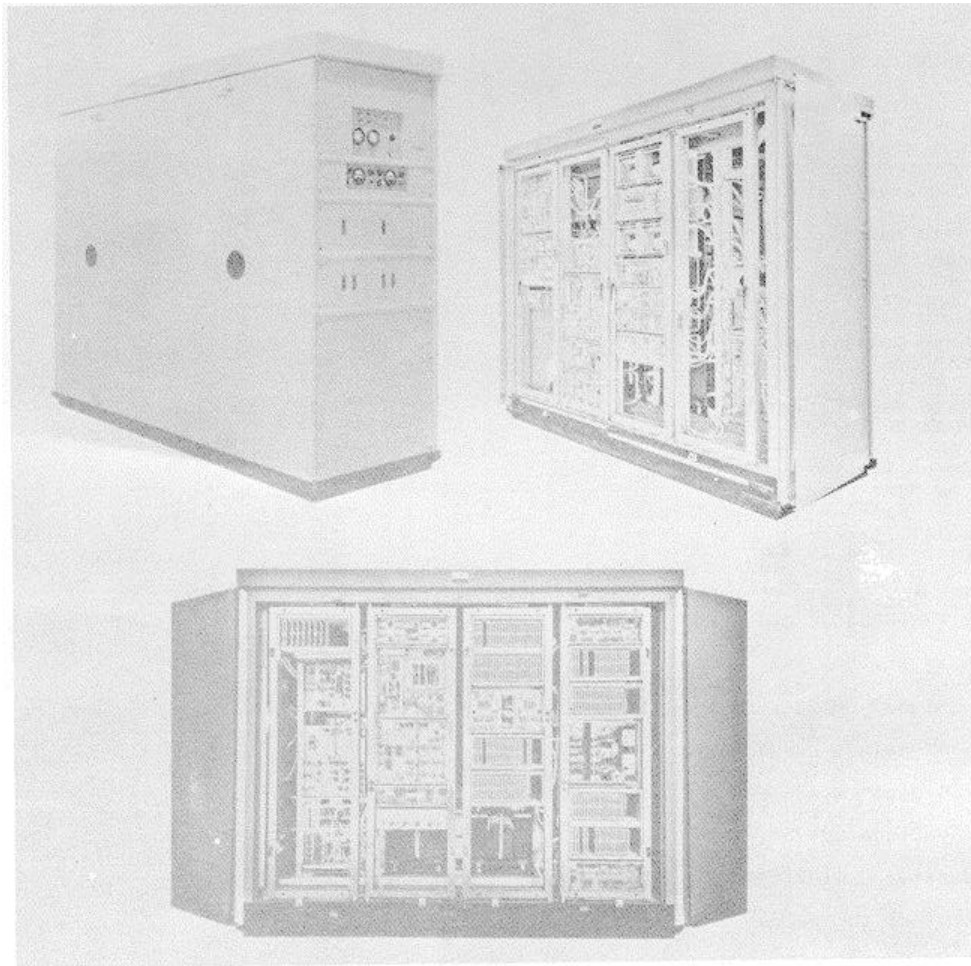

**FUNCTIONAL DESCRIPTION**

The Synchronizer Group AN,/FSA-28 supplies the basic synchronizing trigger for the radar sets.

**RELATION TO SIMILAR EQUIPMENT**

None.

AN/FSA-28: 1

**ITEM NAME:** SYNCHRONIZER GROUP

**TYPE:** AN/FSA-28

**TECHNICAL DESCRIPTION**

Not available.

of BMEWS Site 2 on 474L system, used with, but not part of, AN/FPS-.19, AN/FPS-50(V).

**INSTALLATION CONSIDERATIONS**

Related Equipment: AN/FSA-28 is part

**PRINCIPAL COMPONENTS AND PHYSICAL DATA**

<b>COMPONENT</b>	<b>QTY</b>	<b>HEIGHT (Inches)</b>	<b>WIDTH (Inches)</b>	<b>DEPTH (Inches)</b>	<b>UNIT WT. (Pounds)</b>
Amplifier, Trigger Pulse AM-3315 /FSA	20				
Amplifier Assy AM-3,135/FSA	4				
Amplifier Comparator AM-3298/G	2				
Amplifier Comparator AM-3299/G	2				
Amplifier Comparator AM-3300/G	2				
Amplifier-Gate-Multivibrator AM-3372/FSA	2				
Amplifier Comparator AM-3373/G	2				
Amplifier-Gate-Multivibrator AM-3573/FSA	11				
Amplifier-Gate-Multivibrator AM-3574 /FSA	6				
Amplifier-Generator-Multi- ibrator AM-3434,/FSA	2				
Amplifier Multivibrator AM-3436/FSA	1				
RCA Cabinet, Electrical Equipment P/N 1833.1596-501	1				
Capacitor Assy PL-1005/FSA	2				
Comparator, Signal CM-236/FSA	1				
Comparator, Signal CM-238/FSA	18				
Comparator, Signal CM-244-/FSA	4				
Comparator, Voltage CM-237'FSA	3				
Control-Indicator C-4187/FSA	1				
Converter Digital to Analog CV-1299/F'SA	2				
Converter Digital to Analog CV-1305/FSA	1				
Converter Waveform CV-1306/FSA	1				
Converter Signal Data CV-1719/FSA-27	1				

ITEM NAME: SYNCHRONIZER GROUP

TYPE: AN/FSA-28

PRINCIPAL COMPONENTS AND PHYSICAL DATA (Cont.)

COMPONENT	QTY	HEIGHT (Inches)	WIDTH (Inches)	DEPTH (Inches)	UNIT WT. (Pounds)
Electronic Switch SA-869/F	2				
Gate Electronic Digital TD-554/FSA	13				
Gate Electronic Digital TD-555/FSA	12				
Gate Electronic Digital TD-585/F	1				
Gate, Electronic TD-716/G	1				
Multivibrator Unit 0-963/FSA	6				
Multivibrator Unit 0-988/G	1				
Network, Voltage Dividing CN-860/F	1				
Network, Voltage Dividing PL-1003/FSA	2				
Oscillator, Radio Frequency O-960/FSA	2				
Panel, Indicator SB-1639/FSA	1				
Panel, Indicator SB-1665/FSA	1				
Panel, Power Distribution SB-1614/FSA	1				
Panel, Power Distribution SB-2241/FSA	1				
Power Supply PP-3342/FSA	3				
Power Supply PP-3343/FSA	6				
Power Supply PP-3344/FSA	1				
Power Supply PP-3348/FSA	2				
Power Supply PP-3349/FSA	1				
Power Supply PP-3350/FSA	2				
Power Supply PP-3400/FSA	3				
Power Supply PP-3586/FSA	2				
Power Supply PP-3587/FSA	1				
Power Supply PP-3586/FSA	2				
Power Supply PP-3591/FSA	3				
Relay Assy RE-588/FSA	2				
Relay Assy RE-596/FSA	1				
Relay Assy RE-603/F	1				



**ITEM NAME:** SYNCHRONIZER GROUP

**TYPE:** AN/FSA-28

**PRINCIPAL COMPONENTS AND PHYSICAL DATA (Cont.)**

<b>COMPONENT</b>	<b>QTY</b>	<b>HEIGHT (Inches)</b>	<b>WIDTH (Inches)</b>	<b>DEPTH (Inches)</b>	<b>UNIT WT. (Pounds)</b>
Relay Assy RE-618/FSA	2				
Resistor Assy PL-1001/FSA	1				
Resistor Assy PL-1002/FSA	2				
Resistor Assy PL-1038/F	1				
Selector Unit Signal SA-B64/FSA	1				
Semiconductor Device Assy Diode PL-1004/FSA	2				
Transformer Assy TF-403/FSA	1				

**REFERENCE DATA AND LITERATURE**

Unclassified Nomenclature Card for AN/FSA-28 dated  
16 October 1963.

**DATE:** 1 July 1964

**ITEM NAME:** AIR TRAFFIC DISPLAY GROUP

**COGNIZANT SERVICE:** USN

**TYPE:** AN/FSA-29(XN-1)

**FEDERAL STOCK NUMBER:**

	USA	USN	USAF	USMC
STATUS OR TYPE CLASSIFICATION				
Mfg(s) Name or (de Number: Lockheed Electronics Company, Plainfield, New Jersey				

No Illustration Available.

**FUNCTIONAL DESCRIPTION**

The Air Traffic Display Group AN/FSA-29 (XN-1) is designed to convert the Plan Position Indicator (PPI) radar air-traffic in-

formation to television through the scan-converter tube. This information is then projected through a Schmidt optical system to produce a forty (40) inch display.

**AN/FSA-29(XN-1): 1**

**ITEM NAME:** AIR TRAFFIC DISPLAY GROUP

**TYPE:** AN/FSA-29(XN-1)

**RELATION TO SIMILAR EQUIPMENT**  
None.

**INSTALLATION CONSIDERATIONS**  
Not available.

**TECHNICAL DESCRIPTION**

Not available.

**PRINCIPAL COMPONENTS AND PHYSICAL DATA**

<b>COMPONENT</b>	<b>QTY</b>	<b>HEIGHT (Inches)</b>	<b>WIDTH (Inches)</b>	<b>DEPTH (Inches)</b>	<b>UNIT WT. (Pounds)</b>
Regulator, Voltage	1				
Converter-Monitor	1				
Control-Indicator	1				

**REFERENCE DATA AND LITERATURE**

Technical Manuals:  
NAVSHIPS 93400

**DATE:** 1 March 1965

**ITEM NAME:** RADAR SIGNAL PROCESSING GROUP

**COGNIZANT SERVICE:** USAF

**TYPE:** AN/FSA-30

**FEDERAL STOCK NUMBER:** 5895-603-1779-EG

	USA	USN	USAF	USMC
STATUS OH TYPE CLASSIFICATION			Ltd Std	
Mfg(s) Name or Code Number: General Electric Company, Syracuse, New York				

Illustration not Available.

**FUNCTIONAL DESCRIPTION**

The AN/FSA-30 receives a signal from a main radar set, distinguishes between the desired and undesired signals and processes the desired

signal for transmission to a Computer-Tracking Group, Radar. The AN/FSA-30 is for general purpose use.

**AN/FSA-30: 1**

**ITEM NAME:** RADAR SIGNAL PROCESSING GROUP

**TYPE:** AN/FSA-30

**RELATION TO SIMILAR EQUIPMENT**

None

**TECHNICAL DESCRIPTION**

Not available.

**INSTALLATION CONSIDERATIONS**

Related Equipment: Used with but not part  
of AN/FPS-7 and AN/FPS-24

Equipment Required but not Supplied. (2) Amplifier-Limiter AM-2950/FSA; (2) Amplifier-Limiter AM-2955,/FSA; (2) Amplifier-Limiter AM-2966/FSA: (2) Delay Line MK-3465/FSA-30; (4) Band Pass Filter F-573/FSA; (2) Amplifier-Delay Line AM-296/,FSA-31; (2) Delay Line MX-3464/ FSA-30; (2) Band Pass Filter F-577/FSA; (2) Pulse Generator TD-465/FSA-30; (2) Frequency Mixer Stage CV-1139/FSA-30; (2) Radio Frequency Oscillator 0-819/ FSA-30; (2) Electrical Synchronizer SN298/FSA-30; (2) Band Pass Filter F-702/ FSA; (2) Band Pass Filter F-693/FSA.

**PRINCIPAL COMPONENTS AND PHYSICAL DATA**

<b>COMPONENTS</b>	<b>QTY</b>	<b>OVERALL DIMENSIONS (Inches)</b>	<b>UNIT WT. (Pounds)</b>
Signal Comparator Group OA-32,19/FSA-30	2		
Signal Integrator Group OA-32.15/FSA-30	2		

**REFERENCE DATA AND LITERATURE**

Unclassified Nomenclature Card for AN/FSA-30  
dated 21 March 1963.

**DATE:** 15 January 1965

**ITEM NAME:** RADAR SIGNAL PROCESSING GROUP

**COGNIZANT SERVICE:** USAF

**TYPE:** AN/FSA-31

**FEDERAL STOCK NUMBER:** 5B95-731-4783-EG

	USA	USN	USAF	USMC
STATUS OR TYPE CLASSIFICATION			Ltd Std	
Mfg(s) Name or Code Number: General Electric Company, Syracuse, New York				

No Illustration Available.

#### FUNCTIONAL DESCRIPTION

Receives a signal from a main radar set, distinguishes between the desired and undesired signals and processes the desired signal for transmission to a Computing-Tracking Group, Radar, AN/FSA-12. There is

no present nor anticipated future procurement for the AN/FSA-31 in it's present configuration. Also, there is no present replacement for the AN/FSA-31. In order to meet future Air Force requirements, the AN/FSA-31 will require significant modifications for operational performance.

**AN/FSA-31: 1**

**ITEM NAME:** RADAR SIGNAL PROCESSING GROUP  
**TYPE:** AN/FSA-31

**RELATION TO SIMILAR EQUIPMENT**

None.

**INSTALLATION CONSIDERATIONS**

Used with, but not part of, AN/FPS-20, AN/GPS-4, AN/FSA-12.

**PRINCIPAL COMPONENTS AND PHYSICAL DATA**

<b>COMPONENT</b>	<b>QTY</b>	<b>HEIGHT (Inches)</b>	<b>WIDTH (Inches)</b>	<b>DEPTH (Inches)</b>	<b>UNIT WT.</b>
Comparator Group Signal OA-3247/FSA-31	1				
Integrator Group Signal OA-3250/FSA-31	1				

**REFERENCE DATA AND LITERATURE**

Nomenclature Card and AF Form 81 for AN/FSA-31.

**DATE:** 15 January 1965

**ITEM NAME:** RADAR DATA DISTRIBUTION SET

**COGNIZANT SERVICE:** USAF

**TYPE:** AN/FSA-40

**FEDERAL STOCK NUMBER:** 5895-083-8010-EG

	USA	USN	USAF	USMC
STATUS OH TYPE CLASSIFICATION			Std	
Mfg(s) Name or Code Number: Radio Corporation of America, New York City, New York				

No Illustration Available.

**FUNCTIONAL DESCRIPTION**

The Radar Data Distribution Set processes and distributes data between Radar Set AN/

FPS-49A Missile Imp)act Predictor Set AN' FSQ-2t and other equip)ments at a BMEWS site.

**AN/FSA-40: 1**



**ITEM NAME:** RADAR DATA DISTRIBUTION SET

**TYPE:** AN/FSA-40

**RELATION TO SIMILAR EQUIPMENT**

None.

**INSTALLATION CONSIDERATIONS**

Related Equipment: Used with, but not part of AN/FPS-49A, AN/FSQ-2c, AN/FPS-50(V).

**PRINCIPAL COMPONENTS AND PHYSICAL DATA**

<b>COMPONENT</b>	<b>QTY</b>	<b>HEIGHT (Inches)</b>	<b>WIDTH (Inches)</b>	<b>DEPTH (Inches)</b>	<b>UNIT WT.</b>
Data Analysis-Converter Group OA-3959/FSA-40	1				
Simulator, Group OA-4099/FSA-40	1				
Converter-Programmer Group OA-4100/FSA-40	1				
Control -Power Supply 1 Group OA-3982/FSA-40					

**REFERENCE DATA AND LITERATURE**

Nomenclature Card and AF Form 61 for AN/FSA-40.

**DATE:** 15 January 1965

**ITEM NAME:** RADAR CONTROL CENTER

**COGNIZANT SERVICE:** USAF

**TYPE:** AN/FSA-41

**FEDERAL STOCK NUMBER:** 5895-970-7889-EG

	USA	USN	USAF	USMC
STATUS OR TYPE CLASSIFICATION			Std	
Mfg(s) Name or Code Number: Radio Corporation of America				

No Illustration Available.

**FUNCTIONAL DESCRIPTION**

Controls the assignment of equipment within Radar Central. Functions as a control and processing system.

**AN/FSA-41: 1**

ITEM NAME: RADAR CONTROL CENTER  
TYPE: AN/FSA-41

**RELATION TO SIMILAR EQUIPMENT**

None.

**INSTALLATION CONSIDERATIONS**

Related Equipments: Used with but not part of AN/FPS-50(V), AN/FSP-49, AN/FSQ-2U, and AN/FSA-27. The AN/FSA-41 is used for BMEWS use only.

**PRINCIPAL COMPONENTS AND PHYSICAL DATA**

<b>COMPONENT</b>	<b>QTY</b>	<b>HEIGHT (Inches)</b>	<b>WIDTH (Inches)</b>	<b>DEPTH (Inches)</b>	<b>UNIT WT.</b>
Converter-Data Programming Group OA-4024/FSA-41	1				
Console Group OA-4018/FSA-41	1				
OA-3960/FSA-41					

**REFERENCE DATA AND LITERATURE**

Nomenclature Card and AF Form 81 for AN/FSA-41.

**DATE:** 15 January 1965

**ITEM NAME:** RADAR DATA DISTRIBUTION SET

**COGNIZANT SERVICE:** USAF

**TYPE:** AN/FSA-42

**FEDERAL STOCK NUMBER:**

	USA	USN	USAF	USMC
STATUS OR TYPE CLASSIFICATION			Std	
Mfg(s) Name or Code Number: Radio Corporation of America				

No Illustration Available.

**FUNCTIONAL DESCRIPTION**

Processes and distributes radar data; azimuth  
and elevation information, tar-

get position and equipment status signals.

**AN/FSA-42: 1**

**ITEM NAME:** RADAR DATA DISTRIBUTION SET

**TYPE:** AN/FSA-42

**RELATION TO SIMILAR EQUIPMENT**

None.

Related Equipment: Used with but not part of AN/FPS-49A and AN/FSQ-37. The AN/ FSA-42 is used for BMEWS use only.

**INSTALLATION CONSIDERATIONS**

**PRINCIPAL COMPONENTS AND PHYSICAL DATA**

<b>COMPONENT</b>	<b>QTY</b>	<b>HEIGHT (Inches)</b>	<b>WIDTH (Inches)</b>	<b>DEPTH (Inches)</b>	<b>UNIT WT.</b>
Simulator Group OA-6587/FSA-42	1				
Digital Converter-Programming Group OA-4145/FSA-42	1				
Data Analysis-Converter Group P/N 8636436-502	1				

**REFERENCE DATA AND LITERATURE**

Nomenclature Card and AF Form 81 for AN/FSA-42.

**DATE:** 15 January 1965

**ITEM NAME:** CENTRAL COMPUTER-DISPLAY SET

**COGNIZANT SERVICE:** USAF

**TYPE:** AN/FSA-43

**FEDERAL STOCK NUMBER:** 5895-981-4659-EG

	USA	USN	USAF	USMC
STATUS OR TYPE CLASSIFICATION	Std			
Mfg(s) Name or (de Number: Radio Corporation of America				

No Illustration Available.

**FUNCTIONAL DESCRIPTION**

Correlates and displays the threat level equipment status and launch and impact information for the entire BMEWS. Trans-

mits pertinent data to other sites within the zone of interior. (SAC and Pentagon).

**AN/FSA-43: 1**

**ITEM NAME:** CENTRAL COMPUTER-DISPLAY SET  
**TYPE:** AN/FSA-43

**RELATION TO SIMILAR EQUIPMENT**

None.

**INSTALLATION CONSIDERATIONS**

Related Equipments: Used with, but not part of, AN/FPS-49, AN/FPS-419A, AN/ FPS-50(V), AN/ESQ-37, and AN/FSQ-28. The AN/FSA-43 is used for BMEWS use

**PRINCIPAL COMPONENTS AND PHYSICAL DATA**

COMPONENT	QTY	only.			UNIT WT.
		HEIGHT (Inches)	WIDTH (Inches)	DEPTH (Inches)	
Computer-Display Group OA-4260/FSA-43	1				
Launch-Impact Display RCA P/N 8636446-503	1				

**REFERENCE DATA AND LITERATURE**

Nomenclature Card and AF Form 81 for AN/FSA-43.

**DATE:** 15 January 1965

**ITEM NAME:** COMBAT CONTROL CENTRAL

**COGNIZANT SERVICE:** USAF

**TYPE:** AN/FSQ-8

**FEDERAL STOCK NUMBER:** 5895-524-0584-EG

	USA	USN	USAF	USMC
STATUS OR TYPE CLASSIFICATION			Std	
Mfg(s) Name or (-code Number. International Business Machines Corporation				

Illustration not Available.

### FUNCTIONAL DESCRIPTION

Combat Control Central AN/FSQ-8 is a division level command installation which performs the functions of weapons allocation, threat evaluation and battle supervision. The Control Central processes summarized

data received from Combat Direction Centrals and from other sources in order to develop information needed to analyze the air situation within the division and to allocate weapons properly to meet the threat of hostile action. In addition, the Control Central monitors the activities of its Direction

**AN/FSQ-8: 1**



**ITEM NAME:** COMBAT CONTROL CENTRAL  
**TYPE:** AN/FSQ-8

ion Centrals and transmits intelligence and command information to them. The Control Central exchanges information with other Control Centrals, orders conditions of alert for the division, disseminates defense warning to civilian and military agencies, implements Security Control of Air Traffic (SCAT) and Control of Electromagnetic Radiation (CONELRAD) and presents summary data to the next higher echelon. The function of the air surveillance section at the Control Center is to collect, display and disseminate all pertinent air-situation information to permit adequate assessment of the extent of hostile movements directed toward the division and of the actions being taken by the defense components. The function of the weapons allocation section is the efficient deployment of available weapons to each sector within the division to meet any hostile threat. Combat Control Central AN/FSQ-8 is a modified version of the AN/FSQ-7 Combat Direction Central. The AN/FSQ-8 is modified primarily in the sense that it has no provisions for radar inputs or ground-to-air outputs, its computing capacity is not as heavily committed as the AN/FSQ-7. Therefore, the AN/FSQ-8 is able to assume additional activities as the need arises. The various air defense functions performed by the AN/FSQ-8 are controlled from punched cards or magnetic tapes. By changing these instructions the mode of operations within the Combat Central can be altered without changes in the structure of the electronic equipment. The AN/FSQ-8 contains two digital computers, one being termed as the active computer and the alternate equipment is termed the standby computer. The active computer monitors its own alarms and transfers a summary of defense information, as start over data, to the standby computer. The transfer of start over data keeps the standby computer up-to-date on the air defense situation, thus facilitating a rapid switchover in the event of a failure of the active computer. The Combat Central is housed in a building four stories high, 150 feet square, which is shock-resistant, air-conditioned and contamination proof. Two auxiliary buildings are required to house the maintenance and primary power equipment.

#### RELATION TO SIMILAR EQUIPMENT

Similar to Combat Control Central AN/FSQ-8A except that the AN/FSQ-8A Central Computer Group will be transistorized.

#### TECHNICAL DESCRIPTION

##### General Data

Input System: Crosstell and manual data  
Central Computer: Mathematical and logic operations  
Display System: Situation and digital displays  
Output System: Ground-to-ground and teletypewriter messages

##### Input System Data

Crosstell Lines: Party-line basis  
Number of Channels: 12  
Message Composition  
Length: 71 ms  
Word Bits: b5 (5 words serially interleaved)  
Timing Bits: 6  
Synch Bits: 1  
Manual Data Input  
Reading Rate A: 12 cards, 80 rows per minute.  
Reading Rate B: 16 cards, 60 rows per minute.

##### Central Computer Data

Permissible Error: One part in 32,768  
Reliability: 99.94%  
Address Type: Single  
Internal Operation: Binary  
Operation Type: Parallel  
Arithmetical Operation: Dual  
Word Length  
Instruction Word: 32 bits  
Data Words: 16 bits  
Number of Commands: 159  
Number of Instructions: 48 divided into B classes  
Standard Pulse: 10 usec  
Clock Register Pulse: 31.25 ms

##### Storage Data

Memory Devices: Non-Volatile (ferrite cores, magnetic tape, punch cards)  
Internal Storage: B192 words (ferrite cores)  
Auxiliary Storage: 153,000 words (magnetic tapes)

##### Display System Data

###### Situation Displays

Contents: Geographical picture of division movements  
Display Method: Symbols on oscilloscope  
Oscilloscope Size: 19 in. KRT

###### Digital Displays

Contents: Weapons allocation statistics  
Display Method: Symbols on oscilloscope  
Oscilloscope Size: 5 in. KRT

##### Output System Data

###### Output Message Types

Crosstell Destination: Division-to-division level  
Back-Tell Destination: Division-to-sector level  
Forward-Tell Destination: Division-to-higher echelon

###### Ground-to-Ground Output

Output Form: 70 ms bursts  
Burst Contents: 17 bit half-words serially, interleaved 5 bits apart

Transmission Media: Telephone Lines

###### Teletypewriter Output

Output Form: 500 ms  
Burst Contents: 3 successive TTY characters  
Transmission Media: Telephone Lines  
Power Requirement s: 120/208v ac, 60 cps, 3-ph

**ITEM NAME:**

**ITEM NAME:** COMBAT CONTROL CENTRAL

**TYPE:**

**TYPE:** AN/FSQ-8

Technical Power: 1000 kw  
Non-Technical Power: 2000 kw

Related Equipment: AN/FSQ-7, Combat Direction  
Central.

**INSTALLATION CONSIDERATIONS**

Mounting: Floor-mounted in buildings.

Equipment Required but not Provided: The internal and  
external communications facilities, including digital  
data transmission systems, are usually obtained on  
a leased basis.

This Equipment is Part of: SAGE

**PRINCIPAL COMPONENTS AND PHYSICAL DATA**

<b>COMPONENT</b>	<b>QTY</b>	<b>HEIGHT (Inches)</b>	<b>WIDTH (Inches)</b>	<b>DEPTH (Inches)</b>	<b>UNIT WT.</b>
------------------	------------	----------------------------	---------------------------	---------------------------	-----------------

**REFERENCE DATA AND LITERATURE**

Technical Manuals:  
31S5-2FSQ7- Series

AF Form 81 for AN/FSQ-8.

**DATE:** 1 September 1965

**ITEM NAME:** MISSILE IMPACT PREDICTOR SET

**COGNIZANT SERVICE:** USAF

**TYPE:** AN/FSQ-28

**FEDERAL STOCK NUMBER:**

	USA	USN	USAF	USMC
STATUS OR TYPE CLASSIFICATION			Std	
Mfg(s) Name or (ode Number: Radio Corporation of America, New York, New York				

Illustration not Available.

**FUNCTIONAL DESCRIPTION**

Missile Impact Predictor Set AN/FSQ-28 accepts output of Radar Set AN/FPS-19 or AN/FPS-,19A and Radar Set AN/FPS-00(V) to determine the trajectory of space objects and predicts the point of impact. Fur-

nishes designation data to tracking Radar for enhancing target data accuracy.

The AN/FSQ-2t is a duplex, general purpose computer (IBM-709-TX with real-time terminal and control equipment added).

**ITEM NAME:** MISSILE IMPACT PREDICTOR SET

**TYPE:** AN/FSQ-28

**RELATION TO SIMILAR EQUIPMENT**

Not available.

**INSTALLATION CONSIDERATIONS**

Related Equipment: The AN/FSQ-2b is part of BMEWS Site I General Pattern; also part of Computer-Display-Radar Central.

**TECHNICAL DESCRIPTION**

Not available.

**PRINCIPAL COMPONENTS AND PHYSICAL DATA**

<b>COMPONENT</b>	<b>QTY</b>	<b>HEIGHT (Inches)</b>	<b>WIDTH (Inches)</b>	<b>DEPTH (Inches)</b>	<b>UNIT WT.</b>
Tape Drive Tester (IBM P/N 729-1)	1				
Tape Drive Tester (IBM P/N 729-11)	1				
Data Analysis Group OA-3058/FSQ-28	1				
Data Analysis-Programming Group OA-3054/FSQ-2B	1				
Digital Clock Pulse Generator TD-7-16/FSQ-37	1				

**REFERENCE DATA AND LITERATURE**

Nomenclature card for AN/FSQ-2B dated 3 Mar 65.

**DATE:** 15 January 1965

**ITEM NAME:** MONITORING SET, RADAR

**COGNIZANT SERVICE:** USAF

**TYPE:** AN/FSQ-53

**FEDERAL STOCK NUMBER:**

	USA	USN	USAF	USMC
STATUS OR TYPE CLASSIFICATION			Std	
Mfg(s) Name or Code Number Radio Corporation of America				

No Illustration Available.

**FUNCTIONAL DESCRIPTION**

The Monitoring Set, Radar, provides continuous monitoring of critical operating characteristics within a missile tracking radar set.

It also sequentially monitors test points to localize a source of a malfunction or degradation in performance.

**AN/FSQ-53: 1**

**ITEM NAME:** MONITORING SET RADAR

**TYPE:** AN/FSQ-53

**RELATION TO SIMILAR EQUIPMENT**

None.

**INSTALLATION CONSIDERATIONS**

Related Equipment: Used with, but not part of, AN/FPS-50(V), AN/FPS-49A, AN/FSQ-28, AN/FSA-27. The AN/FSQ-53 is used for BMEWS use only.

**PRINCIPAL COMPONENTS AND PHYSICAL DATA**

<b>COMPONENT</b>	<b>QTY</b>	<b>HEIGHT (Inches)</b>	<b>WIDTH (Inches)</b>	<b>DEPTH (Inches)</b>	<b>UNIT WT.</b>
Comparater-Converter Group OA-64 75/FSQ-53	1				
Console, Radar Set OA-6174/FSQ-53	1				
Control, Power Supply Group OA-4036/FSQ	1				
Converter Group, Signal Data OA-40HO/FSQ	1				
RCA, Interconnecting Cabinet P/N 8332964-501	1				
Monitor Group, Radar Set OA-4029/FSQ	1				
RCA, Oscillator, Radio Frequency P/N 8272737-5	1				
Test Set, Signal Selector Unit AN/FSM-22	1				

**REFERENCE DATA AND LITERATURE**

Nomenclature Card and AF Form 11 for AN/FSQ-53.

**DATE:** 15 January 1965

**ITEM NAME:** MONITORING SET, RADAR

**COGNIZANT:** USAF

**TYPE:** AN/FSQ-54

**FEDERAL STOCK NUMBER:** 5395-073-1702-EG

	USA	USN	USAF	USMC
STATUS OR TYPE CLASSIFICATION			Std	
Mfg(s) Name or Code Number: Radio Corporation of America				

No Illustration Available.

**FUNCTIONAL DESCRIPTION**

The Monitoring Set, Radar, provides continuous monitoring of critical operating characteristics within a missile

tracking radar set. It also provides sequential monitoring of test points to localize the source of a malfunction or degradation

**AN/FSQ-54: 1**

**ITEM NAME:** MONITORING SET, RADAR

**TYPE:** AN/FSQ-54

in performance.

**INSTALLATION CONSIDERATIONS**

Related Equipments: The AN/FSQ-54 is used for BMEWS use only.

**RELATION TO SIMILAR EQUIPMENT**

None.

**PRINCIPAL COMPONENTS AND PHYSICAL DATA**

<b>COMPONENT</b>	<b>QTY</b>	<b>HEIGHT (Inches)</b>	<b>WIDTH (Inches)</b>	<b>DEPTH (Inches)</b>	<b>UNIT WT.</b>
Comparator-Converter Group OA-4079/FSQ-54	3				
Console, Radar Set OA-4091/FSQ-54	3				
Power Supply Group OA-4036/FSQ	3				
Converter Group, Signal Data OA-40tO/FSQ	3				
Monitor Programmer Group OA-4017/FSQ-54	3				
Oscillator Radio Frequency P/N U272738-501	1				
Test Set, Signal Selector Unit AN/FSM-22	3				
Monitor Group, Radar Set OA-4029/FSQ	3				

**REFERENCE DATA AND LITERATURE**

Nomenclature Card and AF Form I1 for AN/FSQ-54.



**DATE:** 15 April 1964

**ITEM NAME:** COORDINATE DATA  
TRANSMITTING SET

**COGNIZANT SERVICE:** USAF

**TYPE:** AN/FST-1

**FEDERAL STOCK NUMBER:** 5895-308-3041B

	USA	USN	USAF	USMC
STATUS OR TYPE CLASSIFICATION			Std	
Mfg(s) Name or Code Number: Lewyt Manufacturing Company				

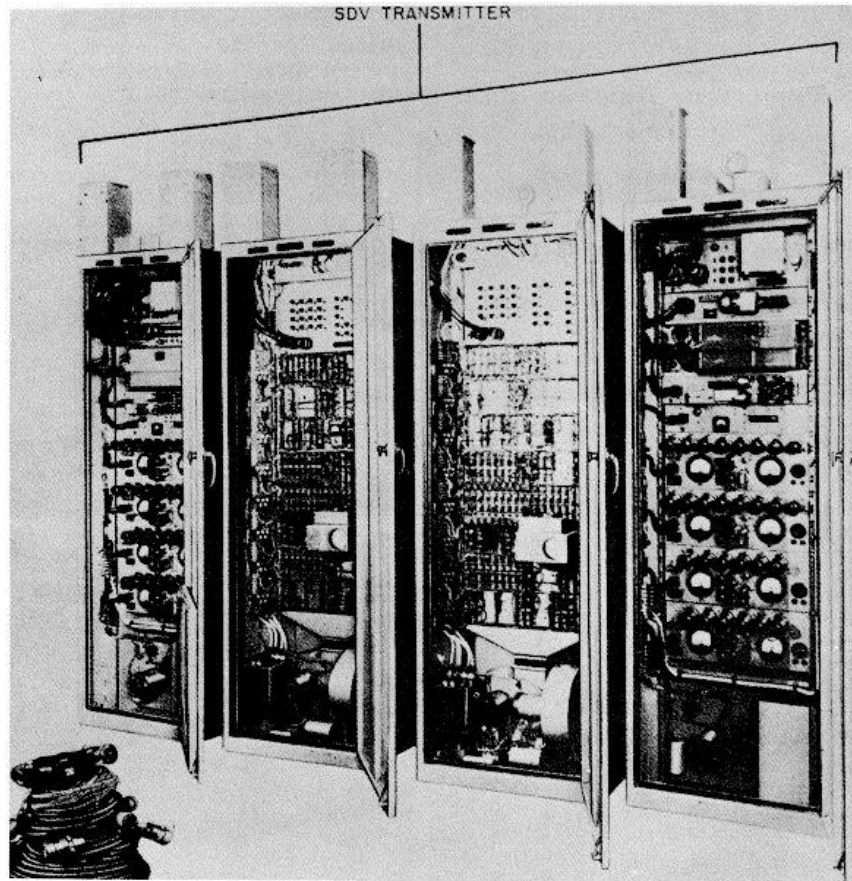

**FUNCTIONAL DESCRIPTION**

Coordinate Data Transmitting Set AN/FST-1 is used to transmit radar data from unmanned gap-

filler radar sites to a heavy radar site. This equipment converts wide band radar video data into coded narrow band audio frequency signals that are transmitted over standard telephone lines. The equipment

**AN/FST-1: 1**

**ITEM NAME:** COORDINATE DATA TRANSMITTING SET

**TYPE:** AN/FST-1

evaluates the radar data before transmission and distinguishes between weak radar pulses and noise, blocking the noise, but passing the weak radar signals.

**RELATION TO SIMILAR EQUIPMENT**

None.

**TECHNICAL DESCRIPTION**

PPI Presentation Divisions  
Azimuth: 256 sectors  
Ranges: 64 sectors  
Presentation Range: 48 mi (max)  
Storage Unit Type: Barrier-grid storage tube  
Transmission Media: Three pairs of telephone lines (single line data) or one pair if data is combined (combined line data)  
Type of Information Output: Data, timing, synchronizing, North Mark  
Read Order Repetition Frequency: 1600 pps Single Line Output:

Frequency - 1600 cps (for three pair line transmission)  
Combined Line Output:  
Frequency - 2000 cps (for single-pair line transmission)  
Trigger: Same as associate gap filter radar or internal for test  
Range Mark Intervals: Choice of 1/2 or 3/4 or 1 mile  
Power Requirements: 120/208V ac, 60 cps, 3-ph, 4-wire, 4 kva

**INSTALLATION CONSIDERATIONS**

Siting: Dependent upon location of associated gap filter radar sets AN/FPS-14 or AN/FPS-18.  
Mounting: Floor-mounted.  
Cabling Requirements: 4-wire power cable.  
Related Equipment: Radar Set AN/FPS-14, AN/FPS-18, Control Monitor Set AN/FSW-1 and Coordinate Data Monitor OA-947/FST-1.

**PRINCIPAL COMPONENTS AND PHYSICAL DATA**

COMPONENT	QTY	HEIGHT (Inches)	WIDTH (Inches)	DEPTH (Inches)	UNIT WT.
Coordinate Data Transmitter T-453/FST-1	2	24	72	16	480
Power Supply Set PP-1084/FST-1	2	24	72	16	430
Power Supply Set Control C-182/FST-1	2	19	7	12	24
Voltage Regulator Assembly CN-354/FST-1	2	19	7	12-1/4	52
Power Supply PP-1407/FST-1	2	19	3-1/2	12-3/4	11
Power Supply PP-1420/FST-1	2	19	3-1/2	8-3/4	12
Power Supply PP-1403/FST-1	4	19	7	12-3/4	58
Power Supply PP-1404/FST-1	4	19	7	12-3/4	53
Coordinate Data Transmitter Transfer Control C-1829/FST-1	1	19	3-1/2	10-1/4	15
Electronic Marker Generator TD-144/FST-1	1	19	3-1/2	10-1/4	11

**REFERENCE DATA AND LITERATURE**

Technical Orders:  
31S1-2FST1- Series

DATE: 1 May 1964 ITEM

NAME: TRANSMITTING SET COORDINATE DATA

COGNIZANT SERVICE: USAF

TYPE: AN/FST-2, \*FST-2A, \*\*FST-2B

FEDERAL STOCK NUMBER: \*5895-583-1140-EG  
\*\*5895-678-2621-EG

	USA	USN	USAF	USMC
STATUS OR TYPE CLASSIFICATION			TS, *LS, **AS	
Mfg(s) Name or Code Number: Burroughs Corporation				

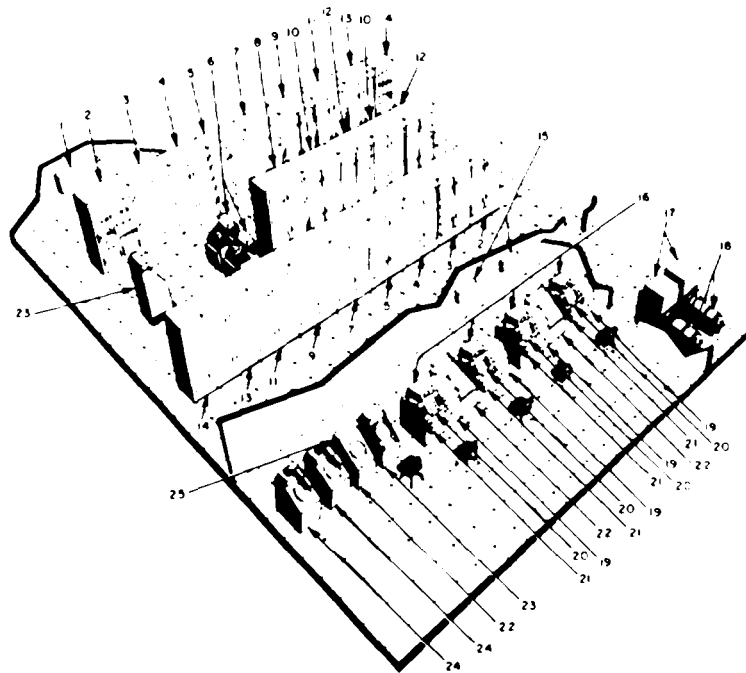

- 1 Interconnecting Bus J 797 FST 2
- 2 Decoder Generator Group (A) 2187 FST 2A or Decoder Power Supply Group (A) 2444 FST 2B
- 3 Modulator Group (A) 2140 FST 2A or Modulator Synthesizer Group (A) 2329 FST 2B
- 4 Coordinate Data Storage Group (A) 2140 FST 2A or Coordinate Data Storage Group (A) 2329 FST 2B
- 5 Magnetic Drum Storage Data Amplifier AM 2107 FST 2A or Magnetic Drum Storage Data Amplifier AM 2218 FST 2B
- 6 Coordinate Data Monitor IP 366 FST 2 or Coordinate Data Monitor IP 404 FST 2
- 7 Data Processing Marginal Check Group (A) 2150 FST 2A or Data Processing Marginal Check Group (A) 2327 FST 2B
- 8 Power Signal Transfer Cabinet SA 821 FST 2A or Power Signal Transfer Cabinet SA 872 FST 2B
- 9 Data Processing Cabinet MX 2840 FST 2A or Data Processing Cabinet MX 2753 FST 2B
- 10 Power Supply Assembly PP 2210 FST 2 or Power Supply Assembly PP 2340 FST 2B
- 11 Converter SNU Register Group (A) 2051 FST 2A or Converter SNU Register Group (A) 2326 FST 2B
- 12 Power Control Regulating Cabinet C 2753 FST 2A or Power Control Regulating Cabinet C 3305 FST 2B
- 13 Electronic Counter SNU Register (C) 467 FST 2A or Electronic Counter SNU Register (C) 492 FST 2B
- 14 Data Processing Automatic Filter Mapper Cabinet (A) AN FST 2A
- 15 Interconnecting Bus J 798 FST 2
- 16 Relative Target Position Indicator IP 370 FST 2
- 17 Motor Generator (A) 1979 FST 2
- 18 Motor Generator (C) 187 FST 2
- 19 Message Indicator (A) 2140 FST 2
- 20 Radar Set Group (A) 270 FST 2 or Indicator Group (A) 828 FST 2A
- 21 Message Indicator Panel PT 443 FST 2
- 22 Coordinate Data Monitor (A) 99 CPS 6Hz Coordinate Data Monitor (A) 175 CPS 3
- 23 Coordinate Data Monitor (A) 1163 FST
- 24 Moving Target Indicator (A) 1638 FST 2
- 25 Control Indicator C 2988 FST 2

**FUNCTIONAL DESCRIPTION**

AN/FST-2, 2A, 2B Target Data Processing Equipment is used to accept search radar and height-finder radar target data information and selective identification feature (SIF) radio target data information. This

target data information is used by the AN/FST-2, 2A, 2B to verify and identify targets; to compute the range, azimuth, height, and size of targets; and to provide special information concerning these targets. The AN/FST-2 or 2A or AN/FST-2B automatically processes target data received

**ITEM NAME:** TRANSMITTING SET COORDINATE DATA

**TYPE:** AN/FST-2, 2A, 2B

from radar and radio sets and transmits the processed data to the direction center. Each direction center evaluates and acts upon target data information supplied by several subordinate AN/FST-2, 2A, 2B equipments.

Operating Power Requirements: 20H3v ac, 60 cycle, 3 ph

**RELATION TO SIMILAR EQUIPMENT**

Transmitting Set AN/FST-2B is similar to and one way interchangeable with AN/FST-2A. Differs in that AN/FST-2B (SIF) portion is transistorized, whereas AN/FST-2A is designed with vacuum tubes.

**INSTALLATION CONSIDERATIONS**

Siting: Dependent on Associated Search Radar Set.

Mounting: All equipment is mounted in equipment cabinets which are designed for subfloor mounting and are housed in an air conditioned building.

Cabling Requirements: All cables from the equipment cabinets to peripheral equipment or junction boxes, or between cabinet groups which are nonadjacent shall run in trenches below the service floor level.

Related Equipments: Associated Search Radar AN/CPS-6B, AN/FPS-3, AN/FPS-6, AN/FPS-7, AN/FPS-20 or any other suitable high power search radar, Radar Identification Set AN/GPX-6A, or AN/GPX-7A. Radar Recognition Set AN/GPX-30; Delay Line Set AM-1796/FPS.

**TECHNICAL DESCRIPTION**

Input Signal Data:

AN/FST-2A - 14 electrical inputs

AN/FST-2B - 31 electrical inputs

Output Signal Data:

AN/FST-2A - 400 cycle Band width, 2v to IO0v level.

AN/FST-2B - 400 cycle Band width, 2v to 10v level.

**PRINCIPAL COMPONENTS AND PHYSICAL DATA**

<u>USED ON</u>	F	F	QTY	HEIGHT (Inches)	WIDTH (Inches)	DEPTH (Inches)	UNIT WT.
	S	S					
COMPONENT	T	T					
	2	2					
	A	B					
Interconnecting Box J-797/FST-2	X	X	1				
Decoder-Generator Group OA-2147/FST-2A	X		2				
Decoder-Power Supply Group OA-2444/FST-2B	X		2				
Quantizer Group OA-2149/FST-2A	X		2				
Quantizer-Synchronizer Group OA-2329/FST-2B	X		2				
Coordinate Data Storage Group OA-2148/FST-2A	X		2				
Coordinate Data Storage Group OA-2328/FST-2B	X		2				
Coordinate Data Monitor IP-366/FST-2	X		2				
Coordinate Data Monitor IP-498/FST-2	X	X	2				
Data Processing Group OA-2150/FST-2A	X		2				

ITEM NAME: TRANSMITTING SET COORDINATE DATA

TYPE: AN/FST-2, 2A, 2B

PRINCIPAL COMPONENTS AND PHYSICAL DATA

<u>USED ON</u>	F	F	QTY	HEIGHT (Inches)	WIDTH (Inches)	DEPTH (Inches)	UNIT WT.
	S	S					
COMPONENT	T	T					
	2	2					
	A	B					
Data Processing Group OA-2327/FST-2B	X		2				
Power-Signal Transfer Cabinet SA-621/FST-2A	X		1				
Power-Signal Transfer Cabinet SA-672/FST-2B	X		1				
Data Processing Cabinet MX-2668/FST-2A	X		2				
Data Processing Cabinet MX-2753/FST-2B	X		2				
Power Supply Assembly PP-2210/FST-2	X		2				
Power Supply Assembly PP-2340/FST-2B	X		2				
Converter-Shift Register Group OA-2051/FST-2A	X		2				
Converter-Shift Register Group OA-2326/FST-2B	X		2				
Power Control-Regulating Cabinet C-2753/FST-2A	X		2				
Power Control-Regulating Cabinet C-3005/FST-2B	X		2				
Electronic Counter-Shift Register CP-117/FST-2A	X		2				
Electronic Counter-Shift Register CP-192/FST-2B	X		2				
Data Processing Automatic Clutter Mapper Cabinet	X		2				
Interconnecting Box J-79B/FST-2	X	X	2				
Target Position Indicator IP-370/FST-2	X	X	4				
Motor-Generator Control C-1979/FST-2	X	X	4				
Motor-Generator PU-367/FST-2	X	X	2				
Message Console OA-2140/FST-2	X	X	4				

AN/FST-2: 3

**ITEM NAME:** TRANSMITTING SET COORDINATE DATA

**TYPE:** AN/FST-2, 2A, 2B

**PRINCIPAL COMPONENTS AND PHYSICAL DATA**

<u>USED ON</u>	F	F					
	S	S					
	T	T					
<b>COMPONENT</b>	<b>2</b>	<b>2</b>	<b>QTY</b>	<b>HEIGHT</b>	<b>WIDTH</b>	<b>DEPTH</b>	<b>UNIT WT.</b>
	<b>A</b>	<b>B</b>		<b>(Inches)</b>	<b>(Inches)</b>	<b>(Inches)</b>	
Message Console Panel PT-443/FST-2	X	X	4				
Moving Target Indicator Group OA-1638/FST-2	X	X	2				
Control-Indicator C-2969/FST-2	X	X	1				
Indicator-Amplifier G-2843/FST-2A	X	X	1				

**REFERENCE DATA AND LITERATURE**

TECHNICAL ORDERS:  
31S1-2FST2- Series  
Specification MIL-T-1664A

DATE: 15 April 1964

ITEM NAME: CONTROL MONITOR SET

COGNIZANT SERVICE: USAF

TYPE: AN/FSW-1

FEDERAL STOCK NUMBER: 5895-334-0038B

	USA	USN	USAF	USMC
STATUS OR TYPE CLASSIFICATION			Std	
Mfg(s) Name or Code Number: Westinghouse Electric Corp.				

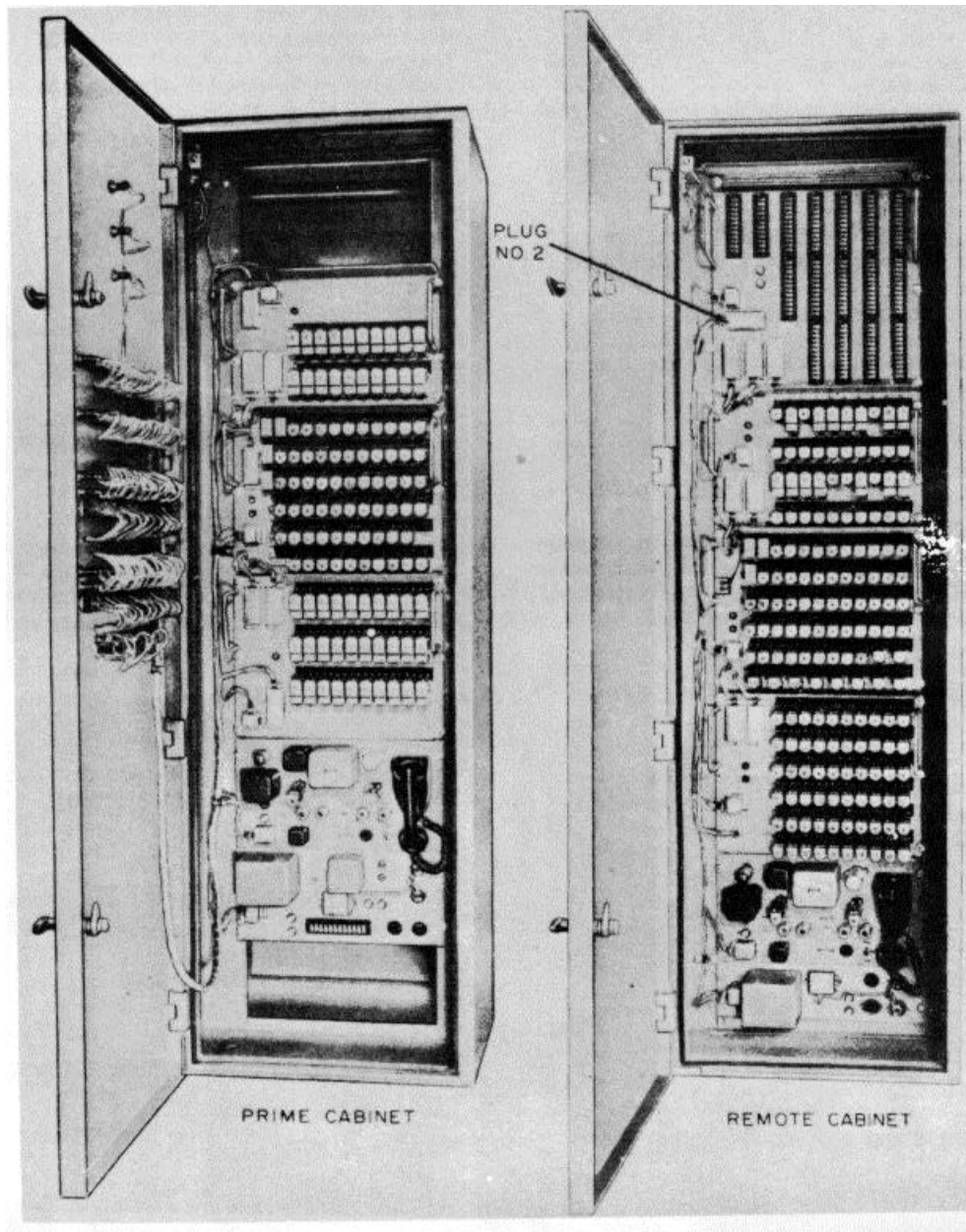

AN/FSW-1: 1

**ITEM NAME:** CONTROL MONITOR SET  
**TYPE:** AN/FSW-1

**FUNCTIONAL DESCRIPTION**

Control Monitor Set AN/FSW-1 is designed primarily for the control of an unmanned gap-filter radar site from its associated prime site. It provides a remote control system for the control and monitoring of equipment functions, building conditions, or both at some remote point.

425 cps  
C-2062, Control Monitor (Remote) -  
1785 cps  
Transmission Media: Standard single-l)air, 600 ohm telephone line  
Speed of Operation:  
Control and Report Back - 2 to 3 sec  
Monitor Only - 1.5 to 2.5 sec  
Power Requirements: 105/130% ac, 60 plus or minus 2 cps, 300w  
Other: Telephone communication provided between local and remote site; self-contained indication lamp)s check; report-back and monitor indications are Go No-Go only.

**RELATION TO SIMILAR EQUIPMENT**

None.

**TECHNICAL DESCRIPTION**

Number of Functions Remotely controlled: 20  
Number of Functions Monitored: 30 (15 visual, 15 audio-visual)  
Temperature Limitations  
Operating: -29 deg C (-20 deg F) to plus 54 deg C (plus 129 deg F)  
Nonoperating: -50 deg C (-58 deg F) to plus 60 deg C (plus 140 deg F)  
Pressure Limitations  
Operating: -30 in. to 20 in. Hg(sea level to 8000 ft)  
Nonoperating: 30 in. to 22 in. Hg (sea level to 30,000 ft)  
Tone Transmitter Power Output: 0 to 10 dbm  
Receiver Input Signal: -25 dbm to plus 5 dbm  
Tone Frequencies:  
C-2063, Control Monitor (Prime) -

**INSTALLATION CONSIDERATIONS**

Siting: The Control Monitor C-2062 is dependent on location of gap filter radar site and Control Monitor C-2063 is dependent on location of associated prime radar site.  
Mounting: Control Monitor C-2062 is floor mounted in the gap filter radar building. Control Monitor C-2063 is floor mounted in the associated prime radar building.  
Cabling Requirements:  
Power Cable - Two conductor, non-special  
Signal Cable - Single-pair, 600-ohm telephone line  
Related Equipment: Gap-filter radar sets AN/FPS-18 and AN/FPS-1, and Coordinate Data Transmitting Set AN/FST-1.

**PRINCIPAL COMPONENTS AND PHYSICAL DATA**

COMPONENT	QTY	HEIGHT (Inches)	WIDTH (Inches)	DEPTH (Inches)	UNIT WT. (Pounds)
Control Monitor (Prime) C-2063	1	84	26	25	690
Control Monitor (Remote) C-2062	1	84	26	25	720

**REFERENCE DATA AND LITERATURE**

Technical Orders:  
31S1-2FSW1- Series



DATE: 1 April 1964  
COGNIZANT SERVICE: USAF

ITEM NAME: ELECTRONIC MAPPING GROUP  
TYPE: AN/GPA-5

FEDERAL STOCK NUMBER: 5840-505-1728

	USA	USN	USAF	USMC
STATUS OR TYPE CLASSIFICATION			Ltd Std	
Mfg(s) Name or Code Number: Reeves Instrument Corporation				

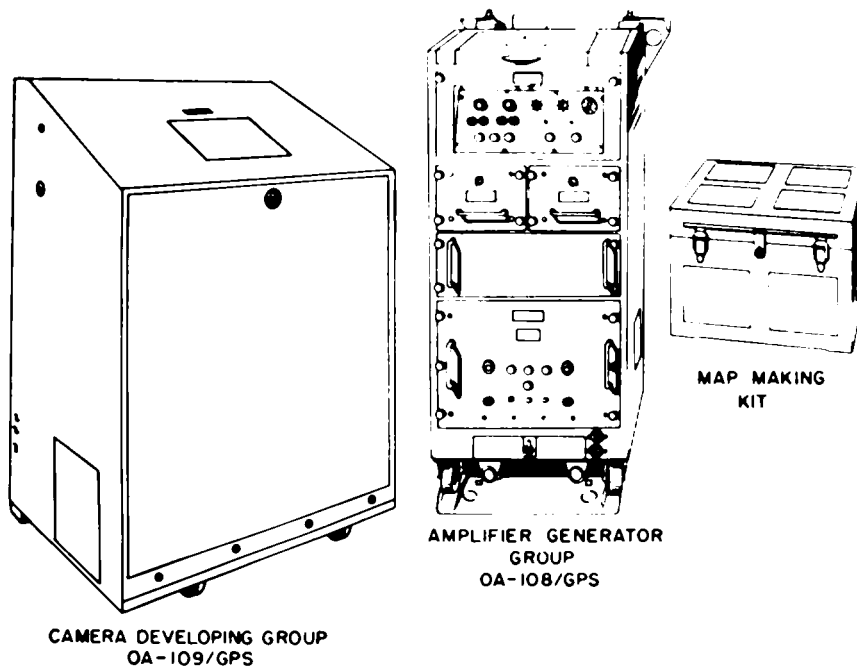

## FUNCTIONAL DESCRIPTION

Electronic Mapping Group AN/GPA-5 furnishes an optical presentation of the region scanned by a radar antenna for presentation on a PPI or B-scope. The AN/GPA-5 equipment generates electronic map signals from an opaque film which contains transparent lines and symbols representing the area within 8.5 to 350 miles of the radar site. Electrical pulses of map video are mixed with radar target video and applied to indicator scopes that display the position of a radar target with respect to a point on the earth's surface. The AN/GPA-5 may be used to represent a circular area with a radius greater than 8.5 miles or less than 250 miles. The AN/GPA-5 may be used with indicators having sweeps longer or shorter than the electronic map ping

operational limits, but mapping signals will not appear on the indicator at distances less than 8.5 miles or greater than the radius of the map in use. Photographic and drafting equipments for making and processing maps are included with Electronic Mapping Group AN/GPA-5.

## RELATION TO SIMILAR EQUIPMENT

None.

## TECHNICAL DESCRIPTIONS

Video Output: 5v max; 75-ohm terminating impedance

**ITEM NAME:** ELECTRONIC MAPPING GROUP

**TYPE:** AN/GPA-5

Pulse Repetition Rate: 200 to 2000 pps  
(conforms to prf of associated radar)  
Range (Mapping): 0.5 to 350 naut mi  
Horizontal Coverage: 360 deg  
Map Table Speed of Rotation: Up to 12 rpm,  
synchronized with associated radar (may be  
modified for higher rotational speeds)  
Resolution: 2000 lines  
Indicator Type: 5-in. oscilloscope, PPI, and B-scope  
Mapping Ranges: 0.5 to 30, 25 to 100, 75 to 200,  
and 150 to 350 naut mi  
Power Requirements:  
115v ac, 60 cps, 1-ph, 575w

115v dc or v ac (60 cps, 1-ph, 1150w)  
Duty Cycle: Continuous

**INSTALLATION CONSIDERATIONS**

Siting: Dependent on associated radar location.

Mounting: The AN/GPA-5 is installed in the  
operations building of the associated radar.

Related Equipment: Radar Sets AN/FPS-3  
AN/CPN-18, AN/CPS-6B.

**PRINCIPAL COMPONENTS AND PHYSICAL DATA**

<b>COMPONENT</b>	<b>QTY</b>	<b>HEIGHT (Inches)</b>	<b>WIDTH (Inches)</b>	<b>DEPTH (Inches)</b>	<b>UNIT WT. (Pounds)</b>
Amplifier Generator Group Including Cabinet OA-100/GPS	1	50	26	21	
Camera Developing Group OA-109/GPS	1				
Map Making Kit	1				

**REFERENCE DATA AND LITERATURE**

Technical Orders:  
31P1-2GPA5- Series

**AN/GPA-5: 2**

DATE: 1 July 1964

ITEM NAME: MOVING TARGET INDICATOR  
GROUP  
TYPE: AN/GPA-7, 7A

COGNIZANT SERVICE: USN

FEDERAL STOCK NUMBER:

	USA	USN	USAF	USMC
STATUS OR TYPE CLASSIFICATION				
Mfg(s) Name or Code Number: Airborne Instruments Lab. Inc., Mineola, N. Y.				

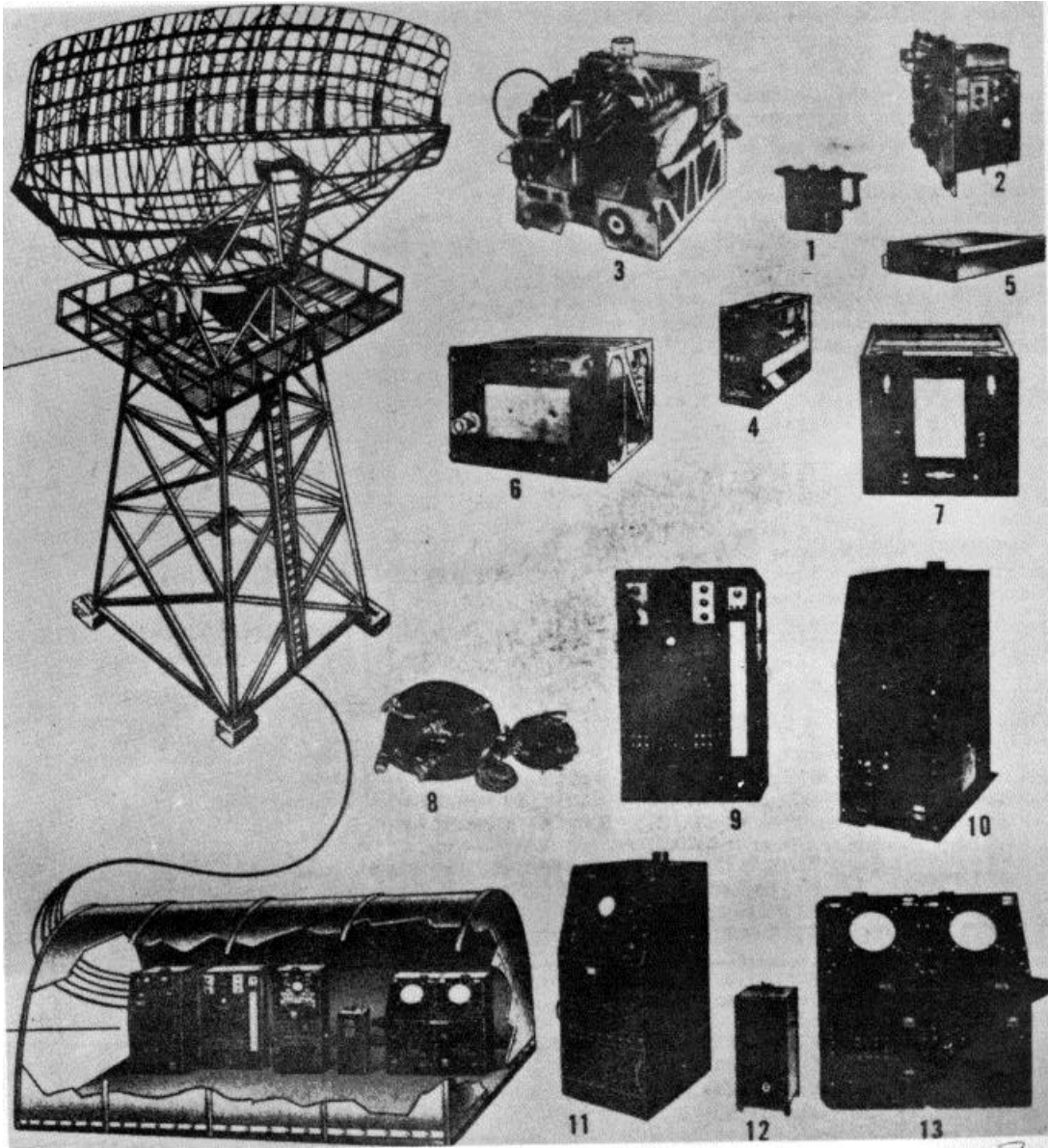

AN/GPA-7: 1

**AN/GPA-7, 7A**

**FUNCTIONAL DESCRIPTION**

Moving Target Indicator Groups AN/GPA-7 and AN/GPZ-7A eliminate or markedly reduce returns from stationary targets that might otherwise obscure echoes from moving targets. These groups modify Radar Set AN/CPS-5 to provide MTI on existing indicators and to allow antenna rotation speeds up to 10 rpm.

**TECHNICAL DESCRIPTION**

Frequency: 1150 to 1400 mc  
Operating Voltage: 120 vac, 60 cps, 1-ph

**RELATION TO SIMILAR EQUIPMENT**

Both the AN/GPA-7 and AN/GPA-7A are similar to, but not interchangeable with, Moving Target Indicator Group AN/GPA-2( ).

**INSTALLATION CONSIDERATIONS**

Not available.

**PRINCIPAL COMPONENTS AND PHYSICAL DATA**

COMPONENT	QTY	HEIGHT (Inches)	WIDTH (Inches)	DEPTH (Inches)	UNIT WT. (Pounds)
AN/GPA-7					
Receiver Group OA-111/GPS	1				
Radar Modulator MD-102/GPS	1				
Trigger Amplifier AM-286/GPS	1				
Power Supply PP-434/GPS	1				
IF. Amplifier AM-287/GPS	1				
RF Oscillator O-89/GPS	1				
Trigger Amplifier AM-288/GPS	1				
Radar Receiver R-300/GPS	1				
Power Supply PP-435/GPS	1				
AN/GPA - 7A					
Power Supply PP-480/GPS	1	14	6	21-3/4	63
RF Oscillator O-89A/GPS	1	4-1/2	14	22	41
Power Supply PP-434A/GPS	1	4-1/4	19-1/2	24-1/4	140
Radar Receiver R-300A/GPS	1	11	20-1/2	23	76
Radar Modulator MD-102A/GPS	1	24	24	24	300
Receiver Group OA-138/GPS	1	51-1/4	28-3/4	23-7/8	565

**REFERENCE DATA AND LITERATURE**

Technical Order (AN/GPA-7A):  
AN/6-30GPA7-3  
Exhibit (AN/GPA-7):  
WLENG-203

DATE: 1 July 1964

ITEM NAME: ANTENNA GROUP

COGNIZANT SERVICE: USN

TYPE: AN/GPA-8

FEDERAL STOCK NUMBER: 5985-501-4891

	USA	USN	USAF	USMC
STATUS OR TYPE CLASSIFICATION				
Mfg(s) Name or Code Number: Maryland Electronic Manufacturing Corp., College Park, Maryland				

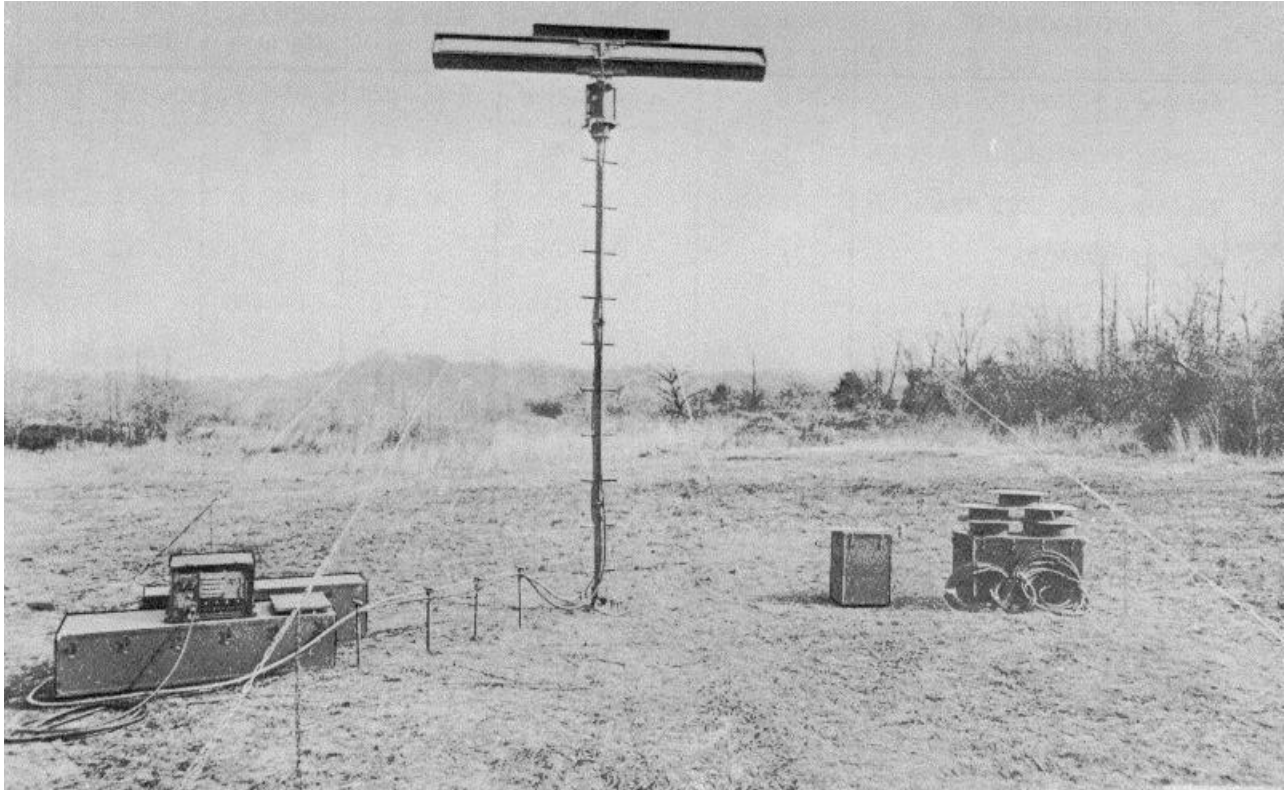

**FUNCTIONAL DESCRIPTION**

The AN/GPA-8 is designed to rotate an antenna in continuous synchronism with a separate radar antenna. The equipment functions as a separate transmitting-receiving antenna for IFF in the 1010 to 1110 mc band, and, by the inclusion of a test prod mounted in the pedestal, provides a means for picking up a portion of the radiations for maintenance checks.

**RELATION TO SIMILAR EQUIPMENT**

None.

**TECHNICAL DESCRIPTIONS**

Frequency: 1010 to 1110 mc  
Type Antenna: Broadside array with 12 fullwave slot radiators

**AN/GPA-8: I**

AN/GPA-8

600w avg, 1500w peak

Polarization: Vertical  
Horizontal Beam Width: 7 deg at half-power  
RF Power Input: 10 kw peak at 0. 25% duty cycle  
Impedance: 50 ohms  
Filter Attenuation: Less than 0. 5 db over antenna frequency range, more than 50 db from 3000 to 10,000 mc  
Power Requirements:  
Heater - 115 or 230v, 50 to 60cps, 1-ph, 100va  
Operation - 115v \*10%, 60 cps \*7. 5%, 1-ph,

**INSTALLATION CONSIDERATIONS**

Siting: Requires most unobstructed field available, in reasonable proximity to associated radar antenna  
Mounting:  
Cabling Requirements:  
Related Equipment: The AN/GPA-8 is a part of Interrogator Sets AN/TPX-17 and AN/TPX- 18.

**PRINCIPAL COMPONENTS AND PHYSICAL DATA**

<b>COMPONENT</b>	<b>QTY</b>	<b>HEIGHT (Inches)</b>	<b>WIDTH (Inches)</b>	<b>DEPTH (Inches)</b>	<b>UNIT WT. (Pounds)</b>
Antenna AT-352/UPA-22	1	15-1/2	111-3/8	12-1/8	55
Antenna Pedestal AB-279/GPA	1	20-3/4	13-3/4	11-3/8	76
Test Prod MX-1263/UPA	1	3	6-3/8	2	0.75
Mast AB-278/GPA	1	153-1/2			133
Electronic Control Amplifier AM-692/GPA-8	1	20-1/16	21-7/8	14-5/16	99
Set of Cables and Equipment Spares, w/case	1	21-3/16	35-3/16	21-1/8	200

**REFERENCE DATA AND LITERATURE**

Technical Manual:  
NAVSHIPS 91635

**AN/GPA-8: 2**

DATE: 1 August 1964

ITEM NAME: AMPLIFIER-INDICATOR GROUP

COGNIZANT SERVICE: USAF

TYPE: AN/GPA-26

FEDERAL STOCK NUMBER:

	USA	USN	USAF	USMC
STATUS OR TYPE CLASSIFICATION			TS	
Mfg(s) Name or Code Number. Advance Industries				



**FUNCTIONAL DESCRIPTION**

The purpose of Amplifier-Indicator Group AN/GPA-26 is to provide a means for the simultaneous display of radar video signals from the parent Radar Set, IFF returns from the Interrogator Set AN/MPX-7, and

topographical map information from a Video Mapping Group AN/GPA-30. This multiple display is accomplished by time-sharing two separate Plan Position Indicator (PPI) sweep traces. One trace presents radar video signals in the normal manner and rotates with the radar antenna. The

**ITEM NAME:** AMPLIFIER-INDICATOR GROUP

**TYPE:** AN/GPA-26

alternate trace presents IFF return signals and/or mapping information, as desired, and rotates with the antenna of the Interrogator Set or with the map table of the Electronic Mapping Group. This simultaneous display capability greatly increases the operational utility of the Close Support Control Set AN/MSQ-1 of which the parent Radar Set, the Interrogator Set, and the Electronic Mapping Group are components parts. Although designed for immediate Mark X operation with Interrogator Set AN/MPX-7, Amplifier-Indicator Group AN/GPA26 has provision for future SIF operation through the use of an AN/GPA-36 Control Unit.

**RELATION TO SIMILAR EQUIPMENT**

None.

**TECHNICAL DESCRIPTION**

Presentations available:

- Operational Mode 1 - Radar only
- Operational Mode 2 - Radar and IFF
- Operational Mode 3 - Radar and Maps
- Operational Mode .1 - Radar, IFF, and Maps

Input Power Requirements:

800 va of single ph, 115v, 60 cycle power.

Four ranges provided: of 50,000 yd, 100,000 yd, 200,000 yd and 360,000 yd.

Input Signal:

- Pre-Trigger Gate - Negative, 60v, 44 usec gate occurs 18.8 usec prior to ea radar
- PPI Triggers - Negative, 8v, 0.8 usec triggers at 110 pps
- Radar Track Gate - Positive, 3.5v, 1.6 usec gate, var in time with target range
- Range Mark Triggers - Positive, 0.6 usec triggers at 81.91 kc
- Radar Video
- IFF Video
- Map Video

Synchro Control Data - One speed and 16-speed synchro ant. azimuth data from AN/MPX-7

IFF Trigger - Positive, 20v, 1 usec trigger preceding ea radar by either 12.2 usec or 36.6 usec as selected by Trigger Select switch on Indicator Control

Map Triggers - Positive, 35v, 1 usec trigger coincident with the radar triggers.

**INSTALLATION CONSIDERATIONS**

Siting: The AN/GPA-26 is designed for installation in Radar Trailer K78 of Radar Set AN/MPS-9.

Mounting: For mechanical reasons, IP-431/GPA-26, PP-1803/GPA-26, and C-2258/GPA should be installed in the order named. The other components may be installed in any convenient sequence.

The interconnecting cables should be installed last.

Cabling Requirements: The interconnecting cables are of two basic types:

inter-van cables, of which there are 5, and intra-van cables, of which there are 21. The inter-van cables provide connections to Interrogator Set AN/MPX-7 which is located in a separate truck. The intra-van cables are of various lengths and are used inside the Radar Van to interconnect the components of the Amplifier-Indicator Group with one another and with the Radar Set.

Related Equipments: Amplifier-Indicator Group AN/GPA-26 is designed for installation in the Radar Van of Radar Set AN/MPS-9. It constitutes a modification to the Radar Set by replacing the former PPI display system. The AN/GPA-26 operates in conjunction with the Radar Set, with an Interrogator Set AN/MPX-7, and with a Video Mapping Group AN/GPA-30.

**PRINCIPAL COMPONENTS AND PHYSICAL DATA**

COMPONENT	QTY	HEIGHT (Inches)	WIDTH (Inches)	DEPTH (Inches)	UNIT WT. (Pounds)
Azimuth and Range Indicator IP-131/GPA-26	1				
Indicator Control C-2258/GPA-26	1				
Power Supply PP-1803/GPA-26	1				
Electronic Control Amplifier AM-1742/GPA-26	1				



ITEM NAME: AMPLIFIER-INDICATOR GROUP  
TYPE: AN/GPA-26

**PRINCIPAL COMPONENTS AND PHYSICAL DATA**

<b>COMPONENT</b>	<b>QTY</b>	<b>HEIGHT (Inches)</b>	<b>WIDTH (Inches)</b>	<b>DEPTH (Inches)</b>	<b>UNIT WT. (Pounds)</b>
Electrical Resolver SN-197/GPA-26	1				
Distribution Box J-8614/GPA-26	1				
Interconnecting Cables	26				

**REFERENCE DATA AND LITERATURE**

TECHNICAL ORDERS:  
31P1-2GPA26 Series

**AN,/GPA-26: 3**

**DATE:** 15 December 1964

**ITEM NAME:** RADAR SET GROUP

**COGNIZANT SERVICE:** USAF

**TYPE:** \*AN/GPA-27, \*\*AN/GPA-27A,  
 ↗AN/GPA-57, ↗↗AN/GPA-57A,  
 ΦAN/GPA-58, ΦΦAN/GPA-58A

\*5840-313-7252 ↗↗5840-602-0474

\*\*5840-602-0476 Φ15840-588-9676

**FEDERAL STOCK NUMBER:** ↗5840-602-0473 ΦΦ5840-602-0475

	USA	USN	USAF	USMC
STATUS OR TYPE CLASSIFICATION			*LS	
Mfg(s) Name or Code Number: Bendix Radio Division of Bendix Aviation Corp., Baltimore, Maryland				

**Illustration Not Available.**

**FUNCTIONAL DESCRIPTION**

Radar Set Groups AN/GPA-27, AN/GPA-27A, AN/GPA-57, AN/GPA-57A, AN/GPA-58, and AN/GPA-58A are conversion kits used to transform long range search Radar Sets AN/FPS-3, AN/FPS-

3A, and AN/MPS-7 (fixed version) from medium-power to high-power output.

The new high-power facility, which features dual channel operation, employs either a single modulator or a dual modulator system. Radar Set AN/FPS-20 employs

**AN/GPA-27: 1**

**ITEM NAME:** RADAR SET GROUP

**TYPE:** AN/GPA-27, AN/GPA-27A, AN/GPA-57, AN/GPA-57A  
AN/GPA-58, AN/GPA-58A

a dual modulator while Radar Set AN/FPS-20A is of the single modulator type. A rotary joint in the antenna pedestal replaces the slip rings used on the systems being converted. The rotary joint permits the entire complement of electronic equipment to be located away from the rotating antenna support. Therefore, the receivers, transmitters, and control equipment have been placed inside a heated shelter to facilitate maintenance. This feature permits training of personnel, using the standby channel, without interrupting normal operation of the facility. In addition, preventative maintenance can be performed on one transmitter receiver group while the other is operating, thereby reducing off-the-air time. Control circuits are simplified since there is no longer a requirement for control at both the antenna and the control shelter locations.

Channel switching is accomplished by a change over switch which automatically changes transmitter-receiver groups and controls the position of the waveguide switch.

Radar Set AN/FPS-20 (dual modulator system) and Radar Set AN/FPS-20A (single modulator system) equipment employs a line feed instead of the four-horn feed used on the systems being converted. The effective range for small targets has been increased by an improvement in noise figure, higher transmitter-power output, and a reduction in receiver bandwidth. However, the maximum range is limited by the system prf (pulse repetition frequency).

The MTI (moving target indicator) system circuits reduce the scanning clutter received from fixed ground targets. This is accomplished with two quartz delay lines in cascade with feedback circuits around the delay lines. MTI performance is further improved by a reduction of power supply ripple in the transmitter and receiver power supplies.

The new receiving system uses a video enhancement circuit which is very effective in reducing interference from other radar equipment using a different pulse repetition frequency. It is not necessary to have a blanking trigger from the interfering radar equipment for the video enhancement circuit to function. Interference from other radar equipment with an identical repetition rate is not a serious problem since it is displayed on the PPI (plan position indicator) scope as a single narrow ring of constant range and does not hamper, to any large extent, normal scope readings.

The antichaff receiver, a useful antijamming device, assists in the elimination of undesirable signals caused by chaff.

The high-power radar system utilizes a three-cavity klystron in place of the magnetron employed in the medium-power sets.

AN/GPA-27A is similar to Radar Set Group AN/GPA-57A and AN/GPA-58A but not interchangeable. The AN/GPA-27 is similar to Radar Set Group AN/GPA-57, and AN/GPA-58 but not interchangeable. Radar Set Groups AN/GPA-27A, AN/GPA-57A, and AN/GPA-58A are similar to and interchangeable as a whole with Radar Set Groups AN/GPA-27, AN/GPA-57, and AN/GPA-58 respectively, but are the preferred models and differ in the four type 1754 thyroton tubes being replaced by a single type 1257 tube.

**TECHNICAL DESCRIPTIONS**

Radar Set Group AN/GPA-27:

Converts Radar Set AN/FPS-3 to dual modulator Radar Set AN/FPS-20.

Radar Set Group AN/GPA-57:

Converts Radar Set AN/FPS-3A to dual modulator Radar Set AN/FPS-20.

Radar Set Group AN/GPA-58B:

Converts Radar Set AN/MPS-7 (fixed) to dual modulator Radar Set AN/FPS-20.

Radar Set Group AN/GPA-27A:

Converts Radar Set AN/FPS-3 to single modulator Radar Set AN/FPS-20A.

Radar Set Group AN/GPA-57A:

Converts Radar Set AN/FPS-3A to single modulator Radar Set AN/FPS-20A.

Radar Set Group AN/GPA-58A:

Converts Radar Set AN/MPS-7 (fixed) to single modulator Radar Set AN/FPS-20A.

Electrical Characteristics of the high-

power Radar Sets AN/FPS-20 and AN/FPS-20A:

Primary Power: 3-ph, 60 plus or minus 5 cycles, 120/206 plus or minus 5v, 4-wire.

Antenna Beam: one.

Frequency Range: 1250 to 1350 mc

Transmitter Power Output: 2 megw min peak power, 4320 w min avg power.

Transmitter R-F Pulse Width: 6 usec

PA Modulator Video Pulse Width: B usec

Pulse Repetition Frequency: 360 cps nom

Noise Figure: 9 db

Cancellation Unit Cancellation Ratio:

single line, greater than 40 db;

cascaded line, greater than 50 db

Coho Cancellation Ratio Limitation: 50 db at 50 mi

Stalo Cancellation Ratio Limitation: 40 db at 50 mi

Receiver Cabinet Sub-clutter Ratio: 36 db

**RELATION TO SIMILAR EQUIPMENT**

**ITEM NAME:** RADAR SET GROUP

**TYPE:** AN/GPA-27, AN/GPA-27A, AN/GPA-57, AN/GPA-57A  
AN/GPA-58, AN/GPA-58A

**Mounting:** In arctic installations the first floor of Antenna Tower AN/199/ FPS-3 or Antenna Tower AB-199A/FPS-3 is used to house the electronic equipment and is referred to as the radar control shelter. For temperate installations a new radar control shelter is required: 25 feet 10 inches by 48 feet 4 inches, inside plan dimensions, by 10 feet clear height. A room of this size houses on active and one standby channel.

**Related Equipment:** Radar Sets AN/FPS-3, AN/FPS-3A, and AN/MPS-7 (fixed version)

at 50 mi  
Velocity Response Shaping Cancellation  
Ratio: 30 db at 3.3 or 5.0 rpm of the antenna  
Transmitter Limit on Cancellation Ratio: 35 db  
Antenna Gain (one way, 1300 mc, nose of beam):  
approx 35 db  
Transmitter Duty Cycle: 0.00216  
Modulator Duty Cycle: 0.00288

**INSTALLATION CONSIDERATIONS:**

**Siting:** Determined by location of existing basic radar.

**PRINCIPAL COMPONENTS AND PHYSICAL DATA**

COMPONENT	QTY	HEIGHT (Inches)	WIDTH (Inches)	DEPTH (Inches)	UNIT WT. (Pounds)
(UNCRATED)					
Amplifier-Mixer AM-1347/FPS-20	2***	54-1/4	24-1/4	27	288
Power Supply PP-1377/FPS-20	2***				
Power Supply PP-1378/FPS-20	2***				
Radio Frequency Amplifier AM-134B/FPS-20	2***	73	50-1/2	32-1/2	550
Radio Frequency Amplifier AM-1654/FPS-20A	2*				
Power Supply PP-1356/FPS-20	4***	12-1/2	23	26-1/2	151
Liquid Electron Tube Cooler HD-230/FPS-20	2***	67	28	31	250
Power Driven Rotary Pump HD-231/FPS-20	2***	46-1/2	24-1/4	50	357
Radio Frequency Amplifier AM-1402/FPS-20	2***	72	30-1/2	32-3/4	464
Radar Modulator MD-276/FPS-20	2***	13-1/4	29-3/4	31-1/4	150
Radar Modulator MD-212/FPS-20	4**	66	36-1/4	36,-1/4	800
Power Supply PP-1301/GPS	4**				
Pulse Generator 0-22B/GPS	8**				
Radar Modulator MD-268/FPS-20A	2*				
Pulse Generator 0-399/FPS-20A	2*				
Power Supply Subassembly PP-1051/FPS-20	4**	24	24	26	
Direct Current Power Filter F-297/FPS-20	4**	24	24	26	
Step-up Power Transformer TF-190/FPS-20	4**	17-1/2	27	26	
Power Supply PP-1409/FPS-20A	2*				
Voltage Regulator CN-323/FPS-20	6**	44	24	20-1/2	495
Voltage Regulator CN-323/FPS-20	2*	44	24	20-1/2	495
Voltage Regulator (None)	2*				
Power Driven Rotary Compressor HD-246/FPS-20	2**	48	36	22	473
Monitor-Oscillator Group OA-955/FPS-20	2***	48-1/2	27-1/2	29-1/4	309
Electrical Equipment Cabinet CY-I q60/FPS-20	2***				
Frequency Meter ME-104/FPS-20	2***				
Radio Frequency Monitor ID-446/GPS	2***				
Power Supply PP-1345/GPS	2***				
Test Adapter UG-I127/GPS	2***				
Mounting Panel SB-424/FPS-20	2***				
Radio Frequency Oscillator O-315/FPS-20	2***				

**ITEM NAME:** RADAR SET GROUP

**TYPE:** AN/GPA-27, AN/GPA-27A, AN/GPA-57, AN/GPA-57A AN/GPA-58, AN/GPA-58A

COMPONENT	PRINCIPAL COMPONENTS AND PHYSICAL DATA					UNIT WT. (Pounds)
	QTY	HEIGHT (Inches)	WIDTH (Inches)	DEPTH (Inches)		
(UNCRATED)						
Radio Frequency Oscillator O-374/FPS-20	2***					
Duplexer CU-510/FPS-20	2***	5	9	16		49
Directional Coupler CU-516/FPS-20	2***	8-1/2	18	17		26
Waveguide Switch SA-448/FPS-20	1***	26	22	25		221
Electrical Dummy Load DA-126/FPS-20	1***	11-1/4	8-1/4	33		86
Receiver Group OA-890/FPS-20	2***	60-1/4	27-1/2	26-1/4		321
Electrical Equipment Cabinet CY-1814/FPS-20	2***					
Receiver Subassembly MX-2073/FPS-20	2***					
Electronic Gate TD-146/FPS-20	2***					
Radar Receiver R-626/FPS-20	2***					
Receiver Subassembly MX-1745/FPS-20	2***					
Signal Comparator CM-72/GPA	2***					
Delay Line MX-1721/GPS	2***					
Power Supply Group OA-954/GPS	2***	32	27-1/2	26-1/4		244
Electrical Equipment Cabinet CY-1876/GPS	2***					
Power Supply PP-1346/GPS	2***					
Power Supply PP-1347/GPS	2***					
Electrical Equipment Cabinet CY-1876/GPS	2***					
Voltage Regulator CN-345/GPS	2***					
Receiver Group OA-1077/FPS-20	2***	48	27-1/2	26-1/4		314
Electrical Equipment Cabinet CY-1932/GPS	2***					
Radar Signal Distribution Panel SB-577/GPS	2***					
Electronic Switch SA-467/GPS	2***					
Electronic Gate TD-137/GPS	2***					
Power Supply PP-1461/GPS	2***					
Counter Measure Receiver R-736/GPS	2***					
Delay Line MX-1970/FPS-20	2***					
Intermediate Frequency Amplifier AM-1260/GPS	2***	6	4	11		5
Power Distribution Panel SB-480/FPS-20	2**	60	25-1/2	27-1/2		275
Power Distribution Panel SB-492/FPS-20A	2*					
Radar Set Control C-1736/FPS-20	2**	60	25-1/2	27-1/2		
Pulse Generator TD-dl/MPS-7	2 <sup>1</sup>					
Interconnecting Box J-754/FPS-20 <sup>2</sup> <sup>2</sup>	1***	72	24-1/2	26-1/4		255
Power Distribution Panel SB-5d7/FPS-20d <sup>2</sup> <sup>2</sup> <sup>2</sup>	1***	4d-1/2	27-1/2	25-1/4		155
Switch Box SA-476/FPS-20	2***	3	5	3		5
Power Supply Group OA-954/GPS	1	32	27-1/2	26-1/4		244
Electrical Equipment Cabinet CY-1859/GPS	1					
Power Supply PP-1346/GPS						
Power Supply PP-1347/GPS						
Electrical Equipment Cabinet CY-187/GPS	1					
Voltage Regulator CN-345/GPS	1					

TYPE: ITEM NAME: RADAR SET GROUP  
AN/GPA-27, AN/GPA-27A, AN/GPA-57,  
AN/GPA-57A AN/GPA-58, AN/GPA-58A

PRINCIPAL COMPONENTS AND PHYSICAL DATA						
COMPONENT	QTY	HEIGHT (Inches)	WIDTH (Inches)	DEPTH (Inches)	UNIT WT. (Pounds)	
Amplifier-Control Group OA-1517/FPS-20	2					
Electrical Equipment Cabinet CY-2180/FPS-20	2					
Coherent Oscillator Assembly P/O MX-1745/FPS-20	2					
Intermediate Frequency Amplifier AM-1691/FPS-20	2					
Intermediate Frequency Amplifier AM-1692/FPS-20	2					
Receiver Control C-2212/FPS-20	2					
Video Amplifier AM-1693/FPS-20	2					
Distribution Box J-855/FPS-20	1					
Amplifier-Power Supply Group OA-1144/FPS-20ΦΦ	1***	10-1/4	27-1/2	10-3/4	95	
Electrical Equipment Cabinet CY-1976/FPS-20ΦΦ	1***					
Amplifier-Power Supply AM-1401/FPS-20ΦΦ	3***					
Power Supply PP-1498/FPS-20	1***					
Electronic Marker Generator TD-140/FPS-20t1	1***	17-1/4	17	21	106	
Transmission Line Rotary Coupler CU-512/FPS-20	1***	56-3/4	48-1/2	44-1/2	750	
Interconnecting Box J-724/GPS	1***	16	19	9	26	
Motor Starter SA-365/FPS-3A	Φ	22	28	11-1/4	8	
Waveguide Horn AT-567/GPS	1***					
Kit for converting Antenna Pedestal AB-180/FPS-3 to Antenna Pedestal AB-414/FPS-20 OR-656150-1	1***					
Kit for converting Antenna Pedestal AB-366/FPS-3A to Antenna Pedestal AB-414/FPS-20 OR-656150-2	1***					
Kit for converting Antenna Pedestal AB-281/MPS-7 to Antenna Pedestal AB-414/FPS-20 OR-656150-3	1***					
Antenna Reflector AT-572/FPS-20‡	1***					
Antenna Drive TG-36/GPS‡	1***					
Radio Frequency Monitor ID-636/GPS	2					
Directional Coupler CU-606/GPS	2					
Modulator-Power Supply MD-305/GPS	2					
Radiac Meter IM-9C/PD	6					
Radiac Charger (None)	2					
Frequency Mixer Stage CU-592/FPS-20	1					
Waveguide Arc-over Detector TS-1146/FPS-20A	2					
Radar Set Performance Indicator ID-668/FPS-20A	1					

\*Used by the single modulator system only.

\*\*Unit is used by the dual modulator system only.

\*\*\*Unit is applicable to both the single modulator and dual modulator systems.

‡Two Pulse Generators TD-81/MPS-7 units are supplied with the conversion kit for Radar Set AN/FPS-3. One unit already exists in Radar Set AN/FPS-3A and Radar Set AN/MPS-7, and one will be supplied for each of these sites.

**ITEM NAME:** RADAR SET GROUP

**TYPE:** AN/GPA-27, AN/GPA-27A, AN/GPA-57, AN/GPA-57A AN/GPA-58, AN/GPA-58A

- Φ These units exist at Radar Set AN/FPS-3A sites. However, these units are required at Radar Set AN/FPS-3 and Radar Set AN/MPS-7 sites.
- ‡ Antenna Reflector AT-251/FPS-3 requires modification of its associated Antenna Drive TG-9/FPS-3 at Radar Set AN/FPS-3 and Radar Set AN/FPS-3A sites. Antenna Reflector AT-393/MPS-7 requires modification of its associated Antenna Drive TG-20/MPS-7 at Radar Set AN/MPS-7 sites.
- ↗↗ The nomenclature of the J-754 junction box is changed to the J-951/FPS-20A junction box when the KY-54 code coordinator is located in the operations building.
- ↗↗↗ The nomenclature of the SB-587/FPS-20 power distribution panel will vary depending on the type of duty required and the location of the KY-54 code coordinator.
- ΦΦ When magnetic fine grain data equipment is supplied, nomenclature assignment is changed as follows: OA-114,1/FPS-20 to OA-1629/FPS-20; CY-1976/FPS-20 to CY-2252/FPS-20; and AM-1401/FPS-20 to AM-1767/FPS-20.

**PRINCIPAL COMPONENTS AND PHYSICAL DATA**

<b>COMPONENT</b>	<b>QTY</b>	<b>HEIGHT (Inches)</b>	<b>WIDTH (Inches)</b>	<b>DEPTH (Inches)</b>	<b>UNIT WT. (Pounds)</b>
(CRATED)					
Interconnecting Box J-724/GPS		15	22	25	90
Power Driven Rotary Compressor HD-246/FPS-20		60	32	45	10
Amplifier-Mixer AM-1347/FPS-20		65	36	38	575
Radar Set Control C-1736/FPS-20		72	35	35	478
Duplexer CU-510/FPS-20		13	17	33	115
Directional Coupler CU-516/FPS-20		22	20	24	125
Amplifier-Power Supply Group OA-1144/FPS-20		38	31	17	215
Electronic Marker Generator TD-140/FPS-20		31	27	27	205
Power Driven Rotary Pump HD-231/FPS-20		55	31	56	710
Liquid Electron Tube Cooler HD-230/FPS-20		83	39	41	640
Electrical Dummy Load DA-126/FPS-20		16	16	41	152
Intermediate Frequency Amplifier AM-1260/GPS		9	16	18	35
Radio Frequency Amplifier AM-1402/FPS-20		83	38	41	680
Radar Modulator MD-276/FPS-20		24	39	43	360
Radar Modulator MD-212/FPS-20		96	17	50	1411
Power Distribution Panel SB-480/FPS-20		71	38	38	598
Power Distribution Panel SB-587/FPS-20		59	33	34	400
Power Supply Subassembly PP-1054/FPS-20		34	33	37	198
Switch Box SA-476/FPS-20		10	16	13	38
Monitor-Oscillator Group OA-955/FPS-20		60	34	35	525
Receiver Group OA-890/FPS-20		71	34	35	650
Power Supply Group OA-954/GPS		43	36	38	465
Receiver Regulator Group (None)		47	36	38	370
Receiver Group OA-1077/FPS-20		57	35	35	560
Waveguide Switch SA-448/FPS-20		35	27	34	344
Interconnecting Box J-754/FPS-20		84	31	34	530
Radio Frequency Amplifier AM-1348/FPS-20		84	60	45	1200
Power Supply PP-1356/FPS-20		23	32	37	318

**ITEM NAME:** RADAR SET GROUP  
**TYPE:** AN/GPA-27, AN/GPA-27A, AN/GPA-57,  
AN/GPA-57A AN/GPA-5S, AN/GPA-58A

**COMPONENTS PRINCIPAL COMPONENTS AND PHYSICAL DATA**

<b>COMPONENT</b>	<b>QTY</b>	<b>HEIGHT (Inches)</b>	<b>WIDTH (Inches)</b>	<b>DEPTH (Inches)</b>	<b>UNIT WT. (Pounds)</b>
Focus Coil		40	20	20	325
Klystron L3035		58	24	24	210
All lead shielding		44	21	33	336
Transmission Line Rotary Coupler CU-512/FPS-20		80	63	63	1560
Azimuth Drive Motor		30	37	45	933
Motor Starter SA-365/FPS-3A		31	35	16	182
Waveguide Horn AT-567/GPS		47	15	154	565
Voltage Regulator CN-323/FPS-20		52	31	32	680
Direct Current Power Filter F-297/FPS-20		35	33	34	545
Step-Up Power Transformer TF-109/FPS-20		33	33	34	685

**REFERENCE DATA AND LITERATURE**

Technical Orders:  
31P6-2GPA27-15

**AN/GPA-27: 7**



DATE: 1 April 1964  
COGNIZANT SERVICE: USAF

ITEM NAME: INTERFERENCE BLANKER GROUP  
TYPE: AN/GPA-28

FEDERAL STOCK NUMBER: 5840-338-4105

	USA	USN	USAF	USMC
STATUS OR TYPE CLASSIFICATION			Alt Std	
Mfg(s) Name or Code Number: Empire Devices Products Corp.				

#### RELATION TO SIMILAR EQUIPMENT

None.

#### TECHNICAL DESCRIPTION

IF. Frequency: 30 mc  
 IF. Bandwidth: 13.5 mc  
 Radar Trigger Input:  
   Amplitude - +20 to +50v, peak  
   Pulse Duration - 0.5 to 10  $\mu$ sec  
   Impedance - 390,000 ohms  
 Radar Trigger Output:  
   Amplitude - 2 to 20v, peak  
   Pulse Rise Time - 0.3  $\mu$ sec  
   Impedance - 50 ohms  
 Receiver Bandpass: 22 to 25 mc and 35 to 38 mc  
 Receiver Rejection Band: 28 to 32 mc  
 Power Requirements: 105 to 125v, rms, 50 to 65 cps, 1-ph, 520w

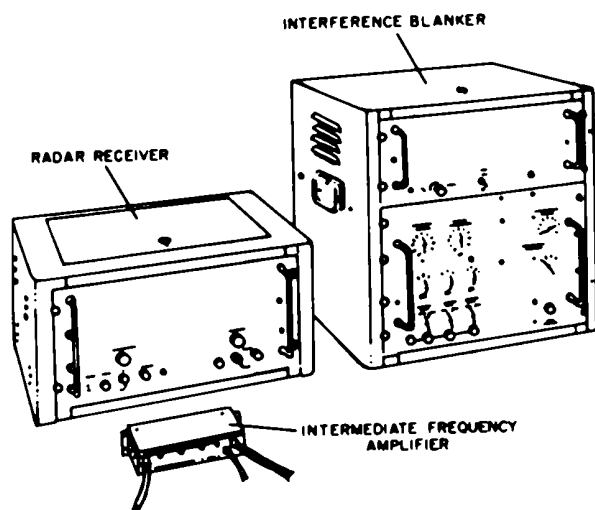

#### FUNCTIONAL DESCRIPTION

Interference Blanker Group AN/GPA-28 is used to protect a group of up to three radar receivers from nearby radar transmitter interference. The trigger output of the radar receiver component is applied to Interference Blanker Group AN/GPA-28. Operation of the blanker unit causes the interference to be bracketed with a negative blanking gate. The width of the blanking gate may be manually adjusted, by front panel controls, within the limits of 5 to 100 M sec. Since the interference is not usually synchronized with the protected radar, the loss of desired information is negligible.

#### INSTALLATION CONSIDERATIONS

Siting: Determined by the location of the particular radar installation to be protected against interference signals.  
 Mounting: Equipment may be located in Shelter S-63/CPN-18. No provision has been made for outdoor operation.  
 Cabling Requirements:  
 Related Equipment: When used with radar sets other than the AN/CPN-18, Delay Line MX1788/CPN-18 is removed from the blanker subassembly, and a different, applicable delay line substituted.

AN/GPA-28: 1

AN/GPA-28

**PRINCIPAL COMPONENTS AND PHYSICAL DATA**

<b>COMPONENT</b>	<b>QTY</b>	<b>HEIGHT (Inches)</b>	<b>WIDTH (Inches)</b>	<b>DEPTH (Inches)</b>	<b>UNIT WT. (Pounds)</b>
Radar Receiver, R-756/GPA-28	1	17- 1/8	22	10- 1/2	65
Interference Blanker MX- 1912/GPA-28	1	17-1/8	22	23-1/4	108
IF. Amplifier, AM-1704/GPA-28	1	8-1/16	1-1/2	3-1/2	1.15

**REFERENCE DATA AND LITERATURE**

Technical Orders:  
31P1-2GPA28- Series

**AN/GPA-28: 2**

DATE: 15 April 1964  
COGNIZANT SERVICE: USAF

ITEM NAME: DISPLAY BOARD PLOTTING GROUP  
TYPE: AN/GPA-29

FEDERAL STOCK NUMBER: 5840-538-2099

	USA	USN	USAF	USMC
STATUS OR TYPE CLASSIFICATION		LS		
Mfg(s) Name or Code Number: Westinghouse Electric Corporation				

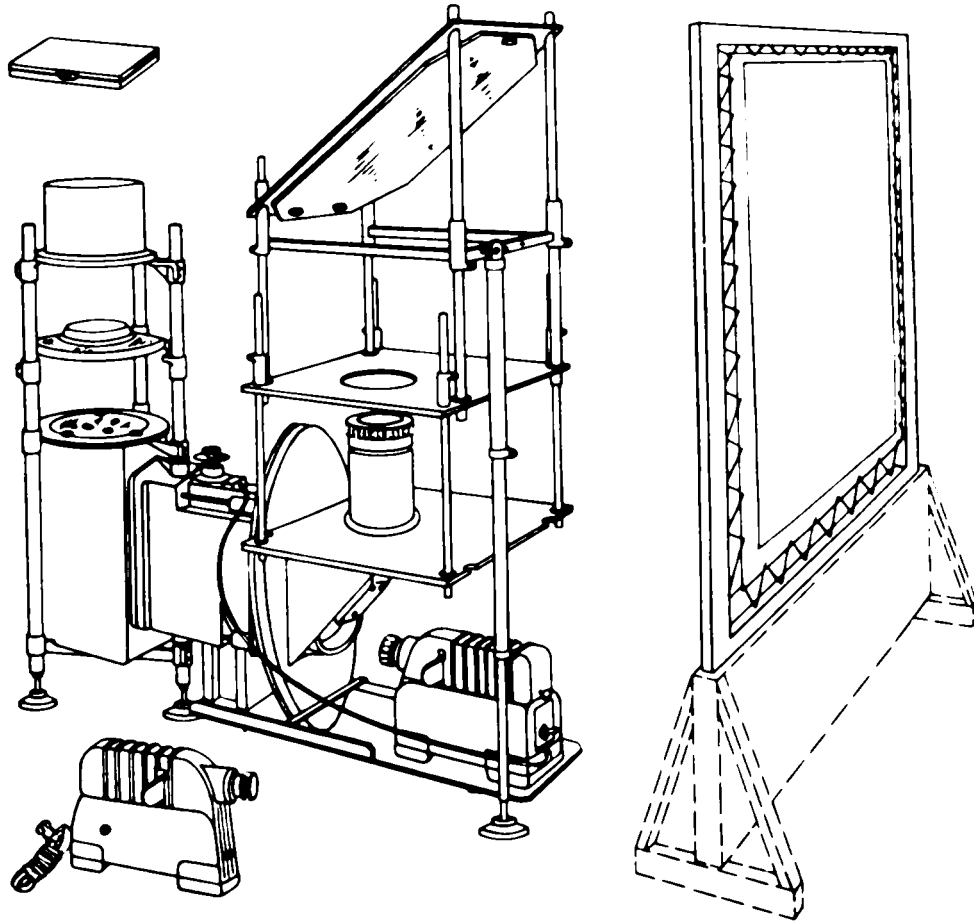

### FUNCTIONAL DESCRIPTION

Provides facilities for receiving information from a radar set PPI scope, filters it and presents the filtered data on a surveillance screen for use in a Tactical Air Control Center.

### RELATION TO SIMILAR EQUIPMENT

AN/GPA-29 is functionally interchangeable with Display-Plotting Board Group AN/GPA-29A the difference being that the AN/GPA-29A has variable magnifications and throw distance and uses JAN parts wherever practical.

**ITEM NAME:** DISPLAY BOARD PLOTTING GROUP  
**TYPE:** AN/GPA-29

**TECHNICAL DESCRIPTION**

Magnification: Variable, 2.25x (min) to 3.75x (max)  
Distance from Center Line of Plotting Surface to Screen (Throw Distance): 15 ft (min) to 25 ft (max)  
Projection Lens: 54 in., f/11  
Projection Screen Size: 6-1/2 ft x 6-1/2 ft (usable surface)  
Tilt of Boom: 80 deg right or left of vertical  
Boom Length, Extended: 7 ft (max)  
Boom Height, Extended: 8 ft (max)  
Boom Weight: 811 lb  
Width (Maximum with Boom at 80 Degree Angle): 7 ft

**INSTALLATION CONSIDERATIONS**

Siting: Dependent on associated radar location.  
Mounting: Azimuth and Range Indicator IP-336/GPA-29 is mounted on Display Plotting Board Group AN/GPA-29. It should be mounted within 50 ft of local radar set. Facsimile Converter Group OA-948/GPA-29 is mounted within 20 ft of the local radar receiver.  
Related Equipments: Radar Set AN/MPS-7 or AN/TPS-ID, Radio Set AN/TRC-1 or AN/TRC-8, Telephone Terminal AN/TCC-7; one standard 600 ohm telephone line.

**PRINCIPAL COMPONENTS AND PHYSICAL DATA**

<b>COMPONENT</b>	<b>QTY</b>	<b>HEIGHT (Inches)</b>	<b>WIDTH (Inches)</b>	<b>DEPTH (Inches)</b>	<b>UNIT WT. (Pounds)</b>
Facsimile Converter Group OA-948/GPA-29	1	30	19	15-1/2	
Azimuth and Range Indicator IP-336/GPA-29	1				

**REFERENCE DATA AND LITERATURE**

TECHNICAL ORDERS:  
31P1-2GPA29 Series

**AN/GPA-29: 2**

DATE: 1 April 1964

ITEM NAME: DISPLAY BOARD  
PLOTTING GROUP  
TYPE: AN/GPA-29A

COGNIZANT SERVICE: USAF

FEDERAL STOCK NUMBER: 5840-646-5489

	USA	USN	USAF	USMC
STATUS OR TYPE CLASSIFICATION			Std	
Mfg(s) Name or Code Number: Westinghouse Electric Corp.				

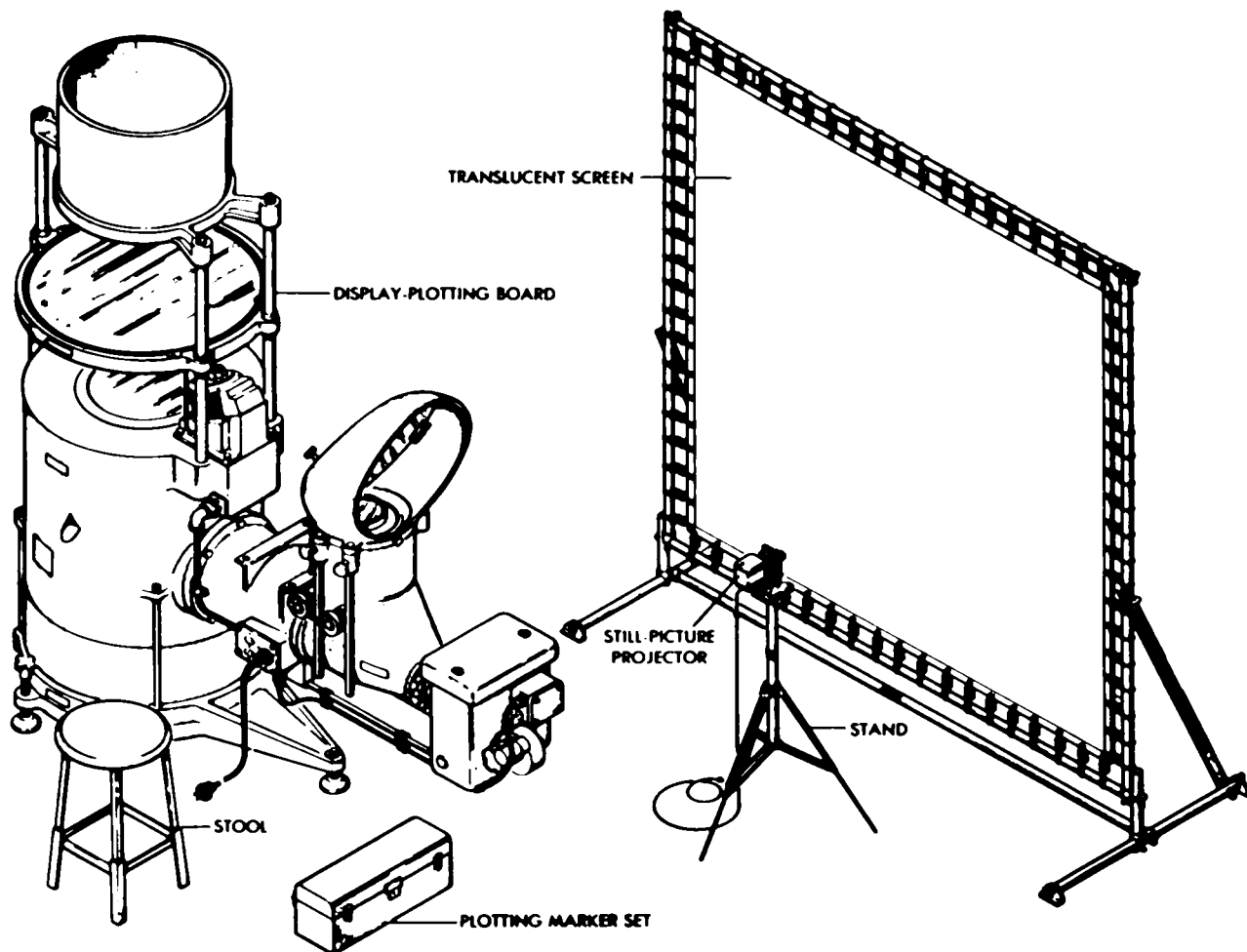

### FUNCTIONAL DESCRIPTION

Display Plotting Board Group AN/GPA-29A is an optical plotting device used in conjunction with conventional radar equipments such as Radar Set AN/MPS-7 or AN/TPS-ID, Radar Recognition Set Mark

X, and Radio Set AN/TRC-1 or AN/TRC-8. The AN/GPA-29A receives video information representing the position of targets displayed on the radar plan position indicator (PPI). Facsimile Converter Group OA-948/GPA-29, of the AN/GPA-29A equipment, reduces the radar video bandwidth, and converts

**AN/GPA-29A**

azimuth synchronizing information to a suitable form for simultaneous transmission with the radar video over a two-wire voice frequency circuit. Facsimile Converter Group Encoder OA-948/ GPA-29 uses a standard 600-ohm telephone line or a frequency-modulated radio link to provide a maximum of five paralleled outputs of radar presentation through carrier bay equipment to remote Video Decoder KY-180-GPA-29. Video Decoder KY-180' GPA-29 decodes the radar data and provides filtering, projection, and plotting data for projection on the translucent surveillance screen.

**RELATION TO SIMILAR EQUIPMENT**

The AN GPA-29A is functionally interchangeable with the AN/GPA-29; differs in that AN/GPA-29A has variable magnification and throw distance and uses JAN parts wherever practical.

**TECHNICAL DESCRIPTIONS**

- Magnification: Variable, 2. 25X (min) to 3. 75X (max)
- Distance from Center Line of Plotting Surface to Screen (Throw Distance): 15 ft (min) to 25 ft (max)
- Projection Lens: 54 in., f/11
- Projection Screen Size: 6-1/2 ft x 6-1/2 ft (usable surface)
- Tilt of Boom: 80 deg right or left of vertical
- Boom Length, Extended: 7 ft (max)
- Boom Height, Extended: 8 ft (max)
- Boom Width: 7 ft (max) with boom at 80-deg angle
- Boom Weight: 811 lb
- Operating Voltages and Power Requirements:
  - 117 vac, 60 cps, 1-ph, 1200w
  - 117 vac, 60 cps, 1-ph, 3.9 amp (local) and 4.8 amp (remote)
- Presentable Range: 200 mi (max)
- Ambient Temperature Range: Operating, -18

- to +60 deg C; non-operating, -55 degC to +60 deg C
- Sync Trigger Output: 2v (min), 6 μsec (max), 75 ohms
- IFF Trigger Input: 2. 5v (min), 0. 5 μsec (max), 50 ohms
- Target Video Input: 2v (min), 6 μsec (max), 75 ohm s
- Range Marks Input: 2v (min), 2 μsec (max), 75 ohms
- Synchro Data Inputs: 1-speed or 36-speed, 60 cps
- Line Frequency: 200 to 3500 cps
- Line Impedance: 600 ohms
- OA-948/GPA-29 Outputs: Four AM tones with mean frequencies of 307, 391, 500, and 2400 cps
- Number of Outputs: Up to five 600-ohm balanced lines
- Power Output: 1 mw into each 600-ohm line

**INSTALLATION CONSIDERATIONS**

- Siting: Site and type of building depend upon type of radar used.
- Mounting: Azimuth and Range Indicator IP-336/ GPA-29A is mounted on Display Plotting Board Group AN /GPA-29. It should be mounted within 50 ft of local Radar Set.
- Facsimile Converter Group OA-948/GPA-29 is mounted within 20 ft of the local radar receiver.
- Cabling Requirements:
- Related Equipments: One Radar Set AN/MPS-7 or AN/TPS-ID; one Radio Set AN/TRC-1 or AN/TRC-8; one Telephone Terminal AN/ TCC-7; one standard 600-ohm telephone line

**PRINCIPAL COMPONENTS AND PHYSICAL DATA**

COMPONENT	QTY	HEIGHT (Inches)	WIDTH (Inches)	DEPTH (Inches)	UNIT WT. (Pounds)
Facsimile Converter Group OA-948/GPA-29	1	30	19	15-1/2	
Azimuth and Range Indicator IP-336 /GPA-29	1				

**REFERENCE DATA AND LITERATURE**

Technical Orders:  
31P1-2GPA29- Series

DATE: 30 April 196,1

ITEM NAME: VIDEO MAPPING GROUP

COGNIZANT SERVICE: USAF

TYPE: AN/GPA-30

USA LINE ITEM NUMBER: 694920

FEDERAL STOCK NUMBER: 5840-505-1097

	USA	USN	USAF	USMC
STATUS OR TYPE CLASSIFICATION			STD	
Mfg(s) Name or Code Number Televiso Corporation				

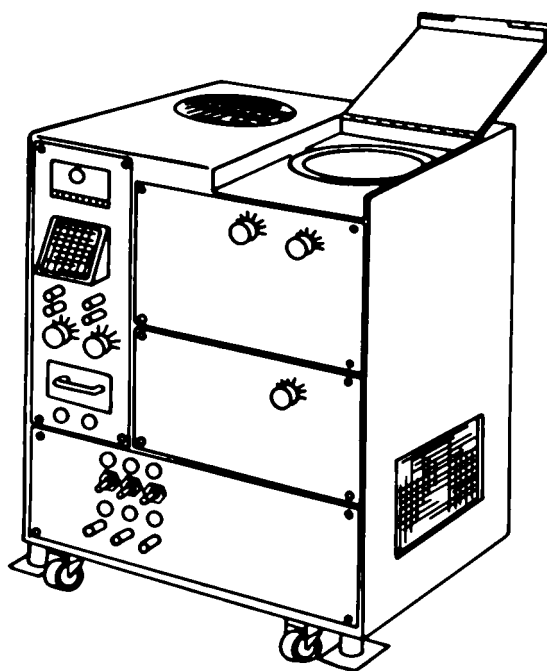

**FUNCTIONAL DESCRIPTION**

Video Mapping Group AN/GPA-30 is used in conjunction with ground based radar sets to provide these sets with an electronic map of the region being scanned by the radar antenna. The equipment generates a map from

opaque film negative of the territory surrounding the radar site. The maps used are circular with the radar site at the center; the range of the map is 10 to 350 nautical miles. On the longest range, the

**ITEM NAME: VIDEO MAPPING GROUP**

**TYPE: AN/GPA-30**

equipment will resolve map lines 0.0025 inches wide and spaced 0.0075 inches apart. This map is presented to the PPI of the associated radar. It is superimposed over the video signals from acquired targets, permitting the operators to locate the position of a radar target with respect to a point on the earth's surface. The AN/GPA-30 is capable of supplying video mapping signals to a maximum of 12 plan position indicators. Map making and photographic facilities for drafting and processing of maps are not included with this equipment.

**RELATION TO SIMILAR EQUIPMENT**

Similar to, but not interchangeable with Electronic Mapping Group AN/GPA-5, as no provisions are included for drafting and processing of maps.

**TECHNICAL DESCRIPTION**

Video Output: 1 to 5v  
Terminating Impedance: 50, 72 or 90 ohms  
Pulse Repetition Rate: 150 to 2000 pps  
(conforms with prr of associated radar)  
Range: 10 to 350 naut mi (mapping)  
Horizontal Coverage: 360 deg  
Map Table Speed of Rotation: 0 to 20 rpm  
Sweep Speeds: 100, 500, 1000, 2000, 5000

and 50,000 usec  
Resolution: 1600 lines  
Range Accuracy: plus or minus 1 pct  
Azimuth Accuracy: plus or minus 15 min  
Video Bandwidth: 4 mc  
Type Presentation: Mapping signals are generated on a 5-inch oscilloscope; mapping data is displayed on the PPI indicators of the associated radar; one 3-in. test synchroscope is part of this equipment.  
Mapping Ranges: 10 to 30, 25 to 100, 75 to 299, and 150 to 350 mi  
Power Requirements: 120, ac, 60 cps, 1-ph, 960 w

**INSTALLATION CONSIDERATIONS**

**Siting:** The AN/GPA-30 equipment should be located in the same operations shelter as the associated radar.

**Mounting:** The equipment is installed in the operations building of the radar which it is used.

**Related Equipments:** Video Mapping Group AN/GPA-30 is used to present mapping information on the indicator of the following sets: AN/CPS-6B, AN/FPS-8, AN/FPS-3, AN/FPS-3A, AN/CPN-16, AN/MPS-7, AN/MPS-11, AN/FPS-10 and Indicator AN/UPA-35.

**PRINCIPAL COMPONENTS AND PHYSICAL DATA**

<b>COMPONENT</b>	<b>QTY</b>	<b>HEIGHT (Inches)</b>	<b>WIDTH (Inches)</b>	<b>DEPTH (Inches)</b>	<b>UNIT WT. (Pounds)</b>
Cabinet Electrical Equipment CY-1643/GPA-30 with shock mounts, with coasters	1	39-5/8 40-1/d	25 25	19-3/b 19-3/8	
Oscilloscope OS-52/GPA-3 and Video Amplifier AM-1133/GPA-30	1	22-1/2	7-13/32		
Electronic Control Amplifier AM-1131/GPA-30 and Sweep Generator 0-322/GPA-30	1	6-7/8	16-21/32		
Power Supply Panel PP-121d/GPA-30	1	11-29/32	24-3/8		
Electrical Synchronizer SN-119/GPA-30 and Power Distribution Panel SB-413/GPA-30	1	13-9/16	16-21/32		

**REFERENCE DATA AND LITERATURE**

**TECHNICAL ORDERS:**  
31P1-2GPA30- Series



DATE: 1 August 1964

ITEM NAME: RADAR SET GROUP

COGNIZANT SERVICE: USAF

TYPE: AN/GPA-33

FEDERAL STOCK NUMBER: 5840-505-2148

	USA	USN	USAF	USMC
STATUS OR TYPE CLASSIFICATION			STD	
Mfg(s) Name or Code Number: Bendix Radio				

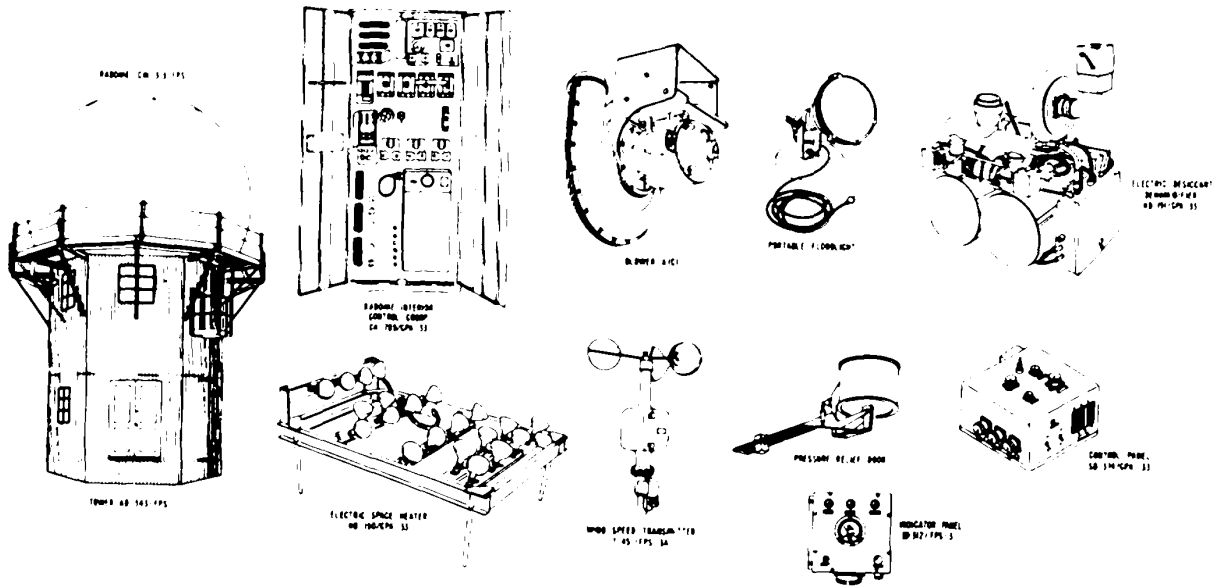

**FUNCTIONAL DESCRIPTION**

AN/GPA-33 Arctic Equipment provides a completely weather-proofed housing for the antenna and radar cabinets of either Radar Set AN4/TPS-IOD (AN/FPS-4) or Radar Set AN/TPS-ID. This installation permits the

radar to remain operable during high winds or under icing conditions, or other extremes of weather which might affect the normal Radar Set installation. Arctic Tower AB-343/FPS provides a base upon which the antenna and radar cabinets of Radar Set AN/FPS-4 (AN/TPS-IOD) or Radar Set AN/TPS-ID

**ITEM NAME:** RADAR SET GROUP  
**TYPE:** AN/(GPA-33

are placed. The platform of the tower is used as a base for the pressure-supported radome. Wind Speed Transmitter T-151/FPS- :A, commonly known as the anemometer, translates wind velocity into dc voltage. The various voltages are fed into a sense circuit to actuate relay controlling radome pressure, so that the radome remains firmly inflated and does not dimple -in, despite wind velocity increases. Indicator Panel ID-312/FPS-3 located within the operations shelter, indicates the radome pressure range at any specific time. Blower blow air into the radome to inflate and support it. Electric Desiccant Dehumidifier HD-191/GPA-33 removes the moisture from the air of the radome proper. Interlockingis provided within each radar system, which prevents the antenna from operating if radome pressure becomes dangerously low. The de-icing lamp banks when focused on the radome interior surface, prevents ice and snow from building up on the radome exterior. The AN/GPA-33 also has a pressure chamber which prevents loss of radome pressure when entry or exit is made.

**RELATION TO SIMILAR EQUIPMENT**

None.

**TECHNICAL DESCRIPTION**

Arctic equipment is designed to keep Radar Set AN/FPS-4 or Radar Set AN/TPS-1D operable in the temperature range of minus 54°C (minus 65.2°F) to 71°C (159.8°F), under wind velocities up to 109 knots, and at altitudes up to 7000 feet. The arctic tower concrete footing for soil foundations withstand loads of 4000 pounds per square foot and 15000 pounds per square foot. The arctic tower is capable of withstanding two inches of ice over the radome without exceeding normal structural safety factors. The anemometer indicates wind speed through a 0-100 knot range, the double-bed dehumidifier has a maximum capacity of 37,000 grams of water per hour at 24°C, inlet air temperature. De-

icing lamp banks each consist of 21 infra-red, 375 watt lamps. The floors and plat-form of the arctic tower are designed to withstand a live load of 100 pounds per square foot. The platform is 20 feet in diameter and the radome is 20 feet high and has a spherical radius of 12-1/2 feet, .

Power Requirements: 120/208v (plus or minus 5v), 60 cycle (plus or minus pct), three-phase primary power through a four-wire" system.

**INSTALLATION CONDSIDERATIONS**

Sitting : In planning the location of the arctic tower site, consideration must be given the amount of space available, natural or man-made structures that would interfere e with the radar pattern, the slope and type of ground where the tower is to be located, and layout of existing facilities.

Mounting: Between components, location of the blowers, dehumidifier, radome junction box and pressure-relief door is determined by the mounting holes provided in the tower structure.

Cabling Requirements: Location of AN/GPA-33 is limited by the lengths of the cables to the power shelter and operation shelter, and the length of the cable connecting the windspeed transmitter to the indicator panel. There also must be 75 feet minimum separation from the prime radar and AN/GPA-33.

Related Equipments: Radar Set Group AN/GPA-33 is designed to support and house the antenna and cabinets of either Radar Set AN//TPS-10D (AN/FPS-4) or Radar Set AN/TPS-1D. While designed specifically for these radars the arctic tower is capable of accommodating similar radars, so long as the floor loading limitations and radome dimensions are not exceeded.

**PRINCIPAL COMPONENTS AND PHYSICAL DATA**

COMPONENT	QTY	HEIGHT (Inches)	WIDTH (Inches)	DEPTH (Inches)	UNIT WT. (Pounds)
Tower AB-343/FPS	1	300	240	240	52,000
Radome CW-:313/FPS	1	240	300	300	450
Radome Interior Control Group OA 709/GPA-:33	1	70-3/4	30-3/4	14	370
Indicator Panel ID-312/FPS-3	1	7	12	151/2	24

**AN /(GPA-33: 2**

**ITEM NAME:** RADAR SET GROUP  
**TYPE:** AN/GPA-33

**PRINCIPAL COMPONENTS AND PHYSICAL DATA**

<b>COMPONENT</b>	<b>QTY</b>	<b>HEIGHT (Inches)</b>	<b>WIDTH (Inches)</b>	<b>DEPTH (Inches)</b>	<b>UNIT WT. (Pounds)</b>
Wind Speed Transmitter T-451/FPS-3A	1	25-5/16	8-5/8	8-5/8	60
Electric Desiccant Dehumidifier HD-191/GPA-33	1	36-5/36	34-5/8	31-13/16	450
Control Panel SB-374/GPA-33	1	10	14-3/8	15-7/8	60
Electric Space Heater HD-190/GPA-33	3	30-1/2	41-1/4	60	240
Blowers	2	27	20-1/16	26-1/4	260
Floodlights	3	19-1/4	15-1/8	19-1/2	45
Pressure Relief Door	1	25	22	58	135

**REFERENCE DATA AND LITERATURE**

Technical Orders:  
31P1-2GPA33-5

**AN/GPA-33: 3**

DATE: 15 September 1964

ITEM NAME: INTERCONNECTING; GROUP

COGNIZANT SERVICE: USAF

TYPE: AN/GPA-.15A

FEDERAL STOCK NUMBER: 5895-080-6599-EG

	USA	USN	USAF	USMC
STATUS OR TYPE CLASSIFICATION			No Status Assigned	
Mfg(s) Name or Code Number. Stewart-Warner Electronics				

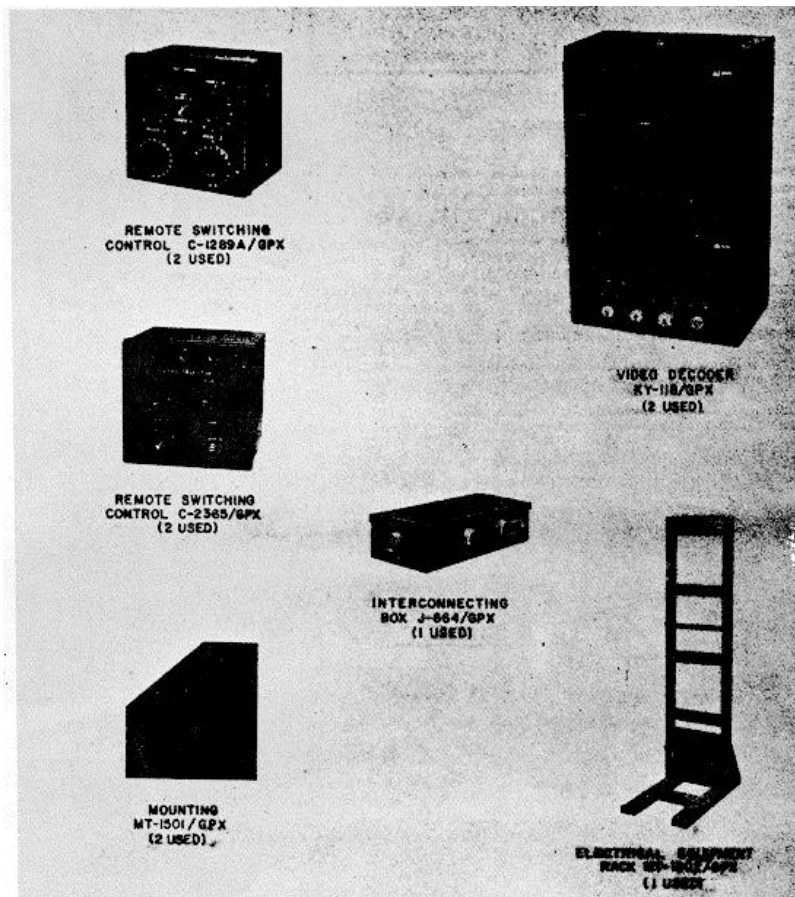

**FUNCTIONAL DESCRIPTION**

Interconnecting Group AN/GPA-15A interconnects Coder-Decoder Group OA-839/GPX-6A, OA-8,10/GPX-7A, OA-B,12/GPX-2(A, OA-886/GPX-18A with Radar Set AN/CPS-6RB, AN/FPS-3, AN/MPS-7, AN/FPS-8 and AN/MPS-11 respectively

to provide passive SIF facilities for 2 additional plan position indicators. Identification "Friend or Foe" and "Friend from Friend" is accomplished through the ability of the Video Decoders KY-118/GPX to

**ITEM NAME:** INTERCONNECTING GROUP

**TYPE:** AN/GPA-45A

decode multiple-pulse response codes as transmitted by the Airborne equipment in reply to interrogations, or challenges, initiated by the associated Radar Identification Set.

Interconnecting Group AN/GPA-45A is provided in the operations room and projection or maintenance room of the installation site of the Radar Identification Set.

**RELATION TO SIMILAR EQUIPMENT**

Similar to and interchangeable with AN/GPA-45, the difference being improved control and cable assemblies in the AN/GPA-45A.

**Mounting:** The Remote Switching Controls, C-1289A/GPX and C-2365/GPX, are mounted on the PPI scopes.

**Cabling Requirements:** The Electrical Equipment Rack MT-1502/GPX, supplied as a part of AN/GPA-1SA, must be located in either the maintenance or Projection room, so that the supplied cable (20 feet) will make connection from the power-panel of this unit to the MT-1502/GPX No. 1 of the Radar Identification Set.

**TECHNICAL DESCRIPTION**

**Power Requirements:** 115v, single ph, 45 to 70 cps, min of 830w

**Related Equipment:** Radar Identification

Sets AN/GPA-7A, AN/GPX-18A, AN/GPX-20A. Radar Sets AN/CPS-6B, AN/FPS-3, AN/MPS-7, AN/FPS-8, AN/MPS-11.

**INSTALLATION CONSIDERATIONS**

**Siting:** Spaces for the components of

**PRINCIPAL COMPONENTS AND PHYSICAL DATA**

<b>COMPONENT</b>	<b>QTY</b>	<b>HEIGHT (Inches)</b>	<b>WIDTH (Inches)</b>	<b>DEPTH (Inches)</b>	<b>UNIT WT. (Pounds)</b>
Video Decoder KY-118/GPX	2	28-3/16	18	13	161
Remote Switching Control C-1289A/GPX	2	6-3/16	6-3/16	6-15/16	4
Remote Switching Control C-2365/GPX	2	6-3/16	6-3/16	6-3/4	3
Mounting MT-1501/GPX	2	18-1/2	19-13/16	3/16	6
Electrical Equipment Rack MT-1502/GPX	1	73-5/8	18	30	132
Interconnecting Box J-664/GPX Kit of Accessories	1	3	13-1/16	7-1/8	5.5

**REFERENCE DATA AND LITERATURE**

Technical Orders:  
31P4-2GPA45-5

**DATE:** 15 September 1964  
**COGNIZANT SERVICE:** USAF

**ITEM NAME:** RADAR SET GROLP  
**TYPE:** AN/GPA-49

**FEDERAL STOCK NUMBER:** 5840-505-1091

	USA	USN	USAF	USMC
STATUS OR TYPE CLASSIFICATION			STD	
Mfg(s) Name or Code Number. General Electric and Dresser-Ideco Company				

No Illustration Available.

**FUNCTIONAL DESCRIPTION**

Radar Set Group AN/GPA-49 is used to provide weather protection for Radar Set AN/FPS-8 or Radar Set AN/MPS-11 at an arctic installation. The AN/GPA-19 consists of a 25 feet high, galvanized, inclosed steel

tower; a neoprene-coated, non-rigid, air-pressurized radome; dehumidifiers; electrical space heaters; and arctic erection equipment.

**RELATION TO SIMILAR EQUIPMENT** None

**AN /GPA-49: 1**

**ITEM NAME:** RADAR SET GROUP  
**TYPE:** AN/GPA-49

**TECHNICAL DESCRIPTION**

Type of Tower: Arctic  
Material: Galvanized Steel  
Height: 25 ft  
Type of Construction: 12-sided, sectionalized, symmetrical structure.  
Platforms: 3 (one ea at the 3, 11 and 25 ft levels)  
Radome CW-353/FPS-8  
Type of Radome: non-rigid, air-preserved  
Material: Nylon fabric, 2-ply, black, neoprene-coated.  
Height: 28.53 ft  
Diameter Base: 35.18 ft  
Diameter Special Center: 8.83 ft above base  
Special Features: Lightning protection, emergency repair kit, carrying case CY-1770/FPS-8 and radome envelope  
Radome Inflation Control C-159/FPS-8.  
Type of Control: Inclosed relay-actuated ram air switches.  
Material: Non-fusible, with olive-drab paint finish.  
Dimensions (Excluding Actuator)  
Length: 25 in.  
Width: 12 i&.   
Depth: 6 ins  
Pressure Gage: Indicates air pressure inside Radome.  
Protex Tube: Indicates humidity of air inside radome.  
Electrical Rating: 120v, ac  
Radome Inflation Control C-15B9/FPS-8  
Wind Velocity Indicator: I  
Operating Pressure Range: 0.1 to 0.35 lb per sq in.  
Electrical Space heater HD-85/CPS-6B  
Material: Aluminum framework housing, blackcrinkle paint finish.  
Legs: Detachable held by clamps at bottom of assembly.  
Dimensions  
Height: 65-9/16 in.  
Width: 75-1/2 in.

Depth: B in.  
Adjustments: ea row of lamps adjustable in vertical plane.  
Power Requirements: 115v, ac, 21 kw  
Heat Rating: 71,652 btu output per hr  
Electric Space Heater HID-b6/CPS-6B  
Type: Portable  
Dimensions  
Height: 57-1/2 in.  
Width: 77-1/2 in.  
Depth: 8 in.  
Power Requirements: 115v, ac, 22.5 kw  
Heat Rating: 76,770 btu output per hr  
Dehumidifier, Electric Desiccant  
HD-212/FPS-8  
Desiccant: Silicon gel  
Desiccant Beds: 2  
Dimensions  
Height: 34-3/5 in.  
Length: 34 in.  
Width: 31-3/4 in.  
Dehumidifier Air Delivery: 125 cfm, 2.0 in. of water  
Dehumidifier Air Pressure Delivery:  
40 cfm standard air, 0.1 in. of water rated performance.  
5.3 lb or water removed per operational hr with 75 deg input air temp.

**INSTALLATION CONSIDERATIONS**

Siting: Dependent on prime radar equipment Arctic location.  
Mounting: Tower AB-313/FPS-8 erected on  
Extension Tower AB-316/FPS-8 or on concrete piers.  
Radome CW-:353/FPS-b mounted on top platform of AB-31:3/FPS-b Tower. Wind Instrument Support MT-793/CPS-6B:  
Placed on wind tower support or on top of operation shelter.  
Related Equipments: Used with, but not part of Radar Set AN/FPS-8 or Radar Set AN/MPS-11, AN/MPS-16.

**PRINCIPAL COMPONENTS AND PHYSICAL DATA**

COMPONENT	QTY	HEIGHT (Inches)	WIDTH (Inches)	DEPTH (Inches)	UNIT WT. (Pounds)
Tower AB-313/FPS-8	1				
Radome Inflation Control C-1589/FPS-8	1				
Radome Inflation Control C-1591/FPS -3	1				
Radome CW-353/FPS-8	1				
Erection Equipment Set	1				
Relief Valve HID-77/CPS-6B	1				

**AN/GPA-49: 2**

**ITEM NAME:** RADAR SET GROUP  
**TYPE:** AN/GPA-49

**PRINCIPAL COMPONENTS AND PHYSICAL DATA**

<b>COMPONENT</b>	<b>QTY</b>	<b>HEIGHT (Inches)</b>	<b>WIDTH (Inches)</b>	<b>DEPTH (Inches)</b>	<b>UNIT WT. (Pounds)</b>
Electric Space Heater HD-85/CPS-6B	3				
Electric Space Heater HD-86/CPS-6B	2				
Dehumidifier, Desiccant, Electrical HD-212/FPS-8	2				
Terminal Box J-385/CPS-6B	1				
Interconnecting Box J-500/FPS-6	1				
Wind Instrument Support MT-793/CPS-6B	1				

**REFERENCE DATA AND LITERATURE**

Nomenclature card for AN/GPA-49

**AN/GPA-49: 3**



DATE: 1 September 1964

ITEM NAME: RADAR SET GRO'P

COGNIZANT SERVICE: USAF

TYPE: AN/GPA-50

FEDERAL STOCK NUMBER: 5610-505-3254

	USA	USN	USAF	USMC
STATUS OR TYPE CLASSIFICATION			LS	
Mfg(s) Name or Code Number. General Electric Company, Syracuse, New York				

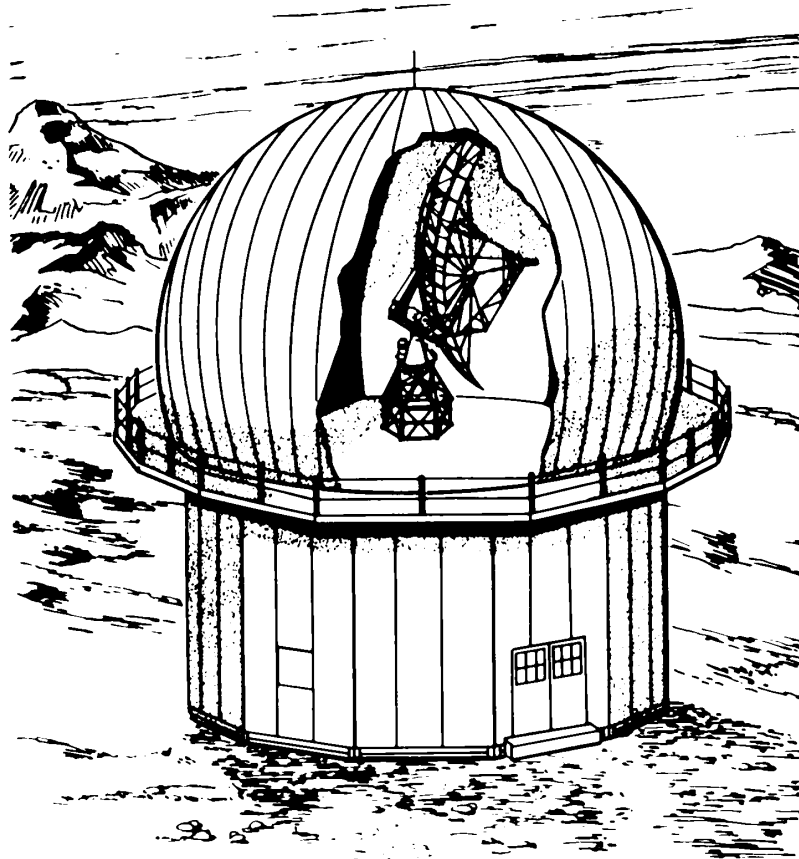

**FUNCTIONAL DESCRIPTION**

Radar Set Group AN/GPA-50 provides an enclosed arctic tower suitable for the installation and operation of a complete radar set, such as Radar Set AN/FPS-6. The ground and second floors of the arctic tower

have adequate floor space and structural strength for the fixed components of a representative radar installation. The top floor of the arctic tower forms an elevated antenna platform with mounting facilities antenna table to any of a wide variety of radar antennas. A flexible

**AN/GPA-50: 1**

**ITEM NAME:** RADAR SET GROUP  
**TYPE:** AN/GPA-50

air-supported radome covers the top floor to give complete protection of the radar antenna against the wind, humidity, and icing conditions to be expected in arctic installations. The Radar Set Group includes automatic pressurizing and dehumidifying equipment that pressurizes the radome in accordance with the external wind conditions, that dehumidifies the air within the radome. Radiant heaters, with manual control, are supplied for de-icing the outer surface of the radome.

**RELATION TO SIMILAR EQUIPMENT**

The AN/GPA-50 is replaced by Radome-Tower Group AN/GPA-89.

**TECHNICAL DESCRIPTION**

The AN/GPA-50 is unaffected by temperature within the range from minus 54C to plus 71C (minus 65 F to 160F). With the radome fully pressurized, the AN/GPA-50 can withstand wind velocities up to 125 knots. The radome, at wind velocities below 60 knots, can support a two-inch thickness of ice. The radome material absorbs less than 10 percent of the radiated power, and does not introduce serious diffraction errors in either beam angle or beam dispersion.

**INSTALLATION CONSIDERATIONS**

**Siting:** The arctic tower requires the area contained within a circle that is 70 feet in diameter. The site should be such that the line-of-sight beam path of the radar equipment is not obstructed or dispersed by mountains, hills, buildings, or wooded areas. The terrain must be reasonably level. Marsh land, soft clay, and loose, sandy soils should be avoided.

**Mounting:** Except for the pressurizing blowers and the two dehumidifiers, the placement of the Radar Set Group components is not critical.

**Cabling Requirements:** Maximum spacing of components is solely determined by intercomponent cable length. The Radar Set Group requires only external power connections, for which bulk cable is supplied. The interconnecting cables that are supplied with the radar equipment are long enough to allow a wide choice of locations of the arctic tower with respect to the operating buildings housing the associated radar equipment.

**Related Equipments:** Radar Set Group AN/GPA-50 is designed to support and house the antenna and cabinets of Radar Set AN/FPS-6.

**PRINCIPAL COMPONENTS AND PHYSICAL DATA**

COMPONENT	QTY	HEIGHT (Inches)	WIDTH (Inches)	DEPTH (Inches)	UNIT WT. (Pounds)
Tower AB-259A/FPS-6	1				
Radome CW-208C/CPS-6B	1				
Case CY-895/CPS-6B	1				
Control, Inflation, Radome C-1034/FPS-6	1				
Switch Box SA-224/CPS-6B	1				
Interconnecting Box J-500/FPS-6	1				
Relief Valve HD-77/CPS-6B					
Wind Instrument Support MT-793/CPS-6B	1				
Dehumidifier, Desiccant, Electric, HD-212/FPS-8	2				
Electric Space Heater HD-85/CPS-6B	5				
Electric Space Heater HD-86/CPS-6B	4				

**AN/GPA-50: 2**

ITEM NAME: RADAR SET GROUP

TYPE: AN/GPA-50

**PRINCIPAL COMPONENTS AND PHYSICAL DATA**

<b>COMPONENT</b>	<b>QTY</b>	<b>HEIGHT (Inches)</b>	<b>WIDTH (Inches)</b>	<b>DEPTH (Inches)</b>	<b>UNIT WT. (Pounds)</b>
Terminal Box J-385/CPS-6B	2				
Floodlight	4				
Blower (1000 cfm)	2				
Blower (100 cfm)	1				
Anemometer	1				
Humidistat, with mounting bracket	1				
De-icing Switch Box	2				

**REFERENCE DATA AND LITERATURE**

**TECHNICAL ORDERS:**  
31P1-2GPA50- Series

**AN/GPA-50: 3**

**DATE:** 15 December 19641

**ITEM NAME:** RADAR SET GROUP

**COGNIZANT SERVICE:** USAF

**TYPE:** /AN/GPA-57, //AN/GPA-57A

**FEDERAL STOCK NUMBER:** /58410-602-0473  
//5840-602-0474,

	USA	USN	USAF	USMC
STATUS OR TYPE CLASSIFICATION			Used By	
Mfg(s) Name or Code Number Bendix Radio Division of Bendix Aviation Corp., Baltimore, Maryland				

Descriptions for Radar Set Group AN/GPA-57 and AN./GPA-57A  
are found on Radar Set Group AN/GPA-27 and AN/GPA-27A  
Data Sheets, Pages AN,/GPA-27: 1 thru AN/GPA-27: 7.

**AN /GPA-57: 1**

**DATE:** 15 December 1964

**ITEM NAME:** RADAR SET GROUP

**COGNIZANT SERVICE:** USAF

**TYPE:** ΦAN/GPA-58, ΦΦAN/GPA-58A

**FEDERAL STOCK NUMBER:** Φ5840-588-9676  
ΦΦ5840-602-0476

	USA	USN	USAF	USMC
STATUS OR TYPE CLASSIFICATION			Used By	
Mfg(s) Name or Code Number: Bendix Radio Division of Bendix Aviation Corp., Baltimore, Maryland				

Descriptions for Radar Set Group AN/GPA-58 and AN/GPA-SBA are found on Radar Set Group AN/GPA-27 and AN/GPA-27A Data Sheets, Pages AN/GPA-27: 1 thru AN/GPA-27: 7.

**AN/GPA-58: 1**

**DATE:** 15 January 1965

**ITEM NAME:** RADAR SET GROUP

**CO(;NIZANT SEHVICE:** USAF

**TYPE:** AN/GPA-59A

**FEDERAL STOCK NUMBER:** 5840-615-5321

	USA	USN	USAF	USMC
STATUS OR TYPE CLASSIFICATION			Used By	
Mfg(s) Name or Coder Number:				

No Illustration Available.

**FUNCTIONAL DESCRIPTION**

Radar Set Group consists of components to be added to a single channel Radar Set

AN/GPS-4 to form a high power dual channel Radar Set AN/GPS-4.

**AN/GPA-59A: 1**

**ITEM NAME:** RADAR SET GROCP  
**TYPE:** AN/GPA-59A

**RELATION TO SIMILAR EQUIPMENT**

AN/GPA-59A is similar to Radar Set Group AN/GPA-59, differs only in additional switching facilities used to switch from one channel to the other.

**INSTALLATION CONSIDERATIONS**

Related Equipment: AN/GPA-59A is used with, but not part of, AN/GPS-4.

**PRINCIPAL COMPONENTS AND PHYSICAL DATA**

<b>COMPONENT</b>	<b>QTY</b>	<b>HEIGHT (Inches)</b>	<b>WIDTH (Inches)</b>	<b>DEPTH (Inches)</b>	<b>UNIT WT. (Pounds)</b>
Generator, Pulse O-228/GPS	1				
Coupler, Electron Tube CU-465/GPS4	1				
Transmitter, Radar T-577/GPS-4	1				
Power Supply PP-1300/GPS-4	1				
Transformer, Power, Step-up TF-216/GPS-4	1				
Modulator, Radar MD-253/GPS-4	1				
Power Supply PP-1301/GPS-4	2				
Pedestal, Antenna AB-443/GPS-4	1				
Reflector, Antenna AT-641/GPS-4	1				
Control, Radar Set C-1713/GPS-4	1				
Duplexer CU-445/GPS-4	1				
Coupler, Directional CU-446/GPS-4	1				
Interconnecting Box J-724/GPS-4	1				
Interconnecting Box J-739/GPS-4	1				
Receiver Group OA-985/GPS-4	1				
Control-Oscillator Group OA-986/GPS-4	1				
Receiver Group OA-1122/GPS-4	1				
Shelter, Electrical Equipment S-113/GPS-4	1				
Shelter, Electrical Equipment S-125/GPS-4	1				
Switch Box SA-468/GPS-4	1				
Panel, Power Distribution SB-500/GPS-4	1				
Tuner, Waveguide TN-241/GPS-4	1				
Adapter UG-1191/GPS-4	1				

**REFERENCE DATA AND LITERATURE**

Nomenclature Card for AN/GPA-59A dated 26 July 1957

DATE: 1 July 1964

ITEM NAME: DECODER GROUP

COGNIZANT SERVICE: USN

TYPE: AN/GPA-60, -60A\*

FEDERAL STOCK NUMBER: 5840-587-0779\*

	USA	USN	USAF	USMC
STATUS OR TYPE CLASSIFICATION				
Mfg(s) Name or Code Number: Bendix Aviation Corporation				

Illustration Not Available

### FUNCTIONAL DESCRIPTION

The AN/GPA-60 and AN/GPA-60A are designed to decode coded pulse trains, as received by a radar recognition set. The AN/GPA-60 may be used in conjunction with the AN/GPA-60A and, except for IFF Gain and GTC Gate Control, provides for control of an additional radar indicator display. One AN/GPA-60 must be used for each indicator display desired other than that provided by basic group AN/GPA-60A. Army-Navy installations utilizing both groups are referred to as interlace operation. The AN/GPA-60A differs from the AN/GPA-60 in that the AN/GPA-60 is used for single indicator operation; the AN/GPA-60 is used only for inter-lace operation in conjunction with the AN/GPA-60A.

### RELATION TO SIMILAR EQUIPMENT

AN/GPA-60 is similar to, but not interchangeable with, AN/UPA-24. AN/GPA-60A is similar to,

but not interchangeable with, AN/APS-60A and AN/UPA-24.

### TECHNICAL DESCRIPTION

Video Input: 70 ohms nom  
Video Output: 70 ohms nom  
Type of Presentation: CRT  
Operating Voltages:  
115v, 60 to 400 cps, 1-ph, 6.3 vdc

### INSTALLATION CONSIDERATIONS

Siting:  
Mounting:  
Cabling Requirements:  
Related Equipment: Both the AN/GPA-60 and AN/GPA-60A are designed for use with Radar Recognition Sets such as the AN/TPX- 17 and AN/TPX- 18A.

AN/GPA-60: 1



AN/GPA- 60,-60A

**PRINCIPAL COMPONENTS AND PHYSICAL DATA**

<b>COMPONENT</b>	<b>QTY</b>	<b>HEIGHT (Inches)</b>	<b>WIDTH (Inches)</b>	<b>DEPTH (Inches)</b>	<b>UNIT WT. (Pounds)</b>
Video Decoder, KY- 196/GPA-60	1				
Radar Control Set, C-1988/GPA-60	1				
Radar Control Set, C-1987/GPA-60A	1				
Cable Assembly Reel CX-3824/GPA-60	1				

**REFERENCE DATA AND LITERATURE**

Not available.

**AN//GPA-60: 2**

DATE: 15 November 1964

ITEM NAME: DECODER GROUP

COGNIZANT SERVICE: USAF

TYPE: AN/GPA-64

FEDERAL STOCK NUMBER: 5895-807-9798-EG

	USA	USN	USAF	USMC
STATUS OR TYPE CLASSIFICATION			STD	
Mfg(s) Name or Code Number: Bell Aerosystems Company, Buffalo, New York				

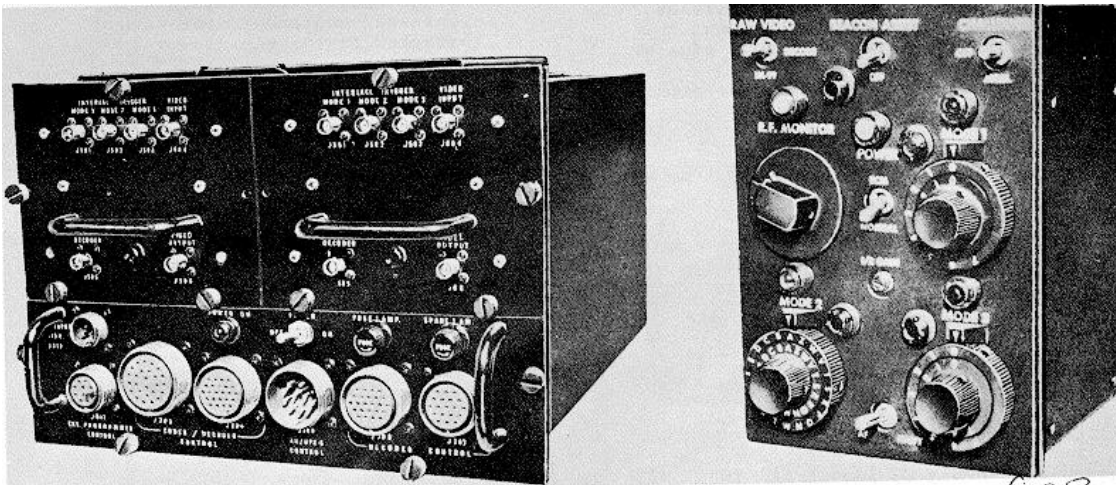

**FUNCTIONAL DESCRIPTION**

Decoder Group decodes video signals from Radar Recognition Set AN/UPX-4 or AN/UPX-6 and supplies appropriate correct decoded codes, wrong codes, Mark X or delayed raw video intelligence to the PPI output. This

group provides for the addition of two plan position indicator stations at the OA-1266/ UPS-1, OA-1267/MPX-7A, OA-1268/GPX-17A, OA-1269/FPS-19, OA-1270/GPX-9B, OA-1271/ GPX-20B, OA-1272/(PX-1UB, OA-2397/MSQ-1A, OA-2605/FPS-30: and AN/GPA-78 Coder-Decoder Groups where the required cable lengths

AN/GPA-64: 1

**ITEM NAME:** DECODER GROUP  
**TYPE:** AN/GPA-64

between the power supply and controls are less than 10 feet.

**RELATION TO SIMILAR EQUIPMENT**

Same as the Coder-Decoder Group OA-1267/ MPX-7A, except no Coder-Interrogator Set KY-274/GPX.

**TECHNICAL DESCRIPTION**

Power Requirements: 115 plus or minus 11.5v, 50 to 410 cps, single ph at 0.65 amp max.

Video Decoder:

Video Pulse Input

Width - 0.35 to 0.55 usec

Rise Time - 0.1 usec, max

Decay Time - 0.2 usec, max

Mode One Response Input

Pulse Train Positions: 8 positions,  
seventh pulse position vacant

Pulse Position Spacing: 2.9 plus or  
minus 0.1 usec

Max Number of Codes: 32 code combi-  
nations

Mode Two Response Input

Pulse Train Positions: 15 positions,  
eighth pulse position vacant

Pulse Position Spacing: 1.15 plus or  
minus 0.1 usec

Max Number of Codes: 400 code combi-  
nations

Mode Three Response Input

Pulse Train Positions: 8 positions,  
none vacant

Pulse Position Spacing: 2.9 plus or  
minus 0.1 usec

Max Number of Codes: 64 code combi-  
nations

**INSTALLATION CONSIDERATIONS**

Siting: The Decoder Group is installed into its associated radar system.

Mounting: Units are contained in an electrical equipment cabinet and installed in the vehicle.

Related Equipments: Used with but not part of AN/UPX-4, AN/UPX-6.

**PRINCIPAL COMPONENTS AND PHYSICAL DATA**

COMPONENT	QTY	HEIGHT (Inches)	WIDTH (Inches)	DEPTH (Inches)	UNIT WT. (Pounds)
Electrical Equipment Cabinet CY-2651/GPX	1				
Video Decoder KY-275/GPX	2				
Coder-Decoder Control C-2738/GPX	2				
Power Supply PP-2191/GPX	1				
Cable Assembly CG-1464/U (11 IN)	4				
Cable Assembly CG;-1464/U (3 FT 6 IN)	4				
Cable Assembly CG-146-4/1 (110 FT)	2				
Cable Assembly CX-4822/U (110 FT)	1				
Cable Assembly CX-,1822/t' (110 FT)	1				
Cable Assembly CX-4820/U (110 FT)	1				
Cable Assembly CX-.1818/ (110 FT)	1				
Cable Assembly CX-4812/U (30 FT)	2				

**ITEM NAME:** DECODER GROUP

**TYPE:** AN/GPA-64

**PRINCIPAL COMPONENTS AND PHYSICAL DATA**

<b>COMPONENT</b>	<b>QTY</b>	<b>HEIGHT (Inches)</b>	<b>WIDTH (Inches)</b>	<b>DEPTH (Inches)</b>	<b>UNIT WT.</b>
Cable Assembly CX-4821/U (6 FT 4 IN)	1				
UG-274/U Adapter	10				
MX-554/U Resistor Termination	2				

**REFERENCE DATA AND LITERATURE**

Nomenclature card for AN/GPA-64  
TECHNICAL ORDERS:  
31P4-2GPX- Series

**AN/GPA-64: 3**

DATE: 1 July 1964  
COGNIZANT SERVICE: USN

ITEM NAME: RECEIVER GROUP  
TYPE: AN/GPA- 68

FEDERAL STOCK NUMBER:

	USA	USN	USAF	USMC
STATUS OR TYPE CLASSIFICATION				
Mfg(s) Name or Code Number: Stewart-Warner Electronics				

Illustration not available.

**FUNCTIONAL DESCRIPTION**

The AN/GPA-68 receives IFF signals from air-borne transponders that are triggered by Transponder Set Group AN/ARA-44. The AN/GPA-68 mixes the received IFF signal with the radar video signal. The mixed signal is applied to Radar Set AN/FPN-16.

**RELATION TO SIMILAR EQUIPMENT**

None.

**TECHNICAL DESCRIPTION**

Not available.

**INSTALLATION CONSIDERATIONS**

Siting:  
Mounting:  
Cabling Requirements:  
Related Equipment: Used with Radar Set AN/FPN-16 and Transponder Set Group AN/ARA- 44.

**PRINCIPAL COMPONENTS AND PHYSICAL DATA**

COMPONENT	QTY	HEIGHT (Inches)	WIDTH (Inches)	DEPTH (Inches)	UNIT WT. (Pounds)
Antenna AT-838/GPA-68	1				
Radar Receiver R-900/GPA-68	1				
Frequency Mixer Stage CV-676/GPA-68	1				
Power Supply PP-2126/GPA-68 1					
Interconnecting Cables					

**REFERENCE DATA AND LITERATURE**

Not available.

DATE: 1 September 1964  
COGNIZANT SERVICE: USAF

ITEM NAME: VIDEO MAPPING SET  
TYPE: AN/GPA-70

FEDERAL STOCK NUMBER: 5840-670-4778

	USA	USN	USAF	USMC
STATUS OR TYPE CLASSIFICATION			STD	
Mfg(s) Name or Code Number: Dayton Electronics Products Company				

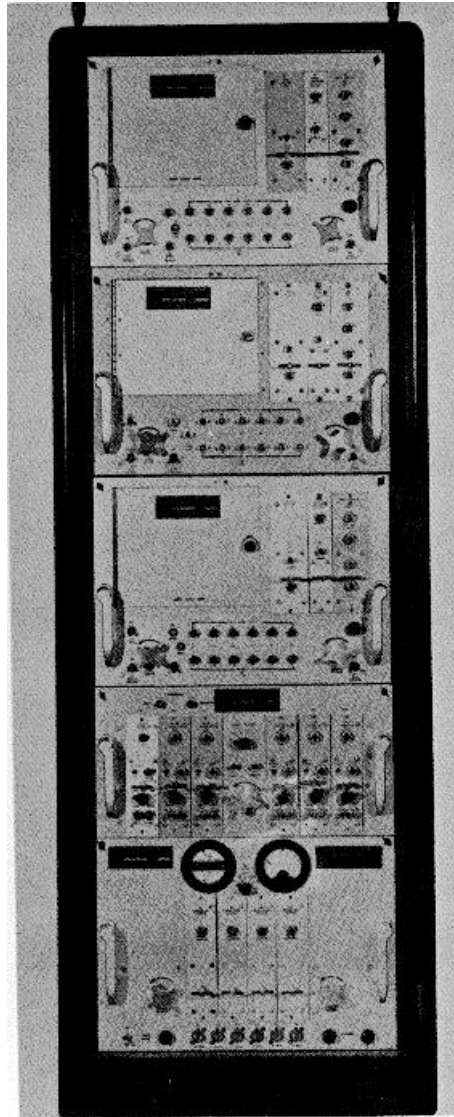

**FUNCTIONAL DESCRIPTION:**

The Video Mapping Set, AN/GPA-70, is a self contained video generator. Provides facilities for ground-based radar sets which will present on the PPI of the radar set an electronic map of the area being scanned by the

radar antenna; the map is superimposed on the normal echoes to render adequate detail of radar targets and geographic data. Provides ten video maps to each of three radar indicators with control of switching at

**ITEM NAME:** VIDEO MAPPING SET  
**TYPE:** AN/GPA-70

either the mapping cabinet or at an indicator position.

**RELATION TO SIMILAR EQUIPMENT**

None.

**TECHNICAL DESCRIPTION**

Primary Power Source Required: 117v ac,  
60 cps, single ph 2.0 kva  
Trigger PRF: 60 to 2000 pps  
Trigger Voltage: 5 to 50v, pos or neg  
Sweep Range: 10 to 2.10 nautical mi  
Ambient Temperature (Operating): minus  
290C to plus 600C  
Ambient Temperature (Non-operating):  
minus 550C to plus 700C  
Relative humidity (Operating): 90%  
(Estimated)  
Relative humidity (Non-operating): 50%  
(Estimated)  
Barometric Pressure, Altitude above Sea  
Level (Operating): 10,000 ft  
Barometric Pressure, Altitude above Sea  
Level (Non-operating): i10,000 ft  
Servo Information Required: X1 and XIO0,  
XI and X36, or XI only at 117v, 60  
cycles, ac ref  
Video Output: 3v at the end of 200 ft of

RG-59B/IU, terminated in a 75 ohms  
resistance.

Video Map Presentation: PPI s(an, 6(X)  
line resolution.

**INSTALLATION CONSIDERATIONS**

Siting: Siting is not critical.

Mounting: The main unit may he located between  
groups of equipment or adjacent to other electronic  
equipment, because the set is shielded for rf and all  
magnetic or electrostatic induction.

Cabling Requirements: The main unit must be located  
within a distance of the radar such that the path length  
of the video output (:able does not exceed 200 feet  
between the rear connector panel of the cabinet and tile  
video input to the PPI of the radar.

Related Equipments: The Video Mapping Set is used for  
the purpose of supply imposing a choice of reference  
map slides on the screen of such radar PPI's as the  
landing Control Sets AN/CPS-4 and Radar Set  
AN/CPN-18C.

**PRINCIPAL COMPONENTS AND) PMIYSICAL DATA**

<b>COMPONENT</b>	<b>QTY</b>	<b>HEIGHT (Inches)</b>	<b>WIDTH (Inches)</b>	<b>DEPTH (Inches)</b>	<b>UNIT WT.</b>
Scanner, Light Generating 0-791/GPA-70	3				
Cabinet, Electrical Equipment CY-3054/GPA-70	1				
Synchronizer, Electrical SN-L29)2/GPA-70	1				
Control Scanner C-3192/GPA-70 -	3				
Power Supply PP-2U33/GPA-70	1				
Installation Accessories					
Maintenance Accessories					

**REFERENCE DATA AND LITERATURE**

TECHNICAL ORDERS:  
31P1 -2GPA70- Series

DATE: 1 September 1964

ITEM NAME: CODER-DECODER GROUP

COGNIZANT SERVICE: USAF

TYPE: AN/GPA-78

FEDERAL STOCK NUMBER: 5B95-604-7459-EG

	USA	USN	USAF	USMC
STATUS OR TYPE CLASSIFICATION			No Status	

Mfg(s) Name or Code Number. Bell Aircraft Corporation

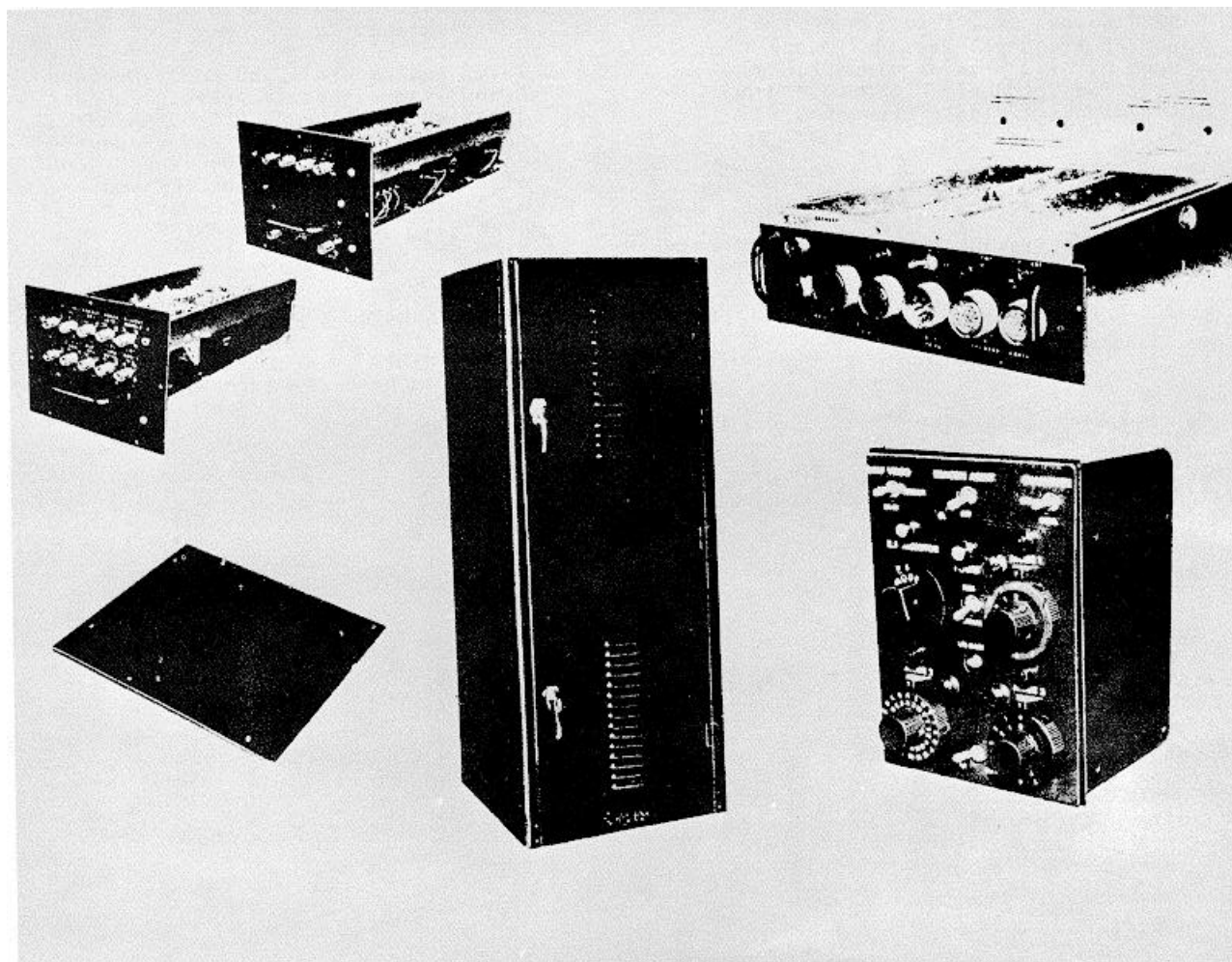

### FUNCTIONAL DESCRIPTION

The Coder-Decoder Group, conjunction with Radar Recognition Set AN/UPX-6, generates paired-pulse coded interrogations. When these interrogations are received by an airborne Transponder Set AN/APX-25, a

coded reply is transmitted back. The coded reply is perceived by the receiver portion of Radar Recognition Set AN/UPX-6, detected, and sent to the Coder-Decoder Group where it is compared with the mode and code requirements and, if correct, it is coded. The decoded signal is then displayed on the Radar Set Plan Position



**ITEM NAME:** CODER-DECODER GROUP

**TYPE:** AN/GPA-78

Indicator as a target IFF response. Provisions are incorporated to differentiate between Mark X IFF response, decoded response, and IM-99 response.

**RELATION TO SIMILAR EQUIPMENT**

None.

**TECHNICAL DESCRIPTION**

- Power Requirements: 115 plus or minus 11.5v, 50 to 110 cps, single ph, at 2.6 amp, maximum.
- Operating Temperature Limits: 29°C to 52°C (minus 20.2°F to 125.6°F)
- Input Pretrigger: Precedes radar main bang by 37.2 plus or minus 1.0 usec
- Repetition Frequency: 150 to 500 pps
- Internal Self-Trigger Frequency:  
Adjustable between 150 and 125 pps

**INSTALLATION CONSIDERATIONS**

Siting: Provisions have been made in the radar installations AN/FPS-3, AN/MPS-7, or AN/FPS-8 to accommodate the Coder Decoder Group.

Mounting: The cabinet containing most of the Coder-Decoder Groups components may be located in any convenient position within the limit of cable lengths. Also, the six controls are mounted on the Radar Set Plan Position Indicators by means of plates.

Cabling Requirements: Cables not furnished are recovered from the existing IFF system installation, or fabricated from material on hand to satisfy the installation.

Related Equipments: The Coder-Decoder Group is designed to operate in conjunction with the AN/UPX-6, AN/APX-25, an external programmer and readout equipment. The Coder-Decoder Group also integrates with the IFF equipment of Radar Set AN/FPS-3, Radar Set AN/MPS-7, or Radar Set AN/FPS-8 to provide SIF capabilities to Mark X IFF.

**PRINCIPAL COMPONENTS AND PHYSICAL DATA**

COMPONENT	QTY	HEIGHT (Inches)	WIDTH (Inches)	DEPTH (Inches)	UNIT WT. (Pounds)
Coder-Interrogator Set KY-27,1/GPX	1				
Video Decoder KY-275/GPX	6				
Power Supply PP-2191/GPX					
Coder-Decoder Control C-2738/GPX	6				
Cabinet CY-2652/GPA-7	11				
Plate MT-2209/GPX	6				

**REFERENCE DATA AND LITERATURE**

TECHNICAL ORDERS:  
31P1-2GPA78-5

**DATE:** 15 January 1965

**ITEM NAME:** RADAR SET GROUP

**COGNIZANT SERVICE:** USAF

**TYPE:** AN/GPA-80

**FEDERAL STOCK NUMBER:**

	USA	USN	USAF	USMC
STATUS OR TYPE CLASSIFICATION		Ltd Std		

Mfg(s) Name or Code Number:

**No Illustration Available.**

**FUNCTIONAL DESCRIPTION**

The Radar Set Group provides facilities for installing

Radar Set AN/FPS-6 and various other radar sets at an arctic installation.

**AN/GPA-80: 1**

**ITEM NAME:** RADAR SET GROUP  
**TYPE:** AN/GPA-80

**RELATION TO SIMILAR EQUIPMENT**

Replaced by AN/GPA-B9.

**INSTALLATION CONSIDERATIONS**

Related Equipment: Used with, but not part of AN/FPS-6.

**PRINCIPAL COMPONENTS AND PHYSICAL DATA**

<b>COMPONENT</b>	<b>QTY</b>	<b>HEIGHT (Inches)</b>	<b>WIDTH (Inches)</b>	<b>DEPTH (Inches)</b>	<b>UNIT WT. (Pounds)</b>
Tower AB-259B/FPS-6	1				
Radome CW-396/GPS	1				
Aluminum Ladder	1	144			
Sectionalized Ladder (for outside service floodlight)	1				
Arctic Erection Equipment and Interconnecting Cables	1				

**REFERENCE DATA AND LITERATURE**

Nomenclature Card for AN/GPA-80

**DATE:** 1 September 1965

**ITEM NAME:** DATA PROCESSING GROUP

**COGNIZANT SERVICE:** USAF

**TYPE:** AN/GPA-88

**FEDERAL STOCK NUMBER:**

	USA	USN	USAF	USMC
STATUS OR TYPE CLASSIFICATION				

Mfg(s) Name or Code Number General Electric Company, Syracuse, New York

**Illustration not Available.**

**FUNCTIONAL DESCRIPTION**

Data Processing Group AN/GPA-88 has facilities necessary to process digital data in a predetermined manner and sequence suitable for application to other

components of the Radar Course Directing Group AN/GPA-73(V). (This is a "used with" item and if and when used, it must be used with various components of the AN/GPA-73(V) only to operate properly).

**AN/GPA-88: 1**

**ITEM NAME:** DATA PROCESSING GROUP  
**TYPE:** AN/GPA-88

**RELATION TO SIMILAR EQUIPMENT**

Not available.

**INSTALLATION CONSIDERATIONS**

Related Equipment: The AN/GPA-88 is used with but not part of AN/GPA-73(V).

**TECHNICAL DESCRIPTION**

Operating Power Requirements: 120/208, ac, 50 -  
6660 cps, 3-ph

**PRINCIPAL COMPONENTS AND PHYSICAL DATA**

<b>COMPONENT</b>	<b>QTY</b>	<b>HEIGHT (Inches)</b>	<b>WIDTH (Inches)</b>	<b>DEPTH (Inches)</b>	<b>UNIT WT. (Pounds)</b>
Electrical Equipment Cabinet CY-1076/GPA-88	1	75	26	26	
Digital Data Processor MX-4929/GPA-88	1				
Control Panel (wired Into Cab Elect Equip.) General Electric Co. dwg #7644523G1	1				
Power Supply (Commercial Equip.)	3				
Blower, Rotron Mfg Co.,Inc P/N AO-32B34	1				

**REFERENCE DATA AND LITERATURE**

Nomenclature card dated 20 Mar 1963.

DATE: 1 November 1964  
COGNIZANT SERVICE: USAF

ITEM NAME: RADOME-TOWER GROUP  
TYPE: AN/GPA-89

FEDERAL STOCK NUMBER: 5840-611-0636

	USA	USN	USAF	USMC
STATUS OR TYPE CLASSIFICATION		Std		

Mfg(s) Name or Code Number: See Note 1

Illustration not Available.

**FUNCTIONAL DESCRIPTION**

Supports and protects antenna, transmitting and

receiving components of various radar sets when used under arctic conditions.

AN/GPA-89: 1

**ITEM NAME:** RADOME-TOWER GROUP  
**TYPE:** AN/GPA-89

**RELATION TO SIMILAR EQUIPMENT**

Not available.

The AN/GPA-89 is not interchangeable with and like item. The AN/GPA-89 is a replacement for Radar Set Group AN/GPA-50 and Radar Set Group AN/GPA-80.

**INSTALLATION CONSIDERATIONS**

Related Equipment: The AN/GPA-89 is used with Radar Sets AN/FPS-6, AN/FPS-8, AN/FPS-20 and AN/FPS-20A.

**TECHNICAL DESCRIPTION**

**PRINCIPAL COMPONENTS AND PHYSICAL DATA**

<b>COMPONENTS</b>	<b>QTY</b>	<b>OVERALL DIMENSIONS (Inches)</b>	<b>UNIT WT. (Pounds)</b>
Radome CW-396A/GPS	1		
Tower AB-563/GPS	1		

**REFERENCE DATA AND LITERATURE**

ARDC Form 81A dated 11 March 1960.

**NOTE 1: Radome CW-396A/GPS - Universal Moulded Products Corporation, Bristol, Va.  
Zenith Construction Company, Seattle, Wash.**

**Tower AR-563/GPS - Wayne Construction Company, Seattle, Wash.**

**AN/GPA-89: 2**

DATE: 1 July 1964

ITEM NAME: VIDEO MAPPING GROUP

COGNIZANT SERVICE: USN

TYPE: AN/GPA-91

FEDERAL STOCK NUMBER: F5810-893-4696

	USA	USN	USAF	USMC
STATUS OR TYPE CLASSIFICATION				

Mfg(s) Name or Code Number: Television Corporation, Des Plaines, Illinois

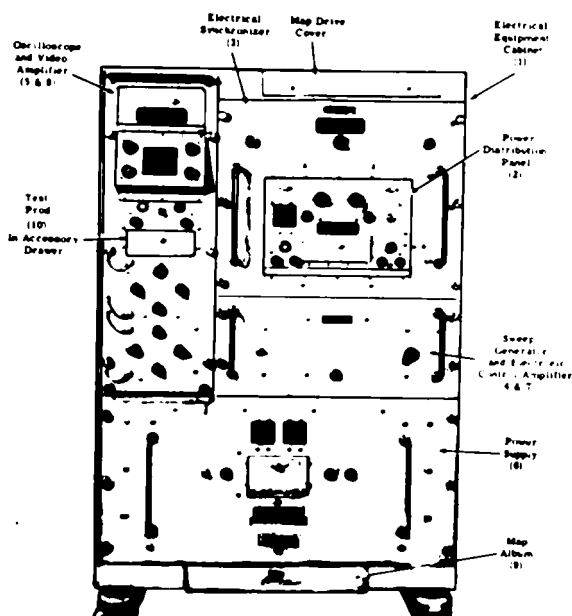

**FUNCTIONAL DESCRIPTION**

Video Mapping Group AN/GPA-91 is designed to be used with search or tracking radar systems. It electronically superimposes a correctly oriented and finely detailed map of the searched area on the Plan

Position Indicator of the associated radar system. Electronic reproduction allows simultaneous and identical appearance on several PPI screens, regardless of the sweep or type of presentation. The map retains correct scale factor even when different range scales or expanded PPI presentations are used.



**ITEM NAME:** VIDEO MAPPING GROUP

**TYPE:** AN4PA-91

The map presentation may be attenuated or eliminated at will by manipulation of PPI controls. Changing of map areas is simple and, disadvantages such as interference with echo presentation, are eliminated.

**RELATION TO SIMILAR EQUIPMENT**

None.

**TECHNICAL DESCRIPTION**

Resolution: At max range (on Range 4) lines 0.0025 in. wide and spaced 0.0075 in. apart will be resolved.  
 Synchros: 1X and 36X (16X with gear change) (60 cycle ref).  
 Map TurnTable Speed: From 1 to 30 rpm  
 Map Diameter: 8 in.  
 Map Range: 10 to 350 naut mi  
 Trigger In: 150 to 1600 pps with an amplitude of 0.5 to 100v peak, pos or neg  
 Internal Trigger: Included and also available externally.  
 Video Amplifier Out: Pos pulses, 5v peak into 72 ohm load.  
 Oscilloscope  
 Sensitivity: 50 mv per in.  
 Bandwidth: 10 cycle to 3.5 mc  
 Input Impedance: Either 50, 72, 91 ohms or 1 mego

Input Capacity: 50 uuf  
 With Probe  
 Input Impedance: 5 mego  
 Capacity: 20 uuf  
 Probe Ratio: 5X  
 Attenuator: Calibrated 1X to 300X and vernier.  
 Trigger: Either pos, neg, internal, ext or 60 cycle  
 Horizontal Sweep: 100, 500, 1000, 2000, 5000 and 50,000 used  
 Calibration Voltage: 100 mv calibration signal included.  
 Operating Temperature: -28 deg C (-18 deg F) to plus 65 deg C (150 deg F)  
 Power Requirements: 120v plus or minus 10%, 60 cycles plus or minus 5%, single ph  
 Power Factor: 750w at 96.6%.  
 Heat Dissipation: 725w

**INSTALLATION CONSIDERATIONS**

Related Equipment: This group is used with but not part of Radar Set AN/FPS-37 and Transmitting Set, Radio AN/FPN-20A.  
 (Equipment required but not supplied) (1)  
 Associate Radar Set with Technical Manual; (as required) Cable RG-59/U; (as required) Connector UG-260/U; (as required) Power and Signal Cables.

**PRINCIPAL COMPONENTS AND PHYSICAL DATA  
SHIPPING DATA**

COMPONENT	BOXES (NR.)	OVERALL DIMENSIONS (Inches)	UNIT WT. (Pounds)
Video Mapping Group AN/GPA-91	1	25 x 29 x 54	53U

**EQUIPMENT SUPPLIED DATA**

COMPONENTS	QTY	OVERALL DIMENSIONS (Inches)	UNIT WT. (Pounds)
Video Mapping Group AN/GPA-91 including:	1	22 x 25-3/8 x 40	375
Cabinet, Electrical Equipment CY-2828/GPA-91	1	22 x 25-3/8 x 40	
Panel, Power Distribution SB-1115/GPA-91	1		
Synchronizer, Electrical SN-279/GPA-91	1		
Generator Sweep O-727/GPA-91	1		
Amplifier, Video AM-2507/GPA-91	1		
Power Supply PP-2565/GPA-91	1		
Amplifier, Electronic Control AM-2506/GPA-91	1		
Oscilloscope OS-107/GPA-91	1		

**AN/GPA-91: 2**

**ITEM NAME:** VIDEO MAPPING GROUP

**TYPE:** AN/GPA-91

**PRINCIPAL COMPONENTS AND PHYSICAL DATA  
EQUIPMENT SUPPLIED DATA (Cont.)**

<b>COMPONENTS</b>	<b>QTY</b>	<b>OVERALL DIMENSIONS (Inches)</b>	<b>UNIT WT. (Pounds)</b>
Album, Map CY-2829/GPA-91	1		
Prod, Test MX-3001/GPA-91	1		
Technical Manual NAVSHIPS 93637	2		

**REFERENCE DATA AND LITERATURE**

Technical Manuals:  
NAVSHIPS 93637

**AN/GPA-91: 3**

DATE: 1 September 1965

ITEM NAME: CODER-DECODER GROUP

COGNIZANT SERVICE: USAF

TYPE: AN/GPA-97

FEDERAL STOCK NUMBER: 5895-708-0664-EG

	USA	USN	USAF	USMC
STATUS OR TYPE CLASSIFICATION Ltd Std				

Mfg(s) Name or Code Number Bell Aircraft Corporation, Buffalo, New York



**FUNCTIONAL DESCRIPTION**

Coder-Decoder Group AN/GPA-97 provides a multiple pulse coding system supplying 3 types of identification:

high security IFF (SI), personal identity (PI) airframe number, traffic identity (TI) for coded triggering of various ground IFF equipment and decoding of airborne responses.

**ITEM NAME:** CODER-DECODER GROUP

**TYPE:** AN/GPA-97

**RELATION TO SIMILAR EQUIPMENT**

Service Test model of this equipment assigned  
Coder-Decoder Group AN/GPA-36.

**INSTALLATION CONSIDERATIONS**

Not available.

**TECHNICAL DESCRIPTION**

Not available.

**PRINCIPAL COMPONENTS AND PHYSICAL DATA**

<b>COMPONENT</b>	<b>QTY</b>	<b>HEIGHT (Inches)</b>	<b>WIDTH (Inches)</b>	<b>DEPTH (Inches)</b>	<b>UNIT WT. (Pounds)</b>
Coder-Decoder Control C-2738/GPX	1				
Coder-Decoder Group OA-2191/GPA-97	1				
Interconnecting Cable Assy's					

**REFERENCE DATA AND LITERATURE**

Unclassified Nomenclature card dated 15 Jan 59 for AN/GPA-97.

**AN/GPA-97: 2**

DATE: 1 September 1965

ITEM NAME: COUNTERMEASURES SIGNALS  
SIMULATOR GROUP

COGNIZANT SERVICE: USAF

TYPE: AN/GPA-98

FEDERAL STOCK NUMBER:

	USA	USN	USAF	USMC
STATUS OR TYPE CLASSIFICATION	Std			

Mfg(s) Name or Code Number:

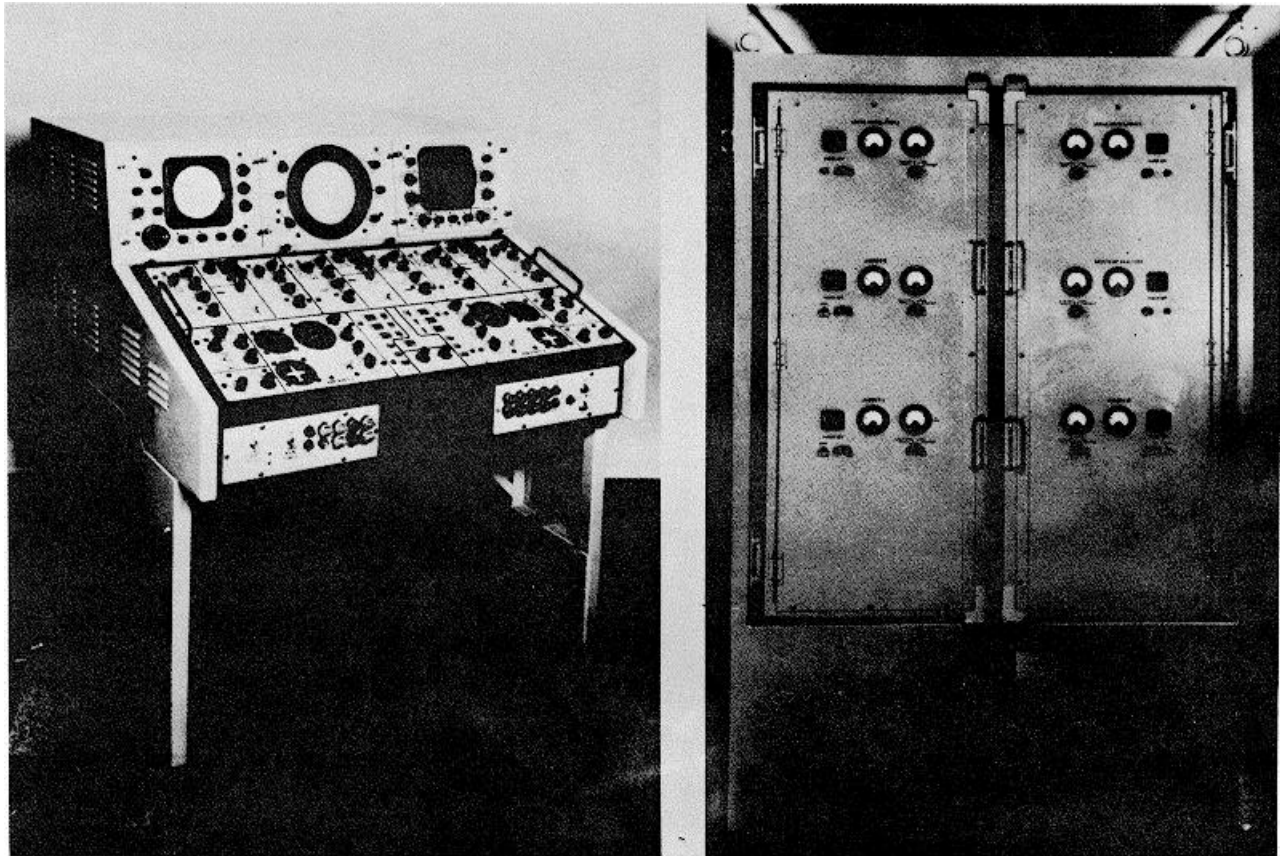

**FUNCTIONAL DESCRIPTION**

Countermeasures Signals Simulator Group AN/GPA-98 provides synthetic jamming signals similar to signals produced by Countermeasures Transmitters. The purpose is to check ECCM operating features and

aid in the maintenance of these circuits.

**RELATION TO SIMILAR EQUIPMENT**

Not available.

**ITEM NAME:** COUNTERMEASURES SIGNALS SIMULATOR GROUP

**TYPE:** AN/GPA-96

**TECHNICAL DESCRIPTION**

Not available.

**INSTALLATION CONSIDERATIONS**

Related Equipment: The AN/GPA-98 is used with but not part of various FD type Radar Sets.

**PRINCIPAL COMPONENTS AND PHYSICAL DATA**

<b>COMPONENT</b>	<b>QTY</b>	<b>HEIGHT (Inches)</b>	<b>WIDTH (Inches)</b>	<b>DEPTH (Inches)</b>	<b>UNIT WT. (Pounds)</b>
Countermeasures Signals Simulator	1				
Cable Assy's					
Waveguide					
Transmission Lines					
Mounting Hardware					

**REFERENCE DATA AND LITERATURE**

Unclassified Nomenclature card for AN/GPA-98 dated 21 May 64.

**AN/GPA-98: 2**

DATE: 15 September 1964

ITEM NAME: INTERFERENCE BLANKER GROUP

COGNIZANT SERVICE: USAF

TYPE: AN/GPA-101

FEDERAL STOCK NUMBER: 5840-778-5646

	USA	USN	USAF	USMC
STATUS OR TYPE CLASSIFICATION			Std	
Mfg(s) Name or Code Number. E.M.I. -Cossar Electronics Ltd.				

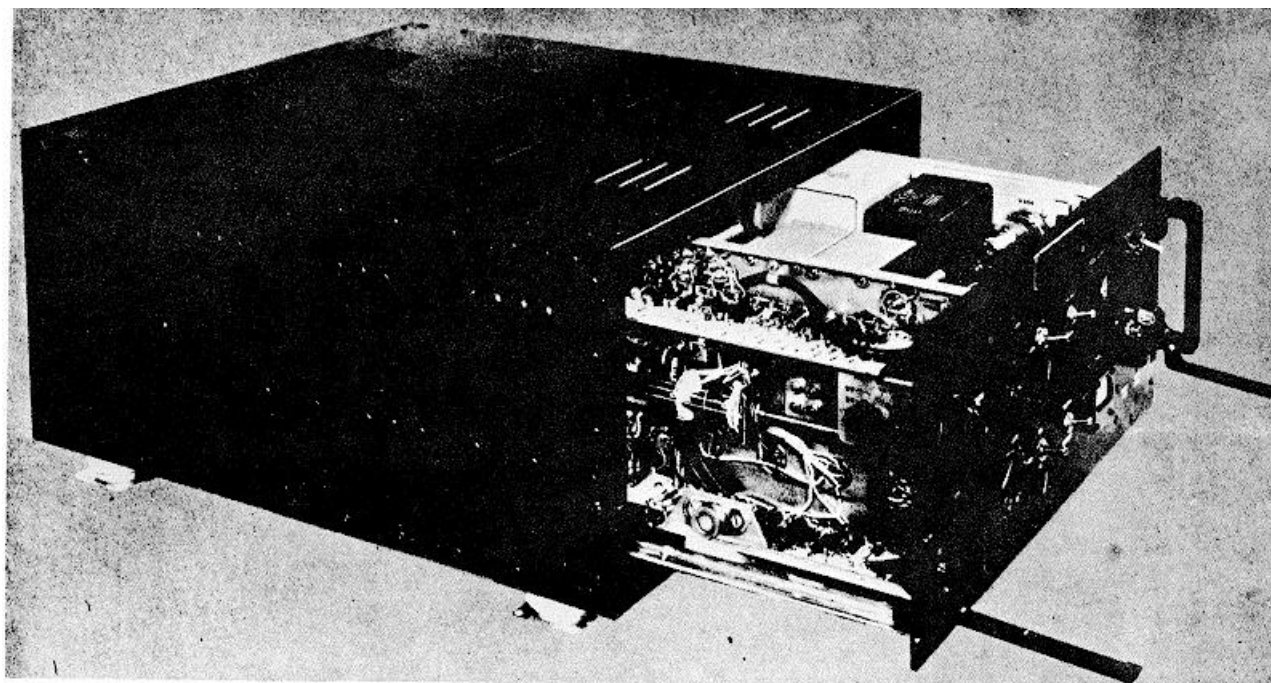

### FUNCTIONAL DESCRIPTION

The Interference Blanker Group is intended to discriminate between received radar signals on the basis of their pulse length and on their recurrence frequency. The purpose of such discrimination is to

eliminate signals or interference from other radars located nearby, since interference of this type makes it difficult to see aircraft signals and may, if sufficiently severe, preclude control of aircraft. The Interference Blanker would reject all unwanted signals and provide a clutter-free picture

AN/GPA-101: 1

**ITEM NAME:** INTERFERENCE BLANKER GROUP  
**TYPE:** AN/GPA-101

of the aircraft signals within the radar coverage area.

Power Source: 105-130v, 52-67 cycles, single ph,  
140 w

Duty Cycle: Continuous

**RELATION TO SIMILAR EQUIPMENT**

None.

**INSTALLATION CONSIDERATIONS**

**TECHNICAL DESCRIPTION**

Blanking of all pulses greater than: 0.7 usec, 1.0 usec, 2.0 usec, 3.0 usec and 4.0 usec (5 position switch)

Repetition Frequency: Up to 2, 000 pps

Minimum Signal Input: 0.2v

Maximum Operating Height: 15, 000 ft

Blanking: Two channels for MTI and Normal radar; blanking can be derived from either video signal

Gain: Maximum gain 2-V2X; ea channel independently controlled.

Input Impedance: 100 ohms

Output: Into 75 ohms load

Siting: Unit dimensions in cabinet - 11-5/8 in. high, 25-5/16 in. deep, 20-1/8 in. deep, 20-1/8 in. wide, weight 76 lb.

Unit dimensions removed from cabinet - 8-1/4 in. high, 19-1/2 in. deep, 16 in. wide, weight 52 lb. Front Panel - 8-23/32 in. height, 19-1/2 in. wide.

Mounting: Unit is supplied with four shockproof mounts on base of cabinet. Removed from the cabinet the chassis may be bolted into a standard relay rack.

Related Equipments: Used with but not part of Radar Set AN/CPN-18, Radar Set AN/CPN-4, Radar Set AN/MPN-11.

**REFERENCE DATA AND LITERATURE**

TECHNICAL ORDERS:  
31P1-2GPA101 series



**DATE:** 1 July 1964

**ITEM NAME:** RADAR DATA DISTRIBUTION GROUP

**COGNIZANT SERVICE:** USN

**TYPE:** AN/GPA-106( )

**FEDERAL STOCK NUMBER:**

	USA	USN	USAF	USMC
STATUS OR TYPE CLASSIFICATION				

Mfg(s) Name or Code Number:

**No Illustration Available.**

**FUNCTIONAL DESCRIPTION**

The Radar Data Distribution Group AN/GPA-106( ) accepts video, synchro, and trigger data from the search

radar and the IFF sets, and it feeds the data to radar site indicators and the radar site-operations site link (or cable). Provision is made for remotely controlled selection of video data.

**AN/GPA-106( ): 1**

**ITEM NAME:** RADAR DATA DISTRIBUTION GROUP

**TYPE:** AN/GPA-106( )

**RELATION TO SIMILAR EQUIPMENT**

None.

Power Supply: 2Bv dc

**INSTALLATION CONSIDERATIONS**

**TECHNICAL DESCRIPTION**

Operating Power Requirements  
Plate Voltage Supply: 250v dc

Related Equipment: The AN/GPA-106( ) is designed to be used with, but not part of AN/FPS-37 or AN/FPS-B, AN/FPS-33, AN/TPS-1D.

**PRINCIPAL COMPONENTS AND PHYSICAL DATA**

<b>COMPONENTS</b>	<b>QTY</b>	<b>OVERALL DIMENSIONS (Inches)</b>	<b>UNIT WT. (Pounds)</b>
Cabinet Relay Rack	2		
Cable Termination Ass) (Cable installation only)	1		
Enclosures	3		
Grated Video Amplifier	2		
IFF Antenna Coaxial Switch	3		
IFF Antenna Control Unit	1		
IFF Equipment Base	1		
IFF and Video Select Panel	1		
Plate Voltage (250v dc) Supply	4		
Power (28v dc) Supply	2		
Range Gate Generator	2		
Range Gate & Mixer Control Unit	2		
Switching Unit, Trigger	1		
Video Patch Panel	2		
Video Switch	8		

**REFERENCE DATA AND LITERATURE**

Nomenclature Card for Radar Data Distribution Group  
AN-GPA-106( ).

**DATE:** 1 July 1964

**ITEM NAME:** RADAR DATA DISTRIBUTION GROUP

**COGNIZANT SERVICE:** USN

**TYPE:** AN/GPA-107(V)

**FEDERAL STOCK NUMBER:**

	USA	USN	USAF	USMC
STATUS OH TYPE CLASSIFICATION				

Mfg(s) Name or Code Number:

**No Illustration Available.**

**FUNCTIONAL DESCRIPTION**

The Radar Data Distribution Group AN/GPA-107(V) is designed to accept, synchro and trigger data from the radar site-operations site link (or cable) and distributes it

to remote radar indicators. The group controls the radar-site distribution equipment via a link or cable. This equipment is capable of expansion on the basis of five (5) indicator modules.

**AN/GPA-107(V): 1**

**ITEM NAME:** RADAR DATA DISTRIBUTION GROUP

**TYPE:** AN/GPA-107(V)

**RELATION TO SIMILAR EQUIPMENT**

Power Supply: 28v dc

None.

**INSTALLATION CONSIDERATIONS**

**TECHNICAL DESCRIPTION**

Operating Power Requirements  
Plate Voltage Supply: 150v dc; 250v dc

Related Equipment: The AN/GPA-107(V) is designed to be used with, but is not part of AN/FPS-37 or AN/FPS-8, AN/FPS-33 and AN/TPS-ID.

**PRINCIPAL COMPONENTS AND PHYSICAL DATA**

<b>COMPONENTS</b>	<b>QTY</b>	<b>OVERALL DIMENSIONS (Inches)</b>	<b>UNIT WT. (Pounds)</b>
Cabinet, Relay Rack	(V)		
Cable Equalizer	(V)		
Cable Termination Assy	(V)		
Enclosure	(V)		
Equalizer Amplifier	(V)		
Gated Video Amplifier	(V)		
Indicator Switching Unit	(V)		
Plate Voltage Supply (150v dc)	(V)		
Plate Supply (250v dc)	(V)		
Power Supply (28v dc)	(V)		
Range Gate Generator	(V)		
Range Gate & Mixer Control Unit	(V)		
Trigger Distribution Amplifier	(V)		
Slaved Decoder	(V)		
Synchro Stator Amplifier	(V)		
Video Distribution Amplifier	(V)		
Video Mixer	(V)		
Video Patch Panel	(V)		

**NOTE:** (V) Indicates the quantity varies depending upon the particular installation.

**REFERENCE DATA AND LITERATURE**

Technical Manuals:  
NAVSHIPS 93400

DATE: 15 September 1961

ITEM NAME: VIDEO CONDITIONING GROUP

COGNIZANT SERVICE: USAF

TYPE: AN/GPA-110(V)

FEDERAL STOCK NUMBER: 5840-876-6221

	USA	USN	USAF	USMC
STATUS OR TYPE CLASSIFICATION			No Status Assigned	

Mfg(s) Name or Code Number: Temco Electronics Division

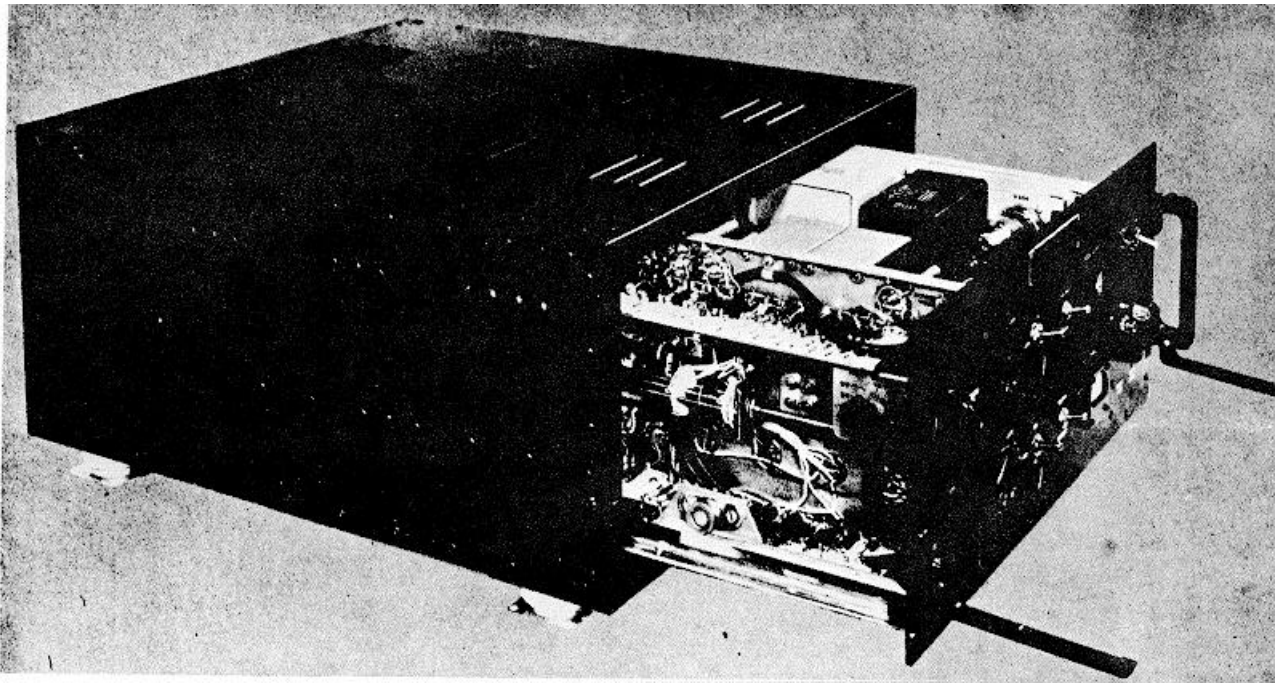

### FUNCTIONAL DESCRIPTION

The Video Conditioning Group amplifies synchronous signals and attenuates non-synchronous signals. As a result, the effects of jamming and interference which tend to distort the scope presentation

of the radar are minimized. The Conditioning Group processes the video to reduce the effects of interference, jamming and noise, provides the radar system with a trigger if desired, and provides a test target signal for alignment and test purposes. The equipment is designed for either single or dual

AN/GPA-110(V): 1

**ITEM NAME:** VIDEO CONDITIONING GROUP

**TYPE:** AN/GPA-110(V)

Radar Set applications.

Cabinet CY-3440/GPA-110(V) and sufficient open space to allow air, circulation.

**RELATION TO SIMILAR EQUIPMENT**

None.

Mounting: The Remote Switching Control C4003/GPA-110(V) is designed to conveniently mount on the indicator for ease of operator control.

**TECHNICAL DESCRIPTION**

Power Input: 120v ac, 8.1 amps 60 cps (plus or minus. cycles) single ph

Cabling Requirements: Cables are supplied in bulk to permit Installation requirements peculiar to any site layout.

**INSTALLATION CONSIDERATIONS**

Siting: Space requirement for AN/GPA-100(V) are limited by the size of the Electrical Equipment

Related Equipment: Used with but not part of AN/FPS-6A, AN/APS-68, and AN/MPS-14.

**PRINCIPAL COMPONENTS AND PHYSICAL DATA**

<b>COMPONENT</b>	<b>QTY</b>	<b>HEIGHT (Inches)</b>	<b>WIDTH (Inches)</b>	<b>DEPTH (Inches)</b>	<b>UNIT WT. (Pounds)</b>
Electrical Equipment Cabinet CY-3410/GPA-110(V)	1	56-1/4	30-1/2	28-1/4	
Remote Switching Control C-4003/GPA- 110(V)	1	11	7	3	

**REFERENCE DATA AND LITERATURE**

TECHNICAL ORDERS:  
31P1-2GPA110- series

**AN/GPA-110(V): 2**

DATE: 1 December 1964

ITEM NAME: SIMULATOR-RADAR SELECTOR GROUP

COGNIZANT SERVICE: USAF

TYPE: AN/GPA-112(V)

FEDERAL STOCK NUMBER:

	USA	USN	USAF	USMC
STATUS OR TYPE CLASSIFICATION			Used By	

Mfg(s) Name or Code Number: General Electric Company, Syracuse, New York

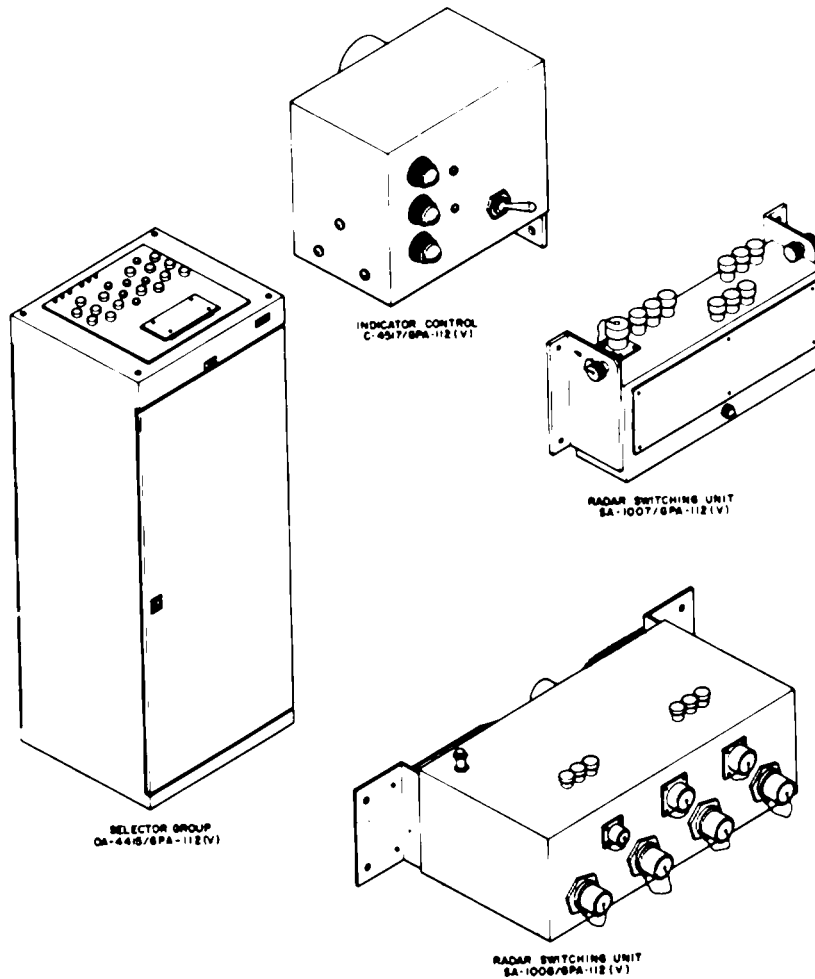

**FUNCTIONAL DESCRIPTION**

The Simulator-Radar Selector Group AN./GPA-112(V) (Radar Selector Group) is essentially signal switching equipment. This equipment provides for the selection, and for the insertion of simulated radar signals

(i-f or video) into a typical Air Weapons Control System 412L fixed site equipment complex. Simulated radar returns are used for operator training and, by maintenance personnel, as convenient inputs for the isolation of equipment malfunctions. Switching capabilities provided

**ITEM NAME:** SIMULATOR-RADAR SELECTOR GROUP

**TYPE:** AN/GPA-112(V)

by the Radar Selector Group permit the selection of one of three equipment modes of operation.

**RELATION TO SIMILAR EQUIPMENT**

None.

**TECHNICAL DESCRIPTION**

Operating Power Requirements: 120/208v ac, 60 cps, 3 ph, 4-wire (floating neutral), 300 w 28v dc, 47 w (max)

Equipment Compatibility

Main I-F

Center Frequency: 30 plus or minus 0.025 mcps  
Bandwidth: plus or minus 3 mcps at 1 db below peak amplitude  
RMS Noise Level: 500 mv  
Signal Range: Linear at least 60 db above rms noise  
Characteristic Impedance: 50 ohms

Coho I-F

Center Frequency: 30 plus or minus 0.025 mcps at 1 db below peak amplitude  
Amplitude: 0.1v peak-to-peak  
Pulse Width: 10 usec  
Characteristic Impedance: 50 ohms

Modes of Operation

(manual selection (remote capability))

Operational Mode: Normal radar i-f and coho i-f are processed into system video and fed to the data processing and display equipment.

Simulation Mode: Simulated radar i-f and coho i-f signals are substituted for normal radar signals. Simulated radar video is fed to the data processing and display equipment. Azimuth reference signals can be selected from radar or simulators.

Operational and Limited Simulation Mode: Normal radar i-f and coho i-f are processed into system video and fed to the data processing and display equipment. Additional simulated videos may be selected and mixed with real target video for presentation by the data processing and display equipment.

Positional Data Transfer

Analog Signals (Synchro)

Reference Signal: 120v dc, 60 cps, 1, 2-wire (1 and 36 speeds)  
Stator Signals (2): AM modulated 0-90v ac, 60 cps, balanced connections, 3-wire (1 and 36 speeds)

Digital Signals

ACP Pulses: Azimuth change pulses  
Polarity: Unipolar - positive  
Amplitude: 35 plus or minus 15v (peak)

Pulse Width: 1 to 5 usec  
Rise Time: 30% of pulse width  
Characteristic Impedance: 72 ohms  
RP Pulses: Reference pulses  
(characteristics as defined)

Timing Data Transfer

(These signals must exhibit the characteristics defined)

Polarity: Unipolar - positive  
Amplitude: 35 plus or minus 15v (peak)  
Rise Time: 0.3 usec (maximum)  
Pulse Width: 0.5 to 5.0 usec  
Characteristic Impedance: 72 ohms

Video Transfer Compatibility

Processed video

Bandwidth: 40 cps to 1 mcps at 3 db points  
Polarity: Unipolar - positive  
Amplitude: 1v to 4v, clipped level  
RMS Noise: 0.25 to 0.75 of video clipped level  
Characteristic Impedance: 72 ohms

Selective identification feature (SIF) video

Polarity: Unipolar - positive  
Amplitude: 2.5 to 5v (peak)  
Pulse Width: 0.4 to 0.6 usec  
Rise Time: 0.1 usec (maximum)  
Characteristic Impedance: 72 ohms

Moving target indicator (MTI) video

Polarity: Unipolar - positive  
Amplitude: 2.5 to 5v (peak)  
Pulse Width: 0.1 to 0.6 usec  
Rise Time: 0.1 usec (maximum)  
Characteristic Impedance: 72 ohms

Main lobe indicator (MLI) video

Polarity: Unipolar - positive  
Amplitude: 2.5 to 5v (peak)  
Pulse Width: 0.4 to 0.6 usec  
Rise Time: 0.1 usec (maximum)  
Characteristic Impedance: 72 ohms

**INSTALLATION CONSIDERATIONS**

Siting: The Selector Cabinet must be located near Electrical Filter Assembly F-585/GPA-73(V) and Radar Signal Simulators AN/GPS-TB and AN/GPS-T6 in order to restrict the length of cabling required to interconnect these units.

Cabling Requirements: Power and signal cables must be separated by a distance of at least 1B inches. Cable crossing should be avoided; however, when necessary, cables must cross at right angles. Additional power and signal cables required to complete the Radar Selector Group installation must be fabricated at the site from bulk cable stock.



**ITEM NAME:** SIMULATOR-RADAR SELECTOR GROUP

**TYPE:** AN/GPA-112(V)

Related Equipment: Radar Selector Group operates in conjunction with three radar simulators: Radar Simulator AN/GPS-T8, Radar Signal Simulator AN/GPS-T6, and Simulator Group OA-3873/GPS-T6. In addition, the equipment provides switching compatibility between the simulators and either of two radar signal processors, Radar Signal Processor AN/FSA-31 or Radar Signal Processor AN/FSA-30.

The Radar Selector Group has two configurations, determined by the type of radar and radar signal processor in the data acquisition equipment. The Type A Switching Unit is used with both Radar Set AN/FPS-20 and Radar Set AN/GPS-4. The Type B Switching Unit is used only with Radar Set AN/FPS-7.

**PRINCIPAL COMPONENTS AND PHYSICAL DATA**

<b>COMPONENT</b>	<b>QTY</b>	<b>HEIGHT (Inches)</b>	<b>WIDTH (Inches)</b>	<b>DEPTH (Inches)</b>	<b>UNIT WT.</b>
(UNCRATED)					
Selector Group OA-4415/GPA-112(V)	1	81	31	20	440
Indicator Control C-4517/GPA-112(V)	1	5	5.12	7.5	2
Radar Switching Unit SA-1007/GPA-112(V) (Type A)	1	6.35	14.5	4	4
Radar Switching Unit SA-1008/GPA-112(V) (Type B)	1	8.38	25.64	13.44	19
(CRATED)					
OA-4415/GPA-112(V)	1	87	36	32	690
C-4517/GPA-112(V)	1	7	10	7	4
SA-1007/GPA-112(V) (Type A)	1	7	19	9	10
SA-1008/GPA-112(V) (Type B)	1	16	29	17	29

**REFERENCE DATA AND LITERATURE:**

Technical Orders:  
31P1-2GPA112-2

**AN/GPA-112(V): 3**

DATE: 15 January 1961  
DISPLAY

ITEM NAME: PROJECTION SET SITUATION

COGNIZANT SERVICE: USAF

TYPE: AN/GPA-114

FEDERAL STOCK NUMBER: 5895-992-0068-EG

	USA	USN	USAF	USMC
STATUS OR TYPE CLASSIFICATION			Used By	

Mfg(s) Name or Code Number: General Electric Company, Syracuse, New York

No Illustration Available.

**FUNCTIONAL DESCRIPTION**

Projection Set, Situation Display has facilities to convert electrical energy into visible form to project dynamic track movements onto a large display screen for evaluation and review.

AN/GPA-114: 1

**ITEM NAME:** PROJECTION SET, SITUATION DISPLAY

**TYPE:** AN/GPA-114

**RELATION TO SIMILAR EQUIPMENT**

None.

120v, 400 cycles, 3-ph

**INSTALLATION CONSIDERATIONS**

Related Equipment: AN/GPA-114 is used with, but not part of, OA-3233/GPA-73(V)

**TECHNICAL DESCRIPTION**

Power Requirements:  
Input - 120v, 60 cycles, 3-ph

**PRINCIPAL COMPONENTS AND PHYSICAL DATA**

COMPONENT	QTY	HEIGHT (Inches)	WIDTH (Inches)	DEPTH (Inches)	UNIT WT.
Amplifier-Converter AM-2943/GPA-73(V)	1				
Amplifier-Electronic Control AM-2942/GPA-73(V)	1				
Amplifier-Electronic Control AM-2946/GPA-73(V)	1				
Amplifier-Mixer AM-2944/GPA-73(V)	1				
Amplifier, Trigger Pulse AM-2945/GPA-73(V)	1				
Control-Detector C-3612/GPA-73(V)	1				
Cabinet, Electrical Equipment CY-3819/GPA-114	1				
Control Indicator C-3613/GPA-73(V)	1				
Control Indicator C-3614/GPA-73(V)	2				
Coupler, Position CU-1001/GPA-73(V)	1				
Generator Pulse TD-464/GPA-73(V)	1				
Generator Sweep TD-463/GPA-73(V)	1				
Generator Sweep TD-462/GPA-73(V)	1				
Panel, Power Distribution SB-1274/GPA-73(V)	1				
Panel, Projection Electrical System SB-1275/GPA-73(V)	1				
Power Supply PP-2929/GPA-73(V)	1				
Power Supply PP-2930/GPA-73(V)	1				
Power Supply PP-2927/GPA-73(V)	2				
Power Supply PP-2928/GPA-73(V)	1				
Regulator Voltage CN-768/GPA-73(V)	2				
Resistor Assembly MX-343B/GPA-73(V)	1				
Transformer Assembly TF-357/GPA-73(V)	1				
Transformer Assembly TF-358/GPA-73(V)	1				
Switching Unit, Power Transfer SA-1103/GPA	1				
Control, Filament Voltage C-4970/GPA-73(V)	1				

**REFERENCE DATA AND LITERATURE**

Nomenclature Card for AN/GPA-114 dated 28 September 1962

**DATE:** 1 January 1965

**ITEM NAME:** INDICATOR GROUP

**COGNIZANT SERVICE:** USAF

**TYPE:** AN/GPA-118

**FEDERAL STOCK NUMBER:**

	USA	USN	USAF	USMC
STATUS OR TYPE CLASSIFICATION			Tent. Std	

Mfg(s) Name or Code Number: Tridea Electronics Inc., South Pasadena, California

**Illustration not Available.**

**FUNCTIONAL DESCRIPTION**

Indicator Group AN/GPA-118 is a self-contained plan-position radar indicator utilizing a very bright, variable persistence display storage tube. The unit is

designed to be compatible with AN/CPN-18, AN/MPN-11, and ASR-4. Ranges of 10, 20 and 10 nautical miles are selectable; 1 mile range marks are visible on the 10-mile range, and 5-mile range marks on the 20and 10-mile ranges.

**AN/GPA-118: 1**

**ITEM NAME:** INDICATOR GROUP

**TYPE:** AN/GPA-118

**RELATION TO SIMILAR EQUIPMENT**

The AN/GPA-118 is not interchangeable with any existing like item in Air Force use.

**INSTALLATION CONSIDERATIONS**

Related Equipment: The AN/GPA-118 is used with but not part of AN MPN-11, AN/CPN-18 and ASR-4.

**TECHNICAL DESCRIPTION**

External Power Requirements: 1-ph, 117v ac, 50 to 60 cps, 360w max

**PRINCIPAL COMPONENTS AND PHYSICAL DATA**

<b>COMPONENT</b>	<b>QTY</b>	<b>HEIGHT (Inches)</b>	<b>WIDTH (Inches)</b>	<b>DEPTH (Inches)</b>	<b>UNIT WT.</b>
Azimuth-Range Indicator (Tridea Electronics P/N 104802)	1				
Power Supply (Tridea Electronics P/N 104832)	1				
Chart Assy (Tridea Electronics P/N 104803)	1				
Electrical Power Cable Assy (Tridea Electronics P/N 104880)	1				
Display Storage Tube (Direct View) Hughes Aircraft P/N H1033BP20	1				

**REFERENCE DATA AND LITERATURE**

Nomenclature Card for AN/GPA-118 dated 12 March 196.1.

DATE: 1 June 19641

ITEM NAME: RADAR TRAINER

COGNIZANT SERVICE: USAF

TYPE: \*AN/GPN-T2, \*\*AN/GPN-T2A

FEDERAL STOCK NUMBER: 6940-282-7406

	USA	USN	USAF	USMC
STATUS OH TYPE CLASSIFICATION			*Ltd Std **Std	

Mfg(s) Name or Code Number Radar Radio and Electrical Co., Inc.

**Illustration not Available.**

**FUNCTIONAL DESCRIPTION**

Radar Trainer AN/GPN-T2 and AN/GPN-T2A are designed primarily for use as a problem generator for controller personnel. This equipment provides realistic radar signals representing aircraft or guided missile

targets for display on the plan position indicators (PPI 's) of the associated radar set. An instructor possessing full control of targets maneuvers can cause this equipment to simulate from six to thirty targets (In multiples of six). These controlled signals, representing actual aircraft are

**AN/GPN-T2: 1**

**ITEM NAME:** RADAR TRAINER

**TYPE:** AN/GPN-T2, AN/GPN-T2A

adjustable in azimuth, elevation, and range. Pulse width, pulse repetition rate, antenna beam width, antenna speed of rotation, and maximum range are adjustable to meet the requirements of a specific search radar set.

**RELATION TO SIMILAR EQUIPMENT**

Radar Trainers AN/GPN-T2 and AN/GPN-T2A are electrically interchangeable.

**TECHNICAL DESCRIPTION**

Number of Targets: 6, 12, 18, 24, or 30  
 Target Speed: 100 to 600 and 200 to 1200 knots  
 Target Turning Rate: 0 to 10 and 0 to 20 deg per sec  
 Radar Range Scales: 0 to 120 and 0 to 240 naut mi  
 Minimum Range: 2 mi (120-mi operation), 4 mi (210-mi operation)  
 Accuracy  
     Range: plus or minus 3% of setting  
     Target Maneuvering  
         Speed: plus or minus 2%  
         Course: plus or minus 2 (leg)  
 Pulse Width: 1 to 2 and 3.5 to .1.5 usec  
 Pulse Repetition Rate  
     External: Same as associated radar  
     Internal : 250 to 450 prr (adjustable)  
 Radar Antenna Horizontal Beam Width  
     Fixed: 1.5 deg  
     Adjustable: 1.5 to 10 deg  
 IFF Antenna Horizontal Beam Width: 4.5 to 47 deg (adjustable)

Antenna Speed of Rotation  
     External: 4 to 12 rpm  
     Internal: 4 to 24 rpm  
 Target Video Output Pulse: plus or minus 2.5v (min)  
 Signal Inputs  
     For Operation with PPI Repeater: None  
     For Operation with Radar Set  
         Video Pulse: plus or minus 2.5v  
         Trigger Pulse: plus 20v (min)  
         Antenna Synchro Voltage: one-speed standard  
 Power Requirements  
     6-Target Equipment: 115v, ac, 1-ph, 1400  
     12-Target Equipment:: 2550w  
     18-Target Equipment: 3720n  
     24-Target Equipment:: 488w  
     30-Target Equipment:: 6040

**INSTALLATION CONSIDERATIONS**

Siting: Maximum permissible distance between this equipment and the search radar or PPI is 100 ft.  
 Mounting: The 6-target signal unit and 6-target generator unit are usually installed on a table or bench. The master unit and 6-target power supply arc located beneath the table or bench top.  
 Related Equipment: Associated radar set and PPI repeater.

**PRINCIPAL COMPONENTS AND PHYSICAL DATA**

COMPONENT	BOXES (NR.)	UNIT WT. (Pounds)
	19	788

**EQUIPMENT SUPPLIED DATA**

COMPONENT	QTY	HEIGHT (Inches)	WIDTH (Inches)	DEPTH (Inches)	UNIT WT.
OA-11161/GPN-T2A, Console, Radar Trainer	1				
OA-804/GPN-T2, Interconnecting group	1				
OA-805/GPN-T2, Interconnecting Group	1				
OA-HO6/GPN-T2, Interconnecting Group	1				
AM-1-17:3/GPN-T2, Amplifier, Audio Frequency	1				

**ITEM NAME:** RADAR TRAINER

**TYPE:** AN/GPN-T2, AN/GPN-T2A

**PRINCIPAL COMPONENTS AND PHYSICAL DATA (Continued)**

<b>COMPONENT</b>	<b>QTY</b>	<b>HEIGHT (Inches)</b>	<b>WIDTH (Inches)</b>	<b>DEPTH (Inches)</b>	<b>UNIT WT.</b>
C-192,1/GPN-T2A, Control, Power Supply	1				
H-130/GPN-T2A, Headset- Microphone	1				
J-761/GPN-T2A, Interconnect- ing Box	1				
CX-3787/U, Cable Assy, Electrical					

**REFERENCE DATA AND LITERATURE**

Technical Manuals:  
31P-1-22

**AN/GPN-T2: 3**



DATE: 1 July 1964

ITEM NAME: RADAR SET

COGNIZANT SERVICE: USN

TYPE: AN/GPN-2

FEDERAL STOCK NUMBER: F5840-50-3756  
F5840-642-8238 W-S

	USA	USN	USAF	USMC
STATUS OR TYPE CLASSIFICATION		Ltd Std		

Mfg(s) Name or Code Number: Bendix Radio Division of Bendix Aviation Corp.

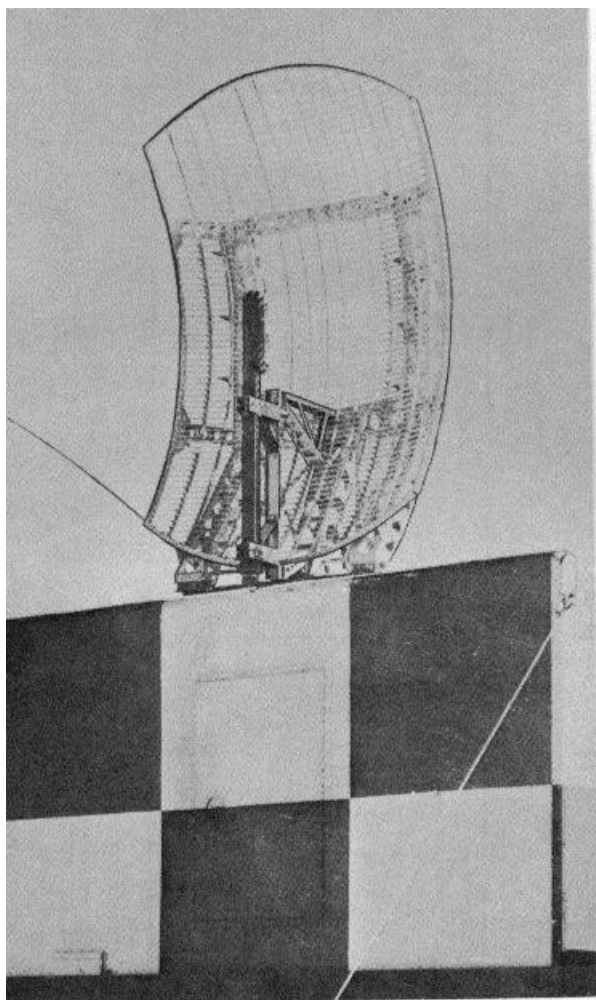

### FUNCTIONAL DESCRIPTION

The AN/GPN-2 is a mobile ground radar search system that provides aircraft traffic control facilities. Means for communication between the radar set operators, surrounding aircraft, and the control tower are provided.

Radar Direction Finder Equipment DBFI is used as part of this equipment so that instant identification of any of several aircraft communicating on VHF signals may be obtained.

The AN/GPN-2 includes Power Trailer V-22/M, which supplies power for the equipment and for the air-conditioning unit.

The operating shelter is constructed on skids and may be removed from the truck for semi-permanent installation.

Facilities have been provided for radio transmission and reception on the UHF bands and for emergency communication in the 200 to 500 kc range.

### RELATION TO SIMILAR EQUIPMENT

None.

### TECHNICAL DESCRIPTION

#### Communications Equipment:

Operating Voltages and Power Requirements-  
117v, 1-ph, 60 cps, 5.1 kw; 28 vdc

Transmitter Emission - A3

Frequency - Transmission, 2.0 to 18.1 mc, 3 to 4 mnc, and 100 t., 156 mnc; receiver, 1.5 to 9.0 mc, 3 to 6 mc, and 100 to 156 mc

Power Output - 8w (100 to 156 mnc), 100w (2 to 18.1 mnc), 15w (3 to 4 mc)

#### Radar Equipment:

Frequency - Transmitter, 2860 to 2900 mc

Range - 20 mi at 5,000 ft; 30 mi max

Peak Power Output - 200 kw

Pulse Rate - 2,000 pps

Pulse Width - 0.5 usec

IF. Frequency - 30 mc

Band Pass - 3.5 mc

Antenna - Ribbed parabolic dish

Antenna Feed - Coaxial line

### INSTALLATION CONSIDERATIONS

Siting: Requires unobstructed field in close proximity to the landing facilities.

Mounting:

Cabling Requirements:

Related Equipments:

**AN/GPN-2**

**PRINCIPAL COMPONENTS AND PHYSICAL DATA**

<b>COMPONENT</b>	<b>QTY</b>	<b>HEIGHT (Inches)</b>	<b>WIDTH (Inches)</b>	<b>DEPTH (Inches)</b>	<b>UNIT WT. (Pounds)</b>
Radar Receiver R-176/GPN-2	1	8-3/4	19	22-1/4	60
Synchroscope TS-504/GPN-2	1	8-3/4	19	22-1/4	50
Transmitter-Modulator T-149,/GPN-2	1	22-1/4	19	22-1/4	115
Rectifier Power Unit PP-200,/GPN-2	1	17-1/2	19	22-1/2	115
Servo Amplifier AM-138/GPN-2	1	10-5/8	19	14-1/2	35.5
Indicator 1D-181/GPN-2	1	33-1/4	19	37	175
Filter Unit F-54/GPN-2	1	5-1/4	19	14	23.5
Connector Panel	2				
(1) J-188/GPN-2		72	7	4	10
(1) J-187/GPN-2		72	7	4	10
Mounting Rack 2					
(1) MT-482 GPN-2		75	22-1/2	21	70
(1) MT-483/GPN-2		65	22-1/2	16-1/2	66
Control Unit C-327/GPN-2	2	5-1/2	14-5/8	8-3/8	9 ea
Relay Unit RE-49/GPN-2	1	19	7-1/4	3	7
Antenna Assembly	4				
(1) AS-338/GPN-2		16	4 dia	4	
(2) AS-78/MPN-1A		180	20		
(1) AS-317/GPN-2		55	5-1/2	12	32
Shelter S-35/GPN-2	1	82	78	138	2, 100
Antenna Reflector AT-109/UPN	1	101	62-1/2	26-1/4	198
Antenna Mount AB-104/GPN-2	1	54	46-1/2	32	375
Power Distribution Panel SB-43/GPN-2	1	13	31	4-1/2	10
Switching Unit SA-104/GPN-2	1	9	8-1/2	7-1/2	24
Motor Generator Set PU-133/U	1	20	11-1/2	41	425
Battery	2	20	11-1/2	41	146
DBF Table Containing:	1				
(1) VHF Radio Direction Finder DBF-1					
(1) Plotting Head for Indicator					
(1) UHF Signal Generator Equipment LAD					

PRINCIPAL COMPONENTS AND PHYSICAL DATA (cont'd)

COMPONENT	QTY	HEIGHT (Inches)	WIDTH (Inches)	DEPTH (Inches)	UNIT WT. (Pounds)
Transmitter-Receiver RT-18/ARC-1 with Mounting Base MT-230A/ARC		9 3-7/8	11 10-19/32	25 51 24	5
Control Unit C-45/ARC with Mounting Plate MT-4/ARR-2	1	8	4	3	1.1
Set of Test Equipment for Aircraft Radio Equipment AN/ARC-1					
Radio Transmitter T-19/ARC-5 with Mounting Rack MT-69/ARC-5 Mounting Base MT-68/ARC-5 Dynamotor DY-8/ARC-5	1	9 3-7/8 1-11/16 3-1/4	7-1/4 6-5/8 7-15/64 2-11/16	15-1/2 14-5/8 11-13/16 4-3/4	11.1
Radio Receiver R-23/ARC-5 with (1) Mounting Rack MT-63/ARC-5 (1) Mounting Base MT-62/ARC-5 (2) Dynamotor DY-2A/ARR-2	1	7 4-3/8 1-9/16 3-1/4	11-1/2 13-1/8 10-23/32 2-3/4	14 11 11-5/8 4-3/4	15.8
Antenna Relay Unit RE-2./ARC-5 with Mounting Base MT-77/ARC-5	1 1	8-1/2 5	6-1/2 5-5/8	8-1/2	2.2
Radio Transmitter T-47/ART-13 with Mounting Plate MT-283/ART-23 Shock-Mounting Base MT-284/ART-13	1	12 1-1/2 2-1/2	23-1/2 13-5/64 14-31/32	15 20-3/4 20-33	70 64
Control Unit C-87/ART-13 with Mounting Base MT-163./ART-13	1	8 3/16	4 3-11/16	3-1/2 5-5	16
Dynamotor Unit DY-12/ART-13 with Mounting Plate MT-164/ART-13	1	8-1/2 1-1/4	13-1/2 7-1/16	8 11- 5/32	31.5
Radio Receiver CG-46116 Receiver Rack-Single Receiver	1	9 3-3/8	7-1/2 7-1/2	17 16-5/8	25
Truck (1) 6 x 6 for Radar Unit (1) K-53 for Spare Parts					8, 200 11, 850
Trailer V-22/M containing: Diesel Engine Generator Equipment EAF-3 Air Conditioner MC-1	1	126	90	176	12, 100

REFERENCE DATA AND LITERATURE

Technical Manual:  
NAVSHIPS 900935

DATE: 1 July 1964

ITEM NAME: RADAR SET

COGNIZANT SERVICE: USN

TYPE: AN/GPN-6

FEDERAL STOCK NUMBER: 5895-557-8022 W/S

	USA	USN	USAF	USMC
STATUS OR TYPE CLASSIFICATION				

Mfg(s) Name Number: Laboratory for Electronics Incorporated, Boston, Mass.

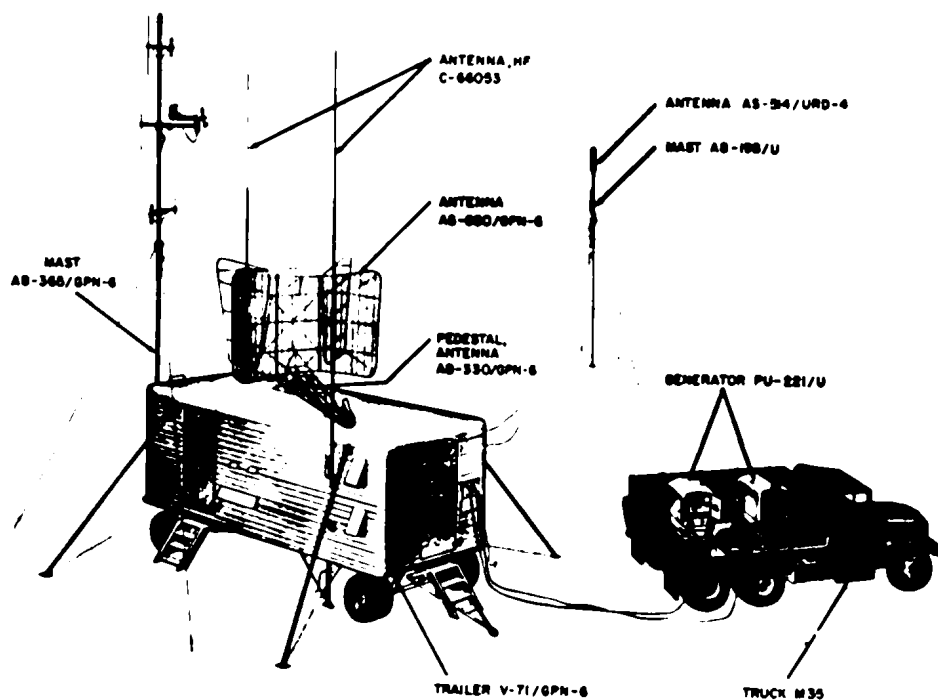

**FUNCTIONAL OR DESCRIPTION**

The Radar Set AN/GPN-6 is a trailer mounted air search radar designed for airport and seadrome surveillance, and traffic handling. It supplies range and bearing information on Plan Position Indicators (PPI),

provides two way voice communication between the Radar Set and aircraft in the HF, VHF and UHF ranges; it is equipped to provide wind direction and speed and altimeter readings, and is designed to accommodate direction finding equipment.

**ITEM NAME:** RADAR SET

**TYPE:** AN/GPN-6

**RELATION TO SIMILAR EQUIPMENT**

Similar to Radar Set AN/GPN-2 except for MTI and added Indicators as well as greater range and larger antenna.

**TECHNICAL DESCRIPTION**

Type of Emission: PO and A3 types  
Operating Frequency Range: 2700 to 2900 mc (Variable).  
Intermediate Frequency: 30 mc  
Type of Receiver Superheterodyne  
Type of Gain: Automatic

Type of Control: Frequency  
Peak Power Output: 500 kw  
Pulse Repetition Rate: 1000 cps  
Pulse Width: 0.9 usec  
Number of Channels: 1 channel  
Search Range: Approx 60 mi  
Operating Power Requirements: 120 and 208v ac, 60 cps, 3 ph, .4-wire  
Power Consumption: 15 kw

**INSTALLATION CONSIDERATIONS**

Mounting: Equipment is mounted in two trailers and a 1-ton truck.

**PRINCIPAL COMPONENTS AND PHYSICAL DATA**

<b>COMPONENTS</b>	<b>QTY</b>	<b>OVERALL DIMENSIONS (Inches)</b>	<b>UNIT WT. (Pounds)</b>
Trailer V-71/GPN-6	1	96 x 137 x 3.11	7500
Truck M-35	1		
Generator Assy PU-221 /U	2		2200
Antenna AS-650/GPN-6	1	48 x 96 x 11,1	225
Antenna Pedestal AB-330/GPN-6	1	30 x 33 dia	650
Mast AB-:365/GPN-6	1	3.5 dia x 406	193
Antenna CBOR-66095	3	5 x 21 x 16	
Antenna AT-150/SCR	2	5 x 13.5 x 22.5	
Wind Direction Velocity Transmitter ML-400/UMQ-5	1	6 x 7 x 19	
Whip Antenna	2	1.5 dia x 300	
Intercommunication Station LS-223/GPN-6	1	1.75 x 2.75 x 7.5	
Air Traffic Table	1	20 x 30 x 30	
Fuel Tank	1		
Switch Box SA-417/U	1	6.19 x 6.75 x B.62	7
Relay Assy, RE-21:3 GPN-6	1	3.62 x 6.25 x 11.25	5
Transformer Assy TF 209/GPN-6	1	9.62 x 10.5 x 15.75	73
Cable Assy, Power Electrical CX-3159/GPN-6	1		
Cable Assy, Power Electrical CX-3160/GPN-6	2		
Heater Air HD-154/U	1	11.25 x 22 x 26	
Air Conditioner HD-138/U	1	14 x 42 x 65-1/4	

ITEM NAME: RADAR SET

TYPE: AN/GPN-6

PRINCIPAL COMPONENTS AND PHYSICAL DATA (Cont.)

COMPONENTS	QTY	OVERALL DIMENSIONS (Inches)	UNIT WT. (Pounds)
Tool Kit and Rack	1		
Fire Extinguisher	1	6-3/4 x 10-1/2 x 30	49
First Aid Kit and Bracket	1		49
Mount Antenna Storage	1		
Operator's Chair	3	24-1/2 x 24-1/2 x 37-1/2	
Guy Wires, Anchors & Ground Stakes	6		
Blower Assy	2		
Loudspeaker	2		
Echo Box TS-270B/UP	1		
Radar Set Group OA-478/GPN-6	1		1898
Indicator Group OA-479/GPN-6	2		850
Communications Control Group OA-498/GPN-6	1		530
Communications, Direction Finder Group OA-477/GPN-6	1		1879

SHIPPING DATA

PKGS (NR.)	UNIT WT. (Pounds)
1	17,780
1	

REFERENCE DATA AND LITERATURE

Technical Manuals:  
NAVSHIPS 92576

AN/GPN-6: 3

DATE: 1 July 1964

ITEM NAME: RADAR TRAINING SET

COGNIZANT SERVICE: USN

TYPE: AN/GPS-T1A

FEDERAL STOCK NUMBER:

	USA	USN	USAF	USMC
STATUS OR TYPE CLASSIFICATION				

Mfg(s) Name or Code Number J. H. Keeney and Company, Inc., Chicago 36, Illinois

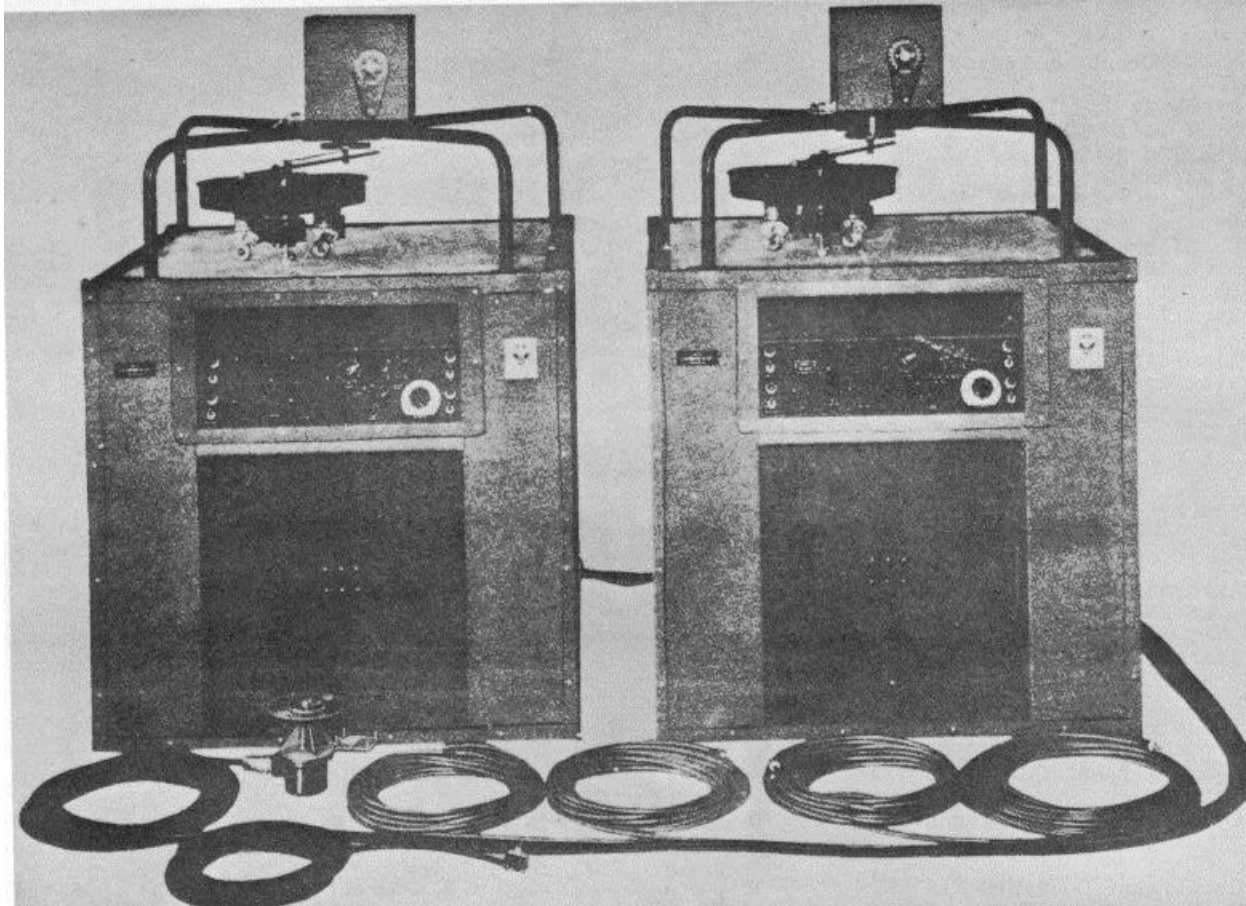

### FUNCTIONAL DESCRIPTION

The AN/GPS-T1A provides training to the GCI controller and his crew in perfecting interception technique without the use of aircraft. It has been designed primarily to operate with the SCR-527, and

with minor modifications will operate with SCR-588, SC-2 and SK, and in general, may be modified to provide a "PPI" or "A" scope presentation on other equipment having a beam width of three degrees or more. It may be used in conjunction with the SCR527 or SCR-588

**ITEM NAME:** RADAR TRAINING SET

**TYPE:** AN/GPS-T1A

with the transmitter operative or non-operative.

Power Requirements: 115v, 60 cycles, 700w  
Simulated Speed: 135 to 285 knots  
Range: 75 mi

**RELATION TO SIMILAR EQUIPMENT**

None.

**INSTALLATION CONSIDERATIONS**

Not available.

**TECHNICAL DESCRIPTION**

Frequency Range: 30 to 110 cycles

**PRINCIPAL COMPONENTS AND PHYSICAL DATA**

**SHIPPING DATA**

<b>COMPONENT</b>	<b>BOXES (NR.)</b>	<b>OVERALL DIMENSIONS (Inches)</b>	<b>UNIT WT. (Pounds)</b>
Console Group consisting of:	2	39 x 42-1/2 x 64	777
Aircraft Simulator MX-261/GPS-T1A			
Bearing Range Assy MX-263/GPS-T1A			
Console CY-226/GPS-T1A			
Control Panel C-160/GPS-TIA			
Coupling Transmission Unit CU-58/GPS-T1A			
Oscillator O-24/GPS-TIA			
Rectifier Power Unit PP-117/GPS-TIA			
Simulator Unit MX-264/GPS-T1A			
Wind-Drift Assy MX-262/GPS-T1A			
Accessories and Spare Parts			

**EQUIPMENT SUPPLIED DATA**

<b>COMPONENTS</b>	<b>QTY</b>	<b>OVERALL DIMENSIONS (Inches)</b>	<b>UNIT WT. (Pounds)</b>
Aircraft Simulator MX-261/GPS-T1A	2	8 x 13-1/2 x 14-1/2	13
Bearing-Range Assy MX-263/GPS-TIA	2	8 x 11-1/2 x 18	25
Console CY-226/GPS-T1A	2	33 x 35 x 44	135
Control Panel C-160/GPS-TIA	2	5 x 11 x 22-1/2	13
Coupling Transmission Unit CU-58/GPS-TIA	1	6 x 6-1/4 x 7-1/4	3
Oscillator O-24/GPS-TIA	2	7-1/2 x 8 x 16	16-1/2
Rectifier Power Unit PP-117/GPS-T1A	2	7-1/2 x 8 x 16	20-1/2
Simulator Unit MX-264/GPS-TIA	2	8 x 14 x 16	13-1/2
Wind-Drift Assy MX-262/GPS-TIA	2	9-1/2 x 10-1/2 x 24-1/2	34

**REFERENCE DATA AND LITERATURE**

Not available.



PRINCIPAL COMPONENTS AND PHYSICAL DATA (cont'd)

COMPONENT	QTY	HEIGHT (Inches)	WIDTH (Inches)	DEPTH (Inches)	UNIT WT. (Pounds)
Antenna Control C-113/FPS-8	1		37	12	13-1/2
Motor-Generator PU-289/G	1	15-1/2	49-1/2	21	

REFERENCE DATA AND LITERATURE

Technical Orders:  
31P6-2GPS3- Series

DATE: 15 April 1964

ITEM NAME: RADAR SET

COGNIZANT SERVICE: USAF

TYPE: AN/GPS-3

FEDERAL STOCK NUMBER: 5840-524-0664

	USA	USN	USAF	USMC
STATUS OR TYPE CLASSIFICATION		Std		

Mfg(s) Name or Code Number: General Electric Company

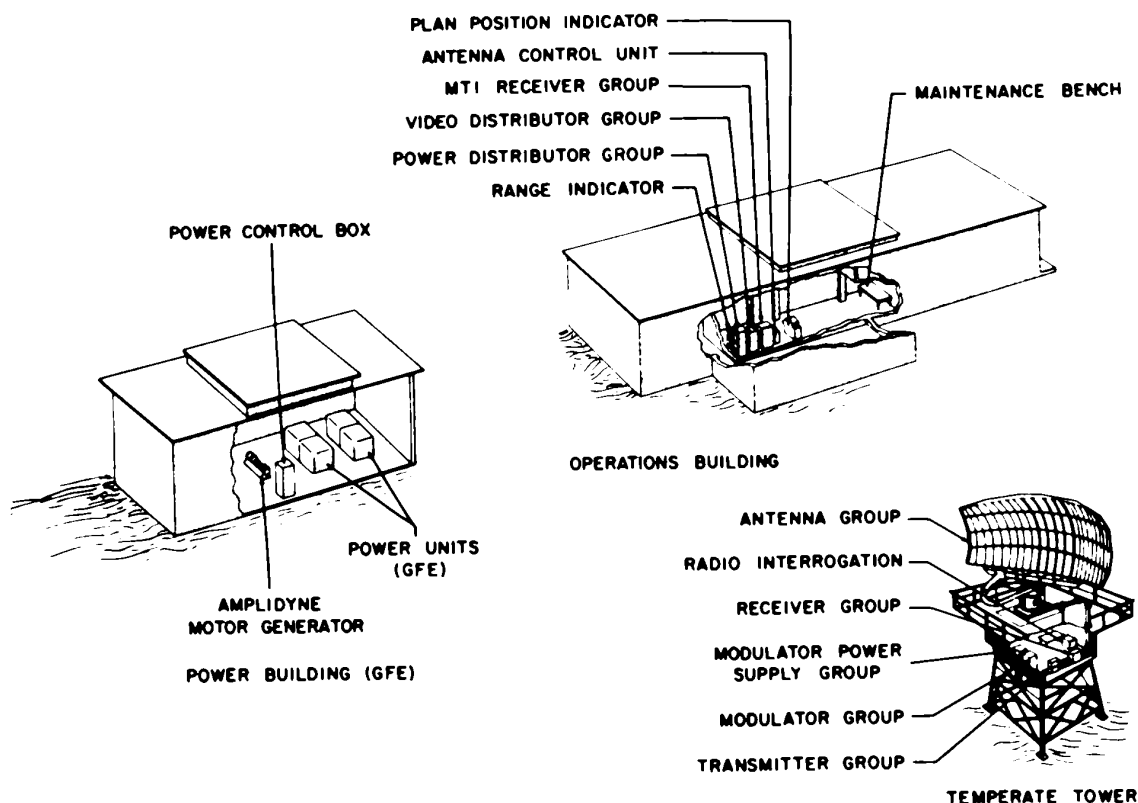

**FUNCTIONAL DESCRIPTION**

Radar Set AN/GPS-3 is used to back-up the search function of a primary surveillance radar set. The AN/GPS-3 equipment has a maximum target detection range of 200 nautical miles. The antenna reflector mounted on Tower AB-397/FPS-8 may be manually preset to the desired angle of vertical tilt and may be rotated in forward or reverse direction through 360 degrees in azimuth. The reflector may be scanned

through any sector of 40 to 120 degrees with the center of the sector at any azimuth position. This radar set includes a coherent video cancellation type of a range indicator, and a PPI for monitoring received target video or for general testing. The antenna circuits for IFF equipment are included in Radar Set AN/GPS-3. The AN/GPS-3 is composed of a surveillance radar set, Tower AB397/FPS-8, and Radar Recognition Set AN/UPX-6.

Either Arctic Tower AB-313/FPS-8 or Temperate

**AN/GPS-3**

Tower AB-397/FPS-8 is used with Radar Set AN/GPS-3, depending upon environmental conditions. When the AN/GPS-3 is used in an arctic installation, the power requirement is increased by 60 kilowatts.

**RELATION TO SIMILAR EQUIPMENT**

None.

**TECHNICAL DESCRIPTION**

Frequency: 1280 to 1350 mc  
 Peak Power Output: 1 megw  
 Pulse Width: 3 psec  
 Pulse Repetition Rate: 360 pps  
 Range Limits:  
     Normal - 160 naut mi (without delay)  
     Normal - 220 naut mi (with delay)  
     MTI - 150 naut mi  
 Azimuth Coverage: 360 deg, continuous rotation in either forward or reverse direction, and sector scanning in individual sectors of 40 to 120 deg  
 Range Accuracy: +0. 5 mi  
 Azimuth Accuracy: 0\*. 5 deg  
 Rate of Antenna Rotation: 0 to 10 rpm cw or ccw  
 Reflector Dimensions: Paraboloidal, 14 ft high and 25 ft long  
 Beam Width: 2. 5 deg  
 Beam Pattern: Cosecant-squared, from 9 to 30-deg elevation  
 Antenna Gain: 30. 3 db relative to isotropic source  
 Receivers: 1 normal receiver, 1 MTI receiver  
 Normal Receiver Bandwidth: 0.6 ± 0.1 mc  
 IF. Frequency: 30 mc

Indicator Type and Quantity: 12-in. PPI (Indicator Group OA-99A/CPS-6B), one A-scope type 5CPIA (IP-209/FPS-8)  
 Indicator Ranges: OA-99A/CPS-6B has radial sweeps of 00 to 50, 0 to 100, 0 to 200 naut mi, IP-209/FPS-8 has 1. 62- to 250-naut mi indicator calibration  
 Range Marks: 10-mi intervals, every fifth mark accentuated  
 Angle Marks: 10-deg intervals, every third mark accentuated  
 Duty Cycle: 0.00108  
 AN/GPS- 3 Loading Conditions: 52-knot wind velocity without antenna reflector ice load  
 Power Requirements: 120/208vac, 60cps, 3-ph, 4-wire  
     Temperature - 16. 9 kva  
     Arctic - 76. 9 kva

**INSTALLATION CONSIDERATIONS**

Siting: For optimum performance, use the highest available location separated from an atmospheric duct by a minimum of 2, 000 feet, from adjacent radar sets by a minimum of 100 feet, and from any refueling operation by a minimum of 500 feet.  
 Mounting: Radar units will be positioned on the first deck cubicle floor platform, 16 ft above ground level; the antenna reflector elements are to be positioned on the top platform level, 25ft above ground, on Tower AB-397/FPS-8.  
 Cabling Requirements: dry locations required.  
 Related Equipment: Any long-range radar set having characteristics c o m p a r a b l e to the AN/GPS-3.

**PRINCIPAL COMPONENTS AND PHYSICAL DATA**

COMPONENT	QTY	HEIGHT (Inches)	WIDTH (Inches)	DEPTH (Inches)	UNIT WT. (Pounds)
Modulator Group OA-414/FPS-8	1	55-1/2	24	24-1/2	
Power Supply Group OA-412/FPS-8	1	65	30	28	
Radar Transmitter T-370/FPS-8	1	57-1/2	32	24	
Receiver Group OA-417/FPS-8	1	50-1/2	33-1/8	27	
Radar Set Group OA-416/FPS-8	1	83-9/16	24	29	
Radar Set Group OA-381/FPS-8	1	60-3/32	34-3/8	27-3/4	
Indicator OA-99A/CPS-6B	1	42	21	43	
Power Switchboard SB-245/FPS-8	1	62	20	22-5/8	
Electrical Power Switching Group OA-41 5/FPS-8	1	60-1/2	25	32	

DATE: 15 April 1964

ITEM NAME: RADAR IDENTIFICATION SET

COGNIZANT SERVICE: USAF

TYPE: AN/GPX-6

FEDERAL STOCK NUMBER: 5895-306-4559B

	USA	USN	USAF	USMC
STATUS OR TYPE CLASSIFICATION		Alt Std		

Mfg(s) Name or Code Number: Hazeltine Electronics Corporation

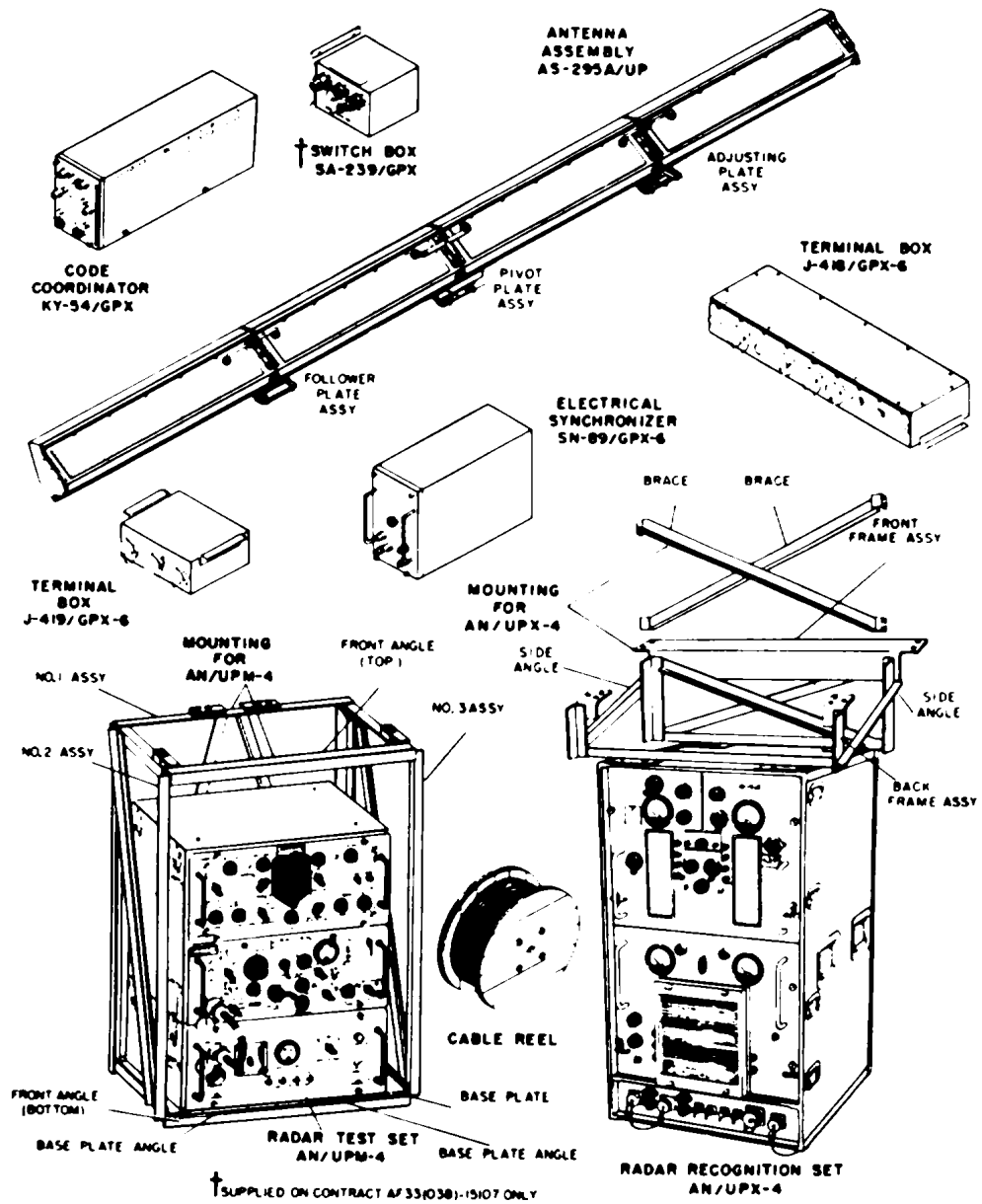

**AN/GPX-6**

**FUNCTIONAL DESCRIPTION**

Radar Identification Set AN/GPX-6 provides Mark X IFF for Radar Set AN/CPS-6B or AN/ FPS-10. The AN/GPX-6 transmits coded radio frequency pulses to trigger an airborne transponder identification set and converts the received transponder reply to video pulses. This equipment permits the video pulses to be displayed on the PPI's of the associated radar set. The interrogator output level and receiver sensitivity are adequate for interrogating and receiving replies from transponders operating within the detection range of the associated radar. The AN/GPX-6 may be independently operated to track targets equipped with a radar identification set.

**TECHNICAL DESCRIPTION**

Frequency: Transmitting, 990 to 1040 mc;  
receiving, 1080 to 1130 mc

Peak Power Output: 20 kw  
Operating Voltage and Power Requirements: 115 vac, 55 to 410 cps, 1-ph  
Type of Presentation: Indicator of associated radar  
Duty Cycle: 0.32  
Pulse Repetition Rate: 180 to 420 pps (adjusted to prr of associated radar)  
Pulse Width: 0.7 to 1.2 æsec

**INSTALLATION CONSIDERATIONS**

Siting: Dependent on location of associated radar  
Mounting: Components of this equipment are installed on the associated basic radar  
Cabling Requirements:  
Related Equipment: Radar Identification Set AN/GPX-6 may be used with Radar Set AN/CPS-6B or AN/FPS-10

**PRINCIPAL COMPONENTS AND PHYSICAL DATA**

<b>COMPONENT</b>	<b>QTY</b>	<b>HEIGHT (Inches)</b>	<b>WIDTH (Inches)</b>	<b>DEPTH (Inches)</b>	<b>UNIT WT. (Pounds)</b>
Radar Recognition Set AN/UPX-4*	1				
Code Coordinator KY-54/GPX	2	8-5/8	6-5/8	23	39
Antenna Assembly AS-295/UP*	1	13-13/32	9-13/32	222	101
Terminal Box J-418/GPX-6	1	4-1/2	30-1/2	9	8
Terminal Box J-419/GPX-6	1	4-1/4	12	9	17

\* Government-furnished equipment

**REFERENCE DATA AND LITERATURE**

Technical Orders:  
31P1-2GPX6- Series

Specification:  
ENG-2140A  
ENG-345

DATE: 1 July 1964

ITEM NAME: RADAR SET

COGNIZANT SERVICE: USN

TYPE: AN/GPX-2

FEDERAL STOCK NUMBER: F5895-265-7287

	USA	USN	USAF	USMC
STATUS OR TYPE CLASSIFICATION				

Mfg(s) Name or Code Number:

Illustration Not Available

#### FUNCTIONAL DESCRIPTION

The AN/GPX- 2 is a lightweight interrogator responder used at airport control towers to check IFF operation. The AN/GPX-2 is used to check Mark III IFF equipments in aircraft. The AN/GPX-2 is a ground installation.

repackaged in 19-in. rack cabinets.

#### TECHNICAL DESCRIPTION

Operating Voltages and Power Requirements: 110 vac, 50 to 70 cps, 400w

#### RELATION TO SIMILAR EQUIPMENT

The AN/GPX-2 is Radio Set SCR-729-A modified to operate from a 50 to 70 cps power source and

#### INSTALLATION CONSIDERATIONS

Not available.

#### PRINCIPAL COMPONENTS AND PHYSICAL DATA

COMPONENT	QTY	HEIGHT (Inches)	WIDTH (Inches)	DEPTH (Inches)	UNIT WT. (Pounds)
Antenna Assembly AS-257( )/GPX-2					
Indicator Control Unit ID-139( )/GPX-2					
Radar Receiver R-151()/GPX-2					
Radar Transmitter T-129( )/GPX-2					
Cabinet CY-339/GPX- 2					

#### REFERENCE DATA AND LITERATURE

Specification:  
EN- 102

DATE: 15 April 1964

ITEM NAME: RADAR IDENTIFICATION SET

COGNIZANT SERVICE: USAF

TYPE: AN/GPX-6A

FEDERAL STOCK NUMBER: 5895-349-0041

	USA	USN	USAF	USMC
STATUS OR TYPE CLASSIFICATION			TS	

Mfg(s) Name or Code Number. Stewart Warner, Hazeltine Electric

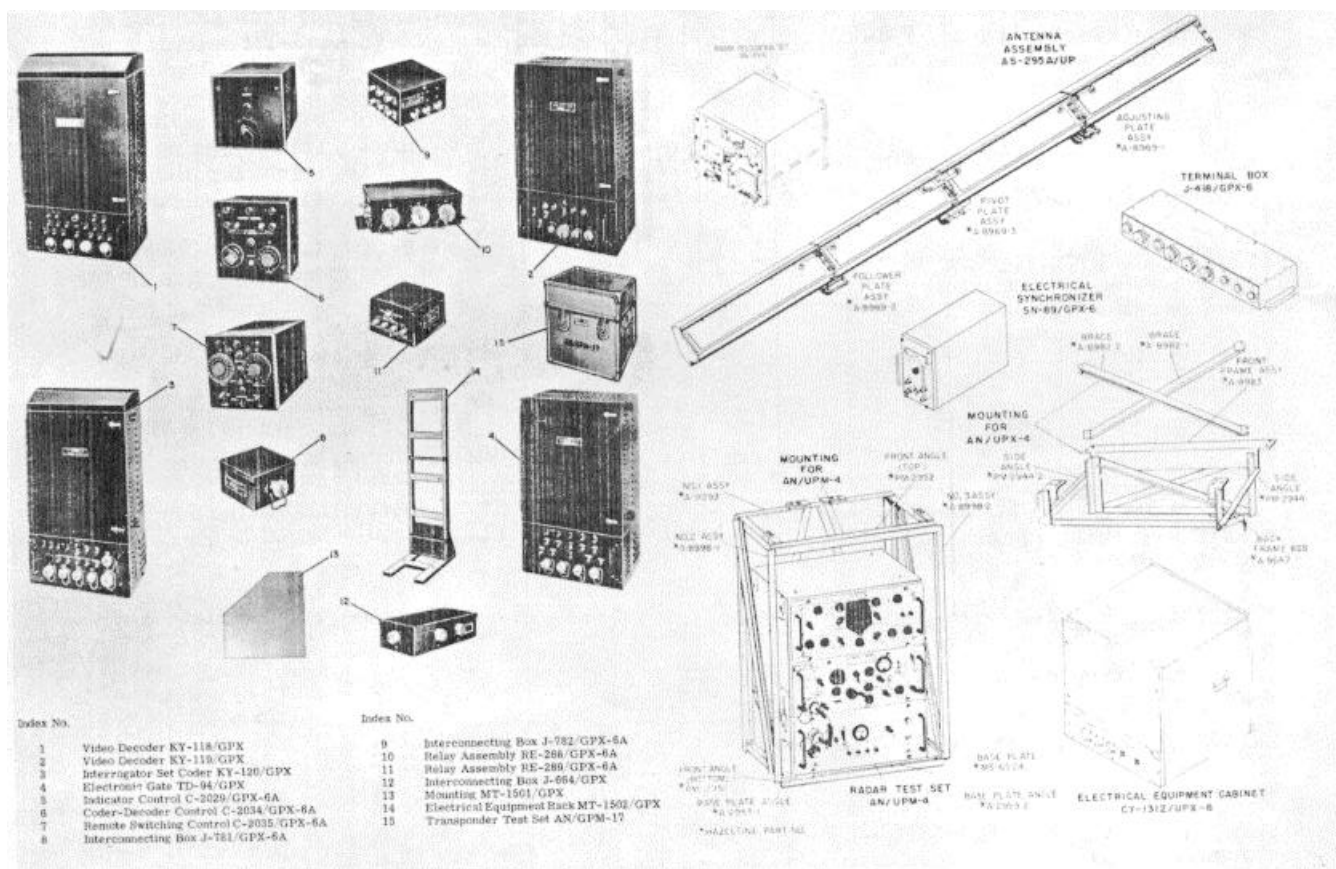

### FUNCTIONAL DESCRIPTION

The AN/GPX-6A serves as a system, separate from AN/CPS-6B main radar, which develops and transmits IFF interrogations into a rotating beam. When the beam intercepts a friendly aircraft, it causes the transponder in

the aircraft to operate and send out a coded response. This response is received by the Radar Recognition Set AN/UPX which then applies video signals, corresponding to the response codes, to Coder Decoder Group

**ITEM NAME:** RADAR IDENTIFICATION SET

**TYPE:** AN/GPX-6A

OA-839/GPX-6A. Coded and uncoded outputs from the OA-839/GPX-6A are selected at the ten PPI scopes as elongated marks. Five PPI scopes are associated with normal (front beam) radar and five PPI scopes are associated with early warning (back beam) radar.

**RELATION TO SIMILAR EQUIPMENT:**

Similar to and interchangeable with Radar Identification Set AN/GPX-6, differs in that this equipment also decodes responses from Transponder Set AN/APX-25.

**TECHNICAL DESCRIPTION:**

Frequency: Transmitting, 990 to 104 mc  
Receiving, 1080 to 1130 mc  
Peak Power Output: 20 kw

Operating Voltage and Power Requirements: 115v ac, 55 to 110 cps, single ph  
Type of Presentation: Indicators PPI  
Duty Cycle: 0.32  
Pulse Repetition Rate: 108 to 120 pps (adjusted to PRR of associated radar)  
Pulse Width: 0.7 to 1.2 usec

**INSTALLATION CONSIDERATIONS:**

Siting: Dependent on location of associated radar.  
Mounting: Components of this equipment are installed on the associated basic radar.  
Related Equipments: Radar Identification(n Set AN/GPX-6A was primarily designed for use with Radar AN/CPS-6B.

**PRINCIPAL COMPONENTS AND PHYSICAL DATA**

<b>COMPONENT</b>	<b>QTY</b>	<b>HEIGHT (Inches)</b>	<b>WIDTH (Inches)</b>	<b>DEPTH (Inches)</b>	<b>UNIT WT. (Pounds)</b>
Video Decoder KY-118/GPX	12	28-3/16	18	13	161
Video Decoder KY-119/GPX	2	28-3/16	18	13	96
Interrogator Set Code KY-120/GPX	1	28-3/16	18	13	121
Electronic Gate TD-94/GPX	1	28-3/16	18	13	93
Coder-Decoder Control C-2034/GPX-6A	1	6-3/16	6-3/16	6-7/16	2-1/2
Remote Switching Control C-2035/GPX-6A	10	6-3/16	6-3/16	12-7/16	6
Indicator Control C-2029/GPX-6A	10	6-3/16	6-3/16	12-7/16	8
Interconnecting Box J-782/GPX-6A	1	7	6-1/8	3	2-1/4
Relay Assy RE-289/GPX-6A	1	6-1/2	6	3	1
Relay Assy RE-288/GPX-6A	1	3-5/16	9-1/1	12	4-1/2
Interconnecting Box J-781/GPX-6A	1	6-1/4	7-5/8	3	1
Electrical Frequency Control C-2028/GPX		8	17	6-1/2	2
Mounting MT-1501/GPX (6 per carton)	10	18-1/2	19-13/16	3/16	6
Electrical Equipment Rack MT-1502/GPX	8	73-5/8	18	30	132
Interconnecting Box J-664/GPX	3	3	13-1/16	7-1/8	5-1/2



ITEM NAME: RADAR IDENTIFICATION SET

TYPE: AN/GPX-6A

PRINCIPAL COMPONENTS AND PHYSICAL DATA

COMPONENT	QTY	HEIGHT (Inches)	WIDTH (Inches)	DEPTH (Inches)	UNIT WT. (Pounds)
Installation Safety Switch	1	15-1/2	10-1/4	5-1/2	19
Transponder Test Set AN/GPM- 17	1	24-3/4	22	16-3/1	160
Antenna Assy AS-295( )/UP	2	13-13/32	222	9-13/32	101
Radar Recognition Set AN/tIPX-6	2	11	15	21	77
Electrical Equipment Cabinet CY-1312/tUPX-6	2	22-1/16	23-13/16	25-13/32	58
Radar Test Set AN/UPM-4	1	29-1/2	2.1	19-1/2	191
Electrical Synchronizer SN-89/GPX-6	1	9-3/1	6	16-9/16	18
Terminal Box J-118/GPX-6	1	4-1/2	30-1/2	9	17

REFERENCE DATA AND LITERATURE

TECHNICAL ORDERS:  
31PI-2GPX6 Series

AN/GPX-6A: 3

DATE: 15 April 1964

ITEM NAME: RADAR IDENTIFICATION SET

COGNIZANT SERVICE: USAF

TYPE: AN/GPX-7

FEDERAL STOCK NUMBER: 5895-342-6395

	USA	USN	USAF	USMC
STATUS OR TYPE CLASSIFICATION			Alt Std	
Mfg(s) Name or Code Number: Hazeltine Electronics Corporation				

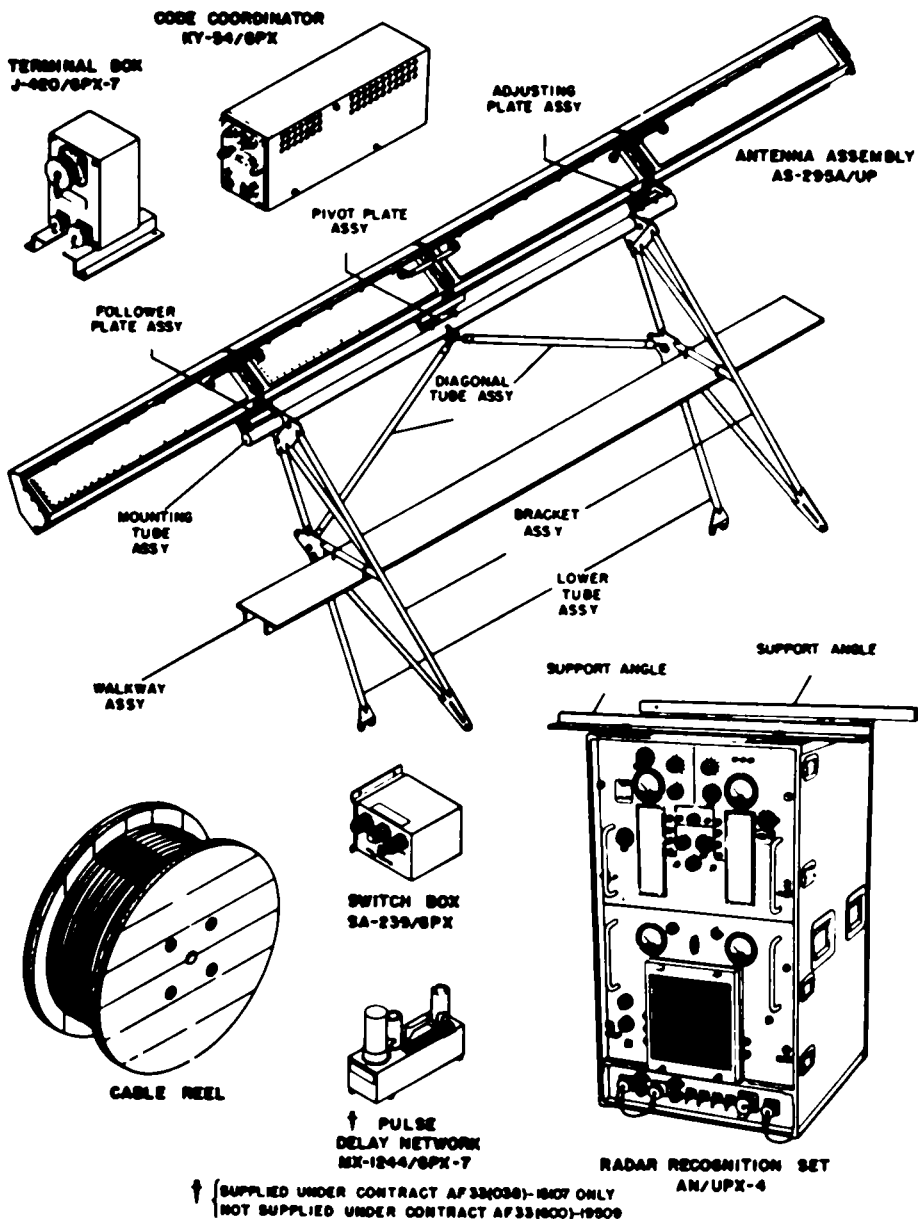

**ITEM NAME:** RADAR IDENTIFICATION SET

**TYPE:** AN/GPX-7

**FUNCTIONAL DESCRIPTION**

Radar Identification Set AN/GPX-7 provides Mark X IFF for Radar Set AN/FPS-3. The AN/ GPX-7 transmits coded radio-frequency pulses to trigger an airborne transponder identification set and converts the received transponder reply to video pulses to be displayed on the PPI's of the associated radar set. The interrogator output level and receiver sensitivity are adequate for interrogating and receiving replies from transponders operating within the detection range of the associated radar. The AN/GPX-7 may be independently operated to track targets equipped with a radar identification set.

receiving, 10t30 to 1130 mc  
Peak Power Ouput: 20 kw  
Operating Voltage and Power Requirements:  
115v ac, 40 to 70 cps, 1-ph  
Type of Presentation: PPI and B-scopes  
of associated radar  
Duty Cycle: 0.32  
Pulse Repetition Rate: 1t0 to 120 p)ps (adjusted to conform with pulse repetition rate of associated radar)  
Pulse Width: 0.7 to 1.2 usec

**RELATION TO SIMILAR EQUIPMENT:**

Similar to and interchangeable with AN/GPX-7A. Differs in that this equipment does not decode responses from the AN/APX-25.

**INSTALLATION CONSIDERATIONS:**

Siting: Dependent on location of basic radar.

Mounting: Components of this equipment are installed on the associated radar.

**TECHNICAL DESCRIPTION:**

Frequency: transmitting, 990 to 1010 mc;

Related Equipment: Radar Identification Set AN GPX-7 may be used with Radar Set AN/FPS-3.

**PRINCIPAL COMPONENTS AND PHYSICAL DATA**

COMPONENT	QTY	HEIGHT (Inches)	WIDTH (Inches)	DEPTH (Inches)	UNIT WT.
Radar Recognition Set AN/UPX-4*	1				
Code Coordinator KY-54/GPX	1	8-5/8	6-5/8	23	39
Pulse Delay Network MX- 1214 /GPX-7**	1				
Switch Box SA-239/GPX	7	4-1/4	4-3/4	6-1/4	1.4
Terminal Box J-420/GPX-7	1				
Antenna Assembly AS-295A/UP*	1	13-13 /32	9 13/32	222	101

\* Government-furnished

\*\* Furnished on contract AF 33(03t3) 15107 only.

**REFERENCE DATA AND LITERATURE**

Technical Orders:

31P4-2GPX7- Series

Specification:

ENG-2141A

ENG-346

ITEM NAME: RADAR IDENTIFICATION SET

TYPE: AN/GP X-7A

PRINCIPAL COMPONENTS AND PHYSICAL DATA

COMPONENT	QTY	HEIGHT (Inches)	WIDTH (Inches)	DEPTH (Inches)	UNIT WT.
Installation Safety Switch	1	15-1/2	10-1/4	5-1/2	19
Transponder Test Set AN/GPM-17	1	2,1-3/4	22	16-3/4	160
Antenna Assembly AS-295( )/UP(GFE)	1	13-13/32	222	9-13/32	101
Radar Recognition Set AN/UPX-6(GFE)	1	11	15	21	77
Electrical Equipment Cabinet CY-1312/UPX-6 (GFE)	1	22-1/16	23-13/16	25-13/32	58
Terminal Box J-42/GPX-7 (GFE)	1	12-5/8	7-7/8	10-3/4	18

REFERENCE DATA AND LITERATURE

Technical Orders:  
31 P1-2GPX272  
31P4-2GPX274  
31P4-2GPX7- Series

DATE: 15 December 1964  
COGNIZANT SERVICE: USAF

ITEM NAME: RADAR IDENTIFICATION SET  
TYPE: AN/GPX-7A

FEDERAL STOCK NUMBER: 5895-349-0042-EG

	USA	USN	USAF	USMC
STATUS OR TYPE CLASSIFICATION			TS	
Mfg(s) Name or Code Number: Hazeltine Electronic Corp., Crosley Div. Avco Mfg Corp.				

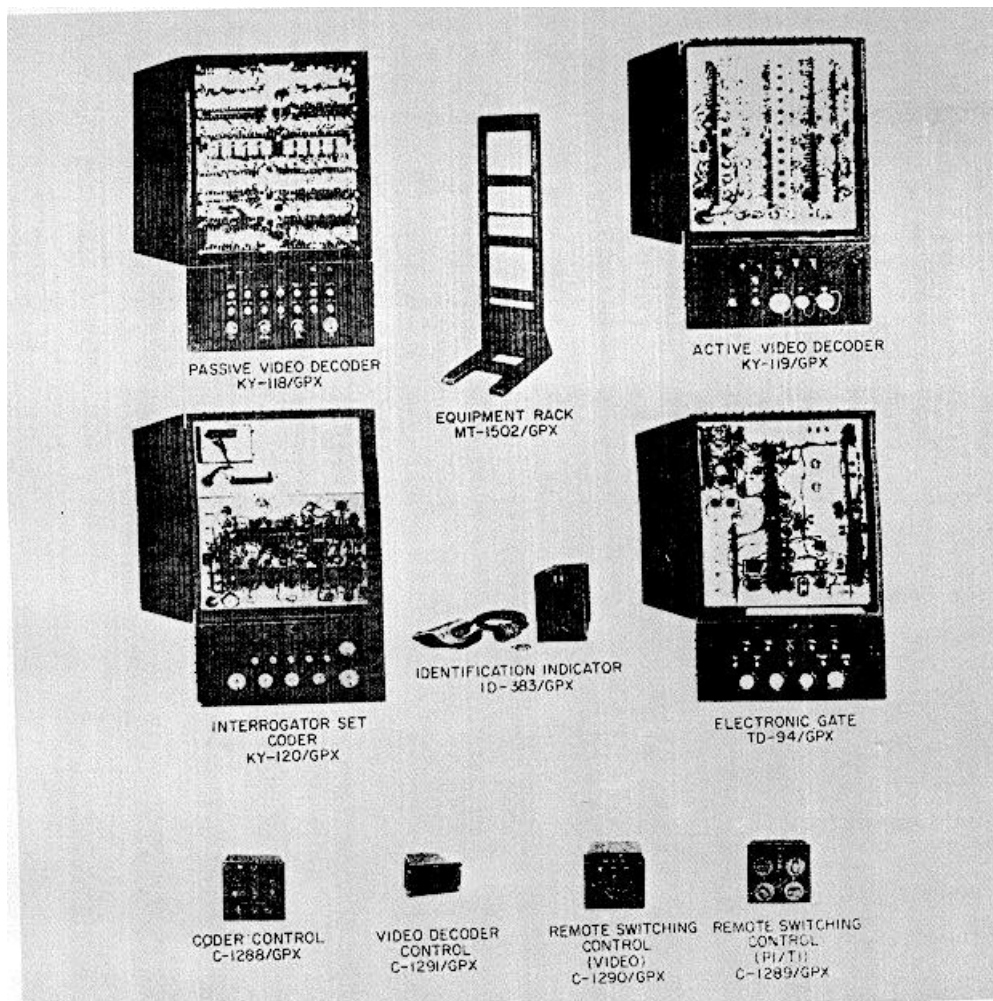

**FUNCTIONAL DESCRIPTION**

Radar Identification Set AN/GPX-7A operates with an airborne transponder identification set. Any of 32 security identity (SI) codes, 400 personnel identity (PI) codes, or 6,1 traffic identity (TI) modes,

provide identification friend or foe (IFF) and selective identification feature (SIF) for Radar Sets AN/FPS-3 or AN/FPS-3A. Two interrogators of the AN/GPX-7A alternately transmit coded rf pulses to trigger the airborne transponder identification set and convert the received transponder reply to

**ITEM NAME:** RADAR IDENTIFICATION SET

**TYPE:** AN/GPX-7A

video pulses. The equipment permits the video pulses to be displayed on the plan position indicators of the associated radar set or supplies the video pulses to SIF Coder-Decoder Group OA-BI40/GPX-7A. The OA-IO0/GPX-7A supplies coded pulses for security identity, personnel identity, and traffic identity. The set decodes multiple-pulse response codes transmitted by airborne equipment in reply to interrogations or challenges and supplies the video reply signals to the indicators of the associated radar. The interrogator output level and receiver sensitivity are adequate for interrogating and receiving replies from transponders operating within the detection range of the associated radar. The AN/GPX-7A may be independently operated to track targets equipped with a radar identification set.

Receiving Frequency: 1010 to 1130 mc  
Peak Power Output: 1.5 kw  
Pulse Width: 1 usec  
Pulse Repetition Rate: 180 to 420 pps (adjusts to conform to prr of associated radar)  
Number of Modes: 3  
Number of Codes: 32 SI, 400 PI, 64 TI  
Antenna Type: Dipole (24 radiating slots)  
Beam Width: 4.5 deg horiz; 30 deg vertical  
Receiver Bandwidth: B to 11mc, broad band at 6 db down; 5 mc, narrow band at 70 db down.  
Receiver Intermediate Frequency: 60 mc  
Type of Presentation: PPI of associated radar  
Operating Voltages and Power Requirements: 115v ac, 60 or 400 cps, 1-ph, 4 kw  
Range: Range of associated radar

**RELATION TO SIMILAR EQUIPMENT:**

The AN/GPX-7A is used with the SIF Coder-Decoder Group OA-UIO/GPX-7A. The AN/GPX-7 is not.

**INSTALLATION CONSIDERATIONS:**

Siting: Physically located with associated radar set.

Mounting: Components of the AN/GPX-7A are mounted on Radar Set AN/FPS-3A.

Related Equipment: AN/FPS-3, -3A and other models of AN/FPS-3 equipment.

**TECHNICAL DESCRIPTION**

Transmitting Frequency: 990 to 1040 mc

**PRINCIPAL COMPONENTS AND PHYSICAL DATA**

COMPONENT	QTY	HEIGHT (Inches)	WIDTH (Inches)	DEPTH (Inches)	UNIT WT.
Video Decoder KY-118/GPX	7	28-3/16	18	13	161
Video Decoder KY-119/GPX	2	26-3/16	18	13	96
Interrogator Set Coder KY-120/GPX	1	21-3/16	1B	13	121
Electronic Gate TD-9'1/GPX	1	28-3/16	18	13	93
Coder Control C-12Bcl/GPX	1	6-3/16	6-3/16	6-7/16	4
Remote Switching Control C-1289/GPX	6	6-3/16	6-3/16	6-15/16	1
Remote Switching Control C-1290/GPX	6	6-3/16	6-3/16	6-3/4	3
Video Coder Group C-1291/GPX	1	3-13/32	5-3/4	6-3/32	1-1/2
Electrical Frequency Control C-202B/GPX	1	8	17	6-1/2	
Interconnecting Box J-66-/GPX	2	3	13-1/16	7-1/8	5-1/2
Mounting MT-1501/GPX	6	18-1/2	19-13/16	3/16	6
Electrical Equipment Rack MT-1502/GPX	6	75-5/8	18-3/8	30	132

DATE: 13 January 1965

ITEM NAME: RADAR IDENTIFICATION SET

COGNIZANT SERVICE: USAF

TYPE: AN/GPX-8

FEDERAL STOCK NUMBER: 5 895-342-9469-EG

	USA	USN	USAF	USMC
STATUS OR TYPE CLASSIFICATION			Alt Std	
Mfg(s) Name or Code Number: Hazeltine Electronics Corporation, Little Neck, New York				

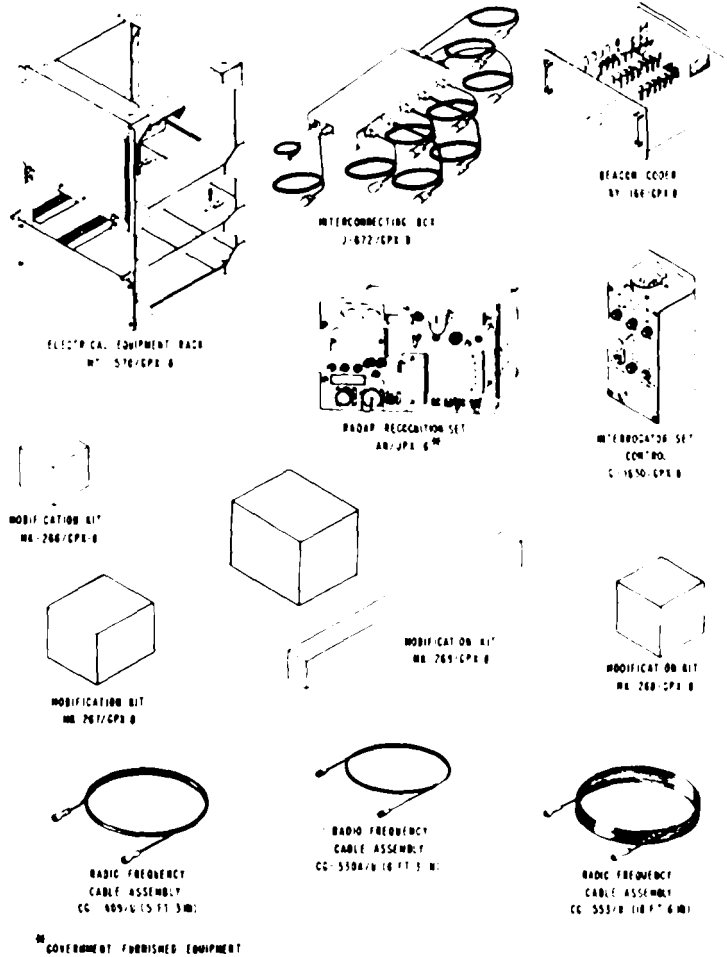

**FUNCTIONAL DESCRIPTION**

The AN/GPX-8 is designed for identification of friendly targets of AN/CPN-4, A, B, AN/MPN11, A, B, C, D, E. Transmits coded RF pulses for triggering transponders of AN/APX-6 carried by friendly aircraft to be identified.

Received the transponded replies and furnishes them to the associated radar indicator in the form of Video pulses. Its narrow, beam interrogation is synchronized with that of the radar in azimuth and time thus permitting the reply pulses to be displayed on the associated radar

**ITEM NAME:** RADAR IDENTIFICATION SET

**TYPE:** AN/GPX-8

PPI in close association to the radar target being identified. The radar recognition set output level and receiver sensitivity are adequate to permit the interrogation of, and the reception of, replies from transponders operating at a range as great as 200 miles.

Operating Power Requirement:  
Voltage; 115 plus or minus 10v  
Frequency; 55 to 65 cps  
Power; 170w

**RELATION TO SIMILAR EQUIPMENT**

Similar to and interchangeable with Radar Identification Set AN/GPX-8A the difference being th3 AN/GPX-8A also decodes the response from Transponder Set AN/APX-25.

**INSTALLATION CONSIDERATIONS**

Siting: The locations of the Radar Set AN/CPN-4( ) and Landing Control Set AN/MPN-11( ) operating sites will in all cases be suitable for the Radar Identification Set.

Mounting: Rack Mounted.

**TECHNICAL DESCRIPTION**

Frequency Data:

Transmitted Signal; 1018 to 1042 mc  
range

Received Signal; 1080 to 1100 mc  
range

Cabling Requirements: No special cables need be fabricated by the installing activity for the radar identification set.

Related Equipment: The AN/GPX-8 is used with, but not part of AN/CPN-4( ),AN/MPN-11( ).

**PRINCIPAL COMPONENTS AND PHYSICAL DATA**

COMPONENT	QTY	HEIGHT (Inches)	WIDTH (Inches)	DEPTH (Inches)	UNIT WT.
Beacon Coder KY-166/GPX-8	1	8-1/2	19-1/2	20-13/16	52
Interconnecting Box J-672/GPX-8	1	8	20-3/8	2-3/4	12
Interrogator Set Control C-1630/GPX-8	3	9	3-3/4	2-13/16	2
Electrical Equipment Rack MT-1570/GPX-8	1	29-7/8	18-1/2	22-7/8	32.5
Radar Recognition Set AN/UPX-6	1	11	21	15	77
Modification Kit MK-266/GPX-8	1				
Modification Kit MK-267/GPX-8	1				
Modification Kit MK-268/GPX-8	2				
Modification Kit MK-269/GPX-8	1				
Radio Frequency Cable Assembly CG-5304/U (6 ft 3 in.)	1				0.3
Radio Frequency Cable Assembly CG-530A/U (6 ft 3 in.)	1				0.3
Radio Frequency Cable Assembly CG-530A/U (6 ft 3 in.)	1				0.3
Radio Frequency Cable Assembly CG-553/U (18 ft 6 in.)	1				2.1
Radio Frequency Cable Assembly CG-1409/U (5 ft 3 in.)	1				0.9



**ITEM NAME:** RADAR IDENTIFICATION SET

**TYPE:** AN/GPX-8

**REFERENCE DATA AND LITERATURE**

Technical Orders:  
31P4-2GPX8- Series

DATE: 15 January 1965

ITEM NAME: INTERROGATOR SET

COGNIZANT SERVICE: USAF

TYPE: AN/GPX-BA

FEDERAL STOCK NUMBER:

	USA	USN	USAF	USMC
STATUS OR TYPE CLASSIFICATION			Used By	
Mfg(s) Name or Code Number: Hazeltine Electronics, Little Neck, New York				

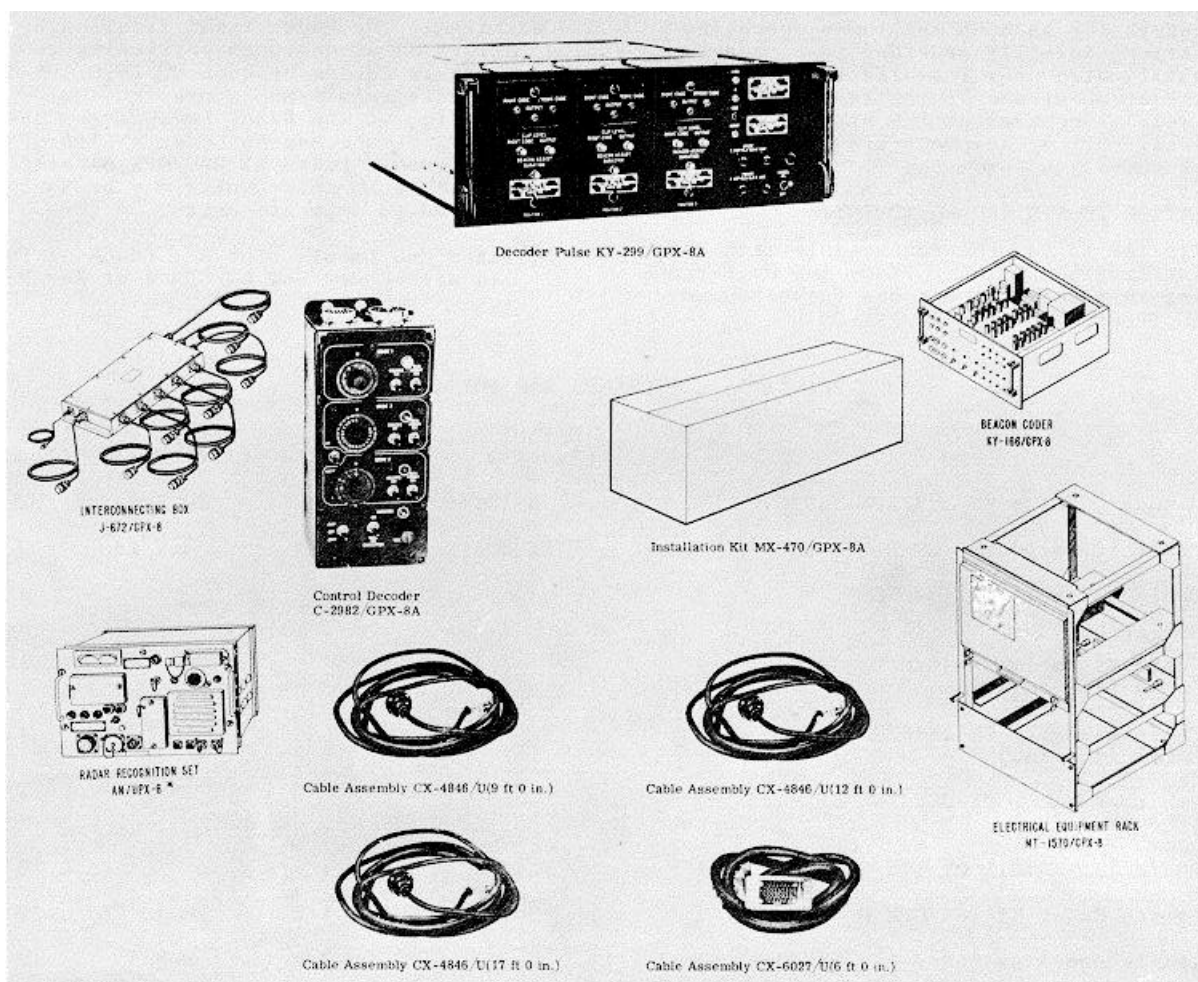

## FUNCTIONAL DESCRIPTION

The AN/GPX-BA is for identification of friendly targets of Radar Set AN/CPN-4, A, B, C, and Landing Control Set, Trailer Mounted, AN/MPN-11, A, B, C, D, E. Transmits coded rf pulses for triggering trans

ponders of Transponder Set AN/APX-25 carried by friendly aircraft to be identified. Receives the transponded replies and furnishes them to the associated radar indicator in the form of video pulses. Its narrow beam interrogation is synchronized with that of the radar in azimuth and time,

**ITEM NAME:** INTERROGATOR SET

**TYPE:** AN/GPX-8A

thus permitting the reply pulses to be displayed on the associated radar PPI in close association to the radar target being identified.

The addition of Decoder Group OA-1133/ GPX-BA adds Mark X SIF (Selective Identification Feature) decoding facilities to Radar Identification Set AN/GPX-B, and the resulting modified equipment is designated as AN/GPX-8A. The addition of SIF to the Mark X IFF system means that aircraft replies are now coded and must be decoded in the ground equipment.

The AN/GPX-8A has independent Mark X SIF decoders for each of the three operating positions normally provided in a radar identification set installation. Facilities for control of one of the three decoders, as well as control of the associated radar identification equipment are provided at each operating position.

**RELATION TO SIMILAR EQUIPMENT:**

Similar to and interchangeable with Radar Identification Set AN/GPX-8, the difference being this set also decodes the response from Transponder Set AN/APX-25.

**TECHNICAL DESCRIPTION**

Transmitted Signal: 1030 mc plus or minus 12 mc, one channel  
 Received Signal: 1090 mc plus or minus 10 mc, one channel  
 Operating Power Requirement: 117v ac, 60 cycles, single ph

**INSTALLATION CONSIDERATIONS:**

Siting: The locations of the radar operating site will in all cases be suitable for the AN/GPX-8A.

Mounting: The Radar Identification Set AN/GPX-8A is designed physically to mount in Equipment Rack MT-1570/GPX-8. If space requirements prevent the mounting of the Radar Recognition Set AN/UPX-6, the Beacon Coder KY-166/GPX-81 and Decoder Pulse KY-299/GPX-bA within the Rack, these units may be installed as separate units.

Related Equipment: The AN/GPX-BA is for use with Radar Set AN/CPN-4 or Radar Set AN/MPN-11.

**PRINCIPAL COMPONENTS AND PHYSICAL DATA**

<b>COMPONENT</b>	<b>QTY</b>	<b>HEIGHT (Inches)</b>	<b>WIDTH (Inches)</b>	<b>DEPTH (Inches)</b>	<b>UNIT WT.</b>
Decoder, Pulse KY-299/GPX-bA	1	6-13/16	19-1/2	20-7/8	57
Control, Decoder C-2982/GPX-8A	3	12-3/4	5-1/4	3-7/16	7
Cable Assembly CX-4846/U (9 ft O in.)	1				1
Cable Assembly CX-4846/U (12 ft O in.)	1				1.25
Cable Assembly CX-4846/U (17 ft O in.)	1				1.5
Cable Assembly CX-6027/U (6 ft O in.)	2				1
Installation Kit MX-470/GPX-BA	1				3
Beacon Coder KY-166/GPX-8	1	8-1/2	19-1/2	20-13/16	52
Interconnecting Box J-672/GPX-8	1	8	20-3/8	2-3/4	12
Electrical Equipment Rack MT-1570/GPX-8	1	29-7/8	18-1/2	22-7/8	32.5
Radar Recognition Set AN/UPX-6	1	11	21	15	77

ITEM NAME: INTERROGATOR SET

TYPE: AN/GPX-3A

PRINCIPAL COMPONENTS AND PHYSICAL DATA

COMPONENT	QTY	HEIGHT (Inches) SHIPPING DATA	WIDTH (Inches)	DEPTH (Inches)	UNIT WT.
Decoder Group OA-1133/GPX-8A	1	22	27	27	125

REFERENCE DATA AND LITERATURE

Technical Orders:  
31P4-2GPX8-11  
31P4-2GPX8-12  
31P4-2GPX8-15

DATE: 15 April 1964

ITEM NAME: RADAR IDENTIFICATION SET

COGNIZANT SERVICE: USAF

TYPE: AN/GPX-9, -9A, -9B

5895-343-9470B

FEDERAL STOCK NUMBER: 5895-342-3084B

5895-574-0387B

	USA	USN	USAF	USMC
STATUS OR TYPE CLASSIFICATION			Alt Std, Tent. Std Tent Std	
Mfg(s) Name or Code Number: Hazeltine Electronic Corp.				

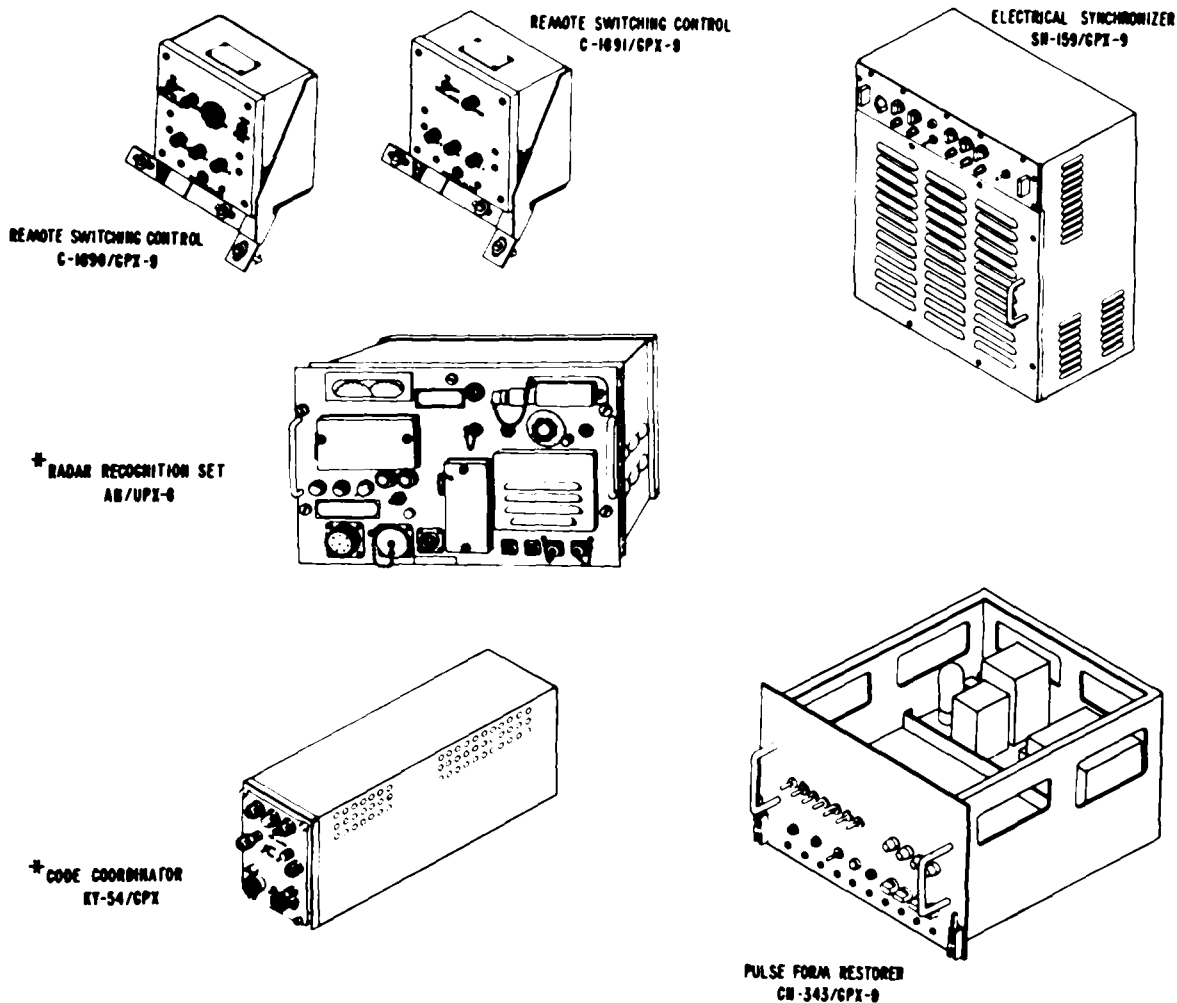

\* GOVERNMENT FURNISHED EQUIPMENT

**FUNCTIONAL DESCRIPTION**

Radar Identification Set AN/GPX-9, -9A, -9B provides Mark X IFF for Radar Set AN/CPN-18A. The AN/GPX-9 series transmits coded radio-frequency

pulses to trigger an airborne transponder identification set and converts the received transponder reply to video pulses. This equipment permits the video pulses to be displayed on the PPI of the associated radar set. The interrogator output.

**ITEM NAME:** RADAR IDENTIFICATION SET

**TYPE:** AN/GPX-9, -9A, -9B

level and receiver sensitivity are adequate for interrogating and receiving replies from transponders operating within the detection range of the associated radar. The AN/GPX-9 series may be independently operated to track targets equipped with a radar identification set. The AN/GPX-9A decodes the response from the transponder in the AN/APX-25. The AN/GPX-9A and AN/GPX-9B represent changes in internal circuitry only.

**RELATION TO SIMILAR EQUIPMENT**

None.

**TECHNICAL DESCRIPTION**

Radar Recognition Set AN/UPX-6  
Frequency: Transmitter, 1010 to 1030 mc; receiver 1090 to 1110 mc  
Power Output: 1.5 kw  
Duty Cycle: 0.15  
Operating Voltage and Power Requirements: 115v ac, 55 to 65 cps, 325w  
Electrical Synchronizer SN-159/GPX-9  
Trigger Input Characteristics:  
Pulse Duration - 0.5 usec (min)  
Pulse Amplitude - 15v (min)  
Rise Time - 0.1 to 0.5 usec  
Decay Time - 0.1 to 1.0 usec  
Polarity - Positive  
Pulse Repetition Rate - 1500 pps  
Coded Trigger Input Characteristics:  
Pulse Duration - 0.7 to 1.2 usec  
Pulse Amplitude - 30 to 50v  
Rise Time - 0.2 usec(max)  
Decay Time - 0.11 usec (max)  
Polarity - Positive  
Pulse Repetition Rate - 300 pps  
Pulse Spacing - Mode 1, 3 (plus or minus 0.2 usec); Mode 2, 5 (plus or minus 0.2 usec); Mode 3, to (plus or minus 0.2 usec)  
Trigger Output Characteristics:  
Duration - 0.7 to 1.2 usec  
Amplitude - 20v (min)  
Rise Time - 0.2 usec (max)  
Decay Time - 0.1, usec (max)  
Polarity - Positive  
Pulse Repetition Rate - 300 pps  
Pre-Trigger - Variable between 0 and 80 usec  
Operating Voltage and Power Requirements: 115v ac, 55 to 65 cps, 152w  
Pulse Form Restorer CN-343/GPX-9

Trigger Input Characteristics (1500 pps):  
Duration - 0.5 to 10 usec  
Amplitude - 20v (min)  
Rise Time - 0.1 to 0.5 usec  
Decay Time - 0.2 usec (max)  
Polarity - Positive  
Pulse Repetition Rate - 300 pps  
Operating Voltage and Power Requirements: 115v ac, 55 to 65 cps, 97w  
Code Coordinator KY-54/GPX  
Pulse Output - paired 1-usec pulse used to key the radar recognition set.  
Pulse Spacing (between leading edges of pulses): Mode 1, 3 usec; Mode 2, 5 usec; Mode 3, 8 usec  
Operating Voltage and Power Requirements: 115v ac, 55 to 65 cps, 100w  
Range Limitations: 200 mi (governed by Radar Recognition Set AN/UPX-6)  
Heat Dissipation: 14.16 btu per  
Type of Presentation:  
Remote Site - 3 indicators, type OA-348/CPN-ItA (two with non-modified range of 53 mi and one modified for 200 mi operation)  
Transmitter Site - 1 indicator, type OA-34t/CPN-ItA  
Voltage Requirements: 115v ac, 60 cps

**INSTALLATION CONSIDERATIONS**

Siting: Radar Identification Set AN/GPX-is for use with Radar Set AN/CPN-11A only. The locations of the radar operating sites will in all cases be suitable for the radar identification set.  
Mounting: Radar Recognition Set AN/UPX-6 and Pulse Form Restorer CN-343/GPN-9 are installed in shelter S-63/CPN-It. Remote Switching Controls C-1690/GPX-9 and C-1691/GPX-9, Electrical Synchronizer SN-159/GPX-9, and Code Coordinator KY-54/GPX are installed at the remote site. Remainder of equipment is located with the associated radar.  
Cabling Requirements: All necessary inter-component cabling for the radar identification set is accomplished at the time initial installation is made; therefore, the operating activity need not install no cables.  
Related Equipment: Radar Identification Set AN/GPX-9 may be used with Radar Set AN/CPN-18A.

ITEM NAME: RADAR IDENTIFICATION SET  
TYPE: AN/GPX-9, -9A, -9B

**PRINCIPAL COMPONENTS AND PHYSICAL DATA**

<b>COMPONENT</b>	<b>QTY</b>	<b>HEIGHT (Inches)</b>	<b>WIDTH (Inches)</b>	<b>DEPTH (Inches)</b>	<b>UNIT WT.</b>
Code Coordinator KY-54/GPX*	1	8-5/6	6-5/8	23	39
Electrical Synchronizer SN-159/GPX-9	1	20	15	8	
Pulse Form Restorer CN-343/GPX-9	1	12-7/32	19	16-1/2	
Radar Recognition Set AN/UPX-6*	1	11	21	15	77
Remote Switching Control C-1690/GPS-9	1	5-3/4	6-1/8	3-1/4	
Remote Switching Control C-1691/GPX-9	1	5-3/4	6-1/8	3-1/4	
Modification Kit MK-270/GPX-9	2				
Modification Kit MK-271/GPX-9	1				
Modification Kit MK-272/GPX-9	1				
Modification Kit MK-273/GPX-9	1				
Coder Decoder Group OA-1270/GPX-9B (Used only with AN/GPX-9B)	1				
Interconnecting Cable Assemblies					

\* Government-furnished equipment

**REFERENCE DATA AND LITERATURE**

Technical Orders:  
31P4-2GPX9- Series  
Specification:  
RADC Exhibit ENG-289A

**AN/GPX-9: 3**

DATE: 15 April 1964

ITEM NAME: RADIO INTERROGATOR SET

COGNIZANT SERVICE: USAF

TYPE: AN/GPX-17

FEDERAL STOCK NUMBER: 5895-342-9466B

	USA	USN	USAF	USMC
STATUS OR TYPE (CLASSIFICATION)			Alt Std	
Mfg(s) Name or (s) de Number: Hazeltine Electronics Corporation				

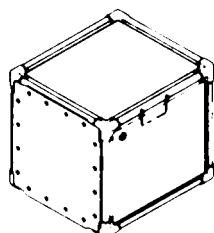

ELECTRICAL SPECIAL  
PURPOSE CASE  
CY-1036/GPX-11  
(FOR INTERCONNECTING  
CABLES SEE TABLE 3-9)

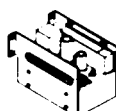

PULSE DELAY NETWORK  
BR-1006/GPX-17

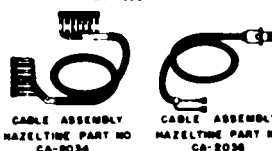

CABLE ASSEMBLY  
HAZELTINE PART NO  
CA-8034

CABLE ASSEMBLY  
HAZELTINE PART NO  
CA-8036

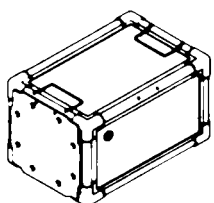

ELECTRICAL SPECIAL  
PURPOSE CASE  
CY-1038/GPX  
(FOR KY-54/GPX)

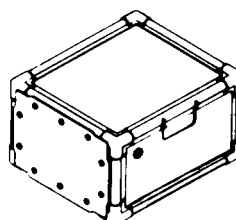

INTERROGATOR SET  
CASE CY-1083/GPX  
(FOR AN/GPX-6X)

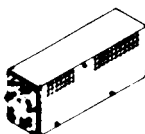

CODE COORDINATOR  
KY-54/GPX



RADAR RECOGNITION SET  
AN/GPX-6X  
(GOVERNMENT FURNISHED EQUIPMENT)

### FUNCTIONAL DESCRIPTION

Radar Identification Set AN/GPX-17 provides Mark X IFF for Radio Set AN/TPS-1D. The AN/GPX-17 transmits coded radio-frequency pulses to trigger an airborne transponder identification set and converts the received transponder reply to video pulses

This equipment permits the video pulses to be displayed on the plan position indicators (PPI) of the associated radar set. The interrogator output level and receiver sensitivity are adequate for interrogating and receiving



**ITEM NAME:** RADIO INTERROGATOR SET

**TYPE:** AN/GPX-17

replies from transponders operating within the detection range of the associated radar. The AN/GPX-17 may be independently operated to track targets equipped with a radar identification set.

**RELATION TO SIMILAR EQUIPMENT:**

AN/GPX-17A is similar to and interchangeable with AN/GPX-17. Differs in that AN/GPX-17A also decodes response from transponder AN/APX-25 whereas AN/GPX-17 will decode response from AN/APX-6 only.

**TECHNICAL DESCRIPTION**

Frequency: transmitting, 990 to 1040 \*c;  
receiving, 1080 to 1130 mc  
Range: Range of the associated radar  
Peak Power Output: 1.5 kw (win)  
Operating Voltage and Power Requirements:  
115v ac, 60 or 400 cps, 1-ph, 250w  
Type of Presentation: PPI o associated  
radar set

Pulse Repetition Rate: 180 to 420 pps  
(adjusted to conform with prr of associ-  
ated radar)  
Pulse Width: 1 usec  
Number of Modes: 3  
Antenna Type: Reflector type of associ-  
ated radar  
Horizontal Beam Width: 4 deg  
Vertical Beam Width: 12 deg  
IF. Frequency: 60 mc  
Broadband Bandwidth: 8 to 11 mc (-6 db)  
Narrowband Bandwidth: 5 mc (-70 db)

**INSTALLATION CONSIDERATIONS:**

Siting: Dependent of physical location of associated radar.  
Mounting: Components of this equipment are installed on the associated basic radar.  
Related Equipment: Radar Identification Set AN/GPX-17 is for use only with Radio Set AN/TPS-1D.

**PRINCIPAL COMPONENTS AND PHYSICAL DATA**

<b>COMPONENT</b>	<b>QTY</b>	<b>HEIGHT (Inches)</b>	<b>WIDTH (Inches)</b>	<b>DEPTH (Inches)</b>	<b>UNIT WT.</b>
Code Coordinator KY-54/GPX	1	8-5/8	6-5/8	23	39
Pulse Delay Network MX-1606/GPX-17	1	4-27/32	5-1/4	6-7/8	3.1
Electrical Special Purpose Case CY-1036/GPX-11	1	23-1/2	23-3/4	27-3/4	65
Interrogator Set Case CY-1653/GPX	1	15-1/4	20-7/8	24-7/8	55
Electrical Special Purpose Case CY-1038/GPX	1	14-1/2	14	26-1/2	55

**REFERENCE DATA AND LITERATURE**

Technical Orders:  
31P4-2GPX17- Series  
Specification:  
MIL-I-9699 (USAF)

DATE: 15 April 1964  
COGNIZANT SERVICE: USAF

ITEM NAME: INTERROGATOR SET  
TYPE: AN/GPX-17A

FEDERAL STOCK NUMBER: 5895-574-0384

	USA	USN	USAF	USMC
STATUS OR TYPE CLASSIFICATION			TS	
Mfg(s) Name or Code Number. Bell Aircraft Corporation and Hazeltine Electronics Corporation				

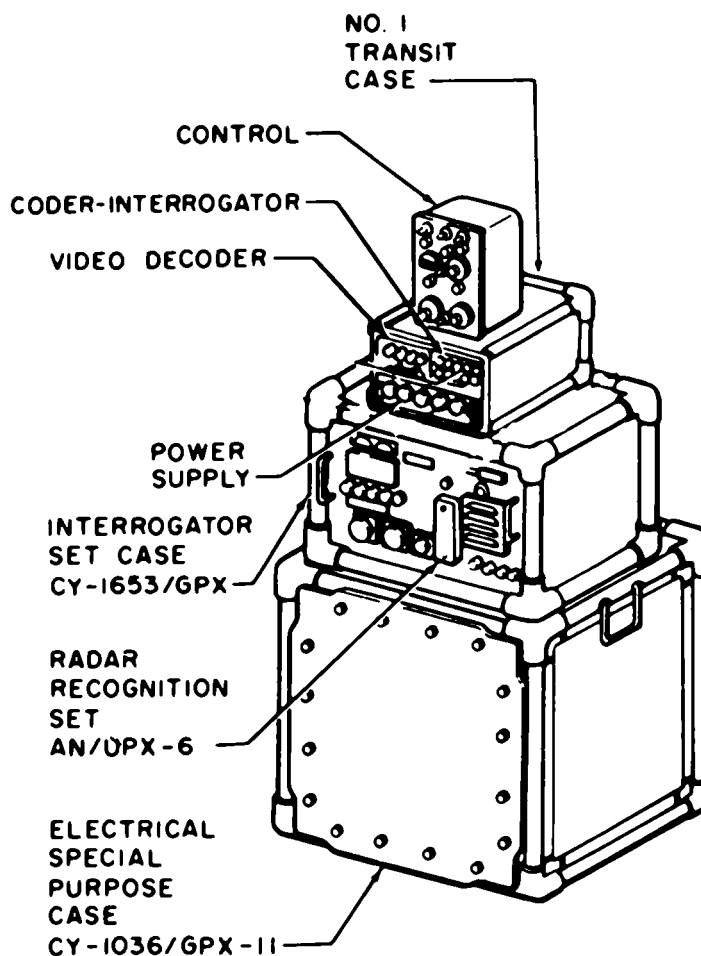

**FUNCTIONAL DESCRIPTION**

AN/GPX-17A is used for identification of friendly targets of Radio Set AN/TPS-ID.

Transmits coded rf pulses for triggering Transponder Set AN/APX-25 which is carried by friendly aircraft to be identified. Re-

ceives the transponded replies and furnishes them to the associated radar indicator in the form of video pulses. Its narrow beam interrogation is synchronized with that of the radar in azimuth and time thus permitting the reply pulses to be displayed on the associated radar PPI in close association

**ITEM NAME:** INTERROGATOR SET

**TYPE:** AN/GPX-17A

to the radar target being identified.

**RELATION TO SIMILAR EQUIPMENT:**

Similar to and interchangeable with Radar Identification Set AN/GPX-17 the difference being this set also decodes the response from Transponder Set AN/APX-25.

**TECHNICAL DESCRIPTION**

Frequency: Transmitting, 990 to 1110 mc

Receiving, 1060 to 1130 mc

Range: Range of the associated radar.

Number of Modes: 3

Antenna Type: Reflector type of associated radar.

Horizontal Beam Width: 4 deg

Vertical Beam Width: 12 deg

Type of Presentation: PPI of associated radar set.

Pulse Repetition Rate: 180 to 425 pps (adjusted to conform with prr of

associated radar).

Pulse Width: 1 usec

Operating Voltage and Power Requirements:

115v ac, 50 to 410 cps, single ph

Power Line Fluctuations: Must not exceed

plus or minus 2.5v with a crest factor

within the range of 1.2 to 1.55

**INSTALLATION CONSIDERATIONS:**

Siting: Radar Identification Set AN/GPX17A is for use only with Radio Set AN/TPS-1D. Operating sites where the radar equipment is installed will in all cases be suitable for the Radar Identification Set.

Mounting: Limitations are those imposed by the designed lengths of the furnished cables.

Related Equipments: Radar Identification Set AN/GPX-17A is for use only with Radio Set AN/TPS-ID.

**PRINCIPAL COMPONENTS AND PHYSICAL DATA**

<b>COMPONENT</b>	<b>QTY</b>	<b>HEIGHT (Inches)</b>	<b>WIDTH (Inches)</b>	<b>DEPTH (Inches)</b>	<b>UNIT WT.</b>
Radar Recognition Set AN/UPX-6X	1				
Coder-Decoder Group OA-1268/GPX-17A	1				
Network, Pulse Delay MX-1606/GPX-17	1	4-27/32	5-1/4	6-7/8	3.1
Case, Interrogation Set CY-1653/GPX	1	15-1/4	20-7/8	24-7/8	55
Electrical Special Purpose Case CY-1036/GPX-11	1				

**REFERENCE DATA AND LITERATURE**

TECHNICAL ORDERS:  
31P,1-2GPX17- Series

DATE: 15 April 1964

ITEM NAME: RADIO INTERROGATOR SET

COGNIZANT SERVICE: USAF

TYPE: AN/GPX-18

FEDERAL STOCK NUMBER: 5895-342-9467-EG

	USA	USN	USAF	USMC
STATUS OR TYPE CLASSIFICATION			ALT. STD	
Mfg(s) Name or (:)de Number: Hazeltine Electronics Corporation				

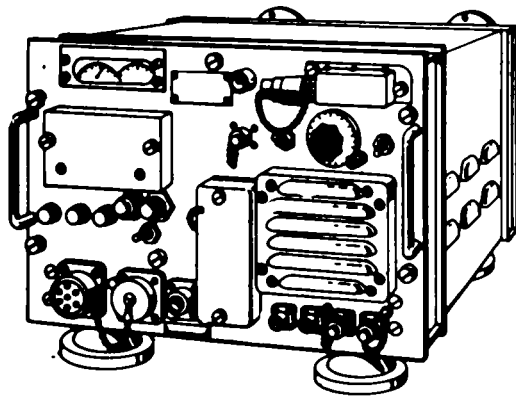

RADAR RECOGNITION SET  
AN/UPX-6

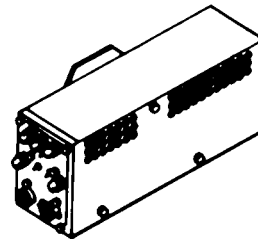

CODE COORDINATOR  
KY-54/GPX

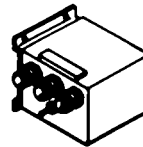

SWITCH BOX  
SA-239/GPX

### FUNCTIONAL DESCRIPTION

Radar Identification Set AN/GPX-18 is used in conjunction with search radar AN/FPS-8 or AN/MPS-11 for the purpose of identifying targets picked up by the radar. This unit interrogates the target by means of coded

pulse emission and then waits for the coded response from the AN/APX-6 transponder with which all friendly aircraft are equipped. The coded response is picked up by this equipment, which then provides video for display on the radar indicator coordinated in range and azimuth. The interrogator

**ITEM NAME:** RADIO INTERROGATOR SET

**TYPE:** AN/GPX-18

output level and receiver sensitivity are adequate for interrogating and receiving replies from transponders operating within the detection range of the associated radar. The AN/GPX-18 may be independently operated to track targets equipped with a radar identification set.

**RELATION TO SIMILAR EQUIPMENT:**

AN/GPX-18A is similar to and interchangeable with Interrogator Set AN/GPX-18, the difference being the AN/GPX-18A also decodes the response for Transponder Set AN/APX-25.

**TECHNICAL DESCRIPTION:**

Frequency: Transmitting, 990 to 1040 mc  
Receiving, 1080 to 1130 mc  
Range: Range of associated radar.  
Peak Power Output: 1.5 kw min  
Type of Presentation: PPI's of associated radar.  
Pulse Repetition Rate: 180 to 420 pps (adjusted to conform with pm of

associated radar).  
Pulse Width: 1 usec  
Number of Modes: 3  
Antenna Type: Reflection-type antenna of associated radar.  
Horizontal Beam Width: 3 deg  
Vertical Beam Width: 10 deg  
Frequency (if.): 60 mc  
Broadband Bandwidth: 8 to 11 mc (-6 db).  
Narrowband Bandwidth: 5 mc (-70 db).

**INSTALLATION CONSIDERATIONS:**

Siting: Dependent on physical location of associated radar.  
Mounting: Components of this equipment are installed on the associated radar.  
Cabling Requirements: Interconnecting facilities are furnished as part of Radar Set AN/FPS-8 or AN/MPS-11.  
Related Equipments: Radar Identification Set AN/GPX-18 may be used with Radar Set AN/FPS-8 and AN/MPS-11.

**PRINCIPAL COMPONENTS AND PHYSICAL DATA**

COMPONENT	QTY	HEIGHT (Inches)	WIDTH (Inches)	DEPTH (Inches)	UNIT WT.
Code Coordinator KY-54/GPX	1	8-5/8	6-5/8	23	39
Recognition Set AN/UPX-6	1				
Switch Box SA-239/GPX	5				
Antenna Group OA-405/FPS-8	1				

**REFERENCE DATA AND LITERATURE**

TECHNICAL ORDERS:			
	31P4-2GPX-101	31P4-2GPX-174	31P4-2GPX-1
	31P4-2GPX-104	31P4-2GPX-184	31P4-2GPX-14
	31P4-2GPX-134	31P4-2GPX-194	31P4-2GPX-24
	31P4-2GPX-164	31P4-2GPX-506	

DATE: 15 December 1964

ITEM NAME: INTERROGATOR SET, RADIO

COGNIZANT SERVICE: USAF

TYPE: AN/GPX-18A

FEDERAL STOCK NUMBER: 5895-349-0038-EG

	USA	USN	USAF	USMC
STATUS OR TYPE CLASSIFICATION			TS	
Mfg(s) Name or Code Number: Hazeltine Electronics Corporation				

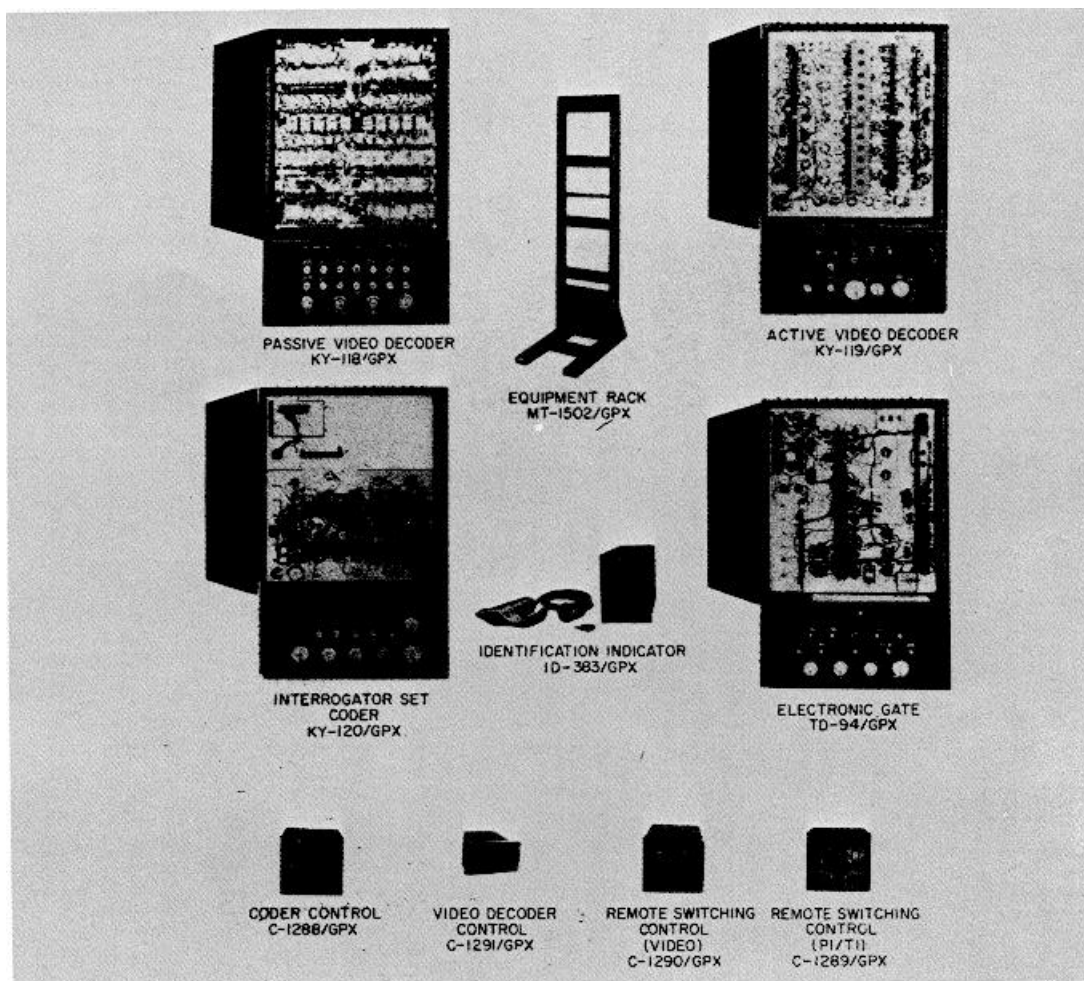

**FUNCTIONAL DESCRIPTION**

Radio Interrogator Set AN/GPX-18A operates with an air borne transponder identification seat on any one of 32 security identity (SI) codes, 400 personnel identity (PI) codes, or 64 traffic identity (TI) modes. The set

provides identification friend or foe (IFF) and selective identification feature (SIF) for Radar Sets AN/FPS-8 or AN/MPS-11. The AN/GPX-18A uses two interrogators. They alternately transmit coded rf pulses to trigger the airborne transponder identification set and convert the received trans-

**ITEM NAME:** INTERROGATOR SET RADIO

**TYPE:** AN/GPX-18A

ponder reply to video pulses. The equipment permits the video pulses to be displayed on the PPI indicators of the associated radar set or supplies the video pulses to SIF Coder-Decoder Group OA-886/GPX-18A. The OA-886/GPX-18A supplies coded pulses for security identity, personnel identity, and traffic identity. The set decodes multiple-pulse response codes transmitted by airborne equipment in reply to interrogations or challenges and supplies video reply signals to the indicators of the associated radar. Interrogator output level and receiver sensitivity are adequate for interrogating and receiving replies from the transponders operating within the detection range of the associated radar. The AN/GPX-18A may be independently operated to track targets equipped with a radar identification set.

**RELATION TO SIMILAR EQUIPMENT:**

AN/GPX-18A is similar to and interchangeable with Interrogator Set AN/GPX-1B. The difference being the AN/GPX-18A also decodes the response for Transponder Set AN/APX-25. Difference between the AN/GPX18 and AN/GPX-1BA is that the A-mode uses a Coder-Decoder Group OA-886/GPX-1BA instead of Code Coordinator KY-54/GPX and Switch Box SA-239/GPX.

AN/GPX-1BB is similar to and interchangeable with AN/GPX-18A, differs only in the Coder-Decoder Group being transistorized.

**TECHNICAL DESCRIPTION**

Transmitting Frequency: 990 to 1040 mc  
 Receiving Frequency: 1060 to 1130 mc  
 Peak Power Output: 1.5 kw (min)  
 Pulse Width: 1 usec  
 Pulse Repetition Rate: 180 to 420 pps  
 (adjusted to conform with prr of associated radar)  
 Number of Modes: 3  
 Number of Codes: 32 SI, 400 PI, 64 TI  
 Range: Range of associated radar  
 Antenna: Reflector type of associated radar  
 Horizontal Beam Width: 3 deg  
 Vertical Beam Width: 10 deg  
 Receiver Bandwidth: 8 to 11 mc at 6 db  
 down, broadband; 5 mc at 70 db down, narrow band  
 Receiver Intermediate Frequency: 60 mc  
 Type of Presentation: PPI of associated radar  
 Operating Voltages and Power Requirements:  
 115v ac, 60 or 400 cps, 1-ph

**INSTALLATION CONSIDERATIONS:**

Siting: Physically located with associated radar.  
 Mounting: Mounted on the basic radar.  
 Cabling Requirements: Some interconnecting facilities are furnished as part of AN/GPX-1BA, others are modifications of AN/FPS-B or AN/MPS-11 furnished cables.  
 Related Equipment: Radar Sets AN/FPS-B, AN/MPS-11, and other models.

**PRINCIPAL COMPONENTS AND PHYSICAL DATA**

COMPONENT	QTY	HEIGHT (Inches)	WIDTH (Inches)	DEPTH (Inches)	UNIT WT.
Video Decoder KY-118/GPX	7	28-3/16	18	13	161
Video Decoder KY-119/GPX	2	28-3/16	18	13	96
Interrogator Set Coder KY-120/GPX	1	28-3/16	1B	13	121
Electronic Gate TD-94/GPX	1	28-3/16	18	13	93
Coder Control C-1288/GPX	1	6-3/16	6-3/16	6-7/16	4
Remote Switching Control C-1289/GPX	6	6-3/16	6-3/16	6-15/16	4
Remote Switching Control C-1290/GPX	6	6-3/16	6-3/16	6-3/4	3
Video Decoder Group C-1291/GPX	1	3-13/32	5-3/4	6-3/32	1.5
Interconnecting Box J-664/GPX	2	3	13-1/16	7-1/8	5.5
Mounting MT-1501/GPX	6	18-1/2	19-3/16	3/16	6
Electrical Equipment Rack MT-1502/GPX	6	73-5/8	18	30	132

**AN/GPX-18A: 2**

ITEM NAME: INTERROGATOR SET RADIO

TYPE: AN/GPX-18A

PRINCIPAL COMPONENTS AND PHYSICAL DATA

COMPONENT	QTY	HEIGHT (Inches)	WIDTH (Inches)	DEPTH (Inches)	UNIT WT.
Installation Safety Switch	1	15-1/2	10-1/4	5-1/2	19
Electrical Frequency Control C-2028/GPX	1	8	17	6-1/2	
Transponder Test Set AN/GPM-6	1	24-1/2	22	16-3/4	
Radar Recognition Set AN/UPX-6 (GFE)	1	11	15	21	77

REFERENCE DATA AND LITERATURE

Technical Orders:  
31P4-2GPX-101  
31P4-2GPX-506  
31P4-2GPX18-1

AN/GPX-18A: 3



DATE: 1 May 1964

ITEM NAME: INTERROGATOR SET

COGNIZANT SERVICE: USAF

TYPE: AN/GPX-18B

FEDERAL STOCK NUMBER: 5895-574-0385

	USA	USN	USAF	USMC
STATUS OR TYPE CLASSIFICATION			STD	
Mfg(s) Name or Code Number: Radio Receptor, Brooklyn, N. Y. C.				

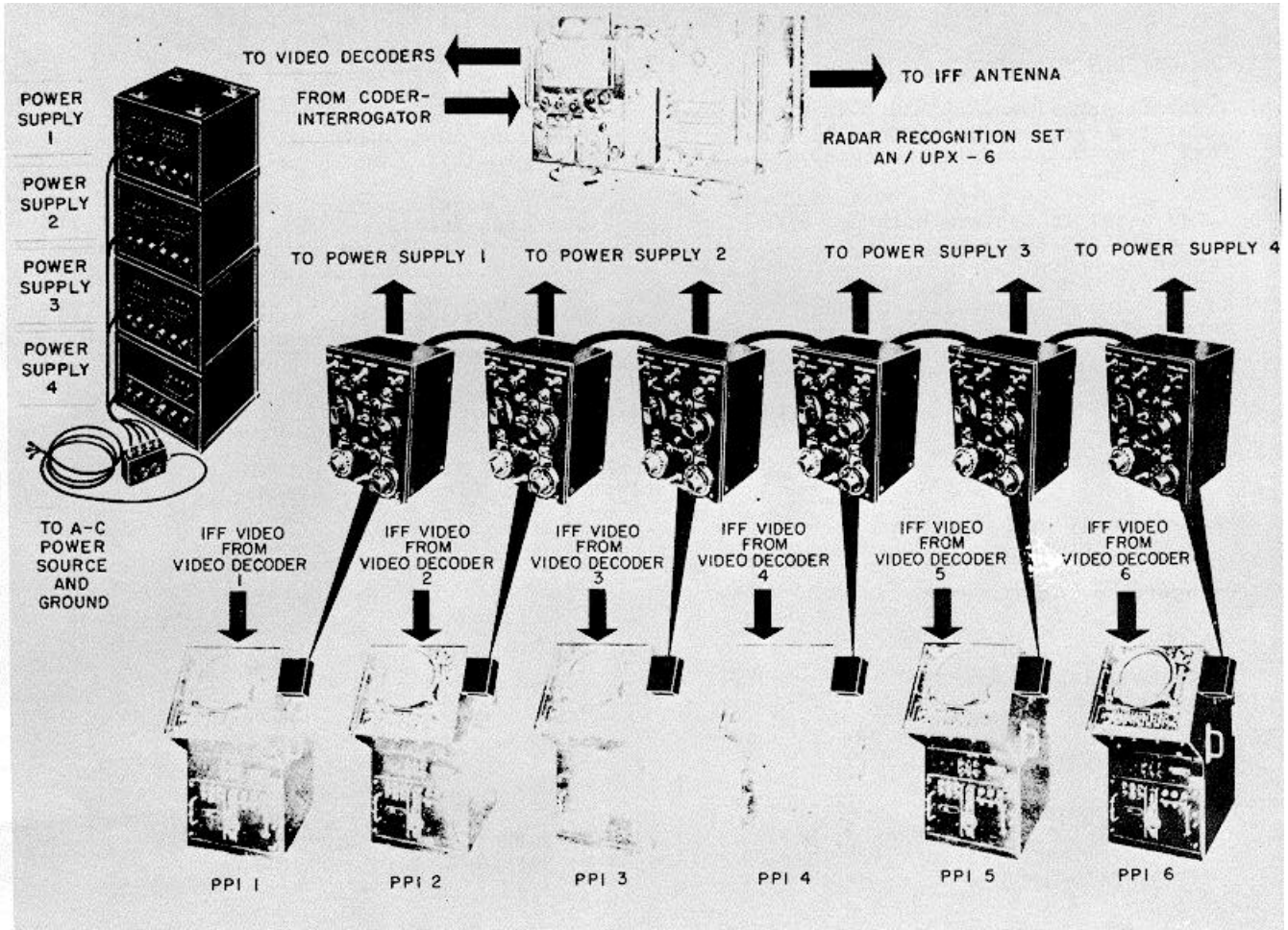

**FUNCTIONAL DESCRIPTION**

The AN/GPX-18B is used for identification of friendly targets of Radar Set AN/MPS-11. Transmits coded rf pulses for triggering of transponders of Transponder Set AN/APX-25 carried by friendly aircraft to be identi-

fied. Receives the transponder replies and after decoding furnishes them to the associated radar indicator in the form of video pulses. Its narrow beam width interrogations is synchronized with that of the radar in azimuth and time thus permitting the reply pulses to be displayed on the associated

**ITEM NAME:** INTERROGATOR SET

**TYPE:** AN/GPX-18B

radar PPI in close association to the radar targets being identified. Also provision is made for symbolic display of the mode 2 response codes from Transponder Set AN/APX-25.

**RELATION TO SIMILAR EQUIPMENT**

Similar to and interchangeable with AN/GPX-18A, differs only in the coder-decoder group being transistorized. The AN/GPX-18C is similar to and one way interchangeable with AN/GPX-18B. Differs in improved Coder-Decoder Group AN/GPA-78 being used.

**TECHNICAL DESCRIPTION**

Transmitting Frequency: 990 to 10,10 mc  
Receiving Frequency: 106t0 to 1130 mc  
Peak Power Output: 1.5 kw (min)  
Pulse Width: 1 usec  
Pulse Repetition Rate: 180 to 120 pps  
(adjusted to conform with prr of associated radar)  
Number of Modes: 3  
Number of Codes: 32 SI, 400 PI, 61 TI  
Range: Range of associated radar  
Antenna: Reflector type of associated radar

Horizontal Beam Width: 3 deg  
Vertical Beam Width: 10 deg  
Receiver Bandwidth: 8 to 11 mc at 6 db down, broad band; 5 mc at 70 db down, narrow band.  
Receiver Intermediate Frequency: 60 mc  
Type of Presentation: PPI of associated radar.  
Operating Voltage and Power Requirements:  
115v ac, 60 or 100 cps, single-ph.

**INSTALLATION CONSIDERATIONS**

Siting: Dependent on physical location of associated radar. Limitations on component location are those imposed by the designed lengths of the furnished cables.

Mounting: Components of this equipment are installed on the associated radar.

Cabling Requirements: Some interconnecting facilities are furnished as part of AN/GPX-18B, others are modification of AN/MPS-11II furnished cables.

Related Equipments: Radar Identification Set AN/GPX-18B may h)( used with Radar Set AN/MPS-11.

**PRINCIPAL COMPONENTS AND PHYSICAL DATA**

COMPONENT	QTY	HEIGHT (Inches)	WIDTH (Inches)	DEPTH (Inches)	UNIT WT.
Coder-Decoder Group OA-1272/GPX-IBB	1				
Recognition Set AN/UPX-6	1				
Antenna Group OA-105/FPS-8 Interconnecting Cable Assemblies	1				

**REFERENCE DATA AND LITERATURE**

**TECHNICAL ORDERS:**

31P,1-2GPX-101, 31P4-2GPX-101, 31P.1-2GPX-13,1, 31P4-2GPX-16,4, 31P4-2GPX-174,  
31P4-2GPX-IBI, 31P4-2GPX-194, 31P,1-2GPX-506, 31P1-2GPXI1-1, 31P1-2(;PXIB-14,  
31P4-2GPX18-241

DATE: 15 April 1964

ITEM NAME: INTERROGATOR SET

COGNIZANT SERVICE: USAF

TYPE: AN/GPX-18C

FEDERAL STOCK NUMBER: 5895-604-4654

	USA	USN	USAF	USMC
STATUS OR TYPE CLASSIFICATION			STD	
Mfg(s) Name or Code Number.				

No Illustration Available.

#### FUNCTIONAL DESCRIPTION

Radar Identification Set AN/GPX-18C provides Mark X SIF for Radar Set AN/FPS-8 or AN/MPS-11. The AN/GPX-18C is used for the identification of friendly targets of Radar Set AN/MPS-11 or AN/FPS-8. Transmits coded rf pulses for triggering of transponders

of AN/APX-25 carried by friendly aircraft to be identified. Receive the transponder replies and after decoding furnishes them to the associated radar indicator in the form of video pulses. Its narrow beam width interrogation is synchronized with

AN/GPX-18C: 1

**ITEM NAME:** INTERROGATOR SET

**TYPE:** AN/GPX-18C

that of the radar in azimuth and time thus permitting the reply pulses to be displayed on the associated radar PPI in close association with the radar target being identified. Also, provision is made for symbolic display of the Mode 2 response codes from AN/APX-25.

Transmitted Signal 1030 mc freq, PM 12 mc, 1 channel  
Received Signal 1090 mc freq, PM 10 mc, 1 channel  
Input Power Requirements: 117v ac, 60 cycle, single ph

**RELATION TO SIMILAR EQUIPMENT**

AN/GPX-18C is similar to and one-way interchangeable with the AN/GPX-18B, differs in improved Coder-Decoder Group being used. Also AN/GPX-18C is interchangeable with the AN/GPX-18A where space and power are available, difference is in the repackaging of the Coder-Decoder Group being used.

**INSTALLATION CONSIDERATIONS**

Siting: Dependent on physical location of associated radar.

Mounting: Components of this equipment are installed on the associated radar.

Related Equipments: Radar Identification Set AN/GPX-18C is used with Radar Sets AN/FPS-8 or AN/MPS-11.

**TECHNICAL DESCRIPTION**

Frequency:

**PRINCIPAL COMPONENTS AND PHYSICAL DATA**

<b>COMPONENTS</b>	<b>QTY.</b>	<b>HEIGHT (Inches)</b>	<b>WIDTH (Inches)</b>	<b>DEPTH (Inches)</b>	<b>UNIT WT. (Pounds)</b>
Coder-Decoder Group AN/GPA-78	1				
Recognition Set AN/UPX-6	1				
Antenna Group OA-405/FPS-8	1				
Interconnecting Cable Assemblies					

**REFERENCE DATA AND LITERATURE**

TECHNICAL ORDERS:

DATE: 1 April 1964

ITEM NAME: RADIO INTERROGATOR SET

(COGNIZANT SERVICE: USAF

TYPE: AN/GPX-20

FEDERAL STOCK NUMBER: 5895-342-9468-EG

	USA	USN	USAF	USMC
STATUS OR TYPE CLASSIFICATION			Alt Std	
Mfg(s) Name or Code Number. Bendix Radio Corporation				

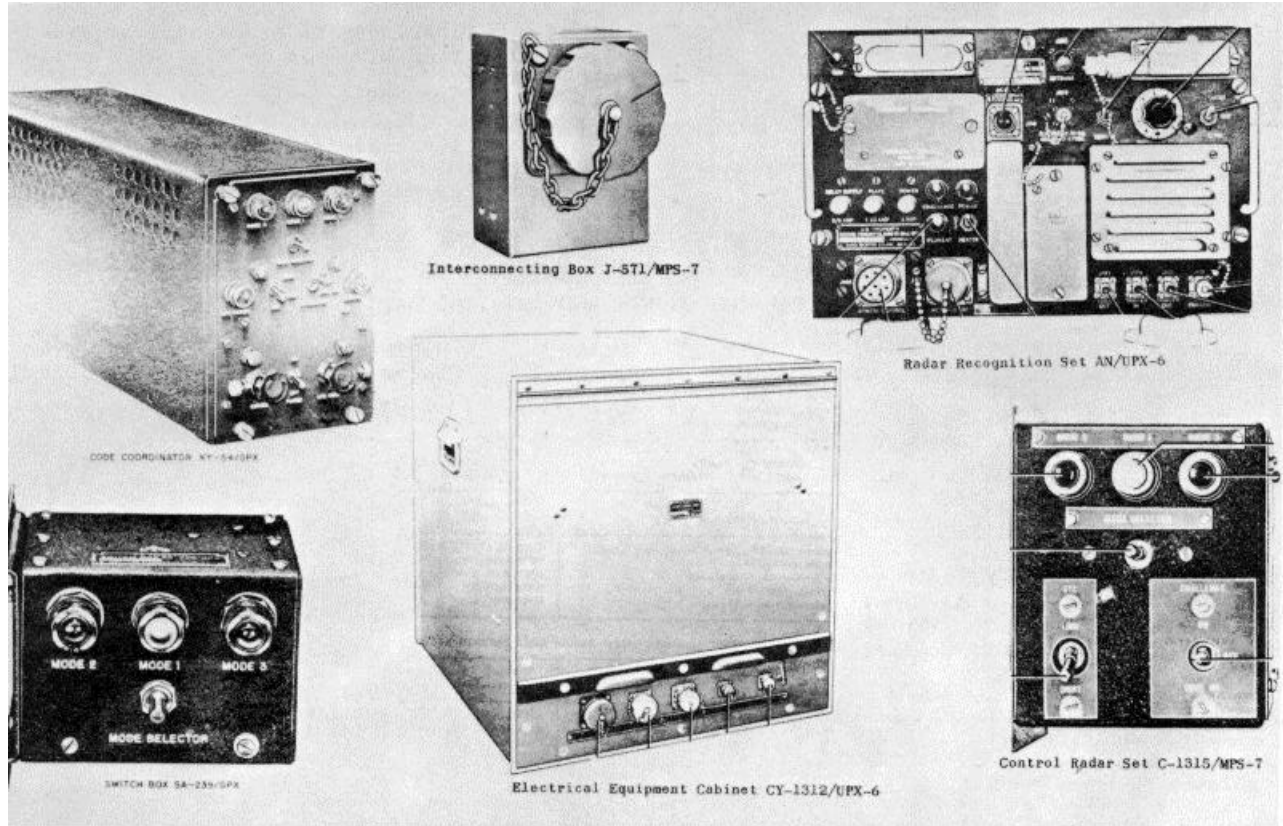

**FUNCTIONAL DESCRIPTION**

Radar Identification Set AN/GPX-20 provides Mark X IFF for Radar Set AN/mPS-7. The AN/GPX-20 transmits coded radio-frequency pulses to trigger an airborne transponder identification set and converts the

received transponder reply to video pulses to be displayed on the PPI's of the associated radar set. The interrogator output level and receiver sensitivity are adequate for interrogating and receiving replies from transponders operating within the detection range of

**ITEM NAME:** RADIO INTERROGATOR SET

**TYPE:** AN/GPX-20

the associated radar. The AN/GPX-20 may be independently operated to track targets equipped with a radar identification set.

**RELATION TO SIMILAR EQUIPMENT**

The AN/GPX-20A is similar to and interchangeable with Interrogator Set AN/GPX-20, the difference being AN/GPX-20A will also decode the response from Transponder Set AN/APX-25.

AN/GPX-20B is similar to and interchangeable with Interrogator Set AN/GPX-20A, the difference being AN/GPX-20B is smaller and weighs less.

**TECHNICAL DESCRIPTION**

Frequency: Transmitting, 900 to 1040 mc;  
receiving, 1080 to 1130 mc  
Range: Range of associated radar  
Peak Power Output: 1.5 kw (min)  
Operating Voltages and Power Requirements:  
105, 117 or 125v ac, 60 or 400 cps\*, 1-ph,  
250w (\*All circuits are designed for both 60  
and 400 cps operation except the blower

system, which must be installed for either 60 or 400 cps, depending on the available power frequency).

Type of Presentation: PPI's of associated radar set.

Pulse Repetition Rate: 125 to 1500 (adjusted to conform with prr of associated radar)

Pulse Width: 1 usec

Number of Modes: 3

Horizontal Beam Width: 4.5 deg

Vertical Beam Width: 30 deg

IF. Frequency: 60 mc

Band Width: 5 mc (-70 db)

**INSTALLATION CONSIDERATIONS**

Siting: The location of associated radar site for AN/MPS-7 is in all cases suitable.

Mounting: Components of this equipment are on the associated radar.

Related Equipment: Radar Identification Set AN/GPX-20 may be used with Radar Set AN/MPS-7.

**PRINCIPAL COMPONENTS AND PHYSICAL DATA**

COMPONENTS	QTY	HEIGHT (Inches)	WIDTH (Inches)	DEPTH (Inches)	UNIT WT. (Pounds)
Antenna Assembly AS-295/UP-	1	13-13/32	9-13/32	222	101
Radar Recognition Set AN/UPX-6*	1	11	15	21	77
Switch Box SA-239/GPX	5	4-1/4	4-3/4	6-1/4	1.4
Code Coordinator KY-54/GPX*	1	5-5/d	6-5/8	23	39
Electrical Equipment Cabinet CY-1312/UPX-6*	1	24-1/2	23-1/2	26	58
Radar Set Control C-1315/MPS-7	1	4-1/4	4-3/4	6-1/4	1.4
Interconnecting Box J-571/MPS-7	1	6	3	4-1/2	2.5
Blower Conversion Kit	1	14	14	14	2.5

\* Government-furnished equipment.

**REFERENCE DATA AND LITERATURE**

Technical Orders:  
31P4-2GPX-101  
31P4-2GPX-121  
31P4-2GPX-506  
31P4-2GPX20-5  
31P4-2GPX20-12  
Specification:  
ENG-299

DATE: 15 December 1964

ITEM NAME: INTERROGATOR SET, RADIO

COGNIZANT SERVICE: USAF

TYPE: AN/GPX-20A

FEDERAL STOCK NUMBER: 5895-349-0039-EG

	USA	USN	USAF	USMC
STATUS OR TYPE CLASSIFICATION			Alt Std	
Mfg(s) Name or Code Number: Hazeltine Electronics Corp., Crosley Division, AVCO Mfg. Co.				

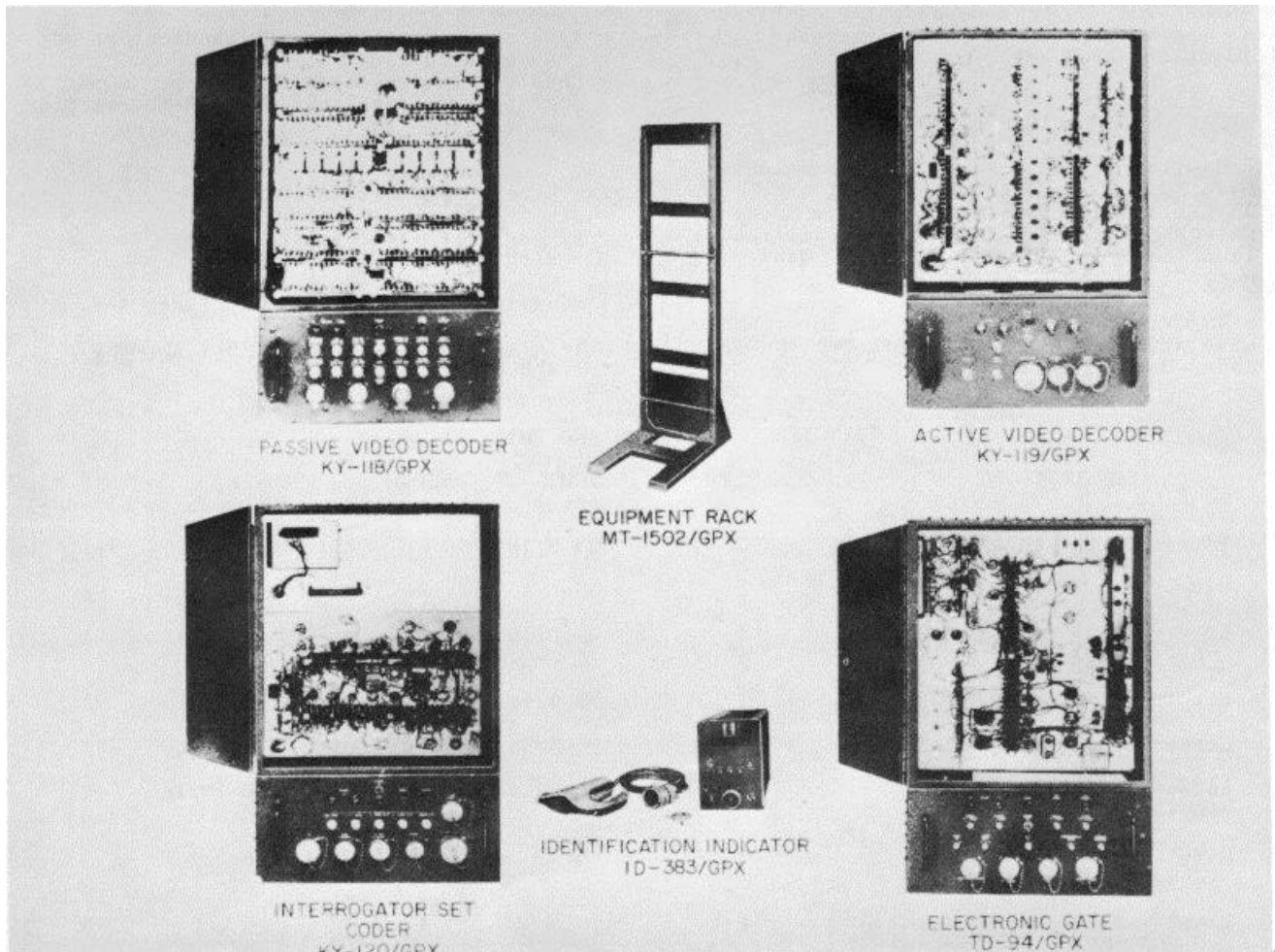

**FUNCTIONAL DESCRIPTION**

Radio Interrogator Set AN/GPX-20A operates with an airborne transponder identification set on any of 32 security identity (SI) codes, 400 personnel identity (PI) codes, or 64 traffic identity (TI) modes. The set provides identification friend or foe (IFF) and selective

identification feature (SIF) for Radar Set AN/MPS-7. The AN/GPX-20A uses two interrogators which alternately transmit coded rf pulses to trigger the airborne transponder identification set and concert the received transponder reply to video pulses.

**ITEM NAME:** INTERROGATOR SET, RADIO

**TYPE:** AN/GPX-20A

The equipment permits the video pulses to be displayed on the PPI indicators of the associated radar set to supplies the video pulses to SIF Coder-Decoder Group OA-842/ GPX-20A. The OA-842/GPX-20A supplies coded pulses for security identity, personnel identity, and traffic identity. The set decodes multiple-pulse response codes transmitted by airborne equipment in reply to interrogations or challenges and supplies the video signals to the indicators of the associated radar. The interrogator output and the receiver sensitivity are adequate for interrogating and receiving replies from transponders operating within the detection range of the associated radar. The AN/GPX-20A may be independently operated to track targets equipped with radar identification set.

**RELATION TO SIMILAR EQUIPMENT:**

Similar to and one-way interchangeable with AN/GPX-20. Differs in that the AN/GPX-20A utilizes Coder-Decoder Group OA-842/GPX-20A for selective identification feature (SIF) and AN/GPX-20 does not.

AN/GPX-20A is similar to and interchangeable with AN/GPX-20B, differs in type of Coder-Decoder Group used.

Transmitting Frequency: 990 to 1040 mc  
 Receiving Frequency: 1080 to 1130 mc  
 Peak Power Output: 1.5 kw (min)  
 Pulse Width: 1 usec  
 Pulse Repetition Rate: 180 to 420 pps (adjusted to conform with prr of associated radar)  
 Number of Modes: 3  
 Number of Codes: 32 SI, 400 PI, 64 TI  
 Range: Range of associated radar  
 Antenna: Dipole (24 radiating slots)  
 Beam Width: 4.5 deg horiz; 30 deg vert  
 Receiver Bandwidth: 8 to 11 mc at 6 db down, narrow; 5 mc at 70 db down, broad  
 Type of Presentation: PPI indicators of associated radar  
 Receiver Intermediate Frequency: 60 mc  
 Operating Voltages and Power Requirements: 115v ac, 45 to 70 cps, 1-ph, 4 kw

**INSTALLATION CONSIDERATIONS:**

Siting: Physically located with associated radar.  
 Mounting: Mounted on basic radar set.  
 Related Equipment: Radar Set AN/MPS-7 and other models.

**TECHNICAL DESCRIPTION**

**PRINCIPAL COMPONENTS AND PHYSICAL DATA**

COMPONENT	QTY	HEIGHT (Inches)	WIDTH (Inches)	DEPTH (Inches)	UNIT WT. (Pounds)
Video Decoder KY-118/GPX	7	28-3/16	18	13	161
Video Decoder KY-119/GPX	2	28-3/16	18	13	96
Interrogator Set Group KY-120/GPX	1	28-3/16	18	13	121
Electronic Gate TD-94/GPX	1	28-3/16	18	13	93
Coder Control C-2364/GPX	1	6-3/16	6-3/16	6-7/16	4
Remote Switching Control C-1289/GPX	6	6-3/16	6-3/16	6-15/16	4
Remote Switching Control C-2365/GPX	6	6	6-3/16	6-3/4	3
Electrical Frequency Control C-2028/GPX	1	8	17	6	2
Interconnecting Box J-664/GPX	2	3	13-1/16	7-1/8	5.5
Mounting MT-1501/GPX	6	18-1/2	19-13/16	13/16	6
Electrical Equipment Rack NT-1502/GPX	6	73-5/8	18-3/8	30	132
Installation Safety Switch	1	15-3/16	10-1/2	7-1/8	19



**ITEM NAME:** INTERROGATOR SET RADIO

**TYPE:** AN/GPX-20A

**PRINCIPAL COMPONENTS AND PHYSICAL DATA**

<b>COMPONENTS</b>	<b>QTY (Inches)</b>	<b>HEIGHT (Inches)</b>	<b>WIDTH (Inches)</b>	<b>DEPTH (Pounds)</b>	<b>UNIT WT.</b>
Transponder Test Set AN/GPM-7	1	24-3/4	22	16-3/4	160
Antenna Assembly AS-295( )/UP (GFE)	1	13-13/32	222	9-13/32	101
Radar Recognition Set AN/UPX-6 (GFE)	1	11	15	21	77
Electrical Equipment Cabinet CY-1312/UPX-6 (GFE)	1	22-1/16	23-13/32	25-13/32	58
Interconnecting Box J-571/MPS-7	1	6	4	4-1/2	2.5

**REFERENCE DATA AND LITERATURE**

Technical Orders:  
31P4-1-185  
31P4-2GPX20- Series

DATE: 15 April 1964

ITEM NAME: INTERROGATOR SET

COGNIZANT SERVICE: USAF

TYPE: AN/GPX-20B

FEDERAL STOCK NUMBER: 5895-574-0386-EG

	USA	USN	USAF	USMC
STATUS OR TYPE CLASSIFICATION			AS	
Mfg(s) Name or Code Number: Bendix Radio Corporation, Bell Aerospace Corporation				

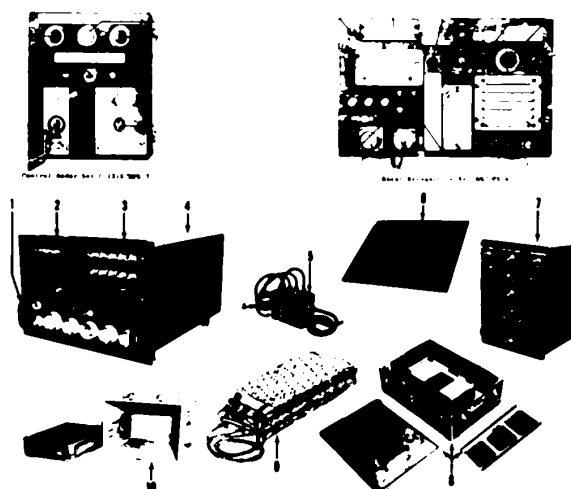

**Coder-Decoder Group OA-1271/GPX-20B**

INDEX NO.	NOMENCLATURE	SHORT FORM NAME
1	Power Supply PP-2191/GPX	Power Supply
2	Video Decoder KY-275/GPX	Video Decoder
3	Coder-Interrogator Set KY-274/GPX	Coder-Interrogator
4	Electrical Equipment Cabinet (Typical)	Cabinet
5	Interconnecting Box J-1094/GPX-18B	Interconnecting Box
6	Plate MT-3209/GPX	Plate
7	Coder-Decoder Control C-2738/GPX	Control
8	No. 3 Transit Case CY-2634/GPX-18B	No. 3 Transit Case
9	Cargo Net	Cargo Net
10	No. 1 Transit Case CY-2655/GPX	No. 1 Transit Case



## FUNCTIONAL DESCRIPTION

Interrogator Set AN/GPX-20B is used for identification of friendly targets on Radar Set AN/MPS-7. The AN/GPX-20B transmits coded radio frequency pulses to trigger transponders of Transponder Set AN/APX-25 carried by friendly aircraft to be identified.

The AN/GPX-20B receives the transponder replies and after decoding furnishes them to the associated radar indicator in the form of video pulses. Its narrow beam width interrogation is synchronized with that of the radar in azimuth and time thus

**ITEM NAME:** INTERROGATOR SET

**TYPE:** AN/GPX-20B

permitting the reply pulses to be displayed on the associated radar PPI in close association to the radar target being identified. Provisions are also made for symbolic display of Mode 2 response codes from Transponder Set AN/APX-25.

**RELATION TO SIMILAR EQUIPMENT**

AN/GPX-20B is similar to and one-way interchangeable with Interrogator Set AN/GPX-20. Differs in that AN/GPX-20 will interrogate Transponder AN/APX-6, where as the AN/GPX-20B will interrogate the AN/APX6 and AN/APX-25. AN/GPX-20B is similar to and interchangeable with Interrogator Set AN/GPX-20A, the difference being AN/GPX-20B is smaller and weighs less through use of a different Coder-Decoder Group.

**TECHNICAL DESCRIPTION**

Frequency:  
 Transmitting 900 to 1040 \*c  
 Receiving 10680 to 1130 mc  
 Range: Same as associated radar  
 Peak Power Output: 1.5 kw (min) Operating  
 Voltages and Power Requirements: 105,

117 or 125v ac, 60 or 400 cps, single ph, 250 w

Type of Presentation: PPI's of associated radar.  
 Pulse Repetition Rate: 125 to 1500 (adjusted to conform with associated radar).  
 Pulse Width: 1 usec  
 Number of Nodes: 3  
 Horizontal Beam Width: 4.5 deg  
 Vertical Beam Width: 30 deg  
 Frequency (if.): 60 mc  
 Bandwidth: 5 mc (-70 db)

**INSTALLATION CONSIDERATIONS**

Siting: The location of the operating site of Radar Set AN/MPS-7 will in all cases be suitable.

Mounting: Components of this equipment are mounted on the associated Radar Set AN/MPS-7 and within the operations shelter.

Related Equipments: Interrogator Set AN/GPX-20B is primarily used with Radar Set AN/MPS-7.

**PRINCIPAL COMPONENTS AND PHYSICAL DATA**

COMPONENT	QTY	HEIGHT (Inches)	WIDTH (Inches)	DEPTH (Inches)	UNIT WT. (Pounds)
Coder-Decoder Group OA-1271/GPX-20B	1				
Antenna AS-295A/UPb	1	13-13/32	9-13/32	222	101
Radar Recognition Set AN/UPX-60	1	11	15	21	77
Electrical Equipment Cabinet CY-1312/UPX6*	1	24-1/2	23-1/2	26	58
Radar Set Control C-1315/MPS-70	1	4-1/2	4-3/4	6-1/4	1.4
Interconnecting Box J-571/MPS-7*	1	6	3	4-1/2	2.5

\* Government furnished equipment.

**REFERENCE DATA AND LITERATURE**

TECHNICAL ORDERS:  
31P4-2GPX20- Series

DATE: 1 September 1964

ITEM NAME: INTERFERENCE BLANKER GROUP

COGNIZANT SERVICE: USAF

TYPE: AN/GPX-27

FEDERAL STOCK NUMBER: 5895-862-4238-EG

	USA	USN	USAF	USMC
STATUS OR TYPE CLASSIFICATION			AS	
Mfg(s) Name or Code Number: Airborne Instruments Laboratory				

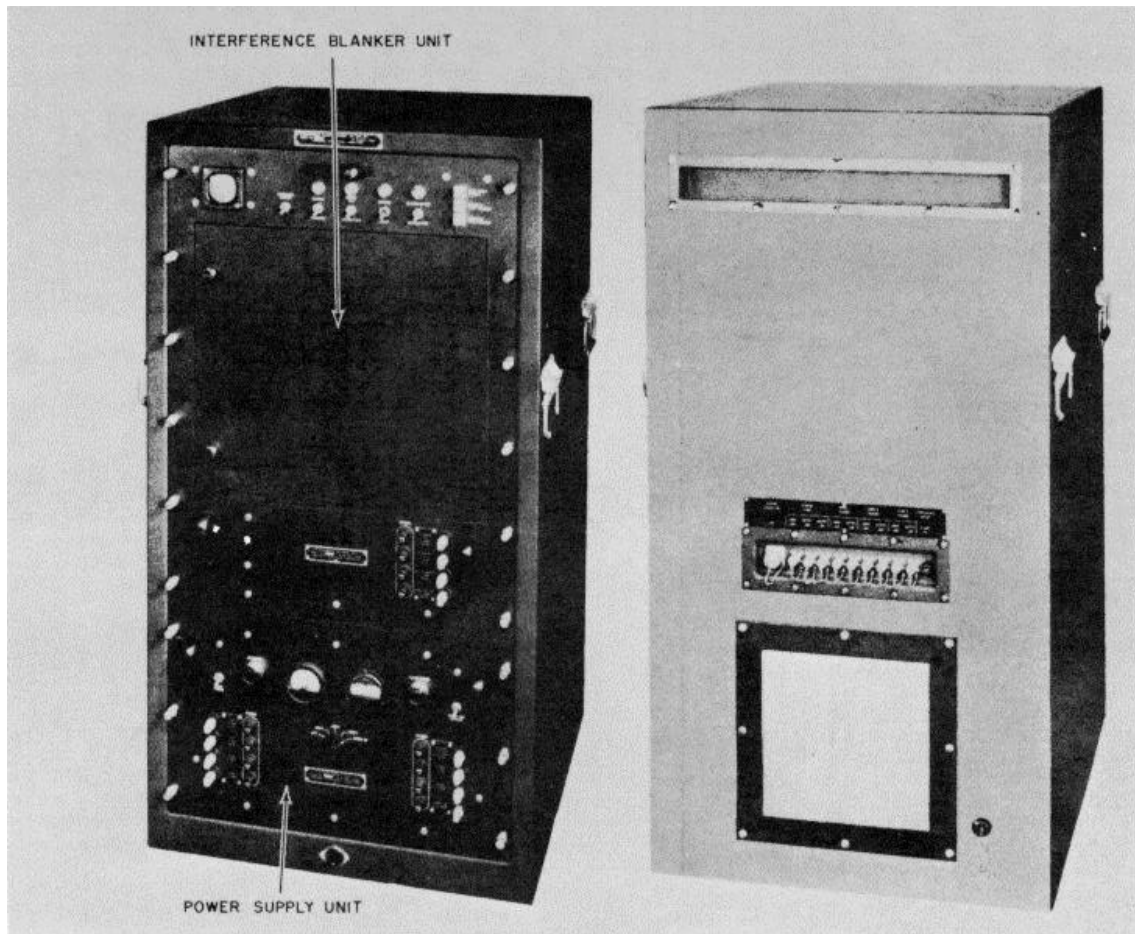

**FUNCTIONAL DESCRIPTION**

Interference Blanker Group AN/GPX-27, Defruiter, is a beacon video "fix" equipment that is essentially two single-mode defruiter modules in one package. The Defruiter is simply a unit, connected between the Interrogator-Receiver and Decoder Unit,

that can pass all incoming video, or can sort and select only synchronous returns at the discretion of the operator. It can select synchronous video pulses on a mode-sensitive basis because it compares only video returns of a particular mode of interrogation. This

**ITEM NAME:** INTERFERENCE BLANKER GROUP

**TYPE:** AN/GPX-27

function is accomplished for two separate modes of interrogation for any selected interface ratio of the modes. In addition, the Defruiter does the thresholding of input noise that is required for decoding, and shapes the input-output characteristic for optimum defruiting and decoding action. Basically, the Defruiter is an electronic equipment that can eliminate false target replies and clutter from ground-beacon radar displays.

**RELATION TO SIMILAR EQUIPMENT**

None.

**TECHNICAL DESCRIPTION**

Primary ac Power

Type: 117v, 2-wire, single ph, 60 and 400 cps, 575 w

Regulation: 105 to 125v, 50 to 63 cps and 390 to 410 cps

Input Video Characteristics

Polarity: Positive

Amplitude: 2 to 7v across 75 ohms Amplitude

Variations: Not to exceed 10 pct within a reply group.

Selective Identification Feature (SIF)

Pulse Duration: 0.35 to 0.55 usec

Rise Time: 0.1 usec or less

Decay Time: 0.2 usec or less

Minimum spacing between pulses in a particular reply train: 1.35 usec

Peak signal-to-noise ratio: 4 to 1

Mark X Identification Friend or Foe (IFF)

Pulse Duration: 0.8 to 1.2 usec

Rise Time: 0.2 usec or less

Decay Time: 0.1 usec or less

Minimum spacing between pulses in a particular reply train: 16 usec

Peak signal-to-noise ratio: 4 to 1

Input Trigger Characteristics

Mode 1, Mode 2, and Mode 3 triggers shall have the following characteristics:

Polarity: Positive\*

Amplitude: 4 to 150v

Duration: 2 to 10 usec

\* AC coupling in the Defruiter trigger input permits use of KY-27.1/GPX Coder which has a quiescent

state of  $-0.5v$ , and trigger goes positive to ground.

Rise Time: 0.4 usec or less

Pulse Repetition Frequency (PRF):

200 to 400 pps

Precision (PAR) Beacon Unit 1833 pps

Impedance: Any value between 75 ohms and 10 k as required.

Timing: Between 37 and 100 usec ahead of radar main trigger.

Output Video Characteristics

Polarity: Positive

Amplitude: 0 to 7v (adjustable)

Duration: 0.4 to 0.6 usec when input pulse width is not greater than 0.5 usec

Rise Time: Not greater than 0.10 usec when input pulse width is 0.05 usec or less.

Fall Time: Not greater than 0.15 usec when input is 0.1 usec or less.

Ambient Temperature

Operating:  $-29$  deg C to plus 52 deg C

Non-operating:  $-54$  deg to plus 71 deg C

Salt Atmosphere: As encountered in coastal regions and during ocean transportation.

**INSTALLATION CONSIDERATIONS**

Siting: The Defruiter should be installed between, or adjacent to, the Beacon Interrogator-Receiver (AN/UPX-6, AN/UPX-14, or other) and Beacon-Coder (KY-120/GPX, KY-274/GPX, or other). When the Interrogator-Receiver and Decoder are at different locations, the Interference Blanker Group should be located at the Coder Interrogator site.

Mounting: The Defruiter cabinet is bolted to the floor.

Cabling Requirements: Cables required to connect the Defruiter into the beacon system are not supplied. Different site arrangements would make it impossible to prefabricate cable lengths suitable for all installations.

Related Equipments: The Defruiter is used with, but not part of, various IFF and SIF equipment.

ITEM NAME: INTERFERENCE BLANKER GROUP

TYPE: AN/GPX-27

PRINCIPAL COMPONENTS AND PHISICAL DATA

COMPONENT	QTY	HEIGHT (Inches)	WIDTH (Inches)	DEPTH (Inches)	UNIT WT. (Pounds)
Interference Blanker Group AN/GPX-27	1	16-5/16 uncrated	25-1/2 uncrated	25-1/2 uncrated	357 crated
Storage Tubes	4	27 crated	27 crated	22 crated	28 crated
Delay Line	2				
Delay Line Driver	1				
Amplifier	1				
Modulator	1				
Power Supply	1				
Cabinet and Interconnecting Cable Assemblies	1				

REFERENCE DATA AND LITERATURE

TECHNICAL ORDERS:  
31P4-2GPX27-2

**DATE:** 1 July 1964

**ITEM NAME:** INTERROGATOR SET

**COGNIZANT SERVICE:** USN

**TYPE:** AN/GPX-29(XN-1)

**FEDERAL STOCK NUMBER:**

	USA	USN	USAF	USMC
STATUS OR TYPE CLASSIFICATION				
Mfg(s) Name or Code Number. Mare Island Naval Shipyard, Vallejo, Calif.				

No Illustration Available.

**FUNCTIONAL DESCRIPTION**

The AN/GPX-29(XN-1) is used for identification of friendly targets of Radar Set AN/MPN5, -5A, by transmitting coded R-F pulses for triggering transponders carried by friendly aircraft to be identified. The set receives the transponded replies and furnishes

them to the associated radar indicator in the form of video pulses. The narrow beam interrogation of Interrogator Set AN/GPX-29(XN-1) is synchronized with the radar beam in azimuth and time, permitting the reply pulses to be displayed on the associated indicator

**AN/GPX-29(XN-1): 1**

**ITEM NAME:** INTERROGATOR SET

**TYPE:** AN /GPX-29(XN-1)

in close association with the radar target being identified. This set is installed in power trailer of Radar Set AN/MPN-5 with antenna mounted on roof.

Transmitter Frequency Range: 1010 to 1030 mc

Receiver Frequency Range: 1090 to 1110 mc  
Operating Power Requirements: 116v ac, 60 cps, single ph

**RELATION TO SIMILAR EQUIPMENT**

None.

**INSTALLATION CONSIDERATIONS**

**TECHNICAL DESCRIPTION**

Type of Emission: PO type  
Impedance: 51 ohms  
Operating Frequency Data

Siting: Power trailer.

Related Equipment: The AN/GPX-29(XN-1) is designed to be used with hut not part of Radar Set AN/MPN-5, -5A.

**PRINCIPAL COMPONENTS AND PHYSICAL DATA**

<b>COMPONENTS</b>	<b>QTY</b>	<b>OVERALL DIMENSIONS (Inches)</b>	<b>UNIT WT. (Pounds)</b>
Radar Recognition Set AN/UPX-1A	2		
Decoder Group AN/UPA-24	3		
Antenna Group AN/UPA-23	1		
Rotary Switch SA-213/U	2	5 x 10-1/4 x 17-1/8	
Switch, Radio Frequency Transmission Line SA-291/U	1	1-1/16 x 5-5/8 x 6-1/16	
Search Indicator Modification Kit	3		
Interconnecting Kit and hardware	1		

**REFERENCE DATA AND LITERATURE**

Technical Manuals:  
NAVSHIPS 93400

**AN/GPX-29(XN-1): 2**



DATE: 1 July 1964

ITEM NAME: INTERROGATOR SET

COGNIZANT SERVICE: USN

TYPE: AN/GPX-30

FEDERAL STOCK NUMBER:

	USA	USN	USAF	USMC:
STATUS OR TYPE CLASSIFICATION				
Mfg(s) Name or Code Number: Mare Island Naval Shipyard				

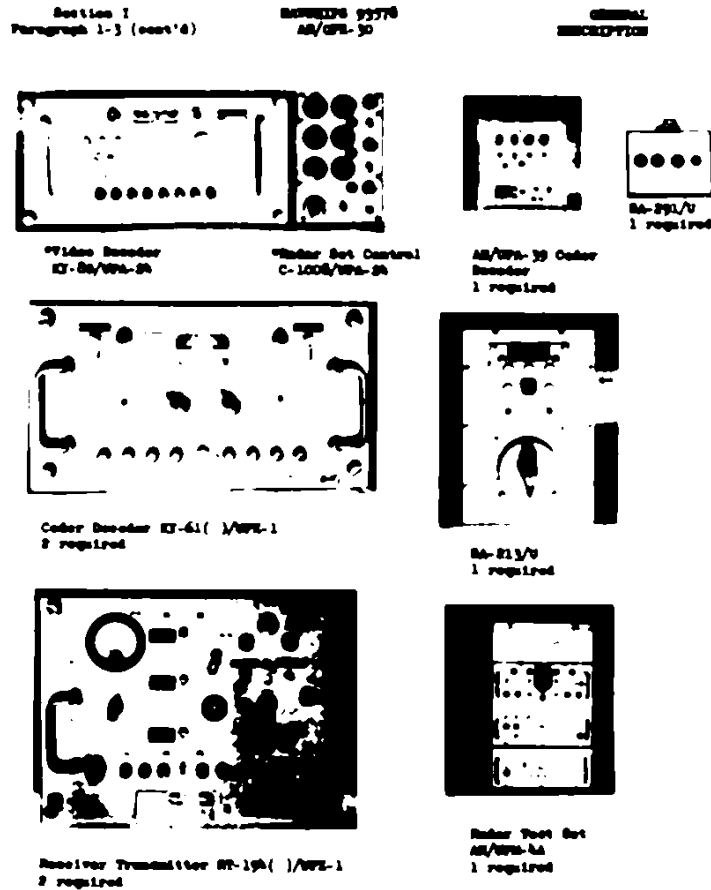

**FUNCTIONAL DESCRIPTION**

Interrogator Set AN/GPX-30 is intended as a supplement to the Radar Air Traffic Control Center Basic Radar System AN/FPN-28. The system will supply complete Selective Identification Features as well as Mark X IFF facilities. The system operates in

conjunction with suitable airborne equipment such as Transponder Set AN/APX-6 and/or AN/APX-25, for the purpose of providing selective identification. "Friend or Foe" is accomplished through the ability of Video Decoder Group AN/WPA-24 to decode

**ITEM NAME:** INTERROGATOR SET

**TYPE:** AN/GPX-30

multiple-pulse response codes as transmitted by the airborne equipment in reply to interrogations, or challenges, which are intended by the Radar Identification Set AN/UPX-1A and corresponding equipment.

**TECHNICAL DESCRIPTION**

Not available.

**INSTALLATION CONSIDERATIONS**

Related Equipment: (1) Radar Set AN/FPN-28.

**RELATION TO SIMILAR EQUIPMENT**

None.

**PRINCIPAL COMPONENTS AND PHYSICAL DATA**

COMPONENTS	QTY	OVERALL DIMENSIONS (Inches)	UNIT WT. (Pounds)
Radar Recognition Set AN/UPX-1A includes:	2		
Coder Decoder KY-61A/UPX-1	2	10 x 18-3/8 x 27-1/8	86
Receiver-Transmitter RT-194A/UPX-1	2	16-3/4 x 18-3/8 x 27-3/4	135
Decoder Group AN/UPA-24 (as req) includes:			
Video Decoder KY-80/UPA-24			
Radar Set Control C-100I/UPA-24			
Radar Selector Switch SA-213/U	1	5 x 10-1/4 x 16-5/8	20.2
Coaxial Switch SA-291/U	1	4-1/16 x 5-5/d x 6-1/4	
Radar Test Set AN/UPM-4A	1		
Coder Decoder Group AN/UPA-39	1	12-3/8 x 12-5/8 x 15-9/32	34
Junction Box	2		
Video Decoder Rack CY-597A/G (modified)	1		
Video Decoder Modification Kit	5		
IP-309/FPN-28 Modification Kit	1*		

**NOTE:** \*FC-5 AN/FPN-28 contains enough material to modify four IP-309/FPN-28 indicators. For those sites having more or less IP-309/28, this quantity will be changed to match the number of IP-309/FPN-28.

**REFERENCE DATA AND LITERATURE**

Technical Manuals:  
NAVSHIPS 93578

DATE: 15 April 1964

ITEM NAME: DISPLAY PLOTTING BOARD GROUP

COGNIZANT SERVICE: USAF

TYPE: AN/GSA- 12

FEDERAL TOCK NUMBER: 5840-505-0871

	USA	USN	USAF	USMC
STATUS OR TYPE CLASSIFICATION			Std	
Mfg(s) Name or Code Number: Doehler Metal Furniture Co., Inc.				

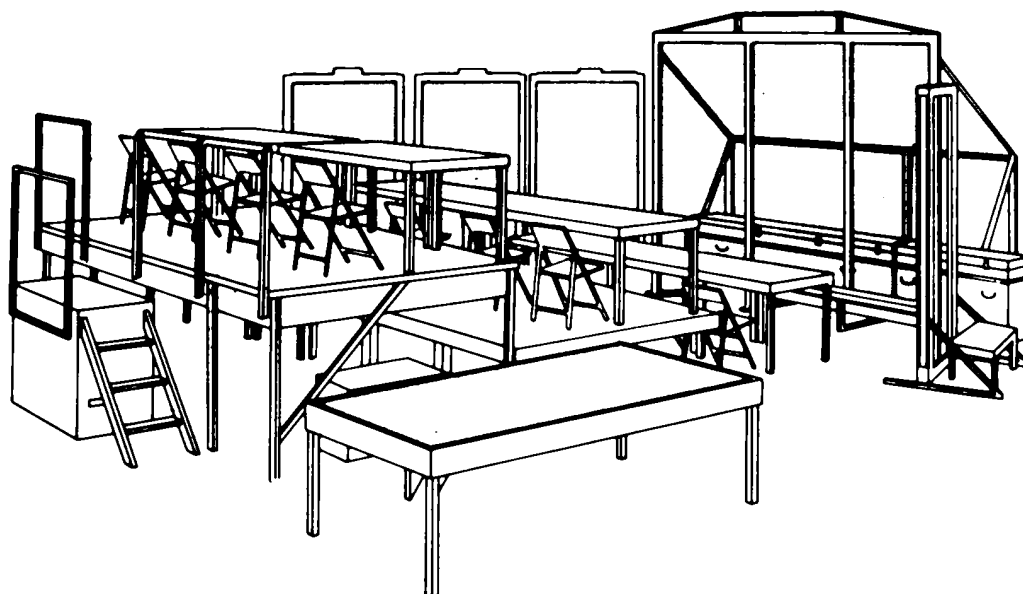

## FUNCTIONAL DESCRIPTION

Display Plotting Board Group AN/GSA-12 is a group of equipments that form the nucleus of a tactical air control center. The AN/GSA12 contains vertical and horizontal plotting surfaces, elevated platforms, and 12 small control desks, having provisions for mounting telephone equipment. Information received by controller personnel at telephone equipment desks is relayed to plotting personnel located at the plotting board assemblies. Status information is shown on the boards by means of the paint and crayons supplied as accessories. Plotting, replotting, and projection may be accomplished as necessary to keep information current and to maintain suitable control over flight movements. The method of construction of the AN/GSA12 permits disassembly and packing into 17 cases containing all parts, spare parts, and accessories needed for the

completed assembly. Eight of these transit cases act as platforms for plotters or controllers in the completed operations setup.

## RELATION TO SIMILAR EQUIPMENT

None.

## TECHNICAL DESCRIPTION

Radar Data Plotting Board:

Material - Plexiglass panels

Plotting Surface Size - 12 ft x 10 ft, 2 in.

Lighting - Edge-light (slimline fluorescent lamps)

Plotting Plane - Vertical

Status Display Plotting Board:

Material - Plexiglass panels

Plotting Surface Size - 4 ft x 8 ft

AN/GSA- 12

Lighting - Edge-light (slimline fluorescent lamps)  
Plotting Plane - Vertical  
Close Support Plotting Board:  
Material - Plexiglass panels  
Plotting Surface Size - 8 ft x 4 ft  
Plotting Plane - Horizontal  
Telephone Equipment Desks:  
Top Material - Top frame linoleum-covered with plexiglass panel work surface cover  
Telephone Units - 4 per desk  
Drawers - 2 per desk  
Dais Case Group:  
Platforms - 2 (one at 2 ft level and one at 4 ft level)

Material - Dais case number 1 and 3 unfold and bolt together to form the dais platforms  
Operating Voltages: 110 to 125 vac, 60 cps, 1-ph

**INSTALLATION CONSIDERATIONS**

Siting: Dictated by logistic demands of the tactical air control center shelter and the communications equipment.  
Mounting: The equipment is installed on or in sight of the transit cases.  
Cabling Requirements:  
Related Equipment: Display Plotting Board Group AN/GSA12 may be used with Display Plotting Board Group AN/GSA29A telephones and communications equipment.

**PRINCIPAL COMPONENTS AND PHYSICAL DATA**

COMPONENT	QTY	HEIGHT (Inches)	WIDTH (Inches)	DEPTH (Inches)	UNIT WT. (Pounds)
Radar Display Plotting Board PT- 193/GSA- 12	1				
Status Display Plotting Board PT- 195/GSA- 12	4				
Close Support Plotting Board PT- 194/GSA- 12	1				
Telephone Equipment Desk FN-62/GSA- 12	12				
Dais Case Group, CN-1453/GSA-12	1				
Display Plotting Board Group AN/GPA-29A*	1				
Jamesway Type Shelter MPS-7*	1				

\* Government-furnished

**REFERENCE DATA AND LITERATURE**

Technical Orders:  
3151 -2GSA12- Series  
Specifications:  
Exhibit ENG-442A

**AN/GSA-12: 2**

DATE: 1 September 1965

ITEM NAME: RADAR COURSE DIRECTING GROUP

COGNIZANT SERVICE: USAF

TYPE: AN/GSA-51

FEDERAL STOCK NUMBER: 5B95-50t3-1516-EG

	USA	USN	USAF	USMC
STATUS OH TYPE CLASSIFICATION			Tent. Std	
Mfg(s) Name or Code Number.				

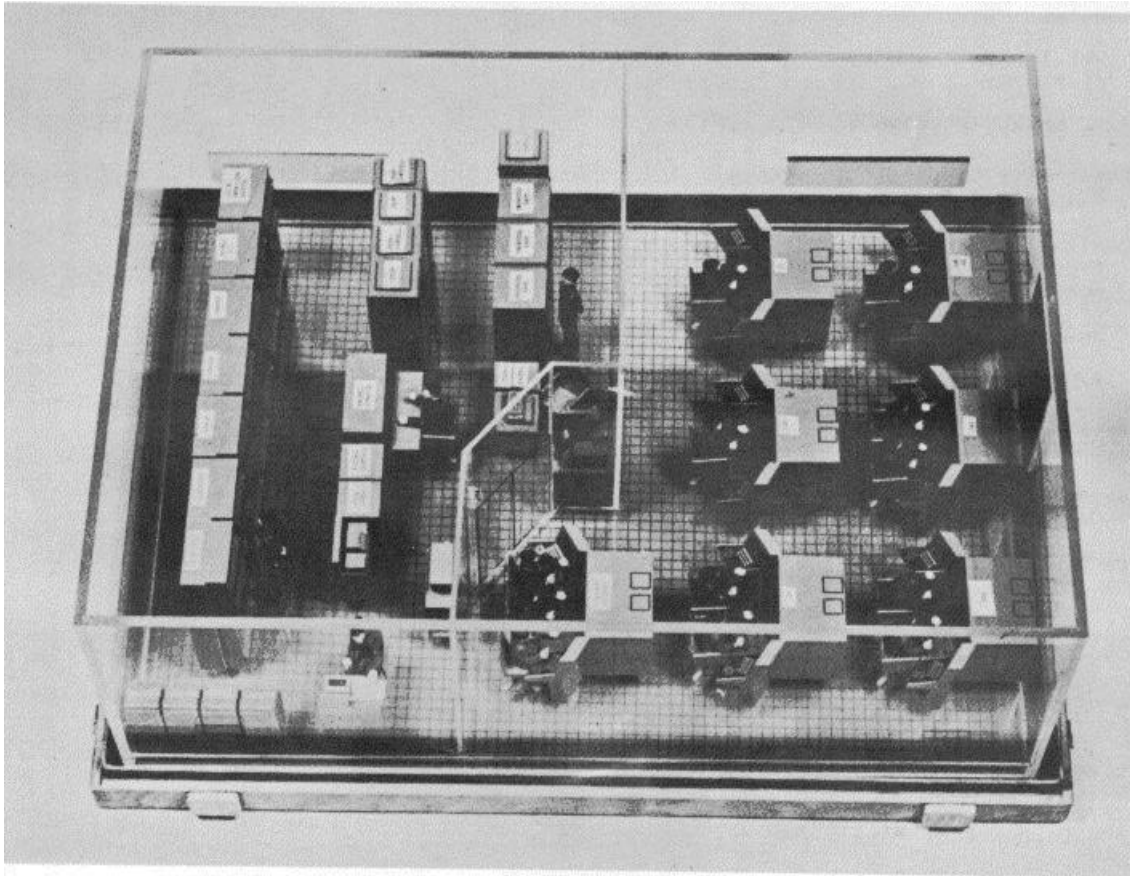

**FUNCTIONAL DESCRIPTION**

The Radar Course Directing Group AN/GSA-51 receives inputs from search, IFF, gap filler, and height' finding radars, it can accept radar track data from remote locations. It provides PPI type consoles for

interception and control, assignment of weapons, insertion of identification information into the system monitoring of gap filler slowed-down-video data. Provides facilities for an operator to evaluate tactical situation. Provides data for intercept weapons.

**AN/GSA-51: 1**

**ITEM NAME:** RADAR COURSE DIRECTING GROUP

**TYPE:** AN/GSA-51

**RELATION TO SIMILAR EQUIPMENT**

Not available.

**INSTALLATION CONSIDERATIONS**

Related Equipment: The AN/GSA-51 is used with but not part of AN/FPS-6, -7, -20, AN/FST-2 and AN/GKA-5.

**TECHNICAL DESCRIPTION**

Not available.

**PRINCIPAL COMPONENTS AND PHYSICAL DATA**

COMPONENT	QTY	HEIGHT (Inches)	WIDTH (Inches)	DEPTH (Inches)	UNIT WT. (Pounds)
Data Processing Set AN/GYK-4 consists of:	1				
Digital Data Computer P-719/GYK-4	2				
Core Memory Unit MU-468/GYK-4	3				
Controller-Comparator C-4634/GYK-4	1				
Controller-Comparator-Message Processor C-4635/GYK-4 consists of:	1				
Message Processor Module	1				
I/O Module	1				
Data Storage Magnetic Drum MU-469/GYK-4	2				
Magnetic Drum Controller- Converter C-4636/GYK-4	2				
Data Display Console OA-4578/GSA-51	6				
Status Display Console OA-4579/GSA-51	1				
Magnetic Tape Recorder- Reproducer RD-251/GSH-12	3				
Recorder-Reproducer Control C-4637/GSH-12	1				
Punch Card Reader UX-4735/GSQ-72	1				
Punch Card Reader Control C-4639/GSQ-72	1				
Tape Typewriter-Putch-Reader TT-398/GYQ-2	1				
Typewriter Punch-Reader Control C-463B/GYQ-2	1				

**REFERENCE DATA AND LITERATURE:** Unclassified Nomenclature card dated 20 Sep 61 for AN/GSA-51.

DATE: 1 July 1964

ITEM NAME: RADAR SET

COGNIZANT SERVICE: USA

TYPE: AN/MPG-1

LINE ITEM NUMBER: 634410

FEDERAL STOCK NUMBER:

	USA	USN	USAF	USMC
STATUS OR TYPE CLASSIFICATION	Obs			
Mfg(s) Name or Code Number:				

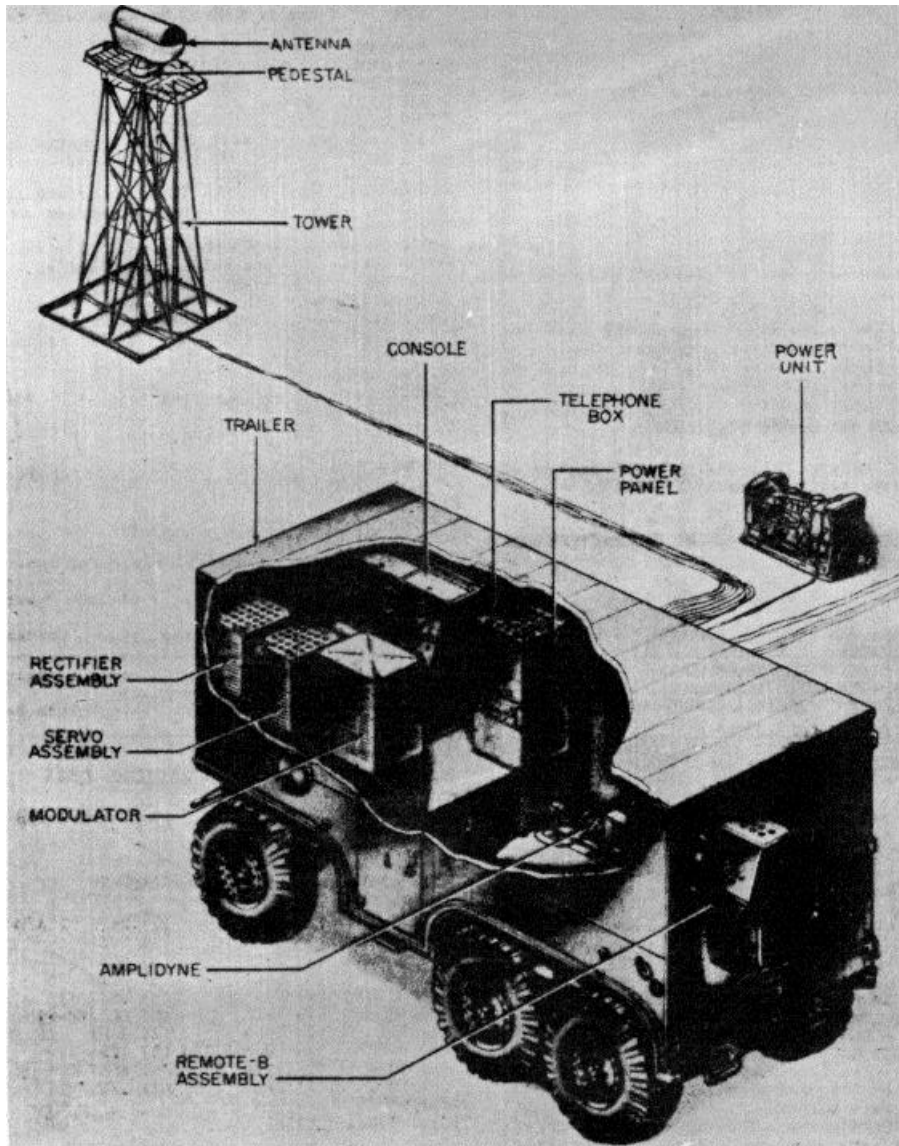

AN/MPG-1: 1

AN/MPG- 1

**FUNCTIONAL DESCRIPTION**

Radar Set AN/MPG-1 is a 3-centimeter mobile fire control set designed for use with seacoast artillery batteries operating against surface craft. The specific functions of the set are: (1) to obtain present position data on targets within 28,000 yards on a B-type oscilloscope and to transmit this data to a gun data computer which is not part of the radar set (the computer transmits radar data corrected for ballistics to the gun batteries); (2) to provide two alternate search ranges (presented on a PPI) of 80, 000 yards and 30, 000 yards; (3) to spot shell splashes on a B-type oscilloscope.

**RELATION TO SIMILAR EQUIPMENT**

Radar Set AN/MPG-1 is the mobile version of the fixed-installation AN/MPG-1

**TECHNICAL DESCRIPTION**

Frequency Range: 9090 mc  
 Range: PPI-500 yd min, 80,000 yd max (30,000 yd for short range) at an accuracy of \*3%  
 B-scope: 500 yd min, 28,000 yd max(max range accuracy of 20 yd max)  
 Peak Power Output: 35 kw  
 Operating Voltage and Power Requirements: 115 vac, 60 cps, 1-ph or 3-ph or 115v, 60 cps 3-ph  
 Type of Presentation: One 7-in. PPI and two B-scopes  
 Range Marks: Range line horizontally through center of target area, 1, 000 yd above and 1, 000 yd below

Pulse Repetition Rate: PPI (search), 1,024 pps  
 B-scope (tracing), 4, 097 pps  
 Pulse Width: PPI-1 usec, B-scopes-0.25 μsec  
 Horizontal Coverage: PPI 360 deg selected sector, automatic or manual control, accuracy ±2 deg; B-scope-360 deg beam sweeps 10 deg angle, accuracy ±5 deg  
 Resolution: PPI-at 20,000 yd two destroyers separated by 500 yds of open water appear as separate targets.  
 B-scope At 20,000 yd, two destroyers separated by 500 yd of open water appear as separate targets.  
 System Accuracy: Range PPI ±3'; B-scope 20 yd max; Azimuth PPI ±2 deg; B-scope ±0.05 deg  
 Beam Width (Half power point):  
 Horizontal 0.6 deg  
 Vertical 3 deg  
 Receiver Bandwidth: 10 mc  
 IF. Frequency: 30 mc Antenna Type: Folded horn with parabolic reflector  
 Antenna Operation:  
 PPI Slewing and scanning rate is 20 deg per sec  
 B-scope Max tracing rate is 1.5 deg per sec

**INSTALLATION CONSIDERATIONS**

Siting:  
 Mounting: Major units are normally housed in trailer V-9MPG-1  
 Cabling Requirements:  
 Related Equipment: None

**PRINCIPAL COMPONENTS AND PHYSICAL DATA**

COMPONENT	QTY	HEIGHT (Inches)	WIDTH (Inches)	DEPTH (Inches)	UNIT WT. (Pounds)
Console CY-230/M PG-1	1	34	52	53-1/2	735
Indicator Cabinet Assembly CY-234/MPG-1	1	19-1/2	30	50-1/2	276
Modulator MD-36/MPG-1	1	24-1/2	30-1/2	59	985
Pedestal AB-8A/GP	1	33	48	48	1000
Power Panel SB-25/MPG-1	1	18-1/4	24	56-1/4	500
Rectifier Cabinet Assembly CY-232/MPG- 1	1	19	21-1/4	50-1/2	312
Servo Motor Generator PU-52/MPG-1	1	13	13-1/4	33-1/2	178
Servo Cabinet Assembly CY-233/MPG- 1	1	19	21-1/4	50-1/2	310



**PRINCIPAL COMPONENTS AND PHYSICAL DATA (cont'd)**

<b>COMPONENT</b>	<b>QTY</b>	<b>HEIGHT (Inches)</b>	<b>WIDTH (Inches)</b>	<b>DEPTH (Inches)</b>	<b>UNIT WT. (Pounds)</b>
Telephone Box TA-14/MPG-1	1	6	13-1/2	26	30
Tower AB-50/WPG-1	1	224-1/2	224-1/2	315	6200
Trailer V-9/MPG-1	1	98	130	240	12175
Transmit-Receive System RF-28/MPG- 1	1	44-7/8	57	143	1290
Power Unit PU-26/U	1	24	50	58-1/2	1164

**REFERENCE DATA AND LITERATURE**

Technical Manual:

TM 11-1366

TM 11-1466

TM 11-1566

Specification:

71-2240 (Sig C Tent.)

DATE: 1 July 1964

ITEM NAME: RADAR SET

COGNIZANT SERVICE: USN

TYPE: AN/MPN-1A

FEDERAL STOCK NUMBER:

	USA	USN	USAF	USMC
STATUS OR TYPE CLASSIFICATION	Used By	Used By		
Mfg(s) Name or Code Number: Bendix Radio Division of Bendix Aviation Corp. (86270)				

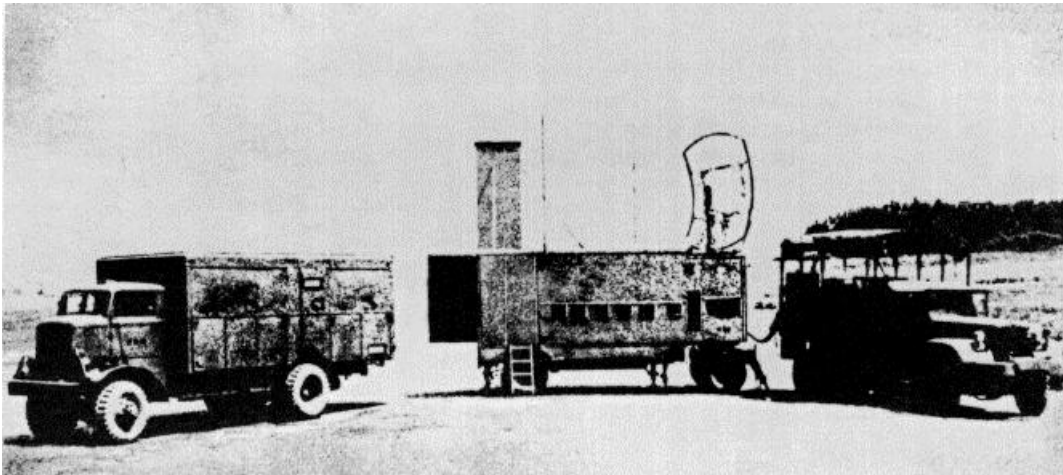

### FUNCTIONAL DESCRIPTION

The Radar Set AN/MPN-1A is a mobile ground radar system providing facilities for directing the movement of aircraft over a predetermined glide path

for a safe approach to an airdrome runway under conditions approaching zero visibility.

The Radar Set AN/MPN-1A provides range azimuth, and elevation on a particular plane, and also supplies range and azimuth information on all planes within the scan area of the search antenna.

AN/MPN-1A: 1

**ITEM NAME:** RADAR SET

**TYPE:** AN/MPN-1A

**RELATION TO SIMILAR EQUIPMENT**

None.

**TECHNICAL DESCRIPTION**

**Magnetron Tube Currents**

Search System: 20 ma  
Precision System: 11 ma

**Range Limits**

Precision System: 10 mi  
Search System: 30 mi

**Pulse Repetition Frequency: 2000 pps**

Pulse Duration: 0.5 usec  
Duty Cycle: .001

**Beam Pattern Dimensions**

**Azimuth Antenna**  
Width in Azimuth: 1 deg  
Height in Elevation: 2 deg  
**Elevation Antenna**  
Width in Azimuth: 3.6 deg  
Height in Elevation: 0.6 deg

**Scanning Rates**

Azimuth and Elevation Antennas: 1 or 4 "looks"  
per sec

Search Antenna: 30 rpm

**Scanning Ranges**

Azimuth Antenna Beam: 20 deg (-1 deg to -21 deg).

Elevation Antenna Beam: 7 deg (plus 1 deg to plus 8 deg).

Search Antenna Beam: 360 deg scan

**Frequency Range**

Precision System: X-band

Search System: S-band

**Communication Equipment**

HF Band: 2 to 9 mc  
VHF Band: 100 to 156 mc

Tower: 200 to 400 kc

Tower: 2300 to 6700 kc

Receiving: 19 to 55 mc and 3 to 6 mc

Transmitting: 34 mc

**Peak Power Output**

Precision System: 15 kw

Search System: 80 kw

**Communications**

HF Range: 9w to 100w

VHF Range: 8w to 10w

**Operating Power Requirements:** 117v and 220v ac, 60 cps, 14.0 kw max, 0.73 to 0.85 pf Primary power supply included in Radio Set in form of two (2) Gasoline or Diesel Motor-Generator Units.

**INSTALLATION CONSIDERATIONS**

Not available.

**PRINCIPAL COMPONENTS AND PHYSICAL DATA**

<b>COMPONENTS</b>	<b>QTY</b>	<b>OVERALL DIMENSIONS (Inches)</b>	<b>UNIT WT. (Pounds)</b>
Track V-10/MPN-1A or V-11/MPN-1A	1	96 x 125 x 268	18,400
Mounting Rack MT-177/MPN-1A	1	16 x 19-1/8 x 68-13/16	150
Mounting Rack MT-178/MPN-1A	1	19-1/8 x 20-3/4 x 69-3/8	75
Mounting Rack MT-179/MPN-1A	1	19-1/8 x 23-5/8 x 58-1/16	50
Sweep Amplifier AM-28/MPN-1A	4	8-3/4 x 17-3/4 x 19	31
Synchronizer SN-10/MPN-1A	2	8-3/4 x 17-3/4 x 19	28
Azimuth Indicator ID-52/MPN-1A	1	19 x 26-1/2 x 26-1/2	100
Elevation Indicator ID-53/MPN-1A	1	19 x 26-1/2 x 26-1/2	100
Approach Indicator ID-55/MPN-1A	1	14 x 19 x 25-1/2	58
Search Indicator ID-54/MPN-1A	2	19 x 24-1/8 x 25-1/2	101
Rectifier Power Unit PP-124/MPN-1A	2	8-3/4 x 17-3/4 x 19	15
Rectifier Power Unit PP-59/MPN-1A	2	8-3/4 x 17-3/4 x 19	64
Rectifier Power Unit PP-60/MPN-1A	2	8-3/4 x 17-3/4 x 19	70
Rectifier Power Unit PP-61/MPN-1A	2	8-3/4 x 17-3/4 x 19	36
Rectifier Power Unit PP-62/MPN-1A	2	19 x 22 x 25-1/8	260
Rectifier Power Unit eP-63,MPN-1A	3	8-3/4 x 10-1/4 x 19	50

**AN/MPN-1A: 2**

**MIL-HDBK-162A**  
15 December 1965

Volume 1  
Section 1

**ITEM NAME:** RADAR BEACON

**TYPE:** AN/MPN-2 AN/MPN-8

## **REFERENCE DATA AND LITERATURE**

### Technical Manuals:

NAVSHIPS 95016: Descriptive Material for USN Model AN/MPN-2.

NAVSHIPS 359-0031: Instructions for Operation and Maintenance of  
Refrigeration Equipment for Navy Model AN/MPN-2.

**AN/MPN-2: 3**

ITEM NAME: RADAR SET  
TYPE: AN/MPN-1A

PRINCIPAL COMPONENTS AND PHYSICAL DATA

COMPONENTS	QTY	OVERALL DIMENSIONS (Inches)	UNIT WT. (Pounds)
Rectifier Power Unit PP-65/MPN-1A	3	11 x 19 x 21	70
Rectifier Power Unit PP-66/MPN-1A	3	11 x 19 x 25-1/4	168
Negative Power Rectifier PP-67/MPN-1A	3	8-3/4 x 17-3/4 x 19	70
Rectifier Power Unit PP-126/MPN-1A	3	5 x 9-1/2 x 13-1/2	20
Synchroscope TS-123/MPN-1A	2	8-3/4 x 17-3/4 x 19	48
Search Communication Panel SB-7/MPN-1A	1	4-3/4 x 7-3/4 x 19	10
Signal Mixer Unit SN-111/MPN-1A	1	5-1/4 x 10 x 19	10
Transmitter-Converter RT-41/MPN-1A	1	19 x 22 x 22-1/4	96
Transmitter-Converter RT-42/MPN-1A	1	19 x 22 x 22-1/4	97
Preamplifier AM-29/MPN-1A	8	3 x 4 x 7-3/4	3
Receiver R-60/MPN-1A	4	8-3/4 x 19 x 22-1/4	60
Modulator MD-17/MPN-1A	2	19 x 22-1/4 x 22-1/4	102
Control Unit C-94/MPN-1A	1	8-3/4 x 19 x 22-1/4	77
Azimuth Antenna AS-75/MPN-1A	1	6-1/2 x 8-1/2 x 100	66
Azimuth Reflector AT-44/MPN-1A	1	28 x 49 x 102	150
Elevation Antenna AS-76/MPN-1A	1		101
Elevation Reflector AT-45/MPN-1A	1		150
Antenna Assy AS-354/MPN-1A	1		35
Antenna Reflector AT-109/UPN	1	25-3/4 x 62 x 101	200
Search Antenna Mount MT-180/MPN-1A	1	20 x 25 x 30	200
Angle Coupling Unit CU-28/MPN-1A	4	5 x 7-1/2 x 11-1/2	13
Angle Coupling Capacitor CU-29/MPN-1A	4	4 x 5 x 5-1/2	4
Motor Drive Unit PU-22/MPN-1A	1	13 x 14 x 24	75
Antenna Drive Switching Assy SA-19/MPN-1A	1	9 x 9-1/4 x 20	27
Switching Unit SA-21/MPN-1A	1	7 x 11 x 19	20
Relay Panel RE-6/MPN-1A	1	3-1/4 x 5 x 19	5
Relay Panel RE-7/MPN-1A	1	3-1/4 x 5 x 19	5
Power Distribution Panel SB-d/MPN-1A	1	6 x 14 x 31	25
Hydraulic Leveling System MX-100/MPN-1A	1		500
Altimeter Panel ID-89/MPN-1A	1	5 x 5-1/4 x 19	5

AN/MPN-1A: 3

**ITEM NAME:** RADAR SET  
**TYPE:** AN/MPN-1A

**PRINCIPAL COMPONENTS AND PHYSICAL DATA**

<b>COMPONENTS</b>	<b>QTY</b>	<b>OVERALL DIMENSIONS (Inches)</b>	<b>UNIT WT. (Pounds)</b>
Switching Panel SA-42/MPN-1A	1	2-1/2 x 6-7/8 x 19-1/8	5
Radio Receiver BC-624-A	3		
Radio Transmitter BC-625-A	3		
Rack FT-244-A	3		
Case CS-80A	3		
Radio Control Box BC-602-A	3	2-1/2 x 5-9/16 x 5-7/8	2
Crystal Unit DC-11A or CR-1/AR	18	11/16 x 1-9/16 x 1-13/16	0.13
Speaker Unit LS-106/MPN-1A	1	3 x 7 dia	3
Receiver AVR-15A	1	4-7/8 x 5-3/8 x 6-1/4	5
Receiver AVR-20	1	5-5/16 x 5-13/16 x 6-3/8	6
Transmitter AVT-15A	1	7-13/16 x 8-7/16 x 10-3/4	18
Receiver Model LAX N.T. CG46116	3	7-1/2 x 7-1/2	22.2
Receiver Rack N.T. CG46128	3	3-3/8 x 7-1/2 x 16-5/8	2.8
Antenna Assy AS-78/MPN-1A	4		20
Antenna Assy AS-79/MPN-1A	3		2
Chest Set CH-T-35	10		
Radio Transmitter	3	10-3/4 x 12-7/8 x 23-9/16	66
Pilots Control Unit	3	3-3/8 x 3-11/16 x 6-1/4	1.4
Filter Unit F-24/MPN-1A	1		
Gasoline-Driven Motor Generator Onan Model 5LS-4	1	16-1/2 x 18 x 21-1/2 165	
Gasoline Heater Hunter Model UH3B	1	12 x 22 x 24-1/2	100
Air Conditioning Unit	1	23 x 35 x 36-1/2	1125
Diffuser Set	1	13-1/2 x 23 x 45	

**REFERENCE DATA AND LITERATURE**

Technical Manuals:  
SHIPS 316A

**AN/MPN-1A: 4**

DATE: 1 July 1964  
COGNIZANT SERVICE: USN

ITEM NAME: RADIO SET  
TYPE: AN/MPN-1B

FEDERAL STOCK NUMBER: 5895-445  
5895-669-7037 w-s

	USA	USN	USAF	USMC
STATUS OR TYPE CLASSIFICATION		Std		
Mfg(s) Name or Code Number: Bendix Radio Division of Bendix Aviation Corp.				

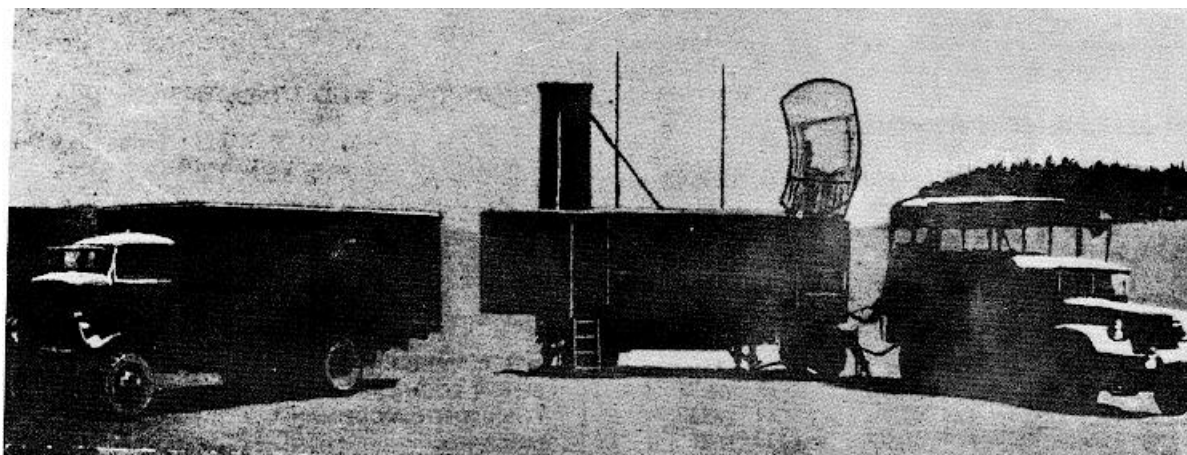

### FUNCTIONAL DESCRIPTION

Radio Set AN/MPN-1B is a mobile, ground radar system. The equipment provides facilities for directing the movement of aircraft over a predetermined glide path. The system functions to provide safe approach to a runway under near-zero visibility conditions. Communication facilities in the 200 to 500 kc range for emergency operation are provided. Means for recording all communications to and from the equipment and VHF-RDF facilities are also included.

### RELATION TO SIMILAR EQUIPMENT

Radar Set AN/MPN- 1A does not provide low frequency communication, recording and direction finding facilities but is otherwise similar to Radio Set AN/MPN- B.

### TECHNICAL DESCRIPTION

Precision System Frequency: X-band  
Search System Frequency: S-band  
HF Band: 2 to 9 mc  
VHF Band: 100 to 156 mc  
Tower Frequency: 200 to 400 kc and 2300 to 6700 kc  
Receiving Frequency: 0. 19 to 0. 55 mc and 3

to 6 mc  
Transmitting Frequency: 3 to 4 mc  
Peak Power Output:  
Precision System - 15 kw  
Search System - 80 kw  
HF Range - 9 to 100w  
VHF Range - 8 to 10w  
Range Limits:  
Precision System - 10 mi  
Search System - 30 mi  
Direction Finder - 135 mi  
Operating Voltage and Power Requirements:  
117 or 220 vac, 60 cps, 0. 73 to 0.85 pf, 14 kw  
(if desired, primary power supply Included in Radio Set AN/MPN-1B may be used)  
Type of Presentation: Indicators and recorders contained in the equipment  
Duty Cycle: 0.001  
Pulse Repetition Rate: 2000 pps  
Pulse Width: 0. 5 µsec  
Horizontal Coverage: 360 deg  
Azimuth Antenna Beam: 20 deg (-1 to -21 deg)  
Elevation Antenna Beam: 7 deg (+1 to +8 deg)

### INSTALLATION CONSIDERATIONS

Not Available

AN/MPN-1B: 1

AN/MPN- 1B

PRINCIPAL COMPONENTS AND PHYSICAL DATA

COMPONENT	QTY	HEIGHT (Inches)	WIDTH (Inches)	DEPTH (Inches)	UNIT WT. (Pounds)
Truck V-100/MPN-1A or V-11/MPN-1A	1	96	125	268	18400
Power Equipment PE-127A or PU-66/U	2				2000
Switching Regulator Unit CN-12A/MPN-1A	1	21	35	48	860
Selenium Rectifier	1	11	11	17	70
Trailer Chassis with Trailer Body V-4/MPN-1A or V-7/MPN- 1A	1	96	125	237	19000
Mounting Rack MT-177/MPN-1A	1	16	19-1/8	68-13/16	150
Mounting Rack MT-178/MPN-1A	1	19-1/8	20-3/4	69-3/8	75
Sweep Amplifier AM-28/MPN-1A	1	8-3/4	17-3/4	19	31
Synchronizer SN-10/MPN-1A	2	8-3/4	17-3/4	19	28
Azimuth Indicator ID-52/MPN-1A	1	19	26-1/2	26-1/2	100
Elevation Indicator ID-53/MPN-1A	1	19	26-1/2	26-1/2	100
Position Deviation Indicator ID-242/MPN-1B	1	14	19	25-1/2	58
Range Azimuth Indicator IP-17/MPN-1B	2	19	24-1/8	25-1/2	101
Rectifier Power Unit PP-124/MPN-1A	2	8-3/4	17-3/4	19	15
Rectifier Power Unit PP-59/MPN-1A	2	8-3/4	17-3/4	19	64
Rectifier Power Unit PP-60/MPN-1A	2	8-3/4	17-3/4	19	70
Rectifier Power Unit PP-61/MPN-1A	2	8-3/4	17-3/4	19	36
Rectifier Power Unit PP-62/MPN-1A	2	19	22	25-1/8	260
Negative Power Rectifier PP-67/MPN-1A	3	8-3/4	17-3/4	19	70
Synchroscope TS-123/MPN-1A	2	8-3/4	17-3/4	19	48
Control Panel C-509/MPN-1B	1	4-3/4	7-3/4	19	10
Signal Mixer Unit SN-11/MPN-1A	1	5-1/4	10	19	10
Transmitter-Converter 1 RT-41/MPN- 1A	19	22	22-1/4	96	
Transmitter-Converter RT-42/MPN-1A	1	19	22	22-1/4	97
Preampplifier AM-29/MPN-1A	8	3	4	7-3/4	3
Receiver R-60/MPN-1A4	8-3/4	19	22-1/4	60	



AN/MPN- 1B

PRINCIPAL COMPONENTS AND PHYSICAL DATA

COMPONENT	QTY	HEIGHT (Inches)	WIDTH (Inches)	DEPTH (Inches)	UNIT WT. (Pounds)
Modulator MD-17/MPN-1A	2	19	22-1/4	22-1/4	102
Control Unit C-94/MPN-1A	1	8-3/4	19	22-1/4	77
Azimuth Antenna AS-75/MPN-1A	1	6-1/2	8-1/2	100	66
Azimuth Reflector AT-44/MPN-1A	1	28	49	102	150
Elevation Antenna AS-76/MPN-1A	1	8-1/4	11	173	101
Elevation Reflector AT-45/MPN-1A	1	14	27	74	and
		14	27	94	150
Antenna Assembly AS-354/MPN-1A	1	5-5/16	11-13/32	55	35
Antenna Reflector AT-109/UPN	1	25-3/4	62	101	200
Search Antenna Mount MT-180/MPN-1A	1	20	25	30	200
Antenna Coupling Unit CU-28/MPN-1A	1	5	7-1/2	11-1/2	13
Antenna Coupling Capacitor CU-29/MPN-1A	4	4	5	5-1/2	4
Motor Drive Unit PU-22/MPN-1A	1	13	14	24	75
Antenna Drive Switching Assembly SA-19/MPN- 1A	1	9	9-1/4	20	27
Switching Unit SA-21/MPN-1A	1	7	11	19	20
Relay Panel RE-6/MPN-1A	1	3-1/4	5	19	5
Relay Panel RE-7/MPN-1A	1	3-1/4	5	19	5
Power Distribution Panel SB-8/MPN- IA	1	6	14	31	25
Hydraulic Leveling System MX- 100/MPN- 1A	1				500
Altimeter Panel ID-89/MPN-1A	1	5	5-1/4	19	5
Speaker Unit LS-106/MPN-1A	3	7	3		
Receiver Model RAX-1 Type CG-46116	3	7-1/2	7-1/2	17	22.2
Receiver Rack Type CG-46128	3	3-3/8	7-1/2	16-5/8	2.8
Antenna Assembly AS-78/MPN-1A	4	15			20
Antenna Assembly AS-79/MPN-1A	3	21			0.5
Chest Set CH-T-35, Modified	10				2
Filter Unit F-24/MPN-1A	1				20
Gasoline-Driven Motor Generator Onan Model 5LS-4	1	16-1/2	18	21-1/2	165

AN/MPN-1B

PRINCIPAL COMPONENTS AND PHYSICAL DATA

COMPONENT	QTY	HEIGHT (Inches)	WIDTH (Inches)	DEPTH (Inches)	UNIT WT. (Pounds)
Gasoline Heater, Hunter Model UH3B	1	12	22	24-1/2	100
Air Conditioning Equipment					1125
Truck V-12/MPN-1A, Van 4 x 4, Consisting of Chassis U-8144 and Body K-30 (if supplied)	1	96	125	300	23400
Recorder Reproducer RD-115/UN	2	12-1/2	17-3/16	21	67.5
Radio Transmitter-Receiver RT- 18/ARC-1	3	9-1/32	10-19/32	24-3/16	47
Mounting Base MT-100/ARC-1	5	9-1/32	10-19/32	24-3/16	4.4
Control Unit C-45/ARC-1	5	2-5/8	3-3/8	6-1/8	1
Mounting Plate MT-4/ARR-2	5	1/4	3-3/4	5-15/32	0.12
Receiver Control C-499A/MPN-1B	1	2-1/8	3-1/8	11-1/8	2.5
Transmitter T-47/ART-13	2	12	15	23-1/2	67
Mounting Plate MT-283/ART-13	2	1-1/2	13-5/164	20-3/4	1.16
Mounting Base MT-284/ART-13	2	2-1/2	15-15/32	20-33/64	1.88
Pilot' s Control Unit C-87/ART-13	1	3-1/4	3-1/2	6-3/16	1.4
Base MT-163/ART-13	1	3/16	3-1/16	5-5/16	0.13
Dynamotor Power Unit DY-12/ART-13	1	7-1/8	8-1/2	12-3/16	30
Base MT-164/ART-13	1	1-1/4	7-1/16	11-5/32	1.13
Antenna Relay Unit RE-2/ARC-5	1	1-3/16	5	5-5/8	1.9
Mounting Base MT-77/ARC-5	1	1	5	5-5/8	0.3
Transmitter T-19/ARC-5	1	5-1/4	7-1/16	12-3/4	9
Rack MT-69/ARC-5	1	3-7/8	6-5/8	14-5/8	1.4
Mounting Base MT-68/ARC-5	1	1-1/16	7-1/4	11-13/16	0.7
Modulator MD-7/ARC-5	1	6-5/8	8-1/4	10-1/6	0.1
Mounting Base MT-76/ARC-5	1	1-1/8	8-7/8	10-3/16	0.7
Receiver R-23/ARC-5	1	4-13/16	5-5/8	11-1/2	6
Dynamotor DY-2A/ARR-2	1	2-3/4	3-1/4	4-3/4	3
Dynamotor DY-8/ARC-5	1	3-3/8	4	7-5/8	8.2
Mounting Base MT-62/ARC-5	1	1-9/16	10-23/32	11-5/8	0.8
Receiver R-26/ARC-5	1	4-13/16	5-5/8	11-1/2	6

AN/MPN-1B: 4

**AN/MPN-1B**

**PRINCIPAL COMPONENTS AND PHYSICAL DATA**

<b>COMPONENT</b>	<b>QTY</b>	<b>HEIGHT (Inches)</b>	<b>WIDTH (Inches)</b>	<b>DEPTH (Inches)</b>	<b>UNIT WT. (Pounds)</b>
Receiver Control C-499/MPN-1B	1	2	3	11	2
Distribution Panelboard SB-81/MPN- B	1	14	22	26	20
Cabinet MT-603/MPN-1B	1	28	61	72	125
Battery Type 19065	2	9-13/16	10-5/8	19-3/16	139
Motor Generator PU-166/U	1	12-3/4	19-3/4	31-3/4	250
Terminal Box J-277/MPN-1B	1	3-1/2	6-1/2	16-1/2	2.4
Recorder Reproducer RD-115/UN	2	12-1/2	17-3/16	21	67.5
Oscillator 0-16/ART-13					
Radio Direction Finder AN/GRD-5	1				

**REFERENCE DATA AND LITERATURE**

Technical Manual:  
SHIPS 316A, Vols I and II  
Specification:  
16A1(RE)  
CS-672

**AN/MPN-1B: 5**

DATE: 1 July 1964

ITEM NAME: RADAR BEACON

COGNIZANT SERVICE: USN

TYPE: \*AN/MPN-2

\*F5825-642-7895 W/S

\*\*AN/MPN-8

\*F5825-665-3688

FEDERAL STOCK NUMBER

\*\*F5825-694-2748

	USA	USN	USAF	USMC
STATUS OR TYPE CLASSIFICATION				
Mfg(s) Name or Code Number. Meissner Manufacturing Co., Mount Carmel, Illinois				

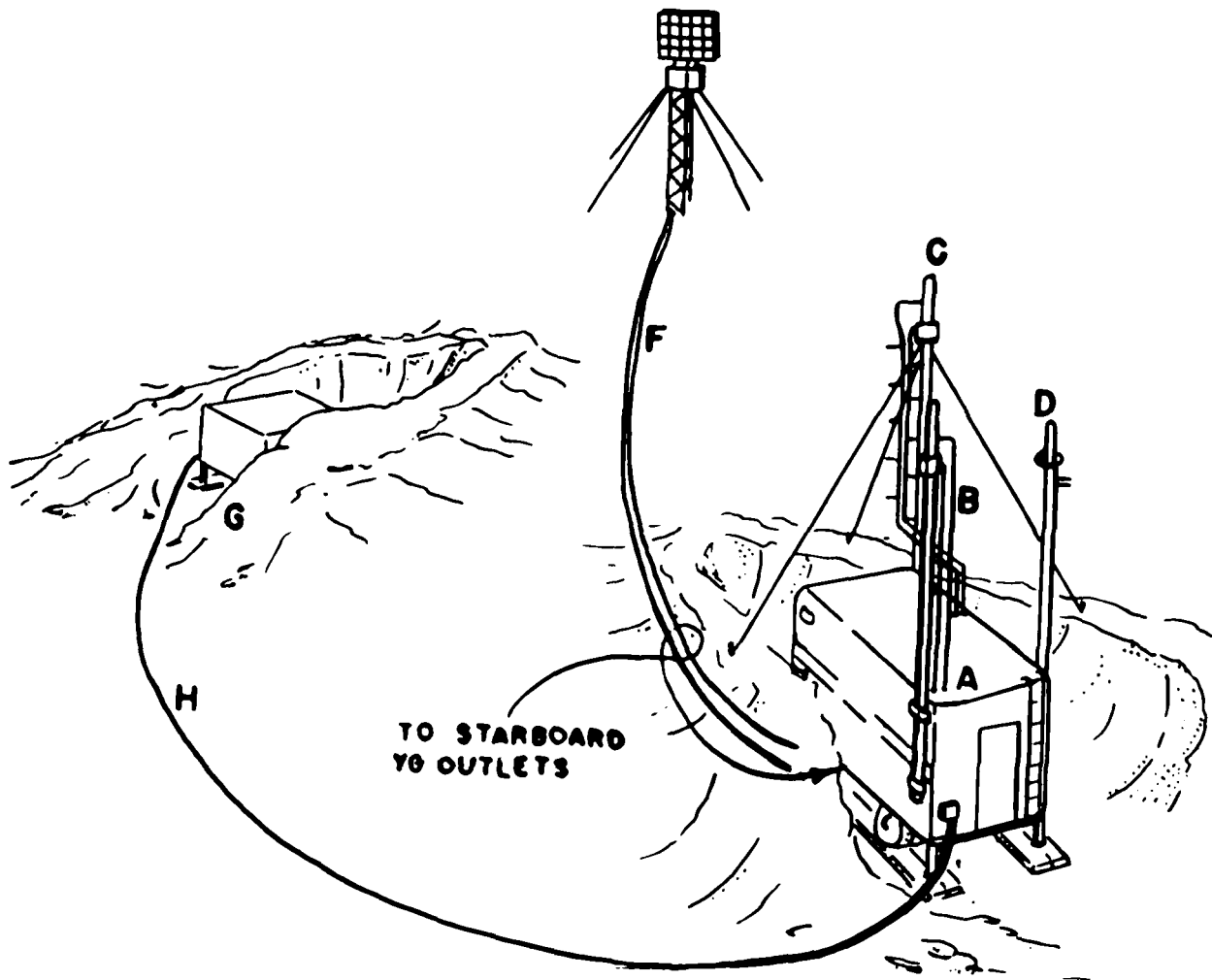

**FUNCTIONAL DESCRIPTION**

The AN/MPN-2 and AN/MPN-B are mobile Radar Beacons which provide navigational aid and homing facilities for aircraft. The major equipments of which each of these beacons is composed are permanently mounted in a beacon trailer or van which is provided

with built-in heating and cooling equipment. Antennas, spare parts and instruction books for the major equipments are stored in the beacon van together with all required test equipment. The AN/MPN-B is a modified version of the AN/MPN-2 which provides a "H" facility

**ITEM NAME:** RADAR BEACON

**TYPE:** AN/MPN-2, AN/MPN-8

not available in the AN/MPN-2. As a result the two beacons differ in the major equipments and accessories furnished.

**RELATION TO SIMILAR EQUIPMENT**

None.

**TECHNICAL DESCRIPTION**

Power Source Required: gasoline-engine driven generator providing 7.5 kw at 115v, 60 cps, single ph

Beacon Service Available

TCJ-1 (Mod) (AN/MPN-8 only)

Type of Signal: A1, A2

Frequency: 300 to 600 kc

Power Output: A1, 400w; A2, 200w

YJ-2 (AN/MPN-2 Only)

Type of Signal: A1

Frequency

Receiver: 171 to 181 mc and 505 to 535 mc.

Transmitter: 172.5 to 182.5 mc and 505 to 535 mc.

Power Output: "A" band, 15w; "B" band 75w

AN/CPN-6

Type of Signal: P2

Frequency

Receiver: 9320 to 9430 \*c

Transmitter: 9310 mc

Power Output: 40 kw

AN/CPN-8

Type of Signal: P2

Frequency

Receiver: 3267 to 3333 mc

Transmitter: 3256 mc

Power Output: 1.1 kw

**INSTALLATION CONSIDERATIONS**

Not available.

**PRINCIPAL COMPONENTS AND PHYSICAL DATA**

COMPONENTS	QTY	OVERALL DIMENSIONS (Inches)	UNIT WT. (Pounds)
*Radar Beacon YJ-2	1		
**Radio Homing Beacon TCJ-1	1		
Radio Homing Beacon, with Antenna Control Unit YG-1	1		
Radar Beacon AN/CPN-8 or -17	1		
Radar Beacon AN/CPN-6	1		
Synchroscope TS-28/UPN	1		
Audio Monitor OCB	1		
Field Telephone EE-8	1		
"Fluid Heat" heater with 6-gal. gasoline tank and accessories	1		
Cooling Equipment	1		
Blower 356, 1/3 hp	1		
Locker "A" (2 door cabinet)	1		
Locker "B" (Tall cabinet)	1		
Cabinet "C" (Test Equipment)	1		
Work Bench	1		
Cutler-Hammer 2-pole Multi-breaker type M-2	1		
8-circuit Frank Adam Load center	1		
Battery, Braking	1		
Antenna Brackets (for YJ-2 Antenna Stowage)	2		
Complete Set Power, Light, Monitor and Telephone cables with outlets, plugs and misc. fittings	1		
Antenna Mast MA-7	1		
Antenna Mast, 3 in. O.D. iron pipe	1		
Rings, Antenna Mast, 3 in. I.D.	4		
Set Guy wires for raising mast	1		
Set various instruction Books and Parts List	1		
*Wavemeter OAP	1		
*Test Set AN/UPI-18	1		

NOTE: \*For AN/MPN-2 only

\*\*For AN/MPN-8 only

**DATE:** 1 July 1964

**ITEM NAME:** RADAR SET

**COGNIZANT SERVICE:** USN

**TYPE:** AN/MPN-3

**FEDERAL STOCK NUMBER:**

	USA	USN	USAF	USMC
STATUS OR TYPE CLASSIFICATION				
Mfg(s) Name or Code Number:				

**No Illustration Available.**

**FUNCTIONAL DESCRIPTION**

The AN/MPN-3 is designed as a mobile ground radar unit consisting of a 6 by 6 Diamond T truck which functions as a prime mover and a four wheel trailer which carries the majority of the operating units,

provides facilities for directing the pilot of an aircraft in making a safe approach to an airdrome runway under conditions of poor visibility. The search system, used for "stacking up" aircraft preparatory of landing, presents a radar map showing the position of aircraft within a circular area of thirty (30) miles and an altitude

**AN/MPN-3: 1**

**ITEM NAME:** RADAR SET  
**TYPE:** AN/MPN-3

of less than four thousand (4000) feet. The precision system presents accurate and continuous information regarding the location of the incoming aircraft with respect to a predetermined glide path and enables the operators to direct the pilot in a safe approach to the runway. The communication system provides two-way communication with aircraft on twenty-one (21) separate channels, of which three (3) may be used simultaneously.

#### RELATION TO SIMILAR EQUIPMENT

The AN/MPN-3 is similar to the AN/MPN-1A except that it has a single, rather than two radar sets for each channel, improved mobility because of decreased weight, fewer communication channels, reduced number of operating personnel, more accessible construction and less complex circuits to facilitate maintenance and improved components to provide more stable performance.

#### TECHNICAL DESCRIPTION

Type of System: One "S" and "X" band radar system.  
Type of Transmission: Pulse transmission  
Pulse Duration Range: 0.5 to 10 usec  
Pulse Width: 0.5 usec  
Pulse Recurrence Frequency: 2000 pps  
Operating Power Requirements: 115v ac  
Type of Indication: Visual  
Range: 30 mi circular area  
Altitude: Approx 4000 ft.

#### INSTALLATION CONSIDERATIONS

Siting: Ground mobile.

#### PRINCIPAL COMPONENTS AND PHYSICAL DATA

COMPONENTS	QTY	OVERALL DIMENSIONS (Inches)	UNIT WT. (Pounds)
Radar Set AN/MPN-3	1		

#### REFERENCE DATA AND LITERATURE

Technical Manuals:  
16-30MPN1-3  
Nomenclature Card AN/MPN-3 for Radar Set

**AN/MPN-3: 2**

DATE: 1 July 1964

ITEM NAME: RADAR SET

COGNIZANT SERVICE: USN

TYPE: AN/MPN-5, AN/MPN-5A

FEDERAL STOCK NUMBER: 5840-642-6712

	USA	USN	USAF	USMC
STATUS OR TYPE CLASSIFICATION		Std		
Mfg(s) Name or C)de Number: Bendix Radio Div., Bendix Aviation Corp., Towson, Maryland				

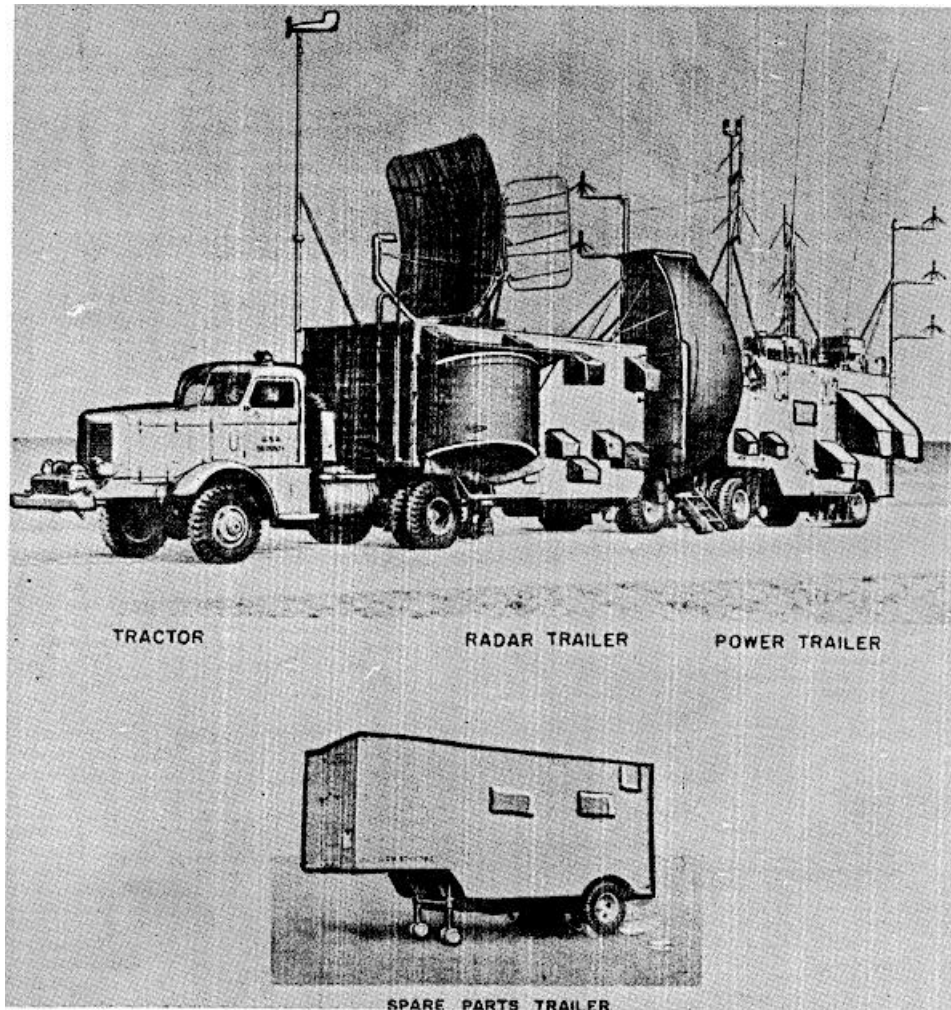

**FUNCTIONAL DESCRIPTION**

The AN/MPN-5, AN/MPN-5A are mobile GCA (ground controlled approach) radar equipments designed to detect aircraft up to a maximum range of 50 miles and to guide them by verbal instructions to a point

within 50 feet above an unobstructed level landing area. Several radio communication equipments included in this Radar Set afford two-way communication between the pilots of incoming aircraft and the operators of the Radar Set. In addition, direction finders are provided to assist the



**ITEM NAME:** RADAR SET  
**TYPE:** AN/MPN-5, AN/MPN-5A

operators in identifying aircraft.

The Radar Sets can be set up to operating positions from a mobile pack condition in 2-1/2 hours. If the radar sets are moved from one runway to another, operations can be resumed in 30 minutes providing that the hard stand has been properly surveyed and constructed.

#### RELATION TO SIMILAR EQUIPMENT

Radar Set AN/MPN-5A incorporates some major units which have been modified slightly and some of later design. All major units used in the two Radar Sets are interchangeable, some may need minor modifications before they can be interchanged.

#### TECHNICAL DESCRIPTION

##### Frequency Range

Precision System: X-Band, 9000 to 9180 mc

Search System: S-Band, 2740 to 2900 mc  
Communications System

LF: 200 to 500 kc (AN/ART-13).

HF: 2000 to 18, 100 kc (AN/ART-13 and AN/ARR-15).

VHF: 100 to 156 mc (AN/ARC-1).

UHF: 225 to 399.9 mc (AN/ARC-27).

##### Frequency Control

Precision System: The highly stabilized circuit employed eliminates the need of true frequency control.

Search System: afc (motor driven frequency control of magnetron).

##### Peak Power Output

Precision System: 25 kw

Search System: 500 kw

Communication System

LF: 5.5w (AN/ART-13).

HF: 31w to 90w depending on freq (AN/ART-13).

VHF: 8w (AN/ARC-1).

UHF: 10w (AN/ARC-27).

##### Pulse Repetition Rate

Precision System: 2, 100 pps

Search System: 1200 pps

##### Pulse Duration

Precision System: 0.5 usec

Search System: 0.8 usec

##### Duty Cycle

Precision System: 0.0012

Search System: 0.00096

##### Range Limits

Precision System: 10 mi

Search System: 50 mi

##### Radial Blind Speeds

Precision System: 77 knots

Search System: 124.5 knots

##### Available Glide Path Angles (Precision

Elevation System): plus 2 to plus 5 deg

##### Touch-Down Point location Limits

Minimum: 2500 ft

Maximum: 7500 ft

##### Precision Radar System Resolution

Azimuth: 1.2 deg

Range: 400 ft

##### Search Radar System Resolution

Azimuth: 1.4 deg

Range: 1% of sweep range or 650 ft whichever is greater.

##### Receiver Data (Precision and Search)

Type: Superheterodyne

Intermediate Frequency: 30 mc

Output: plus or minus 2v video amplitude

##### Antenna Data

Azimuth Antenna: Modified beavertail pattern to give 4 deg coverage in elevation.

Beamwidth: 57 min. in azimuth.

Elevation Antenna: Cosecant Square pattern to 15 deg in azimuth

Beamwidth: 47 min. in elevation.

Search Antenna: Cosecant Square pattern to 25 deg in elevation.

Beamwidth: 2.2 deg in azimuth.

##### Scanning Rates

Azimuth and Elevation: 2 looks per sec

Search: 15 rpm, 30 rpm

##### Scanning Ranges

Azimuth Antenna: 20 deg in azimuth

Elevation Antenna: 7 deg in elevation

Search Antenna: 360 deg

Power Requirements: 120 or 208v, 60 cps, 3 ph, 4-wire plus or minus 15% with 5% fluctuation, 28 kva max, 0.9 pf from commercial line or from 3 Diesel engine generators (two 25 kw and one 7 kw units).

#### INSTALLATION CONSIDERATIONS

Siting: A typical hardstand area should be 80 ft long, 40 ft wide and made of concrete to withstand a wheel load of 9000 lb per wheel.

Related Equipment: Some units of the AN/MPN-5 and the EN/MPN-5A are interchangeable.

ITEM NAME: RADAR SET  
TYPE: AN/MPN-5, AN/MPN-SA

PRINCIPAL COMPONENTS AND PHYSICAL DATA

COMPONENTS	QTY	OVERALL DIMENSIONS (Inches)	UNIT WT. (Pounds)
Pedestal AB-184/MPN-5	1		
Mast AB-192/M	1		
Mast AB-193/M	1		
Mast AB-319/M	1		
Mast AB-320/M	1		
Mast AB-321/M	1		
Mast AB-322/M	4		
Antenna Pedestal AB-323/MPN-5	1		
Antenna Pedestal AB-324/MPN-5	1		
Electronic Control Amplifier AM-414/MPN-5	3		
Electronic Control Amplifier AM-415/MPN-5	2		
RF Amplifier AM-416/MPN-5	4		
Amplifier-Speaker AM-415/U	3		
Video Amplifier AM-499/MPN-5	1		
AF Amplifier AM-517/MPN-5	1		
Radio Direction Finder Set AN/GRD-5	1		
Antenna AS-390/SRC	5		
Antenna Assembly AS-391A/U	5		
Antenna AS-512/MR	2		
Antenna AS-762/MPN-5	1		
Antenna AS-763/MPN-5	1		
Antenna AS-764/MPN-5	1		
Antenna AS-765/MPN-5	1		
Antenna Reflector AT-262/MPN-5	1		
Antenna Reflector AT-263/MPN-5	1		
Antenna Reflector AT-265/MPN-5	1		
Antenna Horn AT-268/MPN-5	1		
Antenna Horn AT-409/MPN-5	1		
Antenna Horn AT-410/MPN-5	1		
Antenna Horn AT-411/MPN-5	1		
Control Panel C-724/MPN-5	1		
Control Panel C-769/MPN-5	1		

AN/MPN-5: 3

**ITEM NAME:** RADAR SET  
**TYPE:** AN/MPN-5, AN/MPN-SA

**PRINCIPAL COMPONENTS AND PHYSICAL DATA**

<b>COMPONENTS</b>	<b>QTY</b>	<b>OVERALL DIMENSIONS (Inches)</b>	<b>UNIT WT. (Pounds)</b>
Control Panel C-770/MPN-5	1		
Control Panel C-771/MPN-5	1		
Control Panel C-772/MPN-5	1		
Control Panel C-773/MPN-5	1		
Power Control C-780/MPN-5	1		
Control Panel C-781/U	1		
Interphone Control C-852/MPN-5	3		
Radar Set Control C-1169/MPN-5	1		
Radar Set Control C-1170/MPN-5	1		
Indicator Control C-1171/MPN-5	2		
Selector Control C-1300/MPN-5	1		
Selector Control C-1301/MPN-5	1		
Selector Control C-1302/MPN-5	1		
Selector Control C-1303/MPN-5	1		
Interphone Control C-1304/MPN-5	1		
Interphone Control C-1305/MPN-5	1		
Interphone Control C-1540/MPN-5	1		
Waveguide Assy CG-179/U (1'0")	1		
Waveguide Assy CG-179/U (1'6")	1		
Waveguide Assy CG-790/MPN-5	1		
Waveguide Assy CG-791/MPN-5	1		
Waveguide Assy CG-792/MPN-5	1		
Waveguide Assy CG-793/MPN-5	1		
Waveguide Assy CG-794/MPN-5	1		
Waveguide Assy CG-795/MPN-5	1		
Waveguide Assy CG-796/MPN-5	1		
RF Cable Assy CG-978/U (18'10")	1		
Signal Comparator CM-53/MPN-5 or CM-53A/MPN-5	2		
Voltage Regulator CN-133/MPN-5	1		
Engine Generator Regulator CN-344/MPN-5	2		
Directional Coupler CU-243/UP	1		

**AN/MPN-5: 4**

ITEM NAME: RADAR SET  
TYPE: AN/MPN-5, AN/MPN-5A

PRINCIPAL COMPONENTS AND PHYSICAL DATA

COMPONENTS	QTY	OVERALL DIMENSIONS (Inches)	UNIT WT. (Pounds)
Duplexer CU-259/MPN-5	2		
Frequency Converter CV-131/CPN-18	2		
Radome CW-305/MPN-5	1		
Radome CW-306/MPN-5	1		
Power Cable Assy CX-1379/U (19')	1		
Power Cable Assy CX-1379/U (50')	1		
Power Cable Assy CX-1527/U (16'9")	1		
Power Cable Assy CX-1527/U (16'6")	1		
Power Cable Assy CX-1528/U (16'6")	1		
Special Purpose Cable Assy CX-1530/U (15')	1		
Special Purpose Cable Assy CX-2474/U (17'11")	1		
Special Purpose Cable Assy CX-2475/U (18'3")	1		
Special Purpose Cable Assy CX-2475/U (18'4")	1		
Special Purpose Cable Assy CX-2475/U (18' 10")	1		
Special Purpose Cable Assy CX-2475/U (19'8")	1		
Special Purpose Cable Assy CX-2475 (20'2")	1		
Special Purpose Cable Assy CX-2475/U (50')	1		
Cabinet CY-837/MPN-5	1		
Cabinet CY-838/MPN-5	1		
Cabinet CY-839/MPN-5	1		
Cabinet CY-846/MPN-5	2		
Cabinet CY-848/MPN-5	3		
Cabinet CY-983/MPN-5	1		
Cabinet CY-984/MPN-5	1		
Electrical Equipment Cabinet CY-1305/MPN-5	1		
Electrical Equipment Cabinet CY-1306/MPN-5	1		
Electrical Equipment Cabinet CY-1307/MPN-5	1		
Electrical Equipment Cabinet CY-1308/MPN-5	1		
Battery Box CY-1337/U	1		

AN/MPN-5: 5

**ITEM NAME:** RADAR SET  
**TYPE:** AN/MPN-5, MPN-5A

**PRINCIPAL COMPONENTS AND PHYSICAL DATA**

<b>COMPONENTS</b>	<b>QTY</b>	<b>OVERALL DIMENSIONS (Inches)</b>	<b>UNIT WT. (Pounds)</b>
Dynamotor CY-81/U	1		
Air Conditioner HD-74/U	1		
Non-Electric Liquid Heater HD-88/U	1		
Non-Electric Space Heater HD-89/U	1		
Air Cooler Unit HD-214/MPN-5	1		
Air Cooler Unit HD-215/MPN-5	2		
Indicator Assy ID-289/MPN-5	1		
Indicator Assy ID-291/MPN-5	1		
Error Voltage Indicator ID-358/MPN-5	1		
Azimuth-Range Indicator IP-102/MPN-5	3		
Azimuth & Elevation Indicator IP-218/MPN-5	3		
Wind Direction-Velocity Transmitter ML-400A/UMQ-5	1		
Lifting Jack MX-1121/M	2		
Lifting Jack MX-1122/M	2		
RF Oscillator O-129/MPN-5	2		
Radar Receiver-Transmitter Group OA-197/MPN-5	1		
Radar Receiver-Transmitter Group OA-198/MPN-5	1		
Communications Central OA-199/MPN-5	1		
Indicator Group OA-200/MPN-5	1		
Indicator Group OA-201/MPN-5	1		
Indicator Group OA-202/MPN-5	1		
Indicator Group OA-203/MPN-5	1		
Power Supply Group OA-264/MPN-5	1		
Amplifier Power Supply Group OA-265/MPN-5	1		
Indicator Receiver Group OA-.80/MPN-5	1		
Comparator-Indicator Group OA-4181/MPN-5	1		
Oscilloscope OS-18/MPN-5 or OS-18A/MPN-5	2		
Gearcase - Motor PD-33/MPN-5	1		
Gearcase - Motor PD-31/MPN-5	1		
Power Supply PP-568/MPN-5	1		

**AN/MPN-5: 6**

ITEM NAME: RADAR SET  
TYPE: AN/MPN-5, MPN-5A

PRINCIPAL COMPONENTS AND PHYSICAL DATA

COMPONENTS	QTY	OVERALL DIMENSIONS (Inches)	UNIT WT. (Pounds)
Power Supply PP-569/MPN-5 or *PP-569A/MPN-5	2		
Power Supply PP-570/MPN-5	2		
Power Supply PP-579/MPN-5	3		
Power Supply PP-646/MPN-5	2		
Power Supply PP-896/MPN-5	3		
Power Supply PP-897/MPN-5 or *PP-897A/MPN-5	3		
Power Supply PP-898/MPN-5	2		
Power Supply Assy PP-925/MPN-5	1		
Motor Generator PU-208/U	2		
Diesel Power Unit PU-275/U	1		
Diesel Engine Generator Set PU-330/U	2		
Radar Receiver R-364/MPN-5 or *R-364A/MPN-5	3		
Radar Receiver-Signal Comparator *R-402/MPN-5 or *R-4 02A/MPN-5	2		
Relay Assy RE-87/U	2		
Target RR-34/U	22		
Waveguide Switch SA-221/MPN-5	1		
Waveguide Switch SA-222/MPN-5	1		
Power Distribution Panel SB-144/MPN-5	1		
Control Panel SB-272/MPN-5	1		
Power Switchboard SB-286/MPN-5	1		
Control Panel SB-287/MPN-5	1		
Control Panel SB-332/MPN-5	1		
Pulse Generator SG-75/MPN-5	1		
Radar Transmitter T-260/MPN-5	2		
Radar Transmitter T-261/MPN-5 or *T-261A/MPN-5	3		
Electro-Mechanical Rotary Actuator TG-24/MPN-5	2		
Echo Box TS-270/UP	1		
Echo Box TS-488/U	1		

AN/MPN-5: 7

ITEM NAME: RADAR SET  
TYPE: AN/MPN-5, MPN-SA

**PRINCIPAL COMPONENTS AND PHYSICAL DATA**

<b>COMPONENTS</b>	<b>QTY</b>	<b>OVERALL DIMENSIONS (Inches)</b>	<b>UNIT WT. (Pounds)</b>
Trailer V-42/MPN-5	1		
Trailer V-43/MPN-5	1		
Trailer V-44/MPN-5	1		
Dolly V-45/U	1		
Automotive Truck V-46/G	1		
COMMUNICATIONS EQUIPMENT SUPPLIED			
HF Transmitter AN/ART-13/U	2		
HF Receiver AN/ARR-15/U	2		
VHF Transmitter-Receiver AN/ARC-1/U	5		
UHF Transmitter-Receiver AN/ARC-27/U	5		
Recorder-Reproducer RD-115/U	2		

NOTE: \*Denotes depot spare replacement unit.

**REFERENCE DATA AND LITERATURE**

Technical Manuals:  
NAVSHIPS 91924(A)

**AN/MPN-5: 8**

**DATE:** 1 July 1964

**ITEM NAME:** RADAR BEACON

**COGNIZANT SERVICE:** USN

**TYPE:** AN/MPN-8

**FEDERAL STOCK NUMBER:** F5825-694-2748

	USA	USN	USAF	USMC
STATUS OR TYPE CLASSIFICATION				
Mfg(s) Name or Code Number: Meissner Manufacturing Co., Mount Carmel, Illinois				

Description for Radar Beacon  
is found on Radar Beacon  
AN/MPN-2 data sheet, pages  
AN/MPN-2: 1 through 3.

**AN/MPN-8: 1**



**DATE:** 1 October 1964

**ITEM NAME:** LANDING CONTROL SET

**COGNIZANT SERVICE:** USAF

**TYPE:** AN/MPN-11A, \*AN/MPN-11B,  
\*\*AN/MPN-11C, \*\*\*AN/MPN-11D

**FEDERAL STOCK NUMBER:** 5840-307-3982 \*\*5895-334-9423-EG  
\*5840-538-2178 \*\*\*5895-538-1425-EG

	USA	USN	USAF	USMC
STATUS OR TYPE CLASSIFICATION			LS, *LS, **LS, ***AS	
Mfg(s) Name or Code Number: Gilfillan Brothers				

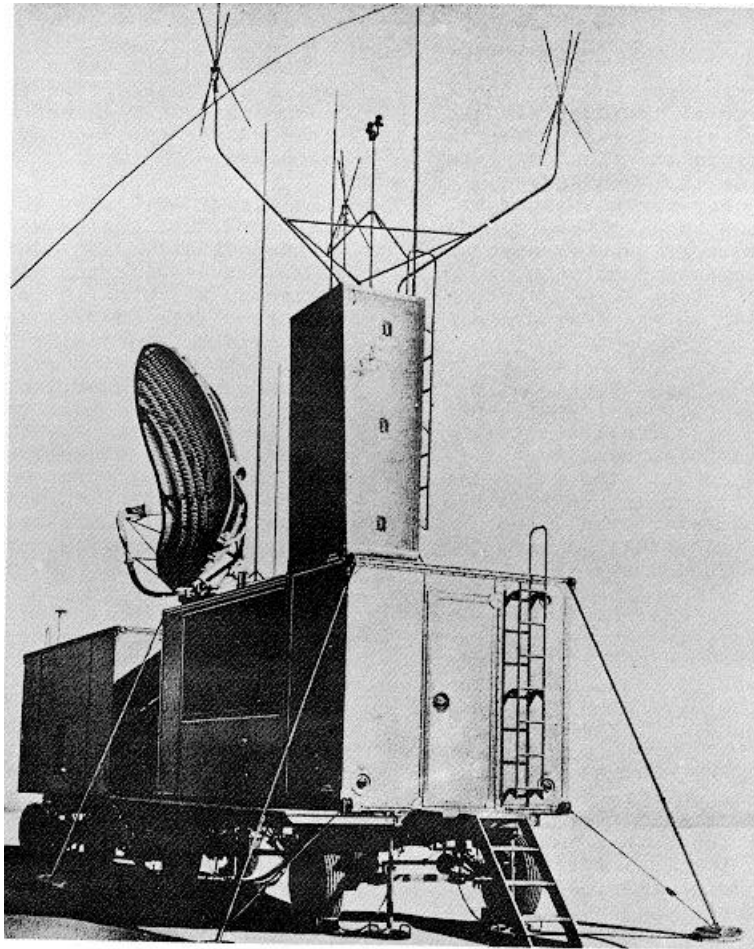

### FUNCTIONAL DESCRIPTION

Landing Control Set AN/MPN-11 is a self-contained, mobile, ground-controlled approach (GCA) radar equipment, used as an air-traffic control center for precision landing of aircraft during periods of reduced

visibility. The AN/MPN-11 consists of a search radar set used for initially locating aircraft flying within a 30-mile radius of the set, a precision radar equipment preset to track aircraft down a specific glidepath during the final approach, and radio communications equipment to provide

**AN/MPN-11A: 1**

**ITEM NAME:** LANDING CONTROL SET

**TYPE:** AN/MPN-11A, AN/MPN-11B, AN/MPN-11C, AN/MPN-11D

essential two-way communication between the ground and the aircraft. Special features incorporated in the AN/MPN-11 are moving target indication (MTI), used with either or both radar sets to eliminate or attenuate return echo signals from stationary targets; instantaneous direction-finding equipment, used in conjunction with the search radar set to locate aircraft in radio communication with the control center; circular polarization gratings on the precision antenna's, to reduce the echoes from rain or snow without comparable loss of echo signals from the aircraft; and operator controlled tilt of the search antenna. In addition, all accessory equipment and power supplies are provided to permit the search radar set to function as a completely independent unit.

The 30-mile approach area must be under constant surveillance so that approaching aircraft can be initially located, identified, and directed into the final approach position. To provide this 360-degree azimuth scan, the power-drive antenna is mounted on a rotating base. This antenna concentrates the radio-frequency energy into a high, narrow radiation pattern, to consistently return echoes strong enough for good presentation on the search indicators.

The direction-finding equipment may use any one of the high-frequency, very-high-frequency, or ultra-high-frequency communication channels to locate and identify aircraft communicating with the radar set. When the direction-finder set is switched on at the search indicator panel, the radio-frequency carrier radiated from the aircraft is used to generate a strobe of light on the plan position indicator (PPI) oscilloscope to indicate aircraft direction. When a high-frequency, very-high-frequency or ultra-high-frequency channel is selected on the communications control panel at a control position, the direction finding set is automatically tuned to the same frequency.

The precision radar equipment incorporates a single X-band transmitter, pulsing alternately through separate azimuth and elevation antennas, to track aircraft down the glidepath during the final approach.

The consistent reliable range of the precision equipment is approximately 10 nautical miles, slant range, for small aircraft flying within an elevation angle of 6 degrees. The electronically traced range marks, occurring at 1-nautical-mile intervals, are spaced logarithmically on the plan-position indicator, so that the most critical first mile of the visual display occupies a greater distance along the indicator sweep than the less critical succeeding miles. This has the effect of expanding that portion of both displays representing the area in which the aircraft actually contacts the runway.

**RELATION TO SIMILAR EQUIPMENT**

AN/CPN-4 and AN/MPN-11 models are all interchangeable with each other. The difference in AN/CPN-4 and AN/MPN-11 models is variation in body styles, AN/CPN-4 has bolted trailer panels and AN/MPN-11 has riveted panels.

Landing Control Set AN/MPN-11A has a self-contained primary power source, and uses communications equipment as follows: Transceiver 185-4 for hf, AN/ARC-3 for vhf, and AN/ARC-27 for uhf operation.

The AN/MPN-11B has a self-contained primary power source, and uses Communication Equipment AN/ART-13 and AN/ARR-15 for hf, AN/ARC-3 for vhf, and AN/ARC-27 for uhf operation.

The AN/MPN-11C uses an external Government-furnished engine-generator in place of the normally used Engine Generator PU-211/G; a 7-1/2 ton electric Air Conditioner HD-237/MPN-11C is used in place of the Diesel Air Conditioner HD-78/G normally used by other models; a Power Distribution Panel SB-503/MPN-11C is used to control an external engine-generator and electric air conditioner; a 28 volt rectifier power supply (Power Supply PP-1383/MPN-1K) is furnished in place of Motor-Generator PU220/GPN, used by other models of the AN/MPN-11; and the AN/MPN-11C does not require the remote line drives, remote line driver power supplies, or associated cabling.

The AN/MPN-11D is similar to the AN/MPN-11C except that it incorporates AFC control of the S and X band transmitter magnetrons as well as AGCA tie-in provisions and does not include Interconnecting Group AN/GPA-41. Subsequent to these circuit and equipment changes, this item is still functionally interchangeable with AN/MPN-11C.

**TECHNICAL DESCRIPTION**

Search System

Frequency Range: 2780 to 2820 mc  
Power Output: 600 kw (peak)  
Pulse Repetition Rate: 1500 pps  
Range: 20 to 30 mi, depending on type of aircraft tracked.

Coverage

Azimuth: 360 deg  
Elevation: 1/2 to 45 deg

System Accuracy

Azimuth: 1 deg  
Range: 4 pct

**ITEM NAME:** LANDING CONTROL SET

**TYPE:** AN/MPN-11A, AN/MPN-11B, AN/MPN-11C, AN/MPN-11D

Range: 200 ft

Communication System: hf, vhf, and uhf radio sets

Air Conditioning System

Temperature Range (Dynamic): -54 deg C (-65 deg F) to plus 49 deg C (plus 120 deg F)

Power Requirements: 120 or 208v, ac, 50

cps, 3 ph, 4-wire, 25 kva

**INSTALLATION CONSIDERATIONS**

Siting: Clear, level area adjacent to runway, removed from any blocking or obstructing structure.

Mounting: Two cargo trailers are used to mount equipment from any model except the AN/MPN-11C which uses one extra cargo trailer to mount special power facilities.

Cabling Requirements:

Control Cable - Furnished with equipment.

Signal Cable - Furnished with equipment.

Power Cable - Furnished with equipment.

Resolution  
Azimuth: 3.3 deg  
Range: 500 ft

Precision System  
Frequency Range: 9000 to 9160 mc  
Power Output: 45 kw (peak)  
Pulse Repetition Frequency: 5500 pps  
(1800 pps on indicator)  
Range: 10 mi  
Coverage  
Azimuth: 20 deg  
Elevation: 7 deg

System Accuracy  
Azimuth: 0.6 pct of range  
Elevation: 0.3 pct of range  
Range: 2.0 pct

Resolution  
Azimuth: 1.1 deg  
Elevation: 0.6 deg

**PRINCIPAL COMPONENTS AND PHYSICAL DATA**

<b>COMPONENT</b>	<b>QTY</b>	<b>HEIGHT (Inches)</b>	<b>WIDTH (Inches)</b>	<b>DEPTH (Inches)</b>	<b>UNIT WT. (Pounds)</b>
Antenna Support (vhf) AB-194/GPN					
Antenna Base AB-195/GPN					
Antenna Support (uhf) AB-333/GPN					
Radar Test Set AN/GPN-16					
Antenna Horn AS-513/GPN					
Antenna (Azimuth) AS-519/GPN					
Antenna (Elevation) AS-520/GPN					
Antenna (uhf) AT-197/GR					
Antenna AT-282/GPN					
Antenna AT-283/GPN					
Antenna Reflector (Search) AT-284/GPN					
Antenna AT-285/GPN					
Antenna Reflector (Azimuth) AT-290/GPN					
Antenna Reflector (Elevation) AT-291/GPN					
Radio Set Control C-872/GPN					
Signal Comparator CM-35/GPN					
Directional Coupler CU-266/GPN					
Signal Data Converter CV-142/GPN					
Air Conditioner HD-78/G					
Electric Exhaust Fan HD-98/GPN					
Electric Exhaust Fan HD-222/GPN					
Air Conditioner HD-237/MPN-11C					
Azimuth Elevation-Range Indicator IP-127/GPN					
Azimuth Elevation-Range Indicator IP-128/GPN					
Modification Kit MX-1211/GPN					
Indicator Group OA-230/GPN					
Indicator Group (Search) OA-231/GPN					
Synchroscope Set OA-233/GPN					
Antenna Group OA-235/GPN					
Transmitter Group OA-243/GPN					

ITEM NAME: LANDING CONTROL SET

TYPE: AN/MPN-11A, AN/MPN-11B, AN/MPN-11C, AN/MPN-11D

PRINCIPAL COMPONENTS AND PHYSICAL DATA

COMPONENT	QTY	HEIGHT (Inches)	WIDTH (Inches)	DEPTH (Inches)	UNIT WT. (Pounds)
Comparator-Power Supply Group OA-244/GPN					
Comparator-Power Supply Group OA-245/GPN					
Dynamotor Power Distribution Group OA-251/GPN					
Radar Set Group OA-257/GPN					
Radar Set Group OA-258/GPN					
Radar Set Group OA-259/GPN					
Radar Set Group OA-262/GPN					
Communication Operation Group (lower) OA-267/GPN					
Indicator Control Group OA-271/GPN					
Radar Set Group OA-276/GPN					
Direction Finder Group OA-277/GPN					
Communications Operation Group (upper) OA-278/GPN					
Radar Set Group OA-279/GPN					
Antenna Group OA-634/MPN-11					
Antenna Group (Elevation) OA-642/MPN-11					
Antenna Group (Azimuth) OA-643/MPN-11					
Radar Set Control Group OA-644/MPN-11					
Communications Operation Group (upper 13) OA-645/MPN-11					
Communications Operation Group (upper 16) OA-646/MPN-11					
Communications Operation Group (upper 10) OA-647A/MPN-11					
Power Supply (10 kw) PP-607/GPN					
Power Supply (28v, dc) PP-1383/MPN-11C					
Engine Generator PU-211/G					
Radio Receiver-Transmitter RT-178/ARC-27					
Power Distribution Panel SB-508/MPN-11C					
Electrical Synchronizer SN-87/GPN					
Electrical Synchronizer SN-88/GPN					
Radar Transmitter T-289/GPN					
Sweep Generator TD-50/GPN					
Sweep Generator TD-51/GPN					
Pulse Generator TD-57/GPN					
Map Generator TD-58/GPN					
Map Generator TD-58A/GPN					
Antenna Drive (Search) TG-11/GPN					
Antenna Drive (Precision) TG-12/GPN					
Cargo Trailer (Operations) V-96/MPN-11					
Cargo Trailer (Power) V-97/MPN-1 1					
Cargo Trailer (Power) V-121/MPN-11C					
REFERENCE DATA AND LITERATURE					
TECHNICAL ORDERS: 31P5-2MPN11	Series	31P5-2CPN4-565		31P5-2MPN11-506 and -504	
		<b>AN/MPN-11A: 4</b>			

DATE: 1 October 1964

ITEM NAME: LANDING CONTROL CENTRAL

COGNIZANT SERVICE: USAF

TYPE: AN/MPN-13

FEDERAL STOCK NUMBER: 5895-885-2274-EG

	USA	USN	USAF	USMC
STATUS OR TYPE CLASSIFICATION			No Status Assigned	
Mfg(s) Name or (code Number. Gilfillan Brothers				

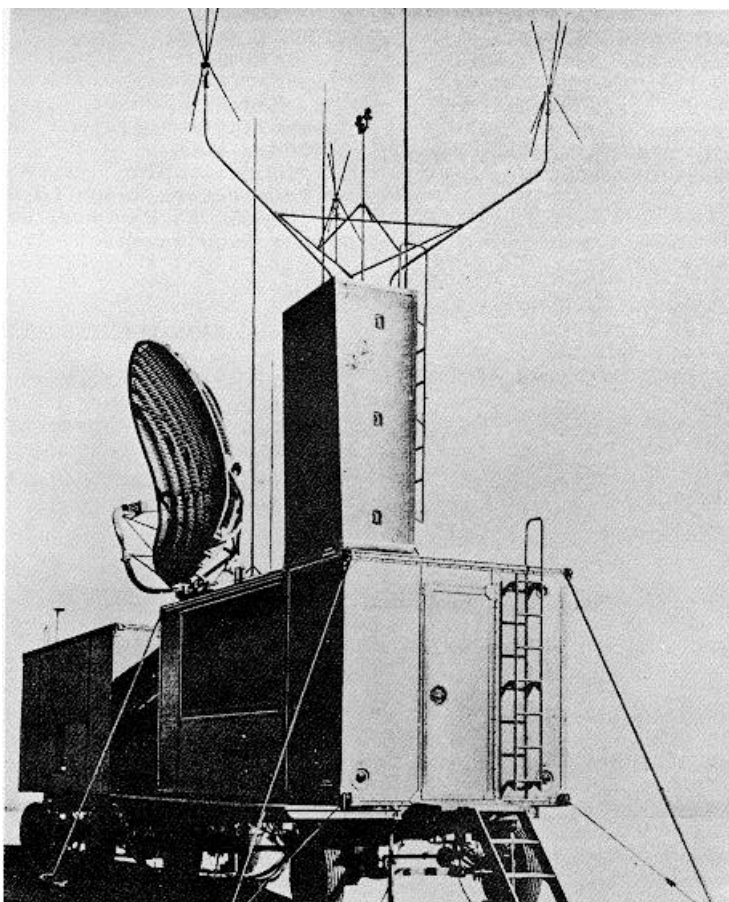

**FUNCTIONAL DESCRIPTION**

Landing Control Set AN/MPN-13 is a self-contained mobile, ground-controlled-approach (GCA) radar equipment, used as an air-traffic control center for precision landing of aircraft during periods of reduced visibility.

The AN/MPN-13 consists of a search radar set used for initially locating aircraft flying within a 30-mile radius of the set, a precision radar equipment preset to track aircraft down a specific glidepath during the final approach, and radio communications equipment to provide essential two-

**ITEM NAME:** LANDING CONTROL CENTRAL

**TYPE:** AN/MPN-13

way communication between the ground and the aircraft. Landing Control Set AN/MPN-13 is an improved model of the AN/CPN-4 models and AN/PPN-11A, AN/MPN-11B, and AN/MPN-11C incorporating recent changes such as extended range coverage, additional search cursors, improved receiver design, and monitoring of the power output, relative tuning, and noise figure characteristics. The AN/MPN-13 has all the modes applicable to the AN/CPN-4 and AN/MPN-11 applied to it.

**RELATION TO SIMILAR EQUIPMENT**

The AN/MPN-13 is similar to the AN/MPN-14 without the mobile RAPCON added. The AN/MPN-13 is either a basic AN/CPN-4, AN/CPN-4A, AN/CPN-4B, AN/MPN-11A, AN/MPN-11B or an AN/MPN-11C, difference is an improved model incorporating recent changes. The AN/MPN-13 is similar to the AN/MPN-15, difference is in production models.

**TECHNICAL DESCRIPTION**

**Search System**

Frequency Range: 2780 to 2820 \*c  
Power Output: 600 kw (peak)  
Pulse Repetition Rate: 1500 pps  
Range: 20 to 30 mi, depending on type of aircraft tracked.

**Coverage**

Azimuth: 360 deg  
Elevation: 1/2 to 45 deg

**System Accuracy**

Azimuth: 1 deg  
Range: 4 pct

**Resolution**

Azimuth: 3.3 deg  
Range: 500 ft  
Precision System  
Frequency Range: 9000 to 9160 mc  
Power Output: 45 kw (peak)  
Pulse Repetition Frequency: 5500 pps (1800 pps on indicator)  
Range: 10 mi  
Coverage  
Azimuth: 20 deg  
Elevation: 7 deg  
System Accuracy  
Azimuth: 0.6 pct of range  
Elevation: 0.3 pct of range  
Range: 2.0 pct  
Resolution  
Azimuth: 1.1 deg  
Elevation: 0.6 deg  
Range: 200 ft

Communication System: hf, vhf and uhf radio sets

**Air Conditioning System**

Temperature Range (Dynamic): -54 deg C (-65 deg F) to 49 deg C (120 deg F)

Power Requirements: 120 or 208v, ac, 50 cps, 3 ph, 4-wire, 25 kva.

**INSTALLATION CONSIDERATIONS**

Siting: Clear, level area adjacent to aircraft runway, removed from any blocking or obstructing structure.

Mounting: Cargo trailers are used to mount equipment.

**PRINCIPAL COMPONENTS AND PHYSICAL DATA**

<b>COMPONENT</b>	<b>QTY</b>	<b>HEIGHT (Inches)</b>	<b>WIDTH (Inches)</b>	<b>DEPTH (Inches)</b>	<b>UNIT WT.</b>
Antenna Support (vhf) AB-194/GPN					
Antenna Base AB-195/GPN					
Antenna Support (uhf) AB-333/GPN					
Radar Test Set AN/GPN-16					
Antenna Horn AS-513/GPN					
Antenna (Azimuth) AS-519/GPN					
Antenna (Elevation) AS-520/GPN					
Antenna (uhf) AT-197/GR					
Antenna AT-282/GPN					
Antenna AT-283/GPN					
Antenna Reflector (Search)					
AT-284/GPN					
Antenna AT-285/GPN					
Antenna Reflector (Azimuth)					
AT-290/GPN					
Antenna Reflector (Elevation)					
AT-291/GPN					
Radio Set Control C-872/GPN					
Signal Comparator CM-35/GPN					
Directional Coupler CU-266/GPN					
Signal Data Converter					
CV-142/GPN					

ITEM NAME: LANDING CONTROL CENTRAL  
TYPE: AN/MPN-13

COMPONENT	PRINCIPAL COMPONENTS AND PHYSICAL DATA			DEPTH (Inches)	UNIT WT.
	QTY	HEIGHT (Inches)	WIDTH (Inches)		
Air Condition HD-78/G					
Electric Exhaust Fan HD-98/GPN					
Electric Exhaust Fan HtD-222/GPN					
Air Condition(r HD-237/MPN-11C					
Azimuth Elevation-Range Indicator IP-.27/GPN					
Azimuth Elevation-Range Indicator IP-128/GPN					
Modification Kit MX-1211/GPN					
Indicator Group OA-230/GPN					
Indicator Group (Search) OA-231/GPN					
Synchroscope Set OA-233/GPN					
Antenna Group OA-235/GPN					
Transmitter Group OA-243/GPN					
Comparator-Power Supply Group OA-244/GPN					
Comparator-Power Supply Group OA-245/GPN					
Dynamotor Power Distribution Group OA-251/GPN					
Radar Set Group OA-257/GPN					
Radar Set Group OA-258/GPN					
Radar Set Group OA-259/GPN					
Radar Set Group OA-262/GPN					
Communication Operation Group (lower) OA-267/GPN					
Indicator Control Group OA-271/GPN					
Radar Set Group OA-276/GPN					
Direction Finder Group OA-277/GPN					
Communications Operation Group (upper) OA-278/GPN					
Radar Set Group OA-279/GPN					
Antenna Group OA-634/MPN-11					
Antenna Group (Elevation) OA-642/MPN-11					
Antenna Group (Azimuth) OA-643/MPN-1 1					
Radar Set Control Group OA-644/MPN-11					
Communications Operation Group (upper 13) OA-645/MPN-11					
Communications Operation Group (upper 16) OA-646/MPN-11					
Communications Operation Group (upper 10) OA-647A/MPN-11					
Power Supply (10 kw) PP-607/GPN					
Power Supply (28v, dc) PP-1383/MPN-11C					
Engine Generator PU-211/G					
Radio Receiver-Transmitter RT-178/ARC-27					
Power Distribution Panel SB-508/MPN-11C					
Electrical Synchronizer SN-87/GPN					
Electrical Synchronizer SN-88/GPN					
Radar Transmitter T-289/GPN					
Sweep Generator TD-50/GPN					
Sweep Generator TD-51/GPN					

**ITEM NAME:** LANDING CONTROL CENTRAL

**TYPE:** AN/MPN-13

**PRINCIPAL COMPONENTS AND PHYSICAL DATA**

<b>COMPONENT</b>	<b>QTY</b>	<b>HEIGHT (Inches)</b>	<b>WIDTH (Inches)</b>	<b>DEPTH (Inches)</b>	<b>UNIT WT.</b>
Pulse Generator TD-57/GPN					
Map Generator TD-SB/GPN					
Map Generator TD-SBA/GPN					
Antenna Drive (Search) TG-11/GPN					
Antenna Drive (Precision) TG-1 2/GPN					
Cargo Trailer (Operations) V-96/MPN-11					
Cargo Trailer (Power) V-97/MPN-11					
Cargo Trailer (Power) V-121/MPN-11C					

**REFERENCE DATA AND LITERATURE**

**TECHNICAL ORDERS:**

- 31P5-2MPN11- Series
- 31P5-2CPN4-565
- 31P5-2MPN11-506 and -504



DATE: 1 October 1964

ITEM NAME: LANDING CONTROL CENTRAL

COGNIZANT SERVICE: USAF

TYPE: AN/MPN-14

FEDERAL STOCK NUMBER: 5895-885-2273-EG

	USA	USN	USAF	USMC
STATUS OR TYPE CLASSIFICATION			No Status Assigned	
Mfg(s) NAME or Code Number: Gilfillan Corporation				

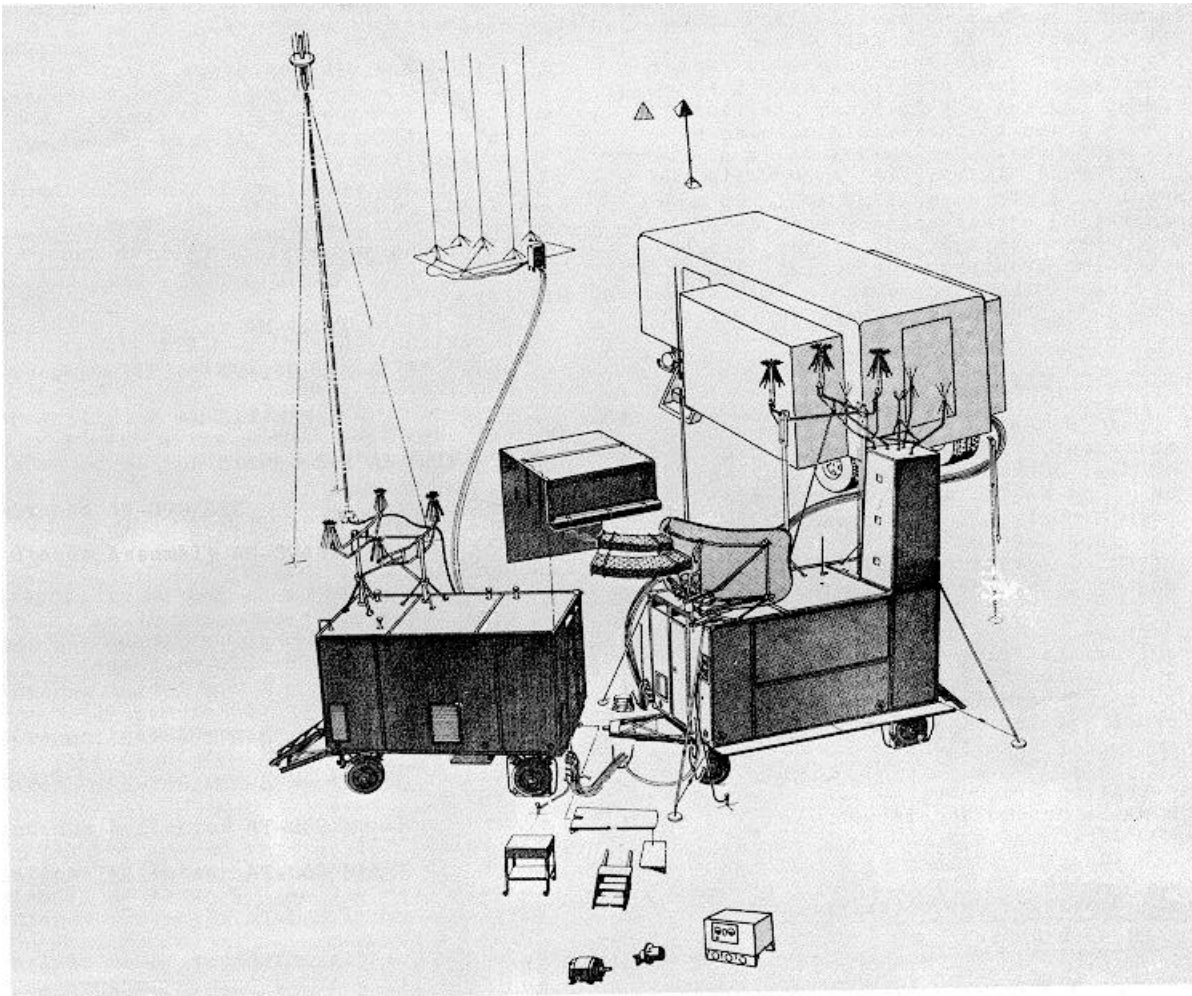

**FUNCTIONAL DESCRIPTION**

The AN/MPN-14 basically functions as an air-traffic control center for directing and landing aircraft. The mobile RAPCON trailer, together with the operations trailer and power trailer, comprise Land-

ing Control Central AN/MPN-14. The mobile RAPCON trailer provides a centralized operating area from which to control the movement of aircraft within a 60 mile radius. The equipment contained in the mobile RAPCON augments the GCA Radar Set to control the movement of air traffic

**ITEM NAME:** LANDING CONTROL CENTRAL  
**TYPE:** AN/MPN-14

approaching or departing from an airfield.

#### **RELATION TO SIMILAR EQUIPMENT**

The AN/MPN-14 is similar to the AN/MPN-16, difference is in production models. The AN/MPN-14 and AN/MPN-16 are similar to the AN/MPN-13 and AN/MPN-15, difference is the mobile RAPCON used with the AN/MPN-14 and AN/MPN-16 but not with the AN/MPN-13 and AN/MPN-15. The AN/MPN-14 is a basic AN/MPN-13 with a mobile RAPCON added. Also, to adapt it for use with the mobile RAPCON, the radar set has been modified to remote search and precision indicating functions, performance monitoring signals, and communications control to the RAPCON van. Additional uhf radio sets have been installed, new telephone facilities have been provided, and two-way intercom stations have been added to facilitate maintenance of the equipment. The AN/MPN-13 is a basic AN/MPN-4, AN/MPN-11A, AN/MPN-11B, or AN/MPN-11C, difference is an improved model incorporating recent changes such as extended range coverage, additional search cursors, improved receiver design, and monitoring of the power output, relative tuning, and noise figure characteristics.

#### **TECHNICAL DESCRIPTION**

##### Primary AC Power

Requirement: 120/208v, 4-wire, 3 ph, 60 cps, 30 kw (min) RAPCON trailer only, 66 kw including radar set, regulated to 117 plus or minus 2v for input of 106-132v

Source: Government furnished diesel-engine generator or commercial

##### DC Power

Requirement: plus 28v

Source: plus 28v, 50 amp power supply in RAPCON trailer, or batteries in power trailer at 10 amp max for emergency conditions.

##### Communication Frequency

Transmitting and Receiving:  
100 to 156 mc and  
225 to 399.9 mc

##### General Operating Characteristics (Search Radar)

Frequency Range: 2780 to 2820 mc

Power Output: 600 kw (peak)

Range (determined with T-33 type aircraft):

At 2000 ft, at least 20 naut mi

At 6000 ft, at least 25 naut mi

At 10,000 ft, at least 30 naut mi

At 25,000 ft, at least 35 naut mi

Coverage

Azimuth: 360 deg

Elevation: Cosecanting to 45 deg

Accuracy

Azimuth: 1 deg when target range is more than 10 pct of indicator range.

Range: 4 pct when target range is more than 20 pct of indicator range setting.

Resolution

Azimuth: 2.3 deg when target range is more than 30 pct of indicator range setting.

Range: 675 ft target separation or

1 pct of indicator range setting, whichever is greater.

PRF: 1100 pps plus or minus 2 pct

Amplitude (terminated in 100 ohms): 35v

min for at least 0.5 usec at 50 pct of peak amplitude.

Rise Time: 400v per usec min

Indicator Characteristics (Search Radar)

Display

Type: 12 in. ppi

Information: Normal and MTI video,

range marks, angle marks, cursors, and IFF/SIF video.

Sweeps: Rotating linear sweep synchronized with antenna scan

Ranges

Range Marks: 5, 10, 20, 40, 60, and 200 naut mi

Range Mark Calibration:

2-mi intervals on 5- and 10-mi ranges

5-mi intervals on 20- and 40-mi ranges

10-mi intervals on 60-mi range

50-mi intervals on 200-mi range

Off-Centering: Sweep center may be moved

to edge of display, approximately doubling range up to 60 mi max in sector displayed except for 40-, 60-, and 200-mi ranges.

Angle Marks: At -5 deg, 0 deg, and plus

15 deg to indicate outline of precision azimuth coverage with respect to runway parallel.

Electronic Cursors: Two (or three if 3rd

Indicator is used) separate cursors to indicate desired flightpaths.

Maps: Navigation head and compass rose

for mechanical calibration of target bearing and as provided by video mapper.

**ITEM NAME:** LANDING CONTROL CENTRAL

**TYPE:** AN/MPN-14

General Operating Characteristics  
(Precision Radar)

Frequency Range: 9000 to 9160 mc

Power Output: 45 kw (peak)

Range (determined with T-33 type aircraft):

At least 8 naut mi

Coverage

Azimuth: 20 deg

Elevation: 7 deg

Accuracy

Azimuth: 0.6 pct of target range plus 10 pct of deviation from optimum approach path.

Elevation: 0.3 pct of target range plus 10 pct of deviation from glidepath.

Range: 2 pct when target range is more than 5 pct of indicator range setting.

Resolution

Azimuth: 1.1 deg target separation

Elevation: 0.6 deg target separation

Range: 200 ft separation

Detectable deviation from glidepath:  
25 ft at one-mi range

PRF: 1833 pps plus or minus 3 pct  
(precision indicator)

Amplitude (terminated in 100 ohms): 35v  
min for at least 0.5 usec at 50 pct of  
peak amplitude.

Rise Time: 400v per usec min

Indicator Characteristics (Precision Radar):

Display

Type: Azimuth (lower half) and elevation (upper half) expanded displays combined on 12 in. CRT with sector limiting to prevent overlap.

Information: Normal and MTI video, range marks, cursors, and servo data.

Sweeps: Logarithmic timebase sweeps 8-5/16 in. long. At 1 mi, sensitivity is 3 times that of linear sweep at one mi

Range

Range Marks: Adjustable for any range between 6 and 10 naut mi

Range Mark Calibration: 1-mi intervals with variable delay between 0 and 55 used (0 to 4.5 mi) with respect to the timebase sweep origin.

Off-Centering: Azimuth scale expanded approx 3 times, with vertex at left

and runway approach course horizontal; elevation up- down scale expanded approx 10 times, with vertex at left and ground line horizontal. Logarithmic range scales provide increasing sensitivity with decreasing range.

Electronic Cursors: Separate cursors to indicate azimuth courseline, elevation glidepath, and glidepath downward deviation limit.

Maps: Separate illuminated maps indicate limits of scan and intervening degree marks for both azimuth and elevation sectors.

Environmental Conditions

Ambient Temperature

Operating: Interior, -22 deg to plus 140 deg F (-30 deg to plus 60 deg C)

Nonoperating: Exterior, -40 deg to plus 140 deg F (-40 deg to plus 60 deg C)

Relative Humidity: 100 pct max under plus 90 deg F (plus 32 deg C)

Barometric Pressure (operating): Sea level to 6000 ft

Salt Atmosphere: As encountered in coastal regions.

Sand and Dust: As encountered in desert regions.

Rain: As encountered in tropical regions.

**INSTALLATION CONSIDERATIONS**

Siting: The mobile RAPCON may be located up to a distance of 500 feet from the GCA repair set. The mobile RAPCON must never be located within the scan area of the precision antennas of the radar set. The AN/MPN-14 equipment must be located a minimum distance of 500 feet from the centerline of any runway, 250 feet from the far edge of any taxiway (350 feet for heavy bomber bases) and 125 feet from the far edge of any apron. These distances are measured to the end of the AN/IPN-14 equipment nearest the runway, taxiway or apron.

Cabling Requirements: The mobile RAPCON equipment is capable of remote operation up to a distance of 500 feet, although only 250 feet of cable is supplied.

**ITEM NAME:** LANDING CONTROL CENTRAL  
**TYPE:** AN/MPN-14

**PRINCIPAL COMPONENTS AND PHYSICAL DATA**

<b>COMPONENT</b>	<b>QTY</b>	<b>HEIGHT (Inches)</b>	<b>WIDTH (Inches)</b>	<b>DEPTH (Inches)</b>	<b>UNIT WT.</b>
		MOBILE RAPCON			
Communication Control Console AN/MPA-19	1				
Communication Control Console AN/MPA-22	1				
Electrical Equipment Cabinet CY-3365/MPA-17	1				
Antenna Support AB-715/MPN	1				
Power Supply PP-3016/GPN	1				
Recorder-Reproducer Assembly RO-193/MPN	1				
Amplifier Control Group AN/MPA-25	1				
Control Indicator Group AN/MPA-9	2				
Electrical Equipment Cabinet Base MT-2617/MPN	2				
Electrical Equipment Shelf FN-131/MPN	2				
Control-Indicator C-3880/MPN	1				
Power Supply Set AN/MPA-26	1				
Control Indicator C-3709/GPN	1				
Controller Seat Assembly 33443	7				
Radar Set Data Display Board PT-458/MPN	2				
Interconnecting Cable Set 95113	1				
Intercommunication Station LS-478/MPN	2				
Aircraft Obstruction Marker Light MX-3652/MPN	1				
Communications Control Console AN/MPA-20	1				
Communications Control Console AN/MPA-21	1				

The remaining Principal Components consist of the Search Radar, Precision Radar, Antennas, and Communication Equipment of either one of the following sets which have been completely modified into the AN/MPN-13. They are the AN/CPN-4 models, AN/MPN-11A, AN/MPN-11B, and some models of the AN/MPN-11C.

- Antenna Support (vhf) AB-194/GPN
- Antenna Base AB-195/GPN
- Antenna Support (uhf) AB-333/GPN
- Radar Test Set AN/GPN-16
- Antenna Horn AS-513/GPN
- Antenna (Azimuth) AS-519/GPN
- Antenna (Elevation) AS-520/GPN
- Antenna (uhf) AT-197/GR
- Antenna AT-282/GPN
- Antenna AT-283/GPN
- Antenna Reflector (Search) AT-284/GPN
- Antenna AT-285/GPN
- Antenna Reflector (Azimuth) AT-290/GPN
- Antenna Reflector (Elevation) AT-291/GPN
- Radio Set Control C-872/GPN
- Signal Comparator CM-35/GPN
- Directional Coupler CU-266/GPN

**AN/MPN-14: 4**

**ITEM NAME:** LANDING CONTROL CENTRAL  
**TYPE:** AN/MPN-14

**PRINCIPAL COMPONENTS AND PHYSICAL DATA**

<b>COMPONENT</b>	<b>QTY</b>	<b>HEIGHT (Inches)</b>	<b>WIDTH (Inches)</b>	<b>DEPTH (Inches)</b>	<b>UNIT WT.</b>
Signal Data Converter CV-142/GPN					
Air Conditioner HD-78/G					
Electric Exhaust Fan HD-98/GPN					
Electric Exhaust Fan HD-222/GPN					
Air Conditioner HD-237/MPN-11C					
Azimuth Elevation-Range Indicator IP-127/GPN					
Azimuth Elevation-Range Indicator IP-128/GPN					
Indicator Group OA-230/GPN					
Indicator Group (Search) OA-231/GPN					
Synchroscope Set OA-233/GPN					
Antenna Group OA-235/GPN					
Transmitter Group OA-243/GPN					
Comparator-Power Supply Group OA-244/GPN					
Comparator-Power Supply Group OA-245/GPN					
Dynamotor Power Distribution Group OA-251/GPN					
Radar Set Group OA-257/GPN					
Radar Set Group OA-258/GPN					
Radar Set Group OA-259/GPN					
Radar Set Group OA-262/GPN					
Indicator Control Group OA-271/GPN					
Radar Set Group OA-276/GPN					
Direction Finder Group OA-277/GPN					
Radar Set Group OA-279/GPN					
Antenna Group OA-634/MPN-11					
Antenna Group (Elevation) OA-6-142/MPN-11					
Antenna Group (Azimuth) OA-6, 13/MPN-11					
Radar Set Control Group OA-6441/MPN-11					
Power Supply (10 kw) PP-607/GPN					
Power Supply (28v, dc) PP-1383/MPN- 11C					
Engine Generator PU-211/G					
Radio Receiver-Transmitter RT-178/ARC-27					
Power Distribution Panel SB-50ot/MPN-11C					
Electrical Synchronizer SN-87/GPN					
Electrical Synchronizer SN-88/GPN					
Radar Transmitter T-289/GPN					
Sweep Generator TD-50/GPN					
Sweep Generator TD-51/GPN					
Pulse Generator TD-57/GPN					
Map Generator TD-5cl/GPN					
Map Generator TD-58A/GPN					
Antenna Drive (Search) TG-11/GPN					
Antenna Drive (Precision) TG-12/GPN					
Cargo Trailer (Operations) V-96/MPN-11					

**ITEM NAME:** LANDING CONTROL CENTRAL

**TYPE:** AN/MPN-14

**PRINCIPAL COMPONENTS AND PHYSICAL DATA**

<b>COMPONENT</b>	<b>QTY</b>	<b>HEIGHT (Inches)</b>	<b>WIDTH (Inches)</b>	<b>DEPTH (Inches)</b>	<b>UNIT WT.</b>
Cargo Trailer (Power) V-97/MPN-11					
Cargo Trailer (Power) V-121/MPN-11C					

**REFERENCE DATA AND LITERATURE**

**TECHNICAL ORDERS:**  
31P5-2MPN14- Series

**AN/MPN-14: 6**

**DATE:** 1 October 1964

**ITEM NAME:** LANDING CONTROL CENTRAL

**COGNIZANT SERVICE:** USAF

**TYPE:** AN/MPN-15

**FEDERAL STOCK NUMBER:** 5895-850-1433-EG

	USA	USN	USAF	USMC
STATUS OR TYPE CLASSIFICATION			No Status Assigned	
Mfg(s) Name or Code Number. Gilfillan Brothers				

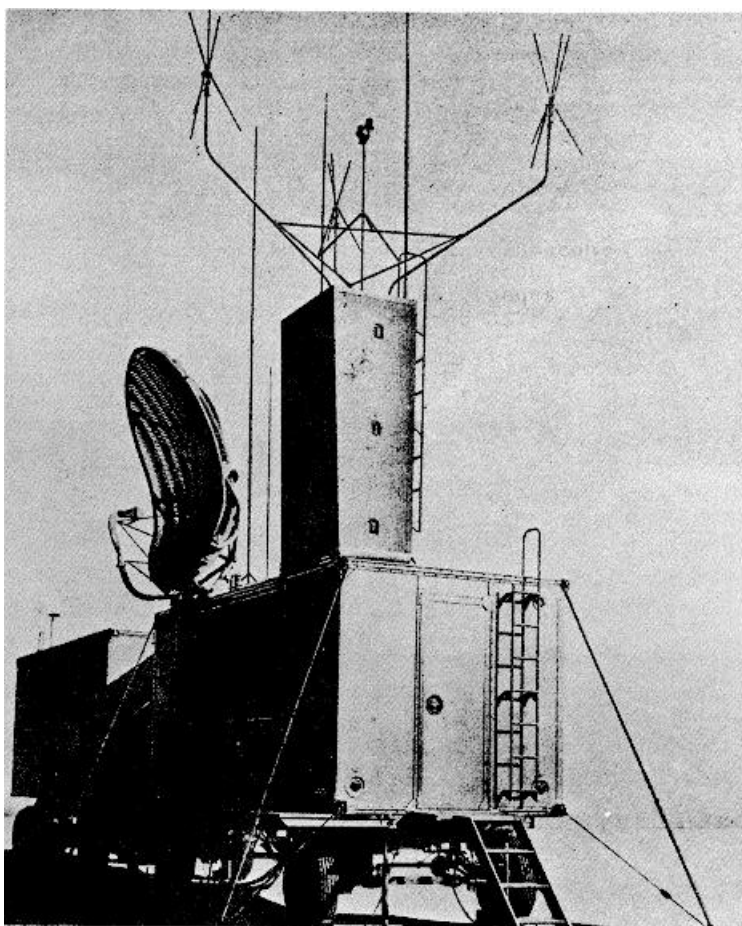

**FUNCTIONAL DESCRIPTION**

Landing Control Set AN/MPN-15 is a self-contained mobile, ground-controlled-approach (GCA) radar equipment, used as an air-traffic control center for precision landing of aircraft during periods of reduced visibility.

The AN/MPN-15 consists of a search radar set used for initially locating aircraft flying within a 30-mile radius of the set, a precision radar equipment preset to track aircraft down a specific glidepath during the final approach, and radio communications equipment to provide essential two-way

**ITEM NAME:** LANDING CONTROL CENTRAL  
**TYPE:** AN/MPN-15

communication between the ground and the aircraft. Landing Control Set AN/MPN-15 is an improved model of the AN/MPN-11C and AN/MPN-11D incorporating recent changes such as extended range coverage, additional search cursors, improved receiver design, and monitoring of the power output, relative tuning, and noise figure characteristics. The AN/MPN-15 has all the modes applicable to the AN/CPN-4 and AN/MPN-11 applied to it.

**RELATION TO SIMILAR EQUIPMENT**

The AN/MPN-15 is similar to the AN/MPN-16 without the mobile RAPCON added. The AN/MPN-15 is a basic AN/MPN-11C or AN/MPN-11D, difference is an improved model incorporating recent changes. The AN/MPN-15 is similar to the AN/MPN-13, difference is in production models.

**TECHNICAL DESCRIPTION**

**Search System**

Frequency Range: 2780 to 2B20 mc  
Power Output: 600 kw (peak)  
Pulse Repetition Rate: 1500 pps  
Range: 20 to 30 mi, depending on type  
of aircraft tracked

**Coverage**

Azimuth: 360 deg  
Elevation: 1/2 to 45 deg

**System Accuracy**

Azimuth: 1 deg  
Range: 4 pct

**Resolution**

Azimuth: 3.3 deg

Range: 500 ft

**Precision System**

Frequency Range: 9000 to 9160 mc  
Power Output: 15 kw (peak)  
Pulse Repetition Frequency: 5500 pps  
Range: 10 mi

**Coverage**

Azimuth: 20 deg  
Elevation: 7 deg

**System Accuracy**

Azimuth: 0.6 1 pct of range  
Elevation: 0.3 pct of range  
Range: 2.0 pct

**Resolution**

Azimuth: 1.1 deg  
Elevation: 0.6 deg  
Range: 200 ft

**Communication System:** hf, vhf, and uhf  
radio sets

**Air Conditioning System**

Temperature Range (Dynamic): -54 deg C  
(-65 deg F) to plus -19 deg C (plus 120 deg F)

**Power Requirements:** 120 or 2COBU, ac, 0()  
cps, 3 ph, 4-wire, 25 kva

**INSTALLATION CONSIDERATIONS**

**Siting:** Clear, level area adjacent to  
aircraft runway, removed from any  
blocking or obstructing structure.

**Mounting:** Cargo trailers are used to  
mount equipment.

**PRINCIPAL COMPONENTS AND PHYSICAL DATA**

<b>COMPONENT</b>	<b>QTY</b>	<b>HEIGHT (Inches)</b>	<b>WIDTH (Inches)</b>	<b>DEPTH (Inches)</b>	<b>UNIT WT.</b>
Antenna Support (vhf) AB-194/GPN					
Antenna Base AB-195/GPN					
Antenna Support (uhf) AB-333/GPN					
Radar Test Set AN/GPN-16					
Antenna Horn AS-513/GPN					
Antenna (Azimuth) AS-519/GPN					
Antenna (Elevation) AS-520/GPN					
Antenna (uhf) AT-197/GR					
Antenna AT-262/GPN					
Antenna AT-2813/GPN					
Antenna Reflector (Search) AT-2B4/GPN					
Antenna AT-2b85/GPN					
Antenna Reflector (Azimuth) AT-290/GPN					
Antenna Reflector (Elevation) AT-291/GPN					
Radio Set Control C-872/GPN					
Signal Comparator CM-35/GPN					
Directional Coupler CU-266/GPN					
Signal Data Converter CV-142/GPN					
Air Conditioner HiD-78/G					
Electric Exhaust Fan HD-9b/GPN					



ITEM NAME: LANDING CONTROL CENTRAL

TYPE: AN/MPN-15

PRINCIPAL COMPONENTS AND PHYSICAL DATA

COMPONENT	QTY	HEIGHT (Inches)	WIDTH (Inches)	DEPTH (Inches)	UNIT WT.
Electric Exhaust Fan HD-222/GPN					
Air Conditioner !tD-237/MPN-11C					
Azimuth Elevation-Range Indicator IP-127/GPN					
Azimuth Elevation-Range Indicator IP-128/GPN					
Modification Kit MX-1211/GPN					
Indicator Group OA-230/GPN					
Indicator Group (Search) OA-231/GPN					
Synchroscope Set OA-233/GPN					
Antenna Group OA-235/GPN					
Transmitter Group OA-2-13/GPN					
Comparator-Power Supply Group OA-2, 1, 1/GPN					
Comparator-Power Supply Group OA-245/GPN					
Dynamotor Power Distribution Group OA-251/GPN					
Radar Set Group OA-257/GPN					
Radar Set Group OA-25d/GPN					
Radar Set Group OA-259/GPN					
Radar Set Group OA-262/GPN					
Communication Operation Group (lower) OA-267/GPN					
Indicator Control Group OA-271/GPN					
Radar Set Group OA-276/GPN					
Direction Finder Group OA-277/GPN					
Communications Operation Group (upper) OA-27B/GPN					
Radar Set Group OA-279/GPN					
Antenna Group OA-631/MPN-11					
Antenna Group (Elevation) OA -612 /MPN-11					
Antenna Group (Azimuth) OA-613/MPN- 11					
Radar Set Control Group OA-644/MPN-11					
Communications Operation Group (upper 13) OA-6, 15/MPN-11					
Communications Operation Group (upper 16) OA-646/MPN-11					
Communications Operation Group (upper 10) OA-647A/MPN-11					
Power Supply (10 kw) PP-607/GPN					
Power Supply (28v, dc) PP-1363/MPN-11C					
Engine Generator PU-211/G					
Radio Receiver-Transmitter RT-178/ARC-27					
Power Distribution Panel SB-506/MPN-11C					
Electrical Synchronizer SN-87/GPN					
Electrical Synchronizer SN-88/GPN					
Radar Transmitter T-2d9/GPN					
Sweep Generator TD-50/GPN					
Sweep Generator TD-51]/GPN					
Pulse Generator TD-57/GPN					
Map Generator TD-58/GPN					

**ITEM NAME:** LANDING CONTROL CENTRAL

**TYPE:** AN/MPN-15

**PRINCIPAL COMPONENTS AND PHYSICAL DATA**

<b>COMPONENT</b>	<b>QTY</b>	<b>HEIGHT (Inches)</b>	<b>WIDTH (Inches)</b>	<b>DEPTH (Inches)</b>	<b>UNIT WT.</b>
Map Generator TD-58A/GPN					
Antenna Drive (Search) TG-11/GPN					
Antenna Drive (Precision) TG-12/GPN					
Cargo Trailer (Operations) V-96/MPN-11					
Cargo Trailer (Power) V-97/MPN- 11					
Cargo Trailer (Power) V-121/MPN-11C					

**REFERENCE DATA AND LITERATURE**

**TECHNICAL ORDERS:**

- 31PS-2MPN11 Series
- 31P5-2CPN4-565 Series
- 31P5-2MPN11-504 and -506

**AN/MPN-15: 4**

DATE: 1 October 1964

ITEM NAME: LANDING CONTROL CENTRAL

COGNIZANT SERVICE: USAF

TYPE: AN/MPN-16

FEDERAL STOCK NUMBER: 5895-850-1434-EG

	USA	USN	USAF	USMC
STATUS OR TYPE CLASSIFICATION			No Status Assigned	
Mfg(s) Name or Code Number: Gilfillan Corporation				

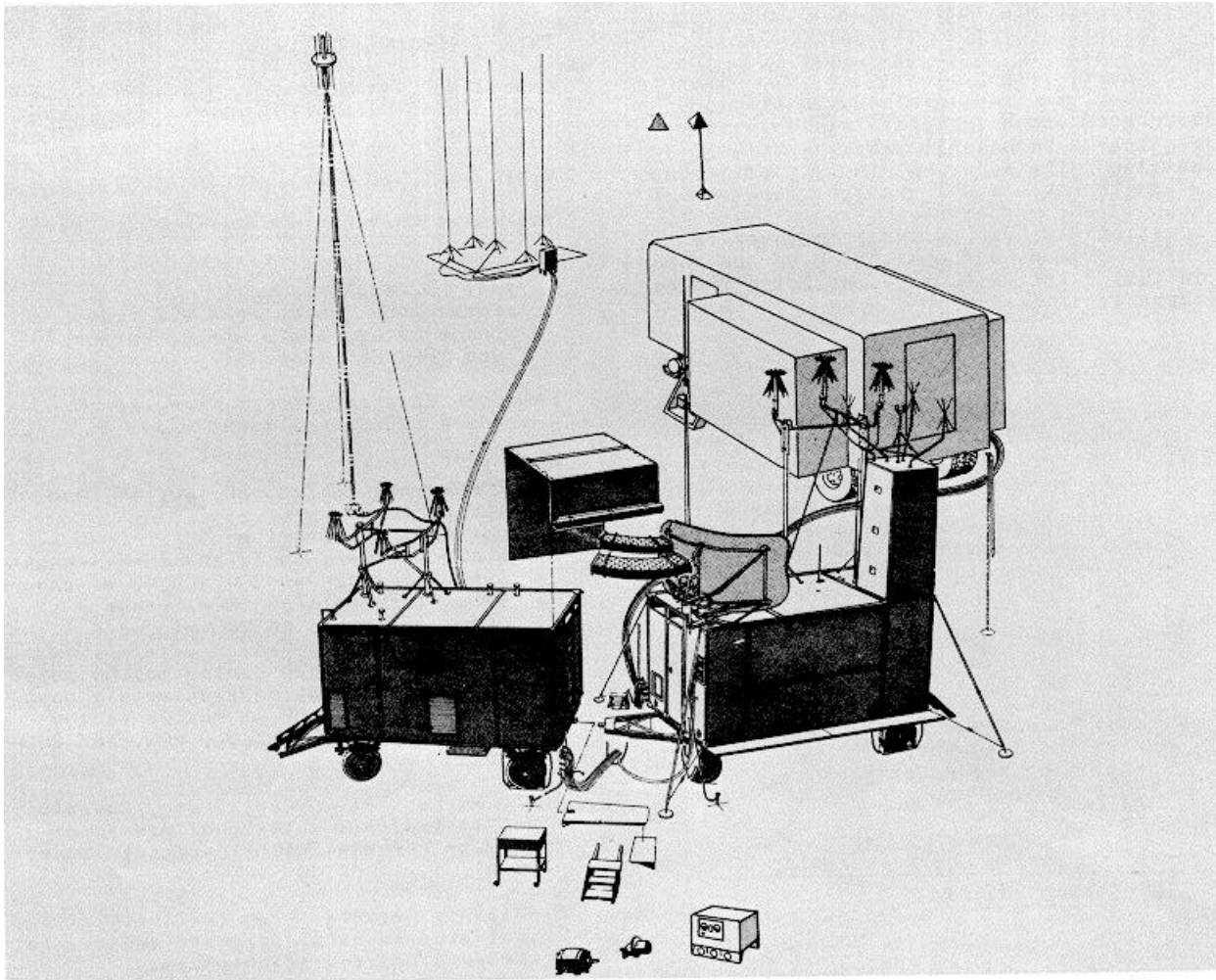

### FUNCTIONAL DESCRIPTION

The AN/MPN-16 basically functions as an air-traffic control center for directing and landing aircraft. The mobile RAPCON trailer, together with the operations trailer and power trailer, comprise Land-

ing Control Central AN/MPN-16. The mobile RAPCON trailer provides a centralized operating area from which to control the movement of aircraft within a 60 mile radius. The equipment contained in the mobile RAPCON augments the GCA Radar Set to control the movement of air traffic approaching or de-

**ITEM NAME:** LANDING CONTROL CENTRAL  
**TYPE:** AN/MPN-16

parting from an airfield.

#### **RELATION TO SIMILAR EQUIPMENT**

The AN/MPN-16 is similar to the AN/MPN-1.1, difference is in production models. The AN/MPN-16 and AN/MPN-14 are similar to the AN/MPN-15 and AN/MPN-13, difference is the mobile RAPCON used with the AN/MPN-16 and AN/MPN-14, but not with the AN/MPN-15 and AN/MPN-13. The AN/MPN-16 is a basic AN/MPN-15 with a mobile RAPCON added. Also, to adopt it for use with the mobile RAPCON, the Radar Set has been modified to remote search and precision indicating functions, performance monitoring signals, and communications control to the RAPCON van. Additional uhf radio sets have been installed, new telephone facilities have been provided, and two-way intercom stations have been added to facilitate maintenance of the equipment. The AN/MPN-15 is a basic AN/MPN-11C or AN/MPN-11D, difference is an improved model incorporating recent changes such as extended range coverage, additional search cursors; improved receiver design, and monitoring of the power output, relative tuning, and noise figure characteristics.

#### **TECHNICAL DESCRIPTION**

##### Primary AC Power

Requirement: 120/208v, 4-wire, 3 ph,  
60 cps, 30 kw (min) RAPCON trailer  
only 66 kw including radar set,  
regulated to 117 plus or minus 2v  
for input of 103-132v

Source: Government furnished diesel-  
engine generator or commercial

##### DC Power

Requirement: plus 28v  
Source: plus 28v, 50 amp power supply  
in RAPCON trailer, or batteries in  
power trailer at 10 amp max for emer-  
gency conditions.

##### Communication Frequency

Transmitting and Receiving:  
100 to 156 mc and  
225 to 399.9 mc

##### General Operating Characteristics (Search Radar)

Frequency Range: 2780 to 2820 mc

Power Output: 600 kw (peak)

Range (determined with T-33 type aircraft):

At 2000 ft, at least 20 naut mi  
At 6000 ft, at least 25 naut mi  
At 10, 000 ft, at least 30 naut mi  
At 25, 000 ft, at least 35 naut mi

##### Coverage

Azimuth: 360 deg

Elevation: Cosecanting to 45 deg

##### Accuracy

Azimuth: 1 deg when target range is  
more than 10 pct of indicator range.

Range: 4 pct when target range is more  
than 20 pct of indicator range setting.

##### Resolution

Azimuth: 2.3 deg when target range is  
more than 30 pct of indicator range setting.

Range: 675-ft target separation or  
1 pct of indicator range setting, whichever is  
greater.

PRF: 1100 pps, 2 pct

Amplitude (terminated in 100 ohms): 35v  
min for at least 0.5 usec at 50 pct of peak  
amplitude.

Rise Time: 400v per usec min

##### Indicator Characteristics (Search Radar)

##### Display

Type: 12 in. ppi  
Information: Normal and MTI video,  
range marks, angle marks, cursors,  
and IFF/SIF video.

Sweeps: Rotating linear sweep synchro-  
nized with antenna scan.

##### Ranges

Range Marks: 5, 10, 20, 40, 60, and  
200 naut mi

##### Range Mark Calibration:

2-mi intervals on 5- and 10-mi ranges  
5-mi intervals on 20- and 40-mi ranges  
10-mi intervals on 60-mi range  
50-mi intervals on 200-mi range

Off-Centering: Sweep center may be moved  
to edge of display, approximately doub-  
ling range up to 60-mi max in sector  
displayed except for 40-, 60-, and 200-mi  
ranges.

Angle Marks: At -5 deg, 0 deg, and plus 15  
deg to indicate outline of precision  
azimuth coverage with respect to runway  
parallel

Electronic Cursors: Two (or three if 3rd  
indicator is used) separate cursors to  
indicate desired flightpaths.

Maps: Navigation head and compass rose  
for mechanical calibration of target  
bearing and as provided by video mapper.

##### General Operating Characteristics (Precision Radar)

Frequency Range: 9000 to 9160 mc

**ITEM NAME:** LANDING CONTROL CENTRAL

**TYPE:** AN/MPN-16

Power Output: 45 kw (peak)  
Range (determined with T-33 type aircraft):  
At least 8 naut mi  
Coverage  
Azimuth- 20 deg  
Elevation: 7 deg  
Accuracy  
Azimuth: 0.6 pct of target range plus  
10 pct of deviation from optimum approach  
path.  
Elevation: 0.3 pct of target range plus  
10 pct of deviation from glidepath.  
Range: 2 pct when target range is more  
than 5 pct of indicator range setting.  
Resolution  
Azimuth: 1.1 deg target separation  
Elevation: 0.6 deg target separation  
Range: 200 ft separation  
Detectable deviation from glidepath:  
25 ft at one-mi range  
PRF: 1833 pps 3 pct (precision indicator)  
Amplitude (terminated in 100 ohms): 35v  
min for at least 0.5 usec at 50 pct of peak  
amplitude.  
Rise Time: 400v per usec min  
Indicator Characteristics (Precision Radar)  
Display  
Type: Azimuth (lower half) and elevation  
(upper half) expanded displays combined  
on 12 in. CRT with sector limiting to  
prevent overlap.  
Information: Normal and MTI video, range  
marks, cursors, and servo data.  
Sweeps: Logarithmic timebase sweeps 8-5/16  
in. long. At 1 mi, sensitivity is 3  
times that of linear sweep at one mi  
Ranges  
Range Marks: Adjustable for any range  
between 6 and 10 naut mi  
Range Mark Calibration: 1-mi intervals  
with variable delay between 0 and 55  
used (0 to 4.5 mi) with respect to  
the timebase sweep origin.  
Off-Centering: Azimuth scale expanded  
approx 3 times, with vertex at left and  
runway approach course horizontal; eleva-  
tion up-down scale expanded approx 10  
times, with vertex at left and ground

line horizontal. Logarithmic range  
scales provide increasing sensitivity  
with decreasing range.  
Electronic Cursors: Separate cursors to  
indicate azimuth courseline, elevation  
glidepath, and glidepath downward devi-  
ation limit.  
Maps: Separate illuminated maps indicate  
limits of scan and intervening degree  
marks for both azimuth and elevation  
sectors.  
Environmental Conditions  
Ambient Temperature  
Operating: Interior, -22 deg to plus  
140 deg F (-30 deg to plus 60 deg C)  
Nonoperating: Exterior, -40 deg to  
plus 140 deg F (-40 deg to plus 60 deg C)  
Relative Humidity: 100 pct max under  
plus 90 deg F (plus 32 deg C)  
Barometric Pressure (operating): Sea  
level to 6000 ft  
Salt Atmosphere: As encountered in  
coastal regions.  
Sand and Dust: As encountered in  
desert regions.  
Rain: As encountered in tropical  
regions.

#### **INSTALLATION CONSIDERATIONS**

Siting: The mobile RAPCON may be  
located up to a distance of 500  
feet from the GCA Radar Set. The  
mobile RAPCON must never be located  
within the scan area of the preci-  
sion antennas of the radar set. The  
AN/MPN-16 equipment must be located  
a minimum distance of 500 feet from  
the centerline of any runway, 250  
feet from the far edge of any taxi-  
way (350 feet for heavy bomber bases)  
and 125 feet from the far edge of  
any apron. These distances are meas-  
ured to the end of the AN/MPN-16  
equipment nearest the runway, taxi-  
way or apron.  
Cabling Requirements: The mobile  
RAPCON equipment is capable of  
remote operation up to a distance  
of 500 feet, although only 250  
feet of cable is supplied.

ITEM NAME: LANDING CONTROL CENTRAL  
TYPE: AN/MPN-16

PRINCIPAL COMPONENTS AND PHYSICAL DATA

COMPONENT	QTY	HEIGHT (Inches)	WIDTH (Inches)	DEPTH (Inches)	UNIT WT.
		MOBILE RAPCON			
Communication Control Console AN/MPA-19	1				
Communication Control Console AN/MPA-22	1				
Electrical Equipment Cabinet CY-3365/MPA-17	1				
Antenna Support AB-715/MPN	1				
Power Supply PP-3016/GPN					
Recorder-Reproducer Assembly RO-193/MPN	1				
Amplifier Control Group AN/MPA-25	1				
Control Indicator Group AN/MPA-9	2				
Electrical Equipment Cabinet Base ST-2617/MPN	2				
Electrical Equipment Shelf FN-131/MPN	2				
Control-Indicator C-3880/MPN	1				
Power Supply Set AN/MPA-26	1				
Control Indicator C-3709/GPN	1				
Controller Seat Assembly 33443	7				
Radar Set Data Display Board PT-458/MPN	2				
Interconnecting Cable Set 95113	1				
Intercommunication Station LS-478/MPN	2				
Aircraft Obstruction Marker Light MX-3652/MPN	1				
Communications Control Console AN/MPA-20	1				
Communications Control Console AN/MPA-21	1				

The remaining Principal Components consist of the Search Radar, Precision Radar, Antennas, and Communication Equipment of either one of the following sets which have been completely modified into the AN/MPN-15. They are the AN/MPN-11D and some models of the AN/MPN-11C.

Antenna Support (vhf) AB-194/GPN  
Antenna Base AB-195/GPN  
Antenna Support (uhf) AB-333/GPN  
Radar Test Set AN/GPN-16  
Antenna Horn AS-513/GPN  
Antenna (Azimuth) AS-519/GPN  
Antenna (Elevation) AS-520/GPN  
Antenna (uhf) AT-197/GR  
Antenna AT-282/GPN  
Antenna AT-283/GPN  
Antenna Reflector (Search) AT-284/GPN  
Antenna AT-285/GPN  
Antenna Reflector (Azimuth) AT-290/GPN  
Antenna Reflector (Elevation) AT-291/GPN  
Radio Set Control C-872/GPN  
Signal Comparator CM-35/GPN  
Directional Coupler CU-266/GPN

**ITEM NAME:** LANDING CONTROL CENTRAL

**TYPE:** AN/MPN-16

**PRINCIPAL COMPONENTS AND PHYSICAL DATA**

<b>COMPONENT</b>	<b>QTY</b>	<b>HEIGHT (Inches)</b>	<b>WIDTH (Inches)</b>	<b>DEPTH (Inches)</b>	<b>UNIT WT.</b>
Signal Data Converter CV-142/GPN					
Air Conditioner HD-78/G					
Electric Exhaust Fan HD-9B/GPN					
Electric Exhaust Fan HD-222/GPN					
Air Conditioner HD-237/MPN-11C					
Azimuth Elevation-Range Indicator IP-127/GPN					
Azimuth Elevation-Range Indicator IP-128/GPN					
Indicator Group OA-230/GPN					
Indicator Group (Search) OA-231/GPN					
Synchroscope Set OA-233/GPN					
Antenna Group OA-235/GPN					
Transmitter Group OA-243/GPN					
Comparator-Power Supply Group OA-244/GPN					
Comparator-Power Supply Group OA-245/GPN					
Dynamotor Power Distribution Group OA-251/GPN					
Radar Set Group OA-257/GPN					
Radar Set Group OA-258/GPN					
Radar Set Group OA-259/GPN					
Radar Set Group OA-262/GPN					
Indicator Control Group OA-271/GPN					
Radar Set Group OA-276/GPN					
Direction Finder Group OA-277/GPN					
Radar Set Group OA-279/GPN					
Antenna Group OA-634/MPN-11					
Antenna Group (Elevation) OA-642/MPN-11					
Antenna Group (Azimuth) OA-6.13/MPN-11					
Radar Set Control Group OA-644/MPN-11					
Power Supply (10 kw) PP-607/GPN					
Power Supply (28v, dc) PP-1383/MPN-11C					
Engine Generator PU-211/G					
Radio Receiver-Transmitter RT-178/ARC-27					
Power Distribution Panel SB-508/MPN-11C					
Electrical Synchronizer SN-87/GPN					
Electrical Synchronizer SN-88/GPN					
Radar Transmitter T-289/GPN					
Sweep Generator TD-50/GPN					
Sweep Generator TD-51/GPN					
Pulse Generator TD-57/GPN					
Map Generator TD-58/GPN					
Map Generator TD-58A/GPN					
Antenna Drive (Search) TG-11/GPN					
Antenna Drive (Precision) TG-12/GPN					
Cargo Trailer (Operations) V-96/MPN-11					

Volume 1  
Section 1

**MIL-HDBK-162A**  
15 December 1965

**ITEM NAME:** LANDING CONTROL. CENTRAL

**TYPE:** AN/MPN-16

**PRINCIPAL COMPONENTS AND PHYSICAL DATA**

<b>COMPONENT</b>	<b>QTY</b>	<b>HEIGHT (Inches)</b>	<b>WIDTH (Inches)</b>	<b>DEPTH (Inches)</b>	<b>UNIT WT.</b>
Cargo Trailer (Power) V-97/MPN-11					
Cargo Trailer (Power) V-121 /MPN-11C					

REFERENCE DATA AND LITERATURE  
TECHNICAL ORDERS:  
31P5-2MPN14- Series

**AN/MPN-16: 6**



DATE: 1 July 1961

ITEM NAME: CLOSE COOPERATION SET

COGNIZANT SERVICE: USN

TYPE: AN/MPQ-2A

	USA	USN	USAF	USMC
STATUS OR TYPE CLASSIFICATION				
Mfg(s) Name or Code Number: L.. H. Terpening Company, New York 23, New York				

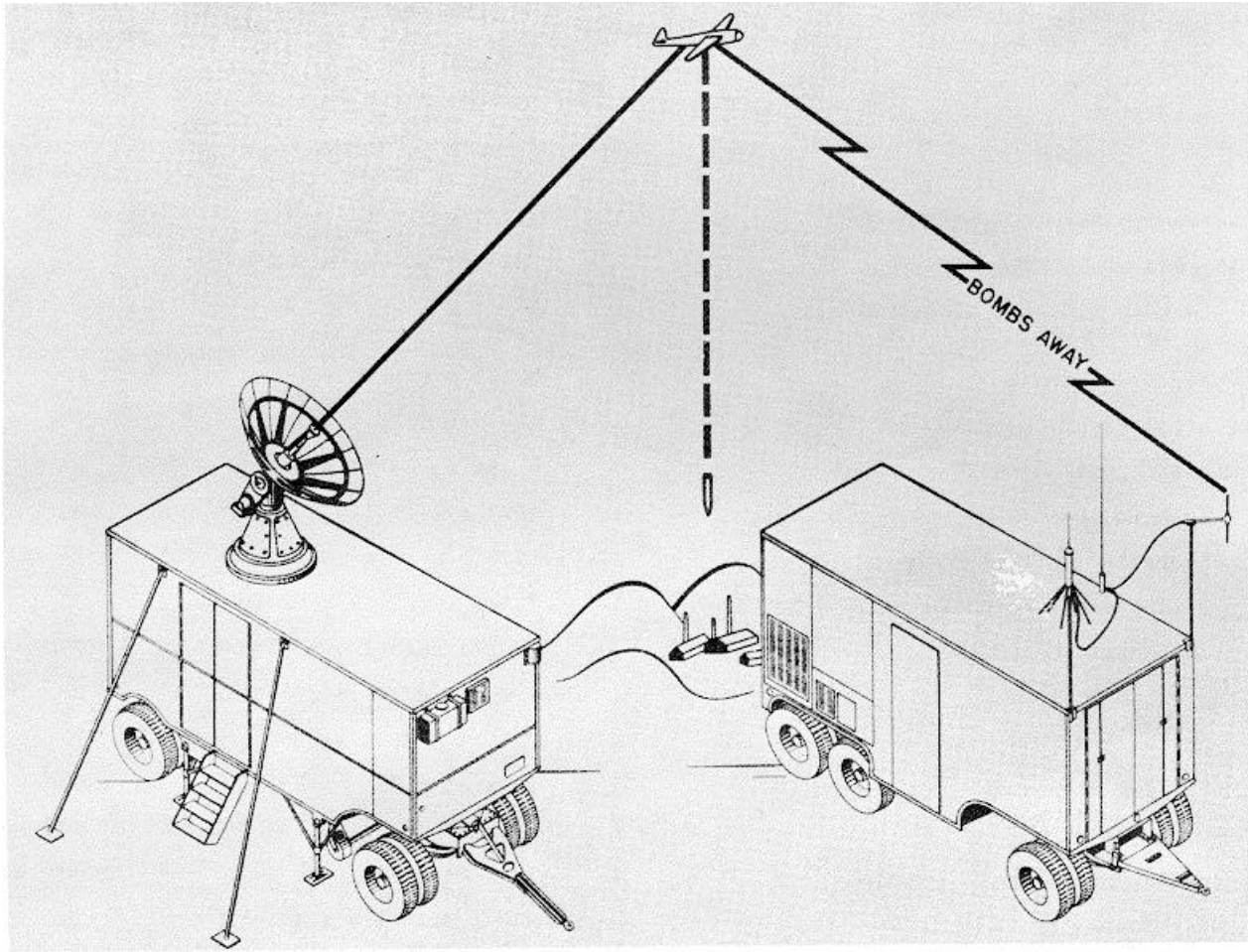

### FUNCTIONAL DESCRIPTION

The AN/MPQ-2A is a system which provides complete facilities for close support bombing. It automatically tracks and records

ground track of aircraft employed in class support tactics to furnish the pilot his position in relation to the target.

AN/MPQ-2A: 1

**ITEM NAME:** CLOSE COOPERATION SET

**TYPE:** AN/MPQ-2A

**RELATION TO SIMILAR EQUIPMENT**

None.

**TECHNICAL DESCRIPTION**

Frequency

Magnetron

2J30 (Fixed): 2900 to 21360 mc

2J31 (Fixed): 2860 to 2B20 mc

2J32 (Fixed): 2820 to 27B0 mc

2333 (Fixed): 27B0 to 2710 mc

2J34 (Fixed): 27.10 to 2700 mc

2J66 (Tunable): 2905 to 2ti15 mc

Pulse Width: 0.8 usec

Pulse Recurrence Frequency

Radar: 731 pps

Coded Beacon: 1462 pps

Intermediate Frequency: 30 mc

PPI Search

Scale 1: Out to 90 naut mi

Scale 2: Out to 50 naut mi

Scale 3: Out to 25 naut mi

Azimuth: 360 deg

Elevation: From 70 mils below to 1580 mils above the horizontal.

Altitude Coverage: 0 to 60, 000 ft

Operating Power Requirements: 115v, 60 cps, 3 ph, 12 kva max

**INSTALLATION CONSIDERATIONS**

Not available.

**PRINCIPAL COMPONENTS AND PHYSICAL DATA**

<b>COMPONENTS</b>	<b>QTY</b>	<b>OVERALL DIMENSIONS (Inches)</b>	<b>UNIT WT. (Pounds)</b>
Antenna Control C-484/MPQ-2A	1	2-3/8 x 6-7/8 x 7-1/4	5
Antenna AT-160/MPQ-2A	1	12 (deep) x 96 wide	
Azimuth & Elevation Indicator ID- 248/MPQ - 2A	1	8-3/4 x 13-1/4 x 19	
Coder KY-31/MPQ-2A	1	8-3/4 x 13-1/8 x 19	40
Control Panel C-482/MPQ-2A	1	4 x 6 x 6	
Control Unit BC-1085	1	8-3/4 x 13-1/4 x 19	50
Data Unit BC-1075	1	10-3/4 x 11-1/2 x 11-1/2	100
Dehydrator	1	14-1/2 x 19 x 23-1/2	
Distribution Panelboard J-278/MPQ-2A	1	7-1/2 x 12-1/2 x 22-1/2	30
Driver Unit BC-1080	1	12-1/4 x 13-1/4 x 21-3/4	75
Indicator BC-1092	1	9-1/8 wide x 15-3/4 deep	20
Junction Box JB-71	1	2 x 12 x 26-1/2	70
Modulator BC-984	1	26 x 34 x 55	1200
Oscillator BC-1096	1	8-3/4 x 13-1/4 x 19	50
Pedestal MP-61	1	74 x 74 x 89	2000
Power Supply PP-325/MPQ-2A	1	8-3/4 x 13-1/4 x 19	75
Power Supply Unit RA-132A	1	8-3/4 x 13-1/4 x 19	64
Pre-Amplifier AM-220/MPQ-2A	1	5-1/2 x 6 x 6-1/2	4
Radio Receiver BC-1056-D	1	8-3/4 x 13-1/4 x 19	50
Range Indicator ID-237/MPQ-2A	1	14 x 19 x 26-1/4	254
Range Tracker C-483/MPQ-2A	1	8-3/4 x 13-1/8 x 19	35

**AN/MPQ-2A: 2**

ITEM NAME: CLOSE COOPERATION SET

TYPE: AN/MPQ-2A

PRINCIPAL COMPONENTS AND PHYSICAL DATA

COMPONENTS	QTY	OVERALL DIMENSIONS (Inches)	UNIT WT. (Pounds)
Rectifier RA-66	1	8-3/4 x 13-1/4 x 19	75
Rectifier RA-68	1	26 x 34 x 55	1200
Rectifier RA-69	1	8-3/4 x 13-1/4 x 19	75
Rectifier RA-71	1	8-3/4 x 13-1/4 x 19	50
Servo Generator	1	8 x 10-1/2 x 29-1/2	100
Sweep Generator O-68/MPQ-2A	1	8-3/4 x 13-1/4 x 19	50
Switch Box SW-214	1	4-3/4 x 16-1/8 x 31-1/4	
Tracking Unit BC-1086	1	8-3/4 x 13-1/4 x 19	50
Tracking Unit BC-1090	1	8-3/4 x 13-1/4 x 19	50
Trailer K-78	1	96 x 124 x 238	9000
Video Amplifier AM-221/MPQ-2A	1	8-3/4 x 13-1/4 x 19	50
Video Amplifier AM-241/MPQ-2A	1	6-1/2 x 7-3/4 x 12-3/4	15

REFERENCE DATA AND LITERATURE

Technical Manuals:  
NAVSHIPS 91077

AN/MPQ-2A: 3

DATE: 1 July 1964

ITEM NAME: RADAR SET

COGNIZANT SERVICE: USA

TYPE: AN/MPQ-4A

LINE ITEM NUMBER: 634425

FEDERAL STOCK NUMBER: 5840-309-3222

	USA	USN	USAF	USMC
STATUS OR TYPE CLASSIFICATION	Std-A			
Mfg(s) Name or Code Number: General Electric Co., Syracuse, N. Y.				

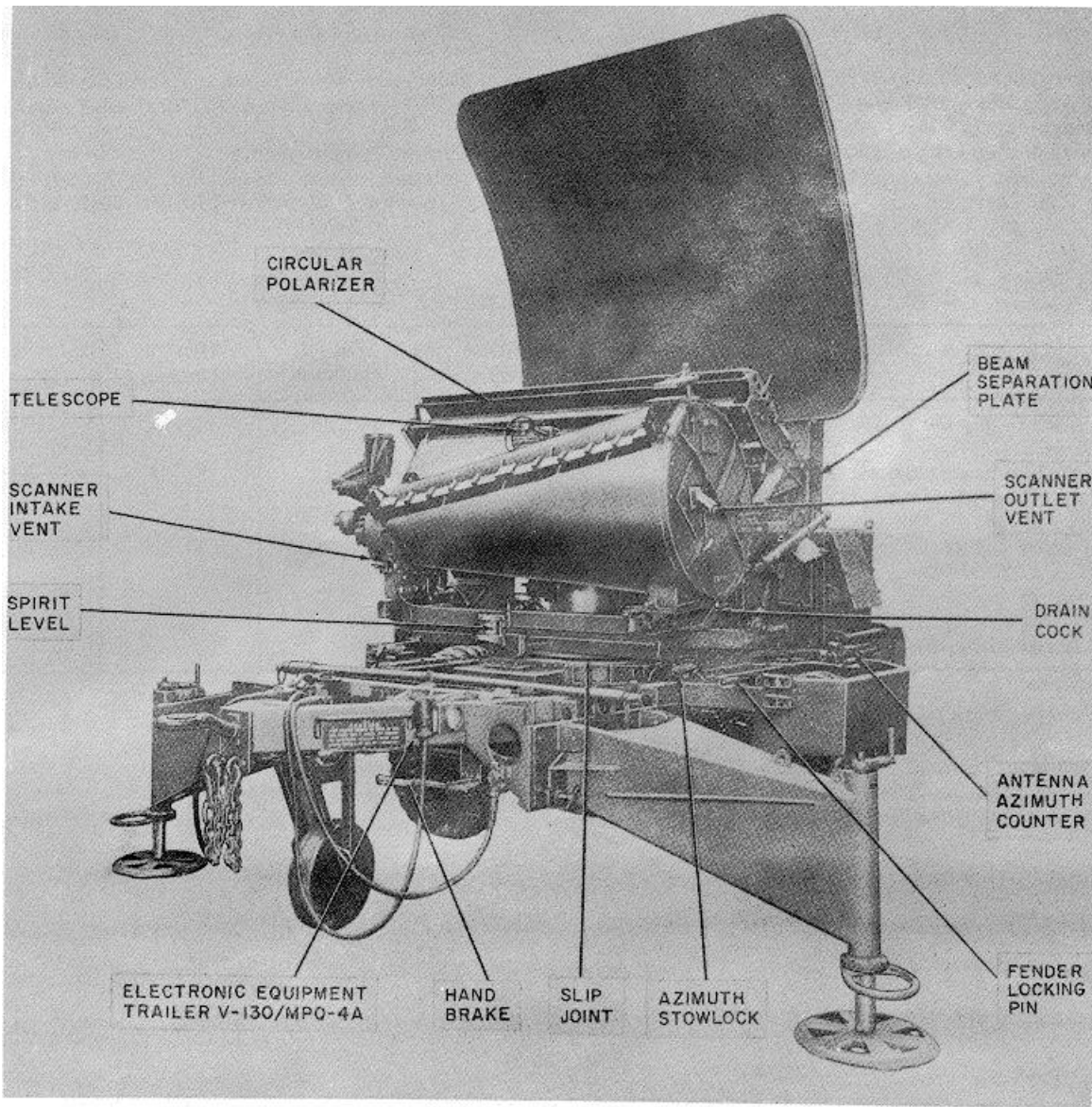

AN/MPQ-4A: 1

AN/MPQ-4A

**FUNCTIONAL DESCRIPTION**

Radar Set AN/MPQ-4A is a mobile, intercept-type (non-tracking) set designed primarily to locate hostile mortars and secondarily to adjust counter-measure (low-velocity artillery) fire. Radar Set AN/MPQ-4A determines the origin or impact points of mortar shells by observing them in flight.

**RELATION TO SIMILAR EQUIPMENT**

None.

**TECHNICAL DESCRIPTION**

Frequency: 16,000 \*160 mc  
 Range, Max: 10,000m  
 Range, Min: 170m  
 Peak Power Output: 50 kw (min)  
 Operating Voltages and Power Requirements:  
 120/208v, 400cps, wye connected, 3-ph, 5 kw  
 (PU-304A/MPQ-4 or PU-304B/MPQ-4 is re-

quired for operation of AN/MPQ-4A)  
 Type of Presentation: One 5-1/2 in B-scope  
 Duty Cycle: 0.00215  
 Pulse Repetition Rate: 8,600 pps  
 Pulse Width: 0.25 µsec  
 Angular Resolution: Angle, 1 deg; range, 50m  
 Horizontal Beam Width: 17.8 mils  
 Vertical Beam Width: 14.25 mils  
 Azimuth Coverage: 450-mil fixed-sector scanning; antenna will fix through 6,400 mils  
 Accuracy of Maximum Range: 10m

**INSTALLATION CONSIDERATIONS**

Siting: A reasonably level spot, free of obstructions  
 Mounting: Major units are normally mounted on Electronic Equipment Trailer V-130/MPQ-4A  
 Cabling Requirements:  
 Related Equipment: Radar Set AN/MPQ-4A is designed to operate with PU-304A/MPQ-4 or PU-304B/MPQ-4.

**PRINCIPAL COMPONENTS AND PHYSICAL DATA**

COMPONENT	QTY	HEIGHT (Inches)	WIDTH (Inches)	DEPTH (Inches)	UNIT WT. (Pounds)
Antenna Group OA-1258/MPQ-4A	1	66.5	90.53	66	1938
Control-Indicator Group OA-1256/MPQ-4A	1	28.42	53.12	31.34	571
Receiver-Transmitter Group OA-1257/MPQ-4A	1	29.5	49.32	30.28	560
Trailer, Electronic Equipment V-130/MPQ-4A	1	36.75	96	192	1858

**REFERENCE DATA AND LITERATURE**

Technical Manuals:  
 TM 11-5840-208-10  
 TM 11-5840-208-20P

**TM 11-5840-208-30**  
 TM 11-5840-208-45  
 Specification:  
 MIL-R-11906B(SigC)

DATE: 1 July 196-1

ITEM NAME: RADAR SET

COGNIZANT SERVICE: USA

TYPE: AN/MFP-10, AN/MPQ-10A

FEDERAL STOCK NUMBER:

	USA	USN	USAF	USMC
STATUS OR TYPE CLASSIFICATION				
Mfg(s) Name or Code Number:				

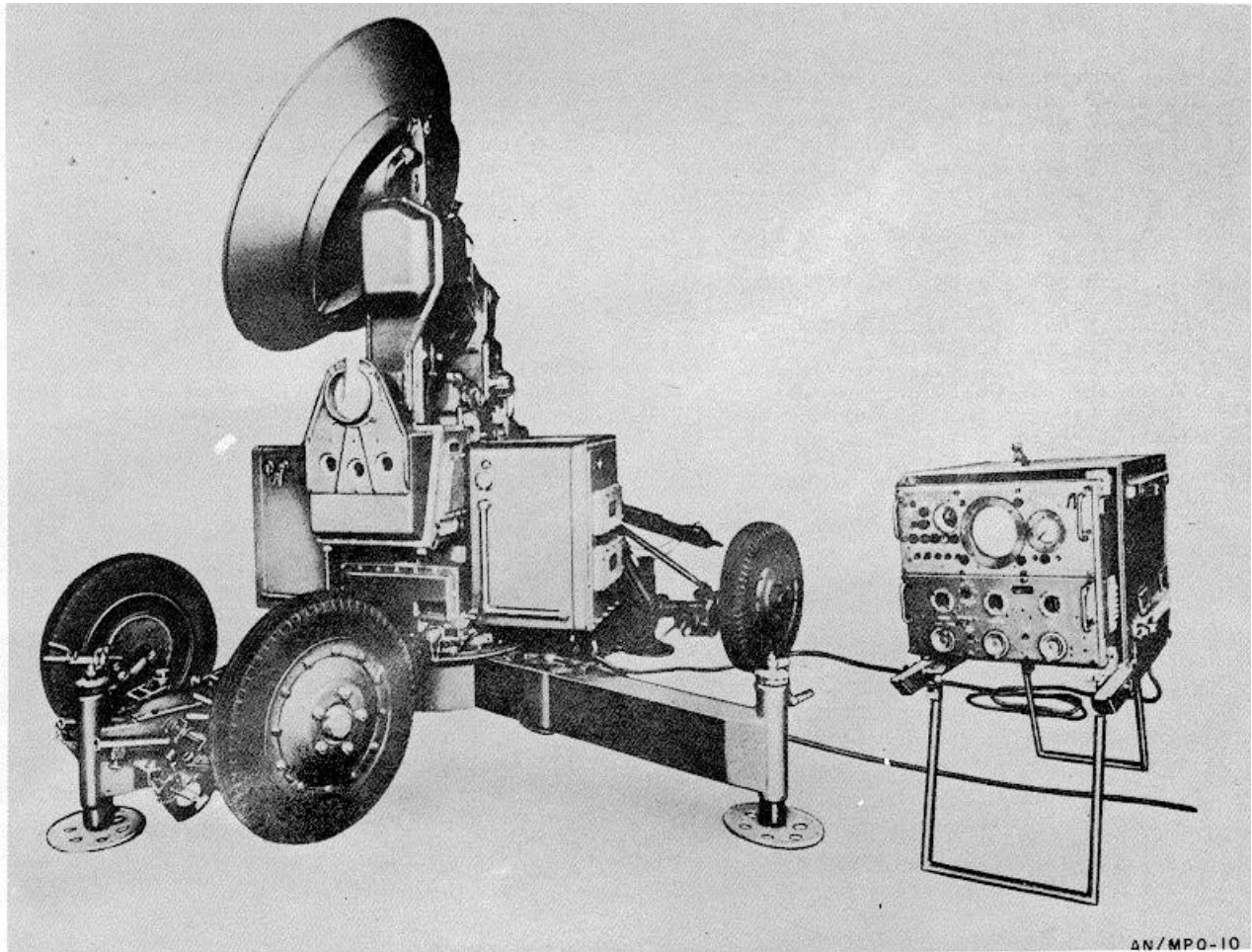

### FUNCTIONAL DESCRIPTION

The AN/MPQ-10 and AN/MFQ-10A are lightweight, transportable radar sets designed to locate the track mortar and artillery shells. When used with associated

recording or computing equipment, the radar set can be used to locate the point of origin and point of impact of the missiles.

AN/MPQ-10: 1

**ITEM NAME:** RADAR SET

**TYPE:** AN./MPQ-10, AN/MPQ-10A

**RELATION TO SIMILAR EQUIPMENT**

The AN/MPQ-10A differs from the AN/MPQ-10 primarily in the type of altitude computer system used. The AN/MPQ-10A uses an electrical resolver-type altitude computer instead of the mechanical resolver computer used in the AN/MPQ-10. This difference does not affect the operating procedures of the radar, but has required that several chassis be modified and 2 chassis added.

**TECHNICAL DESCRIPTION**

**GENERAL**

Power Input: 115v, 60 cps, 3-ph, 5 kva max  
 Range: 20,000 yd max, 500 yd min  
 Range Accuracy: 20 yd probable error.  
 Elevation Coverage  
     Lower Limit: -125 mils  
     Upper Limit: plus 1540 mils  
 Azimuth Coverage: 6400 mils, continuous  
 Azimuth or Elevation Accuracy: 1.5 mils probable error  
 Sector Scan Width: 200 to 800 mils, adjustable  
 Tractor Mount: 1 mm gun carriage M2A1 (modified).  
 Tractor Mount Rotation: c rpm max  
 Automatic Tracking Rates  
     Elevation: 250 mils per sec max  
     Azimuth: 350 mils p1er sec max  
     Slant Range: 1000 yd per sec max  
 Manual Tracking Rates  
     Elevation: 650 mils per sec max  
     Azimuth: 850 mils per sec max  
     Slant Range: 2500 yd pier sec max  
 Sector Scanning Rate: c00 mil cycle in 3.5 sec  
 Resolution  
     Azimuth: 90 mils  
     Elevation: 90 mils  
**RF SYSTEM**  
 Antenna Type: Dipole, with parabolic reflector

Feed: Coaxial lines.  
 Antenna Rotation: 3600 rpm (automatic tracing).  
 Beam Width: (Without Conical Scan)  
     Azimuth: 5 deg at half-power  
     Elevation: 5 deg at half power  
**Transmitting System**  
     Frequency Range: 2700 to 2860 mc  
     Wave Length: 10 cm (nom)  
     Peak Power: 0.18 kw or 52.5 db  
     Average Power: 0.18 kw or 52.5 db above 1 mw  
     Pulse Rate: 1100 pps (norm)  
     Pulse Width: 0.8 usec

**RECEIVING SYSTEM**

Type: Superheterodyne  
 Local Oscillator Frequency: 2770 to 2990 mc (30 mc above magnetron frequency).  
 Intermediate Frequency: 30 mc  
 IF Band Width: 1.8 mc for 3 db down.  
 Maximum Gain: 101 db  
 Minimum Discernible Signal Power: -98 dbm  
 Ringtime: 5200 yd min

**PRESENTATION SYSTEM**

Indicators  
     B Scope: 0 to 10,000, 20,000 yd ranges (presents sector scanned). 7 in CRT.  
     J Scope: 2000 yd range (dial indication of range, azimuth and elevation). 3 in CRT.

**POWER SUPPLY SYSTEM**

Power Unit Required: Power Unit PU-26/U (gasoline-engine driven generator).  
 Rating: 115v, 60 cps, 3-ph, 5 kva  
 Fuel Consumption: 1 gal. per hr

**INSTALLATION CONSIDERATIONS**

Related Equipment: Azimuth-Elevation Range Recorder RD-54/TP or Mortor Locator Computer CP-75/MPQ, Power Unit PU-26/U.

**PRINCIPAL COMPONENTS AND PHYSICAL DATA SHIPPING DATA**

COMPONENTS	BOXES (NR.)	OVERALL DIMENSIONS (Inches)	UNIT WT. (Pounds)
Radar Set Control C-869/MPQ-10	1	36 x 36 x 36	200
Radar Set AN/MPQ-10 or	1	120 x 120 x 2.10	7000

**EQUIPMENT SUPPLIED DATA**

**PRINCIPAL COMPONENTS AND PHYSICAL DATA**

COMPONENTS	QTY AN/MPQ-	OVERALL DIMENSIONS (Inches)	UNIT WT. (Pounds)
Mounting MT-899/MPQ-10	1 1	22-1/4 x 31 x 39	
Frame MT-900/MPQ-10 or	1	27-1 /8 x 59-9/16 x 69-7/8	1005
Radar Set Group (OA-165/MPQ-10)	1	27-1/8 x 59-9/16 x 69-7/8	980

ITEM NAME: RADAR SET  
TYPE: AN/MPQ-10, AN/MPQ-10A

EQUIPMENT SUPPLIED DATA  
PRINCIPAL COMPONENTS AND PHYSICAL DATA

COMPONENTS	QTY		OVERALL DIMENSIONS (Inches)	UNIT WT. (Pounds)
	AN/MPQ-10	10A		
Signal Data Converter CV-256/MPQ-10A	1		16-1/4 x 17-5/8 x 18-1/2	52
Radio Frequency Oscillator 0-164/MPQ-10	1	1	6-3/16 x 6-9/16 x 12-1/4	9
IF Amplifier AM-610/MPQ-10	1		3 x 3-1/2 x 18	5
IF Amplifier AM-610A/MPQ-10		1	3 x 3-1/2 x 18	5
Frequency Converter-Trans- mitter Subassembly RF-54/MPQ-10	1	1	8 x 12 x 12	7
Relay Assembly RE-118/MPQ-10	1	1	3 x 3-1/2 x 12	5
Receiver Control C-969/MPQ-10			3 x 3 x 12-1/2	4
Power Supply PP-888/MPQ-10A		1	6-23/32 x 11 x 14	22
Impedance Matching Network CU-327/MHPQ-10A		1	3-5/8 x 6-5/16 x 7-9/16	2
Antenna AS-546/MPQ-10	1	1	31-3/16 x 68-3/4 dia	150
Radar Modulator MD-142/MPQ-10	1	1	22 x 27-5/8 x 32	278
Range Computer CP-93/MPQ-10 or	1		20-1/4 x 27-3/4 x 32-1/4	381
Range Computer CP-156/MPQ-10A		1	20-1/4 x 27-3/4 x 32-1/4	383.5
Radar Set Control C-869/MPQ-10	1	1	22 x 27 x 32	392
Electrical Contact Ring MX -1279/MPQ-10	1	1	5-1/2 dia x 25	44
Junction Box J-463/MPQ-10	1	1	9 x 10 x 13	30
Electrical Power Cable Assembly CX-1863/MPQ-10	1	1	1800 in. 1g	83
Electrical Special Purpose Cable Assembly CX-1912/U	1	1	1800 in. 1g	260
Hand Cable Reeling Machine RL-166/MPQ-10	1	1	31-1/8 x 37-1/8 x 63-5/8	95
Hand Cable Reeling Machine RL-165/MPQ-10	1	1	17-5/8 x 25-1/4 x 29-1/8	85
Elbow Telescope M62A1	1	1	1-3/4 x 3-5/16 x 3-11/16	
Echo Box TS-270B/UP	1	1	8-7/8 x 11-11/16 x 12-5/8	11.25
Carrying Case CY-64/U	1	1	20 x 20 x 25	
Technical Manuals	2	2		
Maintenance Kit	1	1	18 x 18-5/8 x 26-1/2	77

REFERENCE DATA AND LITERATURE

Technical Manuals for Radar Sets AN/MPQ-10  
and AN/MPQ-10A:

- TM 11-1503
- TM 11-1303 (TO 16-30MPQ10-6)



DATE: 1 July 1964

ITEM NAME: RADAR COURSE DIRECTING  
CENTRAL

COGNIZANT SERVICE: USN

TYPE: \*AN/MPQ-14, -14A

USA LINE ITEM NUMBER: \*634434

FEDERAL STOCK NUMBER:

	USA	USN	USAF	USMC
STATUS OR TYPE CLASSIFICATION				
Mfg(e) Name or Code Number: Ultrasonic Corporation				

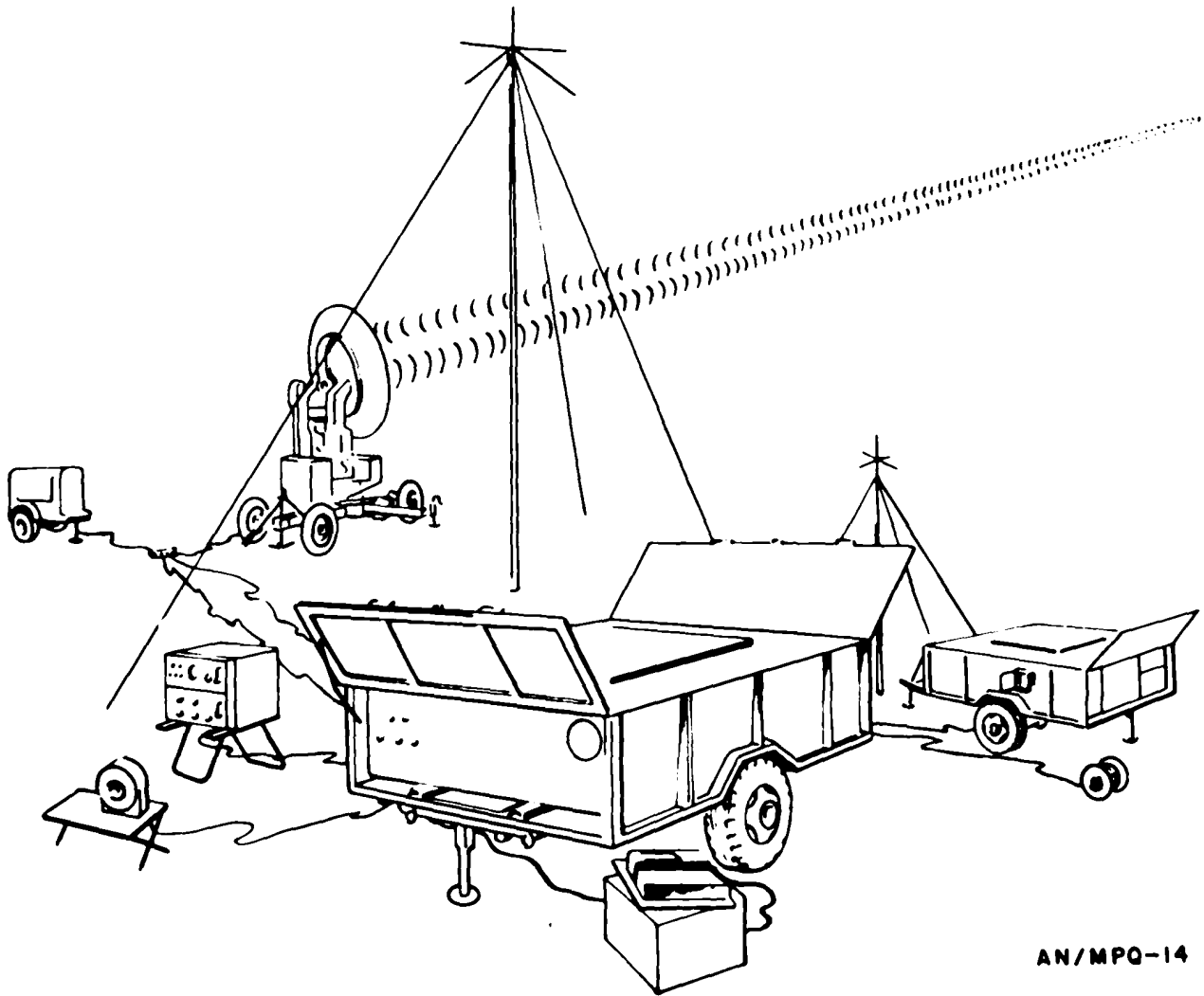

AN/MPQ-14

AN/MPQ-14: 1

AN/MPQ-14, -14A

**FUNCTIONAL DESCRIPTION**

Radar Course Directing Centrals AN/MPQ-14 and AN/MPQ14A automatically track friendly aircraft, compute a course from the aircraft to a predetermined ground target, and guide the aircraft over the ground target. At the proper instant the Radar Course Directing Central automatically command release of a bomb.

The AN/MPQ-14 and the AN/MPQ-14A differ in the radar and radio equipment used. Except for these equipments, AN/MPQ-14 and AN/MPQ-14A are interchangeable by component. Functionally, they are interchangeable as a whole.

Antenna: Dipole  
Frequency Range: 2740 to 2960 mc  
Wave Length: 10 cm  
Peak Power Output: 200 kw (83 db above 1 mw)  
Avg Power: 0. 18 kw  
Pulse Rate: 1100 pps nom  
Pulse Width: 0. 8 ;sec  
RF Source: 2J31, 2J32, 2J33, or 2J34 magnetron  
IF. Frequency: 30 mc  
Type of Presentation: 7-in B-scope; 3-in J-scope; range, azimuth, and elevation indicators

**INSTALLATION CONSIDERATIONS**

**RELATION TO SIMILAR EQUIPMENT**

None.

Siting:  
Mounting: Housed and transported in two modified 3/4-ton trailers, two 2-1/2-ton trucks, one 3/4-ton 4x4 truck, and one mobile radar mount.  
Cabling Requirements:  
Related Equipment:

**TECHNICAL DESCRIPTION**

Power Input: 115 vac, 60 cps, 3-ph, 5. 0kva max Range: 500 to 20, 000 yd

**PRINCIPAL COMPONENTS AND PHYSICAL DATA**

COMPONENT	QTY	HEIGHT (Inches)	WIDTH (Inches)	DEPTH (Inches)	UNIT WT.
AN/MPQ-14 Computer-Transmitter Set AN/MSQ-7 Signal Data Converter CV-280/MSQ-7 Transmissometer Indicator-Recorder ID- 407/MSQ-7 Radio Transmitting Set AN/MRW-4 Generator Set, Diesel Engine PU-273/G Radar Set AN/TPG-2 Radio Set ARW-3 AN/MPQ-14A Computer-Transmitter Set AN/MSQ-7 Signal Data Converter CV-280/MSQ-7 Transmlssometer Indicator-Recorder ID- 407/MSQ-7					

**PRINCIPAL COMPONENTS AND PHYSICAL DATA (cont'd)**

<b>COMPONENT</b>	<b>QTY</b>	<b>HEIGHT (Inches)</b>	<b>WIDTH (Inches)</b>	<b>DEPTH (Inches)</b>	<b>UNIT WT.</b>
AN/MPQ-14A (cont'd)					
Radio Receiver AN/ARW-61					
Radio Transmitting Set AN/MRW-4					
Generator Set, Diesel Engine PU-273/G					
Radar Set AN/MPQ-10B					

**REFERENCE DATA AND LITERATURE**

Technical Orders:  
31P4-2GPX9-1  
31P4-2GPX9-2  
31P4-2GPX9-4

**AN/MPQ 14: 3**

DATE: 1 July 1964

ITEM NAME: RADAR SET

COGNIZANT SERVICE: USA

TYPE: AN/MPQ-16

LINE ITEM NUMBER: 634436

FEDERAL STOCK NUMBER: 5840-545-7327

	USA	USN	USAF	USMC
STATUS OR TYPE CLASSIFICATION	Std -C			
Mfg(s) Name or Code Number: Evans Signal Lab., Belmar, N.J.				



**FUNCTIONAL DESCRIPTION**

Radar Set AN/MPQ-16 is a mobile, long-range, modified Radio Set SCR-584 in which extended range indication up to 100 miles is included for use with slave equipment. The radar set is used for target tracking and

for positioning of Radar Countermeasures Set AN/TPQ-8.

**RELATION TO SIMILAR EQUIPMENT**

None.

AN/MPQ-16

**TECHNICAL DESCRIPTION**

Frequency: 2700 to 2900 mc  
 Range, Max: 196, 000 yd  
 Range, Min: 500 yd at large elevation angles;  
 1, 000 yd at small angles  
 Peak Power Output: 210 kw  
 Operating Voltage and Power Requirements:  
 115 vac (2% regulation), 60 ±2 cps, 3-ph, 12  
 kva (max)  
 Type of Presentation: Two 7-in. PPI and two  
 3-in. J-scopes  
 Duty Cycle: 0.00041  
 Pulse Repetition Rate: 512 pps  
 Pulse Width: 0.8 usecs  
 Resolution: Azimuth, 5 deg; range, 146 yd  
 Horizontal Coverage: 360 deg

Elevation Coverage: From 175 mils below to  
 1,580 mils above horizontal  
 Beam Width: 4 deg (at 1/2 power points)

**INSTALLATION CONSIDERATIONS**

Siting: A comparatively level site is, required for the trailer.  
 The site must be free from obstructions such as large  
 buildings. hills, and towers in the immediate area and in  
 the direction to be searched.  
 Mounting: The equipment is mounted in a trailer.  
 Cabling Requirements: Related Equipment: Radar Set AN  
 /MPQ-16 may be used with Radar Countermeasures Set  
 AN/ TPQ-8.

**PRINCIPAL COMPONENTS AND PHYSICAL DATA**

COMPONENT	QTY	HEIGHT (Inches)	WIDTH (Inches)	DEPTH (Inches)	UNIT WT.
Trailer K-78	1	124	96	234	10 tons (Loaded)

**Note: Refer to instruction literature for complete list  
of components.**

**REFERENCE DATA AND LITERATURE**

Technical Manuals:  
 TM 11-1324  
 TM 11-1363

TM 11-1424  
 TM 11-1524  
 TM 11-1563  
 NavShips 91408  
 Specification:  
 MIL-R-10816 (SigC)  
 Serviceability Standard: SB 11-1524-27

**AN/MPQ-16: 2**

DATE: 1 July 1964

ITEM NAME: RADAR SET

COGNIZANT SERVICE: USA

TYPE: AN/MPQ-22

LINE ITEM NUMBER: 634440

FEDERAL STOCK NUMBER: 5840-503-1087

	USA	USN	USAF	USMC
STATUS OR TYPE CLASSIFICATION	Std - C			
Mfg(s) Name or Code Number: Baltimore Signal Depot, Baltimore, Md.				

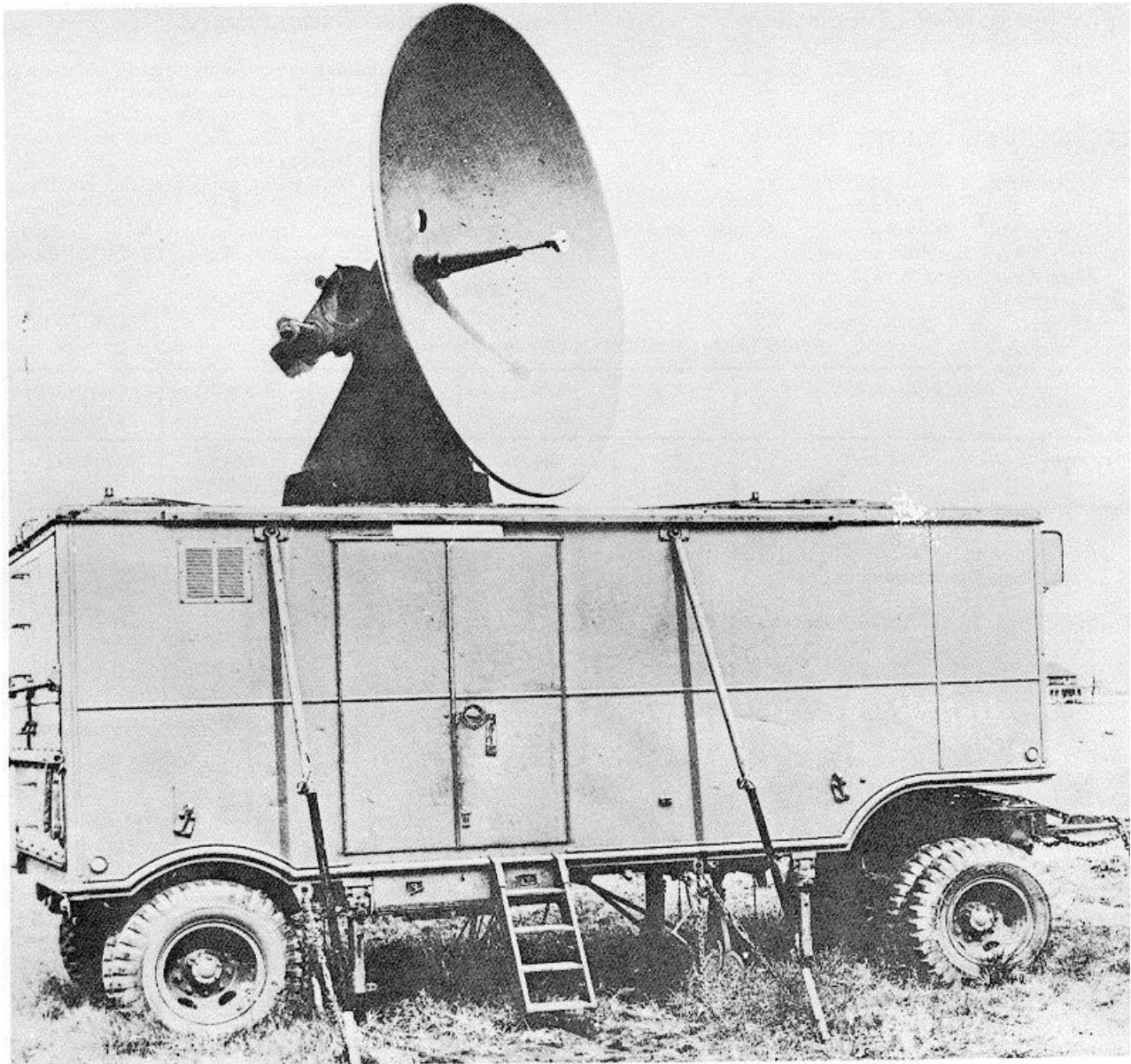

AN/MPQ-22: 1

AN/MPQ-22

Operating Voltages and Power Requirements:  
115 vac (2% regulation), 60 \*2 cps, 3-ph, 12  
kva (max)

**FUNCTIONAL DESCRIPTION**

Type of Presentation:  
7-in. PPI and 3-in. J-scopes  
Duty Cycle: 0.0014  
Pulse Repetition Rate: 853 and 1, 707 pps  
Pulse Width: 0.8 ;sec  
Accuracy of Maximum Range: ±25 yd  
Azimuth and Elevation Accuracy: ±1 mil  
Azimuth Coverage: 360 deg  
Elevation Coverage: 175 mils below to 1,580  
mils above horizontal  
Altitude Coverage: 300 to 10,000 yd (±10 yd)

Radar Set AN/MPQ-22 is a mobile, short-range radar equipment converted from a Radio Set SCR584 for the accurate automatic tracking of artillery projectiles in range, azimuth and elevation. The data transmission system of the set transmits range, azimuth and height synchro data of the projectile being tracked. The radar set and an automatic 3-channel recorder, such as Azimuth Range Elevation Recorder RO-3/MPQ, form a system capable of accurately plotting the flight path or trajectory of an artillery projectile.

**INSTALLATION CONSIDERATIONS**

**RELATION TO SIMILAR EQUIPMENT**

Siting: A comparatively level site is required for the trailer. The site must be free from obstructions such as large buildings, hills, and towers in the immediate area and in the direction to be searched.  
Mounting: The equipment is mounted in a trailer.  
Cabling Requirements: Related Equipment: Radar Set AN/MPQ-22 may be used with Azimuth Range Elevation Recorder RO-3/MPQ.

None.

**TECHNICAL DESCRIPTION**

Frequency: 2700 to 2900 mc  
Range, Max: 70,000 yd  
Range, Min: 500 yd at large elevation angles;  
1, 000 yd at small angles  
Peak Power Output: 210 kw

**PRINCIPAL COMPONENTS AND PHYSICAL DATA**

COMPONENT	QTY	HEIGHT (Inches)	WIDTH (Inches)	DEPTH (Inches)	UNIT WT.
Trailer K-78	1	124	96	234	10 tons (Loaded)

**Note: Refer to instruction literature for complete list of major components.**

Technical Manuals:  
TM 11-1324  
TM 11-1424  
TM 11-1524

**REFERENCE DATA AND LITERATURE**

DATE: 1 July 1964

ITEM NAME: RADAR SET

COGNIZANT SERVICE: USA

TYPE: AN/MPQ-29

LINE ITEM NUMBER: 634442

FEDERAL STOCK NUMBER:

	USA	USN	USAF	USMC
STATUS OR TYPE CLASSIFICATION	S td-A			
Mfg(s) Name or Code Number: Sperry Utah Engineering Lab., Salt Lake City, Utah				

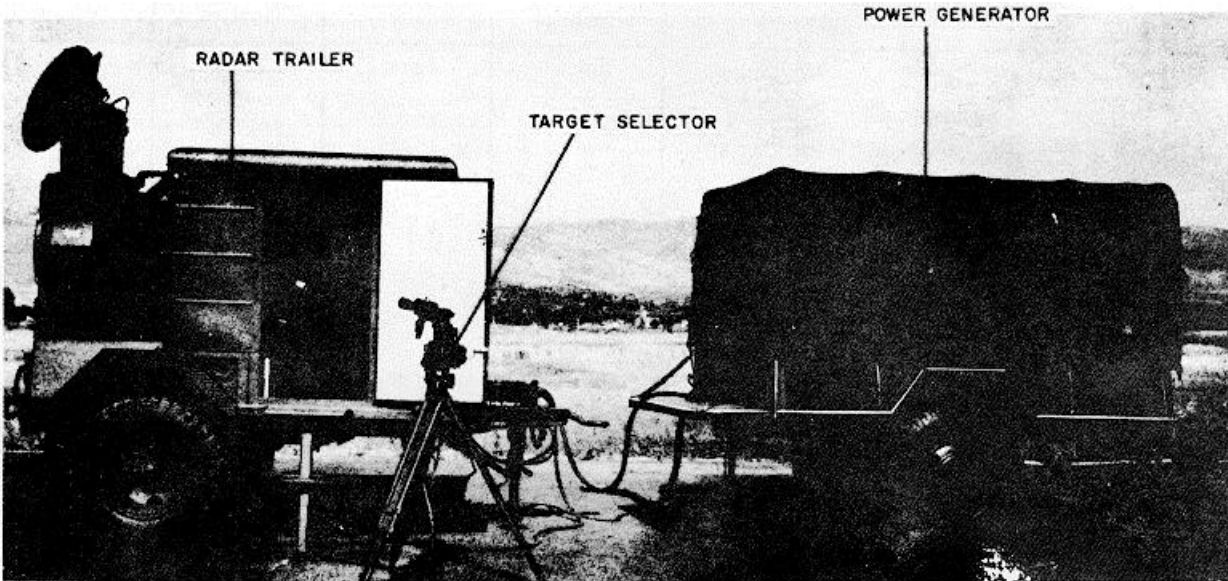

### FUNCTIONAL DESCRIPTION

Radar Set AN/MPQ-29 employs an integrated group of components on a single, highly mobile trailer mount. The system is designed to track and plot the course of an airborne target within a range of 92 km. In automatic-tracking mode, the radar supplies data to a computer and two plotting boards. Servo-operated pencils on the boards plot the course of the target. The system may be employed in conventional radar (skin) tracking operation, or it may be used in conjunction with a beacon transponder placed in the target for beacon tracking. An optical target selector is supplied for auxiliary observation and selection of targets by a remote operator.

### RELATION TO SIMILAR EQUIPMENT

None.

### TECHNICAL DESCRIPTION

Frequency: 8500 to 9600 mc  
 Range, Max: 92 km  
 Range, Min: 300m  
 Peak Power Output: 40 kw  
 Operating Voltage and Power Requirements:  
 115 vac, 60 cps, 3-ph, (3 kw without heaters,  
 6 kw with heaters)  
 Type of Presentation: PPI and J-scopes  
 Duty Cycle: 0.00035 (approx)

AN/MPQ-29: 1



**AN/MPQ-29**

Pulse Repetition Rate: 1, 000 pps  
 Pulse Width: 0.25 to 0.50  $\mu$ sec  
 Separation Between Dual Pulses: 3 or 1.5  $\mu$ sec  
 (beacon operation)  
 Azimuth Coverage: 6, 400 mils (continuous)  
 Elevation Coverage: -175 to 1550 mils  
 Slant Range: 600 yd/sec

Siting: The location selected for the system installation should provide an unobstructed radar view of the area to be taken under observation.

Mounting: The equipment is normally mounted in or adjacent to the trailer when in use.

Cabling Requirements:  
 Related Equipment:

**INSTALLATION CONSIDERATIONS**

**PRINCIPAL COMPONENTS AND PHYSICAL DATA**

COMPONENT	QTY	HEIGHT (Inches)	WIDTH (Inches)	DEPTH (Inches)	UNIT WT.
Radar Tracking Group OA-2291/MPQ-29	1	80	42	73	2080
Target Selector Group OA-2293/MPQ-29	1	88	--	--	85. 5
Control Indicator C-2879/MPQ-29	1	48-1/2	9	11	170
Plotting Board, Radar Data PT-446/MPQ-29	1	49	59	13	700
Generator Set, Gasoline Engine Trailer Mounted PU-269/U	1	98	83	165-1/2	3900
Shelter	1	--	121	166	7250

**REFERENCE DATA AND LITERATURE**

Technical Manuals:  
 TM 11-5840-220-10P  
 TM 11-5840-220-20P  
 TM 11-5840-220-35P

Specification:  
 SCL 5457

Literature:  
 Operating and Maintenance Manual for Radar Set  
 AN/MPQ-29, Sperry, Utah Engineering Laboratories  
 Publication #70-9005.

DATE: 1 July 1964  
COGNIZANT SERVICE: USN

ITEM NAME: RADAR SET  
TYPE: AN/MPS-4B, -4C

FEDERAL STOCK NUMBER: 5840-642-7059

	USA	USN	USAF	USMC
STATUS OR TYPE CLASSIFICATION		Ltd Std		
Mfg(s) Name or Code Number: Hazeltine Electronics Corp.				

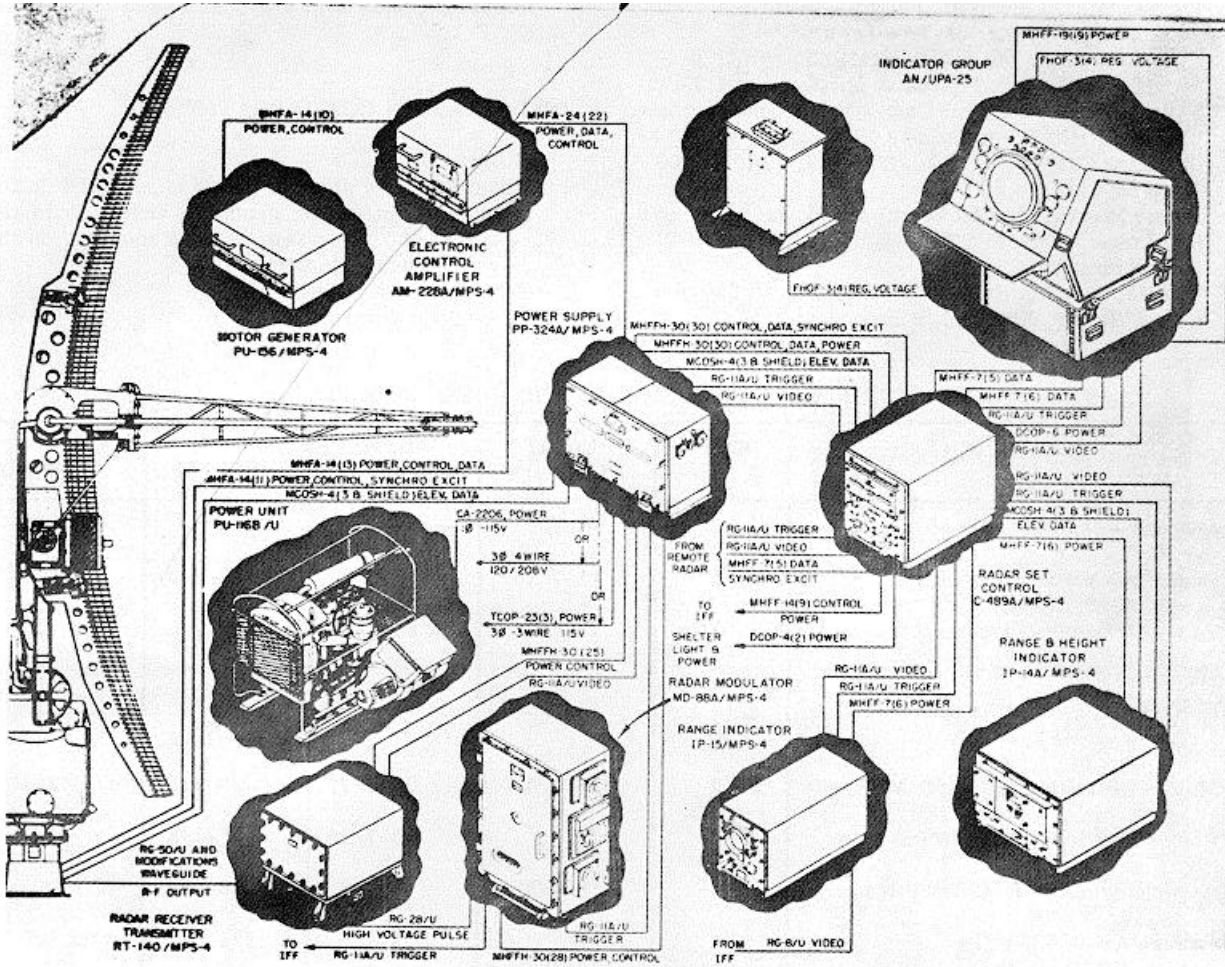

**FUNCTIONAL DESCRIPTION**

Radar Sets AN/MPS-4B, and AN/MPS-4C are mobile height-finding radars, to be used in coordination with search facilities in determining the actual altitude of aircraft targets whose bearing in azimuth is known from the search radar information. In an emergency, when no search radar is available, or when the search radar is

undergoing maintenance or repair, these equipments can be used as combination height-finding and search radars. Radar Set AN/MPS-4C has been improved so that target heights can be read directly in feet above sea level, regardless of station elevation (max station elevation 10,000 ft). Also, an anglemark simulator allows calibration of the Range

AN/MPS-4B: 1

AN/MPS-4B, -4C

Height Indicator display in less time than previously required.

Horizontal Coverage: 360 deg  
Vertical Coverage: -2 deg to +20 deg angular  
Antenna Rotation Speed: 0 to 7 rpm  
Vertical Scanning Rate: 1 to 1.5 scans per sec  
Resolution:

**RELATION TO SIMILAR EQUIPMENT**

None.

Range - 0.031 to 0.11 mi  
Azimuth - 4 deg  
Elevation - 0.8 deg  
System Accuracy:  
Range- ±2%  
Elevation - ±1,000 ft  
Horizontal Beam Width: 4 deg  
Vertical Beam Width: 0.8 deg  
Receiver Bandwidth: 1 to 1.4 mc and 2.2 to 4 mc  
IF. Frequency: 30 mc

**TECHNICAL DESCRIPTION**

Frequency: 6275 to 6575 mc  
Range: 80 mi  
Height-Finding Capability: 40,000 ft  
Range, Min: Less than 500 yd  
Peak Power Output: 140 kw (min)  
Operating Voltages and Power Requirements:  
115 vac, 60 cps, i-ph or 3-ph, 3-wire, 4.3 kw  
Type of Presentation: One 5-in. A-scope; one 7-in. RHI scope; and one PPI scope  
Indicator Ranges: 0 to 20, 20 to 40, 40 to 60, 60 to 80 and 0 to 80 mi  
Range Marks: 5- and 20-mi intervals  
RF Power Source: Type 5J57, 5J58, or 4559 magnetron  
Pulse Repetition Rate: Variable, 615 to 650 pps  
Pulse Width: 0.37 or 1.3 µsec

**INSTALLATION CONSIDERATIONS**

Siting:  
Mounting: The antenna group is mounted on the trailer; indicator group is installed in the truck; and the power unit is mounted on the ground near the trailer.  
Cabling Requirements:  
Related Equipments:

**PRINCIPAL COMPONENTS AND PHYSICAL DATA**

COMPONENT	QTY	HEIGHT (Inches)	WIDTH (Inches)	DEPTH (Inches)	UNIT WT.
Antenna Assembly, AS-403/MPS-4	1	75-7/8	64	94	1525
Radar Modulator, MD-88/MPS-4	1	41-7/16	33-3/8	20-7/8	405
Radar Receiver-Transmitter RT-140/MPS-4	1	17-7/16	24-7/8	30-1/8	175
Electronic Control Amplifier AM-228/MPS-4	1	12-5/8	23-7/8	20-7/8	115
Motor-Generator, PU-156/MPS-4	1	13-1/4	25-5/16	20-7/8	251
Power Supply, PP-324/MPS-4	1	22	33-7/16	16-1/2	177
Radar Receiver, R-422/MPS-4	1	6-1/2	6-3/8	18-5/8	
Tower, AB-204/FPS-5	1	352	233	233	12,500
Antenna Base, AB-241/FPS-5	1	6-7/8	82-1/8	94-7/8	1000
Range and Height Indicator IP-14/MPS-4	1	19-3/4	26	36-1/2	287
Range Indicator, IP- 15/MPS-4	1	18-7/8	14- 1/4	36	154
Range and Azimuth Indicator CG-55AKJ	1	38-1/4	17-7/8	22-5/16	420

**AN/MPS-4B: 2**

**PRINCIPAL COMPONENTS AND PHYSICAL DATA (cont'd)**

<b>COMPONENT</b>	<b>QTY</b>	<b>HEIGHT (Inches)</b>	<b>WIDTH (Inches)</b>	<b>DEPTH (Inches)</b>	<b>UNIT WT.</b>
Power Supply, CG-20AGD	1	22-11/16	25-9/16	13-1/16	239
Radar Set Control, C-489/MPS-4	1	22-1/2	18-1/2	31-3/4	150
Echo Box, TS-501/UP	1	10-1/4	15-1/16	8-7/8	17
Shelter, S-52/MPS-4	1	74	89	144	1500
Trailer, V-32/MPS-4	1	126	88-5/8	194	5280
Truck, V-33/MPS-4	1	93-1/2	92	289	12,500
Power Unit, PU-116A/U	1	32-3/8	20-1/4	35-1/4	536

**REFERENCE DATA AND LITERATURE**

Technical Orders:

31P3-2FPS5-2  
31P3-2FPS5-5  
31P3-2MPS4-34

Technical Manuals:

NAVSHIPS 91373  
NAVSHIPS 92433  
NAVSHIPS 91191  
NAVSHIPS 91300

DATE: 15 April 1964

ITEM NAME: RADAR SET

COGNIZANT SERVICE: USAF

TYPE: AN/MPS-7

FEDERAL STOCK NUMBER: 5840-505-0922

	USA	USN	USAF	USMC
STATUS OR TYPE CLASSIFICATION			Ltd Std	
Mfg(s) Name or Code Number Bendix Radio Division of Bendix Aviation Corporation				

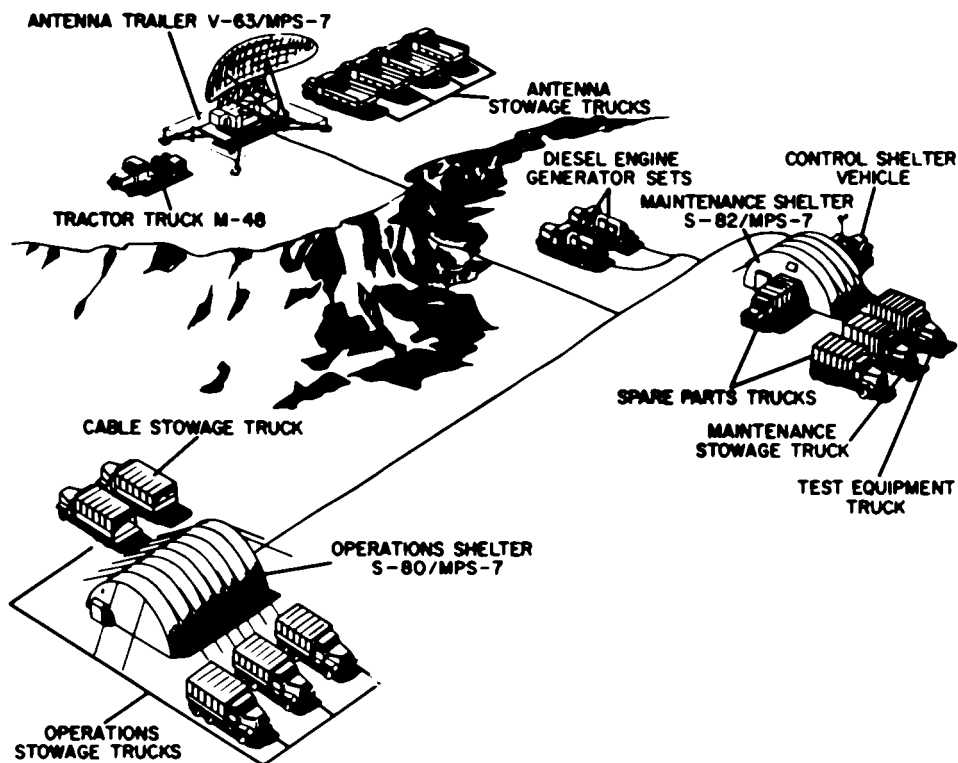

### FUNCTIONAL DESCRIPTION

Radar Set AN/MPS-7 is a mobile, airtransportable, long-range radar set used for aircraft detection or used in conjunction with a height-finding radar in ground controlled-intercept applications. This equipment is

capable of detecting heavy bomber-type aircraft at a range of 300 mi. Radar Set AN/MPS-7 can withstand temperature variations from -20 to plus 40 deg F., humidity conditions up to 100 pct, and altitudes from sea level to 7000 ft above. This set is equipped for MTI

**ITEM NAME:** RADAR SET

**TYPE:** AN/MPS-7

and has provisions for including projection PPI height-finding radar, IFF video mapping and direction finding equipment. These equipments are not supplied; however, power equipment is provided.

Resolution: Range 0.5 mi, azimuth 1.3 deg  
System Accuracy: Range plus or minus 1 mi, azimuth plus or minus 1 deg  
Horizontal Beam Width: 1.3 deg  
Vertical Beam Width: 0 to 3 deg lower; 3 to 15 deg upper  
Receiver Band Width: 0.4 mc  
IF. Frequency: 30 mc

**RELATION TO SIMILAR EQUIPMENT**

Radar Set AN/MPS-7 is a mobile version of the AN/FPS-3, -3A.

**INSTALLATION CONSIDERATIONS**

Siting: Site must have ample space for erection of shelters and operating units along with additional space to park remaining trucks. If possible, the site should be level and free of obstructions which would cause blind spots in the antenna pattern.

**TECHNICAL DESCRIPTION**

Frequency: 1220 to 1350 mc  
Range: 325 naut mi  
Peak Power Output: 650 kw (ea transmitter)  
Operating Voltages and Power Requirements: 120/208v ac, 60 cps, 3-ph, 4-wire, 27 kw  
Type of Presentation: Seven PPI's  
Indicator Ranges: 0 to 50, 150, and 325 naut mi with range marks at 10-and 50-mi intervals  
RF Power Source: Type 5J26 tunable magnetron  
Pulse Repetition Rate: 200 or 400 pps (MTI available or 400 pps only)  
Pulse Width: 3 or 6 usec  
Horizontal Coverage: 360 deg  
Vertical Coverage: Up to 60,000 ft (15 deg angular)  
Antenna Rotation Speed: 5 rpm  
Antenna Tilt: -0.5 to plus 6.5 deg

Mounting: Antenna Group is mounted on Antenna Trailer V-63/MPS-7. Six Indicator Groups OA-175/FPS-3 and Display-Plotting Board Group OA-423/G are installed in Operations Building S-80/MPS-7. The remaining units of the indicator and control group are mounted in Control Shelter S-81/MPS-7. Each of the two power units is mounted on an M-35 truck.

Related Equipments: Telephone Set, Height-Finding Radar, Video Mapping Equipment.

**PRINCIPAL COMPONENTS AND PHYSICAL DATA**

COMPONENT	QTY	HEIGHT (Inches)	WIDTH (Inches)	DEPTH (Inches)	UNIT WT.
Antenna Pedestal AB-2B1/MPS-7	1				
Antenna Support AB-179/FPS-3	1	160	89	101	
Antenna Reflector AT-392/MPS-7	1				
Antenna Horn AS-48B/FPS-3	1	96	60	11-1/2	
Radar Modulator MD-128A/FPS-3	1	48	45	32	800
Radar Transmitter T-360A/FPS-3	2				
Oscilloscope OS-17/FPS-3	1				
Antenna Trailer Outrigger MX-1419/MPS-7	4	36	30	144	860
Receiver Group OA-318/FPS-3	1	59	27	28	450
Radar Set Group OA-355/MPS-7	1	48	25	25	180
Frequency Control Group	1	64	26	26	350
Indicator Group OA-175/FPS-3	7	44	24	45	412

**AN/MPS-7: 2**

ITEM NAME: RADAR SET  
TYPE: AN/MPS-7

**PRINCIPAL COMPONENTS AND PHYSICAL DATA**

<b>COMPONENT</b>	<b>QTY</b>	<b>HEIGHT (Inches)</b>	<b>WIDTH (Inches)</b>	<b>DEPTH (Inches)</b>	<b>UNIT WT.</b>
Display-Plotting Board Group OA-423/G	1	120	240	66	1000
Diesel Engine Generator Set MB-1	2	80	39	126	6200
Antenna Trailer V-63/MPS-7	1	90	96	272	11120
Truck M-35	16	123	99	264	12880
Tractor M-48	1	12000			
Electrical Equipment Shelter S-B1/MPS-7	1	84	99	144	1270
Ready-Cut Prefabricated Building S-80/MPS-7	1	168	336	480	8900
Electrical Equipment Shelter S-82/MPS-7	1	168	336	288	4930

**REFERENCE DATA AND LITERATURE**

Technical Orders:  
31P6-2MPS7- Series

**AN/MPS-7: 3**

DATE: 15 April 1964

ITEM NAME: RADAR SET

COGNIZANT SERVICE: USAF

TYPE: AN/MPS-8

FEDERAL STOCK NUMBER: 5840-505-1850

	USA	USN	USAF	USMC
STATUS OR TYPE CLASSIFICATION			Ltd Std	
Mfg(s) Name or Code Number: Radio Corporation of America				

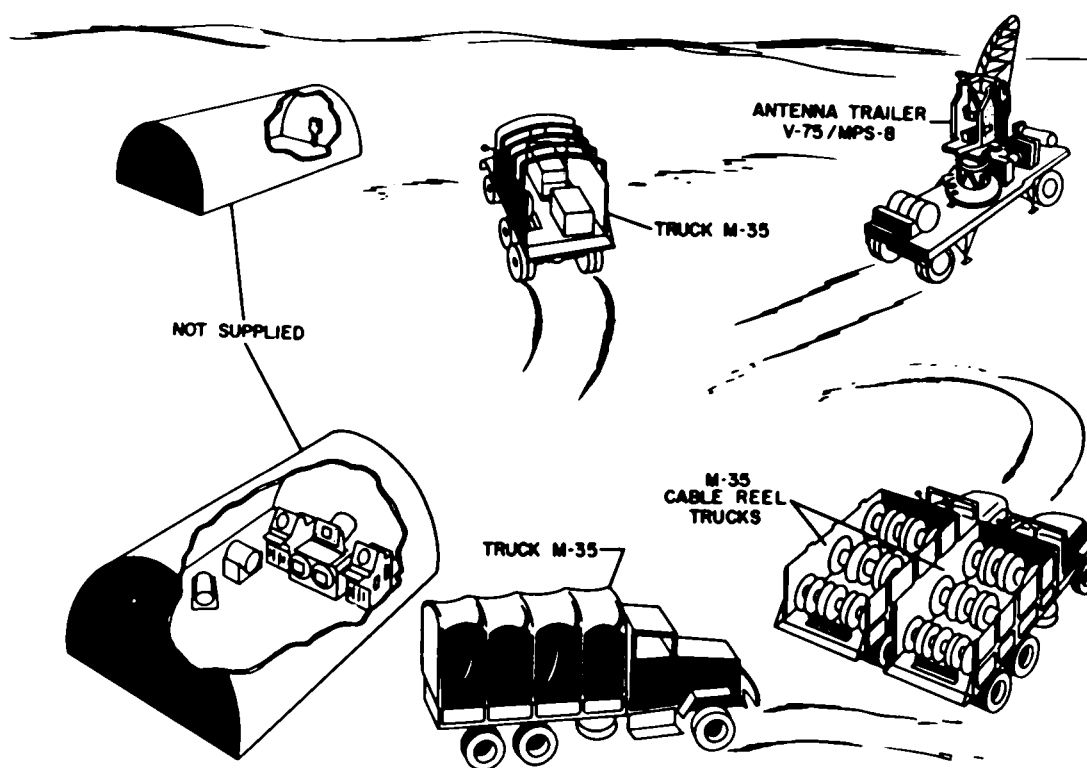

### FUNCTIONAL DESCRIPTION

Radar Set AN/MPS-8 is a mobile, lightweight, medium-range height-finding radar set. This equipment is especially adaptable to installation in mountainous terrain because of the extremely narrow beam width characteristics of the antenna. This radar set has a

maximum presentable range coverage of 120 nautical miles and a height-finding capability of minus 5000 to plus 60,000 feet. Radar Set AN/MPS-8 is airtransportable in a type C-82 cargo aircraft without disassembly of any components other than the upper section of the antenna reflector.

AN/MPS-8: 1



**ITEM NAME:** RADAR SET  
**TYPE:** AN/MPS-B

**RELATION TO SIMILAR EQUIPMENT**

Radar Set AN/FPS-4 is the fixed version and Radar Set AN/TPS-10D the transportable version of Radar Set AN/MPS-8.

**TECHNICAL DESCRIPTION**

Frequency: 9230 to 9404 mc  
Range: 120 naut mi  
Peak Power Output: 250 kw  
Operating Voltages and Power Requirements:  
120/208v ac, 60 cps, 3-ph, 4-wire, 12 kw  
Type of Presentation: one RHI  
Indicator Ranges: 0 to 60 or 0 to 120 mi with range marks at 5- and 10-mi intervals respectively  
RF Power Source: Type JAN-6002 magnetron  
Pulse Repetition Range: 530 pps  
Pulse Width: 0.5 or 2 usec  
Horizontal Coverage: 360 deg  
Vertical Coverage: -5000 to plus 60,000 ft (-2 to plus 23 deg angular)  
Antenna Rotation Speed: Automatic, 1/3 rprm; manual, 0 to 6 rpm  
Antenna Vertical Scanning Rate: Automatic 60 cpm; manual 30 cpm  
Resolution: Range 0.7 mi (120-mi position) 0.43 mi (60-mi position). Azimuth 2.3 deg elevation 0.8 deg

System Accuracy

Range: 1 mi at 100 mi, absolute; 0.5 mi at 100 mi relative  
Azimuth: 2 deg absolute; 0.5 deg relative  
Elevation: plus or minus 1000 ft absolute; plus or minus 500 ft relative  
Horizontal Beam Width: 2.05 deg  
Vertical Beam Width: 0.755 deg  
Receiver Band Width: 3 mc  
IF. Frequency: 30 mc

**INSTALLATION CONSIDERATIONS**

Siting: The area should permit an unobstructed beam search and have ample space for erection of operations and equipment shelters and parking of trucks.

Mounting: Antenna Group is mounted on Antenna Trailer V-75/MPS-8 (Mobile Mounting) or on Antenna Pedestal legs MT-1061/TPS-10D and NT-8B8/TPS-10D (Ground Mounting). The Indicator and Control Group is installed in the operational shelter. The Power Group is mounted on an M-35 Truck.

Related Equipment: Search Radar Sets.

**PRINCIPAL COMPONENTS AND PHYSICAL DATA**

COMPONENT	QTY	HEIGHT (Inches)	WIDTH (Inches)	DEPTH (Inches)	UNIT WT.
Radar Receiver Transmitter RT-206/TPS-10D		27-1/8	27-5/8	32-1/2	215
Radar Modulator MD-140/TPS-10D		22	24	43-1/4	185
Power Supply PP-636/TPS-10D		22-1/4	23-1/2	21-3/4	85
Power Supply PP-635/TPS-10D		22	23-3/4	30-3/4	210
Electronic Control Amplifier AM-493/TPS-10D		32-3/4	35	49-1/2	450
Manifold Dehydrator Type B-1		19-3/4	28	22	230
Antenna Group OA-375/TPS-10D		157	(radius) 63-1/4		
Antenna Pedestal MT-1255/MPS-8	3				
Antenna Pedestal MT-1061/TPS-10D*					
Antenna Pedestal Leg MT-888/TPS-10D*	2				
Control Indicator C-B35/TPS-10D		27-1/4	22	44	200

**AN/MPS-8: 2**

ITEM NAME: RADAR SET  
TYPE: AN/MPS-B

**PRINCIPAL COMPONENTS AND PHYSICAL DATA**

<b>COMPONENT</b>	<b>QTY</b>	<b>HEIGHT (Inches)</b>	<b>WIDTH (Inches)</b>	<b>DEPTH (Inches)</b>	<b>UNIT WT.</b>
Sweep Generator O-145/TPS-10D		21	21-3/4	35	147
Power Supply PP-637/TPS-10D		22	23-3/4	30-3/4	210
Antenna Control C-841/TPS-10D		7-7/8	14-1/4	15	1i
Indicator Control C-B40/TPS-10D		18-1/2	21-1/2	20-3/4	97
Motor Generator PU-219/TPS-10D		31-1/4	59-1/2	22-3/8	950
Trailer V-75/MPS-8					
Truck M-35	4	123	99	264	12880

\* Required for ground installation in place of Antenna Pedestal MT-1255/MPS-B.

**REFERENCE DATA AND LITERATURE**

Technical Orders:  
31P3-2MPS8- Series  
Also see 31P3-2FPS4- Series  
Specification:  
ENG-290B

**AN/MPS-8: 3**

DATE: 15 April 1964

ITEM NAME: RADAR SET

COGNIZANT SERVICE: USAF

TYPE: AN/MPS-11

FEDERAL STOCK NUMBER: 5840-646-4982

	USA	USN	USAF	USMC
STATUS OR TYPE CLASSIFICATION			Std	
Mfg(s) Name or Code Number: General Electric Company				

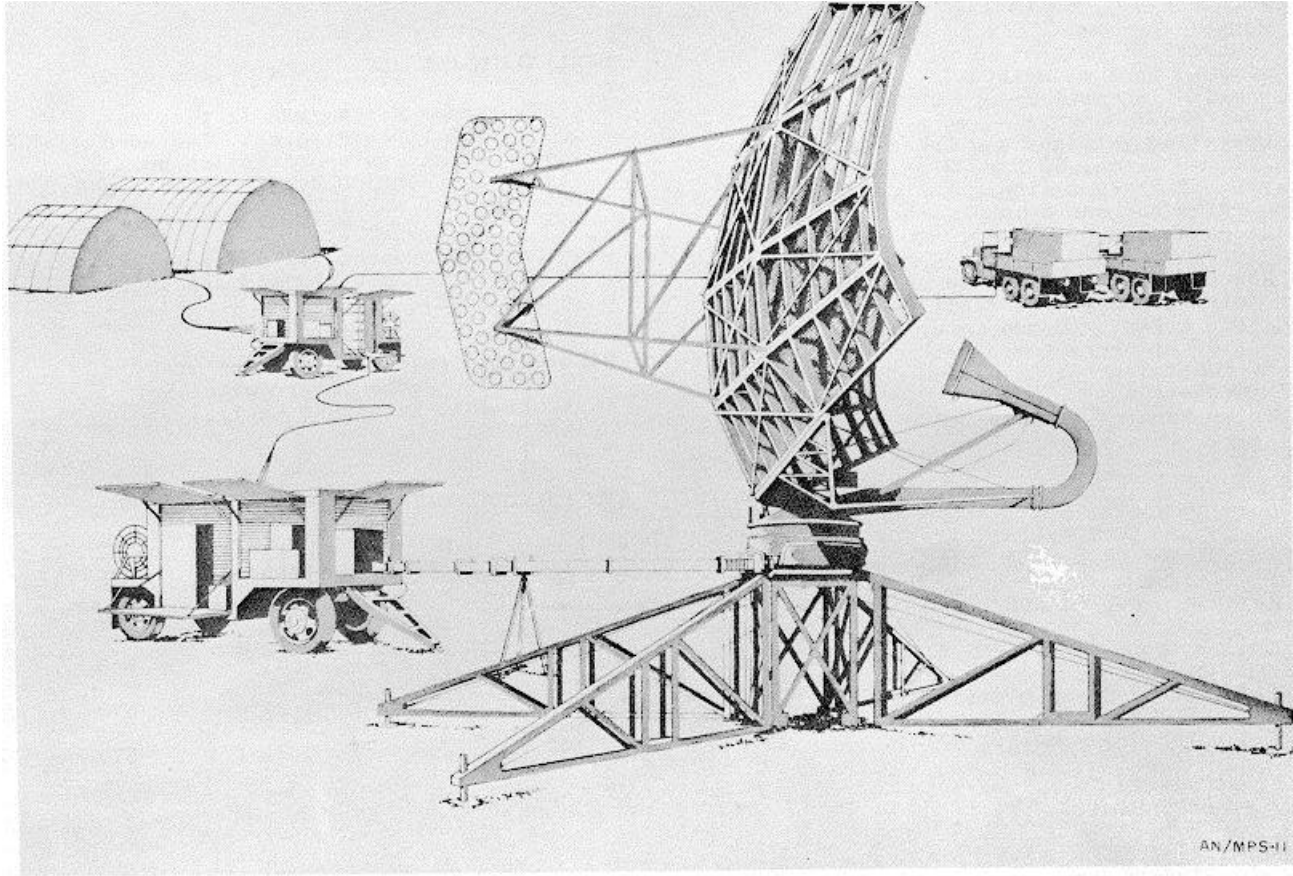

### FUNCTIONAL DESCRIPTION

Radar Set AN/MPS-11 is a mobile version of Radar Set AN/FPS-8, combining the electrical characteristics of the AN/FPS-8 system with the advantages of mobility and flexibility of application. Except for PPI's and power

units, standard radar components of Radar Set AN/FPS-8 are employed in the AN/MPS-11. This equipment is a transportable, land-based search system designed for the detection of aircraft at ranges up to 200 nautical miles and at altitudes up to 40,000 feet. This radar set

AN/MPS-11: 1

**ITEM NAME:** RADAR SET  
**TYPE:** AN/MPS-11

comprises standard AN/FPS-8 radar components mounted on trucks and lightweight trailers together with IFF equipment and the additional electrical and mechanical assemblies required for mobile operation of the system. Radar Set AN/MPS-11 is both air and road transportable.

**RELATION TO SIMILAR EQUIPMENT**

Radar Set AN/MPS-11 is a mobile version of Radar Set AN/FPS-8.

**TECHNICAL DESCRIPTION**

Frequency: 1280 to 1350 mc  
Range:  
Normal - 160 naut mi without delay,  
220 naut mi with delay  
MTI - 150 naut mi  
Peak Power Output: 1 megw  
Operating Voltages and Power Requirement:  
120/208v ac, 60 cps, 3-ph, 4-wire, 20kw  
Type of Presentation: two to six 12-in.  
PPI's and one 5-in. A-scope  
Scope Ranges: 0 to 50, 100 and 160 naut mi  
Range Marks: 10-mi intervals, accentuated at 50-mi intervals  
Angle Marks: 10-deg intervals, accentuated at every third mark  
RF Power Source: Type JANQK-358 tunable magnetron  
Pulse Repetition Rate: 360 pps

Pulse Width: 3 usec  
Horizontal Coverage: 360 deg, manual or automatic, either direction  
Vertical Coverage: Manually adjustable between -2 and plus 5 deg from horizontal (antenna not intended for tilting operation)  
Antenna Rotation Speed: 0 to 10 rpm  
Resolution: plus or minus 0.5 deg in azimuth  
System Accuracy: Range, 0.5 mi; azimuth, 0.5 deg  
Horizontal Beam Width: 2.5 deg  
Vertical Beam Width: 9 deg  
Receiver Band Width: 0.6 plus or minus 0.1 mc  
IF. Frequency: 30 mc

**INSTALLATION CONSIDERATIONS**

Siting: Radar Set AN/MPS-11 requires a 100 by 400 ft level area. The area should permit an unobstructed beam search through 360 deg in azimuth and to an elevation of 7 deg.

Mounting: Components of Radar Set AN/MPS-11 are mounted and transported in vehicles.

Related Equipment: Radar Set Group AN/GPA-49, Radio Interrogator Set AN/GPX-18A, Telephone Central Group AN/GTA-6A.

**PRINCIPAL COMPONENTS AND PHYSICAL DATA**

COMPONENT	QTY	HEIGHT (Inches)	WIDTH (Inches)	DEPTH (Inches)	UNIT WT.
Antenna Group OA-405/FPS-6	1	200	300	72	2429
Receiver Group OA-417/FPS-8	1	50-1/2	33-1/8	27	540
Transmitter Group OA-413/FPS-8	1	57-9/16	32	24	578
Modulator Group OA-414/FPS-8	1	55-1/3	24	24-1/4	578
Power Supply Group OA-412/FPS-8	1	54	30	28	1160
Electrical Power Switching Group OA-415/FPS-8	1	61-1/2	25	32	760
Radar Set Group OA-381/FPS-8	1	40-3/4	33-3/8	26-3/8	150
Radar Set Group OA-416/FPS-8	1	63-9/16	24	29	570
Antenna Control C-1133/FPS-8	1	30	15	15	
Range Indicator IP-209/FPS-8	1	21	28-11/16	15	150
Indicator Group OA-99A/CPS-6B	2 to 6	42	21	43	419 ea

**AN/MPS-11: 2**

ITEM NAME: RADAR SET  
TYPE: AN/MPS-11

PRINCIPAL COMPONENTS AND PHYSICAL DATA

COMPONENT	QTY	HEIGHT (Inches)	WIDTH (Inches)	DEPTH (Inches)	UNIT WT.
Display-Plotting Board Group OA-390/FPS-8	1	49	90	95	
Power Switchboard SB-245/FPS-8	1	62	23	20	270
Motor-Generator MB-3	2				
Antenna Tower AB-396/FPS-8 or AB-396A/FPS-8(Not used with Fixed Version)	1	24	28	50	70
Antenna Tower AB-397/FPS-8 (Used with Fixed Version)	1				
Maintenance Shelter S-94/MPS-11 (Not used with Fixed Version)	1				
Operations Shelter S-95/MPS-11 (Not used with Fixed Version)	1				
Truck M-35 (Not used with Fixed Version)					
Trailer Van V-112/MPS-11	1				5915
Trailer Van V-113/MPS-11	1				5945

REFERENCE DATA AND LITERATURE

Technical Orders:

31P6-2MPS11- Series  
See also 31P6-2FPS8- Series

Specification:

MIL-R-9646

Technical Manuals:

NAVSHIPS 91994  
NAVSHIPS 92216  
TM9-252  
TM9-819  
TM9-1819  
L09-819  
SNL-G742  
SIG MBI-AN/UPS-25  
NAVMC-ELECT-2000

AN/MPS-11: 3

DATE: 1 July 1964

ITEM NAME: RADAR SET

COGNIZANT SERVICE: USN

TYPE: AN/MPS-11A

FEDERAL STOCK NUMBER:

	USA	USN	USAF	USMC
STATUS OR TYPE CLASSIFICATION				
Mfg(s) Name or Code Number:				

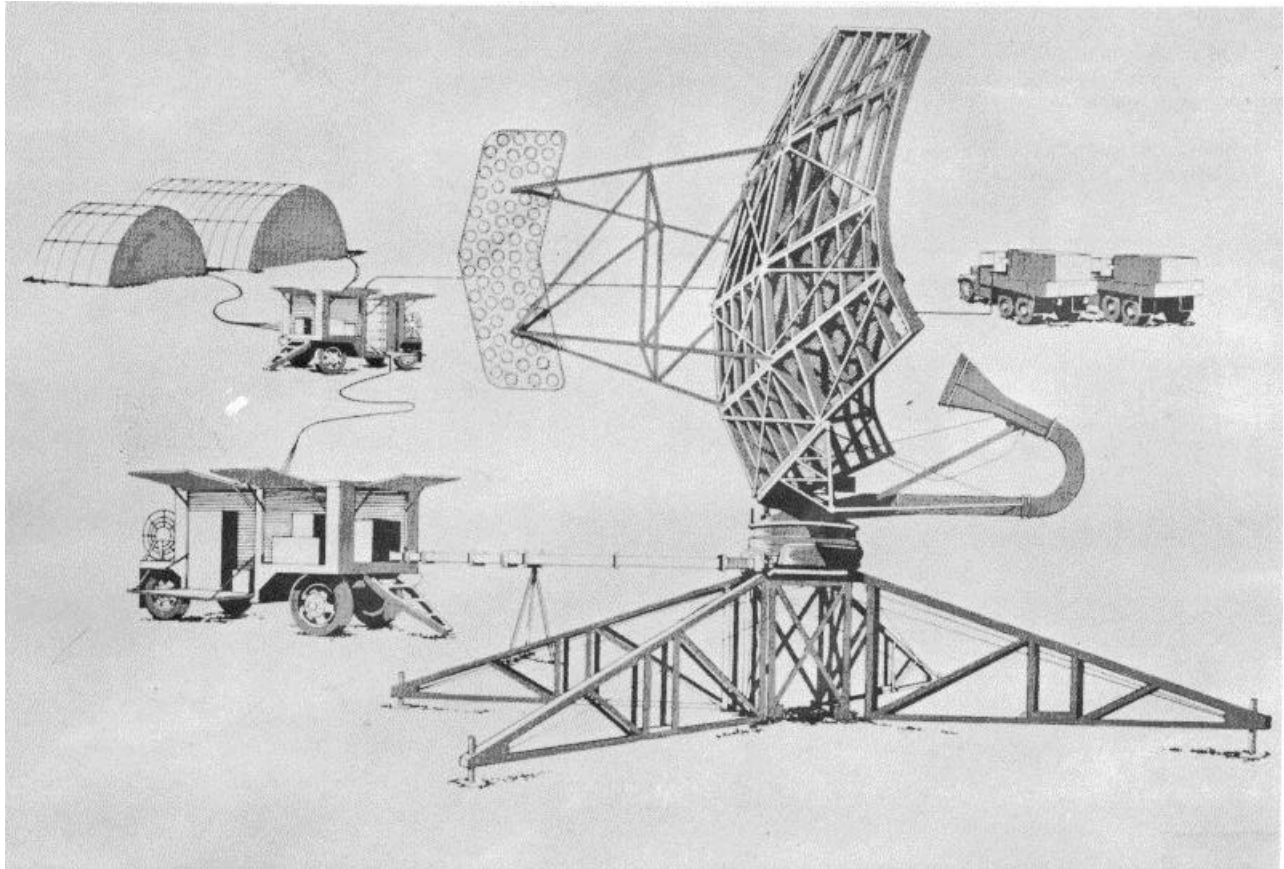

### FUNCTIONAL DESCRIPTION

The AN/MPS-11A operates in the frequency range of 1280 to 1350 megacycles per second and is designed

primarily as a ground control interception and early warning search set. The instrument gives high altitude search detection. Pulse repetition with or without Moving Target Indication is 360 cycles per second.

AN/MPS-11A: 1

**ITEM NAME:** RADAR SET  
**TYPE:** AN/MPS-11A

**RELATION TO SIMILAR EQUIPMENT**

This set is the mobile version of Radar Set AN/FPS-8. Also similar to and interchangeable with Radar Set AN/MPS-11 except for some components which will be furnished GPE by the Marine Corps.

Power Source Required: 208 or 120v, 60 cps, 3 ph, 4-wire  
Emission: P9

**INSTALLATION CONSIDERATIONS**

Not available.

**TECHNICAL DESCRIPTION**

Frequency Range: 1280 to 1350 mc

**PRINCIPAL COMPONENTS AND PHYSICAL DATA**

<b>COMPONENTS</b>	<b>QTY</b>	<b>OVERALL DIMENSIONS (Inches)</b>	<b>UNIT WT. (Pounds)</b>
Radar Set AN/MPS-11A	1		

**REFERENCE DATA AND LITERATURE**

Nomenclature Card for Radar Set AN/MPS-11A  
amended 27 June 1953.

**AN/MPS-11A: 2**

DATE: 15 April 1964  
COGNIZANT SERVICE: USAF

ITEM NAME: RADAR SET  
TYPE: AN/MPS-14

FEDERAL STOCK NUMBER: 5840-505-1739

	USA	USN	USAF	USMC
STATUS OR TYPE CLASSIFICATION		Std		
Mfg(s) Name or Code Number. General Electric Company				

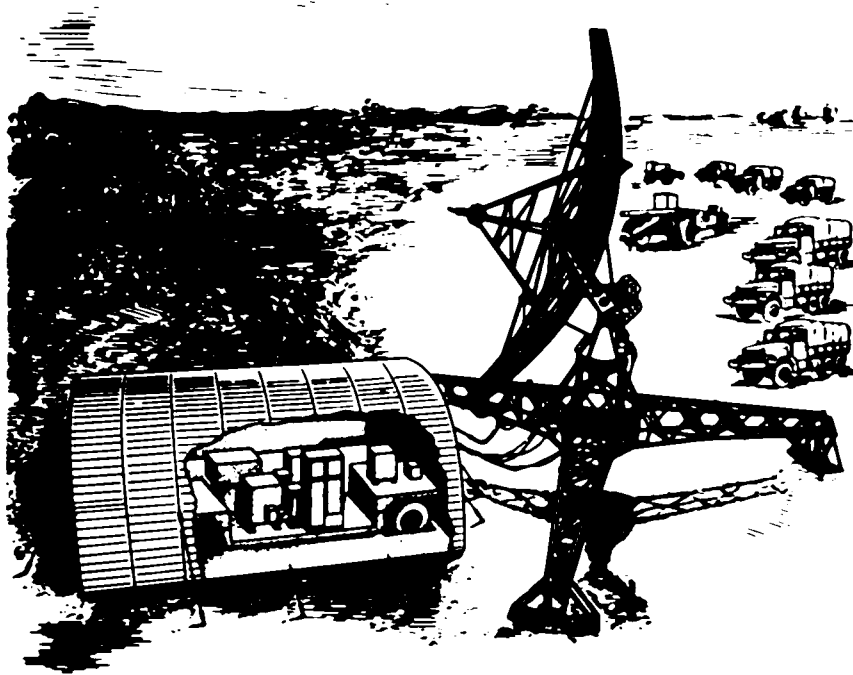

### FUNCTIONAL DESCRIPTION

Radar Set AN/MPS-14 is a mobile, highpower, long-range height-finding equipment for use with a search radar of comparable range capability. This equipment furnishes height information to indicating devices

located at the search radar operations center. Radar Set AN/MPS-14 is capable of determining the height of targets up to 60,000 feet within elevation-angle limits of -2 to plus 32 degrees. Maximum slant range of the equipment is 200 nautical miles in any direction in azimuth. Provisions have been made

AN/MPS-14: 1



**ITEM NAME:** RADAR SET

**TYPE:** AN/MPS-14

for sharing the use of both range-height indicators supplied and for sharing the control of the azimuth positioning of the antenna among four PPI operators of the search radar. Each operator assumes control for an automatically predetermined length of time. Radar Set AN/MPS-14 derives its power from the same source that supplies the associated search radar. With the exception of the trailers and trucks, the major components of this radar set can be transported in cargo-type C-B2 aircraft. The antenna and shelter must be disassembled prior to shipment.

**RELATION TO SIMILAR EQUIPMENT**

Radar Set AN/FPS-6, -6A, -6B are fixed versions of mobile Radar Set AN/MPS-14.

**TECHNICAL DESCRIPTION**

Frequency: 2700 to 2900 mc

Range:

Azimuth - 200 naut mi

Vertical - -5000 to plus 60,000 ft

(within vertical coverage limits)

Peak Power Output: 5 megw

Operating Voltages and Power Requirements:

120/208v ac, 60 cps, 3-ph, 4-wire, 50 kva

Type of Presentation: Two 12.5-in. RHI's

Azimuth Indicator Ranges: 0 to 110 mi,

90 to 200 mi, and a 50-mi sector that

can be started at any range between 0

an 150 mi

Height Indicator Ranges: -5000 to plus

60,000 ft; -5000 to plus 20,000 ft;

15,000 to 35,000 ft; and 35,000 to

60,000 ft

Range Marks: 10-mi intervals, accentuated at 50-mi intervals

Height Marks: 20,000, 10,000 and 60,000 ft

Elevation Angle Marks: 5-deg intervals

from 0 to 30 deg

RF Power Source: Type QK-338 magnetron

Pulse Repetition Rate: 300 to 100 pps

Pulse Width: 2 to 3 usec

Horizontal Coverage: 360 deg

Vertical Coverage: -2 to plus 32 deg angular

Antenna Positioning: Remote manual positioning; may be slewed for rapid positioning

Antenna Vertical Scan Rate: 20 to 30 cpm

Resolution: Range, 0.375 mi or 0.5%;

azimuth, 3.2 deg; and elevation, 0.85 deg

System Accuracy: Range, plus or minus 1%;

azimuth, 0.5 deg; and elevation, 1000ft

Horizontal Beam Width: 3.2 deg

Vertical Beam Width: 0.85 deg

Receiver Bandwidth: 1 mc

IF. Frequency: 30 mc

**INSTALLATION CONSIDERATIONS**

Siting: A rectangular area of not less than 73 feet by 54 feet is required for the antenna group and shelter. Additional area is required for parking trucks.

Mounting: The antenna group) is mounted on Antenna Pedestal Trailer V-65/MPS-14; the shelter group is mounted on Transmitter-Modulator Trailer V-66/MPS-14 and is enclosed by prefabricated Panelized Building S-B7/G; and the indicator and control group is installed in the operations building of the associated radar.

Related Equipment: Search Radar Sets AN/MPS-7 and AN/MPS-1.

**PRINCIPAL COMPONENTS AND PHYSICAL DATA**

COMPONENT	QTY	HEIGHT (Inches)	WIDTH (Inches)	DEPTH (Inches)	UNIT WT. (Pounds)
Antenna Group OA-389/FPS-6	1				
Antenna Pedestal Leg 2 MT-1091/MPS-14	2				
Antenna Pedestal Leg MT-1092/MPS-4					
Motor-Generator PU-293/G	1	18	16	44-5/8	
Prefabricated Panelized Building S-87/G	1	144	288	336	
Radar Set Group OA-357/FPS-6	1	48	22	44	750
Radar Transmitter T-338/FPS-6	1	31	31	37	800

ITEM NAME: RADAR SET  
TYPE: AN/MPS-14

PRINCIPAL COMPONENTS AND PHYSICAL DATA

COMPONENT	QTY	HEIGHT (Inches)	WIDTH (Inches)	DEPTH (Inches)	UNIT WT. (Pounds)
Desiccant Electric Dehydrator HD-187/FPS-6	1	26	26	34	300
Electron Tube Cooler Liquid HD-188/FPS-6	1	21-3/8	34-1/4	30-1/2	300
Modulator Group OA-329/FPS-6	1	60	40	34	1200
Power Supply PP-783/FPS-6 (crated)	1	27-1/2	48	61	1155 (crated)
Voltage Regulator CN-93/CPS-6B (crated)	1	45-1/2	21-1/2	22-1/2	425 (crated)
Radar Set Group OA-320/FPS-6	1	48	24	42	1200
Radar Set Group OA-270/FPS-6					
Antenna Control C-1050/FPS-6					
Antenna Control C-1049/FPS-6					
Antenna Control C-1048/FPS-6					
Height Indicator ID-331/FPS-6					
Terminal Box J-470/FPS-6					
Antenna Pedestal Trailer V-65/MPS-14					
Transmitter-Modulator Trailer V-66/MPS-14					
Outrigger Transport Trailer V-67/MPS-14					
Truck MK-35		123	99	264	12880

REFERENCE DATA AND LITERATURE

Technical Orders:  
31P3-2FPS6- Series  
Specifications:  
ENG-308 Amend. #1

AN/MPS-14: 3

DATE: 15 December 1964

ITEM NAME: RADAR SET

COGNIZANT SERVICE: USAF

TYPE: \*AN/MPS-16, \*\*AN/MPS-16A,  
\*\*\* AN/MPS-16B

FEDERAL STOCK NUMBER: \*5840-307-3988  
\*\*5840-620-4577  
\*\*\*5840-626-8928

	USA	USN	USAF	USMC
STATUS OR TYPE CLASSIFICATION			*Std	**Used By
Mfg(s) Name or Code Number				

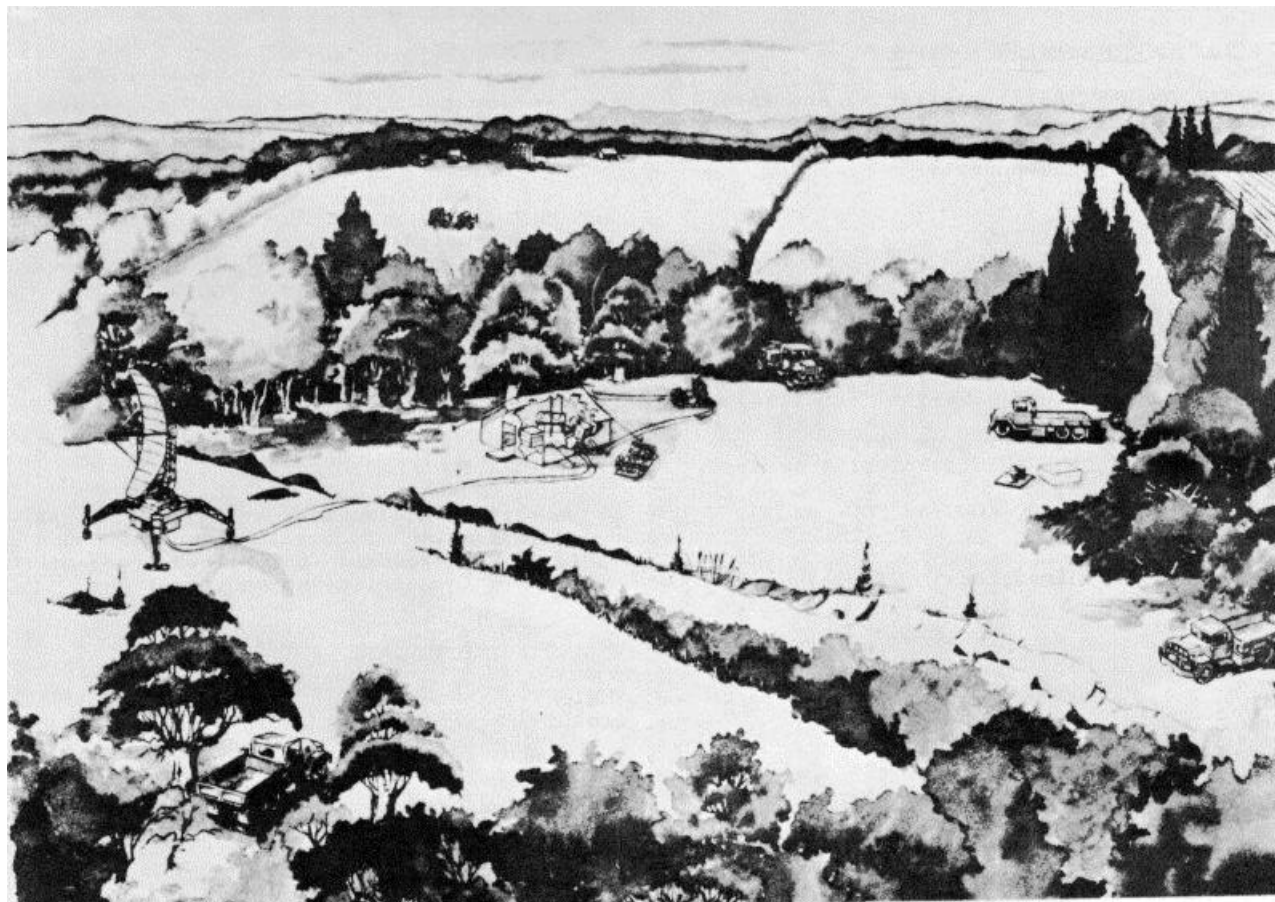

**FUNCTIONAL DESCRIPTION**

The AN/MPS-16, AN/MPS-16A and AN/MPS-16B are high-power, long-range, mobile height finding radar sets which supplement and provide the accurate height information necessary for the most efficient operation of a search radar installation, thereby effecting aircraft

control and ground controlled interception. The radar sets are capable of accepting azimuth control from, and furnishing height data to, search radar sets equipped with either Indicator Group OA-175/FPS-3 or Indicator Group AN/UPA-35.

**AN/MPS-16: 1**

**ITEM NAME:** RADAR SET  
**TYPE:** AN/MPS-16, AN/MPS-16A, AN/MPS-16B

Also the radar sets use an antenna with a paraboloidal reflector to direct its pulsed R-F output. The antenna can rotate continuously in the horizontal plane, and nod in the vertical plane through two arcs of different magnitude. Although it is normally transported in four type M-35 trucks, the lightweight aluminum construction of the AN/MPS-16 permits it to be airlifted in two type C-119 aircraft or six type H-21B helicopters. Radar Set AN/MPS-16 consists of serial numbers 1 through 20; Radar Set AN/MPS-16A consists of serial numbers 21 through 43, 55 through 75; and Radar Set AN/MPS-16B consists of serial numbers 44 through 54.

**RELATION TO SIMILAR EQUIPMENT**

The AN/MPS-16A is similar to and interchangeable as a whole with AN/MPS-16 and AN/MPS-16B, the only difference functionally being in components.

**TECHNICAL DESCRIPTION**

Transmitter

- Frequency: 5280 mc (plus or minus 30 mc)
- R-F Source: Type QK-632 magnetron
- Pulse Rate Capability: 300 to 364 pps
- Pulse Rate (With Crystal Supplied): 360 pps
- Power Output: 1 megw peak
- Pulse Width: 2.5 usec (plus or minus 5%)
- Duty Cycle: 0.0009 at 360 pps

Antenna

- Aperture Dimensions: 21.6 by 5.7 ft
- Focal Length: 6.6 ft

- Gain: 43 db
- Side-Lobe Attenuation: 26 db min
- Beam Width:
  - Azimuth - 2.4 deg plus or minus 0.1 deg
  - Elevation - 0.6 deg plus or minus 0.05 deg
  - Scan Rate: 20 cpm (plus or minus 3 cpm) through sectors of -2 deg to plus 8 deg or -2 deg to plus 32 deg
- Receiver
  - Noise Figure (Overall System): 10 db
  - I-F Frequency: 30 mc
  - I-F Bandwidth: 0.5 mc
- Motor-Generator Set
  - Motor:
    - Input - 25 kw, 60 cps, 3 ph, 4-wire, 120/208v ac
  - Generator:
    - Output - 20 kw, 400 cps, 3 ph, 4-wire, 120/208v ac
- Target Detection Capabilities
  - Height Determination: 100,000 ft max
  - Range Determination: 200 mi (naut) (max slant range)
  - Azimuth Coverage: 360 deg
  - Azimuth Turning Rate: 1/8 rpm

**INSTALLATION CONSIDERATIONS**

Mounting: Components are mounted on pallets which are, in turn, mounted on 1 ea M-35 trucks. The pallets are removable for airlifting equipment.

**PRINCIPAL COMPONENTS AND PHYSICAL DATA**

COMPONENT	QTY	HEIGHT (Inches)	WIDTH (Inches)	DEPTH (Inches)	UNIT WT. (Pounds)
Radar Modulator MD-269/MPS-16 or MD-327/MPS-16A	1				
Radar Set Group OA-1260/MPS-16	1				
Radar Transmitter T-590/MPS-16 or T-668/MPS-16A	1				
Radar Set Group OA-1265/MPS-16	1				
Radar Set Control Group OA-1233/MPS-16	1				
Indicator Group OA-1259/MPS-16	1				
Amplifier-Indicator Group OA-1242/MPS-16	1				
Antenna Group OA-1196/MPS-16	1				
Antenna Control C-2000/MPS-16	4				
Antenna Control C-1999/MPS-16	1				
Interconnecting Box J-736/MPS-16	1				
Dehumidifier, Desiccant, Electric HD-262/MPS-16	1				
Motor-Generator PU-372/MPS-16 or PU-372A/MPS-16	1				

ITEM NAME: RADAR SET  
TYPE: AN/MPS-16, AN/MPS-16A, AN/MPS-16B

**PRINCIPAL COMPONENTS AND PHYSICAL DATA**

<b>COMPONENT</b>	<b>QTY</b>	<b>HEIGHT (Inches)</b>	<b>WIDTH (Inches)</b>	<b>DEPTH (Inches)</b>	<b>UNIT WT. (Pounds)</b>
Material Handling Pallet MX-2050/MPS-16	1				
Material Handling Pallet MX-2055/MPS-16	1				
Material Handling Pallet MX-2056/MPS-16	1				
Material Handling Pallet MX-2057/MPS-16	1				
Truck M-35	4				

**REFERENCE DATA AND LITERATURE**

Technical Orders:  
31P3-2MPS16- Series

**AN/MPS-16: 3**

DATE: 1 July 1964

ITEM NAME: RADAR SET

COGNIZANT SERVICE: USN

TYPE: AN/MPX-2(XN-21)

FEDERAL STOCK NUMBER:

	USA	USN	USAF	USMC
STATUS OR TYPE CLASSIFICATION	Used By	Used By		
Mfg(s) Name or Code Number: Aireon Manufacturing Corporation				

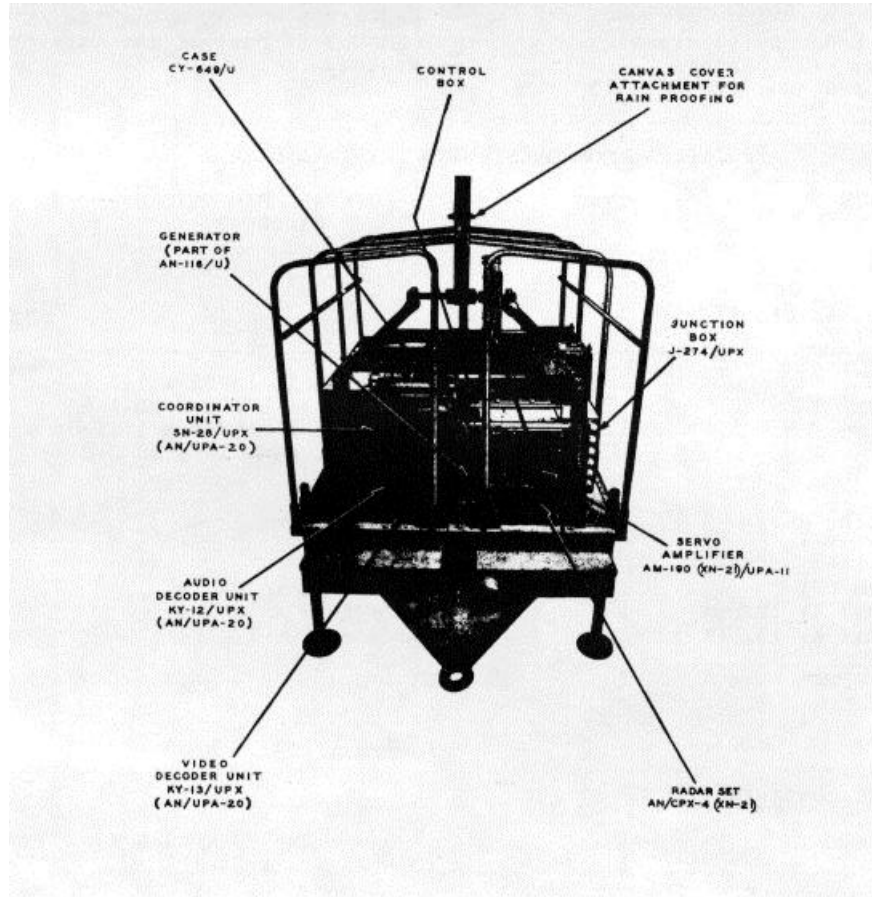

### FUNCTIONAL DESCRIPTION

The Radar Set AN/MPX-2(XN-21) Equipment Trailer provides a mobile IFF unit of medium power adapted to trailer operation, or to field set-up operation for use with associated radar. The IFF equipment is capable of transmitting short pulses of coded ultra-high-frequency

energy for identifying friendly targets equipped with a Mark V IFF transponder; the transponder in turn transmitting reply pulses for display on the PPI and A scopes of the associated radar used in connection with the

AN/MPX-2(XN-21): 1

**ITEM NAME:** RADAR SET  
**TYPE:** AN/MPX-2(XN-21)

Trailer Equipment. The Trailer Equipment provides IFF Mark V identification signals correlated in range and azimuth with radar and MTI (Moving Target Indication) echoes. The system also provides for visual or aural reading of the slow coding of IFF responses.

Operating Power Requirements: 115v ac,  
60 cps, single ph  
Total Output: 4 kva  
Power Factor: 85% pf

**RELATION TO SIMILAR EQUIPMENT**

None.

**TECHNICAL DESCRIPTION**

Type of Signals: Coded pulse signal  
Number of Channels: 12 channels  
Operating Frequency Range: 950 to 1150 mc

**INSTALLATION CONSIDERATIONS**

Siting: Mobile.

Related Equipment: The AN/MPX-2(XN-21) is designed to be used with, but not part of Navy Models SO-7M, SO-7N, SO-12M, SO-12N, SP-1M, and Radio Set AN/TPS-1B, and Radar Set AN/MSG. The AN/MPX-2 (XN-21) is part of the Mark 5 IFF system.

**PRINCIPAL COMPONENTS AND PHYSICAL DATA**

<b>COMPONENTS</b>	<b>QTY</b>	<b>OVERALL DIMENSIONS (Inches)</b>	<b>UNIT WT. (Pounds)</b>
Radar Set AN/CPX-4	1	14-1/4 x 17-1/4 x 22-3/8	126
Directional Antenna AN/UPA-11	1		
consists of:			
Antenna	1	9-13/32 x 13-13/32 x 111	51
Antenna Pedestal	1	10-1/4 x 11-27/32 x 20-1/8	48
Train Control	1	8-19/32 x 11-15/16 x 13-1/8	27
Servo Amplifier	1	12-3/16 x 16-3/16 x 18-7/8	75
Antenna Mast	1	106	
Radar Interconnecting Assy	1		
AN/UPA-20 consists of:			
Coordinator SN-28/UPX	1	9-3/4 x 17 x 17-1/4	108
Audio Decoder Unit KY-12/UPX	1	9-3/4 x 17 x 17-1/4	109
Video Decoder Unit KY-13/UPX	1	9-3/4 x 17 x 17-1/4	107
Radar Test Set AN/UPM-6	1	13-1/2 x 13-3/4 x 17	62.4
consists of:			
Test Set Case	1	15-1/2 x 16-3/8 x 38	32.7
Power Unit PU-116/U consists of:			
Engine	1	19-5/8 x 29-1/2 x 34-3/1	372
Generator	1	13 x 15-1/2 x 21-1/2	164
Trailer V-16(XN-21)/MPX	1	80 x 101-1/2 x 133-1/2	
Case CY-649/U	1	19-3/16 x 22-13/32 x 12-1/16	180
Terminal Box J-274/UPX	1	2-3/4 x 14-1/4 x 20	13.5
Reel RL-133/U	3	10-3/8 w x 25 dia	387

**REFERENCE DATA AND LITERATURE**

Technical Manuals:  
NAVSHIPS 91057

**AN/MPX-2(XN-21): 2**

DATE: 15 April 1964

ITEM NAME: RADAR IDENTIFICATION SET

COGNIZANT SERVICE: USAF

TYPE: AN/MPX-7

FEDERAL STOCK NUMBER: 5895-320-8585B

	USA	USN	USAF	USMC
STATUS OR TYPE CLASSIFICATION			Alt Std	
Mfg(s) Name or Code Number. Ultrasonic Corporation, Advance Industries				

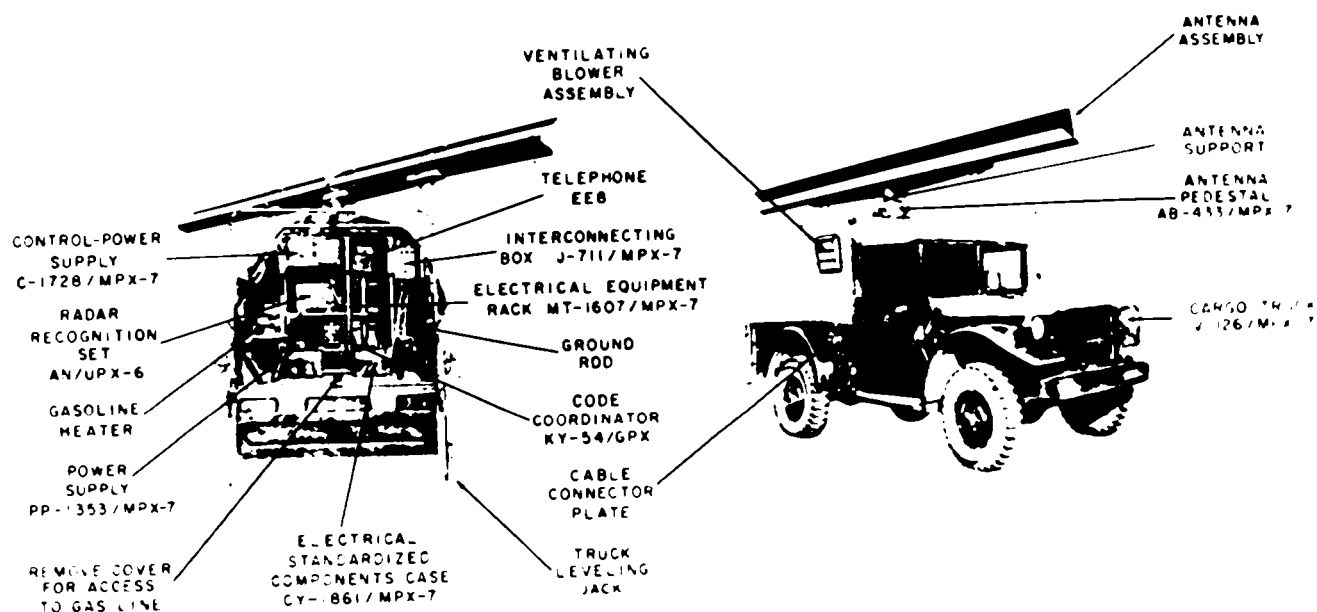

## FUNCTIONAL DESCRIPTION

Radar Identification Set AN/MPX-7 provides Mark X IFF for Close Support Control Set AN/MSQ-1A. The AN/MPX-7 transmits coded rf pulses to trigger an airborne transponder reply to video pulses. The equipment permits the video pulses to be displayed on

the PPI's of the associated radar set. The interrogator output level and receiver sensitivity are adequate for interrogating and receiving replies from transponders operating within the detection range of the associated close support control set.

AN/MPX-7: 1



**ITEM NAME:** RADAR IDENTIFICATION SET  
**TYPE:** AN/MPX-7

**RELATION TO SIMILAR EQUIPMENT**

AN/MPX-7 is similar to and interchangeable with AN/MPX-7A. Differs in that AN/MPX-7A uses Coder-Decoder Group OA-1267/MPX-7A.

Image Ratio: More than 70 db  
Input Impedance: 52 ohms  
Video Output Impedance: 72 ohms

**TECHNICAL DESCRIPTION**

Frequency: Transmitting, 990 to 1040 mc  
receiving, 1080 to 1130 mc  
Peak Power Output: 1.5 kw  
Operating Voltages and Power Requirement  
105, 117, or 125v ac, 60 cps, 1-ph,  
250w  
Type of Presentation: PPI's of associated close support  
control set  
Pulse Repetition Rate: 125 to 1500 pps  
Receiver Bandwidth (Broadband):  
8 to 11 mc (-6 db)  
Receiver Bandwidth (Narrowband):  
5 mc (-70 db)  
IF. Frequency: 60 mc

**INSTALLATION CONSIDERATIONS**

Siting: Physically located with Close Support Control Set AN/MSQ-1A.

Mounting: All equipment is mounted in Truck V-126/MPX-7, except for SA-239, which is mounted in the van of associated radar.

Cabling Requirements: Five cables for interconnecting to associated equipment.

Related Equipment: Radar Identification Set AN/MPX-7 may be operated with Close Support Control Set AN/MSQ-1A.

**PRINCIPAL COMPONENTS AND PHYSICAL DATA**

COMPONENT	QTY	HEIGHT (Inches)	WIDTH (Inches)	DEPTH (Inches)	UNIT WT. (Pounds)
Radar Recognition Set AN/UPX-6*	1	11	15	21	77
Code Coordinator KY-54/GPX*	1	5-5/8	6-5/8	23	39
Switch Box SA-239/GPX*	1	4-1/4	4-3/4	64	1.4
Control-Power Supply C-1728/MPX-7	1	11-1/4	20-1/8	23-1/8	80
Power Supply PP-1353/MPX-7	1	5-3/4	7	12	10
Antenna Assembly AS-295A/UP* or AS-295B/UP	1	13-1/2	9	222	101
Antenna Pedestal AB-433/MPX-7	1	17	20-1/2	24	127
Antenna Support AB-434/MPX-7	1	8-5/8	8	127-7/8	47
Telephone EE-8*	1				
Electrical Equipment Rack MT-1607/MPX-7	1	53-5/8	44-1/4	32-1/4	334
Electrical Standardized Components Case CY-1861/MPX-7	2	14	14	10	20
Interconnecting Box J-711/MPX-7	1	14	10	17-1/2	15
Truck V-126/MPX-7 (Empty)	1	89-3/4	80-1/2	184-3/4	7600

\* Government furnished equipment.

**REFERENCE DATA AND LITERATURE**

Technical Orders:  
31P4-2MPX 7 Series

Specifications:  
RADC Exhibit ENG-440

DATE: 15 April 1964  
COGNIZANT SERVICE: USAF

ITEM NAME: RADAR IDENTIFICATION SET  
TYPE: AN/MPX-7A

FEDERAL STOCK NUMBER: 5895-574-0388-EG

	USA	USN	USAF	USMC
STATUS OR TYPE CLASSIFICATION			TS	
Mfg(s) Name or Code Number:	Ultronics Corporation and Advance Industries (Bell Aircraft Corporation OA-1267/MPX-7A ONLY)			

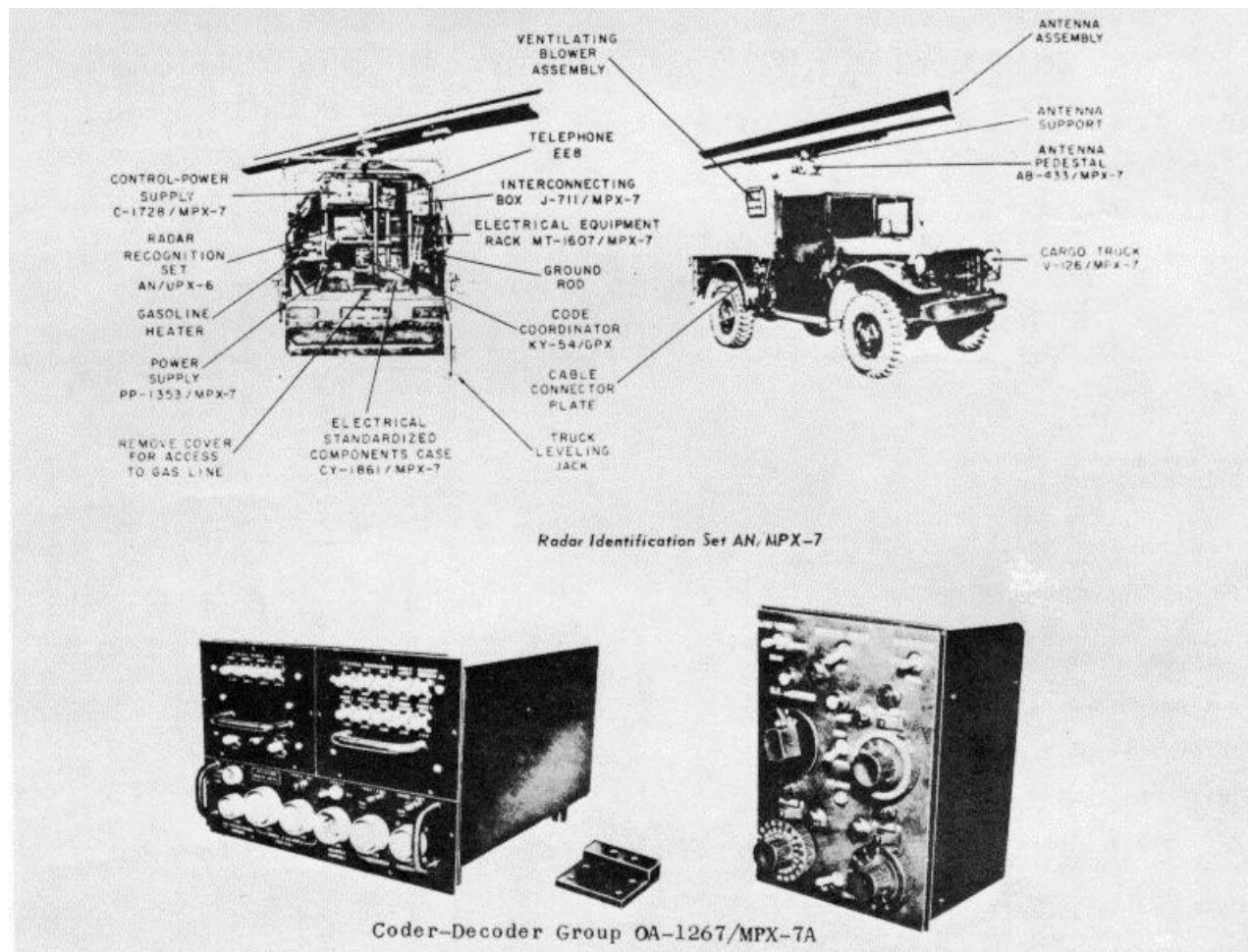

## FUNCTIONAL DESCRIPTION

Radar Identification Set AN/MPX-7A provides Mark X IFF and IM99 response for Close Support Control Set AN/MSQ-1A. The AN/MPX-7A generates paired-pulse coded interrogations. When these coded interrogations

are received by an airborne transponder set, a coded reply is transmitted back. The coded reply is received by the receiver portion of the AN/UPX-6, with the mode and code requirements and, if correct, it is decoded. The decoded signal is then displayed on PPI of the associated radar as a target IFF response.

AN/MPX-7A: 1

**ITEM NAME:** RADAR IDENTIFICATION SET

**TYPE:** AN/MPX-7A

Provisions are incorporated to differentiate between actual Mark X IFF response, decoded response, and IM 99 response.

**RELATION TO SIMILAR EQUIPMENT**

AN/MPX-7A is similar to and one way interchangeable with AN/MPX-7. Differs in that Coder-Decoder Group OA-1267/MPX-7A replaces Code Coordination KY-54 and Switch Box SA-239/GPX.

**TECHNICAL DESCRIPTION**

Frequency: Transmitting, 990 - 10-10 mc  
Receiving, 1080 - 1130 mc  
Peak Power Output: 1.5 kw  
Operating Voltages and Power Requirements:  
105, 117 or 125v ac, 60 cps, single ph,  
250 w (obtained from associated radar set).  
Type of Presentation: PPI of associated close Support Radar Set.  
Pulse Repetition Rate: 125 - 1500 pps

Receiver Bandwidth: Broadband, b - 11 mc (minus 6 db); Narrowband, 5 mc (minus 70 db).  
Frequency (if.): 60 mc  
Image Ratio: More than 70 db  
Input Impedance: 52 ohms  
Video Output Impedance: 72 ohms

**INSTALLATION CONSIDERATIONS**

Siting: Physically located on the same site as Close Support Control Set AN/MSQ-1A.

Mounting: All equipment is mounted in Truck V-126/MPX-7 except for Coder-Decoder C-273B/GPX which is mounted on the Console of the Associated Close Support Radar Set.

Related Equipments: Close Support Control Radar AN/MSQ-1A.

**PRINCIPAL COMPONENTS AND PHYSICAL DATA**

COMPONENT	QTY	HEIGHT (Inches)	WIDTH (Inches)	DEPTH (Inches)	UNIT WT. (Pounds)
Radar Recognition Set AN/UPX-6*	1	11	15	21	77
Coder-Decoder Group OA-1267/MPX-7A	1				
Control Power Supply C-1728/MPX-7*	1	11-1/1	20-1/8	23-1/8	80
Power Supply PP-1353/MPX-7*	1	5-3/1	7	12	10
Antenna Assembly AS-295A or AS ->95B/IP*	1	13-1/2	9	222	101
Antenna Pedestal AB-433/MPX-7*	1	17	20-1/2	24	127
Antenna Support AB-434/MPX-7*	1	8-5/8	8	127-7/8	17
Telephone EE-8*	1				
Electrical Equipment Pack MT-1607/MPX-7*	1	53-5/8	44-1/4	32-1/4	331
Case CY-1861/MPX-7*	2	14	14	10	20
Interconnecting Box J-711/MPX-7*	1	4	10	17-1/2	15
Truck V-126/MPX-7/EMPTY*	1	89-3/1	80-1/2	1841-3/4	7600

\* Government furnished equipment.

**REFERENCE DATA AND LITERATURE**

TECHNICAL ORDERS:  
31P4-2MPX7- Series

DATE: 1 July 1964

ITEM NAME: RADAR SET

COGNIZANT SERVICE: USN

TYPE: AN/MSG-1

FEDERAL STOCK NUMBER:

	USA	USN	USAF	USMC
STATUS OR TYPE CLASSIFICATION				
Mfgr(s) Name or Code Number: Sperry Gyroscope Company, Inc., Great Neck, New York				

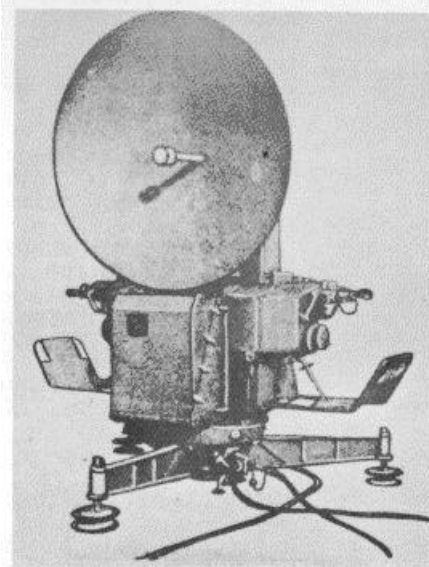

Radar Tracker of Radar Set AN/MSG-1

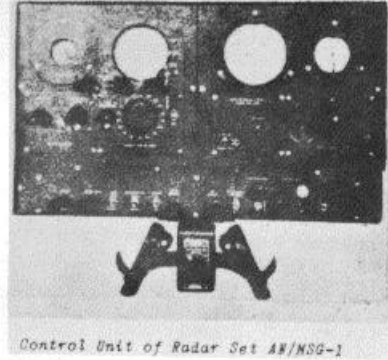

Control Unit of Radar Set AN/MSG-1

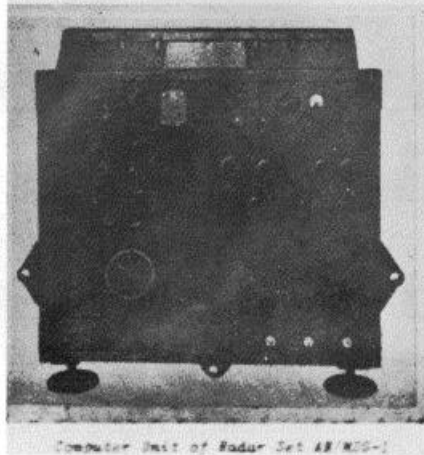

Computer Unit of Radar Set AN/MSG-1

**FUNCTIONAL DESCRIPTION**

The AN/MSG-1 is a 10-cm tire control radar for 90 mm. AA guns. The system consists of an AN/TPG-2

radar tracker and a T18 computer. The equipment is transported by van trailer. The tracker is removed from the van during actual operation.

**AN/MSG-1: 1**

**ITEM NAME:** RADAR SET  
**TYPE:** AN/MSG-1

**RELATION TO SIMILAR EQUIPMENT**

None.

**TECHNICAL DESCRIPTION**

**Transmitter Data**

Frequency: 10,000 mc  
R-F Source: 2J32 magnetron  
Modulator: Hydrogen thyratron (5C22).  
R-F Peak Power: 250 kw  
Pulse Repetition Rate: 1100 pps  
Pulse Length: 0.8 or 0.2 usec

**Receiver Data**

Local Oscillator: 417 C klystron, motor tuned.  
Mixer: Crystal  
Intermediate Frequency: 30 mc  
Bandwidth

Search: 3.5 mc, 5 mc  
Auto Tracking: 10 mc

**Maximum Range**

Search: 80,000 yds  
Auto Track: 45,000 yds

**Accuracy**

Range: 25 yds  
Bearing: 1.5 mil  
Elevation: 1.5 mil

**Tracking Rates**

**Automatic**  
Range: 300 yds per sec  
Azimuth: 350 mil per sec  
Elevation: 250 mil per sec

**Manual**

Range: 300 yds per sec  
Azimuth: 500 mil per sec  
Elevation: 250 mil per sec

Slewing or Scan

Range: 3000 yds per sec  
Azimuth: 500 mil per sec

Minimum Range: 500 yds

Indication and Data Output

**Indicators**

5 in. "A": 40,000; 80,000 ranges available.  
3 in. "J": Any 2000 yd portion of "A" scope sweep.  
5 in. "PPI": 20,000; 40,000; 80,000.

Two 2-in. PIP Matching Scopes: Elevation, azimuth and range are indicated on dials at the tracker. Data is automatically transmitted to the computer which in turn generates the gun laying orders.

**Antenna Data**

Reflector: 67 in. solid aluminum parabolic dish.  
Feed: Dipole  
H.P. Beam Width  
Horizontal: 5 deg  
Vertical: 5 deg  
Polarization: Rotating dipole  
Elevation and Azimuth Control: Manual and motor.  
Height above Ground: 80-1/2 in.  
Scanning: 6 rpm

**Quantity of Operators**

Automatic Tracking: 1  
Manual Radar Track: 3  
Manual Optical: 4

Power Supply: Gasoline engine generator, Navy type 73029, 15 kw, 3 ph, 115v, 60 cps

**INSTALLATION CONSIDERATIONS**

Siting: This equipment is designed for mobile ground installations.

**PRINCIPAL COMPONENTS AND PHYSICAL DATA**

<b>COMPONENTS</b>	<b>QTY</b>	<b>OVERALL DIMENSIONS (Inches)</b>	<b>UNIT WT. (Pounds)</b>
Tracker Mount	1	* 114 x 125 h	
Base Unit	1	23-3/4 x 24 x 30	565
Main Frame	1	21 x 76 x 111	695
Paraboloid and Antenna	1	67-1/2 in dia	140
Transmitter	1	15 x 24 x 32	235
Range Unit	1	20-1/4 x 24 x 32	265
Legs (3)	1	10 x 14-1/2 x 46-1/2	182
Remote Control	1	34-1/2 x 53-1/4 x 66	416
Target Selector	1	6 x 13 x 15	16
Cables and Reel			567
Echo -Box TS-270/UP	1		

**AN/MSG-1: 2**

ITEM NAME: RADAR SET  
TYPE: AN/MSG-1

**PRINCIPAL COMPONENTS AND PHYSICAL DATA**

<b>COMPONENTS</b>	<b>QTY</b>	<b>OVERALL DIMENSIONS (Inches)</b>	<b>UNIT WT. (Pounds)</b>
Synchroscope TS-34A/AP	1		
Voltohmammilliameter Simpson 260	1		
Voltohmammilliameter, Simpson 240	1		
Signal Generator OAP-1			
Electronic Voltmeter	1		

**NOTE: \*Diameter of swing.**

**REFERENCE DATA AND LITERATURE**

Technical Manuals:  
NAVSHIPS 900, 116

**AN/MSG-1: 3**

**DATE:** 1 July 1964

**ITEM NAME:** AIRCRAFT GUIDANCE CENTRAL

**COGNIZANT SERVICE:** USN

**TYPE:** AN/MSN-1

**FEDERAL STOCK NUMBER:** F5895-642-7980

	USA	USN	USAF	USMC
STATUS OH TYPE CLASSIFICATION				
Mfg(s) Name or Code Number:				

No Illustration Available.

**FUNCTIONAL DESCRIPTION**

The AN/MSN-1 is a grouping of equipments such as Radar Beacon AN/CPN-6, the model YG, which sector homing Signal, omnidirectional for the guidance of

returning aircraft and ultra-high-frequency homer all of which are utilized to provide guidance of aircraft.

**AN/MSN-1: 1**

**ITEM NAME:** AIRCRAFT GUIDANCE CENTRAL  
**TYPE:** AN/MSN-1

**RELATION TO SIMILAR EQUIPMENT**

None.

Sector Homing Frequency: 246 mc  
Modulation Frequency: 546 to 830 mc  
Power Source Required: 115v, 60 cps, single ph, 15 to 20 kw

**TECHNICAL DESCRIPTION**

Beacon Frequency Range: 9320 to 9430 mc

**INSTALLATION CONSIDERATIONS**

Not available.

**PRINCIPAL COMPONENTS AND PHYSICAL DATA**

<b>COMPONENTS</b>	<b>QTY</b>	<b>OVERALL DIMENSIONS (Inches)</b>	<b>UNIT WT. (Pounds)</b>
Radar Beacon AN/CPN-6	1		
Model YG	1		
TCJ Rectifier NT-20219	1		
UHF Homer	1		
Frequency Meter LM	1		
Air Conditioner	1		
Heater	1		
Trailer K-34-( ) modified	1		
Engine Generator	1		

**REFERENCE DATA AND LITERATURE**

Nomenclature Card for Aircraft Guidance  
Central AN/MSN-1 dated 14 October 1953.

**AN/MSN-1: 2**



**DATE:** 1 July 1964  
**COGNIZANT SERVICE:** USN

**ITEM NAME:** AIRCRAFT GUIDANCE CENTRAL  
**TYPE:** AN/MSN-2

**FEDERAL STOCK NUMBER:**

	<b>USA</b>	<b>USN</b>	<b>USAF</b>	<b>USMC</b>
<b>STATUS OR TYPE CLASSIFICATION</b>				
Mfg(s) Name or Code Number.				

No Illustration Available.

**FUNCTIONAL DESCRIPTION**

The AN/MSN-2 is a ground mobile Aircraft Guidance

Central designed to provide guidance of returning aircraft.

**AN/MSN-2: 1**

Volume 1  
Section 1

**MIL-HDBK-162A**  
15 December 1965

**ITEM NAME:** AIRCRAFT GUIDANCE CENTRAL

**TYPE:** AN/MSN-2

**RELATION TO SIMILAR EQUIPMENT**

None.

Type of Signal: Sector homing signal  
Beacon Path: Omnidirectional  
Frequency Carrier: 246  
Modulated Frequency: 546 to 830 kc  
Operating Power Requirements: 115v, 10 to 60 cps

**TECHNICAL DESCRIPTION**

Method of Operation: Engine generator  
Interrogation: By Radar Beacon AN/CPN-6  
Frequency Range: 9320 to 9430 mc

**INSTALLATION CONSIDERATIONS**

Siting: Ground mobile.

**PRINCIPAL COMPONENTS AND PHYSICAL DATA**

<b>COMPONENTS</b>	<b>QTY</b>	<b>OVERALL DIMENSIONS (Inches)</b>	<b>UNIT WT. (Pounds)</b>
Aircraft Guidance Central AN/ASN-2	1		

**REFERENCE DATA AND LITERATURE**

Nomenclature Card for Aircraft  
Guidance Central AN/MSN-2.

**AN/MSN-2: 2**

DATE: 15 December 1964  
COGNIZANT SERVICE: USAF

ITEM NAME: CLOSE SUPPORT CONTROL SET  
TYPE: AN/MSQ-1

FEDERAL STOCK NUMBER: 5840-333-9621

	USA	USN	USAF	USMC
STATUS OR TYPE CLASSIFICATION			Ltd Std	
Mfg(s) Name or Code Number, Reeves Instrument Company				

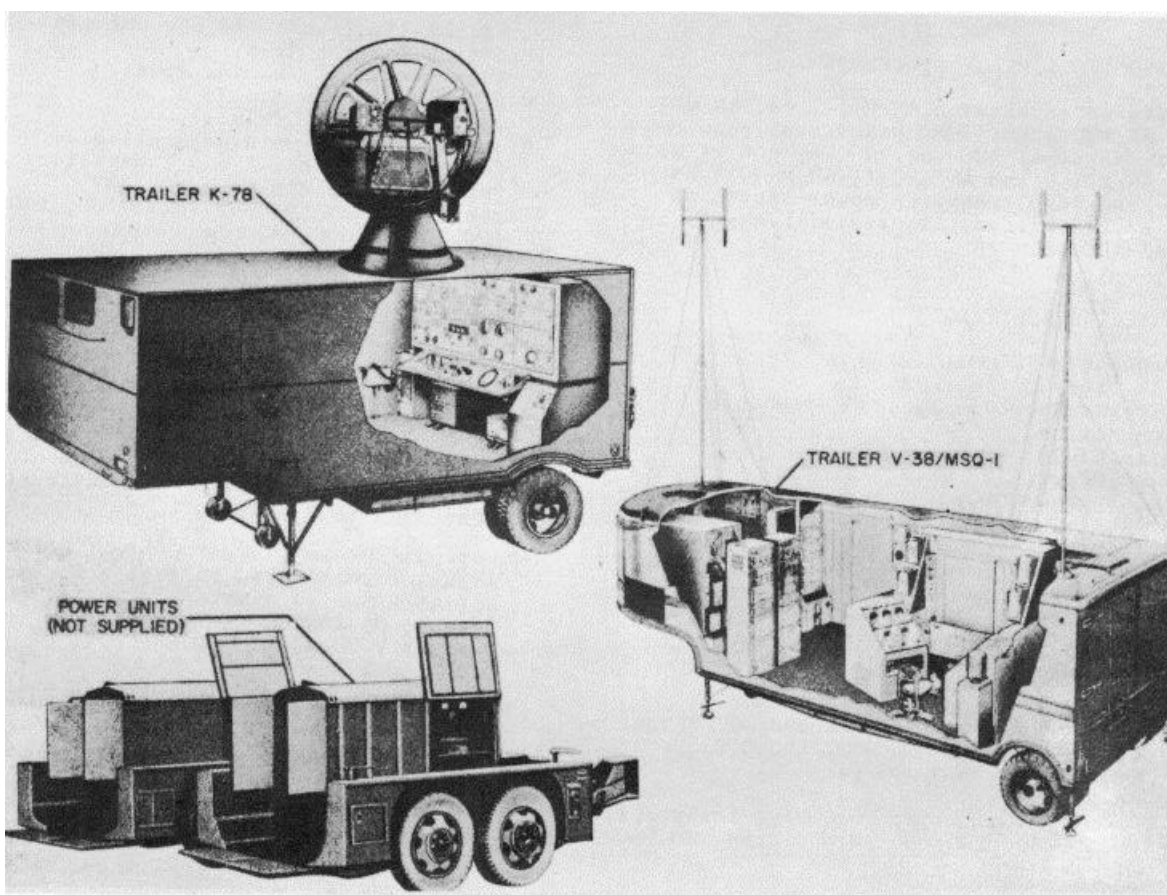

**FUNCTIONAL DESCRIPTION**

Close Support Control Set AN/MSQ-1 directs aircraft for close-support bombing missions, provides information for bomb scoring, and guides and records the flight of guided missiles. Guidance is accomplished by transmitting coded radar pulses to the aircraft or

missile, or by transmitting voice or coded pulses to the pilot. For communication with the pilot, the VHF transmitting and receiving equipment of Communications Central AN/GSC-1 is used. The AN/MSQ-1 and Radar Set AN/MPS-9 are used together. The

AN/MSQ-1: 1

**ITEM NAME:** CLOSE SUPPORT CONTROL SET  
**TYPE:** AN/MSQ-1

AN/MPS-9 tracks piloted or non-piloted aircraft and missiles to furnish slant range, elevation angle, and bearings to the AN/MSQ-1. The data is fed to the computing and plotting console of the AN/MSQ-1 (Console OA-132/MSQ-1). With the data, the AN/MSQ-1 computes horizontal range, height, ground speed, ground course, and steering angle error of the aircraft or missile. In addition, the AN/MSQ-1 computes the distance and the bearing of the target from the aircraft or missile. The AN/MSQ-1 may be used for training. When it is, a flight simulating computing console is used with the AN/MSQ-1. A C-124 type aircraft can transport the AN/MSQ-1.

**RELATION TO SIMILAR EQUIPMENT**

Differences between AN/MSQ-1 and AN/MSQ-1A: AN/MSQ-1 has 4-mc bandwidth, requires power source of 120v ac, 50 kw, and is used with AN/MPS-9 and AN/GSC-1; AN/MSQ-1A has 3-mc bandwidth, requires power source of 208v ac, 12 kw, and is used with AN/MPS-19 and AN/MRC-45.

**TECHNICAL DESCRIPTION**

Frequency: 2700 to 2900 mc  
Peak Power Output: 250 kw  
RF Power Source: Type 5586 tunable magnetron  
Pulse Width: 0.8 usec  
Pulse Repetition Rate: 410 pps  
Range: 360,000 yd  
Vertical Coverage: -4 deg to plus 90 deg  
Horizontal Coverage: 360 deg  
Antenna Speed: 0 to 20 rpm  
System Accuracy:  
    Range - plus or minus 25 yd;  
        azimuth - plus or minus 1 mi  
Beam Width: 2 deg (conical)  
Receiver Bandwidth: 4 mc  
Intermediate Frequency: 30 mc  
Type of Presentation: PPI and 3 J-scopes  
Indicator Ranges: 50,000, 100,000,  
    200,000, and 360,000 yd  
Range Marks:  
    50,000 yd position, 10,000 yd intervals;  
    100,000 and 200,000 yd position, 20,000

intervals;  
    360,000 yd position, 50,000 yd intervals  
Aircraft Horizontal Range: 352,000 yd  
Aircraft Height Above Sea Level:  
    250,000 ft (max)  
Radar Height Above Sea Level: 15,000 ft (max)  
Aircraft Ground Speed: 75 to 2600 knots  
X and Y Target From Radar Coordinate:  
    352,000 yd (max)  
Target From Aircraft Distance:  
    2000 to 352,000 yd  
Aircraft Speed on Flight Simulator:  
    2600 knots (max)  
Wind Speed on Flight Simulator: 104 knots (max)  
Rate of Change of Aircraft Course on  
    Flight Simulator: 10 deg per sec  
Plotting Surface Area:  
    Square with 34.722 in. sides  
Map Scales (Ratio to 1): 62,500, 125,000,  
    250,000, 500,000, and 1,000,000  
Plotting Surface Origins Available:  
    Center and corner X and Y parallax  
    (approx 0.5 plotting surface)  
Expanded Scales (yd per in.): 100, 200,  
    400, 800, 1600, 3200 and 6400  
Horizontal Guidance Codes: 1  
Operating Voltages and Power Requirements:  
    120v ac, 60 cps, 3-ph, 50 kw

**INSTALLATION CONSIDERATIONS**

Siting: Trailers containing equipment and components must be on the highest accessible vantage point. Equipment must be level and have an unobstructed radar sighting range.  
Mounting: Close Support Control Set AN/MSQ-1 is mounted in trailers. Radar Set AN/MPS-9 is mounted in Trailer K-78; Console OA-132/MSQ -1 is installed in Trailer V-38/HSQ-1. Components of Communications Central AN/GSC-1 are distributed and mounted between both trailers.  
Related Equipment: Radar Set AN/MPS-9; Communications Central AN/GSC-1; Control Indicator Group AN/MSA-2; Radar Set Group AN/MSA-3.

**PRINCIPAL COMPONENTS AND PHYSICAL DATA**

COMPONENT	QTY	HEIGHT (Inches)	WIDTH (Inches)	DEPTH (Inches)	UNIT WT. (Pounds)
Radar Set AN/MPS-9	1				
Console OA-132/MSQ-1	1				
Communications Central AN/GSC-1	1				
Radar Set Group AN/MSA-3	1				

**AN/MSQ-1: 2**

**ITEM NAME:** CLOSE SUPPORT CONTROL SET  
**TYPE:** AN/MSQ-1

**PRINCIPAL COMPONENTS AND PHYSICAL DATA**

<b>COMPONENT</b>	<b>QTY</b>	<b>HEIGHT (Inches)</b>	<b>WIDTH (Inches)</b>	<b>DEPTH (Inches)</b>	<b>UNIT WT. (Pounds)</b>
Dehydrator HD-75/MSQ	1				
Trailer K-78	1	228	263	312	
Trailer V-38/MSQ-1	1	360	183	471	
Control Indicator Group AN/MSA-2	1				

**REFERENCE DATA AND LITERATURE**

Technical Orders:  
31P2-2MSQ1-1

**AN/MSQ-1: 3**

DATE: 15 December 1964

ITEM NAME: CLOSE SUPPORT CONTROL SET

COGNIZANT SERVICE: USAF

TYPE: AN/MSQ-1A

FEDERAL STOCK NUMBER: 5840-320-8403

	USA	USN	USAF	USMC
STATUS OR TYPE CLASSIFICATION			AS	
Mfg(s) Name or Code Number: Reeves Instrument Company				

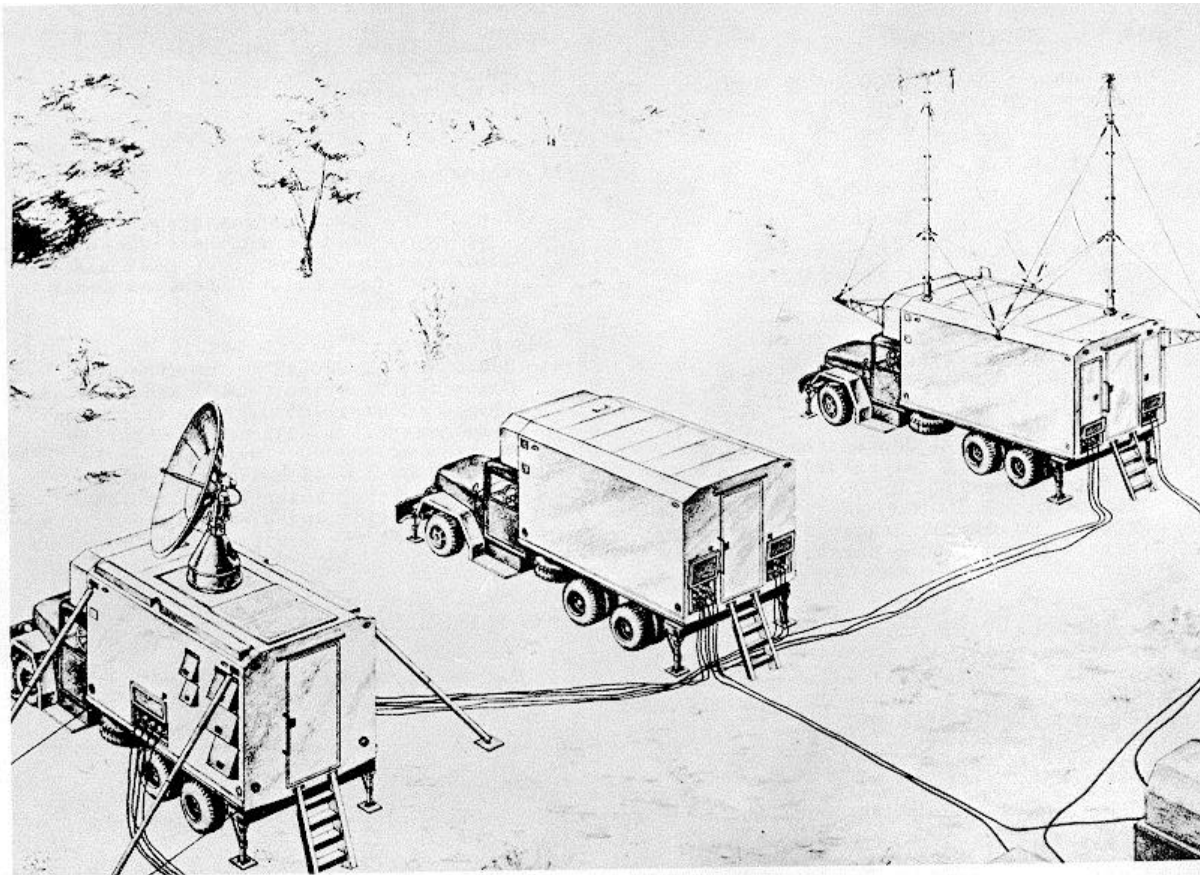

### FUNCTIONAL DESCRIPTION

Close Support Control Set AN/MSQ-1A is used to track a friendly aircraft or missile, and to provide ground-to-air guidance information, which will lead the aircraft or missile over a selected target

area. In addition, Close Support Control Set AN/MSQ-1A provides bombing commands to the aircraft or missile which indicate the time remaining before bomb release or dump, and also the exact moment of bomb release or dump. The equipment is also used for training purposes in bomb scoring

AN/MSQ-1A: 1

**ITEM NAME:** CLOSE SUPPORT CONTROL SET

**TYPE:** AN/MSQ-1A

assignments to evaluate the bombing capabilities of SAC combat crews.

**RELATION TO SIMILAR EQUIPMENT**

Differences between AN/MSQ-1 and AN/MSQ1A: AN/ISQ-1 has 4-mc bandwidth, requires power source of 120v ac, 50 kw, and is used with AN/MPS-9 and AN/GSC-1; AN/MSQ-1A has 3-mc bandwidth, requires power source of 208v ac, 12 kw, and is used with AN/MPS-19 and AN/MRC-45. The AN/MSQ-1A is an air transportable version of Close Support Control Set AN/MSQ-1.

**TECHNICAL DESCRIPTION**

Frequency: S-Band, 2700 to 2900 mc

Peak Power Output: 500 kw

Average Power Output:

Radar - 164w

Triple Pulse - 492w

Pulse Repetition Frequency:

Radar - 300 to 2000 pps

Beacon - 410 pps

Pulse Width Signal: 0.8 usec

Pulse Width, Coded Pulses: 0.8 usec ea

Local Oscillator Frequency Range:

Radar - from 2670 to 2930 mc

Beacon - from 2670 to 2930 mc

Intermediate Frequency: 30 mc

Bandwidth: 3 mc

Aircraft Slant Range (Accepted by Computer):

352,000 yd max

R-F Beam Width: 3 deg (at half-power

point with 8 ft reflector)

Indicator Ranges: 50,000, 100,000,

200,000, and 360,000 yd

Aircraft Horizontal Range: 352,000 yd max

Aircraft Height Above Burst: 250,000 ft

max

Radar Height Above Sea Level: 15,000 ft

max

Aircraft Ground Speed: 15,000 ft max

X and Y Target from Radar Coordinates:

352,000 yd max

Target from Aircraft Distance: 352,000

yd max

Windspeed in Flight Simulator: 300 knots

max

Rate of Change of Aircraft Course on

Flight Simulator: about 12 deg per sec

max

Plotting Surface Dimensions: 34.7 by

34.7 in.

Fixed Map Scales (1000 yd-per-yd): 20,

50, 100, 250, 500, 1000

Expanded Scales (yd-per-in.): 400, 800,

1600, 3200

Power Requirements: 12 kw, 115v, 60

cycle, 3-ph power

**INSTALLATION CONSIDERATIONS**

Siting: Trailer containing equipment and components must be on the highest accessible vantage point.

Equipment must be level and have an unobstructed radar sighting range.

Mounting: Radar Set AN/MPS-19 (Radar Van), Radio

Set AN/MRC-45 (Communications Van) Computing

Tracking Group, Radar OA-626/ MSQ-1A (Control

Van). Each of the major components is mounted in

a separate shelter or "pod". Each shelter is

mounted on a M-45 2-1/2 ton, 6 by 6 cargo

vehicle, which provides ground transportation and also

serves as a base support for the equipment during

operation.

**PRINCIPAL COMPONENTS AND PHYSICAL DATA**

<b>COMPONENT</b>	<b>QTY</b>	<b>HEIGHT (Inches)</b>	<b>WIDTH (Inches)</b>	<b>DEPTH (Inches)</b>	<b>UNIT WT. (Pounds)</b>
Radar Set AN/MPS-19	1 ea				
Radio Set AN/MRC-45	1 ea				
Computing Tracking Group, Radar OA-626/MSQ-1A	1 ea				
Cargo Vehicle M-45	3 ea				

**REFERENCE DATA AND LITERATURE**

Technical Orders:

31P2-2MSQ1-51

31P2-2MSQ1-52

DATE: 15 December 1964

ITEM NAME: CLOSE SUPPORT CONTROL SET

COGNIZANT SERVICE: USAF

TYPE: AN/MSQ-2

FEDERAL STOCK NUMBER: 5840-333-9622

	USA	USN	USAF	USMC
STATUS OR TYPE CLASSIFICATION			Std	
Mfg(s) Name or Code Number. Reeves Instrument Corporation				

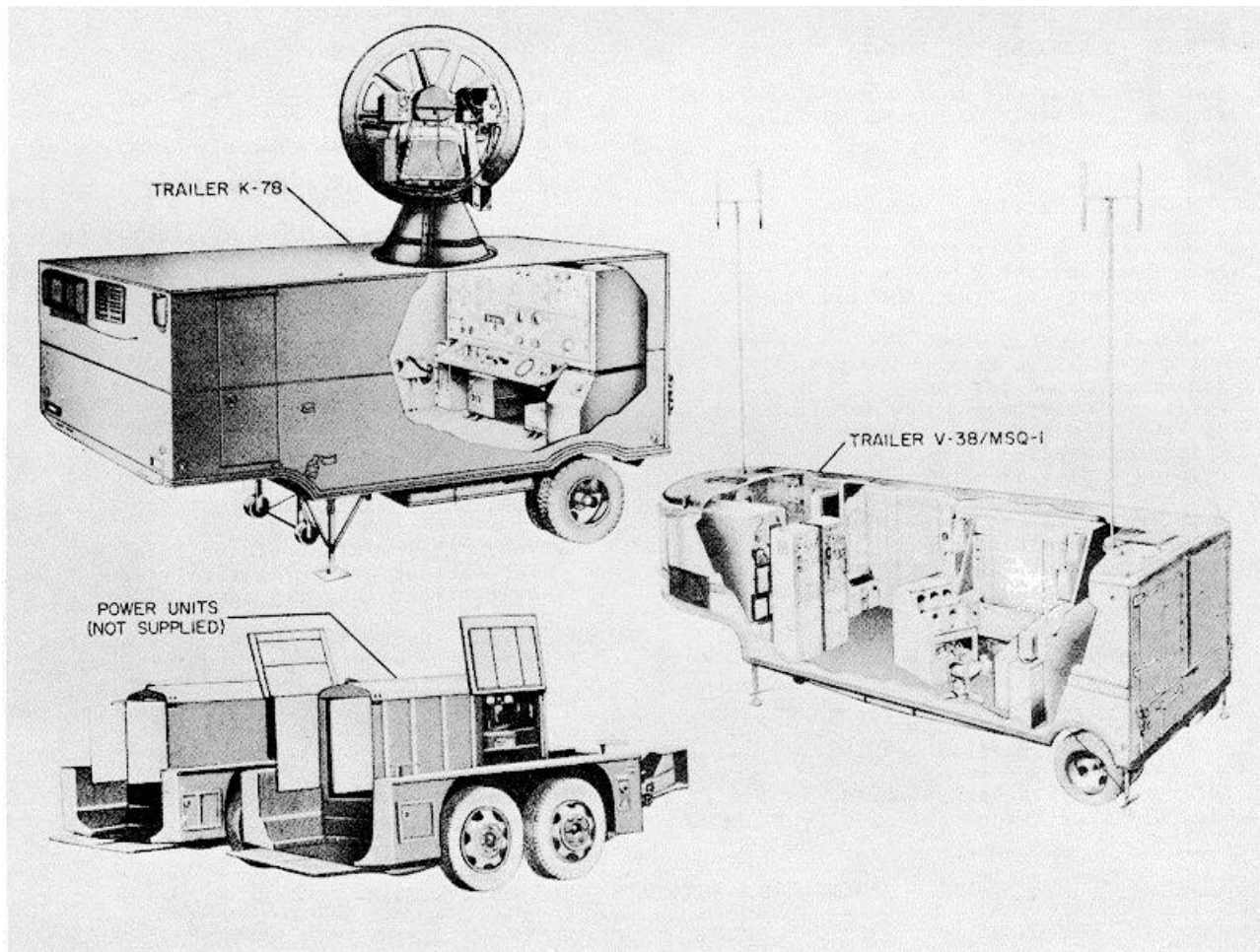

**FUNCTIONAL DESCRIPTION**

Close Support Control Set AN/MSQ-2 is a mobile set. It is used to track, plot, record, and control the flight of piloted aircraft, pilotless aircraft, and missiles. Radar Set AN/MPS-9 tracks the aircraft or

missile and furnishes slant range, elevation angle, and bearing to computing and plotting console OA-215/MSQ-2. The available data enables the AN/MSQ-2 to compute horizontal range, height, ground speed, ground course, steering angle error, and distance and bearing of target from aircraft. This information



**ITEM NAME:** CLOSE SUPPORT CONTROL SET

**TYPE:** AN/MSQ-2

enables the equipment to direct aircraft for close support bombing or strafing missions, provide information for bomb scoring, and guide and record the flight of guided missiles. Guidance may be accomplished by transmitting coded radar pulses to the aircraft or missile, or by voice or coded pulse communication of the pilot, using the VHF transmitting and receiving equipment of Communications Central AN/ GSC-1. The inclusion of a flight simulating console permits the AN/MSQ-2 to be used for training purposes. The AN/MSQ-2 may be transported in a C-124 type aircraft.

**RELATION TO SIMILAR EQUIPMENT**

Some components of the AN/MSQ-2 are identical to components of the AN/MSQ-1 and AN/MSQ-3.

**TECHNICAL DESCRIPTION**

- Frequency: 2700 to 2900 mc
- Peak Power Output: 250 kw
- RF Power Source: Type 5586 tunable magnetron
- Pulse Width: 0.8 usec
- Pulse Repetition Rate: 410 pps
- Range: 360,000 yds
- Vertical Coverage: -1 deg to plus 90 deg
- Horizontal Coverage: 360 deg
- System Accuracy:
  - Range - plus or minus 25 yds
  - Azimuth - plus or minus 1 mil
- Beam Width: 2 deg (conical)
- Receiver Bandwidth: 4 mc
- Type of Presentation: PPI and 3 J-scopes
- Indicator Ranges:
  - 50,000 - yd position: 10,000 yd intervals
  - 100,000 - yd position: 20,000 yd intervals
  - 200,000 - yd position: 20,000 yd intervals
  - 360,000 - yd position: 50,000 yd intervals

Intermediate Frequency: 30 mc  
Aircraft Slant Range Accepted by Plotting

- Board: 88,000 yds (max)
- Aircraft Horizontal Range: 88,000 yds (max)
- Aircraft Height Above Sea Level: 62,000 ft (max)
- Radar Height Above Sea Level: 3750 ft (max)
- Target Height Above Sea Level: 3750 ft (max)
- Aircraft Ground Speed: 25 to 650 knots
- X and Y Target From Radar Coordinators: 88,000 yds (max)
- Target From Aircraft Distance: 500 to 88,000 yds
- Aircraft Speed on Flight Simulator: 650 knots (max)
- Wind Speed on Flight Simulator: 105 knots (max)
- Range of Change of Aircraft Course on Flight Simulator: 10 deg per sec
- Plotting Surface Dimensions: 31.722-in by 34.722-in
- Map Scales (Ratio to 1): 62,500; 125,(000); 250,000
- Plotting Surface Origins Available: Center and corner
- X and Y Parallel: 120,000 yds (approx 1/2 of plotting surface)
- Expanded Scales (yds per in.): 100, 200, 400, 800, and 1600
- Horizontal Guidance Codes: 3
- Vertical Guidance Codes: 1
- Voltage and Power Requirements: 120v ac, 60 cps, 3-p,h, 50 kw

**INSTALLATION CONSIDERATIONS**

Siting: Equipment should be located on a high vantage point relatively free from obstructions that may sever radiation.

Mounting: Radar Set AN/MPS-9 is mounted in Trailer K- 78; Console OA-215/MSQ-2 is installed in Trailer V-38/MSQ-1. The components of Communications Central AN/GSC-1 are distributed and housed between the two trailers.

Related Equipments: Radar Set AN/MPS-9, Communications Central AN/GSC-1.

COMPONENT	QTY	HEIGHT (Inches)	WIDTH (Inches)	DEPTH (Inches)	UNIT WT (Pounds)
Radar Set AN/MPS-9	1				
Console OA-215/MSQ-2	1				
Communications Central AN/GSC-1	1				
Dehydrator HD-75/MSQ	1				
Trailer K-78					

**AN/MSQ-2: 2**

**ITEM NAME:** CLOSE SUPPORT CONTROL SET  
**TYPE:** AN/MSQ-2

**PRINCIPAL COMPONENTS AND PHYSICAL DATA**

<b>COMPONENT</b>	<b>QTY</b>	<b>HEIGHT (Inches)</b>	<b>WIDTH (Inches)</b>	<b>DEPTH (Inches)</b>	<b>UNIT WT. (Pounds)</b>
Trailer V-3B/MSQ-1	1				

**REFERENCE DATA AND LITERATURE**

Technical Orders:  
31P2-2MSQ2-1

**AN/MSQ-2: 3**

DATE: 1 July 1964

ITEM NAME: OPERATIONS CENTRAL

COGNIZANT SERVICE: USN

TYPE: AN/MSQ-16

FEDERAL STOCK NUMBER:

	USA	USN	USAF	USMC
STATUS OR TYPE CLASSIFICATION Mfg(s) Name or Code Number.				

No Illustration Available.

**FUNCTIONAL DESCRIPTION**

The AN/MSQ-16 is used as a "Slave Station" with auto-tracking radar sets to gather and

record information of airborne radiation and provide facilities for jamming.

**AN/MSQ-16: 1**

**ITEM NAME:** OPERATIONS CENTRAL  
**TYPE:** AN/MSQ-16

**RELATION TO SIMILAR EQUIPMENT**

None.

Plotting Method: Strip recorders, polar recorders.

Data Collection: Cameras.

Power Source Required: 115v, 60 cps, 3 ph

**TECHNICAL DESCRIPTION**

Method of Reporting: Radio and by cabling from the master set

**INSTALLATION CONSIDERATION**

Related Equipment: Used with various 60 cycle synchro systems.

**PRINCIPAL COMPONENTS AND PHYSICAL DATA**

<b>COMPONENTS</b>	<b>QTY</b>	<b>OVERALL DIMENSIONS (Inches)</b>	<b>UNIT WT. (Pounds)</b>
Radio Receiving Set	6		
Data Recorder	1		
Strip Recorder	6		
Pedestal Control	1		
Pedestal	1		
Antenna	20		
Trailer, Van Type K-78	1		
Air Conditioner	1		
Heater	1		
Telemetry System	1		
Countermeasures-Transmitters	4		
Intercommunications System	1		

**REFERENCE DATA AND LITERATURE**

Nomenclature Card for Operations Central  
AN/MSQ-16 dated 10 October 1957.

DATE: 1 February 1965

ITEM NAME: RADAR BOMB SCORING CENTRAL

COGNIZANT SERVICE: USAF

TYPE: AN/MSQ-35

FEDERAL STOCK NUMBER: 5840-732-0837

	USA	USN	USAF	USMC
STATUS OR TYPE CLASSIFICATION			Std	
Mfg(s) Name or Code Number: Reeves Instrument Corporation, Garden City, L. I., New York				

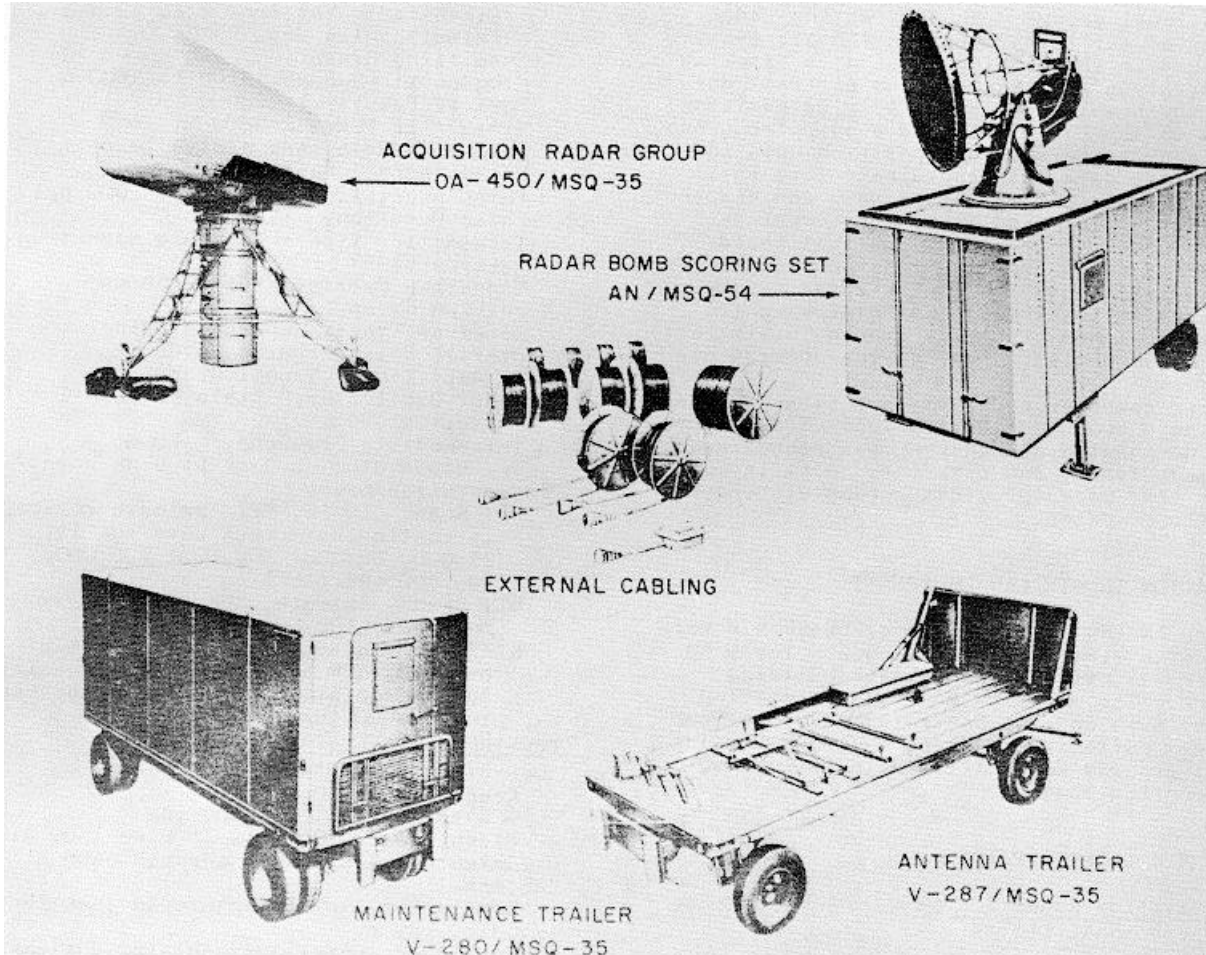

**FUNCTIONAL DESCRIPTION**

Radar Bomb Scoring Central AN/MSQ-35 is a mobile, air-transportable radar facility used to score the accuracy of simulated air to-surface bombing missions. The central is comprised of three trailers known as the

operations, maintenance, and acquisition antenna trailers. Control of the central is accomplished in the operations trailer which contains the tracking radar, ballistic and tracking computers, plotting boards, acquisition radar components, and communications equipment.

**ITEM NAME:** RADAR BOMB SCORING CENTRAL

**TYPE:** AN/MSQ-35

Primary power equipment required for operation of the central is not supplied.

The purpose of the Central is to acquire and track a designated aircraft, permanently record its flight path, and compute the trajectory of a simulated bomb it releases. In addition to providing a continuous plot of aircraft position in the horizontal and vertical planes, weapon trajectory is computed and plotted in the same coordinates. Score data of the mission is computed and the results pointed out on tape. Level, pull-up and other maneuvering type releases may be scored with the central.

The central is divided into three major functional groups: an acquisition radar group of initially locating the aircraft engaged in the bombing mission; a tracking radar group for tracking the aircraft during the bombing run and supplying position data to the computers; and a computer group for converting aircraft position data and ballistic data into coordinate form suitable for plotting aircraft path and weapon trajectory. In addition, the computer group predicts accelerations that would normally cause tracking lags and supplies aided tracking rates to the radar. Complementary to the three major groups is the communications group for ground-to-aircraft voice communication during the bombing mission.

Four computer modes of operation are used during a bomb scoring mission. These modes are designated as acquire, synchronizing (sync), track, and computer. A fifth mode (the test mode) provides a complete check of the computer.

**RELATION TO SIMILAR EQUIPMENT**

The AN/MSQ-35 is not interchangeable with any like item in Air Force use. The M-33 radar was utilized as a basic building block. The modified M-33 was identified Radar Bomb Scoring Central AN/MSQ-35. Techniques established during AN/USQ-9 development program were utilized in the AN/MSQ-35 production program.

**TECHNICAL DESCRIPTION**

Acquisition Radar System

Operational Limits

Range

Fan-Shaped Beam: 150,000 yds max

Pencil Beam: 200,000 yds max

With SIF/IFF: 400,000 yds

Elevation: 35 to 391 mils

Azimuth: Continuous through 6400 mils

Antenna

Type: Hyperbolic reflector; Pill box feed

Gain: 29 db

Coupling: Duplexing (TR and ATR)

Polarization: Horiz

Scan: Reflector tilt and var focus

Elevation Scan Method: Electro-mechanical

Scan Rate

Elevation: 40 sec (up and down) from 35 to 391 mils

Azimuth: Var from 0 to 20 rpm

Drive: 3-speed, 400-cyc, 3-ph motor

Accuracy

Range: plus or minus 150 yds

Azimuth: 18 mils

Beam-width

Elevation: Var from 2 to 22 deg

Azimuth: 1.4 deg

Transmitting Group

Frequency: S-band, 3100 to 3500 mc

Peak rf Power: 1 megw

Average rf Power: 780w

Type of Modulation: Pulse

Pulse Shape: Rectangular

Pulse Repetition Frequency: 600 pps

Pulse Duration: 1.3 usec

Transmitter Type: Tuneable magnetron (type 5795)

Magnetron Current: 25 to 35 ma

Receiving Group

Receiver Type: Superheterodyne

Overall Noise Figure: 6 db

RF Amplifier: Tunnel diode

Local Oscillator: Stalo (stable local oscillator)

Intermediate Frequency: 60 mc

IF. Bandwidth: 2.3 mc at 3 db down

Presentation Group

PPI Scan: 10 in. PPI; azimuth coverage is continuous; range coverage is 25,000; 50,000; 100,000; 200,000; 400,000 yds (IFF)

MTI Scan: Azimuth, 360 deg; var range from 0 to 160,000 yds

SIF/IFF: Interrogator Set AN/TPX-27 provides SIF and IFF return signals for presentation on PPI at ranges up to 400,000 yds

Tracking Radar System

Operational Limits

Range: 200,000 yds

With Beacon: 200,000 yds

Elevation: -180 mils to plus 1500 mils

Azimuth: Continuous through 6400 mils

Antenna

Type: Metal-plate, phase-advance lens

Gain: 39 db

Coupling: Ferrite-circulator duplexing

Polarization: Vert

Scan: Conical

Tracking Rate: Mach 10

Resolution: Can distinguish between targets separated by 65 yds in range and 18 mils in azimuth

Drive: 2-ph, 400 cyc motor; 1-ph, 208v; other phase-variable

**ITEM NAME: RADAR BONE SCORING CENTRAL**

**TYPE: AN/MSQ-35**

Beamwidth: 20 mils  
Transmitting Group  
Frequency: X-band, 8500 to 9600 mc  
Peak rf Power: 250 kw  
Average rf Power: 37.5w  
Type: Pulse  
Pulse Shape: Rectangular  
Pulse Repetition Frequency: 600 pps  
Use Duration: 0.25 usec  
Transmitter Type: Tuneable magnetron  
(type 5780)  
Magnetron Current: 3.5 ma  
Receiving Group  
Receiver Type: Superheterodyne  
Overall Noise Figure: 6 db  
Rf Amplifier: Parametric amplifier  
Local Oscillator: Dual; radar, beacon  
Intermediate Frequency: 60 mc  
IF. Bandwidth: 10 mc  
Presentation Group  
Video Presentation: Three 5-in. A-type  
scan tracking indicators for range,  
azimuth, and elevation  
Dial Presentation: Three servo-driven  
dial indicators for range, azimuth  
and elevation  
Computer System  
Operational Limits  
Scoring Range: 200,000 yds  
Altitude: 300,000 ft  
Ground Velocity: Mach 10  
Vertical Velocity: Mach 5  
Ballistic Limits  
Trail: 1000 mils  
Wind: 250 knots  
Time of Fall: 90 sec  
Accuracy: 400 ft circular error probable,  
50% under the following conditions:  
speed, mach 0.3 to mach 3;  
altitude, 200 to 100,000 ft; horiz  
range; 1 to 100 naut mi  
Television  
Television Camera  
Scanning Standards: 525 lines, 60  
fields, interlaced 2:1  
System Resolution: 600 lines  
Systems Sensitivity: Signal-to-noise  
ratio of 20 db at 28 ft-candles at f/2  
Lens System  
Focal Lengths of Dual Lenses: 40 in;  
8 in.  
Relative Aperture (Both Lenses): f/6.3  
Total Field of View  
40-in. Lens: 0.88 deg  
8 in. Lens: 4.5 deg  
Photographic Resolution  
(with Kodak Plus X film): 45 lines  
per mm  
Visual Resolution (Min): 182.7 lines  
per mm  
Television Monitor  
Input Power Required: 105 to 130v, 60  
plus or minus 3 cyc; 125w  
Video Signal Required: 0.25v peak; 2v  
max sync neg  
Video Input Impedance: 75 ohm terminating  
resistance with switch on rear  
apron

External Sync Input: High impedance, 3  
to 8v peak-to-peak, syn neg  
Kinescope: 14-in. rectangular, aluminized, type 14BAP4  
Stable Local Oscillator  
Operating Characteristics  
Frequency Range: 3100 to 3600 mc  
Dial Calibration: 250 kc per division  
Dial Accuracy: 1 part in 10,000  
Frequency Stability  
Short Term: 150 cps peak-to-peak max  
fm deviation in bandwidth of 15 cps  
to 20 kc  
Long Term: Less than 1 part in  
100,000  
Power Output: 80 mw min  
Power Stability: plus or minus 1 db  
Input Power: 117v plus or minus 10%,  
60 cps, 2 amp  
Moving Target Indicator Group  
Operating Characteristics  
Input Power: 120v plus or minus 10%,  
1-ph 4 amp nom, 10 amp max, 60 cps  
Thermal Cutout: Unit shuts off at 130  
plus or minus 5°F cabinet temperature  
Stability: 24 hr without further adjustment  
Operating Temperature Range: plus  
60°F to plus 90°F  
Input Signals  
Sync Trigger Pulse  
Prf Center Frequency: 500 to 1000  
pps  
Wobulation: up to plus or minus  
10% of center freq  
Max instantaneous prf, 660 pps  
Pulse Rise Time: 0.3 usec or less  
Pulse Duration: 2.3 usec  
Pulse Amplitude: Greater than 10v  
into 75 ohms  
IF. Input Signal  
Center Frequency: 60 mc  
3 db Bandwidth: 2.5 plus or minus  
0.25 mc  
Coho Lock Pulse  
Center Frequency: 60 mc  
3 db Bandwidth: 2 plus or minus  
0.25 mc  
Amplitude: Greater than 1v peak-  
to-peak into 75 ohms  
Output Signals  
Video Output: 2.5 to 4v peak, adjustable,  
into 75 ohms, neg polarity  
Normal Detector Output: 0.1v peak  
into 5000 ohms, pos polarity  
Wobulator Output  
Pulse Repetition Frequency: 500  
to 1000 pps  
Polarity: Pos  
Pulse Amplitude: 10v into 75 ohms  
Pulse Duration: 1.0 usec  
Prf Deviation: plus or minus 10%,  
adjustable  
Cancellation Ration  
30 db min overall (IF.)  
38 db min, two storage tube operation  
24 db min, single storage tube operation





**ITEM NAME:** RADAR BOMB SCORING CENTRAL

**TYPE:** AN/MSQ-35

IFF System

Operating Characteristics

Range: Line of sight - approx 190 mi  
Challenging Modes: 3  
Input Power: 115v ac plus or minus  
10%, 400 cps, 1-ph, 3.25 amp

Transmitting System

Frequency Range: 990 to 1040 mc  
Oscillator: Crystal controlled  
Type of Modulation: Pulse  
Duration: 0.7 to 1.2 usec  
Rise Time: 0.2 plus or minus 0.1 usec  
Decay Time: 0.4 plus or minus 0.2 usec  
Rf Power Output: 1.5 kw  
Output Impedance: 52 ohms

Receiving System

Frequency Range: 1080 to 1130 mc  
Oscillator: Crystal controlled  
Receiver Type: Superheterodyne  
Sensitivity: 76 db below 1v  
Bandwidth  
Narrow: 5 mc  
Broad: 8 to 11 mc  
IF.: 60 mc  
RF Input Impedance: 52 ohms  
Video Output Impedance: 75 ohms  
Video Output Power: 0.2w

Coding System

Input Impedance: 75 to 510 ohms  
Input Pulse Width: 0.3 to 15 usec  
Input Voltage: plus 5 to plus 50v  
(measured across 75 ohms)  
Output Trigger Voltage: plus 55v  
(measured across 75 ohms)  
Pulse Rise Time: 0.1 to 0.5 usec  
Self Trigger Prf: 200 pulse pair per  
sec

Trigger Delay

Out: 9.5 usec  
In: 12.5 plus or minus 0.5 usec to  
35 plus or minus 2 usec

Mode 1

Number of Pulses: 2  
Pulse Width: 0.3 usec (nom)  
Pulse Spacing: 3 plus or minus 0.2  
usec

Mode 2

Number of Pulses: 2  
Pulse Width: 0.3 usec (nom)  
Pulse Spacing: 5 plus or minus 0.2  
usec

Mode 3

Number of Pulses: 2  
Pulse Width: 0.3 usec (nom)  
Pulse Spacing: 8 plus or minus 0.2  
usec

Decoding System

Video Input

Pulse Type: Coded pulse trains  
Pulse Polarity: Pos

Individual Pulse Amplitude: 5v max,  
2v min

Noise: 0 to 1v rms

Sensitivity: 0.4v

Overall Duration of Pulse Train: 20.3  
plus or minus 0.1 usec

Individual Pulse Width: 0.45 plus or  
minus 0.1 usec

Pulse Rise Time: Less than 0.2 usec

Pulse Decay Time: Less than 0.4 usec

Pulse Spacing in Single Train: 2.9  
plus or minus 0.5 usec

Interleaved Pulse Trains: 4 max

Pulse Spacing in Interleaved Pulse  
Trains: 0.05 usec min

Input Impedance: 75 ohms

Video Output

Pulse Type: One pos pulse for ea  
correctly coded pulse train input

Pulse Amplitude: Adjustable from 2  
to 5v

Pulse Width: 0.45 plus or minus 0.1  
usec

Pulse Rise Time: Less than 0.2 usec

Pulse Decay Time: Less than 0.4 usec

Output Impedance: 75 ohms

Operable Altitude: Up to 10,000 ft  
above sea level

Operable Temperature: 40°F to 150°F

Simulating System

System Test

Pulse Type: Pulse prs

Interpulse Spacing: 5.0 plus or min-  
us 0.2 usec

Pulse Width: 0.5 to 1.0 usec

Pulse Rise Time: 0.3 usec (nom)

Receiver Test

Pulse Type: Single type

Pulse Width: 0.5 to 1.0 usec

Pulse Rise Time: 0.3 usec (nom)

Input Pulse Voltage: 10v min

Input Repetition Frequency: 100 to  
2000 pps

Input Impedance: 1500 ohms

Trigger Delay: 10 to 100 usec

Types of Output

System Test: Code 77 rf pulse train

Receiver Test: Single rf pulse

Oscillator Type: Crystal

Output Frequency Range: 1080 to 1130  
mc

Output Pulse

Duration: 0.8 usec

Spacing: 2.9 usec

Output Impedance: 50 ohms

IFF System (Antenna AT-352/UPA-22)

Frequency Range: 1010 to 1110 mc

Dipole (Slot Radiators): Vertically  
polarized

Horizontal Beam Width: less than 7°



**ITEM NAME:** RADAR BOMB SCORING CENTRAL  
**TYPE:** AN/MSQ-35

at half power points

Type of Feed: Coaxial

Transmission: Coaxial

Digital System

Digital Recorder-Printer

Column Capacity: 11 columns (11 digits per line including blank)

Print Rate: 5 lines per sec (3300 characters per minute)

Number Wheels: 12 positions having positions 0 through 9, an asterisk, and a blank space

Impedance

On Line: 500 ma at ground, 1 ma at -6v

Off Line: Greater than 1 mego

Print Command

Positive Pulse Voltage: 10v

Pulse Duration: 10 usec min

Line Spacing: Single or double, automatic paper advance

Input Power: 115 plus or minus 20v, 60 cps

Temperature: 0øC to 55øC

Relative Humidity: 70% max

Digital Ratiometer

DC Voltage Specifications

Range B: .0001 to .9999v

Range C: 0.001 to 9.999v

Range D: 00.01 to 99.99v

Range E: 000.1 to 999.9v

Accuracy: plus or minus .01% or 1 digit

Signal Input Impedance: 1000 meg at balance on plus or minus .9999 and plus or minus 9.999v ranges; 10.1 mego on plus or minus 99.99 and plus or minus 999.9v ranges

Average Reading Time (No Filter): 20 ms

Maximum Balance Time (No Filter): 200 ms

DC/DC Voltage Ratios

Ranges: Same as above

Accuracy: Same as above

Signal Input Impedance: Same as above

External Reference Voltage: 10v plus or minus 10%

External Reference Input Impedance: 1000 mego

Average Reading Time (No Filter): 20 ms

Maximum Balance Time (No Filter): 2000 ms

Digital Clock

Input Power: 115 plus or minus 10v, 60 cps, 15w

Output: BCD coding, pos true; -8v at 2.2k source impedance equals 0; 0v at 5 ma equals 1. 10 line decimal,

plus 12v at 15.6k source impedance equals 1; 0v through a 10 k source equals 0.

Displays

Nixie Readout: 6 digits; up to 23 hrs 59 minutes and 59 sec

Time Base: 10 kc crystal controlled source, stable to 5 parts in 10<sup>6</sup> per week

Communications

Communications Control Console

Input Power Required: 117v, 60 plus or minus 3 cyc, 2 amp

Input Circuits: Six receivers (audio); high impedance and low impedance microphone; 600-ohm line; intercom audio from remote stations

Output Circuits: Keying and audio modulation for six external transmitters; Audio drive for local and remote loudspeakers (receiver, microphone, and intercommunications), and one or two tape recorders (receiver, microphone, and intercommunications)

Primary AC Power

Requirement

208 plus or minus 5v, 3-ph, 4-wire (wye)

60 plus or minus 5% cps, 20 kw

208 plus or minus 5v, 3-ph, 4-wire (wye)

400 plus or minus 5% cps, 20 kw

**INSTALLATION CONSIDERATIONS**

Siting: The general area at which the central is to be located should be relatively flat. Radar Search should be possible for 6400 mils in azimuth, and obstructions such as tall buildings, towers, and land masses should be avoided. The operations trailer must be located 100 to 225 feet from the acquisition radar group.

Mounting: The equipment is self-contained in the trailer.

Cabling Requirements: Primary power cables may be run through conduits (wood, preformed concrete, or tile); however, covered raceways are preferred in a semi-permanent installation. When vehicular traffic cannot be avoided, provisions for crossing, without damage to the cables, must be provided.

Related Equipment: Interrogation Set AN/TPX-27 and Motor Generator MD-4.

**PRINCIPAL COMPONENTS AND PHYSICAL DATA**

<b>COMPONENT</b>	<b>QTY</b>	<b>HEIGHT (Inches)</b>	<b>WIDTH (Inches)</b>	<b>DEPTH (Inches)</b>	<b>UNIT WT. (Pounds)</b>
Antenna Trailer V-287/MSQ-35					
Trailer Mounted Maintenance Shop V-280/MSQ-35					
Ballistics Data Computer Group 4A-4502/MSQ-54	1	70	21	58	3000
Ballistics Tracking Computer OA-4503/MSQ-54	1	74	17	72	1500
Computer-Indicator Group OA-4504/MSQ-54	1	74	30	73	800
Radar Bomb Scoring Set Console OA-4505/MSQ-54	1	72	37	70	1600
Radar Bomb Scoring Set Group OA-4507/MSQ-54	1	74	20	73	1500
Antenna Group OA-4508/MSQ-54	1				
Air Conditioner HD-607/MSQ-54	1	78	29	87	2300
Communications Control Console OA-6522/MSQ-54	1	45	19	29	300
Acquisition Antenna-Receiver- 1 Transmitter Group OA-4501 /MSQ-35					
Moving Target Indicator Group OA-6405/MSQ-54	1	36	18	24	750
Electronic Equipment Compressor Dehydrator HD-606/MSQ-54	1	19	13	22	150

**REFERENCE DATA AND LITERATURE**

Technical Manuals:  
31P2-2MSQ35 -Series

**AN/MSQ-35: 6**

**DATE:** 15 January 1965

**ITEM NAME:** RADAR BOMB SCORING CENTRAL

**COGNIZANT SERVICE:** USAF

**TYPE:** \*AN/MSQ-39, \*\*AN/MSQ-39A

**FEDERAL STOCK NUMBER:** \*5840-732-0838

	USA	USN	USAF	USMC
STATUS OR TYPE CLASSIFICATION			**Ltd Std	
Mfg(s) Name or Code Number: Reeves Instrument Corporation, Garden City, New York				

No Illustration Available.

**FUNCTIONAL DESCRIPTION**

Radar Bomb Scoring Central provides facilities for obtaining aircraft position velocity, acceleration data by

radar techniques and for ballistic computation of simulated bomb release. Impact point is compared with target position to determine bombing errors.

**AN/MSQ-39: 1**

**ITEM NAME:** RADAR BOMB SCORING CENTRAL  
**TYPE:** AN/ISQ-39, AN/SSQ-39A

**RELATION TO SIMILAR EQUIPMENT**

None.

**TECHNICAL DESCRIPTION**

Power Requirements:  
input - 208v, 400 cycles, 3-ph  
120v, 60 cycles, single phase

**PRINCIPAL COMPONENTS AND PHYSICAL DATA**

<b>COMPONENT</b>	<b>QTY</b>	<b>HEIGHT (Inches)</b>	<b>WIDTH (Inches)</b>	<b>DEPTH (Inches)</b>	<b>UNIT WT. (Pounds)</b>
Radar Bomb Scoring Set AN/MSQ-46	1				
Antenna Receiver-Transmitter	1				
Group Acquisition OA-653/MS					
Trailer, Maintenance (Ord No.) 8007194	1				
Trailer, Fire Control (Ord No.) 8358625	1				

**REFERENCE DATA AND LITERATURE**

Nomenclature Card for AN/MSQ-39A

**AN/MSQ-39: 2**

**DATE:** 15 January 1965

**ITEM NAME:** BEACON SET, RADAR

**COGNIZANT SERVICE:** USAF

**TYPE:** AN/PPN-16

**FEDERAL STOCK NUMBER:**

	USA	USN	USAF	USMC
STATUS OR TYPE CLASSIFICATION			Tent. Std	
Mfg(s) Name or Code Number: Wilcox Electric Company, Inc., Kansas City, Missouri				

No Illustration Available.

**FUNCTIONAL DESCRIPTION**

Beacon Set, Radar, is a portable X-band transponder beacon for paratroop and/or similar airborne operations. To be jumped by and set up by

one man. For short range homing, re-supply, front lines demarcation, pathfinder. The AN/PPN-16 will provide assistance to Troop Carrier Units in accurately locating landing zones, drop zones, extraction zones at night or under adverse

**AN/PPN-16: 1**

**ITEM NAME:** BEACON SET, RADAR

**TYPE:** AN/PPN-16

weather conditions.

**RELATION TO SIMILAR EQUIPMENT**

The AN/PPN-16 is similar to Radar Beacon AN/UPN-4, differs mechanically.

**TECHNICAL DESCRIPTION**

Automatically triggered operation.

Transmitter Data:

Pulse Type Emissions

150w peak min power output

Frequency Data; 9310 plus or minus 3 mc

Pulse Width;.5 usec

Power Requirements: 28v dc (facilities are provided for internal battery)

Receiver:

Frequency Range; 9375 plus or minus 40 mc

Sensitivity; minus 45 dbm (nominal)

**INSTALLATION CONSIDERATIONS**

Related Equipment: General Purpose (various airborne radar sets). Compatible with AN/APN-59, AN/APS-42, airborne navigational radar sets.

**PRINCIPAL COMPONENTS AND PHYSICAL DATA**

<b>COMPONENT</b>	<b>QTY</b>	<b>HEIGHT (Inches)</b>	<b>WIDTH (Inches)</b>	<b>DEPTH (Inches)</b>	<b>UNIT WT. (Pounds)</b>
Receiver	1				
Coder	1				
Modulator	1				
Transmitter	1				
Antenna	1				
Power Supply	1				
Carrying Case	1				
Mounting Legs	1				

**REFERENCE DATA AND LITERATURE**

Nomenclature Card and AF Form 81 for AN/PPN-16.

**AN/PPN-16: 2**



DATE: 1 July 1964

ITEM NAME: RADIO SET

COGNIZANT SERVICE: USN

TYPE: AN/PPS-1

FEDERAL STOCK NUMBER:

	USA	USN	USAF	USMC
STATUS OR TYPE CLASSIFICATION	Used By	Used By		
Mfg(s) Name or Code Number. Sperry Gyroscope Company, Inc.(56232)				

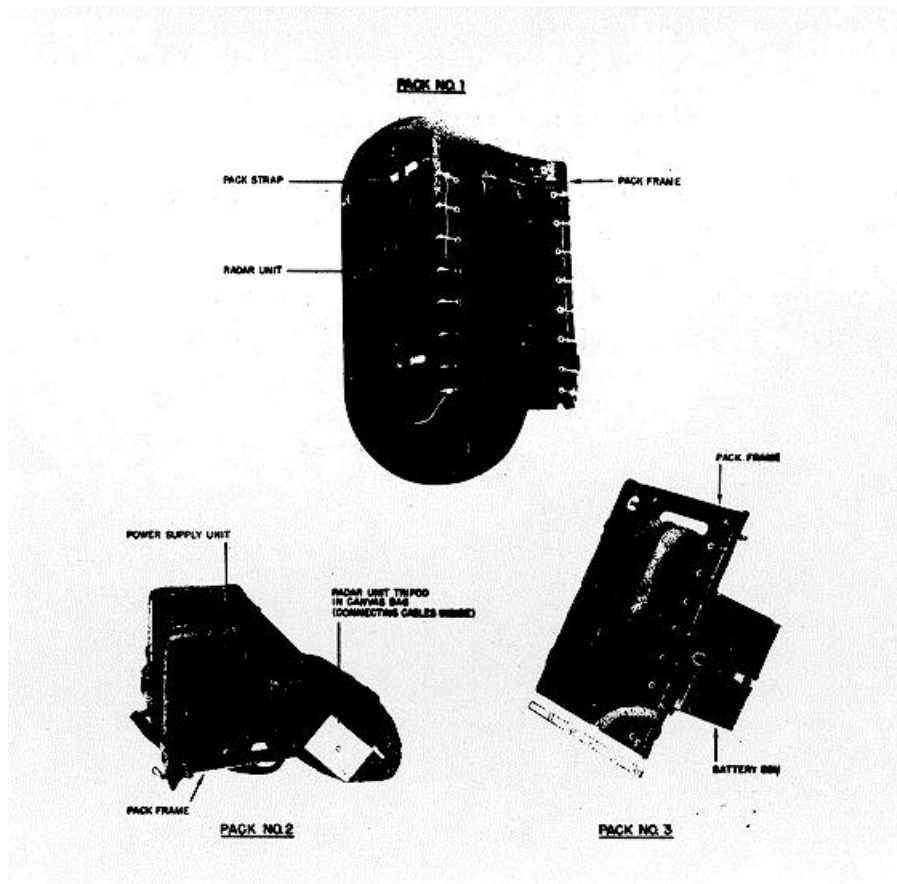

### FUNCTIONAL DESCRIPTION

The Radio Set AN/PPS-1 is a Continuous Wave (CW) Doppler radar system which detects the presence of moving targets only. The system can serve as a sentry warning device which will indicate the presence of

slowly moving (less than 100 mph) targets, such as personnel, ground vehicles, landing craft, etc., at ranges from zero up to two (2) miles, depending on the size of the target. The system does not respond to stationary

AN/PPS-1: 1

**ITEM NAME:** RADIO SET  
**TYPE:** AN/PPS-1

objects; hence their presence near moving targets will not interfere with detection, unless they completely screen a target.

**RELATION TO SIMILAR EQUIPMENT**  
None.

**TECHNICAL DESCRIPTION**

Frequency Range: 10,000 mc  
Doppler Frequency: 30 cps with a target moving 1 mph  
Some Doppler Frequencies produced in AN/PPS-1 by different target velocities are listed as follows:

Target Velocity	Total Doppler Frequency
1 mph	30 cps
3 mph	90 cps
10 mph	300 cps
30 mph	900 cps
50 mph	1500 cps
100 mph	3000 cps

**Power Supply Data**  
Type of Power Supply: 1-(40 lb) battery; 6v dc  
**Voltage Outputs**  
Plate Supply, B Plus: Plus 300v  
Reflector Supply: -210v  
Filament Supply, A: plus 6.3v

**INSTALLATION CONSIDERATIONS**

Siting: Pack and/or portable.

**PRINCIPAL COMPONENTS AND PHYSICAL DATA**

COMPONENT	QTY	HEIGHT (Inches)	WIDTH (Inches)	DEPTH (Inches)	UNIT WT. (Pounds)
Radar Unit, Mounted on Tripod	1				64.5
Power Supply Unit and Cables	1	8-1/4 x 8-1/4 x 14-3/4			24.9
Battery Box	1	7-3/4 x 11-1/2 x 14			58.7
Entire System, Set Up (Less Pack Frame)	1				148.1

**SHIPPING DATA**  
PKGS

PKGS	UNIT WT. (Pounds)
1	53.1
1	18.0
1	5.1
1	45.7
1	22.3
1	19.1
1	63.0
1	8.7
1	4.3

**REFERENCE DATA AND LITERATURE**

Technical Manual for Radio Set AN/PPS-1.

DATE: 1 July 1964

ITEM NAME: RADAR SET

COGNIZANT SERVICE: USA

TYPE: AN/PPS-4

LINE ITEM NUMBER: 63443

FEDERAL STOCK NUMBER: 5840-682-2591

	USA	USN	USAF	USMC
STATUS OR TYPE CLASSIFICATION	Std A			
Mfg(s) Name or Code Number: Sperry Gyroscope Company				



### FUNCTIONAL DESCRIPTION

Radar Set AN/PPS-4 is a lightweight, portable radar designed for battlefield surveillance. The radar set is capable of detecting and locating, under conditions of poor visibility, military targets such as personnel and vehicles moving in the presence of ground clutter.

### RELATION TO SIMILAR EQUIPMENT

None.

### TECHNICAL DESCRIPTION

Frequency: 8900 to 9400 mc  
Range:  
    Detect man walking at 1 mph up to 1,500m;  
    detect vehicle (such as 2- 1/2 ton truck) moving  
    at 15 mph up to 8,000m  
Peak Power Output: 0.8 kw (min)  
Operating Voltage: 24 vdc, (battery operated)  
Type of Presentation: Audio  
Duty Cycle: 0.001  
Pulse Repetition Rate: 5,000 pps  
Pulse Width: 0.2 Msec  
Horizontal Coverage: 6,400 mils  
Vertical Coverage: -800 to +350 mils  
Range Accuracy: :35m  
Beam Width: 6-1/2 deg

### INSTALLATION CONSIDERATIONS

Siting: Radar Set AN/PPS-4 must be so located that large buildings, trees, hills, etc., do not obscure the area being surveyed.

Mounting:  
Cabling Requirements:  
Related Equipment:

AN/PPS-4: 1

AN/PPS-4

**PRINCIPAL COMPONENTS AND PHYSICAL DATA**

<b>COMPONENT</b>	<b>QTY</b>	<b>HEIGHT (Inches)</b>	<b>WIDTH (Inches)</b>	<b>DEPTH (Inches)</b>	<b>UNIT WT. (Pounds)</b>
Receiver-Transmitter RT-553/PPS-4	1	14- 1/2 (dia)		15-19/32	34
Radar Set Tripod MT- 1946/PPS-4	1	54	(extended)		15.5

**REFERENCE DATA AND LITERATURE**

Specifications:  
MIL-R-55018(SigC)

**AN/PPS-4: 2**

DATE: 1 July 1964

ITEM NAME: RADOME GROUP

COGNIZANT SERVICE: USN

TYPE: AN/TPA-1

FEDERAL STOCK NUMBER:

	USA	USN	USAF	USMC
STATUS OR TYPE CLASSIFICATION	Used by	Used by		
Mfg(s) Name or Code Number	Lunn Laminates (94304)			

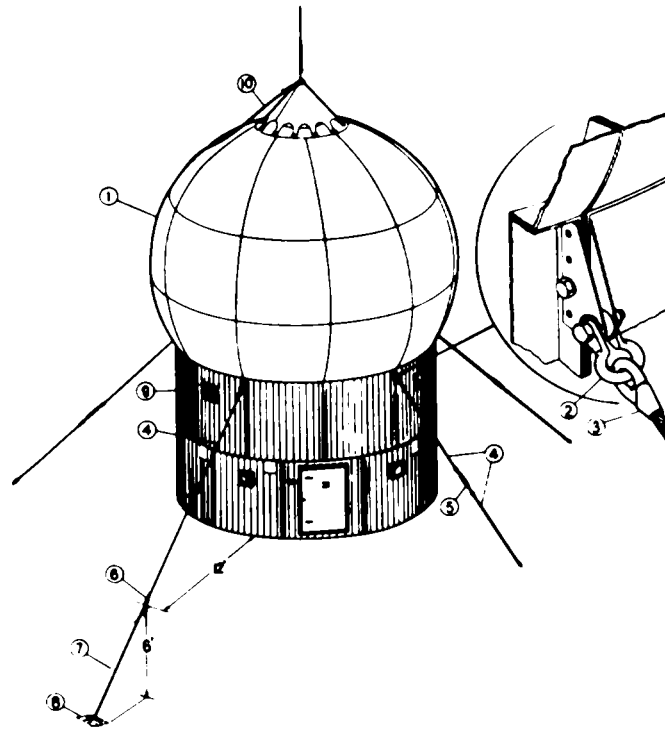

**FUNCTIONAL DESCRIPTION**

The Radome Group AN/TPA-1 is a complete and operative radome system consisting of a 31 panel plastic dome, a 20 panel corrugated aluminum base, 5 adjustable guy ropes and anchors, a 26 foot collapsible

aluminum erecting scaffold, snow rope, lightning arrester system, exhaust fan and rain deflector. The radome and its base can be erected in wind conditions up to 30 mph and can be fully assembled by a working force of six men within approximately sixteen hours.

AN/TPA-1:1

**ITEM NAME:** RADOME GROUP  
**TYPE:** AN/TPA-1

**RELATION TO SIMILAR EQUIPMENT**  
None.

**INSTALLATION CONSIDERATIONS**  
Related Equipment: The AN/TPA-1 Radome Group is designed to be used with, but not part of Radio Set AN/TPS-1 series.

**TECHNICAL DESCRIPTION**  
  
Not available.

COMPONENTS	QTY	PRINCIPAL COMPONENTS AND PHYSICAL DATA		UNIT WT. (Pounds)
		OVERALL DIMENSIONS (Inches)		
Radome (Rigid) CW-453/TPA-1	1	216 h x 232 dia		
Base, Radome MX-2328/TPA-1	1	144 h x 216 dia		
Scaffold consists of:	1			
Lower Section	1	54 x 105 x 108		119
Upper Section	1	54 x 102 x 10		79
Upper Section Intermediate	1	54 x 102 x 108		79
Safety Railing	1	56 x 72 x 96		32
Outboard Supports	2	51 x 78 x 108		18

**SHIPPING DATA**

**PKGS  
(NR.)**

**UNIT WT.  
(Pounds)**

1	925
1	925
1	925
1	925
5	80
2	80
1	925
2	80
5	80
1	925
1	150
1	80
4	80 ea
1	725
1	54
1	15
1	1
1	78
1	35
1	10
10	20
1	8
1	1
1	60
1	5
5	1
1	50
1	5
2	2
1	320
5	10
5	100

ITEM NAME: RADOME GROUP  
TYPE: AN/TPA-1

**PRINCIPAL COMPONENTS AND PHYSICAL DATA**

**SHIPPING DATA (Cont.)**

<b>PKGS (NR.)</b>	<b>UNIT WT. (Pounds)</b>
5	50
5	
15	
5	20
10	
5	
20	1
1	10
230	50

**REFERENCE DATA AND LITERATURE**

Technical Manuals:  
NAVSHIPS 93638

**AN/TPA-1: 3**

COGNIZANT SERVICE: USN

ITEM NAME: RADOME GROUP  
TYPE:: AN/TPA-1 (XN-1)

FEDERAL STOCK NUMBER:

	USA	USN	USAF	USMC
STATUS OR TYPE CLASSIFICATION				
Mfg(s) Name or Code Number	Lunn Laminates Inc., Huntington Station, New York			

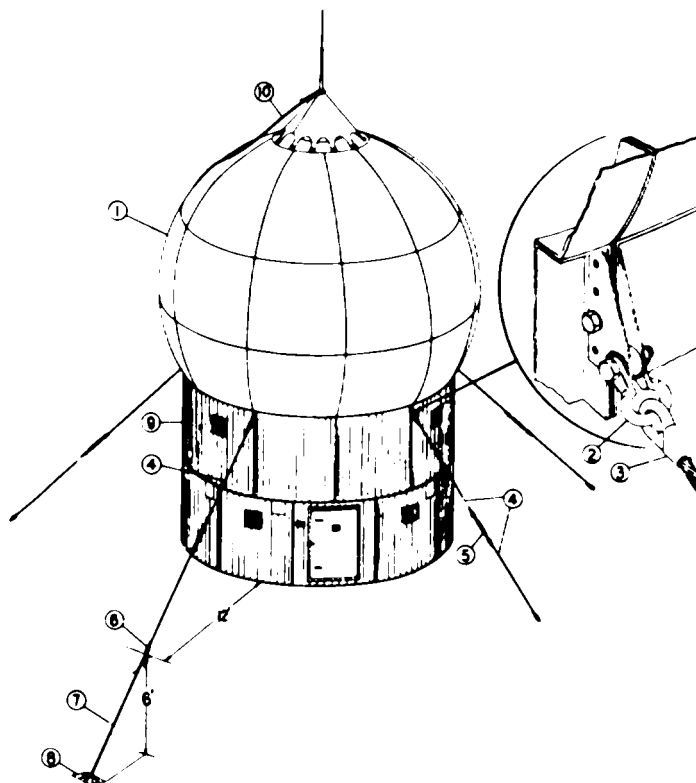

**FUNCTIONAL DESCRIPTION**

Radome Group AN/TPA-1 (XN-1) is used to house Radar Set AN/TPS-1 series. It provides a shelter for the equipment under

almost any environmental condition from the tropics to the polar regions and can be erected in winds up to 30 mph on practically any surface.

AN/TPA-1(XN-1): 1



**ITEM NAME:** RADOME GROUP  
**TYPE:** AN/TPA-1(XN-1)

**RELATION TO SIMILAR EQUIPMENT** None.

**TECHNICAL DESCRIPTION**

The Radome Group AN/TPA-1 consists of two major components:

- (a) Rigid Radome CW-453(XN-1)/TPA-1 is a spherical glass-fiber-plastic laminate structure measuring 21 feet in diameter. It is truncated at the 18 foot latitude to mount on the Radome base or a suitable flat surface.
- (b) Radome Base MX-2328(XN-1)TPA-1 is made up of five types of corrugated aluminum panels arranged in two rows or tiers of ten panels each, forming a cylinder 18 feet in diameter and 12 feet high. A 3 x 5 foot door, nine air-intake louvers and four windows are provided in the lower tier, the upper tier having four windows.
- (c) The Radome can be used separately from the base, mounted on any flat surface more than 19 feet in diameter. Provisions must be made for 60 equally spaced 1/2-13 x 1-1/2 in. long bolts on an 8 ft 11-3/8 in. radius of bolt circle.
- (d) When Radome is used with the Radome Base it is in addition to mounting bolts held in place with five ground anchors attached with guy-rope

assemblies to the top of the Radome Base.

- (e) The only power requirement for the radome group is the power consumed by the 110v, 60 cps, 1 hp motor for the exhaust system. Since the radome group is used for housing radar equipment, the number of operators required and total power consumed is entirely dependent on the radar equipment itself.
- (f) The radome and its base can be erected in wind conditions up to 30 mph.
- (g) When fully erected, this unit will withstand a constant wind force of 125 mph, with gusts up to 140 mph.
- (h) The gaskets used for assembly will remain flexible through a temperature range of 40 deg C (-40 deg F) to 73.9 deg C (165 deg F).
- (i) The exhaust system limits the inside air temperature to a maximum of 51.7 deg C (125 deg F), with an ambient temperature of 110 deg F outside and internal equipment rendering 3.5 kw.
- (j) The expected life of the radome and base is ten years minimum.

**INSTALLATION CONSIDERATIONS**

Related Equipment: (Required but no Supplied) (1)  
Radar Set AN/TPS-1 series.

**PRINCIPAL COMPONENTS AND PHYSICAL DATA**

<b>COMPONENTS</b>	<b>BOXES (NR.)</b>	<b>QTY</b>	<b>OVERALL DIMENSIONS (Inches)</b>	<b>UNIT WT. (Pounds)</b>
"A" Panel part no. 1633-102-31	2	10	48 x 84 x 90	925
"B" Panel part no. 1633-103-32	1	10	48 x 90 x 96	925
Intake Panel part no. 1633-106-4	1	7	66 x 78 x 78	925
Intake Panel part no. 1633-106-4	1	2	66 x 78 x 78	925
Plain Panel part no. 1633-105-1		5		
Door Panel with Door part no. 1633-106-		1	66 x 78 x 78	925
Plain Panel part no. 1633-105-1	1			
Window Panel with Window part no. 1633-106-3		4		
Cap part no. 1633-104-33	1	1	60 x 75 x 75	850

**AN/TPA-I(XN-1): 2**

ITEM NAME: RADOME GROUP  
TYPE: AN/TPA-1 (XN-1)

PRINCIPAL COMPONENTS AND PHYSICAL DATA

SHIPPING DATA (Cont.)

COMPONENTS	BOXES (NR.)	QTY	OVERALL DIMENSIONS (Inches)	UNIT WT. (Pounds)
Rain Deflector P/N 1633-107-22		1		
Lightning Rod P/N 1633-107-34		1		
Electric Motor P/N 1633-107-55		1		
Fan Housing P/N 1633-107-65		1		
Ground Arrestor P/N 1633-107-35		1		
Base Flanges P/N 1633-101-8		10		
Triple Block P/N 1633-107-51		1		
Double Block P/N 1633-107-52		1		
3/8 Rope P/N 1633-107-53		1		
Guy Lugs P/N 1633-106-9		5		
Expanding Anchors P/N 1633-106-10		5		
Anchor Rods P/N 1633-106-11		5		
Turnbuckle P/N 1633-106-12		5		
Wire Sockets P/N 1633-106-13		15		
Wire Shackles P/N 1633-106-14		5		
Wire Clamps P/N 1633-106-15		10		
Wire Ropes P/N 1633-106-16		5		
Nylon Rope P/N 1633-107-36		1		
Bolts, 1/2 x 2, 13 P/N 1633-106-19		20		
Bolts, 1/2 x 1-1/2, 13 P/N 1633-101-38		590		
Ground Clips P/N 1633-107-41		5		
Washers P/N 1633-101-68		590		
Caulking Compound		50 lb		
Caulking Gun, 2-1/2 qt		1		
Aluminum Wool P/N 1633-106-17		10 lb		
SPARE PARTS				
Electric Motor P/N 1633-107-55		1		
Ball Bearing, Flanged P/N 1633-107-59		1		

AN/TPA-1(XN-1): 3

**ITEM NAME:** RADOME GROUP

**TYPE:** AN/TPA-1(XN-1)

**PRINCIPAL COMPONENTS AND PHYSICAL DATA**

**SPARE PARTS**

**SHIPPING DATA (Cont.)**

<b>COMPONENTS</b>	<b>BOXES (NR.)</b>	<b>QTY</b>	<b>OVERALL DIMENSIONS (Inches)</b>	<b>UNIT WT. (Pounds)</b>
Ball Bearing, Flanged P/N 1633-107-60		1		
Fan Blades P/N 1633-107-57		1		
Belts P/N 1633-107-64		2		
Gasket, Neoprene (6 ft) P/N 1633-101-37		6 pcs		
Section	1	1	9 x 55 x 100	110
Sections	1	2	9 x 55 x 100	64
Section	1	1/2	6 x 48 x 60	30
Outriggers	1		8 x 48 x 72	30

**REFERENCE DATA AND LITERATURE**

Technical Manuals:  
NAVSHIPS 93094(A)

**AN/TPA-1(XN-1): 4**

DATE: 1 July 1964  
COGNIZANT SERVICE: USN

ITEM NAME: RADOME GROUP  
TYPE:: AN/TPA-3

FEDERAL STOCK NUMBER: 5895-626-1911

	USA	USN	USAF	USMC
STATUS OR TYPE CLASSIFICATION				
Mfg(s) Name or Code Number: Packard-Bell Electronics Corporation				

Illustration Not Available

**FUNCTIONAL DESCRIPTION**

Decoder Group AN/TPA-3 accepts video pulses received from the IFF receiver, and, upon receipt of a properly coded pulse sequence, produces an output pulse for display on associated equipment. This unit provides SIF video decoding facilities. Formerly identified as Decoder Group OA1134( ) / TPX, the AN/TPA-3 is part of Interrogator Sets AN/TPX-26 and AN/TPX-27.

**TECHNICAL DESCRIPTION**

Power Requirements: The same as the associated master station  
Operating Frequency: As designated for the associated equipment

**INSTALLATION CONSIDERATIONS**

Not available.

**RELATION TO SIMILAR EQUIPMENT**

None.

**PRINCIPAL COMPONENTS AND PHYSICAL DATA**

COMPONENT	QTY	HEIGHT (Inches)	WIDTH (Inches)	DEPTH (Inches)	UNIT WT. (Pounds)
Video Decoder, MX- 1995/TPA-3	1				
Remote Switching Control C-1903/TPA-3	1				

**REFERENCE DATA AND LITERATURE**

Specifications:  
MIL-D- 14503

AN/TPA-3: 1

DATE: 1 July 1964

ITEM NAME: SWITCHBOARD GROUP

COGNIZANT SERVICE: USN

TYPE:: AN/TPA-4

FEDERAL STOCK NUMBER:

	USA	USN	USAF	USMC

STATUS OR TYPE CLASSIFICATION

Mfg(s) Name or Code Number. The Admiral Corporation, Chicago, Illinois

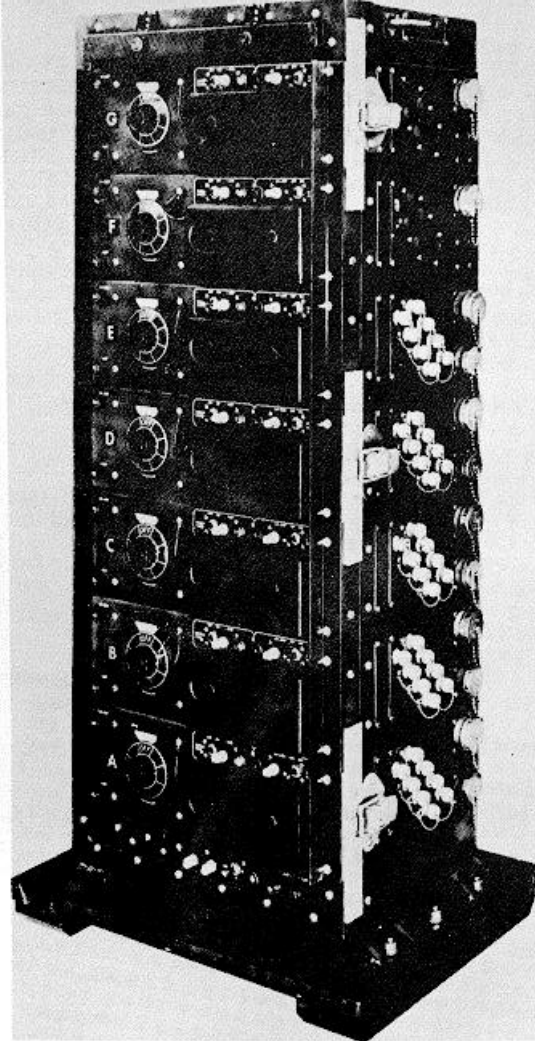

**FUNCTIONAL DESCRIPTION**

The AN/TPA-4 is primarily intended for field use. It is a lightweight, compact switchboard capable of switching any of

seven (7) radar set circuits to any of seven (7) indicator circuits without loss of signal amplitude or distortion of pulse shapes.

AN/TPA-4: 1

**ITEM NAME:** SWITCHBOARD GROUP

**TYPE:** AN/TPA-4

**RELATION TO SIMILAR EQUIPMENT**

None.

**TECHNICAL DESCRIPTION**

Number of Radar Indicator Circuits Accommodated:: 7

Number of Radar Set Circuits Accommodated: 7

Switchboard Input Capabilities

IFF Capability Receivers (4 video signals and 1 trigger signal): 4

Non-IFF Capable Receivers (1 video signal and 1 trigger signal): 3

Video Amplifier Circuit

Input Impedance: 75 ohms

Pulse Polarity: Positive

Pulse Amplitude: 0.2 to 3.0v

Overall Gain: One to one (var).

Output Impedance: 75 ohms

Trigger Regenerator Circuit

Input Impedance: 75 ohms

Output Impedance: 75 ohms

Pulse Polarity: Positive

Input Pulse Amplitude: plus 7v min

Output Pulse Amplitude: plus 20v, plus or minus 5v

Input Pulse Duration: 3.5 to 4 usec at

85% peak amplitude

Output Pulse Rise Time: 0.2 usec (typical).

Normal Operating Temperature of Equipment

Equipment Enclosure: Approx 15 deg C (27 deg F) above room temperature.

Operating Temperature Range of Equipment: 0 deg C (32 deg F) to 50 deg C (122 deg F).

Operating Power Requirement: 115v ac, 60 to 400 cps, single ph, 0.75 amps

Power Dissipation: 280w

**INSTALLATION CONSIDERATIONS**

Related Equipment: (Required but not Supplied) (7)

Output Control Signal Cables type MS3106A-28-1P,

(7) Input Control Signal Cables type MS3106A28-1S, (7) Output Control Signal Cables type

MS3106A-24- 5P(W), (4) Input Control Signal Cables type MS3106A-24-55, (61) Input and Output Video

and Trigger Signal Cables type UG-58A/U N-type.

Cabling Requirements: All cables for any given radar input or output must be of equal length, and shall not exceed 300 ft maximum.

**PRINCIPAL COMPONENTS AND PHYSICAL DATA**

**SHIPPING DATA**

<b>COMPONENTS</b>	<b>BOXES (NR.)</b>	<b>QTY</b>	<b>OVERALL DIMENSIONS (Inches)</b>	<b>UNIT WT. (Pounds)</b>
Switchboard Group AN/TPA-4		1	24-3/8 x 26-3/8 x 65-1/4	475

**EQUIPMENT SUPPLIED DATA**

<b>COMPONENTS</b>	<b>QTY</b>	<b>OVERALL DIMENSIONS (Inches)</b>	<b>UNIT WT. (Pounds)</b>
Switchboard, Signal Distribution, Radar SB-948/TPA-4	1	16-1/8 x 22-1/2 x 49-7/16	
Control, Remote Switching C-3140/TPA-4	7	2-31/32 x 4-3/16 x 18-11/32	
Case, Accessories CY-2740/TPA-4	1	7-7/8 x 19-1/4 x 24	
Case, Switchboard CY-2741/TPA-4	1	19-1/4 x 24 x 50-1/4	
Cable, Assy, Power Electrical CX-4936/U	1		
Cable, Assy, Special Purpose, 7 Electrical CX-4937/U			

**REFERENCE DATA AND LITERATURE**

Technical Manuals:  
NAVSHIPS 93659

DATE: 1 July 1964  
COGNIZANT SERVICE: USA

ITEM NAME: RADAR SET  
TYPE:: AN/TPG-2

FEDERAL STOCK NUMBER:

	USA	USN	USAF	USMC
STATUS OR TYPE CLASSIFICATION				
Mfg(s) Name or Code Number Sperry Gyroscope Co., Inc, Great Neck, New York				

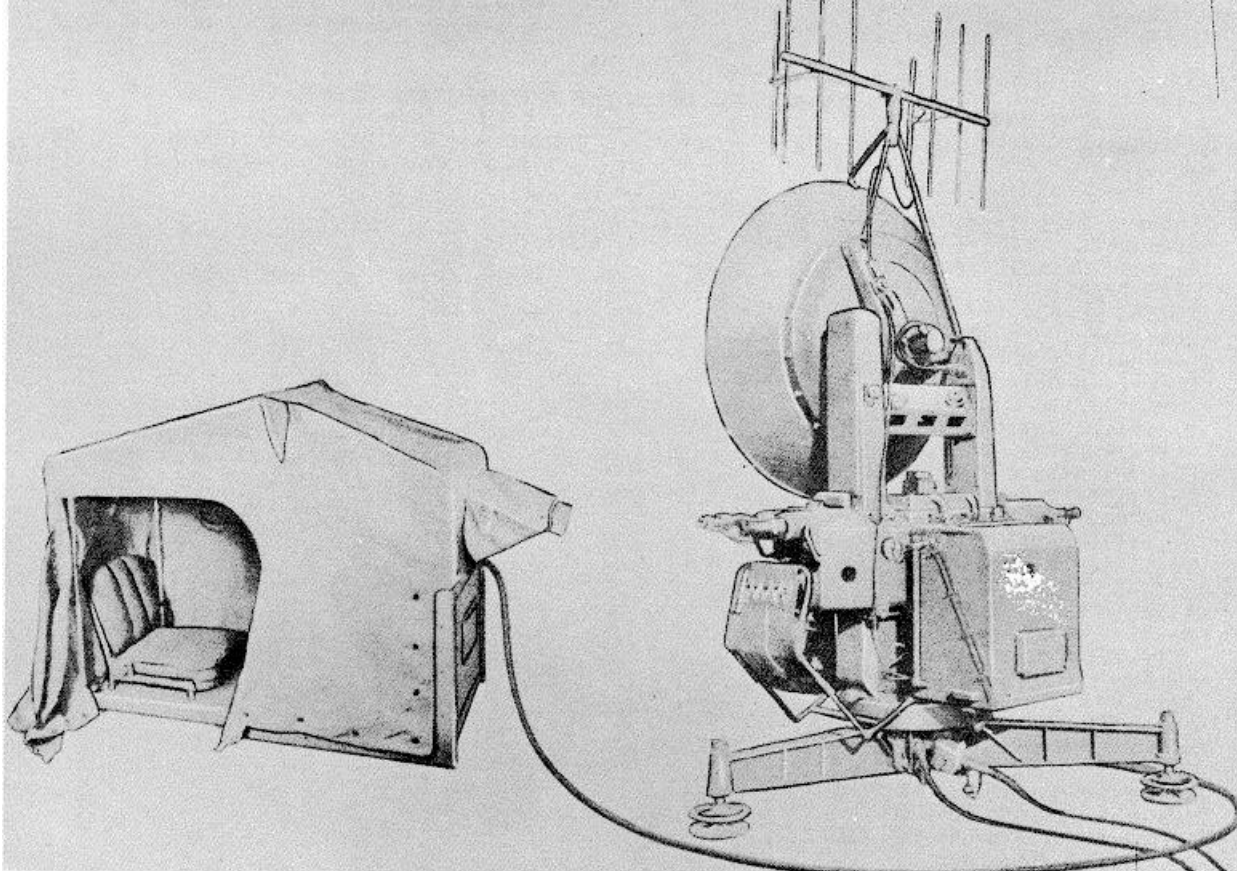

**FUNCTIONAL DESCRIPTION**

The AN/TPG-2 is a lightweight, transportable radar set designed to be used with the computer T18 to direct a battery of anti-aircraft guns. The set may be used

to scan or search the sky for enemy targets. When such a target is located, the set may be used to track it and to furnish present azimuth, present elevation and present slant range data to the computer.

**AN/TPG-2: 1**

Volume 1  
 Section 1  
**ITEM NAME:** RADAR SET  
**TYPE:** AN/TPG-2

**MIL-HDBK-162A**  
 15 December 1965

**RELATION TO SIMILAR EQUIPMENT**

None.

**TECHNICAL DESCRIPTION**

Frequency: 3000 mc  
 Wave Length: 10 cm  
 Pulse Width: 0.2 or 0.8 usec  
 Power Output: 200 kw )peak  
 Range  
   Searching: 80,000 yds max  
   Automatic Tracking  
     Maximum: ,15,000 yds  
     Minimum: 500 yds  
 Elevation Limits  
   Lower: 125 mils  
   Upper: plus 1540 mils

Azimuth Coverage: 6400 mils  
 Range Accuracy: 20 yds portable error  
 Azimuth and Elevation Accuracy: 1.5 mils  
 Antenna Spinner Speed: 3600 rpm  
 Tracker Mount Rotation: 8 rpm  
 Automatic Tracking Rates  
   Elevation: :250 mils per sec  
   Azimuth: 350 mils per sec  
   Range: 300 yds per sec  
 Manual Tracking Rates  
   Elevation: 250 mils per sec  
   Azimuth: 500 mils per sec  
   Range: 300 yds per sec  
 Handlebar Tracking Rates  
   Elevation: 250 mils per sec  
   Azimuth: 640 mils per sec  
 Range Slowing: 3000 yds per sec  
 Operating Power: 115v, 60 cps, 3-ph

**PRINCIPAL COMPONENTS AND PHYSICAL DATA**

<b>COMPONENTS</b>	<b>QTY</b>	<b>OVERALL DIMENSIONS (Inches)</b>	<b>UNIT WT. (Pounds)</b>
Antenna Assy AS-345/TPG-2	1		
Attenuator CN-64/TPX-6A	1		
Azimuth Data Transmitter PU-124/TPG-2	1		
Tripod MT-53,1/TPG-2	1		
Charging Choke MX-721/TPG-2	1		
Demodulator MD-73/TPG-2	1		
Elevation Data Assy MX-713/TPG-2	1		
Elevation Servo Motor PU-122/TPG-2	1		
Control Assy C-381/TPG-2	1		
Rectifier Power Unit PP-2.12/TPG-2	1		
Amplifier AM-170/TPG-2	1		
Indicator Control Assy OA-52/TPG-2	1		
Azimuth Servo Motor PU-123/TPG-2	1		
Rectifier Power Unit PP-241/TPG-2	1		
Tuning Unit TN-127/TPG-2	1		
Rack MT-533/TPG-2	1		
Frame MT-532/TPG-2	1		
Manual Tracking Control C-398/TPG-2	1		
Tracking Control C-37B/TPG-2	1		
Modulator MD-74/TPG-2	1		
Motor Generator PU-125/TPG-2	1		
Rectifier Power Unit PP-240/TPG-2	1		
Circuit Breaker RE-58/TPG-2	1		
Range Assy MX-716/TPG-2	1		
Oscillator O-54/TPG-2	1		
Amplifier AM-166/TPG-2	1		
Range Servo Assy MX-715/TPG-2	1		
Range Synchronizer Assy OA-51/TPG-2	1		
Rectifier Power Unit PP-244/TPG-2	1		
Regenerative Amplifier AM-188/TPG-2	1		
Regulator CN-63/TPG-2	1		

**AN/TPG-2: 2**



**ITEM NAME:** RADAR SET  
**TYPE:** AN/TPG-2

**PRINCIPAL COMPONENTS AND PHYSICAL DATA**

<b>COMPONENTS</b>	<b>BOXES</b>	<b>QTY</b>	<b>OVERALL DIMENSIONS</b>	<b>UNIT WT.</b>
	<b>(NR.)</b>		<b>(Inches)</b>	<b>(Pounds)</b>
Relay Panel RE-55/TPG-2	1			
Remote Control Unit C-376/TPG-2	1			
Rectifier Power Unit PP-243/TPG-2	1			
Search Assy MX-714/TPG-2	1			
Amplifier AM-167/TPG-2	1			
Slip Ring Assy UG-317/TPG-2	1			
Dipole AT-136/TPG-2	1			
Synchronizer SN-I13/TPG-2	1			
Tracking Indicator ID-199/TPG-2	1			
Tracking Indicator ID-207/TPG-2	1			
Tracking Indicator Amplifier AM-187/TPG-2	1			
Modulator Assy OA-50/TPG-2	1			

**REFERENCE DATA AND LITERATURE**

Technical Manual for Radar Set AN/TPG-2.

**DATE:** 1 July 1964  
**COGNIZANT SERVICE:** USN

**ITEM NAME:** BEACON TRANSMITTER RECEIVER  
**TYPE::** AN/TPN-3

**FEDERAL STOCK NUMBER:**

	<b>USA</b>	<b>USN</b>	<b>USAF</b>	<b>USMC</b>
STATUS OR TYPE CLASSIFICATION	Used by	Used by		
Mfg(s) Name or Code Number:				

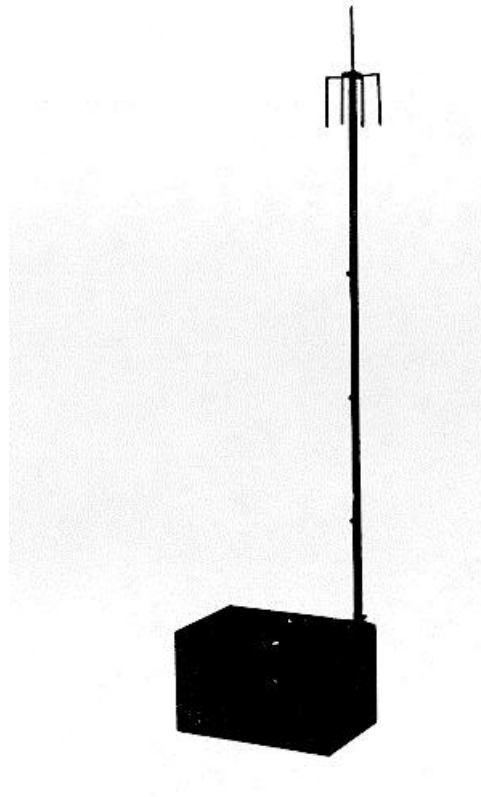

**FUNCTIONAL DESCRIPTION**

The Beacon Transmitter Receiver AN/TPN/3 is designed as a ground transportable beacon

responder. It is a receiver-transmitter used to receive a signal and to transmit a reply for navigational purposes.

**AN/TPN-3: 1**

Volume 1  
Section 1

**MIL-HDBK-162A**  
15 December 1965

**ITEM NAME:** BEACON TRANSMITTER SIGNAL  
**TYPE:** AN/TPN-3

**RELATION TO SIMILAR EQUIPMENT**

The AN,/TPN-3 is functionally the same as Beacon Transmitter AN/TPN-1, except that it operates from an ac power supply instead of batteries.

Number of Bands: 1 band  
Effective Range: Approx 20 mi  
Operating Power Requirements: 115 or 220v ac, 60 cps, single ph  
Power Input: 150w  
Power Output: 15w

**TECHNICAL DESCRIPTION**

Frequency Range: 157 to 187 mc

**INSTALLATION CONSIDERATIONS**

Not available.

**PRINCIPAL COMPONENTS AND PHYSICAL DATA**

<b>COMPONENTS</b>	<b>QTY</b>	<b>OVERALL DIMENSIONS (Inches)</b>	<b>UNIT WT. (Pounds)</b>
Chest	1	17-3/4 x 19-3/4 x 27-7/8	46.5
Antenna Mast	1	1-1/8 dia x 121	5.0
Modified Antenna AN-95-A	1	3-1/3 dia x 14	1.69
Modified Radio Receiver BC-966-A includes: Mounting FT-247-A	1	10 x 12-3/4 x 13-3/8	46.6

**REFERENCE DATA AND LITERATURE**

Technical Manuals:  
AN08-10-190

**AN/TPN-3: 2**

DATE: 1 July 1964  
COGNIZANT SERVICE: USN

ITEM NAME: RADAR SET  
TYPE:: AN/TPN-8

FEDERAL STOCK NUMBER: 2F5840-973-2676

	USA	USN	USAF	USMC
STATUS OR TYPE CLASSIFICATION		Used by		
Mfg(s) Name or Code Number: Gilfillan Corporation (24930)				

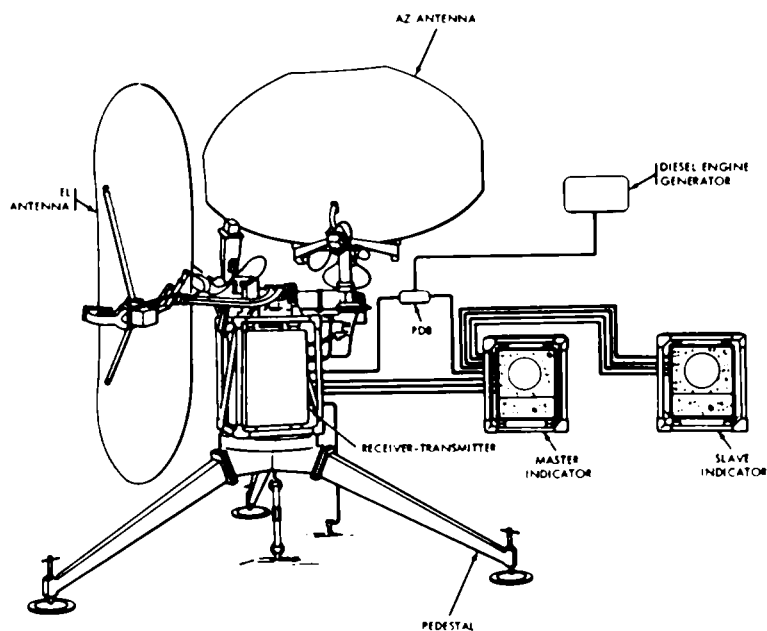

**FUNCTIONAL DESCRIPTION**

Radar Set AN/TPN-B is a lightweight, helicopter-transportable aircraft traffic control and landing approach radar set designed for use during all weather conditions. It is used at forward airstrips and heliports.

The radar set provides information used for air traffic control and for radar surveillance of aircraft. Precision aircraft information (height, range, azimuth and elevation) is displayed and used to direct the aircraft along an elevation glidepath and azimuth approach coarseline

AN/TPN-8: 1

Volume 1  
Section 1

**MIL-HDBK-162A**  
15 December 1965

**ITEM NAME:** RADAR SET

**TYPE:** AN/TPN-8

for a GCA (ground controlled approach) landing.

**RELATION TO SIMILAR EQUIPMENT**

None.

**TECHNICAL CHARACTERISTICS**

Receiver-Transmitter Group

Elevation Antenna

Beamwidth (1/2 Power)

Vertical: 1.1° max

Horizontal: 3.5° max

Gain: 35 db

Polarization: Vertical or circular

Scan Coverage: -1 to plus 10° or -1 to plus 35°

Horizontal Servo: plus or minus 15°

Vertical Height: 8 ft

Horizontal Width: 2 ft

Azimuth Antenna

Beamwidth (1/2 Power)

Vertical: 3.5° max csc<sup>2</sup> to 30°

Horizontal: 1.30 max

Gain: 37 db

Polarization: Horizontal or circular

Scan Coverage: 30°, 60° and 360°

Tilt: -1 to plus 25°

Vertical Height: 4.5 ft

Horizontal Width: 6.5 ft

Transmitter

Operating Frequency: X-band (9.0 to 9.6 gigacycles)

Pulse Width: 0.2 or 0.8 usec

PRF: 1200 pps

Peak Power Output: 200 kw nom

Receiver

Minimum Detectable Signal: -101 dbm

Receiver IF. Bandwidth: 2 mc for 0.8 usec; 7 mc for 0.2 usec pulse

Receiver FTC: Selected by operator

Receiver STC: Selected by operator

Receiver Tuning: Local oscillator tuned from operator's position

RF Noise Figure: 10.5 db

IF. Preamplifier

Gain: Var (plus 27 db to -13 db)

Bandwidth: 13 mc

Center Frequency: 60 mc

Noise Figure: 2.8 db

IF. Amplifier

Gain: Var (plus 84 db to plus 34 db (narrow band); var plus 78 db to plus 28 db wide band)

Bandwidth: 2 or 7 mc

Center Frequency: 60 mc

Dynamic Range: 30 db

Log IF. Amplifier

IF. Gain: 70 db

Bandwidth: 8 mc

Center Frequency: 60 mc

Dynamic Range: 30 db

Video Amplifier

Gain: 10 db

Bandwidth: 500 cps to 3 mc

Dynamic Range: 17v

IF. Delay Line

Delay: 0.24 usec

Impedance: 50 ohms

Attenuation: plus 8 db

Control Indicator Group

General

Number of Indicators: Two Indicator Presentation

PPI: or beta can be displayed on both indicators

in search and PREC modes respectively PPI

display on slave indicator and beta display on

master indicator is SIMULT mode only

Remoting: The radar set shall operate within

specified limits when the distance between

receiver transmitter and indicator is 500 ft or

less

Surveillance

Type Display: PPI (10 in. dia CRT)

Ranges: Linear (5-, 10-, 20- and 40-mi sweeps)

Offset Ranges: Full radius (except 40-mi)

Range Remarks: 1-mi spacing on 5- and

10-mi sweeps; 5-mi spacing on 20- and

40-mi sweeps.

Range Mark Accuracy: plus or minus 2%

Deflexion: Rotating coil

Scan Rate: 16 rpm

Precision Approach and Height Finder

Display: Beta scan (azimuth and elevation)

Ranges: Exponential 5 and 10-mi sweeps;

linear 20 and 40-mi sweeps

Range Marks: 1-mi spacing on 5- and

10-mi sweeps; 5-mi spacing on 20 and

40-mi sweeps

Range Mark Accuracy: plus or minus 1%

Azimuth Display: 30° or 60° sector

scan or 360° in SIMULT mode, within

a -1 to plus 10° elevation sector

Elevation Display: -1 to plus 10° or -1 to plus 35°

within a 30° azimuth sector scan

Date Rate: One azimuth and elevation

picture every sec in NORM mode; one

azimuth and one elevation picture

every sec in 35° EL mode; one azimuth

and one elevation picture every 2 sec

in 60° AZ mode; approx 16 azimuth and

24 elevation pictures every 60 sec on

precision display in SIMULT mode

Glidescope Cursors: Adjustable to any

glideslopes from plus 1° to 45° in elevation

Runway Cursors: Two electronic preset cursors

adjustable to any runway heading the siting

criteria

Height Finding: 300 to 30,000 ft with

accuracy of 0.4% of range and plus or

minus 10% in altitude



**ITEM NAME:** RADAR SET  
**TYPE::** AN/TPN-8

**Service Conditions**

**Ambient Temperature**

Operating: -40 to plus 50°C (-40 to plus 122°F)

Non-Operating: -62 to plus 75°C (-80 to plus 167°F)

Relative Humidity: No adverse effects up to 95% relative humidity (operating and non-operating)

Moisture: In transport condition, the radar set shall suffer no damage when submerged beneath 3 ft of fresh water for a period of 2 hrs

**Altitude**

Operating: Sea level to 6000 ft

Non-Operating: Sea level to 25,000 ft

**Winds**

Operating: 40 knots with hold-downstake

Non-Operating: 100 knots with hold down stake

Sand and Dust: As encountered in arid regions (particles 10-20 microns in size)

Vibration and Shock: No damage or impairment to from 5 cps to 33 cps, or random type shock encountered during

overland transport or helicopter pickup, flight or landing

Transport: Cargo transport helicopter (Hrs 1 or equivalent) or 2-1/2 ton M-35 truck Gross Weight: 3186 lbs

Power Source: Operates from a 120/208v,400 cyc, 3-ph, 4-wire, 4 kw primary source. The equipment is capable of operating within power source variation of plus or minus 10% and freq variations of plus or minus 5%, will not be damaged by a transient voltage of plus or minus 30% of a duration not greater than 1 sec

**INSTALLATION CONSIDERATIONS**

**Related Equipment**

Required but not Supplied: (1) Communications Transceiver ARC-52; (1) Shelter Tent; (2) Technical Manuals for Communications Transceiver ARC-52; (1) Diesel Engine Generator PU-34SA/G (PU-454/G)

**PRINCIPAL COMPONENTS AND PHYSICAL DATA**

<b>COMPONENTS</b>	<b>QTY</b>	<b>OVERALL DIMENSIONS (Inches)</b>	<b>UNIT WT. (Pounds)</b>
Radar Set AN/TPN-8 includes	1		3102
Antenna Reflector Assy	1	33 x 54 x 101	498
Antenna Drive Assy	1	33 x 33 x 56	440
Receiver-Transmitter RT-660/TPN-8	1	28 x 28 x 35	271
Antenna Pedestal AB-738/TPN-8	1	29 x 33 x 68	102
Elevation Horn and Polarizer 102767	1	20 x 20 x 54	72
Miscellaneous Antenna Components	1	25 x 25 x 36	115
Technical Manual NAVSHIPS 94650	2		
Operating Instructions NAVSHIPS 94650.21	1		
RF Cable Assy 103160 and 103168	1	15 x 15 x 34	225
Special Purpose Cable Assy 103171	1	15 x 15 x 34	249
Special Purpose Cable Assy 103161	1	15 x 15 x 34	249
Power Cable Assy 103170	1	15 x 15 x 34	279

Volume 1  
 Section 1  
**ITEM NAME:** RADAR SET  
**TYPE:** AN/TPN-8

**MIL-HDBK-162A**  
 15 December 1965

**PRINCIPAL COMPONENTS AND PHYSICAL DATA (CONTINUED)**

<b>COMPONENTS</b>	<b>QTY</b>	<b>OVERALL DIMENSIONS (Inches)</b>	<b>UNIT WT. (Pounds)</b>
Power Cable Assy 103162	1	15 x 15 x 34	279
Miscellaneous Cables	1	15 x 15 x 34	279
Control Indicator C-4150/TPN-8	*1 or 2	24 x 24 x 27	178

**NOTE:**  
 \*A second control indicator is optional.

**SHIPPING DATA**

<b>COMPONENT</b>	<b>PKGS</b>	<b>VOLUME (CU FT)</b>	<b>UNIT WT. (Pounds)</b>
	1	105	498
	1	35	440
	1	16	271
	1	37.5	102
	1	12.5	72
	1	13	115
	1	10	225
	1	10	249
	1	10	249
	1	10	279
	1	10	279
	1	10	145
	1	9	178
	1	9	178

**REFERENCE DATA AND LITERATURE**

Technical Manuals:  
 NAVSHIPS 94650  
 NAVSHIPS PS 94650.21



DATE: 15 September 1964  
COGNIZANT SERVICE: USAF

ITEM NAME: RADAR SET  
TYPE:: AN/TPN-12

FEDERAL STOCK NUMBER: 5895-622-8202-EG

	USA	USN	USAF	USMC
STATUS OR TYPE CLASSIFICATION			LS	
Mfg(s) Name or Code Number. Laboratory for Electronics				

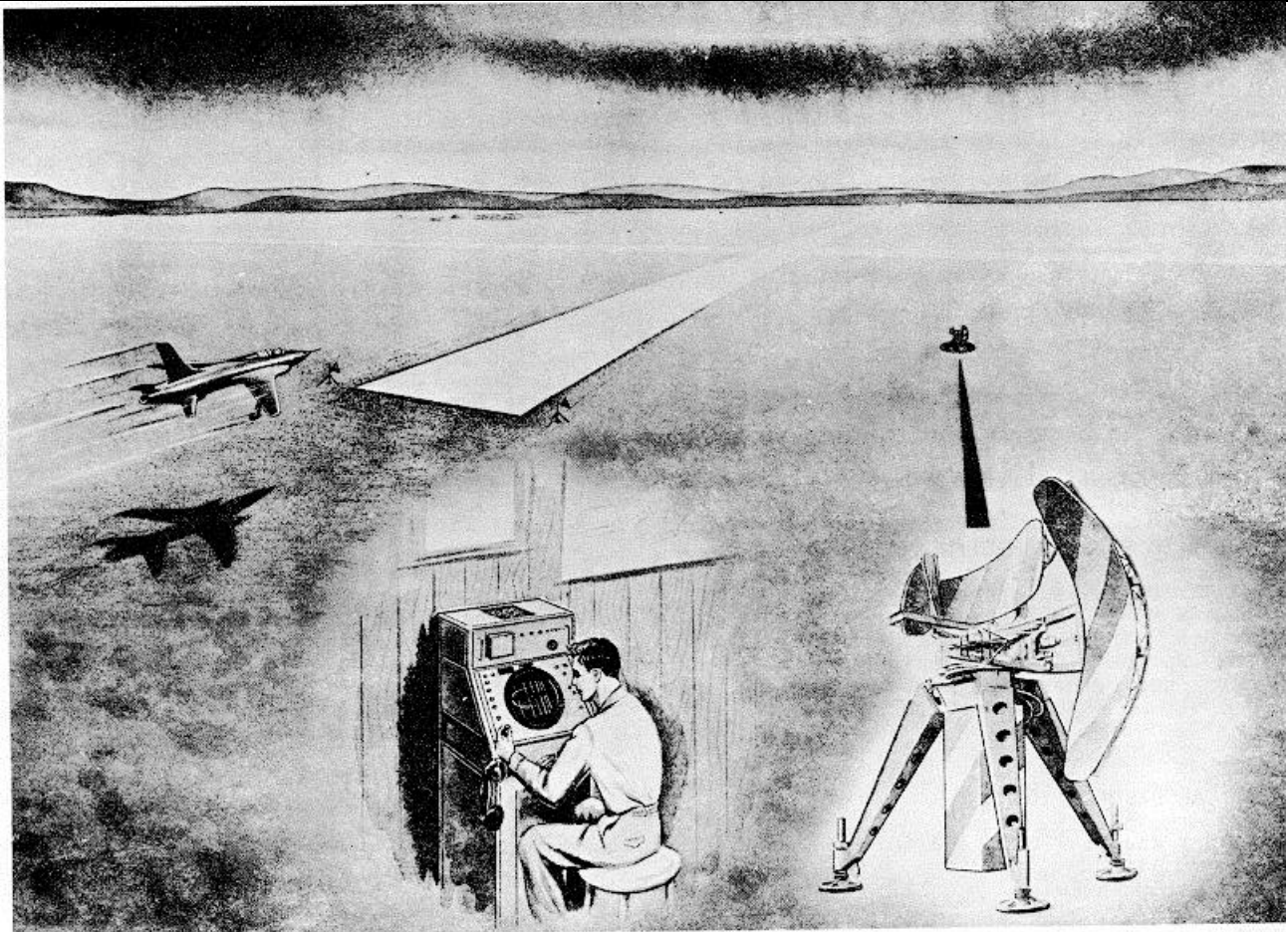

#### FUNCTIONAL DESCRIPTION

Radar Set AN/TPN-12 is a light-weight, transportable, ground-controlled-approach (GCA) Radar Set which can function as a surveillance or precision approach radar. This equipment can be used as the sole

radar approach and landing device or as an augmentation to existing precision approach radar for alternate runway coverage. For aircraft tracking during the initial approach to the airfield, the radar set is operated in the surveillance mode; the Radar Set is then switched to the precision

AN/TPN-12: 1

**ITEM NAME:** RADAR SET  
**TYPE:** AN/TPN-12)

approach made when the aircraft makes the final approach to the runway. Since only one mode of operation is possible at a time, this equipment is suitable only for airfields having low traffic density. The antenna equipment and transmitting and receiving components are housed in a weatherproof shelter, and can be installed on either side of the used runway. The entire antenna assembly can be rotated to provide reciprocal and multiple runway coverage without the requirements of a Radar Set Turntable. The indicator and remote control components are normally installed in the airfield control tower, which can be a maximum cable length of 10,000 feet from the transmitting and receiving equipment. A single indicator functions as a plan position indicator (PPI) during surveillance operation, and provides a time-shared dual beta scan to present azimuth and elevation information during precision approach operation. Glide path, center line, azimuth antenna tilt, and elevation antenna tilt cursors are electrically generated by a computer in the Indicator Group. Four radar target simulators are furnished and are to be erected near the end of the runway to aid in alignment of the indicator. Circular polarizers can be switched into the antenna equipment to reduce the signals returned from rain and clouds. Sensitivity time control (STC) and fast time control (FTC) circuits are included in the receiver to reduce ground clutter on the indicator. Telephones are furnished with the Indicator and Transmitter Groups for maintenance applications.

#### **RELATION TO SIMILAR EQUIPMENT**

The AN/TPN-12 is replaced by Quad Radar P/N GCA-M-MK-IV, which is a more reliable Radar Set. The AN/TPN-12A is similar to AN/TPN-12, the difference being that a pedestal heater has been added to prevent condensation, when the equipment is turned off.

#### **TECHNICAL DESCRIPTION**

Frequency Range: 9000 to 9160 mc (X-band)

Power Output:

Peak - 150 kw (min)

Average - 120 w (min)

Pulse Repetition Rate: 1500 pps

Pulse Width: 0.55 usec

Transmitter Duty Cycle: 0.0008

Receiver Intermediate Frequency: 30 mc

Receiver Bandwidth: 4 mc

Receiver Sensitivity: -95 dbm

Distance Range: 5, 10, 20 and 40 naut mi

Resolution: 300 ft or 1 pct of aircraft distance.

Surveillance Node:

Vertical Coverage: 0.5 to 20 deg (20,000 ft max altitude)

Horizontal Coverage: 360 deg

Indicator Display: PPI

Precision Mode:

Vertical Coverage: -1 to plus 7 deg

Horizontal Coverage: 30 deg

Indicator Display: Dual beta scan

Minimum Distance Range: 1/4 mi, 75 ft altitude (approx)

Waveguide Pressure: 18 to 22 psi

Polarization: Linear or circular

Power Requirements: 120v, ac, 50 to 60 cps, single ph, 12 kva

#### **INSTALLATION CONSIDERATIONS**

**Siting:** The field unit is located in a cleared area, adjacent to the runway to be used. The indicator and remote control components are normally installed in the control tower. Also, any other X-band equipment operation on the same band in the immediate vicinity will cause interference.

**Mounting:** Concrete foundation or directly on the Ground Indicator Group: Floor-mounted.

**Cabling Requirements:** The length of the transmitter power cable is 35 feet, while that of the indicator is 8-1/2 feet and hence, these units must be located within these distances from an external power source outlet. Also, the cable to connect the indicator with the field unit remotely is 500 feet long. Greater than 500 ft cable must be obtained through supply channels.

**Related Equipments:** Wind Measuring Set AN/GMQ-11, Radio-Receiver BC-639, Radio-Transmitter BC-640 ( ), Radio-Receiver R-278( )/GR, Radio Transmitter T-217( )/GR

ITEM NAME: RADAR SET  
TYPE:: AN/TPN-12

COMPONENT	QTY	HEIGHT (Inches)	WIDTH (Inches)	DEPTH (Inches)	UNIT WT.
Antenna Group	1				250
OA-2231/TPN-12	1				
Antenna Group	1				250
OA-2232/TPN-12					
Pedestal, Antenna	1	45.0	48.0	60.0	1250
AB-593/TPN-12					
Leg, Electrical Equipment	3	24.0	22.0	80.0	175
MX-2704/TPN-12					
Radar Set Group	1	74.0	30.0	39.0	160
OA-2096/TPN-12					
Radar Set Group	1	54.5	24.0	24.0	347
OA-2145/TPN-12					
Receiver Group 1					
OA-2095/TPN-12					
Directional Coupler	2	2-3/16	2-7/16	6	2
CU-721/TPN-12					
Waveguide Switch	1	5	6-1/2	18-1/2	26
SA-610/TPN-12					

REFERENCE DATA AND LITERATURE

TECHNICAL ORDERS:  
31P5-2TPN12- Series

AN/TPN-12: 3

DATE: 1 July 1964  
COGNIZANT SERVICE: USA

ITEM NAME: TRAINING SET  
TYPE:: AN/TPQ-T1

FEDERAL STOCK NUMBER:

	USA	USN	USAF	USMC
STATUS OR TYPE CLASSIFICATION	Used By	Used By		
Mfg(s) Name or Code Number.				

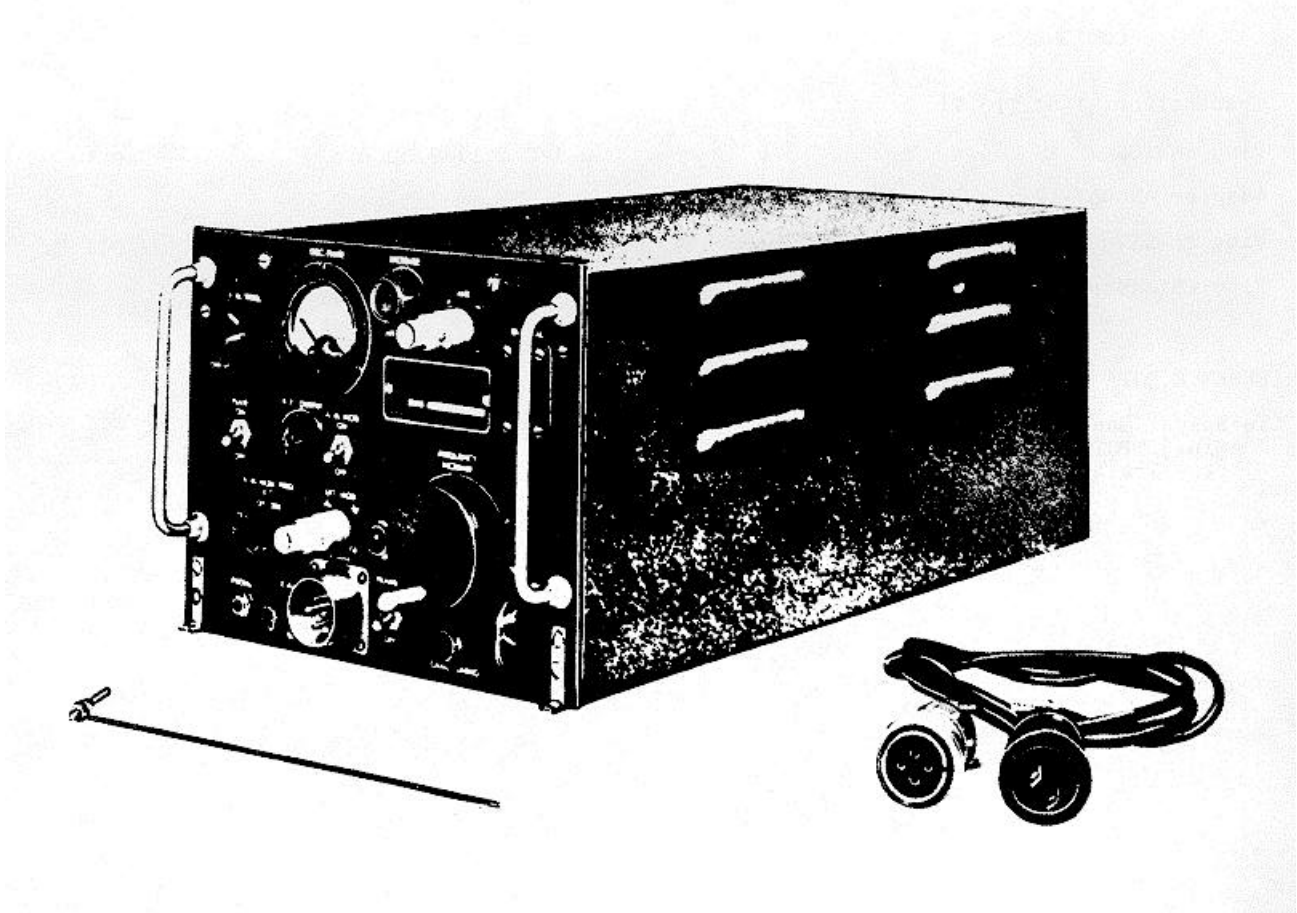

**FUNCTIONAL DESCRIPTION**

The Training Set AN/TPQ-T1 is a transmitter-receiver designed as air-transportable ground equipment and consists of one unit contained in a standard aircraft radio case, size BID. The Training Set is intended

for operation in conjunction with radar equipment to train radar operators to circumvent the effects of enemy jamming. Besides being used as training equipment this set can be operated as a super-regenerative receiver to monitor the radar equipment.

**AN/TPQ-TI: 1**

Volume 1  
Section 1  
**ITEM NAME:** TRAINING SET  
**TYPE:** AN/TPQ-T1

**MIL-HDBK-162A**  
15 December 1965

**RELATION TO SIMILAR EQUIPMENT**

None.

Operating Power Requirement: 115v ac,  
60 to 400 cps, approx 75 w

**INSTALLATION- CONSIDERATIONS -.**

**TECHNICAL DESCRIPTION**

Type of Emission: Amplitude modulated,  
frequency modulated and, external modulation.  
Frequency Range: 100 to 230 mc  
Amplitude Modulation: 25 to 1000 kc in  
6 steps.  
Frequency Modulation: 0 to 1000 cycles  
in a continuous range.

Related Equipment: (As required) Power Cable (115v, 2  
amps, 2 wires,-10 ft lg); As required Wire (copper)  
(self supporting 10 in. lg); (1)Banana Plug; (1)  
Frequency Meter TS-174/U or equivalent; (1) Dial  
Light; (As required) R.F. Cable RG-B/U; (1) Neon  
Bulb (0.1 w); (1) Headset HS-23.

**PRINCIPAL COMPONENTS AND PHYSICAL DATA**

<b>COMPONENTS</b>	<b>QTY</b>	<b>DIMENSIONS (Inches)</b>	<b>UNIT WT. (Pounds)</b>
Transceiver RT-54/TPQ-T1	1	7-27/32 x 19-9/16 x 10-1/4	41
Plug AN3106-22-4S	1	2-1/8 x 11-9/32 dia	0.19
Adapter AN3057-12	1		
Plug PL-259	2	3/4 dia x 1 1/2 lg	0.1
Plug (Standard- AC)	1		

**REFERENCE DATA LITERATURE**

Technical Manuals:  
AN16-30TPQT-2 (TM11-1032)  
for Training Set AN/TPQ-T1

**AN/TPQ-T1: 2**

DATE: 1 July 1965  
COGNIZANT SERVICE: USAF

ITEM NAME: RADAR CLOUD DETECTING SET  
TYPE:: AN/TPQ-11

FEDERAL STOCK NUMBER: 6660-866-5648

	USA	USN	USAF	USMC
STATUS OR TYPE CLASSIFICATION			Tent. Std	
Mfg(s) Name or Code Number. Lear Siegler Inc., Long Island City, New York				

No Illustration Available

**FUNCTIONAL DESCRIPTION**

Radar Cloud Detecting Set is used to measure height, density, base and top

of clouds. Special features of the AN/ TPQ-11 are two antenna reflectors, calibration and test facilities built-in.

**AN/TPQ-11: 1**

Volume 1  
Section 1

**MIL-HDBK-162A**  
15 December 1965

**ITEM NAME:** RADAR CLOUD DETECTING SET  
**TYPE:** AN/TPQ-11

**RELATION TO SIMILAR EQUIPMENT**

None.

Transmitter - 34,512 to 35,208 mc, one band, one channel

Receiver - 34,512 to 35, 208 mc, one band, one channel

**TECHNICAL DESCRIPTION**

Frequency Data:

Power Requirements:

Input - 115v ac, 48 to 62 cycles, single ph

**PRINCIPAL COMPONENTS AND PHYSICAL DATA**

<b>COMPONENT</b>	<b>QTY</b>	<b>HEIGHT (Inches)</b>	<b>WIDTH (Inches)</b>	<b>DEPTH (Inches)</b>	<b>UNIT WT. (Pounds)</b>
Console, Radar Cloud Detecting Set OA-1461/TPQ-11	1				
Radar Cloud Detecting Set Group OA-2455/TPQ-11	1				
Receiver, Radar R-810/TPQ-11	1				
Recorder, Weather Data RO-131/TPQ-11	1				
Transmitter, Radar T-632/TPQ-11	1				

**REFERENCE DATA AND LITERATURE**

Nomenclature Card for AN/TPQ-11 and AF Form 81

**AN/TPQ-11: 2**

**DATE:** 1 July 1964

**ITEM NAME:** MISSILE RANGE INSTRUMENTATION  
SET

**COGNIZANT SERVICE:** USAF

**TYPE::** AN/TPQ-18

**FEDERAL STOCK NUMBER:**

	USA	USN	USAF	USMC
STATUS OR TYPE CLASSIFICATION			Tent. Std	
Mfg(s) Name or Code Number: RCA Defense Electronic Products, Moorestown, New Jersey				

No Illustration Available.

**FUNCTIONAL DESCRIPTION**

This is a long-range precision tracking set used for tracking intercontinental ballistic missiles or satellites. The set will be mounted in modular shelter units. This will provide a set which can be assembled,

aligned, checked out and operational at a previously prepared site. It will meet special coverage requirements for a particular program or provide back-up facilities to the AN/FPQ-6 during overhaul or modification retrofit program. A modular unit will be greater than 14 ft long by 10 ft high by

**AN/TPQ-18: 1**



**ITEM NAME:** MISSILE RANGE INSTRUMENTATION SET  
**TYPE:** AN/TPQ-18

8 ft wide and capable of being transported by a C-124 or C-133 aircraft, ship, rail, or by highway.

Power Requirement:  
120 or 208v ac, 60 cps, 3-ph, 4-wire

**RELATION TO SIMILAR EQUIPMENT**

The AN/TPQ-18 is similar to AN/F: 6 and AN/SPQ-7.

**INSTALLATION CONSIDERATIONS.**

Siting: The AMR Transportable modular Instrumentation Radar AN/TPQ-18 consists of a number of cabinets of electronic equipment designed in modular form to-be housed and transported in eight units

**TECHNICAL DESCRIPTION**

Frequency Data:  
Transmitter; 5400 5900 mc  
Receiver; 5400 5900 mc

Related Equipment: Specific use for Ballistic Missile and Satellite tracking.

<b>COMPONENT</b>	<b>QTY</b>	<b>HEIGHT (Inches)</b>	<b>WIDTH (Inches)</b>	<b>DEPTH (Inches)</b>	<b>UNIT WT.</b>
Radar Set AN/FPS-16 (less building, standard range group, standard antenna group, standard transmitter, standard boresight tower)	1				
30 ft dia Parabolic, hydraulic-driven Antenna Group	1				
Low Noise Receiver Group	1				
Acquisition and Control Console Group	1				
Digital Range Group	1				
Real Time Digital Data Corrector Group	1				
High-Powered Tunable Transmitter	1				
Portable Boresight Tower Equipment Group	1				

**REFERENCE DATA AND LITERATURE**

Nomenclature Card and AF Form 81 for AN/TPQ-18.

DATE: 1 July 1964

ITEM NAME: RADIO SET

COGNIZANT SERVICE: USN

TYPE: AN/TPS-1

FEDERAL STOCK NUMBER:

	USA	USN	USAF	USMC
STATUS OR TYPE CLASSIFICATION	Used By	Used By		
Mfg(s) Name or Code Number: Western Electric Company, Inc. (64959)				

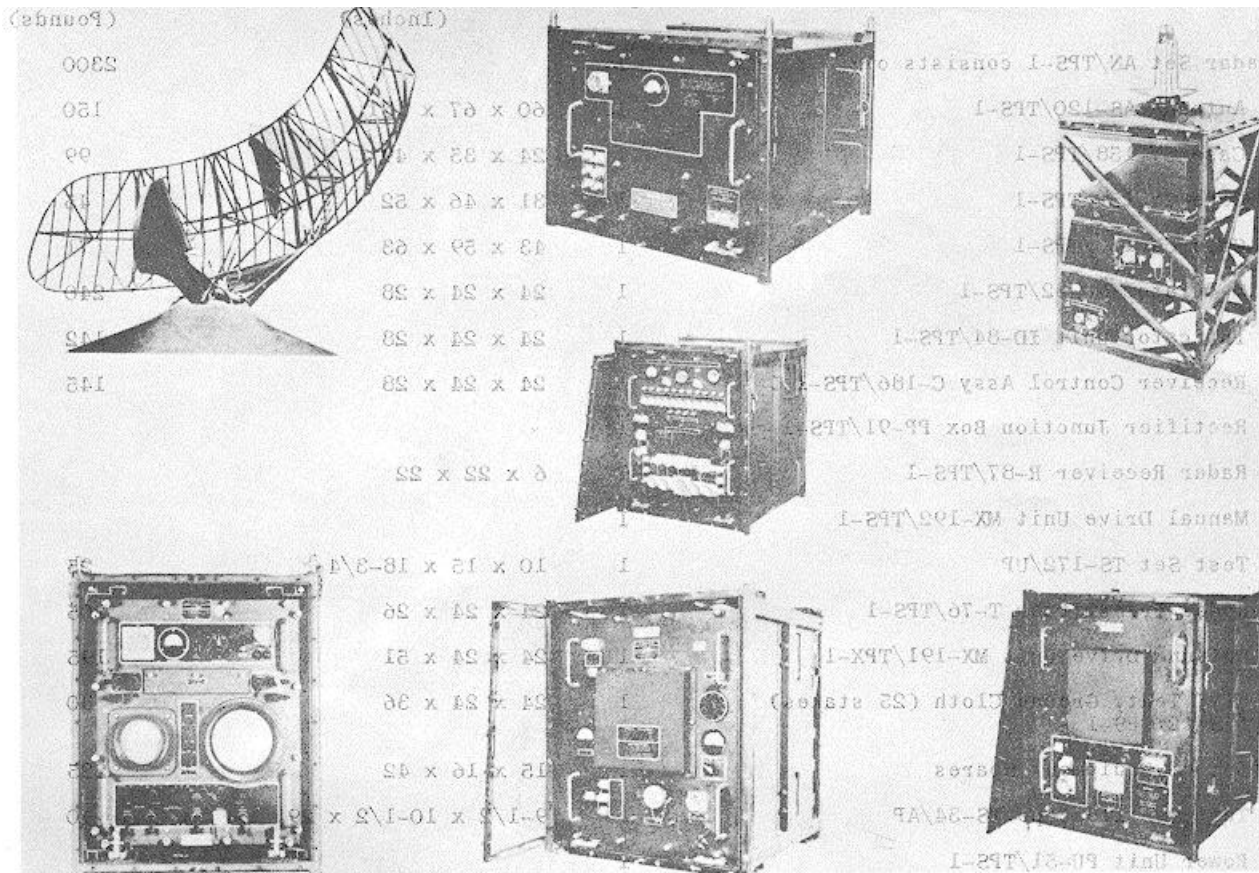

**FUNCTIONAL DESCRIPTION**

Radio Set AN/TPS-1 is a lightweight, highpower, transportable air search radar. It is designed to detect objects at ranges up to 160 nautical miles. The

equipment is intended for ground base operation in the field or at a fixed position.

**AN/TPS-1: 1**

**ITEM NAME:** RADIO SET  
**TYPE:** AN/TPS-1

**RELATION TO SIMILAR EQUIPMENT**

Radio Set AN/TPS-i is similar but not identical to the SCR-602-A equipment.

11,5 ac, 400 cps, 1300w; 28v dc, 400w  
Pulse Repetition Rate: 204 pps  
Pulse Width: 1 usec

**INSTALLATION CONSIDERATIONS**

**TECHNICAL DESCRIPTION**

Maximum Scanning Azimuth: 360 deg  
Scanning Accuracy: plus or minus 3 deg  
Frequency: 1100 mc (approx)  
Range- 160 naut mi  
Operating Voltage and Power Requirements:

Siting: A fixed installations the units may be arranged as desired at the operating position, with the antenna and antenna base remotely located up to 150 ft away.

**PRINCIPAL COMPONENTS AND PHYSICAL DATA**

<b>COMPONENTS</b>	<b>QTY</b>	<b>OVERALL DIMENSIONS (Inches)</b>	<b>UNIT WT. (Pounds)</b>
Radar Set AN/TPS-1 consists of:	1	2300	
Antenna AS-120/TPS-1	1	60 x 67 x 181	150
Case CY-158/TPS-1	1	24 x 35 x 49	99
Case CY-159/TPS-1	1	31 x 46 x 52	45
Case CY-160/TPS-1	1	43 x 59 x 63	71
Modulator MD-32/TPS-1	1	24 x 21 x 28	240
Indicator Unit ID-84/TPS-1	1	24 x 24 x 28	142
Receiver Control Assy C-186/TPS-1	1	24 x 24 x 28	145
Rectifier Junction Box PP-91/TPS-1	1		
Radar Receiver R-87/TPS-1	1	6 x 22 x 22	
Manual Drive Unit MX-192/TPS-1	1		
Test Set TS-172/UP	1	10 x 15 x 18-3/4	25
Radar Transmitter T-76/TPS-1	1	24 x 24 x 26	205
Antenna Drive Unit MX-191/TPX-1	1	24 x 24 x 51	195
Fly, Tent, Ground Cloth (25 stakes) S-12/TPS-1	1	24 x 24 x 36	80
Set of Equipment Spares	1	15 x 16 x 42	225
Test Oscilloscope TS-34/AP	1	9-1/2 x 10-1/2 x 29	40
Power Unit PU-51/TPS-1	1		
Engine	1	21 x 32 x 34	363
Generator	1	13 x 19 x 21	200

**REFERENCE DATA AND LITERATURE**

Technical Manuals:  
SHIPS 296

**AN/TPS-1: 2**

DATE: 1 July 1964

ITEM NAME: RADIO SET

COGNIZANT SERVICE: USN

TYPE: AN/TPS- 1B

FEDERAL STOCK NUMBER: 5840-665-1213  
5840-665-253: w-s

	USA	USN	USAF	USMC
STATUS OR TYPE CLASSIFICATION				
Mfg(s) Name or Code Number: Western Electric Company, Inc.				

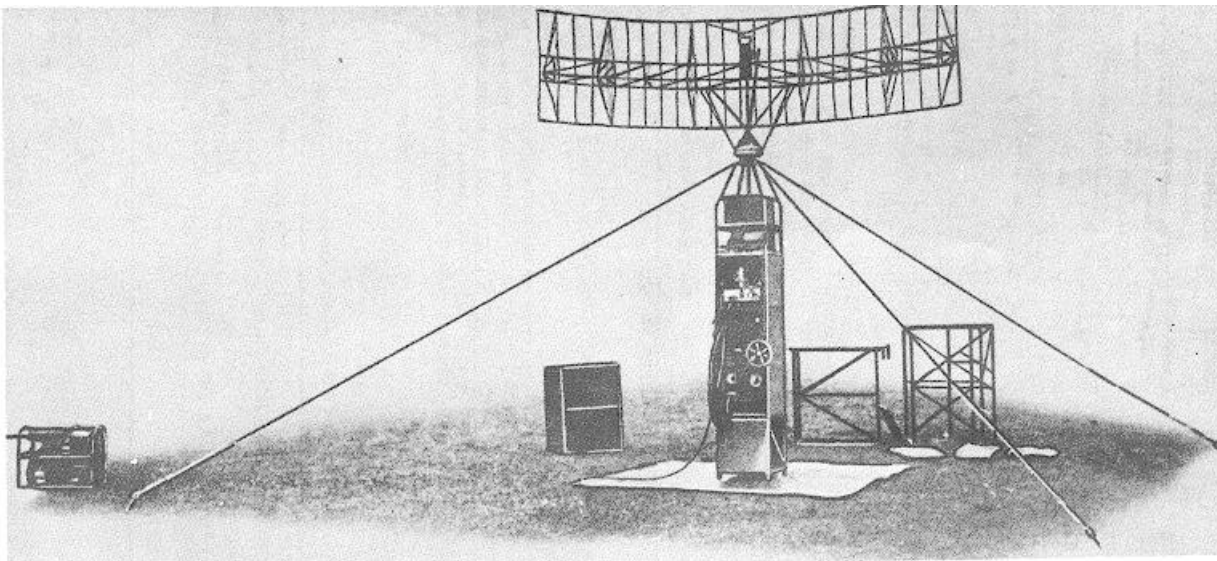

### FUNCTIONAL DESCRIPTION

The AN/TPS-1B is a transportable, ground based, search radar for detecting aircraft and other targets at ranges up to 200 miles. Range data is furnished in nautical miles and azimuth data in degrees. The equipment is assembled from units which can be carried by men or transported by truck or airplane. The units are housed in waterproof cases and, when assembled, form a tower for support of the antenna. Provision is made for connecting IFF equipment and standard Navy remote PPI repeater.

### RELATION TO SIMILAR EQUIPMENT

AN/TPS- 1B is similar to Radio Set AN/TPS- 1D, -1E, -1F, and -1G, except for differences in beam pattern.

### TECHNICAL DESCRIPTION

Frequency: 1220 to 1350 mc  
Range: 200 mi  
Peak Power Output: 500 kw  
Operating Voltages and Power Requirements:  
115 vac, 400 cps, 1-ph, 2,800w;  
27 vdc, 450w  
Type of Presentation: One 7-in. PPI and one 5-in. A-scope  
RF Power Source: 5J26 magnetron  
Pulse Repetition Rate: 380 pps nom (adjustable 360 to 400 pps)  
Pulse Width: 4 ;sec  
Horizontal Coverage: 360 deg  
Horizontal Beam Width: 37 deg  
Vertical Beam Width: 10 to 12 deg  
Azimuth Accuracy: t1 deg  
Range Accuracy: t3% of range plus 1 mi  
Receiver Bandwidth: 1.1 mc  
IF. Frequency: 60 mc

AN/TPS-1B: 1

**AN/TPS- 1B**

**INSTALLATION CONSIDERATIONS**

Siting: Radar Equipment AN/TPS-1B should be located in an area that is free of obstructions.  
Mounting: Major units are normally stacked one on top of the other. When assembled, the

weatherproof cases form a tower support for the antenna.  
Cabling Requirements:  
Related Equipment:

**PRINCIPAL COMPONENTS AND PHYSICAL DATA**

<b>COMPONENT</b>	<b>QTY</b>	<b>HEIGHT (Inches)</b>	<b>WIDTH (Inches)</b>	<b>DEPTH (Inches)</b>	<b>UNIT WT. (Pounds)</b>
Antenna Assembly, AS- 120/TPS- 1B	1				150
Modulator, MD-32/TPS-1B	1	24	24	28	240
Indicator Unit, ID-84/TPS-1B	1	14	21	22	85
Receiver-Control Assembly C- 186/TPS- 1B	1	24	24	28	145
Rectifier Junction Box, PP-96/TPS-1B	1				
Radar Receiver, R-87/TPS-1B	1				
Manual Drive Unit, MX- 192/TPS-1B	1				
Test Set, TS-172/UP	1				
Radar Transmitter, T-76/TPS-1B	1	24	24	26	205
Antenna Drive Unit, MX-191/TPS-1B	1	24	24	51	195
Shelter, S-12/TPS-1B	1				
Maintenance Kit, MK-26/TPS- 1B	1				
Oscilloscope, TS-34/AP	1	9.5	10.5	29	40
Power Unit PU-51/TPS-1B C/O					
Engine	1	21	32	34	363
Generator	1	13	19	21	200
Set of Maintenance Spares	1	10	18	22	50

**REFERENCE DATA AND LITERATURE**

Technical Manuals:  
SHIPS 296

DATE: 1 July 1964  
COGNIZANT SERVICE: USN

ITEM NAME: RADIO SET  
TYPE: AN/TPS-1D

USA LINE ITEM NUMBER: 64510  
FEDERAL STOCK NUMBER: 5840-655-1212

	USA	USN	USAF	USMC
STATUS OR TYPE CLASSIFICATION Std-A		Std		
Mfg(s) Name or Code Number: Raytheon Mfg. Co.				

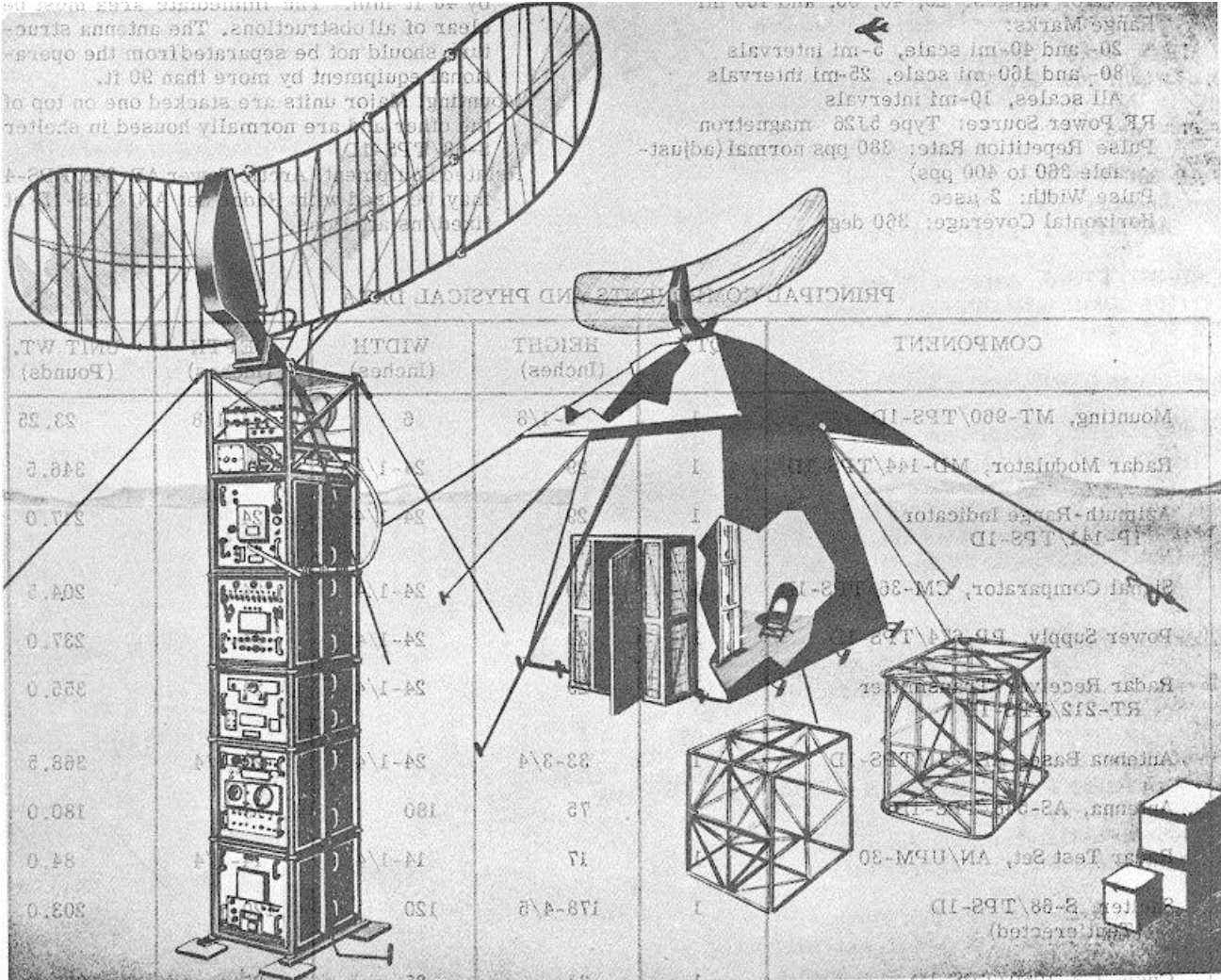

**FUNCTIONAL DESCRIPTION**

Radar Set AN/TPS-1D is a lightweight, transportable, high-power search radar used for detecting aircraft within ranges of 160 naut mi, at altitudes up to 30,000 ft and in any direction in azimuth. It is designed for

ground base operation in the field or at a fixed station. The indicator may be operated at distances up to 50 ft. The equipment provides either normal or MTI operations.

**AN/TPS- 1D**

**RELATION TO SIMILAR EQUIPMENT**

The AN/TPS-1D units are similar to the AN/TPS-16 units although none of the units are interchangeable.

**TECHNICAL DESCRIPTION**

Frequency: 1220 to 1350 mc  
 Range: 160 naut mi  
 Peak Power Output: 500 kw (avg 500w)  
 Operating Voltages and Power Requirements:  
 115 vac, 400 cps t4%, 1-ph, 7.5 kw  
 Type of Presentation: One 7-in. PPI and one 5-in. A-scope  
 Indicator Ranges: 20, 40, 80, and 160 mi  
 Range Marks:  
 20- and 40-mi scale, 5-mi intervals  
 80- and 160-mi scale, 25-mi intervals  
 All scales, 10-mi intervals  
 RF Power Source: Type 5J26 magnetron  
 Pulse Repetition Rate: 380 pps normal (adjustable 360 to 400 pps)  
 Pulse Width: 2 μsec  
 Horizontal Coverage: 360 deg

Antenna Rotation Speed: 0 to 15 rpm  
 Resolution: Range, 0.33 mi; azimuth, 4 deg  
 System Accuracy: Range 3% of range +1 naut mi; azimuth, t 1 deg  
 Horizontal Beam Width: 4 deg  
 Vertical Beam Width: 12 deg  
 Receiver Bandwidth: 5 mc  
 IF. Frequency: 60 mc

**INSTALLATION CONSIDERATIONS**

Siting: Equipment requires a cleared area 40 ft by 40 ft min. The immediate area must be clear of all obstructions. The antenna structure should not be separated from the operational equipment by more than 90 ft.  
 Mounting: Major units are stacked one on top of the other and are normally housed in shelter S-68/TPS1D.  
 Related Equipment: Arctic Tower AB-343/FPS-4 may be used with Radar Set AN/TPS-1D at fixed installations.

**PRINCIPAL COMPONENTS AND PHYSICAL DATA**

COMPONENT	QTY	HEIGHT (Inches)	WIDTH (Inches)	DEPTH (Inches)	UNIT WT. (Pounds)
Mounting, MT-960/TPS-ID	1	5-1/8	6	34-1/8	23.25
Radar Modulator, MD- 144/TPS- 1D	1	29	24- 1/4	24	346.5
Azimuth-Range Indicator IP- 141/TPS- 1D	1	29	24-1/4	24	217.0
Signal Comparator, CM-36/TPS- D	1	20	24-1/4	24	204.5
Power Supply, PP-674/TPS-ID	1	29	24-1/4	24	237.0
Radar Receiver-Transmitter RT-212/TPS- 1D	1	29	24-1/4	24	355.0
Antenna Base, AB-221/TPS-1D	1	33-3/4	24-1/4	23-1/4	368.5
Antenna, AS-548/TPS-1D	1	75	180	79	180.0
Radar Test Set, AN/UPM-30	1	17	14-1/4	14-1/4	84.0
Shelter, S-68/TPS-1D (Tent erected)	1	178-4/5	120	120	203.0
Case, CY-1060/TPS-ID	1	31	25	25	358.0
Case, CY-1061/TPS-ID	1	54	48	57-1/4	230.0
Case, CY-1062/TPS-ID	1	58	56	82	206.0
Case, CY-1279/TPS-1D	1	31	25	25	167.0

**AN/TPS-1D**

**REFERENCE DATA AND LITERATURE**

Technical Orders:

31P1-2FPS-111  
31P1-2GPA29-21  
31P1-2GPA29-22  
31P1-2GPA33-5  
31P3-2TPS1D-519  
31P4-2TPX-104  
31P6-2FPS-125  
31P6-2TPS1-14  
31P6-2TPS1-35  
31P6-2TPS1-51  
31P6-2TPS1-84  
31P6-2TPS1-94

31P6-2TPS1-144  
31P6-2TPS1-162  
31P6-2TPS1-172  
31P6-2TPS1-184  
31P6-2TPS1-194  
31P6-2TPS1-204  
31P6-2TPS1-214  
31P6-2TPS1-224  
31P6-2TPS1-511A

Technical Manuals:

NavShips 91579B  
TM-11-1167

Specifications:

MIL-R-15895(Ships)



DATE: 1 July 1964

ITEM NAME: RADIO SET

COGNIZANT SERVICE: USN

TYPE: AN/TPS-1G

USA LINE ITEM NUMBER: 645150

FEDERAL STOCK NUMBER: 5840-519-7609

	USA	USN	USAF	USMC
STATUS OR TYPE CLASSIFICATION	Std-A			
Mfg(s) Name or Code Number: Hazeltine Electronics Corporation				

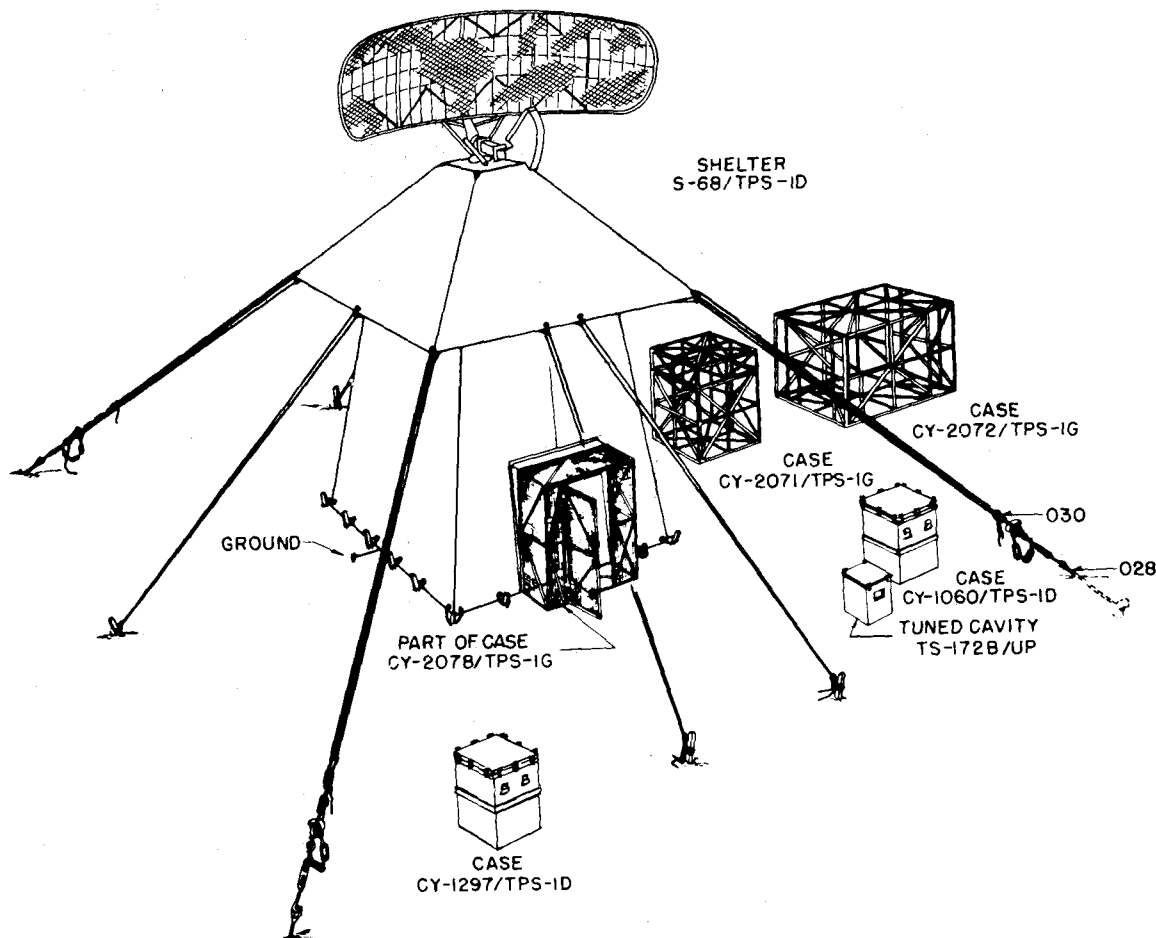

### FUNCTIONAL DESCRIPTION

Radar Equipment AN/TPS-1G is a high-power, transportable, ground-based search radar for detecting aircraft and other targets at ranges up to 160 nautical miles. The equipment is assembled from units (in weatherproof cases) carried by men or transported by trucks. The weatherproof cases are assembled to form

the antenna tower support. Provision is made for connecting IFF and remote PPI repeater equipment.

### RELATION TO SIMILAR EQUIPMENT

Radar Equipment AN/TPS-1G is interchangeable with Radar Set AN/TPS-1D (as modified by FC #9). Generally, components of the AN/TPS-1D can be

**AN/TPS- 1G**

used in the AN TPS-1G, but equipment performance will suffer. Components of AN/TPS-1G equipment can be used in the AN TPS-1D without degrading the performance of the AN TPS-ID.

**TECHNICAL DESCRIPTION**

Frequency: 1220 to 1350 mc  
 Range: 160 naut mi  
 Peak Power Output: 500 kw (min)  
 Operating Voltage and Power Requirements:  
 115 vac, 400 cps, 1-ph, 2.8 kw; 27 vdc, 450w  
 Type of Presentation: One 10-in. PPI and one  
 5-in. A-scope  
 Duty Cycle: 0.0008  
 RF Power Source: 5J26 magnetron  
 Pulse Repetition Rate: 380 pps nom (adjustable  
 360 to 400 pps)  
 Pulse Width: 2 µsec  
 Horizontal Coverage: 360 deg (cw or ccw, auto

or manual)  
 Horizontal Beam Width: 3. 4 to 4 deg  
 Vertical Beam Width: 10 to 12 deg  
 Azimuth Accuracy: ±1 deg  
 Range Accuracy: ±3% of range plus 1 naut mi  
 Receiver Bandwidth: 1.1 mc  
 IF. Frequency: 60 mc

**INSTALLATION CONSIDERATIONS**

Siting: Radar Equipment AN/TPS-1G should be located in an area that is free of obstructions.  
 Mounting: Major units are normally stacked one on top of the other. When assembled, the weatherproof cases form a tower support for the antenna.  
 Cabling Requirements:  
 Related Equipments:

**PRINCIPAL COMPONENTS AND PHYSICAL DATA**

COMPONENT	QTY	HEIGHT (Inches)	WIDTH (Inches)	DEPTH (Inches)	UNIT WT. (Pounds)
Radio Set AN/TPS-1G	1	22.4	188.4	105	3026
Antenna Base AB-498/TPS-1G	1	33.75	24	23.25	347
Antenna AS-673( ) TPS-IE	1	95	188.5	105	260
Signal Comparator CM-36A TPS-1D	1	20	24	23.25	146
Case CY-1060/TPS-1D	1	31	25	25	343
Case CY-2071/TPS-1G	1	54	48	86	178
Case CY-1061/TPS-1D	1	54	48	57	230
Case CY-2072/TPS-1G	1	59	59	86	314
Case CY-1062/TPS-1D	1	58	56	82	206
Case CY-1297/TPX-1D	1	31	25	25	182
Azimuth and Range Indicator IP-141A TPS-1D	1	29	24	23.25	224
Radar Modulator MD-144A/TPS-1D	1	29	24.25	24	346.50
Mounting MT-960/TPS-ID	2	5.13	6	34.13	23
Power Supply PP-674A TPS-1D	1	29	24	23.25	223
Radar Receiver-Transmitter RT-212A/TPS-ID	1	29	24	23.25	330
Shelter S-68./TPS-1D	1	14.9 ft	10 ft	10 ft	203

**PRINCIPAL COMPONENTS AND PHYSICAL DATA**

<b>COMPONENT</b>	<b>QTY</b>	<b>HEIGHT (Inches)</b>	<b>WIDTH (Inches)</b>	<b>DEPTH (Inches)</b>	<b>UNIT WT. (Pounds)</b>
Tuned Cavity TS-172B/UP	1	19.75	17.5	17.5	65
Variable Power Transformer TF-238/U	1	10.75	14.75	9.75	43
Signal Comparator Test Set TS- 1002/TPS-1G	1	3.75	4.25	3	1

**REFERENCE DATA AND LITERATURE**

Technical Order:  
31P6-2TPS1-84

Technical Manual:  
NAVSHIPS 92951  
NAVSHIPS 92920  
Specification:  
M(L-R-0015895D(SHIPS))

DATE: 1 July 1964

ITEM NAME: RADIO SET

COGNIZANT SERVICE: USA

TYPE: AN/TPS-2

FEDERAL STOCK NUMBER:

	USA	USN	USAF	USMC
STATUS OR TYPE CLASSIFICATION	Used By	Used By		
Mfg(s) Name or Code Number: General Electric Company (24446)				

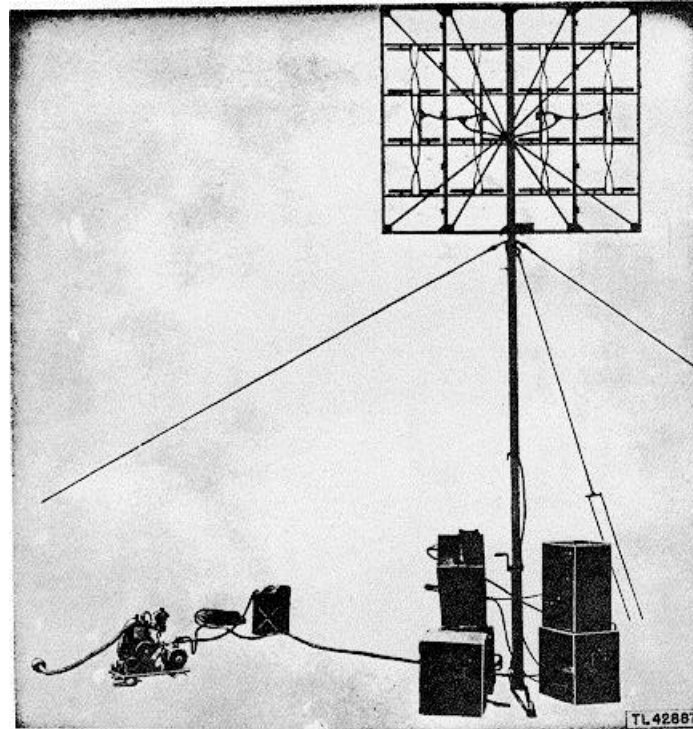

### FUNCTIONAL DESCRIPTION

The Radio Set AN/TPS-2 is a medium range radar unit designed to give fairly early warning of enemy aircraft. At the same time the equipment is compact,

light in weight, easily erected and simple to operate. It is transportable by aircraft, jeep, or pack. For warning purposes, the radio must determine the azimuth and slant range of a target.

AN/TPS-2: 1

**ITEM NAME:** RADIO SET

**TYPE:** AN/TPS-2

**RELATION TO SIMILAR EQUIPMENT**

The AN/TPS-2 is similar to, but not the same as Radio Set SCR-602-A.

Type of Engine: 1 cycle  
 Type of Cooling System: Air cooled  
 Type of Generator: Belt-driven type  
 Number of Revolutions per Minute:  
 8000 rpm  
 Frequency: 400 cycle  
 Power: 825 w  
 Operating Frequency: Approx 400 mc  
 Operating Power Requirements: 115v ac,  
 400 cps, single p)h, 825 w  
 Effective Reception Range: Approx 25 mi

**TECHNICAL DESCRIPTION**

Type of Installation: Portable  
 Equipment Purpose: Detection of aircraft  
 Power Unit Data (PU-9/TPS-2)  
 Type of Power Unit: Motor Generator

**PRINCIPAL COMPONENTS AND PHYSICAL DATA**

<b>COMPONENTS</b>	<b>QTY</b>	<b>OVERALL DIMENSIONS (Inches)</b>	<b>UNIT WT. (Pounds)</b>
Radio Transmitter T-25/TPS-2	1	16 x 17 x 26	75
Receiver-Indicator R-36/TPS-2	1	16 x 17 x 26	75
Generator Portion of Power Unit PU-9/TPS-2	1	16 x 17 x 23	75
Engine Portion of Power Unit PU-9/TPS-2 (Tool Roll)	1	16 x 17 x 19	70
Cables, test meter, spare tubes, ropes	1	16 x 17 x 30-1/2	60
Left, Section of Antenna AT-17/TPS-2	1	8-1/2 x 28 x 60-1/4	35
Right, Section of Antenna AT-17/TPS-2	1	8-1/2 x 28 x 60-1/4	35
Antenna Mast, Struts	1	10 dia x 75 high	60
Spare Engine	1	16 x 17 x 19	65
Spare Generator & Spare Parts	1	16 x 17 x 23	70
Set of Equipment Spares	1	16 x 17 x 26	75

**REFERENCE DATA AND LITERATURE**

Technical Manuals:  
 TM 11-1339 for Radio Set AN/TPS-2.

DATE: 15 April 1964  
COGNIZANT SERVICE: USAF

ITEM NAME: RADAR SET  
TYPE: AN/TPS-10D

FEDERAL STOCK NUMBER: 5840-505-1851

	USA	USN	USAF	USMC
STATUS OR TYPE CLASSIFICATION			Ltd Std	
Mfg(a) Name or Code Number: Radio Corporation of America				

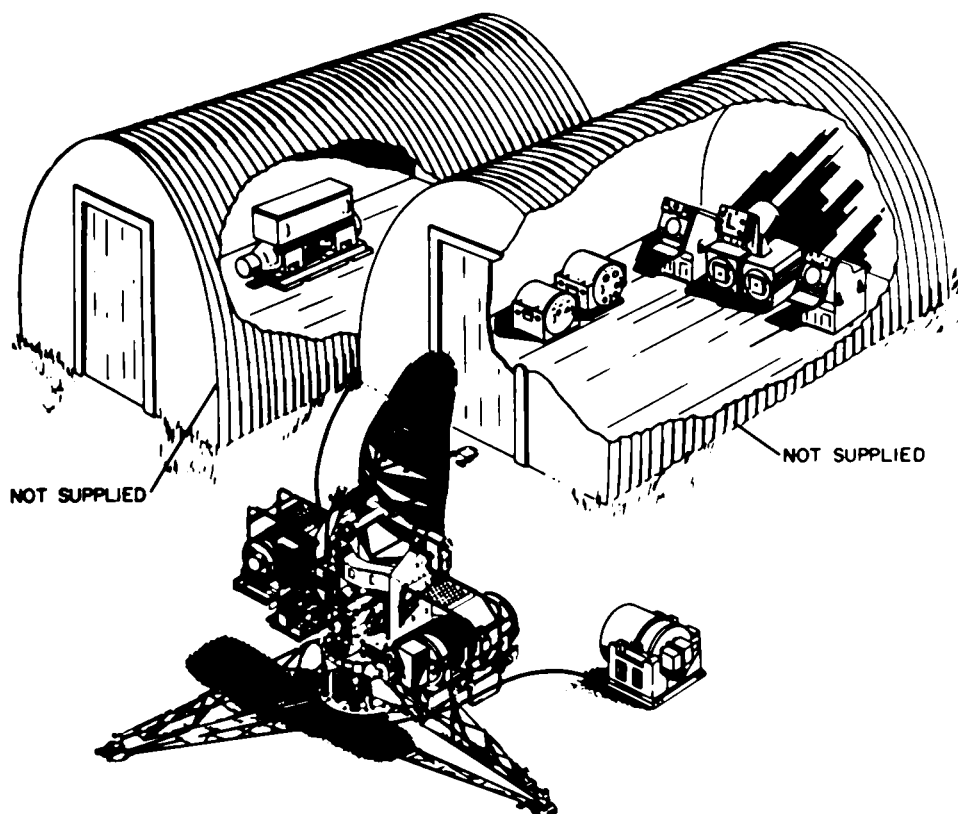

### FUNCTIONAL DESCRIPTION

Radar Set AN/TPS-10D is a lightweight, medium-range height-finding equipment. The extremely narrow beam width of the antenna makes it especially adaptable for use in mountainous terrain. The set has a maximum presentable range coverage of 120 nautical miles and a height-finding capability of -5000 to +60,000 feet. Radar Set AN/TPS-10D is air-transportable in a type C-82 cargo aircraft without disassembly of any components other than the upper section of the antenna reflector.

### RELATION TO SIMILAR EQUIPMENT

Radar Set AN/MPS-9 is the mobile version and Radar Set AN/FPS-4 is the fixed version of Radar Set AN/TPS-10D.

### TECHNICAL DESCRIPTION

Frequency: 9230 to 9404 mc  
Range: 120 naut mi  
Peak Power Output: 250 kw

**AN/TPS-10D**

Operating Voltages and Power Requirements:  
120/208 vac, 60 cps, 3-ph, 4-wire, 12 kw  
Type of Presentation: One RHI  
Indicator Ranges: 0 to 60 or 1 to 120 mi  
Range Marks:  
60-mi scale, 5-mi intervals  
120-mi scale, 10-mi intervals  
RF Power Source: Type Jan-6002 magnetron  
Pulse Repetition Rate: 539 pps  
Pulse Width: 0.5 or 2  $\mu$ sec  
Horizontal Coverage: 360 deg  
Vertical Coverage: -5000 to +60,000 ft;  
-2 to +23 deg angular  
Antenna Rotation Speed: Automatic, 1/3 rpm;  
manual, 0 to 6 rpm  
Antenna Vertical Scanning Rate: Automatic, 60  
cpm; manual, 30 cpm  
Azimuth Resolution: 2.3 deg  
Elevation Resolution: 0.8 deg  
Range Resolution: 0.7 mi on 120-mi scale;  
0.43 mi on a 60-mi scale  
Range Accuracy: 1 mi at 100 mi, absolute;  
0.5 mi at 100 mi, relative

Azimuth Accuracy: 2.0 deg, absolute;  
0.5 deg, relative  
Elevation Accuracy:  $\pm$ 1000 ft, absolute;  
 $\pm$ 500 ft, relative  
Horizontal Beam Width: 2.05 deg  
Vertical Beam Width: 0.755 deg  
Receiver Band Width: 3 mc  
IF. Frequency: 30 mc

**INSTALLATION CONSIDERATIONS**

Siting: Hills and mountains cause blind spots but can be used to screen the AN/TPS-10D from nearby radar.  
Mounting: The antenna group is mounted on Antenna Pedestal Legs MT-1061/TPS-10D and MT-888/TPS-10D (ground mounting) or on antenna tower. The indicator and control group are installed in operational shelter.  
Cabling Requirements:  
Related Equipment:

**PRINCIPAL COMPONENTS AND PHYSICAL DATA**

COMPONENT	QTY	HEIGHT (Inches)	WIDTH (Inches)	DEPTH (Inches)	UNIT WT. (Pounds)
Antenna Group OA-375/TPS-10D	1	157	126 1/2 (diam)		1400
Power Supply PP-636/TPS-10D	1	22 1/4	23 1/2	21 3/4	85
Radar Receiver-Transmitter RT- 208/TPS- 10D	1	27 1/8	27 5/8	32 1/2	215
Radar Modulator MD-140/TPS-10D	1	22	24 1/2	43 1/4	185
Power Supply PP-635/TPS-10D	1	22	23 3/4	30 3/4	210
Antenna Pedestal AB-226/TPS-10D	1	69	168	192	
Waveguide Assembly CG-799/U	1	10-5/8	1-5/8	15-1/2	
Antenna Pedestal Leg MT- 1061/TPS- 10D	1	31-5/8	24-1/4	87-5/8	
Indicator Group OA-268/TPS-10D	1				
Antenna Control C-841/TPS-10D	2	7 7/8	14 1/4	16	18
Electronic Control Amplifier AM-493/TPS- 10D	1	32 3/4	35	49 1/2	450
Control Indicator C-840/TPS-10D	1	18 1/2	21 1/2	20 3/4	97
Interference Blanker MX-1166/ TPS- 10D	1	15 1/2	18	22 1/2	82
Mounting MT-981/TPS-10D	1				

**PRINCIPAL COMPONENTS AND PHYSICAL DATA**

<b>COMPONENT</b>	<b>QTY</b>	<b>HEIGHT (Inches)</b>	<b>WIDTH (Inches)</b>	<b>DEPTH (Inches)</b>	<b>UNIT WT. (Pounds)</b>
Motor Generator PU-219/TPS-10D	1	31 1/4	59 1/2	22 3/8	950
Manifold Dehydrator HD- 147/TPS- 10D	1	19 3/4	28	22	150
Standing Wave Indicator IM- 65/TPS- 10D*	1	7 3/4	24	15 1/4	25
Directional Coupler CU- 263/TPS- 10D	1	8	3	24	
Waveguide Assembly CG-816/TPS-10D	1	1-5/8	1-5/8	48-3/16	
Waveguide Assembly CG-800/U	1	1-5/8	1-5/8	30	

\* Dimensions and weight include directional coupler CU-263/TPS-10D

**REFERENCE DATA AND LITERATURE**

Technical Orders:

31P1-2GPA33-5  
31P3-2FPS4-1  
31P3-2FPS4-2  
31P3-2FPS4-3  
31P3-2MPS8-501  
31P3-2TPS10-5  
31P3-2TPS10-502  
31P3-2TPS10-507  
31P3-2TPS10-508  
31P3-2TPS10-509  
31P3-2TPS10-509A  
31P3-2TPS10-511  
31P3-2TPS10-513  
31P3-2TPS10-514  
31P3-2TPS10-515  
31P3-2TPS10-516

31P3-2TPS10-516A  
31P3-2TPS10-517  
31P3-2TPS10-518  
31P3-2TPS10-519  
31P3-2TPS10-520  
31P3-2TPS10-521  
31P3-2TPS10-523  
31P3-2TPS10-534  
31P3-2TPS10-536  
31P3-2TPS10-537  
31P3-2TPS10-543  
31P3-2TPS10-534A  
31P3-2TPS10-544  
16-30TPS-10-10  
16-30TPS-10-11  
16-30TPS-10-12  
Specification:  
WLENG-171, 171A



DATE: 1 July 1964

ITEM NAME: RADAR SET

COGNIZANT SERVICE: USN

TYPE: AN/TPS-15\*, -15A, -15X

FEDERAL STOCK NUMBER: 5840-505-0010\*

	USA	USN	USAF	USMC
STATUS OR TYPE CLASSIFICATION				
Mfg(s) Name or Code Number: Raytheon Mfg. Co.				

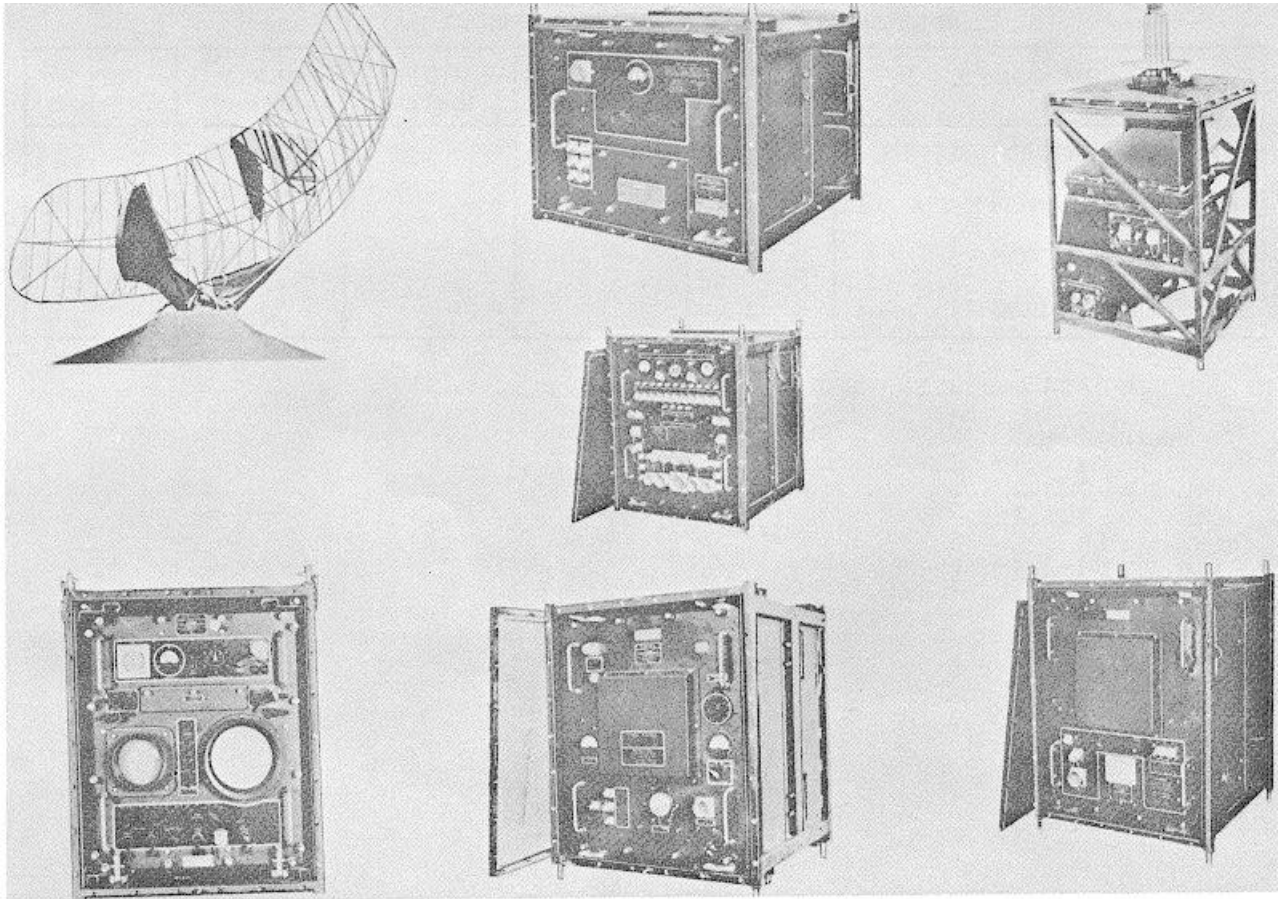

### FUNCTIONAL DESCRIPTION

Radar Set AN/TPS-15, -15A, -15X is a lightweight, air-and-ground surveillance radar, consisting of search and IFF radar sets, a power supply, and a test set. Radio Set AN/TPS-1D, -1E, -1G, a search radar equipment used at ground installations, includes an MTI system and provisions for remote operation.

Interrogator Set AN/TPX-17A is an IFF challenging system that displays IFF responses on the PPI of the associated radar set, either in combination with, or separate from, the regular radar information. The AN/TPX-17A utilizes the antenna assembly of the associated radar equipment.

The AN/TPS-15 includes Radio Set AN/TPS-1D, AN/TPS-15A includes Radio Set AN/TPS-1G. AN/TPS-15X includes Radio Set AN/TPS-1E. All these

AN/TPS- 15, -15A, - 15X

models include AN/TPX- 17A.

**RELATION TO SIMILAR EQUIPMENT**

None.

**TECHNICAL DESCRIPTION**

AN/TPS- 1D, -1E, -1G

Operating Voltages:

115 vac  $\pm 5\%$ , 400 cps  $\pm 40\%$ , 1-ph

Power Consumption: 7.5w

Frequency: 1220 to 1350 mc

Power Output: 500w avg, 500 kw peak

Range: 300 yd to 160 naut mi

AN/TPX- 17A

Operating Voltages:

115 vac  $\pm 10\%$ , 400 cps  $\pm 10\%$ , 1-ph

Power Consumption: 440w

Frequency: 960 to 1150 mc

**INSTALLATION CONSIDERATIONS**

Not available.

**PRINCIPAL COMPONENTS AND PHYSICAL DATA**

<b>COMPONENT</b>	<b>QTY</b>	<b>HEIGHT (Inches)</b>	<b>WIDTH (Inches)</b>	<b>DEPTH (Inches)</b>	<b>UNIT WT. (Pounds)</b>
Radio Set AN/TPS- 1D, - 1E, -1G	1				
Interrogator Set AN/TPX- 17A	1				
Radar Test Set AN/USM-20	1				
Power Generator PU-254/U	2				

**REFERENCE DATA AND LITERATURE**

Technical Manuals

TM 5-5317

NavShips 91579B

NavShips 91785A

Specification:

MIL-R- 16180B(Ships)

DATE: 1 July 1964 ITEM NAME: RADAR SET

COGNIZANT SERVICE: USN TYPE: AN/TPS-21

FEDERAL STOCK NUMBER: 5840-631-1089

	USA	USN	USAF	USMC
STATUS OR TYPE CLASSIFICATION				
Mfg(s) Name or Code Number Admiral Corporation, Chicago, Illinois				

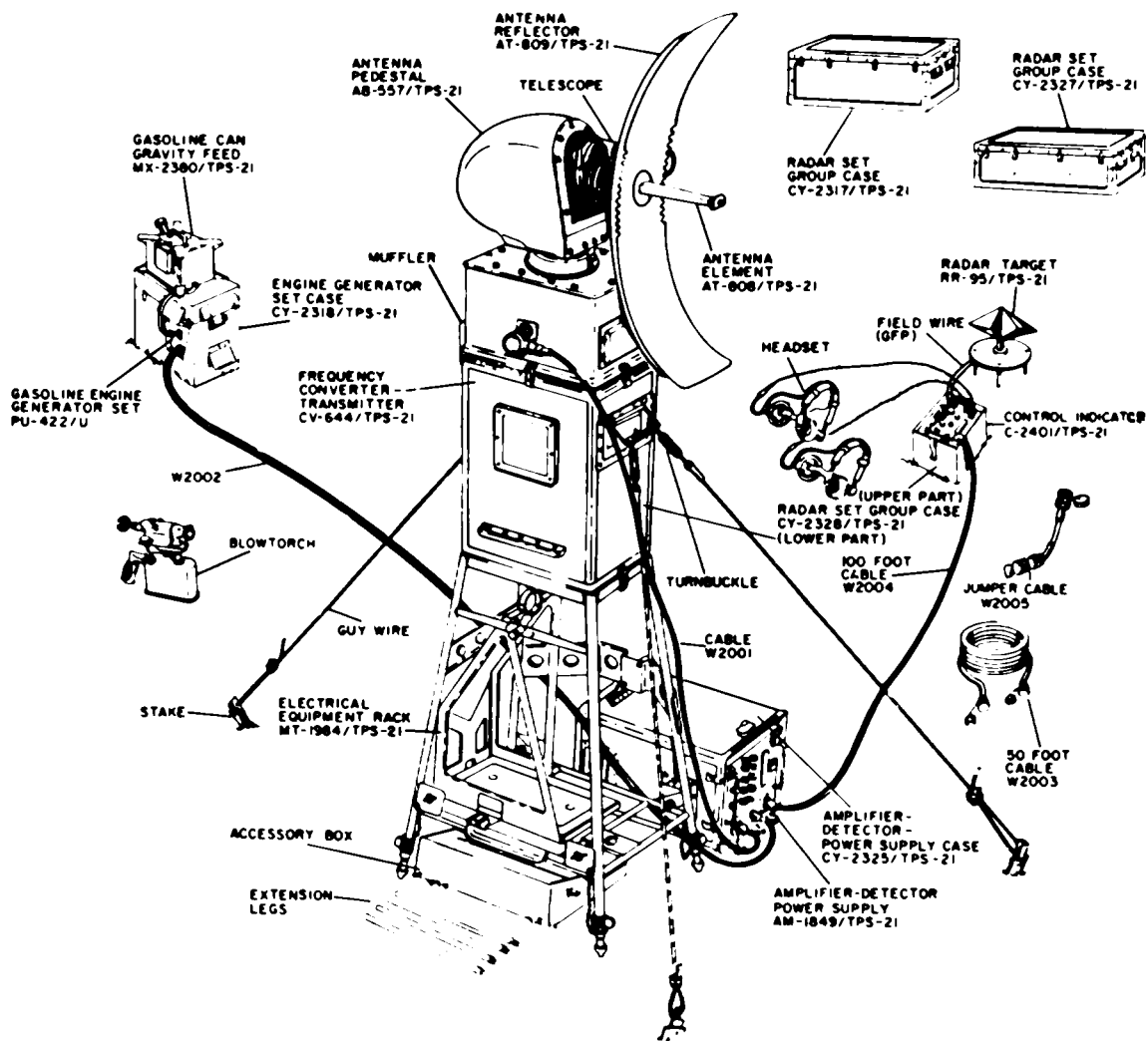

### FUNCTIONAL DESCRIPTION

Radar Set AN/TPS-21 is lightweight, portable battlefield surveillance equipment that will search for and detect moving ground targets. The range of the radar set is 100 to 20,000 yds. A characteristic audio

signal with a frequency variation dependent upon the speed and direction of the moving target is the 'on-target' indication. It is capable of an automatic search or 'sector scan' function in which a terrain area, with a depth of 880 yds and a width variable from 30 to 140 degrees or a continuous 360 degrees, is scanned for

**ITEM NAME:** RADAR SET

**TYPE:** AN/TPS-21

evidence of moving targets. In addition, the equipment may be manually operated to follow the target and indicate its range and azimuth.

**RELATION TO SIMILAR EQUIPMENT**

None.

**TECHNICAL DESCRIPTION**

Frequency: 9375 plus or minus 30 mc  
 Type of Frequency Control: Automatic electronic frequency control.  
 Type of Emission: Pulse-modulated rf  
 Transmitter Bandwidth: 5 mc  
 Local Oscillator Range: 8500 to 10,000 mc  
 Average Power Output: 2 to 4w  
 Peak Power, Duration and Pulse Repetition Rate: 4 to 7 kw, 6.4 usec, 1600 pps  
 IF Frequency: 30 mc  
 Receiver Selectivity: 3 db down at 5.5 mc  
 Receiver Sensitivity: -98 dbm (min discernible signal).  
 Receiver Output: 50 to 100 mw into a 200 ohm headset.

Electrical Input and Output Data  
 Trigger Input: 30 to 45v across 98 ohms at 1600 pps  
 Video Input: 20v across 1 meg  
 Audio Output: 50 to 100 mw across 200 ohms

Antenna  
 Rotation: 4 deg per sec  
 Beam Width: 3 deg x 10 deg  
 Gain: 25 db  
 Ambient Temperature: -54 deg C (-65 deg F) to plus 57 deg C (plus 135 deg F).  
 Altitude Limitations: Up to 10,000 ft  
 Humidity Limitations: Up to 95%  
 Power Supply Characteristics: 115v, 400 cycle, single ph; 28v dc

**INSTALLATION CONSIDERATIONS**

Related Equipment: (Required but not Supplied) (1) Heavy Duty Hammer; (1) Screwdriver, Narrow Blade; (1) Crescent Wrench; (1) Spark Plug Wrench; (350 ft) Phone Wire

**PRINCIPAL COMPONENTS AND PHYSICAL DATA  
SHIPPING DATA**

COMPONENT	BOXES (NR.)	OVERALL DIMENSIONS (Inches)	UNIT WT. (Pounds)
Radar Set Group Case CY-2327/TPS-21 contains:	1	24-3/16 x 36-13/16 x 52-7/16	250.6
Amplifier-Detector-Power Supply AM-1849/TPS-21	1	24-3/16 x 36-13/16 x 52-7/16	250.6
Amplifier-Detector-Power Supply CY-2325/TPS-21			
Frequency Converter-Transmitter CV-644/TPS-21			
Control-Indicator C-2401/TPS-21			
Radar Set Group Case CY-2328/TPS-21			
Radar Target RR-95/TPS-21			
Packboards (5) Mark VIII			
Power Cable (100 ft)			
Control Cable (50 ft)			
Maintenance Parts Box			
Spare Magnetron			
Radar Set Group Case CY-2317/TPS-21 contains:			
Gasoline Engine Generator Set PU-422/U	1	24-7/16 x 36-13/16 x 57-7/16	272.6

ITEM NAME: RADAR SET

TYPE: AN/TPS-21

PRINCIPAL COMPONENTS AND PHYSICAL DATA  
SHIPPING DATA (Cont.)

COMPONENT	BOXES (NR.)	OVERALL DIMENSIONS (Inches)	UNIT WT. (Pounds)
Engine Generator Set Case CY-2318/TPS-21			
Gasoline Can, Gravity Feed MX-2380/TPS-21			
Electrical Equipment Rack MT-1984/TPS-21			
Antenna Reflector AT-809/TPS-21			
Antenna Pedestal AB-557/TPS-21			
Blowtorch			
Telescope and Mounting Brackets			
Control Cable (100 ft)			
Power Cable (10 ft)			
Alternate Azimuth Counter			
Mils Indicator Plate for SECTOR SELECTOR			
Accessory Box			

EQUIPMENT SUPPLIED DATA

COMPONENTS	QTY	OVERALL DIMENSIONS (Inches)	UNIT WT. (Pounds)
Frequency Converter-Transmitter CV-644/TPS-21	1	5-11/16 x 9-3/8 x 17-1/16	17.44
Amplifier-Detector-Power Supply AM-1849/TPS-21	1	9-9/16 x 12-5/8 x 18-5/32	25
Control-Indicator C-2401/TPS-21	1	7-1/16 x 7-11/16 x 10-1/2	9.38
Antenna Pedestal AB-557/TPS-21	1		29.38
Antenna Reflector AT-809/TPS-21	1	7-1/4 x 7-1/2 x 27	1.88
Antenna Element AT-808/TPS-21	1	4-3/16 x 4-13/16 x 12-13/32	1.19
Gasoline Can, Gravity Feed MX-2380/TPS-21	1	11-1/8 x 14 x 17	6.2
Gasoline Engine Generator Set PU-422/U	1	13-3/4 x 15-1/4 x 15-3/4	59.5
Engine Generator Set Case CY-2318/TPS-21	1	16-1/4 x 17-3/4 x	18
Electrical Equipment Rack (Quadrapod) MT-1984/TPS-21	1	18 x 22 x 29-1/2	18
Radar Set Group Case CY-2328/TPS-21	1	11 x 13 x 25-3/4	9
Amplifier-Detector-Power Supply Case CY-2325/TPS-21	1	13-1/2 x 13-1/2 x 18-3/4	11.19
Radar Set Group Case CY-2327/TPS-21	1	20-3/8 x 33 x 48-5/8	114.25
Radar Set Group Case CY-2317/TPS-21	1	17-1/4 x 33 x 48-5/8	113.50

AN/TPS-21: 3

**ITEM NAME:** RADAR SET

**TYPE:** AN/TPS-21

**PRINCIPAL COMPONENTS AND PHYSICAL DATA**

**EQUIPMENT SUPPLIED DATA (Cont.)**

<b>COMPONENTS</b>	<b>QTY</b>	<b>OVERALL DIMENSIONS (Inches)</b>	<b>UNIT WT. (Pounds)</b>
Radar Target RR-95/TPS-21	1		
Accessories			
Electrical Headsets	2		
Stakes	3		
Guy Wires	3		
Guy Wire Clamps	3		
Extension Legs	4		
Antenna Pedestal, Blower Muffler	1		
Folding Corner Reflector	1		
Blowtorch	1		
Telescope, Mounting Bracket, and Lens Cover	1		
Mils Indicator Plate for SECTOR SELECTOR	1		
3-Foot Bead Chain	1		
Power Cable	1	1200 lg	9.88
Control Cable	1	600 lg	13.25
Control Cable	1	1200 lg	25.5
Antenna Pedestal Cable	1	120 lg	3.38
Adapter Cable	1		
Spare Magnetron	1		
Packboards Mark VIII	5		4.5

**REFERENCE DATA AND LITERATURE**

Technical Manuals:

NAVSHIPS 93318

NAVSHIPS 93318.32: Performance Standard Sheet

NAVSHIPS 93318.42: Maintenance Standard Book

DATE: 1 July 1964

ITEM NAME: RADAR SET

COGNIZANT SERVICE: USA

TYPE: AN/TPS-25

LINE ITEM NUMBER: 634479

FEDERAL STOCK NUMBER: 5840-542-7113

	USA	USN	USAF	USMC
STATUS OR TYPE CLASSIFICATION	Std A			
Mfg(s) Name or Code Number: Hazeltine Corp., Little Neck, N. Y.				

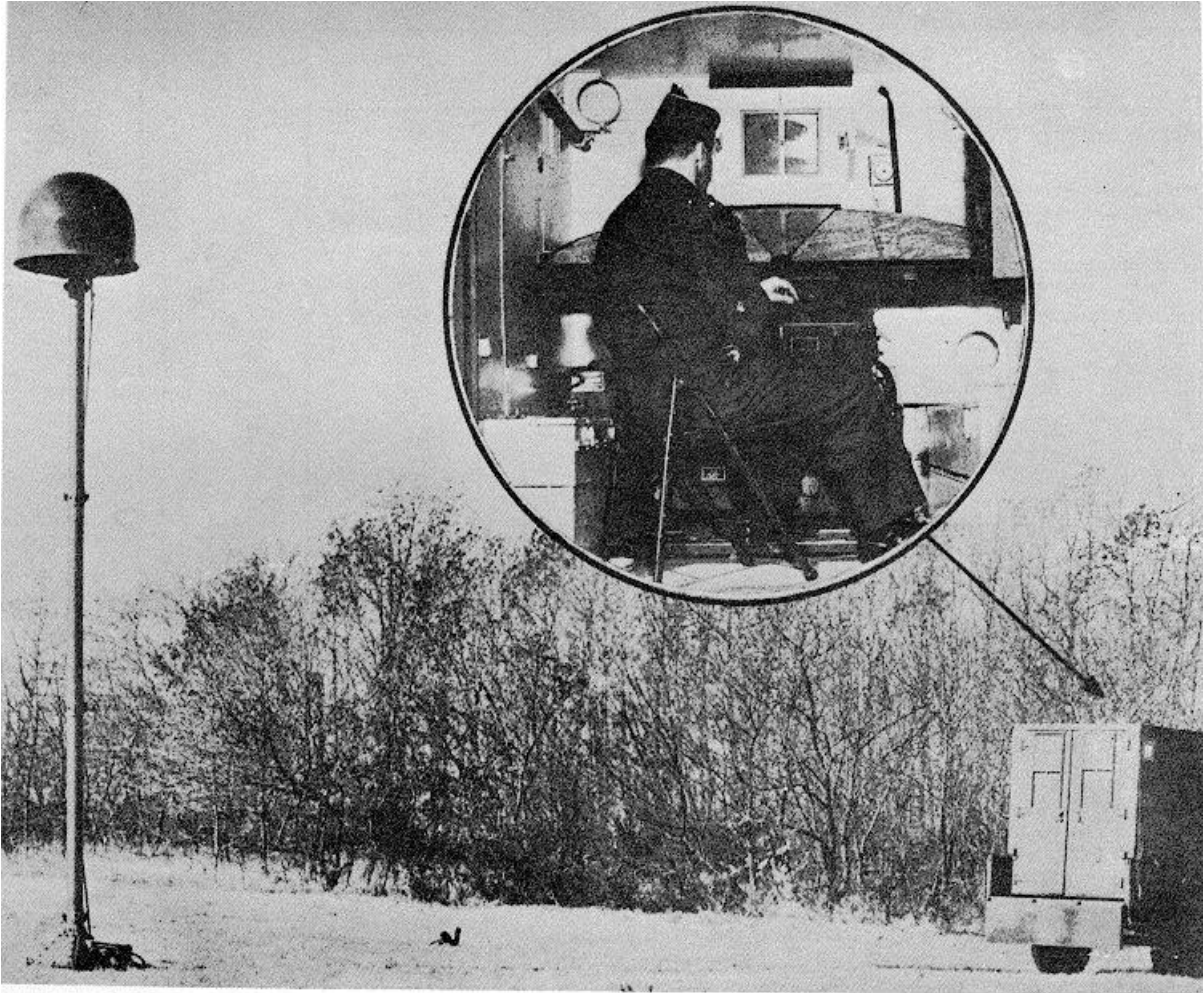

**FUNCTIONAL DESCRIPTION**

Radar Set AN/TPS-25 is a transportable battlefield surveillance radar. The set detects the presence of moving targets and supplied range and azimuth information. The AN/TPS-25 can detect a moving man or moving vehicles.

**RELATION TO SIMILAR EQUIPMENTS**

None.

**TECHNICAL DESCRIPTION**

Frequency: 9375 ±30 mc

AN/TPS-25

Range, Max: 18,280m for a jeep-size moving vehicle; 4,500m for a moving man  
 Range, Min: 450m  
 Peak Power Output: 43 kw  
 Operating Voltages and Power Requirements:  
 115 vac  $\pm 5\%$ , 400 cps  $\pm 5\%$ , 1-ph  
 Type of Presentation: Visual counter indicators, plotting board, CRT  
 Duty Cycle: 0.000925  
 Pulse Repetition Rate: 1,850 pps  
 Pulse Width: 0.5  $\mu$ sec  
 Range Resolution: 250 ft (all ranges)  
 Azimuth Accuracy:  $\pm 2\text{-}1/2$  mils in winds up to

25 mph  
 Elevation Coverage:  $\pm 265$  mils from horizontal

**INSTALLATION CONSIDERATIONS**

Siting: The radar set must be located so that large buildings, trees, hills, etc. do not obscure the area being surveyed.

Mounting:  
 Cabling Requirements:  
 Related Equipments:

**PRINCIPAL COMPONENTS AND PHYSICAL DATA**

COMPONENT	QTY	HEIGHT (Inches)	WIDTH (Inches)	DEPTH (Inches)	UNIT WT. (Pounds)
Antenna AS-981/TPS-25	1	44	48	48	153
Servo Data Coordinator SN-231/TPS-25	1	16-1/4	21	22-1/2	88
Radar Modulator MD-344/TPS-25	1	11-1/2	16	16-7/8	51
Display Plotting Board PT-441./TPS-25	1	51	65-3/4	40	89
Power Supply PP-2166/TPS-25	1	11-1/2	16	16-5/8	54
Radar Receiver-Transmitter AT-500/TPS-25	1	22	24	27-1./2	124
Radar Set Control C-2715/TPS-25	1	13	24-1/2	14-1/2	70
Electrical EquipShelter S-126/G	1	80	72	112	1370

**REFERENCE DATA AND LITERATURE**

Technical Manuals:  
 TM 11-5840-217-10  
 TM 11-5840 217-20

Specifications:  
 MIL-R-55066



DATE: 1 July 1964  
COGNIZANT SERVICE: USN

ITEM NAME: RADAR SET  
TYPE: AN/TPS-28

FEDERAL STOCK NUMBER:

	USA	USN	USAF	USMC
STATUS OR TYPE CLASSIFICATION				
Mfg(s) Name or Code Number: Hazeltine Electronics Div., Little Neck, N. Y.				

Illustration Not Available

**FUNCTIONAL DESCRIPTION**

Radar Set AN/TPS-28 is an air search radar for long-range detection of medium-and high-altitude jet aircraft (primary purpose). The set is dripproof. It can be transported by helicopter.

**RELATION TO SIMILAR EQUIPMENT**

None.

**TECHNICAL DESCRIPTION**

Frequency: 200 to 225 mc  
Range, Max: 200 naut ml  
Range, Min: 1 naut mi  
Peak Power Output: 1 megw  
Operating Voltages and Power Requirements:  
120/208v, 60 cps, 3-ph, 4-wire, wire-connected

**INSTALLATION CONSIDERATIONS**

Not Available

AN/TPS-28: 1

AN/TPS-28

**PRINCIPAL COMPONENTS AND PHYSICAL DATA**

<b>COMPONENT</b>	<b>QTY</b>	<b>HEIGHT (Inches)</b>	<b>WIDTH (Inches)</b>	<b>DEPTH (Inches)</b>	<b>UNIT WT.</b>
Antenna AS-848/TPS-28	1				
Duplexer CU-623/TPS-28	1	32	4-1/4	13	
Electrical Equipment Pressurizing Set HD-302/TPS	1	3. 57	7-5/8	5-5/8	
Test Set OAA-2	1				
Radar Receiver R-757/TPS-28	1	9-5/16	22-9/16	12-1/16	
Electrical Equipment Shelter S- 128/TPS-28	1				
Starter Motor SA-558/U	1	11-5/8	22-1/8	8	
Control Assembly C-1984/TPS-28	1	5	13-1/2	10	
Tower AB-552/TPS-28	1	177	252	144	
Radar Transmitter T-602/TPS-28	1	70	30	52	
REFERENCE DATA AND LITERATURE					
Technical Manual: NAVSHIPS 93104					



**ITEM NAME:** RADAR SURVEILLANCE CENTRAL

**TYPE:** AN/TPS-31

**RELATION TO SIMILAR EQUIPMENT**

The AN/TPS-31 is designed for operation with Standard Navy Repeaters such as the VJ-1, VK-1, AN/SPA-4A, AN/SPA-BA, and AN/SPA-34A. These repeaters can be used as substitutes for the remote harbor-control site, in parallel with the remote site, or as a substitute at the remote harbor-control site.

**TECHNICAL DESCRIPTION**

**Frequency**

Receiver-Transmitter RT-622: 9410 plus or minus 50 mc (preset)

Transmitter-Radio T-829: 7137.5 mc (preset)

Receiver-Transmitter RT-623: 7237.5 mc (preset)

Receiver-Transmitter RT-623: 7337.5 mc (preset)

**Type of Frequency Control**

Receiver-Transmitter RT-622: Pulse-modulated magnetron oscillator v

Transmitter-Radio T-829: Freq modulated klystrons temp and v

Receiver-Transmitter Radio RT-623: Freq modulated klystrons temp and v

Receiver-Transmitter Radio RT-623: Freq modulated klystrons temp and v

**Types of Emission**

Receiver-Transmitter Radar RT-622: PO

Transmitter-Radio T-829: F9

Receiver-Transmitter Radio RT-623: F9

Receiver-Transmitter Radio RT-623: F9

**Output Characteristics**

Receiver-Transmitter Radar RT-622: 40 kw

Transmitter-Radio T-829: 1w (nom)

Receiver-Transmitter Radio RT-623: 1w (nom)

Receiver-Transmitter Radio RT-623: 1w (nom)

**Frequency Stability**

Receiver-Transmitter Radar RT-622: plus or minus 0.03%

Transmitter-Radio T-829: plus or minus 0.05%

Receiver-Transmitter Radio RT-623: plus or minus 0.025%

Receiver-Transmitter Radio RT-623: plus or minus 0.025%

**Electrical Input Output Data**

**Control-Indicator C-3701**

Trigger Output: 20 to 40v peak across 75 ohms pos, at 1000 or 4000 pps, to unit 4A6 via wide-band microwave channel

Video Output: 0.5 to 1.5v, limited, pos, across 75 ohms, to unit 4A6 via wide-band microwave channel

Receiver-Transmitter Radar RT-622 Synchro Data Output: 1 and 36-speed stator v (type 23TX6a) to unit 4A6

via narrow band microwave channel Transmitter-Radio T-b29

Trigger Input: 20 to 40v peak, across 75 ohms pos, at 1000 or 41000 pps, from unit 2A2

Video Input: 0.5 to 1.5v, limited, pos across 75 ohms from unit 2A2

**Receiver-Transmitter Radio RT-623**

Synchro Data: Ref and I and 36-speed signals from unit 2A3

Receiver-Transmitter Radio RT-623 Synchro Data: Ref and I and 36-speed signals from unit 3A3A1

**Indicator Azimuth Range IP-597**

Separated Video and Trigger Signals: (Both pos) trigger 0.5 to 1.5v peak, video 10 to 30v peak from unit 1A3A5

Synchro Data: 1 and 36-speed stator v from unit 4A4A1

**Electrical and Mechanical Antenna Characteristics**

**Antenna Radar AS-1164**

Rotation Rate: 20 plus I to 0 rpm

Beamwidth: Azimuth 0.6 deg to 22 deg elevation

**Ambient Temperature Limitations**

Radar Surveillance Central

Internal Shelter Ambient Temperature

Limitations: plus 32 deg to 122 deg F

**Power Supply**

Radar Site: 120 to 20(v ac, 60 cyc, 30 kva, 4-wire max (GFE))

Remote Control Site: 120 to 20bv ac, 60 cyc, 13 kva, 4-wire max (GFE)

**INSTALLATION CONSIDERATIONS**

**Related Equipment**

Required but not Supplied: (1) AC-DC Volt-Ohm Milliammeter HtP-410B; (1) AC-Voltmeter, DB Meter HP-40011; (1) Oscilloscope, Synchroscope tHP-160BW/ 160BW/162A; (1) Power Meter and Thermister Mount ItP-430CW/477B; (1) Radio Frequency Signal Generator IIP620A; (1) Echo Box TS-4B8A/U; (1) Crystal Rectifier Test Set TS-26BE/tU; (1) Stopwatch; (3) AC Power Generator's: \*15 kva, 115 to 20bv ac, 60 cyc, 3-ph, 4-wire, wye connected.

NOTE: \* Suitable substitute would be one Diesel Engine Generator Set PU-3B3 for use with shelters A, B, and D, and one Diesel Engine Generator Set PU-239 for use with shelter C.

ITEM NAME: RADAR SURVEILLANCE CENTRAL  
TYPE: AN/TPS-31

PRINCIPAL COMPONENTS AND PHYSICAL DATA

COMPONENTS	QTY	OVERALL DIMENSIONS (Inches)	UNIT WT. (Pounds)
Radar Surveillance Central AN/TPS-31 includes: Antenna Group OA-3361/TPS-31 includes:	1		
Antenna Radar AS-1164/TPS-31	1	3 x 6 x 144.5	76
Pedestal, Antenna AB-672/TPS-31	1	15 x 18 x 27	210
Waveguide Assy Set (Hi Pwr)	1		
Tower AB-671/TPS-31 includes:	1		
Tower Section (Universal)	7	53 x 71 x 72	160
Tower Section (Platform)	1	18 x 53 x 71	150
Antenna (Microwave) AS-1 165/TPS-31	1	25 x 48 x 48	44
Waveguide Assy Set (Lo Pwr) 1			
Radar Set Group OA-3366/TPS-31 includes:			
Shelter Electrical Equipment (A) includes:	1	81 x 83 x 100	3060
Air Conditioner HD-473/TPS-31	1	17-1/2 x 39 x 52	480
Control-Indicator C-3701/TPS-31	1	24 x 30 x 51	240
Receiver-Transmitter Radar RT-622/TPS-31	1	16 x 23 x 38	150
Motor Generator PU-51/U	1	13 x 16 x 34	308
Starter-Motor SA-804/U	1	9 x 9 x 10	15
Radio Set AN/URC-7(GFE)	1	34 x 37 x 43	165
Radio Transmitting Set TED-9(GFE)	1	14 x 15 x 19	144
Radio Receiving Set 1 8 x 17 x 19 57 AN/URR-35C (GFE)			
Control-Handset C-3702/TPS-31	1	4 x 5 x 7	3
Test Set, Electron Tube TV-1 7/U	1	7 x 11 x 16	21
Multimeter ME-210/U	1	2 x 6 x 7	2
HF Radio Antenna	1	87 h	10

AN/TPS-31: 3

**ITEM NAME:** RADAR SURVEILLANCE CENTRAL

**TYPE:** AN/TPS-31

**PRINCIPAL COMPONENTS AND PHYSICAL DATA**

<b>COMPONENTS</b>	<b>QTY</b>	<b>OVERALL DIMENSIONS (Inches)</b>	<b>UNIT WT. (Pounds)</b>
Radar Data Transfer Group OA-3360/TPS-31 includes:			
Shelter Electrical Equipment (B) S-218/TPS-31 includes:	1	81 x 83 x 100	2625
Air Conditioner HD-473/TPS-31 Model RM-8070	1	17 x 39 x 52	480
Radar Data Transfer Group (cont'd) includes:	1		
Transmitter Group OA-3363/TPS-31 includes:	1	20 x 21 x 66	230
Rack, Electrical Equipment MT-2535/TPS-31	1	20 x 21 x 66	
Transmitter Radio T-829/TPS-31	1	11 x 19 x 22	
Control Transmitter C-3703/TPS-31	1	11 x 14 x 19	
Control Interconnecting Box C-3704/TPS-31	1	5 x 13 x 19	
Transmitter Radio T-832/TPS-31	1	3 x 10 x 19	
Transmitter Radio T-831/TPS-31	1	3 x 10 x 19	
Transmitter Radio T-830/TPS-31	1	3 x 10 x 19	
Power Supply PP-3013/TPS-31	1	5 x 15 x 19	
Receiver-Transmitter Group OA-3367/TPS-31 includes:	1	16 x 21 x 66 145	
Rack Electrical Equipment MT-2536/TPS-31	1	18 x 21 x 66	
Receiver-Transmitter Radio 1 RT-623/TPS-31 includes:			
RF Case	1		
Baseband Amplifier	1		
Microwave Assy	1		
Ferrite Insulator	1		
Transmitter Klystron	1		
Receiver Klystron	1		
Amplifier IF. AM-3009/TPS-31	1	8 x 9 x 18	
Meter, Assy, Electrical ME-211/TPS-31	1	2 x 9 x 19	

**AN/TPS-31: 4**

ITEM NAME: RADAR SURVEILLANCE CENTRAL

TYPE: AN/TPS-31

PRINCIPAL COMPONENTS AND PHYSICAL DATA

COMPONENTS	QTY	OVERALL DIMENSIONS (Inches)	UNIT WT. (Pounds)
Telephone Set TA-423/TPS-31	1	5 x 6 x 19	
Multiplexer TD-498/TPS-31	1	5 x 8 x 19	
Power Supply PP-3014/TPS-31	1	11 x 16 x 19	
Transmitter Synchro Data (Azimuth) F828/TPS-31	1	5 x 13 x 19	
Transformer Power Voltage Regu- lating TF-369/U	1	6 x 8 x 18	65
Installation Kit Electronic 1 Equipment			
Radar Data Receiving Group 1 OA-3359/TPS-31 includes:			
Shelter Electrical Equipment S-219/TPS-31 includes:	1	81 x 83 x 100	3255
Air Conditioner HD-473/TPS-31 RMB070	1	17 x 39 x 52	480
Receiver Group OA-3362/TPS-31 includes:	1	21 x 21 x 66	226
Rack Electrical Equipment 1 MT-2537/TPS-31			
Receiver Radio R-1058/TPS-31	1	11 x 19 x 22	
Control Receiver C-3706/TPS-31	1	11 x 14 x 19	
Control Interconnecting Box C-3705/TPS-31	1	5 x 13 x 19	
Receiver Radio R-1059/TPS-31	1	3 x 10 x 19	
Receiver Radio R-1060/TPS-31	1	3 x 10 x 19	
Receiver Radio R-1061/TPS-31	1	3 x 10 x 19	
Power Supply PP-3013/TPS-31	1	5 x 15 x 19	
Receiver-Transmitter Group OA-3364/TPS-31 includes:	1	16 x 21 x 66	145
Rack Electrical Equipment 1 MT-2538/TPS-31			
Receiver Transmitter Radio 1 10 x 19 x 21 RT-623/TPS-31 includes:			
RF Case	1		
Baseband Amplifier	1		
Microwave Assy	1		

AN/TPS-31: 5

**ITEM NAME:** RADAR SURVEILLANCE CENTRAL

**TYPE:** AN/TPS-31

**PRINCIPAL COMPONENTS AND PHYSICAL DATA**

<b>COMPONENTS</b>	<b>QTY</b>	<b>OVERALL DIMENSIONS (Inches)</b>	<b>UNIT WT. (Pounds)</b>
Ferrite Isolator	1		
Transmitter Klystron	1		
Receiver Klystron	1		
Amplifier IF. AM-3009/TPS-31	1	8 x 9 x 19	
Meter Assy Electrical ME-211/TPS-31	1	2 x 9 x 19	
Telephone Set TA-423/TPS-31	1	5 x 6 x 19	
Demultiplexer TD-499/TPS-31	1	5 x 6 x 19	
Power Supply PP-3014/TPS-31	1	11 x 16 x 19	
Receiver Synchro Assy Group OA-3365/TPS-31 includes: Rack Electrical Equipment 1 MT-2539/TPS-31	1	13 x 21 x 22	73
Synchro Assy PD-89/TPS-31 (Azimuth)	1	6 x 7 x 19	
Receiver Synchro Data R-1062/TPS-31 (Azimuth)	1	10 x 12 x 19	
Transformer Power Voltage Regulating TF-369/U	1	6 x 8 x 18	65
Radio Set AN/URC-7	1	34 x 37 x 43	165
Radio Transmitting Set (GFE) TED-9	1	14 x 15 x 19	144
Radio Receiving Set. AN/URR-35C	1	8 x 17 x 19	57
Indicator, Azimuth Range IP-597/TPS-31	1	24 x 30 x 51	400
Antenna (Microwave) AS-1165/TPS-31	1	25 x 48 x 48	112
Waveguide Assy Set (LoRnv)	1		
Installation Kit Electronic Equipment	1		
Test Set Electron Tube TV-17/U	1	7 x 12 x 17	21
Multimeter ME-210/U	1	2 x 6 x 7	2
HF Radio Antenna	1	87 h	
Spare Parts (Service)	1		

**AN/TPS-31: 6**



**ITEM NAME:** RADAR SURVEILLANCE CENTRAL

**TYPE:** AN/TPS-31

**PRINCIPAL COMPONENTS AND PHYSICAL DATA**

<b>COMPONENTS</b>	<b>QTY</b>	<b>OVERALL DIMENSIONS (Inches)</b>	<b>UNIT WT. (Pounds)</b>
Shelter Electrical Equipment (D) Storage S-220/TPS-31	1	81 x 83 x 142	3468
Installation Kit Electronic Equipment Cable Assy Set Electrical			

**REFERENCE DATA AND LITERATURE**

Technical Manuals:

- NAVSHIIPS 94139: For Radar Surveillance Central AN/TPS-32.
- NAVSHIPS 91931: Intruction Book for Radio Set AN/URC-7.
- NAVSHIIPS 93212: Instruction Book for Radio Transmitting Set Model TED-9.
- NAVSHIIPS 92022: Instruction Book for Radio Receiving Set AN/URR-35 (C).

DATE: 1 July 1964

ITEM NAME: RADAR SURVEILLANCE CENTRAL

COGNIZANT SERVICE: USN

TYPE: AN/TPS-31(XN-1)

FEDERAL STOCK NUMBER:

	USA	USN	USAF	USMC
STATUS OR TYPE CLASSIFICATION				
Mfg(s) Name or Code Number. Raytheon Company, Waltham, Massachusetts				

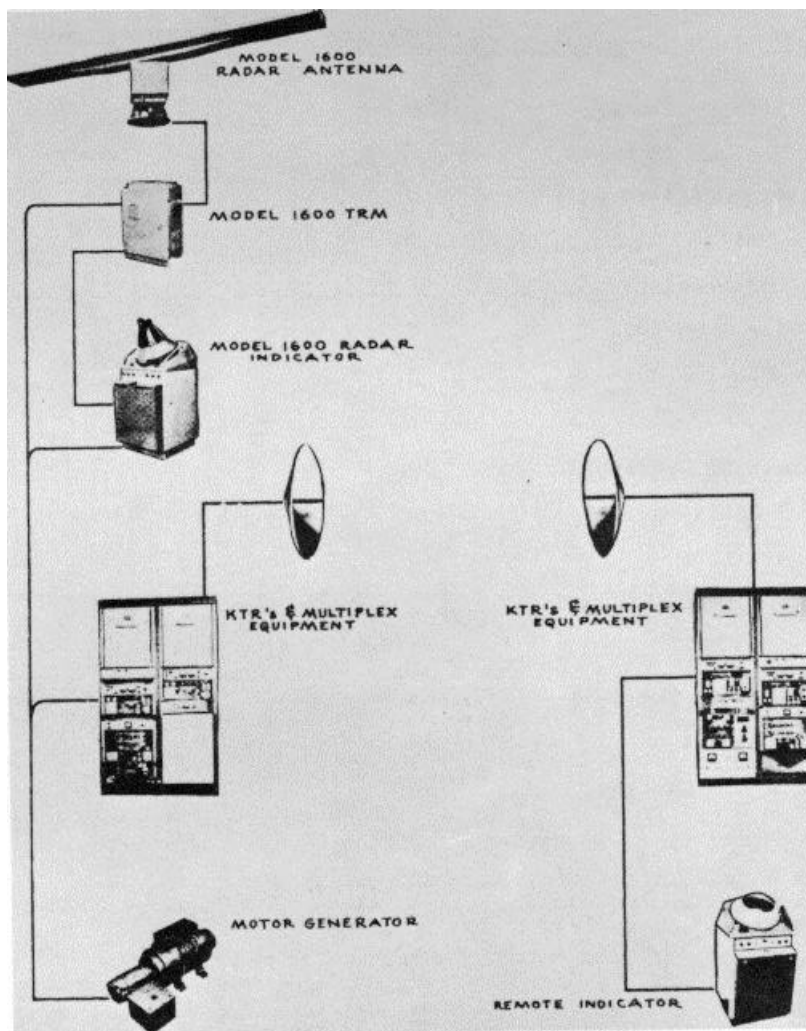

### FUNCTIONAL DESCRIPTION

Radar Surveillance Central AN/TPS-31(XN-1) is a detection system made up of a high definition radar, a radio data link, and a remote indicator. The prime function of the system is to obtain radar information

and relay it to a remote location. The information is transmitted to the remote location by a microwave communication system. Transmission through the microwave system does not lower the quality of signals.

**ITEM NAME:** RADAR SURVEILLANCE CENTRAL

**TYPE:** AN/TPS-31(XN-1)

**RELATION TO SIMILAR EQUIPMENT**

None.

Operating Voltages and Power Requirements  
Communications: 115v, 60 cps, 1-ph  
Radar: 115v, 1000 cps, 1-ph  
Emission: PO  
Number of Bands: 1 band  
Number of Channels: 2 channels

**TECHNICAL DESCRIPTION**

Frequency

Radar Transmitter and Receiver: 9375 mc  
Communications Systems: 7159.5 and  
7234.5mc

**INSTALLATION CONSIDERATIONS**

Not available.

**PRINCIPAL COMPONENTS AND PHYSICAL DATA**

<b>COMPONENTS</b>	<b>QTY</b>	<b>OVERALL DIMENSIONS (Inches)</b>	<b>UNIT WT. (Pounds)</b>
Antenna - Unit 1	1		
Indicator - Unit 2	1		
Receiver-Transmitter-Modulator Unit 3	1		
Remote Indicator - Unit 4	1		
Transmitter Group (G) - Unit 5			
Multiplex Transmitter - Unit 5a	1		
Power Distribution Panel - Unit 5b	1		
Rack - Unit 5c	1		
Synchro Data Transmitter - Unit 5d	1		
Transmitter Control Unit - Unit 5e	1		
RF Transmitter - Unit 5f	1		
Transmitter Group (FS) - Unit 6	1		
Rack - Unit 5c	1		
Transmitter Control Unit - Unit 6a	1		
Transmitter RF Head - Unit 6b	1		
Video Trigger Combiner - Unit 6c	1		
Receiver Group (G) - Unit 7			
Multiplex Receiver - Unit 7a	1		
Power Distribution Panel - Unit 7b	1		
Power Supply (Model 321) - Unit 7c	1		
Rack - Unit 5c	1		
Receiver Control Unit - Unit 7d	1		
Receiver RF Head - Unit 7e	1		
Synchro Data Repeater - Unit 7f	1		
Receiver Group (FS) - Unit B			

**AN/TPS-31(XN-1): 2**

**ITEM NAME:** RADAR SURVEILLANCE CENTRAL

**TYPE:** AN/TPS-31(XN-1)

**PRINCIPAL COMPONENTS AND PHYSICAL DATA**

<b>COMPONENTS</b>	<b>QTY</b>	<b>OVERALL DIMENSIONS (Inches)</b>	<b>UNIT WT. (Pounds)</b>
Rack - Unit 5c	1		
Receiver Control Unit - Unit 8a	1		
Receiver RF Head - Unit 8b	1		
Video Trigger Separator - Unit 8c	1		

**REFERENCE DATA AND LITERATURE**

Technical Manuals:  
NAVSHIPS 93400  
Specifications:  
S-EAF-1

**DATE:** 1 September 1965

**ITEM NAME:** RADAR SET

**COGNIZANT SERVICE:** USAF

**TYPE:** AN/TPS-37

**FEDERAL STOCK NUMBER:**

	USA	USN	USAF	USMC
STATUS OR TYPE CLASSIFICATION			Std	
Mfg(s) Name or Code Number: Avco Electronics & Ordnance Div of Avco Corp., Cincinnati, Ohio				

Illustration not Available.

**FUNCTIONAL DESCRIPTION**

Radar Set AN/TPS-37 is a transportable range and height finding radar set.

**RELATION TO SIMILAR EQUIPMENT**

Not available.

**AN/TPS-37: 1**

**ITEM NAME:** RADAR SET

**TYPE:** AN/TPS-37

**TECHNICAL DESCRIPTION**

Frequency Data  
Transmitter: 5280 mc  
Receiver: 5280 mc  
Operating Power Requirements: ac, 20tv,  
400 cyc, 3-ph

**INSTALLATION CONSIDERATIONS**

Not available.

**PRINCIPAL COMPONENTS AND PHYSICAL DATA**

<b>COMPONENTS</b>	<b>QTY</b>	<b>OVERALL DIMENSIONS (Inches)</b>	<b>UNIT WT. (Pounds)</b>
Amplifier-Indicator Group - OA-1242/MPS-16			
Antenna Group OA-3802/TPS-37	1		
Electronic Equipment Compressor- Dehydrator HD-592/GPS	1		
Antenna Control C-1999/MPS-16	1		
Indicator Group OA-3805/TPS-17	1		
Radar Modulator MD-327/MPS-16A	1		
Radar Set Control Group OA-3803/TPS-37	1		
Audio Frequency Oscillator 1 0-407/MPS-16			
Power Supply PP-1439A/MPS-16	1		
Radar Set Group OA-3799/TPS-37	1		
Radar Set Group OA-1260/MPS-16	1		
Radar Transmitter T-668/MPS-16A	1		

**REFERENCE DATA AND LITERATURE**

Nomenclature card dated t1 Dec 62 for AN/TPS-37.

**DATE:** 1 May 1965

**ITEM NAME:** RADAR SURVEILLANCE SYSTEM

**COGNIZANT SERVICE:** USAF

**TYPE:** AN/TPS-39(V)2, -39(V)1, -39(V)4A,  
-39(V)4BR, -39(V).1C, -39(V)5,  
-39(V)5A and -39(V)5B

**FEDERAL STOCK NUMBER:** Note 1.

	USA	USN	USAF	USMC
STATUS OR TYPE CLASSIFICATION Note 2				
Mfg(s) Name or (A)de Number: Sylvania Electronic Systems, Mountain View, California				

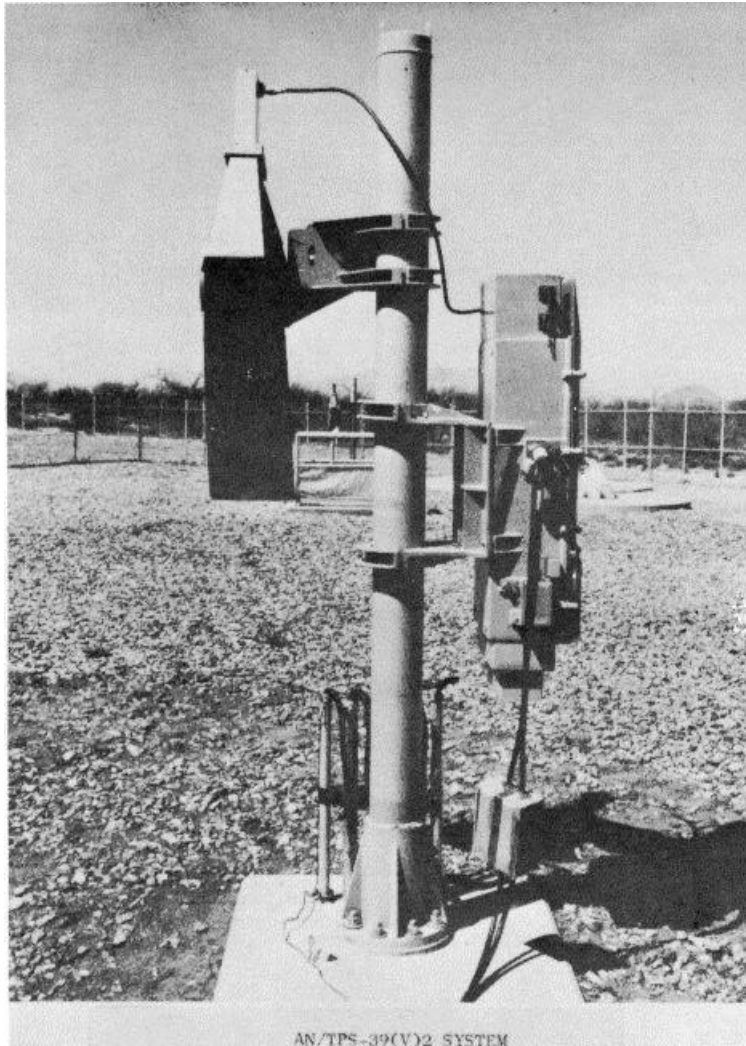

**FUNCTIONAL DESCRIPTION**

The AN/TPS-39(V) uses a doppler radar principle, to detect the approach or movement of a person to or within an established sensitive area, and transmit this information to a central monitoring facility for

visible and audible display. Target characteristics shall be considered to be anybody nominally 50 pounds or more, having a specific density equal to that of a human being. The system shall provide reliable detection when such targets are introduced into the protected area at a rate equal to

**AN/TPS-39(V)2:**

**ITEM NAME:** RADAR SURVEILLANCE SYSTEM

**TYPE:** AN/TPS-39(V)2, -39(V)4, -39(V)4A,  
-39(V)4B, -39(V)4C -39(V)5,  
-39(V)SA and -39(V)55B

or greater than a man walking one 15 inch step per second regardless of angle or aspect of approach, within the reasonable range of limits normally expected of such targets. In addition, the systems shall provide reliable detection of an intruder prepositioned in a sensitive area established on an operational missile site when such an intruder attempts to do useful work.

For the volumetric system AN/TPS-39(V)2, the area to be protected shall be contained within a 100 foot plus 10 feet, minus 5 feet, diameter circle.

For the multiple-volumetric system AN/TPS-39(V)4, -39(V)5, -39(V)4B, -39(V)4C, the area to be protected shall be that area within a square approximately 130 feet on a side. The effective height shall not be less than six feet. For the hybrid volumetric system AN/TPS-39(V)5, -39(V)SA, -39(V)5B, the area to be protected shall be the same as AN/TPS-39(V)2. The hybrid volumetric system will be used for peculiar on-site applications where, due to obstructions, depressions, etc., an additional antenna is required.

**RELATION TO SIMILAR EQUIPMENT**

The AN/TPS-39(V) is not interchangeable with any existing like item in Air Force use.

**TECHNICAL DESCRIPTION**

Operating Power Requirements: 95 to 130v ac, 48 to 62 cycle, 1-ph.

Frequency Range: 1710 to 1780 mc

**Climatic**

**Ambient Temperature**

Outdoor Equipment: -400C (-400F) to plus 60uC (plus 1400F) and does include the effect of solar radiation.

Indoor Equipment: OOC (plus 320F) to plus 52°C (plus 1230F).

Winds: Operating - 52 knots with ice and up to 75 knots without ice.

Ice Load: Operating - 1/2 inch of glaze ice measured radially to all exposed surfaces.

Snow: 30 inches of snow measured vertically from the ground.

**INSTALLATION CONSIDERATIONS**

**Siting:** The AN/TPS-39(V) shall be on a flat, unobstructed surface.

**Mounting:** Components are of modular, integrated design to enable adaptibility for surveillance of almost any configured area.

**Cabling Requirements:** Some installations require direct burial of remote cables while others do not. Direct burial cable shall consist of an inner cable covered with nylon tape, a shield and an outer jacket.

**Related Equipment:** The AN/TPS-39(V) is used with, but not part of, the Atlas Weapons System.

**PRINCIPAL COMPONENTS AND PHYSICAL DATA**

<b>COMPONENTS</b>	<b>QTY</b>	<b>OVERALL DIMENSIONS (Inches)</b>	<b>UNIT WT. (Pounds)</b>
AN/TPS-39(V)2 (Volumetric) System			
consists of:			
Remote Receiver	1		
RF Preselector (Style A)	1		
Remote Transmitter	1		
Annunciator	As Req'd*		
Annunciator Plug-In Module	1		
Annunciator Power Supply	As Req'd*		
Remoting Lines	As Req'd.		
Antennas	2		

**AN/TPS-39(V)2: 2**



**ITEM NAME:** RADAR SET

**TYPE:** AN/TPX-1

**PRINCIPAL COMPONENTS AND PHYSICAL DATA**

<b>COMPONENTS</b>	<b>QTY</b>	<b>OVERALL DIMENSIONS (Inches)</b>	<b>UNIT WT. (Pounds)</b>
Plug, Twist Lock	1	1 dia x 1 1g	0.2
TM 11-1149	2	1/2 x 8-1/2 x 11	2

**REFERENCE DATA AND LITERATURE**

Technical Manuals:  
TM 11-1149 for Radar Set AN/TPX-1.

**ITEM NAME:** RADAR SURVEILLANCE SYSTEM

**TYPE:** AN/TPS-39(V)2, -39(V)4, -39(V)4A,  
-39(V)4B, -39(V)4C, -39(V)5,  
-39(V)5A and -39(V)5B

**PRINCIPAL COMPONENTS AND PHYSICAL DATA**

<b>COMPONENTS</b>	<b>QTY</b>	<b>OVERALL DIMENSIONS (Inches)</b>	<b>UNIT WT. (Pounds)</b>
Antenna Mast 2 Mounting Provisions and Hardware	As Req'd		
**AN/TPS-39(V)4 (Multiple-Volumetric)			
System consists of:			
Remote Receiver	2		
RF Preselector (Style B)	2		
Remote Transmitter	2		
Annunciator	As Req'd*		
Annunciator Plug-In Module 2			
Annunciator Power Supply	As Req'd*		
Remoting Lines	As Req'd*		
Antennas	6		
Antenna Mast	4		
Mounting Provisions and Hardware	As Req'd*		
AN/TPS-39(V)4C consists of:			
Remote Receiver	2		
RF Preselector (Style B)	2		
Remote Transmitter	2		
Power Divider (3-part)	2		
Annunciator	As Req'd*		
Annunciator Plug-In Module 2			
Annunciator Power Supply	As Req'd*		
Remoting Lines	As Req'd*		
Antennas	8		
Antenna Mast	8		
Mounting Provisions and Hardware	As Req'd		
***AN/TPS-39(V)5 (Volumetric-Hybrid)			
System consists of:			
Remote Receiver	1		
RF Preselector (Style C)	1		
RF Preselector (Style D)	1		

**ITEM NAME:** RADAR SURVEILLANCE SYSTEM

**TYPE:** AN/TPS-39(V)2, -39(V)4, -39(V)4A,  
-39(V)4B, -39(V)4C -39(V)5,  
-39(V)SA and -39(V)5B

**PRINCIPAL COMPONENTS AND PHYSICAL DATA**

<b>COMPONENTS</b>	<b>QTY</b>	<b>OVERALL DIMENSIONS (Inches)</b>	<b>UNIT WT. (Pounds)</b>
Remote Transmitter	1		
Annunciator	As Req'd*		
Annunciator Plug-In Module 1			
Annunciator Power Supply	As Req'd*		
Remoting Lines	As Req'd.		
Antennas	3		
Antenna Mast	3		
Mounting Provisions and Hardware	As Req'd		

**NOTE:** \*The quantity of remoting lines, annunciators and annunciator power supplies required for each installation will be based on the results of interface meetings and agreements between the Air Force, prime contractors, and other associate Atlas-Titan contractor.

\*\*AN/TPS-39(V)4A, -39(V)4B shall consist of the same components as AN/TPS-39(V)4 and differ only in antenna configurations.

\*\*\*AN/TPS-39(V)5A, -39(V)5B shall consist of the same components as AN/TPS-39(V)5 and differ only in antenna configurations.

**REFERENCE DATA AND LITERATURE**

Military Specification: MIL-R-27146D (USAF) dated 10 November 1964.  
AFSC Form 81 on AN/TPS-39(V) dated 23 October 1964.

**NOTE 1.** AN/TPS-39(V): 5840-975-8376  
AN/TPS-39(V)2: 5840-975-8376  
AN/TPS-39(V)5: 5840-754-4900

**NOTE 2.** Std Status for AN/TPS-39(V).

**DATE:** 1 September 1965

**ITEM NAME:** RADAR SET

**COGNIZANT SERVICE:** USAF

**TYPE:** AN/TPS-40

**FEDERAL STOCK NUMBER:**

	USA	USN	USAF	USMC
STATUS OR TYPE CLASSIFICATION			Std	
Mfg(s) Name or Code Number: Avco Electronics & Ordnance Div of Avco Corp., Cincinnati, Ohio				

Illustration not Available.

**FUNCTIONAL DESCRIPTION**

Radar Set AN/TPS-40 is a transportable range and height finding Radar Set that incorporates AV and SL features.

**RELATION TO SIMILAR EQUIPMENT**

Not available.

**AN/TPS-40: 1**

**ITEM NAME:** RADAR SET

**TYPE:** AN/TPS-,0

**TECHNICAL DESCRIPTION**

**INSTALLATION CONSIDERATIONS**

Frequency Data  
Transmitter: 52t0 mc  
Receiver: 52t0 mc  
Operating Power Requirements: ac, 20bv,  
400 cyc, 3-ph

Not available.

**PRINCIPAL COMPONENTS AND PHYSICAL DATA**

<b>COMPONENTS</b>	<b>QTY</b>	<b>OVERALL DIMENSIONS (Inches)</b>	<b>UNIT WT. (Pounds)</b>
Amplifier-Indicator Group - OA-12.12/MPS-16	4		
Electronic Equipment Compressor- Dehydrator HD-592/GPS	1		
Antenna Control C-1999/MPS-16	1		
Indicator Group OA-305/TPS-37	1		
Radar Modulator MD-327/MPS-16A	1		
Motor-Generator PU-372A/MPS-16	1		
Radar Set Control Group OA-3803/TPS-:37	1		
Radar Set Group OA-3799/TPS-37	1		
Radar Set Group OA-1260/MPS-16	1		
Audio Frequency Oscillator 0-407 /MPS- 16	1		
Power Supply PP-1439A/MPS-16	1		
Meter Starter SA-5.17/MPS-16	1		
Radio Transmitter T-66B/PMS-16A	1		

**REFERLNCE DATA AND LITERATURE**

Nomenclature card dated 7 Feb 63 for AN/TPS-40.

**DATE:** 15 September 1965

**ITEM NAME:** RADAR SET

**COGNIZANT SERVICE:** USAF

**TYPE:** AN/TPS-44

**FEDERAL STOCK NUMBER:**

	USA	USN	USAF	USMC
STATUS OR TYPE CLASSIFICATION Tent. Std				
Mfg(s) Name or Code Number				

Illustration not Available.

**FUNCTIONAL DESCRIPTION**

Radar Set AN/TPS-44 is a lightweight, air-transportable, search radar whose parameters have been selected so it will function in an optimum manner as the data: collection element of a TAC Forward Air Com-

mand Post (FACP). The radar is transportable by C-130 aircraft and by helicopter, and can be transported by truck or two-wheeled dollies over rough terrain. The radar is housed in one S141-type shelter, with the auxiliary equipment packaged for transport on a pallet. Miniature circuitry

**ITEM NAME:** RADAR SET

**TYPE:** AN/TPS-44

and lightweight construction are used to minimize the size and the weight.

The AN/TPS-4,1 is designed to work with a separate operations room; and, as such, the radar trigger, radar video, rotation data, and IFF signals are all available for remoting over 300-feet of cable. In addition, remote control of certain radar functions are provided by means of a remote control panel located in the operations room. This panel will control the several IF gain levels and will control the insertion of selected receiver circuits.

**RELATION TO SIMILAR EQUIPMENT**

The AN/TPS-44 is based upon the development of lightweight radar techniques which occurred first in the AN/UPS-1 (an unsheltered surveillance radar) and later in the AN/TPS-35 (a sheltered version, with remoteing facilities). The development history of these radars extends over the past five years. While the AN/TPS-4, retains the successful features of both these radars, it is an improved radar set which will provide increased radar coverage in both range and altitude on a one-square meter target. The AN/TPS-44 has been designed to suit the particular requirements for a TAC FACP radar, as such it has a remoting capability and remote control facilities for the FACP Operations Central; it has a modern solid-state IFF Interrogator Set offering increased reliability and performance; and it has a new, higher gain antenna which will fill in and extend the coverage over that of both the AN/UPS-1 and the AN/TPS-35 radar sets.

Existing TAC surveillance radars are heavy, not readily deployable, and not easy to install. The AN/TPS-41 will overcome

these deficiencies by being lightweight, transportable by cargo aircraft or helicopter and truck, and capable of being set-up in two hours.

**TECHNICAL DESCRIPTION**

Transmitting Power: One megw (peak)  
Frequency Band: 1250 to 1350 mc per sec (tunable)  
Pulse Repetition Frequencies: OO pps,  
533 pps, and 267 pps  
Antenna  
Rotation: servo controlled  
Operating Speed: Any speed up to 15  
rpm in winds of 25 knots; 6 rpm in  
winds up to 52 knots  
IFF Antenna: Intergral with the radar horn  
Prime Power: 3-ph, 4-wire, 400 cyc, 20Lv

**INSTALLATION CONSIDERATIONS**

Related Equipment: The AN/TPS-44 is designed for use with the Operations Central AN/TSQ-61 and the AN/TSC-53 Communications Central which provide the necessary radar displays and radio communications equipment.

Weight: The weight of the radar shelter with all installed equipment will not exceed 3350 pounds in transport condition. The pallet with its auxiliary equipment will not exceed 2B50 pounds. The cased antenna will not exceed b00 pounds. The total weight of the radar and auxiliary equipment will be less than 7000 pounds.

**PRINCIPAL COMPONENTS AND PHYSICAL DATA**

<b>COMPONENT</b>	<b>QTY</b>	<b>HEIGHT (Inches)</b>	<b>WIDTH (Inches)</b>	<b>DEPTH (Inches)</b>	<b>UNIT WT.</b>
Receiver Group	1				
Transmitter Group	1				
Indicator Group	1				
General Power Supply Group	1				
Antenna Group	1				
Interrogator Group	1				
Test Group	1				
Miscellaneous Group	1				

**REFERENCE DATA AND LITERATURE:** AFSC Form b1 dated 6 Jul 65 for Radar Set AN/TPS-44.

DATE: 1 July 1964

ITEM NAME: RADAR SET

COGNIZANT SERVICE: USA

TYPE: AN/TPX-1

FEDERAL STOCK NUMBER:

	USA	USN	USAF	USMC
STATUS OR TYPE CLASSIFICATION	Used By	Used By		
Mfg(s) Name or Code Number: Radio Receptor Company, Inc. (77638)				

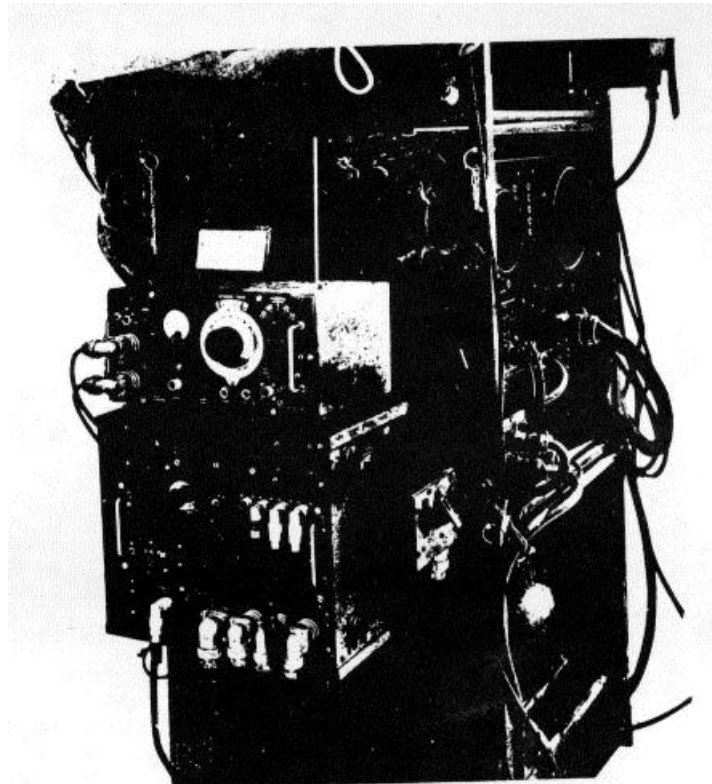

*Transmitter-Receiver RT-48/TPX-1*

### FUNCTIONAL DESCRIPTION

The Radar Set AN/TPX-1 is an auxiliary equipment, designed specifically for use with Radio Set AN/TPS-IA, to identify, as

friend or foe, planes located by Radio Set AN/TPS-IA. It operates in the frequency range of 157 to 187 megacycles (mc).

AN/TPX-1: 1



**ITEM NAME:** RADAR SET

**TYPE:** AN/TPX-1

**RELATION TO SIMILAR EQUIPMENT**

The AN/TPX-1 is the same as Radar Set AN/TPX-3 except control box features are not incorporated in associated radar but included.

**TECHNICAL DESCRIPTION**

Type of Installation: Ground transportable.  
Type of Signals: Pulse type  
Equipment Purpose: IFF identification of aircraft.  
Frequency Range: 157 to 187 mc  
Synchronized Pulse Frequency: 200 to 750 cps  
Free Running Pulse Frequency: 175 cps  
Pulse Width: 5 to 8 usec

Synchronized Pulse Required: 10 to 150v peak; time of use less than 1 usec  
Receiver Sensitivity: Less than 15 uv input for 2:1 signal to noise ratio  
Receiver Gain: Over 60v peak video output for 15 uv input.  
Receiver Bandwidth: 4 mc, 6 db down  
Receiver Intermediate Frequency: 30 mc  
Video Peak Limiter: Adjustable from less than 35v to over 70v.  
Primary Power Required: 175 va at 115 or 80v, 400 or 1200 cps

**INSTALLATION CONSIDERATIONS**

Related Equipment: The AN/TPX-1 is designed to be used with, but not part of Radio Set AN/TPS-1( ) and similar sets.

**PRINCIPAL COMPONENTS AND PHYSICAL DATA**

<b>COMPONENTS</b>	<b>QTY</b>	<b>OVERALL DIMENSIONS (Inches)</b>	<b>UNIT WT. (Pounds)</b>
Transmitter-Receiver RT-48/TPX-1	2	9-1/2 x 13-1/2 x 14-1/2	45
Antenna System AS-96/TPX-1	1	150 x 258	40
Test Set TS-159/TPX	1	6-7/8 x 9-3/4 x 14	14
Chest CY-154/TPX-1	1	11-3/4 x 14 x 16	19
Chest CY-155/TPX-1	1	7 x 19 x 19	18
Chest CY-156/TPX-1	1	13-1/2 x 16-3/4 x 18-3/4	20
Chest CY-157/TPX-1	1	11-1/4 x 16-3/4 x 18-3/4	18
Control Box C-106/TPX-1	1	4-3/8 x 6-3/8 x 2-1/4	2
Cord CG-74/TPX-1	4	13/32 dia x 600 1g	6
Cord CG-77/TPX-1	4	3/16 dia x 65 1g	1/2
Cord CG-78/TPX-1	4	3/16 dia x 600 1g	0.4
Cord CX-156/TPX-1	2	1/2 dia x 30 1g	1
Cord CX-158/TPX-1	2	5/16 dia x 600 1g	1
Cord CX-159/TPX-1	2	5/16 dia x 72 1g	1
Cord CG-76/TPX-1	2	5/16 dia x 72 1g	1
Cord CG-109/TPX-1	2	13/32 dia x 60 1g	1
Cord CG-110/TPX-1	2	3/16 dia x 60 1g	1
Headset HS-30 w/Cord CU-605 and Transformer C-410	1		1
Equipment Tool	1		4

ITEM NAME: INTERROGATOR SET  
TYPE: AN/TPX-17C

PRINCIPAL COMPONENTS AND PHYSICAL DATA  
SHIPPING DATA

COMPONENT	BOXES (NR.)	OVERALL DIMENSIONS (Inches)	UNIT WT. (Pounds)
Receiver-Transmitter Group OA-421C/TPX and Case C-1135A/TPX	1	28-1/4 x 43-1/2 x 45-1/2	590
Cable Assy Kit MK-218A/TPX-17A	1	18 x 31-1/2 x 33	240
Radar Test Set AN/UPM-6B	1	17-1/2 x 22-1/4 x 26-1/2	131

PRINCIPAL COMPONENTS AND PHYSICAL DATA

COMPONENTS	QTY	OVERALL DIMENSIONS (Inches)	UNIT WT. (Pounds)
Radar Receiver-Transmitter RT-273/TPX	1	14 x 18 x 23-1/2	94
Coder-Decoder KY-98A/TPX	1	10 x 18 x 20-1/4	50
Video Amplifier AM-739A/TPX	1	5-7/16 x 6-1/2 x 10	8-1/4
Interrogator Set Control C-1135A/TPX	1	5-3/8 x 5-17/32 x 8-13/16	5-5/8
Radar Test Set AN/UPM-6B	1	14-1/4 x 16 x 17-5/8	76
Cable Assy Kit MK-218A/TPX-17A	1		
Cable Reel Case CY-1686/TPX-17A	1		
Receiver-Transmitter Group OA-421C/TPX	1		

REFERENCE DATA AND LITERATURE

Technical Manuals;  
NAVSHIPS 91785(A): for Interrogator Sets AN/TPX-17( )  
and AN/TPX-18.

AN/TPX-17C: 3

**DATE:** 1 July 1964

**ITEM NAME:** RADAR SET

**COGNIZANT SERVICE:** USA

**TYPE:** AN/TPX-3

**FEDERAL STOCK NUMBER:**

	USA	USN	USAF	USMC
STATUS OR TYPE CLASSIFICATION	Used By		Used By	
Mfg(s) Name or Code Number: Radio Receptor Company, Inc. (77638)				

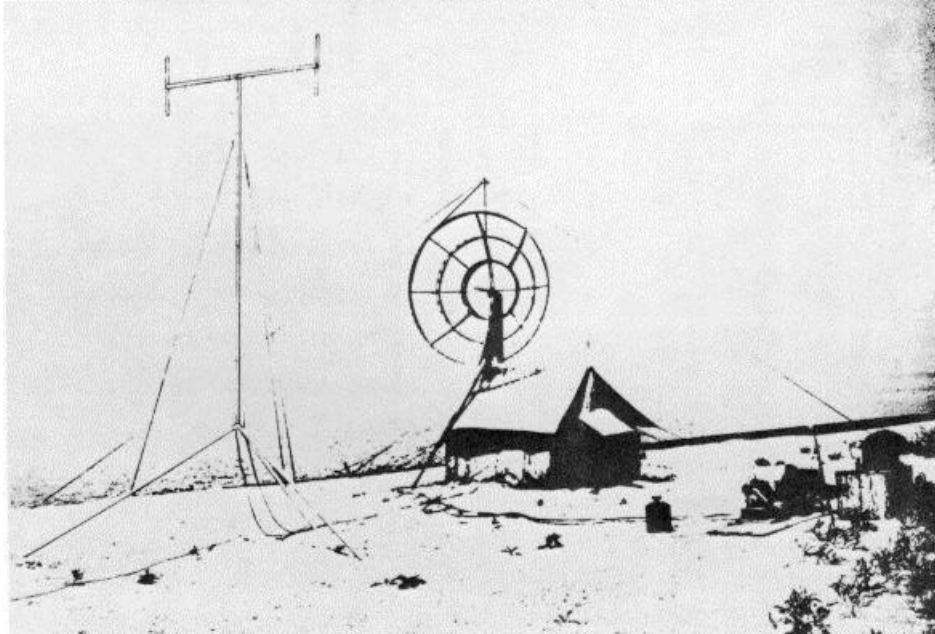

**FUNCTIONAL DESCRIPTION**

The Radar Set AN/TPX-3 is an auxiliary equipment, designed specifically for use with Radio Set AN/TPS-3

to identify as friend or foe, planes located by Radio AN/TPS-3. It operates in the frequency range of 157 to 187 megacycles (mc).

**AN/TPX-3: 1**

**ITEM NAME:** RADAR SET  
**TYPE:** AN/TPX-3

**RELATION TO SIMILAR EQUIPMENT**  
None.

**TECHNICAL DESCRIPTION**

Type of Installation: Ground trans-  
portable.  
Type of Signals: Pulse type  
Equipment Purpose: IFF identification of  
aircraft.  
Frequency Range: 157 to 1B7 mc  
Synchronized Pulse Frequency: 200 to 750  
cps  
Free Running Pulse Frequency: 175 cps  
Pulse Width: 5 to B usec  
Synchronized Pulse Required: 10 to 150v  
peak; time of use less than 1 usec  
Receiver Sensitivity: Less than 15 uv

input for 2:1 signal to noise ratio.  
Receiver Gain: Over 60v peak video output  
for 15 uv input.  
Receiver Bandwidth: 4 mc, 6 db down  
Receiver Intermediate Frequency: 30 mc  
Video Peak Limiter: Adjustable from less  
than 35v to over 70v  
Primary Power Required: 175 va at 115 or  
80v, 400 or 1200 cps

**INSTALLATION CONSIDERATIONS**

Related Equipment: The AN/TPX-3 is designed to  
be used with, but not part of Radio Set AN/TPS-  
3( ).

**PRINCIPAL COMPONENTS AND PHYSICAL DATA**

COMPONENTS	QTY	OVERALL DIMENSIONS (Inches)	UNIT WT. (Pounds)
Transmitter-Receiver RT-48/TPX-1	2	9-1/2 x 13-1/2 x 14-1/2	45
Antenna System AS-96/TPX-1	1	150 dia x 258	40
Test Set TS-159/TPX	1	6-7/8 x 9-3/4 x 14	14
Chest CY-154/TPX-1	1	11-3/4 x 14 x 16	19
Chest CY-215/U	1	7 x 19 x 19	18
Chest CY-156/TPX-1	1	13-1/2 x 16-3/4 x 18-3/4	20
Chest CY-157/TPX-1	1	11-1/4 x 16-3/4 x 1B-3/4	16
Cord CG-74/TPX-1	4	13/32 dia x 600 lg	6
Cord CX-304/TPX-3	2	13/32 dia x 600 lg	3
Cord CX-159/TPX-1	2	5/16 dia x 72 lg	1
Cord CG-76/TPX-1	2	5/16 dia x 72 lg	1
Cord CG-109/TPX-1	2	13/32 dia x 60 lg	1
Cord CG-110/TPX-1	2	3/16 dia x 60 lg	1/2
Headset	1		1
Equipment Tool	1	B-1/2 x 11	2

**REFERENCE DATA AND LITERATURE**

Technical Manuals:  
TM 11-1159 for Radar Set AN/TPX-3.

DATE: 1 July 1964  
COGNIZANT SERVICE: USN

ITEM NAME: INTERROGATOR SET  
TYPE: AN/TPX-17,\* -17A

FEDERAL STOCK NUMBER: F5895-636-3438\*

	USA	USN	USAF	USMC
STATUS OR TYPE CLASSIFICATION				
Mfg(s) Name or Code Number: General Electric Co., Syracuse, N. Y., Hazeltine Electronic Corp.,				

**Illustration Not Available**

**FUNCTIONAL DESCRIPTION**

Interrogator Sets AN/TPX-17 and AN/TPX-17A are used at ground installations to distinguish between friendly and enemy aircraft. Both are similar except for the number of units and the number of operations that may be performed. The AN/TPX-17A obtains similar information which is displayed either alone or on the PPI of the associated radar.

Frequency: Receiver, 1090 to 1110 mc  
Transmitter, 1010 to 1030 mc  
Sensitivity of Receiver: At least 80 db below 1v  
Peak Power Output: 1000w into 52-ohm load  
Transmitter Duty Cycle: 0.1% max  
Voltage Requirements: AN/TPX-17, 115 vac  
±10%, 60 cps ±10% or 400 cps ±10%, 1-ph,  
440w; AN/TPX-17A, 115 vac ±10%, 400 cps,  
1-ph, 400w (115 vac ±10%, 60 cps required  
when antenna AN/GPA-8 is used)

**RELATION TO SIMILAR EQUIPMENT**

The AN/TPX-18 includes all of the AN/TPX-17 components and a distributor group not a part of the AN/TPX-17 (OS-440/TPX-18).

**INSTALLATION CONSIDERATIONS**

Not Available

**TECHNICAL DESCRIPTION**

**AN/TPX-17: 1**

**AN/TPX-17, -17A**

**PRINCIPAL COMPONENTS AND PHYSICAL DATA**

<b>COMPONENT</b>	<b>QTY</b>	<b>HEIGHT (Inches)</b>	<b>WIDTH (Inches)</b>	<b>DEPTH (Inches)</b>	<b>UNIT WT. (Pounds)</b>
AN/TPX-17	1				
Receiver Transmitter Group OA-421/TPX	1				
Cable Assembly Kit MK-119/TPX	1				
Antenna AT-352/UPA-22	1				
Pedestal AB-279/GPA	1				
Mast AB-278/HPA	1				
Electronic Control Amplifier AM-692/GPA	1				
Cables and Spares for Antenna Group					
Radar Test Set AN/UPM-6B AN/TPX- 17A	1				
Receiver Transmitter Group OA-421A/TPX	1				
Cable Assembly Kit MK-218/71A	1				
Radar Test Set AN/UPM-6B	1				

**REFERENCE DATA AND LITERATURE**

Technical Manual:

NAVSHIPS 91785(A)

Specification:

AN/MIL-A-16092C and Amendment 1

DATE: 1 July 1964  
COGNIZANT SERVICE: USN

ITEM NAME: INTERROGATOR SET  
TYPE: AN/TPX-17C

**FEDERAL STOCK NUMBER:**

	USA	USN	USAF	USMC
STATUS OR TYPE CLASSIFICATION				
Mfg(s) Name or Code Number: Hazeltine Corp., Electronic Div., Little Neck, Long Island, N.Y.				

**Illustration not Available.**

**FUNCTIONAL DESCRIPTION**

the associated radar set in combination with, or separate from, the regular radar information.

The AN/TPX-17C is a challenging system, obtains IFF responses on the Plan Position Indicator (PPI) of

**AN/TPX-17C: 1**

**ITEM NAME:** INTERROGATOR SET

**TYPE:** AN/TPX-17C

**RELATION TO SIMILAR EQUIPMENT**

The AN/TPX-17C is the result of the following modifications made to the AN/TPS-17B in order to increase its flexibility: The complete modulator was replaced to increase the life of the tubes in the modulator and to make the transmitter more reliable. The overload protection circuitry for high-voltage protection in the Radar Receiver-Transmitter was modified. The set is for use with a remote indicator (not included).

**TECHNICAL DESCRIPTION**

Radar Receiver-Transmitter RT-273C/TPS, Receiver Section

Tuning Range: 1090 to 1110 mc

Power Consumption: 440w

Sensitivity Ratio: 11:1 -80 db below 1v or better.

Bandwidth at 6 db Down: 8 mc to 11 mc

Bandwidth at 40 db Down: 24 mc max

Image Ratio: 35 db min

Second and Third Harmonic Rejection at 1960: 2480 mc and 2790-3690 mc -40 db min

Positive Video Output

Type A: 10 to 12v high dynamic range (0.03 rms volt noise).

Type B: 4 to 5v low dynamic range (1 rms volt noise).

Intermediate Frequency: 59.5 mc plus or minus 1.5 mc

Local Oscillator Radiation: Max -40 db below 1v

Frequency Drift: plus or minus 2 mc max

Intermediate Frequency Pick-Up: 60 db below signal level.

Receiver Delay: 0.5 usec max

Dynamic Range: 20 db min

GTC-Gate Duration (Both Long and Short): Adjustable from less than 300 usec to more than 2500 usec

Radar Receiver Transmitter RT-273C/TPX, Transmitter Section

Tuning Range: 1010 to 1030 mc

Emission, Into 52-ohm Resistive Load: 1000w peak min

Receiver-Transmitter Frequency Separation For Rated Output: 50 mc min

Duty Cycle: 0.1% max

Transmission Rate, Pulse-Pair: 50 to 410 per sec

Frequency Drift: plus or minus 2.5 mc

Transmitted Pulse Shape, Single Pulse

Rise Time From 10% to 90%: 0.15 usec,

max

Duration at 50% Amplitude: 0.7 to 1.2 usec

Decay Time from 90% to 10%: 0.4 usec max

Pulse Spacing Between Leading Edges of a Pair at 50% Amplitude

Mode 1: 3.0 plus or minus 0.2 usec

Mode 2: 5.0 plus or minus 0.2 usec

Mode 3: 8.0 plus or minus 0.2 usec

Coder-Decoder KY-98A/TPX

Input Pulse Characteristics

Polarity: pos

Voltage: 5 to 50v peak

Rise Time, 0 to 70% Amplitude: 0.02 to 1.0 usec

Repetition Rate: 50 to 4100 pps

Display Trigger

Polarity: pos

Repetition Rate: 50 to 4100 pps

Voltage: 5 to 50v

Rise Time: 0.4 usec

Jitter: 0.05 usec max

Suppressor Pulse

Rise Time: Equals less than 0.25 usec

Duration: 1 to 3 usec

Amplitude: plus 20 to plus 50v

Self-Trigger: 150 to 410 pulse-pairs per sec

Video Distributor SA-300/UPX

IFF Video Input Impedance at Input Terminal: 70 ohms plus or minus 5% nominal (or high impedance of not less than 5000 ohms nor more than 40 uuf).

IFF Video Output Signal

Polarity: pos

Impedance: 75 ohms nom

Video Amplifiers AM-739/TPX and AM-739A/TPX

IFF Input Signal Range: plus 2.5 to plus 5v

Radar Input Signal Range: plus 1 to plus 2.5v (0.75v rms noise min).

Video Output Signal

Polarity: pos

IFF and Radar Video Level: Same as input across 75 ohms nom (or high impedance of not less than 5000 ohms nor more than 40 uuf).

Operating Power Requirements: 115v ac, 400 cps, 1-ph

**INSTALLATION CONSIDERATIONS**

Not available.



DATE: 1 July 1964  
COGNIZANT SERVICE: USN

ITEM NAME: INTERROGATOR SET  
TYPE: AN/TPX-18A

FEDERAL STOCK NUMBER: 5895-296-2892

	USA	USN	USAF	USMC
STATUS OR TYPE CLASSIFICATION		Std		
Mfg(s) Name or Code Number:				

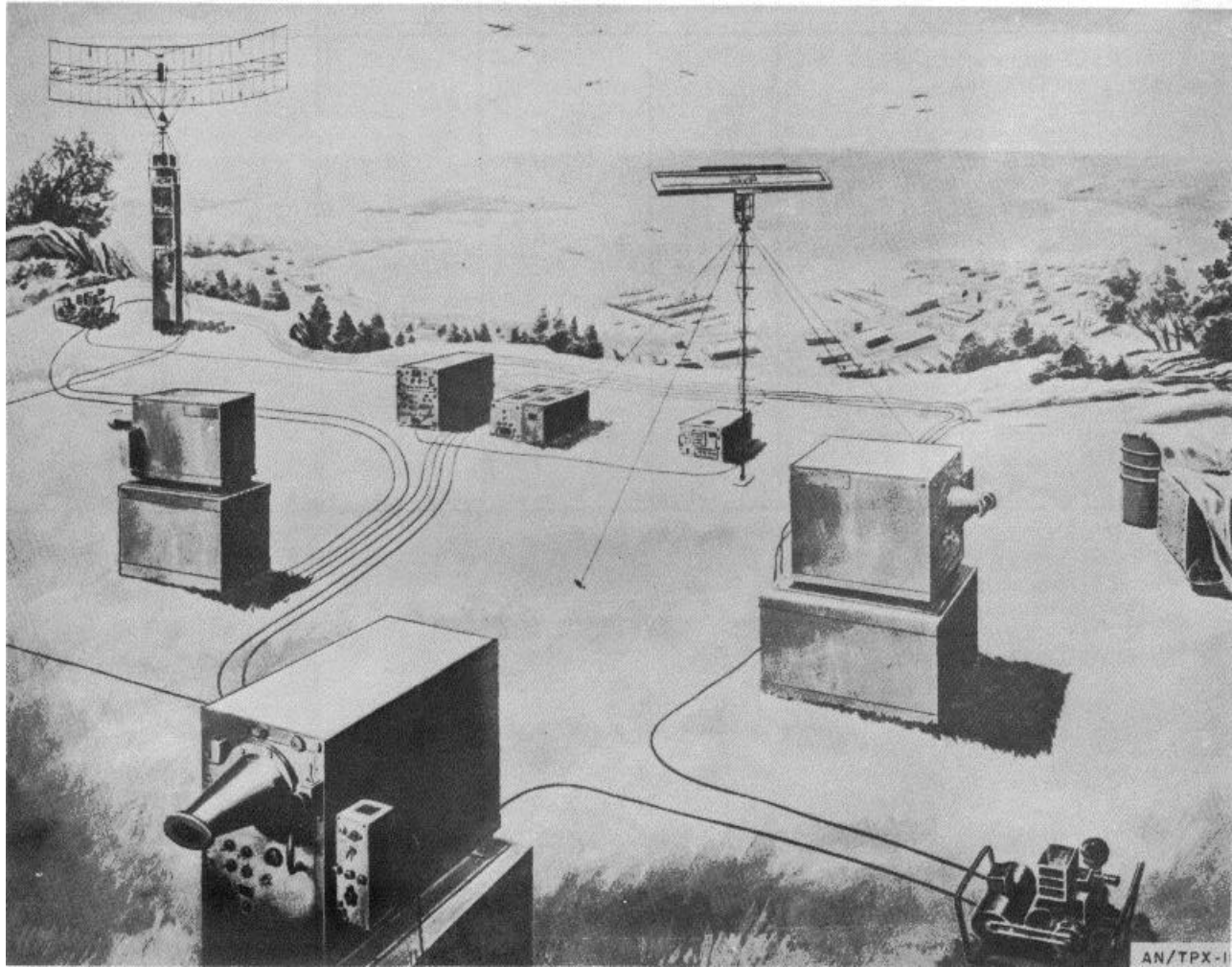

### FUNCTIONAL DESCRIPTION

Interrogator Set AN/TPX-18A is used primarily to recognize friendly radar targets. Radar and identification data is displayed simultaneously on a single, independent, standard display indicator.

### RELATION TO SIMILAR EQUIPMENT

None.

AN/TPX- 18A: 1

**AN/TPX-18A**

**TECHNICAL DESCRIPTION**

Frequency:  
Range, Max:  
Range, Min:  
Peak Power Output:

Operating Voltages and Power Requirements:

115v  $\pm$ 10%, 60 cps  $\pm$ 10% or 115v  $\pm$ 10%, 400  
cps  $\pm$ 10%. (60 cps is required when Antenna Not available.)

AN/GPA-8 is used)

Type of Presentation: Remote indicator

Number and Interval of Range Marks:

Duty Cycle:

**INSTALLATION CONSIDERATIONS**

**PRINCIPAL COMPONENTS AND PHYSICAL DATA**

COMPONENT	QTY	HEIGHT (Inches)	WIDTH (Inches)	DEPTH (Inches)	UNIT WT. (Pounds)
Electrical Equipment Cabinet CY-1651/TPX-18A	1				
Electrical Equipment Cabinet CY-1652/TPX-18A	1				
Interrogator Set Control C-1483/TPX-18A	1				
Interrogator Set Control C-1484/TPX-18A	4				
Receiver-Transmitter Group OA-733/TPX- 18A	1				
Coder-Decoder KY-98/TPX	1				
Radar Receiver-Transmitter RT-273A/TPX	1				
Radar Test Set AN/UPM-6B					

**REFERENCE DATA AND LITERATURE**

Technical Manuals:  
NAVSHIPS 92216  
SIG M8 - AN/TPX-18A  
NAVSHIPS 91467(A)

DATE: 1 July 1964  
COGNIZANT SERVICE: USN

ITEM NAME: CODER-DECODER GROUP  
TYPE: AN/TPX-25

FEDERAL STOCK NUMBER:

	USA	USN	USAF	USMC
STATUS OR TYPE CLASSIFICATION				
Mfg(s) Name or Code Number:				

Illustration not available.

**FUNCTIONAL DESCRIPTION**

None.

Coder-Recorder Group AN/TPX-25 provides a multiple pulse coding system and supplies three types of identification. The three types are high sensitivity IFF(SI), personal identity (PI, airframe number), and traffic identity (TI) for coded triggering radar. The AN/TPX-25 is a general ground installation.

**TECHNICAL DESCRIPTION**

Not available.

**INSTALLATION CONSIDERATIONS**

Not available.

**RELATION TO SIMILAR EQUIPMENT**

**PRINCIPAL COMPONENTS AND PHYSICAL DATA**

COMPONENT	QTY	HEIGHT (Inches)	WIDTH (Inches)	DEPTH (Inches)	UNIT WT. (Pounds)
Interrogator Set KY-120/GPX	1				
Video Decoder KY-118/GPX	7				
Electronic Gate TD-94/GPX	1				
Video Decoder KY- 11 9/GPX	2				
Identification Indicator ID-383/GPX	2				
Coder Control C-1288/GPX	1				
Remote Switching Control C-1290/GPX	6				
Interconnecting Box J-664/GPX	2				
Mounting MT-1501/GPX	8				

**AN/TPX-25**

**PRINCIPAL COMPONENTS AND PHYSICAL DATA (cont'd)**

<b>COMPONENT</b>	<b>QTY</b>	<b>HEIGHT (Inches)</b>	<b>WIDTH (Inches)</b>	<b>DEPTH (Inches)</b>	<b>UNIT WT. (Pounds)</b>
Video Decoder Control C-1291/GPX	1				
Transponder Test Set AN/GPM-17	1				
Oscilloscope AN/USM-24	1				
Factory Assembled Prefabricated Building S-73/TRL-32, modified	1				
Ordnance Type NoM-35 Truck and Interconnecting Cable Assemblies	1				

**REFERENCE DATA AND LITERATURE**

Not available.

**DATE:** 1 July 1964

**ITEM NAME:** INTERROGATOR SET

**COGNIZANT SERVICE:** USN

**TYPE:** AN/TPX-28

**FEDERAL STOCK NUMBER:**

	USA	USN	USAF	USMC
STATUS OR TYPE CLASSIFICATION				
Mfg(s) Name or Code Number: General Communications Company, Boston, Massachusetts				

Illustration not Available.

**FUNCTIONAL DESCRIPTION**

The AN/TPX-28 is an interrogator set which transmits coded interrogations (challenge signals). It is

used in conjunction with a search radar for identification of targets. This set is transportable and miniaturized. It is keyed by a radar trigger.

**AN/TPX-28: 1**

**ITEM NAME:** INTERROGATOR SET  
**TYPE:** AN/TPX-28

**RELATION TO SIMILAR EQUIPMENT**

The AN/TPX-28 is a repackaged AN/UPX-11.

or minus 3 cps, 1-ph  
Keying: Triggered by associated radar  
Type of Presentation: Remote indicator

**TECHNICAL DESCRIPTION**

Frequency  
Transmitter: 10C to 1040 mc  
Receiver: 1090 to 1110 mc  
Operating Voltages: 105/125v ac, 360 to  
440 cps, 1-ph; or 105/125v ac, 60 plus

**INSTALLATION CONSIDERATIONS**

Related Equipment: The AN/TPX-28 is used with,  
but not part of, Radar Set AN/UPS-1, Radio Set  
AN/TPS-1, and Radar Set AN/MPS-11A.

**PRINCIPAL COMPONENTS AND PHYSICAL DATA**

<b>COMPONENT</b>	<b>QTY</b>	<b>HEIGHT (Inches)</b>	<b>WIDTH (Inches)</b>	<b>DEPTH (Inches)</b>	<b>UNIT WT. (Pounds)</b>
Radar Receiver-Transmitter RT-566/TPX-28	1				
Interrogator Set Case CY-2768/TPX-28	1	12.68	16.69	27.87	
Electronic Equipment Maintenance Kit, CY-2767/TPX-2B	1	9.50	16.69	27.87	

**REFERENCE DATA AND LITERATURE**

Specifications:  
SHIPS-I-3176

**AN/TPX-28: 2**

DATE: 1 July 1964  
 COGNIZANT SERVICE: USN

ITEM NAME: RADAR DATA RELAY SET  
 TYPE: AN/TXQ-1

FEDERAL STOCK NUMBER: 5820-642-7584

	USA	USN	USAF	USMC
STATUS OR TYPE CLASSIFICATION		Std		
Mfg(s) Name or Code Number. Motorola Inc., Chicago, Illinois				

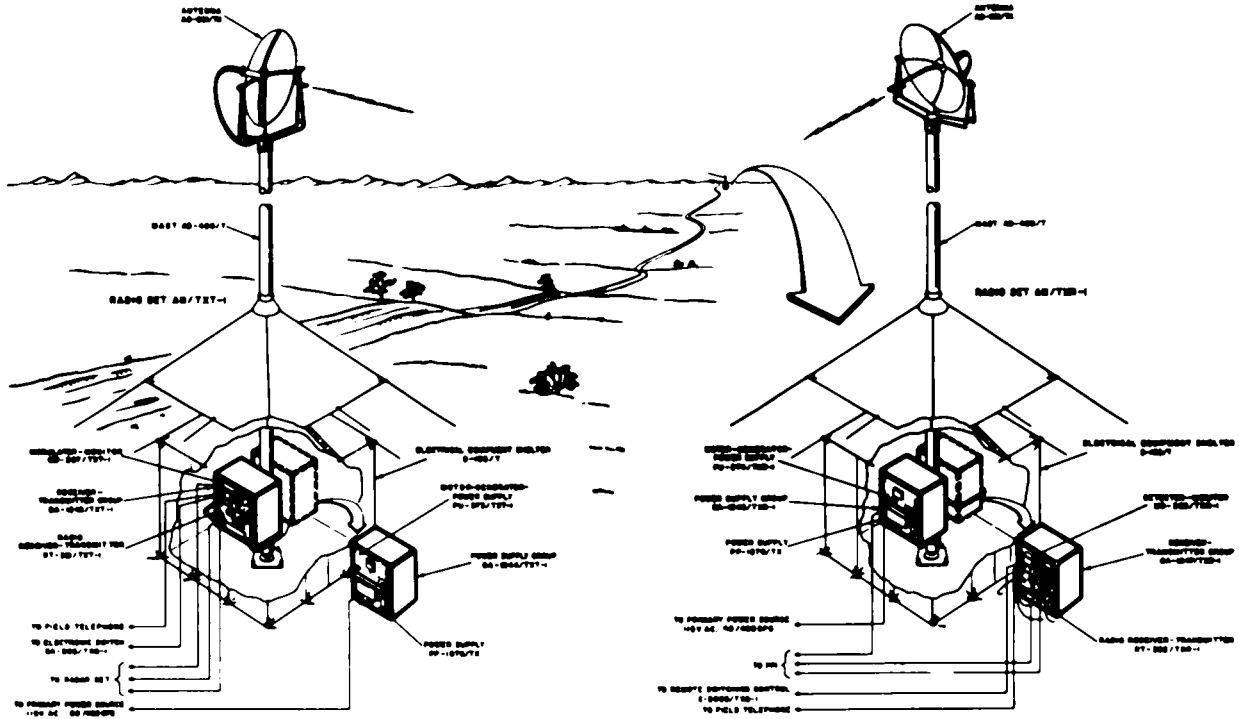

**FUNCTIONAL DESCRIPTION**

The AN/TXQ-1 transmits search radar information via beamed, high-frequency radio waves. The set is a valuable link where impassable terrain prevents the use of cables. The AN/TXQ-1 can be transported by Jeep,

small landing craft, and helicopter or can be carried by personnel. The AN/TXQ-1 transmits radar, video, and azimuth data to a remote control or display center. Two basic components a data transmitter and a data receiver make up the AN/TXQ-1. The data transmitter performs three services

**ITEM NAME:** RADAR DATA RELAY SET  
**TYPE:** AN/TXQ-1

(1) it obtains radar information from a search radar, (2) it modulates the information into microwave form and (3) it transmits the microwave signal to the data receiver. The data receiver demodulates the information and sends it to the indicators.

**RELATION TO SIMILAR EQUIPMENT**

None.

**TECHNICAL DESCRIPTION**

**Receiver Outputs**

- Handset: 0 db W into 150 ohms
- Field Telephone: 0 db W into 600 ohms
- Video: 2.5v into 75 ohms
- Trigger: 35v into 75 ohms

**Frequency Stability**

- AN/TXT-1: 80 kc per deg C
- AN/TXR-1: 25 mc below AN/TXT-1 carrier, plus or minus 250 kc

**Input and Output**

- Video In: plus 1.5 to 2.5 from a 75 ohms source
- Video Out: plus 1.5 to 2.5v across 75 ohms
- Trigger In: plus 25 to 50v across 75 ohms
- Trigger Out: plus 25 to 50v from a 75 ohms source
- Azimuth In and Out: Standard 115/90v synchro voltages (antenna rotation 0 to 15 rpm).
- Maximum Azimuth Error: plus or minus 2.5 deg peak error (antenna rotation of 2 to 10 rpm) or plus or minus 3.5 deg peak error (antenna rotation of 10 to 15 rpm). Average error thru 360 deg; 2 deg.

**Antenna**

- Beamwidth: 4 plus or minus 0.5 deg between half-power points
- Gain: 31.5 db
- Voltage Standing Wave Ratio: 1.15 max
- Front Side-Lobes: 6.5 deg down 20 db from max power point.

Frequency Range: 4600 to 5000 mc, continu-

ously tunable.

**Type of Frequency Control**

- AN/TXT-1: Manual
- AN/TXR-1: Automatic

**Type of Emission and Reception, and Modulation of Characteristics**

- Type of Emission: FM carrier with plus or minus 3 mc deviation.
- Type of Reception: FM with a bandwidth of 9 mc

**Modulation Characteristics**

- AN/TXT-1: FM by video signals and trigger pulses, and three FM sub-carriers.
- AN/TXR-1: FM by voice subcarrier only.

**Power Supply**

- Input Voltage: 115v, 60 or 400 cps, 1-ph
- Input Current
  - AN/TXT-1: 6.5 amp at 60 cps, 6.4 amp at 400 cps
  - AN/TXR-1: 7.4 amp at 60 cps, 7.6 amp at 400 cps

**Power Factor**

- AN/TXT-1: 0.88 at 60 cps, 0.96 at 400 cps
- AN/TXR-1: 0.89 at 60 cps, 0.9b at 400 cps

**Temperature Limitations**

- Operating: Air temperature, -40 deg F to plus 125 dog F
- Not Operating: Air temperature, -65 deg F to plus 165 deg F

**INSTALLATION CONSIDERATIONS**

- Siting: Control and display components can be installed 15 mi from remaining components of the AN/TXQ-1.
- Related Equipment: (Used with but not part of) (1) Radio Set AN/TPS-1D, (1) Indicator Group AN/UPA-25.

**PRINCIPAL COMPONENTS AND PHYSICAL DATA**

COMPONENTS	QTY	OVERALL DIMENSIONS (Inches)	UNIT WT. (Pounds)
AN/TXT-1	1		
Power Supply Group OA-1244/TXT-1			
Electrical Equipment Cabinet CY-2033/TX			
Motor Generator PU-373/TXT-1			
Power Supply PP-1576/TX			
Receiver-Transmitter Group OA-1245/TXT-1			

**AN/TXQ-1: 2**



**ITEM NAME: RADAR DATA RELAY SET**  
**TYPE: AN/TXQ-1**

**PRINCIPAL COMPONENTS AND PHYSICAL DATA**

<b>COMPONENTS</b>	<b>QTY</b>	<b>OVERALL DIMENSIONS (Inches)</b>	<b>UNIT WT. (Pounds)</b>
Modulator Monitor MD-287/TXT-1			
Radio Receiver-Transmitter RT-381/TXT-1			
Mast AB-480/T			
Antenna AS-831/TX			
AN/TXR-1	1		
Power Supply OA-1246/TXR-1			
Electrical Equipment Cabinet CY-2033/TX			
Motor Generator Power Supply PU-374/TXR-1			
Power Supply PP-1576/TX			
Receiver-Transmitter Group OA-1247/TXR-1			
Detector-Monitor MD-288/TXR-1			
Radio Receiver-Transmitter RT-382/TXR-1			
Mast AB-480/T			
Antenna AS-831/TX			
Control Group OA-1162/TXQ-1	1		
Remote Switching Control C-2005/TXQ-1			
Electronic Switch SA-503/TXQ-1			
Electrical Equipment Shelter S-135/T			

**SHIPPING DATA**

<b>COMPONENT</b>	<b>BOXES (NR.)</b>	<b>OVERALL DIMENSIONS (Inches)</b>	<b>UNIT WT. (Pounds)</b>
Receiver-Transmitter Group OA-1245/TXT-1	1	23 x 30 x 32-1/2	
Power Supply Group OA-1244/TXT-1	1	23 x 30 x 32-1/2	
Antenna and Antenna Case AS-831/TX	2	25-1/2 x 30 x 57-1/2	
Mast Section and Carrying Cover Assy CY-229/TX	2		
Electrical Equipment Shelter S-135/T	2	20 x 20 x 38	
Accessories and Accessories Case CY-2230/TXQ-1	2	25-1/2 x 30 x 57-1/2	
Repair Parts Box CY-2269/TXQ-1	2	17 x 21 x 39	
Receiver-Transmitter Group OA-1247/TXR-1	1	23 x 30 x 32-1/2	
Power Supply Group OA-1246/TXR-1	1	23 x 30 x 32-1/2	

**AN/TXQ-1: 3**

**ITEM NAME:** RADAR DATA RELAY SET  
**TYPE:** AN/TXQ-1

**REFERENCE DATA AND LITERATURE**

Technical Manuals:  
NAVSHIPS 92767

Specifications:  
SHIPS-R-1496

**AN/TXQ-1: 4**

ITEM NAME: INDICATOR GROUP  
TYPE: AN/UPA-25

PRINCIPAL COMPONENTS AND PHYSICAL DATA  
SHIPPING DATA

COMPONENT	BOXES (NR.)	OVERALL DIMENSIONS (Inches)	UNIT WT. (Pounds)
Azimuth-Elevation-Range Indicator IP-254/UPA-25	1		
Power Supply PP-996/UPA-25	1		
Voltage Regulator CN-234/UPA-25	1		
Set ac Cables			
Set Accessories	1		
Equipment Maintenance Parts (3 ea)			
Maintenance Parts Kit			

REFERENCE DATA AND LITERATURE

Technical Manuals:  
NAVSHIPS 91994  
SIG MB, Indicator Group AN/UPA-25, Dec 53

AN/UPA-25: 3

DATE: 1 July 1964

ITEM NAME: INDICATOR GROUP

COGNIZANT SERVICE: USN

TYPE: AN/UPA-T2

FEDERAL STOCK NUMBER:

	USA	USN	USAF	USMC
STATUS OR TYPE CLASSIFICATION				
Mfg(s) Name or Code Number. American Machine and Foundry Co., Boston, Massachusetts				

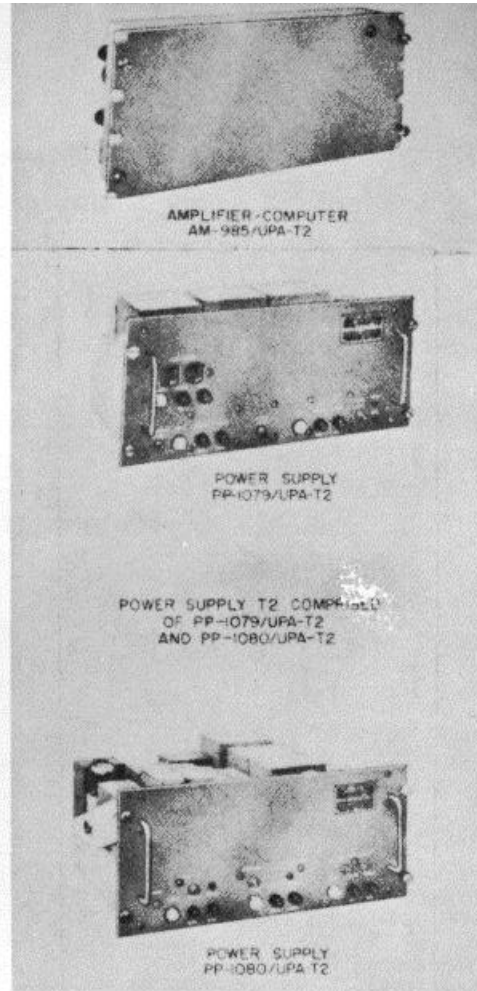
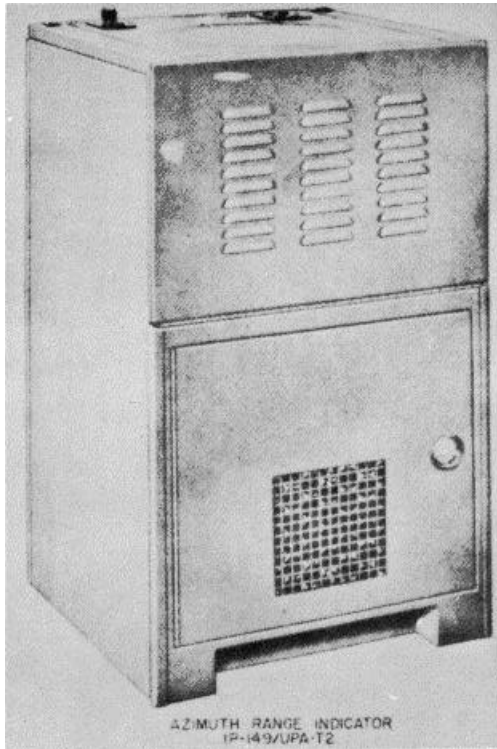

### FUNCTIONAL DESCRIPTION

The AN/UPA-T2 presents in a cathode ray display, digested, simulated radar information on the relative

positions of a number of targets and provides a means of determining the range and bearing of any target from a specified point.

AN/UPA-T2: 1

**ITEM NAME:** INDICATOR GROUP  
**TYPE:** AN/UPA-T2

**RELATION TO SIMILAR EQUIPMENT**

None.

**TECHNICAL DESCRIPTION**

Azimuth Range Indicator  
Display: PPI type  
Target Presentation: No trace between target  
Full Scale Deflection: 0.50v  
Ownships Target Identification: Always appears in center of screen  
Indicator Display: Target seen on ,1000, 1000,.100 and 40 mi ocean  
Indicator Range: 320, 160, 80, 40 and 20 mi var

Amplifier-Computer  
Frequency Response: Output stabilizes in

120 sec if input goes from plus to minus 50v suddenly.  
Input Impedance: 15 meg  
Output Impedance: 0.5 ohms  
Operating Voltage Range: -50 to plus 50v  
Accuracy: plus or minus 15 mw at plus or minus 50v level  
Operating Power: 120v, 60 cps, I-ph  
Heat Dissipation  
Azimuth Range Indicator  
Operation: 598w  
Standby: 276w  
Amplifier Computer  
Operation: 874w  
Standby: 172w

**INSTALLATION CONSIDERATIONS**

Not available.

**PRINCIPAL COMPONENTS AND PHYSICAL DATA  
SHIPPING DATA**

COMPONENT	BOXES (NR.)	OVERALL DIMENSIONS (Inches)	UNIT WT. (Pounds)
Azimuth Range Indicator IP-149/UPA-T2	5	30 x 30 x 52	591
Amplifier Computers AM-985/UPA-T2	5	15 x 22 x 23	87
Power Supply PP-1079/UPA-T2	1	13 x 16 x 23	103
Power Supply PP-1080/UPA-T2	1	13 x 20 x 24	128

**PRINCIPAL COMPONENTS AND PHYSICAL DATA**

COMPONENTS	QTY	OVERALL DIMENSIONS (Inches)	UNIT WT. (Pounds)
Azimuth Range Indicator IP-149/UPA-T2	5	24-1/8 x 24-1/8 x 42	450
Power Supply T2 consists of:	1		
Power Supply PP-1079/UPA-T2	1	2-45/64 x 12-1/4 x 19-1/64	65
Power Supply PP-1080/UPA-T2	1	B-15/64 x 16-1/41 x 19-1/64	85
Amplifier Computer AM-985/UPA-T2	10	8-23/32 x 9-15/32 x 19-1/32	25

**REFERENCE DATA AND LITERATURE**

Technical Manuals:  
NAVSHIPS 92565

DATE: 1 July 1964

ITEM NAME: INDICATOR GROUP

COGNIZANT SERVICE: USMC

TYPE: AN/UPA-25

FEDERAL STOCK NUMBER: 5840-665-2002

	USA	USN	USAF	USMC
STATUS OR TYPE CLASSIFICATION				Std
Mfg(s) Name or (de Number Hazeltine Electronics Corporation, Little Neck, New York				

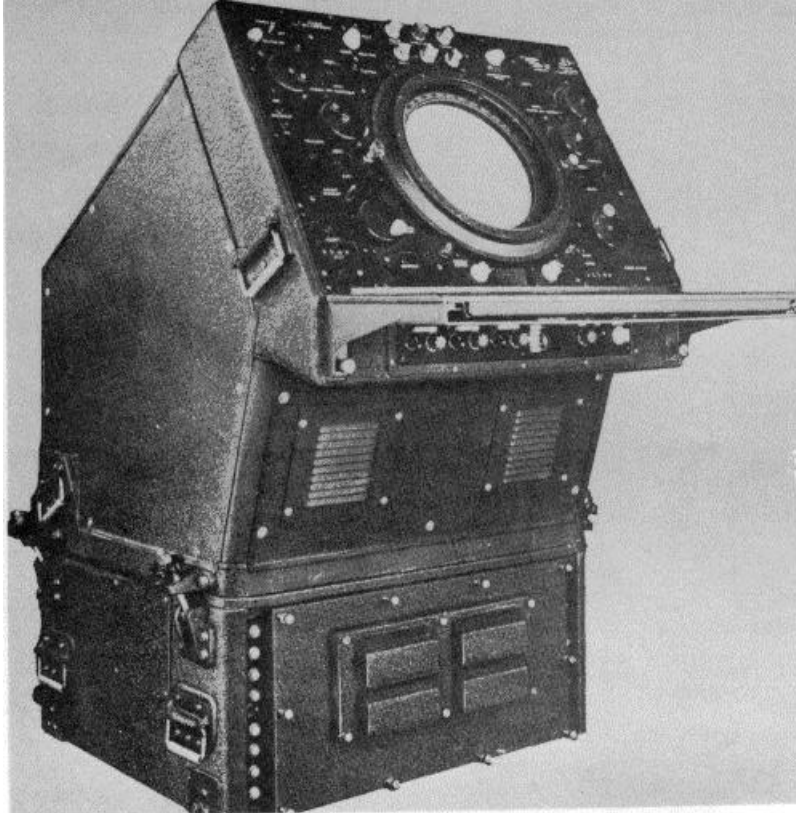

**FUNCTIONAL DESCRIPTION**

Indicator AN/UPA-25 is a console type plan position indicator. The indicator can be used with ordinary radar systems such as the AN/MPS-11A and the AN/TPS-1D

as a master PPI or remote radar repeater. The indicator may also be used in either of these capabilities with airborne early warning system AN/MSQ-3 or with airborne early warning systems similar to the AN/ MSQ-3.

**AN/UPA-25: 1**

**ITEM NAME:** INDICATOR GROUP  
**TYPE:** AN/UPA-25

**RELATION TO SIMILAR EQUIPMENT**

None.

**TECHNICAL DESCRIPTION**

Azimuth-Elevation Range Indicator  
Pulse Repetition Frequency: 60 to 2000 per sec  
Internal-Trigger Frequency: 230 per sec  
Trigger Input: 5 to 50v pos  
Video Input: 1 to 2.5v pos  
Antenna and Trace Speed: 0 to 39 rpm  
Range Selection: I4 to 250 mi, B000 to 500,000 yd continuously var.  
Range Accuracy: 300 to 10,000 yd plus or minus 100 yd. 10,000 to 40,000 yd plus or minus 1% of actual range. -10,000 to 100,000 yd plus or minus 2% of actual range. 100,000 to 500,000 yd plus or minus 3% of actual range.  
Bearing Accuracy: 20 at all antenna speeds.  
Presentation: 10-1/2 in. CR tube.  
Radius of Display: 4.5 in.  
Sweep Speed: 1 to 250 mi per radius, 48.8 to 3049 usec per radius, 0.0923 to 0.00148 in. per usec  
Table of Sweep Lengths  
4 to 21 mi: at least 6 radii  
21 to 2t mi: 125, mi

26 to 42 mi: at least 6 radii  
42 to 250 mi: 250 mi  
Height Counter  
Range: 0 to 60,000 ft  
Accuracy: plus or minus 250 ft  
Power Supply  
Input: 115v, 60 cps, 1-ph, 1560w, pf 85%  
Output  
Regulated: plus 220v dc, 1.3 amp  
-180v dc, 360 to 120 ma  
-350v dc, 25 ma  
115s ac, W.E amp  
Unregulated: 115v ac, 1.3 amp  
24v dc, 0.5 amp  
Voltage Regulator  
Input: 115v, 55 to 65 cps, 1-ph, -1.3 amp  
Output: 115v regulated, 3.05 amp

**INSTALLATION CONSIDERATIONS**

Related Equipment: AN/MPS-11A, AN/TPS-LD, AN/MSQ-3.  
(Equipment Required but not Supplied)  
(1) Cable FLOP-3, (3) MHFF-10 (1) Oscilloscope OS-5/U, OS-8/U, TS-239/U, (1) Multimeter TS-352/U, TS-433A/U, (1) AC Voltmeter, (1) Test Tools Set, AN/USM-3, (1) Range Calibrator TS-573/U, (1) Tube Tester TV-3/U or TV-7/U.

**PRINCIPAL COMPONENTS AND PHYSICAL DATA**

COMPONENT	QTY	HEIGHT (Inches)	WIDTH (Inches)	DEPTH (Inches)	UNIT WT. (Pounds)
Azimuth-Elevation-Range Indicator IP-25,1/UPA-25	1	47-1/8	37-7/8	28-1/8	
Power Supply PP-996/UPA-25	1	13	29-1/2	31-1/4	
Voltage Regulator CN-231/UPA-25	1	16-3/16	12	14-7/8	
Power Supply Case CY-1517/UPA-25	1	17-5/8	35-3/4	40-1/2	
Voltage Regulator Case 1 37-3/4 17-3/4 18-1/2 CY-1520/UPA-25					
Indicator Case CY-1518/UPA-25	1	42-5/8	41	39	
Plotting Set Case CY-1519/UPA-25	1	19	17	16-5/c	

**AN/UPA-25: 2**

DATE: 1 July 1964  
COGNIZANT SERVICE: USN

ITEM NAME: INDICATOR GROUP  
TYPE: AN/UPA-26(XN-1)

FEDERAL STOCK NUMBER:

	USA	USN	USAF	USMC
STATUS OH TYPE CLASSIFICATION	Used By	Used By		
Mfg(s) Name or Code Number: Motorola Incorporated (81223)				

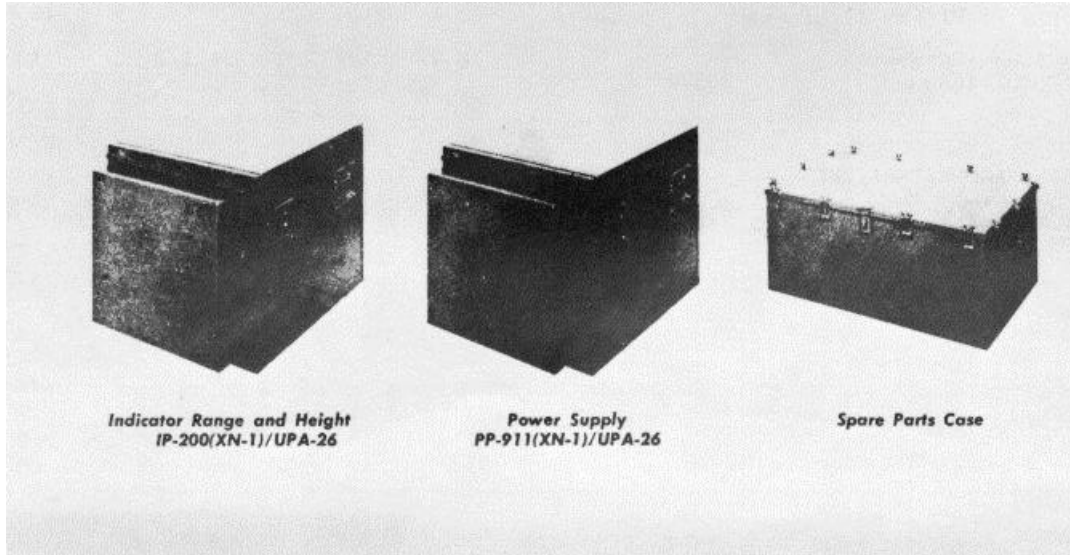

FUNCTIONAL DESCRIPTION

The Indicator Group AN/UPA-26(XN-1) is designed as a transportable range and height indicator with power

supply used in conjunction with the Radar Set AN/MPS-4. It operates in the frequency range of 6275 to 6575 megacycle (mc).

AN/UPA-26(XN-1): 1



**ITEM NAME:** INDICATOR GROUP  
**TYPE:** AN/UPA-26(XN-1)

**RELATION TO SIMILAR EQUIPMENT**

The AN/UPA-26(XN-1) is similar to AN/ SPA-9 except for packaging of components. It is designed to be used with, but not part of Radar Set AN/MPS-4.

**TECHNICAL DESCRIPTION**

Equipment Purpose: As general radar indicator.

Range: 0 to 30 mi; 0 to 60 mi; 0 to 120 mi; 30 to 60 mi; 69 to 90 mi (All mi are naut)

Calibrated Height: 0 to 60,000 ft

Height Measuring Ability:

Relative Accuracy: plus or minus 500 ft measured between two aircraft within same horizontal beamwidth of antenna with vertical separation between aircraft not more than 2000 ft.

Absolute Accuracy: plus or minus 2000

ft at angles above 1/2 deg  
Video Bandwidth: 6 mc  
Video Input Impedance: 75 ohms  
Acceptable Trigger Pulse Repetition Rate: 400 to 650 pps  
Operating Frequency: 6275 to 6575 mc  
Operating Power Requirements: 115v ac, 60 cps, 1-ph, 700w

**INSTALLATION CONSIDERATIONS**

Related Equipment: (Required but not Supplied) (1) Radar Set AN/MPS-4; (1) Technical Manual for Radar Set AN/MPS-4, NAVSHIPS 91373; (1) Technical Manual for AN/UPA-25, NAVSHIPS 91994; (1) Technical Manual for MX-1104/MPS-4, NAVSHIPS 91770; (1) Modification Kit MX-1104/MPS-4; (2) Indicator Groups AN/UPA-25.

**PRINCIPAL COMPONENTS AND PHYSICAL DATA**

<b>COMPONENTS</b>	<b>QTY</b>	<b>OVERALL DIMENSIONS (Inches)</b>	<b>UNIT WT. (Pounds)</b>
Range & Height Indicator IP-200(XN-1)/UPA-26	1	22-1/2 x 24 x 33	201
Power Supply PP-911(XN-1)/UPA-26	1	22-1/2 x 24 x 33	256
Set of Equipment Spares (16-C-170001-466)	1	16-7/8 x 24-1/2 x 39-1/2	138

**REFERENCE DATA AND LITERATURE**

Technical Manuals:  
NAVSHIPS 91763(A)

**AN/UPA-26(XN-1): 2**

DATE: 15 April 1964

ITEM NAME: INDICATOR GROUP

COGNIZANT SERVICE: USAF

TYPE: AN/UPA-35

FEDERAL STOCK NUMBER: 5840-505-0580

	USA	USN	USAF	USMC
STATUS OR TYPE CLASSIFICATION			Alt Std	
Mfg(s) Name or Code Number: Hazeltine Electronics Corp., Little Neck, N. Y.				

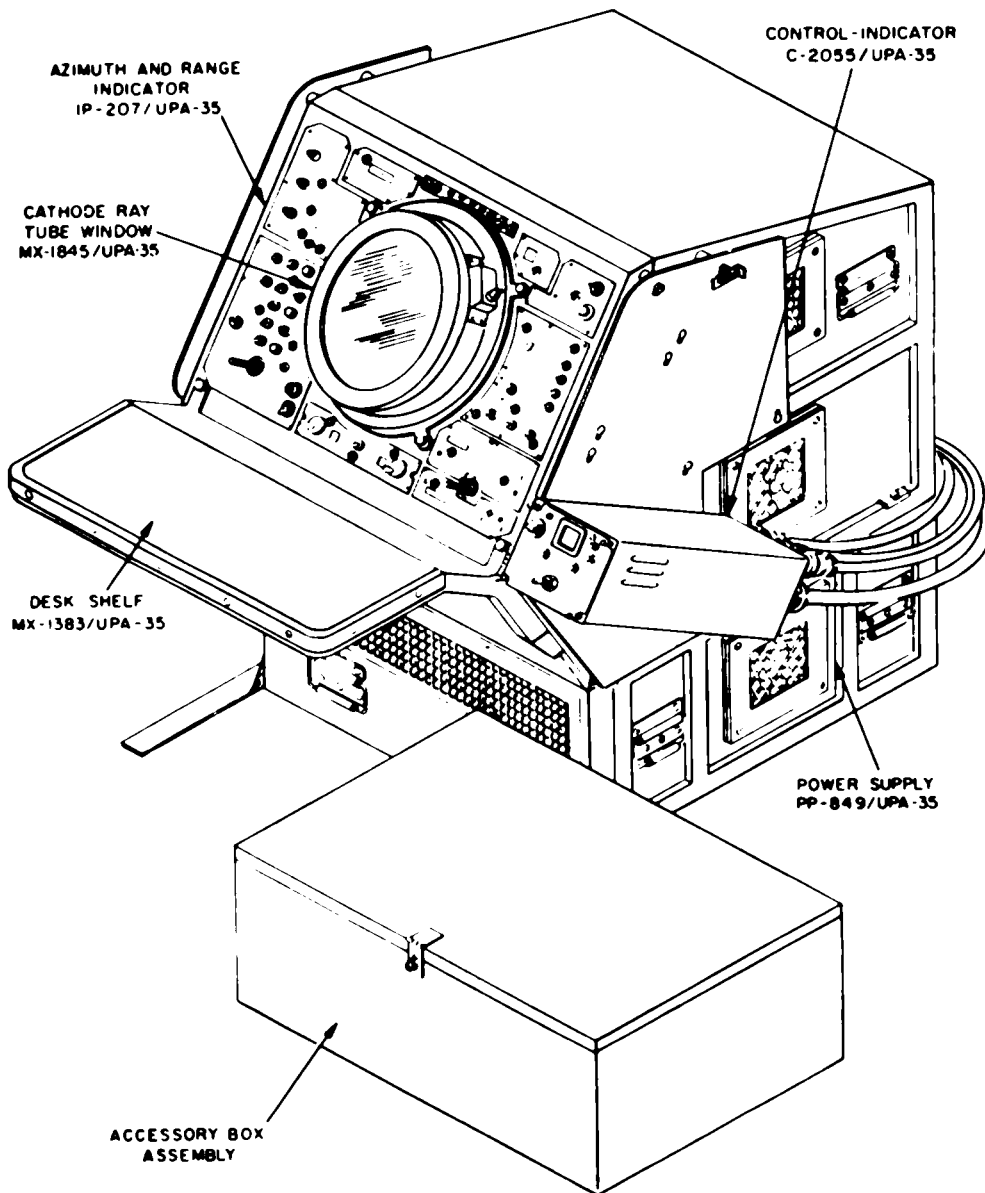

AN/UPA-35: 1

AN/UPA-35

**FUNCTIONAL DESCRIPTION**

Indicator Group AN/UPA-35 is a universal plan position indicator. The indicator provides a visual display of azimuth, range, and height data (both absolute and relative) of targets detected by search and height-finding radar sets. The indicator may be used to display continuous signals from a radar direction finding set. It may be used also to display range and azimuth between any two targets within a range of 10 to 250 naut mi. Ease of operation of the AN/UPA-35 is aided by the ability of the indicator to retain information. Where more than one AN/UPA-35 is used with one height-finding radar antenna, indicators may control the single antenna at preset intervals.

Radar information displayed by the AN/UPA-35 permits control and direction of military aircraft from a ground station.

Video Off-Centering: 0 to 250 rmi in any azimuth  
 Delayed Sweep: 4 to 200 mi  
 Input and Output Impedances: 68 ohms  
 Direction Finder Input: Synchro data from DF system  
 Direction Finder Gate: 2, .05v, 250 to 15,000 μsec  
 Azimuth Accuracy: Total error between sweep input synchros and cursor output synchros does not exceed 1 deg at antenna speeds of 0 to 10 rps; -1.5 deg at antenna speeds of 10 to 15 rps using a 1- and 36-speed servo system. Indicator operates satisfactorily with 1-speed synchro input data.  
 Range Strobe Output: 10 t3v; 2 t1 ;sec  
 Azimuth Output: 1- and 36-speed synchro data output determined by position of electronic cursor for control of height-finder antenna.

**RELATION TO SIMILAR EQUIPMENT**

None.

**TECHNICAL DESCRIPTION**

Range: 10 to 250 mi, variable manually  
 Operating Voltages and Power Requirements:  
 115 vac, 55 to 65 cps, 1-ph, 1.82 kva  
 Type of Presentation: Video (12-in. CRT) and mechanical indicators  
 Pulse Repetition Rate: 200 to 600 pps (determined by prr of associated radar)  
 Trigger Input: 5 to 50v  
 Trigger Pulse Width: 0.5 to 6.5 usec  
 Video Input: 1 to 2.5v, video, IFF and beacon  
 Mapping Antenna and Trace Speed: 0 to 20 rpm (can be sector scanned)

**INSTALLATION CONSIDERATIONS**

Siting: Dependent on associated Radar Set.  
 Mounting: Indicator Group AN/UPA-35 may be installed in the operations building or elsewhere.  
 Cabling Requirements: When Indicator Group AN/UPA-35 is used with Radar Sets AN/TPS-10D, AN/MPS-16, AN/FPS-4, and AN/MPS-8, some interconnecting cables must be fabricated.  
 Related Equipment:  
 Search sets used with the AN/UPA-35 are: AN/FPS-3, AN/FPS-8, AN/FPS-10, AN/CPS-6B, AN/MPS-7, AN/MPS-11, and AN/TPS- ID. Height finder radars used with the AN/UPA-35 are: AN/FPS-4, AN/FPS-6, AN/MPS-8, AN/MPS- 14, AN/MPS- 16, and AN/TPS- 10D.

**PRINCIPAL COMPONENTS AND PHYSICAL DATA**

COMPONENT	QTY	HEIGHT (Inches)	WIDTH (Inches)	DEPTH (Inches)	UNIT WT. (Pounds)
Azimuth and Range Indicator IP-207/UPA-35	1	29- 1/4	35	26	350
Power Supply PP-1113/UPA-35	1	6-3/16	9	12-1/8	11
Power Supply PP-849/UPA-35	1	12-3/4	26	26-1/4	225
Control Indicator C-2055/UPA-35	1	5-7/8	5-7/8	16-5/8	15

**REFERENCE DATA AND LITERATURE**

Technical Orders:  
31P -21:PA35- Series

DATE: 15 September 1964

ITEM NAME: INDICATOR GROUP

COGNIZANT SERVICE: USAF

TYPE: AN/UPA-48

FEDERAL STOCK NUMBER: No Federal Stock Number Non-Pub

	USA	USN	USAF	USMC
STATUS OR TYPE CLASSIFICATION			No Status Assigned	
Mfg(s) Name or Code Number: Westinghouse Electric Corporation				

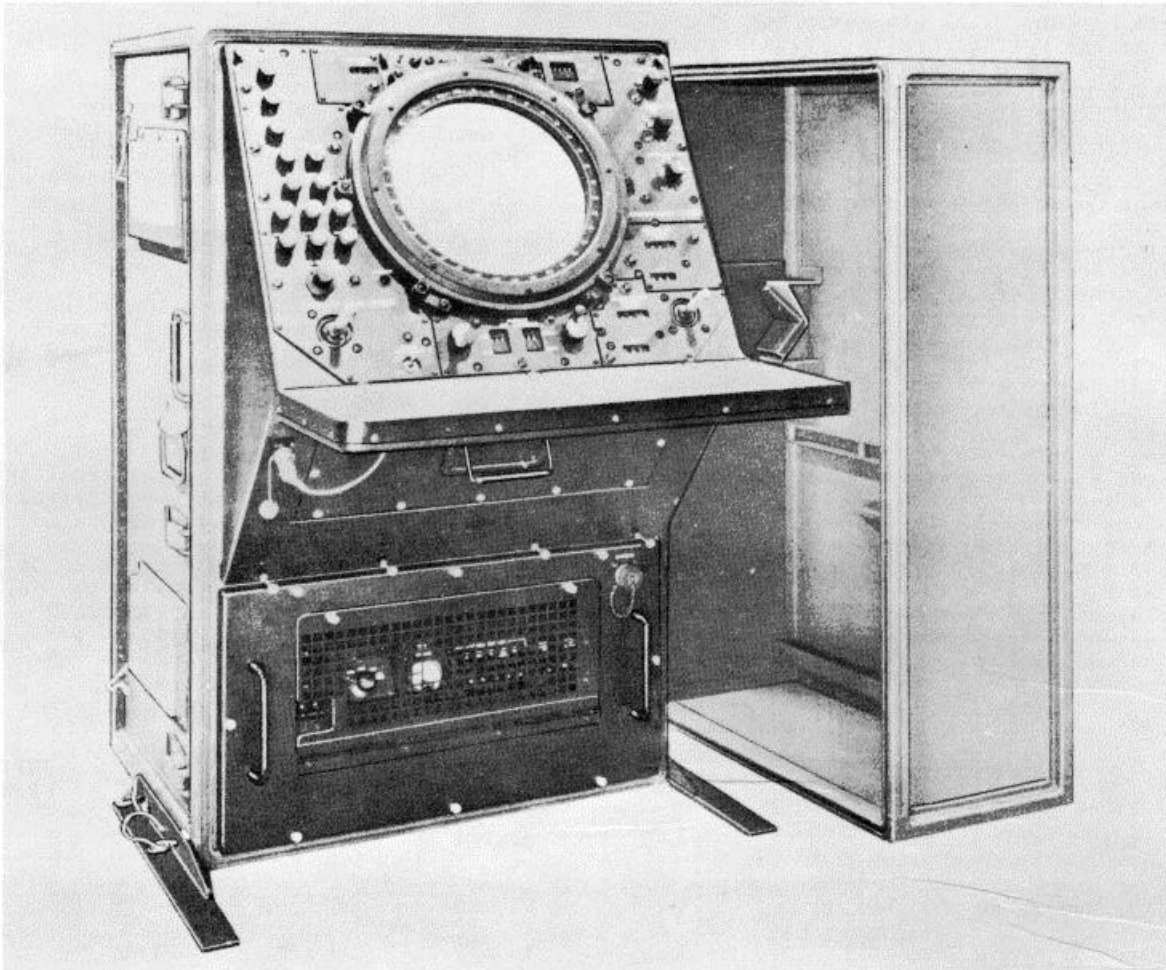

**FUNCTIONAL DESCRIPTION**

Indicator Group is a console type plan-position indicator designed for use with search or height finder radar systems. Provides visual presentation of range, azimuth and height. Special features:

transistorized, portable, ruggedized, off-center scanning, accepts 8 radar video inputs, 1 special input combines 2 videos, 6 digital inputs to mix digital data into video data, delayed sweep capability, adaptable, by motor, servo shychro power supply replacement to any power source, may be

**ITEM NAME:** INDICATOR GROUP

**TYPE:** AN/UPA-48

used in a variety of radar systems applications.

**RELATION TO SIMILAR EQUIPMENT**

None.

**TECHNICAL DESCRIPTION**

**Power Requirements:**

Type: 120v plus or minus 10%, 2-wire single ph, 400 cps plus or minus 35 cps  
Voltage Tolerance: 2.5v (max fluctuation)  
Power Consumption: 800 w  
Crest Factor: 1.4 plus or minus 10%  
Form Factor: 1.11 plus or minus 5%  
Transient Voltage Limits: Plus or minus 30 pct for 3 seconds duration. Equipment may stop operating but will re-stabilize after proper voltage is reapplied.

**Functional Characteristics:**

Range Coverage: Variable from 25 to 375 mi  
Azimuth Coverage: 360 deg or any sector.  
Range Accuracy: Plus or minus 1 pct or 0.5 mi, whichever is the greatest.  
Azimuth Accuracy: Plus or minus 0.5 deg  
Off-Centering Control: Continuously variable up to 250 mi in any direction.  
Displaced Cursor Control: The cursor origin can be located at any position on the display.  
Range Strobe Control: The range strobe can be located at any position on the cursor.  
Height Finder Cursor Control: For height finding information, the cursor origin can be preset to any location within a ten mile radius.  
Delayed Sweep Control: The sweep origin can be delayed any amount between 0 and 350 miles.

**Signal Characteristics:**

**Sweep Trigger Inputs**

Amplitude: 5 to 75v peak (across 75 ohms).  
Pulse Width: 0.5 to 10 usec  
Polarity: Positive.  
Pulse Repetition Frequency (prf): 150 to 1000 pps with up to 10 pct jitter.

**Video Signal Inputs**

Amplitude: 1 to 2.5v peak (across 75 ohms).  
Pulse Width: Between 0.5 and 15,000 usec  
Polarity: Positive.

**Azimuth Signal Inputs: 1 speed and 36**

speed 400 cps, synchro data at antenna.

**Range Pulse Output for Height Computation Gating:**

Amplitude: 10 plus or minus 3v peak (across 75 ohms).

Pulse Width: 2 plus or minus 1 usec

Polarity: Positive.

Pulse Repetition Frequency (prf): 150 to 600 pps

**Azimuth Information for Height Computation**

Gating: 1 speed and 36 speed, 400 cps synchro data for the cursor bearing.

**INSTALLATION CONSIDERATIONS**

**Siting:** Sufficient space should be allowed for rear ventilation as well as adequate servicing room around all sides.

**Mounting:** Portable.

**Cabling Requirements:** All external inter-connection cabling must be supplied by the installing activity (GEP).

**Related Equipments:** The AN/UPA-4b is used with but not part of AN/MPS-16, AN/FPS-26, AN/UPS-1, AN/TPS-21, AN/MSQ-3. Also, AN/UPA-48 is part of AN/TPS-22 and AN/TPS-27.

**PRINCIPAL COMPONENTS AND PHYSICAL DATA**

COMPONENT	QTY	HEIGHT (Inches)	WIDTH (Inches)	DEPTH (Inches)	UNIT WT. (Pounds)
Azimuth-Elevation-Range Indicator IP-607/UPA-48	1	29-1/4	26	31-1/4	
Power Supply PP-3074/UPA-48	1	14.380	26	21-1/8	
Indicator Group Case CY-3215/UPA-48	1	46-1/4	28-1/8	36-7/16	

**REFERENCE DATA AND LITERATURE**

**TECHNICAL ORDERS:**  
31PI-2UPA48 Series

DATE: 1 July 1964

ITEM NAME: RADAR BEACON

COGNIZANT SERVICE: USN

TYPE: AN/UPN-2

FEDERAL STOCK NUMBER:

	USA	USN	USAF	USMC
STATUS OR TYPE CLASSIFICATION				

Mfg(s) Name or Code Number: Hallicrafters Company, Chicago, Illinois

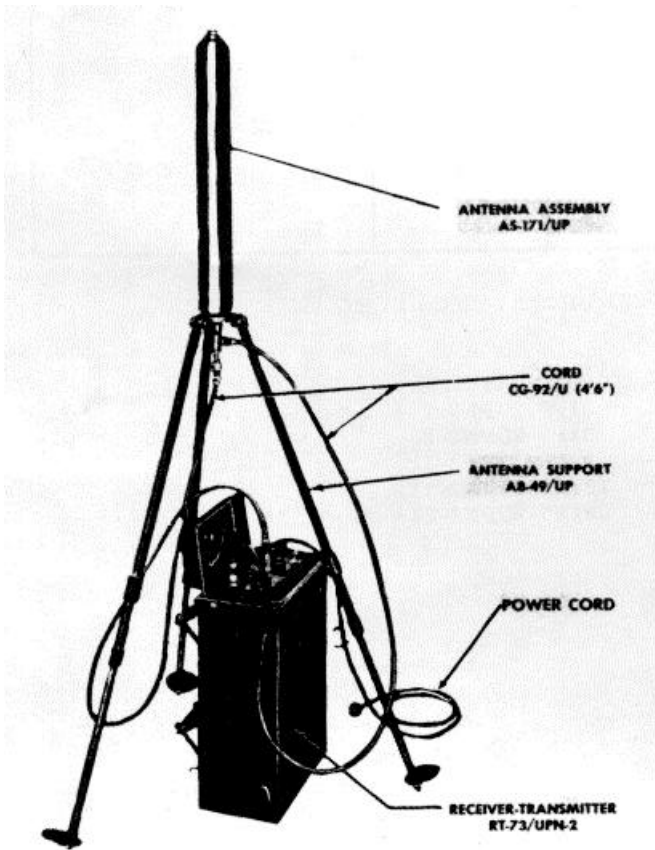

**FUNCTIONAL DESCRIPTION**

Radar Beacon AN/UPN-2 is a ground beacon. It identifies ground installations and operates auto-

matically over line-of-site distances. Provisions are made for the receiver and transmitter of the AN/UPN-2 to be monitored visually and aurally. Monitoring permits personnel to know when the equipment is being interrogated. The AN/UPN-2 is interrogated by, and responds to, various radar equipments on a frequency of 3256 mc.

Receiver-Transmitter RT-73/UPN-2 may be installed in aircraft. Antenna AS-171/UP is not suitable for aircraft installation.

**RELATION TO SIMILAR EQUIPMENT**

None.

**TECHNICAL DESCRIPTION**

Frequency: 3256 mc  
Power Output: 50w  
Operating Voltages and Power Requirements:  
100 to 130v or 200 to 260v, 50 to 2, 400 cps,  
1-ph; PF 95%  
Type of Presentation: Visual and aural  
Type of Signal: Pulse

**INSTALLATION CONSIDERATIONS**

Siting: If Radar Beacon AN/UPN-2 is installed in an aircraft, a different type antenna must be substituted for Antenna Assembly AS- 171/UP.

Mounting:  
Cabling Requirements:  
Related Equipments:

**AN/UPN-2**

**PRINCIPAL COMPONENTS AND PHYSICAL DATA**

<b>COMPONENT</b>	<b>QTY</b>	<b>HEIGHT (Inches)</b>	<b>WIDTH (Inches)</b>	<b>DEPTH (Inches)</b>	<b>UNIT WT.</b>
Receiver-Transmitter RT-73/UPN-2	1	13	11	25-1/2	53- 1/2*
Case, CY-223/UPN-2	1	13	7	21-1/2	
Harness, MX-254/UPN-2	1				
Antenna Assembly AS- 171/UP	1		7 (dia)	25-1/2	17**
Antenna Support, AB-49/UP	1	58-1/2			
Cord, CG-92	2	54			
Case, CY-225/UP	1		7 (dia)	41	6-1/2
Set of Equipment Spares	1	12	7	13	

**NOTES: \*Includes Case CY-223/UPN-2**

**\*\*Includes Ant Support AB-49/UP, Case CY-225/UP and both Cords CG-92.**

**REFERENCE DATA AND LITERATURE**

Technical Manual:  
CO-AN16-30UPN2-2-M

**Technical Orders:**

31P5-2UPN2-1  
31P5-2UPN2-2  
31P5-2UPN2-11  
31P5-2UPN2- 12  
31P5-2UPN2-24

**DATE:** 1 July 1964

**ITEM NAME:** RADAR BEACON

**COGNIZANT SERVICE:** USN

**TYPE:** AN/UPN-3

**FEDERAL STOCK NUMBER:** F5825-302-8066

	USA	USN	USAF	USMC
STATUS OR TYPE CLASSIFICATION				
Mfg(s) Name or Code Number: General Electric Company, Schenectady, New York				

Illustration not Available.

**FUNCTIONAL DESCRIPTION**

The AN/UPN-3 is a portable transponder designed for ground operation in conjunction with airborne radar equipment. It is an "XA" band beacon, having a range of

approximately 25 miles. It is capable of being interrogated by "X" band airborne radars and beacon function and replying with a coded signal permitting the beacon to be located in range and azimuth.

**AN/UPN-3: 1**



**ITEM NAME:** RADAR BEACON

**TYPE:** AN/UPN-3

**RELATION TO SIMILAR EQUIPMENT**

None.

Range: Up to 25 mi

Power Requirements: 110v ac, 60 to 400  
cps

**TECHNICAL DESCRIPTION**

Type of Band: "XA" band

**INSTALLATION CONSIDERATIONS**

Not available.

**PRINCIPAL COMPONENTS AND PHYSICAL DATA**

<b>COMPONENTS</b>	<b>QTY</b>	<b>OVERALL DIMENSIONS (Inches)</b>	<b>UNIT WT. (Pounds)</b>
Radar Beacon AN/UPN-3	1		50

**AN/UPN-3: 2**

DATE: 15 September 1964

ITEM NAME: RADAR BEACON

COGNIZANT SERVICE: USAF

TYPE: AN/UPN-4

FEDERAL STOCK NUMBER: 5895-699-0015-EG

	USA	USN	USAF	USMC
STATUS OR TYPE CLASSIFICATION		LS		
Mfg(s) Name or Code Number: Gilfillan Brothers				

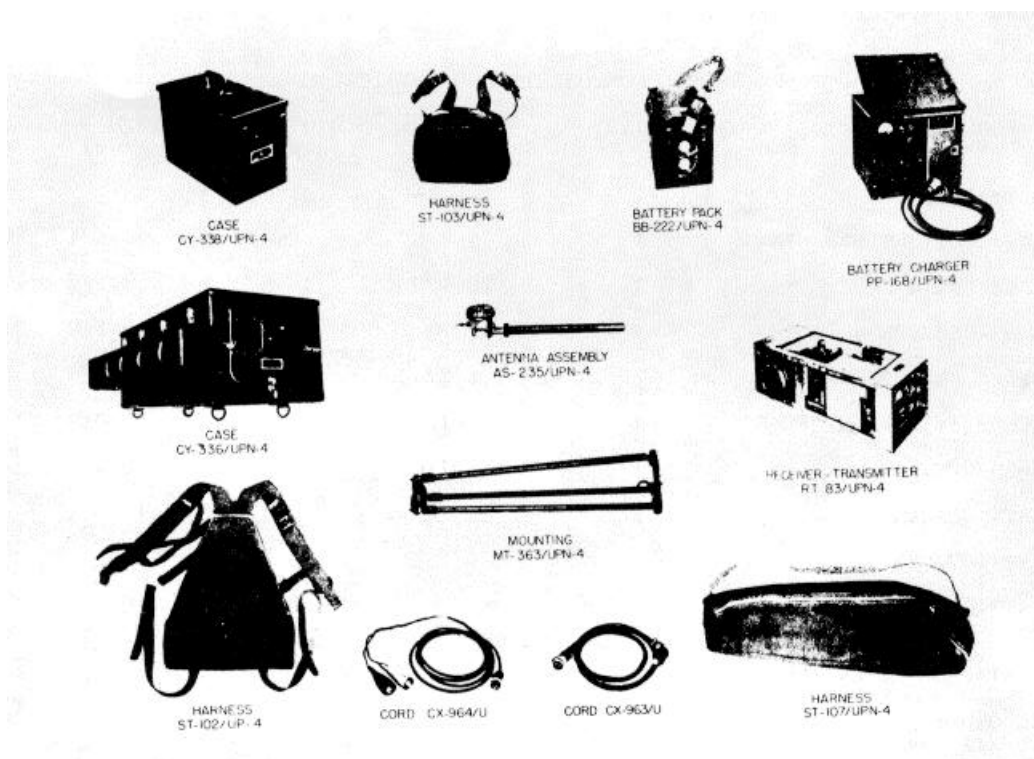

**FUNCTIONAL DESCRIPTION**

Radar Beacon AN/UPN-4 is a portable transponder designed for ground operation in conjunction with airborne radar equipment. Upon reception of signals

from an interrogating radar, the beacon receiver triggers the beacon transmitter which, in turn, transmits coded response signals. The response signals provide recognition, azimuth and range information.

AN/UPN-4: 1

**ITEM NAME:** RADAR BEACON

**TYPE:** AN/UPN--1

**RELATION TO SIMILAR EQUIPMENT**

None.

**TECHNICAL DESCRIPTION**

Power Requirements: 10.5 to 12.5v, dc,  
50 w (furnished by Battery pack  
BB-222/UPN-4).  
Battery Charger: Requires 110v or 220v,  
50 to 400 cycles.  
Receiver: freq range, 9320 mc to 9430 ac  
Band Width: 110 mc  
Sensitivity: 2 μsec pulse, .02 uw  
Transmitter: freq range, 9308.5 mc to  
9311.5 mc  
Pulse Width: 0.5 usec  
Power Output (peak): 500 w  
Code Combinations: 5  
Distance Range: 18 to 65 mi (line of  
sight).  
Antenna: two arrays of 10 vertically

stacked elements.  
Polarization: Horizontal  
Gain: 10 db  
Vertical Beam Width: 10 to 15 deg  
Horizontal Pattern: omnidirectional  
Transmission Line: Waveguide

**INSTALLATION CONSIDERATIONS**

Siting: The equipment should be placed  
in a cleared area of 50 ft radius on  
the highest available location.

Mounting: The equipment is placed on the  
mounting legs of the MT-363/UPN-4.

Cabling Requirements: Furnished with  
equipment.

Related Equipments: Various airborne  
radar equipment.

**PRINCIPAL COMPONENTS AND PHYSICAL DATA**

<b>COMPONENT</b>	<b>QTY</b>	<b>HEIGHT (Inches)</b>	<b>WIDTH (Inches)</b>	<b>DEPTH (Inches)</b>	<b>UNIT WT.</b>
Receiver-Transmitter RT-83/UPN-4	1	7-1/16	10-3/16	23	34.5
Antenna Assembly AS-235/UPN-4	1	4-3/8	5-3/8	24-1/4	3.5
Case CY-336/UPN-4	1	10-1/2	16-5/8	28-1/2	18
Mounting MT-363/UPN-4	1	7	7	33-1/2	10
Battery Pack BB-222/UPN-4	2	6-3/4	7-1/4	11-1/4	24.5
Battery Charger PP-168/UPN-4	1	10-1/4	11-3/4	11-5/8	37.5
Case CY-338/UPN-4	1	6-1/8	7-7/8	12-1/8	16
Harness ST-102/UPN-4	1	3	12-1/8	15	2.75
Harness ST-107/UPN-4	1	6	8-1/2	34	1.75
Harness ST-103/UPN-4	1	7	8-1/4	12	1.75

**REFERENCE DATA AND LITERATURE**

TECHNICAL ORDERS:  
31P5-2UPN- Series

DATE: 1 July 1964

ITEM NAME: RADAR TRAINER

COGNIZANT STOCK: USN

TYPE: AN/UPS-T4

FEDERAL STOCK NUMBER: F6940-295-2562  
F6940-669-6590 W/S

	USA	USN	USAF	USMC
STATUS OR TYPE CLASSIFICATION				
Mfg(s) Name or Code Number: Fada Radio and Electric Co., Inc., Belleville, New Jersey				

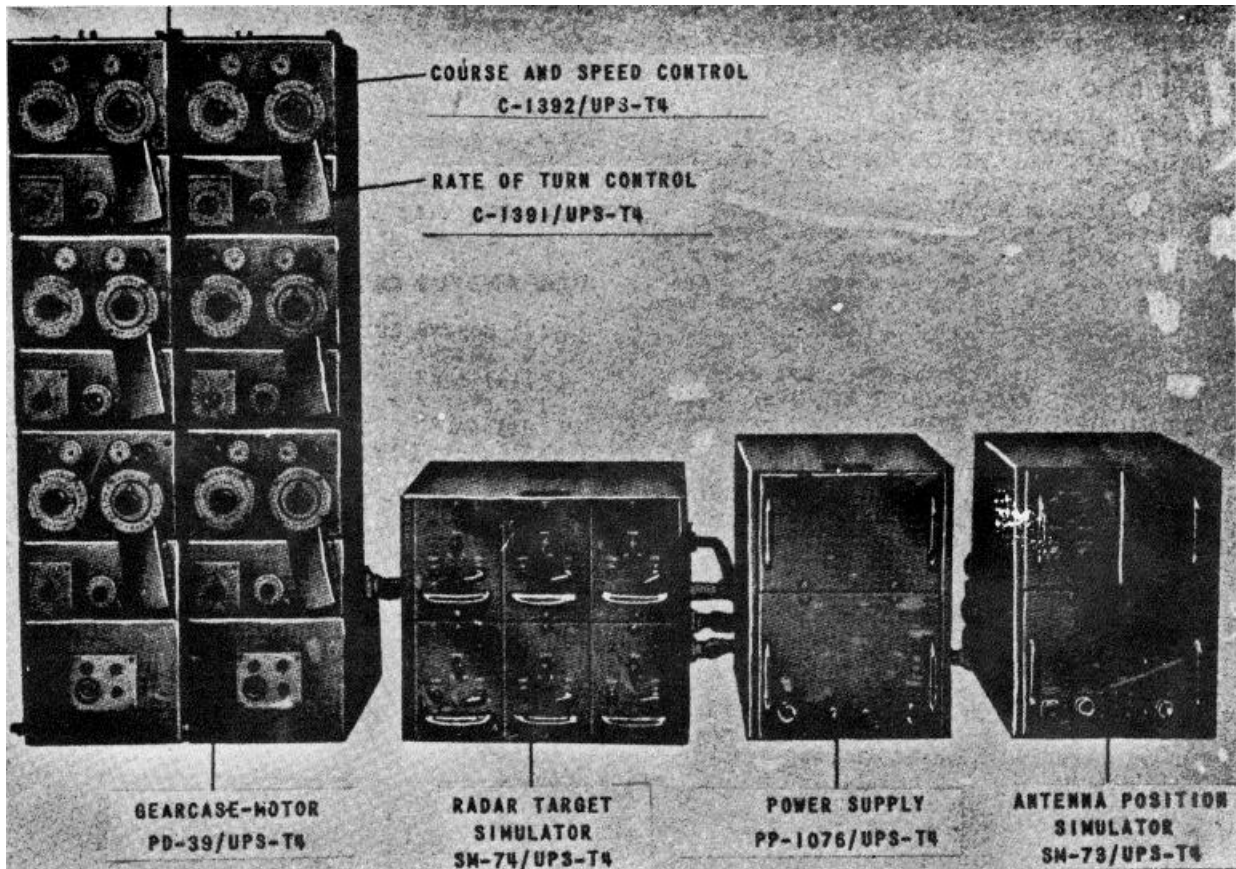

**FUNCTIONAL DESCRIPTION**

The AN/UPS-T4 is designed primarily for use as a problem generator for C/C and related training. It provides realistic radar signals representing ship, moving aircraft, or guided missile targets, which

are displayed by the radar systems associated with the C/C. The Instructor has full control of the target maneuvers. The device also has limited use as a radar operator trainer. The equipment will operate with most standard types of search radar. Pulse width, pulse repetition frequency,

**ITEM NAME:** RADAR TRAINER

**TYPE:** AN/UPS-T4

antenna beam width, rotation speed and maximum range are adjustable to meet the requirements of the specific search radar.

rpm and 1.0° for max rpm.  
Internal Control: With 1 speed synchro  
3 to 24 rpm  
Minimum Range  
30 Naut Mi Operation: 1/2 mi  
120 Naut Mi Operation: 2 mi  
210 Naut Mi Operation: 1 mi  
Accuracy  
Range: plus or minus 3% of setting  
Target Maneuvering: plus or minus 2% in speed, plus or minus 20 in course.  
Target Output Pulse: Video pulse plus or minus 2.5v min  
Signal Inputs  
For Operation with PPI Repeater: None.  
For Operation with Radar Set: 16v min pos trigger pulse and standard 1 speed antenna synchro-information to a control transformer.  
Output Available for PPI Repeater: plus or minus 2.5v video pulse, 20v min pos trigger pulse, standard 1 speed antenna synchro v from 6G.  
IFF Signal: May be selected for as many targets as available.

**RELATION TO SIMILAR EQUIPMENT**

None.

**TECHNICAL DESCRIPTION**

Type of Target

- Ships Speed: 5 to 30 knots.
- Aircraft Speed: 100 to 600 knots.
- Guided Missiles and/or Aircraft Targets  
Speed: 200 to 1200 knots.

Number of Targets: 6, 12, 16, 24 or 30 targets may be simulated.

Pulse Width: 2 μsec nom

Pulse Repetition Frequency

- External: 350 pps max
- Internal: Adjustable from 10 to 1400 pps

Radar Antenna Horizontal Beam Width: Fixed at 1-1/2° or adjustable from 4-1/2 to 10°.

Maximum Radar Range Scales

- Ships: 30 naut mi
- Aircraft Targets: 120 naut mi
- Guided Missiles and/or Aircraft Targets:  
0 to 200 per sec

Antenna Rotation Speed

- External Control: With 1 speed synchro, 4 to 12 rpm, max error 0.1°O for min

**INSTALLATION CONSIDERATIONS**

Related Equipment:  
Required but not Supplied  
Search Radar Equipment and/or Remote Plan Position Indicator.

**PRINCIPAL COMPONENTS AND PHYSICAL DATA**

<b>COMPONENT</b>	<b>BOXES (NR.)</b>	<b>OVERALL DIMENSIONS (Inches)</b>	<b>UNIT WT. (Pounds)</b>
Antenna Position Simulator SM-73/UPS-T4	1		164
Radar Target Simulator SM-74/UPS-T4	1		150
Power Supply PP-1076/UPS-T4	1		155
(6) Course and Speed Control C-1392/UPS-T4	1		198
(6) Rate of Turn Control C-1391/UPS-T,	1		100
(2) Gear Case-Motor PD-39/UPS-T4	1		60
Step-Down Power Transformer TF-194/UPS-T4	1		
Step-Down Power Transformer TF-192/UPS-T4	1		
Box Spares for Unit 3	1		5
Spare Cards and Installation Kit	1		170

**AN/UPS-T4: 2**

ITEM NAME: RADAR TRAINER

TYPE: AN/UPS-T4

PRINCIPAL COMPONENTS AND PHYSICAL DATA

COMPONENTS	QTY	OVERALL DIMENSIONS (Inches)	UNIT WT. (Pounds)
Antenna Position Simulator SM-73/UPS-T4	1	15 x 18 x 20	82
Radar Target Simulator SM-74/UPS-T4	1	17 x 17 x 21	82
Power Supply PP-1076/UPS-T4	1	15 x 18 x 20	90
Course & Speed Control C-1392/UPS-T4	6	7-1/4 x 10-3/4 x 12-1/2	28
Rate of Turn Control C-1391/UPS-T4	6	5-1/16 x 10-5/8 x 15	15
Gear Case-Motor PD-39/UPS-T4	2		
Step-Down Power Transformer TF-194/UPS-T4	1	4 x 4 x 9	24
Step-Down Power Transformer TS-193/UPS-T4	1	5 x 5 x 11	22.5

REFERENCE DATA AND LITERATURE

Technical Manuals:  
NAVSHIPS 92129

AN/UPS-T4: 3

**DATE:** 1 July 1964

**ITEM NAME:** RADAR TRAINING SET

**COGNIZANT SERVICE:** USN

**TYPE:** AN/UPT-T3

**FEDERAL STOCK NUMBER:**

	USA	USN	USAF	USMC
STATUS OR TYPE CLASSIFICATION				
Mfg(s) Name or (de Number: Harvey Radio Laboratories, Inc., Cambridge, Massachusetts				

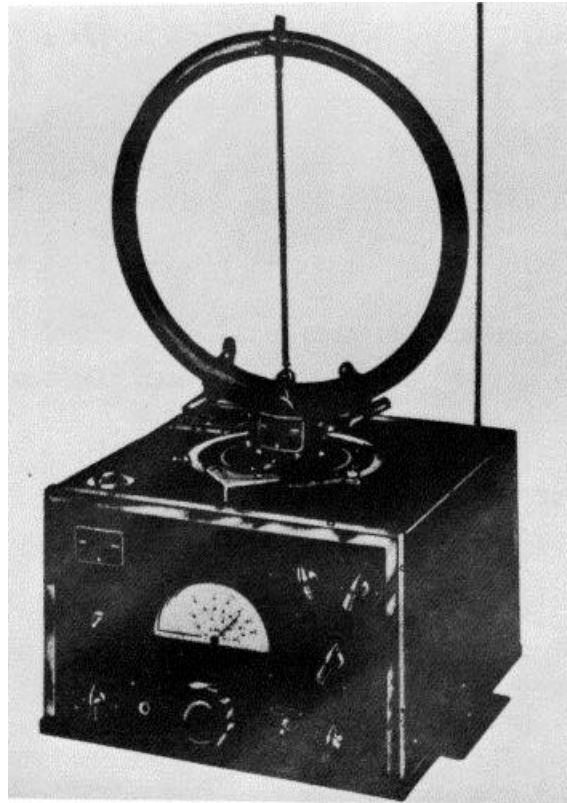

**FUNCTIONAL DESCRIPTION**

The AN/UPT-T3 is a low power Jamming transmitter designed for generating jamming signals and transferring them, either by means of its antenna or by

direct coupling, to a radar equipment. It is used for training radar operators to recognize enemy countermeasures and study techniques useful against such countermeasures.

**AN/UPT-T3: 1**

**ITEM NAME:** RADAR TRAINING SET

**TYPE:** AN/UPT-T3

**RELATION TO SIMILAR EQUIPMENT**

None.

modulated sine wave.  
RF Power Output: 50 mw  
Power Requirements: 110 plus or minus 10v,  
60 cps, 1-ph, 1.4d amps, 90% pf  
Type Antenna: Horn type.  
Antenna Beam: Approx 35°

**TECHNICAL DESCRIPTION**

Frequency Range: 2700 to 3300 mc  
Emission: CW, noise, sine wave, over-modu-  
lated sine wave.  
Modulation: 50 to 100% for all but over-

**INSTALLATION CONSIDERATIONS**

Not available.

**PRINCIPAL COMPONENTS AND PHYSICAL DATA**

**SHIPPING DATA**

<b>COMPONENT</b>	<b>BOXES (NR.)</b>	<b>OVERALL DIMENSIONS (Inches)</b>	<b>UNIT WT. (Pounds)</b>
Chest CY-407/UPT-T3 containing: Transmitter-Modulator T-132/UPT-T3 Antenna AS-268/UPT-T3 Antenna Cable Power Cable	1	21-1/2 x 30-1/4 x 31-1/2	239
Set of Equipment Spares	1	15-1/4 x 15-1/2 x 23	85

**EQUIPMENT SUPPLIED DATA**

<b>COMPONENTS</b>	<b>QTY</b>	<b>OVERALL DIMENSIONS (Inches)</b>	<b>UNIT WT. (Pounds)</b>
Chest CY-407/UPT-T3	1	14-1/4 x 22-1/2 x 24-1/4	59.2
Transmitter-Modulator T-132/UPT-T3	1	12 x 12 x 20	80.2
Antenna AS-268/UPT-T3	1	6 x 6-3/4 x 10-3/8	4.0
Antenna Cable	1	300 lg	2.7
Power Cable	1	120 lg	0.8

**REFERENCE DATA AND LITERATURE**

Technical Manuals:  
NAVSHIPS 900844

**AN/UPT-T3: 2**



DATE: 1 May 1964

ITEM NAME: RADAR RECOGNITION SET

COGNIZANT SERVICE: USAF

TYPE: AN/UPX-6

USA LINE ITEM NUMBER: 621429

FEDERAL STOCK NUMBER: 5895-304-;1934-EG

	USA	USN	USAF	USMC
STATUS OR TYPE CLASSIFICATION			STD	
Mfg(s) Name or Code Number: Radio Receptor, Inc.				

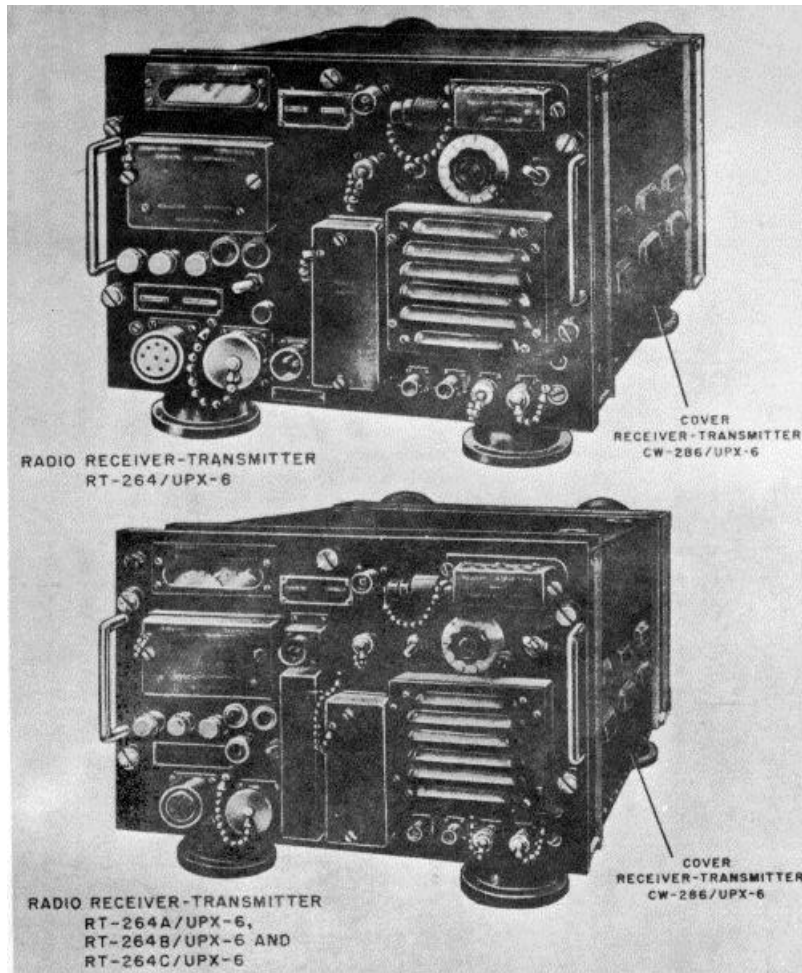

**FUNCTIONAL DESCRIPTION**

Radar Recognition Set AN/UJPX-6 is part of the target identification equipment for a radar set in an IFF system. The AN/UPX-6 is a receiver-Transmitter that transmits coded rf pulses to airborne transponder

identification sets and then converts the transponder reply to video pulses. The video pulses are displayed on the indicators of radar used with the AN/UPX-6. The AN/IUPX-6 has the ability to interrogate any targets detected by its associated radar equipment.

**ITEM NAME:** RADAR RECOGNITION SET

**TYPE:** AN/UPX-6

**RELATION TO SIMILAR EQUIPMENT**

Similar to Interrogator Set AN/IIPX-2 without coder and has power input of 60 and 100 cycles instead of .100 and 800 cycles; similar to Radar Recognition Set AN/I'PX-6X except blower operates on 60 cycles only.

(adjusted to conform with prr of associated radar)  
Receiver Bandwidth:  
Broad - 8 to 11 mc - 60 db  
Narrow - 5 mc - 70 db  
Receiver Input Impedance: 5() ohms  
Receiver Output Impedance: 72 ohms  
Frequency (if.): 60 mc

**TECHNICAL DESCRIPTION**

Frequency:  
Transmitter - 990-10-10 mc  
Receiver - 1080-1130 mc  
Peak Power Output: 1.5 kw  
Operating Voltages and Power Requirements:  
105, 117 or 125v ac, 60 or 100 cps,  
single ph, 250 w  
Type of Presentation: PPI and B indicators  
of associated radar set  
Pulse Width: 1 use<  
Pulse Repetition Rate: 180 to 120 pps

**INSTALLATION CONSIDERATIONS**

Siting: This equipment is located with the associated radar.

Mounting: AN/UPX-6 is installed with the basic radar.

Related Equipments: Radar Recognition Set AN/UPX-6 is used with Identification Sets AN/GPX-9, AN/GPX-17, AN/GPX-18, AN/GPX-20, AN/MPX-7.

**PRINCIPAL COMPONENTS AND PHYSICAL DATA**

<b>COMPONENT</b>	<b>QTY</b>	<b>HEIGHT (Inches)</b>	<b>WIDTH (Inches)</b>	<b>DEPTH (Inches)</b>	<b>UNIT WT.</b>
Radar Recognition Set AN/UPX-6	1	11	15	21	77

**REFERENCE DATA AND LITERATURE**

TECHNICAL ORDERS:  
31P4-2UPX6- Series

DATE: 15 September 1964

ITEM NAME: RADAR RECOGNITION SET

COGNIZANT SERVICE: USAF

TYPE: AN/U1PX-6X

FEDERAL STOCK NUMBER: No Stock Number Assigned

	USA	USN	USAF	USMC
STATUS OR TYPE CLASSIFICATION			AS	
Mfg(s) Name or Code Number: Radio Receptor, Inc.				

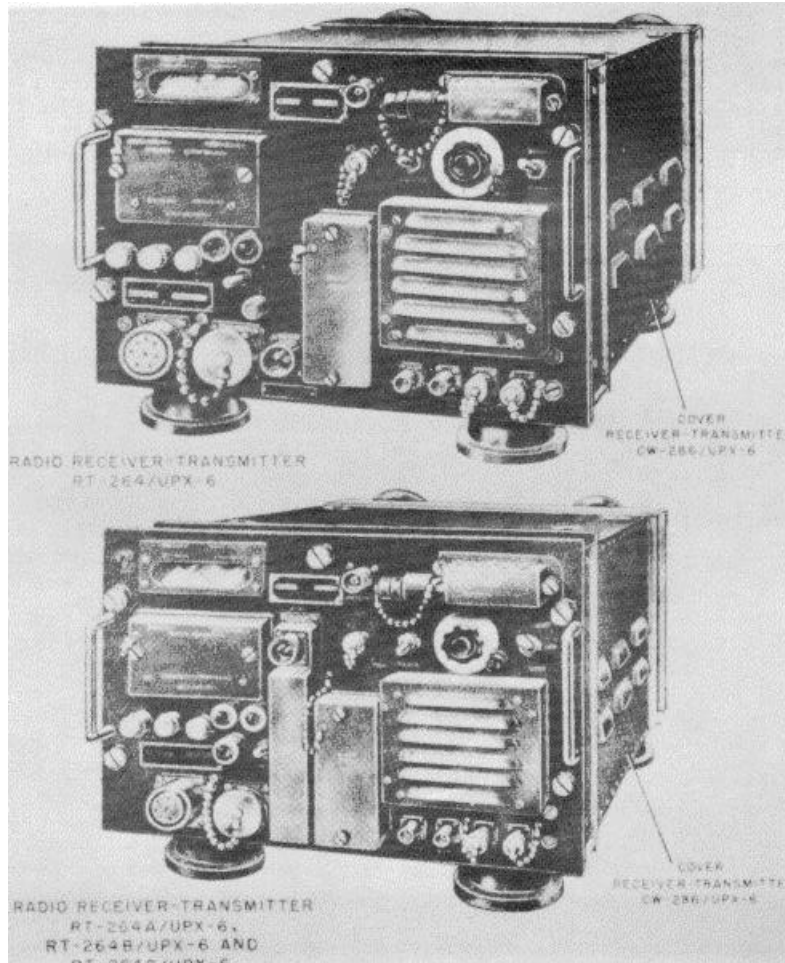

### FUNCTIONAL DESCRIPTION

Radar Recognition Set AN/U1PX-6X is part of the target identification equipment for a radar set in an IFF system. The AN/U1PX-6X is a receiver-transmitter that transmits coded rf pulses to airborne transponder

identification sets and then converts the transponder reply to video pulses. The video pulses are displayed on the indicators of radar used with the AN/U1PX-6X. The AN/U1PX-6X has the ability to interrogate any targets detected by its associated radar equipment.

AN/U1PX-6X: 1

**ITEM NAME:** RADAR RECOGNITION SET

**TYPE:** AN/UPX-6X

**RELATION TO SIMILAR EQUIPMENT**

AN-UPX-6X is similar to Interrogator Set AN/UPX-2 without coder and has power input of 60 and 400 cycles instead of 400 and 800 cycles. Same as Radar Recognition Set AN/UPX-6 except blower operates on 100 cycles only.

**TECHNICAL DESCRIPTION**

Frequency:

Transmitter - 990-1040 mc

Receiver - 1080-1130 mc

Peak Power Output: 1.5 kw

Operating Voltages and Power Requirements:

105, 117 or 125v ac, 60 or 400 cps,  
single ph, 250 w

Type of Presentation: PPI and B indicators  
of associated radar set

Pulse Width: 1 usec

Pulse Repetition Rate: 180 to 420 pps

(adjusted to conform with prr of  
associated radar)

Receiver Bandwidth:

Broad - 8 to 11 mc, 60 db

Narrow - 5 mc, 70 db

Receiver Input Impedance: 50 ohms

Receiver Out put Impedance: 72 ohms

Frequency (if.): 60 mc

**INSTALLATION CONSIDERATIONS**

Siting: This equipment is located with  
the associated radar.

Mounting: AN/UPX-6X is installed with  
the basic radar.

Related Equipments: AN/UPX-6X is used  
with, but not part of Radar Sets  
AN/CPN-4 and AN/CPN-18. Also is used  
with Identification Sets AN/GPX-9,  
AN/GPX-17, AN/GPX-18, AN/GPX-20,  
AN/MPX-7.

**PRINCIPAL COMPONENTS AND PHYSICAL DATA**

<b>COMPONENT</b>	<b>QTY</b>	<b>HEIGHT (Inches)</b>	<b>WIDTH (Inches)</b>	<b>DEPTH (Inches)</b>	<b>UNIT WT.</b>
Radar Recognition Set AN/UPX-64	1	11	15	21	77

**REFERENCE DATA AND LITERATURE**

TECHNICAL ORDERS:

31P1-2UPX6- Series

DATE: 15 November 1964

ITEM NAME: RADAR SET

COGNIZANT SERVICE: USAF

TYPE: AN/UPX-7

FEDERAL STOCK NUMBER: No Federal Stock Number Assigned

	USA	USN	USAF	USMC
STATUS OR TYPE CLASSIFICATION		LS		
Mfg(s) Name or Code Number: Hazeltine Electronics Corporation				



**FUNCTIONAL DESCRIPTION**

The Radar Set is an interrogator set used to provide checking facilities for Radar Identification Set AN/APX-6. The Radar Set AN/UPX-7 tests both the receiver and transmitter portions of the Radar Identifica-

tion Set AN/APX-6. It does this by providing a coded R-F signal that actuates the receiver portion of the AN/APX-6. Replies from the AN/UPX-7, and the reply signal can then be shown on a suitable display tube (synchroscope).

**ITEM NAME:** RADAR SET

**TYPE:** AN/UPX-7

**RELATION TO SIMILAR EQUIPMENT**

The AN/UPX-7A is the same as the AN/UPX-7 except includes Indicator ID-169/ADN-12, or equivalent.

3 usec apart in Mode 1  
5 usec apart in Mode 2  
8 usec apart in Mode 3  
Power Output: 21 to 30 db above one watt into 51-ohm essentially resistive load.

**TECHNICAL DESCRIPTION**

Frequency Range: 950 to 1150 mc in 12 channels

- Channel 1 - 952 mc
- Channel 2 - 969 mc
- Channel 3 - 986 mc
- Channel 4 - 1003 mc
- Channel 5 - 1020 mc
- Channel 6 - 1037 mc
- Channel 7 - 105,1 mc
- Channel 8 - 1071 mc
- Channel 9 - 1088 mc
- Channel 10 - 1100 mc
- Channel 11 - 1122 mc
- Channel 12 - 1139 mc

Receiver Triggering Sensitivity Level:  
81 to 88 db below one volt.

Selectivity: Between 9.5 and 11.5 mc bandwidth at 6 db down from max response.

Power Requirements, ac: 105 to 12.v, 320 to 1760 cps, 220 w

Power Requirements, dc: 24 to 29v, 40 w at 28v

**INSTALLATION CONSIDERATIONS**

Related Equipments: Used with but not part of Oscilloscope TS-239/1UP, and AN/APX-6.

Output Signal

Coded rf pulse-pairs spaced:

**PRINCIPAL COMPONENTS AND PHYSICAL DATA**

COMPONENT	QTY	HEIGHT (Inches)	WIDTH (Inches)	DEPTH (Inches)	UNIT WT.
Radar Receiver-Transmitter RT-19B/IJPX-7	1				
Control Panel C-774/UPX-7	1				
Antenna Assembly AS-133/APX	1	3-3/16	9-7/16	7-1/4	1.1
Synchroscope OS-5/U	1				
Cable RG-8/U	1				
Cables RG-58/U or RG-62/:	2				
Connectors UG-59A/U	2				

**REFERENCE DATA AND LITERATURE**

Nomenclature card for AN/UPX-7  
TECHNICAL ORDER:  
33A1-3-13- Series

DATE: 15 November 1964

ITEM NAME: RADAR SET

COGNIZANT SERVICE: USAF

TYPE: AN/UPX-7A

FEDERAL STOCK NUMBER: No Federal Stock Number Assigned.

	USA	USN	USAF	USMC
STATUS OR TYPE CLASSIFICATION		LS		
Mfg(s) Name or Code Number.: Stewart-Warner Corporation, Chicago, Illinois				



RECEIVER-TRANSMITTER RT-198A/UPX-7

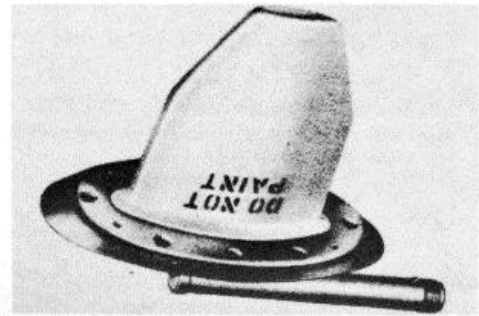

ANTENNA ASSEMBLY AS-133/APX



CONTROL PANEL C-774A/UPX-7

### FUNCTIONAL DESCRIPTION

The Radar Set is an interrogator used for operation in conjunction with Radar Identification Set AN/APX-6 for special checking functions.

### RELATION TO SIMILAR EQUIPMENT

The AN/UPX-7A is the same as the AN/UPX-7, except it includes Indicator ID-169/ADN-12, or equivalent.

AN/UPX-7A: 1

**ITEM NAME:** RADAR SET

**TYPE:** AN/IPX-7A

**TECHNICAL DESCRIPTION**

Frequency Range: 950 to 1150 mc in 12 channels

Center Frequencies:

- Channel 1 - 952 mc
- Channel 2 - 969 mc
- Channel 3 - 986 mc
- Channel 4 - 1003 mc
- Channel 5 - 1020 mc
- Channel 6 - 1037 mc
- Channel 7 - 1054 mc
- Channel 8 - 1071 mc
- Channel 9 - 1068 mc
- Channel 10 - 1100 mc
- Channel 11 - 1122 mc
- Channel 12 - 1139 mc

Output Signal:

- Coded rf pulse-pairs spaced -
  - 3 usec apart in Mode 1
  - 5 usec apart in Mode 2
  - 8 usec apart in Mode 3

Power Output: 24 to d0 db above one into 51-ohm essentially resistive load.

Selectivity: Between 9.5 and 1,1.5 mc bandwidth at 6 db down from max response.

Power Requirements, ac: 105 to 124lv, 320 to 1760 cps; 220 w at 115v

Power Requirements, dc: 2.1 to 29v; 10 w at 27.5v

**INSTALLATION CONSIDERATIONS**

Siting: The location of Radar Set AN/UPX-7A should be such that Antenna AS-133/APX can be mounted so that it will have approximately a line-of-sight path to the pre-flight test location, and high enough to furnish an open space for in-flight testing.

Mounting: If bench testing is to be done, provision for spacing the antenna of the AN/APX-6 at least ten feet from that of the AN/UPX-7A should be made. If only pre-flight or in-flight tests are to be performed, it may be desirable to install the set in a vehicle or trailer.

Cabling Requirements: The length of antenna cable connecting the RT-198A/UPX-7 to the AS-133/APX should be kept under twenty feet.

Related Equipments: Used with, but not part of AN/APX-6. Indicator ID-169A/APN-12, ID-169B/APN-12, BC-929-A or BC-929-C may be used in lieu of Indicator ID-169/APN-12 and Mounting MT-362A/A may be used in lieu of Mounting MT-362/A, depending upon application and availability.

**PRINCIPAL COMPONENTS AND PHYSICAL DATA**

COMPONENT	QTY	HEIGHT (Inches)	WIDTH (Inches)	DEPTH (Inches)	UNIT WT.
Control Panel C-771A/UPX-7	1	3	5-3/4	4-9/16	2
Antenna Assembly AS-133/APX	1	3-3/16	9-7/16	7-1/4	1.1
Mounting for Receiver-Transmitter MT-362A/A	1	2-3/8	11-1/2	9-1/2	3.5
Mounting for Indicator FT-,109-A or suitable mounting for equivalent Indicator	1	2-3/8	8-5/8	15-11/16	2
Receiver-Transmitter RT-198A/UPX-7	1	12-7/16	13-3/16	9-7/8	73.4
Indicator BC--929-C or equivalent	1	8-7/8	8-3/4	16-3/8	21.6

**REFERENCE DATA AND LITERATURE**

Nomenclature card for AN/UPX-7A

TECHNICAL ORDER:  
33A1-3-1.3- Series



**DATE:** 15 January 1965

**ITEM NAME:** INTERROGATOR SET

**COGNIZANT SERVICE:** USAF

**TYPE:** AN/UPX-21

**FEDERAL STOCK NUMBER:** 5895-853-8053-EG

	USA	USN	USAF	USMC
STATUS OR TYPE CLASSIFICATION		Std		
Mfg(s) Name or Code Number: Budd Electronics, Long Island City, New York				

No Illustration Available.

**FUNCTIONAL DESCRIPTION**

Interrogator Set with associated Coder transmits any code group) of two to thirty-six one-half usec pulses or two one usec pulses or both and receives a coded train of one-half usec pulses or one usec pulses.

It supplies video to the PPI of the radar set after processing through the associated decoding equipment. This display coordinated with the radar display provides range azimuth and identification information on targets. Interrogator Set AN/tPX-21 Is a low powered (1.5 to 2.25

**ITEM NAME:** INTERROGATOR SET

**TYPE:** AN/UPX-21

kw) and a high powered (9-11 kw), high duty cycle interrogator-response.

**RELATION TO SIMILAR EQUIPMENT**

The AN/UPX-21 is electrically similar to and interchangeable with Radar Recognition Set AN/UPX-6; differs in that the AN/UPX-21 has additional electrical functions, larger in size and is a simplex system. The AN/UPX-14 has the same characteristics with the exception that it is a duplexed item. Interchangeability of the AN/UPX-21 or AN/UPX-14 with the AN/UPX-6 is size limited, and is dependent upon available space and ac power within the designed site configuration.

**TECHNICAL DESCRIPTION**

Frequency Data:

Transmitted Signal; 1010 to 1050 mc,  
5 channels (1010, 1020, 1030, 1010  
and 1000 mc)

Received Signal; 1070 to 1110 mc,  
5 channels (1070, 1070, 1090, 1110  
and 1110 mc)

5 coded channels; designed for use  
w/remote indicator

Power Requirements:

input; 117v ac, 60 or 100 cycles,  
single phase

**INSTALLATION CONSIDERATIONS**

Siting: Is installed at IFF installations

**PRINCIPAL COMPONENTS AND PHYSICAL DATA**

<b>COMPONENT</b>	<b>QTY</b>	<b>HEIGHT (Inches)</b>	<b>WIDTH (Inches)</b>	<b>DEPTH (Inches)</b>	<b>UNIT WT.</b>
Receiver-Transmitter Group 0A-3607/UPX-14	1				
Power Supply PP-3200/UPX-14	1				
Switch, Radio Frequency Line SA-835/UPX-14	1				
Cabinet, Electrical Equipment CY-3396/UPX-14	1				
Control, Remote Switching C-3950/UPX-14	1				
Generator, Pulse O-1052/UPX-14	1				

Generator, Pulse TD-510/UPX-14 **1 REFERENCE DATA AND LITERATURE**

Nomenclature Card and AF Form 61 for AN/UPX-21.

DATE: 1 May 1964

ITEM NAME: ANTENNA ASSEMBLY

COGNIZANT SERVICE: USAF

TYPE: AS-295/UP\*  
AS-295A/UP\*\*  
AS-295B/UP\*\*\*

FEDERAL STOCK NUMBER: 5985-601-2354-EF\*\*  
5985-341-7742-EF\*\*\*

	USA	USN	USAF	USMC
STATUS OR TYPE CLASSIFICATION		LS*, LS', STD***		

Mfg(s) Name or Code Number: High Aircraft Co.\*, Hughes Aircraft Co.\*e, Maryland Electric Mfg Co.\*\*\*

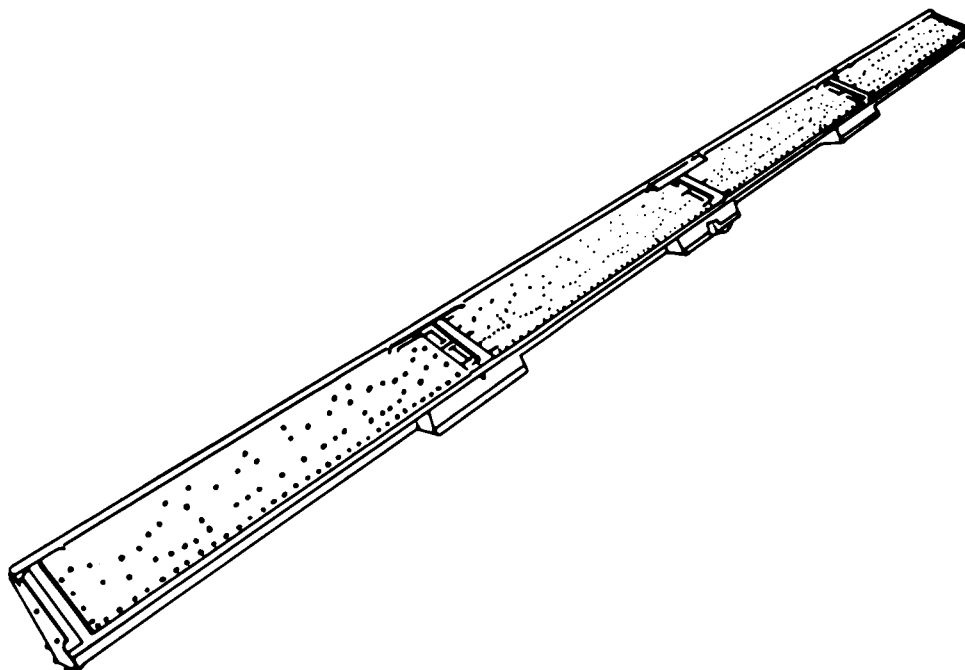

### FUNCTIONAL DESCRIPTION

Antenna Assembly AS-295/UP, AS-295A/UP and AS-295B/UP are designed for high-power transmission or reception of vertically polarized waves. The antenna is divided into four sections. The sections consist of

24 full-wave probe-fed radiators and reflectors and a feeder system. Besides the antenna itself, the antenna assembly includes an RF filter and three mounting boxes. The antenna is a center-fed array with equal path lengths to boxed-in slot antennas. Slot antennas are probe excited.

**ITEM NAME:** ANTENNA ASSEMBLY

**TYPE:** AS-295/UP, AS-295A/UP, AS-295B/UP

The antenna has a fan-shaped beam pattern which has a high degree of horizontal directivity. The width of the slot in each radiating element is the height of the aperture. Each feeder system has a flat aluminum center conductor. The conductor is suspended between two ground planes by solid dielectric insulators. The feeder line is undercut at support positions. The undercutting allows line impedances to remain constant through the support area. The characteristic impedance of each section is determined by the width of the section required for constant spacing between plates.

**RELATION TO SIMILAR EQUIPMENT**

AS-295/UP, AS-295A/UP and AS-295B/P have minor differences in their feeder systems. The three antenna assemblies are interchangeable, but the feeder system of the replacement antenna must be modified to duplicate the feeder system of the antenna being removed. AS-295/UP, AS-295A/UP and AS-295B/UP are similar to Antenna Assembly AT-309 and AT-309A.

**TECHNICAL DESCRIPTION**

Frequency:

AS-295A/UP - 950 to 1150 mc  
 AS-295B/UP - 1010 to 1110 mc  
 Peak Power Output: 10 kw  
 Duty Cycle: 0.0025  
 Wind Loading: 740 lb at 90 mph  
 Temperature Ratings: The antenna will operate over the temp) range of -50 deg F to plus 450 deg F  
 Polarization: Vertical  
 Radiation Pattern:  
 Vertical - Sensitivity decreases as the angle of elevation increases to 90 deg. Above 90 deg sensitivity drops sharply.  
 Horizontal - 4 deg (max) at half power points.  
 Standing Wave Ratio: 3.5 db with 50 ohm transmission line reference. SWR is less than 1.5 over the useful frequency range.

**INSTALLATION CONSIDERATIONS**

Sitting: Dependent on location of associated radar.

Mounting: Designed for mounting on an existing radar antenna provide suitable brackets and fixtures are available.

**PRINCIPAL COMPONENTS AND PHYSICAL DATA**

COMPONENT	QTY	HEIGHT (Inches)	WIDTH (Inches)	DEPTH (Inches)	UNIT WT.
Antenna Assembly AS-295B/UP	1	18-5/8	222-5/16	15-3/4	117
Antenna Assembly AS-295A/UP	1	13-13/32	222	9-13/32	101
Antenna Assembly AS-295/UP	1				

**REFERENCE DATA AND LITERATURE**

TECHNICAL ORDERS:  
 31P4-2GPX131 (AS-295B/UP)  
 31P4-2GPX121 (AS-295A/UP)

DATE: 1 July 1964  
COGNIZANT SERVICE: USN

ITEM NAME: ANTENNA  
TYPE: AS-1065/UPX

FEDERAL STOCK NUMBER: F5985-765-8869

	USA	USN	USAF	USMC
STATUS OR TYPE CLASSIFICATION				

Mfg(s) Name or Code Number: I-T-E Circuit Breaker Co., Philadelphia, Pennsylvania

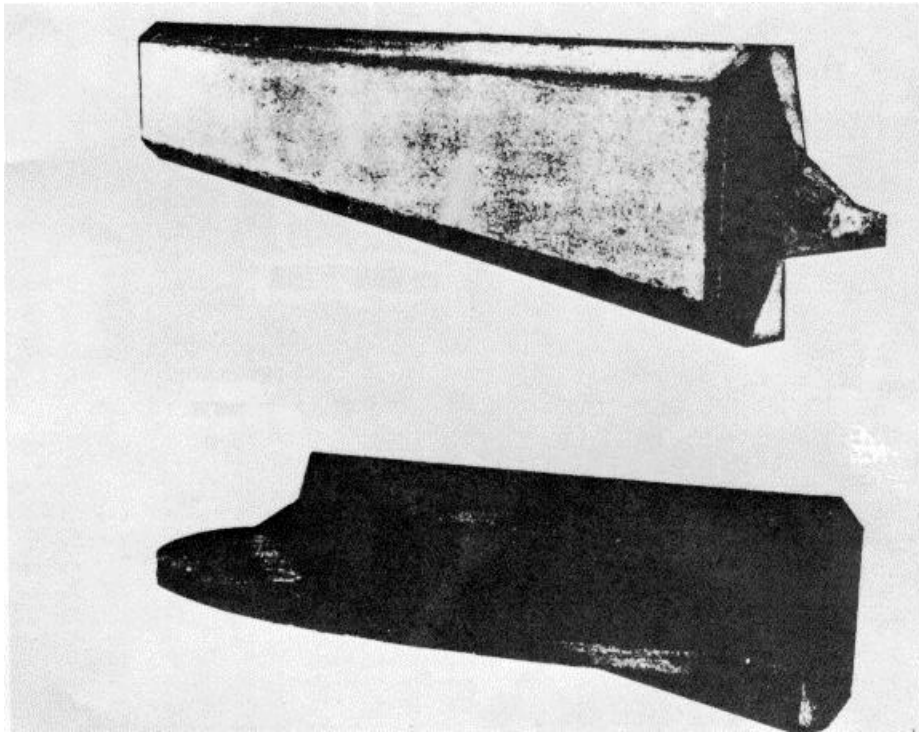

**FUNCTIONAL DESCRIPTION**

Antenna AS-1065/UPX operates in conjunction with recognition equipment as part of an IFF Interrogation system. The antenna transmits and receives standard

pulsed or semi-continuous RF energy in the frequency range from 1010 to 1110 mc. The RF pulse pattern or modulation is determined by the particular recognition equipment used in conjunction with the antenna.

**ITEM NAME:** ANTENNA

**TYPE:** AS-1065/UPX

**RELATION TO SIMILAR EQUIPMENT**

None

**INSTALLATION CONSIDERATIONS**

Related Equipment:

Required but not Supplied. (1) Technical Manual for Antenna AS-1065/UPX, NAVSHIPS 93560; (1) Technical Manual for Radar Recognition Set AN/UPX-1, NAVSHIPS 913,13; (1) Antenna Pedestal or Radar Antenna (AN/SPS-37); (1) Radar Recognition Set/UPX-1.

**TECHNICAL DESCRIPTION**

Maximum Power Handling Capability: 10 kw peak at 0.25% duty cycle.

Frequency Range

Transmit: 1020 plus or minus 10 mc

Receive: 1090 plus or minus 20 mc

Input Impedance: 50 ohms

Output Impedance: 50 ohms

**PRINCIPAL COMPONENTS AND PHYSICAL DATA**

<b>COMPONENTS</b>	<b>QTY</b>	<b>OVERALL DIMENSIONS (Inches)</b>	<b>UNIT WT. (Pounds)</b>
Antenna AS-1065/UPX	1	3-19/32 to 18-7/16 x 39-21/64 x 110-1/2	833
Low Pass L-Hand Filter	1	3/8 x 8-7/8	4 oz
Right Angle [lend UG-567A/U	1	3/4 x 1-1/8	1.5 oz

**SHIPPING DATA  
PKGS**

**UNIT WT.  
(Pounds)**

1

300

**REFERENCE DATA AND LITERATURE**

Technical Manuals:  
NAVSHIPS 93560

**AS-1065/UPX: 2**

DATE: 15 December 1964

ITEM NAME: ANTENNA

COGNIZANT SERVICE: USAF

TYPE: AT-309/GPX,\*AT-309A/GPX,  
\*\*AT-309B/GPX,\*\*\*AT-309C/GPX

FEDERAL STOCK NUMBER: \*5895-347-7390-EG  
\*\*5895-073-9349-EG

	USA	USN	USAF	USMC
STATUS OR TYPE CLASSIFICATION			*LS, **AS, ***Std	

Mfg(s) Name or Code Number: Litton Industries

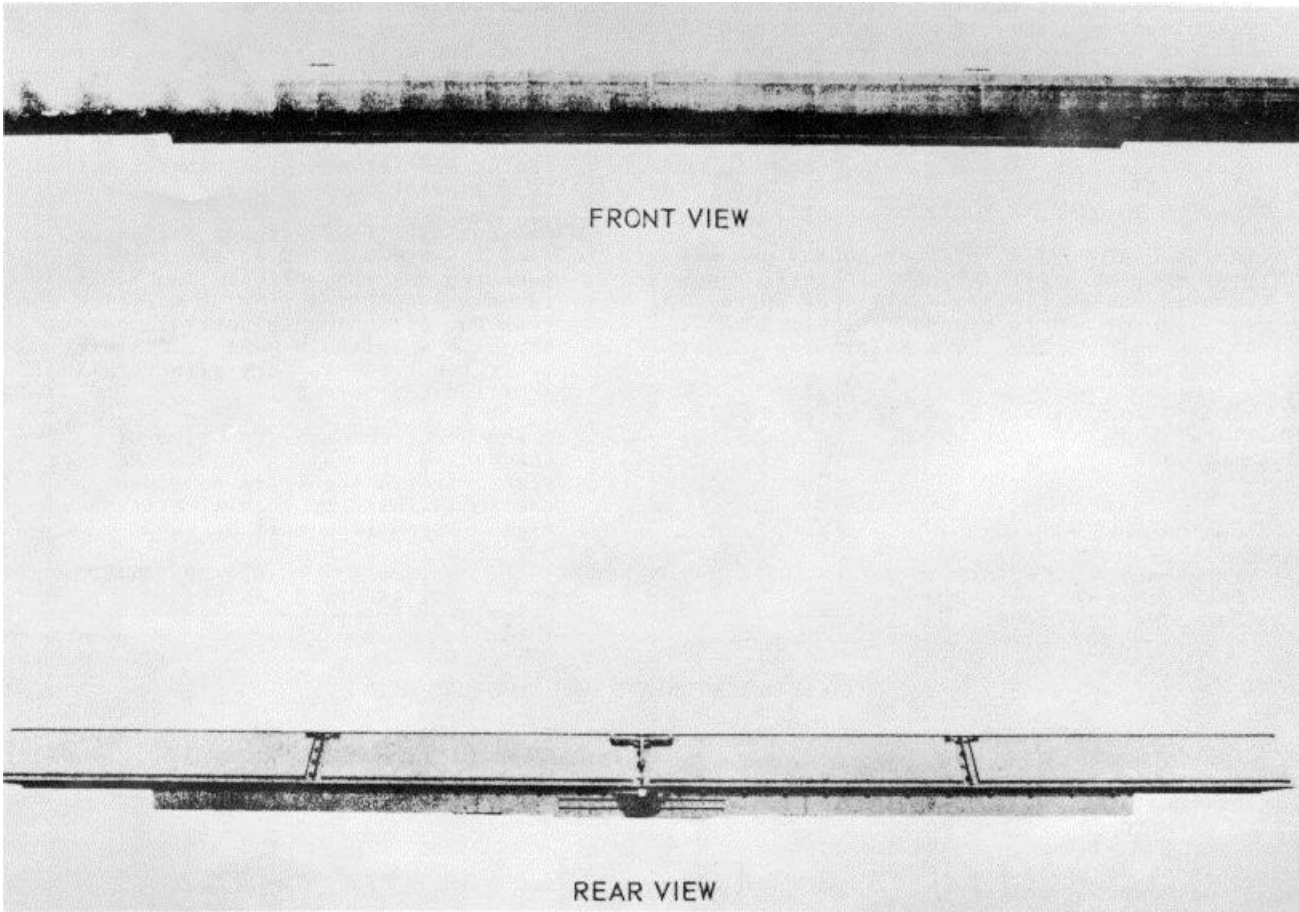

**FUNCTIONAL DESCRIPTION**

Antenna AT-309, 309A/GPX are general purpose, vertically polarized antennas. They are primarily used for IFF. Principal parts of the AT-309A/GPX are: a horizontal linear array of 32 probe-excited cavity resonators, a printed circuit feeder system, and a filter

tee assembly. The principal antenna beam covers 2 deg in horizontal plane and 40 deg in vertical plane.

AT-309C/GPX is a movable or fixed, corner reflector type antenna, operating in the 1000 to 1120 mc frequency range. JThe AT-309C/GPX is either pedestal

**ITEM NAME:** ANTENNA

**TYPE:** AT-309/GPX, AT-309A/GPX, AT-309B/GPX, AT-309C/GPX

or tower mounted with a rotating movement pattern. Special features: narrow main beamwidth, very low backlobe, very low sidelobes, wide environmental operating range, low band pass filter with a 50 db rejection at 1280 through 11,000 mc, combination of coaxial line and stripline use in antenna feed system, and vertical beam width of 52 deg plus or minus 2 deg. The AT-309C/GPX is for all weather operation.

The main assemblies of the antennas are: right and left outboard reflector assemblies, right and left inboard reflector assemblies, right and left outboard box assemblies, and a right and left inboard mounting box assembly. Each reflector assembly and mounting box is approximately 7 ft long. Length of the assembled antenna is approximately 28 ft. Antenna input-output impedance is 50 ohms.

**RELATION TO SIMILAR EQUIPMENT**

Antenna AT-309A is similar to and one way interchangeable with AT-309, the difference being increased power capabilities up to 300 kw. Also AT-309 is hinged while AT-309A is not hinged. AT-309, 309A is similar to Antenna AT-295B.

AT-309C/GPX is electrically interchangeable with AT-309B/GPX; differs in the method of feed.

**TECHNICAL DESCRIPTION**

Frequency: 1000 to 1110 mc  
Peak Power Output: 300 kw  
Duty Cycle: 0.004  
Filter Characteristics:  
1000 to 1110 mc - 0.5 db (max)  
S- and X-bands - 50 db attenuation (min,

Antenna Impedance (Input and Output): 52 ohms  
Horizontal Beam Coverage: 2 deg  
Vertical Beam Coverage: 10 deg  
Standing Wave Ratio: Under 3.5 db between 1030 and 1090 mc, referenced to a 50-ohm transmission line.  
Wind Load: 1350 lb with 90-miph wind at 15 rpm  
Temperature Range: -55 deg C to plus 85 deg C (67 deg F to plus 185 deg F)

**INSTALLATION CONSIDERATIONS**

**Siting:** The antenna assembly can be installed in any location where shielding, natural or man-made does not prevent radiation to or from the antenna. In siting consideration must be given to radio interference from other electronic equipments.

**Mounting:** The four antenna reflector sections are mounted on the three mounting box assemblies. The mounting box assemblies provide mounting pads for attaching the overall assembly atop a suitable mast or fixture. Space requirements vary with rotating or fixed operational.

**Cabling Requirements:** The type of cable connecting the antenna to the Receiver Transmitter Assembly is dependent upon the installation. In all cases 50 ohm transmission line must be used.

**Related Equipment:** AN/GPX-19, AN/FPS-3, AN/FPS-27, AN/FPS-7, AN/FPS-15, AN/FPS-19, AN/FPS-30.

**PRINCIPAL COMPONENTS AND PHYSICAL DATA**

<b>COMPONENT</b>	<b>QTY</b>	<b>HEIGHT (Inches)</b>	<b>WIDTH (Inches)</b>	<b>DEPTH (Inches)</b>	<b>UNIT WT.</b>
Antenna Section, right-hand inboard	1	15	84	15	
Antenna Section, right-hand outboard	1	15	84	15	
Antenna Section , left-hand inboard	1	15	84	15	
Antenna Section, left-hand outboard	1	15	84	15	
Mounting Box Assembly, right-hand outboard	1				
Mounting Box Assembly, left-hand outboard	1				



**ITEM NAME:** ANTENNA

**TYPE:** AT-309/GPX AT-309A/GPX, AT-309B/GPX, AT-309C/GPX

**PRINCIPAL COMPONENTS AND PHYSICAL DATA**

<b>COMPONENT</b>	<b>QTY</b>	<b>HEIGHT (Inches)</b>	<b>WIDTH (Inches)</b>	<b>DEPTH (Inches)</b>	<b>UNIT WT.</b>
Mounting Box Assembly, center	1				
Filter Tee Assembly	1				
Interconnecting Cable Assembly	2				

**REFERENCE DATA AND LITERATURE**

Technical Orders:

31P4-2GPX-142  
31P4-2GPX-143  
31P4-2GPX-144

31P,1-2GPX-145  
Specification:  
MIL-A-9597B

**AT-309/GPX: 3**

DATE: 15 April 1964

ITEM NAME: RADAR SET TRANSFER CONTROL

COGNIZANT SERVICE: USAF

TYPE: C-1604/GP

FEDERAL STOCK NUMBER: 5840-505-2197

	USA	USN	USAF	USMC
STATUS OR TYPE CLASSIFICATION			Std	

Mfg(s) Name or (ode Number. International Projector Corporation

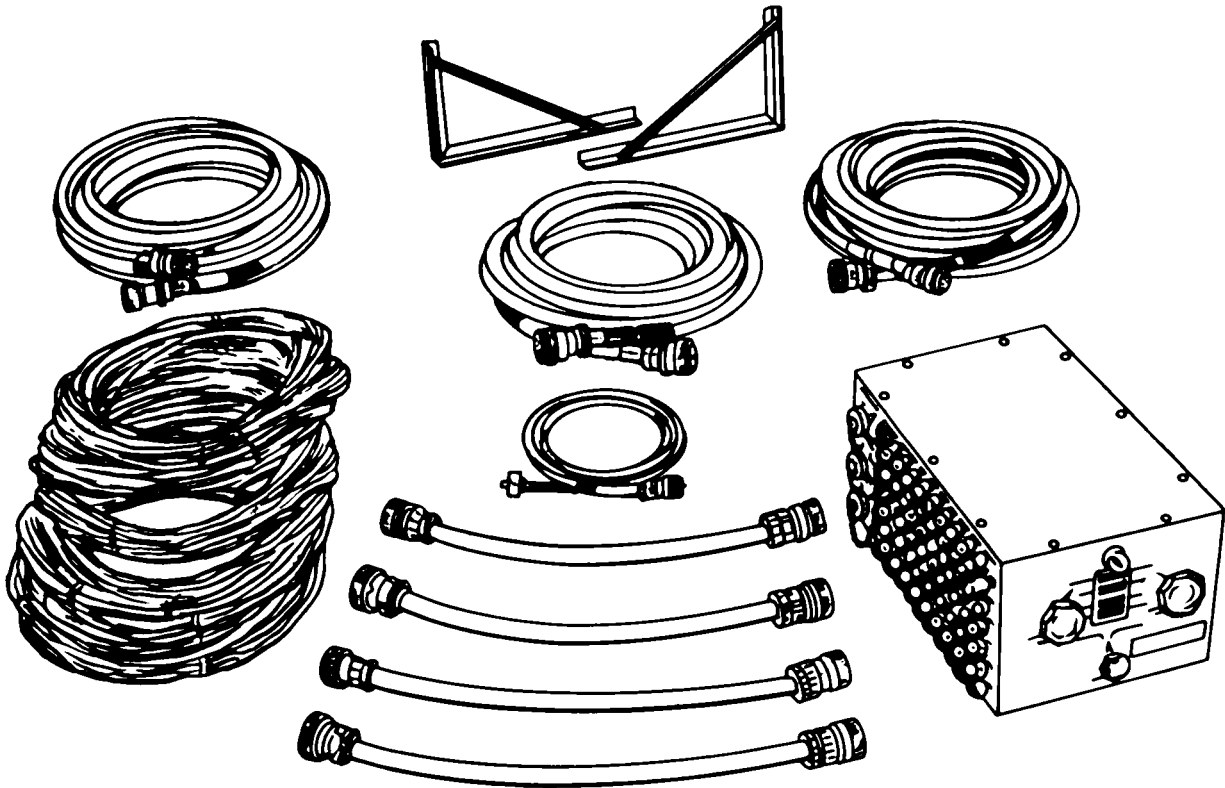

**FUNCTIONAL DESCRIPTION**

Radar Set Transfer Control C-1604/GP provides a means of switching the synchro and rf data from a maximum of four radar sets to a group of plan position indicators. The Data Switch Assembly (G8501) receives

video, trigger, angle-mark, range-mark, and IFF information from the video outputs and IFF receivers of the primary and secondary radar sets. This information is selected and transferred directly to the operational PPI. The Data Switch Assembly (G-8501) may be connected to a plan position indicator monitor, to observe

**ITEM NAME:** RADAR SET TRANSFER CONTROL

**TYPE:** C-1604/GP

the functioning of any radar set connected to the C-1604/GP. Termination is provided in the data switch circuits when they are not in use.

**RELATION TO SIMILAR EQUIPMENT**

None.

**TECHNICAL DESCRIPTION**

Radar Inputs: 4 (max), 1 primary, 1 secondary #1, 1 secondary #2, and simulator

Synchro Switching: Data switch assembly only switches secondary circuits S1, S2, and S3 of antenna synchros. Primary circuits RI and R2 were properly phased by the original radar installation.

RF Switching: Provides video, trigger, angle-mark, and IFF information to number 1 operational PPI.

Monitoring: A monitoring PPI may be connected to the data switch assembly to monitor any individual radar set connected to the data switch assembly.

IFF Switching:

Pre-Trigger - Data switch to coder.

Mode Trigger - Data switch to IFF equipment.

IFF Video - IFF receiver through data switch to PPI's; IFF receiver through data switch to coder-control circuits.

IFF Primary Power: Obtained from primary radar set.

**INSTALLATION CONSIDERATIONS**

Siting: The site shall be chosen as close to the monitor PPI as possible.

Mounting: Data Switch Assembly is fastened to a masonry wall, studded partition, or other similar location. The mounting brackets are placed at right angles to the wall and parallel to each other to assure proper alignment with the studs on the bottom of the data switch assembly.

Cabling Requirements: Ten RF Cable Assemblies CG-1393/U; one power-cable assembly used to connect Synchro output of the data switch to the monitor (PPI).

Related Equipment: Associated primary radar sets, AN/GPS-3, AN/CPS-6B, AN/FPS-3, -3A, AN/MPS-7, AN/FPS-8, AN/MPS-11.

**PRINCIPAL COMPONENTS AND PHYSICAL DATA**

COMPONENT	QTY	HEIGHT (Inches)	WIDTH (Inches)	DEPTH (Inches)	UNIT WT.
Data Switch Assembly IPC G-8501	1	9	12	18	
Cable Assembly CG-1393/U, RF	20	40 ft 1g			
Cable Assembly CX-3622/U, Power	1	40 ft 1g			
Cable Assembly CX-3621/U, Power	1	40 ft 1g			
Cable Assembly CX-3740/U, Power	1	40 ft 1g			
Cable Assembly CX-3620/U, Power	1	10 ft 1g			
Cable Assembly CX-3589/U,	1	2 ft 1g			
Special Purpose					
Cable Assembly CX-3623/U, Special Purpose	1	2 ft 1g			
Cable Assembly CX-3587/U, Special Purpose	1	2 ft 1g			
Cable Assembly CX-3583/U, Special Purpose	1	2 ft 1g			

**REFERENCE DATA AND LITERATURE**

Technical Orders: 31P2-2GP-105  
31P2-2GP-101

31P2-2GP-102  
31P2-2GP-104

DATE: 22 April 1964

ITEM NAME: HEIGHT-RANGE DATA CONVERTER

COGNIZANT SERVICE: USAF

TYPE: CV-601/FPS-6A

FEDERAL STOCK NUMBER: 5840-611-3192

	USA	USN	USAF	USMC
STATUS OR TYPE CLASSIFICATION			None Assigned	

Mfg(s) Name or Code Number: General Electric Company

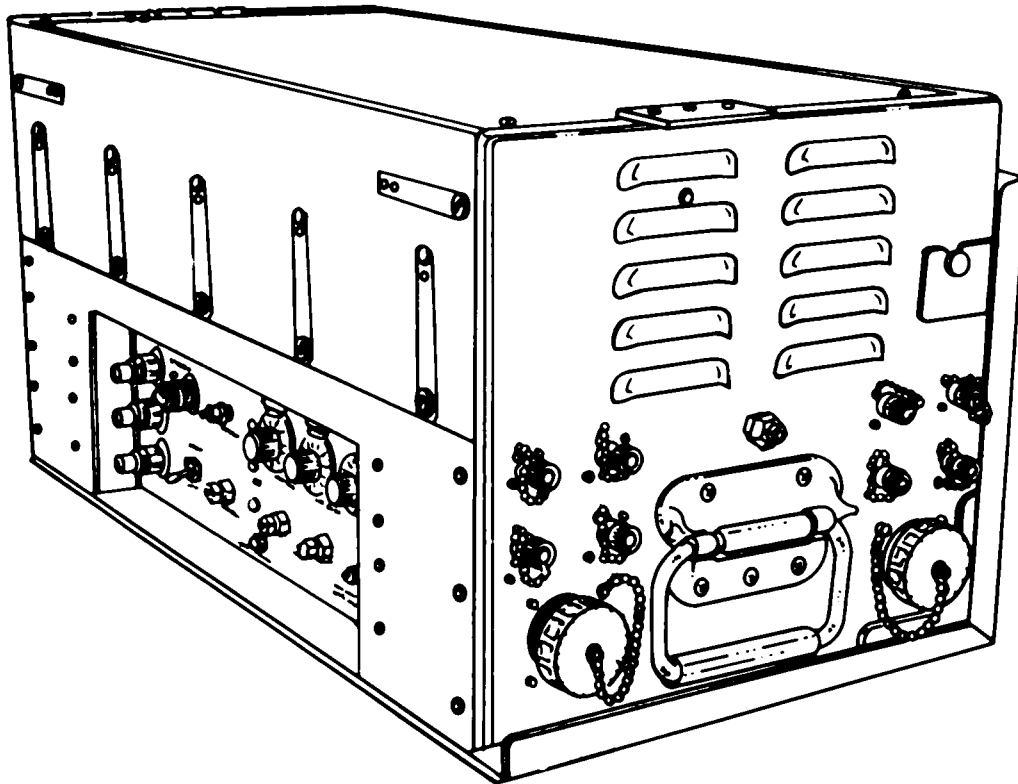

### FUNCTIONAL DESCRIPTION

Height-Range Data Converter CV-601/FPS-6A is used to correct the height-indication error introduced by differences in the amount of radar beam refraction (bending) as the beam passes through the earth's atmosphere. The magnitude of refraction varies with

the density change rate of the medium through which the beam is transmitted.

The CV-601/FPS-6A equipment is used when an external source voltage from Coordinate Data Transmitter AN/FST-2 positions the height cursor (height

**ITEM NAME:** HEIGHT-RANGE DATA CONVERTER

**TYPE:** CV-601/FPS-6A

line) without consideration of the variable refractive index. The CV-601/FPS-6A provides a compensated, integrated height-line voltage for direct application to the indicator circuitry of the OA-270/FPS-6. The OA-929/FPS-6A receives height, range, and correction voltages separately and provides integration within itself. A switch, set at the time of initial installation, selects the proper OA-929/FPS-6A output.

**RELATION TO SIMILAR EQUIPMENT**

None.

**TECHNICAL DESCRIPTION**

Range Input: -0.566v dc per mi  
Height Input: 0.226v dc per 1000 ft  
Power Input: 115v, 60 cps, 1-ph  
OA-929/FPS-6A Output Voltages:  
Height Voltage - -2.2v dc per 1000 ft  
Refraction Voltage - 0.85v dc per 1000 ft  
Range Voltage - 0.733v dc per mi  
OA-270/FPS-6 Output Voltages:  
Height Plus Refraction Voltage - 0.252v dc per 1000 ft

Source Impedance:  
Range - 1000 ohms  
Height - 5000 ohms  
Gear Train Response Time: Not greater than 3 sec from limit to limit

**INSTALLATION CONSIDERATIONS**

Siting: Dependent on associated radar.

Mounting: Dependent on associated radar.

Cabling Requirements:

- 4 height line voltage cables
- 4 range voltage cables
- 1 power cable
- 1 grounding wire

Related Equipment:

- 1 Coordinate Data Transmitter AN/FST-2
- 1 Indicator Group OA-929/FPS-6A
- 1 Radar Set Group OA-270/FPS-6
- 1 Radar Set Group OA-1010/GPS

**PRINCIPAL COMPONENTS AND PHYSICAL DATA**

COMPONENT	QTY	HEIGHT (Inches)	WIDTH (Inches)	DEPTH (Inches)	UNIT WT.
CV-601/FPS-6A	1	12.68	13.28	25.5	

**REFERENCE DATA AND LITERATURE**

- Technical Orders:  
31P3-2FPS6-151  
31P3-2FPS6-153  
31P3-2FPS6-154  
31P3-2FPS6-575

DATE: 1 June 1964

ITEM NAME: RIGID RADOME

COGNIZANT SERVICE: USAF

TYPE: \*CW-396/GPS, \*\*CW-396A/GPS

FEDERAL STOCK NUMBER: \*5840-565-8900  
\*\*5840-556-9640

	USA	USN	USAF	USMC
STATUS OR TYPE CLASSIFICATION		Used by	*Ltd Std **Alt Std	

Mfg(s) Name or Code Number: Geodesic, Inc.

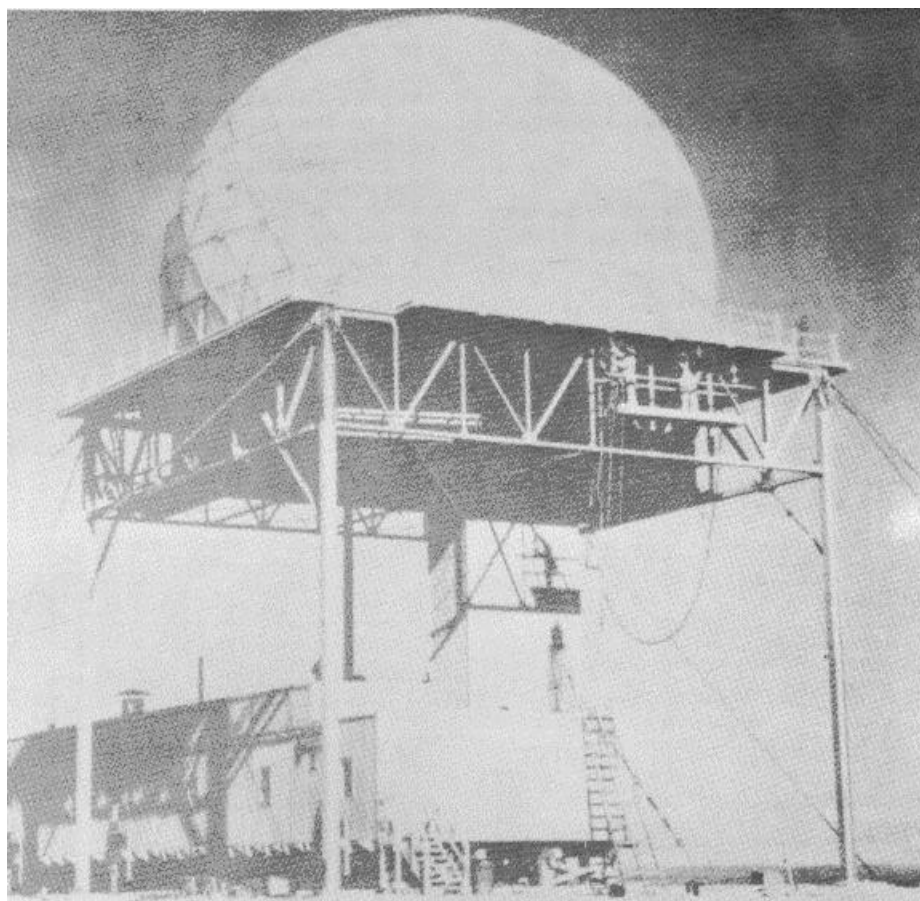

### FUNCTIONAL DESCRIPTION

Rigid Radome CW-396/GPS is composed of rigid galss-reinforced polyester laminate panels, bolted together to form a protective enclosure for the operating antenna of Radar Set AN/FPS-19 during all extremes of

weather. The CW-396/GPS will withstand winds up to 150 miles per hour, and sustain snow or ice loads. The radome contains no electrical wiring or equipment. No test equipment, electrical or otherwise, is necessary for the maintenance of this structure. Panels prepared for shipment should be open-crated to protect membrane

**ITEM NAME:** RIGID RADOME

**TYPE:** CW-396/GPS, CW-396A/GPS

surfaces from puncture and to protect the gasket groove in the side flanges from impact fracture damage.

**RELATION TO SIMILAR EQUIPMENT**

Rigid Radome CW-396/GPS uses fiberglass mat covering, whereas Rigid Radome CW-396A/GPS uses fiberglass cloth covering. The flange depth of the CW-396A/GPS is smaller than that of the CW-396/GPS.

**TECHNICAL DESCRIPTION**

**Construction Material**

CW-396/GPS: Glass-reinforced polyester laminate panels bolted together (fiber- glass matting)

CW-396A/GPS: Glass-reinforced polyester laminate panels bolted together (fiberglass cloth)

**Physical Size**

**CW-396/GPS**

Diameter: 53 ft, 7-1/2 in. (50-ft base)

Height: 43 ft (from base mounting ring to top center)

**CW-396A/GPS**

Diameter: 55 ft (50-ft base)

Height: 43 ft from base mounting ring to top center)

Ambient Temperature: -80°F to plus 160°F

Ice Load (Max): 6 in. of glazed ice on upper 1/4 of radome, or 16 in. of rime ice on entire structure

**Wind Velocity**

**No Ice Load**

CW-396/GPS: 150 mph

CW-396A/GPS: 130 mph

Ice Load (8 in. of Glazed Ice or 16 in. Of Rime Ice): 87 mph

Salt Atmosphere: 10 mph (max)

**Structural Stress**

Net Life (lb): 70,000 (during 150 mph wind)

Horizontal Drag (lb): 90,000 (during 150 mph wind).

**INSTALLATION CONSIDERATIONS**

**Siting (Arctic Use Only):** Site selection for the rigid radome is entirely dependent on the siting requirements of the AS-78t/FPS-19 antenna housed within the radome structure.

**Mounting:** The radome is bolted to a mounting ring located on the top platform of a 50-ft-high tower capable of supporting the 17,000 lb radome.

**Related Equipment:** Used with but not part of AN/FPS-3 or AN/FPS-19 radar sets.

**PRINCIPAL COMPONENTS AND PHYSICAL DATA  
SHIPPING DATA**

<b>COMPONENT</b>	<b>CRATES (NR.)</b>	<b>UNIT WT. (Pounds)</b>
(SFEL REQUIREMENT)	57	2B,070
<b>*INSTALLATION AIDS</b>		
Mast Boom & Gin Pole Assy	6	2600
Radome Erection Scaffold	5 & 13 Bundles	6155
Gasketing Cradle	1	350

**NOTE:** \*The Installation Aids are necessary to effect the radome installation, but are not required for subsequent operation. Therefore, following radome installation, this equipment is repackaged for use elsewhere.

ITEM NAME: RIGID RADOME

TYPE: CW-396/GPS, CW-396A/GPS

**PRINCIPAL COMPONENTS AND PHYSICAL DATA**

<b>COMPONENT</b>	<b>QTY</b>	<b>HEIGHT (Inches)</b>	<b>WIDTH (Inches)</b>	<b>DEPTH (Inches)</b>	<b>UNIT WT.</b>
AL Type Panel	45				
AR Type Panel	40				
BL Type Panel	40				
BR Type Panel	40				
C Type Panel	40				
D Type Panel	30				
HUB, Hexagonal Panel	6				
HUB, Pentagonal Panel	5				
A1 Type Base Panel	5				
B1 Type Base Panel	5				
B2 Type Base Panel	5				
C1 Type Base Panel	5				
C2 Type Base Panel	5				
D1 Type Base Panel	5				
D2 Type Base Panel	5				
D3 Type Base Panel	5				
AB, BC, and CD Type Gaskets	150				

**REFERENCE DATA AND LITERATURE**

Technical Manuals:  
T.O. 31P-1-22

**CW-396/GPS: 3**



DATE: 1 July 1964

ITEM NAME: DIRECTION FINDER

COGNIZANT SERVICE: USN

TYPE: CXGH

FEDERAL STOCK NUMBER:

	USA	USN	USAF	USMC
STATUS OR TYPE CLASSIFICATION				

Mfg(s)Name or Code Number: Federal Telephone and Radio Corp.

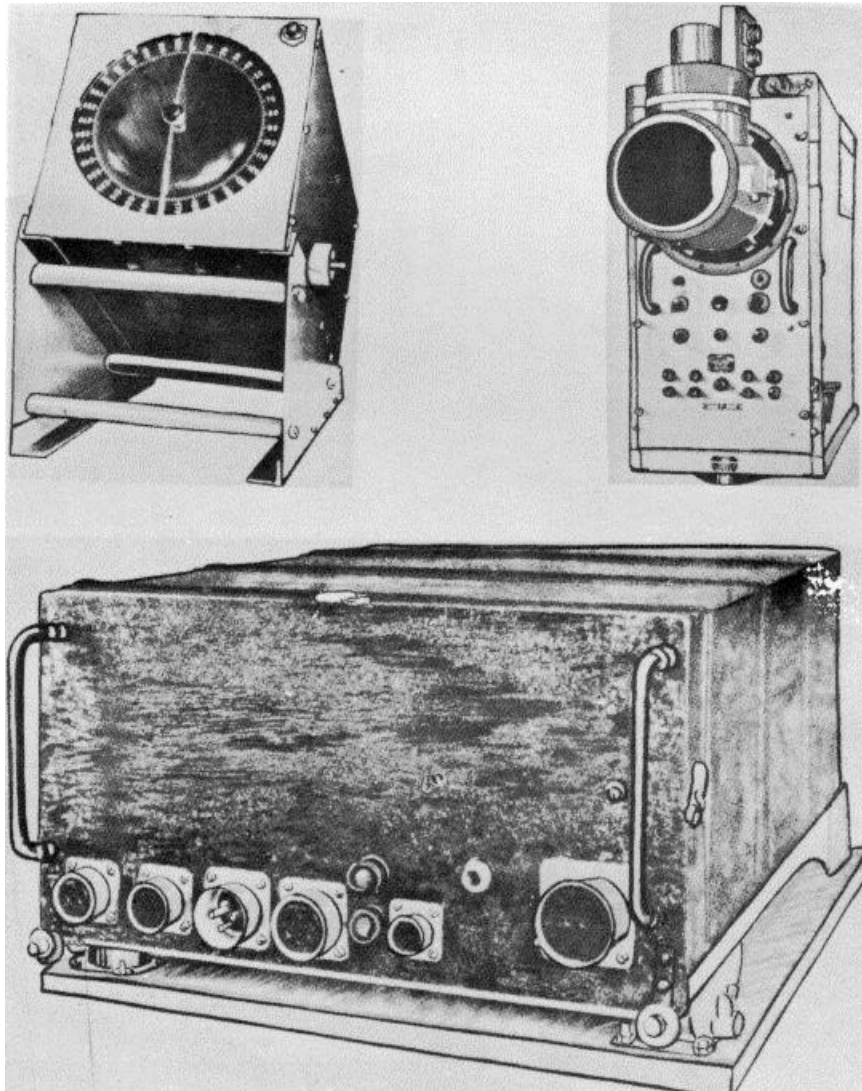

CXGH: 1

**ITEM NAME:** VDIRECTION FINDER

**TYPE:** CXGH

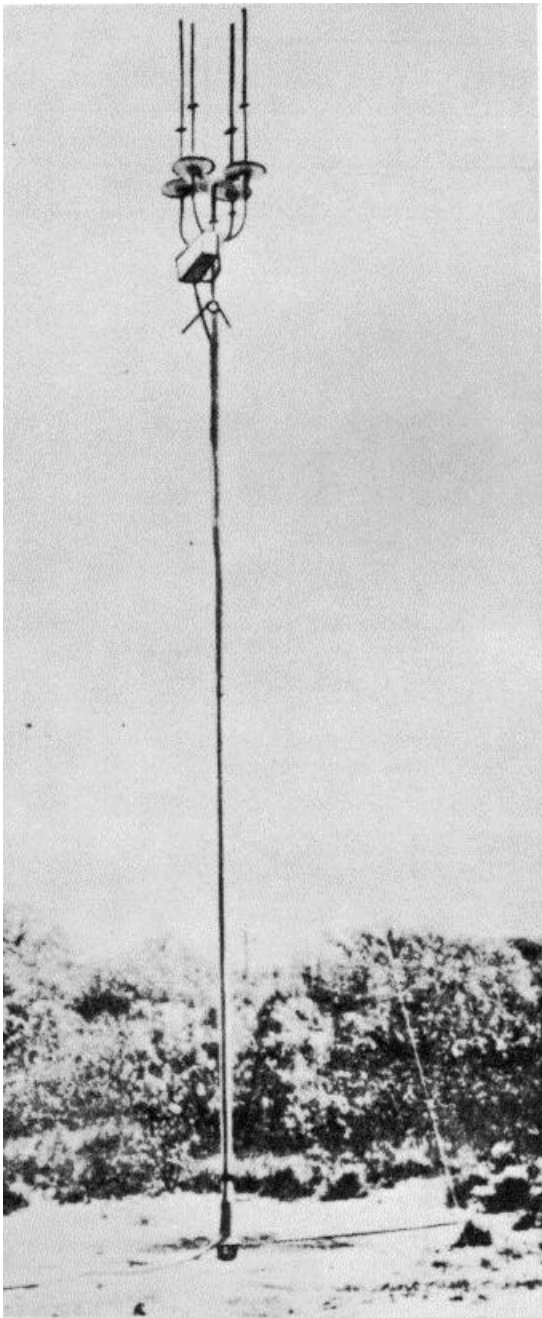

**FUNCTIONAL DESCRIPTION**

The CXGH is designed to take bearings on aircraft transmissions of either a continuous wave or modulated wave, and to superimpose the sense bearing directly on the face of the VE indicator for the purpose of identifying these aircraft. At the same time communications may be carried on with the aircraft with the aid of this same receiver.

**RELATION TO SIMILAR EQUIPMENT**

None.

**TECHNICAL DESCRIPTION**

Frequency Range: 100 to 160 mc  
Operating Power: 110v, 60 cps, 1-ph

**INSTALLATION CONSIDERATIONS**

Not available.

ITEM NAME: DIRECTION FINDER

TYPE: CXGH

PRINCIPAL COMPONENTS AND PHYSICAL DATA

COMPONENTS	QTY	OVERALL DIMENSIONS (Inches)	UNIT WT. (Pounds)
Antenna System and Goniometer	1		
Mast	2	120 1g	
Set RF Power and Interconnecting Cables	1		
Radio Receiver	1		
Pulsing Unit	1		
Control Box	1		
Straight Line Indicator	1		
Remote Straight Line Indicator	1		
Indicator VE	1		

REFERENCE DATA AND LITERATURE

Not available.

CXGH: 3

DATE: 1 July 1964

ITEM NAME: SUPPRESSION GENERATOR

COGNIZANT SERVICE: USN

TYPE: O-30/CPN

FEDERAL STOCK NUMBER: 5840-665-2494  
5840-665-1457 W/S

	USA	USN	USAF	USMC
STATUS OR TYPE CLASSIFICATION				

Mfg(s) Name or Code Number: Andrea Radio Corporation, Long Island City, N. Y.

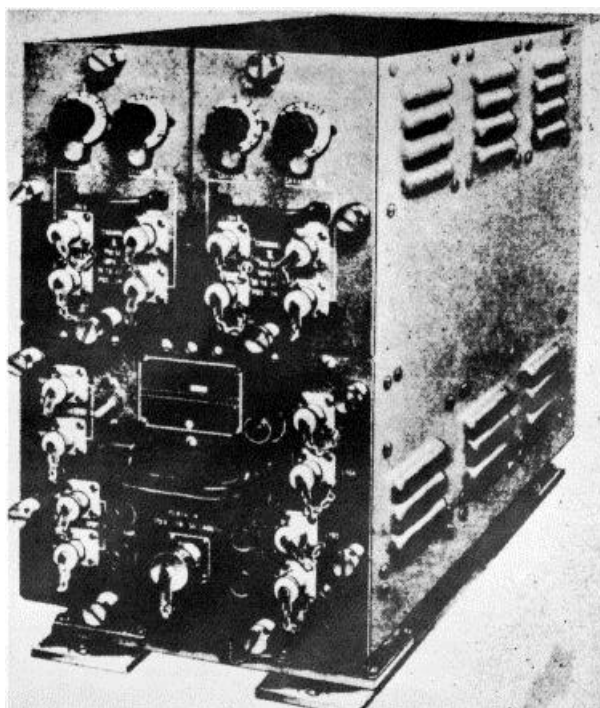

### FUNCTIONAL DESCRIPTION

The O-30/CPN eliminates undesirable interaction between radars, radar beacons, and shipborne IFF equipments by applying output pulses to suitable circuits in the equipments whose radiation is to be killed. It is

actuated by the video pulses which occur either before or concurrent with rf transmission from radar or interrogator equipment. These output pulses prevent any transmission or radiation from the equipment affected, for the duration of the Suppression Generator pulse.

O-30/CPN: 1

**ITEM NAME:** SUPPRESSION GENERATOR

**TYPE:** 0-30/CPN

**RELATION TO SIMILAR EQUIPMENT**

None.

**INSTALLATION CONSIDERATIONS**

Related Equipment:  
Required but not Supplied. (as required) Coaxial  
Cable RG-c/U.

**TECHNICAL DESCRIPTION**

Operating Power: 115v, 50 to 2400 cps, 1-ph.

**PRINCIPAL COMPONENTS AND PHYSICAL DATA  
SHIPPING DATA**

<b>COMPONENTS</b>	<b>BOXES (NR.)</b>	<b>OVERALL DIMENSIONS (Inches)</b>	<b>UNIT WT. (Pounds)</b>
Set Equipment Spare Parts		1	
Suppression Generator O-30/CPN		1	
Power Input Cable-			
Angle Plug Adapters NT-49192			
Single Connectors NT-49195			
Technical Manuals			

**PRINCIPAL COMPONENTS AND PHYSICAL DATA**

<b>COMPONENTS</b>	<b>QTY</b>	<b>OVERALL DIMENSIONS (Inches)</b>	<b>UNIT WT. (Pounds)</b>
Suppression Generator O-30/CPN	1	10-3/4 x 17-7/8 x 22-1/2	
Power Input Cable	1	144 1g	
Angle Plug Adapters NT-49192	16		
Single Connectors NT-49195	16		

**REFERENCE DATA AND LITERATURE**

Technical Manuals:  
NAVSHIPS 900, 824

**0-30/CPN: 2**

DATE: 22 April 1964

ITEM NAME: COORDINATE DATA TRANSMITTER

COGNIZANT SERVICE: USAF

TYPE: OA-682/GPA-29\*, OA-682A/GPA-29 \*

FEDERAL STOCK NUMBER:

	USA	USN	USAF	USMC
STATUS OR TYPE CLASSIFICATION			Ltd Std Stdge	

Mfg(s) Name or Code Number: Westinghouse Electric Corporation

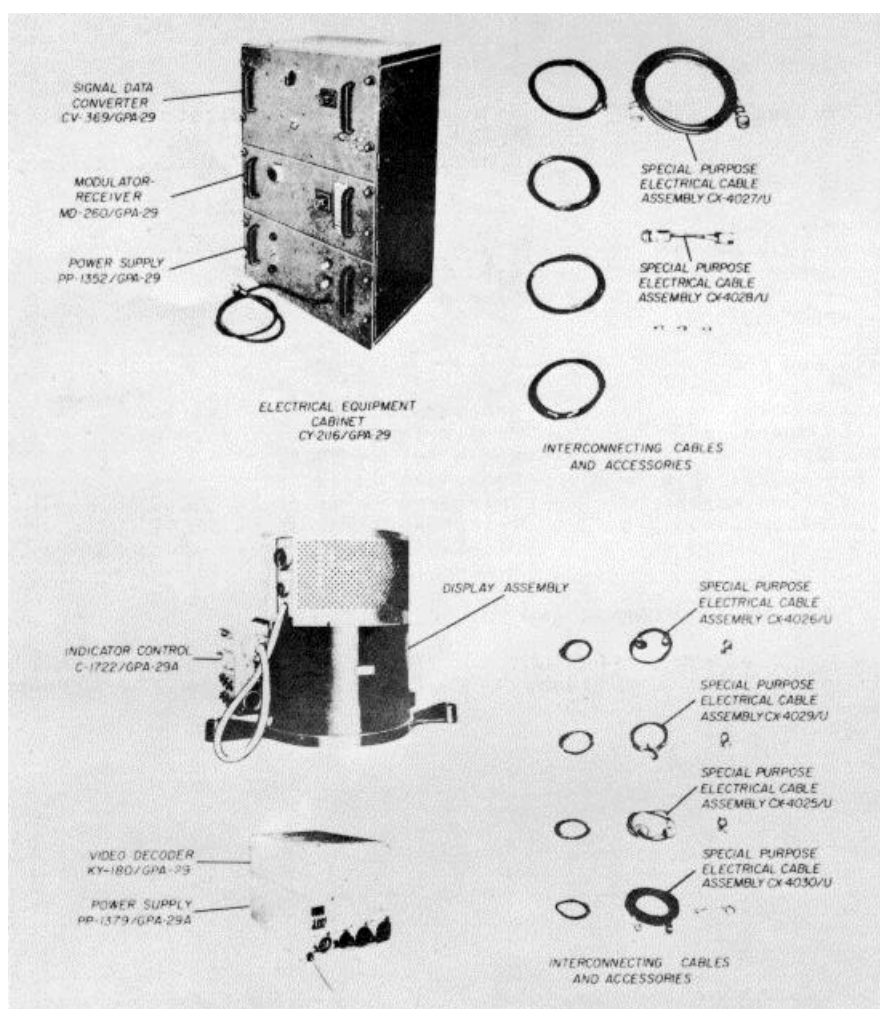

### FUNCTIONAL DESCRIPTION

Coordinate Data Transmitter OA-682A/GPA-29 is used for simultaneous transmission of conventional radar video information and azimuth synchronizing information over a two-wire speech circuit to a local or

remote location. The signal from the OA-682A/GPA-29 is demodulated at the remote location by Video Decoder KY-180/GPA-29 and is applied to the azimuth and range indicator. The facsimile converter group is capable of providing five parallel outputs to five remote installations.

**ITEM NAME:** COORDINATE DATA TRANSMITTER

**TYPE:** OA-682/GPA-29, OA-682A/GPA-29

A FM radio link, in conjunction with carrier bay equipments or a standard 600-ohm telephone line, may be used for the transmission of video information to a remotely located installation.

**RELATION TO SIMILAR EQUIPMENT**

Coordinate Data Transmitter OA-6t2A/GPA29 is functionally interchangeable with Coordinate Data Transmitter OA-682/GPA-29. The OA-6d2A/GPA-29 has greater range and azimuth accuracy, is used for sector scanning, and uses JAN parts wherever possible.

**TECHNICAL DESCRIPTION**

- Target Video Amplitude: plus 2v ac (min peak)
- Target Video Pulse Width: 6 usec
- IFF Trigger Amplitude: 2.5v ac (min peak)
- IFF Trigger Pulse Width: 0.5 usec
- Synchronizing Trigger Amplitude: 2v ac (min peak)
- Range Mark Amplitude: 2v ac (min peak)
- Range Mark Pulse Width: 2 usec
- Radar Synchro Data:
  - Radar Set AN/MPX-7 - 1-speed and 36-speed
  - Radar Set AN/TPS-1D - 1-sjpeed (60-c)ps reference voltage)
- IP-336/GPA-29A Inputs, Local Operation:
  - Synchro Data - 1-speed, 36-speed, and reference voltage
  - Radar Video - Target video signal, synchronizing trigger, and range marks
  - IFF Input - Obtained from Radar Recognition Set Mark X
- Input, IP-336/GPA-29A, Remote Operation:

- Composite Audio Signal- 2.100 c/s, modulated by compressed video (video and sync trigger)
- 391-cjps carrier, modulated by ag c and east mark data 560-cjps carrier, modulated by 60-cips antenna position data (lower side-band, 5'00 cps)
- 247-cps carrier, modulated by 60 cps antenna position data (upper side-band, 307 cps)
- Indicating Stations: 5 (max)
- Range, Local: 100, 150, or 200 mi
- Range, Remote: 200 mi (max)
- Operating Voltage: 107 to 127v ac, 60 plus or minus 1 cps
- Current Requirements:
  - Facsimile Converter Group - 2.d amp
  - Azimuth and Range Indicator - Local, 3.9 amp; remote, 4.6 amp
- Synchronizing Trigger Pulse Width: 6 usec

**INSTALLATION CONSIDERATIONS**

- Siting: Physically located with associated radar set, shielded from weather elements.
- Related Equipment:
  - Radar Set AN/MPS-7
  - Radar Set AN/TPS-ID
  - Radar Recognition Set Mark X
  - Facsimile Converter Group OA-914/GPA-29
  - Radio Set AN/TRC-1
  - Radio Set AN/TRC-d
  - Telephone Terminal AN/TCC-3
  - Telephone Terminal AN/TCC-7
  - Display-Plotting Board Group AN/GPA-29

**PRINCIPAL COMPONENTS AND PHYSICAL DATA**

COMPONENT	QTY	HEIGHT (Inches)	WIDTH (Inches)	DEPTH (Inches)	UNIT WT.
Indicator Control C-1722/GPA-29	1				
Signal Data Converter CV-369/GPA-29	1				
Modulator Receiver MD-260/GPA-29	1				
Power Supply PP-1352/GPA-29	1				
Power Supply PP-1379/GPA-29	1				
Video Decoder KY-1BO/GPA-29	1				

**REFERENCE DATA AND LITERATURE**

	31P1-2GPA29-13	31P1-2GPA29-502
	31P1-2GPA29-54	
Technical Orders:	31P1-2GPA29-71	
31P1-2GPA29-21	31P1-2GPA29-72	
31P1-2GPA29-22	31P1-2GPA29-74	
31P1-2GPA29-24	31P1-2GPA29-96	

DATE: 1 April 1964

ITEM NAME: COORDINATE DATA MONITOR

COGNIZANT STOCK NUMBER: USAF

TYPE: OA-947/FST-1

FEDERAL STOCK NUMBER: 5395-52.1-0651

	USA	USN	USAF	USMC
STATUS OR TYPE CLASSIFICATION			STD	

Mfg(s) Name or Code Number: Lewyt Manufacturing Company

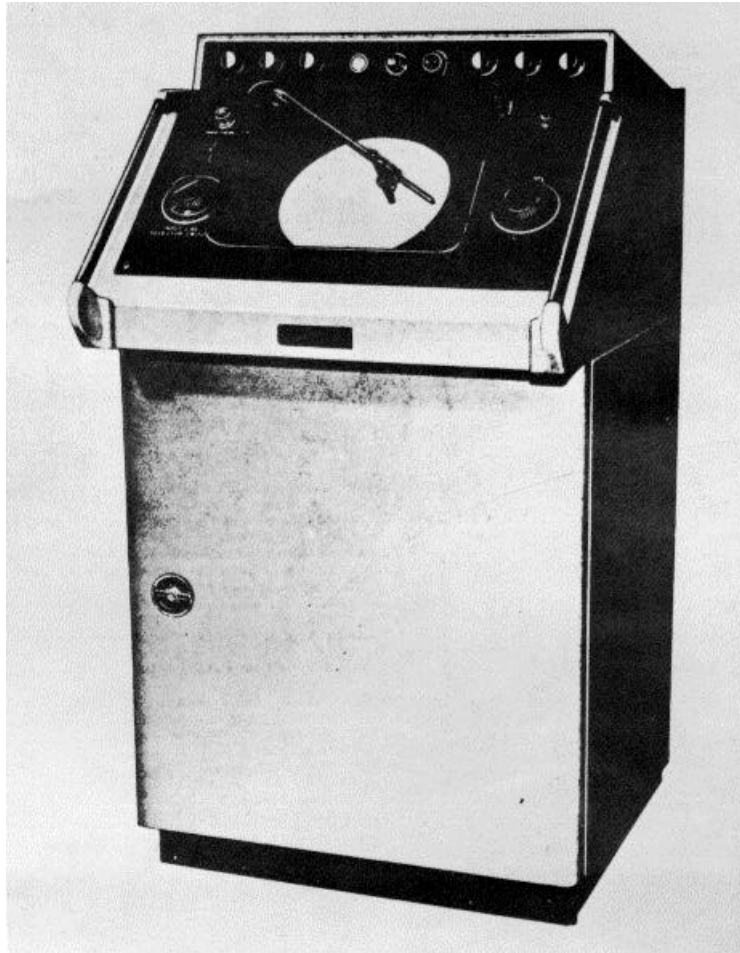

#### FUNCTIONAL DESCRIPTION

Coordinate Data Monitor OA-917/FST-1 is used in conjunction with Coordinate Data Transmitting Set AN/FST-1. The inputs from six such transmitters can be monitored Individually on Coordinate Data Monitor, OA-

947/FST-1, selectable by a switch. The monitor interprets the narrow band coded information coming over telephone lines and presents the information on the face of a cathode ray tube which provides a visual display of target data, its range and its azimuth. The



**ITEM NAME:** COORDINATE DATA MONITOR

**TYPE:** OA-947/FST-1

information to the Coordinate Data Monitor, either comes as a combined coded signal over one pair of telephone lines, or as three separated coded signals representing data, sync, and timing signals, over three separate pairs of telephone lines. The Coordinate Data Monitor can also provide signals which operate a Coordinate Data Recorder RO-65/FST.

**RELATION TO SIMILAR EQUIPMENT**

None.

**TECHNICAL DESCRIPTION**

Input Power: 105 to 115v, single ph  
11 amp without recorder  
19 amp with recorder

Input Impedance:  
Separate Line - (Sync, Data and Timing) About 10,000 ohms ea line.  
Combined Line - About 12,000 ohms  
External Data - Greater than 100,000 ohms

Input Levels:  
Seperate Line - 0.5 to 1.0v, peak to peak.

Combined Line - 0.12 to 0.39v (-20 dbm plus or minus 5 db) on sync amplitude  
External Data - 0 to -30v clamped logic  
0 volts = space  
-30 volts . mark  
-30 volts input level will intensify cathode ray tube controlled by external data intensity controls. Width of input pulse determines length of display mark on CRT Mark factor about 6 ms per in. at normal sweep rate.

**INSTALLATION CONSIDERATIONS**

Siting: Dependent on the location of the prime radar site that is associated with the gap filler radar.

Mounting: Floor-mounted in prime radar building.

Cabling Requirements: A 50 ft cable is used for power connection. The telephone lines are connected to an input filter.

Related Equipments: Coordinate Data Transmitting Set AN/FST-1, and gap filler Radar Sets AN/FPS-14, AN/FPS-18.

**PRINCIPAL COMPONENTS AND PHYSICAL DATA**

COMPONENT	QTY	HEIGHT (Inches)	WIDTH (Inches)	DEPTH (Inches)	UNIT WT.
Monitor, Coordinate Data OA-947/FST-1	1				
Cabinet, Electrical Equipment CY-2227/FST-1	1				
Control, Coordinate Data Monitor CY-2250/FST-1	1				
Power Supply PP-1420/FST-1	1				
Power Supply PP-1403/FST-1	2				
Power Supply PP-1665/FST-1	1				
Cable Assembly, Power, Electrical CX-419/U (50 ft O in.)	1				
48-Pin Connector AN-3106A-36-10S	1				

**REFERENCE DATA AND LITERATURE**

TECHNICAL ORDERS:  
31S1-2FST1-11 through  
31S1-2FST1-16

DATE: 1 April 1964

ITEM NAME: INDICATOR GROUP

COGNIZANT SERVICE: USAF

TYPE: OA-1040/GPS

FEDERAL STOCK NUMBER: 5840-553-3929

	USA	USN	USAF	USMC
STATUS OR TYPE CLASSIFICATION			Std	

Mfg(s), Name or (code Number: General Electric Company

Illustration not available.

**FUNCTIONAL DESCRIPTION**

Indicator Group) OA-1040/GPS uses a RSI in conjunction with a RSRU to examine a target or a group) of targets appearing within any 5-mile sector of the AN/FPS-6A radar set PPI's. Any 2.5 or 5-mile sector

containing a distant object representing a target or group of targets may be presented on an A-type oscilloscope for close-range examination. The RSRU is a control box used to signal the RSI when information pertaining to a group of targets is desired. The RSRU also contains the

OA-1040/GPS: 1

**ITEM NAME:** INDICATOR GROUP  
**TYPE:** OA-410/GPS

dials used to control a visual display of a group) of targets as determined by the RSI operator. The RSI operator cannot send information pertaining to these targets unless requested to do so by the PPI operator using the RSRU. When a request has been made, the RSI operator manually inserts information pertaining to these targets by operating switches on the front panel of the RSI. This information is transmitted to the RSRU and appears on the front panel of the RSRU by means of dial displays. The RSI receives trigger and video inputs from the AN/FPS-6A and displays this video information on a CRT.

**RELATION TO SIMILAR EQUIPMENT**

None.

**TECHNICAL DESCRIPTION**

Type of Presentation: CRT and dial displays  
Ambient Temperature: -20 to plus 126 deg F  
Altitude Limits: Sea level to 10,000 ft

Input Pulse Amplitude: 10 plus or minus 3v  
Input Pulse Width: 1.5 plus or minus 0.5 usec  
Input Polarity: Positive  
Input Impedance: 68 ohms  
Operating Voltages and Power Requirements: 115v ac, 60 cps, 1-ph, 250w

**INSTALLATION CONSIDERATIONS**

Siting: Physically located with the associated radar set.

Mounting: The IP-402/GPS equipment is located adjacent to Indicator Group OA-929/FPS-6A. The ID-593/GPS equipment is located near the AN/FPS-6A radar set PPI.

Related Equipment: Radar Set AN/FPS-6A or AN/FPS-6, AN/MPS-14; Indicator Group AN/UPA-35.

**PRINCIPAL COMPONENTS AND PHYSICAL DATA**

<b>COMPONENT</b>	<b>QTY</b>	<b>HEIGHT (Inches)</b>	<b>WIDTH (Inches)</b>	<b>DEPTH (Inches)</b>	<b>UNIT WT.</b>
Raid Size Indicator IP-402/GPS	1	10	16	20	
Raid Size Remote Unit ID-593/GPS	1	6-3/4	6-3/-1	7-5/8t	

**REFERENCE DATA AND LITERATURE**

Technical Orders:  
31P3-2FPS6-132  
Specification:  
MIL-126836A

ITEM NAME: ANTENNA GROUP  
TYPE: OA-1124/FPS

PRINCIPAL COMPONENTS AND PHYSICAL DATA/  
SHIPPING DATA (Cont.)

COMPONENT	BOXES (NR.)	OVERALL DIMENSIONS (Inches)	UNIT WT. (Pounds)
(1) Amplifier-Filter Assy AM-1570/TPS-1D*			
(1) Directional Coupler CU-549/TPS-1D*			
(1) Cable Assy CX-3914*			
(1) Duplexer CU-5,18/TPS-ID*			
(1) Waveguide Flange UG-1225/TPS-1D*			
(1) Antenna Control C-1894/ FSP*			
(1) Set of Tubes*			
Pulse Generator TD-169/TPS-ID incl: Technical Manuals Set of Maintenance Drawings	1*	1 22 x 27 x 33	130
Hardware for C-1894/FPS incl: (1) Cable Assy CX-3910/U* (1) Cable Assy CX-3911/U* (1) Cable Assy CX-3912/U* (3) Cord CG-247C/U* (1) Cord CG-247C/U* (1) Cable Assy CG-1514/U. (6) Cable Marker Band*	1	20 x 23 x 31   600 lg 73 lg	102
Oil for AB-465-, 5 Gal (2)	3	15 x 15 x 26	117

NOTE:\*

Indicates unit or box that is part of Electronic Modification Kit MK-304/TPS-ID which is shipped with the OA-1124/FPS

PRINCIPAL COMPONENTS AND PHYSICAL DATA/  
SHIPPING DATA (Cont.)

COMPONENTS	BOXES (NR.)	QTY	OVERALL DIMENSIONS (Inches)	UNIT WT. (Pounds)
Antenna AS-847/FPS	1		194 x 205 x 480	1322
Antenna Control C-1894/FPS	1			
Antenna Pedestal AB-465/FPS		1	194 x 205 x 480	7420
Waveguide Assy CG-1435/FPS-19	2		5-1/2 x 14-1/4 x 11-1/4	4.9
Waveguide Assy CG-1436/FPS-19	2		8-3/4 x 11-5/8 x 11-5/8	4.2
Waveguide Assy CG-1512/U	1		5-1/2 x 8-3/4 x 36	16
Waveguide Assy CG-1513/U	2		5-1/2 x 8-3/4 x 120	22.2
Gasket, Waveguide Flange	8		3/16 x 4-1/8 x 7-3/8	0.1
Cable Assy CX-3909/U		11-5/16 x 1-5/16 x 624		
Nuts, Screws, Lockwashers	80			

REFERENCE DATA AND LITERATURE

Technical Manuals:  
TM 11-50,17 for Antenna Group OA-1124/FPS.

DATE: 1 July 1964  
COGNIZANT SERVICE: USA

ITEM NAME: ANTENNA GROUP  
TYPE: OA-1124/FPS

FEDERAL STOCK NUMBER:

	USA	USN	USAF	USMC
STATUS OR TYPE CLASSIFICATION				
Mfg(s) Name or Code Number:				

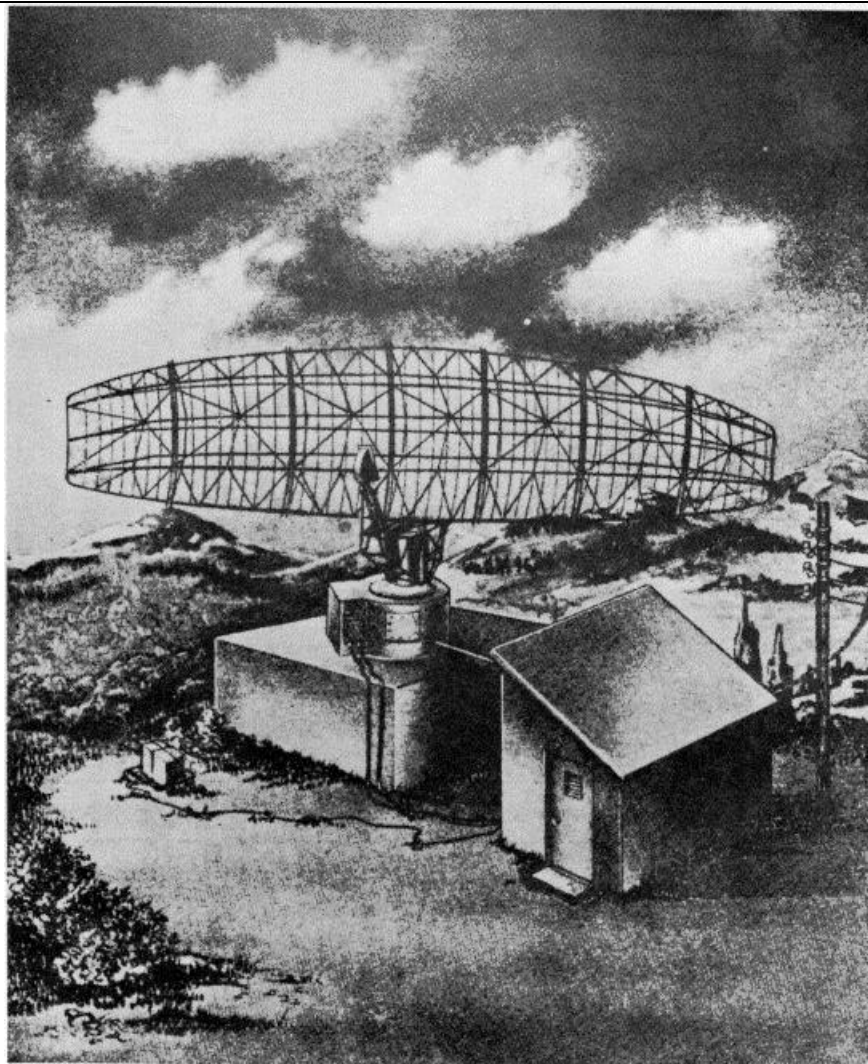

**FUNCTIONAL DESCRIPTION**

The OA-1124/FPS is a large, high-gain, reflector-type antenna and associated components designed for fixed position use. It is installed on and secured to a concrete slab or other suitable foundation. It is

furnished with waveguide assemblies for runs up to 20 feet from the radar set, and it can be controlled from a remote position up to 50 feet from the radar set. It is designed to increase the range capabilities and angle coverage of Radio Set AN/

**ITEM NAME:** ANTENNA GROUP  
**TYPE:** OA-1124/FPS

TPS-ID, and when used with Modification Kit MK-301/TPS-1D, the AN/TPS-1D when modified is redesignated Radar Set AN/FPS-36. Although the OA-1124/FPS is designed for use with modified AN/TPS-ID it can also be used with any L-band radar set when suitable RF and Synchro connections can be made.

**TECHNICAL DESCRIPTION**

Azimuth Scanning: 360 deg continuous clockwise at 6 plus or minus 1 rpm  
Antenna Gain: 34 db along axis of max radiation.  
Beam Width (At Half-Power Points)  
Horizontal: 1.4 plus or minus 0.2 deg

Vertical: 6.2 plus or minus 0.5 deg  
Vertical Beam Position: 2.5 deg above the horizontal  
Reflector Feed: Waveguide horn at reflector focal point  
IFF Reflector Feed: Dipole radiator at reflector focal point  
IFF Beam Width (At Half-Power Points)  
Horizontal: 1.6 plus or minus 0.3 deg  
Vertical: 6.2 plus or minus 0.5 deg  
Power Handling Capacity (Peak RF): 2 megw at 0.001 duty cycle.  
Power Requirements: 120 or 208v plus or minus 5%, 60 cps plus or minus 4%, 4-wire, 3 ph, 27 kw

**PRINCIPAL COMPONENTS AND PHYSICAL DATA**  
**SHIPPING DATA**

<b>COMPONENT</b>	<b>BOXES (NR.)</b>	<b>OVERALL DIMENSIONS (Inches)</b>	<b>UNIT WT. (Pounds)</b>
Reflector Center Section	1	75 x 91 x 146	1290
Reflector Section No. 2, RH	1	76 x 93 x 147	1170
Reflector Section No. 2, LH	17	76 x 93 x 147	1170
Reflector Section No. 3, RH	1	69 x 93 x 130	800
Reflector Section No. 3, LH	1	69 x 93 x 130	800
Reflector Section No. 4, RH	1	42 x 80 x 105	510
Reflector Section No. 1, LH	1	42 x 80 x 105	510
Reflector Support	1	51 x 84 x 101	665
Horn Support Assembly incl: Horn	1	45 x 68 x 162	695
Waveguide Twist			
Waveguide Bend			
Cable Assembly CG-1514/U			
Measuring Rod Assembly			
Antenna Pedestal AB-465/FPS	1	95 x 107 x 113	8790
Cable Assembly CX-3909/ U incl: (10) Waveguide Gasket (80) Hexagonal Cap Screw (80) Lockwasher (80)Hexagonal Nut (2) Lubrication Filling (1) Cable Assembly (X-3913/* (1) Cable Assembly CX-1999/U*	1	11 x 27 x 33	147
Waveguide Assembly CG-1513/1'(2)	1	15 x 18 x 127	140
Modification Kit for IP-405/FPS-36 incl: Modification Kit for IP-3455/TPS-1D	1*	16 x 18 x 25	40
Modification Kit for RT-212/TPS-1D	1*	18 x 20 x 32	73
Waveguide Assembly CG-1512/U incl: (2) Waveguide Assy CG-1,136/FPS-19 (2) Wavetguide Assy CG-1435/FPS-19 (1) Telescope Mount Assy (2) Wrench, Open-Ended (1) Drain-Hose (1) Cable Assy CG 1200/U** (1) Cord CG-92E./U* (1) Adapter UG-1224/TPS-ID** (1) Adapter UG-1223/TPS-ID*	1	26 x 33 x 12	230

DATE: 1 SEPTEMBER 1964  
COGNIZANT SERVICE: USAF

ITEM NAME: COORDINATE DATA MONITOR  
TYPE: OA-1163/FST

FEDERAL STOCK NUMBER: 5895-8644-EG

	USA	USN	USAF	USMC
STATUS OR TYPE CLASSIFICATION	Std			
Mfg(s) Name or Code Number: Lewyt Corporation				

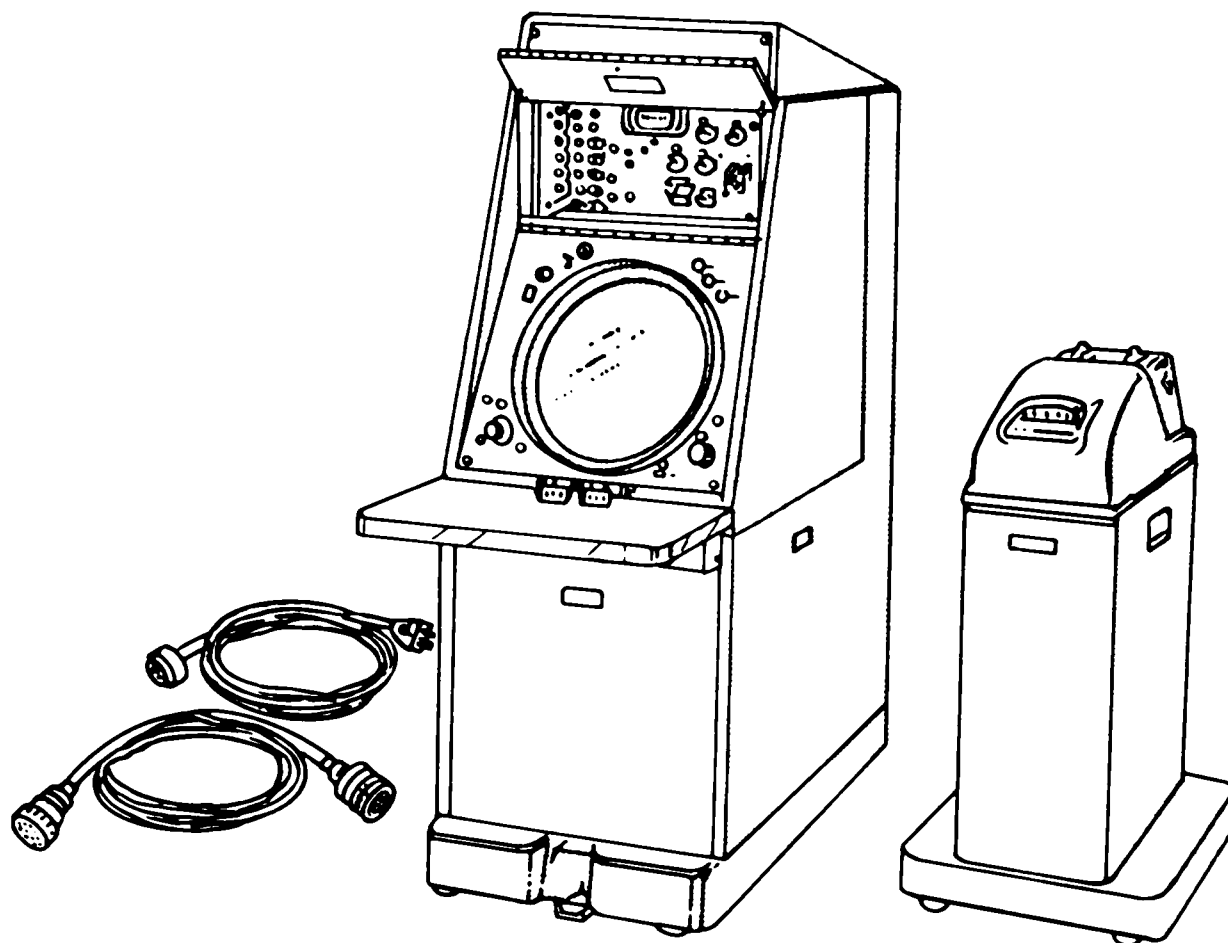

**FUNCTIONAL DESCRIPTION**

Coordinate Data Monitor OA-1163/FST Is a random-access plan position Indicator which provides remote visual monitoring of radar data from a coordinate data transmitter. The monitor displays search radar returns, Identification

friend or foe (Mark X IFF) returns and auxiliary returns received through digital data receivers, digital . data transmitters, and telephone lines. All three types of information may be displayed singly or in any combination. The term "random-access" describes the

OA- 111 t3 'FST: !

**ITEM NAME:** COORDINATE DATA MONITOR  
**TYPE:** OA-1163/FST

ability of the monitor to display a target at any position independent of the position of any previously displayed target. In addition to the usual display of targets, the monitor has provision to supply read-out information and power to Coordinate Data Recorder RO-65/FST, to permanent record the coordinates of any desired available target. This equipment can be connected across the outputs of the digital data receivers without affecting the operation of the equipment to which these outputs are normally supplied

Deflection Yoke: Two-coil, stationary  
Print-Out Control: Gating circle  
Displays per Second: 50  
Range Magnification: .4 times (max)  
Selective Displays  
Desired Targets Ring  
Undesired Targets: Spot  
Power Requirements: 115v ac, 60 cps

**RELATION TO SIMILAR EQUIPMENT**

None.

**INSTALLATION CONSIDERATIONS**

Mounting: Floor-mounted.

Cabling Requirements  
Signal Cable: Fabricated locally  
Power Cable: Furnished with equipment

**TECHNICAL DESCRIPTION**

Type of Indicator: Visual Cathode Ray Tube:  
16 in., long persistence  
Data Input: Digital Internal Conversion:  
Digital to analog

Related Equipment  
Coordinate Data Transmitting Set AN/ FST-2.  
Coordinate Data Recorder RO-65/FST

<b>COMPONENT</b>	<b>QTY</b>	<b>HEIGHT (Inches)</b>	<b>WIDTH (Inches)</b>	<b>DEPTH (Inches)</b>	<b>UNIT WT.</b>
OA-1163/FST, Monitor	1	64	23	38	

**REFERENCE DATA AND LITERATURE**

Not available

**OA-1163/FST: 2**



DATE: 1 July 1964  
COGNIZANT SERVICE: USA

ITEM NAME: POWER UNIT  
TYPE: PU-26A/U

FEDERAL STOCK NUMBER:

	USA	USN	USAF	USMC
STATUS OR TYPE CLASSIFICATION				
Mfg(s) Name or Code Number.				

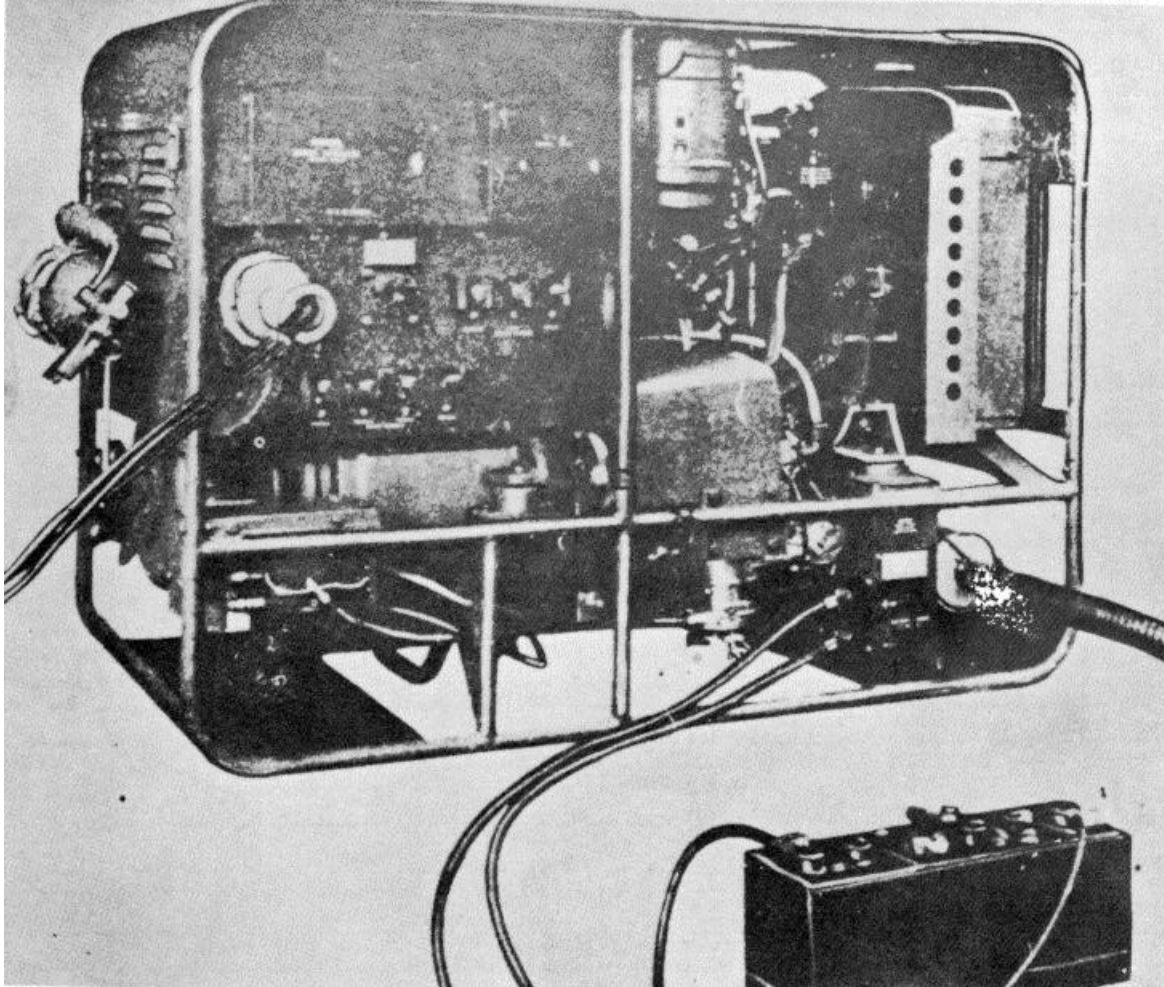

**FUNCTIONAL DESCRIPTION**

The PU-26A/U is intended primarily as a source of power for the operation of Radar Sets AN/CPS-1, AN/CPS-6, AN/FPC-1, AN/FPC-2, AN/MPG-1, AN/MPQ-10 and AN/MPQ-IOA and Radio

Set SCR-615-B. The equipment may be used as a source of power for the operation of any other equipment that requires power within the rated capacity of the unit.

Volume 1  
 Section 1  
**ITEM NAME:** POWER UNIT  
**TYPE:** PU-26A/U

**MIL-HDBK-162A**  
 15 December 1965

**RELATION TO SIMILAR EQUIPMENT**

None.

**TECHNICAL DESCRIPTION**

Engine

Type: 4 stroke cycle  
 Type Cylinder Head: L  
 Number Cylinder: 4  
 Bore: 3-1/8 in.  
 Stroke: 4-3/8 in.  
 Piston Displacement: 134.2 cu in.  
 Compression Ratio: 6.48 to 1  
 Speed: 1800 rpm  
 Horsepower: 35 at 1800 rpm  
 Batteries: 6v ea

Alternator

Type: 4 pole, revolving field  
 Voltage:

Parallel-Delta: 120v ac  
 Series-Delta: 240v ac  
 Parallel-Wye: 120/208v ac  
 Series Wye: 2.10'-116v. ac

Phase

Delta: 3 ph, 3 wire  
 Wye: 3 ph, 4 wire  
 Cycle: 60  
 Power Factor: 0.8  
 Ampere Rating  
 Parallel-Delta: 75 amp  
 Series-Delta: 37.5 amp  
 Parallel-Wye: 13.5 amp  
 Series-Wye: 21.75 amp  
 Kilowatt Rating: 12.5

Speed: 1800 rpm

Drive: Direct

Exciter

Type: 4 pole, shunt field  
 Voltage: 65  
 Ampere Rating: 6

**PRINCIPAL COMPONENTS AND PHYSICAL DATA**  
**SHIPPING DATA**

COMPONENTS	BOXES (NR.)	OVERALL DIMENSIONS (Inches)	UNIT WT. (Pounds)
Power Unit PU-26A/U	1		
Batteries	2		

**EQUIPMENT SUPPLIED DATA**

COMPONENTS	QTY	OVERALL DIMENSIONS (Inches)	UNIT WT. (Pounds)
Power Unit PU-26A/U	1	26 x 37 x 51	1250
Engine	1	24 x 26 x 30	105
Generator	1	21.75 x 22.25 x 25.13	410.75
Batteries	2	10.25 x 12 x 15	50
Set Spare Parts	1		
Set Tools	1		
Installation Equipment	1		
Miscellaneous Equipment c/o			
Batteries, 6v Storage	2		
Bracket, Mtg, Fire	1		
Extinguisher			
Cover, Canvas	1		
Crank, Hand	1		
Fire Extinguisher	1		
Technical Manual			
TM 11-976A			

**REFERENCE DATA AND LITERATURE**

Technical Manuals:  
 TM 11-9'76A for Power Unit Pt'-26A/1'.

**PU-26A/U: 2**

DATE: 1 July 1964  
COGNIZANT SERVICE: USN

ITEM NAME: ROTARY SWITCHES  
TYPE: SA-213/U, SA-233/U, SA-234/U

FEDERAL STOCK NUMBER: See Note 1

	USA	USN	USAF	USMC
STATUS OR TYPE CLASSIFICATION				
Mfg(s) Name or Code Number: Watson Elevator Company, Inc., Englewood, New Jersey				

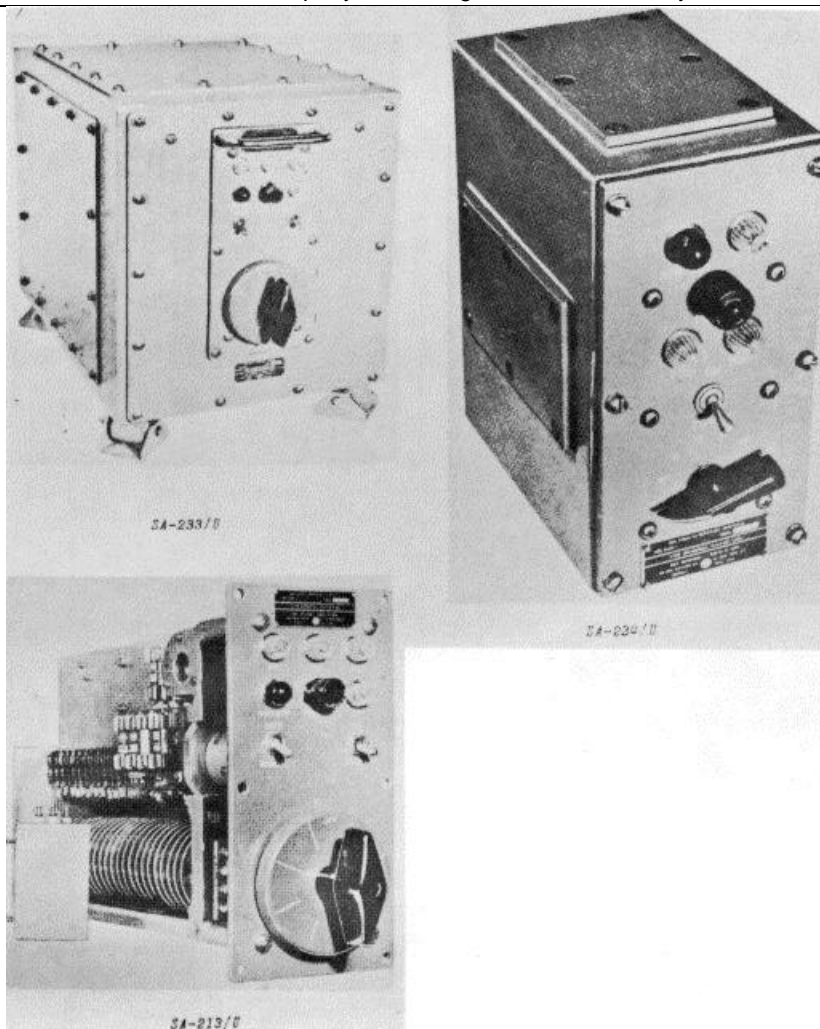

**FUNCTIONAL DESCRIPTION**

The SA-213/U or SA-233/U Is a manually or remotely operated switching unit for general radar

use.

The SA-234/U is a remote control unit for remotely switching the SA-213/U or SA-233/U Rotary Switch.

SA-213/U: 1

Volume 1  
Section 1

**MIL-HDBK-162A**  
15 December 1965

**ITEM NAME:** ROTARY SWITCHES  
**TYPE:** SA-213/U, SA-233/U, SA-234/U

**RELATION TO SIMILAR EQUIPMENT**

None .

SA-234/U

Type: B position, I section  
Power Source Required: No direct connection to power line; obtains 115v, 60 cps by connection to main switch equipment SA-213/U or SA-233/U.

**TECHNICAL DESCRIPTION**

SA-213'U and SA-233/U  
Type: b position, 25 section, multiple rotary.  
Terminal per Section: 8  
Total Terminals: 200  
Operation  
Local: Manual  
Remote: Electrical, by means of a remote unit  
Power Source Required: 115v, 60 cps, 3 ph, 3-wire.

**INSTALLATION CONSIDERATIONS**

Related Equipment:  
Required but not Supplied.  
For remote operation, the SA-233/U must be operated by SA-231/U Rotary Switch.

**PRINCIPAL COMPONENTS AND PHYSICAL DATA**

**SHIPPING DATA**

<b>COMPONENT</b> (NR.)	<b>BOXES</b> (Inches)	<b>OVERALL DIMENSIONS</b> (Pounds)	<b>UNIT WT.</b>
SA-213/U Rotary Switch SA-213/U External Balancing Transformer Technical Manual	1	5-1/4 x 10-1/2 x 20-1/8	34.5
Spare Parts SA-233 /U Rotary Switch SA-233/U Spare Parts	1 1 1	4-3/4 x 7-3/4 x 13-1/2 15 x 1b x 23-1/2 4-3/4 x 7-3/4 x 13-1/2	102 13.5
SA-234/U Rotary Switch SA-234/U	1	6-3/4 x 10-1/2 x 11	14.8

**SHIPPING DATA**

<b>COMPONENT</b>	<b>BOXES</b> (NR.)	<b>OVERALL DIMENSIONS</b> (Inches)	<b>UNIT WT.</b> (Pounds)
SA-213/U Rotary Switch SA-213/U External Balancing Transformer Technical Manual Set Equipment Spares	1 1 1 1	5 x 10-1/4 x 16-5b/t3 1-15/16 x 2-1/2 x 3-27/32 1/8 x b-1/2 x 11 1-1 '1 x 6-1/2 x 12-1,'2	20.2 2.1 0.4 11
SA-233/U Rotary Switch SA-233/U Set Equipment Spares	1 1	13 x 18 x 15,-3/1 1-1/.1 x 6-1/2 x 12-1/2	95 13

**SA-21.3/U: 2**

**ITEM NAME:** ROTARY SWITCHES  
**TYPE:** SA-213/U, SA-233/U, SA-234/U

**FEDERAL STOCK NUMBER:**

**PRINCIPAL COMPONENTS AND PHYSICAL DATA**

<b>COMPONENTS</b> (Inches)	<b>QTY</b> (Pounds)	<b>OVERALL DIMENSIONS</b>	<b>UNIT WT.</b>
SA-234/U Rotary Switch SA-234/U	1	4-9/16 x 7-19/32 x 8-5/8	12.5

**REFERENCE DATA AND LITERATURE**

Technical Manuals:  
NAVSHIPS 91591(A)

**NOTE 1.**

**SA-213/U:** 5930-548-9320  
5930-666-1981 W/S

**SA-233/U:** 5930-508-190.5  
5930-666-1666 W/S

**SA-234/U:** 5840-503-246B  
5840-644-3034 W/S

**SA-213/U: 3**

DATE: 1 July 1964  
COGNIZANT SERVICE: USN

ITEM NAME: VIDEO DISTRIBUTOR  
TYPE: SA-220/UPX\*, SA-220A/UPX\*\*

FEDERAL STOCK NUMBER: \*5840-696-5382  
\*5840-501-4914

\*\*5840-644-4662  
\*\*5840-669-7826 W/S

	USA	USN	USAF	USMC
STATUS OR TYPE CLASSIFICATION				
Mfg(s) Name or (de Number: *General Communication Company, Boston, Massachusetts				



**FUNCTIONAL DESCRIPTION**

The SA-220/UPX and SA-220A/UPX is a unit used with IFF interrogating equipment. The unit is a multiple switching equipment used for switching and distributing video pulses.

The Video Distributor selects any one of the three modes of operation used in IFF interrogating equipment and directs it to a control station for presentation.

**SA-220/UPX: 1**

**ITEM NAME:** VIDEO DISTRIBUTION  
**TYPE:** SA-220/UPX, SA-220A/UPX

**RELATION TO SIMILAR EQUIPMENT**

None

**TECHNICAL DESCRIPTION**

IFF Video Input Impedance: 75 ohms nom  
(or high impedance of not less than  
5000 ohms nor more than 40 uuf).  
IFF Video Output Signal

Polarity: pos  
Level: From zero to input level.  
None. Impedance: 75 ohms nom  
Power Requirements: 115v, 60 cps, 1-ph,  
0.85 amp; or 115v, 400 cps, 1-ph, 0.80  
amp.

**INSTALLATION CONSIDERATIONS**

Not available

**PRINCIPAL COMPONENTS AND PHYSICAL DATA**

COMPONENT	BOXES (NR.)	OVERALL DIMENSIONS (Inches)	UNIT WT. (Pounds)
SA-220/UPX			
Video Distributor SA-220/UPX	1	15-1/4 x 15-1/41 x 34-1/4	102
Spares	1	7 x 7 x 19	29
SA-220A/UPX			
Video Distributor SA-220A/UPX	1	14-1/2 x 17 x 33	175
Equipment Maintenance Parts	1	8 x 8-1/2 x 21	44

**PRINCIPAL COMPONENTS AND PHYSICAL DATA**

COMPONENTS (Inches)	QTY (Pounds)	OVERALL DIMENSIONS	UNIT WT.
SA-220/UPX			
Video Distributor SA-220/UPX	1	9-1/2 x 10-1/4 x 27-5/8	62
Technical Manual NAVSHIPS 91701	2	1/2 x 9 x 11-1/2	1.2
Set Spares	1	6 x 6 x 18	28
SA-220A/UPX			
Video Distributor SA-220A/UPX	1	9-7/16 x 10-1/8 x 27-11/32	60

**REFERENCE DATA AND LITERATURE**

Technical Manuals:  
NAVSHIPS 91701: for Video Distributor SA-220/UPX.  
NAVSHIPS 91765: for Radar Recognition Set AN/UPX-IA.

DATE: 1 July 1964  
COGNIZANT SERVICE: USN

ITEM NAME: ROTARY SWITCHES  
TYPE:: SA-233/U, SA-234/U\*-1

FEDERAL STOCK NUMBER: 5930-500-1905      \*5840-503-2468  
5930-666-1666 W/S                              \*5840-644-3034 W/S

	USA	USN	USAF	USMC
STATUS OR TYPE CLASSIFICATION				
Mfg(s) Name or Code Number: Watson Elevator Company, Inc., Englewood, New Jersey				

Description for Rotary Switches SA-233/U and SA-234/U is found on Rotary Switches SA-213/U data sheets, pages SA-213/U: 1 thru SA-213/U: 3.

**SA-233/U: 1**



**ITEM NAME:** RADAR EQUIPMENT  
**TYPE:** SK-1M

**PRINCIPAL COMPONENTS AND PHYSICAL DATA**

<b>COMPONENTS</b>	<b>QTY</b>	<b>OVERALL DIMENSIONS (Inches)</b>	<b>UNIT WT. (Pounds)</b>
<b>TEST EQUIPMENT</b>			
Radar Test Equipment Model OAA-2	1	5-3/4 x 14-1/2 x 15-1/4	27
Radar Operating Training Equipment Model OAV-1	1	9 x 13-1/2 x 21-3/4	60
Oscilloscope TS-34/AP or Equivalent	1	6 x 8 x 18	26
Tube Tester Model OAL	1	6 x 12 x 13	20
Volt Ohmyst (Jr. RCA Type 165A)	1	6-1/4 x 6-1/2 x 9-1/2	14
Packet Voltohmmilliammeter Type 666H	1	2 x 3 x 6	2
Transmission Line and Cables			
Gas Engine Generator Set NT-73029	2	31 x 47 x 71	1100
Auxiliary Trailer of One of Engine- Alternators NT-10305	1	60 x 79 x 132	1610
Dehumidifying Unit NT-10306	1	38 x 40-1/2 x 51-3/4	1500
Dehumidifier Trailer NT-10311	1	64-1/4 x 74 x 91-3/4	2000
Air Raid Warning Siren	1	19-1/2 x 19-1/2 x 24-1/2	65
Spare Parts (except mobile)			
Mobile Spare Parts			
Technical Manual			

**REFERENCE DATA AND LITERATURE**

Technical Manuals:  
NAVSHIPS 900484

**SK-IM: 3**

DATE: 1 July 1964  
COGNIZANT SERVICE: USN

ITEM NAME: RADAR EQUIPMENT  
TYPE: SK-1M

FEDERAL STOCK NUMBER: 5840-346-3031  
5840-665-2004 W/S

	USA	USN	USAF	USMC
STATUS OR TYPE CLASSIFICATION				
Mfg(s) Name or Code Number: General Electric Company, Schenectady, New York				

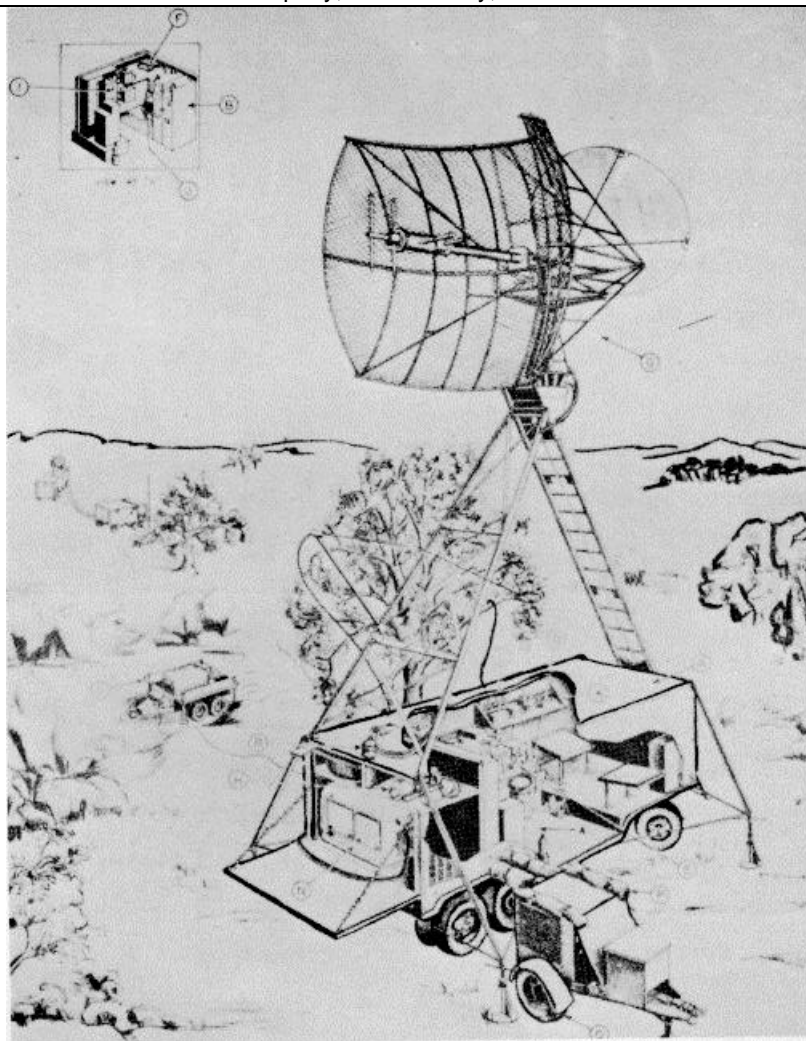

### FUNCTIONAL DESCRIPTION

The SK-1M is a mobile search radar designed primarily for long range detection of medium and high altitude aircraft. Planes at lower altitudes can be detected at correspondingly small ranges and surface

craft at still smaller ranges. Maximum and minimum ranges differ with the size, altitude and nature of the target, conditions of installations, atmospheric conditions, and skill of operator. Estimated ranges under favorable conditions are given to aid visualization of the purpose

SK-1M: 1

**ITEM NAME:** RADAR EQUIPMENT  
**TYPE:** SK-1M

for which this equipment may be used. Field experience with a particular installation will permit revised estimates of its capability.

**TECHNICAL DESCRIPTION**

General  
Maximum Reliable Range Light

**TECHNICAL DESCRIPTION**

General

Bombers: 90 to 120 mi at 20,000 ft.  
Heavy Bomber: 120 to 150 mi at 25,000 ft.  
Battleship: 15 mi  
Destroyer: 8 mi

**INSTALLATION CONSIDERATIONS**

Not available.

**PRINCIPAL COMPONENTS AND PHYSICAL DATA**

<b>COMPONENT</b>	<b>QTY</b>	<b>OVERALL DIMENSIONS (Inches)</b>	<b>UNIT WT. (Pounds)</b>
Operations Trailer NT-10304	1	96 x 123 x 2.10	13,500
Radar Transmitter NT-52ACX	1	31 x 35 x 72	1150
Receiver-Indicator NT-46ADG	1	21-1/.1 x 22 x 22-1/2	280
Plan Position Indicator NT-55A.EW	1	31 x 39 x .10	750
Control Unit NT-23AEO	1	13-1/4 x 21-1/4 x 22-1/2	125
Duplexing Unit NT-50ADU	1	7-3/1 x 12 x 29-5/1t	60
Antenna Assy NT-66AGW or NT-66AGX	1	11-1/2 x 120 x 180	700
Motor-Dynamo Amplifier NT-21ABU	1	9-1/1 x 13 x 24-1/4	150
Power Distribution Unit NT-23AEP	1	9-5/i[ x 45-1/2 x 50-3/16	200
Interrogation Equipment Model-BN	1	14-3/B x 20-1/16 x 20-7/16	156
a-Transmitting Rec.		4-9/16 x 4-5/8 x 20-15/16	18
b-Duplexer			

**COMMUNICATIONS EQUIPMENT**

(a) Radio Equipment Model TCS-9	1		
Transmitter NT-52245	1	11-3/4 x 11-3/4 x 13-3/4	50
Receiver NT-16159	1	11-3/4 x 11-3/4 x 13-3/4	10
Power Unit NT-20218	1	10-1/4 x 16-1/4 x 16-1/4	91
Antenna Load Coil NT-47205	1	6 x 6-3/4 x 9-1/2	4
Remote Control Unit NT-23270	1	4-1/4 x 5-1/4 x 7-1/2	6
Handset Telephones EE-8	2	1 x 8 x 10	13 ea
Headset HS-33	1		
Chest Set TD-1	1		
Connecting Cord	1		191 tot.

**SK-IM: 2**

ITEM NAME: RADAR EQUIPMENT  
TYPE: SK-1M

PRINCIPAL COMPONENTS AND PHYSICAL DATA (Cont.)

COMPONENT	QTY	OVERALL DIMENSIONS (Inches)	UNIT WT. (Pounds)
<b>TEST EQUIPMENT</b>			
Radar Test Equipment Model OAA-2	1	5-3/4 x 14-1/2 x 15-1/4	27
Radar Operating Training Equipment Model OAV-1	1	9 x 13-1/2 x 21-3/4	60
Oscilloscope TS-34/AP or Equivalent	1	6 x 8 x 18	26
Tube tester Model OAL	1	6 x 12 x 13	20
Volt Ohmyst (Jr. RCA Type 165A)	1	6-1/4 x 6-1/2 x 9-1/2	14
Packet Voltohmmilliammeter Type 666H	1	2 x 3 x 6	2
Transmission Line and Cables			
Gas Engine Generator Set NT-73029	2	31 x 47 x 71	1100
Auxiliary Trailer of One of Engine Alternators NT-10305	1	60 x 79 x 132	1610
Dehumidifier Unit NT-10306	1	38 x 40-1/2 x 51-3/4	1500
Dehumidifier Trailer NT-10311	1	64-1/4 x 74 x 91-3/4	2000
Air Raid Warning Siren	1	19-1/2 x 19-1/2 x 24-1/2	65
Spare Parts (except mobile)			
Mobile Spare Parts			
Technical Manual			

REFERENCE DATA AND LITERATURE

Technical Manuals:  
NAVSHIPS 900484

SK-1M: 3

DATE: 1 July 1964  
COGNIZANT SERVICE: USN

ITEM NAME: RADAR TARGET SIMULATOR  
TYPE: SM-42( )/U

FEDERAL STOCK NUMBER: 5840-553-5783

	USA	USN	USAF	USMC
STATUS OR TYPE CLASSIFICATION			Std	
Mfg(s) Name or Code Number: Granite State Machine Co., Inc.				

Illustration not Available.

**FUNCTIONAL DESCRIPTION**

Radar Target Simulator SM-12( )/U is composed of a triangular reflector, mounted with telescopic-fitted tubing, and a vertical polarizer attached to the reflector with four brackets. The SM-12( )/U is used

to simulate a small target with a large cross-sectional reflecting surface from an oriented ground position. This broad response, from a simulated aircraft radar reflection, is used to aid in the adjustment of antenna beam angle and indicator map alignment. The two mast sections,

**SM-42()/U: 1**

**ITEM NAME:** RADAR TARGET SIMULATOR  
**TYPE:** SM-42( )/U

consisting of a paper-base phenolic material, permit operation from heights of 5 feet, 8 feet, or 20 feet. The reflector, molded of polyester resin with aluminum foil lamination between paper laminations, is provided with eight steel stakes, used to provide bearings.

outside dia  
Lower: 4.5 in. inside dia, 1.7 in. outside dia  
Height (Erected): 96-1/2 in.  
Bearing Stakes: 1 (1 stakes 2 in. by 3, 1 in., and 4 stakes 3 in. b) 1 in.  
Frequency (Operating): 30,000 mc

**RELATION TO SIMILAR EQUIPMENT**

None.

**INSTALLATION CONSIDERATIONS**

**TECHNICAL DESCRIPTION**

Reflector

Construction Material: Laminated paper base phenolic and aluminum foil  
Finish: Yellow  
Dimensions (Full) Assembled): 10-1/2 in. by 28-3/1 in. by 24 ft, 6 in.  
Operating Heights: 5 ft, 8 ft, or 20 ft (above ground level).

Circular Polarizer Corner Reflector

Number of Attachment Brackets: 4

Mast Sections: 2

Section Dimensions

Upper: 1.71U In. inside dia, 1.781 in.

Siting: The equipment may be physically located on any cleared area, free from radio-frequency-wave obstructions, of known latitude and longitude, and available to personnel adjusting radar set beam angle or indicator map alignment.

Mounting

Reflector: Installed on top of two-section mast

Vertical Polarizer: Attached to reflector element with the aid of four brackets.

Related Equipment

(Required but not Supplied): Radar Set AN/FPN-16.

COMPONENT	QTY	HEIGHT (Inches)	WIDTH (Inches)	DEPTH (Inches)	UNIT WT.
SM-42()/U, Reflector Element	1	28-3/4	294	10-1/2	
Vertical Polarizer	1				
Bearing Stakes	4	24	2	2	
Bearing Stakes	4	34	4	3	
Mast Sections (erected)	2	96-1/2			
Upper Section			4.718 (ID)	4.718 (OD)	
Lower Section			4.5 (ID)	4.5 (OD)	

**REFERENCE DATA AND LITERATURE**

Technical Manuals:  
T.O. 31P-1-22

DATE: 1 July 1964  
 COGNIZANT SERVICE: USN

ITEM NAME: RADAR EQUIPMENT  
 TYPE: SK-1M

FEDERAL STOCK NUMBER: 5840-642-7050

	USA	USN	USAF	USMC
STATUS OR TYPE CLASSIFICATION				
Mfg(s) Name or Code Number: Raytheon Mfg. Co., Waltham, Mass.				

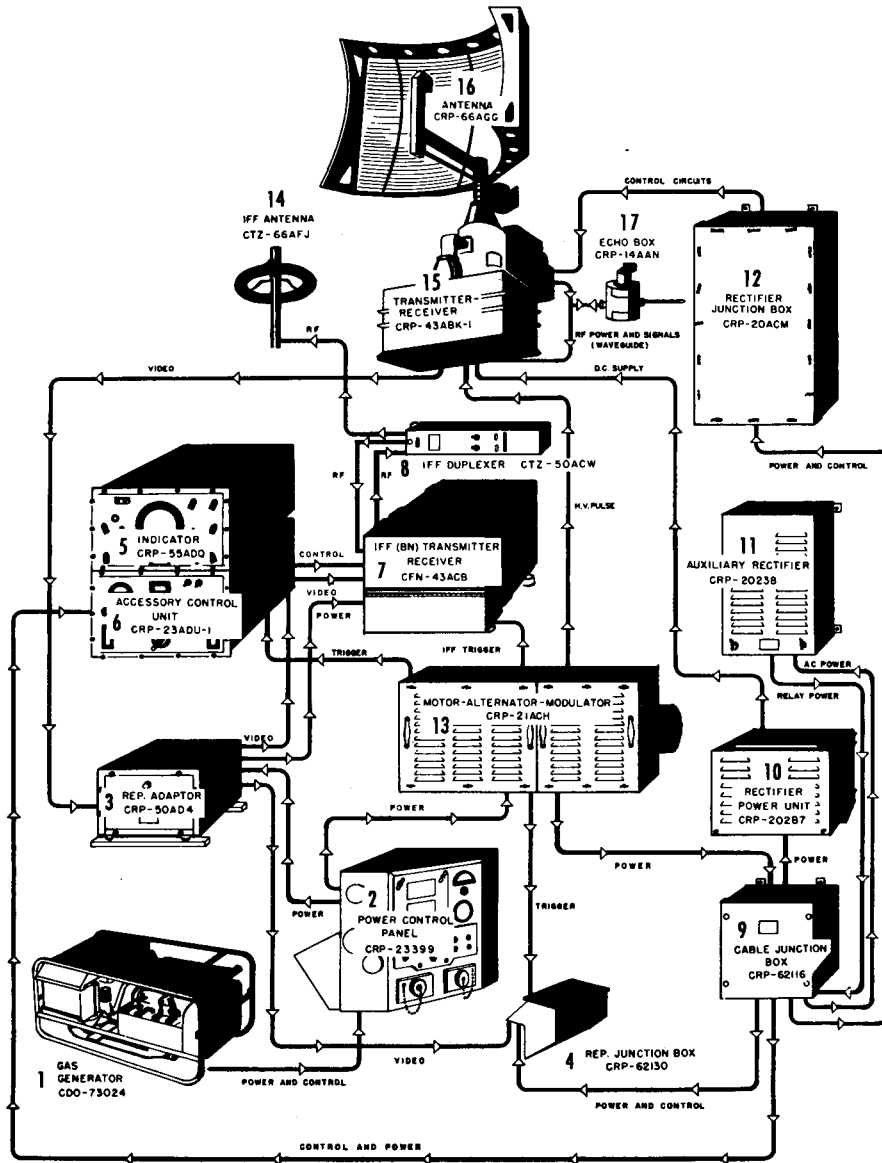

SO-7N: 1

SO-7N: I



SO-7N

SO-7N includes Spares Trailer NT-10284; the SO-7M does not.

**FUNCTIONAL DESCRIPTION**

Radar equipment SO-7N is a medium range land based equipment. It is portable and is used for search over water.

**TECHNICAL DESCRIPTION**

Frequency: 2965 to 3019 mc Type of Emission: Pulse  
Power Output: 80 kw Sensitivity: 15 db above thermal noise.

**RELATION TO SIMILAR EQUIPMENT**

Components of the SO-7N are interchangeable with components of the SO-7M. The two equipments are the same, except for mounting and spare equipment. The SO-7N is mounted in a trailer; the SO-7M is mounted on a frame bolted to a truck bed. The

**INSTALLATION CONSIDERATIONS**

Not Available

COMPONENT	QTY	HEIGHT (Inches)	WIDTH (Inches)	DEPTH (Inches)	UNIT WT. (Pounds)
Radar Receiver NT-46ACA-1	1				
Radar Transmitter-Receiver NT-43ABK- 1	1	15 20 24 93			
Mounting Rack NT-23ADU-1	1				
Adapter for PPI Repeater NT- 50A DI	1	10 12 5 30			
Antenna Assembly NT-66AGG	1	70	76 dia 330		
Antenna Mounting Base NT-10254	1	71	89	95	
Auxiliary Rectifier Unit NT-20238	1	9	13	19 35	
BN Transmitter and Receiver NT-10233 (GFE)					
Duplexing Unit for IFF Equipment 1 NT-50ACW (GFE)					
Electronics Repair Kit NT-10223					
Electrolyte for Gas Engine Battery	1	10	12	15	20
Gas Engine Generator NT-73024	1	23	24	41	340
Cable Junction Box for PPI Repeater NT-62130	1	7	8	8	10
Motor - Alternator Modulator 1 21 23 47 484 NT-21ACH					
Plan Position Indicator NT-55ADQ	1	14	20	25	93
Power Control Unit NT-23399	1	12	19	23	70
Resonance Chamber NT-14AAN	1	7	9	13	3 1/2

**PRINCIPAL COMPONENTS AND PHYSICAL DATA**

<b>COMPONENT</b>	<b>QTY</b>	<b>HEIGHT (Inches)</b>	<b>WIDTH (Inches)</b>	<b>DEPTH (Inches)</b>	<b>UNIT WT. (Pounds)</b>
Rectifier Junction Box NT-20ACM	1	9	17	27	100
Rectifier Power Unit NT-20237 or NT-20287	1	11	12	22	30
Spares Trailer NT-10284 1					

**REFERENCE DATA AND LITERATURE**

Technical Manual:  
NAVSHIPS 900968

**SO-7N: 3**

**DATE:** 1 July 1964  
**COGNIZANT SERVICE:** USN

**ITEM NAME:** RADAR EQUIPMENT  
**TYPE:** SP-1M

**FEDERAL STOCK NUMBER:** F5840-642-7037

	USA	USN	USAF	USMC
STATUS OR TYPE CLASSIFICATION				
Mfg(s) Name or Code Number: General Electric Co., Schenectady, N. Y.				

Illustration Not Available

#### FUNCTIONAL DESCRIPTION

The SP-1M is a mobile radar for fighter direction control. Two main trailers and two auxiliary trailers house the SP-1M. The auxiliary trailers contain the power supply and dehumidifier. The projection PPI is equipped to allow the use of indications from an external direction finder set which uses the aircraft radio for IFF. The PPI presents information from any one of four radars other than the SP-1M. The SP-1M includes an intercom system and remote control equipment for radios.

#### RELATION TO OTHER EQUIPMENT

Used with BO-1 and BN equipments.

#### TECHNICAL DESCRIPTION

Frequency: Transmitter, 2800 mc  
Range, Max: 100 mi on 5-in. A-scope  
Range, Min: 500 yds  
Power Output: 600 kw  
Pulse Repetition Rate: 600 and 120 pps  
Pulse Width: 1 or 5  $\mu$ sec  
Receiver Sensitivity: 13. 5 db above noise level  
Receiver Band pass: IF. 2.0 and 0.35 mc; video  
2.3 mc  
Operating Voltage and Power Requirement  
115v, 60 cps, 3-ph, 15 kw

#### INSTALLATION CONSIDERATIONS

Not Available

**SP-1M: I**

**PRINCIPAL COMPONENTS AND PHYSICAL DATA**

<b>COMPONENT</b>	<b>QTY</b>	<b>HEIGHT (Inches)</b>	<b>WIDTH (Inches)</b>	<b>DEPTH (Inches)</b>	<b>UNIT WT. (Pounds)</b>
IFF Coordination Unit CFN-55AET	1	9-7/16	21-3/16	21-1/8	
Indicator Unit CDY-55AEU	1	10-7/16	21-3/16	21-1/8	
Precision Alignment Unit CDY-55AEV	1	8-11/16	21-1/8	21-3/16	
Modulator "A" CG-35ABD	1	62-3/4	28	24	
Motor-Generator Set CG-21ACV	1	19-3/16	15	36-11/16	
Main Power Unit CG-20ACQ	1	10-7/16	21-13/16	21-1/8	
Modulator "H" CG-35ABE	1	62-3/4	28	24	
Transmitter Assembly CG-52ACZ	1	59-1/4	23-7/8	28-3/4	
Oscillator Preamplifier Unit CG-26ADF	1	10-3/4	13-1/2	18	
Amplifier (K-1) CFW-50AED	1	10-1/4	8-1/4	18-15/16	
Echo Box CUY-14AAW	1	10-5/8	10-3/4	12	
Synchroscope CJA-60ACM	1	13-9/16	7-9/16	17-1/16	
Console Assembly CG-23AEN	1	62	46	28-3/4	
Power Control Unit CG-23AEM	1	9-7/16	21-3/16	21-1/8	
High Voltage Power Unit CDY-20ACP	1	10-7/16	21-3/16	21-1/8	
Auxiliary Power Unit CG-20ACD	1	10-7/16	21-3/16	21-1/8	
Range Unit CG-35ABA	1	12-15/16	21-3/16	21-1/8	
Equipment Trailer CAHU-10301	1	123	96	288	
Operations Trailer CAHU-10302	1	123	96	288	
Auxiliary Trailer CAHU-10305	1	48-1/2	77-3/4	133	
Dehumidifier Trailer CAKL-10311	1	64-1/2	74	91-3/4	
Gas Engine Generator Set CAJG-73029	2	43	31	66-1/2	
Dehumidifying Unit CAJH-10306	1	40-1/2	38	51-1/2	
Antenna Assembly CG-66AGV	1	106	97	88-1/2	
Antenna Control Unit CG-23AEH	1	56-3/8	32-1/4	16-7/8	
Power Distribution Unit CG-23AEP	1	47	54	10-3/8	
Projection PPI CG-55AFN	1				
IFF Equipment Model BO-1	2	2 8-1/2	20	17-3/4	

PRINCIPAL COMPONENTS AND PHYSICAL DATA(cont'd)

COMPONENT	QTY	HEIGHT (Inches)	WIDTH (Inches)	DEPTH (Inches)	UNIT WT. (Pounds)
IFF Equipment Model BN 2 14-3/8 Radio Communications Equipment Model TCS-9 1 Radio Communications Equipment Model SCR-624A	1	20-1/2			
Telephone Switchboard Model BD-72	1				
Selector Control Unit CRB-23367	2	8-23/32	19	11	
Oscilloscope TS-34/AP	1	12-3/4	9-3/4	29	
UHF Signal Generator Equipment CYK-60ACE	1	11-1/4	9-3/4	16-3/4	
Vacuum Tube Testing Equipment CFF-60057	1	6	12	13	
Vacuum Tube Voltmeter CTK-60044-A	1	9-3/8	5-9/16	5-7/8	
Signal Generator CAJA-60ACG	1	9-1/2	9	17	
Volt-Ohm-Milliammeter CTO-60077 Telephone Equipment	1	2-1/8	3-1/16	5-7/8	

REFERENCE DATA AND LITERATURE

Technical Manual:  
NAVSHIPS 900560

DATE:; June 1964

ITEM NAME: ELECTRONIC GATE

COGNIZANT SERVICE: USAF

TYPE: TD-94/GPX

FEDERAL STOCK NUMBER: 5895-307-3975-EG

	USA	USN	USAF	USMC
STATUS OR TYPE CLASSIFICATION				
Mfg(s) Name or Code Number: Electronics Division of Stewart-Warner Corp.				

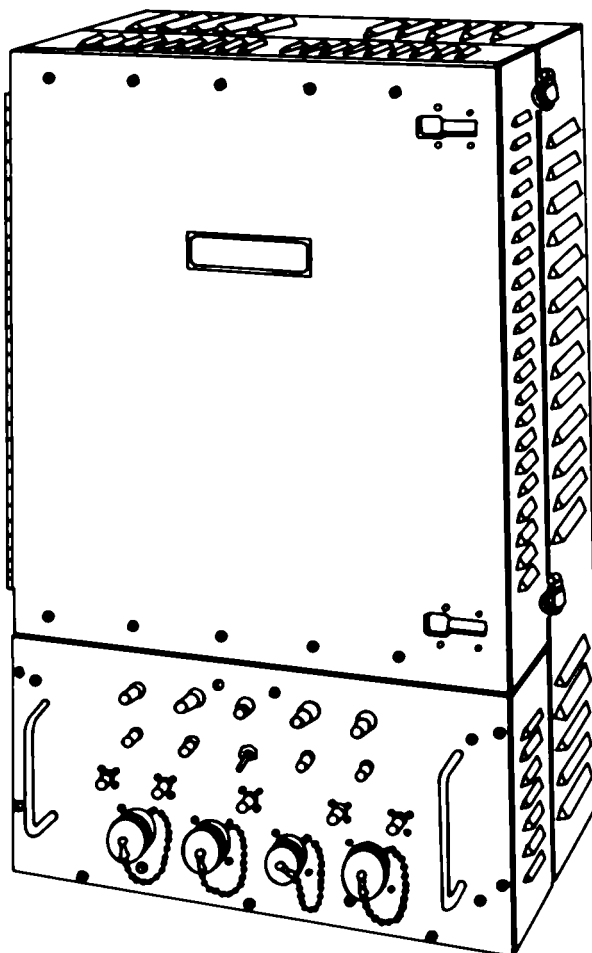

### FUNCTIONAL DESCRIPTION

Electronic Gate TD-94/GPX is part of a coder decoder group in the AN/GPX-( ) equipment, used in conjunction with an active selective identification feature (SIF) sensing unit. This equipment will cause

Interrogator Set Coder KY 120/GPX to develop an active Mode 2 interrogation. The electronic gate also channels the active Mode 2 response code, received from the aircraft, into Video Decoder KY-119/GPX.

**ITEM NAME:** ELECTRONIC GATE  
**TYPE:** TD-91/GPX

**RELATION TO SIMILAR EQUIPMENT**

None.

**INSTALLATION CONSIDERATION'S**

Siting: Depends on associated radar identification set

Mounting: Table-mounted

**Cabling Requirements**

Control Cable:	Furnished with equipment
Signal Cable:	Furnished with equipment
Power Cable:	Furnished with equipment

Related Equipment: Interrogator Set Coder KY-120/GPX, Video Decoder KY-119/GPX

**TECHNICAL DESCRIPTION**

**Power Requirements**

Voltage: 115v, ac  
Frequency: 45 to 70 cps  
Current, Operating: 184w  
Duty Cycle: Intermittent

**Controls**

**Local:**

Receiver Video PE on active Display  
Video Code Pulse  
Video Power Switch  
Remote: None

**PRINCIPAL COMPONENTS AND PHYSICAL DATA  
SHIPPING DATA**

COMPONENT	BOXES (NR.)				UNIT WT. (Pounds)
	QTY	HEIGHT (Inches)	WIDTH (Inches)	DEPTH (Inches)	UNIT WT. (Pounds)
TD-94/GPX, Electronic Gate	1	28-3/16	18	13	193

**REFERENCE DATA AND LITERATURE**

Technical Manuals:  
T.O. 31P-1-22

**TD-94/GPX: 2**

DATE: 15 December 1964

ITEM NAME: MULTIPLEXER

COGNIZANT SERVICE: USAF

TYPE: TD-285/FST

FEDERAL STOCK NUMBER: 5895-776-9687-EG

	USA	USN	USAF	USMC
STATUS OR TYPE CLASSIFICATION			Std	
Mfg(s) Name or Code Number: Budd Electronics (02749)				

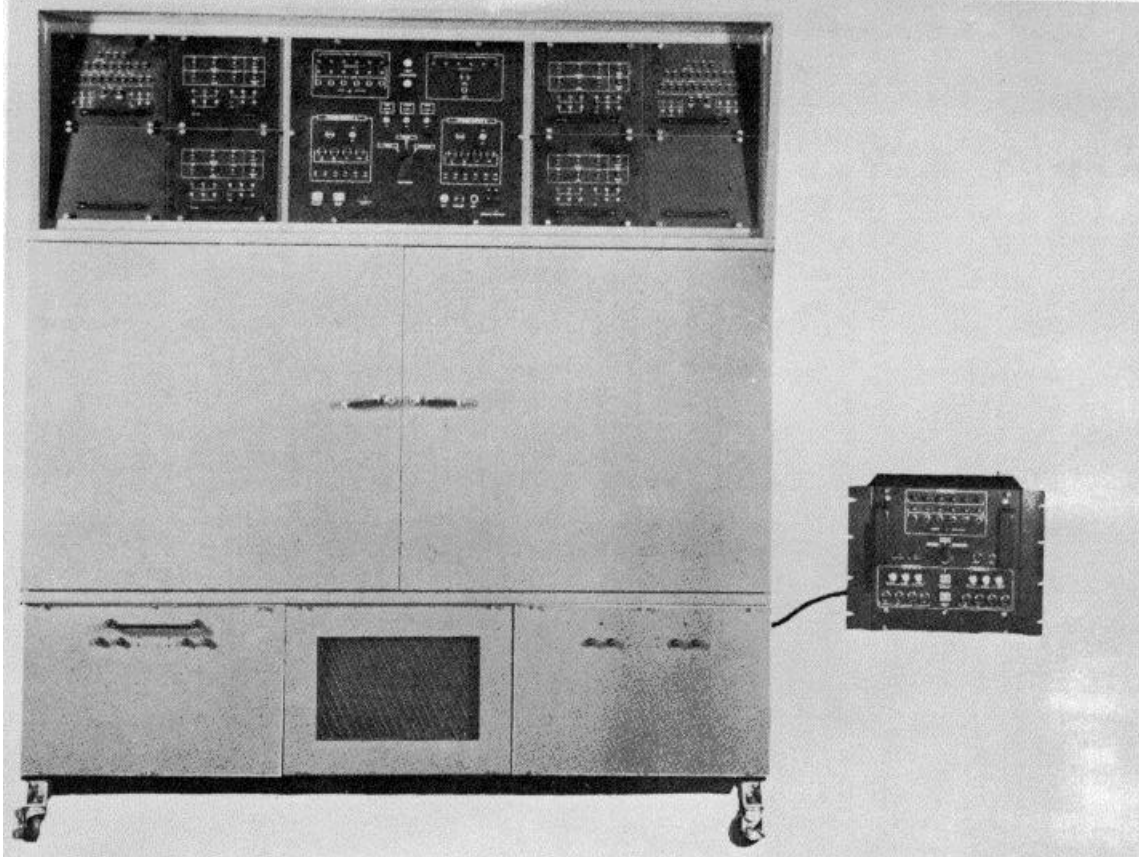

### FUNCTIONAL DESCRIPTION

The Multiplexer is a link in the transmission of data from both long range radar and gap-filler radar sites to the SAGE System Central Computer. The Multiplexer receives any combination of inputs, up to six, from the AN/FST-1 or AN/FPS-I, and -1i Gap Fillers.

The gap filler outputs are interleaved with the output of a long-range radar site. The information is then transmitted over a single pair of telephone wires. Signals from the AN/FST-2 control the reading out and transmission of the store information.

TD-285/FST: 1



**ITEM NAME:** MULTIPLEXER  
**TYPE:** TD-285/FST

Permission to transmit is alternated between the stored gap filler data and long-range radar output. This permits the use of only one pair of telephone lines instead of seven. Multiplexer operation can be remotely controlled from a distance up to 150 feet.

Impedance: 600 ohms  
Frequency Range: 500 to 15.5 kc  
Output  
Band Width: 100 kc  
Impedance: 92 ohms

**RELATION TO SIMILAR EQUIPMENT**

None.

**INSTALLATION CONSIDERATIONS**

Mounting: Clearance requirements for Console, 4 feet minimum to front and rear. Clearance requirements for Remote Box, if wall mounted, 3 feet minimum to front and 2 feet minimum to sides.

**TECHNICAL DESCRIPTION**

Input Voltage: 117v, 1 ph, 60 cycle ac  
Input Current: 7 amps (max)  
Input Power: 800w (max)  
Source: Self-contained, power supplies  
Transportability: C54 or equivalent aircraft, Boxcar or Military Truck  
Data Handling Capacity: 50 targets/sec max  
Input Data Rate: 1300 and 1600 bits/sec  
Azimuth Capacity: 10 bits  
Range Capacity: 7 bits  
Transmission Rate: 20, 00 bits/sec  
Storage Capacity: 640 bits (32 words)  
Input  
Channel: Six  
Bandwidth: 15 kc

Cabling Requirements:  
Power cable length - 10 feet  
Power cable connectors - UP121M, 7313  
Remote cable length - 150 feet  
Remote cable connectors - MS3102A48-5S, MS3102A48-5P  
AN/FST-2 Signal cable length - 130 feet (max)  
AN/FST-2 Signal cable connectors - UG260A/U  
Quantity required - 9

**PRINCIPAL COMPONENTS AND PHYSICAL DATA**

COMPONENT	QTY	HEIGHT (Inches)	WIDTH (Inches)	DEPTH (Inches)	UNIT WT. (Pounds)
Remote Box	1	14	19	8.5	25
Console	1	81.5	73.25	36.25	1100

**REFERENCE DATA AND LITERATURE**

Technical Orders: 31S1-2FST-112  
31S1-2FST-113  
31S1-2FST 111  
31S1-2FST-116  
31S1 2FST-119

Acceptance Test Procedure  
Date: 5 September 1961

DATE: 1 July 1964

ITEM NAME: RADIO EQUIPMENT

COGNIZANT SERVICE: USN

TYPE: YJ

FEDERAL STOCK NUMBER:

	USA	USN	USAF	USMC
STATUS OR TYPE CLASSIFICATION				
Mfg(s) Name or Code Number: Hazeltine Electronics Corporation, New York, N.Y.				

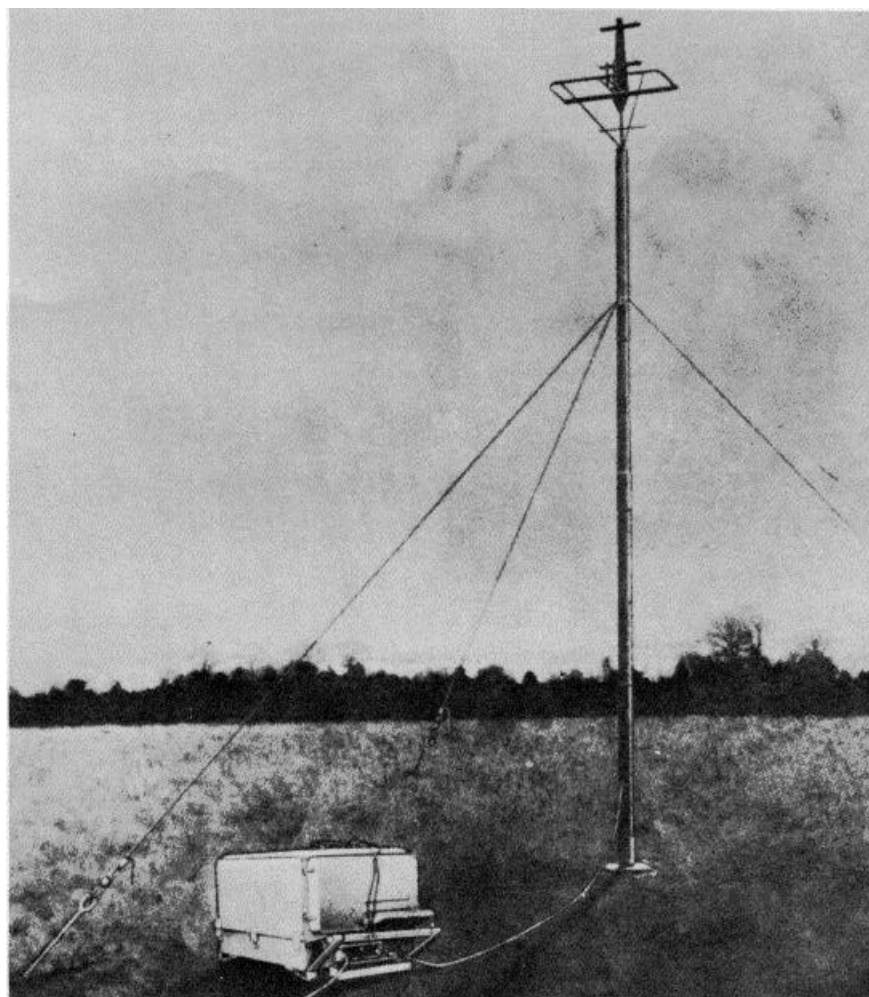

#### FUNCTIONAL DESCRIPTION

The Model YJ is a two-channel, automatic responding radar beacon or "racon" designated for shore installation. It automatically transmits coded signals in reply to interrogating signals from aircraft equipped with suitable radar or IFF equipment. It is capable of

replying to interrogating signals in the 176 megacycle of "A", and in the 515 megacycle or "B" Band.

The coded answer from the Model YJ enables the interrogating aircraft to identify the particular YJ equipment making the reply,

**ITEM NAME:** RADIO EQUIPMENT  
**TYPE:** YJ

and since tile location of the YJ equipment is known, its direction and range can be computed from information appearing on the radar indicator on the Interrogating craft. The interrogating craft can thus determine its own position. In addition, planes can use the signals transmitted by YJ equipments for "hamming" purposes.

**RELATION TO SIMILAR EQUIPMENT**

Similar to Navy Model YF-1 with minor exceptions.

**TECHNICAL DESCRIPTION**

Frequency Data

A Transponder  
Receiver: 176.0 plus or minus 0.5 mc  
Transmitter: 177.5 plus or minus 0.5 mc.

B Transponder  
Receiver: 515 mc  
Transmitter: 520 mc

Interrogation Data

Pulse Rate (Normal): (100 pps.  
Pulse Rate (Maximum)  
A Transponder: 3000 pps

B Transponder: 4000 pps  
Recovery Time (At 400 pps)  
A Transponder: 50 to 120 usec.  
B Transponder: 100 to 200 usec  
Pulse Duration: Approx 2 usec or more.  
Reply Data  
Pulse Duration: 7 to 10 usec  
Pulse Power (At 100 pps)  
A Transponder: 15w min  
B Transponder: 75w min  
Time Sharing Rate: 15 ot 20 cps  
Coding Cycle Duration: 30 sec  
Power Requirements: 115v plus or minus 5%  
or 230v plus or minus 5%, 50 to 60 cps,  
approx 350w.  
Antenna Data  
Type: Half-loops.  
Polarization: Horizontal.  
Impedance: 50 ohms.

**INSTALLATION CONSIDERATIONS**

Not available.

**PRINCIPAL COMPONENTS AND PHYSICAL DATA  
SHIPPING DATA**

COMPONENT	BOXES (NR.)	OVERALL DIMENSIONS (Inches)	UNIT WT. (Pounds)
Radio Equipment Model YJ consisting of:	1	21-1/2 x 23 x 10-1/4	270
Rectifier Power Unit NT-20AC11	1		
RF Unit, A Band NT-43ABW	1		
RF Unit, B Band NT-43ABX	1		
Housing Cover Assy	1		
Antenna Assy NT-66AEY	1	18 x 25 x B4	333
Set of Equipment Spares	1	14 x 18 x 2-1	7(l)

**EQUIPMENT SUPPLIED DATA**

COMPONENTS	QTY	OVERALL DIMENSIONS (Inches)	UNIT WT. (Pounds)
Radio Equipment Model YJ consisting of:	1		
Rectifier Power Unit NT-20ACH	1	10-11/16 x 12-1/2 x 16	57
RF Unit, A Band NT-43ABW	1	7-3/16 x 11 x 12-5/8	13.5
RF Unit, B Band NT-43ABX	1	7-11/16 x 11 x 12-5/8	17.5
Housing Cover Assy	1	19 x 20-1/2 x 35-1/2	
Antenna Assy NT-66AEY	1	15 x 18-3/4 x 67-3/4	230

**YJ: 2**

ITEM NAME: RADIO EQUIPMENT  
TYPE: YJ

PRINCIPAL COMPONENTS AND PHYSICAL DATA  
EQUIPMENT SUPPLIED DATA (Cont.)

COMPONENTS	QTY	OVERALL DIMENSIONS (Inches)	UNIT WT. (Pounds)
Set of Equipment Spares	1		
Set of Accessories	1		

REFERENCE DATA AND LITERATURE

Technical Manuals:  
SHIPS 241: for Navy Models YJ and YJ-1  
Radio Equipment.

YJ: 3

**MIL- HDBK- 162A**

VOLUME 1 OF 2

15 DECEMBER 1965

**SECTION 2**

**AIRBORNE RADAR EQUIPMENT**

**DATE:** 1 September 1964

**ITEM NAME:** ELECTRONIC CONTROL AMPLIFIER

**COGNIZANT SERVICE:** USN

**TYPE:** AM-1600A/APN

**FEDERAL STOCK NUMBER:**

	USA	USN	USAF	USMC
STATUS OR TYPE CLASSIFICATION		Used by		
Mfg(s) Name or Code Number: Ryan Aeronautical Company (78022)				

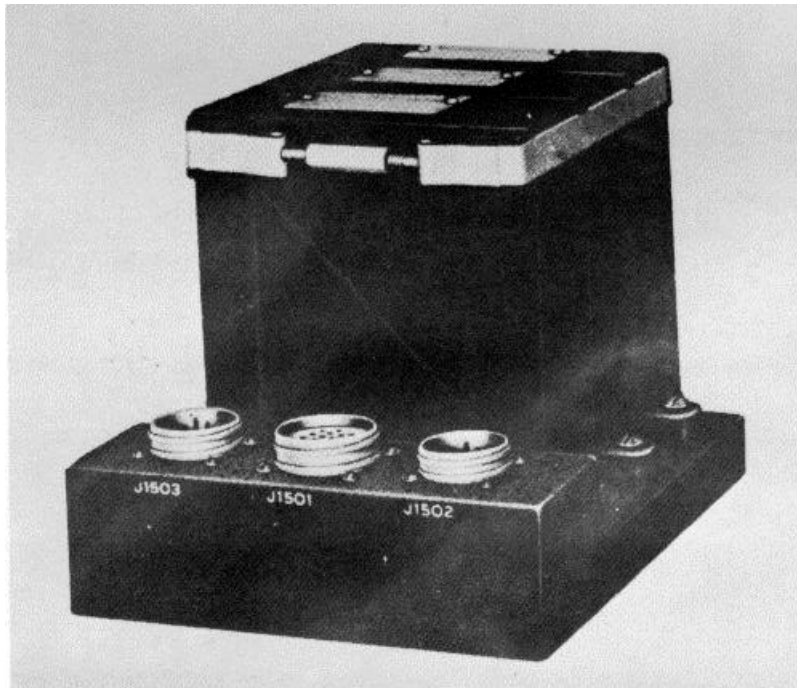

**FUNCTIONAL DESCRIPTION**

Electronic Control Amplifier AM-1600A/APN is used in conjunction with a displacement gyroscope and gyroscopic switch, forms a vertical reference system

used as an accessory to automatic navigation and flight control systems. The vertical reference system provides aircraft altitude information used to correct aircraft velocity data evolved by the navigation equipment.

**AM-1600A/APN: 1**

**ITEM NAME:** ELECTRONIC CONTROL AMPLIFIER

**TYPE:** AM-1600A/APN

**RELATION TO SIMILAR EQUIPMENT**

None.

Temperature: -55 to 71°C (-67 to 160°F)

Humidity: 95% at a max ambient temp of plus 50°C (plus 122°F)

Input: Pitch and roll reference signals

**TECHNICAL DESCRIPTION**

Power Requirements: 115v or 200v, 400 cyc, 3-ph; 27.5v dc

Environmental Limitations

Altitude: Surface to 70,000 ft

**INSTALLATION CONSIDERATIONS**

Not available.

**PRINCIPAL COMPONENTS AND PHYSICAL DATA**

<b>COMPONENTS</b>	<b>QTY</b>	<b>OVERALL DIMENSIONS (Inches)</b>	<b>UNIT WT. (Pounds)</b>
Amplifier, Electronic Control AM-1600(A/APN)	1	5-3/4 x 5-3/-1 x 7-1/4	4.75

**SHIPPING DATA**

<b>COMPONENT</b>	<b>PKGS</b>	<b>VOLUME (CU FT)</b>	<b>UNIT WT. (Pounds)</b>
	1	1.2	6.25

**REFERENCE DATA AND LITERATURE**

Technical Manuals:

NAVWEPS 16-35AM1600-501: Handbook of Service Instruction with Illustrated Parts Breakdown for Amplifier Electronic Control AM-1600/APN, AM-1600A/APN, AM-2209/AJA-3 and AM-2370/APN-129.

**AM-1600A/APN: 2**

DATE: 1 September 1964

ITEM NAME: ELECTRONIC CONTROL AMPLIFIER

COGNIZANT SERVICE: USN

TYPE: AM-1600/APN

FEDERAL STOCK NUMBER:

	USA	USN	USAF	USMC
STATUS OR TYPE CLASSIFICATION		Used by		
Mfg(.) Name or Code Number: Ryan Aeronautical Company (71022)				



### FUNCTIONAL DESCRIPTION

Amplifier, Electronic Control AM-1600/APN is used in conjunction with a displacement gyroscope and a gyroscopic switch, forms a vertical reference system

used as an accessory to automatic navigation and flight control systems. The vertical reference system provides aircraft altitude information used to correct aircraft velocity data evolved by the navigation equipment.

AM-2209/AJA: 1



**ITEM NAME:** ELECTRONIC CONTROL AMPLIFIER  
**TYPE::** AM-1600/APN

**RELATION TO SIMILAR EQUIPMENT**

This equipment is part of Automatic Navigator AN/APN-67.

Temperature: -55 to plus 71°C (-67 to plus 160°F)  
Humidity: 95% at a max ambient temp of plus 50°C (plus 122°F)  
Input: Pitch and roll reference signals

**TECHNICAL DESCRIPTION**

Power Requirements: 115 or 200v, 400 cyc, 3-ph; 27.5v dc  
Environmental Limitations  
Altitude: Surface to 70,000 ft

**INSTALLATION CONSIDERATIONS**

Not available.

**PRINCIPAL COMPONENTS AND PHYSICAL DATA**

<b>COMPONENTS</b>	<b>QTY</b>	<b>OVERALL DIMENSIONS (Inches)</b>	<b>UNIT WT. (Pounds)</b>
Amplifier, Electronic Control	1	5-3/4 x 5-3/4 x 7-1/4	4.75

**SHIPPING DATA**

<b>COMPONENT</b>	<b>PKGS</b>	<b>VOLUME (CU FT)</b>	<b>UNIT WT. (Pounds)</b>
	1	1.2	6.25

**REFERENCE DATA AND LITERATURE**

Technical Manuals:  
NAVWEPS 16-35AM1600-501: Handbook of Service Instructions with Illustrated Parts Breakdown for Amplifier, Electronic Control AM-1600/APN, AM-1600A/APN, AM-2209/AJA-3 and AM-2370/APN-129.

**AM-1600/APN: 2**

DATE: 1 September 1964

ITEM NAME: ELECTRONIC CONTROL AMPLIFIER

COGNIZANT SERVICE: USN

TYPE: AM-2209/AJA-3

FEDERAL STOCK NUMBER:

	USA	USN	USAF	USMC
STATUS OR TYPE CLASSIFICATION		Used By		
Mg(s) Name or Code Number: Ryan Aeronautical Company (78022)				

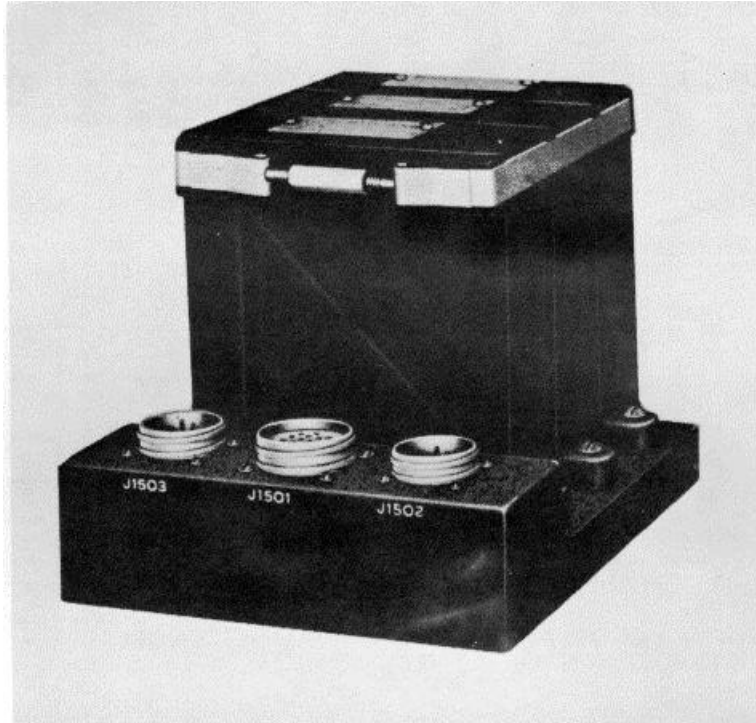

**FUNCTIONAL DESCRIPTION**

Electronic Control Amplifier AM-2209/AJA-3 is used in conjunction with a displacement gyroscope and Gyroscopic switch, forms a vertical reference system

used as an accessory to automatic navigation and flight control systems. The vertical reference system provides aircraft altitude information used to correct aircraft velocity data evolved by the navigation equipment.

**AM-2209/AJA-3: 1**

**ITEM NAME:** ELECTRONIC CONTROL AMPLIFIER  
**TYPE:** AM-2209/AJA-3

**RELATION TO SIMILAR EQUIPMENT**

None.

Temperature: -55 to plus 71°C (-67 to plus 160°F)  
Humidity: 95% at a max ambient temp of plus 50°C (plus 122°F)  
Input: Pitch and roll reference signals

**TECHNICAL DESCRIPTION**

Power Requirements: 115v or 200v, 400 cyc, 3-ph; 27.5v dc  
Environmental Limitations  
Altitude: Surface to 70,000 ft

**INSTALLATION CONSIDERATIONS**

Not available.

**PRINCIPAL COMPONENTS AND PHYSICAL DATA**

<b>COMPONENTS</b>	<b>QTY</b>	<b>OVERALL DIMENSIONS (Inches)</b>	<b>UNIT WT. (Pounds)</b>
Amplifier, Electronic Control AM-2209/AJA-3	1	5-3/1 x 5-3/1 x 7-1/1	1.75

**REFERENCE DATA AND LITERATURE**

Technical Manuals:  
NAVWEPS 16-35AM1600-501: Handbook of Service Instructions with Illustrated Parts Breakdown for Amplifier, Electronic Control AM-1600/APN, AM-1600A/APN, AM-2209/AJA-3 and AM-2370/APN-129.

**AM-2209/AJA-3: 2**

DATE: 1 September 1964

ITEM NAME: ELECTRONIC CONTROL AMPLIFIER

COGNIZANT SERVICE: USN

TYPE: AM-2370/APN-129

FEDERAL STOCK NUMBER:

	USA	USN	USAF	USMC
STATUS OR TYPE CLASSIFICATION		Used by		
Mfg(s) Name or Code Number: Ryan Aeronautical Company (78022)				

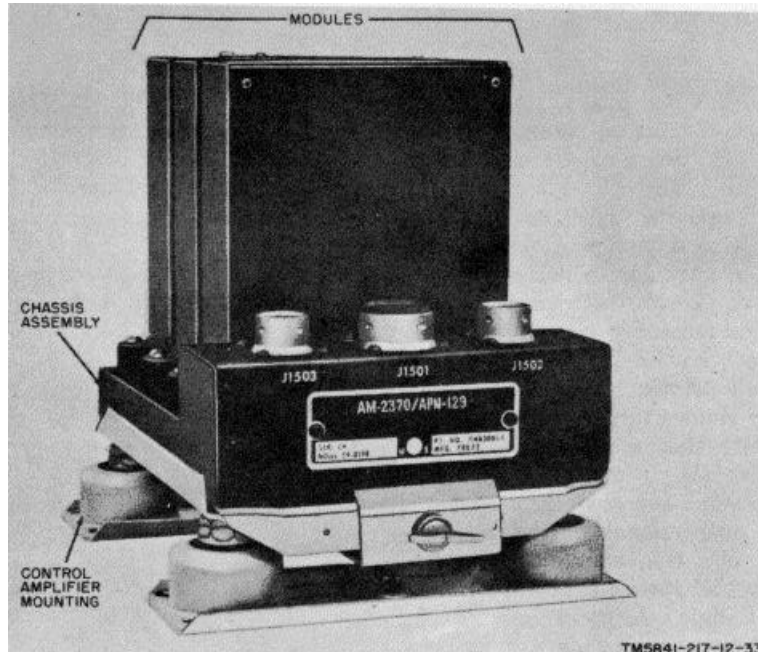

### FUNCTIONAL DESCRIPTION

Electronic Control Amplifier AM-2370/APN-129 is used in conjunction with a displacement gyroscope and a gyroscopic switch, forms a vertical reference system

used as an accessory to automatic navigation and flight control systems. The vertical reference system provides aircraft altitude information used to correct aircraft velocity data involved by the navigation equipment.

AM-2370/APN-129: 1

ITEM NAME: **ELECTRONIC CONTROL AMPLIFIER**  
TYPE: **AM-2370/APN-129**

**RELATION TO SIMILAR EQUIPMENT**

None.

voltages (30v ac); fixed ph gyro erection voltage (18v ac or 115v ac)  
Altitude: Surface to 70,000 ft  
Operating Temperature: -55 to plus 71°C (-67 to 160°F)

**TECHNICAL DESCRIPTION**

Power Requirements: 115v or 200v, 400 cyc, 3-ph  
Input: Pitch and roll reference signals.  
Outputs: Pitch and roll, var, torque

**INSTALLATION CONSIDERATIONS**

Not available.

**PRINCIPAL COMPONENTS AND PHYSICAL DATA**

<b>COMPONENTS</b>	<b>QTY</b>	<b>OVERALL DIMENSIONS (Inches)</b>	<b>UNIT WT. (Pounds)</b>
Amplifier, Electronic Control AM-2370/APN-129	1	5-5/8 x 5-7/8 x 7-3/1	5.3

**REFERENCE DATA AND LITERATURE**

Technical Manuals:  
NAVWEPS 16-35AM1600-501: Handbook of Service Instructions with Illustrated Parts Breakdown for Amplifier Electronic Control AM-1600/APN, AM-1600A/APN, AM-2209/AJA-3, and AM-2370/APN-129.

**AM-2370/APN-129: 2**

DATE: 1 July 1961

ITEM NAME: REPEATER INDICATOR EQUIPMENT

COGNIZANT SERVICE: USN

TYPE: AN/APA-1

FEDERAL STOCK NUMBER:

	USA	USN	USAF	USMC
STATUS OR TYPE CLASSIFICATION		Ltd Std		
Mfg(s) Name or Code Number:				

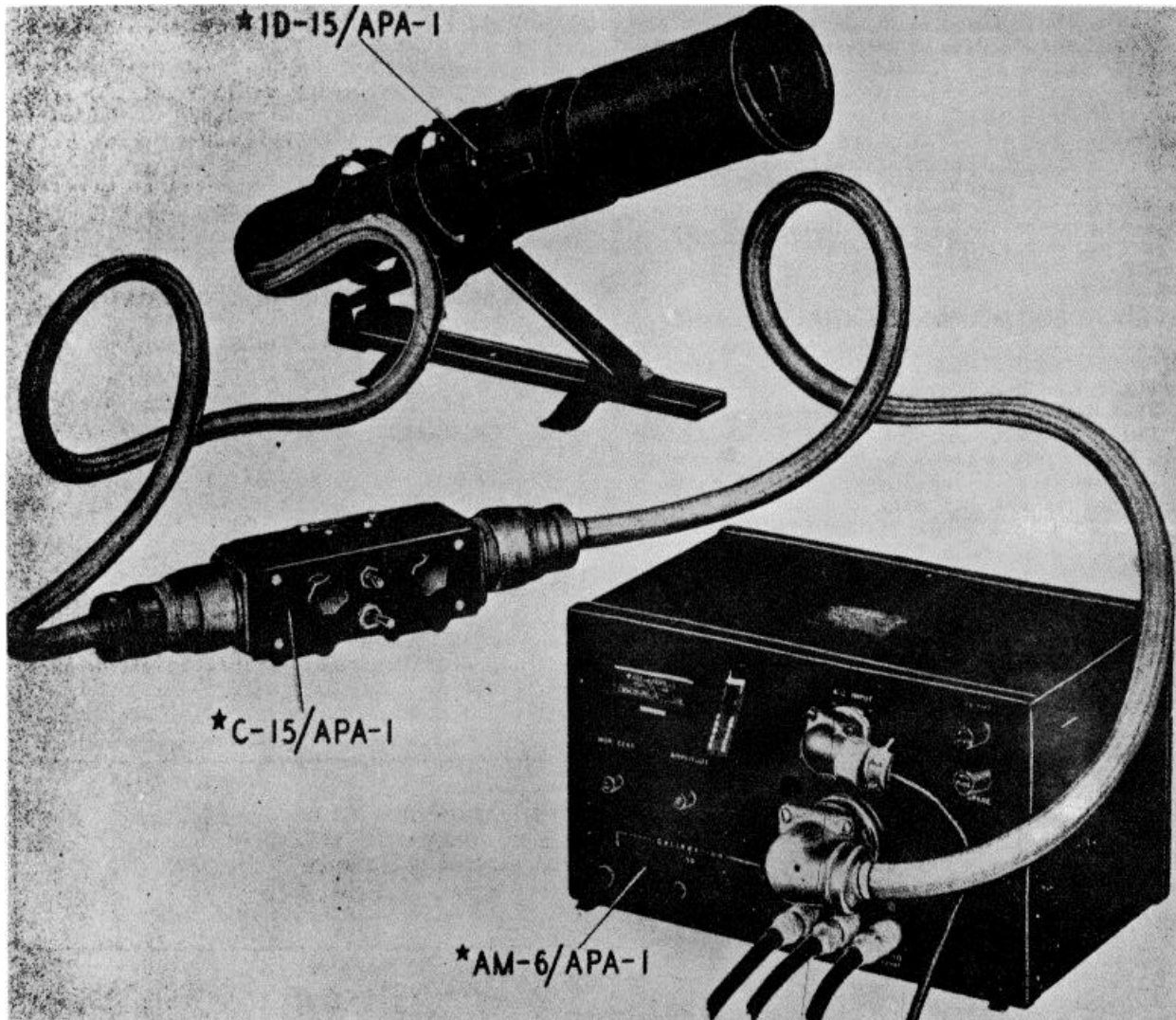

### FUNCTIONAL DESCRIPTION

The AN/APA-1 provides visual indication of the distance between and the relative position of reflecting

objects and an aircraft. It is used as an optional remote indicating system in conjunction with one of the basic aircraft equipments: SCR-729, AN APX-2, and AN APN-2 IFF equipment or with any

AN/APA-1: 1

**AN/APA-1**

model of the ASB series radar equipment. The three ranges provided may be changed independently of the range of the basic equipment.

**RELATION TO SIMILAR EQUIPMENT**

None.

**TECHNICAL DESCRIPTION**

Operating Input Pulses:  
Pulse Width: 1 to 5  $\mu$ sec  
Peak Voltage:  $\pm 10v$  to  $\pm 125v$   
Pulse Recurrence: 250 to 500 pps; 200 pps or lower if component C-203-2 and R-212 are shorted out of the circuit

Horizontal Deflection Sensitivity: 144v  $\pm 20\%$  per in.  
Vertical Deflection Sensitivity: 160v per in.  
Video Signal Sensitivity: 10v min  
Range: 0 to 5 mi; 0 to 50 mi; 0 to 100 mi  
Operating Voltage: 110 to 120 vac, 1-ph, 400 to 2,400 cps, 0.65 amp  
Power Dissipation: 75w  
Presentation: 3-in. CRT, horizontal deflection of vertical trace calibrated on face

**INSTALLATION CONSIDERATIONS**

Siting:  
Mounting: Rigidly mounted to frame of aircraft.

**PRINCIPAL COMPONENTS AND PHYSICAL DATA**

COMPONENT	QTY	HEIGHT (Inches)	WIDTH (Inches)	DEPTH (Inches)	UNIT WT. (Pounds)
Repeater-Indicator Amplifier AM-6/APA-1	1	7-1/8	9-3/8	12-1/4	14.15
Control Unit C-15/APA-1	1	2-1/2	7-7/8	3	1.50
Repeater-indicator ID-15/APA-1	1	20-1/4	3-3/4	23-15/16	5.50

**REFERENCE DATA AND LITERATURE**

Technical Manual:  
AN 16-30APA1-3  
Specification:  
Navy RE-9035-A

DATE: 1 July 1961

ITEM NAME: INDICATOR EQUIPMENT

COGNIZANT SERVICE: USN

TYPE: AN/APA-5

FEDERAL STOCK NUMBER:

	USA	USN	USAF	USMC
STATUS OR TYPE CLASSIFICATION				
Mfg(s) Name or Code Number: Farnsworth Television and Radio Corp., Ft. Wayne, Indiana				



AN/APA-5.: 1



**AN/APA- 5**

**FUNCTIONAL DESCRIPTION**

The AN/APA-5 is an attachment for airborne radars to permit accurate bombing of surface targets under conditions that preclude use of optical bombing instruments. It attaches to Radar Sets AN/APS-2 series, AN/APS-3, AN/APS-15 series and gyro MK 18 or Bombsight Stabilizer MK 15 with Bombsight Mount MK 2 Mod 1.

**RELATION TO SIMILAR EQUIPMENT**

AN/APA-5 is electrically and mechanically similar to AN/APA-5A although all components are not interchangeable. It is also similar to Indicator Attachment AN/APQ-54.

**TECHNICAL DESCRIPTION**

Long Range:  
Max Slant Search and Tracking Range - 10 statute mi  
Max Slant Release Range - 5,000 ft

Altitude - 50 to 3,500 ft (depending on speed)  
Time of Fall - Up to 15 sec  
High Range:  
Max Slant Search and Tracking Range - 30 statute mi  
Max Slant Release Range - 50,000 ft  
Altitude - Up to 35,000 ft  
Time of Fall - Up to 50 sec  
Closing Speed - Up to 400 mph  
Power Requirements: 115 vac, 400 to 2,400 cps, 1-ph, 400 va; 27.5 vdc, 4 amp  
Indication: 3-in. CRT, B-type display

**INSTALLATION CONSIDERATIONS**

Siting:  
Mounting:  
Cabling Requirements:  
Related Equipment: The AN/APA-5 is used with Automatic Flight Control Equipment or a Pilot Direction Indicator.

**PRINCIPAL COMPONENTS AND PHYSICAL DATA**

COMPONENT	QTY	HEIGHT (Inches)	WIDTH (Inches)	DEPTH (Inches)	UNIT WT. (Pounds)
Rectifier PP-58/APA-5	1	10-3/8	12-3/4	21-5/8	41.6
Mounting MT-241/APA-5	2	2-1/2	10-3/8	21-5/8	1.4
Indicator ID- 50/APA-5	1	5-7/8	9-1/16	23-1/4	9.0
Mounting MT- 242/APA-5	1	4-1/2	5	8	1.0
Synchronizer SN-9/APA-5	1	10-3/8	12-3/4	21-5/8	32.0
Control Box C-89/APA-5	1	8-3/8	12-3/8	20-3/8	40.3
Mounting	1	5-1/2	7	20-3/8	4.3
Antenna Control Box C-90/APA-5	1	2-1/2	2-5/8	3-5/8	0.3
Range Tracking Unit C-82/APA-5	1	5-1/4	6-1/2	6-5/8	2.3
Mounting MT-244/APA-5	1	1/2	4-1/2	6-1/2	0.4
Radar Conversion Kit MX156/APA-5	1	6-1/2	11-5/8	13	11.0
Stabilizer Conversion Kit MX96/APA-5	1	5-1/2	6-3/8	8.3/4	2.4
Junction Box J-48/APA-5	1	2-15/16	11-1/2	12-1/2	6.4
Mounting MT-239/APA-5	1	1/2	8-7/8	12-1/2	1.4

**REFERENCE DATA AND LITERATURE**

Technical Manual:  
CO-AN16-30APA-5-2-M

Specification:  
Navy ER-213

DATE: 1 July 1964

ITEM NAME: RADAR BOOSTER-AMPLIFIER  
ASSEMBLY

COGNIZANT SERVICE: USN

TYPE: AN/APA-8

FEDERAL STOCK NUMBER:

	USA	USN	USAF	USMC
STATUS OR TYPE CLASSIFICATION	Used By	Used By		
Mfg(s) Name or Code Number: Harvey Radio Laboratory (27625)				

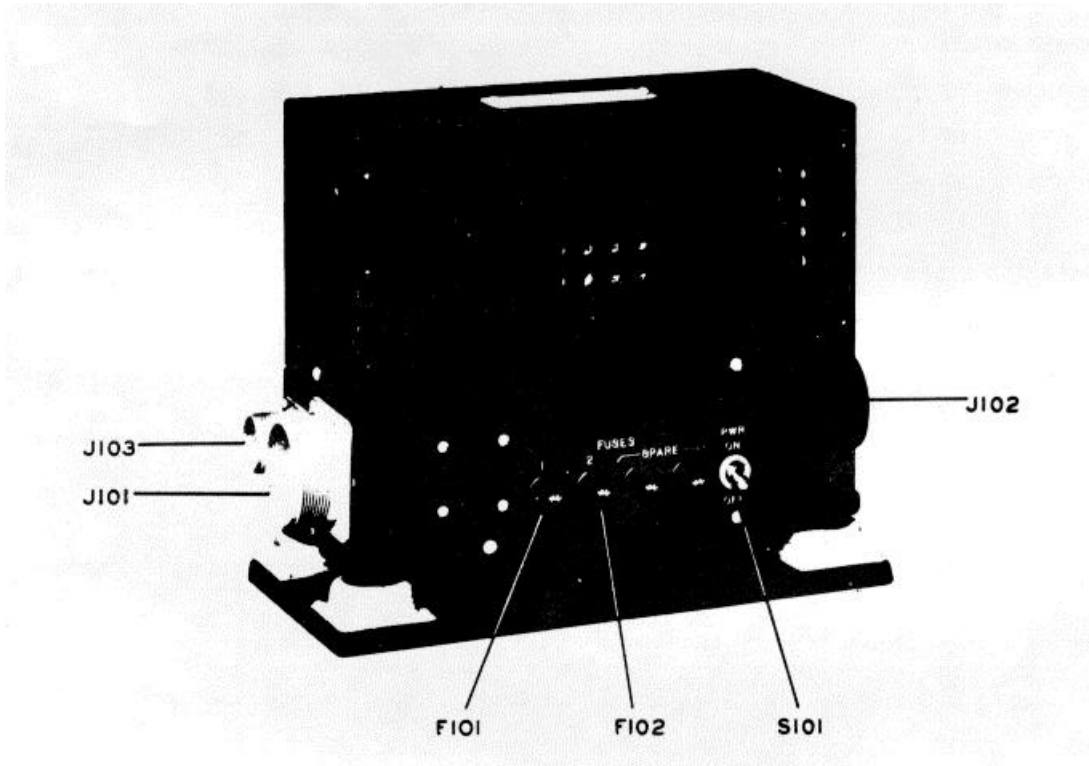

*Amplifier AM-16/APA-8 of the Radar Booster-Amplifier*

**FUNCTIONAL DESCRIPTION**

cable limit to 1(0) feet.

The Radar Booster-Amplifier Assembly AN/ APA--B is designed to provide the amplification for extending the

AN/APA-8: 1

**ITEM NAME:** RADAR BOOSTER-AMPLIFIER ASSEMBLY  
**TYPE:** AN/APA-8

**RELATION TO SIMILAR EQUIPMENT:**

None.

**INSTALLATION CONSIDERATION:**

Related Equipment: The AN/APA-8 is designed to be used with Airborne Radar Equipment AN/APS-2A series and ASG, and ASG-1.

**TECHNICAL DESCRIPTION**

Operating Power Requirements: 115v ac, 400 to 2400 cps, single ph; power factor 0.97

Equipment required but not supplied: (1) Airborne Radar AN/APS-2 series, ASG or ASG-1; (1) Power Supply (115v ac, 400 to 2100 cps, 0.6 amps).

**PRINCIPAL COMPONENTS AND PHYSICAL DATA**

<b>COMPONENTS</b>	<b>QTY</b>	<b>OVERALL DIMENSIONS (Inches)</b>	<b>UNIT WT. (Pounds)</b>
Amplifier AM-16/APA-8	1	5-5/16 x 8-3/8 x 10-7/8	9-1/2
Amplifier AM-17/APA-8	1	5-1/1 x 6-5/8 x 10-7/8	4-1/2
Connector AN3108-28-2P	3	1-31/32 x 2-1/2 x 3-.5/16	.31
Connector AN3108-28-2S	2	1-31/32 x 2-1/2 x 3-5/16	.38
Connector AN3108-16-11S	1	1-3/16 x 1-3/4 x 1-7/8	.13
Connector AN3106-28-2S	1	1-31/32 dia x 2-1/4	.23

**REFERENCE DATA AND LITERATURE**

Technical Manuals:  
CO-NAVAER-08-SS-124 for Radar Booster-Amplifier  
Assembly AN/APA-8.

**AN/APA-8: 2**

DATE: 1 July 1964  
COGNIZANT SERVICE: USAF

ITEM NAME: RADAR INDICATOR ASSEMBLY  
TYPE: AN/APA-11

FEDERAL STOCK NUMBER:

	USA	USN	USAF	USMC
STATUS OR THE CLASSIFICATION				
Mfg(s) Name or Code Number: Wurlitzer, Rudolph, Co., North Tonowanda, New York				

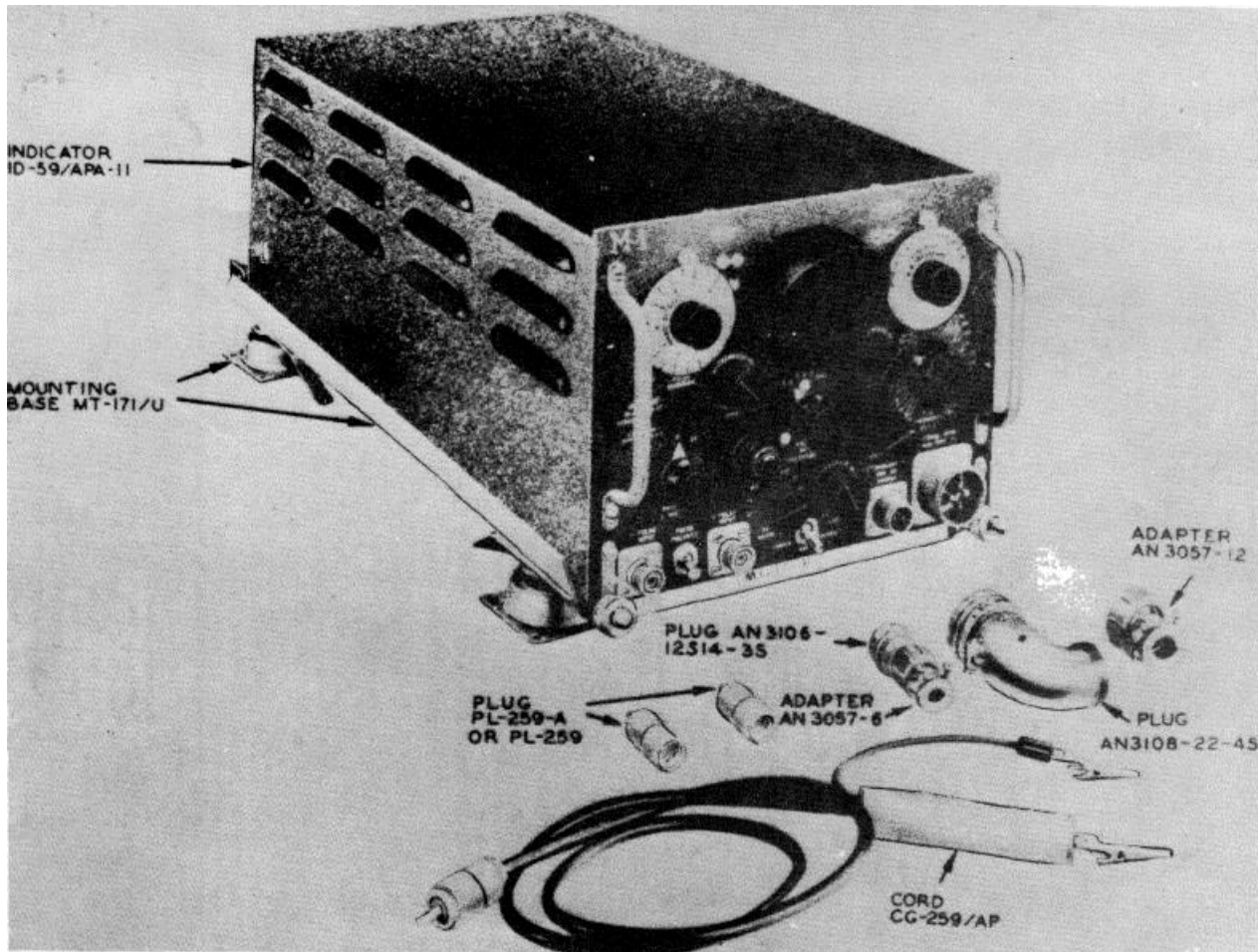

### FUNCTION DESCRIPTION

The AN/APA-11 is designed for airborne use to assist in the Identification and location of radar installations which operate on a pulse repetition frequency between 200 and 6000 cycles per second

when operated in conjunction with a suitable receiver, it may be used to measure pulse duration time between 1/2 and 100 microseconds and to determine the pulse repetition frequency. It may also be used as an ordinary cathode-ray oscilloscope.

AN/APA-11: 1

**ITEM NAME:** RADAR INDICATOR ASSEMBLY  
**TYPE:** AN/APA-11

**TECHNICAL DESCRIPTION**

Indication: 3 in. CR tube

Power Input Requirements: 196 w at  
75 - B5/105 - 125v, 1 ph, 100 - 2600  
cps, 90% pf.  
Pulse Rate: 200 to 6000 cps  
Sweep Rate of Saw Tooth Oscillator: 25  
to 20,000 cps  
Input Impedance 50 ohms

**INSTALLATION CONSIDERATIONS**

Related Equipment: (1) Adapter M-359;  
(2) Standard Voltmeters; (1) Test  
Oscillator TS-17/APR; (1) Audio  
Oscillator Type 652.

**PRINCIPAL COMPONENTS AND PHYSICAL DATA**

<b>COMPONENTS</b>	<b>QTY</b>	<b>OVERALL DIMENSIONS (Inches)</b>	<b>UNIT WT. (Pounds)</b>
Indicator ID-59/APA-11	1	7-7/d x 10-1/4 x 21-1/2	16.25
Mounting Base MT-171/U	1	2-7/16 x 11-1/16 x 23	2
Set of Accessories	1		
Equipment Spare Parts	1		

**REFERENCE DATA AND LITERATURE**

Technical Orders:  
12P1-2APA1-2  
Technical Manual Handbook of Maintenance  
Instructions for Radar Indicator Assembly  
AN/APA-11.

**AN/APA-11: 2**

DATE: 1 July 1964  
COGNIZANT SERVICE: USN

ITEM: NAME: SECTOR SCAN ASSEMBLY  
TYPE: AN/APA-12A

FEDERAL STOCK NUMBER:

	USA	USN	USAF	USMC
STATUS OR CLASSIFICATION	Used By	Used By		
Mfg(s) Name or Code Number: Philco Corporation (82767)				

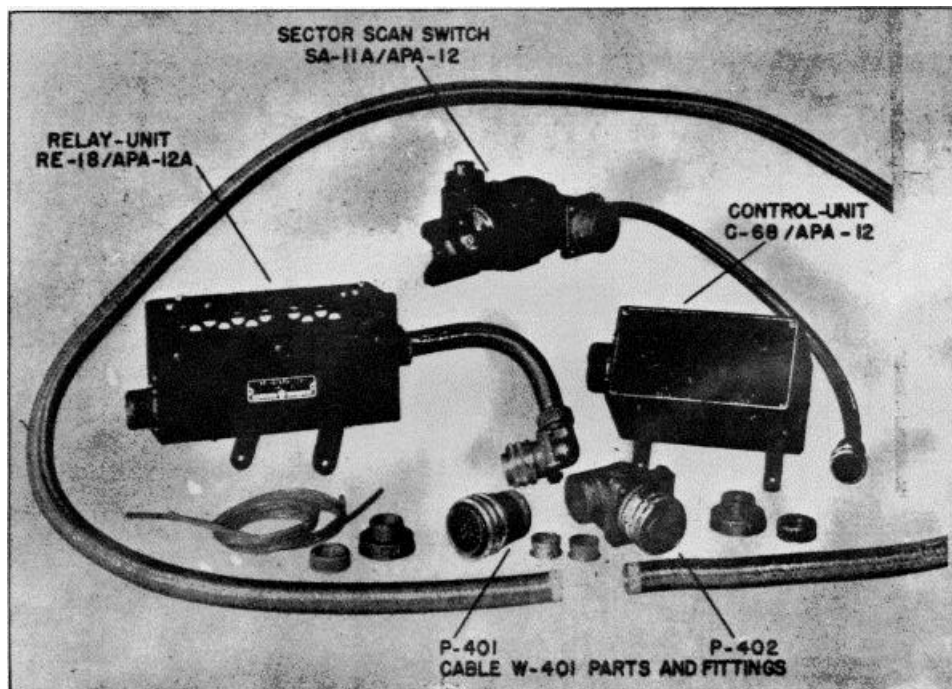

### FUNCTIONAL DESCRIPTION

The Sector Scan Assembly AN/APA-12A is designed to provide scanning of a selected sector, which may be adjusted in width from

60 deg to 330 deg in units of 30 deg centered about any point, as well as permitting continuous 360 deg scanning the usual manner.

AN/APA-12A: 1

**ITEM NAME:** SECTOR SCAN ASSEMBLY  
**TYPE:** AN./APA-12A

**RELATION TO SIMILAR EQUIPMENT**  
The AN/APA-12A is the same as Sector Scan Assembly AN./APA-12 except Relay RE-i/APA-12 is replaced by a relay of new design.

Selected Sector Scan Width: From 60 deg to 360 deg adjustable.  
Increments of Scanning: 30 deg increments  
Operating Power Requirement: 27v dc (nom) approx 2-1/2 amps, 70w

**TECHNICAL DESCRIPTION**  
Continuous Scanning: 360 deg

**INSTALLATION CONSIDERATIONS**  
Not available.

**PRINCIPAL COMPONENTS AND PHYSICAL DATA**

<b>COMPONENTS</b>	<b>QTY</b>	<b>OVERALL DIMENSIONS (Inches)</b>	<b>UNIT WT. (Pounds)</b>
Sector Scan Assembly 1 c/o:			
Relay Unit RE-1I/APA-12A	1	4 x 6 x 8-1/2	2-3/4
Control Unit C-6U/APA-12	1	4-5/8 x 5-1/16 x 6-5/8	1-1/4
Sector Scan Switch SA-11A/APA-12	1	3-7/8 x 4-3/8 x 5-3/8	2
Cable Assembly (W-401)	1		

**REFERENCE DATA AND LITERATURE**  
Technical Manuals:  
AN16-20APA-12-2

**AN/APA-12A: 2**

**DATE:** 1 July 1964

**ITEM NAME:** AZIMUTH STABILIZATION ASSEMBLY

**COGNIZANT SERVICE:** USN

**TYPE:** AN/APA-11

**FEDERAL STOCK NUMBER:**

	USA	USN	USAF	USMC
STATUS OR TYPE CLASSIFICATION				
Mfg(s) (Name or Code Number: Philco Corporation, Philadelphia, Pa.				

**No Illustration Available.**

**FUNCTIONAL DESCRIPTION**

The AN/APA-14 is designed to provide compensation for direction of aircraft with respect to magnetic north so that the target and terrain, rather than the plane direction, will remain in a fixed position on the indi-

cator. It also provides for sector scanning of any integral multiple of 30 degrees up to a maximum of 330 degrees, rather than the continuous rotation of Antenna Assembly AS17/APS or AS-1/APS.

**AN/APA-14: 1**



**ITEM NAME:** AZIMUTH STABILIZATION ASSEMBLY  
**TYPE:** AN/APA-14

**RELATION TO SIMILAR EQUIPMENT**

None.

Power Consumption: 0.5 amps at 115v, iO0  
cps, 0.9 pf and 0.5 amps at 26dc

**INSTALLATION CONSIDERATIONS**

**TECHNICAL DESCRIPTION** Not available.

**PRINCIPAL COMPONENTS AND PHYSICAL DATA**

<b>COMPONENTS</b>	<b>QTY</b>	<b>OVERALL DIMENSIONS (Inches)</b>	<b>UNIT WT. (Pounds)</b>
Torque Amplifier AM-19/APA-11	1	5-3/16 x 5-1/2 x 9-9/16	5.25
Azimuth Differential Unit CN-4/APS-14	1	5-1/1 x 7-1/2 x 9-15/16	6.75
Relay RE-5/APA-13	1	2-9/16 x 1-3/16 x 5-3/4	2.25
Junction Box J-35/APA-14	1	2-5/16 x 6-7/16 x 9-11/32	2.12.5

**REFERENCE DATA AND LITERATURE**

Technical Manuals:  
CO-AN-Ot-30APS2-2 for Models AN/APS-2F and  
AN/APS-2G Aircraft Radar Equipment.  
Nomenclature Card for Azimuth Stabilization  
Assembly AN/APA- 14.

**AN/APA-14: 2**

**DATE:** 1 July 1964

**ITEM NAME:** TILT STABILIZATION ASSEMBLY

**COGNIZANT SERVICE:** USN

**TYPE:** AN/APA-15

**FEDERAL STOCK NUMBER:**

	USA	USN	USAF	USMC
STATUS OR TYPE CLASSIFICATION				
Mfg(s) Name or Code Number. Philco Corporation, Philadelphia, Pa.				

**No illustration available.**

**FUNCTIONAL DESCRIPTION**

The AN/APA-15 is designed to provide up to plus or minus 30 degrees compensation, within the antenna limits, for changes in the tilt angle of Antenna Assembly AS-17A/APS or AS1bA/APS. It compensates for diving, climbing,

and banking of the aircraft, thus eliminating the loss of signals normally incident to these maneuvers. It may also be used with Antenna AS-17/APS or AS-It/APS when they are provided with Rotating Joint CU-17/APS or Cu-18/APS respectively.

**AN/APA-15: 1**

**ITEM NAME:** TILT STABILIZATION ASSEMBLY  
**TYPE:** AN/APA-15

**RELATION TO SIMILAR EQUIPMENT**

None.

**Rotary Converter Power Data**

Input: 26v de, 10 amps

Output: 115v, 100 cps, 3-ph, 0.502  
amp s

**TECHNICAL DESCRIPTION**

Compensation Limits: plus or minus 30 deg  
(within antenna tilt limits).

Accuracy: plus or minus 1 deg Not available.

**INSTALLATION CONSIDERATIONS**

**PRINCIPAL COMPONENTS AND PHYSICAL DATA**

<b>COMPONENTS</b>	<b>QTY</b>	<b>OVERALL DIMENSIONS (Inches)</b>	<b>UNIT WT. (Pounds)</b>
Gyro Torque Unit CN-5/APA-15	1	7-3/1 x 8-3/4 x 15-3/16	13
Servo Amplifier AM-21/APA-15	1	1-19/32 x 6-5/16 x 7-3/16	7
Mounting Base MT-131/APA-15	1	1-7/8 x 6-3/5 x 20-1/4	2
Rotary Converter Pt'U-111/APA-15	1	5-1/4 x 6-1/16 x 9-1/8	9.5

**REFERENCE DATA AND LITERATURE**

Technical Manuals:

CO-AN-Ot-30APS15-2 for Model AN/APS-15 Aircraft  
Radar Equipment.

Nomenclature Card for Tilt Stabilization  
Assembly AN/APA-15.

**AN/APA-15: 2**

DATE: 1 July 1961

ITEM NAME: RADAR COMPENSATING ASSEMBLY

COGNIZANT SERVICE: USN

TYPE: AN/APA-16

FEDERAL STOCK NUMBER:

	USA	USN	USAF	USMC
STATUS OR TYPE CLASSIFICATION		Ltd Std		
Mfg(s) Name or Code Number: Western Electric Company				



AN/APA-16: 1

AN,/APA- 16

**FUNCTIONAL DESCRIPTION**

The AN APA-16 is a low altitude radar bombsight attachment designed for use with search radar that is intended for use in bombing surface vessels from aircraft but can also be used against any target within radar range.

Pulse Output: A range marker pulse and a release pulse, each 0.5 -sec wide at base and 15v in magnitude

**RELATION TO SIMILAR EQUIPMENT**

None.

**TECHNICAL DESCRIPTION**

Altitude: 50 to 500 ft  
Aircraft to Target Velocities (closing rate):  
50 to 400 knots  
Power Requirements: 115 ,5v, 400to 1,000 cps,  
1-ph, 1.5 amp, 150w  
Pulse Input: A trigger pulse in time coincidence  
with the radar pulse  
Pulse Repetition Rate: 2, 000 cps

**INSTALLATION CONSIDERATIONS**

Siting:  
Mounting:  
Cabling Requirements:  
Related Equipment: The AN/APA-16 is used in conjunction with Radar Sets AN,APS19, AN/ APS-20B, AN,APS-31 series, AN APS-33 series, and AN/APS-44.

The AN/APA-16 may be modified for use with: (1) Adapter Unit TD-6/APA-16, (2) Adapter Unit TD-6/APA-16 and Altitude Injector Assembly AN/APA-61, (3) Adapter Unit TD-6/APA-16 with or without Altitude Injector Assembly AN/APA-61, (4) Adapter Unit TD-6/APA-16 and Douglas Aircraft Co Searchlight Computer Adapter with or without Altitude Injector Assembly AN,IAPA-61.

**PRINCIPAL COMPONENTS AND PHYSICAL DATA**

COMPONENT	QTY	HEIGHT (Inches)	WIDTH (Inches)	DEPTH (Inches)	UNIT WT. (Pounds)
Control Unit, C- 160, APA- 16	1	5- 13/32	8-27/32	15- 1/4	12.00
Range Marker Unit SN- 12/APA-16	1	9-1/16	10-7/16	18-3/8	21.00
Capacitor Unit, MX-139,/APA-16	1	3	6	7-5/8	3.00

**REFERENCE DATA AND LITERATURE**

Technical Manuals:  
NAVAER 16-30APA16-506  
NAVAER 16-30APA16-505

DATE: 1 July 1961

ITEM NAME: AIRCRAFT RADAR EQUIPMENT

COGNIZANT SERVICE: USN

TYPE: AN./APA-17, AN./APA-17A, AN./APA-17RB

FEDERAL STOCK NUMBER:

	USA	USN	USAF	USMC
STATUS OR TYPE CLASSIFICATION				
Mfg(s) Name or Code Number: Aviola Radio Corp., Glendale, Calif, Hoffman Radio Corp.				

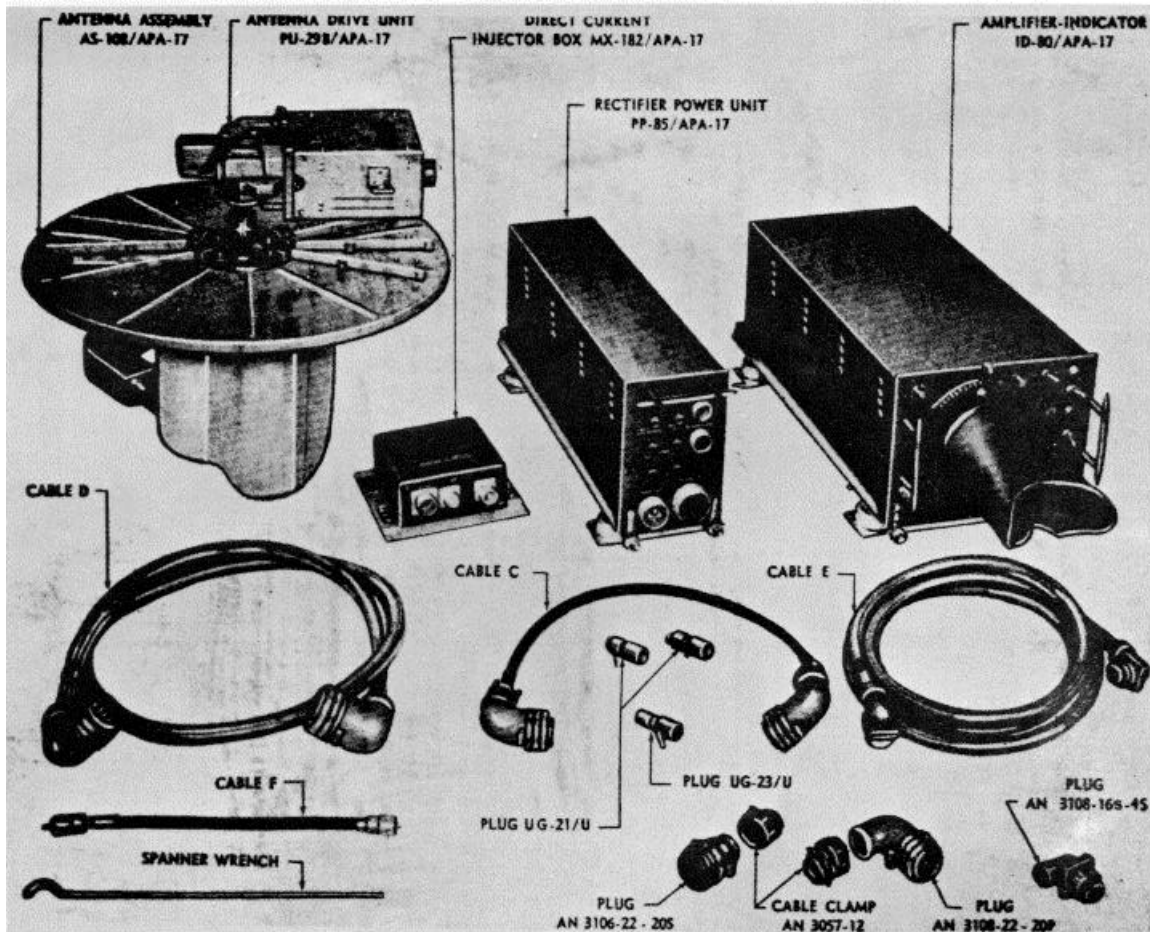

### FUNCTIONAL DESCRIPTION

The AN/APA-17 and AN/APA 17A are airborne equipments which, when used with an intercept radar receiver, provide a visual indication of the relative bearing of radar or radio signals within their frequency range.

The AN/APA-17 is identical to the AN/APA-17A except for different manufacturer and components. The AN/APA-17B is similar to the AN/APA-17 and AN/APA-17A except that Antenna Assembly AS-370/APA-17B and AS-217/APA-17R has been added.

**ITEM NAME:** AIRCRAFT RADAR EQUIPMENT  
**TYPE:** AN/APA-17, AN/APA-17A, AN/APA-17B

Operating Voltages: 26v dc, 80w and 80  
or 115v, 100 to 2600 cps, 1 ph (Selsyns  
require Y0 or 115v, .100 to g00 cps, 1 ph)

**RELATION TO SIMILAR EQUIPMENT**

Replaced by Direction Finding Group AN/APA-69,  
AN/APA-69A.

**INSTALLATION CONSIDERATIONS**

Cabling Requirements: RG-8/U Cable.

**TECHNICAL DESCRIPTION**

Related Equipment: Radar Intercept Receiver  
AN/APR-1 or Radar Set AN/APR-5, or similar  
receiving equipment; Test Transmitter TS-189/U.

Frequency: 250 to 1000 mc for horizon-  
tally polarized signals, 300 to 950  
mc for vertically polarized signals.  
Input Impedance: 2000 ohms  
Bearing Indicator: 5-in. CRT provides  
relative bearing.

**PRINCIPAL COMPONENTS AND PHYSICAL DATA**

COMPONENT	QTY	HEIGHT (Inches)	WIDTH (Inches)	DEPTH (Inches)	UNIT WT. (Pounds)
Amplifier-Indicator ID-b0/APA-17	1	9-1/8	11-1/8	24	34.1
Mounting Base NT-171/U	1	2-3/8	11-1/8	22-5/8	2.7
Viewing Hood	1				
Rectifier Power Unit PP-b5/APA-17	1				
Mounting Base MT-167/U	1	9-1/8	5-78c	23	23.1
Direct Current Injector Box MX-1B2/APA-17	1	7	2-1732	7	2.7
Mounting Plate	1				
Antenna Drive PU-29/APA-17	1	7-1/2	6-3/8	12	9.5
Antenna Assembly AS-108/APA-17B*	1	20 dia	16-5/8		11.6
Antenna Assembly 1 AS-370/APA-17B*					
Antenna Assembly AS-247/APA-17B*					

**NOTE:** \*Used on AN/APA-171 only.

**REFERENCE DATA AND LITERATURE**

Technical Manuals:  
AN16-30APA17-3

**DATE:** 1 July 1961

**ITEM NAME:** ATTENATOR ASSEMBLY

**COGNIZANT SERVICE:** USN

**TYPE:** AN/APA-22

**FEDERAL STOCK NUMBER:**

	<b>USA</b>	<b>USN</b>	<b>USAF</b>	<b>USMC</b>
STATUS OR TYPE CLASSIFICATION	Used By	Used By		
Mfg(s) Name or Code Number: Columbia Machine Works Inc. (96116)				

**FUNCTIONAL DESCRIPTION**

The Attenuator Assembly AN/APA-22 is a device for attenuating radar signals sent out by certain types of AN/APS-2 series Radar Equipment. to which it is attached.

The design of AN/APA-22 permits its use with PB4Y-1 installations of AN/APS 2B, 2C, -2E and -2F equipment, In installations which have the Transmitter-Converter mounted by the antenna assembly.

**AN/APA-22: 1**



**ITEM NAME:** ATTENUATOR ASSEMBLY  
**TYPE:** AN/APA-22

**RELATION TO SIMILAR EQUIPMENT**

None.

**INSTALLATION CONSIDERATIONS**

Related Equipment: The AN/APA-22 is designed to be used with, but not part of Radar Set AN/APS-2B, 2C, -2E and -2F.

**TECHNICAL DESCRIPTION**

Operating Power Requirement: 27v dc,  
2- 1 /1 amp

**PRINCIPAL COMPONENTS AND PHYSICAL DATA**

<b>COMPONENTS</b>	<b>QTY</b>	<b>OVERALL DIMENSIONS (Inches) (P)</b>	<b>UNIT WT. (Pounds)</b>
Attenuator Assembly AN/APA-22 c/o:	1		
Power Divider Unit RF-23/AP	1	7-15/16 x 11-5/16 x 15-1/2	6.3
Mounting Base MT-210/APA-22	1	1 x 15-1/2 x 22-3/4	7
Motor Drive Unit PU-28/APA-22	1	4-5/8 x 6-5/8 x 7 3/16	6.8
Single Right Angle CU-10/A PA - 22	1	1-3/8 x 3-1/16 x 3-13/16 0.6	
Absorber Unit CG-97/AP	1	2-1/2 x 2-1/2 x 9-1/32	1.1
Double Right Angle CU -39) /APA 22	1	1-25/32 x 1-7/16 x 6-3/8	0.9
Control Box C-121 /AP	1	2-1/16 x 1-7/8 x .5	1.1
Junction Box J-69/AP	1	2 1/16 x .1-9/16 x 5-13/16	1

**REFERENCE DATA AND LITERATURE**

Technical Manuals:  
CO-ANC08-30APA22-2

**AN/APA-22: 2**

DATE: 1 July 1961

ITEM NAME: RECORDING ASSEMBLY

COGNIZANT SERVICE: USAF

TYPE: AN/APA-23

FEDERAL STOCK NUMBER:

	USA	USN	USAF	USMC
STATUS OR TYPE CLASSIFICATION				
Mfg(s) Name or Code Number:				

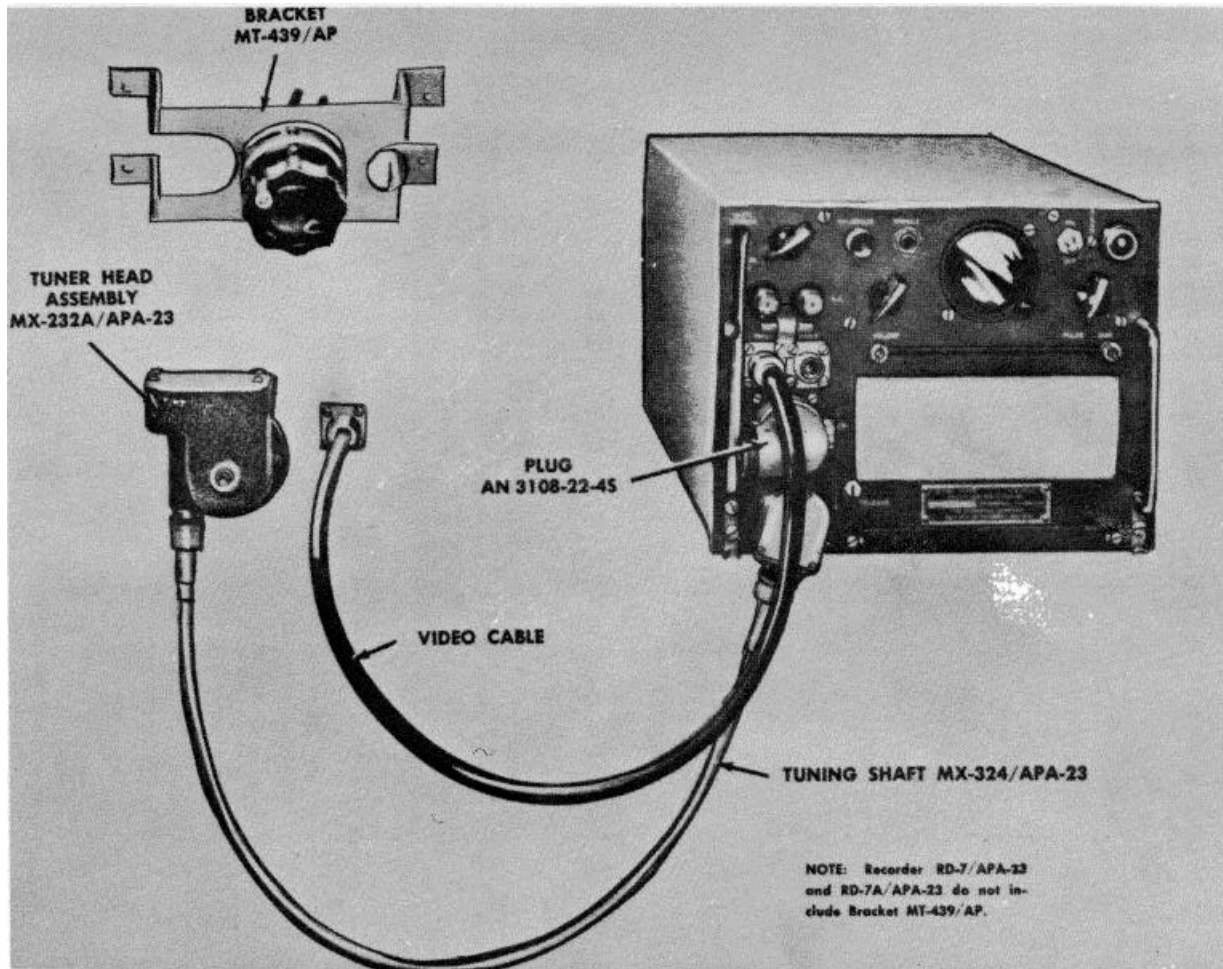

### FUNCTIONAL DESCRIPTION

The AN/APA-23 sweeps any receiver through its tuning range and permanently records the frequency and time of the received signals on electro-chemical sensitive paper.

The recording assembly will operate either manually or automatically at all times. When the recording assembly is set for automatic operation, the attention of an operator is not required.

**ITEM NAME:** RECORDING ASSEMBLY  
**TYPE:** AN/APA-23

**TECHNICAL DESCRIPTION**

Power Input  
Motor: 28v dc, 50 w  
Electronic Tubes: 80 or 115v, 60 to  
2600 cps, 135 w

**INSTALLATION CONSIDERATIONS**

Related Equipment: (1) Receiving Equip-  
ment AN/APR-1, (1) Receiving Equipment  
AN/APR-1, (1) Power Input Cable, (1)  
Mounting Base MT-171/1.

**PRINCIPAL COMPONENTS AND PHYSICAL DATA**

<b>COMPONENTS</b>	<b>QTY</b>	<b>OVERALL DIMENSIONS (Inches)</b>	<b>UNIT WT. (Pounds)</b>
AN/APA (with RD-7 APA-23 or RD-7A/APA-23)			
Recorder RI) 7/APA-23 or RD-7A/APA-23	1		417.5
Rolls Western Teledeltos Paper Grade L	4		
Cable, Video CD-800	1	30 1g	
Tuning Shaft MX-321/APA-23	1	24 1g	
Tuning Shaft MX-325/APA-23	1		
Adapter Kit MX-27A/APA-23	1		
Case CY-330/APA-23			
Power Input Plug AN3108-22-4S	1		
AN/APA-23 (with RD-78/APA-23)			
Recorder RD-78/APA-23	1		
Rolls Western Teledeltos Paper Grade L	4		
Video Cable CD-TOO	1		47.5
Tuning Shaft MX-32-1/APA-23	1		
Tuning Shaft MX-325/APA-23	1		
Adapter Kit MX-267U/APA-23	1		
Case CY-330A/APA-23	1		
Power Input Plug AN31(Yd-22-1S	1		

**REFERENCE DATA AND LITERATURE**

Technical Manuals:  
AN16-30APA23-7 for Recording Assembly  
AN/APA-23.

DATE: 1 July 1961

ITEM NAME: ATTENUATOR ASSEMBLY

COGNIZANT SERVICE: USN

TYPE: AN/APA-26

FEDERAL STO:K NUMBER:

	USA	USN	USAF	USMC
STATUS OR TYPE CLASSIFICATION	Used By	Usec By		
Mfg(s) Name or Code Number: Columbia Machine Products Inc. (96116)				

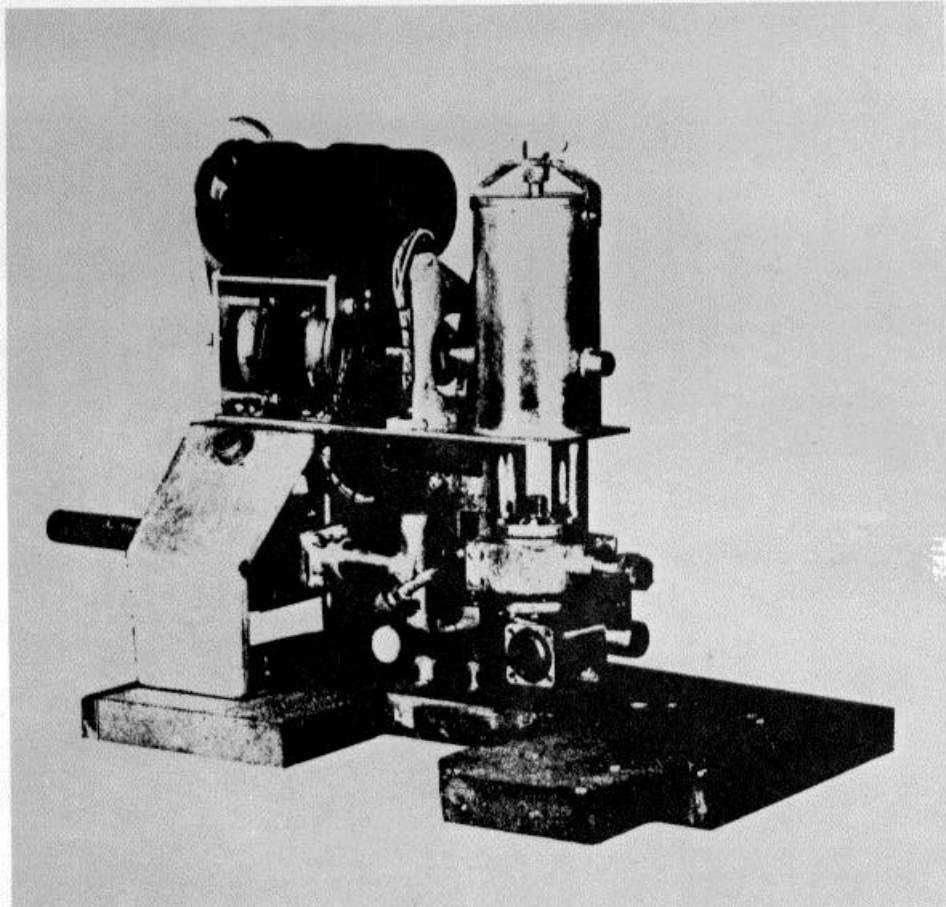

**FUNCTIONAL DESCRIPTION**

The Attenuator Assembly, AN/APA-26 is a device for attenuating radar signals sent out by certain types of

AN/APS-2 series radar equipment to which it is attached.

The design of AN/APA-26 permits its use with PBM installations which have the Transmitter-Converter mounted beside the Antenna assembly.

**ITEM:** ATTENUATOR ASSEMBLY

**TYPE:** AN/APA-26

**RELATION TO SIMILAR EQUIPMENT**

2-1/4 amps.

None.

**INSTALLATION CONSIDERATIONS**

**TECHNICAL DESCRIPTION**

Operating power Requirement: 27v dc,

Related Equipment: The AN/APA 26 is designed to be used with, but not part of Radar Sets AN/APS-2B, 2C, -2E and -2F.

**PRINCIPAL COMPONENTS AND PHYSICAL DATA**

<b>COMPONENTS</b>	<b>QTY</b>	<b>OVERALL DIMENSIONS (Inches)</b>	<b>UNIT WT. (Pounds)</b>
Attenuator Assembly AN APA-26 1 c/o:			
Power Divider Unit RF-25/APA-26	1	8 x 13-1/2 x 16	8.5
Mounting Base MT-296/APA-26	1	1-1/1 x 11-7/16 x 17-7/16	8.0
Motor Driver Unit PU-45/APA-26	1	4-5/8 x 6-5/8 x 7-3/16	6.8
Absorber Unit CG-97/APA	1	2-1/2 x 2-1/2 x 9-1/32	1.4
Double Right Angle CU-53/APA-26	1	1-7/8 x 4-1/4 x 5-1/4	1
Double Right Angle CU-54/APA-26	1	1-7/8 x 5-3/8 x 6-3/8	1.5
Control Box C-121/AP	1	2-1 /16 x 4-7/8 x 5	1.1
Junction Box J-69/AP	1	2-1/16 x 1-9/16 x 5-13/16	1

**REFERENCE DATA AND LITERATURE**

Technical Manuals:  
CO-AN08-30APA26 - 2X

**AN/APA-26: 2**

DATE: 1 July 1964

ITEM NAME: COMPUTER ASSEMBLY

COGNIZANT SERVICE: USN

TYPE: AN/APA-30

FEDERAL STOCK NUMBER:

	USA	USN	USAF	USMC
STATUS OR TYPE CLASSIFICATION	Used By	Used By		
Mfg(s) Name or Code Number: Lewyt Corporation (36001)				

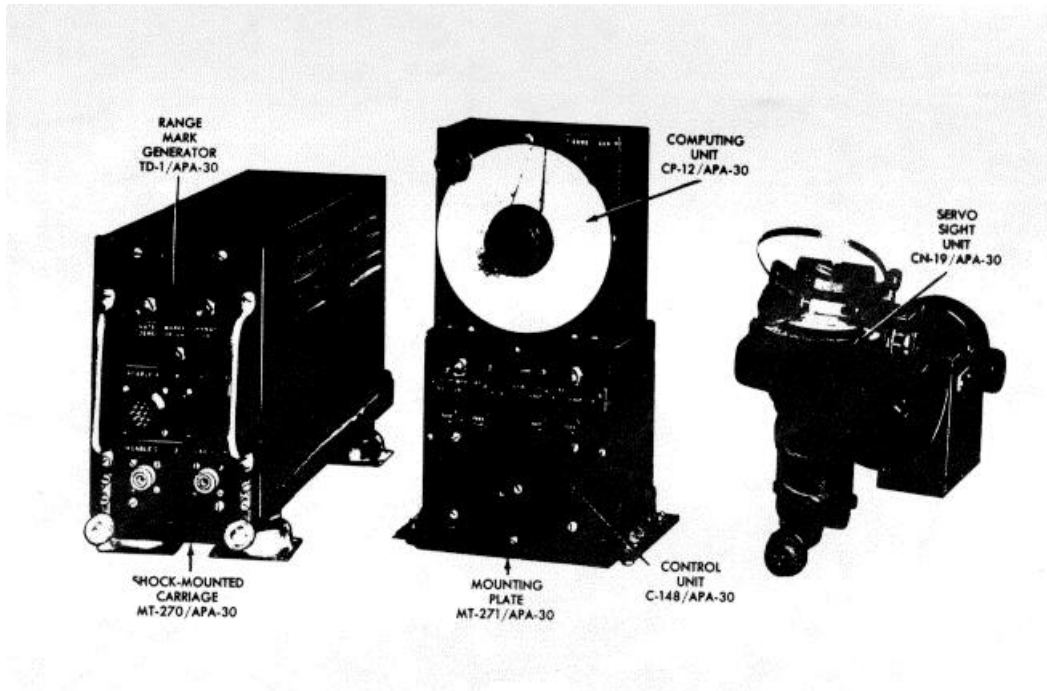

### FUNCTIONAL DESCRIPTION

The Computer Assembly, AN/APA-30 is a ranging and tracking attachment for any airborne pulse radar set. It is designed to perform either of two functions:

Gunning. In conjunction with a radar set it furnished continuous accurate information for aiming cannon or rockets from aircraft. With the range information a ballistic cam, cut in accordance with the ballistics of the ammunition for a [prescribed

AN/APA-30: 1

**ITEM:** COMPUTER ASSEMBLY  
**TYPE:** AN/APA-30

approach to the target, continuously positions the tilting mirror of Navy Mark III illuminated Adjustable Sight, so that the sight is always properly adjusted with range.

Bombing. It puts a release point marker on the radar inductor tube for bombing. The correct slant release range is found with the help of a simple dial computer.

None.

**TECHNICAL DESCRIPTION**

Operating Power Requirement: 115v ac, 400 to 2600 cps, 2 ph, 1 amp; 26v dc, ½ amp

**INSTALLATION CONSIDERATIONS**

Not available.

**PRINCIPAL COMPONENTS AND PHYSICAL DATA**

**PRINCIPAL COMPONENTS AND PHYSICAL DATA**

<b>COMPONENTS</b>	<b>QTY</b>	<b>OVERALL DIMENSIONS (Inches)</b>	<b>UNIT WT. (Pounds)</b>
Computer Assembly AN/APA-30 c/o: Control Unit C-148/APA-30	1		
Range Mark Generator TD-1/APA-30	1	5-3/4 x 7-1/2 x 7-1/2	5-1/4
Computing Unit CP-12/APA-30	1	5 x 7-3/4 x 17-1/4	20-1/2
Servo Sight Unit CN-19/APA-30	1	5 x 5-3/4 x 5-3/4	4-1/4
	1	7-1/4 x 8 x 11	8-1/2
Mounting Plate MT-270/APA-30	]		1-3/4
Mounting Plate MT-271 /APA-30	1		3/4

**REFERENCE DATA AND LITERATURE**

Technical Manuals:  
CO -NAVAER 16-5S-519

DATE: 1 September 1964

ITEM NAME: GROUND POSITION INDICATOR

COGNIZANT SERVICE: USAF

TYPE: AN/APA-44A

FEDERAL STOCK NUMBER: 1210-533-6965

	USA	USN	USAF	USMC
STATUS OR TYPE CLASSIFICATION			Alt Std	
Mfg(s) Name or Code Number: Western Electric Company				

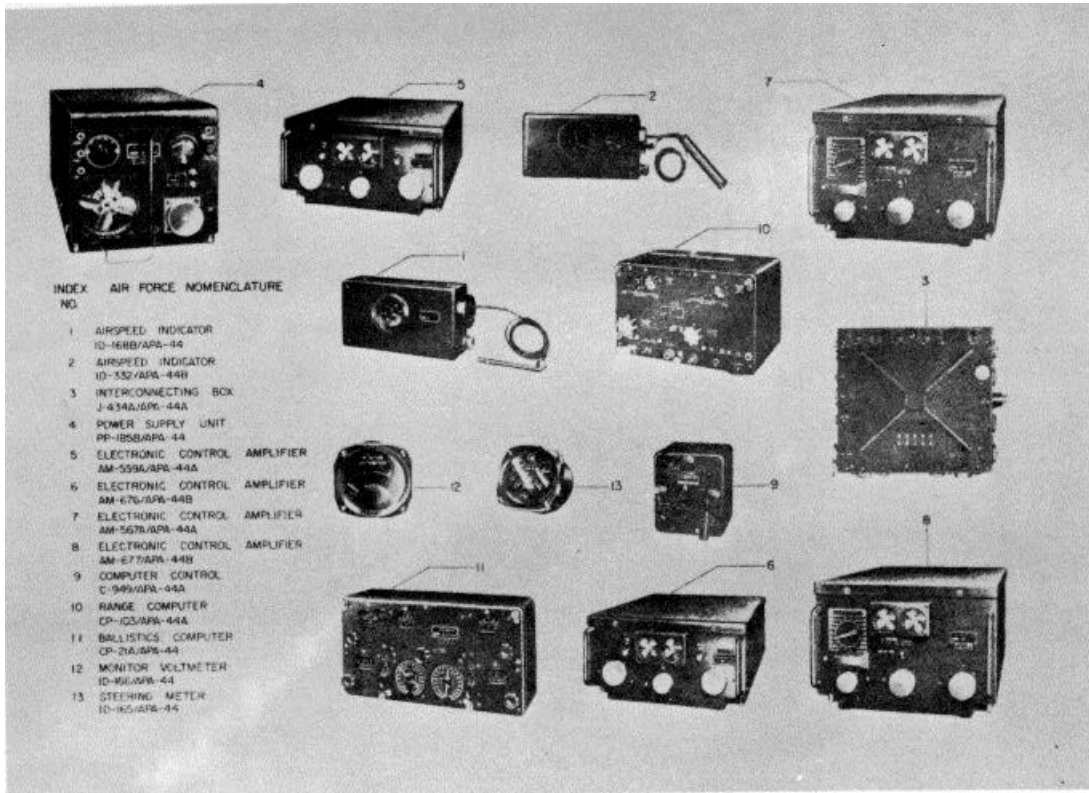

**FUNCTIONAL DESCRIPTION**

Ground Position Indicator AN/APA-44A or AN/APA-44B referred to as the computer, is computing equipment designed to operate in conjunction with Radar Set AN/APS-23 ( ) or

equivalent. The computer performs accurate computations for navigation and bombing at altitudes to 50,000 feet, also provides visual steering and timing information for navigation and bombing.



**ITEM NAME:** GROUND POSITION INDICATOR  
**TYPE:** AN/APA-44A

**RELATION TO SIMILAR EQUIPMENT**

The major differences between Ground Position Indicators AN/APA-44A and AN/ APA-44B consists of changes in three components as indicated in the component listing.

plus 30 deg C (plus 86 deg)  
Relative Humidity: Continous or intermittent operation 100% at temp up to plus 55 C  
Weight: Approx 300 lbs  
Accuracy  
High Altitude Bombing : 20 mils  
Navigation Error: Less than 3% of distance traveled.  
Max Airspeed: 434 knots air speed Ind. ID-168/APA-44A-44B.  
Ind. ID-332?APA-44B.  
Wind Accuracy: 3 to 5 knots  
Time of Fall: 0 - 105 sec  
Max Trail: 36,000 ft  
Max Range "Fix": 20 mi east, 20 mi west, 20 mi north, 20 mi south.

**TECHNICAL DESCRIPTION**

**Power Requirements**

dc: 26.5v, 10 amps  
ac, Regulated: 115v, 380-420-cps, 26 va  
ac, Unregulated: 115v, 380-1000 cps, 750 va

**Operating Limits**

Max Altitude: 50,000 ft above terrain  
Ambient Temp  
Min below 15,000 ft above sea level  
-55 deg C (-67 deg F)  
Max below 15,000 ft above sea level  
plus 55 deg C (plus 131 deg F)  
Max above 15,000 ft above sea level

**INSTALLATION CONSIDERATIONS**

Detailed installation instructions are contained in each applicable aircraft handbook.

**PRINCIPAL COMPONENTS AND PHYSICAL DATA**

COMPONENT	QTY	HEIGHT (Inches)	WIDTH (Inches)	DEPTH (Inches)	UNIT WT. (Pounds)
Airspeed Indicator ID-168B/APA-44	1*	7-5/32	5-1/4	16-1/2	13
ID-332/APA-44B	1**	7-5/32	5-1/4	16-1/2	13
Interconnecting Box J-434/APA-44A	1	5-7/8	18	22-1/4	37
Power Supply PP-185B/APA-44	1	10-41/64	10-13/32	22-9/16	49
Electronic Control Amplifier AM-559A/APA-44A	1*	11-1/16	16-3/16	23-11/16	86
AM-677/APA-44B	1**	11-1/16	16-3/16	23-11/16	86
Computer Control C-949/APA-44A	1	7-1/8	6	7-5/16	6
Range Computer CP-103/APA-44A	1	7-9/16	9-3/8	12-9/16	21
Ballistic Computer	1	8-1/32	6-5/16	16-1/32	18
Monitor Voltmeter	1	2-9/16	3-1/4	3-1/4	1
Steering Meter	2	2-3/4	3-1/4	3-1/4	1
Mtg Airspeed Indicator	1	9-1/4	4-1/4	11-3/4	1-1/2
Mtg Power Supply MT-1103/U	1	2-5/8	11-1/8	22-13/16	2-3/4

**AN/APA-44A: 2**

ITEM NAME: GROLIND POSITION INDICATOR  
TYPE: AN/APA-44A

**PRINCIPAL COMPONENTS AND PHYSICAL DATA**

COMPONENT	QTY	HEIGHT (Inches)	WIDTH (Inches)	DEPTH (Inches)	UNIT WT. (Pounds)
Mtg Electronic Control MT-1102/U	1	2-5/8	16-3/8	22-13/16	2-3/4
Mtg Electronic Control MT-1101/U	1	2-7/8	16-3/8	22-13/16	3
Mtg Computer Control MT-498/APA-44	1	5/8	4	5-3/4	7/8
Mtg Range Computer MT-500/APA-44	1	5/8	6-5/16	12-3/16	3
Mtg Ballistics Computer MT-499/APA-44	1	5/8	7-11/16	15-11/16	4-1/4

**NOTE: \*AN/APA-41A Application**  
**\*AN/APA-44B Application**  
**All other items applicable to both.**

**REFERENCE DATA AND LITERATURE**

Technical Orders:  
11B21-6-2-11  
11B21-6-2-22  
11B21-6-2-23

**AN/APA-44A: 3**

DATE: 1 July 1964  
COGNIZANT SERVICE: USN

ITEM NAME: HOMING EQUIPMENT  
TYPE: AN/APA-48

FEDERAL STOCK NUMBER:

	USA	USN	USAF	USMC
STATUS OR TYPE CLASSIFICATION	Used By	Used By		
Mfg(s) Name or Code Number:				

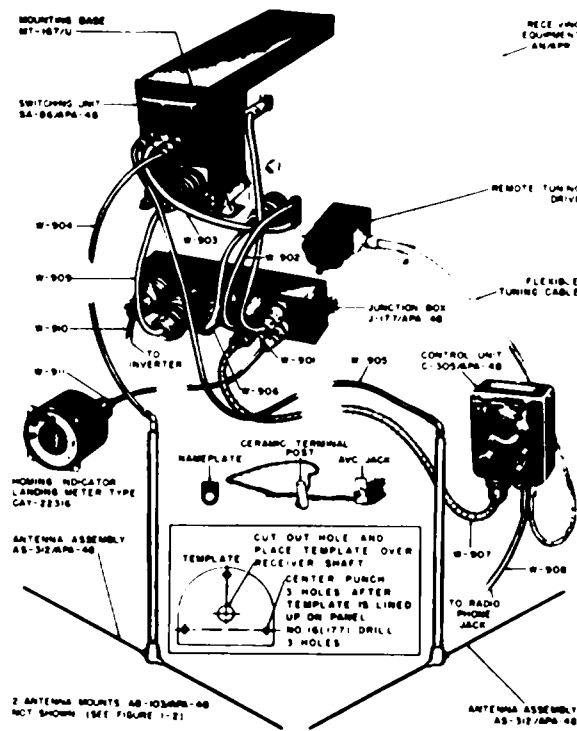

### FUNCTIONAL DESCRIPTION

The Homing Equipment AN/APA-48 is designed to provide for detection and homing on radar signals in the frequency range 125 to 190 megacycles (mc). The Antenna Mounts AB-103/FPA-18 are design-

ed for mounting the antennas on the F6F type aircraft. Different mounts may be necessary if the equipment is installed in other aircraft.

The AN/APA-48 is so designed that signals picked up by the antennas are fed through a modified Receiving Equipment

**ITEM NAME:** HOMING EQUIPMENT  
**TYPE:** AN/APA-48

AN/APR-1 operating in conjunction with the Switching Unit SA-86/APA-48 and ultimately appear as visual information on the Homing Indicator, Landing Meter Type CAY-22316. The correct interpretation of the position of the cross pointers of this meter gives the pilot accurate information in azimuth for homing on the source of the received signal.

Operating Power Requirement: 115v ac, 440 cps, 51w, 93% pf; 28v dc, 5.5w

**INSTALLATION CONSIDERATIONS**

Related Equipment: The AN/APA-48 is designed to be used with, but not part of Receiver Equipment AN/APR-1 or similar receivers.

**RELATION TO SIMILAR EQUIPMENT**

None.

**TECHNICAL DESCRIPTION**

Frequency Range: 125 to 190 mc

(Required but not Supplied) (1) Set of Headphones H-1/AR; (1) Mounting Bracket (to mount Homing Indicator); (1) Receiving Equipment AN/APR-1.

**PRINCIPAL COMPONENTS AND PHYSICAL DATA**

<b>COMPONENTS</b>	<b>QTY</b>	<b>OVERALL DIMENSIONS (Inches)</b>	<b>UNIT WT. (Pounds)</b>
Homing Equipment AN/APA-48	1		
c/o: Switching Unit SA-86/APA-48	1	5-3/16 x 8 x 21-1/8	22
Mounting Base MT-167/U	1	2-1/2 x 5-3/4 x 22-3/4	1.7
Antenna Assy AS-312/APA-48	2	2 x 29-1/16 x 36	5
Antenna Mounts AB-103/APA-48	2	5-3/8 x 6-5/8 x 15-1/2	6
Control Unit C-305/APA-48	1	2-15/16 x 3-3/8 x 5-1/2	2-3/4
Junction Box J-177/APA-48	1	2-7/8 x 3-1/4 x 12-1/4	2.2
Homing Indicator CAY-22316	1	3-1/16 x 3-1/4 x 3-1/4	2
R.F. Adapter UG-28/U	1		
Set of Connecting Cables	1		
AVC Jack & Nameplate Template for Modifying Receiver	1		0.125

**REFERENCE DATA AND LITERATURE**

Technical Manuals:  
AN16-30APA-48-3

DATE: 1 July 1961

ITEM NAME: DOPPLER DRIFT ATTACHMENT

COGNIZANT SERVICE: USAF

TYPE: AN/APA-52A

FEDERAL STOCK NUMBER:

	USA	USN	USAF	USMC
STATUS OR TYPE CLASSIFICATION	Used By	Used By	Std	
Mfg(s) Name or Code Number Gibbs Mfg. & Research Corporation (82092)				

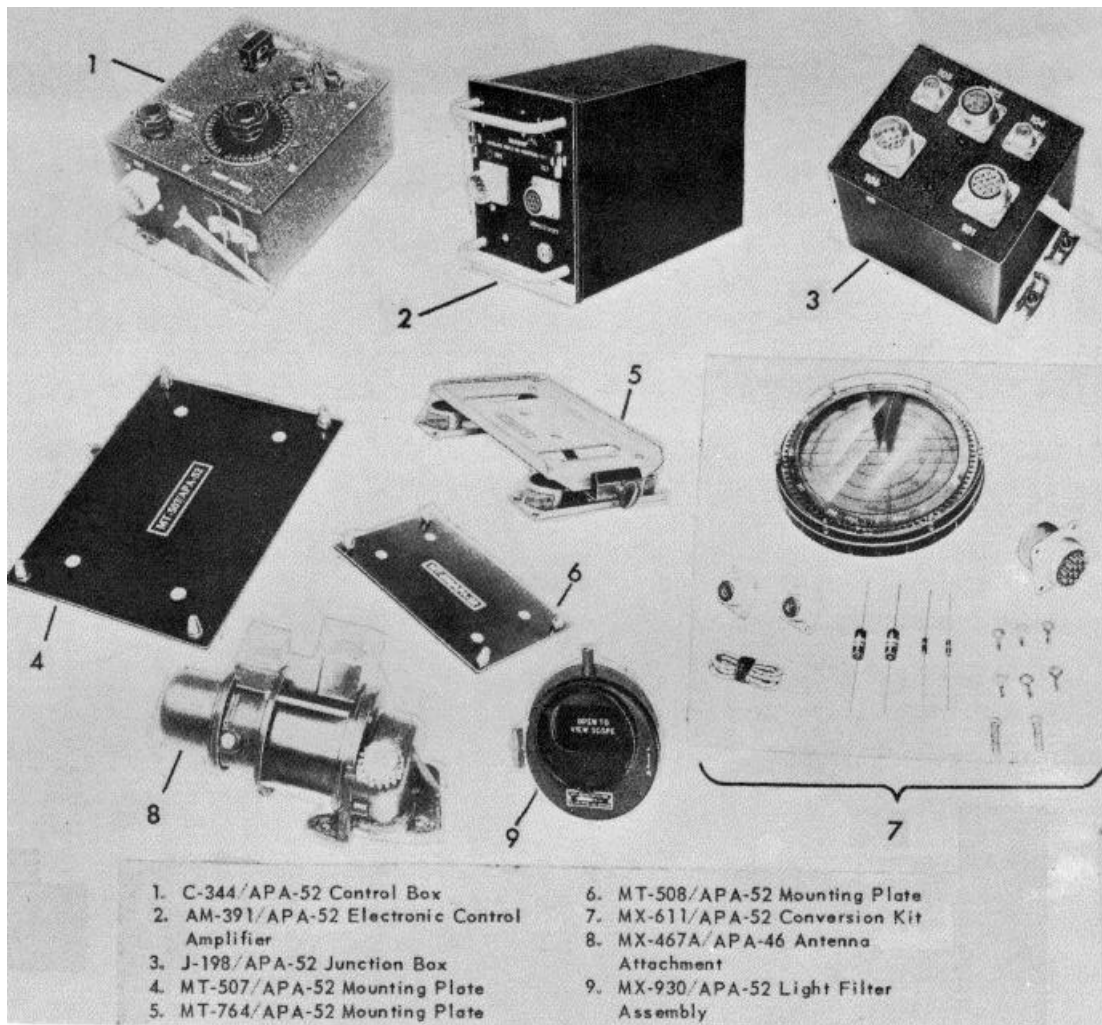

**FUNCTIONAL DESCRIPTION**

The Doppler Drift Attachment AN/APA-52A consists of equipment for determination of the true ground track of an aircraft by the use of the pulse doppler effect. The attachment provides a means for "search

lighting" the antenna until a minimum pulse doppler is observed on the radar scope. With the antenna then switched to its normal function of continuous rotation or sector scan, the attachment provides an azimuth and mark on the PPI scope at the previously determined drift angle. Means

**ITEM NAME:** DOPPLER DRIFT ATTACHMFENT  
**TYPE:** AN/APA-52A

are provided for control from a dark line to a bright line. The angle between tile lubber line (dead ahead) and the azimuth line represents the angle of drift.

Servo Information: 100 cycle  
Operating Power Requirement  
Input: 115ac, 100 cycle, 1 amp  
Output: 2dv de, 5 amps

**RELATION TO SIMILAR EXQUIPMENT**

The AN/APA-52A is similar to the AN/APA52 except for Servo Amplifier AM-1O4/APA46 and Mounting Base MT-119/APA-46 are replaced by AM-391/APA-52 and MT-761/APA-52. The AN/APA-52A is used with but not part of Radio Set AN/APQ-13 and AN/APQ-23A Radar Set.

**INSTALLATION CONSIDERATIONS**

Related Equipment: (Equipment Required but not Supplied) (1) Receptacle, Male Contact Pt. no. PL-259; (4) Adapters Type UG-176/U; (as required) Cabling Type RG-59/U; (4) Cable Clamp Type AN3057-12; (2) Cable Clamp Type AN3057-10; (2) Cable Clamp Type AN3057-t; (as required) Shielded Cable Spec no. 95-27273; (as required) Cable (Wire) Type AN-J-C-18.

**TECHNICAL DESCRIPTION**

Signal Frequency: 400 cycle at 26v

**PRINCIPAL COMPONENTS AND PHYSICAL DATA**

COMPONENTS	QTY	OVERALL DIMENSIONS (Inches)	UNIT WT. (Pounds)
Doppler Drift Attachment AN/APA-52A c/o:	1		
Control Box C-34-/APA-52	1	1-3/8 x 6-1/1 x 8-3/1	3.0
Mounting Plate MT-507/APA-52	1	6-1/1 x d-3/1 x 11/16	0.68
Junction Box J-198/APA-52	1	5 x 5-13/16 x 7-1/2	4.5
Mounting Plate MT-508/APA-52	1	11/16 x 5 x 7-1/2	0.44
Antenna Attachment MX-467A/APA-46	1	5 x 5 x 8	3.0
Control Amplifier AM-391/APA-52	1	5 x 8 x 11-1/4	9.5
Mounting MT-761/APA-52	1	2-1/2 x 5 x 12-5/8	1.5
Set of Cable Receptacles	1	1.0	
Conversion Kit MX-611/APA-52	1		1.5
Light Filter MX-930/APA-52	1	2-1/1 x 7-3/8 x 8-9/16	1.25

**REFERENCE DATA AND LITERATURE**

- Technical Manuals:
- AN16-30APA52-2
- T.O. 11B18-2-2-4
- T.O. 11B18-2-2-11
- T.O. 11B18-2-2-12
- T.O. 11B18-2-2-14

DATE: 1 July 1961

ITEM NAME: INDICATOR ASSEMBLY

COGNIZANT SERVICE: USN

TYPE: AN/APA-56, -56A, -56B

FEDERAL STOCK NUMBER:

	USA	USN	USAF	USMC
STATUS OR TYPE CLASSIFICATION		Alt Std'		
Mfg(s) Name or Code Number: General Electric Company; Texas Instruments, Inc.				



AN/APA-56, -56A, -56B

**FUNCTIONAL DESCRIPTION**

The AN/APA-56, -56A, -56B provides the airborne portion of an airborne combat information center when operated in conjunction with associated radar, IFF, and other electronic equipment. The AN/APA-56, -56A, -56B displays azimuth, range, and amplitude of detected targets and the radar, beacon, and IFF signals.

**RELATION TO SIMILAR EQUIPMENT**

None.

**TECHNICAL DESCRIPTION**

Display: 12-in. CRT (5 supplied)  
5-in. centered PPI (2 supplied)  
Console Ranges and Sweeps:

Range	Sweep
20 mi per radius	80 mi duration
50 mi per radius	200 mi duration
100 mi per radius	200 mi duration
250 mi per radius	250 mi duration
Operating Altitude: 0 to 25,000 ft	
Operating Temperature: -55 to +55 deg C	
Power Requirements:	
115v, 1-ph, 380 to 420 cps, 450 va	
115v, 3-ph, 380 to 1,000 cps, 5,800 va	
28 vdc, 14 amp (continuous)	
28 vdc, 18 amp for 0.1 sec	

**INSTALLATION CONSIDERATIONS**

Not available.

**PRINCIPAL COMPONENTS AND PHYSICAL DATA**

COMPONENT	QTY	HEIGHT (Inches)	WIDTH (Inches)	DEPTH (Inches)	UNIT WT. (Pounds)
AN/APA- 56					
Converter Control C-1216/APS-56	1	4-5/16	10-1/2	16-11/32	10.0
Video Converter CU-78/APA-56	1	45-1/2	20-1/2	22	192.0
Azimuth and Range Indicator IP-229/APA-56	5	45-3/4	38	28	375.0
Azimuth and Range Indicator IP-230/APA-56	1	19-3/4	16-3/8	25	80.0
Voltage Regulator CN-212/APA-56	1	19-1/2	18-11/16	18-5/8	85.0
Relay Assembly RE-144/APA-56	1	25-1/16	23-13/16	8-5/8	40.0
Signal Distributor J-294/APA-56	1	28	35-3/4	10-9/16	93.0
AN/APA-56A					
Converter Control C-1848/APA-56A	1	3-13/16	10-3/8	5-5/8	3.1
Video Converter CV-401/APA-56A	1	45-1/2	20-1/2	22	177.0
Azimuth and Range Indicator IP-229/APA-56	5	45-3/4	38-1/16	28	368.0
Azimuth and Range Indicator IP-230/APA-56	1	19-3/4	15- 1/2	24- 1/4	94.5
Voltage Regulator CN-212A/APA- 56	1	18-3/4	18-1/8	18-5/8	40.5



AN/APA-56, -56A, -56B

PRINCIPAL COMPONENTS AND PHYSICAL DATA (Cont'd)

COMPONENT	QTY	HEIGHT (Inches)	WIDTH (Inches)	DEPTH (Inches)	UNIT WT. (Pounds)
Relay Assembly RE-144A/APA-56	1	25-1/16	23-13/16	8-5/8	40.5
Signal Distributor J-294A/APA-56 AN/APA- 56B	1	28	35-3/4	10-9/16	97.0
Signal Distributor J-294A/APA-56	1	28-7/8	35-13/16	10-1/2	98.0
Video Converter CV-401/APA-56A	1	45-9/16	21-1/3	22-7/16	184.0
Azimuth and Range Indicator IP-230A/APA-56	1	20-3/32	15-13/16	25-5/8	97.0
Azimuth and Range Indicator IP-390/APA- 56B	5	46-3/16	38-13/16	31-1/16	357.0
Converter Control 1 3-29/32 10-7/16 5-7/8 4.0 C-1848/APA-56A	1				
Relay Assembly RE-144A/APA-56	1	25-1/8	22-9/16	8-3/4	41.0
Voltage Regulator CN-212A/APA-56	1	19-7/16	18-7/16	20-7/16	79.0

REFERENCE DATA AND LITERATURE

Handbooks:

AN16-30APA56-1  
NAVAER 16-30APA56-501  
NAVAER 16-30APA56-505

Specification:

MI L-I-6988C

DATE: 1 July 1961

ITEM NAME: GROUND POSITION INDICATOR

COGNIZANT SERVICE: USN

TYPE: AN/APA-57

FEDERAL STOCK NUMBER:

	USA	USN	USAF	USMC
STATUS OR TYPE CLASSIFICATION				
Mfg(s) Name or Code Number:				

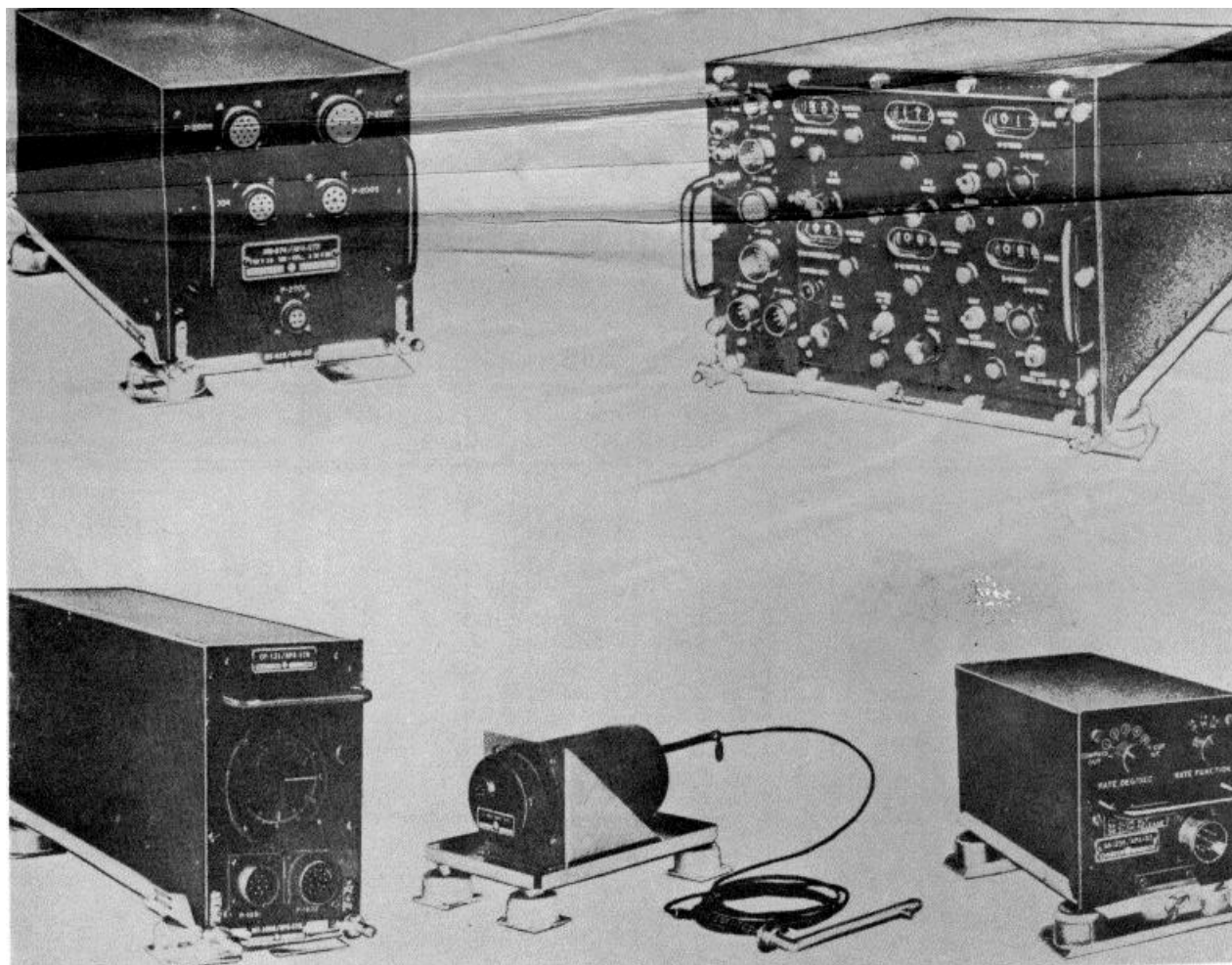

**FUNCTIONAL DESCRIPTION**

The AN/APA-57 is airborne equipment used to indicate the displacement in naut mi of the aircraft from an initial ground position in terms of N-S and E-W coordinates. From true air speed, heading and wind, and information supplied to various units of the equipment, the AN/APA-57 derives direct indication of

the relative position of the aircraft from an initial ground reference. The resultant N-S and E-W coordinates are converted into corresponding variable dc voltages which are used to stabilize the PPI presentation of radar indicating systems, including Indicator Assembly AN/APA56 or Indicator Group AN/APA-81.

The AN/APA-57 also supplies ground displacement

**AN/APA-57**

information to Dead Reckoning Tracer equipment and true heading data to the antenna of Radar Set AN/APS-20A. Although the AN/APA-57 is designed specifically for use with Indicator Assembly AN/APA-56 or Indicator Group AN/APA-81 equipments, it may also be used with other radar indicators provided with means for sweep offset.

**RELATION TO SIMILAR EQUIPMENT**

Similar to AN/APA-57A except for use of different Computer-Indicators and to AN/APA-57B, and AN/APA-57C. The basic differences are the source of air speed information and the manner of coordinate resolution and combination with wind data.

**TECHNICAL DESCRIPTION**

Input Power Requirements:

AC Supply - 115v, delta connected or 208v wye connected,  $\pm 5\%$ ; 3-ph; 400 cps  $\pm 5\%$ ; ph-A 45 va, ph-B 75 va, ph-C 26 va. Ph-A must be supplied from same source as that used for the G-2 compass system.

DC Supply - 28v  $\pm 5\%$ , 8 amp

Data Voltages:

Heading Signal - 0 to 0.3v, 1-ph, 400 cps from G-2 compass system or 0 to 9v, 1-ph, 400 cps from adapter.

Air Speed Signal - 0 to 65v, 3-ph, 40 to 160 cps from air pump or 0 to 12v, 1-ph, 400 cps from air speed transmitter.

Wind Signal - 0 to 1.5v, 1-ph, 400 cps

Output Voltages:

Heading Signal- 0 to 12v, 3-ph, 400 cps ac synchro output; azimuth displacement signal relative to true north, for use at antenna of Radar Set AN/APS-20.

Ground Position Coordinates: -150 to +150 vdc potentiometer outputs. Initial fix corresponds to N-S and E-W ground displacement coordinates for sweep displacement circuits of the PPI.

**INSTALLATION CONSIDERATIONS**

Not available.

**PRINCIPAL COMPONENTS AND PHYSICAL DATA**

COMPONENT	QTY	HEIGHT (Inches)	WIDTH (Inches)	DEPTH (Inches)	UNIT WT. (Pounds)
Computer- indicator CP-32/APA-57	1	5-5/16	7-3/8	11-13/16	8-3/5
Amplifier-Wind Servo AM-202/APA-57	1	7-5/8	7-5/8	21-1/2	35
Control C-441/APA-57	1	10- 5/8	15-3/8	17- 1/2	51
Air Pump MX-912/APA-57	1	9-5/16	9-5/16	9-5/8	8
Inertia Switch SA-235/APA-57	1	5-5/16	5-5/16	10- 1/4	5
A.P.I. Controller AN5843-1	1	3-1/4	3-1/4	4-5/32	1-3/4

**REFERENCE DATA AND LITERATURE**

Technical Manual:

AN16-30APA57-3

Specification:

NAVAER M-733A

DATE: 1 July 1964,  
COGNIZANT SERVICE: USN

ITEM NAME: PULSE ANALYZER GROUP  
TYPE: AN/APA-64, AN/APA-64A

FEDERAL STOCK NUMBER

	USA	USN	USAF	USMC
STATUS OR TYPE CLASSIFICATION				
Mfg(s) Name or Code Number: Loral Electronics Corporation				

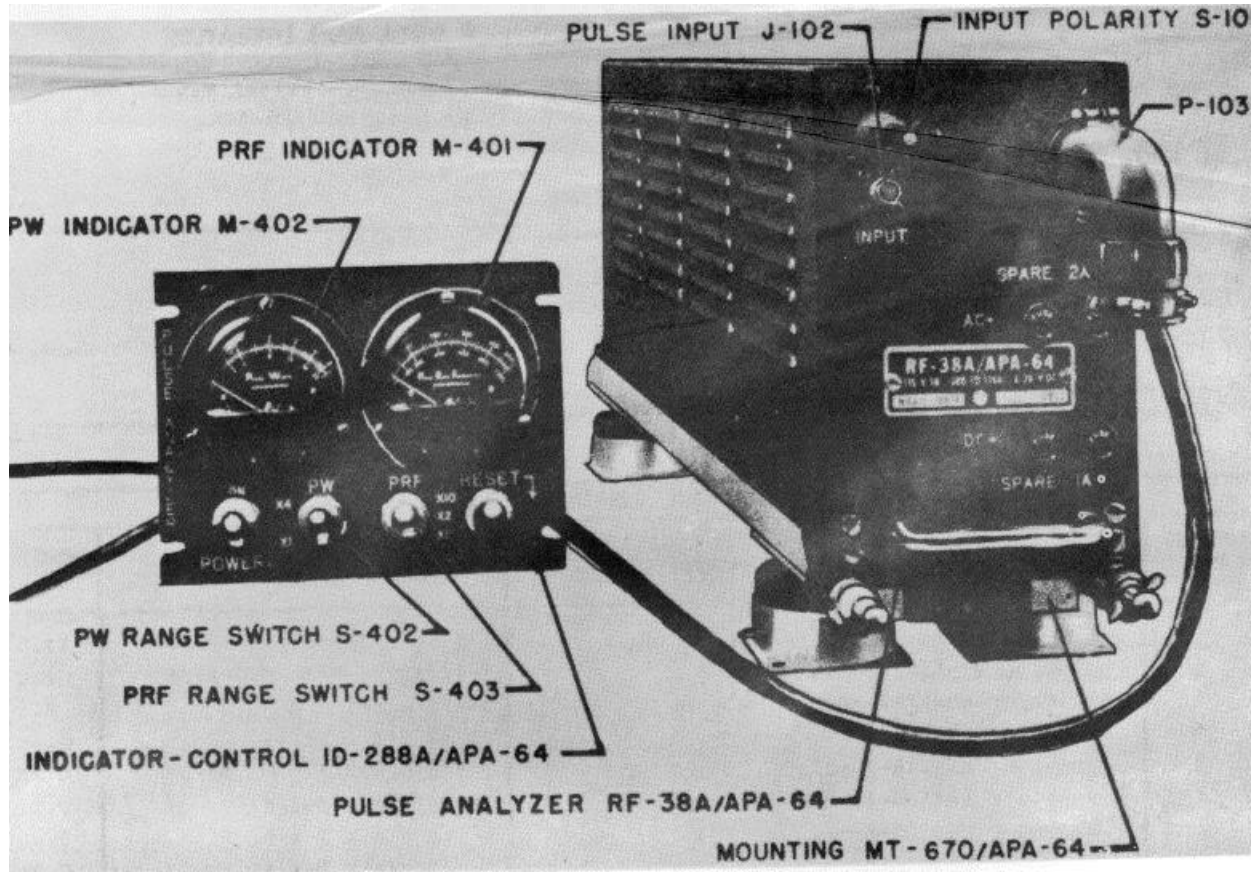

FUNCTIONAL DESCRIPTION

The AN/APA-64, AN/APA-64A are designed for use in service aircraft to operate in conjunction with radar search receivers. The video output signal of the search receiver is fed to the Pulse Analyzer which translates

either a continuous signal, or a short "burst" of pulses, into a meter reading in terms of pulse width and pulse repetition frequency, holding this information for 15 sec. The operator may clear the instrument manually at any time or the next burst of pulses will automatically reset the instrument

**ITEM NAME:** PULSE ANALYZER GROUP

**TYPE:** AN/APA-64, AN/APA-64A

to the correct meter reading.

**RELATION TO SIMILAR EQUIPMENT**

None.

12 uw  
Accuracy: plus or minus 5% for all pulse widths and prf's  
Input Impedance: 50 ohms  
Video Sensitivity: 1.5v

**TECHNICAL DESCRIPTION**

Pulse Durations: 0.5 to 20 usec  
Repetition Frequencies: 50 to 5000 cps  
Video Input Amplitude: 1.5 to 10v, either positive or negative  
Operating Power: 109 to 119v, single ph, 380 to 1760 cps, and 25 to 29.5v dc,

**INSTALLATION CONSIDERATIONS**

Related Equipment: (Equipment Required but not Supplied) (1) Receiver AN/APR-1 or (1) Receiver AN/APR-4, or (1) Receiver AN/APR-SA, or (1) Receiver AN/APR-9, (1) Power Supply, (1) Cable RG-58/U, (1) Cable.

**PRINCIPAL COMPONENTS AND PHYSICAL DATA**

<b>COMPONENT</b>	<b>QTY</b>	<b>HEIGHT (Inches)</b>	<b>WIDTH (Inches)</b>	<b>DEPTH (Inches)</b>	<b>UNIT WT. (Pounds)</b>
Indicator Connate ID-228A/APA-64	1	3-1/8	4-1/2	6	2.5
Pulse Analyzer RF-38A/APA-64 or RF-33B/APA-64	1	7-5/8	5-5/16	19-3/4	17.0

**REFERENCE DATA AND LITERATURE**

Technical Manuals:                      Specifications:  
NAVAER 16-30APA64-12              RE-16A44(Aer)  
NAVAER 16-30APA64-501

DATE: 1 July 1964

ITEM NAME: REMOTE CONTROL-MONITOR GROUP

COGNIZANT SERVICE: USN

TYPE AN/APA-65

FEDERAL STOCK NUMBER:

	USA	USN	USAF	USMC
STATUS OR TYPE CLASSIFICATION	Used By	Used By		
Mfg(s) Name or C(ode Number. Western Electric Co. (139515)				

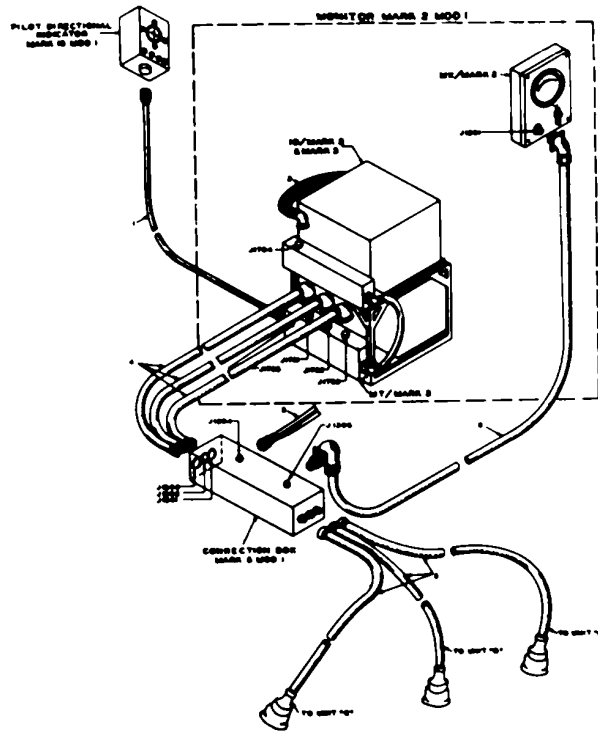

**FUNCTIONAL DESCRIPTION**

The Remote Control-Monitor Group AN/APA-65 is an airborne device for remotely controlling a radar equipment inaccessible to the operator. It enables the

operator to monitor and control any one of three (3) radars, the radars being a part of SWOD Mark 9 Mod O or SWOD Mark 9 Mod 1.

**ITEM NAME:** REMOTE CONTROL-MONITOR GROUP  
**TYPE:** AN/APA-65

**RELATION TO SIMILAR EQUIPMENT:**

The AN/APA-65 was formerly tile Navy Model Monitor Mark 2 Mod 2.

**INSTALLATION CONSIDERATIONS**

Related Equipment:: Tile AN/APA-65; is designed to be used with, but not part of Navy BuOrd SWOD Mark 9 Mod 0 and Mod 1.

(Equipment Required but not supplied): (3) Connection Box to Rack; (1) Connection Box to Battery Voltage Indicator; (1) Connection Box to Battery; (3) Connection Box to Radar; (1) Rack to Pilot's Indicator: (1) Rack to 115v ac Supply.

**TECHNICAL DESCRIPTION**

Type of Equipment: Radar  
Equipment Purpose: Remote control and monitor.  
Operating Power Requirement: 115v ac, -100 to 2400 cps, single, 28v dc.

**PRINCIPLE COMPONENTS AND PHYSICAL DATA**

<b>COMPONENTS</b>	<b>QTY</b>	<b>OVERALL DIMENSIONS (Inches)</b>	<b>UNIT WT. (Pounds)</b>
Control Unit or Mark 2 Mod 3	1	10-7/16 x 10-7/8 x 16-7/8	15.0
Operator's Indicator ID/Mark 2 Mark 3	1	7-27/32 x 10-1/4 x 16-61/64	23.7
Rack MT/Mark 2	1	14-5/8 x 16-3/4 x 22-1/4	15.8
Battery Voltage Indicator MX/Mark 2	1	2-1/4 x 3-1/8 x 4-13/32	7/8
Pilot's Indicator Mark 16 Mod 1	1	6 x 7-1/7 x 8-21/32x 4-3/16	5.3
Connection Box Mark 5 Mod 1	1	3-13/16 x 9-15/16 x 16-27/32	9.1
Plug AN-3106-36-1P	3		
Plug AN-3106-36-1S	3		
Plug AN-3106-20-1P	3		
Plug AN-3108-20-1S	1		
Plug AN-3108-20-4S	1		
Plug AN-3108-24-9S	1		
Plug AN-3108-14S-5P	1		
Plug AN-3108-14S-5S	1		
Plug Monowatt Top Housing 4106P	3		

**REFERENCE DATA AND LITERATURE**

Technical Manuals:  
CO-NAVAER 16-30APA66-500

**AN/APA-65: 2**

DATE: 1 July 1964  
COGNIZANT SERVICE: USN

ITEM NAME: REMOTE CONTROL-MONITOR GROUP  
TYPE: AN/APA-67

FEDERAL STOCK NUMBER:

	USA	USN	USAF	USMC
STATUS OR TYPE CLASSIFICATION	Used By	Used By		
Mfg(s) Name or Mode Number: Western Electric Company (159515)				

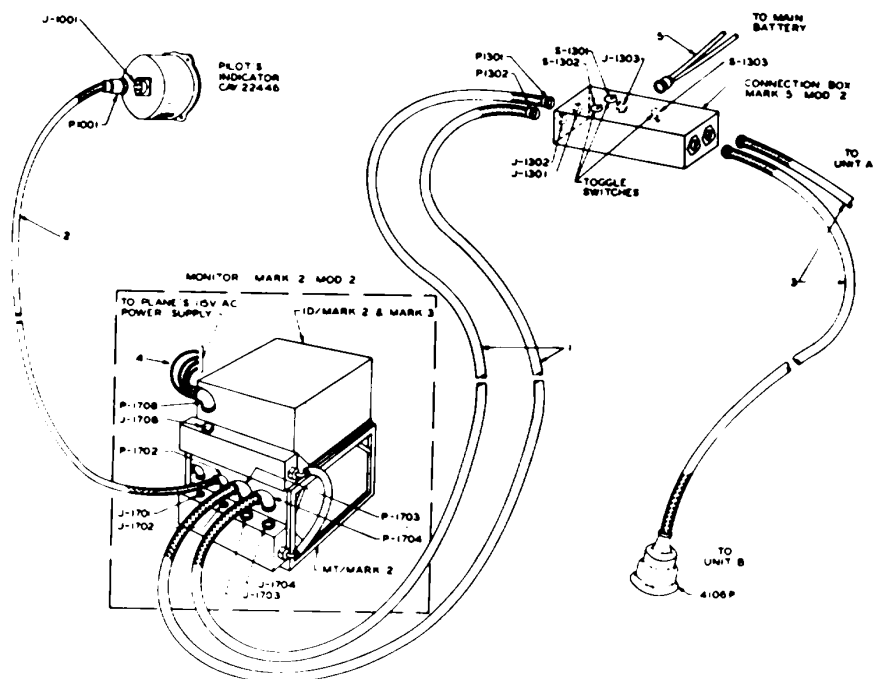

**FUNCTIONAL DESCRIPTION**

The Remote Control-Monitor Group AN/APA-66 is an airborne equipment for remotely controlling a radar equipment inaccessible to the operator. It enables the

operator to monitor and control any one of two radars, the radar being a part of SWOD Mark 9 Mod 0 or Mark 9 Mod 1.



**ITEM NAME:** REMOTE CONTROL-MONITOR GROUP

**TYPE:** AN/APA-66

**RELATION TO SIMILAR EQUIPMENT**

The AN/APA-67 was formerly the Navy Model BuOrd Monitor Mark 3 Mod 0. The AN/APA-67 is similar to the AN/APA-65 and AN/APA-66 except unit and rack.

**TECHNICAL DESCRIPTION**

Type of Installation: Airborne  
Type of Equipment: Radar  
Equipment Purpose: Remote control and monitor.  
Operating Power Requirement: 115v ac, 400 to 2400 cps; 28v- dc.

**INSTALLATION CONSIDERATIONS**

Related Equipment: The AN/APA-66 is designed to be used with, but not part of BuOrd SWOD Mark 9 Mod 0 and Mod 1.  
(Equipment Required but not Supplied): (2) Connection Box to Rack; (1) Rack to Pilot's Indicator; (2) Connection Box to Radar; (1) Rack to 115v ac Power Supply; (1) Connection Box to Plane 26.5v Battery.

**PRINCIPAL COMPONENTS AND PHYSICAL DATA**

<b>COMPONENTS</b>	<b>QTY</b>	<b>OVERALL DIMENSIONS (Inches)</b>	<b>UNIT WT. (Pounds)</b>
Control Unit Monitor Mark 2 Mode 2	1	7-27/32 x 10-1/4 x 16-61/64	11-1/4
Operator's Indicator ID/Mark 2 & Mark 3	1	7-27/32 x 10-1/4 x 16-61/64	23.44
Rack MT/Mark 2	1	14-1/8 x 14-3/4 x 22-1/4	15.1/2
Pilot's Indicator CAY-22446	1	3-3/4 x 3-3/4 x 1-3/16	2.06
Connection Box Mark 5 Mod 2	1	4-1/4 x 7-23/32 x 16-27/32	5.62
Plug AN-3106-14S-2S	1	1-1/16 dia x 1-11/32	0.05
Plug AN-3106-24-9S	1	1-23/32 dia x 2-1/4	0.24
Plug AN-3106-36-1P	2	2-3/8 x 2-15/32 dia	0.31
Plug AN-3106-14S-2P	1	1-1/16 x 1-3/4 x 1-17/32	0.06
Plug AN-3106-20-4S	1	1-15/32 x 2-3/641 x 2-15/16	0.22
Plug AN-310b-36-1S	2	2-15/32 x 3-1/6-1 x 3-11/16	0.61
Plug Monowatt Top Housing 4106P	2	3-1/2 dia x 4-7/8	1.06

**REFERENCE DATA AND LITERATURE**

Technical Manuals:  
CO-NAVAER 16-30APA66-500

**AN/APA-66: 2**

DATE: 1 July 1964

ITEM NAME: REMOTE CONTROL-MONITOR GROUP

COGNIZANT SERVICE: USN

TYPE: AN/APA-67

FEDERAL STOCK NUMBER:

	USA	USN	USAF	USMC
STATUS 011 TYPE CLASSIFICATION	Used By	Used By		
Mfg(s) Name or (Code Number: Western Electric Comp)any (139515)				

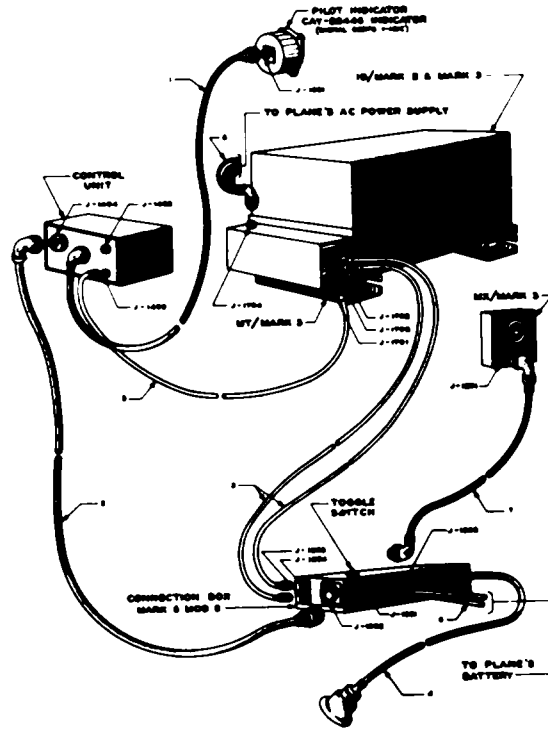

**FUNCTIONAL DESCRIPTION**

The Remote Control-Monitor Group AN/APA-67 is an airborne equipment designed for remotely controlling a

radar equipment inaccessible to the operator. It enables the operator to monitor and control one radar, the radar being a part of SWOD Mark 9 Mod 0 or Mod 1.

**ITEM NAME:** REMOTE CONTROL-MONITOR GROUP

**TYPE:** AN/APA-67

**RELATION TO SIMILAR EQUIPMENT**

The AN/APA-67 was formerly the Navy BuOrd Monitor Mark 3 of Mod 0. The AN/APA-67 is similar to the AN/APA-65 and AN/APA-66 except unit and rack.

**TECHNICAL DESCRIPTION**

Type of Installation: Airborne  
Type of Equipment: Radar  
Equipment Purpose: Remote control and monitor.  
Operating Power Requirement: 115v ac, 400 to 2400 cps, 28v dc.

**INSTALLATION CONSIDERATIONS**

Related Equipment: (Equipment Required but not supplied) (1) Control Unit to Pilot's Indicator (Cable); (1) Control Unit to Connection Box (Cable); (3) Control Unit to Rack (one cable) and Rack to Connection Box (two cables); (1) Connection Box to Radar (Cable); (1) Connection Box to Plane 26.5v Battery (Cable); (1) Connection Box to Battery and AVC Voltage Indicator (Cable).

**PRINCIPAL COMPONENTS AND PHYSICAL DATA**

<b>COMPONENTS</b>	<b>QTY</b>	<b>OVERALL DIMENSIONS (Inches)</b>	<b>UNIT WT. (Pounds)</b>
Control Unit Mark 3 Mod 0	1	4-7/8 x 6-5/8 x 7-1/2	4.75
Operators Indicator ID/Mark & Mark 3	1	7-27/32 x 10-1/4 x 16-61/64	23.44
Rack MT/Mark 3	1	5-1/16 x 11-9/16 x 20-3/16	5.38
Battery Voltage & AVC Indicator MX/Mark 3	1	3-1/8 x 4-13/32	0.91
Pilot's Indicator CAY-22446	1	3-3/4 x 3-3/4 x 4-3/16	2.06
Connection Box Mark 6 Mod 0	1	4-1/4 x 5-1/8 x 16-27/32	3.75
Plug AN-3106-14S-2S	1	1-1/16 dia x 1-11/32	0.05
Plug AN-3106-24-9S	1	1-22/32 dia x 2-1/4	0.24
Plug AN-3106-36-1P	1	2-3/8 x 2-15 32 dia	0.34
Plug AN-3108-14S-2P	1	1-1/16 x 1-3/4 x 1-17/32	0.06
Plug AN-3108-14S-5P	1	1-1/16 x 1-3/4 - 1-17/32	0.06
Plug AN-3108-14S-5S	1	1-1/16 X 1-3/4 x 1-17/32	0.07
Plug AN-3108-20-4S	1	1-15/32 X 2-5/16 x 2-15/16	0.22
Plug AN-3108-28-2S	1	1-31/32 X 2-1/2 x 3-3/16	0.38
Plug C-19195	6	3/4 dia x 1-9/16	0.06
Plug Monowatt Top Housing 4106P	1	3-1/2 dia x 4-7/8	1.06

**REFERENCE DATA AND LITERATURE**

Technical Manuals:  
CO-NAVAER 16-30APA67-500

**AN/APA-67: 2**

DATE: 1 July 1964

ITEM NAME: INDICATOR GROUP

COGNIZANT SERVICE: USAF

TYPE: AN/A PR-81

FEDERAL STOCK NUMBER:

	USA	USN	USAF	USMC
STATUS OR TYPE CLASSIFICATION			Alt Std	
Mfg(s) Name or Code Number:				

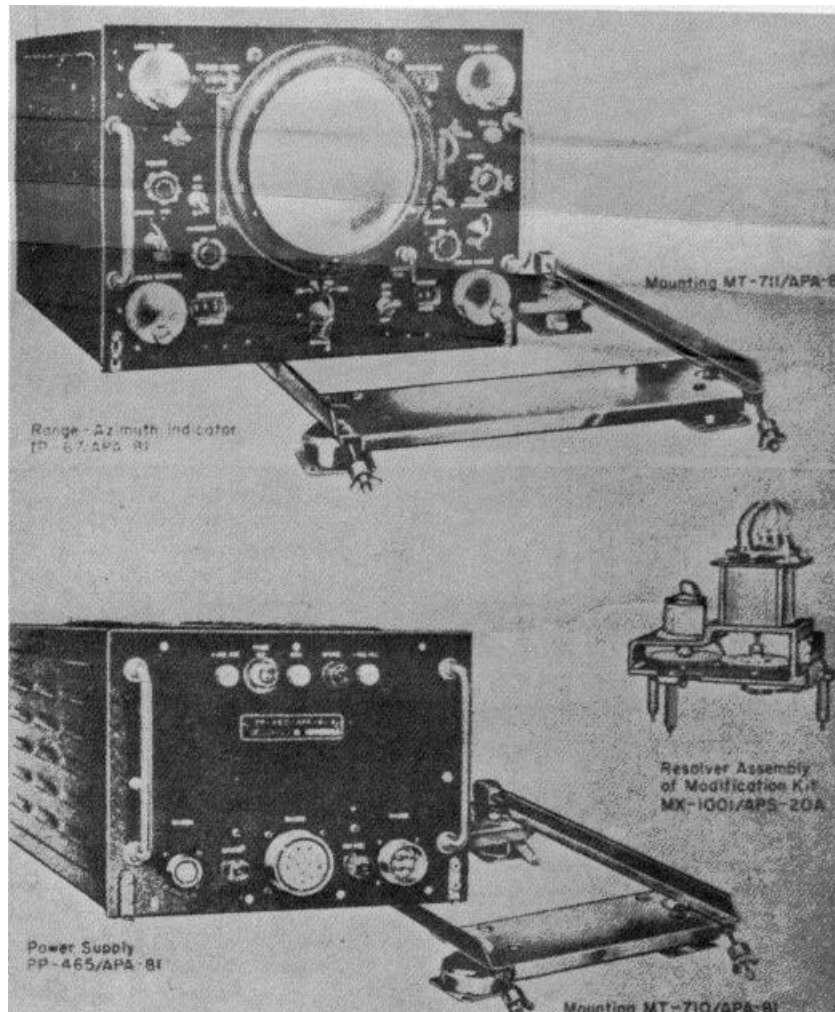

**FUNCTIONAL DESCRIPTION**

The AN/APA-81 is a remote PPI indicator equipment for use with Radar Set AN/APS-20A or the AN/APS-20C.

The AN/APA-81 when used with Radar Set AN/APS-20A, Ground Position Indicator AN/APA-57, and

appropriate IFF equipment, is primarily intended for use as a radar navigation aid. In this function it provides a ground positioned PPI display with a predetermined ground point at the center. The ground-positioned display can be locally slewed at Range-Azimuth Indicator IP-67/APA-81

**ITEM NAME:** INDICATOR GROUP**TYPE:** AN/APA-81

APA-81 so that the aircraft carrying it is shown at the center of the display, as in a conventional PPI display. IFF returns can be shown on either ground-positioned or locally slewed displays. An electronic cursor provides an alternate method of operation, by means of which the range and bearing of either the predetermined ground point or a target can be found.

E-W compensating voltages from Control Unit C-441/APA-57.  
Sweep Ranges: 80, 200 mi, 20, 50 and 100 mi  
Power Source: 120v, 400 to 800 cps, single ph

**TECHNICAL DESCRIPTION**

Presentation: 7 in. CRT PPI, Ground Position Indication (GPI).  
Signal Receiver: Radar and heading marker IFF and beacon video signals from Radar Set AN/APS-20A, N-S and

**INSTALLATION CONSIDERATIONS**

Related Equipment: Used in conjunction with Radar Set AN/APS-20A, AN/APS-20C. Equipment required, but not supplied: Interconnecting cables, Connector plugs and Adapters and Cable clamps.

**PRINCIPAL COMPONENTS AND PHYSICAL DATA**

<b>COMPONENTS</b>	<b>QTY</b>	<b>OVERALL DIMENSIONS (Inches)</b>	<b>UNIT WT. (Pounds)</b>
Range-Azimuth Indicator IP-67/APA-81	1	11-1/4 x 16-1/4 x 18	58
Mounting MT-711/APA-81	1	2-1/8 x 16-3/8 x 18-11/16	2.5
Power Supply PP-465/APA-81	1	7-5/16 x 11 x 17	32
Mounting MT-710/APA-81	1	2-1/8 x 11-1/8 x 18-7/16	2
Modification Kit MX-1001/APS-20A	1		
Viewing Hood Assembly	1		
Bezel Window	1		

**REFERENCE DATA AND LITERATURE**

Technical Manuals:  
AN16-20APA81-3 for Indicator Group AN/APA-81.

**AN/APA-81: 2**

DATE: 1 September 1964

ITEM NAME: INDICATOR GROUP

COGNIZANT SERVICE: USAF

TYPE: AN/APA-82

FEDERAL STOCK NUMBER:

	USA	USN	USAF	USMC
STATUS OR TYPE CLASSIFICATION			Ltd Std	
Mfg(s) Name or Code Number: Western Electric Company				

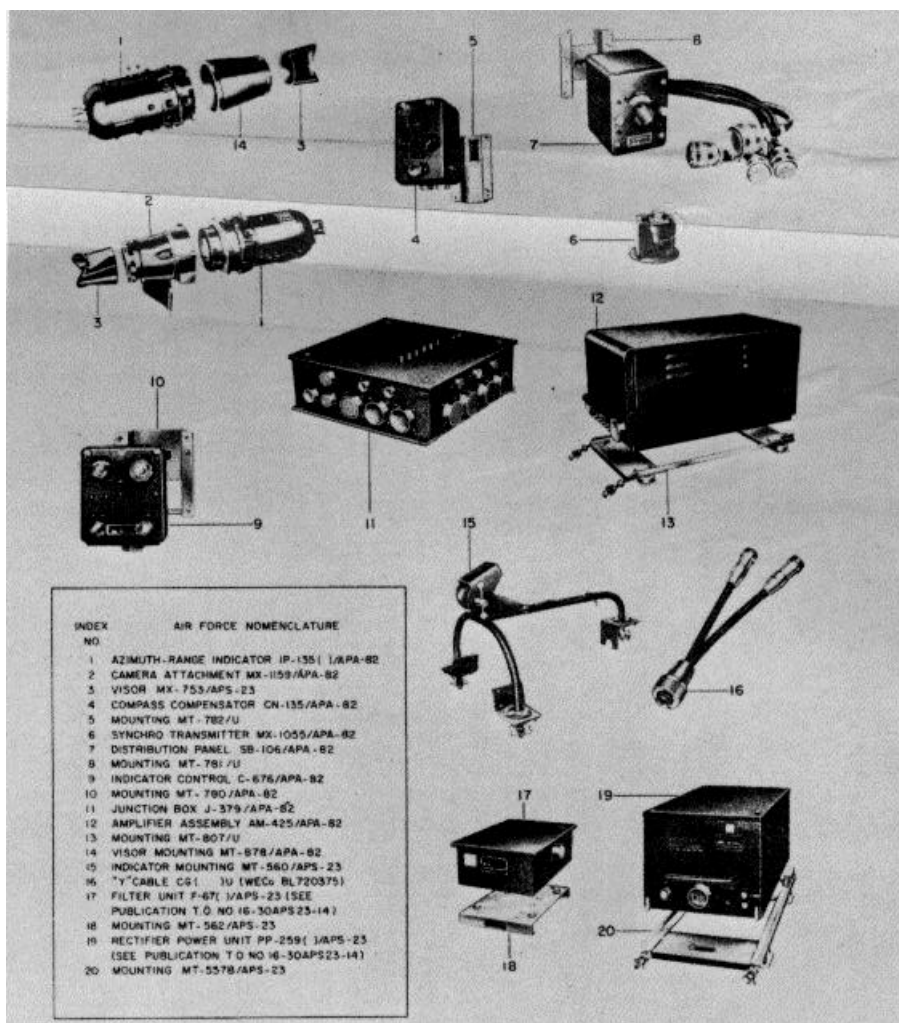

### FUNCTIONAL DESCRIPTION

Indicator Group AN/APA-82 provides facilities for "in flight" training of three students simultaneously under the direction of an instructor, when used with either

Radar Set AN/APQ-24( ) or Radar Set AN/APS-23( ). It also has the capability of switching control of the Radar Set to each of the four indicators positions.

**ITEM NAME:** INDICATOR GROUP

**TYPE:** AN/APA-82

**RELATION TO SIMILAR EQUIPMENT**

The AN/APA-82 becomes the OA-602/APA-23A Indicator Group when certain components, which eliminate the switching capability, are deleted.

dc: 26.5 plus or minus 2v, 14w,  
(0.5 amp)

**INSTALLATION CONSIDERATIONS**

The AN/APA-82 Indicator Group provides multiscope attachment for Radar Set AN/ APQ-24( ) or AN/APS-23( ) required for student training in Radar Bombing problems; therefore installation consideration would be peculiar to its various uses.

**TECHNICAL DESCRIPTION**

Power Requirements  
ac, Regulated: 115v, 380 - 420 cps,  
236 va  
ac, Unregulated: 115v, 380 - 1000 cps,  
535 va

**PRINCIPAL COMPONENTS AND PHYSICAL DATA**

COMPONENT	QTY	HEIGHT (Inches)	WIDTH (Inches)	DEPTH (Inches)	UNIT WT. (Pounds)
Filter Unit F-67A/APS-23	1	3-1/2	7-5/8	10-1/4	8-1/2
Mounting MT-562/APS-23	1	15/16	6-7/16	9-5/8	3/4
Rectifier Power Unit PP-259B/APS-23	1	7-7/8	10-3/4	23-5/16	34
Mounting MT-557B/APS-23	1	2-5/8	11-7/16	23-27/32	4
Azimuth Range Indicator IP-135A/APA-82	2 or 3**		8-1/4 (dia)	13-7/8	22
Indicator ID-218( )/APS-23	2 or 3**		8-1/4	13-5/8	22
Mounting MT-560/APS-23	2 or 3**	8-15/16	11-1/2	13-39/64	2
H.V (G-467/U)	"Y" Cable 3**	2 or			
Indicator Control C-676/APA-82	3#	5-3/16	5-3/4	7-1/8	4-1/2
Mounting MT-780/U	3#	1/2	5-3/4	7	1/3
Distribution Panel SB-106/APA-82	1#	5-7/8	4-3/4	6-1/2	3
Mounting MT-781/U	1#	1/2	4-3/4	6-1/2 1/4	
Compass Compensator CN-135/APA-82	1*	5-3/8	4	6-7/8	3
Mounting MT-782/U	1*	1/2	3-7/8	6-7/8	1/4
Amplifier Assembly AM-425/APA-82	1	11-9/16	12-3/8	23-1/4	38
Mounting MT-807/U	1	1-9/16	10-1/8	23-1/4	3
Junction Box J-379/APA-82	1	5-5/16	16-5/8	17	29
Synchro Transmitter MX-1055/APA-82	1		4-1/16 (dia)	5-7/16	1

**AN/APA-82: 2**

**ITEM NAME:** INDICATOR GROUP

**TYPE:** AN/APA-H2

**PRINCIPAL COMPONENTS AND PHYSICAL DATA**

<b>COMPONENT</b>	<b>QTY</b>	<b>HEIGHT (Inches)</b>	<b>WIDTH (Inches)</b>	<b>DEPTH (Inches)</b>	<b>UNIT WT. (Pounds)</b>
Modification Kit MX-1157/APA-H2	3***				
Modification Kit MX-1 153/A PA-)32	1				

**NOTE:** \*Required only for AN/APS-23( ) T1 Operation.  
\*\*Two required if basic radar set has two indicators.  
\*\*\*Required only if {}referred indicator IP-135( )/APA-H2 not available.  
#Not used on CA-602/APS-23A Indicator Group.

**REFERENCE DATA AND LITERATURE**

Technical Orders:  
11B21-3-3-1  
11B21-3-3-2  
11B21-3-3-3  
11B21-3-3-4

**AN/APA-82: 3**



**DATE:** 1 July 1964

**ITEM NAME:** INDICATOR GROUP

**COGNIZANT SERVICE:** USN

**TYPE:** AN/APA-113

**FEDERAL STOCK NUMBER:**

	USA	USN	USAF	USMC
STATUS OR TYPE CLASSIFICATION				
Mfg(s) Name or Code Number: Lavoie Laboratories, Morganville, N. J.				

Illustration Not Available

### FUNCTIONAL DESCRIPTION

Indicator Group AN/APA-113 is used in conjunction with several other equipments, all commonly installed in 2PG-2W aircraft, for airborne search, tracking, and plotting of targets and for controlled intercept operations.

determination of bearing and range between any two targets displayed on the indicator.

Height Data Request System: Receives azimuth and range data to identify a target; transmits height data. Indicators of this equipment also receive and display IFF, sonobuoy, beacon, and other selected video data.

### RELATION TO SIMILAR EQUIPMENT

None.

Number of Indicators: 4 max

Type of Presentation: PPI

Azimuth Coverage: 360 deg

Range Markers: 10 and 15 mi, displayed on PPI sweep

Range Strobe: 2; displayed on centered cursor and slewed cursor sweep. each independently variable from 0 to 200 mi

Input Height Data: 0 to 60, 000 ft above sea level

Power Requirements: 115 to 200 vac, 3-ph, 320 to 1,000 cps, 3, 500 va; 115 to 200 vac, 3-ph 380 to 420 cps, 115 va; 28 vdc, 150w

### TECHNICAL DESCRIPTION

Display: Three indicators which provide PPI displays on 10 inch CRT.

Sweep: Three displayed on each indicator at selected ranges of 20, 50, 100, or 200 mi. On the first sweep, the PPI rotates in synchronization with the antenna to provide azimuth and range data of the displayed video. The centered cursor sweep and its range strobe are used to select and identify video targets when requesting height information from the associated height finder equipment. The sicwed cursor sweep and range strobe permits

### INSTALLATION CONSIDERATIONS

Not Available.

**AN APA-113**

**PRINCIPAL COMPONENTS AND PHYSICAL DATA**

<b>COMPONENT</b>	<b>QTY</b>	<b>HEIGHT (Inches)</b>	<b>WIDTH (Inches)</b>	<b>DEPTH (Inches)</b>	<b>UNIT WT. (Pounds)</b>
Amplifier, Electronic Control AM-945 :APA-113	1	10-5/8	15-3/8	19-9/16	35.0
Control Indicator C-1497/APA-113	1	7	5	3	3.0
Control Indicator C-2080/APA-113	3	6-5/8	5	7-7/16	3.0
Indicator Azimuth Range IP-266/APA-113	3	19	25	21	120.0
Light Assembly Indicator ID-587/APA-113	1	1-1/2 5-3	4	2	20
Power Supply PP-1057 APA-113	4	7-5/8	10-1/8	10-9/16	22.0
Power Supply PP-1639 APA-113	1	7-5/8	10-1/8	15-9/16	20.0
Relay Assembly RE- 190 APA-113	1	7-5/8	10-1/8	19-9/16	18.0
Voltmeter ME-117/APA-113	1	5-1/2	8-1/4	5	2.0

**REFERENCE DATA AND LITERATURE**

Technical Manuals:

NAVAER 16-30APA113-501  
NAVAER 16-30APA113-503  
NAVAER 16-30APA113-504

Specification:

MIL-I- 18285

**AN/APA- 113:**

DATE: 1 July 1964

ITEM NAME: INDICATOR GROUP

COGNIZANT SERVICE: USN

TYPE: AN/APA-125, AN/APA-125A

FEDERAL STOCK NUMBER:

	USA	USN	USAF	USMC
STATUS OR TYPE CLASSIFICATION	Used By	Used By		
Mfg(s) or Code Number: Hazeltine Electronics Corp., Texas Instrument Co.				

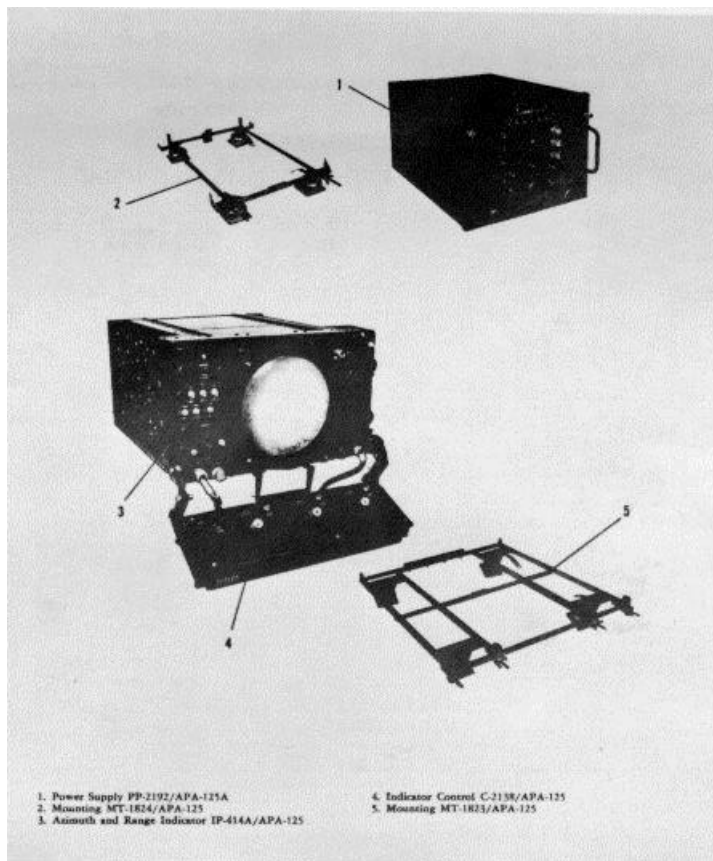

### FUNCTIONAL DESCRIPTION

Indicator Group AN/APA-125, AN/APA-125A are general purpose, airborne indicators capable of displaying radar, MTI, sonobuoy, beacon, and IFF video

singly or in display combinations, as required in either AEW of ASW operations. The indicator Groups are used with, but not a part of, Radar Set AN/APS-80 and AN/APS-88.

### AN/APA 125:

**ITEM NAME:** INDICATOR GROUP

**TYPE:** N/APA-125, AN/APA-125A

**RELATION TO SIMILAR EQUIPMENT**

The AN/APA-125A differs from the AN/APA125 in that the servos have been deleted from the PP unit and added to the IP indicator, thus eliminating the need for a cable between these units and resulting in increased performance.

**TECHNICAL DESCRIPTION**

Presentation: 10-in. CRT (long persistence)  
 Range Selection: 10 to 250 mi  
 Video Inputs: 10, 1.0 to 600v peak  
 Trigger Input: 5 to 100v peak, 0.6 to 5.0 usec duration.  
 Off-Centering Data  
 By External Slew (GPI or PMI): 150 mi max in the N/S or E/W direction.  
 By Cursor (Joystick) Slew: 500 mi  
 By combined Slew 300 mi  
 Antenna and Trace Rotation Speed: 0 to

30 rpm  
 Sweep Range: 10 to 250 mi per CRT radius  
 Sweep Duration: 36 to 250 mi (limited by PRF restrictions)  
 Presentation: 10-in. PPI, capable of off-center control.  
 PRF: 100 to 2000 pps  
 Power Requirements: 115v, 400 cps, 3-ph, 1500 va, 28v dc, 50w

**INSTALLATION CONSIDERATIONS**

Siting: Airborne.  
 Related Equipment: Associated with Radar Set AN/APS-80, AN/APS-88, Indicator AN/ASA-13, Sonobuoy Receiver AN/ARR-62A, Radar Identification Set AN/APX-7 or AN/APX-20.

**PRINCIPAL COMPONENTS AND PHYSICAL DATA**

COMPONENT	QTY	HEIGHT (Inches)	WIDTH (Inches)	DEPTH (Inches)	UNIT WT. (Pounds)
Control Indicator C-2138/APA-125	1	3	19-1/2	5-7/8	12.5
Indicator, Azimuth and Range IP-414/APA-125	1	12-3/16	21	28-3/4	110.0
Mounting MT-1823/APA-125	1	3-5/8	19	24	5.5
Mounting MT-1824/APA-125	1	3-1/8	12-5/16	19-5/16	2.5
Power Supply PP-1688/APA-125 or	1	11-5/8	15	24	
Power Supply PP-2192/APA-125A	1	16-5/8	12-1/2	20-7/8	40

**REFERENCE DATA AND LITERATURE**

Technical Manuals: NAVAER 16-30APA125  
 Specifications: MIL-I-19165(Aer)

**DATE:** 1 July 1964

**ITEM NAME:** ANTENNA GROUP

**COGNIZANT SERVICE:** USN

**TYPE:** AN/APA-137

**FEDERAL STOCK NUMBER:**

	USA	USN	USAF	USMC
STATUS OR TYPE CLASSIFICATION				
Mfg(s) Name or Code Number: Goodyear Aircraft Corporation, Akron, Ohio				

No Illustration Available.

**FUNCTIONAL DESCRIPTION**

The Antenna Group AN/APA-137 consists of an antenna which radiates and receives electromagnetic energy, an

antenna feed system which transmits this energy between the antenna and the AN/APS-70 Radar Set, and a mechanical system which positions the antenna.

**AN/APA-137: 1**

**ITEM NAME:** ANTENNA GROUP

**TYPE:** AN/APA-137

**RELATION TO SIMILAR EQUIPMENT**

None

Control, Antenna (C-213t/ APA-137  
Type of Control: Manual  
Operating Power Requirement: 26v ac, (x))  
cps, single ph; 28v dc  
Control-Monitor C-225.1/APA-137  
Type of Monitoring: Visual  
Type of Reset: Manual  
Power Requirement: 28d dc  
Dummy Load, Electrical DA-165/APA-137  
Power Dissipation  
Peak: 2 megw  
Nominal: 3.6 kt  
Frequency: 435 mc  
Impedance: 50 ohms  
Filter Radio Interference F-357/APA-137  
Power Requirement: 28v d(, 1(x) amp;  
100v, 30 amp)  
Motor-Generator: PU-3880/APA-137  
Rated Output Data: 60v dc, 16.7 amps,  
1000w  
Rated Input Data: 28v dc, 75 amp, 2025w  
Rated Speed: 7200 rpm

**TECHNICAL DESCRIPTION**

Pedestal, Antenna AB-519/APA-137  
Type: Horizontal  
Direction: Continuous in one direction  
Type of Drive: Electrically driven  
Type of Mounting: Deck mounted  
Power Requirement: 28v dc  
Amplifier, Electronic Control AM-161t.1/APA-13t  
Input Signal Channel Data: 1 control  
transformer signal  
Output Signal Channel Data: 1 emplidyne  
generator field signal  
Impedance Data  
Input : 1700 ohms  
Output: 5000 ohms  
Antenna  
Type: Horn type  
Type of Pattern: Rotating movement  
pattern  
Type of Drive: Motor Driven  
Type of Mounting: Pedestal mounted.  
Frequency: Lp band 435 mc freq range

**INSTALLATION CONSIDERATIONS**

Related Equipment: The AN/APA-137 is designed to be used with, but not part of AN/APS-70 Radar Set.

**PRINCIPAL COMPONENTS AND PHYSICAL DATA**

<b>COMPONENTS</b>	<b>QTY</b>	<b>OVERALL DIMENSIONS (Inches)</b>	<b>UNIT WT. (Pounds)</b>
Pedestal Antenna AB-519/APA-137	1	30 dia x 60 h	
Amplifier, Electronic Control AM- 1614/APA-137	1	10 x 16 x 24	
Antenna AS-872/APA-137	1		
Antenna, Control C-2134/APA-137	1	5-3/4 x 6-3/8 x 8-1/4	
Control-Monitor C-2254/APA-137	1	5-3 x 6 x 6-3/4	
Dummy Load, Electrical DA-165/APA-137	1	12 x 24 x 132	
Motor-Generator PU-380/APA-137	1	6 x 7 x 12	
Filter, Radio Interference F-357/APA-13	1	5 x 5-1/8 x 5-7/8	

**REFERENCE DATA AND LITERATURE**

Technical Manuals:  
NAVWEPS 16-45-789

DATE: 1 July 1964  
 COGNIZANT SERVICE: USN

ITEM NAME: RADAR SET  
 TYPE: AN/APG-0, AN/APG-30A

FEDERAL STOCK NUMBER: 1270-512-2284

	USA	USN	USAF	USMC
STATUS OR TYPE CLASSIFICATION				
Mfg(s) Name or Code Number: Hoffman Lab., Inc., Los Angeles,7, Calif., Admiral Corp., Chicago, Ill.				

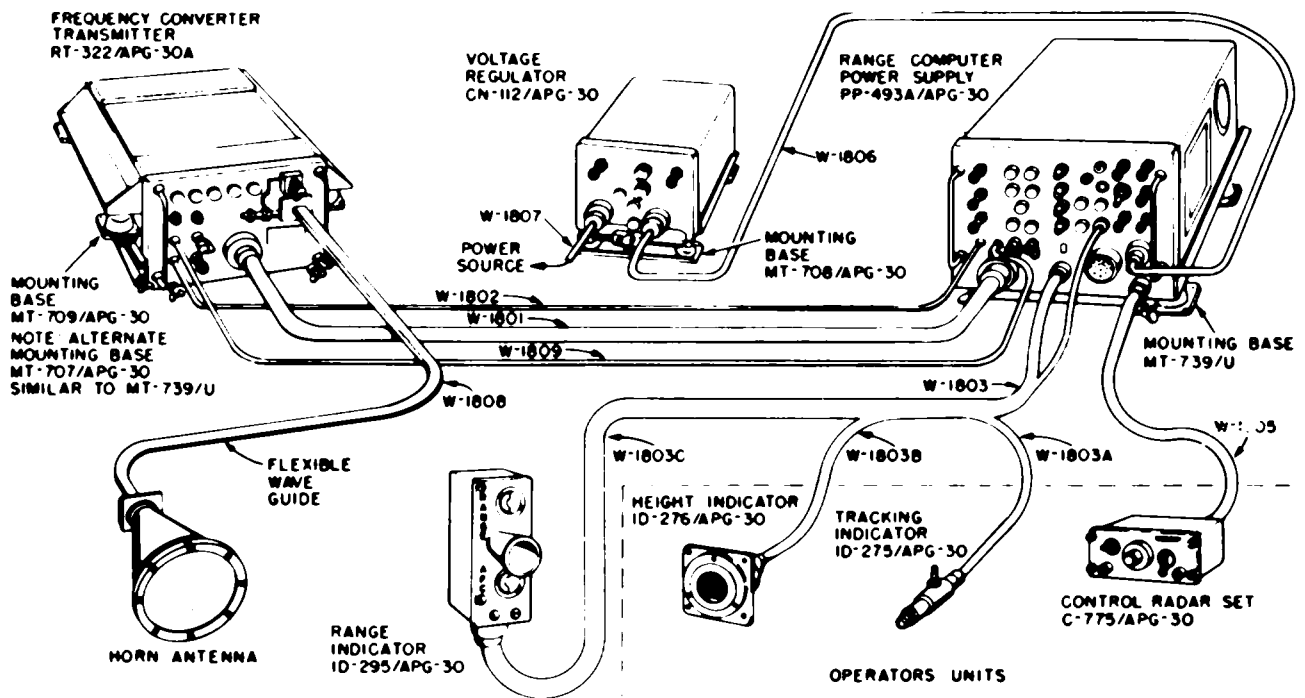

**FUNCTIONAL DESCRIPTION** Radar Set AN/APG-30 and AN/APG-30A are lightweight, airborne, radar fire control systems designed for daytime air-to-air operation in fighter and patrol aircraft. They will continuously supply target range

information to a range servomechanism for operation and control of a lead-computing gunsight system. Use of Radar Set AN/APG30A will substantially increase the accuracy and effectiveness of offensive and defensive armament of modern high-speed aircraft.

AN/APG-30: 1

**ITEM NAME:** RADAR SET  
**TYPE:** AN/APG-30, AN/APG-30A

**RELATION TO SIMILAR EQUIPMENT**

Similar to APG-30 series.

**TECHNICAL DESCRIPTION**

AN/APG-30

**Transmitter**

Frequency Range: 9335 to 9415 mc  
Peak Pulse Power Output: 5 kw min  
Average Power Output: 1.6w  
Pulse Repetition Rate: 600 pps  
Pulse Duration: 0.3 to 0.55 usec

**Receiver**

Intermediate Frequency: 30 mc  
IF. Bandwidth: 6 mc  
Noise Figure: 14 db  
Overall Receiver Gain: -90 dbm

Power Input: 115v, 320 to 1760 cps; 115v,  
380 to 420 cps; and 28v dc

AN/APG-30A

**Transmitter**

Frequency Range: 9300 plus or minus 300  
mc X Band

Peak Pulse Power Output: 4 kw min

Average Power Output: 1.6w

Pulse Repetition Rate: 800 pps

Pulse Duration: 0.3 to 0.55 usec

**Receiver**

Range: Max 3000 yd, min 225 yd

Intermediate Frequency: 30 mc

IF. Bandwidth: 5.3 plus or minus 1.1 mc

Noise Figure: 14 db max

Overall Receiver Gain

Operating Power: 115v, 320 to 1760 cps,  
300w; 115v, 380 to 420 cps, 75w, and  
28v dc, 100w

**INSTALLATION CONSIDERATIONS**

Mounting: Major components are mounted on  
vibration mount racks and stack-mounted  
in the nose of the aircraft.

Related Equipment: (Required but not  
Supplied) (3) Cable, (1) Waveguide,  
(2) Cover Flange UG-135/U (1) Choke  
Flange UG-136/U, (1) Cable RG-71/U.

**PRINCIPAL COMPONENTS AND PHYSICAL DATA**

COMPONENT	QTY	HEIGHT (Inches)	WIDTH (Inches)	DEPTH (Inches)	UNIT WT.
Frequency Converter-Transmitter RT-322A/APG-30A	1	16.06	9.25	6.06	22.00
Power Supply-Range Computer PP-493B/APG-30A	1	20.00	10.75	10.25	27.00
Voltage Regulator CN-112/APG-30A	1	8.00	4.47	5.12	7.00
Shock Mount Assy MT-707/APG-30A	1	19.00	10.06	2.50	2.25
Shock Mount Assy MT-707/A PG-30A	1	8.50	6.06	2.00	0.07
Shock Mount Assy MT-739/U	1	17.25	2.96	2.68	2.75
Shock Mount Assy MT-709/APG-30	1	19.00	15.25	6.12	2.00
Range Indicator ID-295/APG-30A	1	1.87	3.50	1.96	1.00
Radar Set Control C-775/APG-30A	1	3.62	5.75	2.62	1.50
Antenna Support Base AB-172/APG-30	1	3.00	1.62	0.62	0.15
Tracking Indicator ID-275 /APG-30	1	2.50	2.21	1.96	0.20
Tracking Indicator ID-270A/APG-30	1	3.37	2.13	1.12	0.27
Tracking Indicator ID-270 'APG-30	1	3.31	2.43	1.12	00.27
Height Indicator ID-276/APG-30	1	3.37	6.00	6.00	0.50
Control, Radar Set C-637/APG-30	1	3.88	6.00	3.38	1.50
Antenna AT-223/APG-30	1	8.81	5.25	4.18	0.75
Antenna AT-245/APG-30	1	8.81	5.25	4.18	0.75
Antenna AT224/APG-30	1	1.63	1.63	14.72	0.20
Antenna Support Base AB-171/APG-30	1	50	3.00	2.00	0.25

**AN/APG-30: 2**



**ITEM NAME:** RADAR SET

**TYPE:** AN/APG-30, AN/APG-30A

**PRINCIPAL COMPONENTS AND PHYSICAL DATA**

<b>COMPONENT</b>	<b>QTY</b>	<b>HEIGHT (Inches)</b>	<b>WIDTH (Inches)</b>	<b>DEPTH (Inches)</b>	<b>UNIT WT.</b>
Antenna AT-488/APG-30A	1	8.75	5.25	4.75	0.75
Antenna AT-561/APG-30A	1	8.75	5.25	4.75	0.75

**REFERENCE DATA AND LITERATURE**

Technical Orders:  
11F35-2-10-2  
1 F35-2-10-4  
11F35-2-10-12  
11F35-2-10-14

**AN/APG-30: 3**

DATE: 1 September 1964

ITEM NAME: RADAR SET

COGNIZANT SERVICE: USAF

TYPE: AN/APG-32A

FEDERAL STOCK NUMBER: 1270-296-5101

	USA	USN	USAF	USMC
STATUS OR TYPE CLASSIFICATION				
Mfg(s) Name or Code Number: General Electric Company				



**FUNCTIONAL DESCRIPTION**

Radar Set AN/APG-32A is an Airborne, Gunlaying Radar System which operates in the X Band of the frequency spectrum. It is designed for the detection of enemy fighters

and for the automatic tracking of nose or tail guns in bomber type aircraft. Actual firing is accomplished by the operator who actuates the firing button at his discretion.

AN/APG-32A: 1

**ITEM NAME:** RADAR SET  
**TYPE:** AN/APG32A

**RELATION TO SIMILAR EQUIPMENT**

Radar Set AN/APG-32A is similar to Radar Set AN/APG-32, with improvements in functional performance being the major difference.

**TECHNICAL DESCRIPTION**

X Band Frequency: 9245 mc plus or minus 45 mc  
Maximum Range: 24,000 yds (for search only)  
Operating Range: 0 - 8000 yds  
Peak Transmitter Power: 30 kw min  
Operating Voltages: 115v ac, 380 - 425 cps, 14 amps, 1800 va; 26v dc, 15 amps  
Type of Presentation: One (1) 3 in. "B" scope  
Number and Interval of Range Marks  
Azimuth: 0 deg - 60 deg right and 0 deg - 60 deg left in 30 deg intervals  
Range: 0 - 8000 yds in 1000 yd intervals.

Modulation Rate: 2000 pps  
RF Power Source: 2556 Magnetron  
Horizontal Coverage: 114 deg  
Vertical Coverage: 76 deg  
Antenna Rotation Speed: 2100 rpm  
Receiver Bandwidth: 3.5 mc  
IF Frequency: 30 mc  
Maximum Altitude: 50,000 ft  
Max Altitude without Pressurization: 7000 ft

**INSTALLATION CONSIDERATIONS**

Detailed installation instructions are contained in each applicable Aircraft Handbook.

Mounting: The AN/APG-32A Radar Set is composed of twelve major components which are mounted to the Aircraft by the remaining installation and mounting components listed under "Principal Components".

**PRINCIPAL COMPONENTS AND PHYSICAL DATA**

COMPONENT	QTY	HEIGHT (Inches)	WIDTH (Inches)	DEPTH (Inches)	UNIT WT.
Radio Freq Head RF-51/APG-32	1	13.25	13	16.43	30
Mounting MT-706/APG-32	1	6.75	14.56	10.37	2
Voltage Regulator CN-96/APG-32	1	5.90	5.75	9.75	9
Mounting MT-698/U	1	2.07	6.68	10.81	1
Radar Modulator MD-113/APG-32	1	16.93	12.12	13.25	30
Installation Kit 1 12.75 1 MX-998/APG-32					
External Blower MX-283/APG-3	2	3.93	5.12	5.12	2.5 ea
Waveguide Assy CG-605/U	1	9.62	10.12	47.65	3.5
Waveguide Assy CG-896/APG	1	9.62	10.12	32.68	
Waveguide Assy 5901-D7603687P1	1				
Cord Assy CG-456/U	1		5	56	3.7
Radar Set Sub-Assy MX-1284/APG-32	1				
Installation Kit 1 31.25 1 MX-999/APG-32					
Antenna Control C-636/APG-32	1	11.43	5.25	6.43	4.2
Control Indicator C-542/APG-32	1	17.75	11.44	22.5	15
Mounting MT-705/APG-32	1	2.28	10.46	19.37	1.5
Antenna Assy AS-573/APG-32A	1	65			
Range-Azimuth Indicator IP-47/APG-32	1	4.67	3.75	12.31	3.5

TOTAL WEIGHT 173.2

**REFERENCE DATA AND LITERATURE**

Technical Orders:  
11F35-2-12-1  
11F35-2-12-2

DATE: 1 March 1965  
COGNIZANT SERVICE: USAF

ITEM NAME: RADAR SET  
TYPE: AN/APG-41B

FEDERAL STOCK NUMBER:

	USA	USN	USAF	USMC
STATUS OR TYPE CLASSIFICATION			Tent Std	
Mfg(s) Name or Code Number: General Electric Corporation				

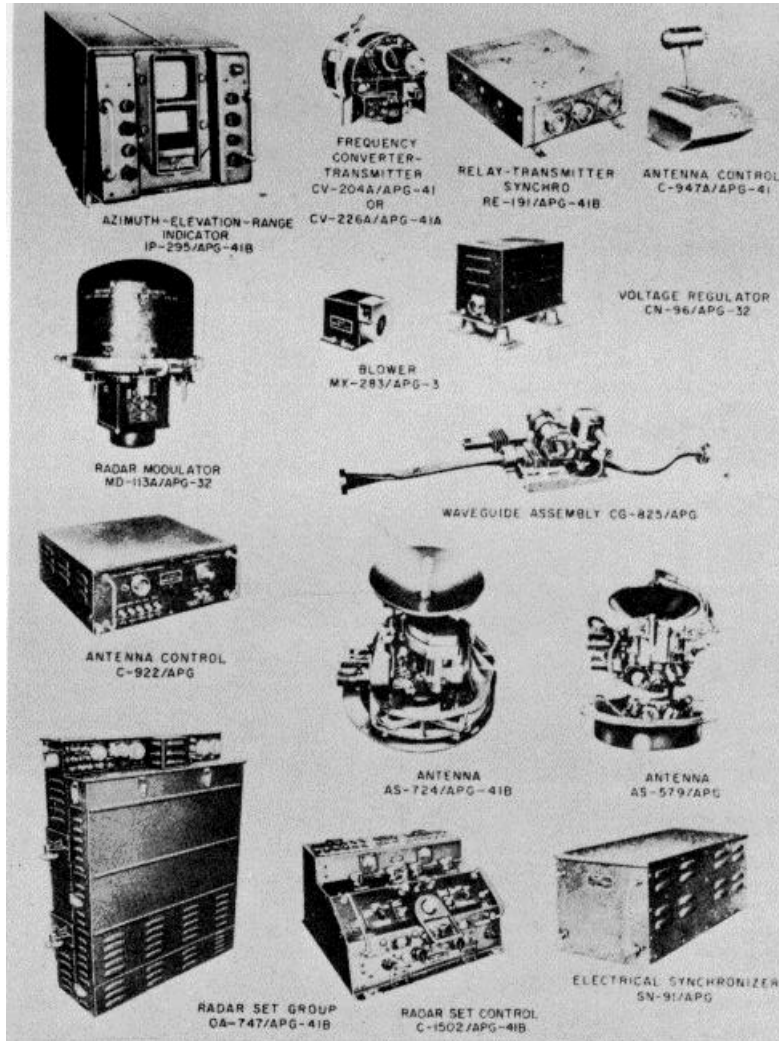

**FUNCTIONAL DESCRIPTION**

The AN/APG-41B Radar Set is an automatic gun laying radar designed for control of the tail turret. The necessary controls and indicating equipment are included. This is a flexible fire control radar capable of

search, lock on and track of one target with continued search, lock on and tracking of two (2) targets simultaneously with computer fire control data available for either target.

**ITEM NAME:** RADAR SET

**TYPE:** AN/APG41-B

**RELATION TO SIMILAR EQUIPMENT**  
None.

Long Range Operation : 2,0 - 20, O(K yd max  
range tracking error plus or minus 50 yds  
Tracking Range: 250 - 8000 yds

**TECHNICAL DESCRIPTION**

Power Requirements: 115v ac, 310 - 420  
cps, 1800v amp; 26v dc, 300w  
Output: Peak power 30 kw R-F pulse  
Frequency: X band, 9015 mc plus or minus  
.15 mc and 9215 mc plus or minus 45 mc  
Normal Operating Range: 250 to 10,000 yds

**INSTALLATION CONSIDERATIONS**

Siting: To be installed in B-52 tall fire control  
system.  
Mounting: Volume, 23 cubic feet; weight,  
687 pounds.

**PRINCIPAL COMPONENTS AND PHYSICAL DATA**

<b>COMPONENT</b>	<b>QTY</b>	<b>HEIGHT (Inches)</b>	<b>WIDTH (Inches)</b>	<b>DEPTH (Inches)</b>	<b>UNIT WT.</b>
Antenna AS-724/APG--41B	*2	217/32	20-3/1	26-11 '16	79 ea
Antenna AS-579/APG	*		20-3 /4	25	71 ea
Relay-Transmitter Synchro RE-191/APG-41B	1	3-7/8	9-9/16	11-15/16	9.5
Waveguide Assy CG-8325/APG	2	6	10-7/8	37-3/16	16.13 ea
Frequency Converter Transmitter CV-201A/APG-I	1	13-1/4	13	14-7/16	30
Frequency Converter Transmitter CV-226A/APG-41A	1	13-1/4	13	14-7/16	30
Radar Modulator MD-113A,/APG-32	2	16-15/16	12-1/8	13-1/4	36.38 ea
Blower MX-233/APG-3	1	3-15/16	5 1/8	2.13	ea
Azimuth Elevation Range Indicator IP-295/APG-41B	1	13-3/16	13-1/2	24	55
Radar Set Control C-1502/APG-41	1	8-5/8	17-3/8	14-3/16	27.5
Antenna Control C-947A/APG-11	1	7-9/32	6-11/16	8-7/8	5.5
Antenna Control C-922/APG	1	5-3/32	15-11/16	14--5/16	18
Electrical Synchronizer SN-91/APG	1	7-21/32	9-1/16	21 29/32	24.6
Radar Set Group OA-747/APG-41B	2	29-1/2	29-3/4	8-5/8	95.5 ea
Voltage Regulator CN-96/APG-32	3	5-29/32	5-3/12	9-3/4	10.13 ea
Mounting MT-706/APG-32	2	6-21/32	14-1/4	10-3/8	2.25 ea
Mounting MT-980/U	1	2-9/16	14-1/2	19-5/8	2.75
Mounting MT -1034/U	1	2 11/16	16-3/8	16-1/8	2.25
Mounting MT-979/APG	1	2-3/4	9-5/8	25-13/32	1.88
Mounting MT-698/U	3	2-5/64	6-11/16	10-13/16	1 ea

**AN/APG-41B: 2**

ITEM NAME: RADAR SET  
TYPE: AN/APG-41B

**PRINCIPAL COMPONENTS AND PHYSICAL. DATA**

<b>COMPONENT</b>	<b>QTY</b>	<b>HEIGHT (Inches)</b>	<b>WIDTH (Inches)</b>	<b>DEPTH (Inches)</b>	<b>UNIT WT.</b>
Installation Kit 2 MX-998/APG-32**	2				1.25 ea
Installation Kit MX-999/APG-32**	2				1 ea

**NOTE: \*Two of either Stock Number or one of each.  
\*\*Kits consist of four (4) shock mounts.**

**REFERENCE DATA AND LITERATURE**

Technical Manuals:  
11F35-2-15-22  
11F35-2-15-23  
11F35-2-15-24

**AN/APG-41 B: 3**

DATE: 1 July 1964

ITEM NAME: RADAR SET

COGNIZANT SERVICE: USN

TYPE: AN/APN-1\*, 1B, 1X

FEDERAL STOCK NUMBER:

	USA	USN	USAF	USMC
STATUS OR TYPE CLASSIFICATION	Ltd Std*			
Mfg(s) Name or Code Number: Admiral Corp., Chicago, Ill. RCA Victor Division of RCA, Camden, N. J.				

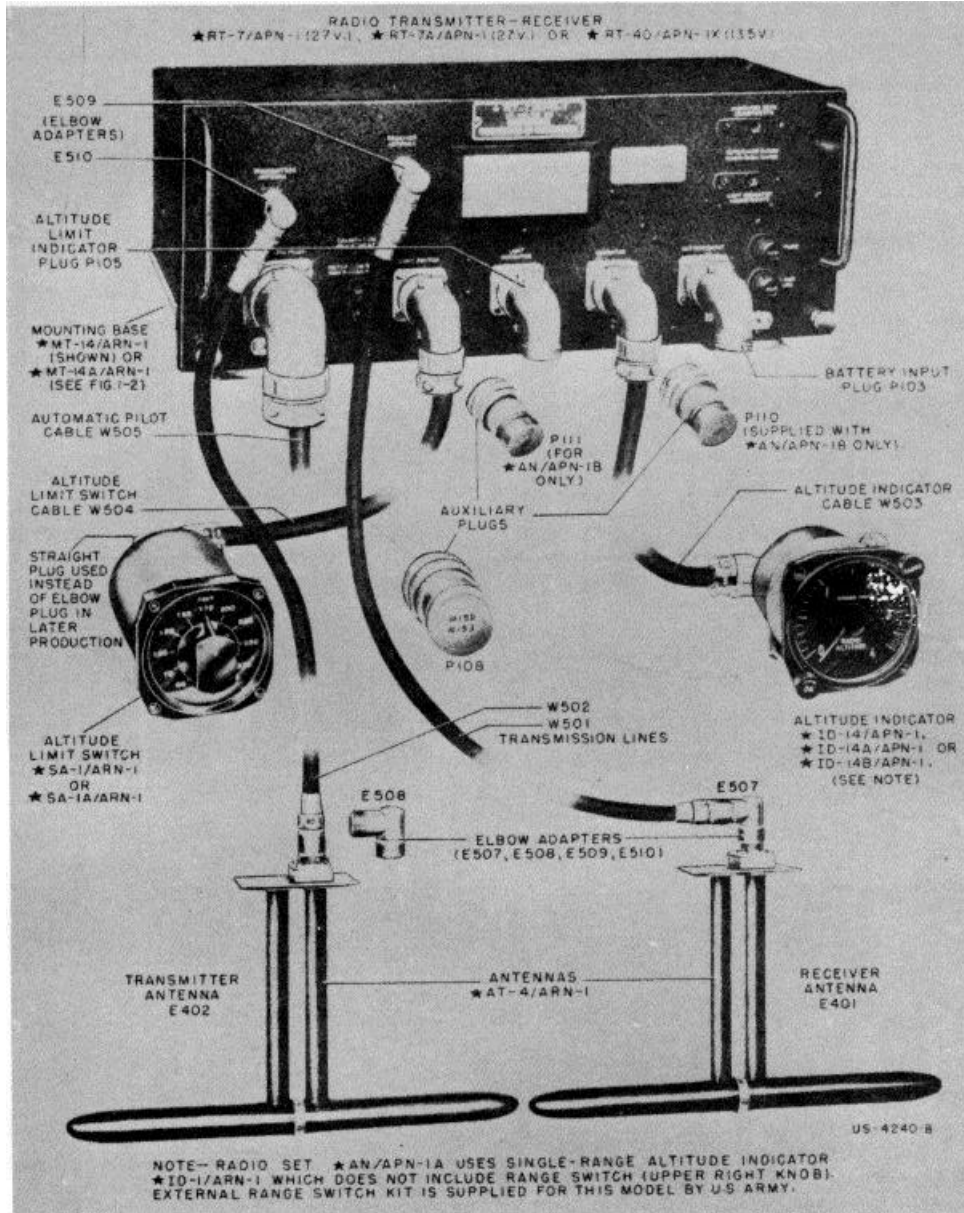

AN/APN-1: 1

**FUNCTIONAL DESCRIPTION**

The AN/APN-1, 1B, 1X provide direct measurement of terrain clearance by electrically measuring the time interval required for a transmitted radio signal to travel to earth and return to the aircraft. Altitude is indicated directly by a dc meter (Altitude Indicator) operated from the altimeter. Two altitude ranges are provided.

**RELATION TO SIMILAR EQUIPMENT**

Similar to Radio Set AN/ARN-1 except the AN/ APN-1 has dual range.

**TECHNICAL DESCRIPTION**

Operating Voltages and Power Requirements:  
AN/ANP-1, 1B -22 TO 29.5 vdc, 2.6 amp at 27v  
AN/APN-1X - 11 to 14.75 vdc, 5.3 amp at 13.5 vdc

**INSTALLATION CONSIDERATIONS**

Not available.

**PRINCIPAL COMPONENTS AND PHYSICAL DATA**

<b>COMPONENT</b>	<b>QTY</b>	<b>HEIGHT (Inches)</b>	<b>WIDTH (Inches)</b>	<b>DEPTH (Inches)</b>	<b>UNIT WT. (Pounds)</b>
Radio Transmitter-Receiver RT-7/APN-1 or RT-40/APN-1X or RT-7A/APN-1	1	8-19/32	7-9/64	18-1/16	18.70
Mounting Base MT-14/ARN-1 or MT-14A/ARN-1	1	7-9/64	18-1/16	19. 20	
Attitude Indicator ID-14/APN-1 or ID-14A/APN-1, or ID-14B/APN-1	1	7-5/8	2-1/4	18-1/16	1. 50
Attitude Limit Switch SA-1/ARN-1 or SA-IA/ARN-1	1	7-41/64	2-27/64	18-3/16	2.40
Antenna AT-4/ARN-1	2	3-1/4	3-1/4	5-1/32	1.80
	1	3-1/4	3-1/4	5-23/32	0.95
	2	7-9/16	1-25/32	11-9/16	0. 70 ea.

**REFERENCE DATA AND LITERATURE**

- Technical Manuals:  
AN- 16-30APN1-3  
AN- 16-30APN1-4  
Specifications:  
RCA-AS-5796-G  
MIL-R-5689(Aer)



DATE: 15 May 1964

ITEM NAME: RADAR SET

COGNIZANT SERVICE: USAF

TYPE: AN/APN-1A

FEDERAL STOCK NUMBER:

	USA	USN	USAF	USMC
STATUS OR TYPE CLASSIFICATION		Ltd Std		
Mfg(s) Name or Code Number: Radio Corporation of America				

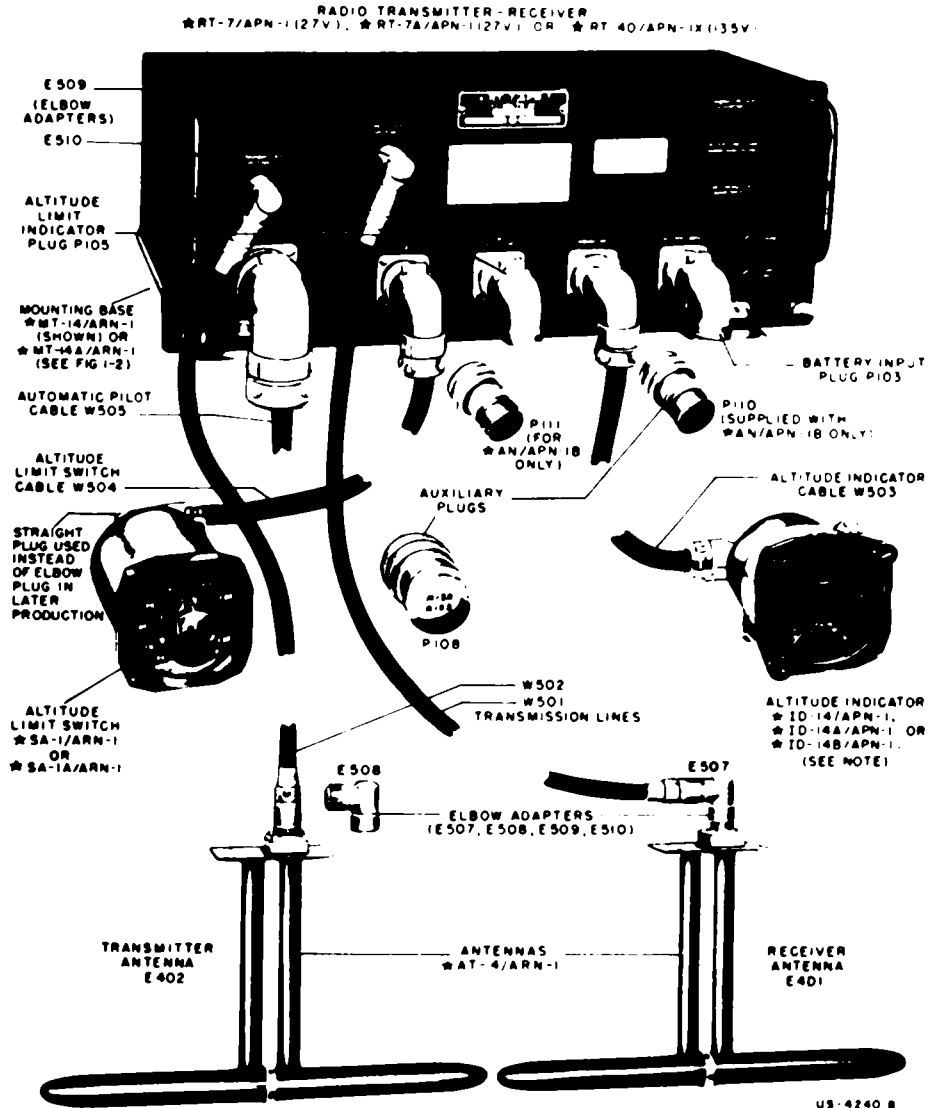

NOTE - RADIO SET ★AN/APN-1A USES SINGLE-RANGE ALTITUDE INDICATOR ★ID-1/ARN-1 WHICH DOES NOT INCLUDE RANGE SWITCH (UPPER RIGHT KNOB) EXTERNAL RANGE SWITCH KIT IS SUPPLIED FOR THIS MODEL BY US ARMY

US-4240 B

AN/APN-1A

**FUNCTIONAL DESCRIPTION**

The AN/APN-1A is designed for installation in aircraft to provide direct indication of altitude relative to the terrain during flight. This cw-fm altimeter also may be used in conjunction with an automatic pilot system.

**RELATION TO SIMILAR EQUIPMENT**

None.

**TECHNICAL DESCRIPTION**

Frequency: 420 to 460 mc  
Range, Max: 4,000 ft

Range, Min: 10 ft  
Peak Power Output: 1w  
Operating Voltages and Power Requirements:  
27.5 vdc, 2.7 amp  
Type of Presentation: Meters  
Number and Interval of Range Markers:  
2 ranges, 0 to 400 ft and 400 to 4,000 ft  
Duty Cycle: Continuous  
Environmental Limitations:  
Maximum length of antenna coaxial cables - 50 ft  
Maximum ambient temperature - 122 deg F  
Altitude indicators must be at least 20 in. from any magnetic compass

**INSTALLATION CONSIDERATIONS**

Not available.

**PRINCIPAL COMPONENTS AND PHYSICAL DATA**

<b>COMPONENT</b>	<b>QTY</b>	<b>HEIGHT</b>	<b>WIDTH (Inches)</b>	<b>DEPTH (Inches)</b>	<b>UNIT WT. (Inches)</b>
Radio Transmitter-Receiver RT-7/APN- 1	1	7.14	18.06	8.59	18.7
Altitude Indicator ID-14/APN-1	1	8.25	3.25	5.03	1.8
Altitude Limit Switch SA-1/APN-1	1	3.25	3.25	5.72	0.95
Antenna AT-4/APN	2	7.25	11.56	1.72	0.7

**REFERENCE DATA AND LITERATURE**

Technical Orders: Specifications:  
12P5-2APN1-2 RCA-AS-5796-G  
12P5-2APN 1-1  
12P5-2APN 1- 14

DATE: 1 July 1964

ITEM NAME: RADIO SET

COGNIZANT SERVICE: USN

TYPE: AN/APN-4

USA LINE ITEM NUMBER: 63700

FEDERAL STOCK NUMBER:

	USA	USN	USAF	USMC
STATUS OR TYPE CLASSIFICATION				
Mfg(s) Name or Code Number: General Electric Company				

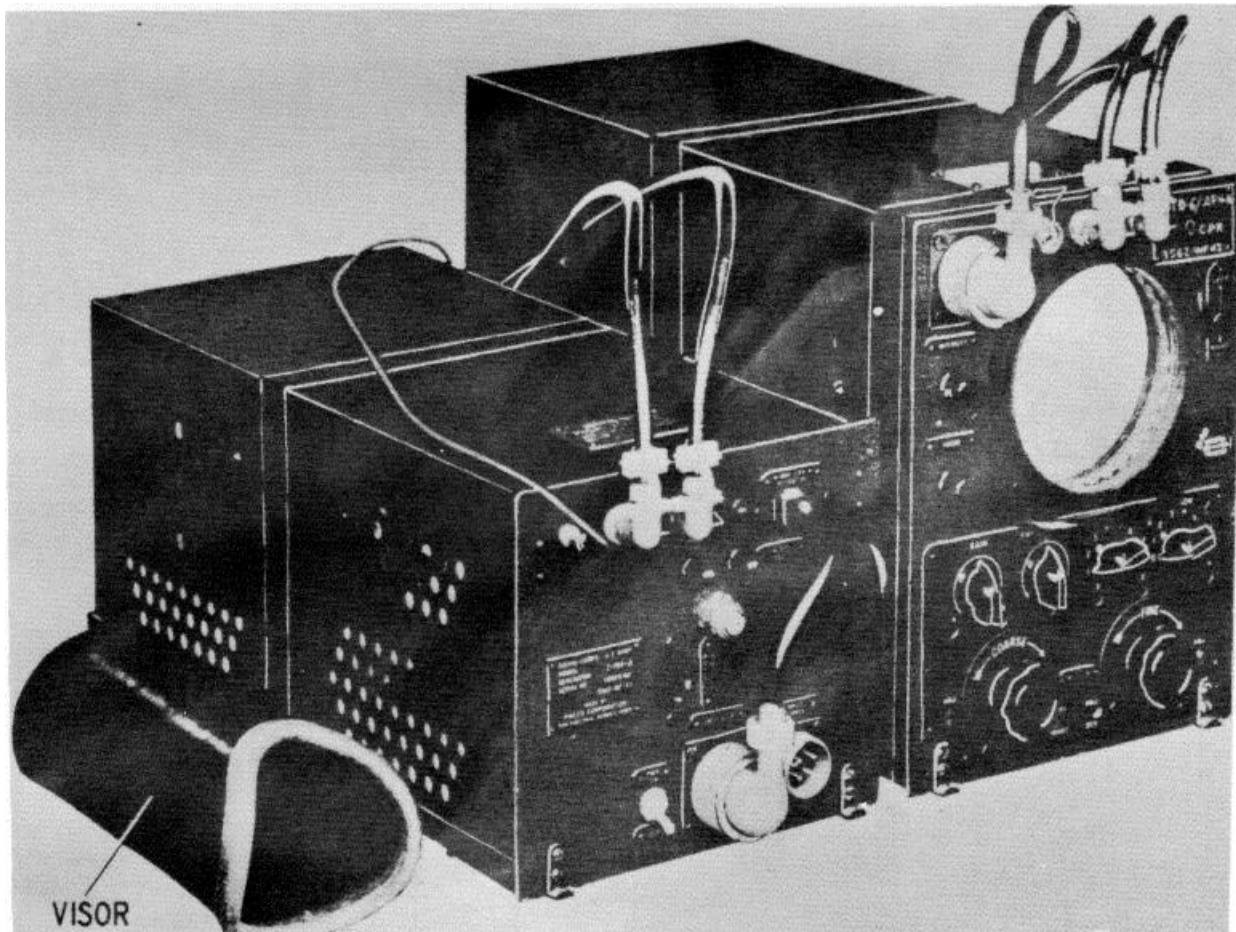

**FUNCTIONAL DESCRIPTION**

The AN/APN-4 is airborne navigational equipment used to determine the geographic position of the aircraft in which it is installed.

This equipment is the receiving system of an overall Long Range Navigation (LRN) system, and is used in conjunction with an associated ground system.

AN/APN-4: 1

**ITEM NAME:** RADIO SET

**TYPE:** AN/APN-4

**RELATION TO SIMILAR EQUIPMENT**

Used in conjunction with a ground system to provide an overall Loran system.

**TECHNICAL DESCRIPTION**

Frequency Range: 1.6 to 3.3 mc in 2 channels, 7.58 to 11.75 in 2 channels except for Radio Receiver R-9B/APN which has a freq range of 1.7 to 2.5  
Quantity of Preset Frequencies Possible: 1  
Receiver Sensitivity: 4 to 5 uv and 10 to 15 uv  
Receiver Selectivity: 6 db down from max response

Signal to Noise Ratio: 5.1

**INSTALLATION CONSIDERATIONS**

Related Equipment: (Required but not supplied) (3) Radio Frequency Cables RG-7/U, (3) Pen Wire No. 16 Airplane Cable AN-J-C-.18, (1) Radio Frequency Cable RG-u/U, (1) Antenna Switch SA-13/U or SW-225, (7) Cable Clamps M-297 or M-297-A, (1) Cordage CO-239-A, -C, or -D, (1) RF Cable Coupling MC-277 or MC-277-A, (6) RF Cable Couplings MC-320 or MC-320-A, (1) Plug PL.-167, (2) Plugs PL-QI71 and (2) Ferrules.

**PRINCIPAL COMPONENTS AND PHYSICAL DATA**

<b>COMPONENTS</b>	<b>QTY</b>	<b>OVERALL DIMENSIONS (Inches)</b>	<b>UNIT WT. (Pounds)</b>
Radio Receiver R-9/APN-4	1	7.87 x 9 x 19.5	25.,15
Mounting FT-447-A or MT-203/APN-4 or	1	2.5 x 8.6 x 19.5	2.3
Radio Receiver R-9A/APN-4	1	7.87 x 9 x 19.5	25.45
Mounting FT-,147-A or MT-203/APN-,I or	1	2.5 x 8.6 x 19.5	2.3
Radio Receiver R-9B/APN-4	1	7.87 x 9 x 19.5	25.,13
Mounting FT-447-A or MT-203/APN-4	1	2.5 x 11.6 x 19.5	2.3
Indicator ID-6,/APN-4	1	9 x 11.75 x 19.5	35.2
Mounting FT-4-16 or	1	2.5 x 8.6 x 19.5	2.3
Indicator ID-6A/APN-,I or	1	9 x 11.75 x 19.5	35.2
Indicator ID-6B/APN-4	1	9 x 11.75 x 19.5	35.2
Mounting FT-.166 or FT-446-A	1	2.5 x 1.6 x 19.5	2.3

**NOTE: Only one Indicator and one receiver are furnished as components of one Radio Set AN/APN-I, however, any receiver may be installed with any indicator.**

**REFERENCE DATA AND LITERATURE**

Technical Manuals:  
TO16-30APN-4-3

DATE: 1 July 1964

ITEM NAME: RADAR TRANSPONDER BEACON

COGNIZANT SERVICE: USN

TYPE: AN/APG-32A

FEDERAL STOCK NUMBER: 5895-265-7258

	USA	USN	USAF	USMC
STATUS OR TYPE CLASSIFICATION				
Mfg(s) Name or Code Number: General Electric Company				

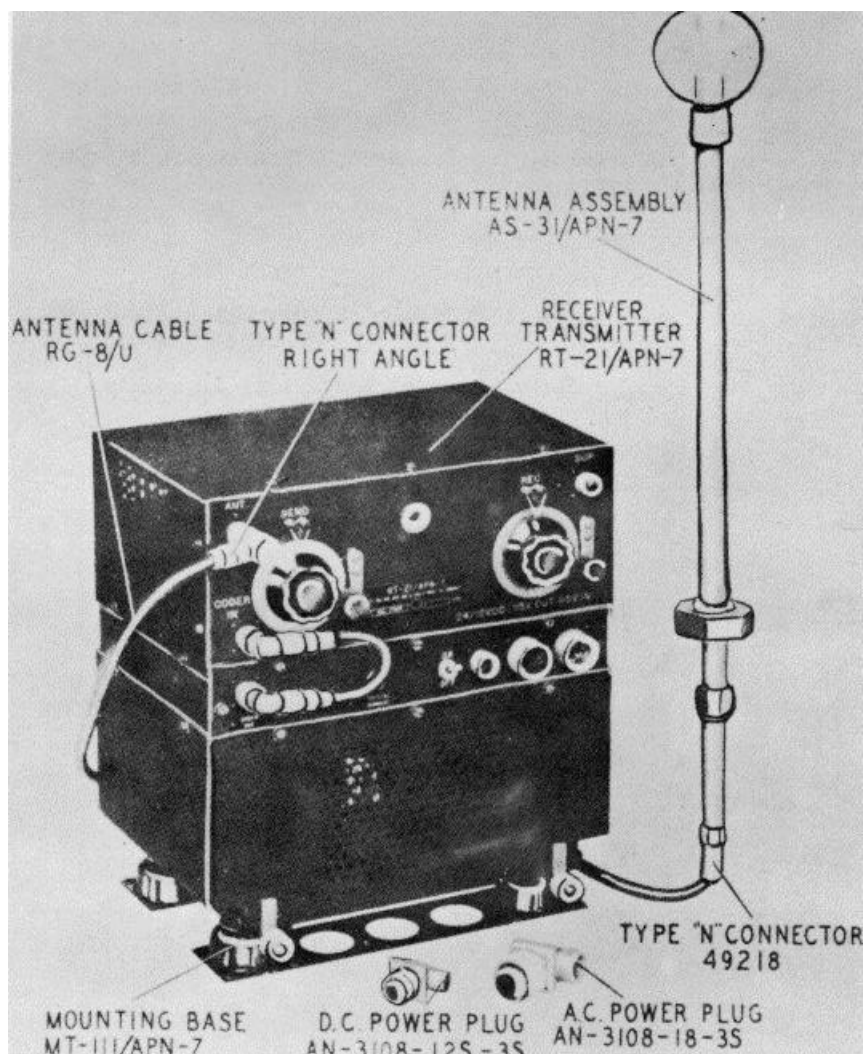

**FUNCTIONAL DESCRIPTION**

The AN/APN-7 is designed for installation in heavier-than-air aircraft, and operates in the "S" band of frequencies, approximately 3300 megacycles. Its purpose is to establish the identity of the aircraft in

which it is installed. Ultra-high frequency pulses, which set its circuits into operation are received from radar equipment. It modifies these pulses by changing their duration and amplitude, and then transmits them to the radar equipment transmitting the original pulses.

**ITEM NAME:** RADAR TRANSPONDER BEACON

**TYPE:** AN/APN-7

Provision is made for using a coder in conjunction with the receiver-transmitter unit to assure more positive identification of the aircraft in which it is installed, as the coding can be changed from day to day or as often as operating conditions require.

Center IF Frequency: 30 mc  
Pulse Data  
Repetition Rate: 600 pps  
Duration: 0.4 usec  
Monitoring Voltage: 5 to 70V  
Peak Power Output: Approx 500w  
Video Output Dynamic Impedance: Approx 600 ohms  
Equipment Range: Approx 50 naut mi  
Power Requirements: 105 to 130v ac, 250 va and 12 or 24v dc, 0.15 amps  
Antenna Data  
Type: 3-dipole type  
Radiation Pattern: Omnidirectional in plane of radiating elements.  
Temperature Range: -27 to plus 122 deg F (-35 to plus 50 deg C)

**RELATION TO SIMILAR EQUIPMENT**

None.

**TECHNICAL DESCRIPTION**

Frequency Range: 3220 to 3320 mc  
Local Oscillator Frequency Range: 3190 to 3290 mc  
IF Bandwidth: Approx 12 mc  
IF Amplifier Gain: 2 to 7 per stage  
Video Amplifier Band Width: Approx 2 mc  
Video Amplifier Gain: 60 to 90 times overall.

**INSTALLATION CONSIDERATIONS**  
Not available.

**PRINCIPAL COMPONENTS AND PHYSICAL DATA**

<b>COMPONENTS</b>	<b>QTY</b>	<b>OVERALL DIMENSIONS (Inches)</b>	<b>UNIT WT. (Pounds)</b>
Receiver-Transmitter	1	9-3/4 x 12-15/16 x 13	36
Antenna Assembly	1	3-1/4 x 3-1/4 x 24-5/8	2.5
AS-31/APN-7			
Mounting Base	1	1-5/16 x 9-7/16 x 11-1/2	2.25
MT-111/APN-7			
AC Power Plug	1	1-3/16 x 1-7/8 x 3	0.15
AN-310t-18-3S			
DC Power Plug	1	1-1/16 x 1-1/2 x 1-3/4	0.03
AN-3106-12S-3S			
Connector NT-49218	1	5/8 x 5/8 x 1-3/4	0.06
Connector, Type N	1	7/8 x 1-3/4 x 1-7/8	0.16
Cable Clamp AN-3057-4	1	25/32 x 25/32 x 1	0.02
Cable Clamp AN-3057-10	1	1-1/8 x 1-3/16 x 1-3/16	0.001
Antenna Cable RG-8/U	1		

**REFERENCE DATA AND LITERATURE**

Technical Manuals:  
CO-AN-08-30APN7-2

**AN/APN-7: 2**

DATE: 1 July 1964

ITEM NAME: RADAR BEACON

COGNIZANT SERVICE: USN

TYPE: AN/APN-11

FEDERAL STOCK NUMBER:

	USA	USN	USAF	USMC
STATUS OR TYPE CLASSIFICATION				
Mfg(s) Name or Code Number:				

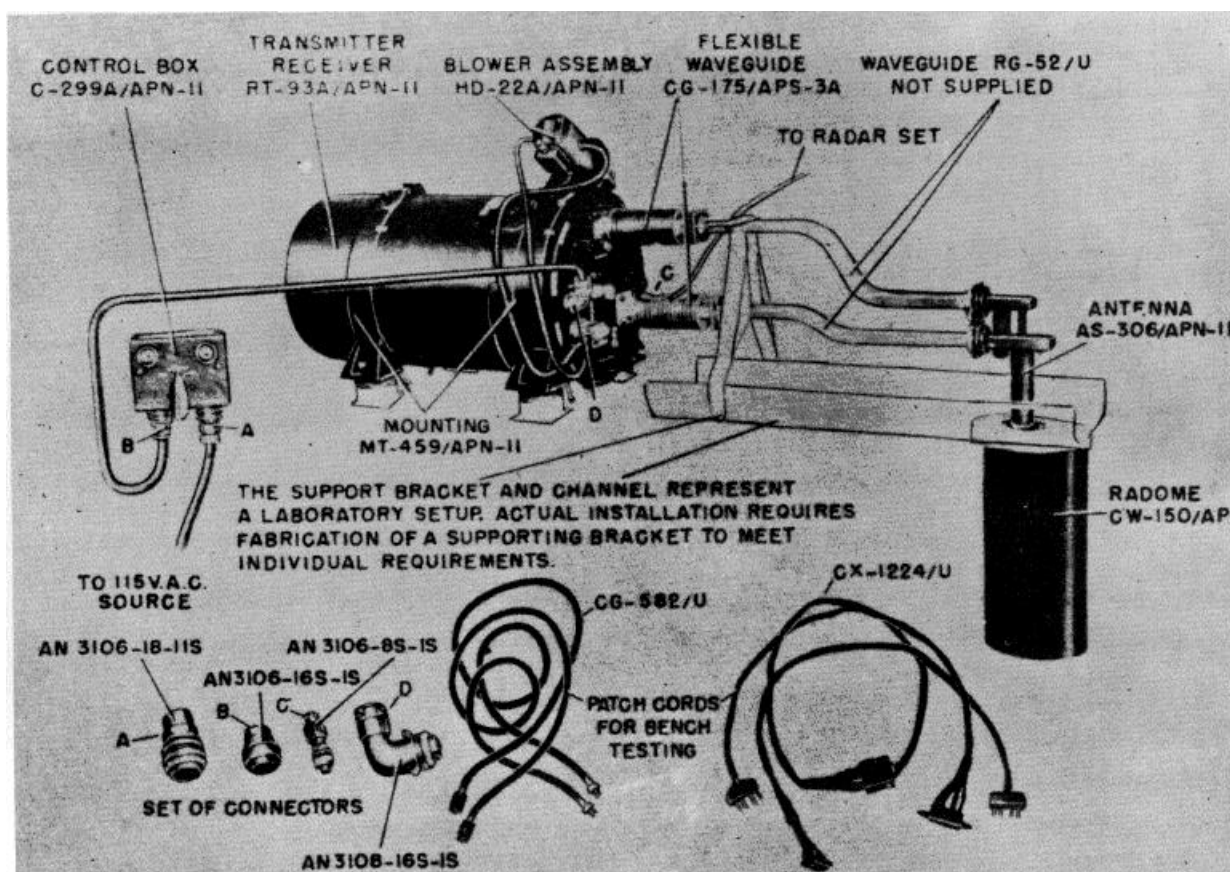

**FUNCTIONAL DESCRIPTION**

The AN/APN-11 is an airborne responder beacon designed to automatically transmit an identifying coded signal upon being interrogated by a received radar signal. The interrogating source is thereby

able to identify and determine the azimuth and range of the beacon-equipped aircraft.

The entire operation of the equipment is automatic and requires no attention from the operator during flight, except for starting or stopping it, or placing it in standby. The AN/APN-11 may be used with

**ITEM NAME:** RADAR BEACON

**TYPE:** AN/APN-11

Radar Sets AN/APQ-13, AN/APS-3, AN/APS-I, AN/APS-6, AN/APS-10, AN/APS-I5, AN/APS-19, AN/APS-23, AN/APS 31, AN/APS-33 and SCR-717-T3.

Power Output: 300w min average during pulses at transmitting antenna input.

Coder Data

Type: Range coding

Spacing (Between Code Pips)

Short Space: 15 usec nom

Long Space: 10 usec nom

Quantity of Codes: 12 used, none more than ,1 pips or longer than 100 usec

Power Requirements: 115v plus or minus 5%, .100 to 2400 cps, 150w max and 26.5v dc plus or minus 10%, 50w max

Antenna Data

Polarization: Horizontal

Pattern

Horizontal Plane: Omnidirectional to within 3 to 1 in power

Vertical Plane: Beam width of 30 to 40 deg in free space at 3 db down points

Axis of Principal Lobe: Horizontal to within plus or minus 5 deg in free space with antenna vertical.

Standing Wave Ratio (-55 to plus 55 deg C)

Transmitting Antenna: Less than 1.-, to 1 at 9310 mc

Receiving Antenna: Less than 3 to 1 over entire bandwidth.

**RELATION TO SIMILAR EQUIPMENT**

None .

**TECHNICAL DESCRIPTION**

Transmitter-Receiver Unit

Pressurization: Positive pressure of 6.5 lbs per sq in. min should be maintained for 2.1 hr

Receiver Data

Type: Crystal video

Frequency: 9375 mc

Bandwidth: 110 mc at 3 db down

Crystal Protection: Shutter in receiver waveguide attenuates incoming signals by at least 25 db when equipment is off.

Transmitter Data

Frequency: 9310 mc

Frequency Stability: 2 mc for 2% change in primary supply voltage, 1 mc for change in duty cycle from 0.000.5 to 0.003 at temp range of -55 to plus 55 deg C

Pulse Data

Width: 0.5 usec plus or minus 1 usec at 90% peak amplitude

**INSTALLATION CONSIDERATIONS**

Not available.

**PRINCIPAL COMPONENTS AND PHYSICAL DATA**

COMPONENTS	QTY	OVERALL DIMENSIONS (Inches)	UNIT WT. (Pounds)
Transmitter-Receiver Unit RT-93/APN-11 or RT-93A APN- 11	1	10 x 10 x 19-21 32	30
Mounting MT-459/APN-11	2	10-5/8 x 10-19/32	1
Blower Assy HD-22A/APN-11	1		2.25
Antenna Assy AS-306/APN-11	1	1-5/6 x 3-3/8 x 16-3/4	2
Radome CW-150/AP	1	2-1/16 x 4-1/16 x 4-1/8	1
Set of Accessories	1		
Set of Operating Spares	11		
Set of Equipment Spares	1		

**REFERENCE DATA AND LITERATURE**

Technical Manuals:  
AN16-30APN 11-3

**AN/APN-11: 2**



DATE: 1 September 1964

ITEM NAME: RADAR SET

COGNIZANT SERVICE: USAF

TYPE: \*AN/APN-12  
\*\*AN/APN-12A

FEDERAL STOCK NUMBER:

	USA	USN	USAF	USMC
STATUS OR TYPE CLASSIFICATION			*Ltd Std **Ltd Std	

Mfg(s) Name or Code Number: Wilcox electric company and Olympic Radio and Television, Inc.

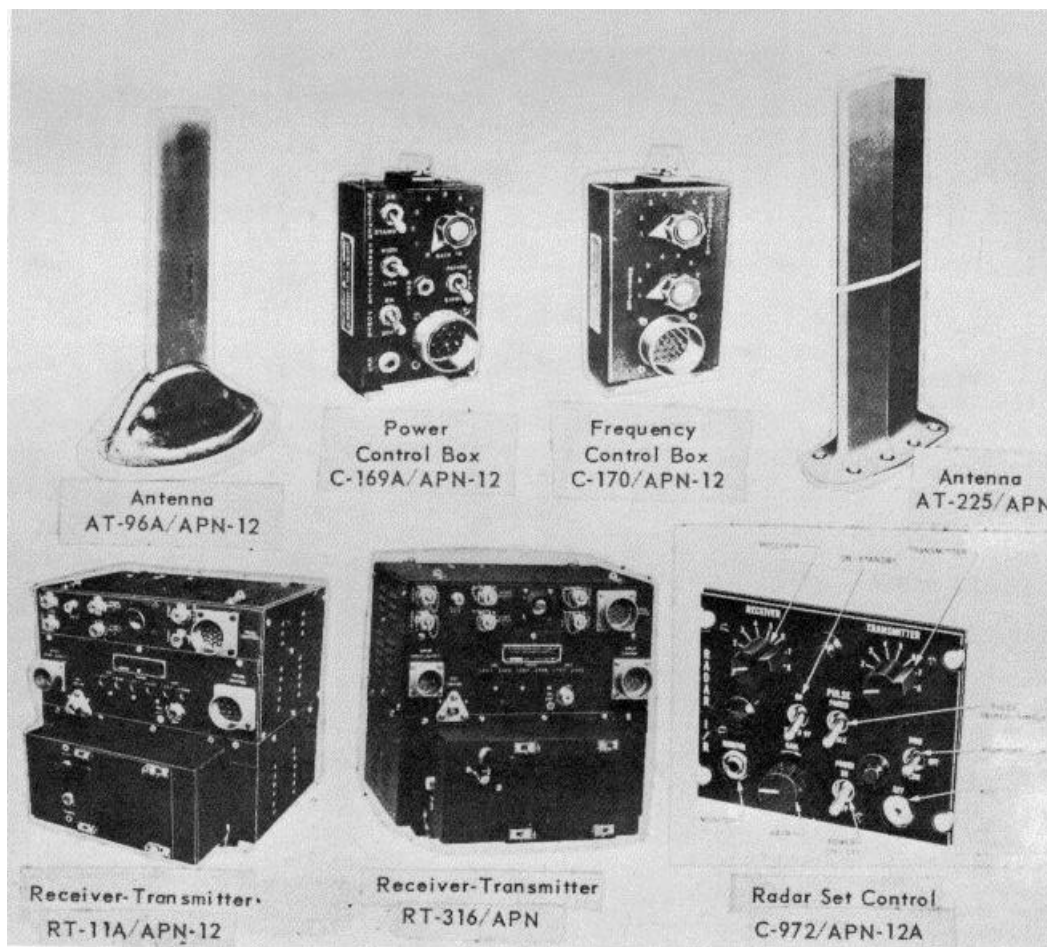

**FUNCTIONAL DESCRIPTION** The Radar Set AN/APN-12A consists of several units and operates either as a Radar Beacon or as an Interrogator-Responder. The set can be employed in Airborne, Ground Mobile, or stationary installations.

When used as an Interrogator-Responder, its purpose is to guide an airplane or other craft to within 200 yards of the Beacon location; furnish Beacon range and azimuth information; or against IFF equipment, furnish identification information.

AN/APN-12: 1

**ITEM NAME:** RADAR SET

**TYPE:** AN/APN-12, AN/APN-12A

**RELATION TO SIMILAR EQUIPMENT**

AN/APN-12, AN/APN-12A and AN/APN-12B replaced by AN/APN-12C.

Transmitter: B preset freq in the 160 to 237 mc band

Receiver: 3 preset freq in 160 to 200 mc band; 5 are in 200 to 237 mc band.

**TECHNICAL DESCRIPTION**

Operating Power Requirements

dc: 24v (approx 60w) for relays, motors

ac: 115v at a freq of 400 to 1600 cps

approx 150w) for all other operational functions.

**INSTALLATION CONSIDERATIONS**

Airborne, Ground Mobile or stationary installations.

Related Equipment: (Equipment required but not supplied) (I) Indicator ID169/APN-12.

Frequency Range

**PRINCIPAL COMPONENTS AND PHYSICAL DATA**

COMPONENT	QTY	HEIGHT (Inches)	WIDTH (Inches)	DEPTH (Inches)	UNIT WT.
Antenna AT-96A/APN-12	As Req'd	15	10	6	1.5
*Frequency Control Box C-170/APN-12	1	7.38	3.63	2.80	1
*Power Control Box C-169A/APN-12	1	7.38	3.63	2.80	1
Receiver-Transmitter RT-11A/APN-12	1	13.50	12.87	11.75	40
Receiver-Transmitter RT-316/APN	1 12.70	12.90	12.50	42	
Antenna AT-225/APN	As Req'd	14.2	6.6	3.3	1.5
Mounting FT-116A	1				2.5
Mounting FT-406A	2	0.5			
**Radar Set Control	1	5.	4.5	2.75	1.1

**NOTE:** \*Used with Radar Set AN/APN-12

\*\*Used with Radar Set AN/APN-12A

**REFERENCE DATA AND LITERATURE**

Technical Orders:

12P5-2APN12-1

12P5-2APN12-2

12PS-2APN12-11

12P5-2APN12-13

12P-12APN 12-13C

12P5-2APN12-14

12P5-2APN12-22

12P5-2APN12-24

12P5-2APN12-34

12P5-2APN12-42

12P5-2APN12-54

Specifications:

MIL-R-9485

MIL-C-6693

MIL-C7358

MIL-P-7358

MIL-M 9272

DATE: 1 July 1964

ITEM NAME: RADAR TRANSPONDER BEACON

COGNIZANT SERVICE: USN

TYPE: AN/APN-13

FEDERAL STOCK NUMBER:

	USA	USN	USAF	USMC
STATUS OR TYPE CLASSIFICATION		Std		
Mfg(s) Name or Code Number: Pratt Industries, Inc., Philco Corp.				

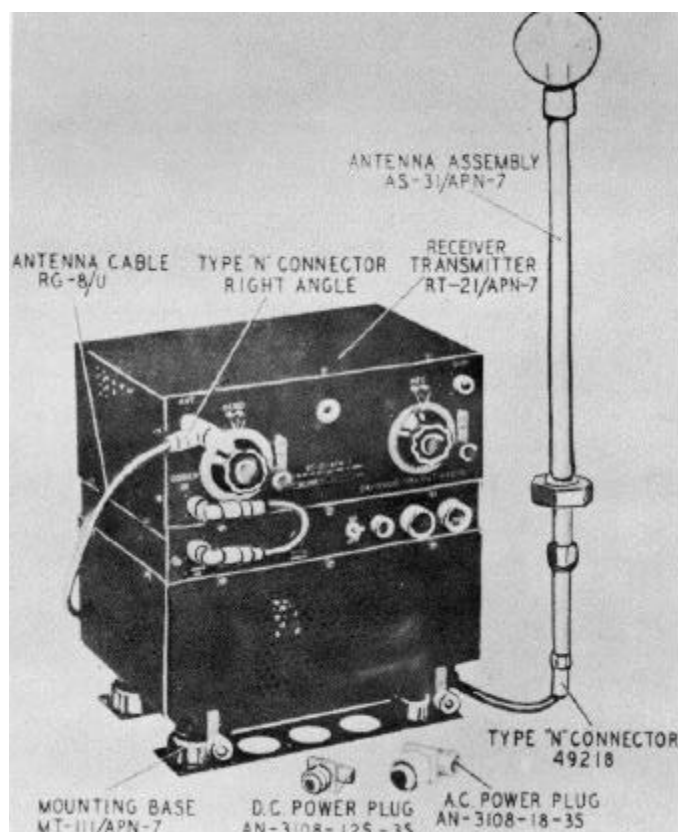

### FUNCTIONAL DESCRIPTION

The AN/APN-13 is designed to establish the identity of the aircraft in which it is installed. The

pulses received from radar equipments are used to key its transmitter and send pulses to the interrogating radar. Provision is made for the installation of a coder for more positive identification.

### RELATION TO SIMILAR EQUIPMENT

None.

### TECHNICAL DESCRIPTION

Frequency: Transponder - 2960 to 3060 mc  
Local Oscillator - Approx 2930 to 3030 mc  
(30 mc lower than received signals)  
Bandwidth:  
Intermediate Frequency - 12 mc  
Video Amplifier - 2 mc  
Pulse Repetition Rate: 600 pps  
Pulse Duration: 0.4  $\mu$ sec  
Pulse Monitoring Voltage: 5 to 70v  
Peak Power Output: 500w  
Video Output Dynamic Impedance: 600 ohms  
Operating Range: 50 naut mi  
Ambient Temperature Range: -27 deg F to +122 deg F (-35 deg C to +50 deg C)  
Power Requirements:  
105 to 130v, 400 to 2,400 cps, 1-ph, 250 va  
12 or 24 vdc, 0.15 amp  
Antenna Characteristics: 3-dipole, omnidirectional radiating element

### INSTALLATION CONSIDERATIONS

Not available.

AN/APN- 13

**PRINCIPAL COMPONENTS AND PHYSICAL DATA**

<b>COMPONENT</b>	<b>QTY</b>	<b>HEIGHT (Inches)</b>	<b>WIDTH (Inches)</b>	<b>DEPTH (Inches)</b>	<b>UNIT WT. (Pounds)</b>
Receiver-Transmitter RT - 6 I/APN - 13	1	12-15/16	13	9-3/4	36.0
Antenna - 135/APN - 13	1	24-5/8	3-1/4	3-1/4	2.5
Mounting Base MT - 11 I/APN-7	1	1-5/16	11-1/2	9-7/16	2.25

**REFERENCE DATA AND LITERATURE**

Technical Manuals:  
CO-AN-16-30APN13-3

**AN/APN-13: 2**

DATE: 1 July 1964

ITEM NAME: RADAR SET

COGNIZANT SERVICE: USN

TYPE: AN/APN-22

USA LINE ITEM NUMBER: 637110

FEDERAL STOCK NUMBER:

	USA	USN	USAF	USMC
STATUS OR TYPE CLASSIFICATION	Std	Std	Ltd Std	
Mfg(s) Name or Code Number: Sylvania Electric Products Inc., Buffalo, N. Y.				

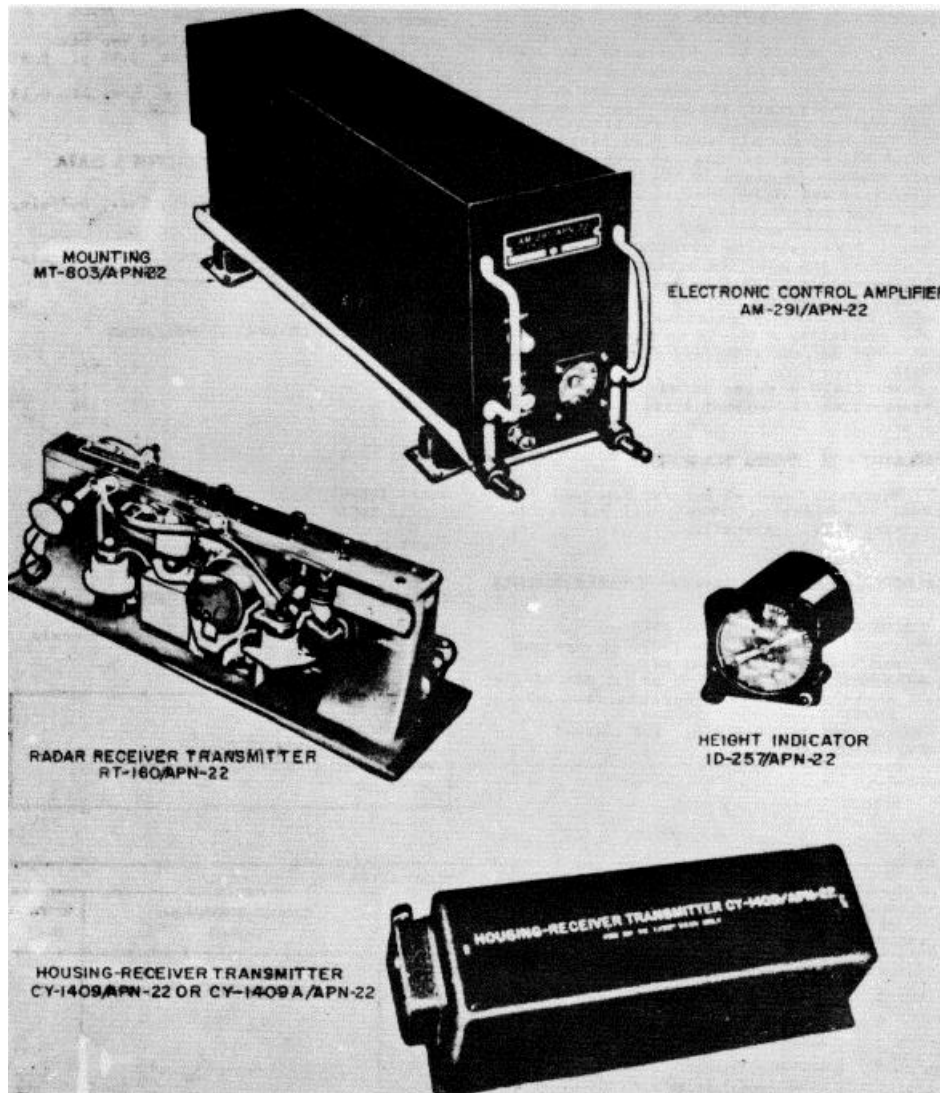

AN/APN-22: 1

AN/APN-22

**FUNCTIONAL DESCRIPTION**

The AN/APN-22 is a microwave altimeter that is designed to measure the terrain clearance of an aircraft without the necessity of adding antennas or other equipment external to the surface of the aircraft.

The drop-out altitude (the altitude at which the signal becomes too weak to operate the system) is above 10,000 feet when flying over land and higher when flying over water. The drop-out altitude is reduced in banks of 60 degrees or more and in climbs or dives of 70 degrees or more. A reliability circuit disables the indicator and shields the needle behind a mask to prevent the pilot using the indication when the signal is too weak to provide reliable operation. Provisions have been made for completing a tie-in to automatic pilots or other devices requiring selected altitude data.

**RELATION TO SIMILAR EQUIPMENT**

None.

**TECHNICAL DESCRIPTION**

Frequency: 4200 to 4400 mc  
 Reliability Range: 0 to 10, 000 ft over land; 0 to 20,000 ft over water  
 Accuracy: ± 2 ft from 0 to 40 ft; + 5% of the correct terrain clearance from 40 to 20,000 ft.  
 Transmitter Power Output: 1w nom  
 Modulation Capability: 60 mc  
 Type of Modulation: FM  
 Modulation Method: Vibrating reed  
 Operating Voltages and Power Requirements:  
 28 vdc, 1.35 amp normal, 4 amp max; 115 vac, 320 to 1, 000 cps, 0.85 pf, 0.87 amp normal, 1 amp max; 115 vac, 380 to 420 cps, 0.95 pf, 0. 13 amp normal, 0.15 amp max

**INSTALLATION CONSIDERATIONS**

Not available.

**PRINCIPAL COMPONENTS AND PHYSICAL DATA**

COMPONENT	QTY	HEIGHT (Inches)	WIDTH (Inches)	DEPTH (Inches)	UNIT WT. (Pounds)
Electronic Control Amplifier AM-291/APN-22	1				19.5
Mounting MT-803/APN-22	1				4.0
Height Indicator ID-257/APN-22	1				2.0
Radar Receiver-Transmitter RT-160/APN-22	1				4.75
Housing, Receiver-Transmitter CY-1409/APN-22 or CY-1409A/APN-22	1				2.75
Connector AN31088-18-15	1				

**REFERENCE DATA AND LITERATURE**

Technical Manuals:  
 AN16-30APN22-1  
 AN16-30APN22-2  
 AN16-30APN22-4  
 Technical Order:  
 12P5-2APN22-2

DATE: 1 September 1964

ITEM NAME: ELECTRONIC ALTIMETER SET

COGNIZANT SERVICE: USAF

TYPE: AN/APN-42A

FEDERAL STOCK NUMBER: 5841-978-0425

	USA	USN	USAF	USMC
STATUS OR TYPE CLASSIFICATION			Tent. Std	
Mfg(s) Name or Code Number. Sperry Gyroscope Company (56232)				

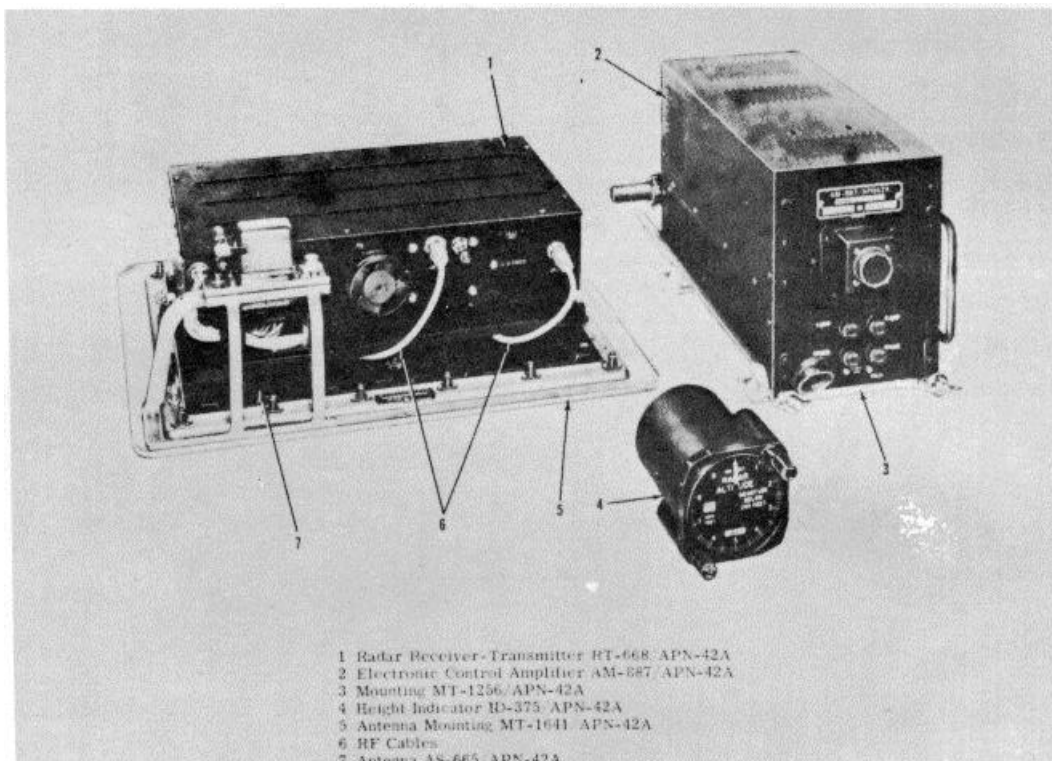

### FUNCTIONAL DESCRIPTION

The AN/APN-42A Altimeter is a radar type altimeter that computes and displays true absolute aircraft altitude above terrain. The altimeter transmits a pulsed RF signal toward the terrain below. The reflected signal is received by the altimeter and a range computer

determines the true altitude from the time delay between the transmitted and reflected echo signal. As a result of the altitude computation, a range computer generates altitude analog signals to drive a height indicator that visually displays the computer altitude.

AN/APN-42A: 1

**ITEM NAME:** ELECTRONIC ALTIMETER SET

**TYPE:** AN/APN-42A

**RELATION TO SIMILAR EQUIPMENT**

None.

Altitude Accuracy: plus 20 ft plus or minus 0.025% of altitude  
Altitude Rate: Up to 1000 ft per sec  
Transmitter Power Output: 2000w peak min  
Loop Sensitivity: No less than 115 db  
Receiver Sensitivity: No less than 82 dbm  
Antenna Gain: 17 db min  
Input Power Requirements  
dc: 25.0 to 29v, 22.5w  
ac: 101 to 121v, 380 to 120 cps, single ph, 193 va (174w with 0.905 lagging power factor).

**TECHNICAL DESCRIPTION**

Transmitted Frequency: 4225 plus or minus 5 mc  
Pulse Width: Less than 0.1 usec  
Pulse Repetition Rate: 4916.45 pps plus or minus 0.025%  
Intermediate Frequency: 60 plus or minus 2 mc  
Altitude Range: 200( to 70,000 ft

**PRINCIPAL COMPONENTS AND PHYSICAL DATA**

<b>COMPONENT</b>	<b>QTY</b>	<b>HEIGHT (Inches)</b>	<b>WIDTH (Inches)</b>	<b>DEPTH (Inches)</b>	<b>UNIT WT.</b>
Amplifier, Electronic Control AM-887/APN-42A	1	7-5/8	5-7/8	13-5/8	14.43
Receiver-Transmitter RT-66L/APN-12A	1	3-7/8	13-3/4	11-3/8	12.49
Antenna AS-665/APN-42A	1	1-1/2	15	12-1/4	3.61
Indicator ID-375/APN-42A	1	3-1/4	3-1/4	5-29/64	2.27
Mounting MT-1256/APN-42A	1	6 1/16	6-3/4	16-1/2	2.35
Mounting MT-1641/APN-42A	1	6	17-13/32	14-19/32	1.41

**REFERENCE DATA AND LITERATURE**

Technical Orders:  
12P5-2APN42-12  
12P5-2APN42-14

**AN/APN-42A: 2**



DATE: 1 September 1964

ITEM NAME: RADAR SET

COGNIZANT SERVICE: USAF

TYPE: AN/A PN-59

FEDERAL STOCK NUMBER: 5841-505-0759

	USA	USN	USAF	USMC
STATUS OR TYPE CLASSIFICATION			Std	
Mfg(s) Name or Code Number: Sperry Gyroscope Co., Div. of Sperry Rand Corp. (56232)				

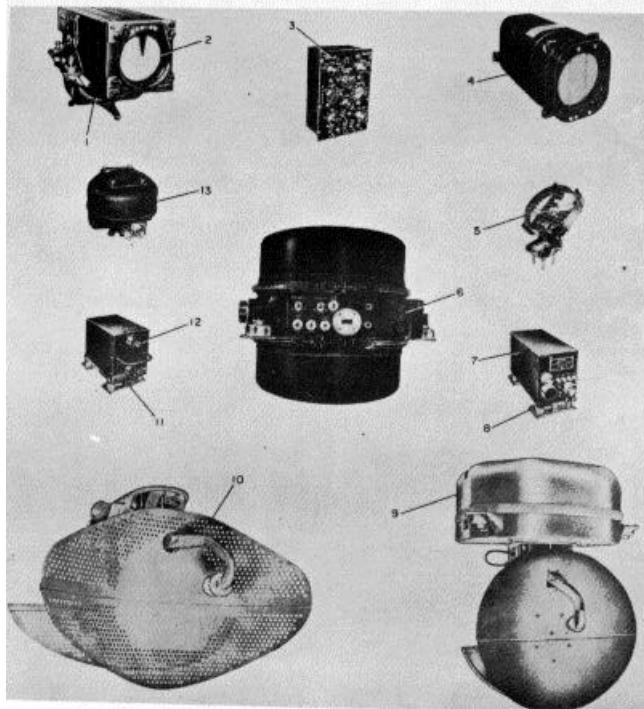

- |  |  |
|--|--|
| 1 Mount MT-1254/APN-59*                                      | 8 Mounting Base MT-1557/APN-59*                |
| 2 Azimuth and Range Indicator IP-239/APN-59                  | 9 Antenna AS-652/APN-59*                       |
| 3 Radar Set Control C-1242/APN-59                            | 10 Antenna Reflector AT-560/APN-59 to complete |
| 4 Azimuth and Range Indicator IP-268/APN-59                  | 11 Mounting Base MT-1497/APN-59                |
| 5 Vaneaxial Fan HD-150/APN-59                                | 12 Electronic Control Amplifier AM-853/APN-59  |
| 6 Radar Receiver-Transmitter RT-289/APN-59 or RT-289A/APN-59 | 13 Stabilization Data Generator CN-221/APN-59  |
| 7 Power Supply PP-11073/APN-59                               |  |

### FUNCTIONAL DESCRIPTION

RADAR Set AN/APN-59 is a small, lightweight, airborne radar system designed to operate as a navigational and search radar, a weather observation radar or an interrogator-receiver. When used as a search radar, it displays a visual, map-like scope picture

showing cities and towns, highways, airplane hangers, rivers, islands, shorelines, mountains, and ships at sea. When used as weather radar, because of increased sensitivity, it displays less substantial objects such as storm fronts, heavy rainfall, or other turbulent weather features with precipitation.

**ITEM NAME:** RADAR SET

**TYPE:** AN/APN-59

**RELATION TO SIMILAR EQUIPMENT**

None.

**TECHNICAL DESCRIPTION**

Operating Frequency  
 Transmitting: 9375 plus or minus ,40 mc  
 Receiving: 9310 mc (Beacon) and 9375 plus or minus 40 mc (Radar)  
 Intermediate Frequency: 30 mc  
 Pulse Repetition Frequency: 2000, 1025, 350 and 180 pps  
 Pulse Length: 0.35, 0.8, 2.35 and 4.5  
 Peak Power Output: 58 kw rain  
 Operating limits  
 PPI Scan: (Continuous full rotation)

Sector Scan: Selectable angle in steps of 30° from 21 to 291° (installation setting)  
 Slant Range: 80 yds to 240 naut mi  
 Altitude: Up to 50,000 ft above sea level  
 Antenna Tilt: 25° of total angular travel; 100 up to 15° down  
 Power Requirements: 24 to 29v dc, 6.0 amp; 109 to 121v, 380 to 1000 cyc, 12 amp; 109 to 121v, 380 to 420 cyc, 1.6 amp  
 Operating Temperature: -55 to plus 55°C (-67 to plus 131°F)

**INSTALLATION CONSIDERATIONS**

Related Equipment  
 Required but not Supplied: (1) North-Stabilized Data Source; (1) Radome; (12) Connector UG-260B/II; (17) Connector; (as reqd) Wire & Cables; (as reqd) Waveguide

**PRINCIPAL COMPONENTS AND PHYSICAL DATA**

COMPONENTS	QTY	OVERALL DIMENSIONS	UNIT WT.
		(Inches)	(Pounds)
Receiver-Transmitter, Radar RT-289A/APN-59	1	17 dia x 17	69
Antenna AS-653/APN-59	1	34 dia x 31-1/2	55
Generator, Stabilization Data CN-221/APN-59	1	6 dia x 7	
Amplifier, Electronic Control AM-853/APN-59	1	5-1/2 x 6-1/2 x 7.5	
Mounting Base MT-1497/APN-59	1	2 x 6-1/2 x 7-1/2	1
Control, Radar Set C-1242/APN-59	1	6 x 6 x 9	
Indicator, Azimuth and Range IP-239/APN-59	1	6 3/4 x 6-3/4 x 17	
Mount MT-1254/APN-59	1	4 x 4 x 7	
Indicator Azimuth and Range IP-268/PN-59	1	5-1/8 x 5-7/8 x 8	8
Power Supply PP-1073/APN-59	1	6 x 7 x 9	17
Mounting Base MT-1557/APN-59	1	2 x 6-1/16 x 11-5/8	1.06
Fan, Vaneaxil HD-150/APN-59	2	5 x 6-5/16 x 7	2

**AN/APN-59: 2**

DATE: 15 May 1964

ITEM NAME: RADAR SET

COGNIZANT SERVICE: USAF

TYPE: AN/APN-59B

FEDERAL STOCK NUMBER: 5841-815-9375

	USA	USN	USAF	USMC
STATUS OR TYPE CLASSIFICATION			Std	
Mfg(s) Name or Code Number: Sperry Gyroscope Company				

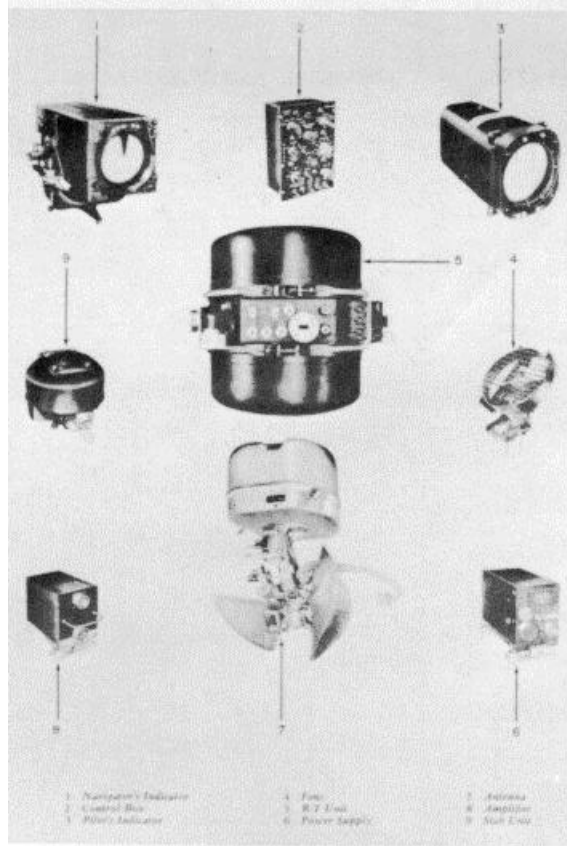

**FUNCTIONAL DESCRIPTION**

The AN/APN-59B is a small, lightweight airborne radar system designed to operate as a navigational and

search radar, a weather radar, or an interrogator-receiver.

**AN/APN-59B: 1**

**ITEM NAME:** RADAR SET

**TYPE:** AN/APN-59B

**RELATION TO SIMILAR EQUIPMENT**

None.

24 to 29v dc, 6 amp  
 TYPE of Presentation: PPI  
 Interval of Range Markers:  
 3 to 30 mi, var - 1-mi markers  
 3 to 30 mi, var - 5-mi markers  
 50 mi, fixed - 10-mi markers  
 100 mi, fixed - 2-mi markers  
 240 mi, fixed - 30-mi markers  
 Duty Cyc1e: 0.002  
 Environmental Limitations: -55 to plus 55 deg C  
 Horizontal Coverage: Rotates 360 deg continuous  
 sector scan selectable angle in steps of :30 deg  
 from 21 to 29 deg.  
 Altitude: Up to 50,000 ft above sea level  
 Antenna Tilt: 25 deg; 10 deg up, 15 deg down

**TECHNICAL DESCRIPTION**

Frequency  
 Transmitting: 9375 plus or minus 40 mc  
 Receiving: 9310 and 9375 plus or minus  
 40 mc  
 Range, Max: 2110 naut mi  
 Range, Min: 0.040 mi  
 Peak Power Output: 58 kw  
 Operating Voltage and Power Requirement:  
 109 to 121v ac, 380 to 1000 cps, 12 amp  
 max  
 109 to 121v ac, 380 to 420 cps, 1.6 amp

**PRINCIPAL COMPONENTS AND PHYSICAL DATA**

COMPONENT	QTY	HEIGHT (Inches)	WIDTH (Inches)	DEPTH (Inches)	UNIT WT.
Receiver-Transmitter T-289B /APN-59	1	18	16-3/4	16-3/4	80
Antenna AS-652A /APN-59	1	29	25	25	43
Antenna AS-653A /APN-59	1	32	28	34-3/4	55
Amplifier AM-853A /APN-59	1	10-1/2	8-1/8	5-3/4	8-1/2
Control C-1242/APN-59	1	9-3/4	5-3/4	6-1/4	4-3/4
Indicator IP-239A /APN-59	1	6-3/4	6-3/4	15-5/8	15
Indicator IP-268 /APN-59	1	5-7/8	5-1/8	9	8
Power Supply PP-1073A /APN-59	1	7-5/8	5-1/8	9-7/8	14
Fan, Vaneaxial HD-150 /APN-59	1	8	6-1/2	5	2
Generator, Stabilization CN-221A /APN-59	1	7	8	8	8

**REFERENCE DATA AND LITERATURE**

Technical Orders:

12P5-2APN59-1	12P5-2APN59-24D
12P5-2APN59-4	12P5-2APN59-2
12P5-2APN59-12	12P5-2APN59-3
12P5-2APN59-14	
12P5-2APN59-21	Specifications:
12P5-2APN59-22	2 MIL-R-25527C
12P5-2APN59-23	
12P5-2APN59-23D	
12P5-2APN59-24	

**AN/APN-59B: 2**

**MIL-HDHK-162A**  
15 December 1965

Volume 1  
Section 2

**ITEM NAME:** RADAR SET

**TYPE:** AN/APN-59

**SHIPPING DATA**

<b>COMPONENT</b>	<b>PKGS</b>	<b>VOLUME (CU FT)</b>	<b>UNIT WT. (Pounds)</b>
	10		

**REFERENCE DATA AND LITERATURE**

Technical Manuals:

NAVAER 16-30APN59-1  
NAVAER 16-30APN59-2  
NAVWEPS 16-30APN59-3  
NAVWEPS 16-30APN59-4  
T.O. 12P5-2APN59-1  
T.O. 12P5-2APN59-2  
T.O. 12P5-2APN59-3  
T.O. 12PS-2APN59-4

**AN/APN-59: 3**

DATE: 1 July 1964

ITEM: RADAR BEACON

COGNIZANT: USN

TYPE: AN/APN-63

FEDERAL STOCK NUMBER: F595-265-7260

	USA	USN	USAF	USMC
STATUS OR TYPE CLASSIFICATION				
Mfg(s) Name or Code Number: Melpar, Inc., Alexandria, Va.				

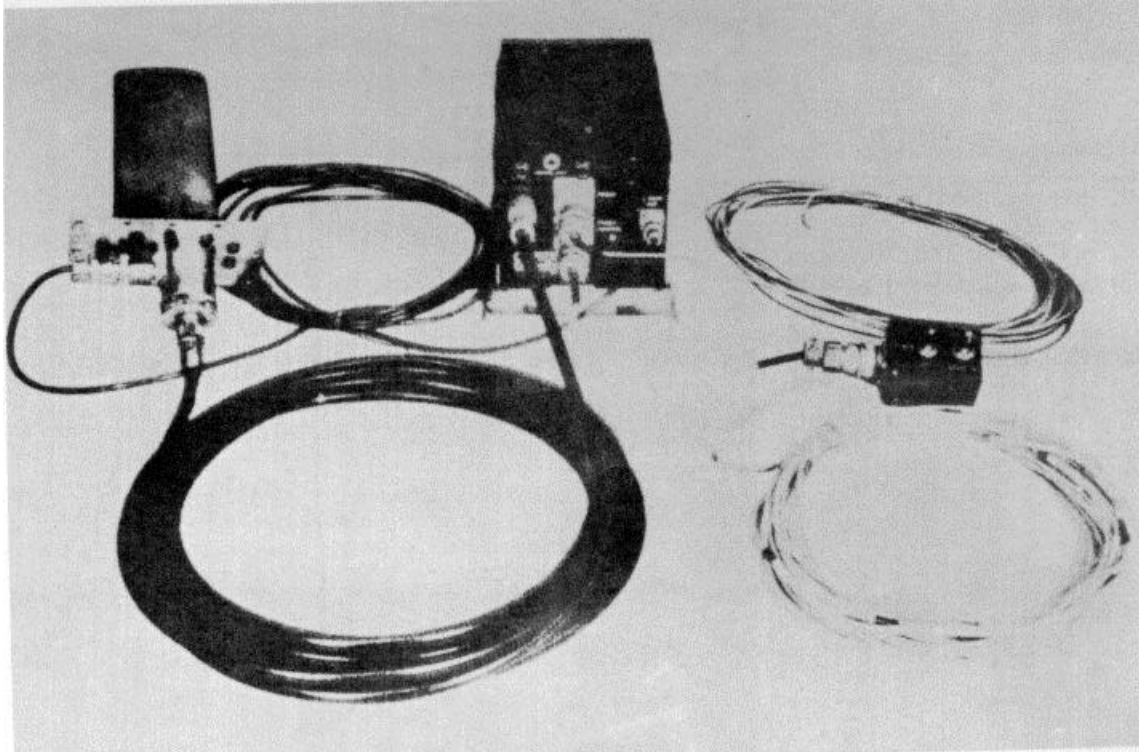

**FUNCTIONAL DESCRIPTION**

The AN/APN-63 is a light weight, air transportable, pulse type, crossband, radar beacon. It is capable of receiving radar pulses of one-half microsecond duration on

any frequency between 2700 and 2900 megacycles in the "S" band and replying with single pulses of seven to ten microseconds duration on a frequency of 968 megacycles in the "L" bands.

**AN/APN-63: 1**

**ITEM NAME:** RADAR BEACON

**TYPE:** AN/APN-63

**RELATION TO SIMIAR EQUIPMENT**

None.

Emission: Pulse  
Sensitivity: 5 dhm  
Range: 20 mi  
Power Requirements: 28v dc, 2.5 amps  
Antenna: Rod type

**TECHNICAL DESCRIPTION**

Frequency Data  
Receiving: 2700 to 2900 mc  
Transmitting: 968 plus or minus 2.5 mc  
Power Output: 25w peak

**INSTALLATION CONSIDERATIONS**

Not available.

**PRINCIPAL COMPONENTS AND PHYSICAL DATA**

<b>COMPONENTS</b>	<b>QTY</b>	<b>OVERALL DIMENSIONS (Inches)</b>	<b>UNIT WT. (Pounds)</b>
Receiver-Transmitter RT-164/APN-63	1	5 x 6 x 8	9.08
Antenna AS-456/APN-63	1	3-1/2 x 5-1 /2 x 10-1/8	1..52
Radar Set Control C-573/APN-63	1	1-5/8 x 2 x 2-1/2	0.31
Vibration Isolation Rack	1	2-1/16 x 6-1/16 x 9-3/8	0.77
Set of Interconnecting Cables	1		

**REFERENCE DATA AND LITERATURE**

Technical Manuals:  
NAVSHIPS 91141

**AN/APN-63: 2**

DATE: 15 May 1964

ITEM: RADAR SET

COGNIZANT SERVICE: USAF

TYPE: AN/APN-81

FEDERAL STOCK NUMBER: 5841-

	USA	USN	USAF	USMC
STATUS OR TYPE CLASSIFICATION				
Mfg(s) Name or Code Number: General Precision Laboratory				

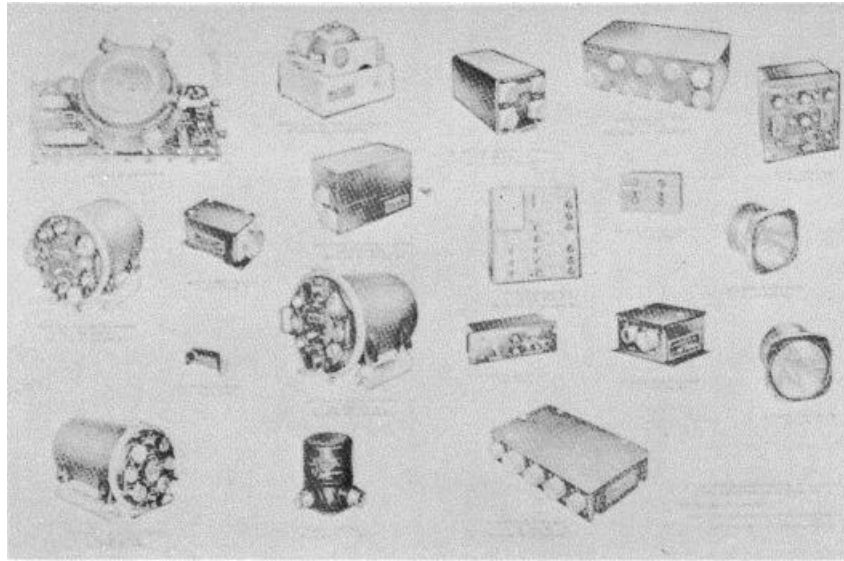

**FUNCTIONAL DESCRIPTION**

Radar Set AN/APN-81 is an automatic and self-contained airborne equipment which provides continuous ground speed and drift angle information of

high accuracy. It operates anywhere over the globe, independently of ground based navigation aids, weather conditions or visibility.

**AN/APN-81: 1**



**ITEM NAME:** RADAR SET  
**TYPE:** AN/APN-81

**RELATION TO SIMILAR EQUIPMENT**

Similar to the AN/APN-t39 and AN/APN-tt2.

**TECHNICAL EQUIPMENT**

Frequency: 8700 to 8900 mc  
Range, Max: 70,000 ft  
Range, Min: 500 ft  
Peak Power Output: 35w  
Operating Voltages and Power Requirements:  
115 plus or minus 5v ac, 380 to 1000 cps, 3-ph, 1200w max  
115 plus or minus 5,v ac, 360 to 420 cps, 1-ph, 500w max  
26.4 plus or minus 2.5v dc, 100w  
Type of Presentation: Meters  
Duty Cycle: 0.0,15  
Environmental Limitations: Pressurized components require a forced air cooling

source.  
Pulse Repetition Rate: 50 kc  
Frequency Modulated: 63 cps  
Probable Accuracy  
Ground Speed: plus or minus 2.5 knots below 250 knots, plus or minus 1% actual speed at higher speeds.  
Drift Angle: plus or minus 0.5%;  
Wind Speed: plus or minus 3 knots or 2% of wind speed, whichever is greater.  
Wind Direction: Varies with wind speed. Typical extremes - plus or minus 1.1 deg error at a wind speed of 215 knots, plus or minus 120 at a wind speed of 13 knots.

**INSTALLATION CONSIDERATIONS**

Not available.

**PRINCIPAL COMPONENTS AND PHYSICAL DATA**

COMPONENT	QTY	HEIGHT (Inches)	WIDTH (Inches)	DEPTH (Inches)	UNIT WT.
Antenna AS-618A/APN-81 or AS-618-C/APN-81	1	15	17	28	42.8
Radar Receiver-Transmitter RT-274A./APN-81* or RT-274B/APN-81* or RT-27 IC/APN-81*	1	17	17	24	87.5
Computer Frequency Tracker CP-185/APN-81* or CP-185A/APN'-81* or CP-185B/A PN-81*	1	10	10	19	33.6
Amplifier, Electronic Control AM-742/APN-81* or AM-742/APN-81*	1	14	14	24	63.4
Amplifier, Electronic Control AM-743/APN-81*	1	7	8	11	9.4
Amplifier, Electronic Control AM-T58A/APN-81* or AM-T5t3B/APN-81*	1	17	17	24	89.5
Control, Vertical Gyro C-1160/APN-81*	1	8	7	9	8.3
Control, Radar Set C-1195 /APN -81	1	6	4	4	1.3
Directional Coupler CU-323 /APN-81	1	3	3	7	0.25
Control, Radar Set C-1416/APN-81 or C-14116A/APN-81	1	6	6	5	3
Interconnecting Box J-605/APN-81 or J-605A/APN-81	1	4	4	7	2
Interconnecting Box J-607/APN-81*	1	11	6	16	24.5
Interconnecting Box J-608/APN-81*	1	9	5	11	6.8
Interconnecting Box J-518/APN-81	1	6	3	16	1.2
Indicator, Drift Angle ID-3.12/APN'-81	1	4	4	4	1.2

**AN/APN-81: 2**

ITEM NAME: RADAR SET

TYPE: AN/APN-61

PRINCIPAL COMPONENTS AND PHYSICAL DATA

COMPONENT	QTY	HEIGHT (Inches)	WIDTH (Inches)	DEPTH (Inches)	UNIT WT.
Indicator, Ground Speed ID-341/APN-81	1	4	4	4	1.2
Compass System, N-1	1	5	6	5	3.8

NOTE: \*With mount.

REFERENCE DATA AND LITERATURE

Technical Orders:  
12P5-2APN81-1  
12P5-2APN81-2  
12P5-2APN81-3

Specifications:  
MIL-R-8103A

AN/APN-81: 3

DATE: 15 May 1964

ITEM NAME: NAVIGATION SET, RADAR

COGNIZANT SERVICE: USAF

TYPE: AN/APN-82

FEDERAL STOCK NUMBER: 5841-303-2626

	USA	USN	USAF	USMC
STATUS OR TYPE CLASSIFICATION			Alt Std	
Mfg(s) Name or Code Number: GPL and Ford Instrument				

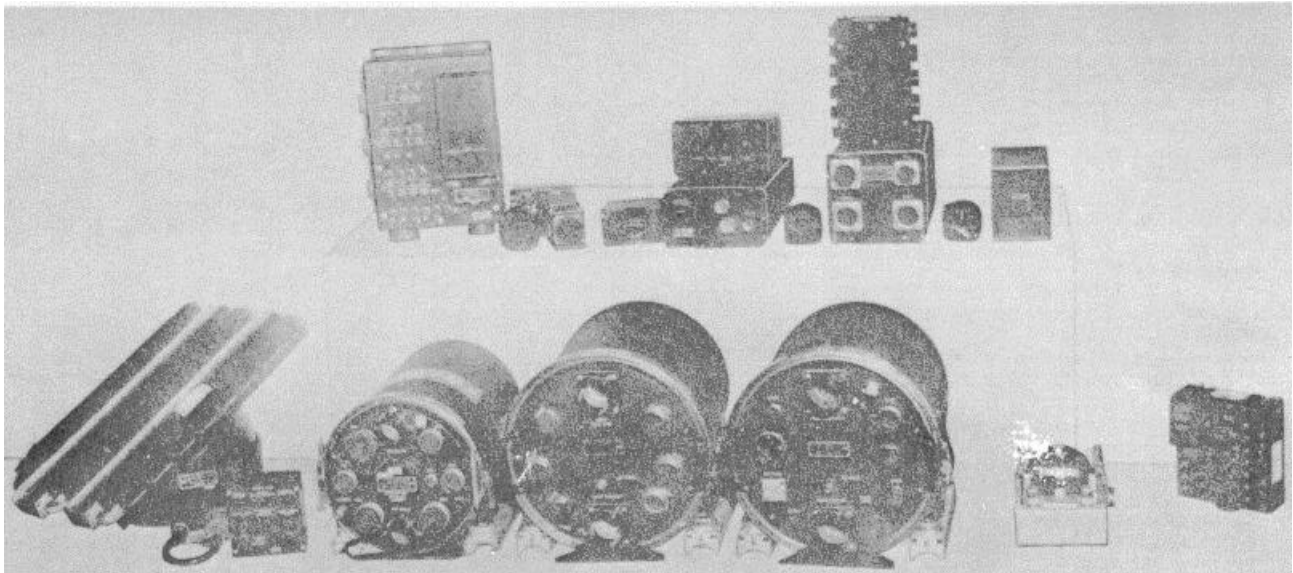

**FUNCTIONAL DESCRIPTION**

Radar Set AN/APN-82 is an automatic and self-contained airborne equipment which provides continuous ground speed, drift angle, latitude and

longitude information of high accuracy. It operates anywhere over the globe, independently of ground based navigation aids, weather conditions or visibility.

**AN/APN-82: 1**

**ITEM NAME:** NAVIGATION SET, RADAR

**TYPE:** AN/APN-82

**RELATION TO SIMILAR EQUIPMENT**

Radar Set AN/APN-82 is identical to Radar Set AN/APN-81 except for the addition of Computer Set AN/ASN-6.

**TECHNICAL DESCRIPTION**

Frequency: 8700 to k1900 mc  
Range, Max: 70,000 ft  
Range, Min: 500 ft  
Peak Power Output: 35w  
Operating Voltages and Power Requirements:  
115v ac, 400 cps, 67 va

115v ac, 380 to 1000 cps, 3-ph, 1200w 28v-dc, 100w

Type of Presentation: Counter type indexes and meters.

Duty Cycle: Con tinuous  
Environmental limitations

Space Requirement: 1.4 cu ft  
Operation Limits: 70 deg N or S latitude  
Aircraft Speed Range: 70 to 800 knots

**INSTALLATION CONSIDERATIONS**

Not available.

**PRINCIPAL COMPONENTS AND PHYSICAL DATA**

COMPONENT	QTY	HEIGHT (Inches)	WIDTH (Inches)	DEPTH (Inches)	UNIT WT.
Antenna AS-618A/APN-81 or AS-618C/APN--81	1	15	17	28	42.8
Radar Receiver-Transmitter RT-274A/APN-81* or RT-274B/APN-81* or RT-274C/APN-81*	1	17	17	21	87.5
Computer Frequency Tracker CP-185-/APN-81* or CP-185A/APN-81* or CP-185B/APN-81*	1	10	10	19	33.6
Amplifier, Electronic Control AM-742/APN-81* or AM-7412A/APN-81	1	14	14	24	63.4
Amplifier, Electronic Control AM-7413/APN-81	1	7	8	11	9.4
Amplifier, Electronic Control AM-758A/APN-81* or AM-758BR/APN-81*	1	17	17	24	89.5
Control, Vertical Gyro C-1160/APN-81*	1	8	7	9	8.3
Control, Radar Set C-1196/APN-81	1	6	4	4	1.3
Directional Coupler CU-323/APN-81	1	3	3	7	0.25
Control, Radar Set C-1416A/APN-81	1	6	6	5	3
Interconnecting Box J-605, /APN-81* or J-605A /APN-81	1	4	4	7	2
Interconnecting Box J-607/APN-51	1	11	6	16	24.5
Interconnecting Box J-608/APN-81'	1	9	5	11	6.8
Interconnecting Box J-530/APN-81	1	6	3	16	1.2
Indicator, Drift Angle ID-341/APN-81	1	4	4	4	1.2
Indicator, Ground Speed ID-341/APN-81	1	4	4	4	1.2
Compass System, N-1	1	5	6	5	3.8
Control, Radar Set C-1316/ASN-6	1	5.5	5.8	3.8	3
Computer CP-188A/ASN-6	1	6.2	8.5	13.7	17.5

ITEM NAME: NAVIGATION SET, RADAR

TYPE: AN/APN-82

**PRINCIPAL COMPONENTS AND PHYSICAL DATA**

COMPONENT	QTY	HEIGHT (Inches)	WIDTH (Inches)	DEPTH (Inches)	UNIT WT.
Indicator ID-3U9/ASN-6	1	3.3	3.3	11.5	4.1
Amplifier AM-916/ASN-6	1	6.2	8.9	22.5	19.5

**NOTE: \*With mount.**

**REFERENCE DATA AND LITERATURE**

Technical Orders:

5N1-3-2-1  
5N1-3-2-2  
12P5-.2APN81-1  
12P5-2APN81-2  
12P5-2APN81-3

Specifications:

MIL-N-25129  
MIL-R-B103A

**AN/APN-82: 3**

DATE: 15 May 196.1

ITEM NAME: RADAR SET

COGNIZANT SERVICE: USAF

TYPE: AN/APN-89

FEDERAL STOCK NUMBER: 5841-561-4269

	USA	USN	USAF	USMC
STATUS OR TYPE CLASSIFICATION			Ltd Std	
Mfg(s) Name or Code Number: General Precision Laboratory				

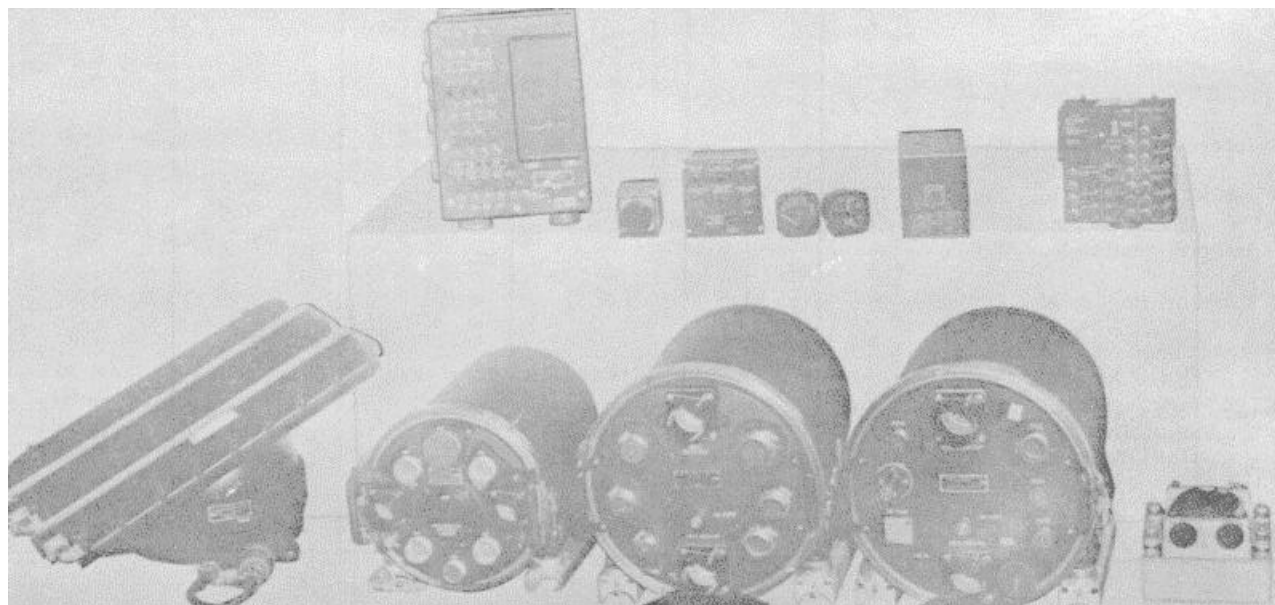

### FUNCTIONAL DESCRIPTION

Radar Set AN/APN-89 is an airborne, doppler radar ground speed and drift angle measuring equipment, designed to provide accurate ground speed and drift angle information to an AN/ASB-4 system under normal operation. The radar set operates anywhere over the globe independently of ground based navigation aids, weather conditions, or visibility.

### RELATION TO SIMILAR EQUIPMENT

Uses some components of the AN/APN-81.

### TECHNICAL DESCRIPTION

Frequency: 8700 to 8900 mc  
Range, Max: 70,000 ft  
Range, Min: 500 ft  
Peak Power Output:  
Operating Voltages and Power Requirements:  
115/200v, 380 to 1,000 cps, 2-ph 1,500w nom

26.4 :2.5 vdc  
Type of Presentation: Meters  
Duty Cycle: 0.045  
Environmental Limitations: Pressurized components require a forced air cooling source.  
Ground Speed: 70 to 700 knots  
Acceleration Without Signal Loss: 0.7g  
Drift Angle:  
Right - 0 to 49 deg  
Left - 0 to 49 deg  
Aircraft Pitch Without Signal Loss:  
Nose up - 14 deg  
Nose down - 24 deg  
Aircraft Roll Without Signal Loss:  
Right wing down - 14 deg  
Left wing down - 14 deg  
Probable Accuracy:  
Ground speed- :2.1 knots(..0.3 of top speed)  
Drift angle - ±0.15%

### INSTALLATION CONSIDERATIONS

Not available.

AN/APN-89

**PRINCIPAL COMPONENTS AND PHYSICAL DATA**

<b>COMPONENT</b>	<b>QTY</b>	<b>HEIGHT (Inches)</b>	<b>WIDTH (Inches)</b>	<b>DEPTH (Inches)</b>	<b>UNIT WT. (Pounds)</b>
Antenna 1 17 AS-618 A+C/APN-81	15	29	43.00		
Radar Receiver-Transmitter RT-274 A,B,+C/APN-81	1	17	17	24	88.00
Amplifier, Electronic Control AM-758 A+B/APN-81	1	17	17	24	90.00
Directional Coupler CU-323/APN-81	1	3	3	7	0.25
Interconnecting Box, J-607/APN-81	1	6	11	16	25.00
Interconnecting Box, J-608/APN-81	1	5	9	11	7.00
Interconnecting Box, J-605/APN-81	1	4	4	7	2.00
Control, Radar Set C-1416/APN-81	1	6	6	5	3.00
Amplifier, AM-946/APN-89 & AM-916A/APN-89	1	14 in. dia	22 in. long		58.00
Indicator, Ground Speed ID-341/APN-81	1	4	4	4	1.12
Indicator, Drift Angle ID-342/APN-81	1	4	4	4	1.12

**REFERENCE DATA AND LITERATURE**

Specifications:  
MIL-R-25519

Technical Orders:  
12P5-2APN89-12  
12P5-2APN89-3  
12P5-2APN89-4

**AN/APN-89: 2**

**DATE:** 1 July 1961

**ITEM NAME:** RADAR SET

**COGNIZANT SERVICE:** USN

**TYPE:** AN/APN-97

**FEDERAL STOCK NUMBER:**

	USA	USN	USAF	USMC
STATUS OR TYPE CLASSIFICATION				
Mfg(s) Name or Code Number: Ryan Aeronautical Co., San Diego, Calif.				

Illustration not available

### FUNCTIONAL DESCRIPTION

The AN/APN-97 is a doppler radar set designed to provide a continuous measurement of heading, drift, and vertical components of the aircraft velocity.

### RELATION TO SIMILAR EQUIPMENT

Similar to AN/APN-122.

### TECHNICAL DESCRIPTION

Transmitted Signal: 13, 500 mc  
Received Doppler Signal: 13, 500 mc minus received signal or, received signal minus 13, 500 mc  
Amplifier Signal, Audio Gain: Between 28 and 44 db  
Audio Signal Frequency: 20 to 3500 (approx)  
Converter Input Signals: Audio Doppler  
Converter Output Signals: Positive or negative current pulse; low doppler alarm

Modulator Input Signals: Positive or negative current pulse from converters  
Modulator Output Signals: AC signal proportional in amplitude to frequency of input pulse and phased to match polarity of input signals; dc signals proportional in level to frequency of input pulse and with same polarity as input signal  
Velocity Computer Input Signals: Modulator ac output signals; 4 converter low doppler alarm output signals  
Velocity Computer Output Signals: AC voltages proportional to aircraft velocities; low doppler hover, navigate  
Operating Altitudes: 0 to 15, 000 ft, temperature range, -44. 4 to 55 deg C  
Acceleration: up to 4G in any axis,  
Acceleration Accuracy: 5°- for velocities above 10 knots  
Operating Voltages and Power Requirements: 115v, 400 cps, 110w at a 0. 8 pf 28 vdc, 14w

### INSTALLATION CONSIDERATIONS

Not available.



AN/APN-97

**PRINCIPAL COMPONENTS AND PHYSICAL DATA**

<b>COMPONENT</b>	<b>QTY</b>	<b>HEIGHT (Inches)</b>	<b>WIDTH (Inches)</b>	<b>DEPTH (Inches)</b>	<b>UNIT WT. (Pounds)</b>
Receiver Transmitter, Radar RT-455/APN-97	1				
Converter Power Supply CV-693/APN-97	1				
Direction-Velocity Indicator ID-701/APN	1				

**REFERENCE DATA AND LITERATURE**

Handbook:  
NAVAER 16-30APN-97-2

**AN/APN-97: 2**

DATE: 15 May 1964

ITEM NAME: RADAR SET

COGNIZANT SERVICE: USAF

TYPE: AN/APN-99A

FEDERAL STOCK NUMBER:

	USA	USN	USAF	USMC
STATUS OR TYPE CLASSIFICATION			Std	
Mfg(s) Name or Code Number: General Precision Laboratory; Ford Instrument Company, Airborne Installation				

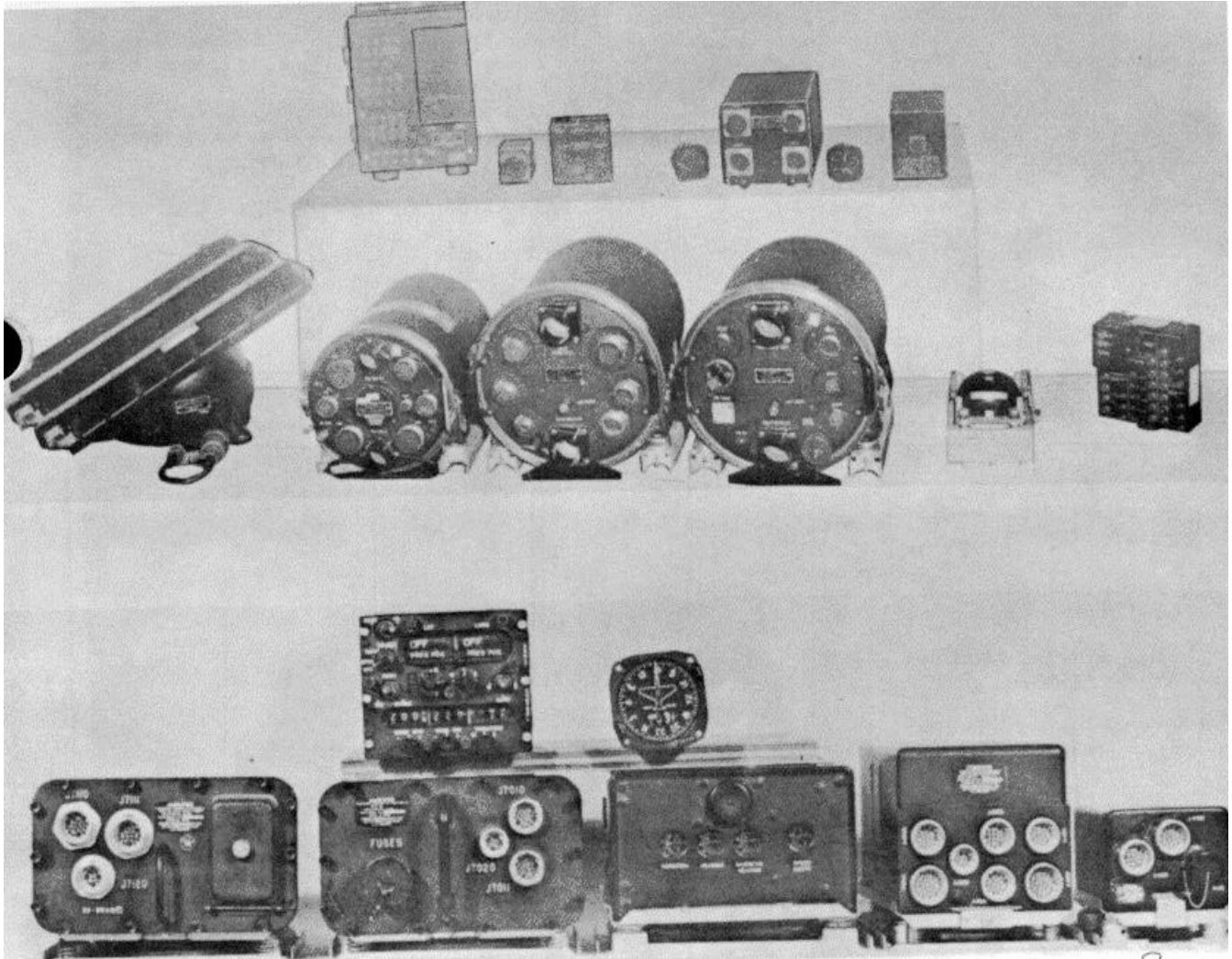

**FUNCTIONAL DESCRIPTION**

Radar Set AN/APN-99A is a self-contained airborne set which continually and automatically computes and indicates present position, ground track thumb-line course, and rhumb-line distance to a known destination.

These computations are based on present position from inputs of true air speed, compass heading, automatic or manually set magnetic variations, and manually set wind data.

AN/APN-99A

The provides true ground speed and drift angle information of high accuracy.

**RELATION TO SIMILAR EQUIPMENT**

Similar to Radar Navigation Set AN/APN-82( ), except that the AN/APN -99A computes and indicates the additional information of course and distance to destination.

Same as the AN/APN-99 except the AN/ASN-7A is a transistorized version of the AN/ASN-7.

**TECHNICAL DESCRIPTION**

- Frequency: 8700 to 8900 mc
- Range, Max: 70, 000 ft
- Range, Min: 500 ft
- Peak Power Output: 35w
- Operating Voltages and Power Requirements:
  - 115 vac, 1-ph, 380 to 420 cps, 750w
  - 115 vac, 3-ph, 380 to 1,000 cps, 1,300w
  - 22 vdc, 100w
- Type of Presentation: Meters

Duty Cycle: .045

Environmental Limitations: The computer set is designed to operate within the limits of 70 deg N and 70 deg S latitude and at speeds of 70 to 2,000 knots. The distance from present position to destination at any time during operation cannot exceed 1, 000 naut mi. At latitudes of more than 70 deg the computer operates transverse coordinates and with transverse readings instead of the conventional coordinates used in lower latitudes.

The AN/APN-99A is a pressurized set and requires a forced cooling source.

Pulse Repetition Rate: 50 kc

Modulation: 63 cps, FM

Ground Speed Accuracy:  $\pm 2.5$  knots below 250 knots,  $\pm 10\%$  of actual speed at speeds greater than 250 knots.

Drift Angle Accuracy:  $\pm 0.5\%$

Wind Speed Accuracy: -3 knots or  $2\sigma$  of wind speed, whichever is greater

**INSTALLATION CONSIDERATIONS**

Not available.

**PRINCIPAL COMPONENTS AND PHYSICAL DATA**

COMPONENT	QTY	HEIGHT (Inches)	WIDTH (Inches)	DEPTH (Inches)	UNIT WT. (Pounds)
Antenna AS-618A/APN-81	1	17	15	28	42.75
Radar Receiver-Transmitter RT-274A/APN-81	1	17	17	24	87.50
Frequency Computer CP-185/APN-81	1	10	10	19	33.62
Electronic Control Amplifier AM-742/APN-81	1	14	14	24	63.37
Electronic Control Amplifier AM-743/APN-81	1	8	7	11	9.37
Electronic Control Amplifier AM-758/APN-81	1	17	17	24	89.5
Vertical Gyro Control C-1160/APN-81	1	7	8	9	8.25
N-1 Compass System	1	6	5	5	3.75
Directional Coupler CU-323/APN-81	1	3	3	7	0.25
Drift Angle Indicator ID-342/APN-81	1	4	4	4	1.12
Ground Speed Indicator ID-341/APN-81	1	4	4	6	1.12

AN/APN-99A

**PRINCIPAL COMPONENTS AND PHYSICAL DATA (cont'd)**

<b>COMPONENT</b>	<b>QTY</b>	<b>HEIGHT (Inches)</b>	<b>WIDTH (Inches)</b>	<b>DEPTH (Inches)</b>	<b>UNIT WT. (Pounds)</b>
Radar Set Control C-1195/APN-81	1	4	6	4	1.25
Radar Set Control C-1416/APN-81	1	6	6	5	3.00
Computer CP-221/ASN-7	1	10.6	8.4	5	17.1
Control C-1317/ASN-7	1	5	5	7	8.40
Computer CP-289A/ASN-7	1	10	5.9	6	17.9
Course and Drift Computer CP-290/ASN-7	1	5.9	4.4	3.4	4.85
Electronic Control Amplifier AM-1069/ASN-7A	1	5	9	7	1.50
Electronic Control Amplifier AM-917A/ASN-7	1	9	8	5	8.60
Indicator LD-526/ASN-7A					2.70
Radar Set AN/APN-82	1				
Computer Set Navigational AN/ASN-7A	1				
Interconnector Box J-530/APN-82	1				
Control Radar Set C-1196/APN-82	1				

**REFERENCE DATA AND LITERATURE**

Technical Orders:  
12P5-2APN81-1  
12P5-2APN81-2  
12P5-2APN81-3  
5-N-1-3-4-2

Specification:  
MIL-R-8103A

DATE: 1 July 1961

ITEM NAME: RADAR SET

COGNIZANT SERVICE: USN

TYPE: AN/APN-100

FEDERAL STOCK NUMBER:

	USA	USN	USAF	USMC
STATUS OR TYPE CLASSIFICATION				
Mfg(s) Name or Code Number: Emerson Research Laboratories				

Illustration Not Available

**FUNCTIONAL DESCRIPTION**

Radar Set AN/APN-100 is an electronic altimeter designed to indicate terrain clearance when the aircraft is operated at altitudes below 3,000 ft and at speeds not in excess of 450 knots. The AN/APN-100 is a general purpose, airborne equipment for installation in either rotary- or fixed-wing aircraft.

**TECHNICAL DESCRIPTION**

Frequency: 4200 to 4400 mc  
Operating Voltages: 27.5 vdc

**INSTALLATION CONSIDERATIONS**

Not available.

**RELATION TO SIMILAR EQUIPMENT**

None.

**PRINCIPAL COMPONENTS AND PHYSICAL DATA**

COMPONENT	QTY	HEIGHT (Inches)	WIDTH (Inches)	DEPTH (Inches)	UNIT WT. (Pounds)
Height Indicator ID-721/APN-100	1				
Radar Receiver-Transmitter RT-466/APN-100	1				
Electronic Altimeter Set Calibrator FR-129/APN-100	1				

**REFERENCE DATA AND LITERATURE**

Not available.

AN/APN-100: 1

DATE: 1 September 1964

ITEM NAME: RADAR SET

COGNIZANT SERVICE: USAF

TYPE: AN/APN-102

FEDERAL STOCK NUMBER: 5841-825-8810

	USA	USN	USAF	USMC
STATUS OR TYPE CLASSIFICATION			Std	
Mfg(s) Name or Code Number: GPL Division - General Precision, Inc (84347)				

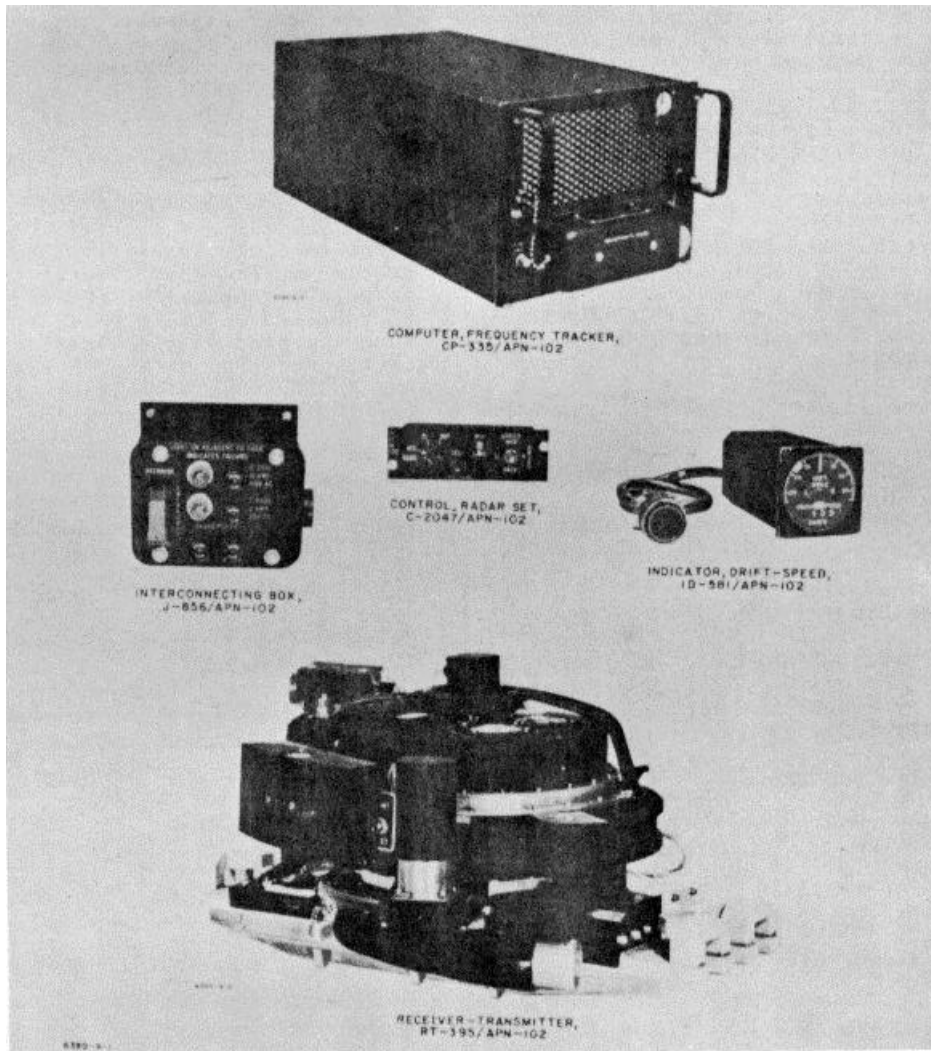

**FUNCTIONAL DESCRIPTION**

Radar Set AN/APN-102 is a lightweight, airborne, doppler-radar groundspeed and drift angle measuring system which is designed to fulfill the navigational

requirements of high-speed, high-altitude aircraft. The AN/APN-102, using doppler-radar techniques, measures groundspeed and drift angle directly, accurately, and continuously.

**ITEM NAME:** RADAR SET

**TYPE:** AN/APN-102

**RELATION TO SIMILAR EQUIPMENT**

The AN/APN-102 is a smaller version of the AN/APN-81.

**TECHNICAL DESCRIPTION**

Outputs

Groundspeed

Visual: Displayed in indicator.  
Electrical: Synchro output with scale factor of 36 deg of shaft rotation per 100 knots of ground-speed. 10K potentiometer output. Scale factor 360 deg per 100 knots. 2.5K potentiometer output. Scale factor 360 deg per 100 knots.

Drift Angle

Visual: Displayed on indicator.  
Electrical: Synchro differential output with scale factor of one deg of shaft rotation per deg of drift angle.

Limits of Operation

Groundspeed: Min 70 knots, max 939 knots.  
Drift Angle: Min 0 deg, max 35 deg  
Altitude: Min 200 ft, max 70,000 ft  
Pitch Stabilization: Max plus or minus 10 deg

Accuracy

Groundspeed: Probable error less than

0.3% plus 1.5 knots.  
Drift Angle: Probable error less than 0.25 deg  
Input Power Requirements: 115v ac, single ph, 400 cycles, 500 va; 28v dc, 3 amp  
Frequency Output: 8800 plus or minus 30 mc  
Power Output: 10w avg  
Range, Max: 70,000 ft  
Range, Min: 200 ft  
Duty Cycle: 0.25  
Environmental Limitations: All components, -55 deg C to plus 71 deg C  
Pulse Width: 1.5 usec above 35,000 ft varied continuously between 1.04 and 3.13 usec below 35,000 ft.  
Pulse Repetition Frequency: 55 kc above 35,000 ft. Varied continuously between 80 and 240 kc below 35,000 ft.

**INSTALLATION CONSIDERATIONS**

The Receiver Transmitter and computer require an external flow of cooling air for proper operation. Forced air must be supplied to these units through air ducts located on the units. Interconnecting cabling between units of the AN/APN-102 have to be fabricated for the particular installation.

**PRINCIPAL COMPONENTS AND PHYSICAL DATA**

COMPONENT	QTY	HEIGHT (Inches)	WIDTH (Inches)	DEPTH (Inches)	UNIT WT.
Receiver-Transmitter RT-395/APN-102	1	12-1/4	18-7/8	23-3/4	39 3/4
Mounting MT- 2148/APN-102	1	9-3/4	19 -1/4	22-1/4	2-3/4
Computer, Frequency Tracker CP-335/APN-102	1	8-9/32	10-1/8	23-1/32	44
Mounting MT-1754/APN-102	1	9-3/8	11-1/8	25-1/4	3-5/8
Control, Radar Set C-2047/APN-102	1	1-7/8	5-3/4	3-51/64	7/8
Indicator, Drift Speed ID-581/APN-102	1	3-1/4	3-1/4	7-13/32	3-9 /16
Interconnecting Box J-856/APN-102	1	5--1/16	4-15/16	5-13/32	1-9/16
Mounting MT-2147/APN-102	1	15/32	4-15/16	5	3/16

**REFERENCE DATA AND LITERATURE**

Technical Orders: Specifications:  
12P5-2APN102-2  
12P5-2APN102-3  
12P5-2APN102-4

USAF Exhibit WCLG-8  
MIL-R-27234

DATE: 15 May 1964  
COGNIZANT SERVICE: USAF

ITEM NAME: RADAR SET  
TYPE: AN/APN-105

FEDERAL STOCK NUMBER: 5841-612-8109

	USA	USN	USAF	USMC
STATUS OR TYPE CLASSIFICATION		Ltd Std		
Mfg(s) Name or Code Number: Laboratory for Electronics				

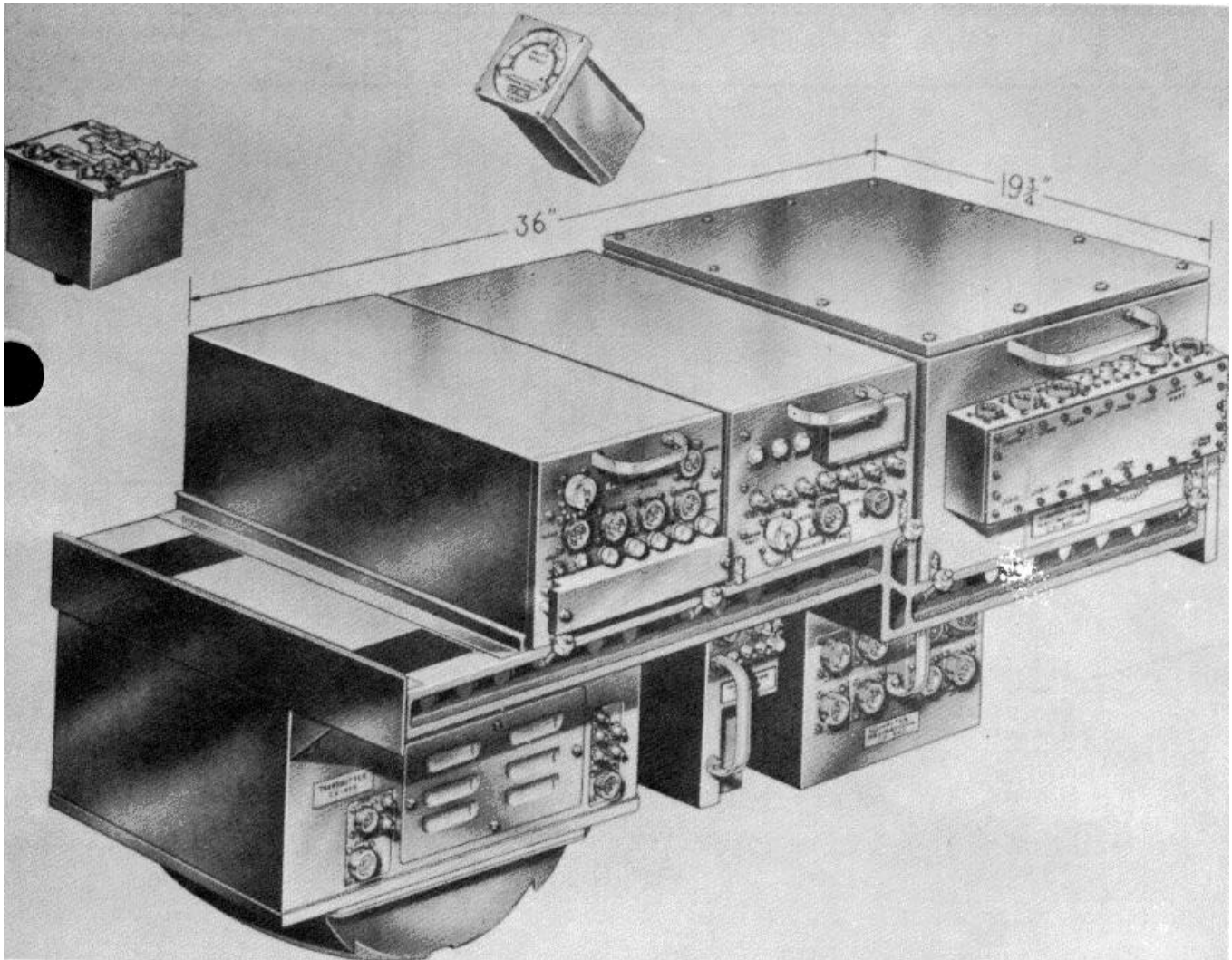

**FUNCTIONAL DESCRIPTION**

The AN/APN-105 is an airborne navigational radar which utilizes the doppler effect to obtain the velocity components of the aircraft. The velocities are processed in a computer to provide the aircraft's

present position, ground speed, drift angle, and course and distance to a destination.

**RELATION TO SIMILAR EQUIPMENT**

Similar to the AN APN-131



AN/APN-105

**TECHNICAL DESCRIPTION**

Frequency: 9800 t10 me., transmitting and receiving  
 Range, Max: 70,000 ft  
 Range, Min: ground level  
 Peak Power Output: 3w avg  
 Operating Voltages and Power Requirements:  
 28 vdc, 9. 2 amp, 250w  
 115 vac, 3-ph, 4-wire, 400 cps, 1, 242 va

Type of Presentation: Meters and counters  
 Duty Cycle: 0. 5  
 Environmental Limitations: -54 to +85 deg C (Will operate satisfactorily for 30 minutes at 95 deg C, then temp. must be lowered)

**INSTALLATION CONSIDERATIONS**

Not available.

**PRINCIPAL COMPONENTS AND PHYSICAL DATA**

COMPONENT	QTY	HEIGHT (Inches)	WIDTH (Inches)	DEPTH (Inches)	UNIT WT. (Pounds)
Tracker CV-447	1	8	10	19	30.0
Power Supply PP-1504	1	8	10	20	32.0
Computer, Navigational CP-340	1	7	10	15	30.0
Control C-1932	1	6	4	5	5.5
Indicator, Ground Speed ID-617	1	3	3	6	4.0
Frequency, Converter C-525	1	9-3/4	4-1/8	15	8-1/2
Transmitter CV-448	1	13	20	16	53.0
Computer. Navigational CP-301	1	11	15	20	54.0

**REFERENCE DATA AND LITERATURE**

Technical Orders:

- |                   |                  |
|-------------------|------------------|
| 12PC5-2APN105 -2  | 12P5-2APN105-44  |
| 12P5-2APN105-13   | 12P5-2APN105-53  |
| 12P5-2APN105-3-14 | 12P5-2APN105-54  |
| 12P5-2APN105-14C  | 12P5-2APN105-63' |
| 12P5-2APN105-23   | 12P5-2APN105-64  |
| 12P5-2APN105-24   |                  |
| 12P5-2APN105-33   | Mil Spec X-28668 |
| 12P5-2APN105-34   |                  |
| 12P5-2APN105-43   |                  |

DATE: 15 May 1964  
COGNIZANT SERVICE: USAF

ITEM NAME: RADAR SET  
TYPE: AN/APN-107

FEDERAL STOCK NUMBER:

	USA	USN	USAF	USMC
STATUS OR TYPE CLASSIFICATION				
Mfg(s) Name or Code Number: Sperry Gyroscope Company				

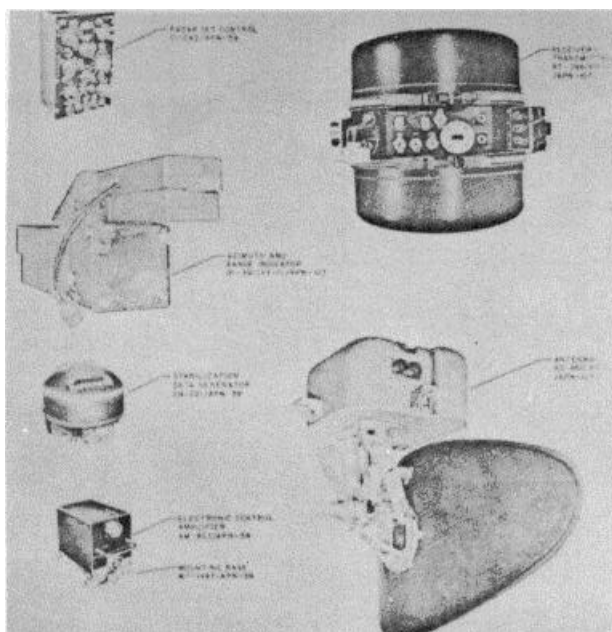

### FUNCTIONAL DESCRIPTION

Radar Set AN/APN-107 is a small, lightweight airborne radar system designed to operate as a navigational and search radar. An automatically operated recording camera is provided so that the radar set can be used for reconnaissance purposes.

### RELATION TO SIMILAR EQUIPMENT

Similar to the AN/APN-59.

### TECHNICAL DESCRIPTION

Frequency: 9375 mc 40 mc  
 Range, Max: 240 naut mi  
 Range, Min: 0. 24 naut mi  
 Power Output (Peak Power): 75 kw  
 Operating Voltages and Power Requirements:  
 110 to 120 vac, 380 to 420 cps, 2 amp  
 110 to 120 vac, 380 to 1,000 cps, 12 amp  
 24 to 29 vdc, 6. 5 amp  
 Type of Presentation: PPI  
 Number and Interval of Range Markers:  
 Range 3 to 30 mi 5-mi markers  
 Range 50 mi 10-mi markers  
 Range 100 mi 20-mi markers  
 Range 240 mi 30-mi markers  
 Duty Cycle: 0.002

#### Environmental Limitations:

May be operated at ambient temperatures ranging from 55 deg C at altitudes up to 50,000 ft  
 The antenna scans continuously at 45 rpm clockwise, for 3-mi to 30-mi and 50-mi ranges: and at 12 rpm, either clockwise or counterclockwise on the 100 and 240mi ranges.

Sector Scan: The sector through which the antenna scans is adjustable upon installation in 30 deg steps from 21 deg to 290 deg.

### INSTALLATION CONSIDERATIONS

Not available.

AN/APN-107: 1

AN APN-107

**PRINCIPAL COMPONENTS AND PHYSICAL DATA**

<b>COMPONENT</b>	<b>QTY</b>	<b>HEIGHT (Inches)</b>	<b>WIDTH (Inches)</b>	<b>DEPTH (Inches)</b>	<b>UNIT WT. (Pounds)</b>
Receiver-Transmitter RT-396(XY-1) APN-107	1	17	17	24	87.0
Antenna AS-850(XY-1) APN-107	1	17	17	28	42.0
Azimuth and Range Indicator IP-391(XY-1) APN-107	1	4	4	4	1.12
Radar Set Control C-1242 APN-59	1	7	8	7	22
Electronic Control Amplifier, AM-853, APN-59 Mounting Base MT-1497 APN-59	1	17	17	24	22
Stabilization Data Generator CN-22 APN-59	1	3	3	7	22

**REFERENCE DATA AND LITERATURE**

Technical Orders:  
12P5-2APN107-2  
12P5-2APN107-3  
12P5-2APN107-4

Specifications:  
MIL-E-5400

**AN/APN-107: 2**

DATE: 1 March 1965

ITEM NAME: RADAR SET

COGNIZANT SERVICE: USAF

TYPE: AN/APN-108

FEDERAL STOCK NUMBER:

	USA	USN	USAF	USMC
STATUS OR TYPE CLASSIFICATION			Ltd Std	

Mfg(s) Name or Code Number: GPL Division - General Precision Inc. (84347)

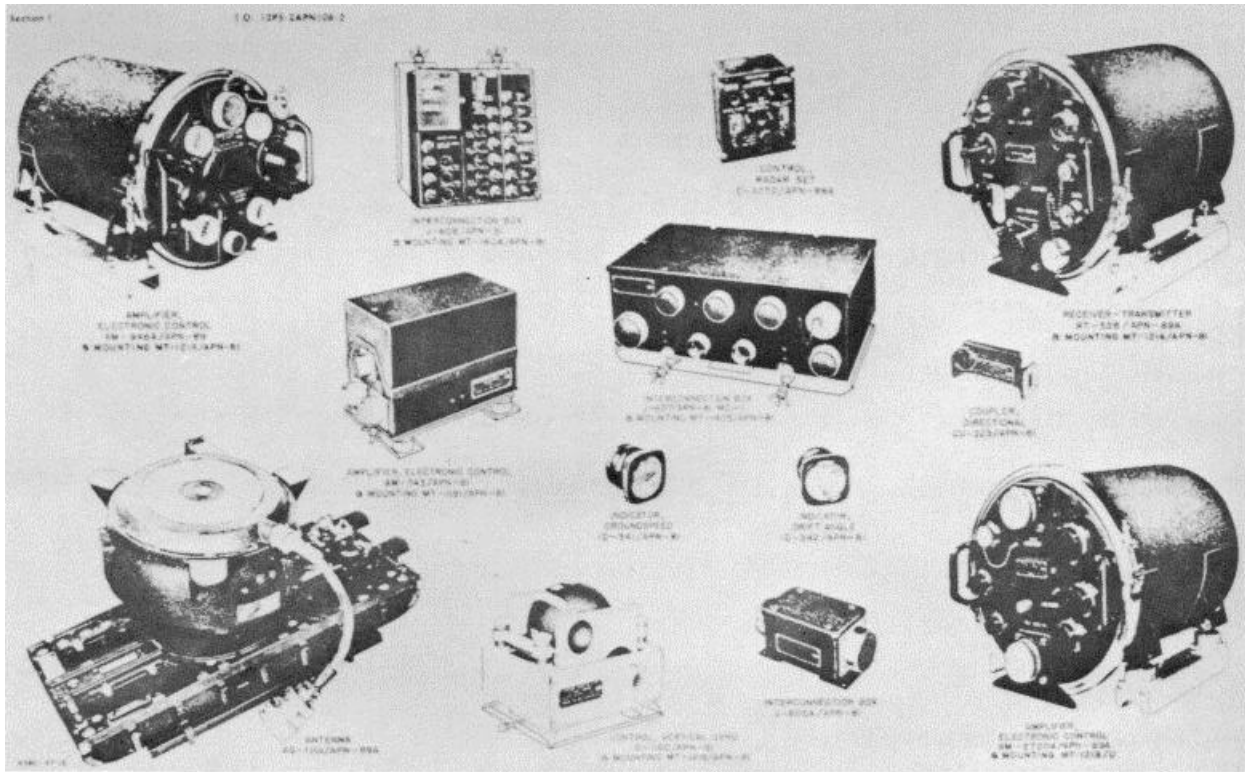

### FUNCTIONAL DESCRIPTION

The AN/APN-108 is an airborne, doppler radar, groundspeed and drift angle measuring equipment. It is designed to provide accurate groundspeed and drift angle data for a bombing-navigational system (BNS)

under normal operation. In memory mode of operation, the radar accepts dynamic values of groundspeed and drift angle from the BNS. The radar set is completely automatic and operates in normal mode over any surface except stretches of smooth water.

AN/APN-108: 1

**ITEM NAME:** RADAR SET  
**TYPE:** AN/APN-108

**RELATION TO SIMILAR EQUIPMENT**

The AN/APN-108 is comprised of components of the AN/APN-81 and AN/APN-89A Radar Sets.

**TECHNICAL DESCRIPTION**

Limits of Operation

- Altitude: Min 200 ft, max 70,000 ft
- Groundspeed: Min 70 knots, max 700 knots
- Acceleration without Signal Loss, G's:  
Max 0.7
- Drift Angle: min 0 deg max 49 deg
- Aircraft Pitch Without Loss of Signal  
Nose Up: Min 0 deg, max 24 deg  
Nose Down: Min 0 deg, max 14 deg
- Aircraft Roll Without Loss of Signal  
Right Wing Down: Min 0 deg, max 14 deg  
Left Wing Down: Min 0 deg, max 14 deg
- Aircraft Pitch Rate: Min 0 deg per sec,  
max 18 deg per sec
- Aircraft Roll Rate: Min 0 deg per sec,  
max 18 deg per sec
- Aircraft Yaw Rate: Min 0 deg per sec,

- max 18 deg per sec
- Radiation Frequency: 8700 to 8900 mc
- Probable Accuracy  
Groundspeed: plus or minus 2.5 knots at  
speed below 250 knots. Plus or minus  
1% of actual speed at higher speeds.
- Drift Angle: plus or minus 0.5 deg
- Required Inputs:  
Two sources, 3-wire heading information;  
shaft speed ratio to be 25/1 memory  
mode drift error correction  
memory mode groundspeed (variable gain)  
correction, variable gain potentiometers  
excitations
- Power Requirements: 108 - 120v ac, 380 -  
400 cps, 3-ph, 1900w; 28v dc, 65w

**INSTALLATION CONSIDERATIONS**

Not available.

**PRINCIPAL COMPONENTS AND PHYSICAL DATA**

COMPONENT	QTY	HEIGHT (Inches)	WIDTH (Inches)	DEPTH (Inches)	UNIT WT. (Pounds)
Antenna AS-1101/APN-89A	1	13-5/8	15	28-1/8	46
Receiver-Transmitter RT-528/APN-89A	1	16-7/8	16-1/4	23-5/8	90
Mounting MT-1216/APN-81	1				
Amplifier, Electronic Control AM-2720A/APN-89A	1	16-7/8	16-1/4	23-5/8	91
Coupler, Directional CU-323/APN-81	1	2-1/2	2-3/8	5	1/4
Interconnection Box J-607/APN-81 MD-1	1	5-7/8	11	16	24-1/2
Mounting MT-1405/APN-81	1				
Interconnection Box J-603/APN-81	1	4-7/8	8-1/4	10-7/8	6-3/4
Mounting MT-1404/APN-81	1				
Interconnection Box J-605A/APN-81	1	3-3/8	3-1/4	7-1/4	2
Control, Radar Set C-3270/APN-89A	1	6	5-3/4	5	3
Amplifier, Electronic Control AM-946A/APN-89	1	13-3/8	13-1/2	21-7/8	58
Mounting MT-1218/U	1				
Amplifier, Electronic Control AM-743/APN-81	1	7-3/4	6-1/8	10-5/8	10-1/2
Mounting MT-1191/APN-81	1				

**ITEM NAME:** RADAR SET  
**TYPE:** AN/APN-108

**PRINCIPAL COMPONENTS AND PHYSICAL DATA**

<b>COMPONENT</b>	<b>QTY</b>	<b>HEIGHT (Inches)</b>	<b>WIDTH (Inches)</b>	<b>DEPTH (Inches)</b>	<b>UNIT WT. (Pounds)</b>
Control, Vertical Gyro C-1160/APN-81	1	7	7-1/2	8-1/8	8-1/4
Mounting MT-1219/APN-81	1				
Indicator, Groundspeed ID-341/APN-81	1	3-1/4	3-1/4	3-1/2	1-1/4
Indicator, Drift Angle ID-342/APN-81	1	3-1/4	3-1/4	3-1/2	1-1/4

**REFERENCE DATA AND LITERATURE**

Technical Orders:

12P5-2APN108-2  
12P5-2APN81-           Series  
12P5-2APN89-           Series

**AN/APN-108: 3**

DATE: 1 September 1964

ITEM NAME: RADAR SET

COGNIZANT SERVICE: USN

TYPE: AN/APN-117

FEDERAL STOCK NUMBER:

	USA	USN	USAF	USMC
STATUS OR TYPE CLASSIFICATION		Used by		
Mfg(s) Name or Code Number: Sylvania Electric Products Inc., (00011)				

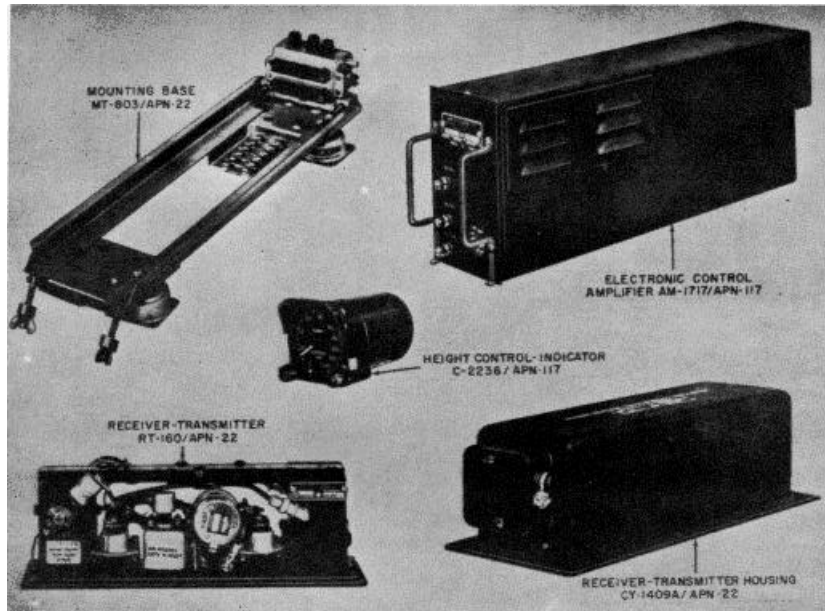

### FUNCTIONAL DESCRIPTION

Radar Set AN/APN-117 is a microwave altimeter which is designed to measure the surface or terrain clearance of an aircraft

without the necessity of adding antennas or other equipment external to the surface of the aircraft.

AN/APN-117: 1

**ITEM NAME:** RADAR SET  
**TYPE:** AN/APN-117

**RELATION TO SIMILAR EQUIPMENT**

This equipment is similar to, but not interchangeable with Radar Set AN/APN-22. The AN/APN-22 gives altitude readings from 0 to 20,000 ft. In the AN/APN-117 a modification of the servo system and indicator system gives improved read-out to 1000 ft.

Normal Operating Current: 1.35 amp (28v dc), 0.87 amp (115v, 320 to 1000 cyc), 0.13 amp (115v, 380 to 420 cyc)  
Maximum Starting Current: 4 amp (28v dc), 1 amp (115v, 320 to 1000 cyc), 0.15 amp (115v, 380 to 420 cyc)  
Altitude Range: 0 to 1000 ft  
Accuracy of Indication: plus or minus 2 ft (0 to 40 ft), plus or minus 5% (40 to 1000 ft)

**TECHNICAL DESCRIPTION**

Frequency Range: 4200 to 4400 mc  
Transmitter Output Power: 1w nom  
Modulation Capacity: 60 mc  
Type of modulation: FM  
Method of Modulation: Vibrating reed  
Power Requirements: 28v dc; 115v, 320 to 1000 cyc, 1-ph, 0.95 pf; 115v, 380 to 420 cyc, 1-ph, 0.95 pf

**INSTALLATION CONSIDERATIONS**

Related Equipment  
Required but not Supplied: (1) Radar Test Set AN/APM-66.

**PRINCIPAL COMPONENTS AND PHYSICAL DATA**

<b>COMPONENTS</b>	<b>QTY</b>	<b>OVERALL DIMENSIONS (Inches)</b>	<b>UNIT WT. (Pounds)</b>
Amplifier, Electronic Control AM-1717/APN-117	1	5-1/2 x 7-61/64 x 22-29/32	19.5
Mounting Base MT-803/APN-22	1	5-1/8 x 5-7/8 x 23-1/4	4.0
Control-Indicator, Height C-2236/APN-117	1 or 2	3-17/64 x 3-9/16 x 6-1/16	2.0
Receiver-Transmitter, Radar RT-160/APN-22	1	3-49/64 x 4-1/16 x 12-17/64	4.75
Housing, Receiver-Transmitter CY-1409A/APN-22	1	4-11/16 x 5-11/16 x 14-3/16	2.25

**REFERENCE DATA AND LITERATURE**

Technical Manuals:  
NAVWEPS 16-30APN117-1: Handbook of Operation Instructions  
NAVWEPS 16-30APN117-2: Handbook of Service Instructions  
NAVWEPS 16-30APN117-3: Handbook of Overhaul Instructions  
NAVWEPS 16-30APN117-4: Illustrated Parts Breakdown



DATE: 1 July 1964

ITEM NAME: RADAR SET

COGNIZANT SERVICE: USN

TYPE: AN/APN-120

FEDERAL STOCK NUMBER:

	USA	USN	USAF	USMC
STATUS OR TYPE CLASSIFICATION				
Mfg(s) Name or Code Number: Emerson Research Laboratories. Washington. D. C.				

Illustration Not Available

#### FUNCTIONAL DESCRIPTION

Radar Set AN/APN120 is an electronic altimeter that contains both a low and a high altitude altimeter. The low altitude altimeter, Radar Set AN/APN-100, measures from 0 to 3,000 ft. The high altitude altimeter, Radar Set AN/APN-42, measures from 1,500 to 75,000 ft. Low altitude accuracy is  $\pm (2 \text{ ft} + 2 \text{ qc h})$ . High altitude accuracy is  $\pm (22 \text{ ft} + 0.025 \text{ c h})$ . Low altitude information is displayed on a dial in the pilot cockpit. High altitude information is transmitted to an air data computer and a digital dial in the navigator's cockpit. The equipment is free from microphonics and other interference caused by the aircraft environment. Modular construction is employed and all units are bonded to a cold plate for efficient cooling.

#### RELATION TO SIMILAR EQUIPMENT

None.

#### TECHNICAL DESCRIPTION

Power Requirements: 115/200v, 400 cps, 3-ph  
4-wire, 26.5 vdc  
Presentation: Dial indications  
No. of Channels: 2 (one each band)  
Frequency: High altitude, 4225  $\pm$  25 mc; low altitude, 9150  $\pm$  50 mc  
Emission: High altitude, pulse; low altitude FMCW

#### INSTALLATION CONSIDERATIONS

Siting:  
Mounting: Hard mounted. Units are bonded to a cold plate for efficient cooling.  
Related Equipment:  
Cabling Requirement:

AN/APN- 120

<b>COMPONENT</b>	<b>QTY</b>	<b>HEIGHT (Inches)</b>	<b>WIDTH (Inches)</b>	<b>DEPTH (Inches)</b>	<b>UNIT WT. (Pounds)</b>
Radar Set AN/APN-42	1				
Radar Set AN/APN-100	1				
Computer, Air Data	1				
Indicator, Low Altitude	1				
Indicator, Digital, High Altitude	1				

**REFERENCE DATA AND LITERATURE**

Specification:  
MIL-E-18300(AER)

**AN/APN-120: 2**

DATE: 1 July 1961  
COGNIZANT SERVICE: USN

ITEM NAME: RADAR SET  
TYPE: AN/APN-122

FEDERAL STOCK NUMBER:

	USA	USN	USAF	USMC
STATUS OR TYPE CLASSIFICATION				
Mfg(s) Name or Code Number: Ryan Electronics, Div. of Ryan Aeronautical Co., San Diego, Calif.				

Illustration Not Available

#### FUNCTIONAL DESCRIPTION

Radar Navigation Set AN/APN-122 was designed for installation on several types of aircraft. Variations exist on some of the units used in the set. The set uses doppler effect to determine the amount of clearance between terrain and aircraft flights.

#### RELATION TO SIMILAR EQUIPMENT

Similar to AN/APN-97.

#### TECHNICAL DESCRIPTION

Frequency: Transmitting, 13.3 kmc  $\pm$ 5 mc; receiving, transmitted frequency minus frequency change due to doppler effect  
RF Power Output, Avg: 150w min  
Beam Width: Two 3-1/2 deg beams  
Operating Voltages and Power Requirements:  
Phase 1 - 108 to 131v to line neutral, 380 to 420 cps, 196.1w, 247 va  
Phase 2 - 108 to 121v to line neutral, 380 to 420 cps, 175.0w, 245 va

Phase 3 - 108 to 121v to line neutral, 380 to 420 cps, 203.0w, 275 va

Phase Total - 574.1w, 749 va, 420.6 var, 0.770 pf

Temperature Limits (Overall):

-55 to 71 deg C, continuous operation at sea level

-55 to 8 deg C, continuous operation at 70,000 ft

Temperature Limits for Ground Speed and Drift

Angle Indicator:

-55 to 55 deg C, continuous operation at sea level

-55 to 20 deg C, continuous operation at 70,000 ft

-55 to 71 deg C, intermittent operation (30-min intervals) at 70,000 ft

Altitude Limits: Sea level to 70,000 ft over land or over water having a sea state of Beaufort 1 or greater

#### INSTALLATION CONSIDERATIONS

Not available.

AN APN-122

COMPONENT	QTY	HEIGHT (Inches)	WIDTH (Inches)	DEPTH (Inches)	UNIT WT. (Pounds)
Receiver-Transmitter, Radar I RT-512/APN-122 or RT-457,'APN-122 or RT-533'APN-122 or RT-534 APN-122 or RT-535/APN-122 or RT-536 APN-122 or RT-511 IAPN-122					
Power Supply PP-2060.'APN-122	1				
Amplifier Assembly Doppler Signal AM-1969 APN-122	1				
Converter, Signal Data CV-698 'APN-122	1				
Computer. Ground Speed CP-435 APN-122	1				
Cooler, Liquid, Electronic Tube HD-334 APN-122	1				
Box Assembly, Interconnecting J-1006 APN-122	1				
Control Indicator C-2683 APN- 1 22	1				
Indicator,Ground Speed and Drift Angle 80-800 knots ID-733 APN-122 or	1				
Indicator, Ground Speed and Drift Angle 80-400 knots ID-757 APN-122	1				
Transmitter, Altitude Data T-624 APN-67	1				
Amplifier Assembly, Electronic Control AM-2209 AJA-3					
Gyroscope Assembly, Displacement CN-561 AJA-3					

**REFERENCE DATA AND LITERATURE**

Handbooks:

- NAVAER 16-30APN122-1
- NAVAER 16-30APN122-2
- NAVAER 16-30APN122-3

DATE: 1 July 196.1

ITEM NAME: RADAR NAVIGATION SET

COGNIZANT SERVICE: USN

TYPE: AN/APN-130

FEDERAL STOCK NUMBER!

	USA	USN	USAF	USMC
STATUS OR TYPE CLASSIFICATION				
Mfg(s) Name or Code Number: Ryan Electronics Div. of Ryan Aeronautical Company				

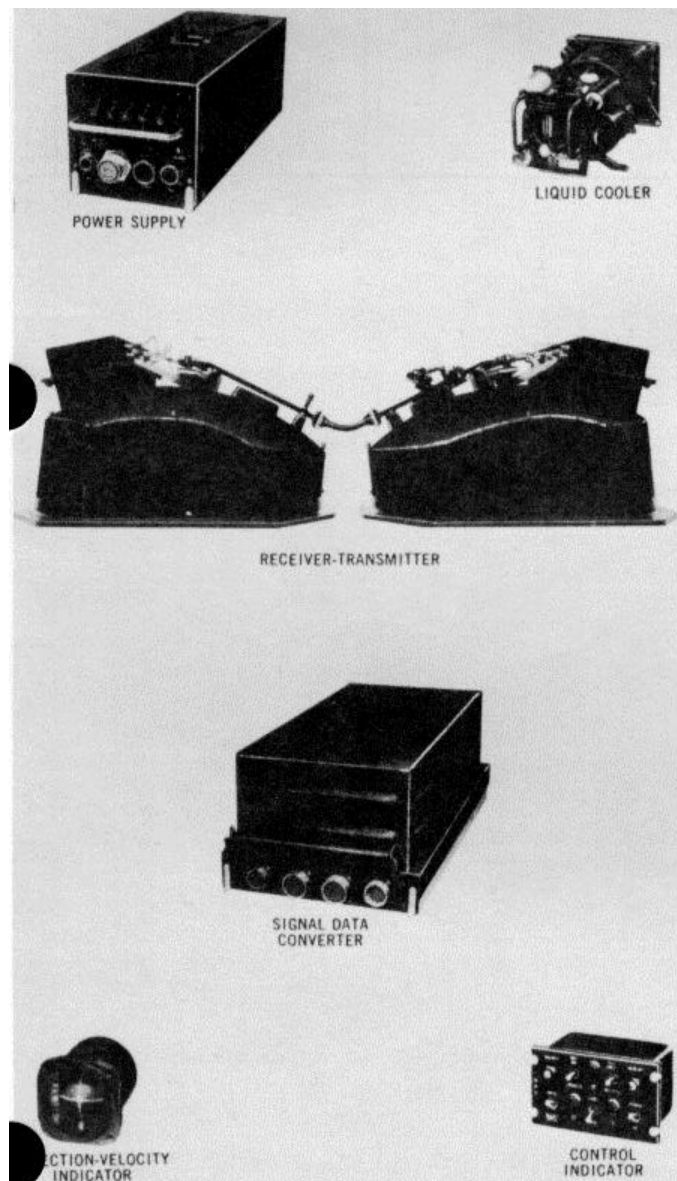

### FUNCTIONAL DESCRIPTION

The AN/APN-130 is a cw doppler navigation set designed primarily as an all weather ground velocity indicator for helicopters, airships, and other aircraft with hovering or negative speed characteristics. The set automatically and continuously measures and displays heading speed, drift speed, and vertical speed without the aid of ground stations, wind estimates, or true air speed data. Outputs are provided for tie-in with helicopter automatic stabilization equipment, ground position computing and indicating equipment, and distance computing and indicating equipment.

### RELATION TO SIMILAR EQUIPMENT

None.

### TECHNICAL DESCRIPTION

Heading Speed: 0 to  $\pm 150$  knots  
 Drift Speed: 0 to  $\pm 150$  knots  
 Ground Speed: 0 to  $\pm 150$  knots  
 Drift Angle: Any  
 Vertical Speed: 0 to  $\pm 3,500$  ft per min  
 Altitude Range: 0 to 10,000 ft  
 Type of System: C-W Doppler; four fixed beams  
 Transmitter Frequency: 13,300 mc  
 Transmitter Power: 5w  
 Antenna Beam Width: 3 deg  
 Power Consumption: 500w  
 Power Requirements: 115/200v, 400 120 cps,  
 1-ph  
 Navigational Accuracy: Error of less than 2%  
 at altitudes up to 10,000 ft

### INSTALLATION CONSIDERATIONS

Not available.

AN/APN-130:

AN/APN- 130

COMPONENT	QTY	HEIGHT (Inches)	WIDTH (Inches)	DEPTH (Inches)	UNIT WT. (Pounds)
Radar Receiver-Transmitter RT-( *)/APN-130	1				20.6
Signal Data Converter CV-( *)/APN-130	1	7	10-1/8	19	22.5
Power Supply, PP-( *)/APN-130	1	6-3/4	7-5/8	19-3/4	18.8
Direction-Velocity Indicator ID-( *)/APN	1		3-1/4 (dia)	4	1.5
Control Indicator, C-( *)/APN- 130	1	3-3/8	5-3/4	4-3/8	1.2
Liquid Cooler, HD-334/APN-122	1	4-1/2	6	10-3/4	6.4

\*Number not yet assigned.

#### REFERENCE DATA AND LITERATURE

Not available.

AN/APN-130: 2

DATE: 15 May 1964

ITEM NAME: RADAR SET

COGNIZANT SERVICE: USAF

TYPE: AN/APN-131

FEDERAL STOCK NUMBER:

	USA	USN	USAF	USMC
STATUS OR TYPE CLASSIFICATION			S td	
Mfg(s) Name or Code Number: Laboratory for Electronics				

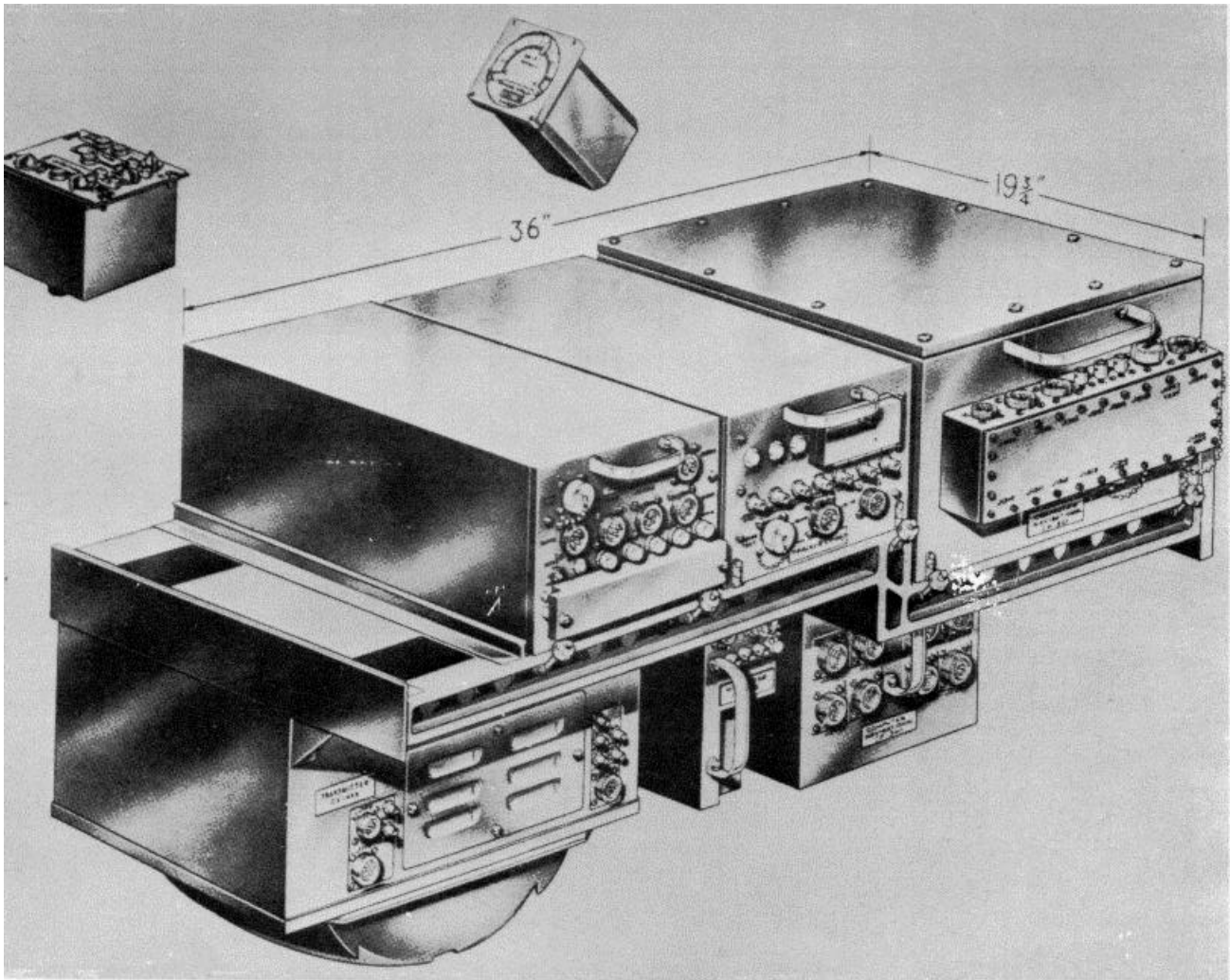

**FUNCTIONAL DESCRIPTION**

The AN/APN-131 is an airborne navigational radar which utilizes the doppler effect to obtain the velocity components of the aircraft. The velocities are processed in a computer to provide the aircraft's

present position, ground speed, drift angle course and the distance to a destination, and other outputs.

**RELATION TO SIMILAR EQUIPMENT**

Similar to the AN/APN-105.

AN/APN-131

**TECHNICAL DESCRIPTION**

Frequency: 9800 \*10 mc, transmitting and receiving  
 Range, Max: 70, 000 ft  
 Range, Min: Ground level  
 Peak Power Output: 3w avg  
 Operating Voltages and Power Requirements:  
 28 vdc to 9. 2 amp, 250w  
 115 vac, 3-ph, 4-wire, 400 cps, 1,242va

Type of Presentation: Meters and counters  
 Duty Cycle: O. 5  
 Environmental Limitations: -54 to 85deg C; for a 30-min period will operate satisfactorily at +90 deg C, then must be lowered.

**INSTALLATION CONSIDERATIONS**

Not available.

**PRINCIPAL COMPONENTS AND PHYSICAL DATA**

<b>COMPONENT</b>	<b>QTY</b>	<b>HEIGHT (Inches)</b>	<b>WIDTH (Inches)</b>	<b>DEPTH (Inches)</b>	<b>UNIT WT. (Pounds)</b>
Tracker CV-447	1	8	10	19	30.0
Computer, Navigational CP-301	1	11	15	20	54.0
Computer, Navigational CP-340	1	7	10	15	30.0
Power Supply PP-1504	1	8	10	20	32.0
Indicator, Ground Speed ID-617	1	3	3	6	4.0
Frequency Converter CV-525 Control C-1932	1 1	9-3/-4 6	4 4	15 5	8-1/2 5. 5
Transmitter CV-448	1	13	20	16	53.0

**REFERENCE DATA AND LITERATURE**

Technical Orders:

12P5-2APN131-2  
 12P5-4-12-3  
 12P5-4-12-4  
 12P5-4-12-13  
 12P5-1-12-14

12P5-4-12-23  
 12P5-4-12-24  
 12P5-1-12-24C

USAF Exhibit WCLG-13.

**AN/APN-131: 2**



DATE: 1 December 1964

ITEM NAME: ELECTRON'IC ALTIMETER SET

COGNIZANT SERVICE: USAF

TYPE: AN/APN-133

FEDERAL STOCK NUBMER: 5841-887-7447

	USA	USN	USAF	USMC
STATUS OR TYPE CLASSIFICATION			Ltd Std	
Mfg( ) Name or Code Number: Stewart-Warner Corporation (57733)				

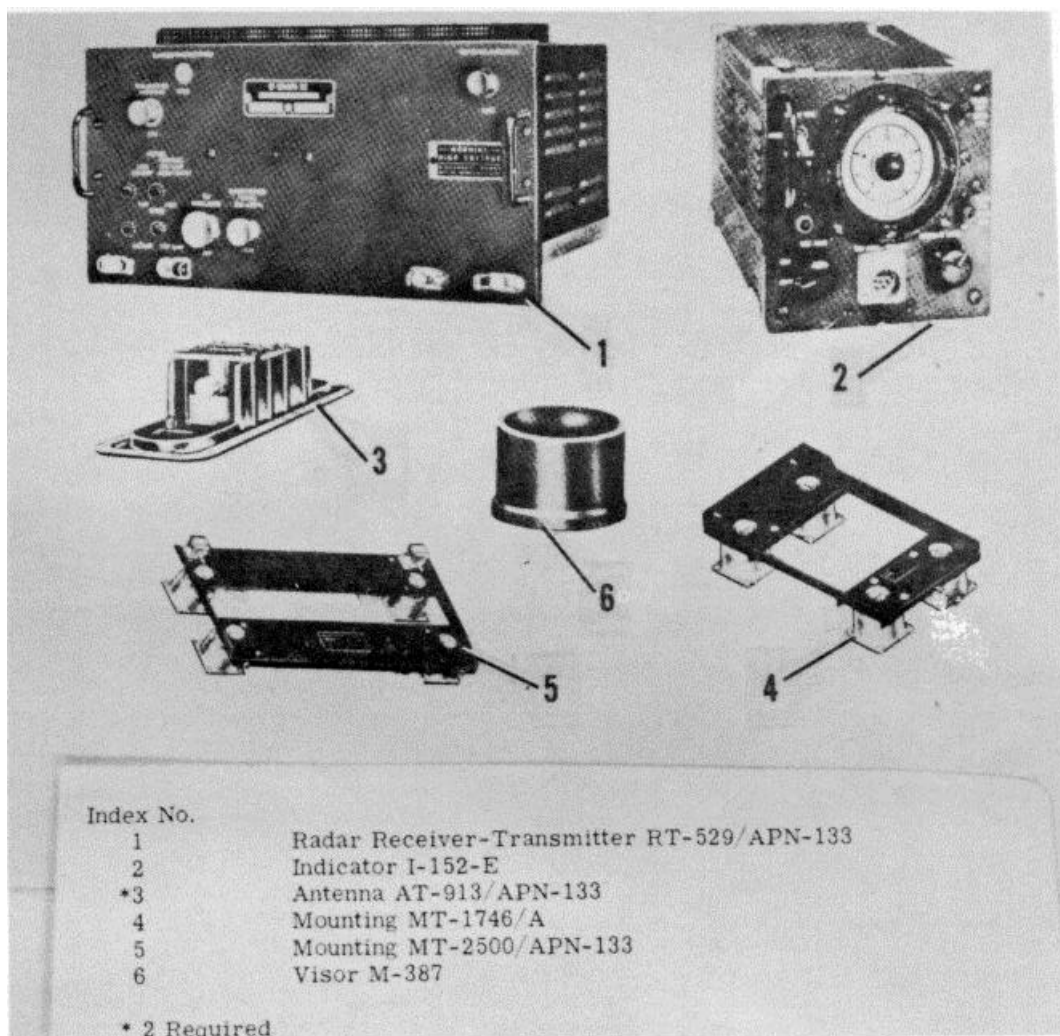

**FUNCTIONAL DESCRIPTION**

The AN/APN-133 Electronic Altimeter Set is a high altitude radar-type altimeter for airvorne use, designed to indicate absolute altitude up to 50,000 feet. Altitude indication is presented on the calibrated face of

a cathode ray tube. Operation of the equipment in non-pressurized cabins is limited to 50,000 feet above sea level. The indications are accurate to plus or minus 2% on the high range (50,000 foot) scale.

**ITEM NAME:** ELECTRONIC ALTIMETER SET  
**TYPE:** AN/APN-133

**RELATION TO SIMILAR EQUIPMENT**

The Indicator I-152-E is also used in Radio Set SCR-718-D, E & F auxiliary Height Indicator ID-951/APN-133 may be used as an accessory to Indicator I-152-E to provide digital readout of altitude indications.

On times - ten scale, 0.3 usec max  
Loop Sensitivity: Transmitter-output attenuation to receiver input required to produce 1/4- in. lobe height on indicator, 120 db  
Receiver Sensitivity  
Tangential (Min) - 88 dbm  
Noise Figure: 14 db (max)  
Input Impedance: 5( ohms  
IF Receiver: 30 mc; -4 mc bandwidth  
Indicator:  
Video Bandwidth, 0.5 mc; masking of received pulse by initial pulse, 700 ft max  
Antenna Beamwidth: 50 deg to 60 deg conical  
Operational Altitude (In non-pressurized cabin):  
Receiver-Transmitter and Antenna - 70,000 ft  
Indicator - 50,000 ft above sea level

**TECHNICAL DESCRIPTION**

Input Power Requirements: 100 to 121v ac, 380 to -420 cps, single ph, 1.3 amp 150w. (with auxiliary indicator, 180w)  
Transmitter & Receiver Freq: 1640 plus or minus 5 mc; max freq difference between transmitter and receiver, 1 mc.  
Transmitter Power Output: Min, 75w peak into 50 ohm load  
Pulse Repetition Frequency:  
On times - one scale 49.164 kc plus or minus 0.02%  
On times - ten scale 9.83 kc plus or minus 0.3%  
Pulse Width:  
On times - one scale, 0.2 usec max

**INSTALLATION CONSIDERATIONS**

Not Available.

**PRINCIPAL COMPONENTS AND PHYSICAL DATA**

COMPONENT	QTY	HEIGHT (Inches)	WIDTH (Inches)	DEPTH (Inches)	UNIT WT. (Pounds_)
Receiver-Transmitter 1 RT-529/-APN- 133	1	8-1/2	15-1/8	8-3/8	18
Indicator I-152-E	1	6-1/2	6-9/16	12-1/2	10-1/2
Antenna AT-913/APN-133	2	1	13	2-1/U	
Mounting MT-17.16'A	1	2-3/4	10-5/16	6-3/-i	
Mounting MT-2500/APN-133	1	1-7/5	115-1/16	7 1	
Visor M-3857	1				

**REFERENCE DATA AND LITERATURE**

Technical Orders:  
12P5-2APN133-2                      12PS-3SCR718-21  
12P5-2APN133-4                      12P5-3SCR718-22  
12P5-2APN133-12                      12P5-3SCR718-23  
12PS-2APN133-14                      12P5-3SCR718-24

DATE: 1 March 1965

ITEM: RENDEZVOUS RADAR BEACON SET

COGNIZANT SERVICE: USAF

TYPE: AN/APN-135

FEDERAL STOCK NUMBER:

	USA	USN	USAF	USMC
STATUS OR TYPE CLASSIFICATION			Std	
Mfg (s) Name or Code Number: Bendix Corporation (77068)				

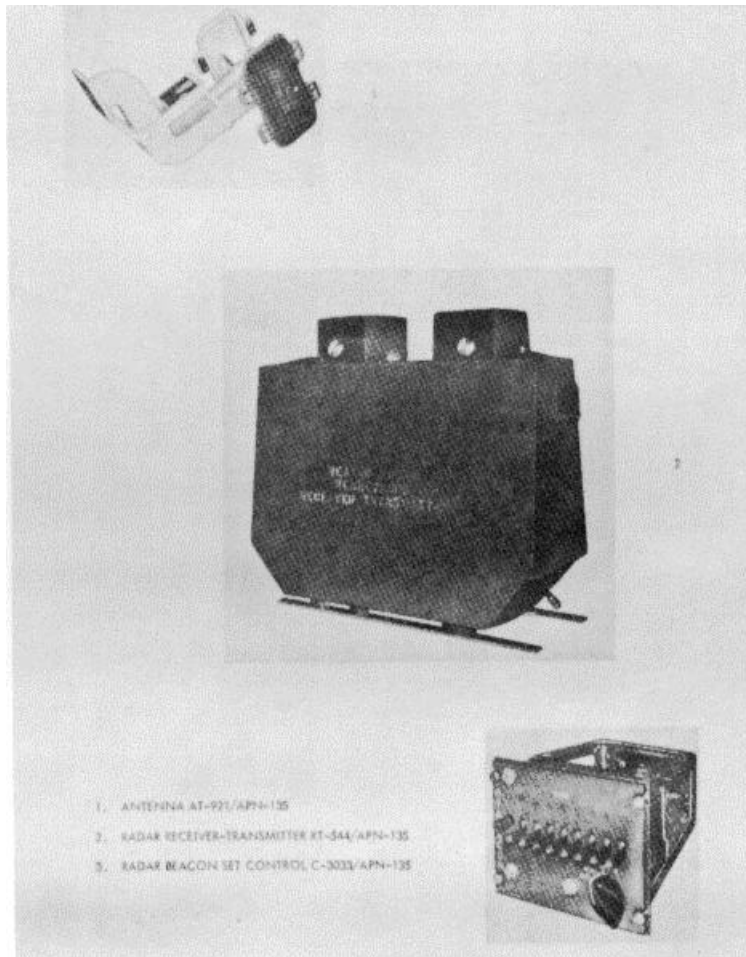

**FUNCTIONAL DESCRIPTION**

The AN/APN-135 is an airborne X-band radar beacon designed to serve as a navigational aid. The beacon is used in conjunction with in-flight refueling tankers with X-band radar systems equipped with

appropriate beacon interrogation facilities. In response to proper interrogation signals from a radar system, the beacon transmits a coded reply which results in a presentation on the radar display indicating the range, bearing, and identity of the beacon-equipped aircraft.

**ITEM NAME:** RENDEZVOUS RADAR BEACON SET

**TYPE:** AN/APN-135

**RELATION TO SIMILAR EQUIPMENT**

None .

IF. Amplifier Bandwidth: 105 mc (rain)  
Number Code Elements Available: 9 (max)  
1 (min)  
Number Code Combinations Available: 53  
(min)  
Power Output: 1000w peak (min), 1.1w to  
1.4w avg (min)  
Input Power Requirement: 115v ac, .100  
cps, 3-ph, 1.1 amp; 2tv ac, 0.2 amps;  
plus 150v dc, 0.260 amp; -150v dc,  
0.057 amp; plus 28v dc, 0..4 amp

**TECHNICAL DESCRIPTION**

Transmitter Frequency: 9310 plus or  
minus 1.5 mc  
Input Signal Frequency: 9335 to 9.15 mc  
Local Oscillator Frequency: 9310 mc  
Type Signal Transmitted: 0.5 plus or  
minus 0.1 usec pulses  
Input Signal Pulse Width: 2.2 usec (min),  
2.5 usec (max)  
System Sensitivity: -66 dbm

**INSTALLATION CONSIDERATIONS**  
Not available.

**PRINCIPAL COMPONENTS AND PHYSICAL DATA**

<b>COMPONENT</b>	<b>QTY</b>	<b>HEIGHT (Inches)</b>	<b>WIDTH (Inches)</b>	<b>DEPTH (Inches)</b>	<b>UNIT WT. (Pounds)</b>
Antenna AT-921/APN-135	1	6.96	6.52	3.46	0.627
Radar Beacon Set Control C-3033/APN-135	1	-1.5	5.75	5.75	2..13
Radar Receiver-Transmitter RT-544/APN-135	1	15.125	6.0	18.75	37.33

**REFERENCE DATA AND LITERATURE**

Technical Orders:  
12PS-2APN135- Series

DATE: 1 September 1964

ITEM NAME: ELECTRC .IC ALTIMETER SET

COGNIZANT SERVICE: USN

TYPE: AN/APN-I 11

FEDERAL STOCK NUMBER:

	USA	USN	USAF	USMC
STATUS OR TYPE :CLASSIFICATION		Used by		
Mfg(s) Name or Code Number: Bendix Corporation, Bendix-Pacific Div. (77068)				

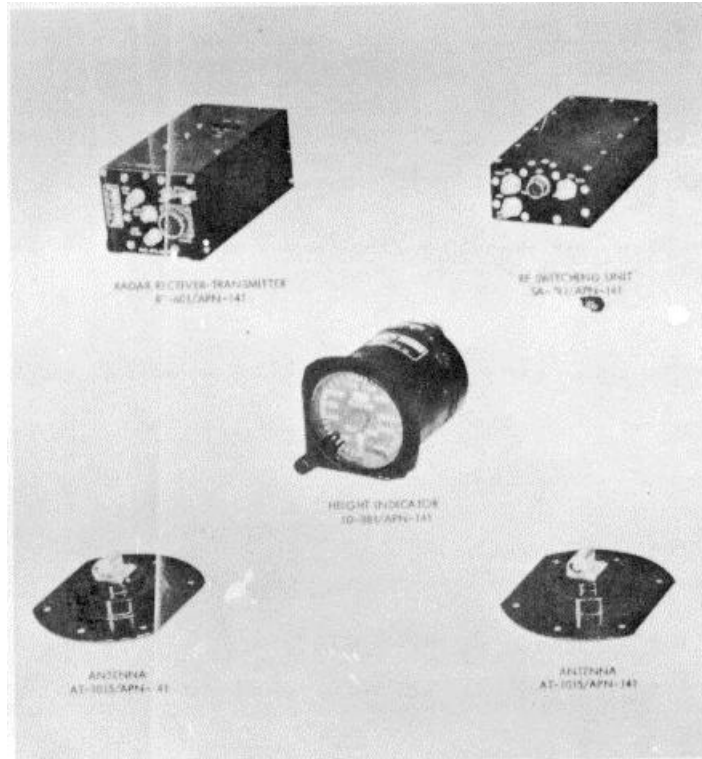

**FUNCTIONAL DESCRIPTION**

Altimeter Set, Electronic AN/APN-141 is an airborne, pulsed range-tracking radar, designed to provide highly accurate altitude information from 0 to 5000 ft. Altitude information is developed by radiating a short duration RF

pulse from the transmit antenna towards the ground, and measuring the time interval until RF energy returns through the receive antenna and is detected in the receiver. The altitude information is continuously presented to the aircraft pilot, in feet of altitude, on the dial

AN/APN-141: 1

**ITEM NAME:** ELECTRONIC ALTIMETER SET  
**TYPE:** AN/APN-141  
of an indicator mounted in the aircraft instrument panel.

System Sensitivity: -125 dbm max  
Antenna Characteristics  
Type: Double slot array  
Gain: 7.5 db  
Voltage Standing Wave Ratio: 1.5 to 1  
Beamwidth at 3 db Points: 800 line-of-flight axis, 600 roll axis  
Power Requirements: 115v, 400 cyc, 1-ph, 75w max  
Shock Tolerance  
RF Switching Unit: 15g max (operational), 30g max (survival)  
Antenna: 15g max (operational), 30g max (survival)  
Indicator: 15g max  
Temperature Range  
RF Switching Unit: -54 to plus 950C (-63 to 2030F)  
Antenna: -54 to plus 950C (-63 to plus 2030F)  
Indicator: -54 to plus 71JC (-63 to plus 160°F)

**RELATION TO SIMILAR EQUIPMENT**

None.

**TECHNICAL DESCRIPTION**

Type of Equipment: Radar, range tracking  
Altitude Range: 0 to 5000 ft  
System Response to Changes in Altitude (Tracking Rate): 0.2 A ft per sec, where A is aircraft altitude in ft (600 ft per sec max)  
Operating Frequency: 4300 plus or minus 10 mc  
Pulse Repetition Frequency: 1500 pps in low altitude, 3000 pps in high altitude  
Pulse Length at 3 db Points: 10 to 30 nanoseconds in low, 85 in high altitude  
Power Output: 33 dbm (2.00w) peak in low altitude, 60 dbm (1.0 kw) peak in high altitude  
Receiver Sensitivity: -65 dbm min

**INSTALLATION CONSIDERATIONS**  
Not available.

**PRINCIPAL COMPONENTS AND PHYSICAL DATA**

<b>COMPONENTS</b>	<b>QTY</b>	<b>OVERALL DIMENSIONS (Inches)</b>	<b>UNIT WT. (Pounds)</b>
Receiver-Transmitter, Radar RT-601/APN-141	1	3-1/8 x 3-21/64 x 8-3/64	6
Switching Unit, RF SA-791/APN-141	1	2-5/64 x 3-1/2 x 8-9/64	3
Indicator, Height ID-881/APN-141	1	3-15/64 x 3-15/64 x 5-5/16	2
Antenna AT-1015/APN-141	1	1-15/32 x 3-7/16 x 4-17/64	0.2

**SHIPPING DATA**

<b>COMPONENTS</b>	<b>PKGS</b>	<b>VOLUME(CU FT)</b>	<b>UNIT WT. (Pounds)</b>
	1		

**REFERENCE DATA AND LITERATURE**

Technical Manuals:  
NAVWEPS 16-30APN141-1: Handbook of Service Instructions for AN/APN-141 & AN/APN-141A  
NAVWEPS 16-30APN141-2: Handbook of Overhaul Instructions for AN/APN-141 & AN/APN-141A  
NAVWEPS 16-30APN141-3: Illustrated Parts Breakdown for AN/APN-141 & AN/APN-141A

DATE: 1 September 1964

ITEM NAME: ELECTRONIC ALTIMETER SET

COGNIZANT SERVICE: USN

TYPE: AN/APN-141A

FEDERAL STOCK NUMBER:

	USA	USN	USAF	USMC
STATUS OR TYPE CLASSIFICATION		Used by		
Mfg(s) Name or Code Number: Bendix Corporation, Bendix-Pacific Divo (77068)				

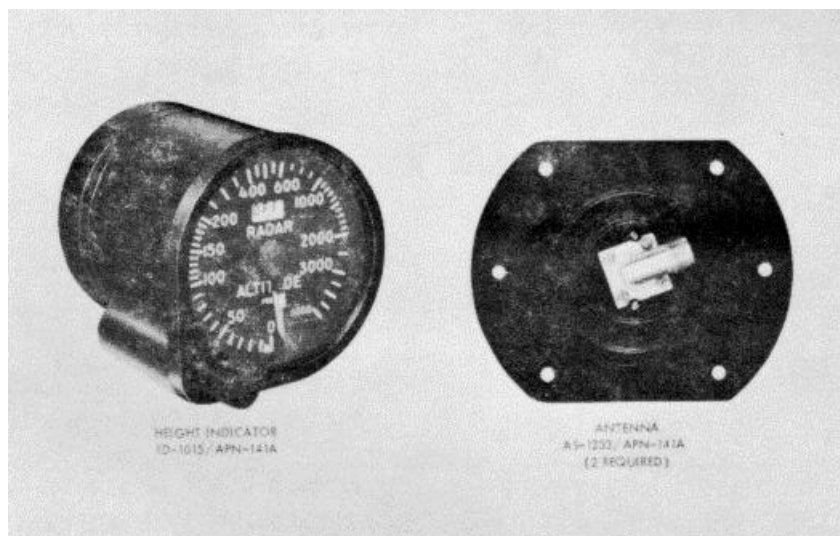

**FUNCTIONAL DESCRIPTION**

Electronic Altimeter Set AN/APN-141A is an airborne, pulsed range-tracking radar, designed to provide highly accurate altitude information from 0 to 5000 ft. Altitude information is developed by radiating a short

duration RF pulse from the transmit antenna towards the ground, and measures the time interval until RF energy returns through the receive antenna and is detected in the receiver. The altitude information is continuously presented to the aircraft pilot, in feet of altitude, on the

**AN/APN-141A: 1**

**ITEM NAME:** ELECTRONIC ALTIMETER SET  
**TYPE:** AN/APN-141A

dial of an indicator mounted in the aircraft instrument panel.

System Sensitivity: -125 dbm max  
Antenna Characteristics  
Type: Double slot array  
Gain: 7.5 db  
Voltage Standing Wave "Ratio: 1.5 to 1  
Beamwidth at 3 db Points. 800 line-of-flight axis, 600 roll axis  
Power Requirements: 115v, 400 cyc, 1-ph, 75w max  
Shock Tolerance  
RF Switching Unit: 15g max (operational), 30g max (survival)  
Antenna: 15g max (operational), 30g max (survival)  
Indicator: 15g max  
Temperature Range  
RF Switching Unit: -54 to plus 950C (-63 to plus 2030F)  
Antenna: -54 to plus 950C (-63 to plus 203°F)  
Indicator: -54 to plus 71°0C (-63 to plus 1600F)

**RELATION TO SIMILAR EQUIPMENT**

None.

**TECHNICAL DESCRIPTION**

Type of Equipment: Radar, range tracking  
Altitude Range: 0 to 5000 ft  
System Response to Changes in Altitude (Tracking Rate): 0.2 A ft per sec, where A is aircraft altitude in ft (600 ft per sec max)  
Operating Frequency: 4300 plus or minus 10 mc  
Pulse Repetition Frequency: 1500 pps in low altitude, 3000 pps in high altitude  
Pulse Length at 3 db Points: 10 to 30 nanoseconds in low altitude, 85 nanoseconds in high altitude  
Output Power: 33 dbm (2.0w) peak in low altitude, 60 dbm (1.0 kw) peak in high altitude  
Receiver Sensitivity: -65 dbm min

**INSTALLATION CONSIDERATIONS**

Not available.

**PRINCIPAL COMPONENTS AND PHYSICAL DATA**

COMPONENTS	QTY	OVERALL DIMENSIONS (Inches)	UNIT WT. (Pounds)
Receiver-Transmitter, Radar RT-601/APN-141	1	3-1/8 x 3-21/64 x 8-3/64	6
Switching Unit, RF SA-791/APN-141	1	2-5/64 x 3-1/2 x 8-9/64	3
Indicator, Height ID-1015/APN-141A	1	3-15/64 x 3-15/64 x 5-5/16	2
Antenna AS-1233/APN-141A	2	1-15/32 x 3-7/16 x 4-17/64	0.2

**SHIPPING DATA**

COMPONENTS	PKGS	OVERALL DIMENSIONS (Inches)	UNIT WT. (Pounds)
------------	------	-----------------------------	-------------------

**REFERENCE DATA AND LITERATURE**

Technical Manuals:  
NAWWEPS 16-30APN141-1: Handbook of Service instructions for AN/APN-141 & AN/APN-141A  
NAWWEPS 16-30APN141-2: Handbook of Overhaul instructions for AN/APN-141 & AN/APN-141A  
NAWWEPS 16-30APN141-3: Illustrated Parts Breakdown for AN/APN-141 & AN/APN-141A.





DATE: 1 September 1964

ITEM NAME: RADAR SET

COGNIZANT SERVICE: USAF

TYPE: AN/APN-144

FEDERAL STOCK NUMBER:

	USA	USN	USAF	USMC
STATUS OR TYPE CLASSIFICATION			Std	
Mfg(s) Name or Code Number: General Precision, Inc. (84347)				

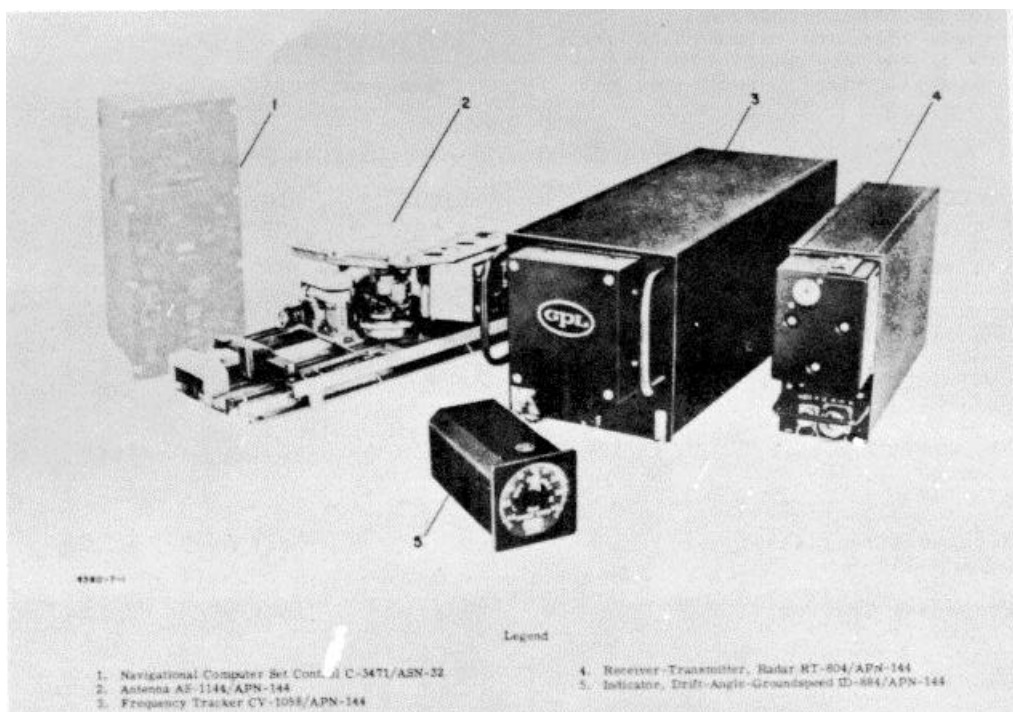

### FUNCTIONAL DESCRIPTION

The AN/APN-144 is an airborne, doppler navigational radar system designed for high-speed, high-altitude aircraft. The radar presents groundspeed and drift angle data visually on an indicator and in

addition supplies the same data as electrical inputs to navigational computer set AN/ASN-32. The AN/APN-144, AN/ASN-32, and Inertial Reference Group OA3077/AJN-10 comprise Doppler-Inertial Navigational Control AN/AJN-10.

AN/APN-144: 1

**ITEM NAME:** RADAR SET  
**TYPE:** AN/APN-144

**RELATION TO SIMILAR EQUIPMENT**

None.

**TECHNICAL DESCRIPTION**

Outputs

Groundspeed

Visual: Displayed on Indicator as digital readout.

Electrical: Synchro output with scale factor of 36 deg shaft rotation per 100 knots of ground-speed. Potentiometer output with 360 deg per 100 knots.

Drift Angle

Visual: Displayed on Indication as pointer an expanded scale.

Electrical: Synchro output with scale factor of one deg shaft rotation per deg of drift angle; Synchro output

with scale factor of three deg shaft rotation per deg of drift angle.

Limits of Operation

Groundspeed: 70 to 1000 knots.

Drift Angle: 40 deg max to left or right.

Altitude: 200 to 50,000 ft

Altitude: Pitch angles within plus or minus 15 deg from horizontal

Accuracy

Groundspeed: plus or minus 0.6% plus 1.0 knot for 95% of observations.

Input Power Requirements:

115 plus or minus 11v ac, 380 to 420 cps, 525 va.

26v ac plus or minus 2.5, 400 cps

28v dc plus or minus 2.5, 100 ma (max)

**INSTALLATION CONSIDERATIONS**

Not available.

**PRINCIPAL COMPONENTS AND PHYSICAL DATA**

COMPONENT	QTY	HEIGHT (Inches)	WIDTH (Inches)	DEPTH (Inches)	UNIT WT. (Pounds)
Radar Receiver-Transmitter RT-604/APN-144	1	7-5/8	3-9/16	12-9/16	13-3/4
Antenna AS-1144/APN-144	1	12	5-1/2	22	14-3/4
Frequency Tracker 1 CV-1058/APN-144	7-5/8	7-1/2	19-9/16	42	
Indicator, Drift Angle-Groundspeed ID-884/APN-144	1	3-1/4	3-1/4	6-1/2	4
Mount, Receiver-Transmitter MT-2460/APN-144	1	9	4-7/8	15-5/8	2-3/4
Mount, Frequency Tracker MT-2461/APN-144	1	9-5/16	8-1/2	22-5/8	5

**REFERENCE DATA AND LITERATURE**

Technical Orders:

- 12P5-2APN144-2
- 12P5-2APN144-3
- 12P5-2APN144-4
- 12P5-2APN144-501

DATE: 1 September 1964  
COGNIZANT SERVICE: USAF

ITEM NAME: RADAR SET  
TYPE: AN/APN-147

FEDERAL STOCK NUMBER:

	USA	USN	USAF	USMC
STATUS OR TYPE CLASSIFICATION		Alt Std		
Mg(s) Name or Code Number: Canadian Marconi Company (90073)				

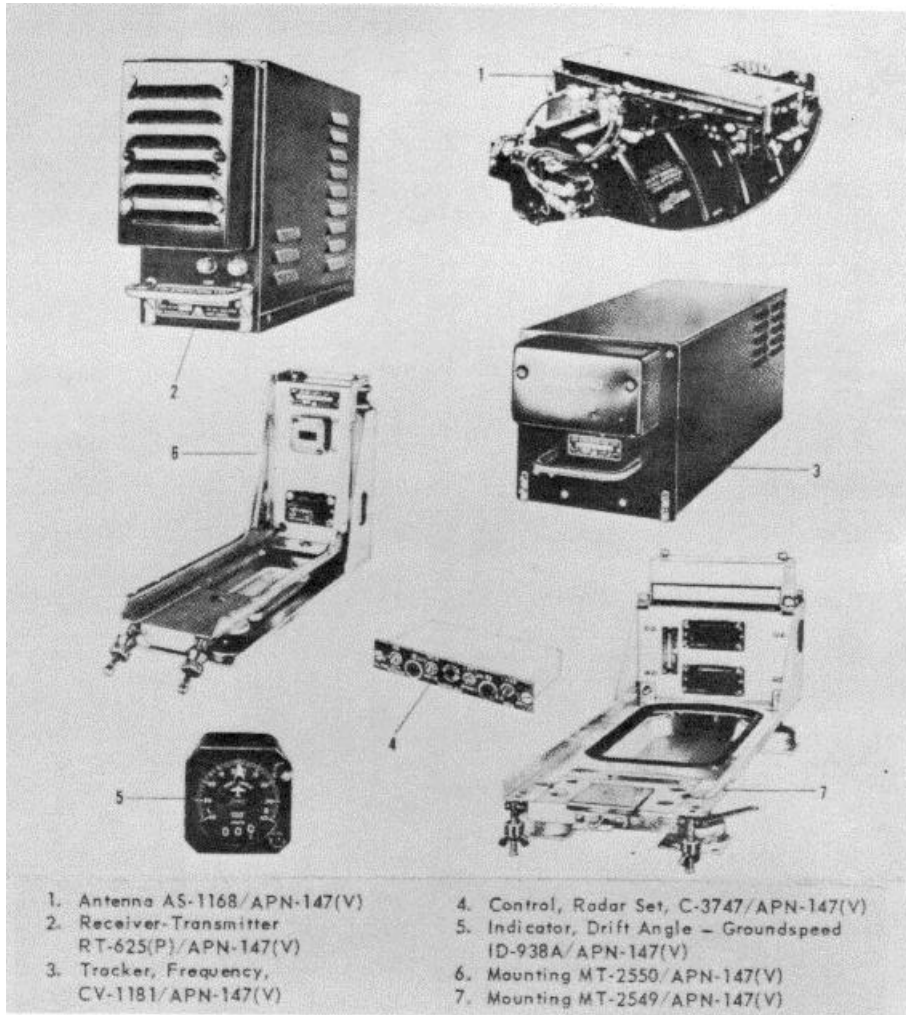

**FUNCTIONAL DESCRIPTION**

The AN/APN-147 is a compact airborne doppler radar system used for navigation. The radar provides a continuous direct reading indication of the aircraft groundspeed and drift angle.

AN/APN-147: 1

**ITEM NAME:** RADAR SET  
**TYPE:** AN/APN- 147

**RELATION TO SIMILAR EQUIPMENT**

None.

**TECHNICAL DESCRIPTION**

Operational Altitude: 100 to 50,000 ft  
Drift Angle: Up to 40 deg, left or right, plus or minus 0.25 deg  
Groundspeed: 70 to 100 knots plus or minus 0.5%  
Antenna Altitude Limits  
Pitch: plus or minus 20 deg stabilized to plus or minus 1 deg  
Roll: plus or minus 30 deg  
Antenna Drive Rates  
Pitch: 1 deg per sec  
Drift: 3 deg per sec

Transmitter Frequency: 8800 mc plus or minus 15 mc  
Type of Emission: Frequency, modulated continuous wave.  
Modulating Frequencies  
High: 1010 kc  
Low: 720 kc  
Modulating Frequencies Interchange Rate: 15 cps plus or minus 3 cps  
Power Output: 500 mw plus or minus 150 mw  
Power Requirements  
ac: 115v, single ph, 330 va  
dc: 28v, 30w

**INSTALLATION CONSIDERATIONS**

Not available.

**PRINCIPAL COMPONENTS AND PHYSICAL DATA**

<b>COMPONENT</b>	<b>QTY</b>	<b>HEIGHT (Inches)</b>	<b>WIDTH (Inches)</b>	<b>DEPTH (Inches)</b>	<b>UNIT WT. (Pounds)</b>
Radar Receiver-Transmitter RT-625/APN-147	1	8.75	4.69	17.06	9.4
Mounting MT-2550/APN-147	1	8.75	4.69	16.41	2.9
Tracker, Frequency 1 CV-1181/APN-147	8.38	9	24.63	34.9	
Mounting MT-2549/APN-147	1	8.38	9	25.63	7.5
Antenna AS-1168/APN-47	1	8.75	19.13	26.75	32.9
Control, Radar Set 1 C-3747/APN-147	1.13	5.75	2.69	0.6	
Indicator, Drift Angle Groundspeed ID-938A/APN-147	1	3.25	3.25	6	3.1

**REFERENCE DATA AND LITERATURE**

Technical Orders:  
12P5-2APN147-2  
12P5-2APN147-3  
12P5-2APN147-4  
12P5-2APN147-501

DATE: 1 December 1964  
COGNIZANT SERVICE: USAF

ITEM NAME: ELECTRONIC ALTIMETER SET  
TYPE: AN/APN-150(V)

FEDERAL STOCK NUMBER:

	USA	USN	USAF	USMC
STATUS OR TYPE CLASSIFICATION			Std	
Mfg(s) Name or Code Number: Sperry Gyroscope Company				

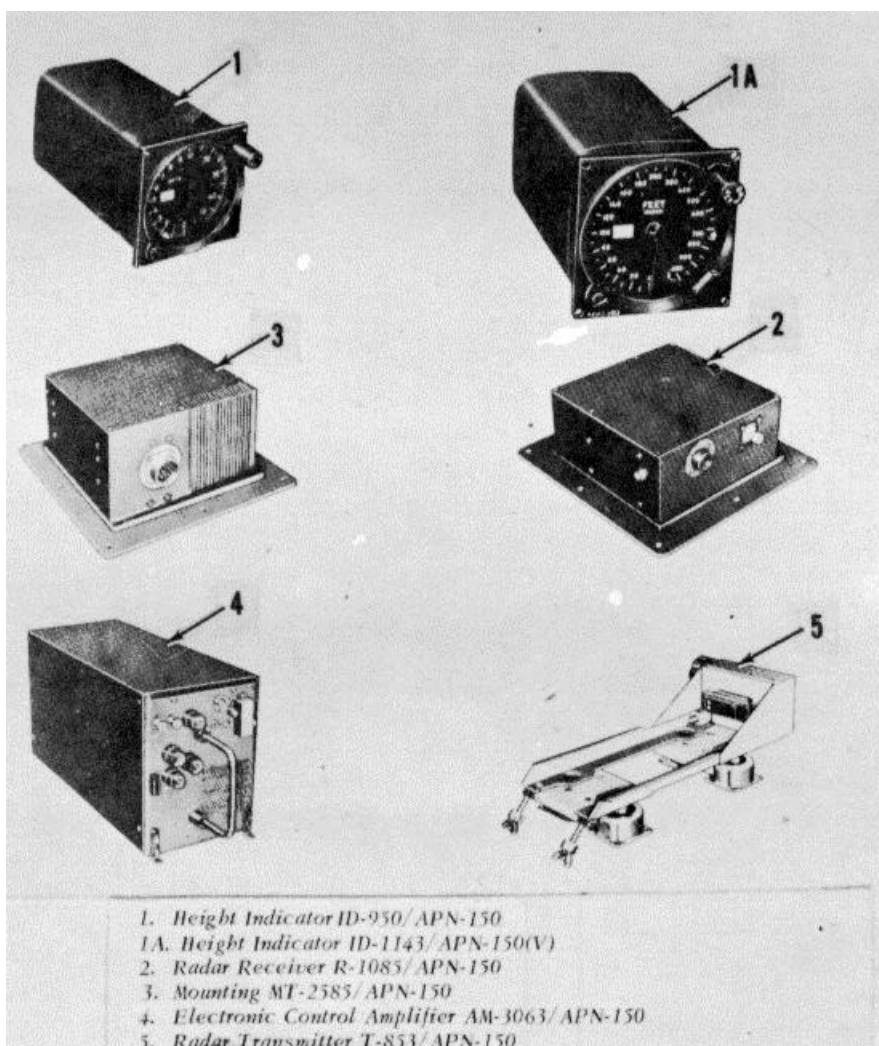

### FUNCTIONAL DESCRIPTION

The AN/APN-150 Altimeter Set is an airborne, high accuracy, low altitude, beam averaging radar altimeter

designed for low level flying and landing of aircraft. It provides a continuous visual display of the "absolute-above-terrain" data of the aircraft in flight.

AN/APN-150(V): 1

**ITEM NAME:** ELECTRONIC ALTIMETER SET  
**TYPE:** AN/APN-150(V)

**RELATION TO SIMILAR EQUIPMENT**

None.

minus 5%  
Altitude Rate: Up to 150 ft per sec  
Transmitter Power Output: plus 23.5 db  
above 1 mw  
Loop Sensitivity: Greater than 125 db  
Power Requirements:  
dc, 21.5 to 29v, 75w  
ac, 106 to 121v, 380 to 420 cps, single  
ph, 30 va

**TECHNICAL DESCRIPTION**

Frequency (cw): 4330 plus or minus 50 mc  
Frequency Modulation: 30 kc  
Amplitude Modulation: 300 cycles  
IF Frequency: 455 kc  
Altitude Range: 0 to 5000 ft  
Altitude Accuracy: 0 to 40 ft plus or  
minus 2 ft; 40 to 5000 ft plus or

**INSTALLATION CONSIDERATIONS**

Not Available.

**PRINCIPAL COMPONENTS AND PHYSICAL DATA**

<b>COMPONENT</b>	<b>QTY</b>	<b>HEIGHT (Inches)</b>	<b>WIDTH (Inches)</b>	<b>DEPTH (Inches)</b>	<b>UNIT WT. (Pounds)</b>
Radar Transmitter T-853/APN-150	1	4-13/32	10-3/32	10-3/8	8
Radar Receiver R-1085/APN-150	1	3-3/8	9-9/16	9-5/16	5
Electronic Control Amplifier AM-3063/APN-150	1	6-13/32	4-7/8	11-1/2	11
Height Indicator ID-950/APN-150, or ID-996/APN-150, or ID-1143/APN-150	1	3-9/32	3-9/32	5-15/16	2
Mounting MT-2585/APN-150	1	5-1/4	5-7/8	16-3/8	3-3/4

**REFERENCE DATA AND LITERATURE**

Technical Orders:  
12P5-2APN150-2  
12P5-2APN150-4

**AN/APN-150(V): 2**

DATE: 1 September 1964

ITEM NAME: RADAR NAVIGATION SET

COGNIZANT SERVICE: USN

TYPE: AN/APN-153(V)

FEDERAL STOCK NUMBER:

	USA	USN	USAF	USMC
STATUS OR TYPE CLASSIFICATION		Used by		
Mfg(s) Name or Code Number: GPL Division of General Precision Inc., (84347)				

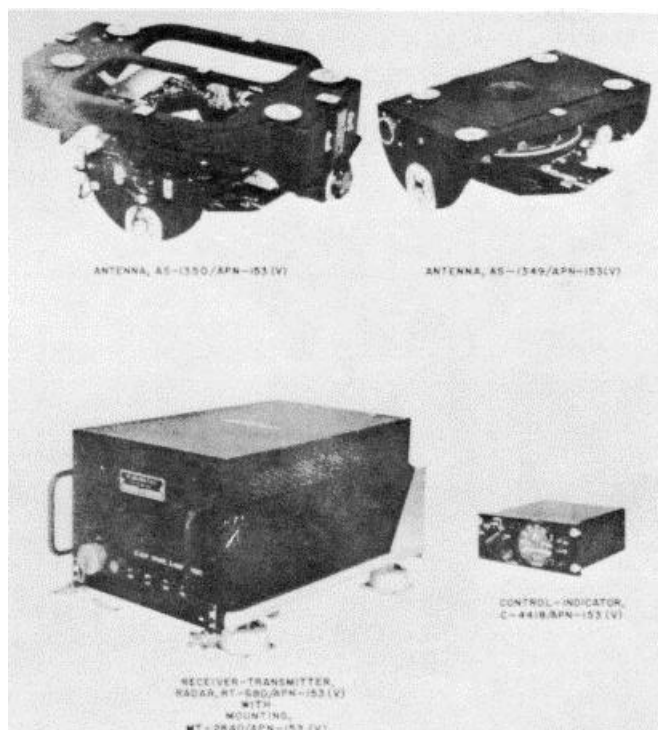

### FUNCTIONAL DESCRIPTION

Radar Navigation Set AN/APN-153(V) is a lightweight miniaturized groundspeed and drift angle measuring system which is designed to satisfy the navigational requirements of modern military aircraft. It

uses Doppler radar techniques to measure groundspeed and drift angle directly, continuously, and accurately. It operates anywhere on the globe, is unaffected by weather conditions, and is completely independent of ground-base navigational aids.

AN/APN-153(V): 1



**ITEM NAME:** RADAR NAVIGATION SET  
**TYPE:** AN/APN-153(V)

**RELATION TO SIMILAR EQUIPMENT**

None.

**TECHNICAL DESCRIPTION**

Altitude  
 Maximum: 50,000 ft above sea level,  
 over land or water with sea state  
 conditions at least as rough as  
 Beaufort 1  
 Minimum: 40 ft above terrain  
 Ground Speed: 80 to 800 knots  
 Drift Angle: 0 to 40°(left or right)  
 Pitch Stabilization: plus or minus 25°  
 Roll Stabilization: plus or minus 60°  
 (when Roll Stabilized Antenna is used)  
 Temperature Range  
 Operating: -54 to 71°C (-39.6 to

159.8°F)  
 Non-Operating: -62 to 95°C (-54 to  
 203°F)  
 Frequency Characteristics: 13,325 plus  
 or minus 50 mc  
 Modulation Characteristics  
 PRF: 60 plus or minus 3 kc to 107 plus  
 or minus 12 kc  
 Pulse Width: Varied in unison to main-  
 tain constant 25 plus or minus 2%  
 duty cycle  
 Power Requirements: 107.5 to 119.5v ac,  
 1-ph, 380 to 420 cps, 425 va  
 Control Panel Lighting: 5v ac, 380 to  
 420 cps, 6 va

**INSTALLATION CONSIDERATIONS**

Not available.

**PRINCIPAL COMPONENTS AND PHYSICAL DATA**

<b>COMPONENTS</b>	<b>QTY</b>	<b>OVERALL DIMENSIONS (Inches)</b>	<b>UNIT WT. (Pounds)</b>
Receiver-Transmitter Radar RT-680/APN-153(V)	1		
Mounting MT-2d40/APN-153(V)	1		
Control-Indicator C-441-/APN-I53(V)	1		
Antenna AS-1349/APN-153(V)	1		
Antenna AS-1350/APN-153(V)	1		

**REFERENCE DATA AND LITERATURE**

Technical Manuals:

- NAVWEPS 16-30APN153-1: Handbook of Operation instructions.
- NAVWEPS 16-30APN153-2: Handbook of Service instructions.
- NAVWEPS 16-30APN153-4: Illustrated Parts Breakdown.

**AN/APN-153(V): 2**

DATE: 1 July 1964  
COGNIZANT SERVICE: USAF

ITEM NAME: RADAR TRAINING SET  
TYPE: AN/APQ-T2

FEDERAL STOCK NUMBER: 6940-030-2611

	USA	USN	USAF	USMC
STATUS OR TYPE CLASSIFICATION			Ltd Std	
Mfg(s) Name or Code Number:				

No Illustration Available.

**FUNCTIONAL DESCRIPTION**

The AN/APQ-T2 is an airborne equipment designed to simulate radar echo presentation obtained in actual flight for training purposes. It provides signals for associated Radar Sets AN/APQ-23, AN/APQ 24, and

AN/APQ-31 by ultrasonic waves in water which simulate electro-magnetic wave propagation through space. The motion of the aircraft is simulated by moving an ultrasonic transducer over a submerged ultrasonic map to provide practically normal operation of radar

**AN/APQ-T2: 1**

**ITEM NAME:** RADAR TRAINING SET  
**TYPE:** AN/APQ-T2

set, permitting training in radar navigation and bombing procedure. The simulated area of the terrain is approximately 197 by 296 nautical miles.

**TECHNICAL DESCRIPTION**

Power Requirements: 115v, 60 cps, single ph, and 230v, 60 cps, 3 ph.

**RELATION TO SIMILAR EQUIPMENT**

None.

**INSTALLATION CONSIDERATIONS**

Not available.

**PRINCIPAL COMPONENTS AND PHYSICAL DATA**

Not available.

**REFERENCE DATA AND LITERATURE**

Nomenclature Card for Radar Training Set  
AN/APQ-T2

**AN/APQ-T2: 2**

DATE: 1 July 1964

ITEM NAME: RADIO SET

COGNIZANT SERVICE: USAF

TYPE: AN/APQ-13

USA LINE ITEM NUMBER: 637105

FEDERAL STOCK NUMBER:

	USA	USN	USAF	USMC
STATUS OR TYPE CLASSIFICATION	Obs	Std		
Mfg(s) Name or Code Number:				

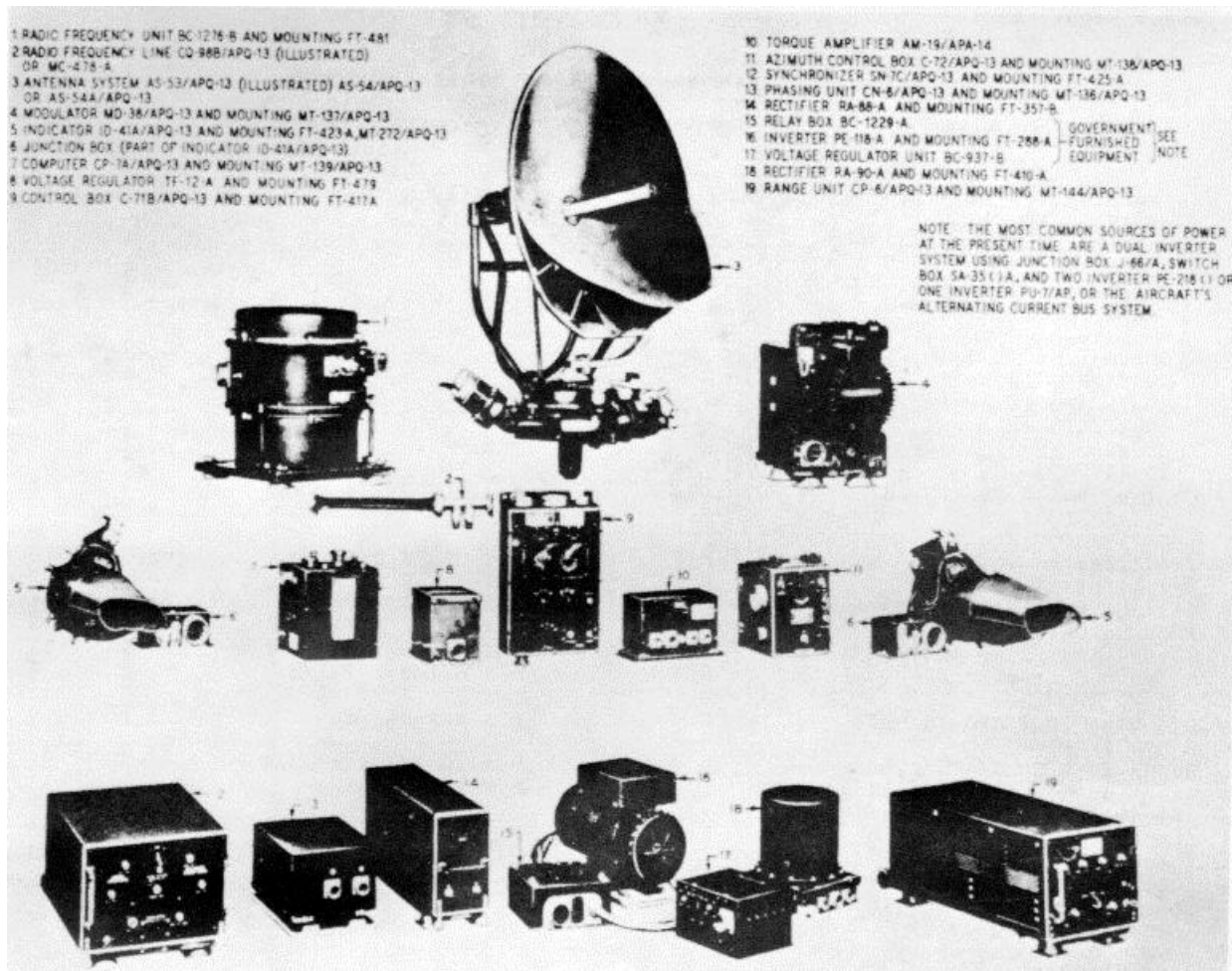

**FUNCTIONAL DESCRIPTION**

The AN/APQ-13 is an airborne radar system designed for navigation and high altitude bombing, and contains provisions for accurate beacon ranging, for operation with Indicator Equipment AN/APQ-5 or

AN/APQ-5B, and for operation with interrogator responder equipment (IFF).

It provides 4, 10, 20, 50, and 100 nautical mile ranges of operation; the 20 mile range being continuously variable from 5 to 20 miles, whereas the other ranges are fixed. In Beacon ranging, extended range

**ITEM NAME: RADIO SET**

**TYPE: AN/APQ-13**

operation is provided by a sweep delay control which inserts a delay up to 200 miles, in 10 mile steps, ahead of the desired indicator sweep. This gives a theoretical maximum beacon range of 300 miles.

**TECHNICAL DESCRIPTION**

- Operation Ranges: 4, 10, 20, 50, 100 mi
- Power Output in X-Band Freq: 40 kw (peak)
- Operating Data
  - Altitude: 35,000 ft max
  - Temperature Range: -40 to plus 50 deg C (-40 to plus 122 deg F)
  - Relative Humidity: Up to 90%.
- Power Requirements

- dc: 26.5 to 2Bv, 6 to 7 amps norm, 12 to 13 amps extreme.
- ac: 115v plus or minus 2%, 90% pf, 400 va at 400 plus or minus cps regulated, 700 va at 400 to 2400 cps unregulated.

**INSTALLATION CONSIDERATIONS**

Related Equipment: (Required but not Supplied) (1) Inverter Unit PE-218-C or PE-218-D or PE-118-A, (1) Relay Box BC-1229-A, (1) Voltage Regulator Unit BC-937-B, Test Equipment as required.

**PRINCIPAL COMPONENTS AND PHYSICAL DATA**

COMPONENTS	QTY	OVERALL DIMENSIONS (Inches)	UNIT WT. (Pounds)
Antenna System AS-53/APQ-13 or AS-54/APQ-13	1	29 x 29 x 40	77
Modulator MD-12/APQ-13 or MD-38/APQ-13 or AS-54A/APQ-13	1	10-1/2 x 15 x 18	61
RF Unit BC-1276-A or BC-1276-B	1	15 x 15-3/4 x 16	61
Synchronizer SN-7/APQ-13 or SN-7A/APQ-13 or SN-7B/APQ-13 or SN-7C/APQ-13	1	9 x 9-1/2 x 23	18
Indicator ID-41/APQ-13 or ID-41A/APQ-13	2	4-3/4 x 9-1/4 x 15	7
Control Box C-71/APQ-13 or C-71A/APQ-13 or C-71B/APQ-13	1	4-3/4 x 9-1/4 x 15	7
Rectifier RA-90-A	i	B x B x B-3/4	10
Rectifier RA-BB-A	i	5-1/4 x 9 x 19-3/4	17.5
Voltage Regulator TF-12-A	1	5 x 5-3/4 x 7-3/4	11.5
Phasing Unit CN-6/APQ-13	i	6 x 7-1/2 x 14-1/2	15
Torque Amplifier AM-19/APA-14	1	5-1/2 x 5-1/2 x 9-1/2	15
Azimuth Control Box C-72/APQ-13	i	6 x 6-1/4 x 7-1/2	7
Computer CP-7/APQ-13 or CP-7A/APQ-13	1	6 x 7 x 8-1/4	9
Range Unit CP-6/APQ-13	i	9 x 10-1/4 x 19-3/4	21.5
Junction Box J-40/APQ-13 or J-40A/APQ-13 or J-40B/APQ-13	i	3 x 15 x 15-1/4	13
Junction Box 3-39/APQ-13	1	2-1/2 x 8 x 9	5
Junction Box JB-B7-B	i	2-1/2 x 6-1/4 x 9-1/2	5
Junction Box J-38/APQ-13	1	1-1/2 x 2 x 5	5
Transmission Line MC-478-A or CG-115/APQ-13 or CG-115A/APQ-13 or CG-11SB/APQ-13 or CG-35/APQ-13 or CG-98/APQ-13 or CG-98A/APQ-13 or CG-98B/APQ-13	1	6 x 7 x 8-1/4	9
Mounting MT-137/APQ-13 or MT-378/APQ-13	1	9 x 10-1/4 x 19-3/4	21.5
Mounting FT-481 or MT-143/APQ-13	1	3 x 15 x 15-1/4	13

ITEM NAME: RADIO SET  
TYPE: AN/APQ-13

**PRINCIPAL COMPONENTS AND PHYSICAL DATA**

<b>COMPONENTS</b>	<b>QTY</b>	<b>OVERALL DIMENSIONS (Inches)</b>	<b>UNIT WT. (Pounds)</b>
Mounting FT-425-A	1		2.5
Mounting Plate MT-221/AP	2		
Mounting MT-272/APQ-13 or FT-423-A	2		3
Mounting FT-417-A	1		1.5
Mounting FT-410-A	1		1
Mounting FT-357-B	1		1.5
Mounting FT-479	1		1
Mounting MT-136/APQ-13	1		1.5
Mounting MT-138/APQ-13	1		1
Mounting MT-139/APQ-13	1		1
Mounting MT-144/APQ-13	1		2.5
Set of Interconnecting Cables	1		

**REFERENCE DATA AND LITERATURE**

Technical Manuals:  
AN16-30APQ13-2 for Radio Sets  
AN/APQ-13 and AN/APQ-13A.

**AN/APQ-13: 3**

DATE: 1 July 1964  
COGNIZANT SERVICE: USN

ITEM NAME: RADAR SET  
TYPE: AN/A P-20

FEDERAL STOCK NUMBER:

	USA	USN	USAF	USMC
STATUS OR TYPE CLASSIFICATION				
Mfg(s) Name or Code Number: Belmont Radio Corporation, Chicago, Illinois				

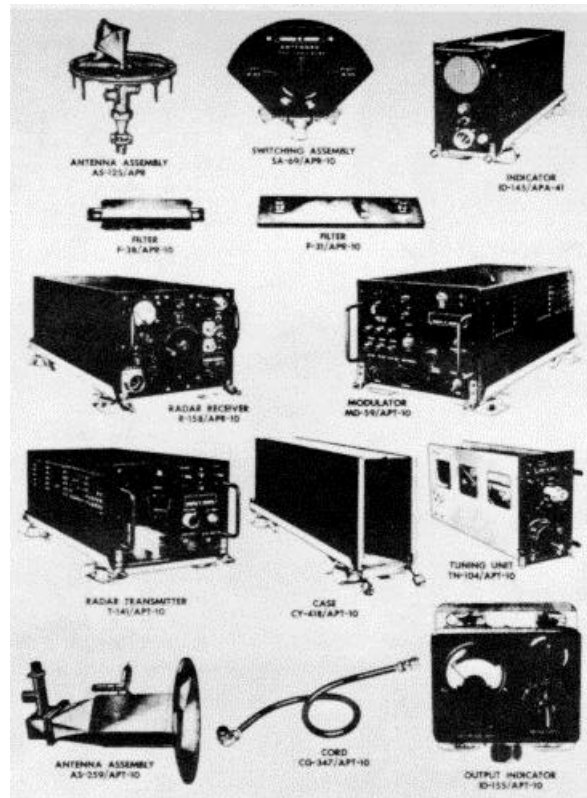

**FUNCTIONAL DESCRIPTION**

The Radar Set AN/APQ-20 is an airborne, manually operated radar jamming system. The system may be used to jam gun laying or early warning radar sets of any polarization.

**AN/APQ-20: 1**

**ITEM NAME:** RADAR SET  
**TYPE:** AN/APQ-20

**RELATION TO SIMILAR EQUIPMENT**

None.

**TECHNICAL DESCRIPTION**

Receiver Frequency Range: 2300 to 3750 mc  
Modulator Noise Signal Frequency: 750,000 cycles to 5 mc  
Performance Limiting Factors  
Altitude: Up to 40,000 ft  
Temperature Ranges: -55 deg C (-67 deg F) to plus 64 deg C (plus 147 deg F)  
Effective Receiving Signal Radius: At

least 50 mi when equipment is operated at 5000 ft

Transmitter Effective Transmissions Range: 10 to 15 mi at altitudes in excess of 5000 ft

Operating Power Requirements: 85/115v ac, 400 to 2600 cps; 28v dc

**INSTALLATION CONSIDERATIONS**

Related Equipment: (Required but not Supplied) (1) Headset HS-33 (600 ohms impedance); (1) Test Oscillator TS-252/AP; (1) Power Meter TS-125/AP; a set of Cabling (Length as required).

**PRINCIPAL COMPONENTS AND PHYSICAL DATA**

COMPONENTS	QTY	OVERALL DIMENSIONS (Inches)	UNIT WT. (Pounds)
Radar Receiver R-158/APR-10	1	7-7/8 x 10-1/2 x 21-1/4	46
Mounting Base MT1-171/I	1	10-5/16 x 19-7/16	1.5
Filter F-38/APR-10	1	1 x 2-1/8 x 5-3/16	1.0
Filter F-31/APR-10	1	1-5/16 x 2-7/8 x 11-5/16	2.2
Antenna Assy AS-125/APR	3	5-3/4 dia x 7-5/16	1.5
Blister CWI-92/AP	3		
Switching Assy SA-69/APR-10	1	3-3/16 dia x 3-11/16	1.56
Plug UG-21/U	40		.3
Adapter UG-27/U	1		.2
Plug PL-259-A	1		.05
Adapter M-359	1		.06
Plug AN-3106-22-4S	1		.22
Clamp AN-3057-12	1		.06
Adapter UG-265/U	1		
Cable	1	2760 lg	
Radar Transmitter T-141/APT-10	1	7-1/ x 10-1/8 x 22	36
Tuning Unit TN-104/APT-10	1	5-1/ x 7-1/2 x 21	10
Tuning Unit TN-105/APT-10	1	5-1/8 x 7-1/2 x 21	10
Tuning Unit TN-106/APT-10	1	5-1/8 x 7-1/2 x 21	10
Tuning Unit TN-107/APT-1	0	1 5-1/8 x 7-1/2 x 21	10
Modulator MD-59/APT-10	1	7-1/2 x 10-1/8 x 22	35
Output Indicator ID-155/APT-10	1	3-5/8 x 5 x 5-1/4	1.5
Case CY-418/APT-10	3	5-1/8 x 7-1/2 x 21	1
Mounting Base MT-167/U	3	5-3/ x 23-1/8	1
Mounting Base MT-171/U	2	10-5/16 x 23-1/8	1
Mounting Base MTbL-114/APT-1	1	7/8 x 5 x 5-5/8	.5
Antenna Assy AS-259/APT-10	1		
Cord CG-347/APT-10	1	36 lg	
Plug AN-3106-22-4S	1		.22
Plug AN-3106-22-28P	1		.22
Plug AN-3106-22-289	1		.06
Clamp AN-3057-12	3		
Plug AN-3106-10S-8S	1		
Plug AN-3106-16S-SP	1		
Clamp AN-3057-8	2		
Plug PL-259A	2		.05
Adapter M-359	2		.06

**REFERENCE DATA AND LITERATURE**

Technical Manuals:  
CO-AN16-30APQ20-2-M



DATE: 1 July 1964  
COGNIZANT SERVICE: USAF

ITEM NAME: RADAR SET  
TYPE: AN/APQ-23D

FEDERAL STOCK NUMBER:

	USA	USN	USAF	USMC
STATUS OR TYPE CLASSIFICATION			Ltd Std	
Mfg(s) Name or Code Number: Western Electric				



**FUNCTIONAL DESCRIPTION**

Radar Set AN/APQ-23D is an Airborne Radar System designed for navigation and high altitude bombing. Provision is also made for accurate beacon

ranging and for operation with interrogation responder equipment.

**AN/APQ-23D: 1**

**ITEM NAME:** RADAR SET  
**TYPE:** AN/APQ-23D

**RELATION TO SIMILAR EQUIPMENT**

The AN/APQ-23D is identical to the AN/APQ-13 Series Radar Sets with the exception of Modification Kit MX-344/ APQ which gives the following advantages: Provides a steering azimuth marker with steering information for fixing the aircraft on a collision course to the target; accommodation of range offsets up to 10 miles, with unlimited azimuth offset; provides a ground-range tracking marker; provides continuous information enabling the bombardier to track the radar information regarding the position of the target; automatic Sweep expansion; correction of Cross-Trail.

**TECHNICAL DESCRIPTION**

X Band Frequency: Radar 9375 mc plus or minus 40 mc, Beacon 9310 mc plus or minus 3 mc  
Maximum Range: 100 naut mi, 300 naut mi for beacon (theoretical)  
Peak Power Output: 35 kw  
Power Requirements: 13 amps at 27.5v dc, 3 amps at 115v 380 to 420 cycle ac; 9 amps at 115v 400 to 1600 cycle ac  
Presentation: PPI on two indicators (Operators and Navigators)  
Pulse Duration: .5 usec for radar 4, 10 and 20-mi ranges; .75 usec for radar 50 and 1(X-mi ranges; 2.25 usec for all beacon ranges.  
Pulse Repetition Rate: 1350 pps for radar 4, 10 and 20-mi ranges; 675 pps for radar 50 and 100-mi ranges; pps for beacon all ranges.  
Ranges: 4, 10, 20, 50 and 100 naut mi. The 20-mi range is continuously variable from 5 to 20 mi.  
Range Marks: 1-mi and 5-mi intervals for radar or beacon on all ranges. Also, continuously variable 0.5 to 15 naut mi timed from the transmitted pulse plus 10 N Sweep Delay.

Sweep Delays: Altitude delay zero and 15,000 to 35,000 feet continuously visible and timed from the transmitted pulse plus 10 deg N Sweep Delay; 10 to 200 mi in multiples of 10 naut mi timed from the transmitted pulse.

Tuning: Radar afc or Manual; Beacon Manual.

Intermediate Frequency: 60 mc

Bandwidth: IF 5 mc, Video 3 mc

Antenna: Center fed Feedhorn with a full parabolic reflector and cosecant squared-skirt.

Beam Widths: Approx 3 deg Scan:

Horizontal "Continuous" or "Search" through full 360 deg "Sector Scan" through an arc of 40 to 50 deg in a sector 70 deg either side of "Dead-A-Head".

Vertical Manual "Tilt" 10 deg above and 30 deg below horizontal.

Scan Speed: continuous 20 to 27 rpm, search 13 to 21 rpm, sector scan 50 to 60 scans per minute.

Bombing Computations: Ballistic computations for bombings are automatically performed by computer CP-16/APQ-23 which determines the bomb release point for a pre-determined course based on accepted navigational procedures.

Operating Temperatures: 40 deg C to plus 50 deg C (-40 deg F to plus 120 deg F) with relative humidities of up to 90%.

**INSTALLATION CONSIDERATIONS**

Related Equipment: (Required but not supplied) (1) 35MM Camera, USAF Type 0-15; (1) Camera Control Box USAF type P-3B; (1) Doppler Drift Attachment AN/APA-52.

**PRINCIPAL COMPONENTS AND PHYSICAL DATA**

COMPONENT	QTY	HEIGHT (Inches)	WIDTH (Inches)	DEPTH (Inches)	UNIT WT. (Pounds)
Antenna System AS-54/APQ-13	1	40	29	29	77
Modulator 1	15	10.5	18	61	
Radio Freq Unit BC-1276-B	1	16	15.75	15	61
Synchronizer SN-7C/APQ-13	1	9	11.25	19.5	22.5
Indicator (Aux) ID-41I/APQ-13	1	9	9.5	23	18
Indicator (Main) ID-41G/APQ-13	1	9	9.5	27	20
Radar Set Control 1 C-548D/APQ-13	15	4.75	9.25	20	
Rectifier (High Voltage) RA-90-A	1	8.75	8	8	10
Rectifier (Regulated) RA-88-A	1	9	5.25	19.75	17.5
Voltage Regulator TF-12-A	1	5.75	5	7.75	11.5
Computer CP-16/APQ-23	1	10.75	26.38	16.75	92
Amplifier AM-77/APQ-23	1	10.13	21.56	10.38	25

ITEM NAME: RADAR SET  
TYPE: AN/APQ-23D

PRINCIPAL COMPONENTS AND PHYSICAL DATA

COMPONENT	QTY	HEIGHT (Inches)	WIDTH (Inches)	DEPTH (Inches)	UNIT WT. (Pounds)
Direction Range Indicator ID-122/APQ-23	1	2.75	5.25	3.25	2
Angle Azimuth Indicator ID-123/APQ-23	1	2.75	6.25	3.25	2
Torque Amplifier AM-119/AP9-23	1	5.25	3	5.25	4
Potentiometer Box 1 MX-357/A PQ-23.	4.75	3.5	2.75	3	
Range Unit CP-6/APG-13	1	9	10.25	19.75	21.5
Junction Box 1-106C/APQ-13A	1	16.16	4.78	16.16	15
Junction Box J-105/APQ-13A	1	9.5	2.5	8.25	5
Junction Box J-38/APQ-13	1	1.5	5	2	.5
Set of Cable Parts	1				159
Transmission Line CG-98B/APQ-13	1				
Mounting (Modulator) MT-378/APQ	1				2
Mounting (RF Unit) MT-143/APQ-13	1				3
Mounting (Synchronizer) FT-425-A	1				2.5
Mounting Plate (Indicator Junction Box) MT-221/AP	2				
Mounting (Radar Set Control) FT-417-A	1				1.5
Mounting (High Voltage Rectifier) FT-410-A	1				1
Mounting (Regulated Rectifier) FT-357-B	1				1.5
Mounting (Voltage Regulator) FT-479	1				1
Mounting (Computer) MT-359/APQ-23	1				
Mounting (Amplifier) MT-144/APQ-13	1				
Mounting Plate (Direction Range Indicator) MT-360/APQ-23	1				
Mounting (Angle Azimuth Indicator) MT-361/APQ-23	1				
Mounting (Range Unit) MT-144/APQ-13	1				2.5
Mounting (Junction Box J-106/APQ-13A)MT-34 2/A PQ-13A	1				
Mounting (Junction Box J-106/APQ-13A)MT-341 /APQ-13A	1				
Inverter PE-218-D	1	9.75	6.25	17.75	52

REFERENCE DATA AND LITERATURE

Technical Orders:  
11B 1-APQ23-2

AN/APQ-23D: 3

DATE: 1 July 1964

ITEM NAME: RADAR SET

COGNIZANT SERVICE: USN

TYPE: AN/APQ-35, -35A

FEDERAL STOCK NUMBER:

	USA	USN	USAF	USMC
STATUS OR TYPE CLASSIFICATION				
Mfg(s) Name or Code Number:				

**Illustration Not Available**

**FUNCTIONAL DESCRIPTION**

Radar Set AN/APQ-35, -35A is a night intruder system that consists of: Radar Sets AN/APS-21 and AN/APS-21A, airborne long range search and intercept radar; Radar Sets AN/APG-26 and AN/APG-26A, airborne gun aim radar; and Radar Set AN/APS-28, airborne tail warning radar. The set is capable of functioning as a radar aid to navigation and as a ground-mapping equipment.

**RELATION TO SIMILAR EQUIPMENT**

Some, but not all components of the AN/APQ-35, -35A and the AN/APQ-35B are interchangeable.

**TECHNICAL DESCRIPTION**

AN/APQ-35, -35A

Power Requirements:

- AC Voltage - 115 vac, 400 cps, 1-ph
- Standby Current - 15 amp, 0.905 pf lagging
- High Power Current - 28 amp, 0.911 pf lagging
- Low Power Current - 24 amp, 0.927 pf lagging

Total Volt-Amperes:

- Standby Current - 1,725 va
- High Power Current - 3,220 va
- Low Power Current - 2,760 va

Total Active Power:

- Standby Current - 1,561w
- High Power Current - 2,935w
- Low Power Current - 2,560w

DC Voltage: 28 vdc

- Starting Current - 170 amp
- Standby Current - 62 amp
- High Power Current - 95 amp
- Low Power Current - 61 amp

Total Power:

- Standby Current - 1,736w

High Power Current - 2,660w  
Low Power Current - 1,708w

AN/APS-21, -21A

Ambient Temperature Operation:  
-55 to +55 deg C

Transmitting Frequency (Radar and Beacon):  
9375 ±30 mc

Receiving Frequency (Beacon): 9310 +1 mc  
Range, Max:

- 60 naut mi for 5,000 ton ship
- 25 naut mi for 30,000 lb bomber
- 15 naut mi for 15,000 lb fighter
- 120 naut mi for large coastal city

IFF Synchronizing Pulses:

40v amplitude, 0.35 /sec time duration into a  
500-ohm load shunted with 200 -/f

IFF Video: Pulses with amplitude up to 100v  
above a dc level of 12v. Input impedance is  
3,000 ohms shunted with 30 -f. Pulse dura-  
tion 0.5 to 100 /Msec at 50% amplitude. All  
pulses above this level limited at 20v.

Peak RF Power Output: 200 kw to antenna feed

Receiving System IF. Frequency: 30 mc

Receiver Noise and TR Loss: 13.5 db (max)

Bandwidth: 1.4 or 5 mc depending on range and  
prf

RF Response: Flat, within 1 db from 360 cps  
to 5 mc

Presentation: PPI, s e c r scan continuously  
variable from 30 to 170 deg

Range Marks:

- 2-mi intervals on 10-mi scale
- 5-mi intervals on 25-mi scale
- 10-mi intervals on 60-mi scale
- 20-mi intervals on 120- and 200-mi scales

Display: PPI with adjustable depressed center,

AN/APQ-35, -35A

fixed and movable range markers; C-scope indicates target, relative azimuth, and relative elevation.

Viewing: Any target on PPI with a range of not more than 170 naut mi can be selected for viewing in the C-scope. In practice selectives are limited to 4,000 yd or less.

Beam Width: Approx 3.3 deg at half-power points

AN/APG-26, -26A

Antenna Shift: Horizontal, through azimuth angle of 120 deg; Vertical, through elevation angle of 120 deg

Pulse Repetition Frequency: 2,400 to 2,500 pps

IF. Frequency: 30 mc

Auto Tracking Error: 66 cps

Target Indication: Dot or circle

Beam Diameter: Approx 4.7 deg at half-power points

Total Scan Angle: 9.4 deg

Local Oscillator: 30 ±0.25 mc below transmitting frequency

Transmitting Frequency: 9245 ±30 mc

Pulse Width: 0.4 µsec

Peak Power Output: 50 kw

Range, Max: 4,000 yd, but computation of firing problem does not start until range is 2,000 yd

Range, Min: 150 yd

Presentation: C-scope

Range Accuracy: ±25 yd

Angular Accuracy in Azimuth and Elevation: ±0.25 deg

Relative Target Tracking Speed:

900 knots closing and 300 knots at angular rates up to 45 deg per sec

Minimum Ballistics Solution Time: 0.25 sec

AN/APS-28

Transmitting Frequency: 9245 ±30 mc

Pulse Width: 0.5 µsec

Pulse Repetition Frequency: 2,000 pps

Peak Power Output: 35 kw

Range, Max: 4 mi

Range, Min: 150 yd

Maximum Practical Range: 3 mi

Display: O-scope

IF. Frequency: 30 mc

Combined Receiver Noise and TR Loss: Not in excess of 13.5 db

Bandwidth: 3 mc at -3 db

Video Frequency Response:

Flat within 1 db from 2 to 3 mc

**INSTALLATION CONSIDERATIONS**

Not available.

**PRINCIPAL COMPONENTS AND PHYSICAL DATA**

COMPONENT	QTY	HEIGHT (Inches)	WIDTH (Inches)	DEPTH (Inches)	UNIT WT. (Pounds)
AN/APQ-35, -35A					
Radar Modulator MD-103/APQ-35	1	15-1/2	15-1/2	21-23/32	91.5
Capacitor Assembly CB-2/APQ-35	1	4-11/16	5-5/8	7-3/8	5.5
Power Supply PP-444/APQ-35	1	5-17/32	13-5/32	25-1/8	42.0
Azimuth-Elevation Range Indicator IP-60/APG-26	1	6-21/32	5-3/16	16-7/16	13.75
AN/APS-21, -21A					
Radar Receiver-Transmitter RT-167/APS-21	1	14-7/8	13-5/8	20-15/16	67.00
Electrical Synchronizer SN-69/APS-21	1	7-1/32	14-3/8	21-11/16	40.00
Antenna AS-461/APS-21	1	30	30	45-7/8	115.00
Antenna AS-518/APS-21A	1	9-1/8	15-3/16	41-5/8	90.00

PRINCIPAL COMPONENTS AND PHYSICAL DATA (cont'd)

COMPONENT	QTY	HEIGHT (Inches)	WIDTH (Inches)	DEPTH (Inches)	UNIT WT. (Pounds)
AN/APG-26,-26A					
Antenna AS-459/APG-26	1	19-9/64	10-5/8	12-1/8	35.00
Motor Generator Set PU-199/U* or	1	10	5-1/2	5-1/8	5.75
Motor Generator Set PU-217/U*	1	10	8-7/16	6-7/8	7.25
Dynamotor DY-69/U	1	14-19/32	9-27/32	5-15/32	43.50
Radar Receiver-Transmitter RT-165/APG-26	1	41-5/8	9-1/8	15-3/16	90.00
Flight Data Computer CP-78/APG-26	1	9-23/32	5-1/8	9-7/8	7.00
Ballistics Computer CP-63/APG-26 or CP-92/APG-26A**	1	27-7/16	17-1/2	11-31/32	92.00
Power Supply PP-528/APG-26	1	15-5/16	6-3/16	8-1/8	23.00
Azimuth Elevation Range Indicator IP-60/APG-26*** or	1	16-7/16	6-21/32	5-3/16	13.75
IP-129/AP G-26A****	1	18-11/16	7-3/8	4	13.00
AN/APS-28					
Antenna AS-460/APS-28	1	12-1/2	12-1/2	21-3/4	18.00
Radar Receiver-Transmitter RT-168/APS-28	1	19-11/16	20-1/32	21-21/32	78.00
Electrical Synchronizer SN-68/APS-28	1	8-15/32	15-1/2	22-5/16	32.00

\* AN/APG-26A only

\*\* CP-63/APG-26 is used with AN/APQ-35, either CP-63/APG-26 or CP-92/APG-26 is used with AN/APQ-35A

\*\*\* AN/APQ-35 only

\*\*\*\* AN/APQ-35A only

REFERENCE DATA AND LITERATURE

Handbooks:

AN16-30APQ35-2

CO-AN16-30APQ35-3

DATE: 1 July 1964

ITEM NAME: RADAR SET

COGNIZANT SERVICE: USN

TYPE: AN/APQ-35B

FEDERAL STOCK NUMBER:

	USA	USN	USAF	USMC
STATUS OR TYPE CLASSIFICATION				
Mfg(s) Name or Code Number:				

Illustration Not Available

### FUNCTIONAL DESCRIPTION

AN/APQ-35B is a system of three clearly related and integrated airborne radar sets. The AN/ APQ-35B is designed to search for targets, compute ballistic data, provide beacon interrogation and display beacon replies, and provide tail warning facilities. The system consists of Radar Sets AN/APS-21B, AN/APG-26B, and AN/APS-28.

### RELATION TO SIMILAR EQUIPMENT

Functionally, but not otherwise, similar to other AN/APQ-35 series equipments.

### TECHNICAL DESCRIPTION

Search Range: 5, 000 ton ship, 60 naut mi; medium bomber, 25 naut mi; fighter, 15 naut mi; large coastal city, 120 naut mi  
Gun Aim Range: 4, 000 yd max, 150 yd min  
Tail Warning Range: 4 mi max, 150 yd min

Search Frequency: 9375  $\pm$ 30 me  
Beacon Frequency: Transmitting, 9375 +30 mc; receiving, 9310  $\pm$ 1 mc  
Gun Aim and Tail Warning Frequency: 9245  $\pm$  30 mc  
Search Display: PPI and C-scope  
Gun Aim Display: Azimuth-elevation-range indication  
Tail Warning Display: Double dot O-scope  
Range Markers:  
10-mi scale, 2-mi intervals  
25-mi scale, 5-mi intervals  
60-mi scale, 10-mi intervals  
120-and 200-mi scales. 20-mi intervals  
Power Output: Search, 200 kw peak or 200w avg; gun aim, 50 kw peak or 200w avg; tail warning, 35 kw peak or 35w avg

### INSTALLATIONS CONSIDERATIONS

Not Available.

AN/APQ-35B: 1

AN/APQ-35B

**PRINCIPAL COMPONENTS AND PHYSICAL DATA**

<b>COMPONENT</b>	<b>QTY</b>	<b>HEIGHT (Inches)</b>	<b>WIDTH (Inches)</b>	<b>DEPTH (Inches)</b>	<b>UNIT WT. (Pounds)</b>
Antenna AS-459/APG-26	1	10-5/8	12-1/8	19-9/64	35.00
Antenna AS-549/APS-21B	1	50	35	27	
Electrical Synchronizer SN-69/APS-21	1	7-1/32	14-3/8	21-11/16	40.00
Radar Modulator MD-103A/APQ-35	1	15-1/2	15-1/2	21-21/32	91.50
Radar Receiver Transmitter RT-167/APS-21	1	14-7/8	13-5/8	20-15/16	67.00
Radar Receiver Transmitter RT-218/APG-26B	1	21	27	25	
Power Supply PP-441/APQ-35	1	5-17/32	13-5/32	25-1/8	42.00
Console C-883/APQ-35B	1	21-1/2	27-1/2	33-1/2	
Azimuth-Elevation-Range Indicator IP-129/APG-26A	1	7-3/8	4	18-11/16	13.75
Flight Data Computer CP-78/APG-26	1	5-1/8	9-7/8	9-23/32	7.00
Power Supply PP-684/APG-26B	1	10-1/2	10-1/2	21	
Ballistic Computer CP-97/APG-26B	1	22	16	35	
Capacitor Assembly CB-2/APQ-35	1	4-11/16	5-5/8	7-3/8	5.50
Electrical Synchronizer SN-68/APS-28	1	8-15/32	15-1/2	22-5/16	32.00
Radar Receiver-Transmitter RT-168A/APS-28	1	19-11/16	20-1/32	21-21/32	78.00
Antenna AS-460A/APS-28	1	12-1/2	12-7/8	21-3/4	20.75
Electrical Control Amplifier AM-578/APQ-35A	1	8-1/2	5-1/2	4-1/2	
Synchro Transmitter PD-29/APQ-35A	1	6	6	7	

**REFERENCE DATA AND LITERATURE**

Handbook:

CA-AN 16-30APQ35-12

**AN/APQ-35B: 2**



DATE: 1 July 1964

ITEM NAME: RADAR SET

COGNIZANT SERVICE: USN

TYPE: AN/APQ-41

FEDERAL STOCK NUMBER:

	USA	USN	USAF	USMC
STATUS OR TYPE CLASSIFICATION				
Mfg(s) Name or Code Number:				

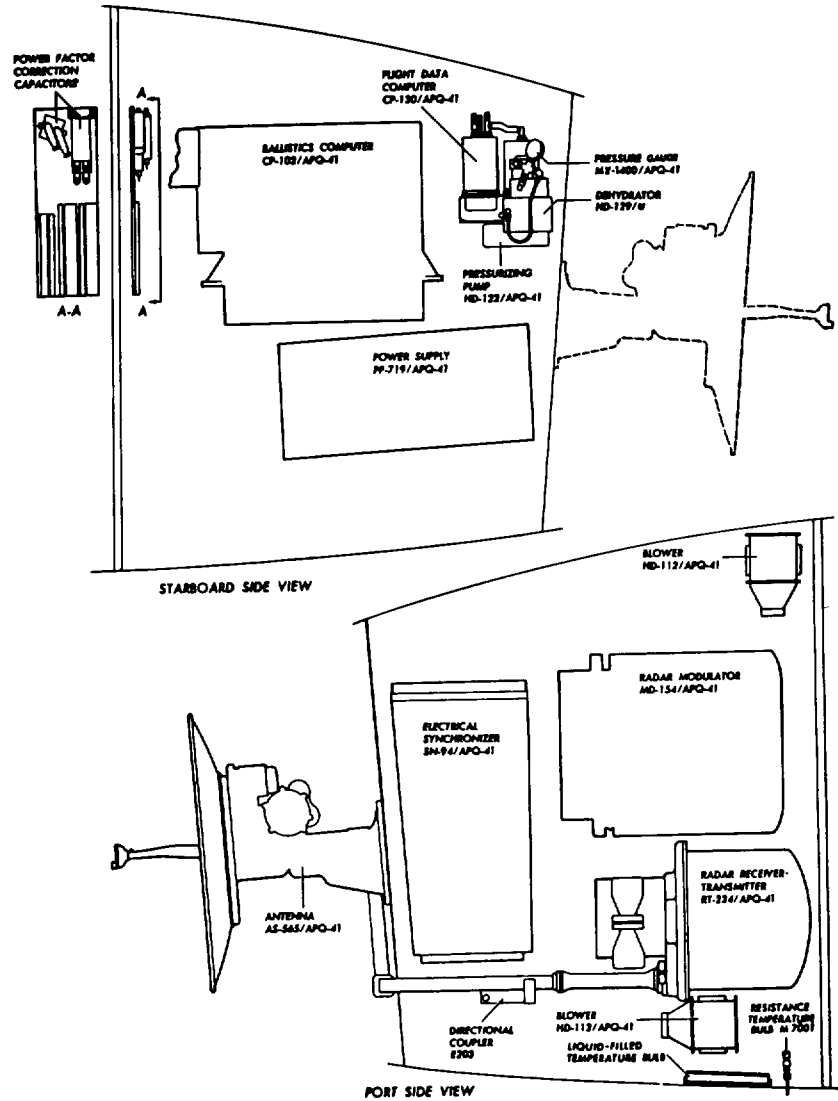

AN/APQ-41: 1

**AN/APQ-41**

**FUNCTIONAL DESCRIPTION**

The AN/APQ-41 is designed to provide air intercept search, to automatically track a selected target, and to supply lead angle and range information. Facilities are also provided for air-to-surface search, for beacon interrogation and response display, and for response display when used in connection with IFF.

**RELATION TO SIMILAR EQUIPMENT**

None.

**TECHNICAL DESCRIPTION**

Search or Gun-Aim Range: 24 naut mi max, 200 yd min  
 Ground Mapping Range: 100 naut mi  
 Beacon Range: 200 naut mi  
 Reliable Gun-Aim Prediction: 2,000 yd max  
 Tracking Accuracy:  $\pm 25$  yd within the ranges of 200 and 2,000 yd  
 Future Range Accuracy:  $\pm 25$  yd  
 Azimuth (Search): 106.5 deg  
 Elevation (Search): 13 deg (within  $\pm 30$  deg of aircraft center line)

Azimuth (Track): 116.5 deg  
 Elevation (Track): 116.5 deg  
 Accuracy (Search and Track): 4% all indications  
 Type of Presentation:  
     B-scope (Search)-Target azimuth and range, range strobe, range markers, beacon and IFF responses  
     C-scope (Search)-Target strobe, targets, straddled by range strobe, artificial horizon line, scan pattern  
     C-scope (Track)-Target dot, range rate circle and dot, artificial horizon line  
 Fixed Range Marker: 25-mi markers on 100- and 200-mi scales  
 Radar Frequency (Search and Track): 9375  $\pm 30$  mc  
 Beacon Frequency: Transmitting, 9375  $\pm 30$  mc; receiving, 9310  $\pm 1$  mc  
 Operating Temperature: -55 to +55 deg C  
 Altitude Limit: 52,000 ft

**INSTALLATION CONSIDERATIONS**

Not available.

**PRINCIPAL COMPONENTS AND PHYSICAL DATA**

COMPONENT	QTY	HEIGHT (Inches)	WIDTH (Inches)	DEPTH (Inches)	UNIT WT. (Pounds)
Antenna and Gyroscope AS-565/APQ-41	1	25-1/2	24	30	48.00
Azimuth Elevation-Range Indicator IP-164/APQ-41	1	12-7/8	8-3/4	22-1/4	26.25
Ballistic Computer CP-102/APQ-41	1	17-1/2	12	27-1/2	100.00
Blower HD-112/APQ-41	2	5-3/8	5	6-7/8	2.00
Dehydrator HD-129/U	1	3-7/8	3-3/8	5-1/8	1.75
Directional Coupler and Waveguide	1	11-3/4	4-1/4	17-1/4	2.50
Electrical Synchronizer SN-94/APQ-41	1	14-3/8	12-5/8	26-5/8	71.00
Flight Data Computer CP-130/AP-41	1	7-1/2	4	11-5/8	6.50
Indicator Control C-930/APQ-41	1	8-5/8	4-7/8	11-3/8	8.75
Pressure Pump HD-1221/APQ-41	1	0-1/4	3-1/8	9	3.00
Power Supply PP-719/APQ-41	1	14	12-1/4	22-3/4	60.00
Radar Modulator MD-154/APQ-41	1	15-1/2	15-1/2	22-3/4	66.00

**PRINCIPAL COMPONENTS AND PHYSICAL DATA (cont'd)**

<b>COMPONENT</b>	<b>QTY</b>	<b>HEIGHT (Inches)</b>	<b>WIDTH (Inches)</b>	<b>DEPTH (Inches)</b>	<b>UNIT WT. (Pounds)</b>
Radar Receiver-Transmitter RT-234/APQ-41	1	13-3/4 13-3/4	20	.600	
Radar Set Control C-931/APQ-41	1	9-7/8 8-3/4	9-3/4	6.00	
Range Adapter, Aero 1A	1	7-1/2 3-3/4	8-1/2	8.00	

**REFERENCE DATA AND LITERATURE**

Technical Manuals:  
AN16-30APQ41-4  
AN16-30APQ41-1

DATE: 1 July 1964

ITEM NAME: RADAR RECEIVING EQUIPMENT

COGNIZANT SERVICE: USN

TYPE: AN/APR-2

FEDERAL STOCK NUMBER:

	USAUSN	USAF	USMC	
STATUS OR TYPE CLASSIFICATION				
Mfg(s) Name or Code Number: Galvin Manufacturing Company				

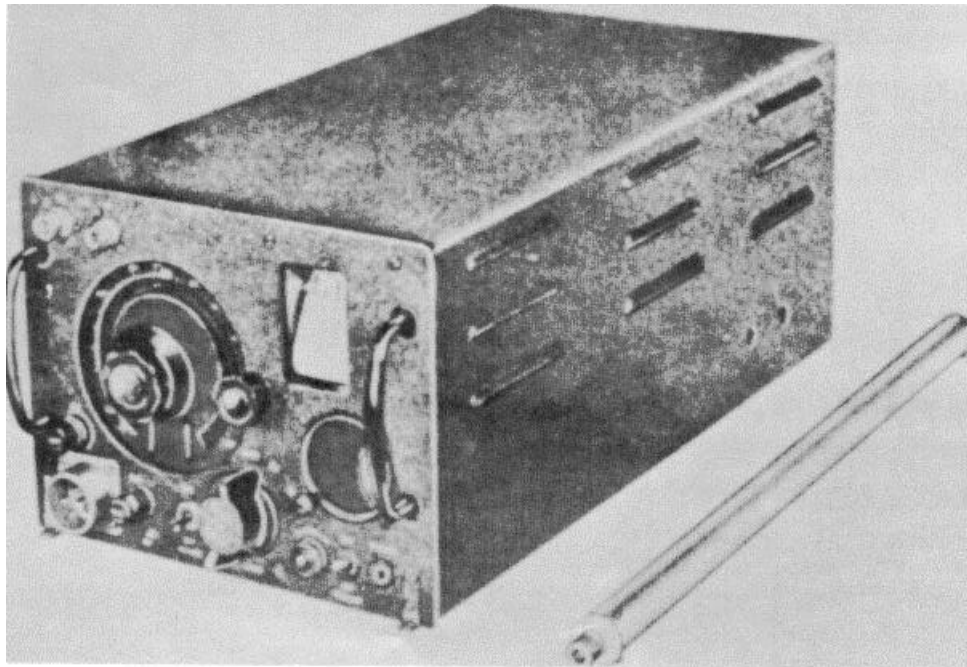

### FUNCTIONAL DESCRIPTION

The AN/APR-2 is a receiver designed to scan automatically or manually the frequency band of 90 to 100 megacycles and to indicate radar or radio signals received. The approximate frequencies and time of the received signals is indicated visually in panoramic

fashion on a dial, and recorded on electro-sensitive tape. It also provides facilities for aural presentation of the received signals.

Volume 1  
Section 2

**MIL-HDBK-162A**  
15 December 1965

**ITEM NAME:** RADAR RECEIVING EQUIPMENT  
**TYPE:** AN/APR-2

**RELATION TO SIMILAR EQUIPMENT:**  
None.

Recording Tape: 600 ft lg, lasts 50  
hours with speed switch on high  
Power Requirements: Either 75 to 85v  
or 105 to 125v 100w, 400 to 2600 cps,  
single ph, and 28v, 50w dc.

**TECHNICAL DESCRIPTION**

Frequency Range: 90 to 1000 mc  
Tuning Bands  
    Low Frequency Tuner: 90 to 420 mc  
    High Frequency Tuner: 420 to 1000 mc  
Types of Signal Indication: Aural,  
    electro-sensitive tape recorder, and  
    rotating dial  
Scanning Rates: 2 sweeps per sec, 6  
    sweeps per sec and manual control

**INSTALLATION CONSIDERATIONS**

Related Equipments: (Required but not  
Supplied) (1) Headset, (2) Clips  
AN-742-20C Radio Frequency Cable  
RG-8/U as required.

**PRINCIPAL COMPONENTS AND PHYSICAL DATA**

<b>COMPONENTS</b>	<b>QTY</b>	<b>OVERALL DIMENSIONS (Inches)</b>	<b>SUNIT WT. (Pounds)</b>
Radar Receiver R-34/APR-2	1	7-5/8 x 10-1/2 x 21	46.5
Antenna Assy AS-25/APR-2	1	30 5.2	
Antenna Assy AS-26/APR-2	1	8 3.6	
Cover CW-3/APR-2	1		
Antenna Filter F-3/APR-2	1	1-1/4 x 21-1/8	1.4
Radio Frequency Plug UG-21/U	7	5/8 x 1-1/2	0.3
Plug PL-259	1	5/8 x 1-1/2	0.2
Plug AN3108-22-4S	1	1-19/32 x 2-1/8	0.25
Adapter AN3057-12	1		
Mounting Base MT-171/U	1	1.5	
Filter F-11/APR	1	5/8 x 8-1/2	0.24

**REFERENCE DATA AND LITERATURE**  
Not Available.

DATE: 1 July 1964

ITEM NAME: RECEIVING EQUIPMENT

COGNIZANT SERVICE: USAF

TYPE: AN/APR-4

USA LINE ITEM NUMBER: 658470

FEDERAL STOCK NUMBER:

	USAUSN	USAF	USMC	
STATUS OR TYPE CLASSIFICATION	Std			
Mfg(s) Name or Code Number: Crosley Corporations Cincinnati, Ohio				

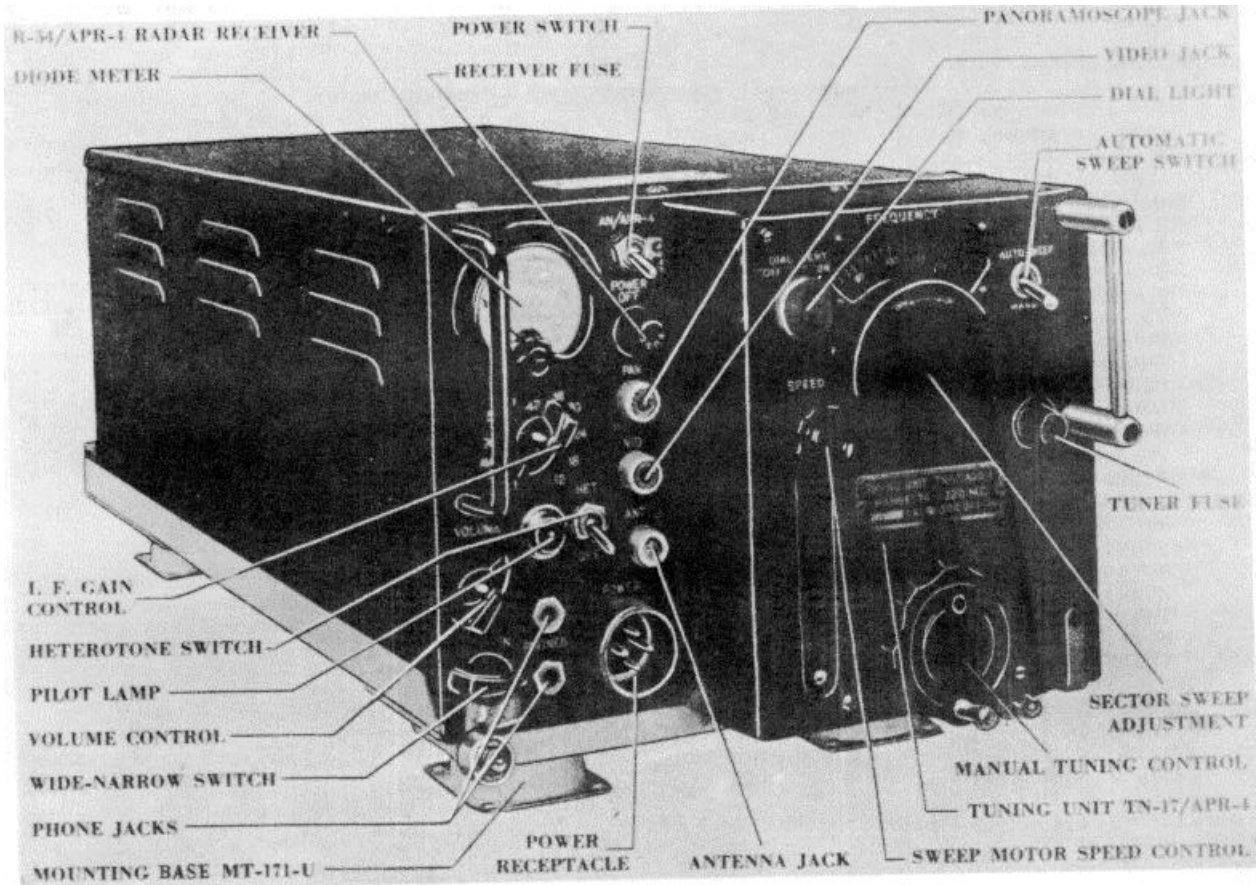

**FUNCTIONAL DESCRIPTION**

The AN/APR-4 is a search receiver intended for use in aircraft or on naval vessels. The receiver may be used to determine the presence and measure the frequency of any radar and radio signals within the

frequency range of 38 mc to 4000 mc. Either automatic or manual tuning may be used.

**ITEM NAME:** RECEIVING EQUIPMENT

**TYPE:** AN/APR-4

**RELATION TO SIMILAR EQUIPMENT**

None.

**TECHNICAL DESCRIPTION**

Frequency Range: 39 to 4000 mc using four plug in tuning units.

Audio Power Output: 100 to 200 mw

Audio Output Impedance: 8000 to 600 ohms

Video Output: 1.5v

Video Output Impedance: 70 ohms

Broad Band Sensitivity: 35 uv input to give an increase of 100 uamp on the diode meter.

Narrow Band Sensitivity: 20 uv to give an increase of 100 uamp on the diode meter.

Temperature Range: -55 deg to 72 deg C;

-67 deg to 162 deg F

Altitude Data: 40,000 ft

Humidity Range: 0 to 95%

Power Requirements: 125w at 80/115v,  
60 to 2600 cps, single ph; 25w at 28v  
dc

**INSTALLATION CONSIDERATIONS**

Related Equipment: (Required but not Supplied) (1) Headset HS-23, HS-33 or HS-38; (1) Plug LP-55; (1) Panoramic Adapter with cable and Power Supply AN/APA-10; (1) Radar Indicator Assembly AN/APA-6 or AN/APA-11 (1) Antenna AT-190B/AP; (1) Antenna AT-191B/AP.

**PRINCIPAL COMPONENTS AND PHYSICAL DATA**

COMPONENTS	QTY	OVERALL DIMENSIONS		UNIT WT.
		(Inches)	(Pounds)	
Radar Receiver R-54-APR-4	1	8 x 10-1/2 x 21-1/2		29
including:				
Amplifier AM-27/APR-4		8 x 6-1/2 x 14-1/16		
Tuning Unit TN-16	1	6-1/2 x 8 x 14-1/16		12.75
Tuning Unit TN-17	1	6-1/2 x 8 x 14-1/16		13.75
Tuning Unit TN-18	1	6-1/2 x 8 x 14-1/16		14.25
Tuning Unit TN-19	1	6-1/2 x 8 x 14-1/16		16
Tuning Unit TN-54	1	6-1/2 x 8 x 14-1/16		15.50
Case CY-31/APR-4	4	6-1/2 x 7-3/4 x 9		7
Mounting Base MT-171/U	1		2.8	
Switching Assembly SA-23/APR-4	1		3.4	
*Antenna Assembly AS-23/APR-4	1			
*Antenna Stub AT-38/APT or AT-38A/APT	1	29	10	
*Fan Antenna consisting of:				
Antenna Support AB-27/A	1	3 x 3-3/8		.62
Insulator IN-88	2			
Tension Unit	1			
Wire W-106A	20 ft			
Thimble AN-100-3	2			
*Radio Frequency Cable RG-8/U	As Req'd			
Wire AN-20	As Req'd			
*Radio Frequency Plug UG-21/U	3	5/8 x 1-1/2		.3
*Radio Frequency Adapter UG-27/U	3	.68 x 1.25 x 1.37		.2
Plug PL-259	3	3/9 x 1-1/2		.5
Adapter M-359	3	3/4 x 1-1/4 x 1-1/4		.08
Adapter AN3057-12	1	1-3/16 x 1-9/16		.06
Plug AN3108-22-4S	11-19/32	2.17 x 3-1/32		.22

**NOTE:** \*Issued in twice above quantity for installations requiring a complete antenna pattern.

**REFERENCE DATA AND LITERATURE**

Technical Manuals: AN 08-30APR4-3 for Receiving Equipment AN/APR-4.

**AN/APR-4: 2**

**DATE:** 1 July 1964

**ITEM NAME:** RADAR SET

**COGNIZANT SERVICE:** USAF

**TYPE:** AN/APR-7

**FEDERAL STOCK NUMBER:**

	USAUSN	USAF	USMC	
STATUS OR TYPE CLASSIFICATION				
Mfg(s) Name or Code Number:				

No illustration available.

**FUNCTIONAL DESCRIPTION**

The AN/APR-7 is an airborne direct detection radar search receiving equipment covering the frequency range from 1000 to 3500 mc. It has a bandwidth from 10 to 40 mc with single dial tuning. It employs a coaxial line tunable resonator in which a crystal detector is

mounted. The crystal detector is followed by a supersonic amplifier, a diode rectifier and an audio amplifier. The receiver is contained in an A1-D standard Aircraft Radio Case and weights.

**AN/APR-7: 1**



Volume 1  
Section 2

**MIL-HDBK-162A**  
15 December 1965

**ITEM NAME:** RADAR SET

**TYPE:** AN/APR-7

**RELATION TO SIMILAR EQUIPMENT**

None.

Bandwidth: 10 to 40 mcs

Power Source Required: 115v, 60 to 2600  
cps, 30w

**TECHNICAL DESCRIPTION**

Frequency Range: 1000 to 3500 mc

**INSTALLATION CONSIDERATIONS**

.Not available.

**PRINCIPAL COMPONENTS AND PHYSICAL DATA**

Not available.

**REFERENCE DATA AND LITERATURE**

Nomenclature Card for AN/APR-7  
dated 12 August 1944.

**AN/APR-7: 2**

DATE: 1 July 1964  
COGNIZANT SERVICE: USN

ITEM NAME: RECEIVING SET, RADAR  
TYPE: AN/APR-12

FEDERAL STOCK NUMBER:

	USAUSN	USAF	USMC	
STATUS OR TYPE CLASSIFICATION				
Mfg(s) Name or Code Number:				

Illustration not available

**FUNCTIONAL DESCRIPTION**

Radar Receiving Set AN/APR-12 provides for the reception of both radar echoes and beacon signals in the S-band. The set operates with the AN/APS-20A and AN/APS-20C radar systems. The AN/APR-12 modified AN/APS-20A, -20C equipments which are capable of only radar reception.

Radar Carrier Frequency: 2850 to 2910 mc (S-band)  
Power Requirements: 115 to 200 vac, 380 to 1000 cps, 3-ph, 460 va; 28 vdc  
Beacon Receiver IF. Frequency: 40 + 0. 2 mc  
Radar Receiver IF. Frequency: 30 + 0. 2 mc  
Beacon IF. Band Width: 7 + 1 mc  
Radar IF. Band Width: 1. 2 + 0. 2 mc  
AMT IF. Band Width: 1. 5 + 0. 2 mc  
Minimum Radar Perceptibility: 136 db below 1 watt  
Minimum Beacon Perceptibility: 120 db below 1 watt

**RELATION TO SIMILAR EQUIPMENT**

None.

**INSTALLATION CONSIDERATIONS**

**TECHNICAL DESCRIPTION**

Not available.

Beacon Carrier Frequency: 2740 to 2830 mc (S-band)

**PRINCIPAL COMPONENTS AND PHYSICAL DATA**

COMPONENT	QTY	HEIGHT (Inches)	WIDTH (Inches)	DEPTH (Inches)	UNIT WT. (Pounds)
Radar Receiver R-242/APR-12	1	13.3810. 88	25.06	52.0	
Multiplexer CU-163/APR-12	1	15.7410. 5	20.5	34.0	
Modification Kit MK-93/APR- 12	1			8.0	

**REFERENCE DATA AND LITERATURE**

Handbook:  
AN 16-30APR12-1

AN/APR-12: 1

**DATE:** 1 July 1964

**ITEM NAME:** RADAR SET

**COGNIZANT SERVICE:** USN

**TYPE:** AN/APS-2

**FEDERAL STOCK NUMBER:**

	USAUSN	USAF	USMC	
STATUS OR TYPE CLASSIFICATION				
Mfg(s) Name or Code Number: Philco Corporation, Philadelphia, Pa.				

No Illustration Available.

**FUNCTIONAL DESCRIPTION**

The AN/APS-2 is designed to located objects, such as surface vessels on the sea and aircraft in the air and to indicate to the pilot and operator the relative direction and distance between the aircraft and object detected. This detection is accomplished through the use of Ultra-

High Frequency (UHF) waves and portrayed visually through the use of cathode ray tube indicators. It is designed for use in heavier than air aircraft, and is to be installed in a fixed position in the nose

**AN/APS-2: 1**

**ITEM NAME:** RADAR SET

**TYPE:** AN/APS-2

or upper nacelle of the aircraft, and may be arranged in the positions most advantageous for the pilot and operator.

**RELATION TO SIMILAR EQUIPMENT**

The AN/APS-2 is similar to the AN/APS-2A, AN/APS-2B except for minor improvements and for rearrangement of components for installation purposes.

**TECHNICAL DESCRIPTION**

**Pulse Repetition Rate:** When the equipment is being used for searching purposes, 650, plus or minus 75, pps are transmitted on 3300 mc freq. When the equipment is used for beacon reception, the pulse rate is changed to 325, plus or minus 25, pps.

**Pulse Duration Rate**

- Search Operation: 1 usec
- Beacon Operation: 2 usec

**Signal Beam Sweep Ranges:** From 0 to 100 naut mi in four steps; 5, 20, 50 and 100 mi

**Antenna Azimuth Range:** The antenna is designed to rotate 360 deg continuously at 12 or 24 rpm, or to rotate back and forth over any chosen sector of 30 deg or multiple of 30 deg

**Antenna Tilt Range:** The antenna may be tilted from 20 deg above to 20 deg below the horizontal.

**Type of Frequency Control:** Automatic local oscillator.

**Operating Frequency Range**

Search Operation: 3300 mc plus or minus 1%

Beacon Operation: 3256 mc

**Operating Power Requirements:** 26v dc, and 115v ac, single ph, 400 to 2400 cycles.

**INSTALLATION CONSIDERATIONS**

**Related Equipments:** (Required but not supplied) (1) Power Supply (115v ac, 400 to 2400 cycles 782w), (1) Power Supply (24v dc, 163w), (1) Set of Cables and Plugs as required.

**PRINCIPAL COMPONENTS AND PHYSICAL DATA**

COMPONENTS	QTY	OVERALL DIMENSIONS		SUNIT WT. (Pounds)
		(Inches)	(Inches)	
Antenna Assy AS-5/APS-2	1	29 x 29	39-3/16	65
Mounting Base MT-15/APS-2	1	2-1/16 x 14-3/4	x 19	4.75
Remote Tuning Control C-5/APS-2	13-1/16 x 3-13/16	x 5-3/16		1
Coaxial Line CU-7/APS-2	1	1-5/8 x 5.4	x 7.65	11.5
Coaxial Line CU-9/APS-2	1	1-3/8 x 6-1/8	x 19	2.38
Junction Box J-6/APS-2	1	4-1/8 x 6-1/2	x 8-1/4	2.3
Receiver Indicator R-7/APS-2	113-3/8 x 19-1/2	x 22-3/16		88
Mounting Base MT-16/APS-2	112-13/64 x 19-15/32	x 22-1/2		9.75
Plan Position Indicator ID-2/APS-2	1	7-1/2 x 8-5/8	x 15-1/8	7.75
Transmitter Converter RT-4 /APS -2	115-3/4 x 15-3/4	x 17-3/4		81.50
Mounting Base MT-45/APS-2	1	2-1/16 x 19	x 31	9.25
Shock Mounts MT-45/APS-2	6	1-1/2 x 3	x 3	2.50
Visors	2	6-1/2 dia	x 11-1/4	1
Phantom Target Equipment Model OAJ	1	5-5/8 x 8-3/8	x 9-3/8	2.81

**REFERENCE DATA AND LITERATURE**

Technical Manuals: CO-AN-08-5GA-1

DATE: 1 July 1964

ITEM NAME: AIRCRAFT RADAR EQUIPMENT

COGNIZANT SERVICE: USN

TYPE: AN/APS-2G

FEDERAL STOCK NUMBER:

	USAUSN	USAF	USMC	
STATUS OR TYPE CLASSIFICATION				
Mfg(s) Name or Code Number: Philco Corporation, Philadelphia, Pa.				

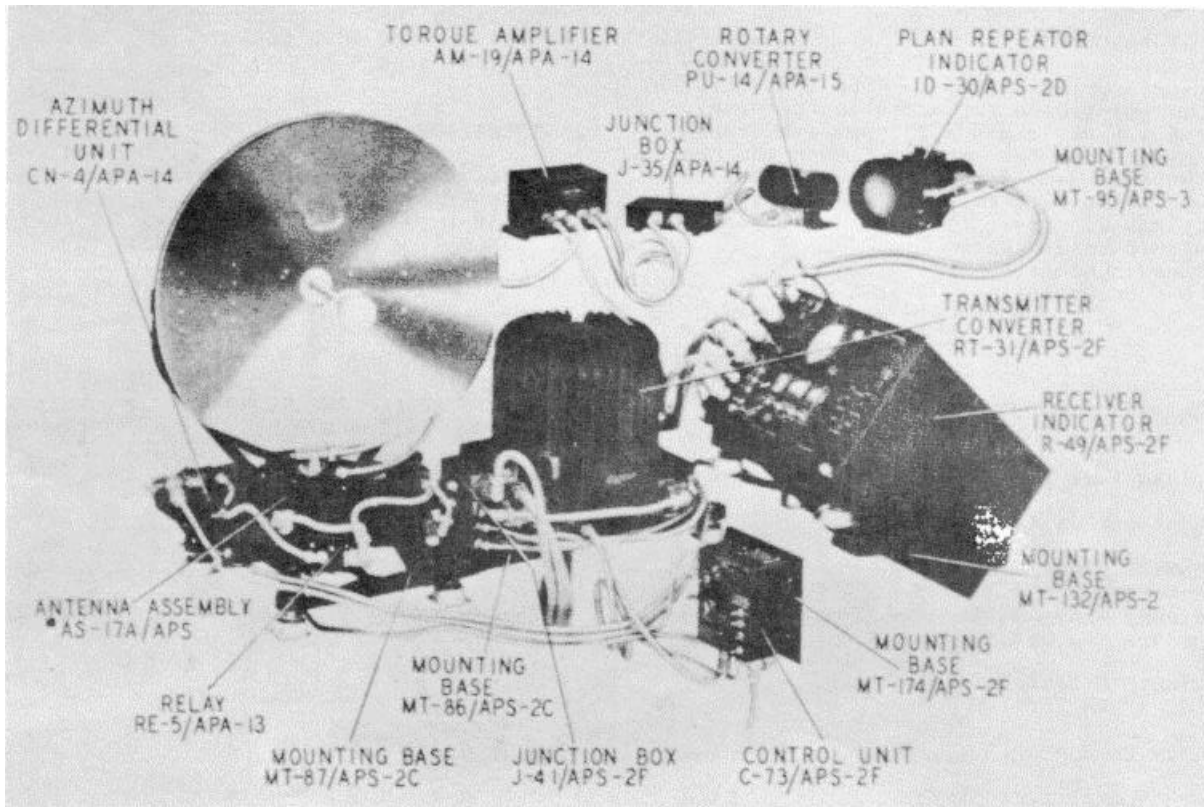

**FUNCTIONAL DESCRIPTION**

The AN/APS-2G radar equipment is designed for use in heavier-than-air aircraft to aid in the location and identification of objects of land and sea, and as an aid in navigation during day or night and in all kinds of weather. Distances to objects, in nautical miles, and direction of objects, within a radius of 100 miles, are

presented to the operator on the screen of a cathode-ray tube indicator. The position of objects with respect to the heading of the aircraft may also be observed without calculation, and, in

**ITEM NAME:** AIRCRAFT RADAR EQUIPMENT

**TYPE:** AN/APS-2G

certain applications of the equipment, the compass bearing of objects is directly indicated. Different classes of objects, such as towns, coast lines, rivers, bridges, and ships, may be distinguished by observing their characteristic screen patterns and relative positions. The exact bearing of the aircraft may be determined from beacon signals.

**RELATION TO SIMILAR EQUIPMENT**

The AN/APS-2G is similar to the AN/APS-2F except for minor improvements and for rearrangement of components for installation purposes.

**TECHNICAL DESCRIPTION**

**Pulse Repetition Rate:** When the equipment is being used for searching purposes, 650, plus or minus 75, pps are transmitted on 3300 mc freq. When the equipment is used for beacon reception, the pulse rate is changed to 325, plus or minus 25, pps.

**Pulse Duration Rate**  
Search Operation: 1 usec  
Beacon Operation: 2 usec

**Signal Beam Sweep Ranges:** From 0 to 100 naut mi in four steps; 5, 20, 50 and 100 mi  
**Peak Radio Frequency Output:** 50 kw  
**Antenna Azimuth Range:** The antenna is designed to rotate 360 deg continuously or to rotate back and forth over any chosen sector of 30 deg or multiple of 30 deg  
**Antenna Tilt Range:** The Antenna may be tilted from 20 deg above to 20 deg below the horizontal.

Type of Frequency Control: Automatic local oscillator.

**Operating Frequency Range**  
Search Operation: 3300 mc plus or minus 1%  
Beacon Operation: 3256 mc  
**Operating Power Requirements:** 541w at 26v dc, and 782w at 115v, 400 to 2400 cycle, single ph, ac

**INSTALLATION CONSIDERATIONS**

Related Equipments: (Required but not Supplied) (1) Power Supply (782w at 115v ac, 400 to 2400 cycles), (1) Power Supply (541w at 24v dc), (1) Flux-Gate Compass Equipment.

**PRINCIPAL COMPONENTS AND PHYSICAL DATA**

COMPONENTS	QTY	OVERALL DIMENSIONS	SUNIT WT.
		(Inches)	(Pounds)
Transmitter T-64/APS-2G	1	15-19/32 x 17-3/4 x 20	74
Junction Box J-63/APS-2G	1	6-29/32 x 15 x 15-7/32	17
Coaxial Line CU-35/APS-2G	1	5-3/4 x 6 x 12	4.06
Antenna Assy AS-17A/APS (less mtg base)	1	25-3/8 x 28-3/4 x 40-1/32	82
Azimuth Differential Unit CN-4/APA-14	1	15-1/4 x 7-1/2 x 9-15/16	6.75
Relay RE-5/APA-13	1	12-9/16 x 4-3/16 x 5-3/4	2.25
Torque Amplifier AM-19/APA-14	1	15-3/16 x 5-1/2 x 9-9/16	5.25
Junction Box J-35/APA-14	1	12-5/16 x 6-7/16 x 9-11/32	2.125
Receiver Indicator R-73/APS-2G	1	113-3/8 x 19-1/2 x 22-3/16	88
Plan Repeater-Indicator ID-30A/APS-2D	1	16-7/8 x 6-15/16 x 14-3/16	9.75
Control Unit C-73/APS-2F	1	15-7/16 x 7-15/16 x 8-5/16	4.50
Servo Amplifier AM-21/APA-15	1	14-19/32 x 6-5/16 x 7-3/16	7

**AN/APS-2G: 2**

ITEM NAME: AIRCRAFT RADAR EQUIPMENT  
TYPE: AN/APS-20

PRINCIPAL COMPONENTS AND PHYSICAL DATA

COMPONENTS	QTY	OVERALL DIMENSIONS	UNIT WT. (Pounds)
		(Inches)	
Gyro Torque Unit CN-21/APA-15A	1	7-3/4 x 8-3/4 x 15-1/2	13.06
Rotary Converter PU-14/APA-15	1	5 x 6-1/16 x 9-1/8	9.50
Resonance Chamber TS-114/APS-2F	***	15-5/8 x 8-3/8 x 14-19/32	5.8
Test Antenna TS-115/APS-2F	1	2-3/4 x 3-3/8 x 3-3/8	0.19
Mounting Base MT-217/APS-2&		12-1/4 x 24-13/16 x 24-3/8	13.5
Mounting Base MT-132/APS-2		112-13/64 x 19-15/32 x 22-1/2	4.50
Mounting Base MT-95/APS-3		11-3/4 x 5-1/8 x 9-15/16	0.5
Mounting Base MT-174/APS-2F	1	5/8 x 8-1/2 x 9-5/8	0.6
Mounting Base MT-131/APA-15	1	1-7/8 x 6-3/4 x 20-1/4	2
Visor	2	6-1/2 x 6-1/2 x 11-1/4	1

NOTE: \*Includes Azimuth Differential Unit CN-4/APA-14 and Relay RE-5/APA-13.  
\*\*Weight includes Cables and Plugs.  
\*\*\*Weight less Cables and Plugs.

REFERENCE DATA AND LITERATURE

Technical Manuals:  
CO-AN-8-30APS2-2

AN/APS-2G: 3

DATE: 1 July 1964

ITEM NAME: AIRCRAFT RADAR EQUIPMENT

COGNIZANT SERVICE: USN

TYPE: AN/APS-3

FEDERAL STOCK NUMBER:

	USAUSN	USAF	USMC	
STATUS OR TYPE CLASSIFICATION Mfg(s) Name or Code Number:				

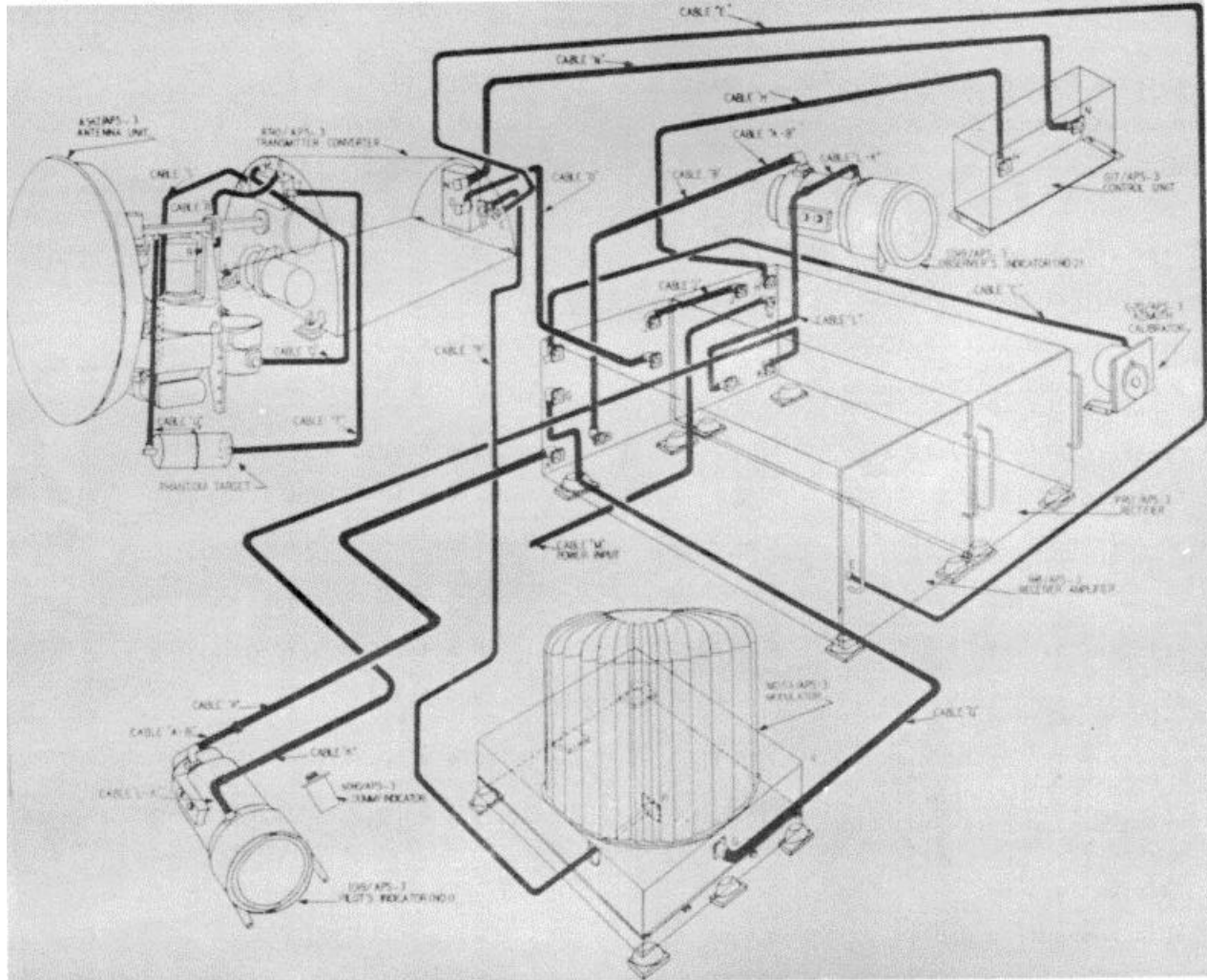

**FUNCTIONAL DESCRIPTION**

The AN/APS-3 is designed for search or beacon operation. The search function is used to locate objects, provides a direct indication of their bearing and distance on the repeater indicator screen.

The beacon function is used for homing or navigational purposes, providing an indication on the repeater-indicator screen of the bearing and distance of fixed beacon station ahead of the aircraft.



**ITEM NAME:** AIRCRAFT RADAR EQUIPMENT

**TYPE:** AN/APS-3

**RELATION TO SIMILAR EQUIPMENT**

None.

Search: 4, 10, 40, 80 naut mi

Beacon: 4, 10, 40, 120 naut mi

Operating Power: 115v, 800 to 2400 cps, single ph, and 26v dc

Temperature Range: -55 deg to plus 50 deg C

**TECHNICAL DESCRIPTION**

RF Operating Frequency

Search: 9375 mc

Beacon: 9310 mc

RF Power Output: 25 kw

Ranges

**INSTALLATION CONSIDERATIONS**

Related Equipments: (Required but not Supplied) (1)  
Power Supply Equipment.

**PRINCIPAL COMPONENTS AND PHYSICAL DATA**

COMPONENTS	QTY OVERALL DIMENSIONS UNIT WT.	
	(Inches)	(Pounds)
Antenna Unit AS-12/APS-3	116-3/4 x 18-1/2 x 19-3/8	21
Modulator MD-SA/APS-3	115-1/2 x 17-7/32 x 17-13/32	72.5
Modulator Mounting Base MT-96/APS -3	12-1/2 x 5-1/2 x 15-1/8	4.5
Transmitter Converter RT-10/APS-3	113-1/8 x 17-1/8 x 19-1/4	48
Transmitter Mounting Base	1	
Receiver Amplifier R-18/APS-3	17-11/16 x 10-7/16 x 17-27/32	34
Receiver Amplifier Mounting Base MT-97/APS-3	1 2 x 11-1/8 x 22-5/8	3
Control Unit C-17/APS-3	13-1/4 x 5-9/16 x 10-1/4	4
Rectifier Unit PP-12/APS-3	17-11/16 x 10-7/16 x 17-27/32	46
Rectifier Mounting Base MT-97/APS-3	1 2 x 11-1/8 x 22-5/8	3
Dummy Indicator MX-10/APS-3	13-3/4 x 4-1/2 x 9-7/8	1.75
Azimuth Calibrator C-20/APS-3	14-1/8 x 4-1/2 x 5-7/16	1.75
Repeater Indicator ID-19/APS-3	27-1/2 dia x 14-13/32	9.5
Repeater Indicator Mounting Base No. 1	11-13/16 x 5-13/16 x 9-11/16	0.5
Repeater Indicator Mounting Base No. 2	11-3/4 x 5-1/8 x 9-11/16	0.5
Phantom Target	13-7/16 x 4-3/4 x 10-1/32	2.25
Interconnecting Cables	20	

**REFERENCE DATA AND LITERATURE**

Technical Manuals:

AN-08-10-196

DATE: 1 July 1964

ITEM NAME: AIRCRAFT RADAR EQUIPMENT

COGNIZANT SERVICE: USN

TYPE: AN/APS-4A

FEDERAL STOCK NUMBER:

	USAUSN	USAF	USMC	
STATUS OR TYPE CLASSIFICATION				
Mfg(s) Name or Code Number:				

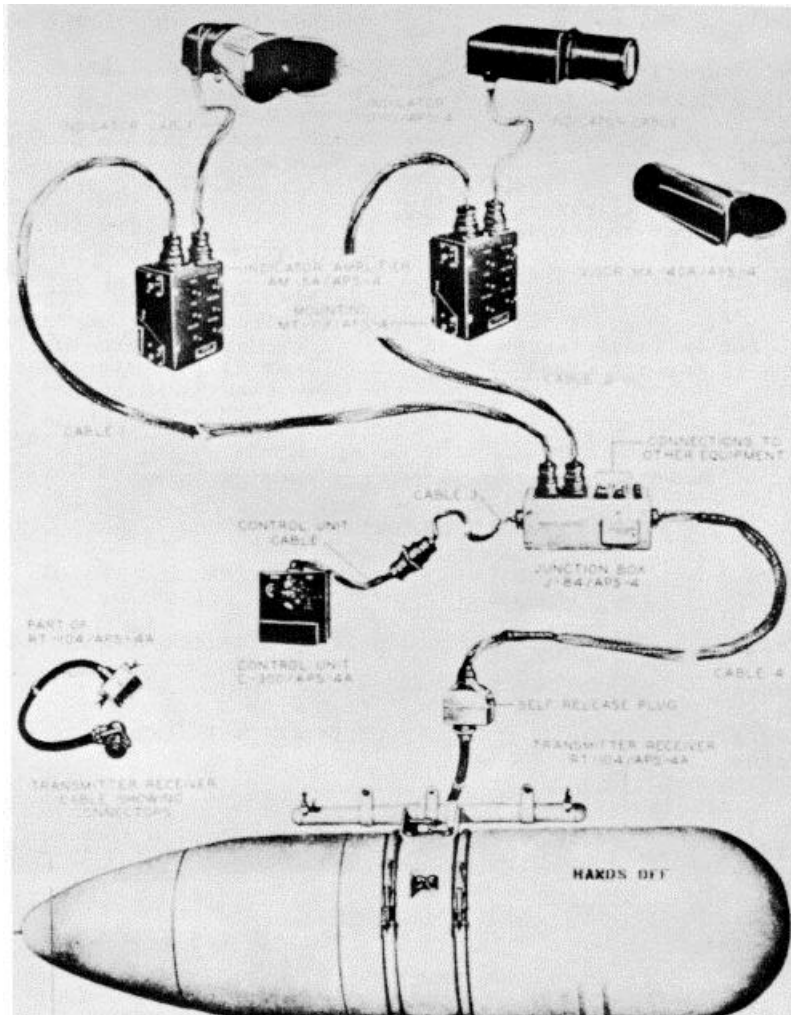

**FUNCTIONAL DESCRIPTION**

The AN/APS-4A is designed primarily for the detection of surface vessels and aircraft. The equipment supplies both radar and beacon services. By means of cathode-ray tube indicators, the apparatus provides to the pilot and to the radar operator, visual

indications of the location of surface targets or beacon transmitters in terms of azimuth (degrees) and range (nautical miles). In searching for airborne targets, the equipment also indicates the approximate angle of elevation

**ITEM NAME:** AIRCRAFT RADAR EQUIPMENT

**TYPE:** AN/APS-4A

of the target with respect to the intercepting aircraft.

**RELATION TO SIMILAR EQUIPMENT**

The AN/APS-4A is similar to the AN/APS-4 but are not directly interchangeable.

**TECHNICAL DESCRIPTION**

Frequency Range: 9375 plus or minus 55 mc  
 Indication: Type "B" scan for search; modified type "H" scan for intercept. (3 in CRT).  
 Peak Power: 35 kw (approx)  
 Pulse Duration  
     Radar: 0.6 usec  
     Beacon: 2.1 usec  
 Pulse Repetition Rate  
     1000 plus or minus 80 pps: For radar on 2, 7, 20 and 50 naut mi ranges  
     600 plus or minus 50 pps: For radar on 100 naut mi range  
     350 plus or minus 30 pps: For beacon on all ranges  
 Antenna Data  
     Type: Resonant slit on focal length of 6.3 in. in a 14 in. dia parabola (2B.2 db gain)  
 Beam Width: 6 deg  
 Scan

Search: 150 deg horizontal; 12 deg vertical (in two steps)  
 Intercept: 150 deg horizontal; 24 deg vertical (in four steps)  
 Speed of Scan  
     Search: 2 and 7 mi ranges, 44 to 68 (56 nom) two line frames per minute; 20, 50 and 100 mi ranges, 22 to 34 (28 nom) two line frames per minute  
     Intercept: 27.5 to 42.5 (35 nom) four line frames per minute  
 Intermediate Frequency: 60 mc  
 IF Band Width: 2.7 mc  
 Mixer: Crystal  
 Temperature Range: -30 deg C to plus or minus 50 deg C  
 Humidity: 95% relative  
 Maximum Elevation: Up to 30,000 ft  
 Power Requirements  
     ac: 115v, 800 to 2400 cps, single ph, 6 amp  
     dc: 26v, 3 to 4 amp

**INSTALLATION CONSIDERATIONS**

Related Equipments: (Required but not Supplied) (1)  
 Generator NEA 3, 4 or 5 or Motor-Alternator PU-1BA or PU-43/A, (1 or 2) Indicator Mountings, and Test Equipment as Required.

**PRINCIPAL COMPONENTS AND PHYSICAL DATA  
SHIPPING DATA**

COMPONENTS	BOXES OVERALL DIMENSIONS UNIT WT.		
	(NR.)	(Inches)	(Pounds)
Transmitter-Receiver RT-O04/APS-4A (1) Technical Manual AN 16-30APS4-3	1	31 x 31-1/4 x 75	395
Indicator ID-11/APS-4 Indicator-Amplifier AM-SA/APS-4 Control Unit C-300/APS-4A Visor MX-40A/APS-4	1	14-1/4 x 15-1/2 x 19	30
Indicator ID-11/APS-4 Indicator-Amplifier AM-5A/APS-4 Visor MX-40A/APS-4	1	12-1/4 x 14-1/4 x 15-1/4	22
Set of Equipment Spares	1*	18 x 19-1/8 x 29-5/8	59

**NOTE: \*One for each three equipments**

MIL-HDBK- 162A  
15 December 1965

Volume 1  
Section 2

ITEM NAME: AIRCRAFT RADAR EQUIPMENT

TYPE: AN/APS-4A

**PRINCIPAL COMPONENTS AND PHYSICAL DATA**

**EQUIPMENT SUPPLIED DATA**

<b>COMPONENTS</b>	<b>QTY (Inches)</b>	<b>OVERALL DIMENSIONS (Pounds)</b>	<b>UNIT WT.</b>
Mounting MT-113/APS-4	1 or 2**	2-31/32 x 5-14/32 x 6-19/32	0.6
Junction Box 3-84/APS-4	1*	3-25/32 x 6-17/32 x 11-3/4	3.8
Set of Interconnecting Cables	1*		
Indicator ID-11/APS-4	1 or 2**	3-1/2 x 3-21/32 x 15-1/2	3.7
Visor MX-40A/APS-4	1 or 2**	3-3/16 x 5-1/4 x 11-1/4	0.9
Indicator-Amplifier AM-5A/APS-4	1 or 2**	3-21/32 x 6-5/8 x 7-1/2	3.1
Control Unit C-300/APS-4A		13-7/32 x 6-1/32 x 7-1/8	3.3
Transmitter-Receiver RT-104/APS-4A		117-1/8 dia x 66-15/16	135

**NOTE: \*These items are shipped directly to the aircraft for permanent installation.**

**\*\*Depending upon whether installed in single or double place installation.**

**REFERENCE DATA AND LITERATURE**

Technical Manuals:

AN 16-30APS-4-11  
(CO AN 16-30APS4-3-M)

**AN/APS-4A: 3**

DATE: 1 July 1964

ITEM NAME: AIRCRAFT RADAR EQUIPMENT

COGNIZANT SERVICE: USN

TYPE: AN/APS-6

FEDERAL STOCK NUMBER:

	USA	US\$	USAF	USMC
STATUS OR TYPE CLASSIFICATION				
Mfg(s) Name or Code Number:				

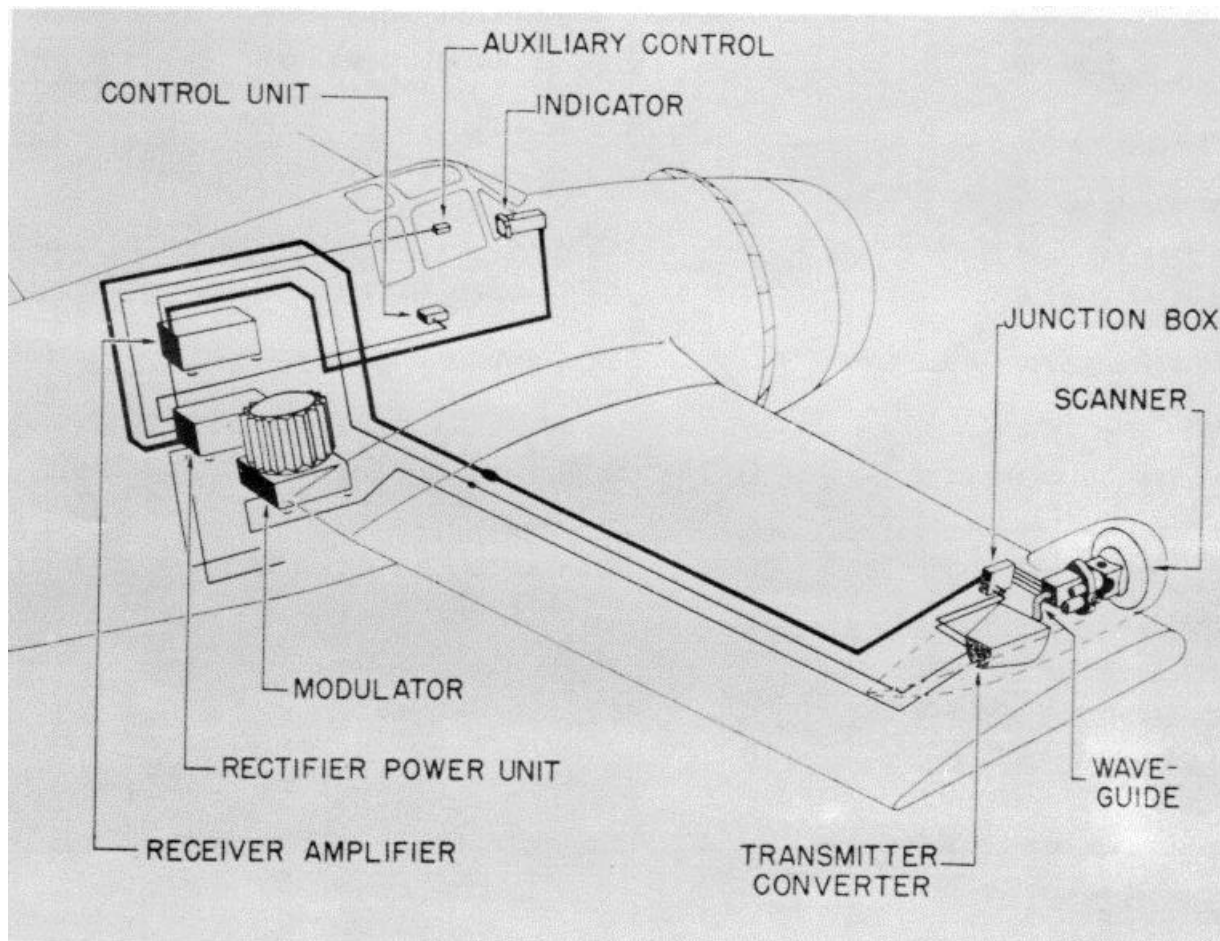

**FUNCTIONAL DESCRIPTION**

The AN/APS-6 is designed for installation in night-fighter aircraft. The equipment is primarily used for searching for enemy aircraft and surface craft during

night operation, in for or during other low visibility conditions. It provides radar indications on a cathode-ray tube indicator which enable the pilot to locate enemy surface craft within a 65 nautical-mile range and aircraft within a 25-mile range. It enables the pilot to approach to within gun-firing range

**ITEM NAME:** AIRCRAFT RADAR EQUIPMENT

**TYPE:** AN/APS-6

and to aim and fire the night-fighter aircraft's guns accurately without ever actually seeing the enemy at any time.

Conical Scan

Gun Aim: 25 deg cone

Radar Search: 120 deg con

Intermediate Frequency: 60 mc

Operating Power: 24 to 28-1/2v dc and 115v, 800 to 2400 cps

**RELATION TO SIMILAR EQUIPMENT**

Similar mechanically and electrically to AN/APS-6A.

**TECHNICAL DESCRIPTION**

Ranges: 65, 25, 5 and 1 mi

**INSTALLATION CONSIDERATIONS**

Not available.

**PRINCIPAL COMPONENTS AND PHYSICAL DATA**

COMPONENTS	QTY OVERALL DIMENSIONS UNIT WT.	
	(Inches)	(Pounds)
Scanner AS-24/APS-6	117 x 19-3/4 x 25-19/32	50
Transmitter Converter RT-17/APS-6	110 x 10-1/2 x 13-5/8	34
Junction Box J-24/APS-6	1 3-9/16 x 5 x 7-5/8	2.5
Rectifier Power Unit PP-16A/APS-6	17-27/32 x 10-53/64 x 23-1/8	27.5
Receiver Amplifier R-35/APS-6	17-27/32 x 10-5/8 x 21-7/32	27.5
Modulator MD-9B/APS-6	115-1/2 x 17-1/4 x 17-29/32	59
Indicator ID-32/APS-6	14-11/16 x 5-5/8 x 17-1/2	5.5
Control Unit C-46/APS-6	1 2-13/16 x 5 x 5-1/2	1.5
Auxiliary Control Unit C-47/APS-6	11-21/32 x 2-5/16 x 3-13/32	1-1/4
Mounting Base MT-103/APS-6	2	
Mounting Base MT-96/APS-6	1	
Mounting Base MT-105/APS-6	1	
Set of Cables	1	

**REFERENCE DATA AND LITERATURE**

Technical Manuals:  
AN 16-30APS6-3

DATE: 1 July 1964

ITEM NAME: AIRCRAFT RADAR EQUIPMENT

COGNIZANT SERVICE: USN

TYPE: AN/APS-15A, AN/APS-15B

FEDERAL STOCK NUMBER:

	USAUSN	USAF	USMC	
STATUS OR TYPE CLASSIFICATION				
Mfg(s) Name or Code Number: Philco Corporation, Philadelphia, Pa.				

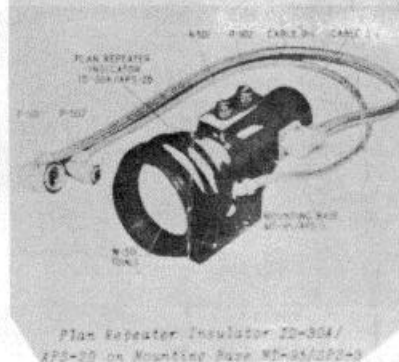
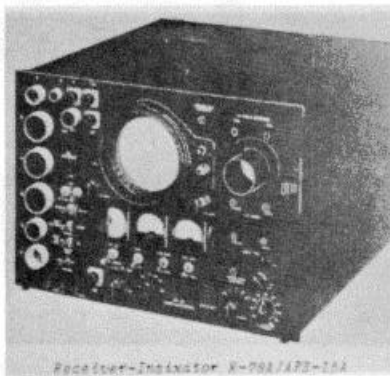
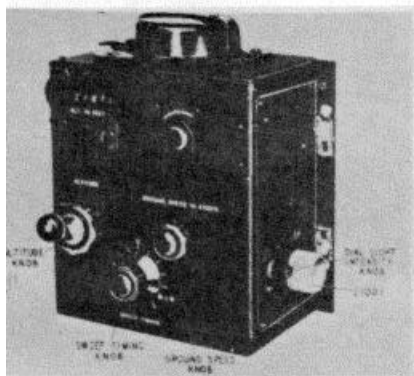
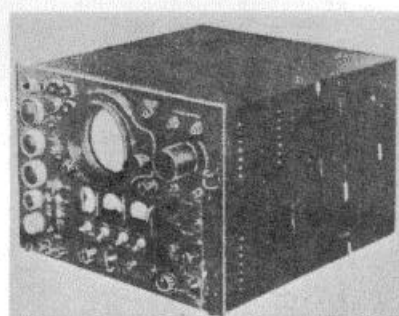
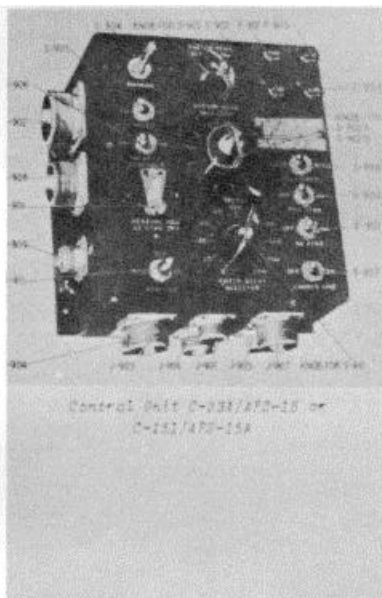
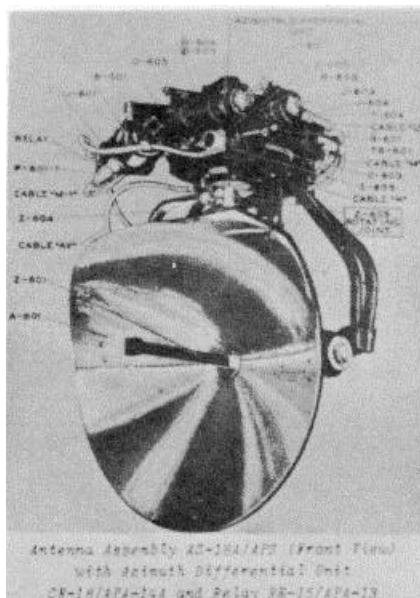

## FUNCTIONAL DESCRIPTION

The AN/APS-15A and -15B are used for searching, precision ranging, bombing and navigation in conjunction with radio beacons. Their fundamental operation is searching; in which the general surrounding area is viewed and in objects bearing and distance with

respect to the aircraft and it's approximate compass bearing can be determined.

Precision ranging with a high degree of accuracy is employed. Bombing of areas invisible with ordinary bomb sights can be

AN/APS-15A:

**ITEM NAME:** AIRCRAFT RADAR EQUIPMENT

**TYPE:** AN/APS-15A, AN/APS-15B

accomplished so that bombing operations may be carried out day or night, regardless of weather conditions. With beacon stations of the transponder type, this equipment can be used for homing and other navigational procedures.

**RELATION TO SIMILAR EQUIPMENT**

Similar to AN/APS-15 except for changes principally in computer, range unit and receiver-indicator.

**TECHNICAL DESCRIPTION**

Frequency Range

Transmitter: 9375 plus or minus 40 mc

Receiver (Search and Bombing): 9375

plus or minus 40 mc

Receiver (Beacon Operation): 9310 plus or minus 10 mc

Power Output: 24 kw

Pulse Width

Search on 50 and 100 mi Ranges: 0.95 plus or minus 0.05 usec

Precision Ranging and Bombing on 5 to 30 mi Ranges: 0.5 plus or minus 0.5 usec

Beacon: 2.1 plus or minus 0.10 usec

Pulse Rate

Search: 622 pps on 50 and 10 mi ranges

Precision Ranging: 622 pps on 50 and 100 mi ranges and on 5 to 30 mi range when sweep delay is introduced.

Bombing: 1155 or 1347 pps on 5 to 30 mi ranges.

Beacon: 300 plus or minus 50 to 10 pps.

Sweep Ranges

Search and Beacon: 5 to 30, 50 to 100 naut mi

Precision Long-Range Beacon: Sweep delays in 10 mi steps from 10 to 200 naut mi.

Power Source Required: 115v, 400 to 2400 cps, single ph, 975w; 26v dc at 480w

Antenna Beam Width: 4 deg at half-power points in the horizontal plane.

**INSTALLATION CONSIDERATIONS**

Related Equipment: (Required but not Supplied) (1)  
Flux Gate Compass equipment.

**PRINCIPAL COMPONENTS AND PHYSICAL DATA**

COMPONENTS	QTY	OVERALL DIMENSIONS	SUNIT WT.
		(Inches)	(Pounds)
Antenna Assy AS-18A/APS (incl Rotating Joint CU-18/APS)		125-3/8 x 28-3/4 x 40-1/32	(7) 82
(1) Wave Selector CG-116/APS-15	1	2 x 8 x 11-1/2	1.25
(2) Wave Selector CU-72/APS-15B	1	2-1/4 x 3-29/32 x 9-1/2	1.0
(1) Wave Selector CU-73/APS-15A	1	1 3-4 x 7-1/4 x 10-3/4	1.25
Heater MX-160/APS-15		1 1-1/2 x 2-1/2 x 4-5/8	0.31
Pressurizing Unit MK-23/AP		12-29/32 x 4-3/8 x 10-1/4	3.25
(8) Pressurizing Unit HD-3/AP		13-1/4 x 4-3/8 x 10-1/4	3.13
Torque Amplifier AM-19/APA-14		15-1/4 x 5-1/2 x 9-1/2	5.5
Azimuth Differential Unit CN-18/APA-14A		15-1/4 x 7-1/2 x 9-15/16	6.75
Relay-RE-5/APA-13 or Relay RE-14/APA-14A		12 -9/16 x 4-3/16 x 5-3/4	2.25
Relay RE-14/APA-14A	1	3-1/2 x 3-3/4 x 6	3.5
Servo Amplifier AM-21/APA-15		14-19/32 x 6-5/16 x 7-3/16	7.0
Gyro Torque Unit CN-21/APA-15A		17-3/4 x B-3/4 x 15-1/2	13.0
Rotary Converter PU-14/APA-15	1	5 x 6-1/16 x B	9.5
(2) Modulator MD-5C/APS-3		115-1/B x 15-1/8 x 17-3/4	63.0
(2) Transmitter-Converter RT-59/APS-15B		112-7/16 x 17 x 18-1/4	54.0



ITEM NAME: AIRCRAFT RADAR EQUIPMENT

TYPE: AN/APS-15A, AN/APS-15B

PRINCIPAL COMPONENTS AND PHYSICAL DATA

COMPONENTS	QTY	OVERALL DIMENSIONS	SUNIT WT.
		(Inches)	(Pounds)
(1) Transmitter-Converter RT-15A/APS-15 incl: Modulator MD-4C/APS-2		115-3/4 x 15-3/4 x 17-3/4	82.0
Receiver-Indicator R-78/APS-15A or R-78A/APS-15A		113-3/8 x 19-1/2 x 22-3/16	75.0
Plan Repeater Indicator ID-30A/APS-2D		16-7/8 x 6-15/16 x 14-3/16	10.0
Range Unit CP-11/APS-15A or CP-11A/APS-15A		15 x 7-13/16 x 21-3/4	22.5
(7) Computer CP-IO/APS-15A		15-1/2 x 7-7/8 x 8-5/8	6.0
Control Unit C-33A/APS-15 or C-151/APS-15A		15-5/16 x 7-15/16 x 8-11/32	4.0
(3) Junction Box J-15B/APS-15		15-1/2 x 7-1/4 x 7-3/4	7.5(4)
(3) Junction Box J-156/APS-15A		15-1/2 x 7-1/4 x 7-3/4	7.5(4)
(3) Junction Box J-159/APS-15B		15-1/2 x 7-1/4 x 7-3/4	7.5(4)
(3) Junction Box J-35/APA-14		12-5/16 x 6-7/16 x 9-11/32	2.1(4)
(3) Junction Box J-67/APS-15		1 3 x 3-1/16 x 3-1/2	0.75
(5) Mounting Base MT-231/APA-15		11-7/8 x 6-3/4 x 20-1/4	2.0
Mounting Base MT--132/APS-2		112-13/64 x 19-15/32 x 22-1/2	4.5
Mounting Base MT--311/APS-15B		12-5/16 x 15-9/16 x 18-7/32	4.5
Mounting Base MT-51/UR		12-5/8 x 5-3/4 x 22-5/8	3.25
Mounting Base MT-174/APS-2F		2 5/8 x 8-1/2 x 9-5/8	0.6
Mounting Base MIT-95/APS-3		11-3/4 x 5-1/8 x 9-15/16	0.5
(2) Mounting Base MKT-264/APS-15B		12-1/4 x 24-13/64 x 24-3/8	13.25
Visor		26-1/2 x 6-1/2 x 11-1/4	1.0
Computer Dials-Group 1	4		
Computer Dials-Group II	4		
Computer Dials-Group III	4		
Aircraft "B" Modification Kit MX-343J/APS -15A	1		
Interconnecting Cables	49		
Plugs	84		
Operating Spare Parts			

- NOTE:** (1) For Model AN/APS-15A only.  
(2) For Model AN/APS-15B only.  
(3) Overall Dimensions include conduit couplings without Cables.  
(4) Includes attached cables and plugs.  
(5) Without Brackets.  
(6) Includes Azimuth Differential Unit and Relay.  
(7) Includes 11 supplementary Computer dials.  
(8) Used only with Equipment supplied on Contracts NXsa 87733 and 93886.

Overall Dimensions of Units do not include Mounting Bases attached.  
Weights of Units do not include Mounting Bases attached.

AN/APS-15A: 3

Volume 1  
Section 2

**MIL-HDBK-162A**  
15 December 1965

**ITEM NAME:** AIRCRAFT RADAR EQUIPMENT

**TYPE:** AN/APS-15A, AN/APS-15B

**REFERENCE DATA AND LITERATURE**

Technical Manuals:

AN 16-30APS15-7

**AN/APS-15A: 4**

**DATE:** 1 July 1964

**ITEM NAME:** RADAR SET

**COGNIZANT SERVICE:** USN

**TYPE:** AN/APS-19, -19A, -19B, -19C

**FEDERAL STOCK NUMBER:**

	USA	USN	USAF	USMC
STATUS OR TYPE CLASSIFICATION				
Mfg(s) Name or Code Number: Sperry Gyroscope Co., Inc. Lavoise Labs., Inc.				

Illustration Not Available

### FUNCTIONAL DESCRIPTION

The AN/APS-19, -19A, and -19C are airborne radar sets that provide search, intercept, gun-aiming, beacon, and IFF data. The sets may be installed in the fuselage or in a nacelle suspended from a Mark 51 bomb rack. Minor design changes improve the AN/APS-19A over the AN/APS-19. The changes involve Synchronizer Power Unit SN-51/ APS-19A, Indicator ID-158/APS-19, Control Box C-282A/APS-19 or C-282B/APS-19, and Directional Coupler CV-129/APS-19. The AN/APS-19B and AN/APS-19A are interchangeable. AN/APS-19C is interchangeable with AN/APS-19A and 19B except for Antenna AS-630/APS-19C, Radar Set Control C-1184/APS-19C, Transmitter-Receiver RT-100A/ APS-19 or RT-100B/APS-19, Synchronizer Power Unit SN-51A/APS-19 or SN-51B/APS-19.

### RELATION TO SIMILAR EQUIPMENT

None.

### TECHNICAL DESCRIPTION

Frequency: Search - 9375 mc, beacon - 9310 mc  
Voltage and Power Requirements:

AN/APS-19-

115 vac, 1-ph, 400 to 2,400 cps, 650w;

28 vdc, 3.5 amp (standby) to 30 amp (full load)

AN/APS-19A, -19B-

115 vac, 1-ph, 380 to 1,760 cps, 650w;

28 vdc, 700w

AN/APS-19C-

115 vac, 1-ph, 380 to 1,760 cps, 650w;

28 vdc, 500w

Peak Power Output (AN/APS-19A, - 19B):

40 kw

### INSTALLATION CONSIDERATIONS

Not available.

AN/APS-19, -19A, -19B, -19C

**PRINCIPAL COMPONENTS AND PHYSICAL DATA**

COMPONENT	QTY	HEIGHT (Inches)	WIDTH (Inches)	DEPTH (Inches)	UNIT WT. (Pounds)
AN/APS-19  Transmitter-Receiver RT-100( )/APS-19  Radar Receiver R-161( )/APS-19  Synchronizer Power Unit SN-35( )/APS-19  Antenna Assembly AS-238( )/APS-19  Control Box C-282( )/APS-19  Indicator ID-158( )/APS-19 Test Panel J-209( )/APS-19  Directional Coupler CU-129/APS- 19  Mounting Base MT-437/APS-19  Mounting Base MT-438/APS-19  Nacelle CW- 144( )/APS-19					
AN/APS-19A  Transmitter-Receiver RT-100/APS-19  Synchronizer Power Unit SN-51/APS-19A  Indicator ID-158A/APS-19  Antenna Assembly AS-238/APS-19  Control Box C-282A/APS-19 or Control Box C-282B/APS-19  Test Panel J-209/APS-19  Directional Coupler CU-129/APS-19 or  Directional Coupler CU-129A/APS-19  Nacelle CW-144/APS-19  Mounting Base MT-437/APS-19					

AN/APS-19, -19A, -19B, -19C

**PRINCIPAL COMPONENTS AND PHYSICAL DATA (cont'd)**

<b>COMPONENT</b>	<b>QTY</b>	<b>HEIGHT (Inches)</b>	<b>WIDTH (Inches)</b>	<b>DEPTH (Inches)</b>	<b>UNIT WT. (Pounds)</b>
Mounting Base MT-438/APS-19					
AN/APS-19B					
Nacelle CW-144/APS-19					
Antenna AS-602/APS-19					
Transmitter-Receiver RT-100A/APS-19					
Synchronizer Power Unit SN-51A/APS-19A					
Indicator ID-158A/APS-19					
Radar Set Test Panel Control C-1072/APS-19B					
Mounting MT-1111/APS-19B					
Visor MX-1204/APS-19A					
Light Filter MX-1355/APS-19B					
Directional Coupler CU-129A/APS-19					
Waveguide Assembly CG-913/U					
AN/APS- 19C					
Antenna AS-630/APS-19C					
Radar Set Control C-1184/APS-19C					
Waveguide Assembly CG-913/U					
Jack Box J-494/APS-19B					
Mounting MT-1111/APS-19B					
Light Filter MX-1335/APS-19A					
Visor MX-1204/APS-19A					
Transmitter - Receiver RT-100B/APS-19					
Synchronizer Power Unit SN-51B/APS-19A					
Directional Coupler CU-129A/APS-19					

AN/APS-19, -19A, -19B, -19C

**PRINCIPAL COMPONENTS AND PHYSICAL DATA (cont'd)**

<b>COMPONENT</b>	<b>QTY</b>	<b>HEIGHT (Inches)</b>	<b>WIDTH (Inches)</b>	<b>DEPTH (Inches)</b>	<b>UNIT WT. (Pounds)</b>
Indicator ID-158A/APS-19					
Air Compressor HD-142/APS-19C					
Waveguide Assembly CG-1069/APS-19C					

**REFERENCE DATA AND LITERATURE**

Specifications:

- MIL-R-7123A
- R 16R83(AER)
- AN-W-14
- NAVAER EI-181

DATE: 1 September 1964

ITEM NAME: RADAR SET

COGNIZANT SERVICE: USN

TYPE: AN/APS-20A, AN/APS-20C

FEDERAL STOCK NUMBER:

	USA	USN	USAF	USMC
STATUS OR TYPE CLASSIFICATION				
Mfg(s) Name or Code Number: Hazeltine Electronics Corp., Little Neck, New York				

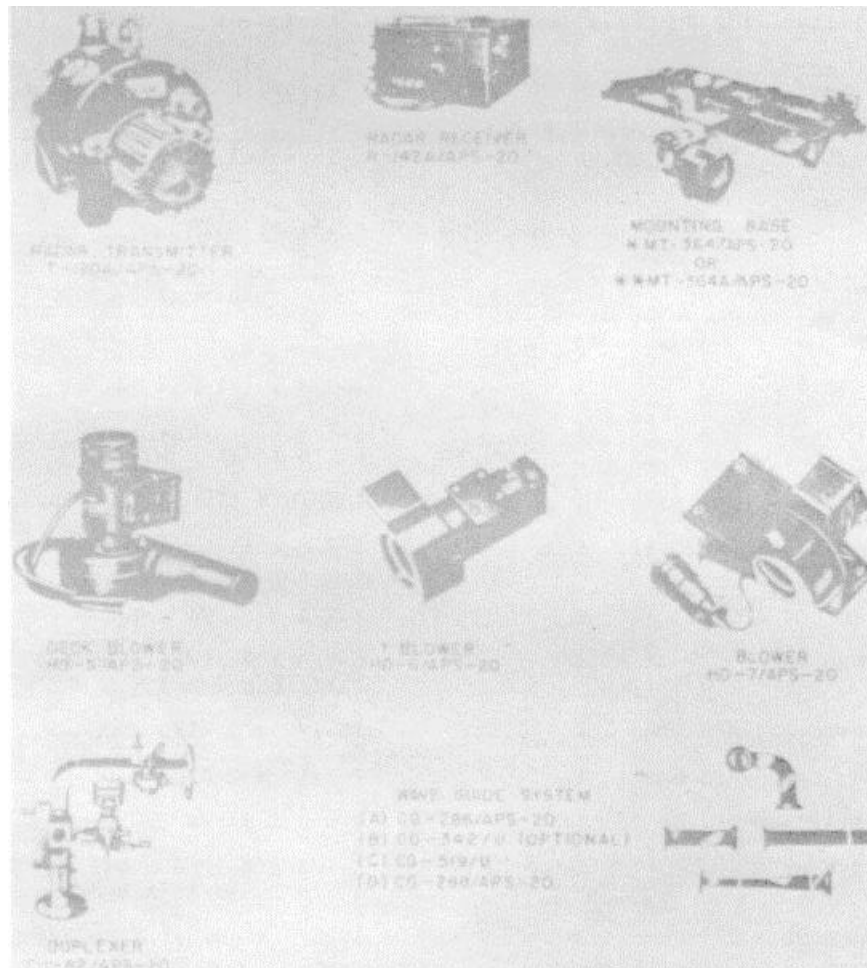

**FUNCTIONAL DESCRIPTION**

The AN/APS-20A and AN/APS-20C are high-powered airborne search equipments capable of scanning through 360 degrees for a map type presentation of land masses, ships and aircraft.

Installed in various type of specially equipped aircraft, they are designed for operation with other airborne and ship-borne equipments in the airborne early warning system to extend the normal radar horizon of the shipboard search equipment.

**ITEM NAME:** RADAR SET

**TYPE:** AN/APS-20A, AN/APS-20C

**RELATION TO SIMILAR EQUIPMENT**

The AN/APS-20A, AN/APS-20C are essentially identical, electrically and physically, differing mainly in that the AN/APS-20C has been changed to accommodate a newer flux-gate compass system.

**TECHNICAL DESCRIPTION**

Frequency: 2880 mc  
Power Output: 1 megw  
Pulse Data  
Width: 2 usec  
Repetition Rate: 300 pps  
Receiver Sensitivity: 132 db below 1w  
IF. Data  
Frequency: 30 mc  
Bandwidth: 1.5 mc  
Range: 200 mi max  
Power Requirements: 28v dc, 1008w and 115v, 380 to 420 cps, 1-ph, 250 va and

120/208v, 400/800. cps, 3-ph, 3/150 va  
Antenna Data  
Type: Parabolic reflector  
Beam Width  
Vertical: 8 deg  
Horizontal: 3.5 deg  
Polarization: Horizontal  
Scanning Rates: 6 or 10 rpm  
Beam Tilt Angle: -2 deg

**INSTALLATION CONSIDERATIONS**

Related Equipment  
Required but not Supplied: (1) Radar Set AN/APX-13A, (1) Aircraft Radio Equipment AN/ARW-35, (1) Aircraft Radio Transmitter AN/ART-26 or AN/ART-28, (1) Alternator, (1) Voltage Regulator, (1) DC Generator (1) Gearbox and Generator Drive, (1) Gyrostabilized Flux-Gate Compass System, (1) Inverter, (1) Distribution Box.

**PRINCIPAL COMPONENTS AND PHYSICAL DATA**

COMPONENTS	QTY	OVERALL DIMENSIONS (Inches)	UNIT WT. (Pounds)
AN/APS-20A			
Air Cleaner M(-973/U	1	1-7/8 x 1-7/8 x 5-1/4	0.5
Air Pump HD-27/U or HD-58/APS-20A	1	5-3/8 x 5-5/8 x 8-1/2 6 x 6-15/16 x 15-7/8	8.0 10.0
Antenna Assy AS-298/APS-20A	1	43-3/8 x 57-5/8 x 94-13/16	210.0
Antenna Control C-219A/APS-20 or C-219B/APS-20	1	3-7/8 x 11 x 16-7/16	8.0
Antenna Control C-804/APS-20A	1	4-1/4 x 6-3/4 x 7-3/8	7.0
Blower HD-6/APS-20 or HD-7/APS-20	1	6-7/8 x 9-11/16 x 16-1/4 3-11/16 x 4-3/4 x 5	6.0 2.5
Control Indicator C-294/APS-20A	1	15-1/2 x 24-1/2 x 26	92.0
Control Meter Box C-295/APS-20A	1	7-1/16 x 7-3/8 x 10	7.0
Deck Blower HD-5/APS-20	1	7 x 8 x 8-1/4	3.0
Dehydrator HD-14/U or HD-59/APS-20A	1	3-1/4 x 6-3/16 x 6-1/2 4-7/8 x 5-9/16 x 8-3/8	10.0 6.0
Duplexer CU-82/APS-20	1	12-3/4 x 15-3/8 x 18-3/8	22.5
Junction Box J-117/APS-20	1	2-11/16 x 3-3/8 x 5-5/8	0.5
Junction Box J-168/APS-20A	1	2-3/16 x 3-1/8 x 4-5/8	2.0
Modulator MD-53A/APS-20 or MD-53B/APS-20	1	22 x 26-1/2 x 67-1/2	375.0

**AN/APS-20A: 2**



ITEM NAME: RADAR SET

TYPE: AN/APS-20A, AN/APS-20C

PRINCIPAL COMPONENTS AND PHYSICAL DATA

COMPONENTS	QTY	OVERALL DIMENSIONS (Inches)	UNIT WT. (Pounds)
Mounting Base MT-364/APS-20 or MT-364A/APS-20	1	6-1/2 x 25-1/B x 52-1/4	36.5 28.0
Mounting Base MT-366A/APS-20	1	12-5/8 x 23-3/4 x 23-3/4	16.0
Mounting Base MT-367A/APS-20	1	1-7/16 x 17-1/B x 20-13/16	2.5
Mounting Base MT-405/APS-20A or MT-405A/APS-20A	1	5-1/2 x 19-7/16 x 24	9.0
Pressure Gauge Panel ID-131/APS-20 or ID-131A/APS-20	1	3-1/16 x 7-5/8 x 7-3/4	3.0
Radar Receiver R-142A/APS-20	1	8-1/2 x 15 x 24	50.0
Radar Transmitter T-120A/APS-20	1	14 x 14 x 18	150.0
Rectifier Timing Central TD-9/APS-20A	1*	13-1/8 x 23-11/16 x 27	82.0
Repeat Indicator ID-12BA/APS-20 or ID-128B/APS-20	1	7-7/8 x 8-1/8 x 14-5/8	10.0
Synchronizer SN-22A/APS-20	1	9-1/2 x 17-1/8 x 22-3/4	52.0
Transmission Line CG-186/APS-20	1	5-1/8 x 12-7/16 x 14-1/8	18.0
Transmission Line CG-288/APS-20	1	5-5/16 x 5-5/16 x 75-1/2	20.0
Transmission Line CG-342/U	1	5-5/16 x 5-5/16 x 14	4.0
Waveguide Assy CG-519/U	1	5-5/16 x 5-5/16 x 47	11.0
Variable Autotransformer TF-107/APS-20A	1	5 x 6-1/2 x 6-1/2	6.0
Set of Cables 1 AN/APS-20C			
Air Cleaner MX-973/U	1	1-7/8 x 1-7/8 x 5-1/4	0.5
Air Pump HD-58/APS-20A	1	6 x 6-15/16 x 15-7/8	10.0
Antenna Assy AS-29§/APS-20A	1	43-3/8 x 57-5/8 x 94-13/16	210.0
Antenna Control C-219B/APS-20A	1	3-7/8 x 11 x 16-7/16	8.0
Antenna Control C-804/APS-20A	1	4-1/4 x 6-3/4 x 7-3/8	7.0
Control Indicator C-294/APS-20A	1	15-1/2 x 24-1/2 x 26	92.0
Control Meter Box C-295/APS-20A	1	7-1/16 x 7-3/8 x 10	7.0
Deck Blower HD-5APS-20	1	7 x 8 x 8-1/4	3.0
Dehydrator HD-59/APS-20A	1	4-7/8 x 5-9/16 x 8-3/8	6.0

AN/APS-20A: 3

**ITEM NAME:** RADAR SET

**TYPE:** AN/APS-20A, AN/APS-20C

**PRINCIPAL COMPONENTS AND PHYSICAL DATA**

<b>COMPONENTS</b>	<b>QTY</b>	<b>OVERALL DIMENSIONS (Inches)</b>	<b>UNIT WT. (Pounds)</b>
Duplexer CU-82/APS-20	1	12-3/4 x 15-3/8 x 18-3/8	22.5
Junction Box J-117/APS-20	1	2-11/16 x 3-3/8 x 5-5/8	0.5
Junction Box J-352/APS-20C	1	2-1/2 x 4 x 5	2.0
Modulator MD-53B/APS-20	1	22 x 26-1/2 x 67-1/2	375.0
Mounting Base MT-364A/APS-20	1	9-5/8 x 23-1/4 x 31-1/4	28.0
Mounting Base MT-366A/APS-20	1	12-5/8 x 23-3/4 x 23-3/4	16.0
Mounting Base MT-367A/APS-20	1	1-7/16 x 17-1/8 x 20-13/16	2.5
Mounting Base MT-405A/APS-20A	1	5-1/2 x 19-7/16 x 24	9.0
Pressure Gauge Panel ID-131A/APS-20	1	3-1/16 x 7-5/8 x 7-3/4	3.0
Radar Receiver R-142A/APS-20	1	8-1/2 x 15 x 24	50.0
Radar Transmitter T-120A/APS-20	1	14 x 14 x 18	150.0
Rectifier Timing Central TD-9/APS-20A	1*	13-1/8 x 23-11/16 x 27	82.0
Repeat Indicator ID-128B/APS-20	1	7-7/8 x 8-1/8 x 14-5/8	10.0
Synchronizer SN-75/APS-20C	1	9-1/2 x 17-1/8 x 22-3/4	54.0
Transmission Line CG-286/APS-20	1	5-1/8 x 12-7/16 x 14-1/8	18.0
Transmission Line CG-288/APS-20	1	5-5/16 x 5-5/16 x 75-1/2	20.0
Transmission Line CG-342/U	1	5-5/16 x 5-5/16 x 14	4.0
Waveguide Assy CG-519/U	1	5-5/16 x 5-5/16 x 47	11.0
Variable Autotransformer TF-107/APS-20A	1	5 x 6-1/2 x 6-1/2	6.0
Set of Cables	1		

**NOTE:** \*Indicates that weight and clearance dimensions of Mounting Base  
MT-366A/APS-20 is included.

**REFERENCE DATA AND LITERATURE**

Technical Manuals:  
AN16-30APS20-12

**DATE:** 1 September 1964

**ITEM NAME:** RADAR SET

**COGNIZANT SERVICE:** USN

**TYPE:** AN/APS-20E

FEDERAL STOCK NUMBER:

	USA	USN	USAF	USMC
STATUS OR TYPE CLASSIFICATION				
Mfg(s) Name or Code Number:				



**AN/APS-20E: 1**

**ITEM NAME:** RADAR SET

**TYPE:** AN/APS-20E

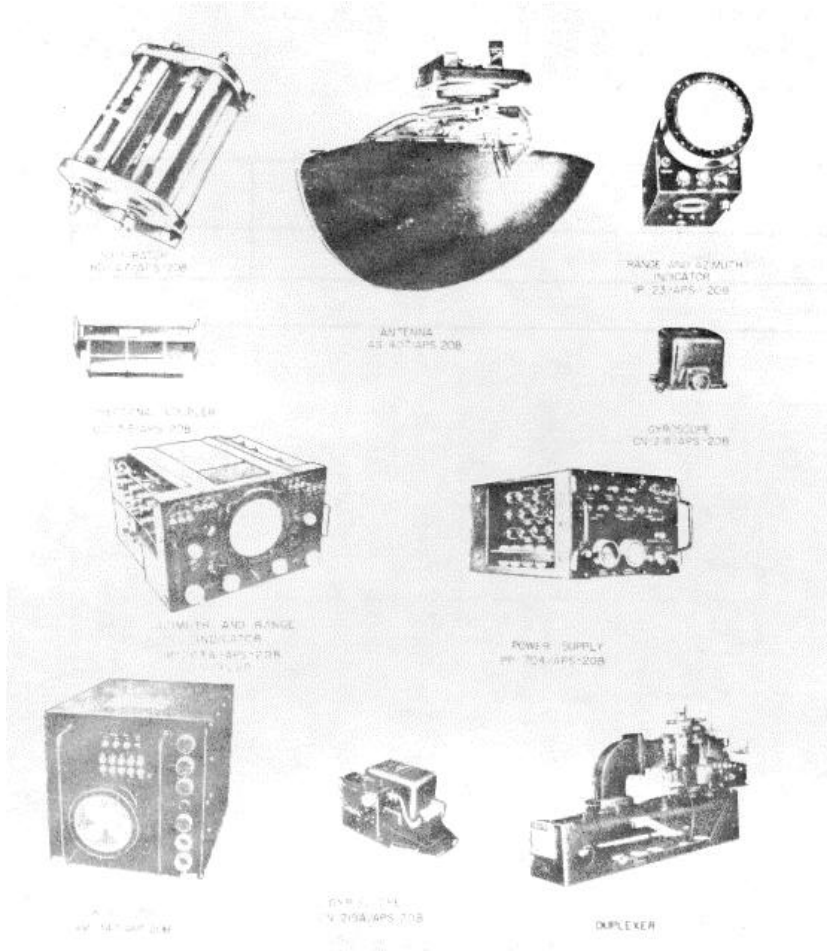

**FUNCTIONAL DESCRIPTION**

The AN/APS-20E is an airborne, high-powered search radar designed for use with Aircraft Early Warning (AEW) systems. Installed in aircraft, it operates in conjunction with airborne shipboard or ground equipment of the AEW system to extend the normal horizon of surface search equipment.

**RELATION TO SIMILAR EQUIPMENT**

None.

**TECHNICAL DESCRIPTION**

Transmitted Power (Pulse Peak): 2.0 megw

- Pulse Width
  - 300 pps: 2 usec
  - 900 pps: 0.67 usec
- Radar Frequency
  - S-Band: 2880 plus or minus 30 mc
  - Beacon Frequency
    - S-Band: 2820 plus or minus 1 mc
- Antenna Scanning Rates
  - Low Range: 2.4 or 6 rpm
  - High Range: 6 or 15 rpm
- Width of Sector Scan: From plus or minus 20 to plus or minus 55 deg
- Beam Tilt Angle Limits: plus or minus 15 beam deg
- Beam Width
  - Vertical: 8.5 deg at half-power point
  - Horizontal: 3.5 deg at half-power point
- Pulse Repetition Frequency: 300 to 900 pps
- Maximum Starch Range

**ITEM NAME:** RADAR SET

**TYPE:** AN/APS-20E

**INSTALLATION CONSIDERATIONS**

300 pps: 200 mi  
900 pps: 50 mi  
Receiver Bandwidth  
Radar: 1.2 mc plus or minus 0.2 mc  
Beacon: 6 to 8 mc  
Receiver Intermediate Frequency  
Radar: 30 mc  
Beacon: 40 mc  
Input Voltages to Radar: 28v dc, 115v,  
380/420 cycle exact, 115v, 380/1000  
cyc, 3-ph  
Total Power Required by Radar  
Standby: 3460w  
Operate: 8574w  
Power Required by Supplies  
Operate: 115v, 380 to 1000 cyc, 3-ph,  
7360w, 115v, 380 to 420 cyc, 1-ph,  
316w, 28v de, 868w

**Related Equipment**

Required but not Supplied: (1) Indi-  
cator Assy Type AN/APS-56, (1) Grou-  
nd Position Indicator AN/APA-57B  
(1) Radar Compensating Assy AN/APA-  
16, (1) Indicator Equipment AN/APA-  
5A, (1) Radio Transmitting Set AN/  
ART-28, (1) Radar Set AN/APX-7, (1)  
Antenna Group 0A-492/APS-20B, (1)  
Set of Cables, Connectors, Cable  
Clamps & Electrical Wire as Re-  
quired.

**PRINCIPAL COMPONENTS AND PHYSICAL DATA**

<b>COMPONENTS</b>	<b>QTY</b>	<b>OVERALL DIMENSIONS (Inches)</b>	<b>UNIT WT. (Pounds)</b>
Electrical Synchronizer SN-55/APS-20B	1	12-5/16 x 15-3/8 x 22	40
Mounting MT-1168/APS-20B	1		
Radar Transmitter T-467/APS-20B	1	20-5/16 x 23-5/8 x 37	
Duplexer CU-165/APS-20B	1	6-1/16 x 16-1/4 x 29-1/2	
Mounting MT-802/APS-20B	4		
Antenna AS-407/APS-20B	1		
Radar Receiver R-251/APS-20B	1	12 x 12 x 18	
Azimuth & Range Indicators IP-203A/APS-20B	2	12-1/2 x 19-1/2 x 19-1/2	
Mounting MT-1135/APS-20B	2		
Azimuth & Range Indicator IP-23/APS-20B	1	5-1/2 x 6-1/4 x 13	15
Power Supply PP-704/APS-20B	1	7-1/4 x 10 x 14-7/16	approx 10
Mounting MT-954/APS-20B	1	1-7/8 x 10-1/4 x 13-3/8	2
Power Supply PP-829/APS-20B	1	19-5/8 x 20 x 23-1/4	261
Power Supply PP-347/APS-20B	1	15-7/16 x 15-7/8 x 23-1/2	75
Mounting MT-1134/APS-20B	1		approx 40
Radar Set Control C-1449/APS-20E	1	11-1/8 x 11-1/4 x 12	
Mounting MT-1136/APS-20B	1	1-3/4 x 8-1/4 x 10-11/16	3
Transformer Assy TF-158/APS-20B	1		

**AN/APS-20E: 3**

**ITEM NAME:** RADAR SET

**TYPE:** AN/APS-20E

**PRINCIPAL COMPONENTS AND PHYSICAL DATA**

<b>COMPONENTS</b>	<b>QTY</b>	<b>OVERALL DIMENSIONS (Inches)</b>	<b>UNIT WT. (Pounds)</b>
Air Compressor HD-126/APS-20B	1		
Dehydrator HD-127/APS-20B	1	3-3/16 x 6-1/8 x 8-1/2	
Liquid Electron Tube Cooler HD-125/APS-20B	1	10-1/8 x 10-5/8 x 16-15/32	approx 25
Mounting Mr-1137/APS-20B	1	2-3/4 x 11-1/8 x 19-3/16	approx 10
Magnetic Amplifier AM-767/APS-20B	1	4-9/16 x 6-9/16 x 6-13/16	
Directional Coupler CU-316/APS-20B	1	4-1/4 x 5-1/8 x 11-3/8	
Electronic Control Amplifier AM-839/APS-20B	1	4-7/8 x 6-1/2 x 7-5/8	
Gyroscope CN-219A/APS-20B	1	7 x 9-3/4 x 12-1/2	
Gyroscope CN-218/APS-20B	1	3-31/64 x 3.914 x 4.212	

**REFERENCE DATA AND LITERATURE**

Technical Manuals:

- AN16-30APS20-31
- AN16-30APS20-32
- AN16-30APS20-33
- AN16-30APS20-34
- AN16-30APS20-34S

**AN/APS-20E: 4**

DATE: 1 July 1964

ITEM NAME: RADAR SET

COGNIZANT SERVICE: USN

TYPE: AN/APS-20F

FEDERAL STOCK NUMBER:

	USA	USN	USAF	USMC
STATUS OR TYPE CLASSIFICATION				
Mfg(s) Name or Code Number: General Electric Company				

Illustration Not Available

### FUNCTIONAL DESCRIPTION

The AN/APS-20F is an airborne radar designed to provide early warning search radar with beacon reception and ground stabilized display.

### RELATION TO SIMILAR EQUIPMENT

The AN/APS-20F is functionally, electrically, and mechanically interchangeable as a whole with AN/APS-20E, but has new control, transmitter, transformer assembly, and antenna to provide improved circuitry for increased reliability.

### TECHNICAL DESCRIPTION

Frequency Data:

Transmitter - 2880  $\pm$ 30 mc (1 fixed band)  
Receiver Range - 2800 to 2910 mc (1 band)  
Emission: P2d  
Transmitter Data:  
Pulse Width - 2.0 or 0.67 -sec  
Pulse Rate - 300 or 900 cps  
Receiver Data:  
Channels - 2 (2820 and 2880 mc)  
Power Requirements:  
115 or 200 vac, 380 to 1,000 cps, 3-ph, 6,500w  
115 vac, 380 to 420 cps, 1-ph, 250 va  
28 vdc, 36 amp

### INSTALLATION CONSIDERATIONS

Not available.

AN/APS-20F

**PRINCIPAL COMPONENTS AND PHYSICAL DATA**

<b>COMPONENT</b>	<b>QTY</b>	<b>HEIGHT (Inches)</b>	<b>WIDTH (Inches)</b>	<b>DEPTH (Inches)</b>	<b>UNIT WT. (Pounds)</b>
Antenna AS-825/APS-20F	1				176.3
Control, Radar Set C-1963/APS-20F	1				30.9
Range and Azimuth Indicator IP-23/APS-20B	1				11.6
Range and Azimuth Indicator IP-203A/APS-20B	1				78.7
Range and Azimuth Indicator IP-203B/APS-20B	1				78.7
Power Supply PP-347/APS-20B	1				67.1
Power Supply PP-704/APS-20B	1				22.0
Power Supply PP-829/APS-20B	1				219.2
Radar Receiver R-251/APS-20B	1				40.4
Amplifier, Magnetic AM-767/APS-20B	1				6.1
Radar Transmitter T-607/APS-20F	1				410.0

**REFERENCE DATA AND LITERATURE**

Technical Orders:  
AN16-30APS20-31  
12PS-2APS20-11



DATE: 1 July 1964

ITEM NAME: RADAR SET

COGNIZANT SERVICE: USAF

TYPE: AN/APS-23A

FEDERAL STOCK NUMBER: 1280-669-7209

	USA	USN	USAF	USMC
STATUS OR TYPE CLASSIFICATION			Ltd Std	
Mfg(s) Name or Code Number: Philco Corp 46859 - Western Electric				

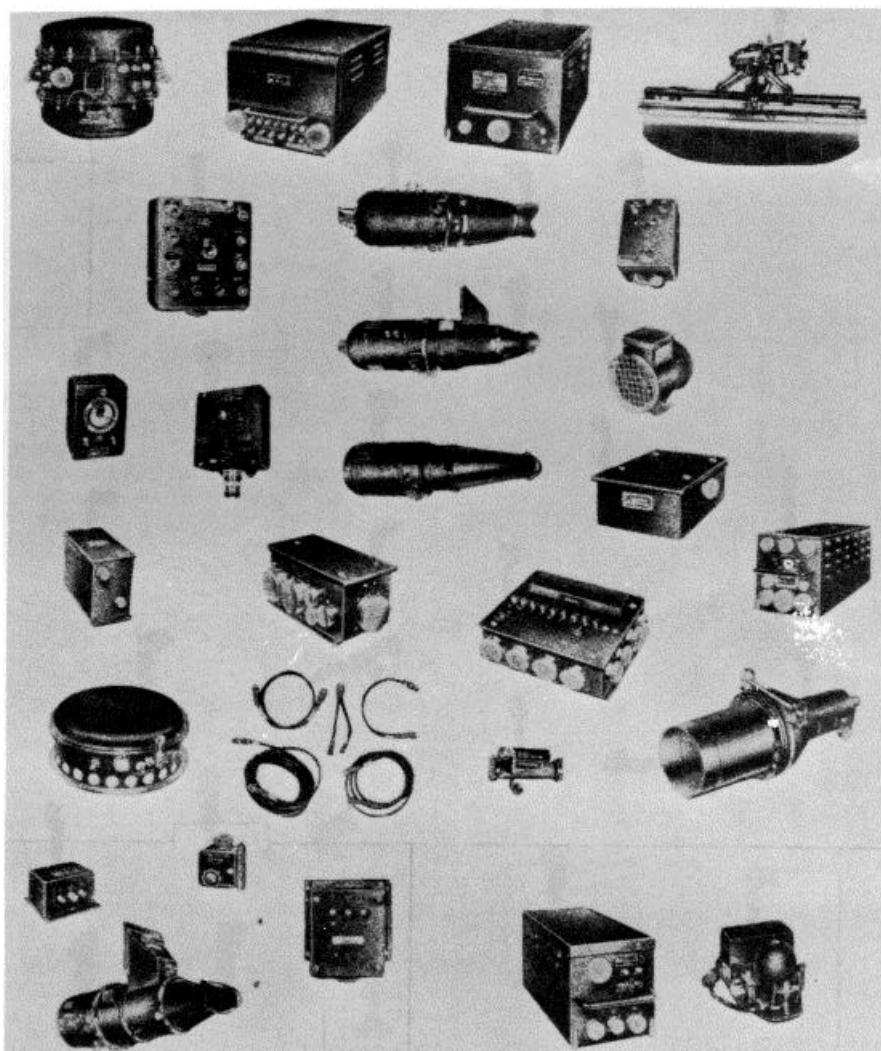

**FUNCTIONAL DESCRIPTION**

Radar Set AN/APS-23A is an Airborne Radar System which operates in the X-Band of the Frequency Spectrum. It may be used as an independent search

radar but is primarily designed to operate in conjunction with a computer, such as Ground Position Indicator AN/APA-44A or equivalent, to give accurate navigation and bombing information. Operates at 40 - 50,000 ft altitude.

**ITEM NAME:** RADAR SET

**TYPE:** AN/APS-23A

**RELATION TO SIMILAR EQUIPMENT**

The AN/APS-23A Radar Set is not interchangeable with other set(s). Six components of the AN/APS-23A and their mountings are used in the Radar Set AN/APS-64.

**TECHNICAL DESCRIPTION**

X-Band Frequency: 9375 mc plus or minus 55 mc

Maximum Range:

200 haut mi for large city.

100 haut mi for land mapping.

200 haut mi for Beacon.

Peak Power Output:

at 5 mi, 40.5 dbm

at 65 mi, 44.0 dbm

at 150 mi, 44.0 dbm

Beacon, 44.0 dbm

Power Requirements:

400 w (15 amps) 26.5v dc

550v amps, 115v regulated ac 500 cys

1750 or amps, 115v unregulated ac 380 to 1000 cycles

Intermediate Frequency: 60 mc

Antenna Rotation Speed: 6 or 14 rpm

at slow scan

Beam Width

Horizontal (Azimuth): 1.5 deg

Vertical (Elevation): 55 deg

Presentations

Pattern: Sector or 360 deg PPI. De-pressed center sector scan up to 50 mi range.

Sweep Travel: Linear without altitude correction in ranges from 0 to 200 mi or for depressed center operation with ranges up to 50 mi. Hyperbolic for presenting ground range with altitude correction.

Sweep Timing: Sweep delay operation permits distant target areas to be presented near center of indicator screen for ranges up to 200 mi.

Range: 0 to 20 mi, 5 mi intervals

20 to 50 mi, 10 mi intervals

50 to 80 mi, 20 mi intervals

80 to 200 mi, 50 mi intervals

Bearing: Target bearing shown by 360 deg Azimuth scale calibrated in two deg intervals.

Heading Marks: Shows aircraft heading either at zero azimuth or compass bearing.

**INSTALLATION CONSIDERATIONS**

The AN/APS-23A Radar Set is a major subsystem of several Bombing Fire Control Systems which comprise the offensive armament system of six different USAF Bomber Type Aircraft. Therefore, installation consideration of the AN/APS-23A would be peculiar to its various uses.

Mounting: The AN/APS-23A Radar Set is composed of forty major components which require thirteen different mounts, both surface and bulkhead type. All surface mounts are constructed with shock absorbers.

**PRINCIPAL COMPONENTS AND PHYSICAL DATA**

COMPONENT	QTY	DEPTH (Inches)	WIDTH (Inches)	HEIGHT (Inches)	UNIT WT. (Pounds)
Servo Amplifier AM-193A/APS-23	1	22.17	7.94	7.75	27
Antenna AS-361C/APS-23	1	60.50	20.38	30.75	104
Control Unit C-412/APS-23	1	8.19	5.50	5.81	6
Control Unit C-413/APS-23	1	12.94	12.56	6.56	13.50
Control Unit C-416/APS-23	1	3.53	2.28	2.63	.50
Gyroscope CN-66A/APS-23	1	12.63	13.06	8.56	21
Volt Reg. CN-189/APS-23A	1	18.25	8.00	8.25	25
Directional Coupler CU-137/APS-23	1-11	5	2.25	2.44	.25
Line Balancing Network CU-365/APS-23	1-12	5	5	2.72	4
Filter Unit F-67A/APS-23	1	10.25	7.06	3.50	6
Azimuth Range Indicator IP-135A/APS-82	1 or 2				
Blower HD-46/APS-23	2	5.69	4.75	7.50	6
Indicator IP-277/APS-23	1	27.75	17	13	35
Interconnecting Box J-438/APS-23A	1	14.25	11.38	5.13	13.50
Junction Box J-219A/APS-23	1	10.50	5.88	4.31	4.50
Radar Modulator MD-152A/APS-23A	1		22 dia	17	76
Visor (Main or Aux), MX-753/APS-23	2	5.13	5.13	5.44	.25
Visor (10" Indicator), MX-1459/APS-23	1	4.00	10.50		.25

**AN/APS-23A: 2**

ITEM NAME: RADAR SET

TYPE: AN/APS-23A

PRINCIPAL COMPONENTS AND PHYSICAL DATA

COMPONENT	QTY	DEPTH (Inches)	WIDTH (Inches)	HEIGHT (Inches)	UNIT WT. (Pounds)
Electrical Protector MK-1348/APS-23A	1	8.25	5.50	5.00	9
Rectifier, Power Unit, PP-259B/APS-23	1	22.06	10.75	7.88	27
Receiver, Transmitter, RT-124 B/APS-23	1		19.75 dia	9	47
Switch Box SA-276/APS-23A	1	7.09	6.25	3.44	5
Synchronizer SN-47B/APS-23	1	23.31	12.38	10.63	40
Variable Auto-Transformer TF-106C/U	1	8.25	4.88	3.75	3.06
Power Supply PP-919/APS-23	1	10	4.72	7.38	9
Mount (Main Indicator) MT-546/APS-23	1	13.75	10.88	13.91	7.50
Mount (Control Unit) MT-547/APS-23	1	7.25	5.25	.50	.25
Mount (Control Unit) MT-548/APS-23	1	11.56	10.13	.63	1
Mount (Power Unit) MT-557B/APS-23	1	23.38	11.13	2.63	3
Mount (Servo Amplifier) MT-558/APS-23	1	23.38	8.50	2.63	2.50
Mount (Synchronizer) MT-559B/APS-23	1	23.38	11.13	2.63	3
Mount (Aux Indicator) MT-560/APS-23	1	13.61	11.50	8.94	2
Mount (Receiver-Transmitter) MT-561A/APS-23	1		19.75 dia	1.88	3.25
Mount (Filter Unit) MT-562/APS-23	1	9.63	6.44	.94	.75
Mount (Aux Indicator Visor) MT-878/APA-82	1	8.94	7.63 dia		1.50
Mount (Elec Protector) MT-1100/U	1	7.25	5.25	.63	.25
Mount (Volt Reg) MT-1126/U	1	20.06	8.50	2.25	2.50
Mount (Power Supply) MT-1206/APS-23	1	10.13	4.50	.63	.50
Cable CA-24 CG-456/U	1				
Cable CA-25 CG-467/U	4				
Indicator IP-218A/APS23	1	16.87	9.50	9.50	22
TOTAL WEIGHT					554.81

REFERENCE DATA AND LITERATURE

Technical Orders:  
11B31-2-3-14  
11B31-2-3-22

AN/APS-23A: 3

DATE: 15 July 1964

ITEM NAME: RADAR SET

COGNIZANT SERVICE: USN

TYPE: AN/APS-30

FEDERAL STOCK NUMBER:

	USA	USN	USAF	USMC
STATUS OR TYPE CLASSIFICATION				
Mfg(s) Name or Code Number: Philco Corp.				

Illustration not available

**FUNCTIONAL DESCRIPTION**

The AN/APS-30 is an airborne search radar equipment used in Navy fighter and torpedo bomber aircraft. It is primarily used for locating objects of military significance, but may be used for navigation. It has provisions for IFF and beacon, and is designed to work with bombing calculators. It uses two depressed center PPI's which give relative and bombing course bearing.

**RELATION TO SIMILAR EQUIPMENT**

The AN/APS-30 is similar to the AN/APS-31, except the AN/APS-30 antenna is not stabilized.

**TECHNICAL DESCRIPTION**

Peak Power Output: 70 to 90 kw  
 Range: 200 yd to 200 naut mi  
 Fixed Range Expansion: 5 or 30 naut mi sweep  
 display delayed up to 200 naut mi  
 Power Requirements: 115v, 600 to 1600 cps,  
 1-ph; and 27.5 vdc  
 Sector Scan: Fixed at 50 and 150 deg  
 Antenna Tilt: Up 10 deg or down 30 deg  
 Beam Pattern: Cosecant squared  
 Type Reflector: Cut paraboloid

**INSTALLATION CONSIDERATIONS**

Not available.

**PRINCIPAL COMPONENTS AND PHYSICAL DATA**

Not available.

**REFERENCE DATA AND LITERATURE**

Specification:  
 RE-13A1107

**AN/APS-30: 1**

DATE: 1 July 1964

ITEM NAME: RADAR SET

COGNIZANT SERVICE: USN

TYPE: AN/APS-31\*, AN/APS-31B

FEDERAL STOCK NUMBER:

	USA	USN	USAF	USMC
STATUS OR TYPE CLASSIFICATION Ltd Std*				
Mfg(s) Name or Code Number: Philco Corporation, Philadelphia, Pa.				

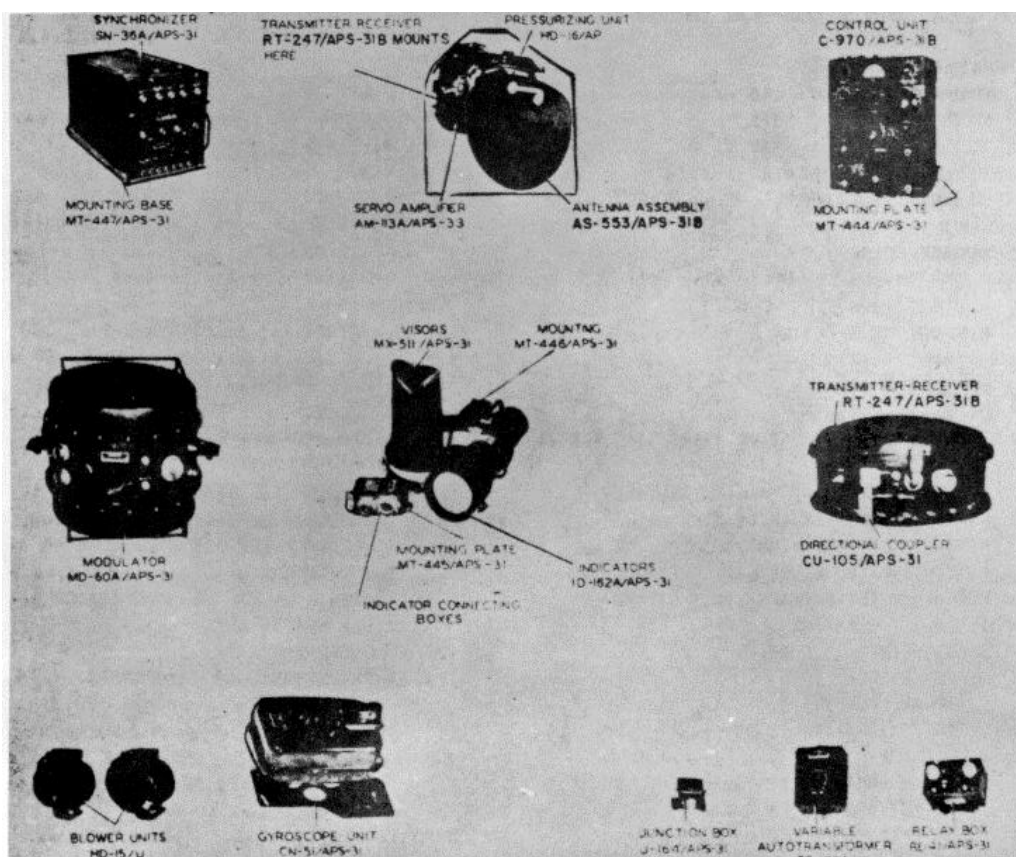

### FUNCTIONAL DESCRIPTION

AN/APS-31 and AN/APS-31B are radio detection and ranging equipments designed for installation in larger aircraft primarily for use in locating surface vessels, aircraft, beacons, and other objects of military significance.

They have a range of from 200 yards to 200 miles, provisions for the connection of IFF equipment and bombing computer, 5TD or 30 TD target discrimination operation, an altitude delay function, an open-center function, and beacon reception.

AN/APS-31: 1

**ITEM NAME:** RADAR SET

**TYPE:** AN/APS-31, AN/APS-31B

**RELATION TO SIMILAR EQUIPMENT**

Same as AN/APS-31A except uses Antenna AS-553/SPS-31B instead of AS-287( )/APS-31; RT-247/APS-31B instead of RT-193/APS-31A; and C-970/APS-31B instead of C-729/APS31A. The AN/APS-31 and -31B are also similar to Radar Sets AN/APS-33 and AN/APS-33A.

**TECHNICAL DESCRIPTION**

Frequency

Transmitter: 9375 plus or minus 55 mc

Receiver (Search): 9375 plus or minus 55 mc

Receiver (Beacon): 9310 plus or minus 3 mc

Power Output: 52 kw min

Video Output Impedance: 95 ohms plus or minus 10%

Noise Output, Max: 5 db

Noise Output: 0.5v rms (at full gain)

IF. Amplifier Gain: 130 db approx

IF. Frequency: 60 plus or minus 1.25 min

Pulse Duration: Short pulse, 0.5 usec; beacon pulse (MD-60/APS-31) 2.5 usec; beacon pulse (MD-60A/APS-31), 2.24 usec; long pulse (MD-60/APS-31) 5.0 usec; long pulse (MD-60A/APS-31, 4.5 usec

Pulse Repetition Frequency: Short pulse, 800 pps; beacon pulse, 400 pps; long pulse, 200 pps

Pulse Repetition Frequency (Modulator)

Short Pulse: 800 pps

Beacon Pulse: 400 pps

Long Pulse: 200 pps

Trigger Modulator Input

Amplitude: 20 to 50v

Duration: 1.5 usec at half amplitude

Rate of Rise: 0.2 usec at 90% amplitude

IFF Amplitude: 25 to 54v

IFF Duration: 0.25 to 0.5 usec

IFF Rate of Rise: 0.04 to 0.1 usec at 90% amplitude

Power Requirements: 115v 380 to 1600 cps, 9 amp, 95% pf (leading), 90% pf (lagging); 27.5v dc, 40 amp

Antenna Type: Feed horn radiator and parabolic reflector

Beam Width

AS-287/APS-31, AS-287B/APS-31: 3 deg in azimuth ea side at 3 db points.

AS-553/APS-31B: 1.5 deg in azimuth ea side at 3 db points.

Azimuth Range

AS-287/APS-31, AS-387B/APS-31: 150 to 160 deg wide sector, 50 to 60 deg narrow sector.

AS-553/APS-31B: 120 deg wide sector, 50 to 60 deg narrow sector

Fast Scanning Speed

AS-287/APS-31, AS-287B/APS-31: 40 to 50 looks per minute at 150 deg, 90 to 100 looks per minute at 60 deg.

AS-553/APS-31B: 52 to 65 looks per minute at 120 deg, 90 to 100 looks per minute at 60 deg

Slow Scanning Speed

AS-287/APS-31, AS-287B/APS-31: 16 to 20 looks per minute at 150 deg, 45 to 55 looks per minute at 60 deg.

AS-553/APS-31B: 26 to 33 looks per minute at 120 deg, 45 to 55 looks per minute at 60 deg

Manual Beam Tilt Range: plus 10 to -20 deg

Beam Tilt Stabilization Range: plus 24 to -30 deg with manual tilt setting of 0 deg.

Directional Coupler: 25 db fixed attenuation, 15 db directivity attenuation.

Reflector Dish Gain

AS-287/APS-31, AS-287B/APS-31: 600 with strip, 800 without strip.

AS-553/APS-31B: 2500

Receiver Sensitivity Maximum Noise: (RT-101/APS-31, RT-101A/APS-31), 5.5 db; (RT-247/APS-31), 5 db

IF. Amplifier Gain: (RT-101/APS-31, RT-101A/APS-31), 105 db min; (RT-247/APS-31B), approx 130 db

**INSTALLATION CONSIDERATIONS**

Not available.

ITEM NAME: RADAR SET

TYPE: AN/APS-31, AN/APS-31B

PRINCIPAL COMPONENTS AND PHYSICAL DATA

COMPONENT	QTY	DEPTH (Inches)	WIDTH (Inches)	HEIGHT (Inches)	UNIT WT. (Pounds)
Synchronizer SN-36/APS-31 or SN-36A/APS-31	1	10-11/16	10-3/4	21-7/8	44.63
Indicator ID-162/APS-31 or ID-162A/APS-31	2	7-3/16	7	15-11/16	14.25
Visor MX-511/APS-31	2	7-3/16	7	15-11/16	14.25
Control Unit C-289/APS-31 or C-289A/APS-31 or C-970/APS-31B	1	6-3/8	5-5/8	10-7/8	0.56
Modulator MD-60/APS-31 or MD-60A/APS-31	1	10-1/2	5	13-7/16	11.38
Transmitter-Receiver 1 RT-101/APS-31, RT-101A/APS-31 or RT-247/APS-31B	1	10-1/2	5	13-7/16	12.95
Antenna Assy AS-287/APS-31 or AS-287B/APS-31 or AS-553/APS-31B	1	22-1/2	18	22-1/2	90.00
Gyroscope Unit CN-51/APS-31	1	22-1/2	18	22-1/2	91.00
Junction Box J-164/APS-31	1	19-3/4	8-15/16	19-3/4	49.00
Inverter PU-92/U or PU-92A/U	1	19-3/4	8-15/16	19-3/4	48.50
Relay Box RE-41/APS-31	1	23-1/2	22-1/8	24-7/16	77.75
Blower Unit HD-15/U	2	23-1/2	22-1/8	24-7/16	83.50
Variable Auto Transformer TF-106/U or TF-106A/U	1	28	24	32	91.50
Control Unit C-289/APS-31 or C-289A/APS-31 or C-970/APS-31B	1	9-1/8	7-5/8	12-13/16	10.50
Modulator MD-60/APS-31 or MD-60A/APS-31	1	2-7/8	1-53/64	3-3/8	0.60
Transmitter-Receiver 1 RT-101/APS-31, RT-101A/APS-31 or RT-247/APS-31B	1	6-9/16	5	9-15/16	11.13
Antenna Assy AS-287/APS-31 or AS-287B/APS-31 or AS-553/APS-31B	1	7-9/32	4-5/8	9-13/16	13.25
Gyroscope Unit CN-51/APS-31	1	4-3/4	3-11/16	5-3/4	2.25
Junction Box J-164/APS-31	2	5-11/16	5-1/4	7-7/16	3.19
Inverter PU-92/U or PU-92A/U	1	5	3-5/8	7-1/8	2.44
Relay Box RE-41/APS-31	1	5	3-5/8	7-1/8	2.44

REFERENCE DATA AND LITERATURE

Technical Manuals:  
AN16-30APS-31-12

AN/APS-31: 3

DATE: 1 July 1964

ITEM NAME: RADAR SET

COGNIZANT SERVICE: USN

TYPE: AN/APS-31A

FEDERAL STOCK NUMBER:

	USA	USN	USAF	USMC
STATUS OR TYPE CLASSIFICATION		Std		
Mfg(s) Name or Code Number: Texas Instruments, Inc. Motorola, Inc.				

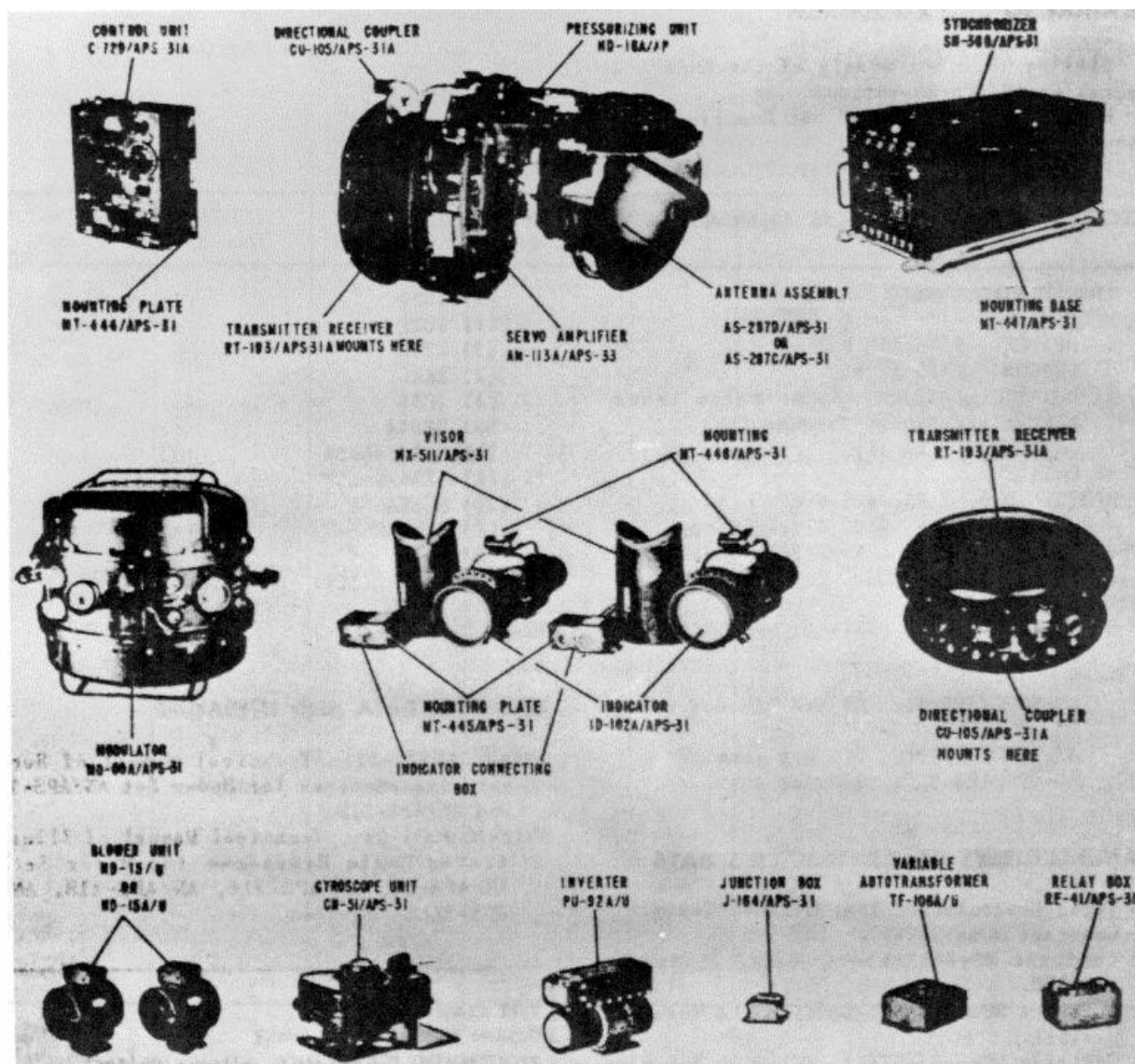

AN/APS-31A: 1



AN/APS-31A

**FUNCTIONAL DESCRIPTION**

The AN/APS-31A is a radio detection and ranging equipment designed for installation in larger aircraft for use in locating objects of military significance. It has a range of 200 yd to 200 naut mi, provision for connection of IFF equipment and bombing computers, 5TD or 30TD target discrimination operations, an altitude delay function, an open center function, and beacon reception.

Search - 9375 +55 mc, Beacon - 9310 +3 mc  
Local Oscillators: 60 mc below transmitter and beacon frequencies  
Power Output: 52 kw rain  
Pulse Width: 0.5, 2.25, and 4.5  $\mu$ sec  
Pulse Repetition Rate: 800, 400, and 200 pps  
Operating Voltages: 115v, 380 to 1,600 cps, 1-ph; 27.5 vdc  
Antenna Type: Feed horn radiator and parabolic reflector  
Scan Characteristics:  
AS-287C/APS-31, 60 and 150 deg sector scan  
AS-287D/APS-31, 360 deg scan  
AS-628/APS-31C, 360 deg scan

**RELATION TO SIMILAR EQUIPMENT**

The AN/APS-31A is similar to other models of the AN/APS-31 series and the AN/APS-33 series.

**TECHNICAL DESCRIPTION**

Frequency: Transmitter - 9375  $\pm$ 55 mc,

**INSTALLATION CONSIDERATIONS**

Not available.

**PRINCIPAL COMPONENTS AND PHYSICAL DATA**

COMPONENT	QTY	DEPTH (Inches)	WIDTH (Inches)	HEIGHT (Inches)	UNIT WT. (Pounds)
Antenna Assembly AS-287C/APS-31, AS-287D/APS-31 or AS-628/APS-31	1	23-1/2	22-1/8	24-7/16	83.50
Blower Unit HD-15/U or HD-15A/U	2	5-11/16	5-1/4	7-7/16	3.19
Control Unit C-729/APS-31A	1	10-1/2	4-7/8	12-1/8	10.00
Directional Coupler CU-105/APS-31A	1	4-1/8	1-15/16	7-13/16	1.00
Gyroscope Unit CN-51/APS-31 or CN-51A/APS-31	1	9-1/8	7-5/8	12-13/16	10.50
Indicator ID-162A/APS-31	2	7-3/16	7	15-11/16	14.25
Inverter PU-92A/U	1	7-9/32	4-5/8	9-13/16	13.25
Junction Box J-164/APS-31	1	2-7/8	1-53/64	3-3/8	0.60
Modulator MD-60A/APS-31 or MD-60B/APS-31	1	22-1/2	18	22-1/2	91.00
Pressurizing Unit HD-16/AP or HD-16A/AP	1	4-1/8	3-9/16	10-1/4	3.50
Relay Box RE-41/APS-31	1	4-3/4	3-11/16	5-3/4	2.25
Servo Amplifier AM-113A/APS-33	1	5-7/8	4-3/8	12-1/2	11.00
Synchronizer SN-36A/APS-31 or SN-36B/APS-31	1	10-11/16	10-3/8	21-7/8	42.50

**PRINCIPAL COMPONENTS AND PHYSICAL DATA (cnt'd)**

<b>COMPONENT</b>	<b>QTY</b>	<b>DEPTH (Inches)</b>	<b>WIDTH (Inches)</b>	<b>HEIGHT (Inches)</b>	<b>UNIT WT. (Pounds)</b>
Transmitter-Receiver RT-193/APS-31A	1	9	19-3/4 dia		48.50
Variable Auto Transformer TF-106A/U	1	5	3-5/8	7-1/8	2.44
Visor MX-511/APS-31	2	6-3/8	5-5/8	10-7/8	0.56

**REFERENCE DATA AND LITERATURE**

Technical Manuals:  
AN16-30APS31-12  
AN16-30APS31-24

DATE: 1 July 1964  
COGNIZANT SERVICE: USN

ITEM NAME: RADAR SET  
TYPE: AN/APS-31C

FEDERAL STOCK NUMBER:

	USA	USN	USAF	USMC
STATUS OR TYPE CLASSIFICATION				
Mfg(s) Name or Code Number:				

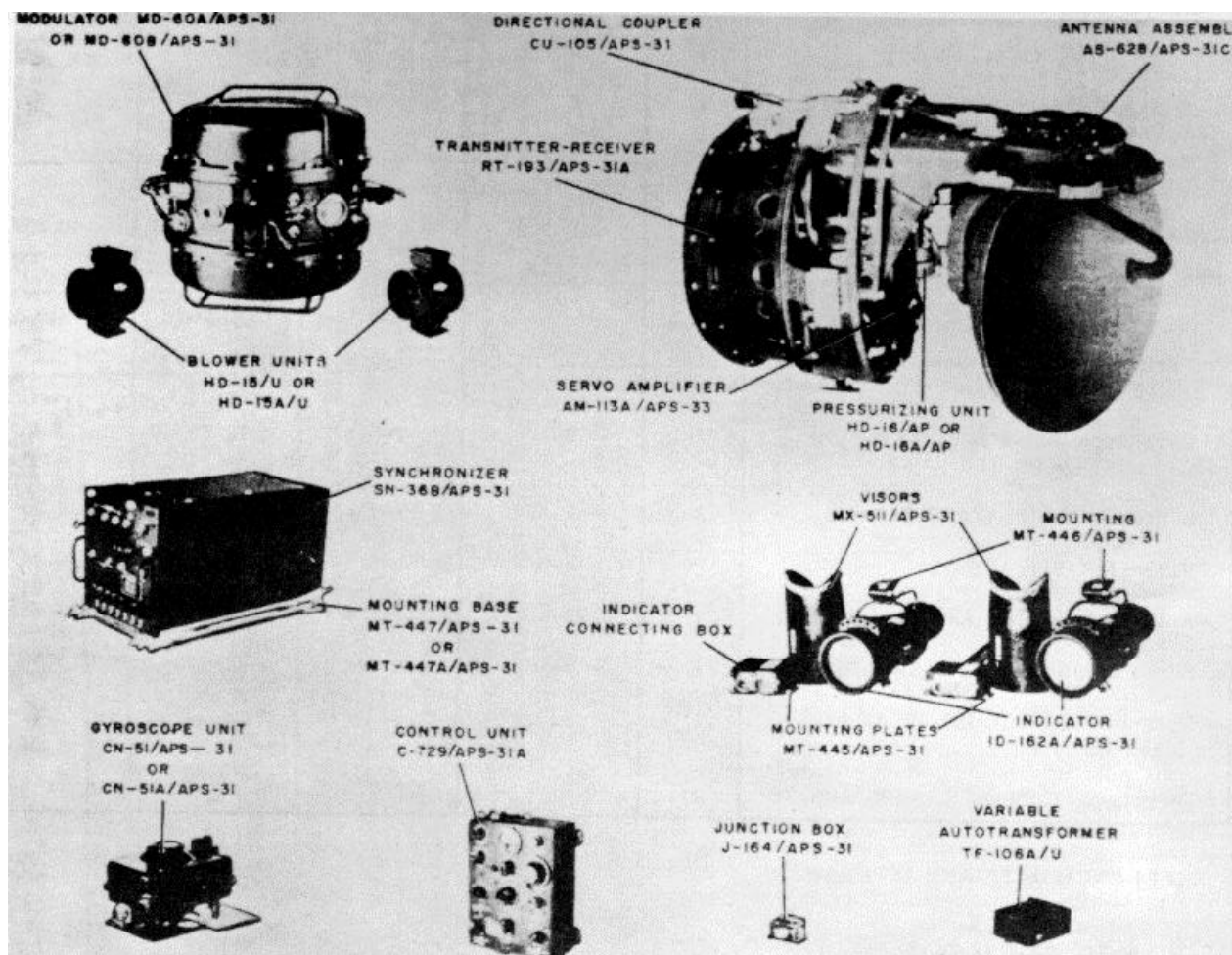

**FUNCTIONAL DESCRIPTION**

The AN/APS-31C is designed for search, beacon, and low altitude bombing operations from large aircraft. It is designed to operate in ambient temperatures of -55 to +55 deg C.

**RELATION TO SIMILAR EQUIPMENT**

Similar to other AN/APS-31 series equipments.

**TECHNICAL DESCRIPTION**

Operating Voltages and Power Requirements:  
 115 ± 5 vac, 380 to 420 cps, 3-ph, 150 va  
 115 ± 5 vac, 380 to 1,600 cps, 1-ph, 1,350 va  
 28 ± 3 vdc, 616w (with inverter) or 275w (without inverter)  
 Temperature Limits: -55 to +55 deg C (continuous); up to 71 deg C (continuous operation not to exceed 30 min)

AN/APS-3 1C

Altitude Limits (max): 35,000 ft  
 Humidity Limits: 100% (relative) at temperatures  
 up to 50 deg C  
 Heat Dissipation: 1,800w (with inverter), 1,450w  
 (without inverter)

**INSTALLATION CONSIDERATIONS**

Not available.

**PRINCIPAL COMPONENTS AND PHYSICAL DATA**

<b>COMPONENT</b>	<b>QTY</b>	<b>HEIGHT (Inches)</b>	<b>WIDTH (Inches)</b>	<b>DEPTH (Inches)</b>	<b>UNIT WT. (Pounds)</b>
Blower Unit HD-15/U or HD-15A/U	2	5-11/16	5-1/4	7-71/6	3.19
Junction Box J-164/APS-31	1	2-7/8	1-53/64	3-3/8	0.60
Synchronizer SN-36B/APS-31	1	5-7/8	10-3/8	12-1/2	11.00
Modulator MD-60A/APS-31 or MD-60B/APS-31	1	22-1/2	18	22-1/2	91.00
Control Unit C-729/APS-31A(modified)	1	10-1/2	4-7/8	12-1/8	10.00
Transmitter-Receiver RT-193/APS-31B	1	19-3/4 dia	9		48.50
Variable Auto Transformer TF-106A/U	1	5	3-5/8	7-1/8	2.44
Gyroscope Unit CN-51/APS-31 or CN-51A/APS-31	1	9-1/8	7-5/8	12-13/16	10.50
Indicator ID-162A/APS-31	2	7-3/16	7	15-11/16	14.25
Visor MX-511/APS-31	2	6-3/8	5-5/8	10-7/8	0.56
Antenna Assembly AS-628/APS-31C	1	23-1/2	22-1/8	24-7/16	83.50
Servo Amplifier AM-113A/APS-33	1	5-7/8	4-3/8	12-1/2	3.50
Pressurizing Unit HD-16/AP or HD-16A/AP	1	4-1/8	1-15/16	7-13/16	1.00
Directional Coupler CU-105/APS-31	1				

**REFERENCE DATA AND LITERATURE**

Technical Manuals:  
 AN16-30APS31-24  
 AN16-30APS31-31

DATE: 1 September 1964

ITEM NAME: RADAR SET

COGNIZANT SERVICE: USN

TYPE: AN/APS-33

FEDERAL STOCK NUMBER:

	USA	USN	USAF	USMC
STATUS OR TYPE CLASSIFICATION		Used by		
Mfg(s) Name or Code Number: Philco Corporation (46859)				

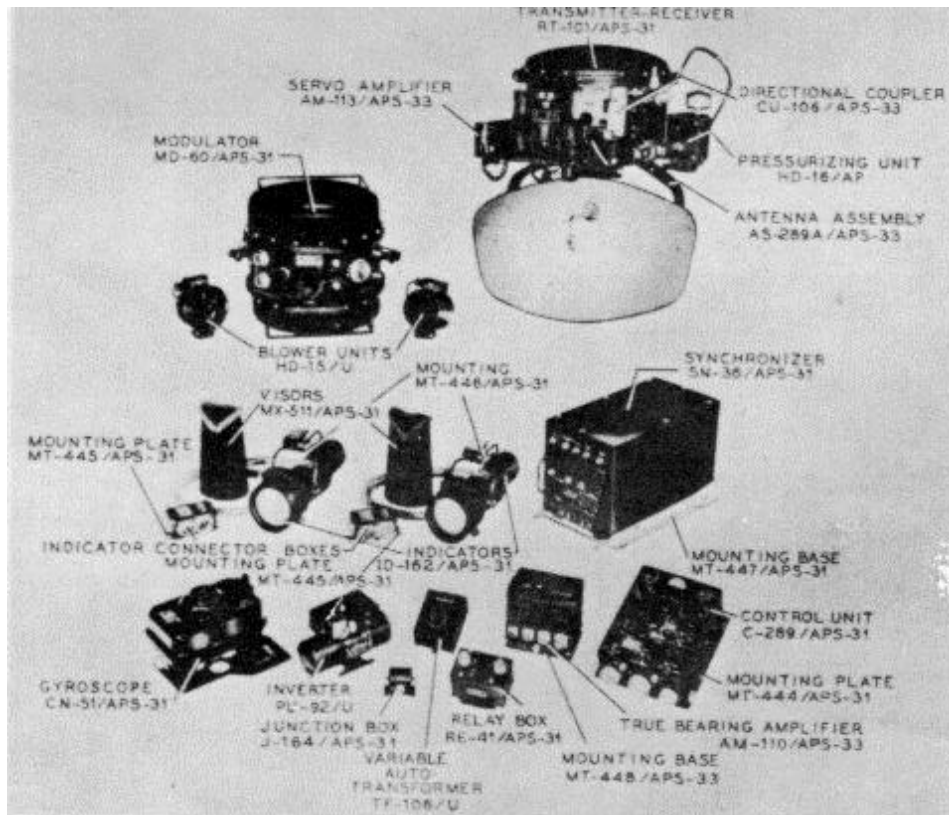

**FUNCTIONAL DESCRIPTION**

Radar Set AN/APS-33 is a radio detection and ranging equipment designed for installation in large aircraft such as patrol bombers. It is primarily for use in revealing the

presence and determining the location of surface vessels, aircraft, beacons, and other objects within the area encompassed by the range of the equipment.

**AN/APS-33: 1**

**ITEM NAME:** RADAR SET

**TYPE:** AN/APS-33

**RELATION TO SIMILAR EQUIPMENT**

**TECHNICAL DESCRIPTION**

Power Requirements at Room Temperature

AC: 9 amp at 115v, 380 to 1600 cyc; pf  
95% leading to 90% lagging

DC: 40 amp at 27.5v

Rectified Voltages

-300 plus or minus 5v, regulated; 12 - 20 ma

-105 plus or minus 5v, regulated; 15 ma

Plus 105 (plus 50, -15) v, unregulated; 65 - 135 ma

Plus 150 plus or minus 5v, regulated; 121- 206 ma

Plus 300 plus or minus 5v, regulated; 102- 204 ma

Plus 335 (plus 105, -65) v, unregulated; 0 - 115 ma

Plus 440 (plus 275, -80) v, unregulated; 20 - 200 ma; or plus

740 (plus 305,-155) v, unregulated; 10 - 50 ma

Plus 4800 (plus or minus 250) v, unregulated; 20- 100 ua

RF Operating Frequencies

Transmitter: 9375 plus or minus 55 mc

Receiver Search: 9375 plus or minus 55 mc

Receiver Beacon: 9310 plus or minus 3 mc

Search Local Oscillator: 60 mc below  
transmitter freq

Beacon Local Oscillator: 60 mc below  
beacon-transmitter freq

AFC Circuit

Sweep Center (-60v Mode): Var from -135 to -175v

Sweep Frequency Range: 30 mc about center freq

Follows Freq Shift: At a rate of 150 mc  
per sec from 0.5 usec pulse at a rate  
of 25 mc per sec for 5.0 usec pulse

Center of 40v Sweep: Can be varied from 100 to 200v

IF. Amplifier RT-101/APS-31 or RT-101A/ APS-31

Gain: 105 db min

Bandwidth Normal: 5 plus or minus 1 mc at 3 db down

Bandwidth Long Range Search: 1 mc

Center IF.: 60 plus or minus 1.25 mc

Video Output Impedance: 95 ohms plus or minus 10%

Indicator Video Amplifier

Voltage Gain: 25 approx

Frequency Response: Flat within 3 db  
from 20 cyc to 5 mc

Receiver Sensitivity RT-101/APS-31 or  
RT-101A/APS-31

Max Noise Figure: 5.5 db

Min Noise Output: 5v rms at full gain

Peak RF Power Output: 52 kw min

Output-Pulse Duration Modulator MD-60/APS-31

Short Pulse: 0.5 usec

Beacon Pulse: 2.5 usec

Long Pulse: 5.0 usec

Output-Pulse Duration Modulator MD-60A/APS-31

Short Pulse: 0.5 usec

Beacon Pulse: 2.25 usec

Long Pulse: 4.5 usec

Pulse Repetition Frequency Modulator MD-60/  
APS-31 or MD-60A/APS-31

None

Short Pulse: 800 pps

Beacon Pulse: 400 pps

Long Pulse: 200 pps

Modulator Input Trigger

Amplitude: 20 to 50v

Duration: 1.5 usec at half amplitude

Rate of Rise: 90% amplitude on 0.2 usec

IFF Trigger

Amplitude: 25 to 54v

Duration: 0.25 to 5 usec

Rate of Rise: 90% amplitude in 0.04 to  
0.1 usec

Lab Trigger

Amplitude: 25 to 54v

Duration: 0.25 to 0.5 usec

Ranges

Range (Naut Mi)

5-60 var

0-120 fixed

0-200 search

80-20 beacon

5-TD

30-TD

Pulse Duration

short, long, beacon

long, beacon

long

beacon

short, long, beacon

short, long, beacon

Range Markers

Range (Naut Mi)

5-102

10-25

25-60

0-120 or

80-200 beacon

0-200 search

Range

Marker Intervals (N-M)

5

10

20

50

Beam Characteristics of Antenna Assy

AS-289A/APS-33 or AS-289B/APS-33

Beam Width: 1.8° ea side in azimuth at half power point

Beam Depth (Vertical): Conforms to  
cosecant-squared pattern for depression  
angles from 5° to 300.

General Characteristics of Antenna Assy

AS-289A/APS-33

Method of Propagation: Feed-horn type  
radiator and parabolic reflector

Waveguide: Hollow, rectangular TEO1  
mode of propagation

Azimuth Range: PPI scan 3600, sector  
60° plus or minus 10°

Fast Scanning Speed: 24 plus or minus 4  
rpm, 360° rotation; 90 to 100 looks  
per minute at 60° sector

Slow Scanning Speed: 8 plus or minus 2  
rpm, 360° rotation; 40 to 50 looks per  
minute at 60° sector

Manual Beam Tilt Range: plus 10 to -20°

Beam Tilt (Line of Sight) Stabilization  
Range: plus 30 to -30° w/manual tilt

ITEM NAME: **RADAR SET**

TYPE: **AN/APS-33**

Duty Cycle: 75% max at sea level  
Pressure Switch Control: Automatic

**INSTALLATION CONSIDERATIONS**

Related Equipment

Required but not Supplied: (1) Power Supply (115v, 380 to 1600 cyc, 1-ph, 1500 va, w/power factor between 90% lagging and 95% leading); (1) Power Supply (27.5v dc 1100w at room temperature); (1- Power Supply (115v, 400 cyc, 1-ph, 50 va); (1) Flux-Gate Compass Mfg by Eclipse Pioneer.

setting of 0°  
Azimuth Motor: 27.5v dc, shunt wound, 1/20 hp, carbon-pile regulated at slow speed  
Azimuth Torque Motor: Two ph induction, 400 cyc, 115v  
Tilt Torque Motor: Two ph induction, 400 cyc, 115v  
Directional Coupler: 25 db fixed attenuation, 15 db front to back (directivity) attenuation  
Reflector Dish Gain: 1300  
Pressurizing Unit HD-16/AP  
Operating Pressure: 15 plus or minus 2 psi

**PRINCIPAL COMPONENTS AND PHYSICAL DATA**

COMPONENT	QTY	OVERALL DIMENSIONS (Inches)	UNIT WT. (Pounds)
Synchronizer SN-36/APS-31	1	10-11/16 x 10-3/8 x 21-7/8	44.63
Mounting Base MT-447/APS-31	1	2-1/2 x 11-7/16 x 23-7/8	4.13
Indicator ID-162/APS-31	2	7 x 7-3/16 x 15-11/16	14.25
Visor MX-511/APS-31	2	5-5/8 x 6-3/8 x 10-7/8	0.56
Mounting Base MT-445/APS-31	2	3/8 x 1-5/8 x 6-1/8	0.13
Mounting MT-446/APS-31	2	5-7/8 x 6-11/16 x 7-7/16	0.63
Control Unit C-289/APS-31	1	5 x 10-1/2 x 13-7/16	11.38
Mounting Plate MT-444/APS-31	1	7/8 x 10-1/2 x 12-1/8	0.81
Modulator MD-60/APS-31	1	18 x 22-1/2 x 22-1/2	90.00
Transmitter-Receiver RT-101/APS-31	1	8-5/16 x 19-3/4 x 19-2/4	49.00
Antenna Assy AS-289A/APS-33	1	28-1/4 x 28-3/8 x 35-9/16	75.00
Servo Amplifier AM-113/APS-33	1	4-3/8 x 5-7/8 x 12-1/2	11.00
Pressurizing Unit HD-16/AP	1	3-9/16 x 4-1/8 x 10-1/4	3.50
Directional Coupler CU-106/APS-33	1	2-1/4 x 5-13/16 x 7-1/8	2.00
Gyroscope Unit CN-51/APS-31	1	7-5/8 x 9-1/8 x 12-13/16	10.50
Junction Box 3-164/APS-31	1	1-13/16 x 2-7/8 x 3-3/8	0.60
Inverter PU-92/U	1	5 x 6-9/16 x 9-15/16	11.13
True Bearing Amplifier AM-110/APS-33	1	5-5/16 x 6-1/8 x 7-11/16	7.31
Relay Box RE-41/APS-31	1	3-11/16 x 4-3/4 x 5-3/4	2.25

**AN/APS-33: 3**

**ITEM NAME:** RADAR SET

**TYPE:** AN/APS-33

**PRINCIPAL COMPONENTS AND PHYSICAL DATA**

<b>COMPONENT</b>	<b>QTY</b>	<b>OVERALL DIMENSIONS (Inches)</b>	<b>UNIT WT. (Pounds)</b>
Blower Unit HD-15/U	2	5-1/4 x 5-11/16 x 7-7/16	3.19
Variable Autotransformer TF-106/U	1	3-5/8 x 5 x 7-1/8	2.44
Mounting Base MT-448/APS-33	1	1-1/4 x 7 x 7-9/16	1.50

**REFERENCE DATA AND LITERATURE**

Technical Manuals:

AN16-30APS33-12: Handbook of Service instructions for Radar Set AN/APS-33, AN/APS-33A, AN/APS-33C, AN/APS-33D and AN/APS-33F.

**AN/APS-33: 4**





**ITEM NAME: RADAR SET**

**TYPE: AN/APS-B3A**

**RELATION TO SIMILAR EQUIPMENT**

This equipment is similar to Radar Set AN/ APS-33 except uses different antenna.

**TECHNICAL DESCRIPTION**

Power Requirements at Room Temperature

AC: 9 amp at 115v, 380 to 1600 cyc; pf  
95% leading to 90% lagging

DC: 40 amp at 27.5v

Rectified Voltages

-300 plus or minus 5v, regulated; 12 - 20 ma

-105 plus or minus 5v, regulated; 15 ma

Plus 105 (plus 50, -15) v, unregulated; 65 - 135 ma

Plus 150 plus or minus 5v, regulated; 121- 206 ma

Plus 300 plus or minus 5v, regulated; 102- 204 ma

Plus 335 (plus 105, -65) v, unregulated; 0 - 115 ma

Plus 440 (plus 275, -80) v, unregulated;

20 - 200 ma; or plus 740 (plus 305,

-155) v, unregulated; 10 - 50 ma

Plus 4800 (plus or minus 250) v, unregulated;

20 - 100 ua

RF Operating Frequencies

Transmitter: 9375 plus or minus 55 mc

Receiver Search: 9375 plus or minus 55 mc

Search Local Oscillator: 60 mc below  
transmitter freq

Beacon Local Oscillator: 60 mc below  
beacon-transmitter freq

AFC Circuit

Sweep Center (-60v Mode): Var from -135 to -175v

Sweep Frequency Range: 30 mc about center freq

Follow Freq Shift: At a rate of 150 mc  
per sec for 0.5 usec pulse at a rate of  
25 mc per sec for 5.0 usec pulse

Center of 40v Sweep: Can be varied from 100 to 200v

IF. Amplifier RT-101/APS-31 or RT-101A/APS-31

Gain: 105 db min

Band Width Normal: 5 plus or minus 1 mc  
at 3 db down

Band Width Long Range Search: 1 mc

Center IF.: 60 plus or minus 1.25 mc

Video Output Impedance: 95 ohms plus or minus 10%

Indicator Video Amplifier

Voltage Gain: 25 approx

Frequency Response: Flat within 3 db from  
20 cyc to 5 mc

Receiver Sensitivity RT-101/APS-31 or  
RT-101A/APS-31

Max Noise Figure: 5.5 db

Min Noise Output: 5v rms at full gain

Peak RF Power Output: 52 kw min

Output-Pulse Duration Modulator MD-60/APS-31

Short Pulse: 0.5 usec

Beacon Pulse: 2.5 usec

Long Pulse.: 5.0 usec

Output-Pulse Duration Modulator MD-60A/APS-31

Short Pulse: 0.5 usec

Beacon Pulse: 2.25 usec

Long Pulse: 4.5 usec

Pulse Repetition Frequency Modulator

MD-60/APS-31 or MD-60A/APS-31

Short Pulse: 800 pps

Beacon Pulse: 400 pps

Long Pulse: 200 pps

Modulator Input Trigger

Amplitude: 20 to 50v

Duration: 1.5 usec at half amplitude

Rate of Rise: 90% amplitude on 0.2 usec

IFF Trigger

Amplitude: 25 to 54v

Duration: 0.25 to 5 usec

Rate of Rise: 9% amplitude in 0.04 to 0.1 usec

Lab Trigger

Amplitude: 25 to 54v

Duration: 0.25 to 0.5 usec

Ranges

Range (Naut Mi)

Pulse Duration

50-60 Var

short, long, beacon

0-120 fixed

long, beacon

0-200 search

long

80-20 beacon

beacon

5-TD

short, long, beacon

30-TD

short, long, beacon

Range Markers

Range

Range (Naut Mi)

Marker Intervals (N-M)

5-10

2

10-25

5

25-60

10

0-120 or

20

80-200 beacon

0-200 search

50

Beam Characteristics of Antenna Assy

AS-378/APS-33A

Beam Width: 1.20 ea side in azimuth at  
half power point

Beam Depth (Vertical): Conforms to cosecant-  
squared pattern for depression angles  
from 3° to 30°

General Characteristics of Antenna Assy

AS-378/APS-33A

Method of Propagation: Feed-horn type  
radiator and parabolic reflector

Waveguide: Hollow, rectangular TE<sub>01</sub> mode  
of propagation

Azimuth Range: PPI scan 360°, sector 60°  
plus or minus 10°

Fast Scanning Speed: 24 plus or minus 4  
rpm, 360° rotation; 90 to 100 looks per  
minute at 60° sector

Slow Scanning Speed: 8 plus or minus 2  
rpm, 360° rotation; 40 to 50 looks per  
minute at 60° sector

Manual Beam Tilt Range: plus 10 to -20°

Beam Tilt (Line of Sight) Stabilization

Range: Plus 30 to -30° w/manual tilt  
setting of 0°

ITEM NAME: RADAR SET

TYPE: AN/APS-33A

**INSTALLATION CONSIDERATIONS**

Related Equipment

Required but not Supplied: (1) Power Supply (115v, 380 to 1600 cyc, 1-ph, 1500 va, w/power factor between 90% lagging and 95% leading; (1) Power Supply (27.5v dc, 110w at room temperature); (1) Power Supply (115v, 400 cyc, 1-ph, 50 va); (1) Flux-Gate Compass Mfg by Eclipse Pioneer.

Azimuth Motor: 27.5v dc, shunt wound, 1/20 hp, carbon-pile regulated at slow speed  
Azimuth Torque Motor: Two ph induction, 400 cyc, 115v  
Directional Coupler: 25 db fixed attenuation, 15 db front to back (directivity) attenuation  
Reflector Dish Gain: 1300  
Pressurizing Unit HD-16/AP  
Operating Pressure: 15 plus or minus 2 psi  
Duty Cycle: 75% max at sea level  
Pressure Switch Control: Automatic

**PRINCIPAL COMPONENTS AND PHYSICAL DATA**

COMPONENT	QTY	OVERALL DIMENSIONS (Inches)	UNIT WT. (Pounds)
Synchronizer SN-36A/APS-31	1	10-11/16 x 10-3/8 x 21-7/8	42.50
Mounting Base MT-447/APS-31	1	2-1/2 x 11-7/16 x 23-7/8	4.13
Indicator ID-162A/APS-31	2	7 x 7-3/16 x 15-11/16	14.25
Visor MX-511/APS-31	2	5-5/8 x 6-3/8 x 10-7/8	0.56
Mounting Base MT-445/APS-31	2	3/8 x 1-5/8 x 6-1/8	0.13
Mounting MT-446/APS-31	2	5-7/8 x 6-11/16 x 7-7/16	0.63
Control Unit C-289A/APS-31	1	5 x 10-1/2 x 13-7/16	12.95
Mounting Plate MT-444/APS-31	1	7/8 x 10-1/2 x 12-1/8	0.81
Modulator MD-60A/APS-31	1	18 x 22-1/2 x 22-1/2	91.00
Transmitter-Receiver RT-101A/APS-31	1	8-5/16 x 19-3/4 x 19-3/4	48.50
Antenna Assy AS-378/APS-33A	1	28-1/4 x 36-3/4 x 45	85.00
Servo Amplifier AM-113/APS-33	1	4-3/8 x 5-7/8 x 12-1/2	11.00
Pressurizing Unit HD-16/AP	1	3-9/16 x 4-1/8 x 10-1/4	3.50
Directional Coupler CU-106A/APS-33	1	2-1/4 x 6-1/16 x 7	1.00
Gyroscope Unit CN-51/APS-31	1	7-5/8 x 9-1/8 x 12-13/16	10.50
Junction Box J-164/APS-31	1	1-13/16 x 2-7/8 x 3-3/8	0.60
Inverter PU-92A/U	1	4-5/8 x 7-5/16 x 9-13/16	13.25
True Bearing Amplifier AM-110/APS-33	1	5-5/16 x 6-1/8 x 7-11/16	7.31
Relay Box RE-41/APS-31	1	3-11/16 x 4-3/4 x 5-3/4	2.25
Blower Units HD-15/U	2	5-1/4 x 5-11/16 x 7-7/16	3.19

**AN/APS-33A: 3**

**ITEM NAME:** RADAR SET

**TYPE:** AN/APS-33A

**PRINCIPAL COMPONENTS AND PHYSICAL DATA**

<b>COMPONENT</b>	<b>QTY</b>	<b>OVERALL DIMENSIONS (Inches)</b>	<b>UNIT WT. (Pounds)</b>
Variable Autotransformer TE106A/U	1	3-5/8 x 5 x 7-1/8	2.44
Mounting Base MT-448/APS-33	1	1-1/4 x 7 x 7-9/16	1.50

**REFERENCE DATA AND LITERATURE**

Technical Manuals:

AN16-30APS33-12: Handbook of Service instructions for Radar Sets AN/APS-33, AN/APS-33A, AN/APS-33C, AN/APS-33D and AN/APS-33F.

**AN/APS-33A: 4**

DATE: 15 September 1964

ITEM NAME: RADAR SET

COGNIZANT SERVICE: USN

TYPE: AN/APS-33C

FEDERAL STOCK NUMBER:

	USA	USN	USAF	USMC
STATUS OR TYPE CLASSIFICATION		Used by		
Mfg(s) Name or Code Number: Philco Corporation (46859)				

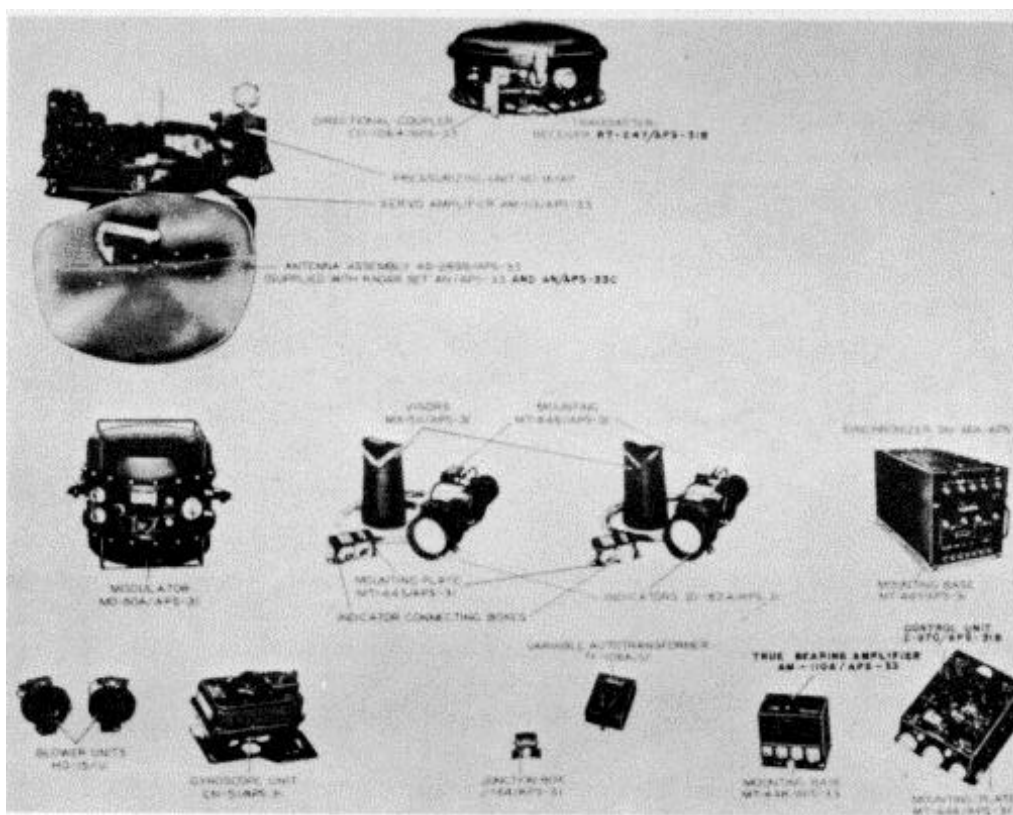

**FUNCTIONAL DESCRIPTION**

Radar Set AN/APS-33C is a radio detection and ranging equipment designed for installation in large aircraft such as patrol bombers. It is primarily for use in revealing the

presence and determining the location of surface vessels, aircraft, beacons and other objects within the area encompassed by the range of the equipment.

**ITEM NAME:** RADAR SET

**TYPE:** AN/APS-33C

**RELATION TO SIMILAR EQUIPMENT**

This equipment is similar to and interchangeable with Radar Set AN/APS-33 except uses different control and receiver-transmitter, does not include inverter and relay box.

**TECHNICAL DESCRIPTION**

**Power Requirements at Room Temperature**

AC: 9 amp at 115v, 380 to 1600 cyc; pf  
95% leading to 90% lagging

DC: 40 amp at 27.5v

**Rectified Voltages**

-300 plus or minus 5v, regulated; 12 - 20 ma  
-105 plus or minus 5v, regulated; 15 ma  
Plus 105 (plus 50, -15) v, unregulated; 65 - 135 ma  
Plus 150 plus or minus 5v, regulated; 121- 206 ma  
Plus 300 plus or minus 5v, regulated; 102- 204 ma  
Plus 440 (plus 275, -80) v, unregulated; 20 - 200 ma;  
or plus 740 (plus 305, -155) v, unregulated;  
10 - 50 ma  
Plus 4800 (plus or minus 250) v, unregulated; 20 - 100 ua

**RF Operating Frequencies**

Transmitter: 9375 plus or minus 55 mc  
Receiver Search: 9375 plus or minus 55 mc  
Receiver Beacon: 9310 plus or minus 3 mc  
Search Local Oscillator: 60 mc below transmitter freq  
Beacon Local Oscillator: 60 mc below  
beacon-transmitter freq

**AFC Circuit**

Sweep Center (-60v mode): Var from -135 to -175v  
Sweep Frequency Range: 30 mc about center freq  
Follows Freq Shift: At a rate of 150 mc  
per sec for 0.5 usec pulse at a rate of  
25 mc per sec for 5.0 usec pulse  
Center of 40v Sweep: Can be varied from  
100 to 200v

**IF. Amplifier Transmitter-Receiver**

**RT-247/APS-31B**

Gain: Approx 130 db  
Band Width: 5 plus or -1 mc at 3 db down  
Band Width Long Range Search: 1 mc  
Center Intermediate Frequency: 60 plus  
or minus 1.25 mc  
Log Range: 70 db

Video Output Impedance: 95 ohms plus or minus 10%

**Indicator Video Amplifier**

Voltage Gain: 25 approx  
Frequency Response: Flat within 3 db  
from 20 cyc to 5 mc

**Receiver Sensitivity Transmitter-Receiver**

**RT-247/APS-31B**

Max Noise Figure: 5.5 db  
Min Noise Output: 0.5v rms at full gain

Peak RF Power Output: 52 kw min

**Output-Pulse Duration Modulator MkD-60/APS-31**

Short Pulse: 0.5 usec  
Beacon Pulse: 2.5 usec  
Long Pulse: 5.0 usec

**Output-Pulse Duration Modulator**

**MD-60A/APS-31**

Short Pulse: 0.5 usec  
Beacon Pulse: 2.25 usec  
Long Pulse: 4.5 usec

**Pulse Repetition Frequency Modulator**

**MD-60/APS-31 or MD-60A/APS-31**

Short Pulse: 800 pps  
Beacon Pulse: 400 pps  
Long Pulse: 200 pps

**Modulator Input Trigger**

Amplitude: 20 to 50v  
Duration: 1.5 usec at half amplitude  
Rate of Rise: 90% amplitude on 0.2 usec

**IFF Trigger**

Amplitude: 25 to 54v  
Duration: 0.25 to 5 usec  
Rate of Rise: 90% amplitude in 0.04 to  
0.1 usec

**Lab Trigger**

Amplitude: 25 to 54v  
Duration: 0.25 to 0.5 usec

**Ranges**

Range (Naut Mi)	Pulse Duration
5-60 var	short, long, beacon
0-120 fixed	long, beacon
0-200 search	long
80-20 beacon	beacon
5-TD	short, long, beacon
30-TD	short, long, beacon

**Range Markers**

Range (Naut Mi)	Marker Intervals (N-M)
5-10	2
10-25	5
25-60	10
0-120 or 80-200 beacon	20
0-200 search	50

**Beam Characteristics of Antenna Assy**

**AS-289A/APS-33 or AS-289B/APS-33**

Beam Width: 1.80 ea side in azimuth at  
half power point

Beam Depth (Vertical): Conforms to  
cosecant-squared pattern for depression  
angles from 50 to 300

**General Characteristics of Antenna Assy**

**AS-289B/APS-33**

Method of Propagation: Feed-horn type  
radiator and parabolic reflector.

Waveguide: Hollow, rectangular TE<sub>01</sub> mode  
of propagation

Azimuth Range: PPI scan 360°, sector 60°  
plus or minus 10°

Fast Scanning Speed: 24 plus or minus 4 rpm, 360°  
rotation; 90 to 100 looks per minute at 60° sector

Slow Scanning Speed: 8 plus or minus 2

**ITEM NAME:** RADAR SET

**TYPE:** AN/APS-33C

**INSTALLATION CONSIDERATIONS**

Related Equipment

Required but not Supplied: (1) Power Supply (115v, 380 to 1600 cyc, 1-ph, 1500 va, w/power factor between 95% lagging and 95% leading); (1) Power Supply (27.5v dc, 1100w at room temperature); (1) Power Supply (115v, 400 cyc, 1-ph, 50 va); (1) Flux-Gate  
Compass Mfg by Eclipse Pioneer.

rpm, 360° rotation; 40 to 50 looks per minute at 600 sector  
Manual Beam Tilt Range: plus 10 to -20°  
Beam Tilt (Line of Sight) Stabilization Range: plus 30 to -30° w/manual tilt setting of 0°  
Azimuth Motor: 27.5v dc, shunt wound, 1/20 hp, carbon-pile regulated at slow speed  
Azimuth Torque Motor: Two ph induction, 400 cyc, 115v  
Tilt Torque Motor: Two ph induction, 400 cyc, 115v  
Directional Coupler: 25 db fixed attenuation, 15 db front to back (directivity) attenuation  
Reflector Dish Gain: 1300  
Pressurizing Unit HD-16/AP  
Operating Pressure: 15 plus or minus 2 psi  
Duty Cycle: 75% max at sea level  
Pressure Switch Control: Automatic

**PRINCIPAL COMPONENTS AND PHYSICAL DATA**

COMPONENT	QTY	OVERALL DIMENSIONS (Inches)	UNIT WT. (Pounds)
Directional Coupler CU-106A/APS-33	1	2-1/4 x 6-1/16 x 7	1.00
Transmitter-Receiver RT-247/APS-31B	1	8-5/16 x 19-3/4 x 19-3/4	48.50
*Transmitter-Receiver RT-193/APS-31A	1	8-5/16 x 19-3/4 x 19-3/4	48.50
Pressurizing Unit HD-16/AP	1	3-9/16 x 4-1/8 x 10-1/4	3.50
Servo Amplifier AM-113/APS-33	1	4-3/8 x 5-7/8 x 12-1/2	11.00
*Servo Amplifier AM-113A/APS-33	1	4-3/8 x 5-7/8 x 12-1/2	11.00
Antenna Assy AS-289B/APS-33	1	28-1/4 x 28-3/8 x 35-9/16	71.00
Modulator MD-60A/APS-31	1	18 x 22-1/2 x 22-1/2	91.00
Visor MX-511/APS-31	2	5-5/8 x 6-3/8 x 10-7/8	0.56
Mounting MTr-446/APS-31	2	5-7/8 x 6-11/16 x 7-7/16	0.63
Mounting Plate MT-445/APS-31	2	3/8 x 1-5/8 x 6-1/8	0.13
Indicator ID-162A/APS-31	2	7 x 7-3/16 x 15-11/16	14.25
Synchronizer SN-36A/APS-31	1	10-3/8 x 10-11/16 x 21-7/8	42.50
*Synchronizer SN-36B/APS-31	1	10-3/8 x 10-11/16 x 21-7/8	45.00
Mounting Base MT-447/APS-31	1	2-1/2 x 11-7/16 x 23-7/8	4.13

**AN/APS-33C: 3**

**ITEM NAME:** RADAR SET

**TYPE:** AN/APS-33C

**PRINCIPAL COMPONENTS AND PHYSICAL DATA**

<b>COMPONENT</b>	<b>QTY</b>	<b>OVERALL DIMENSIONS (Inches)</b>	<b>UNIT WT. (Pounds)</b>
Gyroscope Unit CN-51/APS-31	1	7-5/8 x 9-1/8 x 12-13/16	10.50
Blower Unit HD-15/U	2	5-1/4 x 5-11/16 x 7-7/16	3.19
*Blower Unit HD-15A/U	2	4-3/8 x 5-1/4 x 7-1/2	3.50
Junction Box J-164/APS-31	1	1-13/16 x 2-7/8 x 3-3/8	0.60
Variable Autotransformer TF-106A/U	1	3-5/8 x 5 x 7-1/8	2.44
True Bearing Amplifier AM-110A/APS-33	1	5-5/16 x 6-1/8 x 7-11/16	7.31
Mounting Base MT-448/APS-33	1	1-1/4 x 7 x 7-9/16	1.50
Control Unit C-970/APS-31B	1	5 x 10-1/2 x 13-7/16	12.95
*Control Unit C-729/APS-31A	1	5 x 10-1/2 x 13-7/16	12.95
Mounting Plate MT-444/APS-31	1	7/8 x 10-1/2 x 12-1/8	0.81

**NOTE:** \*Supplied under Contract NOa(s)53-296

**REFERENCE DATA AND LITERATURE**

Technical Manuals:

AN-30APS33-12: Handbook of Service instructions for Radar Sets AN/APS-33, AN/APS-33A, AN/APS-33C, AN/APS-33D and AN/APS-33F.

**AN/APS-33C: 4**



DATE: 15 September 1964

ITEM NAME: RADAR SET

COGNIZANT SERVICE: USN

TYPE: AN/APS-33D

FEDERAL STOCK NUMBER:

	USA	USN	USAF	USMC
STATUS OR TYPE CLASSIFICATION		Used by		
Mfg(s) Name or Code Number: Philco Corporation (46859)				

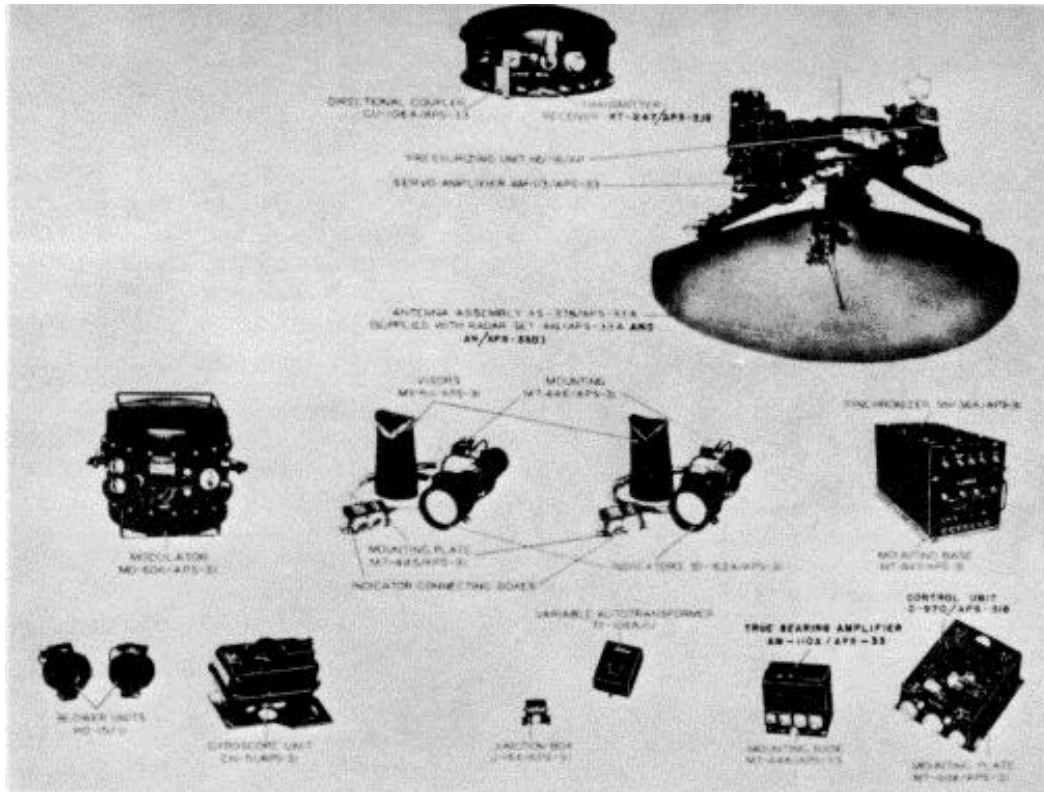

**FUNCTIONAL DESCRIPTION**

Radar Set AN/APS-33D is a radio detection and ranging equipment designed for installation in large aircraft such as patrol bombers. It is primarily for use in revealing the

presence and determining the location of surface vessels, aircraft, beacons and other objects within the area encompassed by the range of the equipment.

AN/APS-33D: 1

**ITEM NAME: RADAR SET**

**TYPE: AN/APS-33D**

**RELATION TO SIMILAR EQUIPMENT**

This equipment is similar to and interchangeable with Radar Set AN/APS-34A except uses different control and receiver-transmitter. Does not include inverter and relay box.

**TECHNICAL DESCRIPTION**

**Power Requirements at Room Temperature**

AC: 9 amp at 115v, 380 to 1600 cyc; pf  
95% leading to 90% lagging

DC: 40 amp at 27.5v

**Rectified Voltages**

-300 plus or minus 5v, regulated; 12 - 20 ma

-105 plus or minus 5v, regulated; 15 ma

Plus 105 (plus 50, -15) v, unregulated; 65 - 135 ma

Plus 150 plus or minus 5v, regulated; 121 - 206 ma

Plus 300 plus or minus 5v, regulated; 102 - 204 ma

Plus 335 (plus 105, -65) v, unregulated; 0 - 115 ma

Plus 440 (plus 275, -80) v, unregulated;

20 - 200 ma; or plus 740 (plus 305, -155) v,  
unregulated; 10 - 50 ma

Plus 4800 (plus or minus 250) v, unregulated; 20 - 100 ua

**RF Operating Frequencies**

Transmitter: 9375 plus or minus 55 mc

Receiver Search: 9375 plus or minus 55 mc

Receiver Beacon: 9310 plus or minus 3 mc

Search Local Oscillator: 60 mc below transmitter freq

Beacon Local Oscillator: 60 mc below

beacon-transmitter freq

**AFC Circuit**

Sweep Center (-60v Mode): Var from -135 to -175v

Sweep Frequency Range: 30 mc about  
center freq

Follows Freq Shift: At a rate of 150 mc  
per sec for 0.5 usec pulse at a rate of  
25 mc per sec for 5.0 usec pulse

Center of 40v Sweep: Can be varied from 100 to 200v

**IF. Amplifier Transmitter-Receiver**

**RT-247/APS-31B**

Gain: Approx 130 db

Band Width: 5 plus or - 1 mc at 3 db down

Band Width Long Range Search: 1 mc

Center Intermediate Frequency: 60 plus or  
minus 1.25 mc

Log Range: 70 db

Video Output Impedance: 95 ohms plus or minus 10%

**Indicator Video Amplifier**

Voltage Gain: 25 approx

Frequency Response: Flat within 3 db from  
20 cyc to 5 mc

Receiver Sensitivity Transmitter-

Receiver RT-247/APS-31B

Max Noise Figure: 5.5 db

Min Noise Output: 0.5v rms at full gain

Peak RF Power Output: 52 kw min

**Output-Pulse Duration Modulator**

MD-60A/APS-31

Short Pulse: 0.5 usec

Beacon Pulse: 2.25 usec

Long Pulse: 4.5 usec

**Pulse Repetition Frequency Modulator**

MD-60/APS-31 or MD-60A/ASP-31

Short Pulse: 800 pps

Beacon Pulse: 400 pps

Long Pulse: 200 pps

**Modulator Input Trigger**

Amplitude: 20 to 50v

Duration: 1.5 usec at half amplitude

Rate of Rise: 90% amplitude on 0.2 usec

**IFF Trigger**

Amplitude: 25 to 54v

Duration: 0.25 to 5 usec

Rate of Rise: 90% amplitude in 0.04 to 0.1 usec

**Lab Trigger**

Amplitude: 25 to 54v

Duration: 0.25 to 0.5 usec

**Ranges**

Range (Naut Mi)

5-60 var

0-120 fixed

0-200 search

80-200 beacon

5-TD

30-TD

**Range Markers**

Range (Naut Mi)

5-10

10-25

25-60

0-120 or

80-200 beacon

0-200 search

**Beam Characteristics of Antenna Assy**

AS-37B/APS-33A

Beam Width: 1.2° ea side in azimuth of half power point

Beam Depth (Vertical): Conforms to cosecant-squared  
pattern for depression angles from 3° to 30°

**General Characteristics of Antenna Assy**

AS-378/APS-33A

Method of Propagation: Feed-horn type  
radiator and parabolic reflector

Waveguide: Hollow, rectangular TE<sub>01</sub>  
mode of propagation

Azimuth Range: PPI scan 360°, sector 60° plus or minus  
10°

Fast Scanning Speed: 24 plus or minus 4 rpm, 360°  
rotation; 90 to 10° looks per minute at 60° sector

Slow Scanning Speed: 8 plus or minus 2  
rpm, 360° rotation; 90 to 10° looks per

**ITEM NAME:** RADAR SET

**TYPE:** AN/APS-33D

Operating Pressure: 15 plus or minus  
2 psi  
Duty Cycle: 75% max at sea level  
Pressure Switch Control: Automatic

**INSTALLATION CONSIDERATIONS**

Related Equipment

Required but not Supplied: (1) Power Supply  
(115v, 380 to 1600 cyc, 1-ph, 1500 va,  
w/power factor between 95% lagging and  
95% leading); (1) Power Supply (27.5v dc,  
1100w at room temperature); (1) Power Supply  
(115v, 400 cyc, 1-ph, 50 va); (1) Flux-Gate  
Compass Mfg by Eclipse Pioneer.

minute at 60° sector  
Manual Beam Tilt Range: plus 10 to -20°  
Beam Tilt (Line of Sight) Stabilization  
Range: plus 30 to -30° w/manual tilt  
setting of 0°  
Azimuth Motor: 27.5v dc, shunt wound,  
1/20 hp, carbon-pile regulated at slow speed  
Azimuth Torque Motor: 2-ph induction,  
400 cyc, 115v  
Tilt Torque Motor: 2-ph induction, 400 cyc, 115v  
Directional Coupler: 25 db fixed attenuation,  
15 db front to back (directivity) attenuation  
Reflector Dish Gain: 1300  
Pressurizing Unit HD-16/AP

**PRINCIPAL COMPONENTS AND PHYSICAL DATA**

<b>COMPONENT</b>	<b>QTY</b>	<b>OVERALL DIMENSIONS (Inches)</b>	<b>UNIT WT. (Pounds)</b>
Transmitter-Receiver RT-247/APS-31B	1	8-5/16 x 19-3/4 x 19-3/4	48.50
Directional Coupler CU-106A/APS-33	1	2-1/4 x 6-1/16 x 7	1.00
Pressurizing Unit HD-16/AP	1	3-9/16 x 4-1/8 x 10-1/4	3.50
Servo Amplifier AM-113/APS-33	1	4-3/8 x 5-7/8 x 12-1/2	11.00
Antenna Assy AS-378/APS-33A	1	28-1/4 x 36-3/4 x 45	85.00
Modulator MD-60A/APS-31	1	18 x 22-1/2 x 22-1/2	91.00
Visor MX-511/APS-31	2	5-5/8 x 6-3/8 x 10-7/8	0.56
Mounting MT-446/APS-31	2	5-7/8 x 6-11/16 x 7-7/16	0.63
Indicators ID-162A/APS-31	2	7 x 7-13/16 x 15-11/16	14.25
Mounting Plate MT-445/APS-31	2	3/8 x 1-5/8 x 6-1/8	0.13
Synchronizer SN-36A/APS-31	1	10-3/8 x 10-11/16 x 21-7/8	42.50
Mounting Base MT-447/APS-3	1	2-1/2 x 11-7/16 x 23-7/8	4.13
Blower Units HD-15/U	2	5-1/4 x 5-11/16 x 7-7/16	3.19
Gyroscope Unit CN-51/APS-31	1	7-5/8 x 9-1/8 x 12-13/16	10.50
Junction Box S-164/APS-31	1	1-13/16 x 2-7/8 x 3-3/8	0.60
Variable Autotransformer TF-106A/U	1	3-5/8 x 5 x 7-1/8	2.44
True Bearing Amplifier AM-110A/APS-33	1	5-5/16 x 6-1/8 x 7-11/16	7.31

**AN/APS-33D: 3**

**ITEM NAME:** RADAR SET

**TYPE:** AN/APS-33D

**PRINCIPAL COMPONENTS AND PHYSICAL DATA**

<b>COMPONENT</b>	<b>QTY</b>	<b>OVERALL DIMENSIONS (Inches)</b>	<b>UNIT WT. (Pounds)</b>
Control Unit C-970/APS-31B	1	5 x 10-1/2 x 13-7/16	12.95
Mounting Plate MT-444/APS-31 MT-444/APS-31	1	7/8 x 10-1/2 x 12-1/8 0.81	
Mounting Base MT-448/APS-33	1	1-1/4 x 7 x 7-9/16	1.50

**REFERENCE DATA AND LITERATURE**

Technical Manuals:

AN16-30APS33-12: Handbook of Service instructions for Radar Sets AN/APS-33, AN/APS-33A, AN/APS-33C, AN/APS-33D and AN/APS-33F.

**AN/APS-33D: 4**

DATE: 15 September 1964

ITEM NAME: RADAR SET

COGNIZANT SERVICE: USN

TYPE: AN/APS-33F

FEDERAL STOCK NUMBER:

	USA	USN	USAF	USMC
STATUS OR TYPE CLASSIFICATION		Used by		
Mfg(s) Name or Code Number. Philco Corporation (46859)				



### FUNCTIONAL DESCRIPTION

Radar Set AN/APS-33F is a radio detection and ranging equipment designed for installation in large aircraft such as patrol bombers. It is primarily for use in revealing the

presence and determining the location of surface vessels, aircraft, beacons and other objects within the area encompassed by the range of the equipment.

AN/APS-33F: 1

**ITEM NAME: RADAR SET**

**TYPE: AN/APS-33F**

**RELATION TO SIMILAR EQUIPMENT**

This equipment is similar to AN/APS-33A except uses different antenna, 1 in. log receiver and 7 inch indicators.

**TECHNICAL DESCRIPTION**

**Power Requirements at Room Temperature**

AC: 9 amp at 115v, 380 to 1600 cyc; pf leading to 90% lagging

DC: 40 amp at 27.5v

**Rectified Voltages**

-300 plus or minus 5v, regulated; 12 - 20 ma

-105 plus or minus 5v, regulated; 15 ma

Plus 105 (plus 50, -15) v, unregulated; 65 - 135 ma

Plus 150 plus or minus 5v, regulated; 121 - 206 ma

Plus 300 plus or minus 5v, regulated; 102 - 204 ma

Plus 335 (plus 105, -65) v unregulated; 0 - 115 ma

Plus 440 (plus 275, -80) v, unregulated; 20 - 200 ma

or plus 740 (plus 305, -155) v, unregulated;  
10 - 50 ma

Plus 4800 (plus or minus 250) v, unregulated; 20 - 100 ua

**RF Operating Frequencies**

Transmitter: 9375 plus or minus 55 mc

Receiver Search: 9375 plus or minus 55 mc

Receiver Beacon: 9310 plus or minus 3 mc

Search Local Oscillator: 60 mc below transmitter freq

Beacon Local Oscillator: 60 mc below  
beacon-transmitter freq

**AFC Circuit**

Sweep Center (-60v Mode): Var from -135 to -175v

Sweep Frequency Range: 30 mc about center freq

Follows Freq Shift: At a rate of 150 mc  
per sec for 0.5 usec pulse at a rate of  
25 mc per sec for 5.0 usec pulse

Center of 40v Sweep: Can be varied from 100 to 200v

**IF. Amplifier Transmitter-Receiver**

**RT-247/APS-31B**

Gain: Approx 130 db

Band Width: 5 plus or minus 1 mc at 3 db down

Band Width Long Range Search: 1 mc

Center Intermediate Frequency: 60 plus or minus 1.25 mc

Log Range: 70 db

Video Output Impedance: 95 ohms plus or minus 10%

**Indicator Video Amplifier**

Voltage Gain: 25 approx

Frequency Response: Flat within 3 db  
from 20 cyc to 5 mc

**Receiver Sensitivity RT-101/APS-31 or**

**RT-101A/APS-31**

Max Noise Figure: 5.5 db

Min Noise Output: 5v rms at full gain

**Receiver Sensitivity Transmitter-Receiver**

**RT-247/APS-31B**

Max Noise Figure: 5.5 db

Min Noise Output: 0.5v rms at full gain

Peak RF Power Output: 52 kw min

**Output-Pulse Duration Modulator**

**MD-60A/APS-31**

Short Pulse: 0.5 usec

Beacon Pulse: 2.25 usec

Long Pulse: 4.5 usec

**Pulse Repetition Frequency Modulator**

**MD-60/APS-31 or MD-60A/APS-31**

Short Pulse: 800 pps

Beacon Pulse: 400 pps

Long Pulse: 200 pps

**Modulator Input Trigger**

Amplitude: 20 to 50v

Duration: 1.5 usec at half amplitude

Rate of Rise: 90% amplitude on 0.2 usec

**IFF Trigger**

Amplitude: 25 to 54v

Duration: 0.25 to 5 usec

Rate of Rise: 90% amplitude in 0.04 to 0.1 usec

**Lab Trigger**

Amplitude: 25 to 54v

Duration: 0.25 to 0.5 usec

**Ranges**

**Range (Naut Mi)**

5-60 Var short, long, beacon

0-120 fixed long, beacon

0-200 search long

80-200 beacon beacon

5-TD short, long, beacon

30-TD short, long, beacon

**Range Markers**

**Range**

Range (Naut Mi) Marker Intervals (N-M)

5-10 2

10-25 5

25-60 10

0-120 or 20

80-200 beacon

0-200 search 50

**Beam Characteristics of Antenna Assy**

**AS-617/APS-33F**

Beam Width: 1.2° ea side in azimuth at  
half power point

**General Characteristics of Antenna Assy**

Method of Propagation: Feed-horn type radiator and  
parabolic reflector

Waveguide: Hollow, rectangular TEO1 mode of  
propagation

Azimuth Range: PPI scan 36°, sector 60° plus or minus  
10°

Fast Scanning Speed: 24 plus or minus 4 rpm, 360°  
rotation; 90 to 100 looks per minute at 60° sector

Slow Scanning Speed: 8 plus or minus 2 rpm, 360°  
rotation; 40 to 50 looks per minute at 60° sector

Manual Beam Tilt Range: plus 10 to -20°

Beam Tilt (Line of Sight) Stabilization

Range: plus 30 to -30°w/manual tilt

ITEM NAME: RADAR SET

TYPE: AN/APS-33F

INSTALLATION CONSIDERATIONS

Related Equipment

Required but not Supplied: (1) Power Supply (115v, 380 to 1600 cyc, 1-ph, 1500 va, w/power factor between 95% lagging and 95% leading); (1) Power Supply (27.5v dc, 1100w at room temperature); (1) Power Supply (115v, 400 cyc, 1-ph, 50 va); (1) Flux-Gate Compass Mfg by Eclipse Pioneer.

setting of 0°  
Azimuth Motor: 27.5v dc, shunt wound, 1/20 hp, carbon-pile regulated at slow speed  
Azimuth Torque Motor: 2-ph induction, 400 cyc, 115v  
Tilt Torque Motor: 2-ph induction, 400 cyc, 115v  
Directional Coupler: 25 db fixed attenuation, 15 db front to back (directivity) attenuation  
Reflector Dish Gain: 1300  
Pressurizing Unit HD-16/AP  
Operating Pressure: 15 plus or minus 2 psi  
Duty Cycle: 75% max at sea level  
Pressure Switch Control: Automatic

PRINCIPAL COMPONENTS AND PHYSICAL DATA

COMPONENT	QTY	OVERALL DIMENSIONS (Inches)	UNIT WT. (Pounds)
Synchronizer SN-36B/APS-31	1	10-3/8 x 10-11/16 x 21-7/8	45.00
Mounting Base MT-447/APS-31	1	2-1/2 x 11-7/16 x 23-7/8	4.13
Transmitter-Receiver RT-247/APS-31B	1	8-5/16 x 19-3/4 x 19-3/4	48.50
Directional Coupler CU-106A/APS-33	1	2-1/4 x 6-1/16 x 7	1.00
Servo Amplifier AM-113/APS-33	1	4-3/8 x 5-7/8 x 12-1/2	11.00
Pressurizing Unit HD-16/AP	1	3-3/16 x 4-1/8 x 10-1/4	3.50
Antenna Assy AS-617/APS-33F	1	28-1/4 x 36-3/4 x 45	85.00
Visor MX-1269/AP	1	10 x 10 x 12	1.00
Azimuth Range Indicator Mounting MT-1011/AP	1	7 x 7-3/4 x 8-3/4	2.00
Control Unit C-970/APS-31B	1	5 x 10-1/2 x 13-7/16	12.95
Mounting Plate MT-445/APS-31	1	3/8 x 1-5/8 x 6-1/8	0.13
Azimuth Range Indicator IP-166/APS-33B	1	9-7/8 x 12-1/8 x 1B-5/8	17.00
Mounting Plate MT-444/APS-31	1	7/8 x 10-1/2 x 12-1/8	0.81
Modulator MD-60A/APS-31	1	18 x 22-1/2 x 22-1/2	91.00
Gyroscope Unit CN-51/APS-31	1	7-5/8 x 9-1/8 x 12-13/16	10.50
Junction Box J-164/APS-31	1	4-3/8 x 5-1/4 x 7-1/2	3.50
Mounting Base MT-448/APS-33	1	1-1/4 x 7 x 7-9/16	1.50
Blower Unit HD-15/U	1	5-1/4 x 5-1/16 x 7-7/16	3.19
Variable Auto Transformer TF-106A/U	1	3-5/8 x 5 x 7-1/8	2.44

AN/APS-33F: 3

**ITEM NAME:** RADAR SET

**TYPE:** AN/APS-33F

**REFERENCE DATA AND LITERATURE**

Technical Manuals:

AN16-30APS33-12: Handbook of Service instructions for Radar Sets AN/APS-33, AN/APS-33A, AN/APS-33C, AN/APS-33D and AN/APS-33F.

**AN/APS-33F: 4**



DATE: 1 July 1964

ITEM NAME: RADAR SET

COGNIZANT SERVICE: USN

TYPE: AN/APS-42

FEDERAL STOCK NUMBER:

	USA	USN	USAF	USMC
STATUS OR TYPE CLASSIFICATION		Ltd Std		
Mfg(s) Name or Code Number: Houston Mfg. Company				

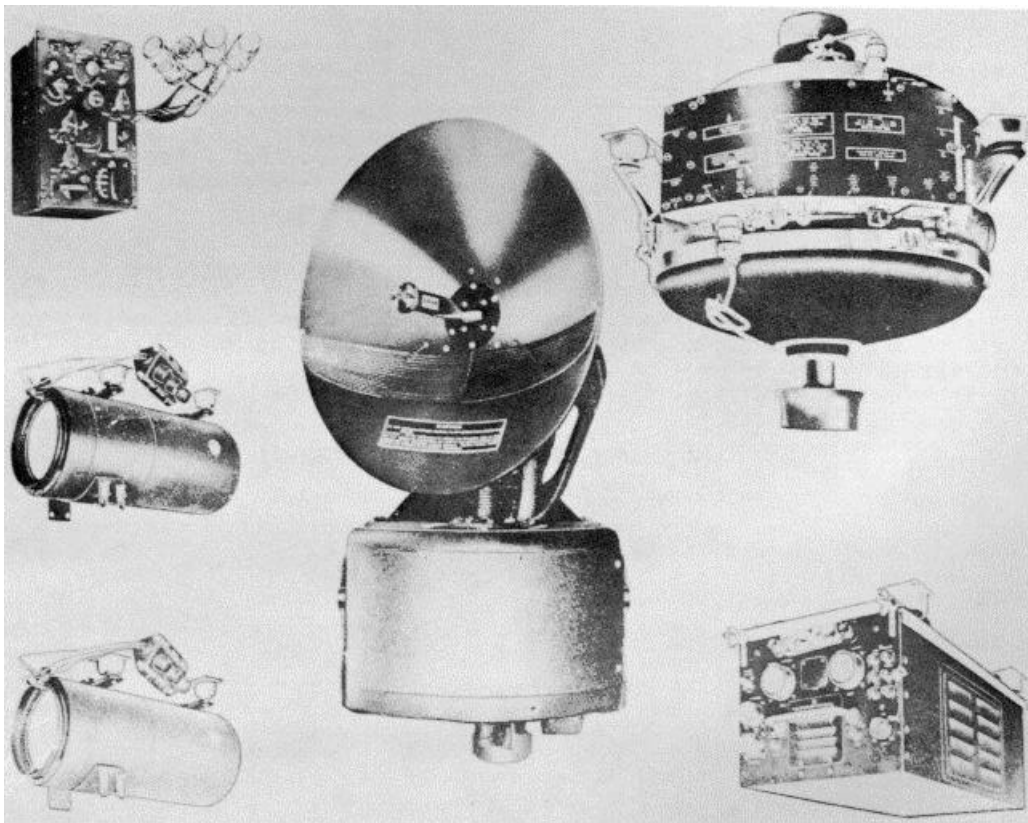

**FUNCTIONAL DESCRIPTION**

Radar Set AN/APS-42 is an airborne search-radar equipment designed for use as a navigational aid as well as an anti collision warning device. The AN/APS-42 provides a visual indication of the position of cities,

landmarks, shorelines, islands, ships, other aircraft, and cloud formations. Coded radar range-beacon indications can also be received and are presented in the conventional spaced code groups.

**ITEM NAME:** RADAR SET

**TYPE:** AN/APS-42

**RELATION TO SIMILAR EQUIPMENT**

Electrically similar to Radar Sets AN/APS-42A and AN/APS-42B.

**TECHNICAL DESCRIPTION**

Frequency  
 Transmitting: 9375 plus or minus 55 mc  
 Receiving: 9310 and 9375 mc  
 Range, Max: 200 naut mi  
 Range, Min: 150 yd  
 Peak Power Output: 50 kw  
 Operating Voltages and Power Requirements  
 ac: 115v, 380 to 420 cps, 1100 va max, single ph  
 dc: 28v, 100w  
 Type of Presentation: PPI  
 Number and Interval of Range Markers:

Range	Range Markers	Spacing (miles)
5	2	2
10	5	2
30	6	5
100	4	25
200	8	25

Duty Cycle: 0.00065  
 Sensitivity  
 Search Operation: 98 db min below 1 mw with IF. band width of 3 mc.  
 Beacon Operation: 96 db below 1 mw

Receiver Recovery: Within 6 db of full sensitivity in less than 6 usec after completion of any transmitter pulse for all settings of gain control.

Environmental Limitations:

Pressurized receiver-transmitter unit

Pulse Repetition Rate

Search: (5 to 10 mi and 30 mi) 800 pps, 0.75 usec pulse; (100 to 200 mi) 200 pps, 3.5 usec pulse.

Weather: (All ranges) 200 pps, 3.5 usec pulse

Type of Beams

Pencil (5.5 deg in both vertical and horizontal plane)

Cosecant Squared

Equal-Energy-Return Beam: Beam width in vertical plane is 37 deg between depression angles of between 3 and 40 deg with antenna tilt set at 0 and aircraft at 10,000 ft. Horizontal side lobes are down 25 db from max amplitude.

Type of Presentation: Offset sector

Scan and Sector Scan: 360 deg

Azimuth Scan: Full, 120 deg, or 240 deg

Accuracy: Sweeps on indicator tube are within 1 deg of antenna position.

**INSTALLATION CONSIDERATIONS**

Related Equipments: (Required but not Supplied) (1) Pressurizing Kit MK-59/AP.

**PRINCIPAL COMPONENTS AND PHYSICAL DATA**

COMPONENT	QTY	HEIGHT (Inches)	WIDTH (Inches)	DEPTH (Inches)	UNIT WT. (Pounds)
Radar Receiver-Transmitter RT-156/APS-42	1	19 dia	24		66
Amplifier AM-442/APS-42	1	5	4	3	*
Amplifier AM-443/APS-42	1	3	3	9	*
Control C-524/APS-42	1	8	4	4	*
Suppressor, Electrical Noise F-148/APS-42	1	6	3	6	4
Range-Azimuth Indicator IP-35/APS-42	1	8	8	14	22
Mounting MT-639/APS-42	1	12	2	24	2
Synchronizer SN-59/APS-42	1	11	8	20	38
Antenna AS-428/APS-42	1	18	35	21	49

**NOTE:** \*Weight included with RT-156/APS-42

**MIL-HDBK-162A**  
15 December 1965

Volume 1  
Section 2

**ITEM NAME:** RADAR SET  
**TYPE:** AN/APS-42

**REFERENCE DATA AND LITERATURE**

Technical Orders:

12P6-2APS42-1  
12P6-2APS42-2  
12P6-2APS42-3

Specifications:  
MIL-R-25721

**AN/APS-42: 3**

DATE: 1 July 1964  
COGNIZANT SERVICE: USN

ITEM NAME: RADAR SET  
TYPE: AN/APS-42A

FEDERAL STOCK NUMBER:

	USA	USN	USAF	USMC
<b>STATUS OR TYPE CLASSIFICATION</b>		Alt Std		
Mfg(s) Name or Code Number: Bendix Aviation Corp.				

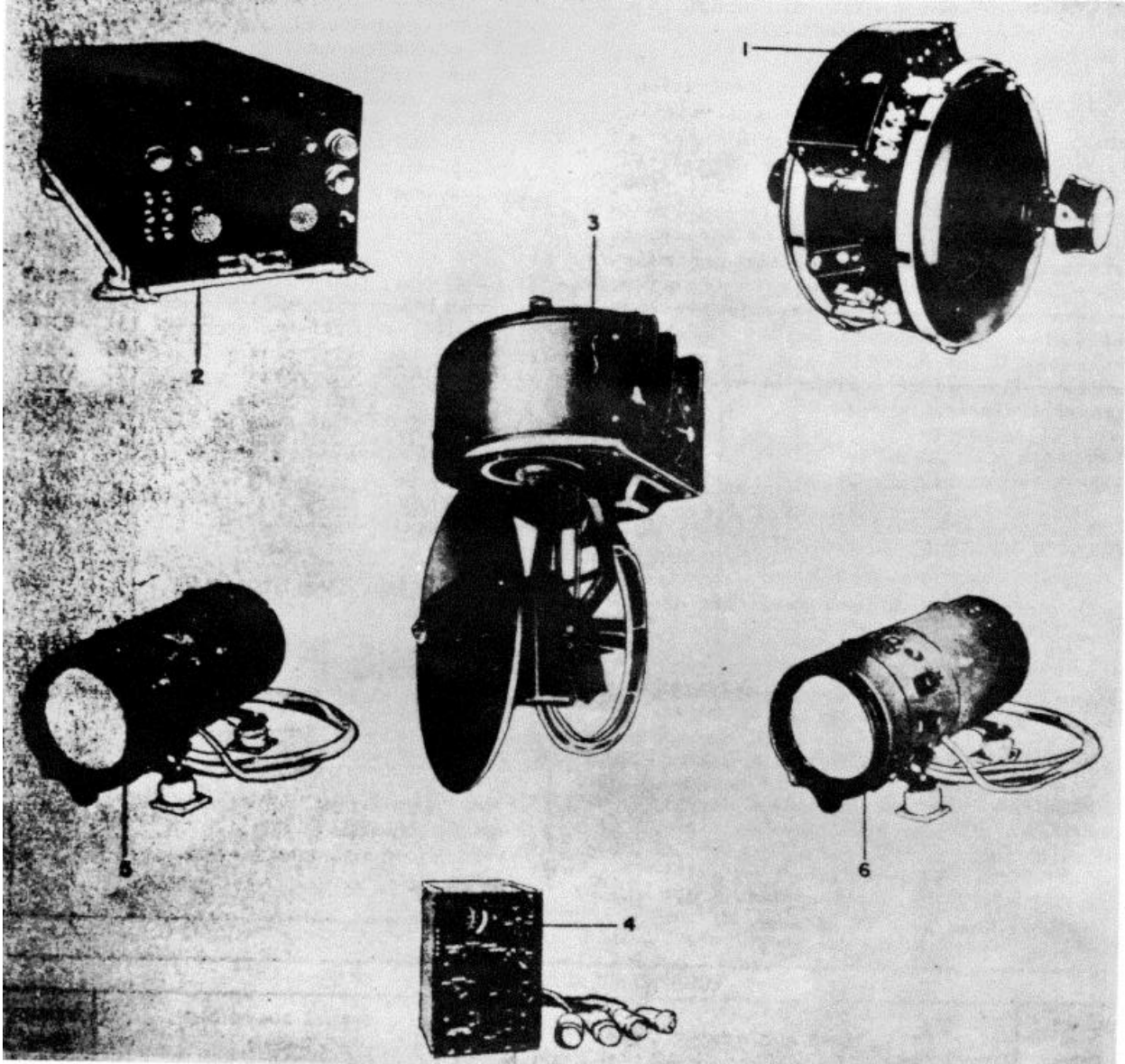

AN/APS-42A: 1

AN/APS-42A

**FUNCTIONAL DESCRIPTION**

The AN/APS-42A is an airborne search radar equipment designed for use as a navigational aid as well as an anticollision warning device. The position of targets is indicated visually in range and azimuth in relation to the heading of the aircraft. Coded radar range beacon indications can be received and presented in the conventional, spaced coded groups.

**RELATION TO SIMILAR EQUIPMENT**

The AN/APS-42A is electrically similar to Radar Set AN/APS-42 and AN/APS-42B.

**TECHNICAL DESCRIPTION**

Frequency: Transmitter 9320 to 9430 mc; Receiver 9300 to 9430 mc; Beacon 9309 to 9311 mc  
Emission: PO

Presentation: 5-in. RT  
Power Requirements:  
115v, 380 to 420 cps, 1,250 va  
27 vdc, 5 amp  
Scan: Up to 360 deg  
Slant Range: 150 yd to 200 naut mi  
Altitude: 50,000 ft above sea level  
Antenna Tilt: 25 deg of total angular travel;  
either 10 deg up and 15 deg down or 15 deg up  
and 10 deg down depending on installation  
Operating Temperature: -55 deg to + 55 deg C (continuous), 71 deg C (not to exceed 30 min)  
IF. Frequency: 60 ± 0.5 mc  
Local Oscillator, Search: 60 ± 0.5 mc above transmitting frequency  
Local Oscillator, Beacon: 60 ± 0.5 mc below nom beacon frequency  
Pulse Repetition Rate: 200, 300, and 800 pps  
Pulse Width: 3.5, 2.35, and 0.75 -µsec  
Range Markers:  
5-and 10-mi scale, 2-mi intervals  
30-mi scale, 5-mi intervals  
100-and 200-mi scale, 25-mi intervals  
TD range interval (30 mi), 5-mi intervals

**PRINCIPAL COMPONENTS AND PHYSICAL DATA**

COMPONENT	QTY	HEIGHT (Inches)	WIDTH (Inches)	DEPTH (Inches)	UNIT WT. (Pounds)
Receiver-Transmitter RT-275/APS-42A	1				
Synchronizer SN-59A/APS-42	1				
Antenna AS-428A/APS-42	1				
Console Control C-818A/APS-42	1				
Indicator, Azimuth and Range IP-217/APS-42A	2				

**REFERENCE DATA AND LITERATURE**

Technical Manuals:  
AN16-30APS42-24

**AN/APS-42A: 2**

DATE: 1 July 1964  
COGNIZANT SERVICE: USN

ITEM NAME: RADAR SET  
TYPE: AN/APS-42B

FEDERAL STOCK NUMBER:

	USA	USN	USAF	USMC
<b>STATUS OR TYPE CLASSIFICATION</b>				
Mfg(s) Name or Code Number: Allen B. Dumont Laboratories Inc., Passaic, N.J.				

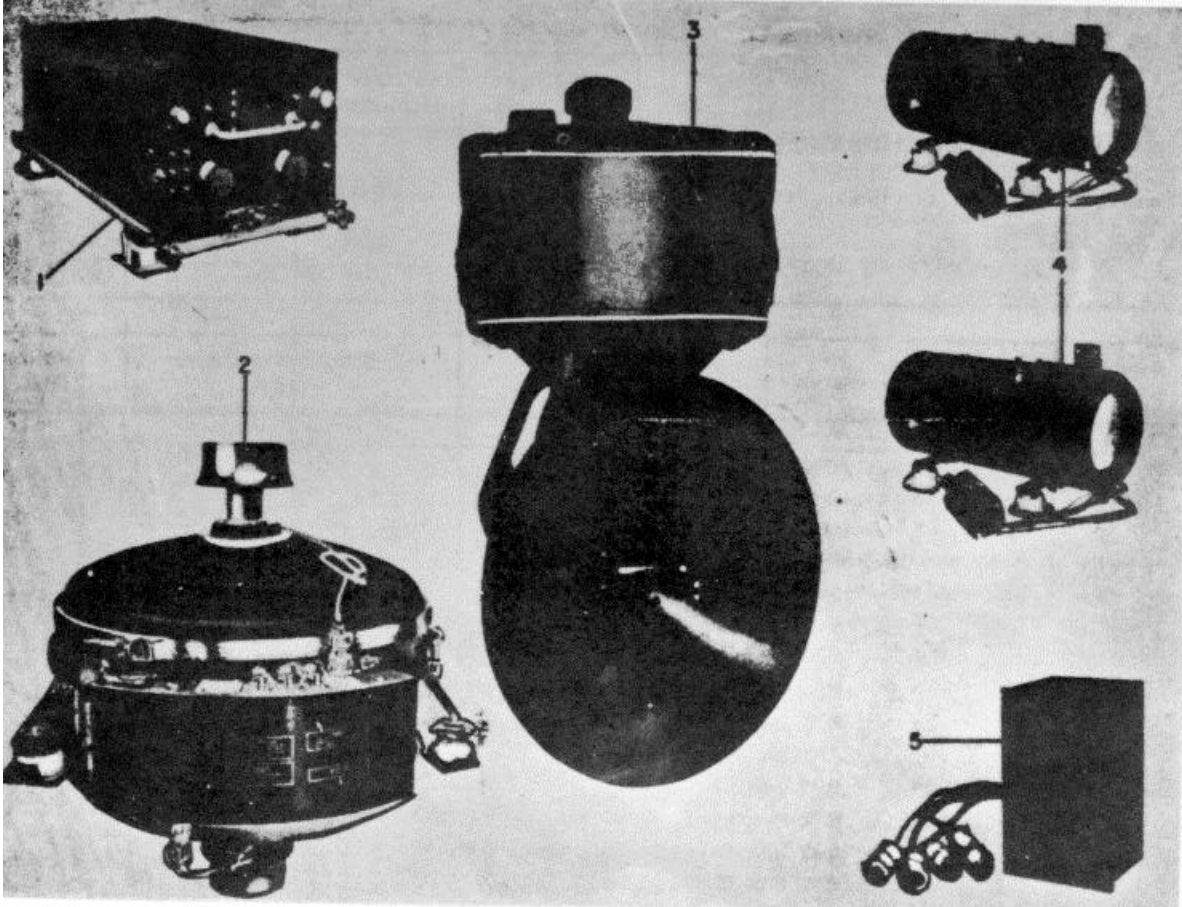

**FUNCTIONAL DESCRIPTION**

The AN/APS-42B is an airborne search-radar equipment designed for use as a navigational aid as well as an anticollision warning device. The position of targets is indicated visually in range and azimuth in relation to the heading of the aircraft. Coded radar range-beacon indications can also be received

and are presented in the conventional, spaced code groups.

**RELATION TO SIMILAR EQUIPMENT**

The AN/APS-42B is electrically and mechanically interchangeable with AN/APS-42 and AN/APS-42A except for maintenance parts.

AN/APS-42B

**TECHNICAL DESCRIPTION**

Power Requirements: 115 vac, 380 to 420 cps,  
1500 va; 28 vdc, 5 amp  
Scan: Up to 360 deg  
Slant Range: 150 yd to 200 naut mi  
Altitude: Up to 50, 000 ft above sea level  
Antenna Tilt: 25 deg of total angular travel;  
either 10 or 15 deg up and/or 15 or 10 deg  
down (Limits determined by antenna installation)  
Operating Temperature: Continuous, -55 to +55  
deg C; for 30-min intervals, as high as +71 deg C

Frequency: Transmitting,  $9375 \pm 35$  mc; receiving,  
9309 to 9420 mc; IF.,  $60 \pm 0.5$  mc  
Search Local Oscillator:  $60 \pm 0.5$  mc above transmitting  
frequency  
Beacon Local Oscillator:  $60 \pm 0.5$  mc below nom  
beacon frequency (9310 mc)  
Pulse Repetition Frequency: 200, 300, and 800 pps  
Pulse Width: 3.5, 2.35, and 0.75  $\mu$ -sec

**INSTALLATION CONSIDERATIONS**

Not Available.

**PRINCIPAL COMPONENTS AND PHYSICAL DATA**

COMPONENT	QTY	HEIGHT (Inches)	WIDTH (Inches)	DEPTH (Inches)	UNIT WT. (Pounds)
Radar Set Control C-818B/APS-42	1				
Azimuth and Range Indicator IP-215/APS-42B	2				
Synchronizer SN-59B/APS-42	1				
Radar Receiver-Transmitter RT-276/APS-42B	1				
Antenna AS-428B/APS-42	1				

**REFERENCE DATA AND LITERATURE**

Handbook:  
AN16-30APS42-11

**AN/APS-42B: 2**

DATE: 1 September 1964

ITEM NAME: RADAR SET

COGNIZANT SERVICE: USN

TYPE: \*AN/APS-45, AN/APS-45A

FEDERAL STOCK NUMBER:

	USA	USN	USAF	USMC
<b>STATUS OR TYPE CLASSIFICATION</b>			*A1t Std	
Mfg(s) Name or Code Number: Texas Instrument Inc., Dallas, Texas				



AN/APS-45: 1



**ITEM NAME:** RADAR SET  
**TYPE:** AN/APS-45, AN/APS-45A



### FUNCTIONAL DESCRIPTION

The AN/APS-45 and AN/APS-45A is designed primarily for height-finding operation, when used in conjunction with early-warning search radar and combat information center (CIC) indicating equipment. Search operation is a secondary function of this radar set. The AN/APS-45 and AN/APS-45A is a complete height finding radar system that operates independently of other radar equipments in the aircraft, and is designed to be controlled locally; however, certain height-finding functions may be controlled remotely for associated display equipment such as Indicator Assembly AN/APA-56.

### RELATION TO SIMILAR EQUIPMENT

The AN/APS-45 and AN/APS-45A are identical Radar Sets except for major equipments supplied.

### TECHNICAL DESCRIPTION

Types of Presentation: RHI and PPI  
Ranges  
Azimuth: 0 to 60 naut mi; 0 to 120 naut mi  
Altitude: 40,000 ft of altitude between the limits of plus 40,000 and -20,000 ft with respect to aircraft altitude.

**ITEM NAME:** RADAR SET  
**TYPE:** AN/APS-45, AN/APS-45A

Transmitter Pulse Width: 1.8 plus or minus  
0.1 usec at 50% peak amplitude  
Receiver Data  
Sensitivity: Not less than 100 dbm  
Intermediate Freq Center Frequency:  
30 plus or minus 0.5 mc; afc provided.  
Intermediate Frequency Bandwidth: 1.2 plus  
or minus 0.3 mc between half power points  
Intermediate Frequency Gain: Continuously  
var, over a range of 65 to 70 db  
Video Output: plus 2.5 plus or minus  
0.5v  
Recovery Time: Less than 18 usec

Radio Frequency Constants  
Transmitting Frequency: 9375 plus or  
minus 55 mc, QK172 magnetron  
Receiving Frequency: 9375 plus or minus  
55 mc  
Local Oscillator Frequency: 30 mc above  
transmitted freq  
Radio Frequency Power Output: 356w min  
Operating Power Requirements: 115/200v  
ac, 320 to 1000 cps, 3300 va max, 110/  
120v line to neutral, 3-ph; 115v ac,  
380 to 420 cps, 3-ph, 560 va

**Pressurizing**

Waveguide: 45 plus or minus 2 lbs per  
sq in., absolute  
Transmitter Radar T-311/APS-45: 15 plus  
or minus 2 lbs per sq in., absolute

**Trigger and Synchronizing Pulses**

Trigger Pulse: 450 plus or minus 1 pps  
Trigger Output: 450 (actually 449.33)  
pps at an amplitude of 57 plus or  
minus 10% volts, peak  
Trigger to Magnetron: Neg 33 kva, 1.8  
usec

**INSTALLATION CONSIDERATIONS**

**Related Equipment**

Required but not Supplied: (1) Primary  
Power Supply 115/200v, 320 to 1000  
cycles, (1) Primary Power Supply 115/  
200v, 380 to 420 cycles, (1) Primary  
Power Supply 27.5v dc, 1200w, (1) Com-  
puter Assy 131/APA-57B, (1) Radio Con-  
trol Box C-628/ARC-27, (1) ICS Control  
Box, (1) Magnetron Blower (1) Set of  
Cables and Connectors as required.

**PRINCIPAL COMPONENTS AND PHYSICAL DATA**

COMPONENTS	QTY		OVERALL DIMENSIONS (Inches)	UNIT WT. (Pounds)
	AN/APS 45	45A		
Antenna AS-556/APS-45	1		48-1/2 dia x 114	370
Antenna AS-809/APS-45A		1	48-1/2 dia x 114 lg	344
Amplifier Audio Frequency AM-551/APS-45	1		4-61/64 x 6-3/16 x 10-1/4	8.4
Amplifier Electronic Control AM-552/APS-45	1	1	3-3/8 x 6-1/2 x 7-5/8	2.2
Gyroscope CN-148/APS-45	1		9-3/4 dia x 12-27/64 lg	9.75
Gyroscope CN-149/APS-45	1		3-3/8 x 4-3/16 x 4-11/16	3.1
Console OA-295/APS-45	1		32 x 48-3/4 x 58-1/8	825
Console OA-295A/APS-45		1	32 x 48-3/4 x 58-1/8	833
Control Indicator C-908/APS-45	1	1	20 x 23-1/2 x 29	146
Radar Receiver R-426/APS-45	1		7 x 9-5/8 x 12	7.3
Radar Receiver R-743/APS-45A		1	7 x 9-5/8 x 12	7.2
Power Supply PP-705/APS-45	1	1	8-1/8 x 15-1/2 x 16	27
Radar Transmitter T-311/APS-45	1	1	23-3/4 x 29-3/8 x 35-1/2	320

**AN/APS-45: 3**

**ITEM NAME:** RADAR SET  
**TYPE:** AN/APS-45, AN/APS-4SA

**PRINCIPAL COMPONENTS AND PHYSICAL DATA**

<b>COMPONENTS</b>	<b>QTY</b>		<b>OVERALL DIMENSIONS (Inches)</b>	<b>UNIT WT. (Pounds)</b>
	<b>AN/APS 45</b>	<b>45A</b>		
Transformer Variable Power TF-147/APS-45	1	1	6-1/4 x 7-1/2 x 14	16
Air Compressor HD-104/APS-45	1	1	7-1/2 x 8-3/4 x 14	19
Cabinet Electrical Equipment CY-1301/APS-45	1		32 x 48-3/4 x 58-1/8	295
Cabinet Electrical Equipment CY-1301A/APS-45		1	32 x 48-3/4 x 58-1/8	303

**REFERENCE DATA AND LITERATURE**

Technical Manuals:  
AN16-30APS45-1  
T.O. 12P6-APS45-1

**AN/APS-45: 4**

DATE: 1 July 1964

ITEM NAME: RADAR SET

COGNIZANT SERVICE: USN

TYPE: AN/APS-69

FEDERAL STOCK NUMBER:

	USA	USN	USAF	USMC
<b>STATUS OR TYPE CLASSIFICATION</b>	Used By	Used by		
Mfg(s) Name or Code Number: Radio Corporation of America (49671)				

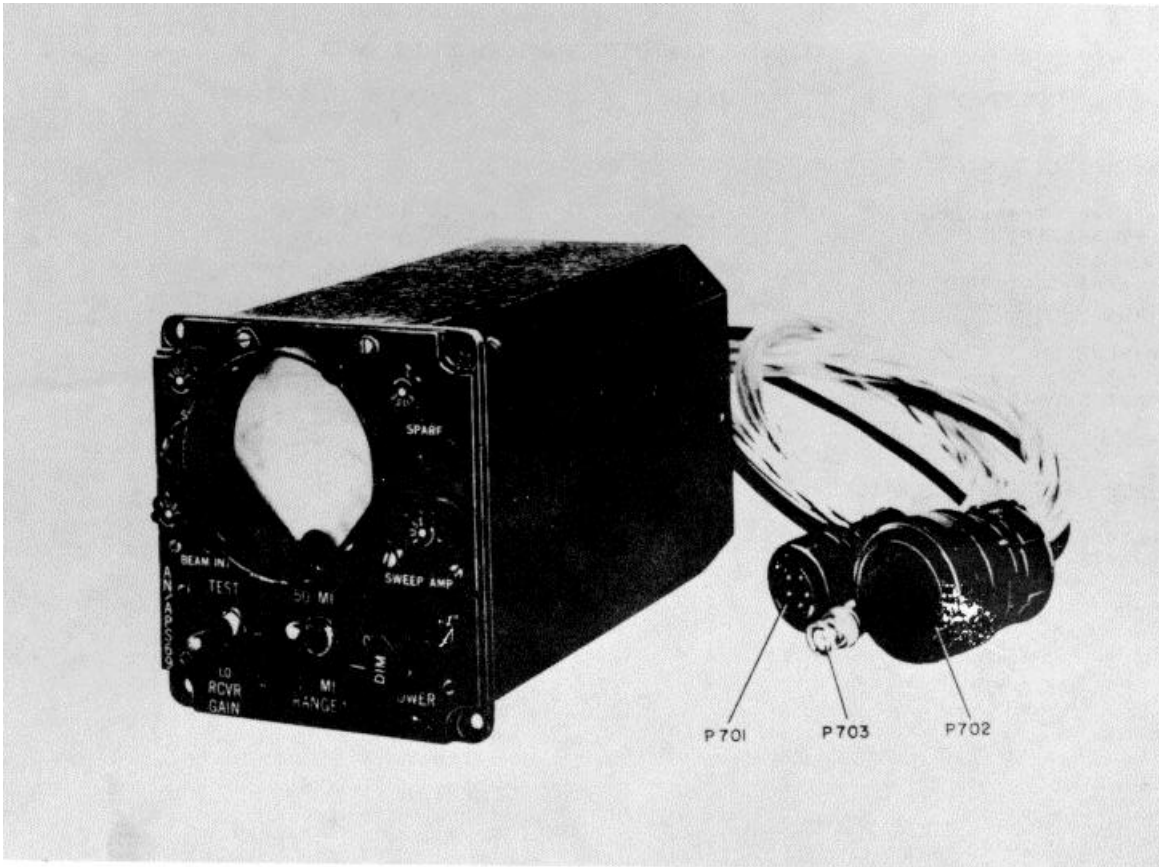

**FUNCTIONAL DESCRIPTION**

The Radar Set AN/SPS-69 is a lightweight radar set, designed primarily for the detection of turbulent weather areas. This equipment locates storm areas and presents

an indication of the intensity of precipitation on the indicator screen. With this weather information the pilot is able to chart a course around the turbulent areas.

**AN/APS-69: 1**

**ITEM NAME:** RADAR SET  
**TYPE:** AN/APS-69

**RELATION TO SIMILAR EQUIPMENT**

None.

Siting: Aircraft mounted.

**TECHNICAL DESCRIPTION**

Type of Emission: P9 type  
Operating Frequency: 9375 mc  
Operating Power Requirements: 115v ac,  
380 to 420 cps, 500 va, single ph,  
25 to 29v, 50w

Related Equipment: (Required but not Supplied) (1) Oscilloscope TS-239/UP; (1) Oscilloscope, Delay Generator 05-4/AP or Dumont Model 256; (1) Test Set TS-147/UP; (1) Spectrum Analyzer TS-148/UP; (1) Dummy Load os-22/U; (1) Crystal Rectifier Test Set TS-268/U; (1) Voltage Divider TS-453/U; (1) Multi-meter TS-352/U; (1) Signal Generator TS-452/U; (1) Tube Tester Hickok 545 or 547; (1) R-F Test Set TS-13/AP; (1) Ammeter (0.7.5A, 400 cps); (1) "T" Connector UG-274A/U.

**INSTALLATION CONSIDERATIONS**

**PRINCIPAL COMPONENTS AND PHYSICAL DATA**

<b>COMPONENTS</b>	<b>QTY</b>	<b>OVERALL DIMENSIONS (Inches)</b>	<b>UNIT WT. (Pounds)</b>
Radar Set AN/APS-69 c/o:	1		
Receiver-Transmitter RT-366/APS-69	1	15 dia x 30	65
Control-Indicator C-1833/APS-69	1	5 x 5 x 10	12
Antenna	1		
Power Supply	1		

**REFERENCE DATA AND LITERATURE**

Technical Manuals:  
1B96418-1 RCA

**AN/APS-69: 2**

DATE: 1 July 1964

ITEM NAME: RADAR SET

COGNIZANT SERVICE: USN

TYPE: AN/APS-80

FEDERAL STOCK NUMBER:

	USA	USN	USAF	USMC
<b>STATUS OR TYPE CLASSIFICATION</b>	Used By	Used by		
Mfg(s) Name or Code Number: Texas Instruments Incorporated (06228)				

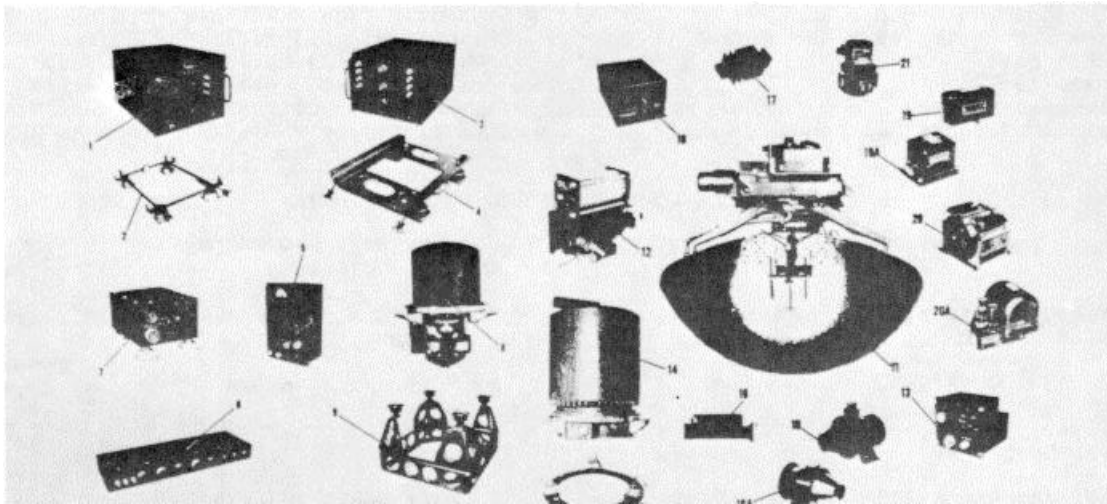

- |   |   |
|---|---|
| <ol style="list-style-type: none"> <li>1. Power Supply PP-2192/APA-125A</li> <li>2. Mounting MT-1824/APA-125</li> <li>3. Electrical Synchronizer SN-234/APS80</li> <li>4. Mounting MT-2136/APS-80</li> <li>5. Radar Set Control C-2786/APS-80</li> <li>6. Interconnecting Box J-1035/APS-80</li> <li>7. Variable Power Transformer TF-284/APS-80</li> <li>8. Radar Receiver-Transmitter RT-508/APS-80</li> <li>9. Mounting MT-2134/APS-80</li> <li>10. Electronic Control Amplifier AM-2135/APS-80</li> <li>11. Antenna AS-1000/APS-80</li> <li>12. Power Driven Rotary Compressor HD-358/AP</li> </ol> | <ol style="list-style-type: none"> <li>13. Antenna Control C-2785/APS-80</li> <li>14. Modulator-Power Supply MD-34)/(APS-80</li> <li>15. Mounting MT-2135/APS-80</li> <li>16. Directional Coupler CU-733/APS-80</li> <li>17. Electrical Dummy; Load DA-148/U</li> <li>18. Tubeaxial Fan HD-359/APS-80</li> <li>18A. Tuheaxial Fan HD-359/APS-80</li> <li>19. Rate Gyroscope CN-550/APS-80</li> <li>19A. Rate Gyroscope CN-612/APS-80A</li> <li>20. Displacement Gyroscope CN-549/APS-8(</li> <li>20A. Displacement Gyroscope CN-611/APS-80A</li> <li>21. Waveguide Switch SA-512/U</li> </ol> |
|---|---|

**FUNCTIONAL DESCRIPTION**

The Radar Set AN/APS-80 is an airborne search radar system designed for detecting submarines, surface vessels, aircraft and other objects of military significance.

The Radar Set AN/APS-80 has three unique

features which increases its combat capabilities over other radars; they are as follows:

- (1) The radar pulse repetition rate is line-locked to the power line frequency.
- (2) The accuracy and the extent of the tilt stabilization system of the radar antenna.

**ITEM NAME:** RADAR SET  
**TYPE:** AN/APS-69

(3) It incorporates a variable delay in the synchronizer.

**TECHNICAL DESCRIPTION**

Altitude Limits: 30,000 ft  
Humidity: 90% relative  
Temperature: -54 deg C to plus 71 deg C  
Beam Pattern  
Horizontal: 2.4 deg wide at half-power point  
Vertical: 3.6 deg wide at half-power points  
Gain: 35 db  
Azimuth Scanning Rate  
Full Scan: 36 deg per sec  
Sector Scan: 48 looks per minute  
Frequency Data  
Transmitter  
Frequency Range: 8500 to 9600 mc  
Number of Bands: 1 band

Number of Channels: 1 channel  
Receiver  
Frequency Range: 8500 to 9600 mc  
Number of Bands: 2 bands, normal and IFF L-band.  
Number of Channels: 1 channel  
Operating Power Requirement: 115v ac, 380 to 420 cps, 3 ph; 28v dc

**INSTALLATION CONSIDERATIONS**

Related Equipment: The AN/APS-80 is designed to function as a portion of an ASW (Anti-Submarine Warfare) airborne system; and is designed to be used with but not part of AN/APA-125 Indicator Group. (Equipment Required but not Supplied) (1) Radar Recognition Set AN/APX-7; (1) Navigational Group Computer AN/ASA-13; (1) Radio Receiving Set AN/ARR-26; (2) Indicator Group AN/APA-125A; (1) Data Display Group AN/ASA-25.

**PRINCIPAL COMPONENTS AND PHYSICAL DATA**

<b>COMPONENTS</b>	<b>QTY</b>	<b>OVERALL DIMENSIONS (Inches)</b>	<b>UNIT WT. (Pounds)</b>
Amplifier, Electronic AM-2135/APS-80	2	5 x 5-5/8 x 8-1/8	6.9
Antenna AS-1000/APS-80	1	32 x 45-1/2 x 46-3/4	98
Compressor, Rotary, Power Driven HD-358/AP	1	5-1/2 x 7-5/8 x 10-1/4	7.5
Control, Antenna C-2785/APS-80	1	5-5/8 x 5-3/4 x 7-1/4	5.8
Control, Radar Set C-2786/APS-80	1	5-3/4 x 6 x 9	5
Coupler, Directional CU-733/APS-80	1	2-5/16 x 2-7/8 x 7	1.5
Dummy Load, Electrical DA-148/U	1	2-5/8 x 3-1/4 x 6-1/2	1.5
Fan, Tubeaxial HD-359/APS-80	2	5-5/16 x 6-11/16 x 7-5/8	3
Gyroscope, Displacement CN-549/APS-80 or CN-611/APS-80A	1	5-1/8 x 5-5/8 x 5-3/4 5-13/16 x 6-7/16 x 9-1/8	6 9
Gyroscope, Rate CN-550/APS-80 or CN-612/APS-80A	1	2-1/2 x 2-5/8 x 4-15/16 3-1/4 x 4-1/8 x 5-7/16	2 2-1/2
Interconnecting Box J-1035/APS-80	1	3 x 10 x 25	15
Modulator-Power Supply MD-348/APS-80	1	17-1/2 x 17-1/2 x 22-3/4	63
Mounting MT-2135/APS-80	1	5-1/2 x 20 dia	6.5
Mounting MT-1824/APA-125	1	3-1/2 x 13 x 20	2.5

**AN/APS-80: 2**

ITEM NAME: RADAR SET  
TYPE: AN/APS-80

**PRINCIPAL COMPONENTS AND PHYSICAL DATA**

<b>COMPONENTS</b>	<b>QTY</b>	<b>OVERALL DIMENSIONS (Inches)</b>	<b>UNIT WT. (Pounds)</b>
Mounting MT-2134/APS-80	1	12 x 17-1/2 x 17-1/2	8
Mounting MT-2136/APS-80	1	3 x 11-1/4 x 15-3/4	2-1/2
Power Supply PP-2192/APA-125A	1	10-3/4 x 13 x 19-1/4	40
Radar, Receiver-Transmitter RT-508/APS-80	1	16 x 16 x 20-5/8	69
Switch Waveguide SA-512/U	1	4-5/16 x 4-7/8 x 6-1/16	5
Synchronizer, Electrical SN-234/APS-80	1	7-5/8 x 10-1/8 x 13-7/8	19.5
Transformer, Variable Power TF-284/APS-80	1	7-3/8 x 9-1/8 x 12-1/8	20

**REFERENCE DATA AND LITERATURE**

Technical Manuals:  
NAWEPS 16-30APS80-1

**AN/APS-80: 3**



DATE: 1 July 1964

ITEM NAME: RADAR SET

COGNIZANT SERVICE: USN

TYPE: AN/APS-80

FEDERAL STOCK NUMBER:

	USA	USN	USAF	USMC
<b>STATUS OR TYPE CLASSIFICATION</b>				
Mfg(s) Name or Code Number: Bendix - Pacific Division Bendix Aviation Corp.				

Illustration Not Available

### FUNCTIONAL DESCRIPTION

The AN/APS-88 is a compact lightweight, airborne radar used in ASW and weather warning operations and for general purpose search. Provision is made for associated sonobuoy and IFF equipment. The area to be scanned may be varied from a small sector to 360 degrees. The range is from 3 to 240 nautical miles.

Receiver Sensitivity: Minimum detectable signal, -104 dbm

Indication: 7-in. CRT with north stabilized PPI displays

Pulse Repetition Frequency: (Tolerance,  $\pm 10\%$ ):

Range (Naut Mi)	Search (pps)	Warning (pps)
3 and 30	2000	180
50	1025	180
100	180	180
240	180	180

### RELATION TO SIMILAR EQUIPMENT

None.

IF. Frequency: 30 mc

IF Bandwidth: 1.5 to 3 mc

Range Markers: (1% accuracy):

1 or 5 naut mi (selectable by operator) for 3 to 30 mi ranges

10 naut mi for 50-mi range

20 naut mi for 100-mi range

30 naut mi for 240mi range

### TECHNICAL DESCRIPTION

Frequency: 8500 to 9700 mc

No. of Channels: 1

Emission: PO

Power Requirements: 115v, 400 cps, 3-ph, 1500 kva (max); and 28 vdc, 10 amps (max)

Modulation Characteristics: Pulse modulated at PRR of 2000, 1025, and 180 pps by pulse width of 0.35, 0.80, and 4.5  $\mu$ sec, respectively

Transmitter Power Output: 75 kw nom, not less than 60 kw peak

System Noise Figure: Not more than 8.0 db

IF. Noise Figure: Not more than 13 db

### INSTALLATION CONSIDERATIONS

Siting:

Mounting:

Cabling Requirements:

Related Equipment: Associated with Radar Recognition Set AN/APX-7; Computer, Group, Navigation AN/ASA-13; Radio Receiving Set AN/ARR-26; Indicator Group AN/ASA-16.

**AN/APS-88: 1**

AN/APS-88

COMPONENT	QTY	HEIGHT (Inches)	WIDTH (Inches)	DEPTH (Inches)	UNIT WT. (Pounds)
Radar Receiver-Transmitter RT-497/APS-88	1	16-3/4 dia.	18		76. 0
Antenna AS-985/APS-88	1	32-7/8	42	42	58. 0
Stabilization Data Generator CN-221/APN-59	1	8 dia.	7		7. 5
Amplifier, Electronic Control AM-2086/APS-88	1	6-11/16	8-1/2	5-1/2	8. 5
Control, Radar Set C-2719/APS-88	1	7	4-1/2	5-3/4	4. 5
Control, Antenna C-2718/APS-88	1	6-1/2	5-1/8	5-3/4	4. 5
Indicator, Azimuth and Range IP-483/APS-88	1	8-1/2	13	9-1/2	12. 0
Synchronizer, Electrical SN-230/APS-88	1	7-5/8	9-7/8	5-1/8	11. 0
Switch, Wave guide SA-511/U	1	3-1/2	5-1/4	3-1/2	5. 0
Dummy Load, Electrical DA-146	1	2-3/4	5-1/2	2-3/4	1. 5
Fan, Vaneaxial HD-349/APS-88	2	6-1/2	4-7/8	8	2. 5

**REFERENCE DATA AND LITERATURE**

Technical Manual:

NAVAER 16-30APS88

**AN/APS-88: 2**

DATE: 1 March 1964

ITEM NAME: RADAR SET

COGNIZANT SERVICE: USAF

TYPE: AN/APS-95

FEDERAL STOCK NUMBER:

	USA	USN	USAF	USMC
STATUS OR TYPE CLASSIFICATION			Std	
Mfg(s) Name or Code Number:				

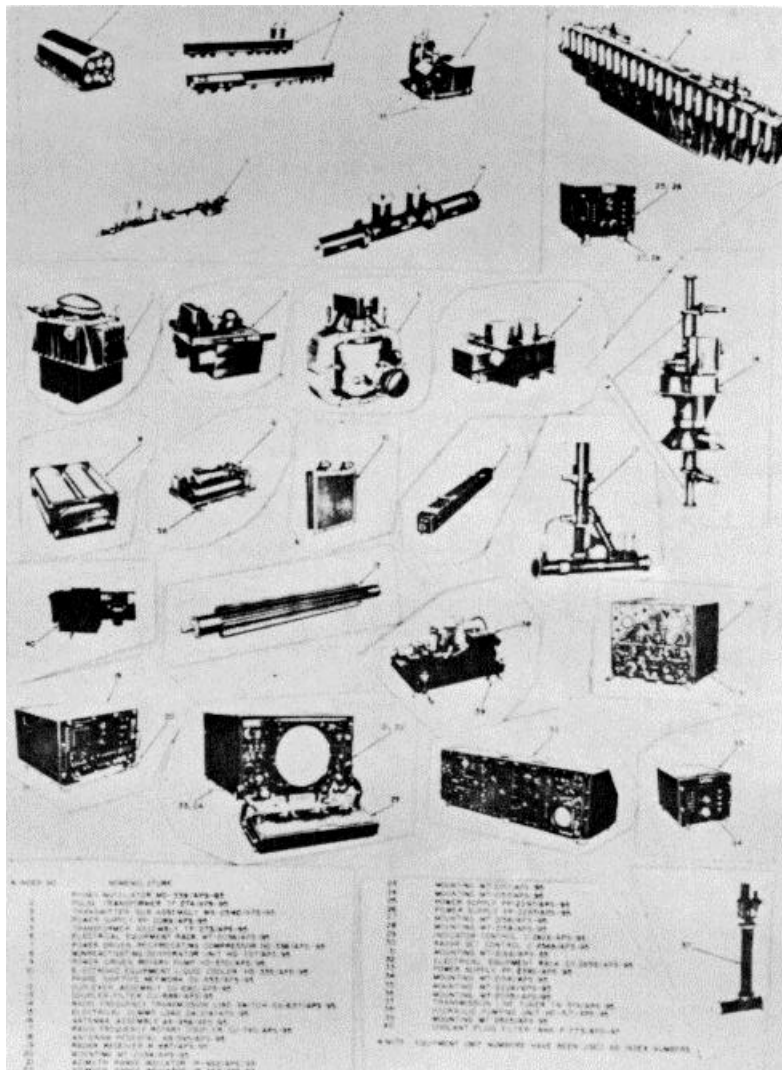

**FUNCTIONAL DESCRIPTION**

The AN/APS-95 is an airborne search radar designed for use in airborne early warning and control type aircraft for detection of airborne moving targets. The

system may be operated in any one of three modes. These modes are (1) AMTI operation; (2) Gated AMTI operation; and (3) Normal Radar Operation.

**ITEM NAME:** RADAR SET  
**TYPE:** AN/APS-95

**RELATION TO SIMILAR EQUIPMENT**

None.

Azimuth: 2 deg  
Elevation: Cosecant Squared  
I.F. Frequencies  
100 mc after first conversion  
15 mc after second conversion  
I.F. Bandwidth: 4 plus or minus 0.5 mc  
as measured at the 3 db points  
Indicator Presentation: PPI  
Radar Range: 250 mi

**TECHNICAL DESCRIPTION**

Transmitter Frequency: 420 to 450 mc  
Pulse Width: 6 usec  
Pulse Repetition Frequency: 280 pulse  
per sec  
Power Output:  
Min, 2 megw peak 3360w avg  
Max, 3 megw peak 5040w avg  
Antenna Beam

**INSTALLATION CONSIDERATIONS**

Not available.

COMPONENT	QTY	HEIGHT (Inches)	WIDTH (Inches)	DEPTH (Inches)	UNIT WT. (Pounds)
Radar Modulator MD-339/APS-95	1	31	23	21	380
Pulse Transformer TF-274/APS-95	1	30	20	14-1/2	210
Transmitter Subassembly MX-2540/APS-95	1	14	20	13	230
Power Supply PP-2089/APS-95	1	15	30	19	250
Transformer Assy TF-273/APS-95	1	12-1/2	10-3/8	26-3/4	60
Electrical Equipment Rack MT-2036/APS-95	1	42	27-3/4	4	50
Power Driven Reciprocating Comp HD-336/APS-95	1	9-1/2	13-1/2	12-1/4	18
Nonreactivating Dehydrator Unit HD-337/APS-95	1	9-1/2	13-1/2	12-1/4	18
Nonreactivating Dehydrator Unit HD-337/APS-95	1	5-1/4	10-1/2	13	99
Power Driven Rotary Pump HD-370/APS-95	1	8	15	20	20
Electronic Equipment Liquid Cooler HD-335/APS-95	1	17	17	4-1/2	25
Transmission Line Tuner TN-374/APS-95	1	36	5-1/4	12-1/2	12
Hydraulic Pumping Unit HD-517/APS-95	1	8	15	10-1/8	25
Mounting MT-2825/APS-95	1	5	16	12-1/2	3
Filter-Tank, Coolant Fluid F-773/APS-95	1	12	18-3/4	6-1/4	17
Phase Shifting Network CV-853/APS-95	1	3-1/2	3-1/2	36-1/2	15

ITEM NAME: RADAR SET  
TYPE: AN/APS-95

COMPONENT	QTY	HEIGHT (Inches)	WIDTH (Inches)	DEPTH (Inches)	UNIT WT. (Pounds)
Duplexer Assy CU-690/APS-95	1	38	29-3/4	5	30
Coupler-Filter CU-688/APS-95	1	32	8	2	15
R-F Transmission Line Switch SA-637/APS-95	1	33-1/4	8-1/4	6	30
Electrical Dummy Load DA-219/APS-95	1	51	6	6	55
Antenna Assy AS-956/APS-95	1	48	209	30	390
R-F Rotary Coupler CU-740/APS-95	1	57	15	8	35
Antenna Pedestal AB-595/APS-95	1	23	16-1/2	16-1/2	25
Radar Receiver R-BB7/APS-95	1	18-7/16	33	29	250
Mounting MT-2034/APS-95	1	3-7/8	33	29	15
Azimuth Range Indicator IP-462/APS-95	2	12-5/16	19-5/8	25-1/4	238
Mounting MT-2157/APS-95	2	4	19	25	16
Power Supply PP-2297/APS-95	2	10-1/2	12-3/4	19	76
Mounting MT-215B/APS-95	2	2	12-3/4	20	4
Indicator Control C-2826/APS-95	1	5-7/8	19-1/2	3	11
Radar Set Control C-2566/APS-95	1	12	15	15	30
Mounting MT-2166/APS-95	1	1-1/2	15	12	3
Electrical Equipment Rack CY-2659/APS-95	1	16-1/4	50	19	250
Power Supply PP-2392/APS-95	1	10-1/2	12-3/4	19	38
Mounting MT-2158/APS-95	1	2	12-3/4	20	4
Mounting MT-2226/APS-95	1	2-3/8	11-1/4	11-1/4	2
Mounting MT-2035/APS-95	1	2-3/4	13	18-3/8	3

REFERENCE DATA AND LITERATURE

Technical Orders:  
12P6-2APS95- Series

AN/APS-95: 33

DATE: 1 July 1964

ITEM NAME: RADAR EQUIPMENT

COGNIZANT SERVICE: USN

TYPE: AN/APX-1

FEDERAL STOCK NUMBER:

	USA	USN	USAF	USMC
<b>STATUS OR TYPE CLASSIFICATION</b>				
Mfg(s) Name or Code Number: Hazeltine Electronics Corp.				

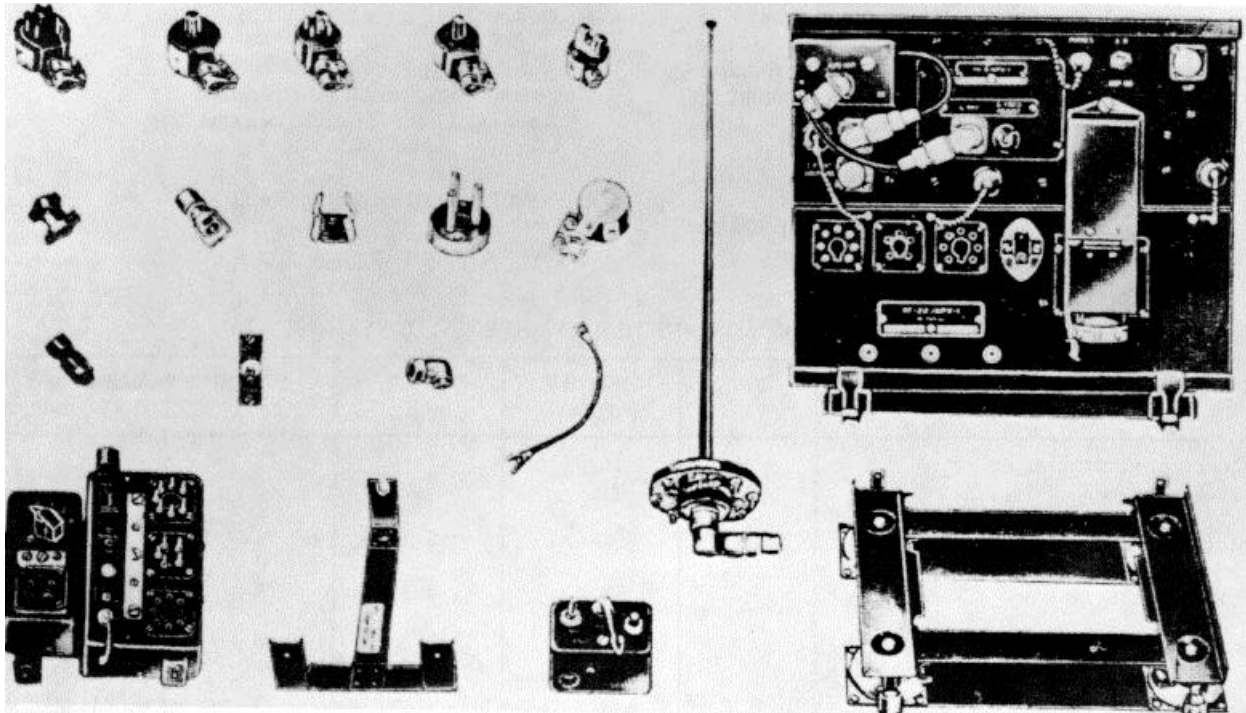

**FUNCTIONAL DESCRIPTION**

The AN/APX-1 is a receiver-transmitter used to automatically identify the craft in which it is installed by response to received coded impulses. A swept-frequency characteristic permits it to receive interrogations and transmit replies to a number of interrogators, on different frequencies, over a wide band. It can reply by predetermined coded pulses or distress signal, or with modification to act as a sound guide to "home" other craft. It can share time between two band ranges, one as interrogation reply and the other for special fighter director purposes. It is used in conjunction with MK III IFF basic element I-Interrogator and basic element III-Responder, or with other basic element II-Transponder equipment.

**RELATION TO SIMILAR EQUIPMENT**

Some major units of AN/APX-1, AN/APX-1X, and AN/APX-2 are identical and interchangeable.

**TECHNICAL DESCRIPTION**

Frequency:  
 A-band - 157 to 187 mc  
 G-band - 194 to 212 mc  
 R-band - 172 to 182 mc (modification required)  
 Frequency Sweep (A-band): From low to high frequency in  $3.0 \pm 0.6$  sec; sweep retract time does not exceed 1/7 of the sweep time  
 Frequency Drift: A-band -  $\pm 1.0$  mc  
 G- or R-band -  $\pm 0.5$  mc

AN/APX-1

Pulse Power Output: A-band - 4 to 11w at A-ANT J-507 (per pulse, into a 50-ohm resistive dummy antenna); G- or R-band - 4w min at G-ANT J-501 (per pulse, into a 50-ohm resistive dummy antenna)

A-band Sensitivity:

Narrow Pulses - 70 to 84 db (320 to 63  $\mu$ v)  
Wide Pulses - +3 db of sensitivity on narrow pulses  
Emergency Pulses -  $\pm$ 8 db of sensitivity on narrow pulses

G- or R-band Sensitivity: 70 to 84 db (320 to 63  $\mu$ v)

Modulation (A-, G- or R-band):

Type - Pulse; Method - Plate

Recovery Time: A-band (narrow pulses) - 100  $\mu$ sec min with 67-db(450  $\mu$ v) input, 200 -sec min with 75-db (180  $\mu$ v) input; G- or R-band - 100  $\mu$ sec min with 67-db (450  $\mu$ v) input, 200  $\mu$ sec min with 75-db (180  $\mu$ v) input

Repetition Rate:

A-band (narrow and wide pulses) - At least 2,000 pps  
A-band emergency pulses - At least 700 pps  
G- or R-band: At least 2,000 pps

A-band Pulse Width:

Narrow Pulses - 5 to 11  $\mu$ sec  
Wide Pulses - 15 to 38  $\mu$ sec  
Emergency Pulses - 65 to 150  $\mu$ sec

G- or R-band Pulse Width: 10 to 20  $\mu$ sec

Time Sharing (when normal G-band operation is instituted):

Cycling Rate - 5 -1 cps  
Ratio of A-band on to G-band on - From 2:1 to 4:1

No Transmission - 15% max

G-band Holding Time - Time sharing operation continues 10 to 20 sec after G-band switch is returned to off position

Power Requirements: 22.5 to 29.5 vdc, 160w, 6.5 amp

Antenna Type: Tapered rod

Antenna Polarization: Vertical

Antenna Feed: 50-ohm coaxial line

Standing Wave Ratio: 3 to 1 max

**INSTALLATION CONSIDERATIONS**

Not available.

COMPONENT	QTY	HEIGHT (Inches)	WIDTH (Inches)	DEPTH (Inches)	UNIT WT. (Pounds)
Receiver-Transmitter RT-22/APX- 1	1	11-5/16	12	12-7/8	27.8
Mounting Base MT-108/APX-1	1	2-5/16	9-1/4	11-7/16	2.4
Antenna Assembly AS-32/APX-1	1	22	3	3	0.7
Antenna Coupling Unit CU-13/APX-1 or CU-13A/APX-1	1	2	2-1/4	3	0.7
Control Unit C-54/APX-1	1	6	3-5/8	2	1.1
Selector Unit C-55/APX-1	1	3	4-7/16	2-1/4	0.5
Auxiliary Control Unit C-53/APX-1	1	1-3/4	2	3	0.3
Securing Plate MT-109/APX-1	1	1-3/4	5-1/4	8	0.4
Mounting Bracket MT-110/APX-1	1	2	5-3/8	7	0.4
Control Unit C-119/APX	1	7-1/4	6	2-1/4	1.1
Set of Spares and Accessories	1				

**REFERENCE DATA AND LITERATURE**

Technical Orders:  
AN16-30APX1-7

DATE: 1 July 1964

ITEM NAME: RADAR EQUIPMENT

COGNIZANT SERVICE: USN

TYPE: AN/APX-1

FEDERAL STOCK NUMBER:

	USA	USN	USAF	USMC
<b>STATUS OR TYPE CLASSIFICATION</b>				

Mfg(s) Name or Code Number: Hazletine Electronics Corp., Little Neck, L.I., N.Y.

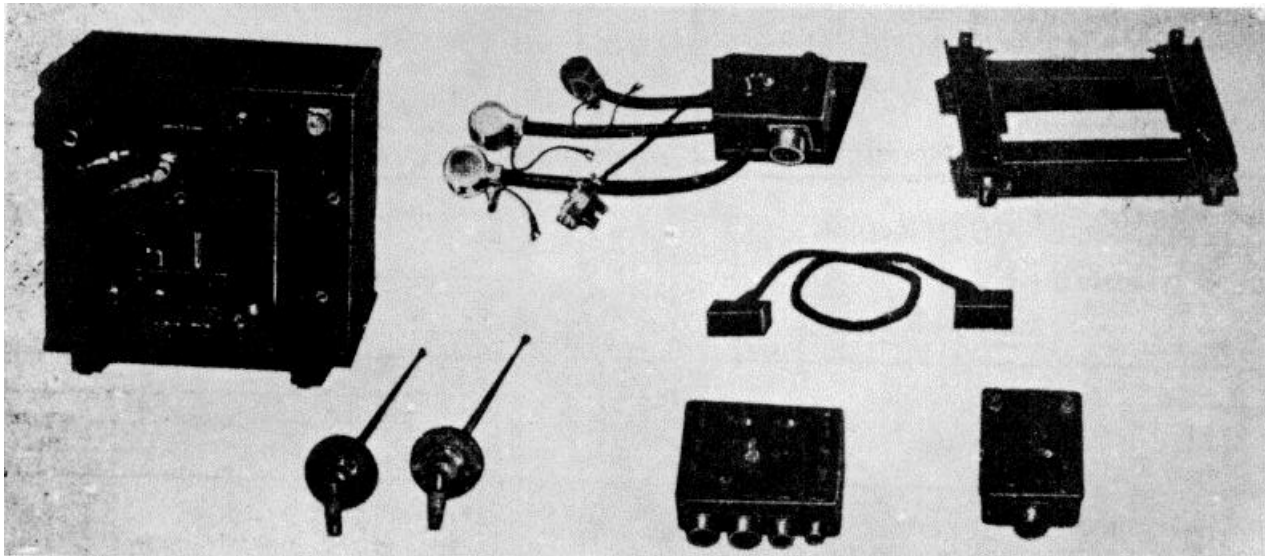

**FUNCTIONAL DESCRIPTION**

This equipment combines all three basic elements of an IFF system within a common housing: (1) It enables an aircraft to identify itself as friendly, or show distress, when challenged by other craft or ground forces; (2) it is able to challenge other craft for identification; and (3) it receives replies from those equipped with AN/APX-3 or other IFF Mark III Transponder equipment. Four methods of operation are possible: (1) Automatic operation of one band alone, or two or three bands concurrently on a time sharing basis, (2) interrogator-responder alone, (3) continuous "Rooster" transponder operation alone or "Rooster" transponder suppression on each interrogation and receptive period, and (4) transponder operation emitting distress pulses, or emergency pulses sharing normal operation of one or two other bands. Coupled with other radar equipment, the AN/APX-2 permits visual identification or response

on the same screen with echo location of other craft.

**RELATION TO SIMILAR EQUIPMENT**

None.

**TECHNICAL DESCRIPTION**

Power Requirements: 115 vac  $\pm$ 5%, 400 to 2400 cps, 160w +10%; 26 vdc, 30w  
 Frequency:  
 Interrogator-Responder - 160 to 184 mc  
 A-band - 157 to 187 mc  
 G-band - 194 to 212 mc  
 R-band - 172 to 182 mc (modification required)

**INSTALLATION CONSIDERATIONS**

Not available.

AN/APX-2: 1



AN/APX-2

COMPONENT	QTY	HEIGHT (Inches)	WIDTH (Inches)	DEPTH (Inches)	UNIT WT. (Pounds)
Receiver-Transmitter RT-24/APX-2	1	12-1/2	12-7/8	10-7/8	28.6
Operator Control Unit C-56/APX-2	1	5-7/8	6-3/4	3-3/8	2.0
Pilot Control Unit C-57/APX-2	1	6	4-1/4	3-7/8	1.3
Antenna Assemblies AS-32/APX-1	2	3	18-5/16	3-5/8	0.7
Antenna Coupling Unit CU-13A/APX-1	1	2	3	2-1/4	0.7
Mounting Base MT-108/APX-1	1	2-1/4	11-1/2	9-1/4	2.4
Adapter Junction Box J-25/APX-2	1	5	6	3-1/4	1.8
Set Equipment Plugs and Accessories					

**REFERENCE DATA AND LITERATURE**

Technical Manual:  
AN08-20-12

**AN/A PX-2: 2**

DATE: 1 July 1964

ITEM NAME: RADAR EQUIPMENT

COGNIZANT SERVICE: USN

TYPE: AN/APX-1

FEDERAL STOCK NUMBER:

	USA	USN	USAF	USMC
<b>STATUS OR TYPE CLASSIFICATION</b>			Ltd Std	
Mfg(s) Name or Code Number: Packard-Bell, Hazeltine Electronics Corp., Stewart-Warner Corp.				

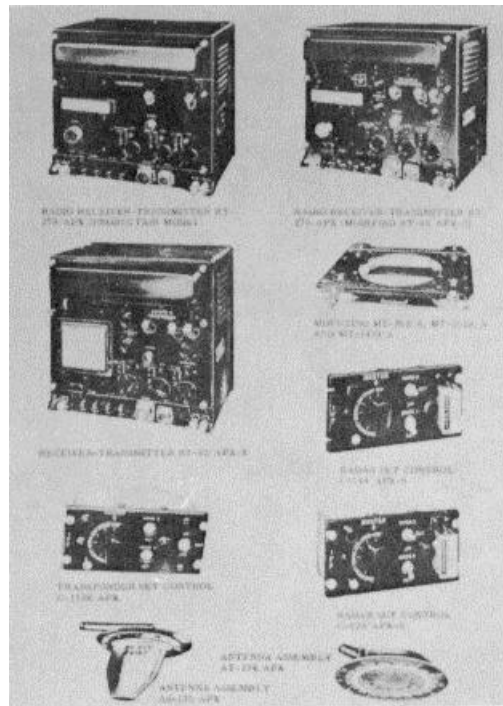

**FUNCTIONAL DESCRIP-ON**

The primary purpose of Radar Set AN/APX-6 is to enable the airplane in which it is installed, to identify itself automatically as friendly whenever it is properly challenged by suitable equipped friendly surface

and airborne radars.

Two supplementary purposes of the equipment are: Two provide two separate channels for the identification of specific friendly airplanes among many friendly planes, and to provide means for transmitting a special reply referred to as "emergency".

**AN/APX-6: 1**

**ITEM NAME:** RADAR IDENTIFICATION SET  
**TYPE:** AN/APX-6

**RELATION TO SIMILAR EQUIPMENT**

The AN/APX-6 is similar to AN/APX-25, and is replaced by AN/APX-6A.

Duty Cycle: .0052  
Sensitivity: 100 uv; selectivity at 6 db below max response, 9.5 mc to 14.5 mc; responds to pulsed interrogations between 74 and 83 db below iv  
Interrogation Signal Paired Pulse Spacing  
Mode 1: 3 usec  
Mode 2: 5 usec  
Mode 3: 8 usec

**TECHNICAL DESCRIPTION**

Frequency: 950 to 1150 mc  
Range, Max: 150 naut mi  
Input Impedance: 51 ohms  
Antenna: One-half wavelength vertical diamond-shaped radiator, end feed  
Power Output: 1 kw, peak; 24 and 30 db above lw rf power to 51 ohm resistive termination at the antenna  
Operating Voltages and Power Requirements  
ac: 105 to 124v, 320 to 1760 cps, 220w  
dc: 24 to 29v, 40w  
Intermediate Frequency: 59.5 mc plus or minus 1.5 mc

**INSTALLATION CONSIDERATIONS**

Related Equipment: The AN/APX-6 can be used for "Black Maria" operation when responds to pulsed interrogations be used in conjunction with Radar Receiver R-269/APX-6. When used in this manner the AN/APX-6 will reply to special interrogations routed through the R-269/APX-6, giving azimuth to the IFF reply. Also used with the AN/APX-28.

COMPONENT	QTY	HEIGHT (Inches)	WIDTH (Inches)	DEPTH (Inches)	UNIT WT. (Pounds)
Receiver-Transmitter RT-82/APX-6 or RT-279/APX	1	9-7/8	13-3/16	14-1/8	38.4
Control Radar Set C-544/APX-6 or C-1158/APX	1	3-3/8	6	4-9/16	3.3
*Antenna Assembly AS-133/APX or AT-234/APX	1	9-7/16	3-3/16	7-1/4	1.1
Mounting MT-362/A or MT-362A/A	1	12.25	9.75	2.31	3.5

**NOTE:** \*Type used dependent upon aircraft installation.

**REFERENCE DATA AND LITERATURE**

Technical Manuals:  
AN16-30.2APX6-3

Specifications:  
MIL-R-6335B

Technical Orders:  
12P4-2APX6-1  
12P4-2APX6-2  
12P4-2APX6-3  
12P4-2APX6-506

12P4-2A PX6-506B  
12P4-2APX6-506C  
12P4-2APX6-506D

DATE: 1 July 1964

ITEM NAME: RADAR RECOGNITION SET

COGNIZANT SERVICE: USN

TYPE: N/APX-7

FEDERAL STOCK NUMBER:

	USA	USN	USAF	USMC
STATUS OR TYPE CLASSIFICATION			Std	

Mfg(s) Name or Code Number: Federal Telephone and Radio Corporation

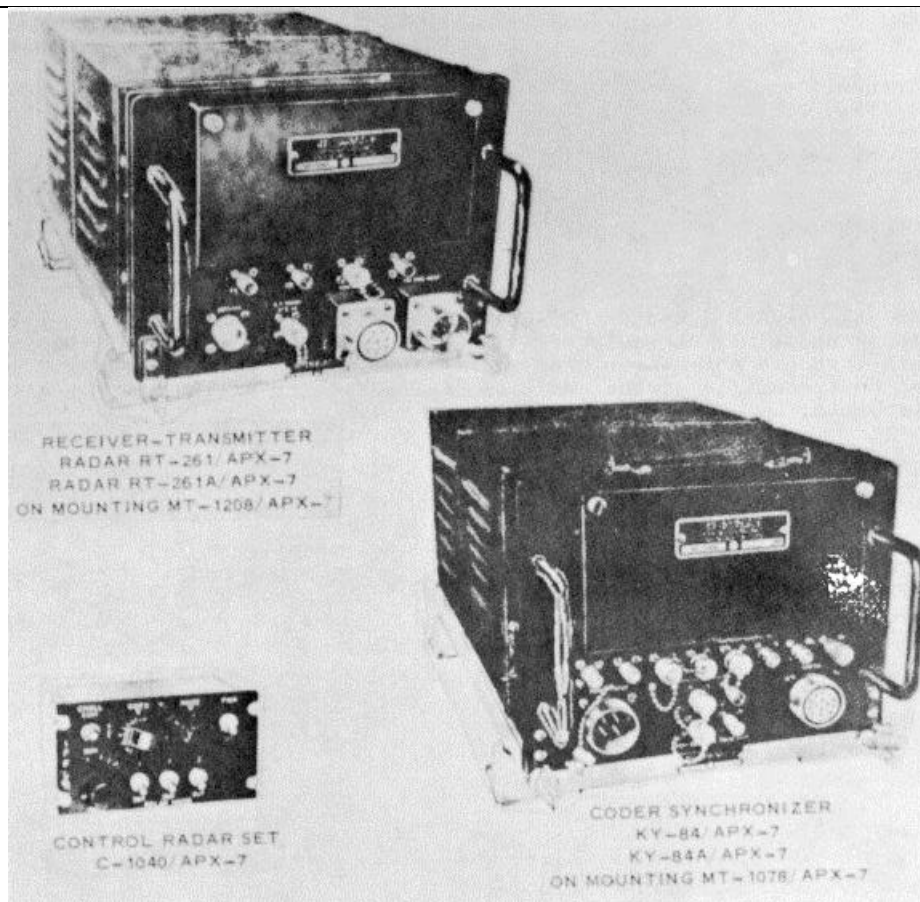

**FUNCTIONAL DESCRIPTION**

The primary purpose of Radar Recognition Set is to challenge the identity of targets which are detected and displayed by the search Radar Set with which it is associated,

distinguishing between friendly targets and enemy targets. In addition, the AN/APX-7 provides a more detailed recognition of friendly targets for additional security and tactical information.

**ITEM NAME:** RADAR RECOGNITION SET  
**TYPE:** AN/APX-7

**RELATION TO SIMILAR EQUIPMENT**

Similar to AN/APX-6.

115v, 320 to 1760 cps, single ph,  
450w  
dc: 26.5v, 0.3 amps  
Receiver Frequency: 1090 mc to 1110 mc  
Intermediate Frequency: 59.5 mc  
Transmitter Frequency: 1010 mc to 1030 mc

**TECHNICAL DESCRIPTION**

Peak R-F Power Output: Over 2 kw for  
aircraft altitudes up to 35, 000 ft.  
Power Requirements  
ac: 115v, 380 to 420 cps, single ph,  
60w;

**INSTALLATION CONSIDERATIONS**

B-47, B-52 - RC-121D & H and C130 aircraft.

**PRINCIPAL COMPONENTS AND PHYSICAL DATA**

COMPONENT	QTY	HEIGHT (Inches)	WIDTH (Inches)	DEPTH (Inches)	UNIT WT. (Pounds)
*Receiver-Transmitter RT-261( )/APX-7	1	7-13/16	10-3/4	19-11/16	52.0
Coder-Synchronizer KY-84( )/APX-7	1	7-3/16	10-3/4	19-4/16	38.0
Radar Set Control C-1040/APX-7	1	3-3/8	5-3/4	4-11/16	2.0

**NOTE:** \*The RT-261/APX-7 and the RT-261A/APX-7 are interchangeable and either of those units may be replaced with an RT-261B/APX-7. However the RT-261B/ APX-7 should not be replaced with either of the other Receiver-Transmitters without checking if the additional capabilities of the RT-261B/APX-7 are required.

**REFERENCE DATA AND LITERATURE**

Technical Manuals:  
12P4-2APX7-1  
12P4-2APX7-2  
12P4-2APX7-2C  
12P4-2APX7-2D  
12P4-2APX7-2E

12P4-2APX7-3  
12P4-2APX7-4  
12P4-2APX7-4C  
12P4-2APX7-14

Specifications:  
MIL-I-5532

DATE: 15 May 1964

ITEM NAME: TRANSPONDER SET

COGNIZANT SERVICE: USAF

TYPE: AN/APX-25

FEDERAL STOCK NUMBER: 5895-302-9152-EA

	USA	USN	USAF	USMC
STATUS OR TYPE CLASSIFICATION			Std	

Mfg(s) Name or Code Number: Stewart-Warner Electronics

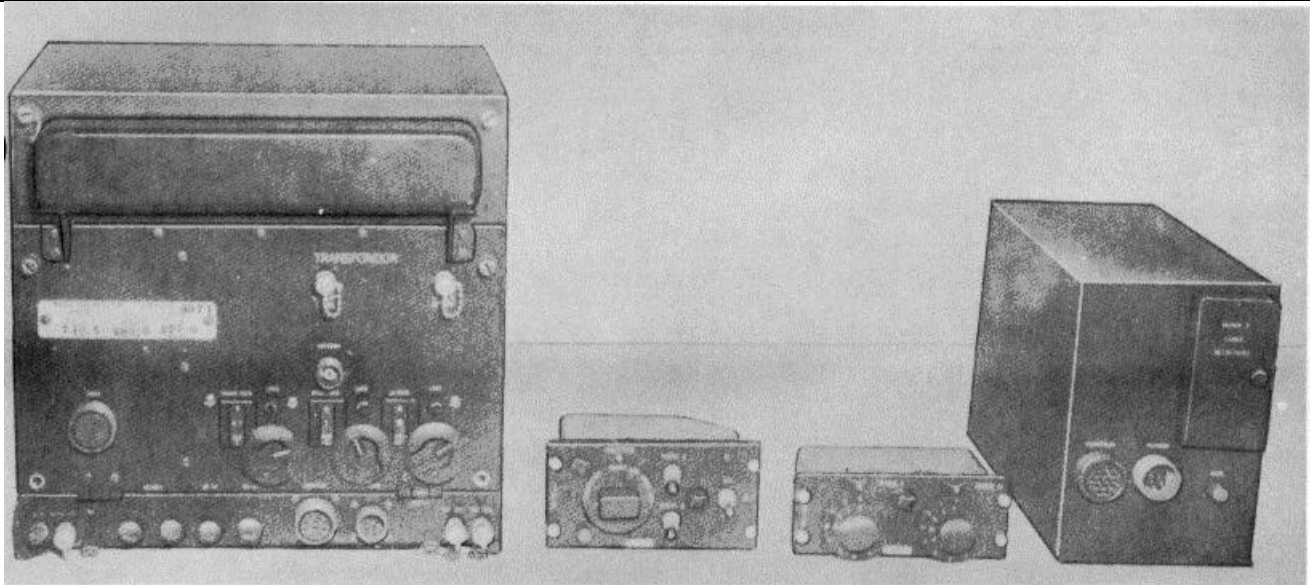

**FUNCTIONAL DESCRIPTION**

Transponder Set AN/APX-25 is an airborne pulse-type transponder set which provides

automatic selective identification of the aircraft to airborne, shipboard or ground IFF recognition installations.

**AN/APX-25: 1**

**ITEM NAME:** TRANSPONDER SET  
**TYPE:** AN/APX-25

**RELATION TO SIMILAR EQUIPMENT**

Similar to AN/APX-6 and replaced by AN/APX-25A.

Operating Voltages and Power Requirements:

ac: 105 to 124v, 320 to 1760 cps, 220w

dc: 24 to 29v, 30w at 27.5v

Duty Cycle: 0.0025

Environmental Limitations: Antenna cable should not be longer than 20 ft

**TECHNICAL DESCRIPTION**

Frequency: 990 to 1050 mc

Range, Max: 150 naut mi

Peak Power Output: 1 kw

**INSTALLATION CONSIDERATIONS**

Not available.

**PRINCIPAL COMPONENTS AND PHYSICAL DATA**

<b>COMPONENT</b>	<b>QTY</b>	<b>HEIGHT (Inches)</b>	<b>WIDTH (Inches)</b>	<b>DEPTH (Inches)</b>	<b>UNIT WT. (Pounds)</b>
Radar Receiver-Transmitter RT-279/APX-25	1	10.5	13.19	12.52	38
Transponder Set Control C-1158/APX-25	1	3.0	5.75	4.52	1.25
Antenna *AS-133/APX or AT-234/A PX-25	1	9.4	3.17	7.19	1
Coder-Decoder KY-95/APX-25 or KY-95A/APX-25	1	10.52 10.7	5.19 5.12	7.75 7.52	13.5 9.5
Coder Group Control 1 C-1 12B/A PX-25		2.25	5.75	5	1.5
Mounting MT-362A/A	1	12.25	9.75	2.31	3.5

**NOTE:** \*Type used dependent upon aircraft installation.

**REFERENCE DATA AND LITERATURE**

Technical Orders:

- 12P4-2APX25-2
- 12P4-2APX25-2C
- 12P4-2APX25-2E
- 12P4-2APX25-2F
- 12P4-2APX25-3
- 12P4-2APX25-3C

- 12P4-2APX25-4C
- 12P4-2APX25-501
- 12P4-2APX25-501B

Specifications:  
MIL-I-2534B

DATE: 1 March 1965

ITEM NAME: TRANSPONDER SET

COGNIZANT SERVICE: USAF

TYPE: AN/APX-25A

FEDERAL STOCK NUMBER:

	USA	USN	USAF	USMC
STATUS OR TYPE CLASSIFICATION			Ltd Std	

Mfg(s) Name or Code Number: Stewart-Warner Electronics



**FUNCTIONAL DESCRIPTION**

Transponder Set AN/APX-25A is an airborne pulse type transponder set which provides automatic selective identification of the aircraft in which it is installed to

ground, shipboard or airborne IFF recognition installations. The equipment receives and decodes challenging radio signals originated and beamed by either of two IFF interrogating systems; mark X or selective identification feature (SIF).



**ITEM NAME:** TRANSPONDER SET  
**TYPE:** AN/APX-25A

**RELATION TO SIMILAR EQUIPMENT**

The AN/APX-25A is similar to AN/APX-6, and replaces the AN/APX-25.

Transmitting: 1090 mc  
Intermediate Frequency: 59.5 mc plus or minus 1.5 mc  
Output Power (For either Mark X (norm) or SIF (Mod) operation): Transmitter delivers between 24 and 30 db above 1w R-F peak power to a 51 ohm antenna termination.

**TECHNICAL DESCRIPTION**

Power Requirements  
ac: 105 to 124v root-mean-square, 320 to 1760 cps, 220w max  
dc: 24 to 29v, 30w at 27.5v  
Frequency  
Receiving: 1030 mc

**INSTALLATION CONSIDERATIONS**

C130, C135, KC135, F105, T-39A & B aircraft.

**PRINCIPAL COMPONENTS AND PHYSICAL DATA**

COMPONENT	QTY	HEIGHT (Inches)	WIDTH (Inches)	DEPTH (Inches)	UNIT WT. (Pounds)
Receiver-Transmitter RT-279/APX	1	10-1/2	13-3/16	12-5/8	38
Transponder Set Control C-1158/APX	1	4-5/8	5-3/4	3	1-1/4
Antenna Assy 1 9-13/32 3-11/64 7-3/16 1 ***AS-133/APX or AT-234/APX					
Mounting MT-362A/A	1	12-1/4	9-3/4	2-5/16	3-1/2
Transponder Set Coder KY-95/APX-25 or KY-95A/APX-25	1	10-5/8	5-3/16	7-3/4	13-1/2
Mounting MT-1151/APX-25	1	10-11/16	5-1/8	7-5/8	9-1/2
Filter, Radio Interference F-245/APX-25	1	11-1/2	6-1/8	2-1/8	1
Filter, Radio Interference F-245/APX-25	1	4-5/8	1-1/2	1-3/16	1/2

**NOTE:** \*\*\*Type used dependent upon aircraft installation.

**REFERENCE DATA AND LITERATURE**

Technical Manuals:  
12P4-1-1  
12P4-2APX25- Series

Specifications:  
MIL-C-25341A  
MIL-T-25036  
MIL-T-25348  
MIL-M-25460A  
MIL-C-8327A

**DATE:** 15 May 1964

**ITEM NAME:** INTERROGATOR SET

**COGNIZANT SERVICE:** USAF

**TYPE:** AN/APX-26

**FEDERAL STOCK NUMBER:** 5895-509-0875-EA

	USA	USN	USAF	USMC
STATUS OR TYPE CLASSIFICATION			Ltd Std	

Mfg(s) Name or Code Number: Hughes Aircraft

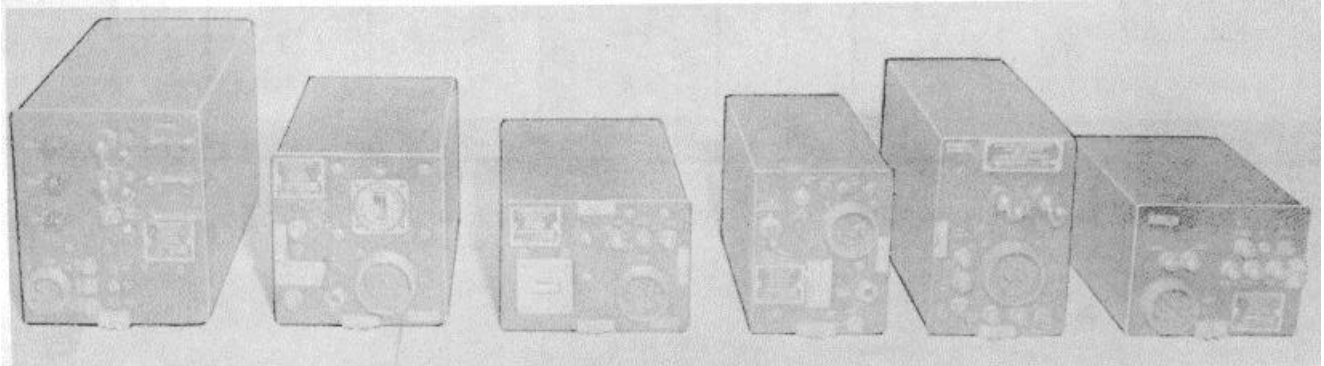

#### FUNCTIONAL DESCRIPTION

This air-to-air identification system consists of an interrogator and a cooperative transponder operating in the X-band. It is operated in conjunction with a separate radar set, and uses the radar antenna and indicator to display identification information.

#### RELATION TO SIMILAR EQUIPMENT

Similar to AN/APX-27B.

#### TECHNICAL DESCRIPTION

Frequency: Interrogator, 9290 mc;  
Transponder, 9310 mc

Range, Max: 30 to 70 mi (detection range of associated fire control system)

Range, Min: 0.5 mi

Peak Power Output: 110w

Operating Voltages and Power Requirements:

108 to 121 vac, 380 to 1, 000 cps, 220w

25 to 29 vdc, 5 amp

Type of Presentation: Fire control presentation, blank or bloom targets

Duty Cycle: 0.027

Environmental Limitations:

Class-2, MIL-E-5400A

#### INSTALLATION CONSIDERATIONS

Not available.

**AN/APX-26: 1**

**AN/APX-26**

**PRINCIPAL COMPONENTS AND PHYSICAL DATA**

<b>COMPONENT</b>	<b>QTY</b>	<b>HEIGHT (Inches)</b>	<b>WIDTH (Inches)</b>	<b>DEPTH (Inches)</b>	<b>UNIT WT. (Pounds)</b>
Radio-Transmitter T-641/APX-26	1	5	5.25	10	9.1
Amplifier Synchronizer AM- 1243	1	4	5	9.5	5.3
Amplifier Converter 1 4 5.5 10 6.3 AM- 1242					
Amplifier AM-1709	1	4	6	10.25	7.4
Coupler CU-462	1	2.8	3.9	7.3	4.5
Coupler CU-568	1	2.9	3.8	5	3.9

**REFERENCE DATA AND LITERATURE**

Specifications:  
MIL-I-8319C

Technical Orders:  
12P4-2APX-26  
11F1-MA 1-12-16

DATE: 1 December 1964  
COGNIZANT SERVICE: USAF

ITEM NAME: INTERROGATOR SET  
TYPE: AN/APX-26B

FEDERAL STOCK NUMBER: 5895-612-8108-EA

	USA	USN	USAF	USMC
STATUS OR TYPE CLASSIFICATION		Ltd Std		
Mfg(s) Name or Code Number: Hughes Aircraft Company				

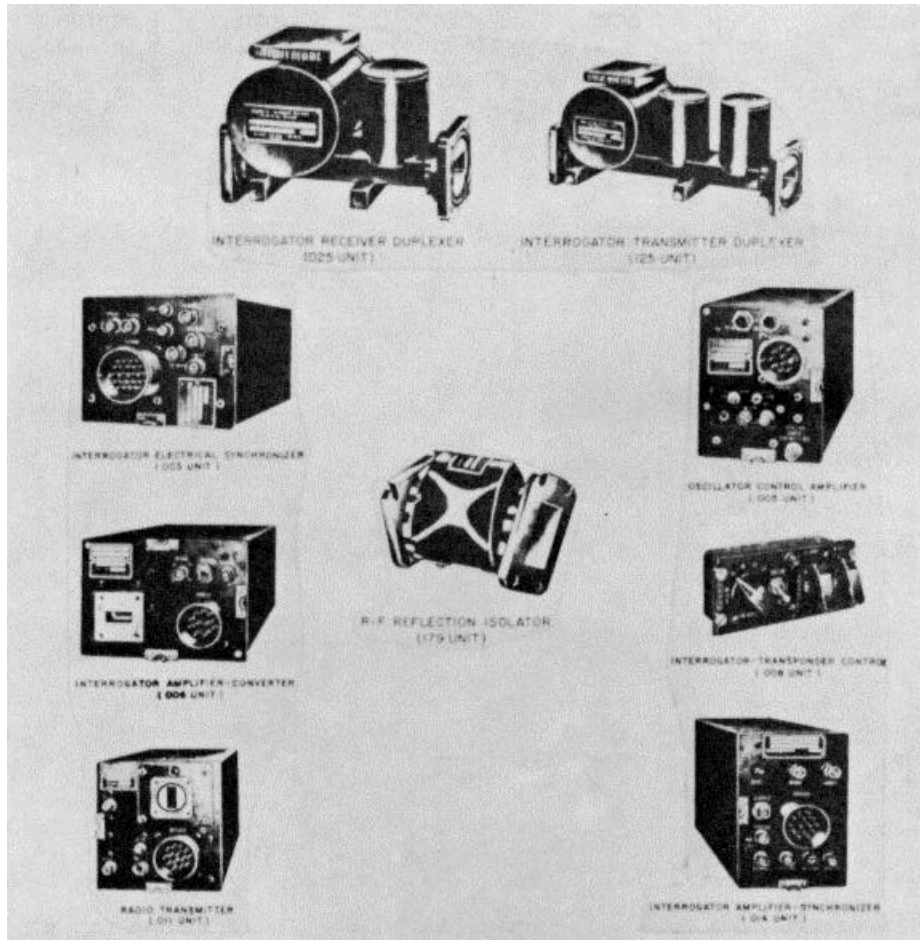

**FUNCTIONAL DESCRIPTION**

The Interrogator Group, with the radar subsystem, generates and transmits coded paired-pulse R-F energy in space to challenge unidentified airborne targets and processes the return to mark or erase tar-

get video as displayed on the flight command indicator, The Interrogator Group consists of two functions: The interrogator transmit function and the interrogator receive and beacon function.

**ITEM NAME:** INTERROGATOR SET  
**TYPE:** AN/APX-26B

**RELATION TO SIMILAR EQUIPMENT**

AN/APX-26B replaces the AN/APX-26.

Receiver-Frequency: 9310 plus or minus  
1 mc- Bandwidth 10 mc  
Intermediate Frequency: 30 plus or  
minus 0.5 mc local oscillator  
Frequency: 9340 plus or minus 0.3 mc  
Power Requirements:  
ac, 115v, 400 - 1600 cps, 2.6 amps  
dc, 28v, 1.5 amps

**TECHNICAL DESCRIPTION**

Transmitter  
Power Output: 60w  
Pulse Width: 0.5 plus or minus 0.1  
usec  
Magnetron Frequency: 9290 plus or  
minus 1 mc

**INSTALLATION CONSIDERATIONS**

B-52 aircraft.

**PRINCIPAL COMPONENTS AND PHYSICAL DATA**

<b>COMPONENT</b>	<b>QTY</b>	<b>HEIGHT (Inches)</b>	<b>WIDTH (Inches)</b>	<b>DEPTH (Inches)</b>	<b>UNIT WT. (Pounds)</b>
Electrical Synchronizer SN-195/APX-R6B	1	8.75	5	4	6
Oscillator Control Amplifier AM-1243A/APX	1	10.25	5	4	5.4
Interrogator Transponder Control C-2237/APX	1	5.75	2.62	4.21	0.9
Amplifier-Synchronizer 1 11 6 4 8 AM-1709/APX-26B					
Radio Transmitter T-641/APX	1	11	5.25	5	8.5
Frequency Converter Amplifier AM-1242B/APX-26	1	10.69	5.50	4	6.9
Duplexer CU-568A/APX-26A	1	5	2.84	3.25	3.7
Duplexer CU-462B/APX-26	1	6.86	2.84	2.5	4.3
RF Reflection Isolator MX-1814A/APX	2	3	2	2	1

**REFERENCE DATA AND LITERATURE**

Technical Orders:  
12P4-2APX-112  
12P4-2APX-123  
12P4-2APX2-6-14

Specifications:  
MIL-I-8319C(USAF)

**RN/APX-26B: 2**

**DATE:** 15 May 1964

**ITEM NAME:** TRANSPONDER SET

**COGNIZANT SERVICE:** USAF

**TYPE:** AN/APX-27B

**FEDERAL STOCK NUMBER:** 5895-612-8106-EA

	USA	USN	USAF	USMC
STATUS OR TYPE CLASSIFICATION Ltd Std				

Mfg(s) Name or Code Number: Hughes Aircraft

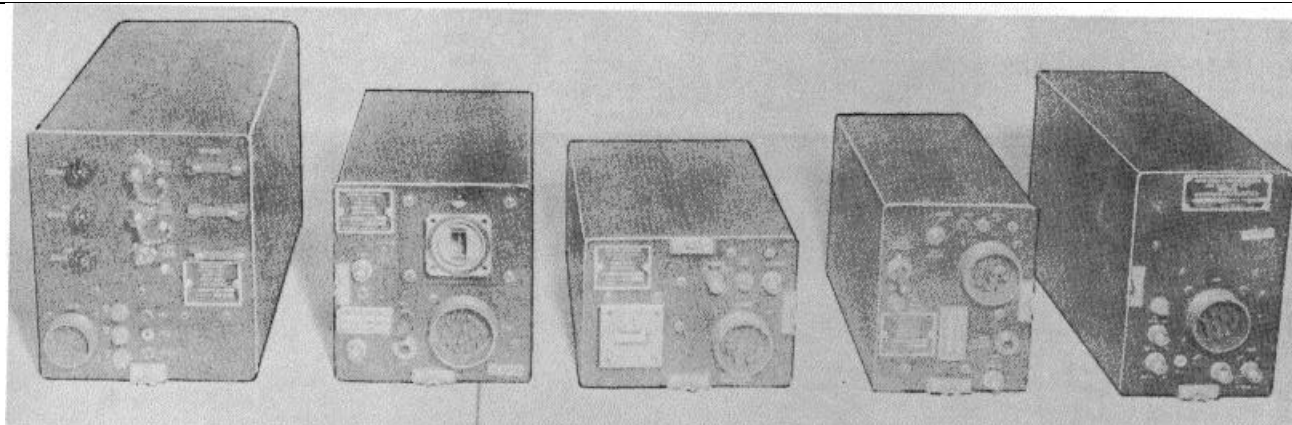

### FUNCTIONAL DESCRIPTION

This air-to-air identification system consists of a transponder and a cooperative interrogator operating in the X-band. It is operated in conjunction with a separate radar set and uses the radar antenna and indicator to display identification information.

Range, Max: 30to70 naut mi (detection range of associated fire control system)

Range, Min: 0. 5 mi

Peak Power Output: 110w

Operating Voltages and Power Requirements:

108 to 121 vac, 380 to 1, 000 cps, 220w

25 to 29 vdc, 5 amp

Type of Fire Control Presentation:

Blank or Bloom Targets

Duty Cycle: 0.027

Environmental Limitations:

Class 2, MIL-E-5400A

### RELATION TO SIMILAR EQUIPMENT

Similar to AN/APX-26B.

### TECHNICAL DESCRIPTION

Frequency: Transponder - 9290 mc  
Interrogator - 9310 mc

### INSTALLATION CONSIDERATIONS

Used on B-52 aircraft.

**AN/APX-27B: 1**

AN/APX-27B

**PRINCIPAL COMPONENTS AND PHYSICAL DATA**

<b>COMPONENT</b>	<b>QTY</b>	<b>HEIGHT (Inches)</b>	<b>WIDTH (Inches)</b>	<b>DEPTH (Inches)</b>	<b>UNIT WT. (Pounds)</b>
Transmitter Radio T-641/APX-26	1	5	5.25	10	9.1
Amplifier, Synchronizer AM-1243	1	4	5	9	5.3
Amplifier, Converter AM-1244B	1	4	5.5	10	6.3
Coupler CU-460	1	2.9	3.7	5.3	3.6

**REFERENCE DATA AND LITERATURE**

Technical Order:  
12P4-2APX-112  
12P4-2APX-133  
12P4-2APX27-14

Specification:  
MIL-T-8320C

**AN/APX-27B: 2**

DATE: 15 May 1964

ITEM NAME: INTERROGATOR SET

COGNIZANT SERVICE: USAF

TYPE: AN/APX-28( )

FEDERAL STOCK NUMBER: 5895-342-2233-EA

	USA	USN	USAF	USMC
STATUS OR TYPE CLASSIFICATION		Ltd Std		

Mfg(s) Name or Code Number: Packard-Bell

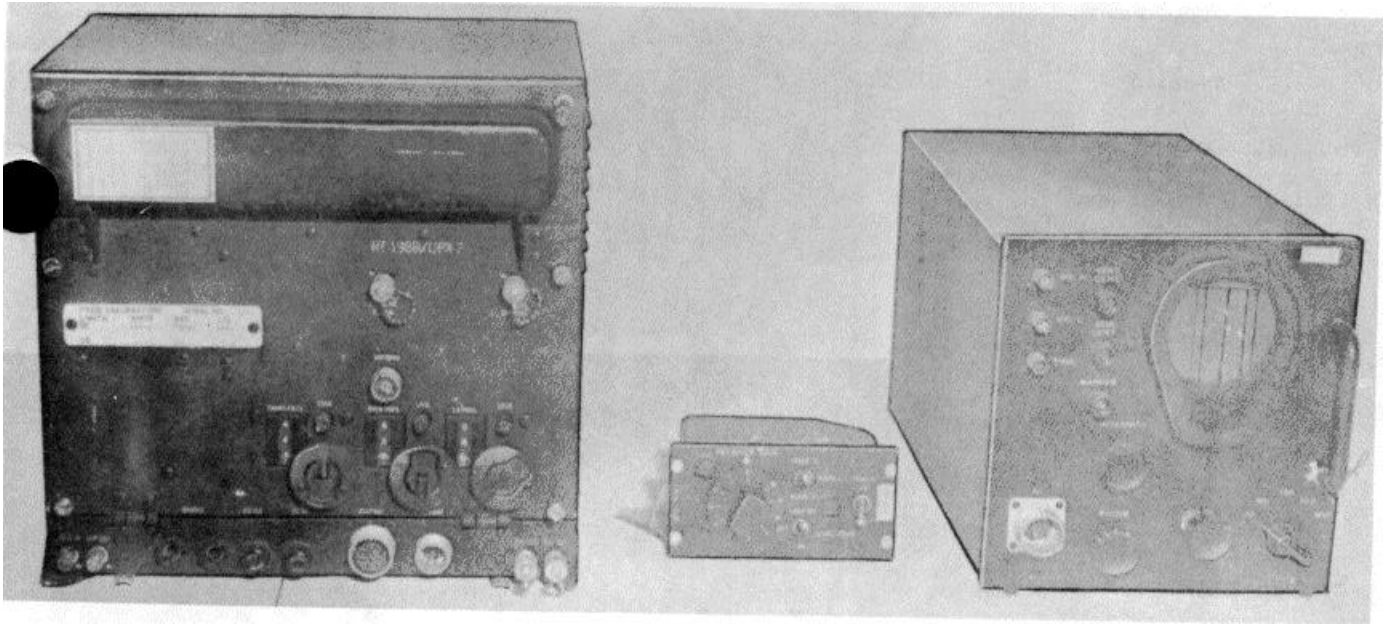

**FUNCTIONAL DESCRIPTION**

Interrogator Set AN/APX-28 is an IFF Mark X interrogation set intended for use in interrogating Radar Identification Set AN/

APX-6 and presenting visual indication of the range and azimuth of the AN/APX-6 reply source for air-to-air rendezvous of aircraft.

**AN/APX-28( ): 1**



**ITEM NAME:** INTERROGATOR SET  
**TYPE:** AN/APX-28( )

**RELATION TO SIMILAR EQUIPMENT**

Detailed operation of most of the stages in Interrogator Set AN/APX-2B are similar to the operation of like stages in Radar Identification Set AN/APX-6. The RT-198B/ UPX-7 is identical to the RT unit used in AN/UPX-7. Interrogator Set AN/APX-29A can be used by Air Rescue Service as a replacement for AN/APX-28 equipment.

24 to 29v ac, 40w  
Type of Presentation: L-scope  
Number and Interval of Range Markers  
Undelayed: 10, 50, and 150 mi  
Delayed: var to 200 mi, expanded to 10 and 50 mi  
Duty Cycle: 0.0032  
Channels: 12  
RF Output Signal (Pulsed-Pairs) Spacing:  
Mode 1, 3 usec; Mode 2, 5 usec; Mode 3, 8 usec  
Selectivity: 9.5 to 14.5 mc, 6 db down from max response  
Range Accuracy: plus or minus 0.20 mi

**TECHNICAL DESCRIPTION**

Frequency: 950 to 1100 mc  
Range, Max: 150 naut mi  
Peak Power Output: 1000w  
Operating Voltages and Power Requirements:  
115v ac, 380 to 1000 cps, 220w

**INSTALLATION CONSIDERATIONS**  
Used on HU-16 and SC-54 aircraft.

**PRINCIPAL COMPONENTS AND PHYSICAL DATA**

COMPONENT	QTY	HEIGHT (Inches)	WIDTH (Inches)	DEPTH (Inches)	UNIT WT. (Pounds)
Receiver-Transmitter RT-198B/UPX-7	1	14	13	10	36.7
Mounting MT-1439/A	1	2	13	10	3.5
Control C-774A/UPX-7	1	3	6	5	2.0
Range Indicator IP-219/APX	1	8-7/8	8-3/4	16-3/8	21.6
Antenna AS-624/APX	1				
Antenna AS-625/APX	1				
Antenna Lobe Switch SA-314/APX	1	5-1/2	6-1/2	5-11/32	3.5
Mounting MT-11B9/U	1	1/2	6	5	1
FT-409/U	1	16	9	3	2

**REFERENCE DATA AND LITERATURE**

Technical Orders:  
12P4-2APX28-1  
12P4-2APX28-2  
12P4-2APX28-3

Specifications:  
MIL-I-8723  
MIL-I-25086

**AN/APX-28( ): 2**

DATE: 15 May 1964

ITEM NAME: INTERROGATOR SET

COGNIZANT SERVICE: USN

TYPE: AN/APX-29A

FEDERAL STOCK NUMBER: 5895-327-4578

	USA	USN	USAF	USMC
STATUS OR TYPE CLASSIFICATION		Std		
Mfg(s) Name or Code Number: Stewart-Warner Electronics				

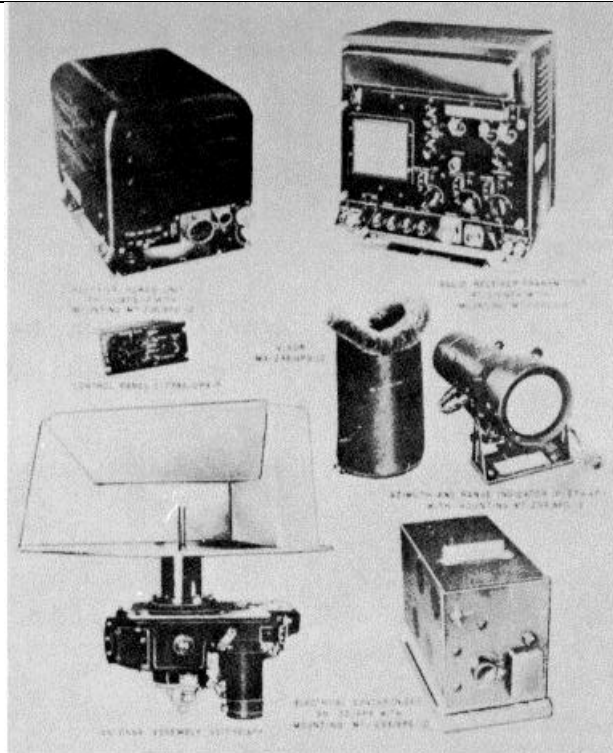

**FUNCTIONAL DESCRIPTION**

The Interrogator Set AN/APX-29A is an airborne interrogator-responder to be used in

conjunction with Radar Identification Sets AN/APX-6 or AN/APX-25 for air-to-air rendezvous of aircraft.

AN/APX-29A: 1

**ITEM NAME:** INTERROGATOR SET

**TYPE:** AN/APX-29A

**RELATION TO SIMILAR EQUIPMENT**

Interrogator Set AN/APX-29A replaces the AN/APX-28 and the AN/APX-29. AN/APX-29A uses components of the AN/APS-10 and AN/ UPX-7.

Interval of Range Markers

Range Scale (mi)	Interval (mi)
4 and 25	2
50	10
90	20
70 to 160	20

**TECHNICAL DESCRIPTION**

Frequency: 950 to 1150 mc  
 Range, Max: 180 naut mi  
 Peak Power Output: 250w  
 Operating Voltages and Power Requirements  
     ac: 115v, 380 to 1000 cps, 325w  
     dc: 28v, 50w  
 Type of Presentation: PPI

Duty Cycle: 0.0052  
 Environmental Limitations: 50, 000 ft max  
 Beam Width: 35 deg at -3 db, 100 deg at  
                   -20 db  
 Receiver Sensitivity: 83 db below Iv for  
                           2-to-1 signal plus noise-to-noise ratio

**INSTALLATION CONSIDERATIONS**

Used with HU-16 and SC-54 aircraft.

**PRINCIPAL COMPONENTS AND PHYSICAL DATA**

COMPONENT	QTY	HEIGHT (Inches)	WIDTH (Inches)	DEPTH (Inches)	UNIT WT. (Pounds)
Radio Receiver-Transmitter RT-319B/APX	1	9-1/8	13-5/32	12-11/32	39.3
Mounting MT-1439/A	1	9-3/4	12-1/4	1-3/4	3.5
Electrical Synchronizer SN-147/APX	1	6-39/64	14-5/32	8-25/64	13.0
Mounting MT-1484/APX	1	8-7/8	13-5/16	2-7/8	1.5
Antenna AS-874/APX	1	18-3/4	20 in. dia		22.0
Control C-1528/APX	1	5-3/4	4-11/32	4-1/2	1.6
Indicator IP-304/APX	1	7	18-3/4	14-5/16	9.5
Mounting MT-294/APS-10	1	6-1/4	10-3/16	1/2	0.25
Visor MX-238/APS-10	1	7-3/8	12-1/2	7-3/8	
Rectifier Power Supply PP-111/APS-10	1	9	12	11-1/2	19.4
Mounting MT-295/APS-10	1	9	12	4	1.2

**REFERENCE DATA AND LITERATURE**

Technical Orders:  
12P4-2APX29- Series

Specifications:  
MIL-I-25322 (USAF)

**AN/APX-29A: 2**

DATE: 15 May 1964

ITEM NAME: TRANSPONDER

COGNIZANT SERVICE: USAF

TYPE: AN/APX-35()

FEDERAL STOCK NUMBER:

	USA	USN	USAF	USMC
STATUS OR TYPE CLASSIFICATION		Tent. Std		
Mfg(s) Name or Code Number: Hazeltine Electronics Division				

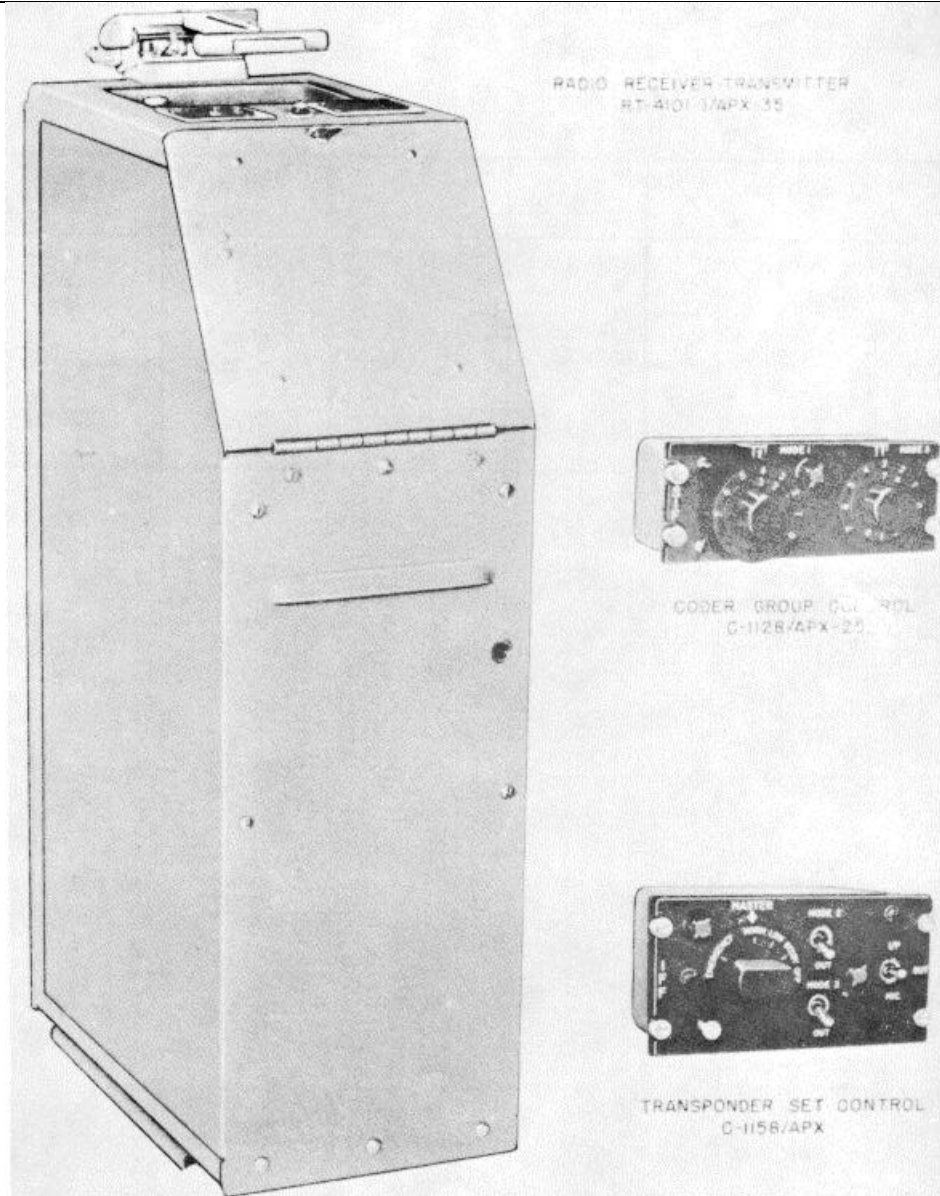

AN/APX-35( ): 1

**AN/APX-35( )**

**FUNCTIONAL DESCRIPTION**

Transponder Set AN/APX-35( ) is a lightweight, airborne equipment which provides for the reception, detection, decoding of IFF Mark XI interrogations, coding of IFF Mark XI replies, and the transmission of coded reply.

**RELATION TO SIMILAR EQUIPMENT**

The AN/APX-35( ) is similar to the AN/APX- 19, AN/APX-34, and AN/APX-37.

**TECHNICAL DESCRIPTION**

Frequency: Receiver - 1020 to 1040 mc, transmitter - 1080 to 1100 mc  
Range, Max: 50 naut mi  
Peak Power Output: 500w  
Operating Voltages and Power Requirements:  
115 vac, 320 to 480 cps, 3-ph, 250w  
24 to 29 vdc, 10w  
Duty Cycle: 1.0% max  
Environmental Limitations:  
Refer to MIL-E-5400

**INSTALLATION CONSIDERATIONS**

Not available.

**PRINCIPAL COMPONENTS AND PHYSICAL DATA**

<b>COMPONENT</b>	<b>QTY</b>	<b>HEIGHT (Inches)</b>	<b>WIDTH (Inches)</b>	<b>DEPTH (Inches)</b>	<b>UNIT WT. (Pounds)</b>
Radio Receiver Transmitter RT-410( )/APX-35	1	31	10	24	
Transponder Set Control C-1158/APX	1	4.5	5.75	3	1.25
Coder Group Control C-1128/APX-25	1	4.9	5.75	2.25	1.25

**REFERENCE DATA AND LITERATURE**

Technical Orders:  
12P4-3-2-2

**Specifications:**

MIL-T-25740  
Lockheed ER2-1265

DATE: 15 May 1964

ITEM NAME: TRANSPONDER

COGNIZANT SERVICE: USAF

TYPE: AN/APX-37

FEDERAL STOCK NUMBER:

	USA	USN	USAF	USMC
STATUS OR TYPE CLASSIFICATION		Std		
Mfg(s) Name or Code Number: Hazeltine Electronic Div.				

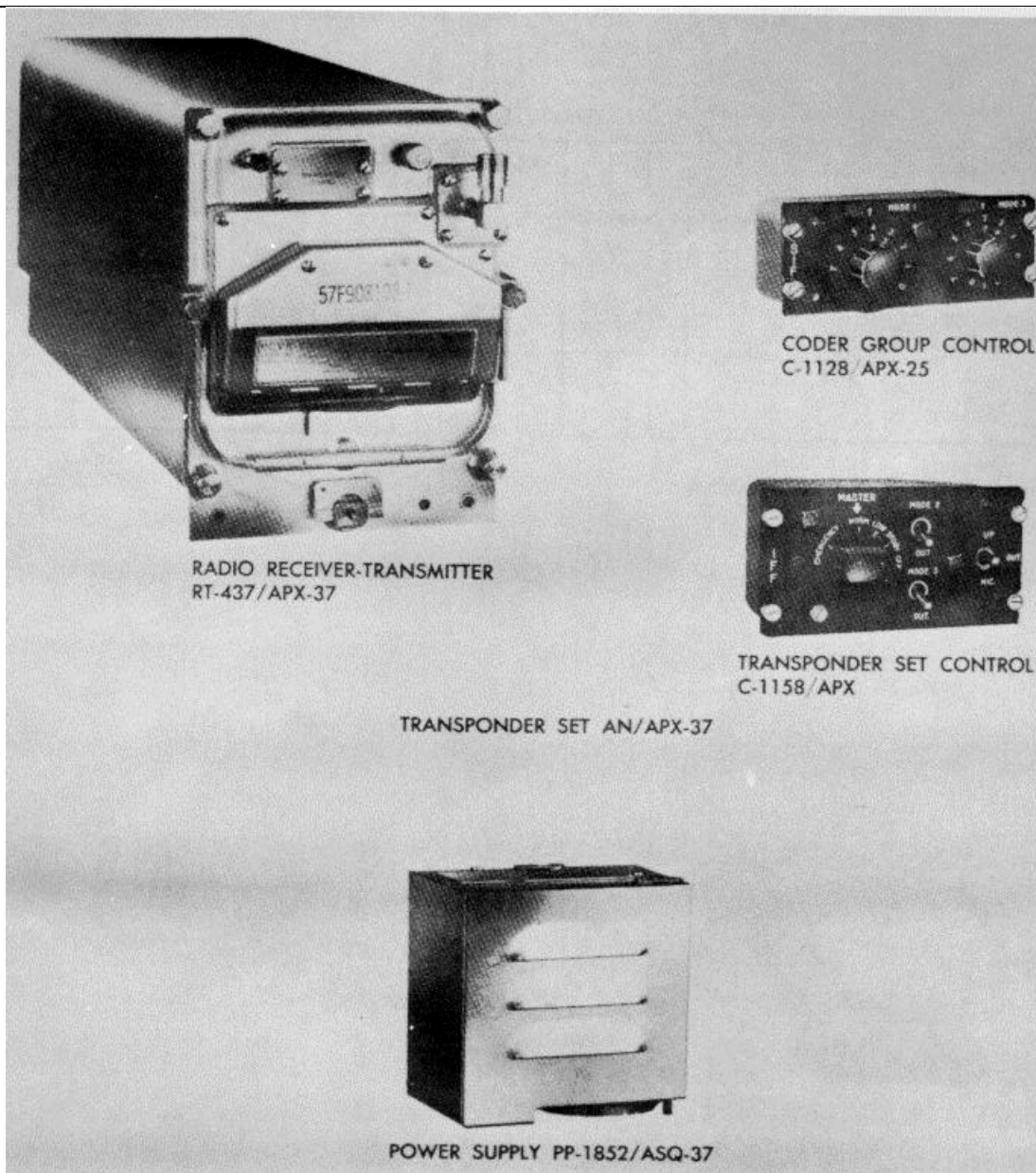

AN/APX-37: 1

**AN/APX-37**

**FUNCTIONAL DESCRIPTION**

The transponder set provides for the reception, detection, and decoding of IFF Mark X, interrogation, the coding of IFF Mark X replies, and the transmission of the coded reply.

**RELATION TO SIMILAR EQUIPMENT**

AN/APX-37 is similar to the AN/APX-19, AN/APX-34, and AN/APX-35.

**TECHNICAL DESCRIPTION**

Frequency: Receiver, 1020 to 1040 mc; trans-

mitter, 1080 to 1100 me  
Range, Max: 50 naut mi  
Peak Power Output: 500w  
Operating Voltages and Power Requirements:  
115 vac, 2500 cps, 172. 5w  
25 to 29 vdc, 294w  
Type of Presentation:  
Duty Cycle: 1.0% max  
Environmental Limitations: M[L-E-5400

**INSTALLATION CONSIDERATIONS**

Not available.

**PRINCIPAL COMPONENTS AND PHYSICAL DATA**

<b>COMPONENT</b>	<b>QTY</b>	<b>HEIGHT (Inches)</b>	<b>WIDTH (Inches)</b>	<b>DEPTH (Inches)</b>	<b>UNIT WT. (Pounds)</b>
Radio Receiver-Transmitter RT-437/APX-37	1	9.9	7.5	21.25	
Transponder Set Control C-1158/APX	1	4.5	5.75	3.00	1.25
Coder Group Control C-1128/APX-25	1	4.9	5.75	2.25	1.25

**REFERENCE DATA AND LITERATURE**

Technical Order:  
12P4-2APX37

DATE: 1 March 1965

ITEM NAME: TRANSPONDER SET

COGNIZANT SERVICE: USAF

TYPE AN/APX-46(V)

FEDERAL STOCK NUMBER:

	USA	USN	USAF	USMC
STATUS OR TYPE CLASSIFICATION		Std		
Mfg(s) Name or Code Number: Hazeltine Electronics Company				

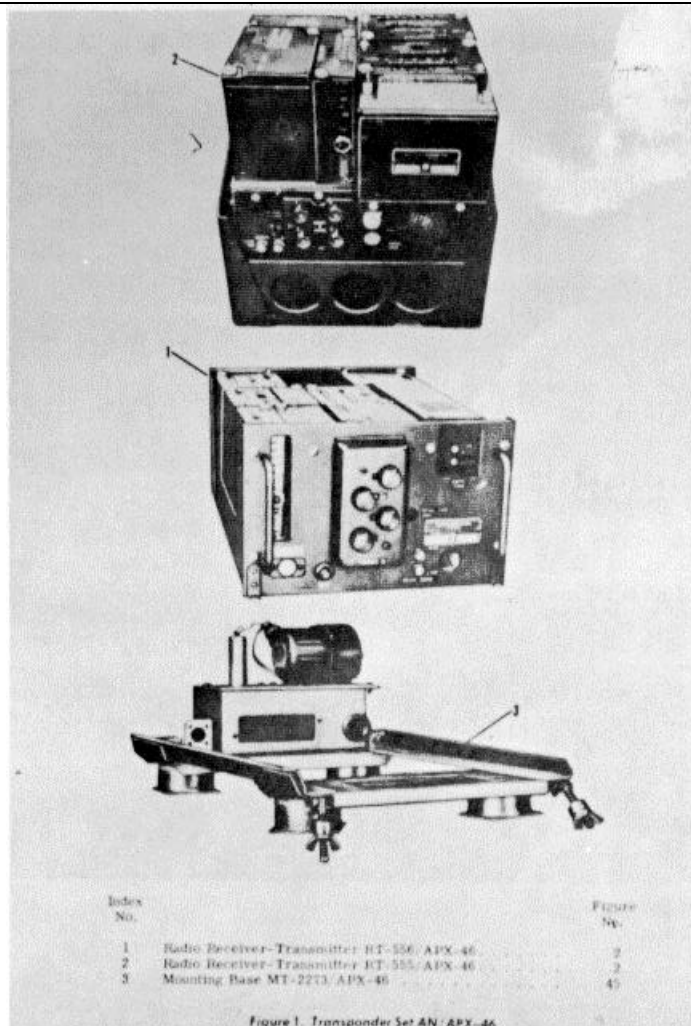

### FUNCTIONAL DESCRIPTION

Transponder Set AN/APX-46(V) is a lightweight airborne IFF equipment consisting of either radio receiver-transmitter RT556/APX-46 or radio receiver transmitter RT-555/APX-46, and coder group control

C-1128/APX-25 and transponder set control C-1158/APX. This set provides for the reception, detection, decoding, encoding and transmission of signals in the IFF Mark X (SIF) system.



**ITEM NAME:** TRANSPONDER SET

**TYPE:** AN/APX-46(V)

**RELATION TO SIMILAR EQUIPMENT**

The AN/APX-46(V) is similar to the AN/ APX-37 in operation. It employs the same control panels as the AN/APX-37.

Operating Altitude Range: Sea level to 100,000 ft

Receiver Frequency: 101B mc to 1042 mc

Peak Power Output: Transmitter, 500w

Average Power Output: Transmitter, 5w

**TECHNICAL DESCRIPTION**

Power Requirements

ac: 115v, 320 to 480 cps, 70w

dc: 25v, 5w

Operating Temperature Range: -55 deg C

(-67 deg F) to 71 deg C (160 deg F)

**INSTALLATION CONSIDERATIONS**

Siting: The installation of Transponder Set AN/APX-46(V) is dependent upon the type of aircraft and allocated space in which the equipment is to be installed.

**PRINCIPAL COMPONENTS AND PHYSICAL DATA**

<b>COMPONENT</b>	<b>QTY</b>	<b>HEIGHT (Inches)</b>	<b>WIDTH (Inches)</b>	<b>DEPTH (Inches)</b>	<b>UNIT WT. (Pounds)</b>
Receiver-Transmitter RT-555/APX-46 or RT-556/APX-46	1 6.43	12.46 10.00	10.40 15.72	8.03 25	25
**Coder Group Control C-1128/APX-25	1	2-1/4	5-3/4	4-7/8	1
**Transponder Set Control C-1158/APX	1	3.0	5-3/4	4-9/16	1
*Mounting Base MT-2273/APX-461		2.0	11.04	19.60	1.5

**NOTE:** \*Used only with RT-556/APX-46.

\*\*Accessory components (not supplied).

**REFERENCE DATA AND LITERATURE**

Technical Manuals:

12P4-2APX46-2

12P4-2APX46-4

12P4-2APX46-4C

USAF Drawings:

64C43347

64C43348

**AN/APX-46(V): 2**

DATE: 1 March 1965

ITEM NAME: INTERROGATOR SET

COGNIZANT SERVICE: USAF

TYPE: AN/APX-49

FEDERAL STOCK NUMBER:

	USA	USN	USAF	USMC
STATUS OR TYPE CLASSIFICATION		Std		
Mfg(s) Name or Code Number: Packard-Bell Electronics				

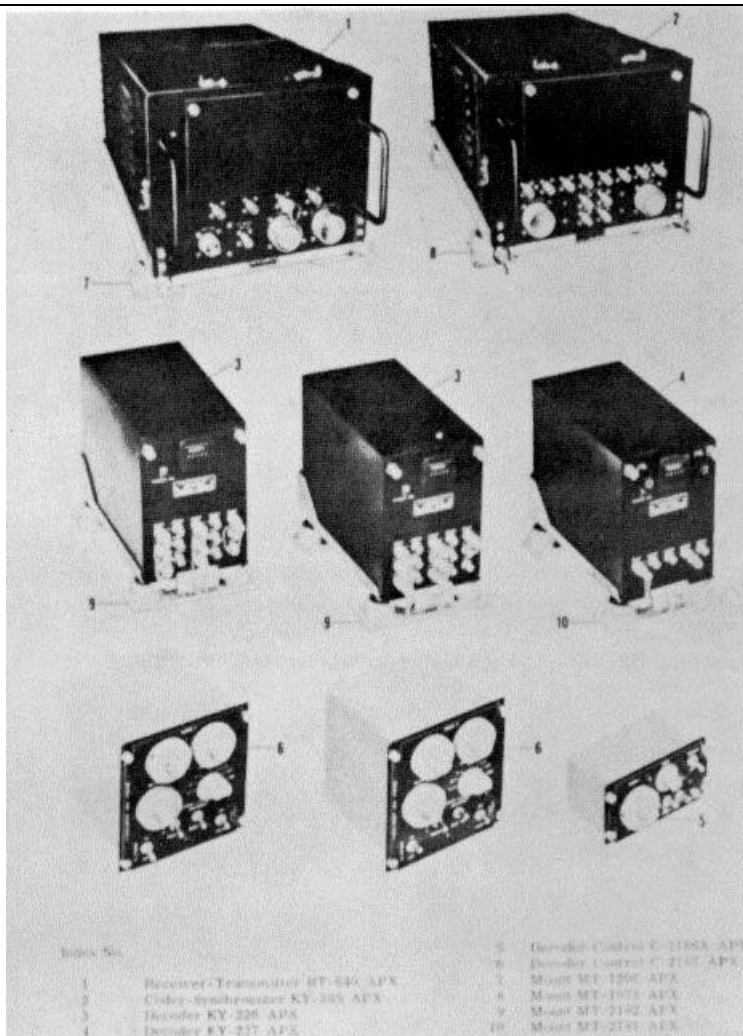

### FUNCTIONAL DESCRIPTION

The prime purpose of the AN/APX-49 is to challenge the identity of targets that are detected and displayed by Radar Set AN/APS95 operating with the interrogator set. The AN/APX-49 distinguishes between friendly targets

and enemy targets and provides a more detailed recognition of friendly targets for additional security and tactical information.

**ITEM NAME:** INTERROGATOR SET

**TYPE:** AN/APX-49

**RELATION TO SIMILAR EQUIPMENT**  
None.

Output: 2000w min  
Power Requirements:  
ac: 115v, 380 to 420 cps  
dc: 28v

**TECHNICAL DESCRIPTION**

Receiver Frequency: 1090 to 1110 mc  
Intermediate Frequency: 59.5 plus  
0.5 mc  
Transmitter Frequency  
Peak Pulse Power: 1010 mc to 1030 mc

**INSTALLATION CONSIDERATIONS**  
Related Equipment: The AN/APX-49 is  
used with AN/APS-20B, APS-95 and  
USQ-25.

**PRINCIPAL COMPONENTS AND PHYSICAL DATA**

<b>COMPONENT</b>	<b>QTY</b>	<b>HEIGHT (Inches)</b>	<b>WIDTH (Inches)</b>	<b>DEPTH (Inches)</b>	<b>UNIT WT. (Pounds)</b>
*Receiver-Transmitter RT-640/APX	1	7-3/4	10-3/4	19-5/8	51-1/2
*Coder-Synchronizer KY-385/APX	1	7-3/4	10-3/4	19-5/8	37-1/2
*Decoder KY-226/APX	2	9.0	4-3/4	14-1/4	14
*Decoder KY-227/APX	1	9.0	5.0	11.0	11
Control, Decoder C-2187/APX	2	6.0	5-3/4	4-7/8	2-3/4
Control, Decoder C-2186A/APX	1	3-3/4	5-3/4	5-3/8	1-3/4
*Mounting MT-2182/APX	2				
*Mounting MT-2181/APX	1				
*Mounting MT-1208/APX-7	1				
*Mounting MT-1078/APX-7	1				

**NOTE:** \*Measurements and weights include components and mountings.

**REFERENCE DATA AND LITERATURE**

Technical Manuals:  
12P4-2APX49-2  
12P4-2APX49-2C  
12P4-2APX49-4

Specifications:  
MIL-I-27177  
64F39322

USAF Drawings:  
64H39321

DATE: 1 July 1964

ITEM NAME: RADIO RECEIVING SET

COGNIZANT SERVICE: USN

TYPE: AN/ARR-27, -27A

FEDERAL STOCK NUMBER:

	USA	USN	USAF	USMC
STATUS OR TYPE CLASSIFICATION				
Mfg(s) Name or Code Number:				



**AN/ARR-27, -27A**

**FUNCTIONAL DESCRIPTION**

Radar Receiving Sets AN/ARR-27 and -27A are airborne radar relay receiving equipments for AEW systems. Their purpose is to receive video, [FF, and azimuth information originating in a remote search radar and transmitted by a radar relay transmitter. Radio Receiving Sets AN/ARR-27 and AN/ARR-27A have two functions, either or both of which may be utilized separately or simultaneously in a normal installation. The equipment may be used with a radar relay transmitter as part of a relay station, or it may serve as a remote indicator by presenting the basic information on a PPI at the receiver location.

**RELATION TO SIMILAR EQUIPMENT**

None.

**TECHNICAL DESCRIPTION**

Operating Voltages:  
115 vac, 320 to 1, 000 cps, 3-ph, 625 ma

28 vdc, 3 amp  
Frequency: 465 to 510 mc  
Pre-Set Tuning: Any 4 channels between 465 and 510 mc  
Type of Tuning: Rotary air capacitors adjusted in channel steps by remotely controlled, motor driven, detent tuning mechanism  
Input Signal: Video modulated if. energy fed from either of two antennas into the ANT 1 or ANT2 input receptacle  
RF Input Impedance: 52 ohms  
IF. Frequency: 60 mc with a bandwidth of 4 mc at -3 db  
Sensitivity: A pulsed rf input signal having a peak value of 4  $\mu$ v or less will produce an output signal equal to the rms value of the noise signal at the video output of the receiver  
Selectivity: The selectivity curve at -40 db from resonance has a width of 11 mc or less for cw signals  
Basic Receiver: Superheterodyne

**INSTALLATION CONSIDERATIONS**

Not available.

**PRINCIPAL COMPONENTS AND PHYSICAL DATA**

COMPONENT	QTY	HEIGHT (Inches)	WIDTH (Inches)	DEPTH (Inches)	UNIT WT. (Pounds)
Radio Receiver R-267/ARR-27	1	7-13/16	10-17/32	23-1/32	31.50
Video Decoder KY-42/ARR-27	1	7-13/16	10-17/32	23-1/16	28.50
Power Supply PP-389/ARR-27	1	7-3/4	5-5/16	22-1/2	25.40
Receiver Control C-532/ARR-27*	1	4-3/16	5	9-15/16	3.60
Receiver Control C-750/ARR-27A**	1	4-1/8	5-3/4	7-1/4	2.00
Power Supply PP-444/ARR-27	1	4-5/8	2-7/16	13-15/16	4.30
Range-Azimuth Indicator IP-41/ARR-27	1	5-15/16	6	13-7/8	14.50

\* AN/ARR-27 only

\*\* AN/ARR-27A only

**REFERENCE DATA AND LITERATURE**

Handbook:  
AN16-30 ARR27-3

DATE: 1 July 1964  
 COGNIZANT SERVICE: USN

ITEM NAME: RADIO TRANSMITTING SET  
 TYPE: AN/ART-26

FEDERAL STOCK NUMBER:

	USA	USN	USAF	USMC
STATUS OR TYPE CLASSIFICATION				
Mfg(s) Name or Code Number:				

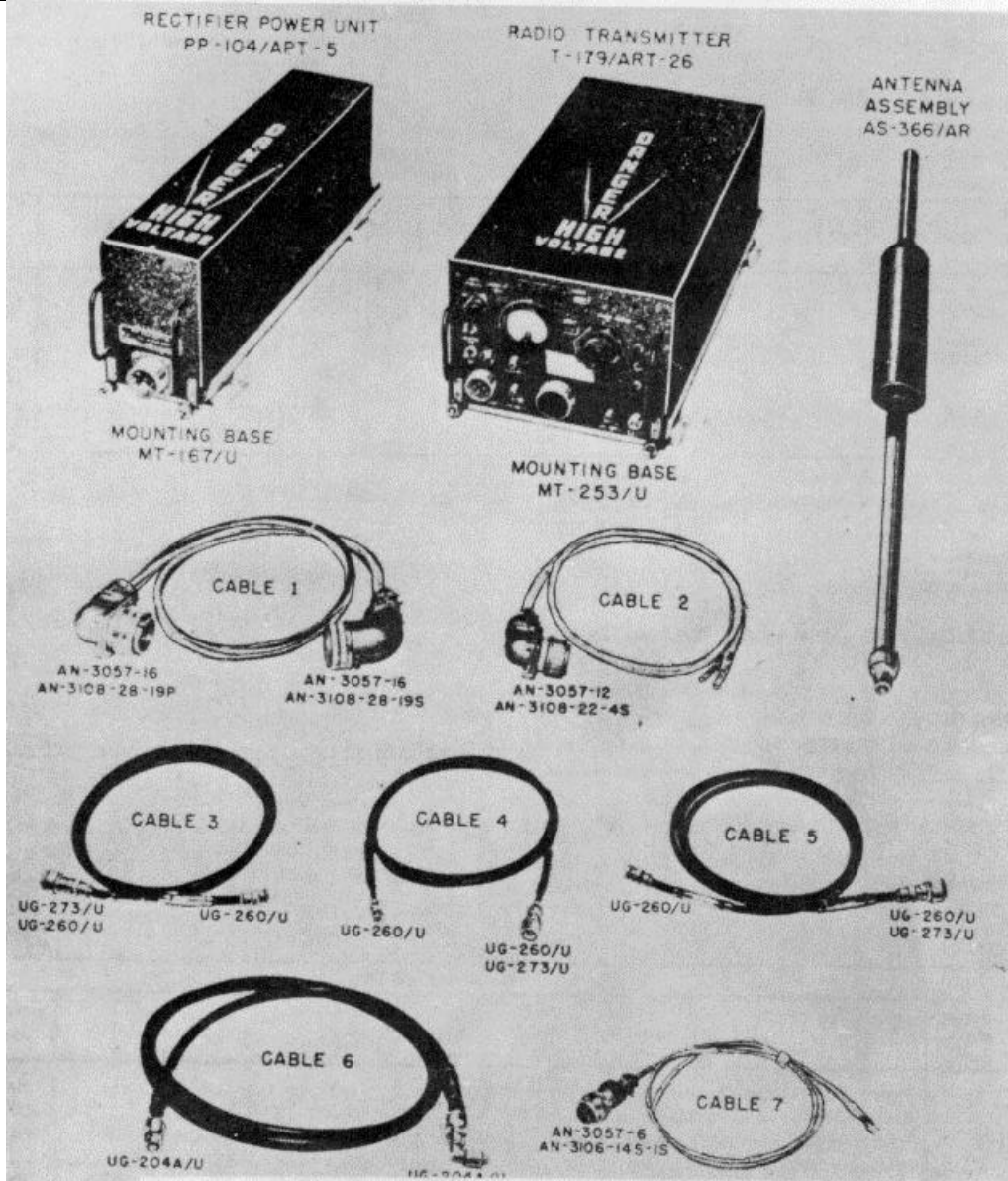

**AN/ART- 26**

**FUNCTIONAL DESCRIPTION**

Radio Transmitting Set AN/ART-26 is intended for airborne use as part of an AEW system. It is designed to relay the radar video, together with the synchronizing signals, to the surface control station or airborne control station for presentation on the control station indicator.

**RELATION TO SIMILAR EQUIPMENT**

None.

**TECHNICAL DESCRIPTION**

Operating Voltages and Power Requirements:

115 vac, 400 to 2, 600 cps, 1-ph, 3.2 amp, 600w  
28 vdc, 1.5 amp 30w, 90% pf  
Frequency: 465 to 515 mc  
Power Output: 15w nom  
Antenna Characteristics: 50 ohms input impedance, omnidirectional, 2-element dipole  
CW Power Output: 2. 5 to 7.0w (avg) Modulation: AM

**INSTALLATION CONSIDERATIONS**

Siting:  
Mounting: Antenna of the AN/ARR-26 must be shielded from those of other radars installed in the aircraft.  
Cabling Requirements:  
Related Equipment:

**PRINCIPAL COMPONENTS AND PHYSICAL DATA**

COMPONENT	QTY	HEIGHT (Inches)	WIDTH (Inches)	DEPTH (Inches)	UNIT WT. (Pounds)
Rectifier Power Unit PP-104/APT-5	1	7-13/16	5	21-1/4	37.0
Radio Transmitter T-179/ART-26	1	7-13/16	10-1/4	21-1/4	57.0
Antenna Assembly AS-366/AR	1	2-1/4 dia	39		4.0

**REFERENCE DATA AND LITERATURE**

Handbook:  
AN 16-30 ART-26-3

**ITEM NAME:** AIRCRAFT RADAR EQUIPMENT

**TYPE:** ASA

**RELATION TO SIMILAR EQUIPMENT**

Similar to other members of the ASA series.

Power Input: Dynamotor requires 1.300 w et 24.0 to 28.6v dc

Ranges

Search Radar: 20 to 73 naut mi

Altimeter: 2000 and 20,000 ft

Presentation

Altimeter: J-scan

Radar: A-scan

**TECHNICAL DESCRIPTION**

Frequency Range: 399 mc

Peak Power Output: 1.25 kw for altimeter operation, 15 kw for radar operation.

Pulse Repetition Rate

Altimeter Operation: 24.589 and 81.966 kc

Radar Operation: 1010.68 cycles

Pulse Width

Altimeter: 0.25 usec

Radar: 1.7 usec

**INSTALLATION CONSIDERATIONS**

Related Equipment:

Required but not Supplied

(1) Set Altimeter Antenna, (1) Set Searching Antennas, (1) Set Homing Antennas, (1) Cable.

**PRINCIPAL COMPONENTS AND PHYSICAL DATA**

<b>COMPONENTS</b>	<b>QTY</b>	<b>OVERALL DIMENSIONS (Inches)</b>	<b>UNIT WT. (Pounds)</b>
Transmitter NT-52AAN	1		130
Receiver NT-46AAJ	1		23.1
Radar Indicator NT-55AAJ	1		35.4
Altimeter Indicator NT-55AAK	1		9.8
Dynamotor Assembly NT-21AAR	1		22.5
Junction Box NT-62AAA	1		9.0
Antenna Switch NT-50AAN	1		13.0

**REFERENCE DATA AND LITERATURE**

Technical Manuals:

NAVAER 08-5S-38



**DATE:** 1 July 1964

**ITEM NAME:** NAVIGATIONAL COMPUTER GROUP

**COGNIZANT SERVICE:**USN

**TYPE:** AN/ASA-13

**FEDERAL STOCK NUMBER:**

	USA	USN	USAF	USMC
STATUS OR TYPE CLASSIFICATION				

Mfg(s) Name or Code Number:

**FUNCTIONAL DESCRIPTION**

The AN/ASA-13 has been designed primarily to provide ground track information in the form of dc voltages, for ground stabilization of radar indicators in AEW and ASW aircraft. It is intended for use in patrol aircraft, airships, and helicopters. It is also used to

supply ground track data, in the form of synchro voltages, for driving dead reckoning tracer and plotting equipment. In addition, true heading is supplied for azimuth stabilization of the radar indicators. Navigational data is supplied by counters which indicate the ground displacement in miles from an initial fix.

**AN/ASA-13: 1**

**ITEM NAME:** NAVIGATIONAL COMPUTER GROUP

**TYPE:** AN/ASA-13

**RELATION TO SIMILAR EQUIPMENT**

The AN/ASA-13 supplies several outputs used by associated equipments Radars AN/APS-20, AN/APS-38, AN/APS-44; Indicators IP-67/APA-81, IP-224/APS-38, IP-168/APA-91, IP-159/APS-44, IP-203/APS-20, IP-229/APA-56; Navigational Computer CP-265/ASA-14 and Compass Adapter R88-A0209-0025.

Output: plus 150 to -15v, providing 1v per mi  
Airspeed Range  
Indicator: 10 to 150 knots  
True: 10 to 400 knots  
Wind Range: 120 knots max  
Power Requirements: 115v, 400 cps, 100 va and 28v dc, 6 amps. Ea additional ID-499/ASA-13 requires 115v, 400 cps, 50 va and 28v dc, 1.5 amps

**TECHNICAL DESCRIPTION**

Altitude: 30,00 ft max  
Temperature: -55 to plus 55 deg C (-67 to plus 131 deg F)  
Distance Data  
Range: 300 mi

**INSTALLATION CONSIDERATIONS**

Related Equipment: (Required but not Supplied) (1) Stopwatch R88-W-640; (1) Stroboscope TS-969/U.

**PRINCIPAL COMPONENTS AND PHYSICAL DATA**

<b>COMPONENTS</b>	<b>QTY</b>	<b>OVERALL DIMENSIONS (Inches)</b>	<b>UNIT WT. (Pounds)</b>
Computer, Navigational CP-262/ASA-13	1		
Amplifier, Electronic Control AM-1234/ASA-13	1		
Transmitter Airspeed T-349/APA-57B or T-570/ASA-13	1		
Mounting, Airspeed Transmitter MT-1572/ASA-13	1		
Mounting MT-1571/ASA-13 (for Amplifier)	1		
Mounting MT-1571/ASA-13 (for indicator)	*		
Indicator, Position ID-499/ASA-13	*		

**NOTE: \*One each varying with installation.**

**REFERENCE DATA AND LITERATURE**

Technical Manuals:  
NAVAER 16-30ASA13-501

DATE: 1 July 1964

ITEM NAME: DEAD RECKONING TRACER

COGNIZANT SERVICE: USN

TYPE: AN/ASA-14

FEDERAL STOCK NUMBER:

	USA	USN	USAF	USMC
STATUS OR TYPE CLASSIFICATION	Used By	Used By		

Mfg(s) Name or Code Number: Servo Corporation of America (92110)

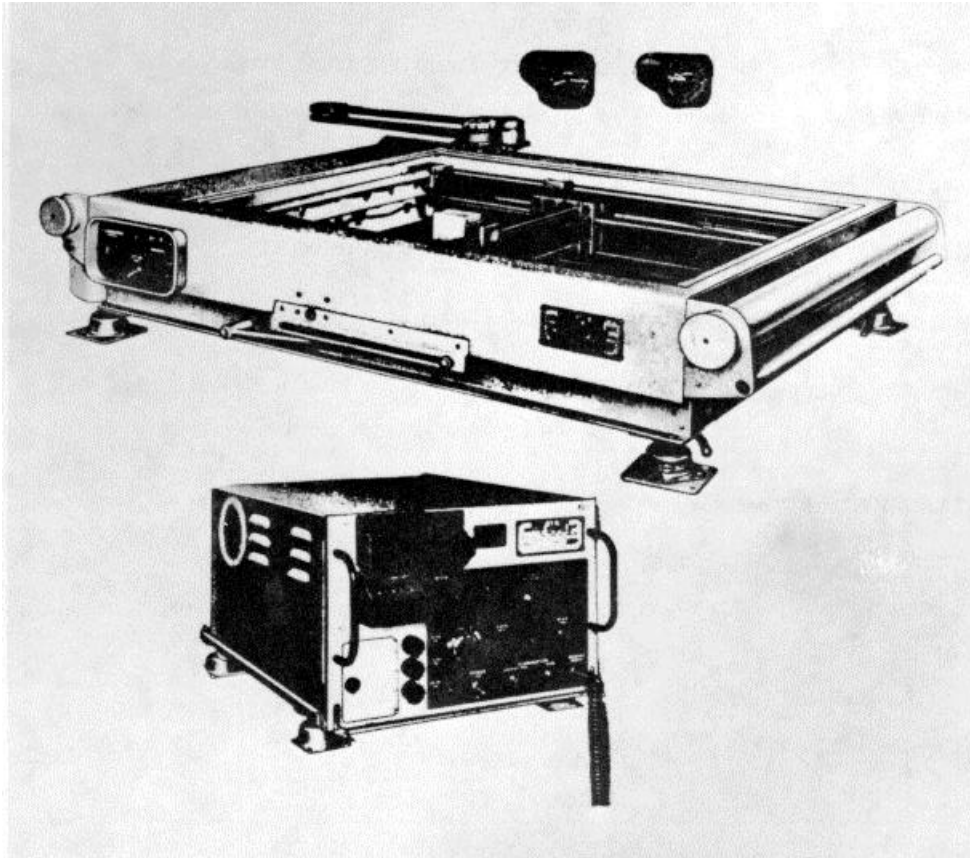

### FUNCTIONAL DESCRIPTION

The Dead Reckoning Tracer AN/ASA-14 is an airborne equipment designed to provide a continuous indication and record of the position of the aircraft in which it is installed. Latitude and logitude are presented

on counter-type indicators which read directly in degrees and minutes. In addition, position is recorded continuously by a pencil moving on a Mercator projection chart and by a lighted cross on a transparent window.

**ITEM NAME:** DEAD RECKONING TRACER

**TYPE:** AN/ASA-14

**RELATION TO SIMILAR EQUIPMENT**

The AN/ASA-14 is designed to be used with, but not part of AN/APA-57, AN/ASA-13 and AN/APN-67.

**TECHNICAL DESCRIPTION**

Operating Power Requirements: 28v dc plus or minus 10% at 3 amps; 115v ac plus or minus 10v, 400 cps at 3 amps, single ph

**INSTALLATION CONSIDERATIONS**

Related Equipment: (Required but not Supplied) (1)

Power Source to Navigational Computer CP-265/AS-14; (1) Ground Position Indicator to Navigational Computer CP-265/ASA-14: (1) Position Indicator (Latitude) ID-519/ ASA-14 to Navigational Computer CP265/ASA-14; (1) Position Indicator (Longitude) ID-520/ASA-14 to Navigational Computer CP-265/ ASA-14; (1) Tactical Display Plotting Board, PT393/ASA-14 to Navigational Computer CP-265/ASA-14; Tracing Paper: 30 in. w, 20 yd roll, White Albanene; Keuffel and Esser No. 195-L or equivalent.

**PRINCIPAL COMPONENTS AND PHYSICAL DATA**

<b>COMPONENTS</b>	<b>QTY</b>	<b>OVERALL DIMENSIONS (Inches)</b>	<b>UNIT WT. (Pounds)</b>
Tactical Display Plotting Board PT-393/ASA-14	1	8-1/2 x 36 x 44	
Navigational Computer CP-265/ASA-14'	1	12 x 16 x 25	
Position Indicator (Latitude) ID-519/ASA-14	1	3-1/4 dia x 5-1/2	
Position Indicator (Longitude) ID-520/ASA-14	1	3-1/4 dia x 5-1/2	

**REFERENCE DATA AND LITERATURE**

Technical Manuals:  
NAVAER 05-35-568

DATE: 1 September 1964

ITEM NAME: DETECTING SET

COGNIZANT SERVICE: USN

TYPE: AN/ASQ-8

FEDERAL STOCK NUMBER:

	USA	USN	USAF	USMC
STATUS OR TYPE CLASSIFICATION		Std		

Mfg(s) Name or Code Number: See Note 1.



**FUNCTIONAL DESCRIPTION**

The AN/ASQ-8 is designed to detect submerged submarines from low-flying aircraft. The presence of a submarine is indicated by deflections in inked trace on the paper chart of a recording meter.

**ITEM NAME:** DETECTING SET

**TYPE:** AN/ASQ-8

**RELATION TO SIMILAR EQUIPMENT**

Magnetic Detecting Sets AN/ASQ-8 and -10 are similar in function.

**TECHNICAL DESCRIPTION**

Type of Indication: Visual.  
Range: 1000 ft approx.  
Horizontal Coverage: 360 deg.  
Operating Power Requirements: 115v ac, 320 to 1000 cps, 3-ph; 28v de.

**INSTALLATION CONSIDERATIONS**

Related Equipment  
Required but not Supplied: (1) Set of Cables Clamps, Plugs as required, (1) Pilots Indicator Meter, (1) Mounting Rack for Detecting Control Set C-820/ASQ-8, (1) Manual Release Switch, (1) Recording Chart, Green and Red Ink as required.  
Siting: Aircraft must be especially configured for this equipment.

**PRINCIPAL COMPONENTS AND PHYSICAL DATA**

COMPONENTS	CONTRACT NUMBER	QTY	OVERALL DIMENSIONS (Inches)	UNIT WT. (Pounds)
Position Deviation Indicator ID-378/ASQ-8	NOas 55-104 & NOas 55-546	1	3 x 5.03 x 10	2.5
Amplifier Relay AM-579/ASA-8	Supplied Separately	1	5 x 7.812 x 14.531	7.5
Mounting MT-993/ASA-8	Supplied Separately	1	2-3/4 x 5-7/8 x 16-3/8	1.5
Relay Amplifier Control C-934/ASA-8	Supplied Separately	1	3 x 4-21/32 x 5-3/4	1.25
Detecting Head DT-37/ASQ-8	NOas-10853 NOas-10391 NOas-12273 NOas 53-340 NOas 55-546 NOas 52-77	1	6-5/8 x 7-13/16 x 39-5/16	14.5
Electronic Control Amplifier AM-294/ASQ-8	NOas-10391 NOas-10853 NOas-12273	1	7-13/16 x 10-7/16 x 21-17/32	26.0
Electronic Control Amplifier AM-294/ASQ-8	NOas 52-77 NOas 53-340 NOas 55-546	1	7-13/16 x 10-7/16 x 21-17/32	26.0
Mounting MT-776/ASQ-8	NOas-10853 NOas-10391 NOas-12273 NOas 53-340 NOas 55-546 NOas 52-77	4	2-3/4 x 11-1/8 x 23-3/8	2.0
Magnetometer Driver 0-90/ASQ-8	NOas-10853 NOas-10391 NOas-12273	1	7-13/16 x 10-7/16 x 21-17/32	30.0
Magnetometer Driver 0-90A/ASQ-8	NOas 52-77	1	7-13/16 x 10-7/16 x 21-17/32	30.0
Magnetometer Driver 0-90B/ASQ-8	NOas 53-340 NOas 55-546	1	7-13/16 x 10-7/16 x 21-17/32	29.0
Amplifier Detector AM-295/ASQ-8	NOas-10853 NOas-10391 NOas-12273 NOas 53-340 NOas 55-546 NOas 52-77	1	7-13/16 x 10-7/16 x 21-17/32	29.0

**AN/ASQ-8: 2**

ITEM NAME: DETECTING SET

TYPE: AN/ASQ-8

PRINCIPAL COMPONENTS AND PHYSICAL DATA (Continued)

COMPONENTS	CONTRACT NUMBER	QTY	OVERALL DIMENSIONS (Inches)	UNIT WT. (Pounds)
Power Supply PP-447/ASQ-8	NOas-10853 NOas-10391 NOas-12273 NOas 53-340 NOas 55-546 NOas 52-77	1	7-13/16 x 10-1/4 x 21-17/32	42.0
Recorder RD-47/ASQ-8 (Ser. No. 1-12)	NOas-10391	1	7-21/64 x 8-11/32 x 10-1/2	11.562
Recorder RD-47/ASQ-8 (Ser. No. 13-17)	NOas-10391	1	7-21/64 x 8-11/32 x 10-1/2	12.187
Recorder RD-47/ASQ-8 (Ser. No. 18-200)	NOas-12273	1	7-21/64 x 8-11/32 x 10-1/2	12.187
Mounting MT-B30/ASQ-8	NOas-10391 NOas-12273	1	2-1/8 x 6-27/32 x 7-17/64	0.625
Recorder RD-47A/ASQ-8 (Ser. No. 1-350)	NOas-12273	1	7-13/16 x 8-27/32 x 9-19/32	14.7
Recorder RD-47A/ASQ-8 (Ser. No. 1-566)	NOas 52-77	1	7-13/16 x 8-27/32 x 9-19/32	14.7
Recorder RD-47A/ASQ-8 (Ser. No. 1-10)	NOas-10853	1	7-13/16 x 8-27/32 x 9-19/32	14.7
Recorder RD-47/ASQ-8 (Ser. No. 1-1094)	NOas 53-340 NOas 55-546	1	7-13/16 x 8-27/32 x 9-19/32	14.7
Mounting MT-830/ASQ-8	NOas-10391 NOas-10853 NOas-12273 NOas 52-77	1	2-1/8 x 6-27/32 x 7-17/64	0.625
Detecting Set Control C-820/ASQ-8	NOas-10853 NOas-10391 NOas-12273 NOas 53-340 NOas 55-546 NOas 52-77	1	5-3/4 x 7-1/8 x 8-1/4	7.0
Switch Box SA-181/ASQ-8	NOas-10391 NOas-10853 NOas-12273	1	4-25/64 x 7-27/32 x 12-9/16	6.25
Switch Box SA-1B1A/ASQ-8	NOas 52-77 NOas 53-340 NOas 55-546	1	4-25/64 x 7-27/32 x 12-9/16	6.25
Magnetic Compressor CN-191/ASQ-8	NOas 53-340 NOas 55-546 NOas 53-514 NOas 55-1065	1	5-1/2 x 5-3/4 x 7-1/8	6.0
Coil Assy MX-1361/ASQ-8	NOas 53-340 NOas 55-546 NOas 53-514 NOas 55-1065	1	5-1/4 x 5-1/4 x 13	9.5

**ITEM NAME:** DETECTING SET

**TYPE:** AN/ASQ-8

**REFERENCE DATA AND LITERATURE**

Technical Manuals:  
AN16-30ASQ8-3

**NOTE 1. General Instruments Inc., Dallas, Texas  
Dalmo Victor Co., San Carlos, California  
Geophysical Services Inc., Dallas, Texas**

**AN/ASQ-8: 4**



DATE: 1 July 1964

ITEM NAME: DETECTING SET, MAGNETIC

COGNIZANT SERVICE: USN

TYPE: AN/ASQ-10

FEDERAL STOCK NUMBER:

	USA	USN	USAF	USMC
STATUS OR TYPE CLASSIFICATION				

Mfg(s) Name or Code Number: Dalmo Victor Company

Illustration Not Available

#### FUNCTIONAL DESCRIPTION

Magnetic Detecting Set AN/ASQ-10 is designed to detect submarines from low-flying aircraft. The presence of a submarine is indicated by deflections of the inked trace on a paper chart. The AN/ASQ-10 determines the presence of a submarine by measuring the change produced in the earth's magnetic field. The change in the earth's magnetic field is measured by means of a saturable core magnetometer. The magnetometer element, when held parallel to the earth's magnetic field, produces a signal when any change in this field occurs. When a signal is produced, the signal is amplified and presented as a deflection on Magnetic Distortion Recorder RO-32/ASQ.

#### RELATION TO SIMILAR EQUIPMENT

The AN/ASQ-10 is similar in function to the AN/AS-8.

#### TECHNICAL DESCRIPTION

Power Requirements: 115  $\pm$ 5 vac, 1-ph, 380 to 420 cps, 1.9 amp, 145w, 0.78 pf (lagging); 28 vdc, 6.6w

Operating Temperature: -65 to +160 deg F

#### INSTALLATION CONSIDERATIONS

Not available.

#### PRINCIPAL COMPONENTS AND PHYSICAL DATA

COMPONENT	QTY	HEIGHT (Inches)	WIDTH (Inches)	DEPTH (Inches)	UNIT WT. (Pounds)
Amplifier-Power Supply AM-1967/ASQ-10	1	7-3/4	10-1/8	14-1/4	26.0
Detecting Set Control C-2548/ASQ-10	1	5-1/2	5-3/4	6	3.4
Detecting Head DT-37B/ASQ-8	1	6-5/8	7-13/16	39-5/16	14.5

#### REFERENCE DATA AND LITERATURE

Handbook:  
NAVAER 16-30ASQ10-501

AN/ASQ-10: 1

DATE: 1 July 1964

ITEM NAME: RADAR BEACON

COGNIZANT SERVICE: USN

TYPE: AN/DPN-3A

FEDERAL STOCK NUMBER:

	USA	USN	USAF	USMC
STATUS OR TYPE CLASSIFICATION	Used By	Used By		

Mfg(s) Name or Code Number: Glenn L. Martin Company (38597)

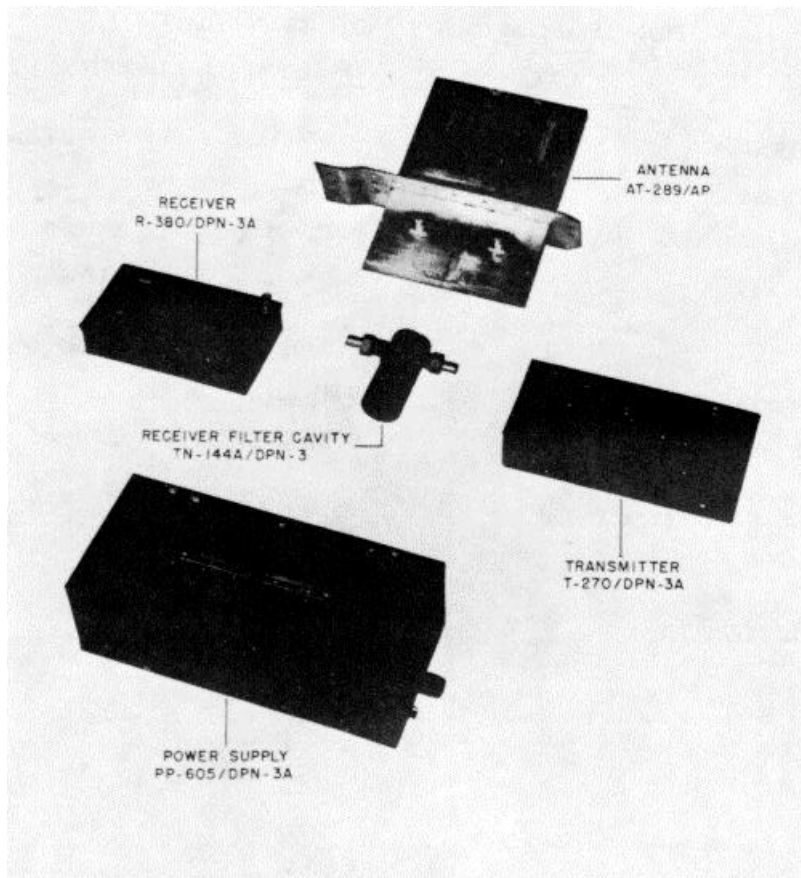

### FUNCTIONAL DESCRIPTION

The Radar Beacon AN/DPN-3A is an airborne equipment designed for use as a small lightweight beacon to aid in the radar tracking of pilotless aircraft in

flight. It has been designed for single frequency band ("S" band) usage with pulse type operation at a pretuned frequency of reception and of transmission in the range of 2700 to 2900 megacycles (mc).

**ITEM NAME:** RADAR BEACON

**TYPE:** AN/DPN-3A

**RELATION TO SIMILAR EQUIPMENT**

The AN/DPN-3A is designed for use with Navy SP radar or similar radar equipment in the "S" band at ranges up to 50 miles and altitudes up to 20,000 feet.

Frequency Range: 2700 to 2900 mc  
Number of Bands: 1 band  
Peak Power Output: 50w  
Operating Power Requirements: 28v dc, 2.3 amps

**TECHNICAL DESCRIPTION**

Type of Emission: Pulse type  
Receptive Ranges  
Miles: 0 to 50 mi  
Altitude: 0 to 20,000 ft

**INSTALLATION CONSIDERATIONS**

Related Equipment: (Required but not Supplied) (1)  
Receptacle, Electrical Connection AN3102-10SL-4P; (as required) Coaxial, Cable type RG-58/U; (as required) Wire, Interconnection (16 strands no. 36 gauge).

**PRINCIPAL COMPONENTS AND PHYSICAL DATA**

<b>COMPONENTS</b>	<b>QTY</b>	<b>OVERALL DIMENSIONS (Inches)</b>	<b>UNIT WT. (Pounds)</b>
Transmitter T-270/DPN-3A	1	2-9/64 x 3-51/64 x 7-17/32	2.44
Receiver R-380/DPN-3A	1	2-3/64 x 3-15/32 x 6-1/8	1.32
Power Supply PP-605/DPN-3A	1	3-43/64 x 4-7/16 x 10-31/64	9.13
Receiver Filter Cavity TN-144A/DPN-3	1	1-3/8 x 3-3/8 x 4-1/64	0.56
Antenna AT-289/AP	1	3-1/32 x 8-13/32 x 10	4.44
Connector, Male Coaxial UG-88/U	6	9/16 dia x 31/32	.030
Adapter, Coaxial Right Angle UG-306/U	2	9/16 x 31/32 x 1	.021
Plug Miniature (MTS Winchester Electric Co.)	3	23/32 dia x 1 lg	.021

**REFERENCE DATA AND LITERATURE**

Technical Manuals:  
AN-16-30DPN3-3

DATE: 1 July 1964

ITEM NAME: RADAR BEACON

COGNIZANT SERVICE: USN

TYPE: AN/DPN-17

FEDERAL STOCK NUMBER:

	USA	USN	USAF	USMC
STATUS OR TYPE CLASSIFICATION				

Mfg(s) Name or Code Number: Motorola Incorporated, Chicago, Illinois

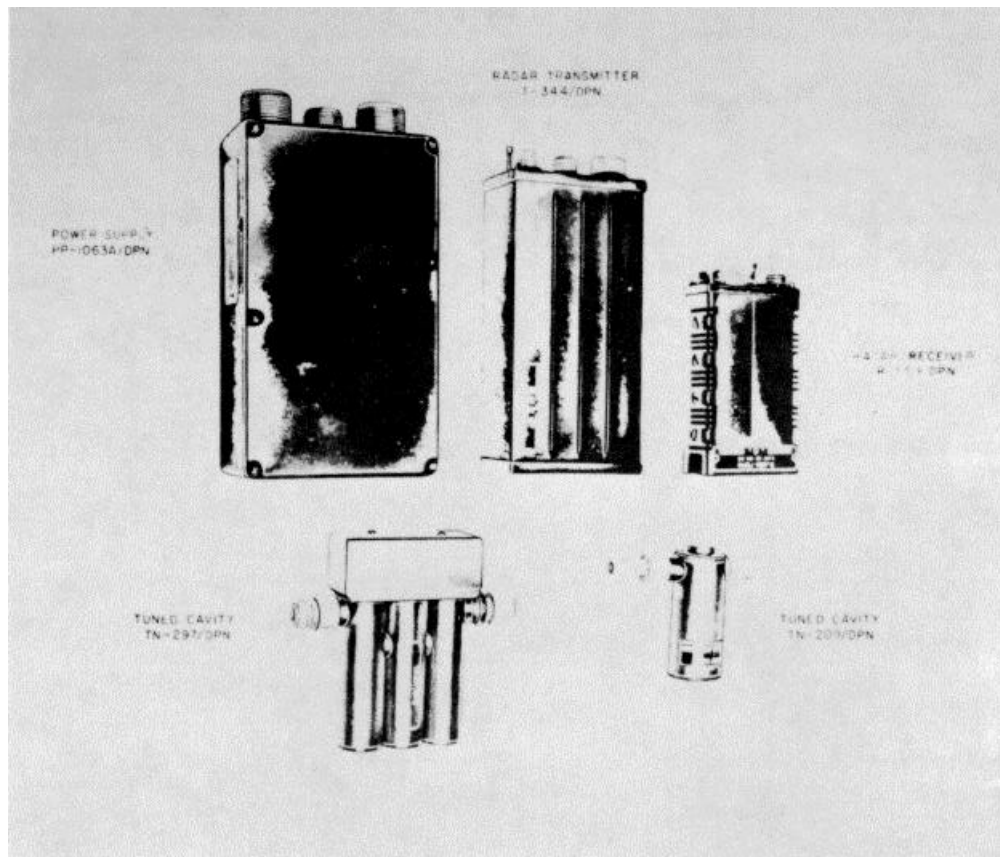

**FUNCTIONAL DESCRIPTION**

The Radar Beacon AN/DPN-17 is designed for use in piloted and pilotless aircraft and functions in missile

guidance systems. The AN/DPN-17 receives radar transmitted pulses and transmits reply pulses at a pretuned frequency for use as radar tracking range.

**ITEM NAME:** RADAR BEACON

**TYPE:** AN/DPN-17

**RELATION TO SIMILAR EQUIPMENT**

None.

Input Impedance: High  
Input Pulse Width: 0.7 to 2.0 usec  
Trigger Level: 43 db below 1.0 mw  
Trigger Rate: 0 to 2000 cps  
Power Supply PP-1063A/DPN  
Input Power: 115v ac, 400 cps  
Output Power: plus 300v dc at 25 ma; plus 135v dc at ma; -35v dc at 5 ma; 6.3v ac at 1.4 amp and 2.8 amp

**TECHNICAL DESCRIPTION**

Radar Transmitter T-344/DPN-17  
Frequency Range: 2750 to 2950 mc  
Frequency Stability: Plus or minus 2 mc  
Peak Power Output: 100w  
Output Pulse Duration: 0.65 usec  
Output Impedance 52 ohms  
Tuned Cavity TN-209/DPN  
Frequency Range: 2750 to 2950 mc  
Frequency Stability: Plus or minus 2 mc  
R-F Bandwidth: 6 to 12 mc  
Input Impedance: 52 ohms  
Radar Receiver R-471/DPN  
Output Pulse Amplitude: 25v  
Output Pulse Duration: 1.0 usec

**INSTALLATION CONSIDERATIONS**

Related Equipment: (Required but not Supplied) (1) Receiving Antenna (52 ohm impedance); (1) Transmitting Antenna (52 ohm impedance); (as required) R-F Cable Type RG-87/U; (as required) Video Frequency Cable Boston Wire and Cable Part no. Cox-2FS-032-GV; (as required) Power Cable Belden Part no. 8425.

**PRINCIPAL COMPONENTS AND PHYSICAL DATA**

<b>COMPONENTS</b>	<b>QTY</b>	<b>OVERALL DIMENSIONS (Inches)</b>	<b>UNIT WT. (Pounds)</b>
Radar Receiver R-471/DPN	1	1-1/4 x 2-7/6 x 5-3/4	1.4
Radar Transmitter T-344/DPN-17	1	1-31/32 x 3-5/8 x 7-9/16	3.43
Tuned Cavity TN-209/DPN	1	1-3/8 x 3-1/2 x 4-5/6	3/4
Power Supply PP-1063A/DPN	1	2-9/16 x 4-7/16 x 8-5/16	4.8

**REFERENCE DATA AND LITERATURE**

Technical Manuals  
AN16-30DPN-17-3  
12P5DPN17-2

DATE: 1 July 1964

ITEM NAME: RADAR BEACON

COGNIZANT SERVICE: USN

TYPE: AN/DPN-17A

FEDERAL STOCK NUMBER:

	USA	USN	USAF	USMC
STATUS OR TYPE CLASSIFICATION				

Mfg(s) Name or Code Number: Motorola Incorporated, Chicago, Illinois

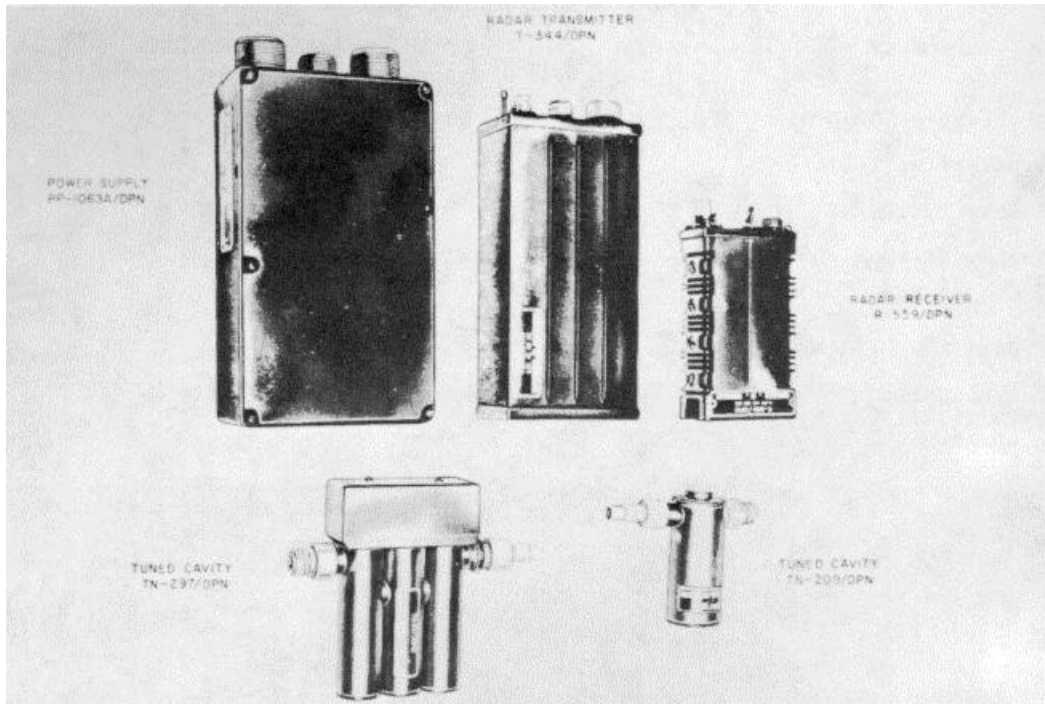

**FUNCTIONAL DESCRIPTION**

The Radar Beacon AN/DPN-17A is designed for use in piloted and pilotless aircraft and functions in missile

guidance systems. The AN/DPN-17A receives radar transmitted pulses and transmits reply pulses at a pretuned frequency for use as radar tracking range.

AN/DPN-17A: 1

**ITEM NAME:** RADAR BEACON

**TYPE:** AN/DPN-17A

**RELATION TO SIMILAR EQUIPMENT**

The AN/DPN-17A is the same as AN/DPN-17, except R-559/DPN substituted for R-471/DPN.

Input Power: 115v ac, 400 cps  
Output Power: plus 300v dc at 25 ma; plus 135v dc at 15 ma; minus 35v dc at 5 ma; 6.3v ac at 1.4 amps and 2.8 amps

**TECHNICAL DESCRIPTION**

Type of Emission: P2e type  
Frequency Range: 2750 to 2950 mc  
Frequency Stability: Plus or minus 2 mc  
R-F Bandwidth at 3 db Down: 6 to 12 mc  
R-F Bandwidth at 40 db Down: 6 mc max  
Input Impedance: 52 ohms  
Number of Bands: 1 band  
Power Supply Characteristics

**INSTALLATION CONSIDERATIONS**

Related Equipment: (Required but not Supplied) (1) Receiving Antenna (52 ohm impedance); (1) Transmitting Antenna (52 ohm impedance); (as required) R-F Cable Type RG-87/U; (as required) Video Frequency Cable Boston Wire and Cable Part no. Cox-2FS-032-GV; (as required) Power Cable Belden Part no. 8425.

**PRINCIPAL COMPONENTS AND PHYSICAL DATA**

<b>COMPONENTS</b>	<b>QTY</b>	<b>OVERALL DIMENSIONS (Inches)</b>	<b>UNIT WT. (Pounds)</b>
Radar Receiver R-559/DPN	1	1-1/4 x 2-7/8 x 5-3/4	1.4
Radar Transmitter T-344/DPN-17	1	1-31/32 x 3-5/8 x 7-9/16	3.4
Tuned Cavity TN-209/DPN	1	1-3/8 x 3-1/2 x 4-5/8	3/4
Power Supply PP-1063A/DPN	1	2-9/16 x 4-7/16 x 8-5/16	4.8

**REFERENCE DATA AND LITERATURE**

Technical Manuals:  
AN16-30DPN17-3  
12P5-2DPN17-2

DATE: 1 July 1964

ITEM NAME: RADAR BEACON

COGNIZANT SERVICE: USN

TYPE: AN/DPN-17B

FEDERAL STOCK NUMBER:

	USA	USN	USAF	USMC
STATUS OR TYPE CLASSIFICATION				

Meg(s) Name or Code Number: Motorola Incorporated, Chicago, Illinois

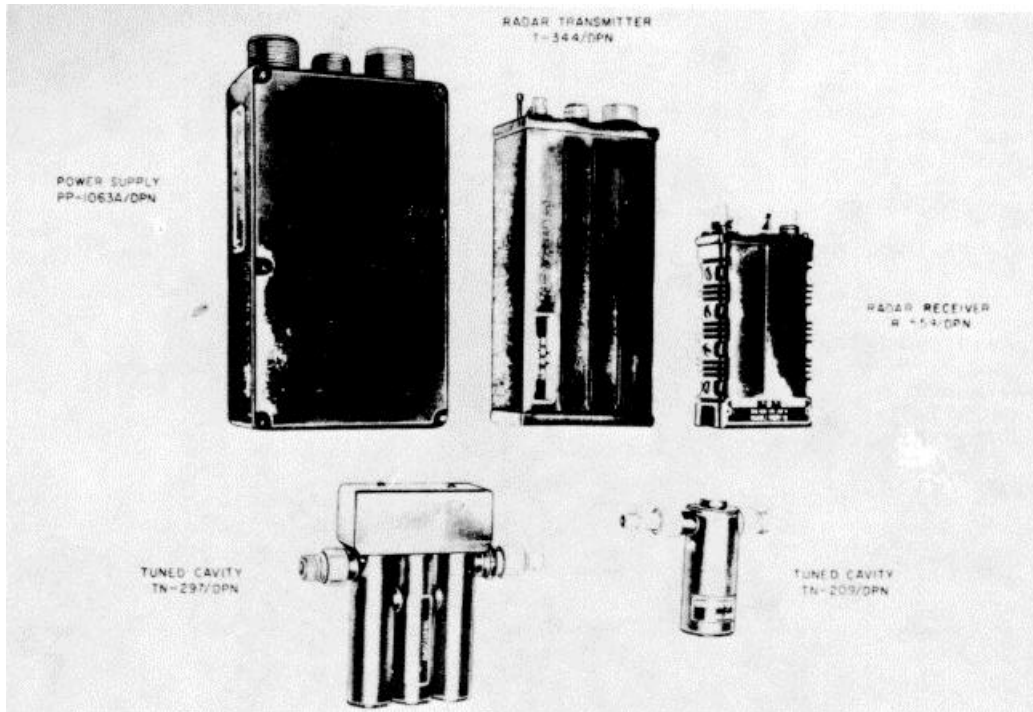

### FUNCTIONAL DESCRIPTION

The Radar Beacon AN/DPN-17B is designed for use in piloted and pilotless aircraft and functions in missile

guidance systems. The AN/DPN-17B receives radar transmitted pulses and transmits reply pulses at a pretuned frequency for use as radar tracking range.

AN/DPN-17B: 1



**ITEM NAME:** RADAR BEACON

**TYPE:** AN/DPN-17B

**RELATION TO SIMILAR EQUIPMENT**

The AN/DPN-17B is the same as AN/DPN-17A except TN-297/DPN is substituted for TN209/DPN. Functionally and electrically interchangeable.

**Power Supply Characteristics**

Input Power: 115v ac, 400 cps

Output Power: Plus 300v dc at 25 ma; plus 135v dc at 15 ma; minus 35v dc at 5 ma; 6.3v ac at 1.4 amps and 2.8 amps

**TECHNICAL DESCRIPTION**

Type of Emission: P2e type  
Frequency Range: 2750 to 2950 mc  
Frequency Stability: Plus or minus 2 mc  
R-F Bandwidth at 3 db Down: 6 to 12 mc  
R-F Bandsidth at 40 db Down: 6 mc max  
Input Impedance: 52 ohms  
Number of Bands: 1 band

**INSTALLATION CONSIDERATIONS**

Related Equipment: (Required but not Supplied) (1) Receiving Antenna (52 ohm impedance); (1) Transmitting Antenna (52 ohm impedance); (as required) R-F Cable Type RG-87/U; (as required) Video Frequency Cable Boston Wire and Cable Part no. COX-2FS-OEW-GV; (as required) Power Cable Belden Part no. 8425.

**PRINCIPAL COMPONENTS AND PHYSICAL DATA**

<b>COMPONENTS</b>	<b>QTY</b>	<b>OVERALL DIMENSIONS (Inches)</b>	<b>UNIT WT. (Pounds)</b>
Radar Receiver R-559/DPN	1	1-1/4 x 2-7/8 x 5-3/4	1.4
Radar Transmitter T-344/DPN-17	1	1-31/32 x 3-5/8 x 7-9/16	3.4
Tuned Cavity TN-297/DPN	1	1-1/4 x 4-3/4 x 5-15/16	1-3/4
Power Supply PP-1063A/DPN	1	2-9/16 x 4-7/16 x 8-5/16	4.8

**REFERENCE DATA AND LITERATURE**

Technical Manuals:  
AN16-30DPN17-3  
12P5-2DPN17-2

**DATE:** 1 July 1964

**ITEM NAME:** RADAR BEACON

**COGNIZANT SERVICE:** USN

**TYPE:** AN/DPN-25

**FEDERAL STOCK NUMBER:**

	USA	USN	USAF	USMC
STATUS OR TYPE CLASSIFICATION				

Mfg(s) Name or Code Number: Motorola Inc., Chicago, Illinois

**No Illustration Available**

**FUNCTIONAL DESCRIPTION**

The AN/DPN-25 is miniaturized general purpose transponder set for use in guided missile operations. Equipment operates at X-band frequencies in conjunction with a ground based X-band tracking radar.

**AN/DPN-32: 1**

**ITEM:** TRANSPONDER SET

**TYPE:** AN/DPN-32

**RELATION TO SIMILAR EQUIPMENT**

None.

Transmitted Signal: 9300 to 9500 mc  
Received Signal: 8500 to 950 mc  
Number of Channels: 1 coded  
Power Source Required: 6-1/2v, -22-1/2v and 160v  
facilities provided for internal batteries.

**TECHNICAL DESCRIPTION**

Frequency Range

**PRINCIPAL COMPONENTS AND PHYSICAL DATA**

<b>COMPONENT</b>	<b>QTY</b>	<b>HEIGHT (Inches)</b>	<b>WIDTH (Inches)</b>	<b>DEPTH (Inches)</b>	<b>UNIT WT. (Pounds)</b>
Radar Receiver-Transmitter RT-415/DPN	1				
Duplexer CU-585/DPN-32	1				
Band Pass Filter F-351/DPN-32	1				
Power supply PP-1713/DPN-32	1				

**REFERENCE DATA AND LITERATURE**

Nomenclature Card for Transponder Set AN/DPN-32  
dated 12 March 1957.

**DATE:** 1 July 1964

**ITEM NAME:** RADAR BEACON

**COGNIZANT SERVICE:** USN

**TYPE:** AN/DPN-25

**FEDERAL STOCK NUMBER:**

	USA	USN	USAF	USMC
STATUS OR TYPE CLASSIFICATION				

Mfg(s) Name or Code Number: Motorola Inc., Chicago, Illinois

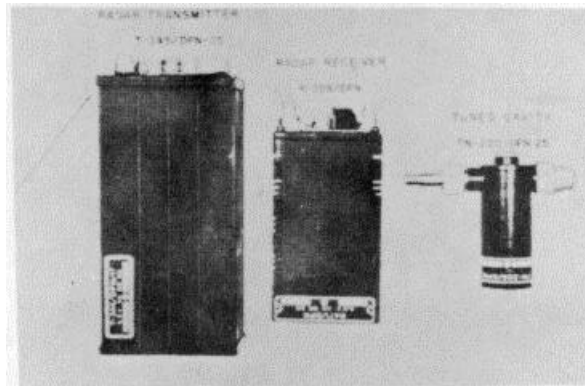

**FUNCTIONAL DESCRIPTION**

use with airborne equipment. It extends the range of ground radar used to track the airborne equipment.

The AN/DPN-25 is designed as a radar beacon for

**AN/DPN-25: 1**

**ITEM NAME:** RADAR BEACON

**TYPE:** AN/DPN-25

**RELATION TO SIMILAR EQUIPMENT**

The AN/DPN-25 is similar to the AN/DPN-17 except that it differs in frequency range coverage and in equipment supplied.

Operating Power Requirements: 300v dc at 25 ma;  
30v dc; 6.3v dc or ac at 1.38 amps; 135v dc at 15  
ma; 6.3v dc or ac at 0.9 amp

**INSTALLATION CONSIDERATIONS**

**TECHNICAL DESCRIPTION**

Type of Emission: P2e type of emission.  
Operating Frequency Range: 3380 to 3460 mc

Related Equipment: (Required but not Supplied) (1)  
Receiving Antenna (52 ohms impedance), (1)  
Transmitting Antenna (52 ohms impedance), (1)  
Power Supply (plus 300v dc at 25 ma; plus 135v  
dc at 15 ma; -35v dc at 5 ma; 6.3 v ac or dc at 2.6  
amp).

**PRINCIPAL COMPONENTS AND PHYSICAL DATA**

<b>COMPONENTS</b>	<b>QTY</b>	<b>OVERALL DIMENSIONS (Inches)</b>	<b>UNIT WT. (Pounds)</b>
Cavity Tuned TN-220/DPN-25	1	1-3/8 x 3-1/2 x 4-13/32	9.6
Radar Receiver R-559/DPN	1	1-1/4 x 2-7/8 x 5-31/64	20.0
Radar Transmitter T-345/DPN-25	1	1-31/32 x 3-39/64 x 7-9/16	55.5

**REFERENCE DATA AND LITERATURE**

Technical Manuals:  
AN16-30DPN17-3 (NAVY)  
1 12P5-2DPN17-2 (USAF)

DATE: 1 July 1964

ITEM NAME: TRANSPONDER SET

COGNIZANT SERVICE: USA

TYPE: AN/DPN-32

FEDERAL STOCK NUMBER: 5895-739-1360-EA

	USA	USN	USAF	USMC
STATUS OR TYPE CLASSIFICATION				

Mfg(s) Name or Code Number: Motorola Inc., Scottsdale, Arizona

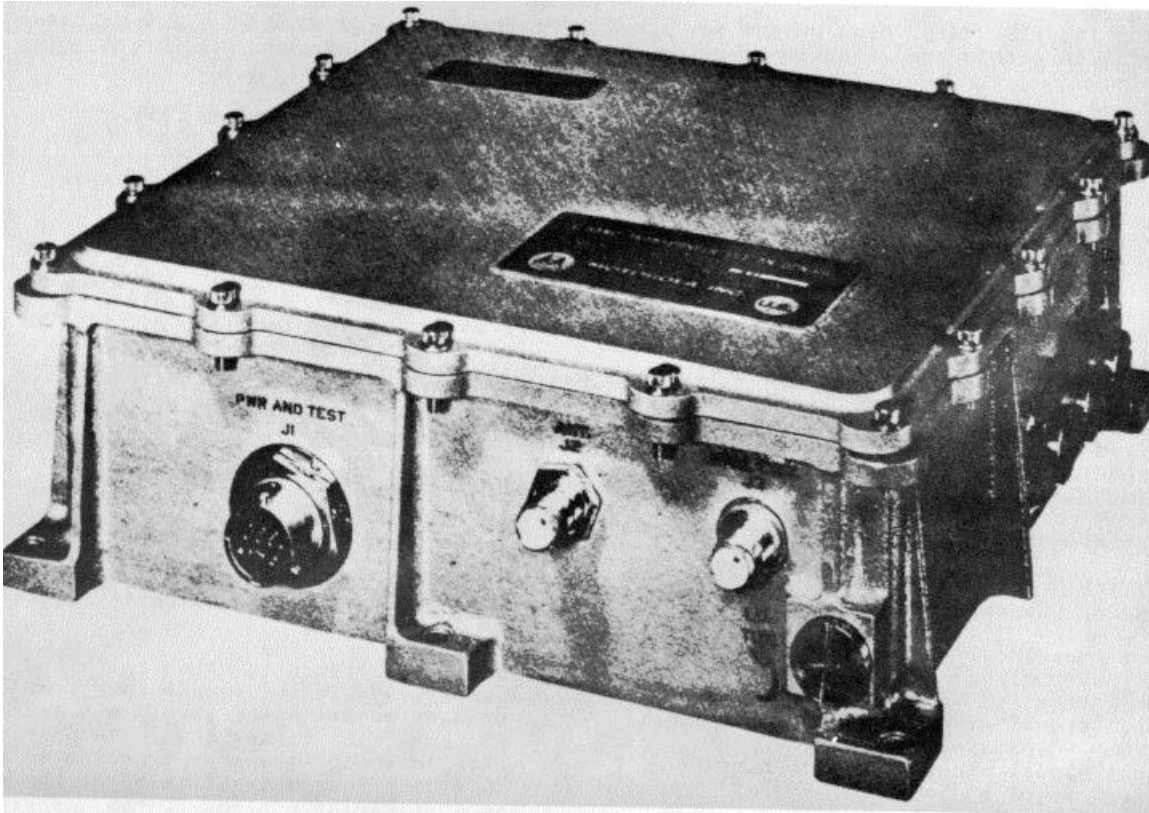

**FUNCTIONAL DESCRIPTION**

The AN/DPN-66 Transponder Set is intended to extend the racking range of a precision racking C-Band instrumentation radar and to provide information-

transferring facilities between the radar and transponder-carrying vehicle. To accomplish this function, the transponder receives pulse type signals and transmits a pulse type signal at a different frequency in the same frequency band.

AN/DPN-66: 1

**ITEM NAME:** TRANSPONDER SET  
**TYPE:** AN/DPN-66

### RELATION TO SIMILAR EQUIPMENT

AN/DPN-66 is a miniaturized version of the AN/DPN-54.

### TECHNICAL DESCRIPTION

#### RECEIVER

Frequency (tunable externally): 5395-5905 mc  
Frequency Stability: plus or minus 2.0 mc  
Input Impedance: 50 ohms  
Bandwidth (3 db): 10 plus or minus 2 mc  
Off-Frequency Rejection:  
Image: 60 db min  
Vhf, L, S and X Band: 70 db min  
Sensitivity: -70 dbm minimum over entire freq range.  
Maximum Input Signal: plus 20 dbm for operation within specification requirements.  
Number of Interrogation Pulses: 1, 2 or 3  
Number of Codes: 4 total for 2 and 3 pulse code groups (code selectable by externally accessible switch).  
Pulse Width: 0.25-5.0 usec (single pulse), 0.25-1.0 usec (multiple pulse)  
Pulse Spacing:  
First 2 pulses - 3.5 plus or minus 0.1 usec (codes 1 and 3) or 5.0 plus or minus 0.1 usec (codes 2 and 4).  
Third pulse - From 2.8 usec to 7.2 usec from second pulse (codes 3 and 4).  
Decoder Limits, first two pulses:  
Accept Zone - Plus or minus 0.5 usec from nominal first to second pulse spacing.  
Reject Zone - Plus or minus 0.7 usec from nominal first to second pulse spacing.

#### TRANSMITTER

Frequency (tunable externally): 5400-5900 mc  
Output Impedance: 50 ohms  
Peak Power Output: 500 w min  
Pulse Jitter:  
Input signal minus 60 dbm to plus 20 dbm - 0.02 usec max  
Input signal minus 67 dbm to minus 60 dbm - 0.05 usec max  
Pulse Width: 0.25 plus or minus 0.05 usec or 0.75 plus or minus 0.10 usec (selectable by changing internal jumper lead).  
Pulse Rise Time (10% to 90%): 0.10 usec max  
Pulse Fall Time (90% to 10%): 0.20 usec max

Duty Cycle: .002 max

VSWR of Load: Built in ferrite isolator permits operation into a load VSWR of 3:1 (any phase) without system degradation.

TRANSPONDER RECOVERY TIME: 50 usec max, for input signal levels differing by up to 77 db. Recovery time is to full sensitivity with no change in transmitter reply power or frequency with three radars interrogating simultaneously.

#### REPLY PULSE REPETITION RATE

0 to 2670 pps - 0.75 usec pulse width setting.  
0 to 4000 pps - 0.25 usec pulse width setting.

#### TRANSPONDER DELAY

Min setting: 2.0 plus or minus 0.1 usec  
Max setting: 4.3 plus or minus 0.2 usec  
Alternate: 3.2 plus or minus 0.5 usec (selectable by changing internal jumper lead).

DELAY VARIATION WITH SIGNAL LEVEL: 0.05 usec max from -60 dbm to plus 20 dbm.

LIFE: 150 hours minimum without maintenance or readjustment.

#### POWER REQUIREMENTS

Wiring: Two-wire, remote grounded negative.  
Operating Voltage Limits: 24.5 to 30v dc  
Operating current requirements (independent of line voltage):  
0.95 amps, standby.  
1.40 amps, at 1200 pps reply rate.  
1.75 amps, at 2700 pps reply rate.

#### INSTALLATION CONSIDERATIONS

Mounting: The transponder should be mounted in a manner which will allow the positions of the selector switches to be observed.

Cabling Requirements: When installed, the power leads to the transponder from the primary power source should not exceed 15 feet. The cables should be properly clamped to the transponder mounting base to prevent excessive flexing at the connectors during periods of vehicle vibration.

Related Equipments: The AN/DPN-66 is intended for use with such precision tracking radar equipment as the AN/FPS-16, AN/FPQ-6, AN/TPQ-18 and AN/MPS-26.

ITEM NAME: TRANSPONDER SET

TYPE: AN/DPN-66

PRINCIPAL COMPONENTS AND PHYSICAL DATA

COMPONENT	QTY	HEIGHT (Inches)	WIDTH (Inches)	DEPTH (Inches)	UNIT WT. (Pounds)
Cable Assembly Radio Frequency Motorola P/N 30-22862A01	1				
Cable Assembly Special Purpose Electrical, Motorola P/N 30-22861A01	1				
Receiver-Transmitter, Radar AN/DPN-66	1	3.26	9.34	8.03	10.8

REFERENCE DATA AND LITERATURE

Nomenclature card for AN/DPN-66  
and Motorola Document Nr. 68-23613A

AN/DPN-66: 3



DATE: 1 July 1964

ITEM NAME: TRANSPONDER SET

COGNIZANT SERVICE: USA

TYPE: AN/DPW-9

FEDERAL STOCK NUMBER:

	USA	USN	USAF	USMC
STATUS OH TYPE CLASSIFICATION				

Mfg(s) Name or Code Number: Melpar Inc., Falls Church, Virginia

**No Illustration Available.**

**FUNCTIONAL DESCRIPTION**

The AN/DPW-9 is an airborne pulse-type remote control receiver and radar tracking aid in guided missiles and aerial drones. It is capable of operating at "S", "C", or "X" band frequencies through the use of interchange

able radio-frequency heads. The receiver transmitter responds to coded pulse interrogation from a single radar. It features internal secondary power supply to provide audio command signal output and control functions, and provides and accepts trigger pulse from auxiliary telemetering equipment.

**AN/DPW-9: 1**

**ITEM NAME:** TRANSPONDER SET

**TYPE:** AN/DPW-9

**RELATION TO SIMILAR EQUIPMENT**

None.

**TECHNICAL DESCRIPTION**

Frequency Range: 2700 to 9500 mc  
Indication: Meter type  
Power Requirements: 24 to 32v dc

**PRINCIPAL COMPONENTS AND PHYSICAL DATA**

<b>COMPONENT</b>	<b>QTY</b>	<b>HEIGHT (Inches)</b>	<b>WIDTH (Inches)</b>	<b>DEPTH (Inches)</b>	<b>UNIT WT. (Pounds)</b>
Receiver-Transmitter RT-211/DPW-9	1				
Control-Indicator C-2050/DPW	1				
Junction Box J-788/DPW	1				
Control, Frequency Selector C-2052/DPW	1				

**REFERENCE DATA AND LITERATURE**

Nomenclature Card for Transponder/Set AN/DPW-9.

**AN/DPW-9: 2**

DATE: 1 July 1964

ITEM NAME: TRAINING TRANSMITTER EQUIPMENT

COGNIZANT SERVICE: USN

TYPE: AN/UPT-T1

FEDERAL STOCK NUMBER:

	USA	USN	USAF	USMC
STATUS OR TYPE CLASSIFICATION				

Mfg(s) Name or Code Number: Maquire Industries, Inc., Greenwich, Connecticut

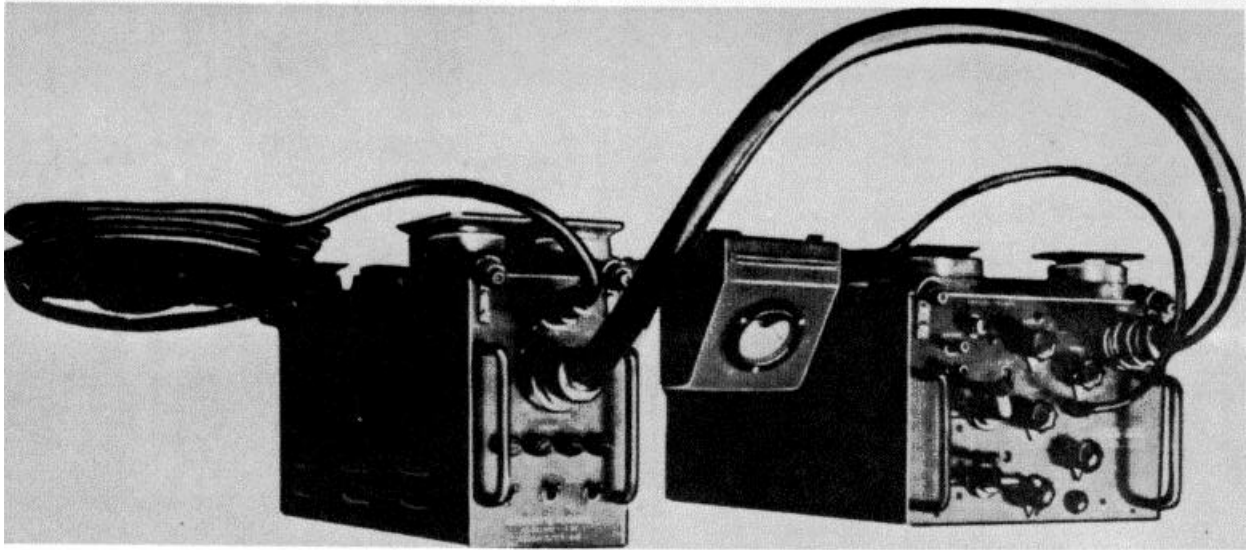

### FUNCTIONAL DESCRIPTION

The AN/UPT-T1 is designed for use to train personnel in the jamming of radar or communication

signals. Under optimum conditions, it may also be used for actual jamming purposes. It is mounted in standard aircraft racks.

AN/UPT-T1: 1

**ITEM NAME:** TRAINING TRANSMITTER EQUIPMENT

**TYPE:** AN/UPT-T1

**RELATION TO SIMILAR EQUIPMENT**

None.

Antenna Data

Type: Dipole  
Reflector: Corner type  
Polarization: Horizontal or vertical or 45°  
Impedance: 50 ohms  
Horizontal Beamwidth (Half-Power Points)  
Antenna Polarization  
Horizontal: 50°  
Vertical: 40°

**TECHNICAL DESCRIPTION**

Frequency Range: 450 to 720 mc  
Power Output: 2 to 8w  
Types Amplitude Modulation: Random noise, sine wave,  
pulse.  
Pulse Data  
Width: Approx 1.5 usec  
Repetition Rate: 10 to 100 kc  
Power Requirements: 115v, 50 to 60 cps, 350w

**INSTALLATION CONSIDERATIONS**

Related Equipment: (Required but not Supplied) (1)  
High Frequency Receiver.

**PRINCIPAL COMPONENTS AND PHYSICAL DATA**

<b>COMPONENTS</b>	<b>QTY</b>	<b>OVERALL DIMENSIONS (Inches)</b>	<b>UNIT WT. (Pounds)</b>
Antenna AS-71/SPT-2	1	18-1/4 x 21-5/8 x 23-5/8	16
Transmitter-Modulator T-42/UPT-T1	1	7-5/8 x 10-1/8 x 19-9/16	50
Rectifier-Power Supply PP-53/UPT-T1	1	4-7/8 x 7-5/8 x 19-9/16	45
Test Meter TS-205/U	1	2 x 4 x 4	2
Power Cable	1	36 lg	
Antenna Cable RG-8/U	1	180 lg	
AC Line Cord	1	300 lg	

**REFERENCE DATA AND LITERATURE**

Technical Manuals: SHIPS 256

**AN/UPT-T1: 2**

DATE: 1 July 1964

ITEM NAME: RADAR TRAINING SET

COGNIZANT SERVICE: USN

TYPE: AN/UPT-T4

FEDERAL STOCK NUMBER:

	USA	USN	USAF	USMC
STATUS OR TYPE CLASSIFICATION				

Mfg(s) Name or Code Number: Radio Research Lab., Harvard University, Cambridge, Massachusetts

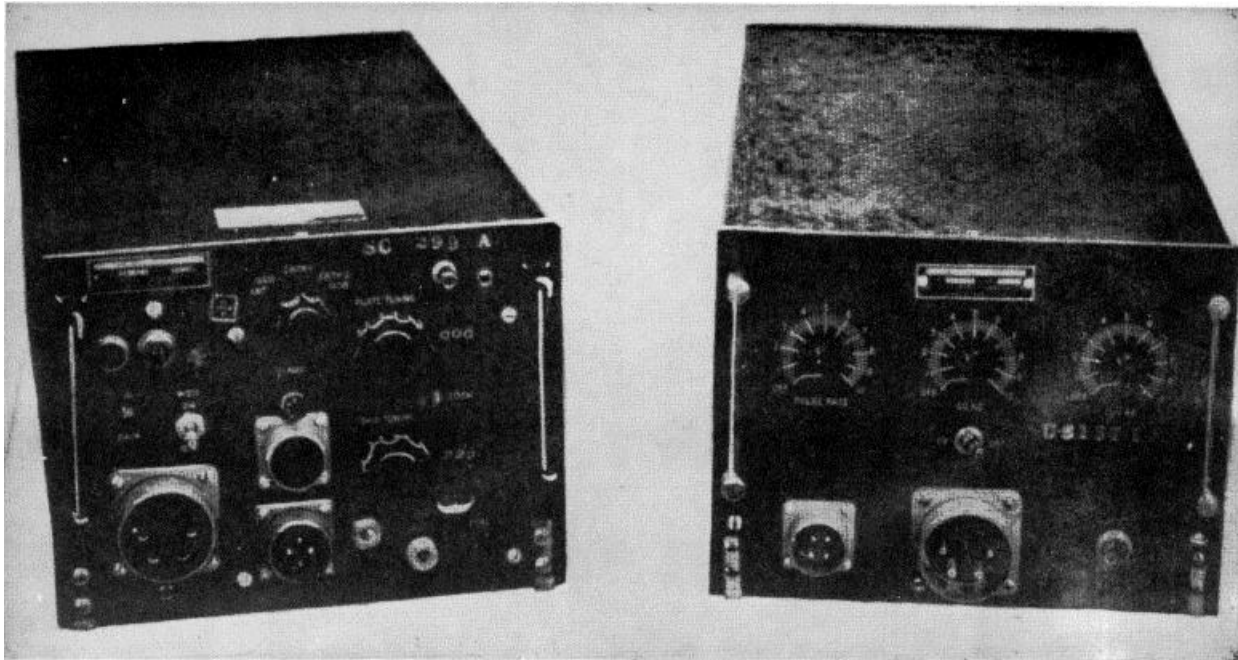

### FUNCTIONAL DESCRIPTION

The AN/UPT-T4 is a practice jammer used in training to demonstrate jamming produced by various types of signals or to aid the study of anti-jamming techniques in the operation of a radar.

The AN/UPT-T4 is a modification of Aircraft Transmitting Equipment AN/APQ-2. In addition to the amplitude modulated by noise carrier output of the AN/APQ-2, this equipment is capable of pulsed operation of sine wave modulated output in order to demonstrate the way such signals confuse or obliterate

AN/UPT-T4: 1

**ITEM NAME:** RADAR TRAINING SET

**TYPE:** AN/UPT-T4

the information presented by radar systems.

Power Requirements: 115v plus or minus 10%, 60 cps,  
1-ph, 450w, 90% pf

**RELATION TO SIMILAR EQUIPMENT**

None.

**INSTALLATION CONSIDERATIONS**

Related Equipment

Required but not Supplied

- (1) Antenna (AS-263/UPT for directional use),
- (1) Test Meter I-139-A, (1) Frequency Meter of Calibrated Receiver to cover desired operating frequency, (1) Pick-up Antenna Assembly AS-168/AP with Control Box C-157/AP or other RF output indicator, Power Cable as Required, Antenna Cable RG-8/U as Required.

**TECHNICAL DESCRIPTION**

Frequency Range: 175 to 550 me

Power Output: 7 to 30w

Modulation Capability

Noise: Sidebands approx 7 mc, 3.5 mc ea side of carrier.

Sine Wave: Approx 65% modulation can be obtained.

**PRINCIPAL COMPONENTS AND PHYSICAL DATA**

<b>COMPONENTS</b>	<b>QTY</b>	<b>OVERALL DIMENSIONS (Inches)</b>	<b>UNIT WT. (Pounds)</b>
Transmitter F3804	1	7-11/16 x 10-3/8 x 21-5/32	48
Power Supply F3805	1	7-11/16 x 10-3/8 x 21-5/32	71
Mounting Base MT-171/U	2	2-1/8 x 11-3/8 x 25-9/16	2
Cable with Plugs	3	36 lg	1.17
RF Plug UG-21/U	1	5/8 dia x 1-5/8	0.2
RF Adapter UG-27/U	1	3/4 x 1-1/2 x 1-1/2	0.2
Plug AN310B-22-4S	1	0.5	

**REFERENCE DATA AND LITERATURE**

Handbook of Maintenance Instructions for  
F3800 Transmitter (AN/UPT-T4).

DATE: 1 July 1964

ITEM NAME: AIRCRAFT RADAR EQUIPMENT

COGNIZANT SERVICE: USN

TYPE: ASB-5

FEDERAL STOCK NUMBER:

	USA	USN	USAF	USMC
STATUS OR TYPE CLASSIFICATION				

Mfg(s) Name or Code Number: Bendix Radio Division of Bendix Aviation Corp., Townson, Md.

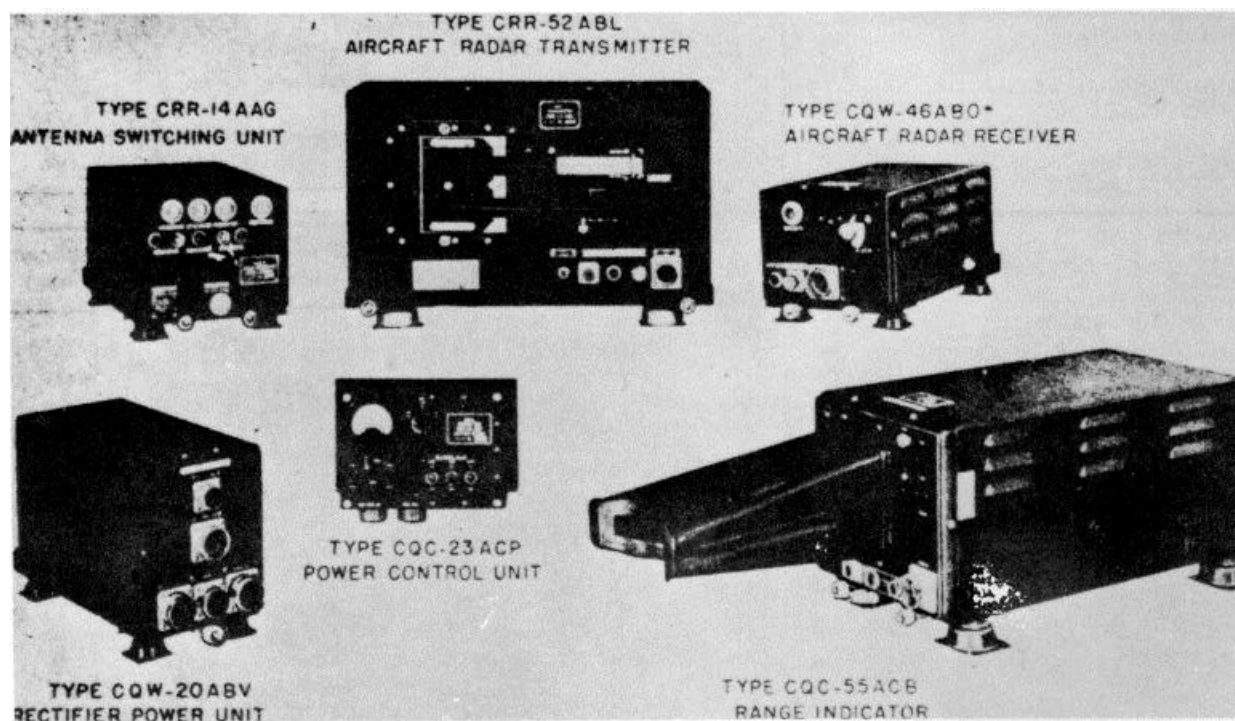

### FUNCTIONAL DESCRIPTION

The AN/ASB5 is installed in carrier-borne aircraft for use in locating surface objects. When used with the proper antenna system, the equipment will indicate both the distance and relative direction of the surface object from the aircraft.

### RELATION TO SIMILAR EQUIPMENT

Similar to other members of the ASB series.

### TECHNICAL DESCRIPTION

Power Output: 5 kw at approx 515 mc during a 2 $\mu$ sec pulse occurring at the rate of 400 pps  
 Current Drain: 3.3 amp at 115 vac, 800 cps  
 Operating Voltage: 115 vac, 600 to 1400 cps, 1-ph  
 Frequency: 515 mc (approx)  
 PRF: 400 pps  
 Pulse Width: 2.0 sec

### INSTALLATION CONSIDERATIONS

Not Available.

**ASB-5**

**PRINCIPAL COMPONENTS AND PHYSICAL DATA**

<b>COMPONENT</b>	<b>QTY</b>	<b>HEIGHT (Inches)</b>	<b>WIDTH (Inches)</b>	<b>DEPTH (Inches)</b>	<b>UNIT WT. (Pounds)</b>
Antenna Switching Unit Navy Type CRR- 14AAG	1				13.75
Rectifier Power Unit Navy Type CQW- 20ABV	1				16.00
Power Control Unit Navy Type CQC-23ACP	1				3.70
Aircraft Radar Receiver Navy Type CQW-46ABO	1				10.80
Aircraft Radar Transmitter Navy Type CRR-52ABL	1				26.30
Indicator Navy Type CQC-55ACB	1				21.80

**REFERENCE DATA AND LITERATURE**

Technical Manual: NAVAER 08-5S-27





ITEM NAME: AIRCRAFT RADAR EDUIPMENT

TYPE: ASA

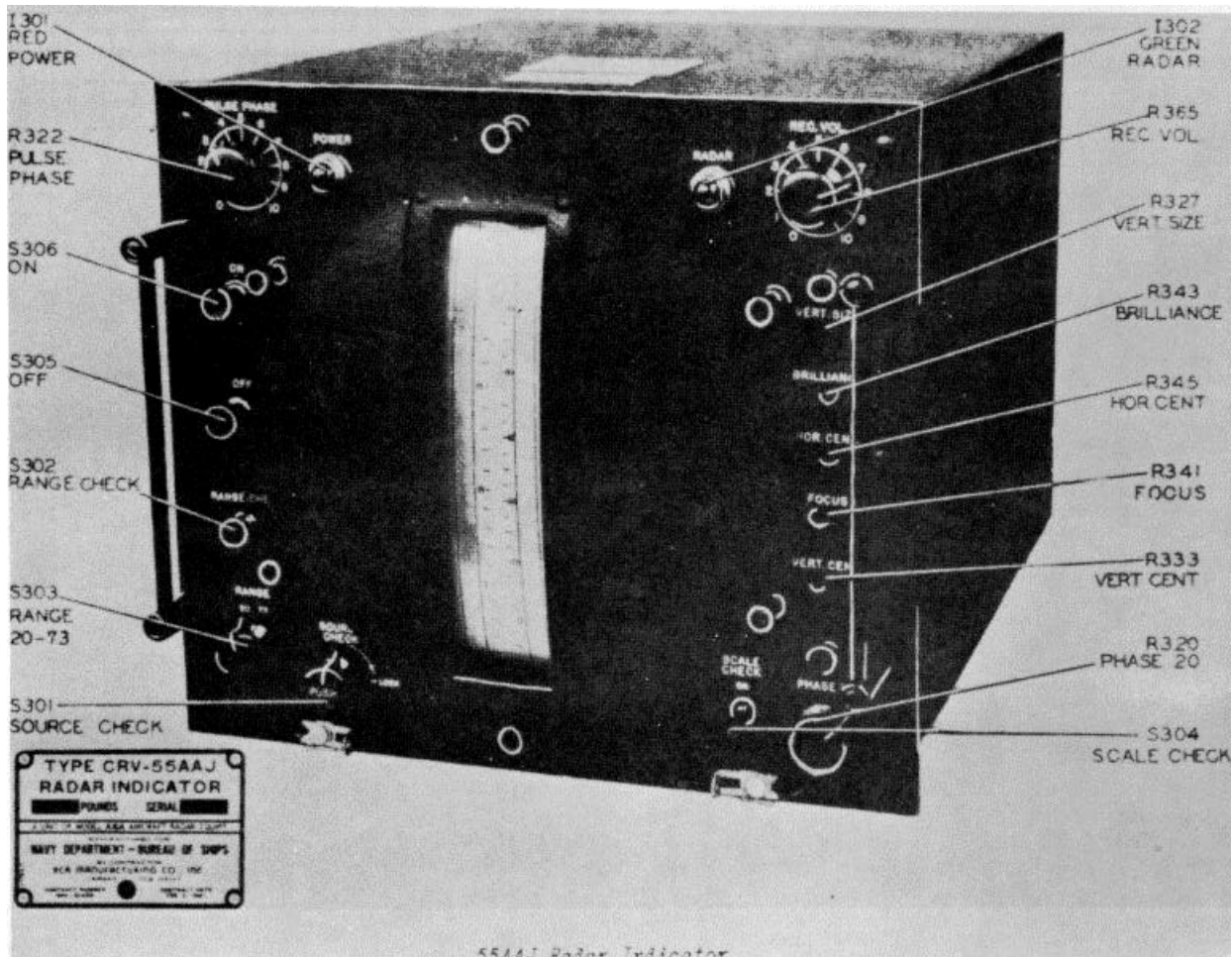

### FUNCTIONAL DESCRIPTION

The ASA is designed for installation on aircraft for use in searching for surface objects, and for determining the absolute altitude at which the aircraft is flying.

When used with the proper antenna system, the equipment will indicate both the distance and the relative direction of the target, and will enable the aircraft to be directed straight to the target.

ASA: 2

DATE: 1 July 1964

ITEM NAME: AIRCRAFT RADAR EQUIPMENT

COGNIZANT SERVICE: USN

TYPE: ASB-6, ASB-7

FEDERAL STOCK NUMBER:

	USA	USN	USAF	USMC
STATUS OR TYPE CLASSIFICATION				

Mfg(s) Name or Code Number: Westinghouse .Electric Mfg Co., Baltimore, Maryland

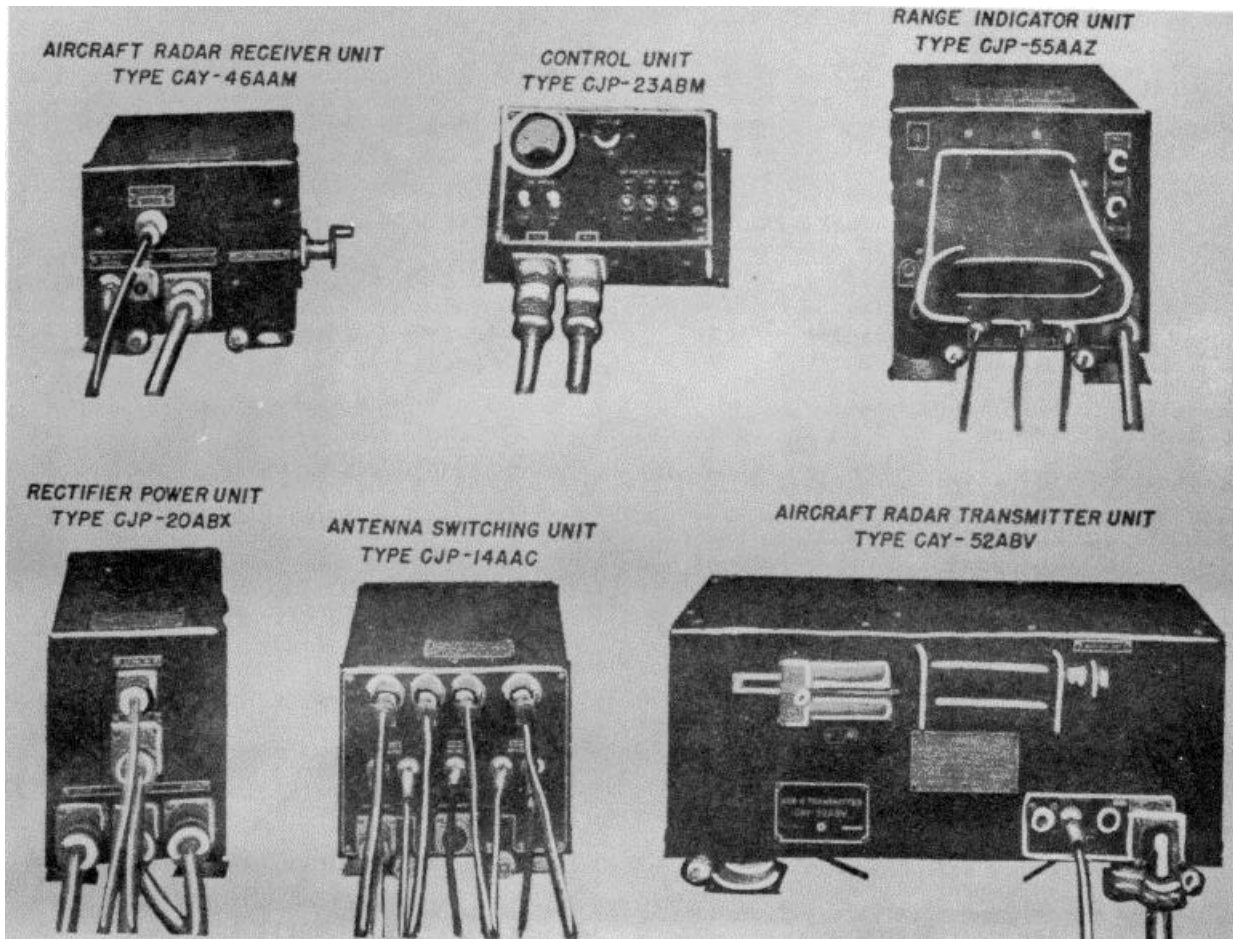

**FUNCTIONAL DESCRIPTION**

The ASB-6 and ASB-7 are lightweight radar equipment especially designed for installation on carrier-borne aircraft for use in searching for surface objects.

Each of the equipments is comprised of seven units. Each unit is contained in an individual treated aluminum case. They may be individually mounted in various sections of the airplane, or grouped in one position as desired.

They are designed to operate from a typical aircraft power source delivering 115 volts, 600 to 1400 cycles,

**ITEM NAME:** AIRCRAFT RADAR EQUIPMENT

**TYPE:** ASB-6, ASB-7

single phase ac. The equipment draws 345 watts while in operation. The transmitter operates on a carrier frequency of approximately 515 mc with a pulse length of approximately 1.5 usec and a pulse frequency of 400 cycles per second. The peak power output is in the order of 5 kilowatts.

**RELATION TO SIMILAR EQUIPMENT**

The ASB-6 and ASB-7 are essentially similar, the only difference being that Aircraft Radar Receiving Unit 46AAM is supplied with the ASB-6 where as Aircraft Radar Receiving Unit 46ACE is supplied with the ASB-7.

**TECHNICAL DESCRIPTION**

Transmitter  
Frequency: 515 mc

Type of Emissions: Self-pulsed.  
Pulse Duration: 1.5 usec  
Keying Frequency: 400 cps  
Peak Power Output: 5 kw  
Receiver  
Frequency Range: 510 to 525 mc  
First Intermediate Frequency: 55 mc  
Second Intermediate Frequency: 16 mc  
Output: Pos Video Pulse Signal  
Input Impedance: 50 ohms  
Output Impedance: 230 ohms  
Operating Power Requirements: 115v, 600 to 1400 cps, 1-ph

**INSTALLATION CONSIDERATIONS**

Not available.

**PRINCIPAL COMPONENTS AND PHYSICAL DATA**

COMPONENTS	QTY		OVERALL DIMENSIONS (Inches)	UNIT WT. (Pounds)
	ASB-6	ASB-7		
Antenna Switching Unit NT-14AAC incl Shock Mount	1 1	1 1	6-15/16 x 7-5/8 x 13-7/32	12.75
Rectifier Power Unit NT-20ABX incl Shock Mount	1 1	1 1	6 x B-1/16 x 14-11/32	15
Control Unit NT-23ABM	1	1	3-19/32 x 6-3/16 x 8-1/2	3.50
Aircraft Radar Receiver Unit NT-46AAM incl Shock Mount	1	1	6-11/16 x 9-15/64 x 15-3/8	10
Aircraft Radar Receiver Unit NT-46ACE incl Shock Mount		1	6-11/16 x 9-15/64 x 15-3/8	10
Aircraft Radar Transmitter Unit NT-52ABV incl Shock Mount	1 1	1 1	8-9/16 x 10-6/32 x 18-7/16	20.75
Indicator Unit NT-55AAZ incl Shield	1 1	1 1	9-5/16 x 10-7/8 x 31-7/32	19.50
Antenna Switching Unit NT-14AAC incl Shock Mount	1 1	1 1	6-15/16 x 7-5/8 x 13-7/32	12.75
Rectifier Power Unit NT-20ABX incl Shock Mount	1 1	1 1	6 x 8-1/16 x 14-11/32	15
Control Unit NT-23ABM	1	1	3-19/32 x 6-3/16 x 8-1/2	3.50
Aircraft Radar Receiver Unit NT-46AAM incl Shock Mount	1 1		6-11/16 x 9-15/64 x 15-3/8	10
Aircraf* Radar Receiver Unit NT-46ACE incl Shock Mount		1 1	6-11/16 x 9-15/64 x 15-3/8	10

**ITEM NAME:** AIRCRAFT RADAR EQUIPMENT

**TYPE:** ASB-6, ASB-7

COMPONENTS	PRINCIPAL COMPONENTS AND PHYSICAL DATA (Cent.)		OVERALL DIMENSIONS (Inches)	UNIT WT. (Pounds)
	QTY	ASB-6		
Aircraft Radar Transmitter Unit NT-52ABV incl Shock Mount	1	1	8-9/16 x 10-6/32 x 1B-7/16	20.75
Indicator Unit NT-55AAZ incl Shield	1	1	9-5/16 x 10-7/8 x 31-7/32	19.50

**REFERENCE DATA AND LITERATURE**

Technical Manuals: NAVAer 08-5S-23

**ASB-6: 3**

DATE: 1 July 1964

ITEM NAME: AIRCRAFT RADAR EQUIPMENT

COGNIZANT SERVICE: USN

TYPE: ASC, ASC-1

FEDERAL STOCK NUMBER:

	USA	USN	USAF	USMC
STATUS OR TYPE CLASSIFICATION				

Mfg(s) Name or Code Number: Western Electric Co., Inc., New York, N. Y.



**FUNCTIONAL DESCRIPTION**

The ASC and ASC-1 are installed in aircraft for use in the detection of surface vessels at ranges of 4, 20, 50, and 100 nautical miles. They are also equipped to provide beacon operation for homing and navigation, and for operation with IFF equipment.

They will operate satisfactorily at altitudes up to 15,000 feet in the temperature range of -40 to +55 degrees C with relative humidities as high as 95%.

**RELATION TO SIMILAR EQUIPMENT**

The ASC and ASC-1 are identical in performance but different slightly in mechanical construction.

**TECHNICAL DESCRIPTION**

Frequency: 3300 mc  
Peak Power Output: 25 kw  
Frequency Control: AFC  
Presentation: 3-, 5-, and 7-in. CRT

**ASC, ASC-1**

Pulse Width: radar operation, 1  $\mu$ sec; beacon operation, 2.5  $\mu$ sec  
 Pulse Repetition Rate: radar operation, 800pps; beacon operation, 400 pps  
 Type Receiver: Superheterodyne  
 Range: 4, 20, 50, and 100 naut mi with 1- and 5-mi markers  
 Operating Voltages: 27.5 vdc, 88 amp for ASC, 105 to 110 amp for ASC-1

Antenna Type: Horizontal half-wave dipole with parabolic reflector  
 Beam Width: 9 deg horizontal, 11 deg vertical Tilt: 57 deg above or 18 deg below horizontal

**INSTALLATION CONSIDERATIONS**

Not Available.

**PRINCIPAL COMPONENTS AND PHYSICAL DATA**

COMPONENT	QTY	HEIGHT (Inches)	WIDTH (Inches)	DEPTH (Inches)	UNIT WT. (Pounds)
Transmitter-Receiver Assembly NT-43AAZ	1	28-7/8	13-13/16	34-27/32	145
Antenna Assembly NT-66ACH or NT-66ACY(ASC-1)	1	29	26-23/32	40-3/8	80
	1	32-5/8	25-5/8	40-3/8	102
Indicator NT-55ABY	1	21-1/8	13-1/16	21-1/8	52. 5
Modulation Generator Assembly NT-35AAK	1	10-7/16	9-1/8	22-3/8	21. 6
Regulated Rectifier Power Unit NT-20ABQ	1	8-7/8	5-7/8	21-9/16	17.1
Motor-Alternator Unit NT-21ABV	1	10-1/16	5-7/8	14-5/16	39. 3
Voltage Regulator NT-20ABR	1	7-3/8	4-5/16	8	4. 5
Control Amplifier NT-50AAX or NT-50ABP (ASC-1)	1	9-3/4	5-3/8	12-1/2	9.8
	1	8-13/16	3-19/32	10-1/4	9.3
Motor-Alternator Unit NT-21ABV	1	10-1/16	5-7/8	14-5/16	39. 3
Motor-Dynamo Amplifier Unit NT-21ABW or NT-21ACA9ASC-1)	1	8	5-31/32	11-3/8	18. 1
	1	8	5-31/32	11-3/8	18
Power Control Unit NT-23ACK	1	9-13/32	5-3/4	14	12. 5
Power Distribution Unit NT-23ACJ or NT-23ACU (ASC-1)	1	10-3/4	3-7/8	17-3/16	15. 5
	1				
Repeater Indicator NT-55ACJ (ASC-1)	1	7	6-3/8	13-13/32	12.7
Repeater Indicator Preamplifier NT-50ABQ (ASC-1)	1	8-1/4	4-3/4	8-5/8	5.0

**REFERENCE DATA AND LITERATURE**

Technical Manual: AN08-55-58

**MIL-HDBK-162A**  
15 December 1965

Volume 1  
Section 2

**DATE:** 1 September 1964

**ITEM NAME:** DISPLACEMENT GYROSCOPE

**COGNIZANT SERVICE:** USN

**TYPE:** CN-611/APS-80A

**FEDERAL STOCK NUMBER:**

	USA	USN	USAF	USMC
STATUS OR TYPE CLASSIFICATION Used by				

Mfg(s) Name or Code Number: Minneapolis-Honeywell Regulator Co., Aeronautical Div. (94580)

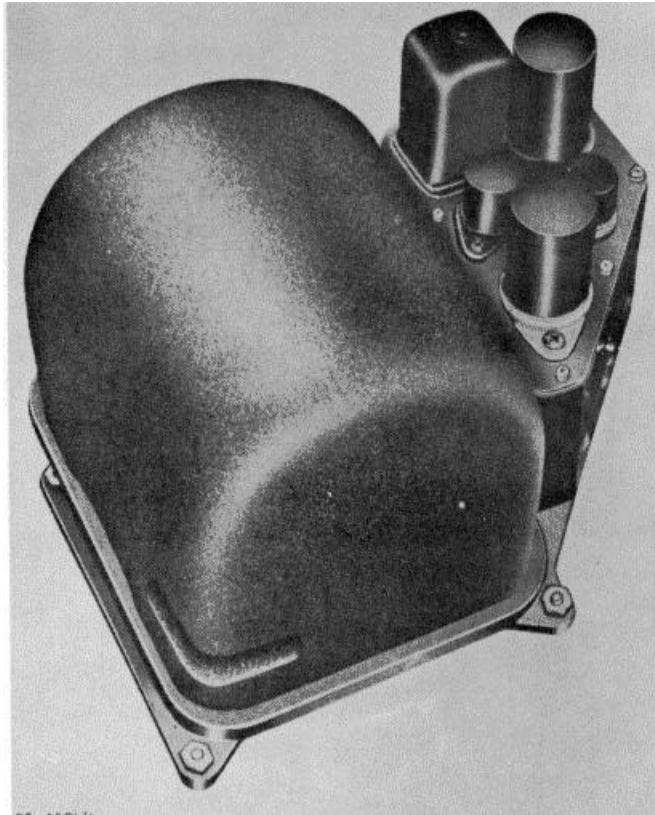

**FUNCTIONAL DESCRIPTION**

Displacement Gyroscope CN-611/APS-80A provides

a primary reference of angular position by producing electrical signals proportional to the pitch and roll angles.

**CN-611/APS-80A: 1**



**ITEM NAME:** DIS PLACEMENT GYROSCOPE

**TYPE:** CN-611/APS-80A

**RELATION TO SIMILAR EQUIPMENT**

None.

Running: 28w  
Gimbal Freedom  
Outer Gimbal: Unlimited  
Inner Gimbal: plus or minus 850  
Rotor Speed: 24,000 rpm synch  
Erection Rate  
Normal: 4 to 8° per minute  
Fast: 30° per minute  
Drift Rate: 0.250 per minute avg

**TECHNICAL DESCRIPTION**

Electrical Requirements

Rotor: 115v, 400 cps, 3-ph

Erection Torque Motors

Fast Erection Rate: 115v, 400 cps, 3-ph

Normal Erection Rate: 40v, 400 cps, 1-ph

Output Synchros: 28v, 400 cps, 1-ph

Maximum Power Requirements

Starting: 90w

**INSTALLATION CONSIDERATIONS**

Related Equipment

Required but not Supplied: (1) Radar Stabilization System AN/APS-80

**PRINCIPAL COMPONENTS AND PHYSICAL DATA**

<b>COMPONENTS</b>	<b>QTY</b>	<b>OVERALL DIMENSIONS (Inches)</b>	<b>UNIT WT. (Pounds)</b>
Displacement Gyroscope CN-611/APS-80A includes:	1	5-53/64 x 6-13/32 x 9-1/8	8.4
Ram Gyroscope GG64D1	1	5-1/16 x 5-21/64 x 6-15/64	5.5
Mounting Rack QG122A1	1	5 x 6-13/32 x 9-1/8	2.9

**REFERENCE DATA AND LITERATURE**

Technical Manuals:

NAVWEPS 16-35CN611-1: Handbook of Overhaul instructions.

DATE: 1 July 1964

ITEM NAME: ANTENNA GROUP

COGNIZANT SERVICE: USN

TYPE: OA-493/APS-20

FEDERAL STOCK NUMBER:

	USA	USN	USAF	USMC
STATUS OR TYPE CLASSIFICATION				

Mfg(s) Name or Code Number:

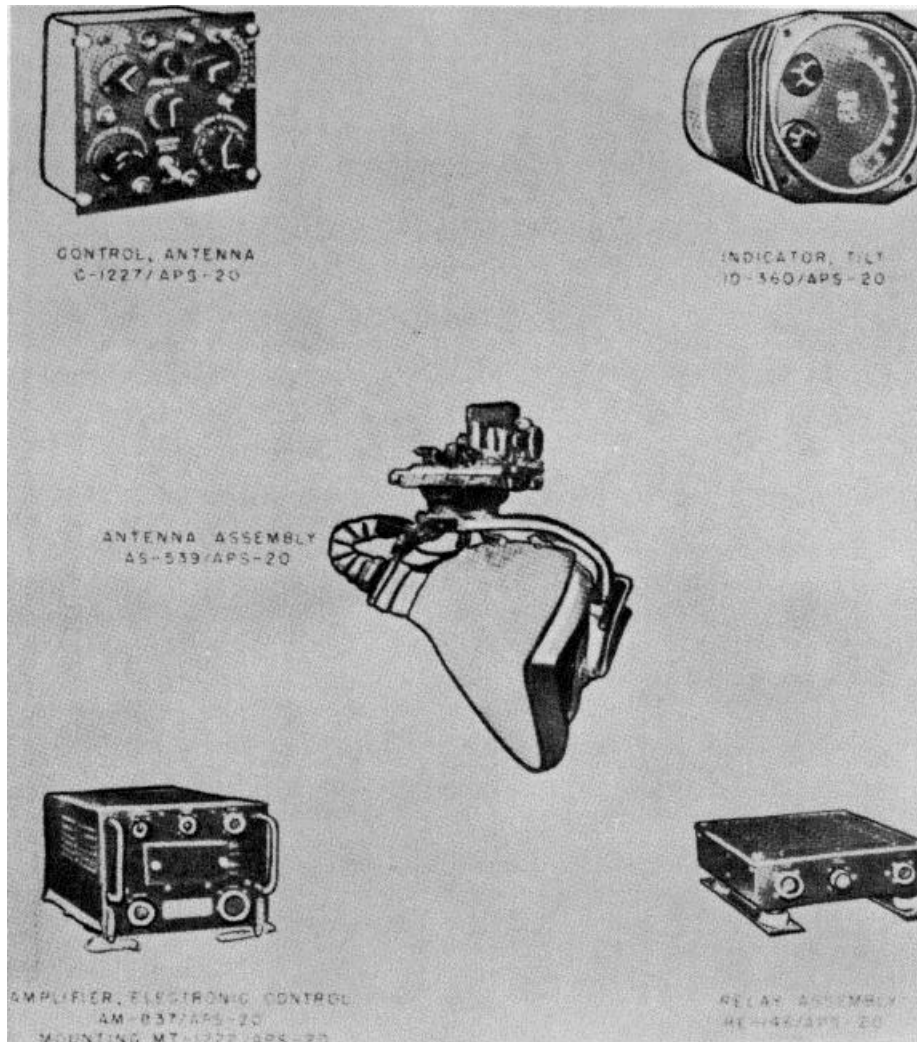

**FUNCTIONAL DESCRIPTION**

The OA-493/APS-20 is an improved antenna system for Radar Set AN/APS-20A or AN/APS20C and for Radar Recognition Set AN/APX-7. It is used to

extend the usefulness of the AEW system by providing an antenna that can vary the tilt of the radar and IFF beams and stabilize them against the effects of pitching and rolling by the aircraft.

**ITEM NAME:** ANTENNA GROUP

**TYPE:** OA-493/APS-20

**RELATION TO SIMILAR EQUIPMENT**

None.

**Operating Power**

AC: 115v plus or minus 5v, 1-ph, 380 to 1000 cps  
DC: 28v dc, 300v regulated.

**Operating Temperature:** -450C to plus60°C.

**TECHNICAL DESCRIPTION**

**Radar**

Method of Radiation: Feed-horn-type radiator illuminating parabolic reflector.

Radiated Field: Horizontally polarized.

Horizontal Beam Width: Not greater than 3.7 deg, over-all between half-power points.

Side Lobes: At least 16 db below the power in the main lobe for the worse possible condition.

Azimuth-Scan Speeds: 2, 4, 6 and 8 rpm in continuous search.

**Sector Scan**

Maximum Width: Greater than 108°

Minimum Width: Less than 250 at 6 rpm.

**INSTALLATION CONSIDERATIONS**

**Related Equipment:**

Required but not Supplied. (1) Radar Set AN/APS-20A or AN/APS-20C, less Antenna Assy AS-298I/APS-20A or AS-298/APS-20C, Antenna Control C-219A/APS-20 or C-219B/APS-20 or C-219B/APS-20A, and C-804/APS-20A, Speed Control Box and Switching Assy, (1) Inertia Switch SH-235/APA-57, (1) Radar Recognition Set AN/APX-7, (1) Dimmer Control.

**PRINCIPAL COMPONENTS AND PHYSICAL DATA**

<b>COMPONENTS</b>	<b>QTY</b>	<b>OVERALL DIMENSIONS (Inches)</b>	<b>UNIT WT. (Pounds)</b>
Amplifier, Electronic Control AM-837/APS-20	1	7-31/32 x 11 x 18	27
Antenna Assy AS-539/APS-20	1	48-15/32 x 62-7/16 x 92-3/16	216
Antenna Control C-1227/APS-20	1	4-1/4 x 5-3/4 x 6	4
Relay Assy RE-146/APS-20	1	4-3/4 x 11 x 14	10
Tilt Indicator ID-360/APS-20	1	3-1/4 x 3-1/4 x 7-11/16	1
Mounting MT-1222/APS-20	1	2-1/8 x 11-1/8 x 19	2

**REFERENCE DATA AND LITERATURE**

Technical Manuals: AN16-350A493-1

DATE: 1 July 1964

ITEM NAME: ANTENNA STABILIZING GROUP

COGNIZANT SERVICE: USN

TYPE: OA-1375/APS-62

FEDERAL STOCK NUMBER:

	USA	USN	USAF	USMC
STATUS OR TYPE CLASSIFICATION				

Mfg(s) Name or Code Number: Goodyear Aircraft Corporation, Akron, Ohio

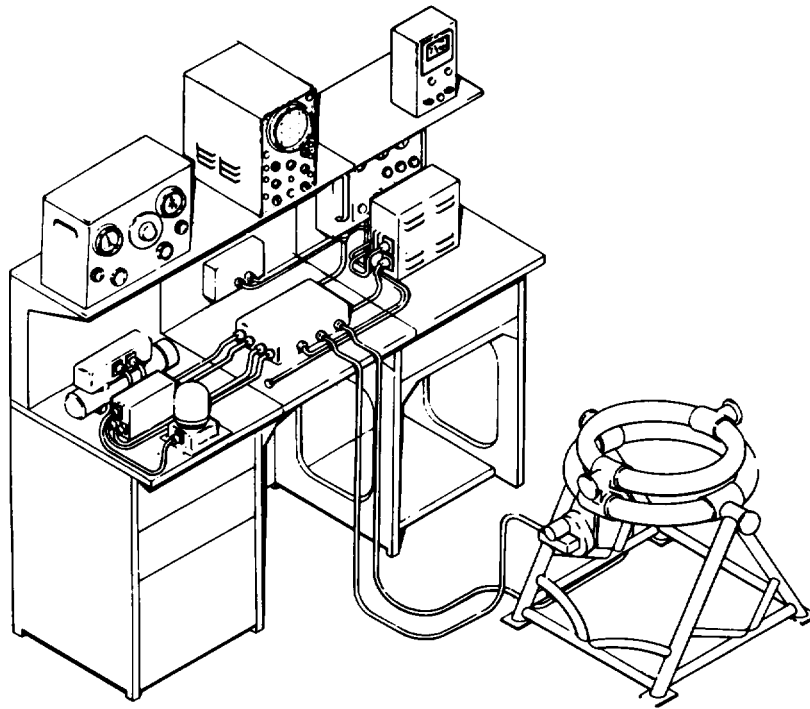

**FUNCTIONAL DESCRIPTION**

The Antenna Stabilizing Group OA-1375/APS62 is designed to maintain a level platform for a height finder antenna. It provides for the mounting of an AN/APS-62

height finder antenna and provides the additional pitch and roll stabilization required for airship installation. The system senses the roll and pitch of the airship and amplifies this error signal to drive a gimballed antenna mounting thereby maintaining the antenna level.

**ITEM NAME:** ANTENNA STABILIZING GROUP

**TYPE:** OA-1375/APS-62

**RELATION TO SIMILAR EQUIPMENT**

None.

**TECHNICAL DESCRIPTION**

Major Component Data

Gyroscope

Type: CN-42O/APS-62  
Type of Transmission System: Synchro  
Rotor Data  
Number of Rotors: 1 rotor  
RPM: 2400 rpm  
Type Reference: Vertical  
Operating Power Requirements: 26v ac, 400 cps, 1-ph

Amplifier Electronic Control

Type: AM-1612/APS-62  
Input Signal Channel Data  
Number of Channels: 2  
Type of Signal: Control transformer signal.  
Output Signal Channel Data

Number of Channels: 2  
Type of Signal: Generator field.  
Impedance Data  
Input: 270 to 500 ohms  
Output: 4000 ohms  
Operating Power Requirements: 115v ac, 400 cps, 1-ph, 2Bv dc.  
Amplifier, Audio Frequency  
Type: AM-1613/APS-62  
Number of Input Channels: 2  
Normal Operating Frequency: 400 cps  
Operating Power Requirements: 115v ac, 400 cps, 3-ph, 28v dc  
Motor-Generator  
Type: PU-379/APS-62  
Rated Input Voltage: 2Bv dc  
Rated Output Voltage: 28v dc

**INSTALLATION CONSIDERATIONS**

Related Equipment: The OA-1375/APS-62 is designed to be used with, but not part of AN/APS-62.

**PRINCIPAL COMPONENTS AND PHYSICAL DATA**

<b>COMPONENTS</b>	<b>QTY</b>	<b>OVERALL DIMENSIONS (Inches)</b>	<b>UNIT WT. (Pounds)</b>
Platform Antenna Pedestal AB-520/APS-62	1	26 x 44 x 53	
Amplifier, Electronic Control AM-1612/APS-62	1	6-7/8 x 9-7/8 x 11-1/4	
Interconnecting Box J-810/APS-62	1	3 x 7-7/8 x 12-7/8	
Amplifier, Audio Frequency AM-1613/APS-62	1	4-9/64 x 5-7/32 x 8-3/8	
Gyroscope CN-42O/APS-62	1		
Motor-Generator PU-379/APS-62	1	4-1/2 x 5-3/4 x 16-1/2	

**REFERENCE DATA AND LITERATURE**

Technical Manuals:  
NAVWEPS 16-45-787

DATE: 1 September 1964

ITEM NAME: DECODER GROUP

COGNIZANT SERVICE: USN

TYPE: OA-3369/APX-7

FEDERAL STOCK NUMBER:

	USA	USN	USAF	USMC
STATUS OR TYPE CLASSIFICATION Used by				

Mfg(s) Name or Code Number. Admiral Corporation (08128)

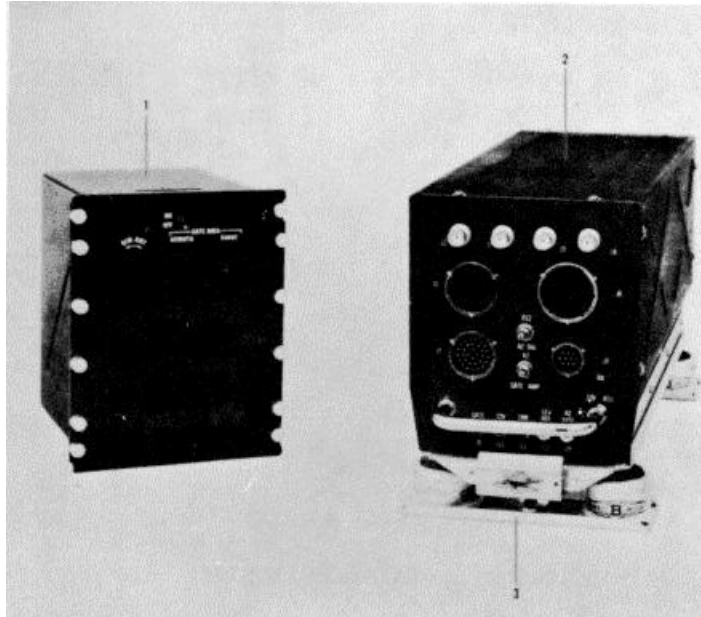

1. Control-Indicator C-3707/APX-7
2. Pulse Decoder KY-384/APX-7
3. Mounting MT-2648/APX-7

### FUNCTIONAL DESCRIPTION

Decoder Group OA-3369/APX-7 is a selective identification feature (SIF) decoding equipment designed for use in an airborne Mark X IFF system and is comprised of three units: Pulse Decoder, Video

Decoder and Control Indicator. Translation and read out of digital SIF codes are an integral function. Numerical display of code designations for three targets replying from a preset challenge sector is provided. The challenge sector is delimited by controls and circuitry within the Decoder Group units.

**ITEM NAME:** DECODER GROUP  
**TYPE:** OA-3369/APX-7

**RELATION TO SIMILAR EQUIPMENT**

None.

**TECHNICAL DESCRIPTION**

**Input Signals**

SIF Code Inputs: Mode 1, 2 or 3 reply pulses received from Video Decoder KY-364/APX via 12 parallel lines

Amplitude: 5.6v

Pulse Width: 0.5 usec

Polarity: Negative

Baseline: plus 11.2 plus or minus 0.6v dc

Read Gate: Gate pulse received from

Video Decoder KY-364/APX for ea SIF code train

Amplitude: 6v

Pulse Width: 0.13 usec

Polarity: Negative

Baseline: plus 11.2 plus or minus 0.6v dc

IFF Video Input: Video pulses received from Video Decoder KY-364/APX

Amplitude: 2v

Polarity: Positive

Baseline: Ground

Range-Azimuth Enabling Signals: Received from associated azimuth range indicator that has been modified to provide these signals

Azimuth Signals: 26v, 400 cyc reference voltage and phases 1 and 2 ranging from 0 to 22v rms

Range Strobe Pulse

Amplitude: 10 to 25v

Pulse Width: 1 plus or minus 0.7 usec

Polarity: Positive

Baseline: Ground

**Output Signals**

Video Output: Either same as IFF video input or mixed with range azimuth gate

Range Azimuth Gate: Series of pulses supplied to video input of associated azimuth range indicator for display at target sector gate

Amplitude: 2v

Polarity: Positive

Baseline: Ground

**Power Requirements**

Supply Voltage: 28 plus 1, -3v dc

Current

Decoding Circuitry: 0.73 amp at 28v

Indicator Lamps: 0.48 amp at 28v (max brightness)

Panel Lamps: 0.8 amp at 28v (max brightness)

Total Power Consumption: 36w nom

Reference Voltage from KY-364/APX: 11.2 plus or minus 6v dc

**INSTALLATION CONSIDERATIONS**

**Related Equipment**

Required but not Supplied: (1) Video Decoder KY-364/APX; (1) Radar Recognition Set AN/APX-7; \*(1) Azimuth Range Indicator IP-203B/APS-20B or IP-414A/APA-125 or IP-229/APA-56; \*\*(4) Cable Electrical; \*\*(4) Cable Coaxial.

**NOTE: \*Azimuth-Range Indicator must be modified for use with the pulse decoder and control indicator.**

**\*\*Fabricated at time of installation.**

**PRINCIPAL COMPONENTS AND PHYSICAL DATA**

<b>COMPONENTS</b>	<b>QTY</b>	<b>OVERALL DIMENSIONS (Inches)</b>	<b>UNIT WT. (Pounds)</b>
Pulse Decoder KY-384/APX-7	1	5-9/16 x 6-5/16 x 14-3/4	8.75
Control Indicator C-3707/APX-7	1	5-3/4 x 7-1/8 x 7-1/4	6.50
Mounting MT-2648/APX-7	1	2-1/8 x 5-3/4 x 14-1/4	1.00

**REFERENCE DATA AND LITERATURE**

**Technical Manuals:**

NAVWEPS 16-350A3369-1: Handbook of Operation instructions.

NAVWEPS 16-350A3369-2: Handbook of Service instructions.

NAVWEPS 16-350A3369-3: Handbook of Overhaul instructions.

NAVWEPS 16-350A3369-4: Illustrated Parts Breakdown.

DATE: 1 July 1964

ITEM NAME: RADAR OPERATOR TRAINING  
EQUIPMENT

COGNIZANT SERVICE: USN

TYPE: OU

FEDERAL STOCK NUMBER:

	USA	USN	USAF	USMC
STATUS OR TYPE CLASSIFICATION				

Mfg(s) Name or Code Number: Philco Corporation, Philadelphia, Pennsylvania

**Illustration not Available.**

**FUNCTIONAL DESCRIPTION**

The model OU is a device for producing the necessary signals to train personnel in the use of type ASE Aircraft Radar Equipment. It consists of Type

60AAE Radar Operator Trainer and 20ABD Rectifier Power Unit, with the necessary connecting cable.

The 20ABD Rectifier Power Unit operates from a power source of 100 to 130v ac with a frequency of 50 or 60 cycles. It delivers the necessary direct and alternating voltages to operate 60AAE Radar Operator

**OU: 1**



**ITEM NAME:** RADAR OPERATOR TRAINING EQUIPMENT

**TYPE:** OU

Trainer. The dc output voltage is regulated for both load and line voltage variations.

60AAE Radar Operator Trainer delivers four types of output signals at 175 megacycles, simulating the reflections observed with type ASE Aircraft Radar Equipment from the sea, the land, a ship or a convoy. These signals are fed into the ASE Radar Receiver and are observed on the equipment's Indicator. The output frequency can be adjusted between 170 and 180 megacycles.

**TECHNICAL DESCRIPTION**

Frequency Range: 170 to 180 mc  
 Type of Output Signal: Land, ship, sea or convoy.  
 Output Signal Pulse Duration  
     Ship: 3 usec  
     Convoy: 5 to 15 usec, adjustable range.  
     Land: 250 to 500 usec, adjustable range.  
     Sea: 40 to 80 usec, adjustable range.  
 Power Source Required: 100 to 130v, 50 or 60 cps, 1-ph.

**RELATION TO SIMILAR EQUIPMENT**

None.

**INSTALLATION CONSIDERATIONS**

Not available.

**PRINCIPAL COMPONENTS AND PHYSICAL DATA  
SHIPPING DATA**

<b>COMPONENTS</b>	<b>BOXES QTY (NR.)</b>	<b>OVERALL DIMENSIONS (Inches)</b>	<b>UNIT WT. (Pounds)</b>
Radar Operator Training Equipment Model OU	1		

**EQUIPMENT SUPPLIED DATA**

<b>COMPONENTS</b>	<b>QTY</b>	<b>OVERALL DIMENSIONS (Inches)</b>	<b>UNIT WT. (Pounds)</b>
Rectifier Power Unit NT-20ABD	1	9-7/16 x 9-11/16 x 12-3/4	30
Radar Operator Trainer NT-60AAE	1	11-13/16 x 12-3/16 x 21-1/16	42
Cord CD-567-T1	1	8 ft lg	1-1/4
Cord CD-568-T1	1	6 ft lg	5/8
Cord CD-569-T1	1	12 ft lg	1-5/8
Cord CD-570-T1	2	8 ft lg	1-1/4

**REFERENCE DATA AND LITERATURE**

Technical Manuals: NAVSHIPS 95194

**DATE:** 1 September 1964

**ITEM NAME:** SUPERSONIC RADAR REFLECTIVE  
AERIAL TOW TARGET

**COGNIZANT SERVICE:** USN

**TYPE:** AN/APS-31C

**FEDERAL STOCK NUMBER:** RM6920-953-9927

	USA	USN	USAF	USMC
STATUS OR TYPE CLASSIFICATION		Used by		
Mfg(s) Name or Code Number: Del Mar Engineering Lab Inc. (18666)				

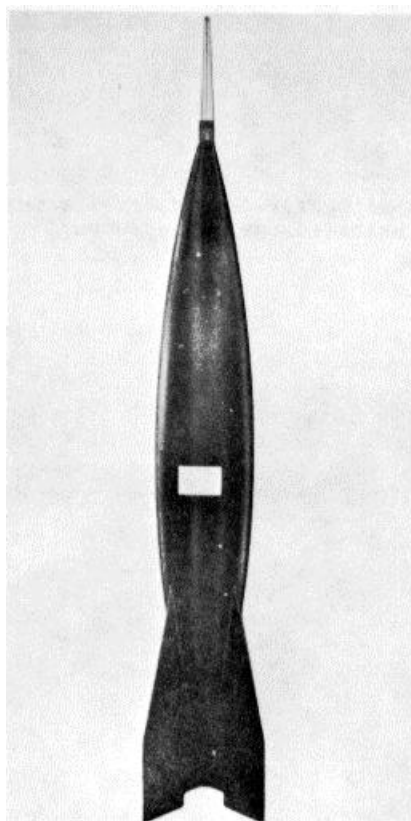

**FUNCTIONAL DESCRIPTION**

Supersonic Radar Reflective Aerial Tow Target TDU-21/B is designed to be towed by aircraft. The target is an

expendable component of a system for air-to-air weapons training at both subsonic and supersonic airspeeds.

**TDU-21/B: 1**

**ITEM NAME:** SUPERSONIC RADAR REFLECTIVE  
AERIAL TOW TARGET

**TYPE:** TDU-21/B

**RELATION TO SIMILAR EQUIPMENT**

None.

Air Speed Limitation: 630 knots equivalent air speed  
Mach Number Limitation: 1.5

**TECHNICAL DESCRIPTION**

Flight Rotation: 0.5 rpm (approx) per knot true air speed up to 1.2 mach, then constant beyond.  
Radar Reflective Source: 3 passive reflectors with multiple corners

**INSTALLATION CONSIDERATIONS**

Related Equipment  
Required but not Supplied: (1) Tow Reel; (1) Pilot's Control Unit; (1) Towline; (1) Launcher with Del Mar Model DL-6 Series Launcher Subassy.

**PRINCIPAL COMPONENTS AND PHYSICAL DATA**

<b>COMPONENT</b>	<b>QTY</b>	<b>OVERALL DIMENSIONS (Inches)</b>	<b>UNIT WT. (Pounds)</b>
Supersonic Radar Reflective Aerial Tow Target TDU-21/B	1	15 x 24 x 121	26

**REFERENCE DATA AND LITERATURE**

Technical Manuals:  
NAVWEPS 11-55BA-2: Handbook of Operation and Service instructions with Illustrated Parts Breakdown.

DATE: 1 July 1964

ITEM NAME: RADAR RECEIVER

COGNIZANT SERVICE: USN

TYPE: 46ACJ

FEDERAL STOCK NUMBER:

	USA	USN	USAF	USMC
STATUS OR TYPE CLASSIFICATION				
Mfg(s) Name or Code Number: Philco Corporation				

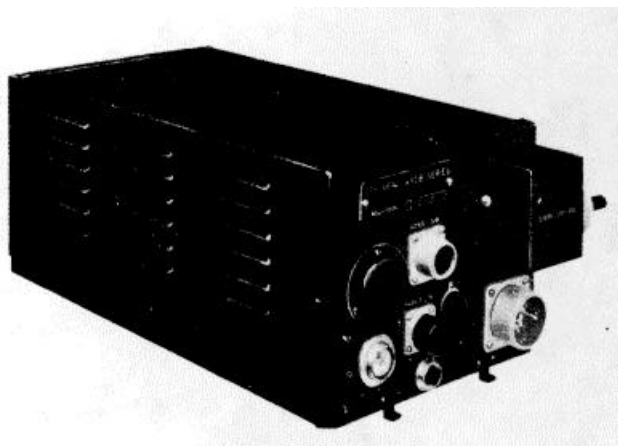

#### FUNCTIONAL DESCRIPTION

The purpose of 46ACJ is to detect and amplify any reflected signal which is received by the antennas during the intervals between pulses from the ASB Radar Transmitter. The signals are applied to the receiver through the Antenna Switching Unit. The reflected rf pulses are amplified, converted to an if. frequency of 55

mc, and again amplified and converted to a second if. frequency of 16 mc. After a third application, the signal is detected and applied as video pulses to a video amplifier, which drives the cathode follower output stage of the receiver. The output video pulses from the receiver are fed through the Antenna Switching Unit, which alternately transmits them to the horizontal deflection plates of the CRT in an indicator unit where they appear as target indications.

#### RELATION TO SIMILAR EQUIPMENT

None.

#### TECHNICAL DESCRIPTION

Frequency: 509 to 556 mc  
IF. Frequencies: 55 to 16 mc  
Operating Voltages: 6.3v, 6. 6 amp, 1-ph, 600 to 2400 cps

#### INSTALLATION CONSIDERATIONS

Not available.

#### PRINCIPAL COMPONENTS AND PHYSICAL DATA

COMPONENT	QTY	HEIGHT (Inches)	WIDTH (Inches)	DEPTH (Inches)	UNIT WT. (Pounds)
Radar Receiver NT-46ACJ	1	6-1/8	5-7/8	15-11/16	10

#### REFERENCE DATA AND LITERATURE

Technical Manual:  
NAVAER 08-5S-29

**SECTION 3**

**SHIPBORNE RADAR EQUIPMENT**

DATE: 1 July 1964

ITEM NAME: ELECTRONIC CONTROL AMPLIFIER

COGNIZANT SERVICE: USN

TYPE: \*AM-316/U, \*\*AM-317/U

FEDERAL STOCK NUMBER: \*5990-669-5186  
\*6110-669-6B02 W/S

\*\*5990-369-5185  
\*\*.5990-566-B754 W/S

	USA	USN	USAF	USMC
STATUS OR TYPE CLASSIFICATION				
Mfg(s) Name or Code Number: The Austin Company, Special Devices Div., New York, N. Y.				

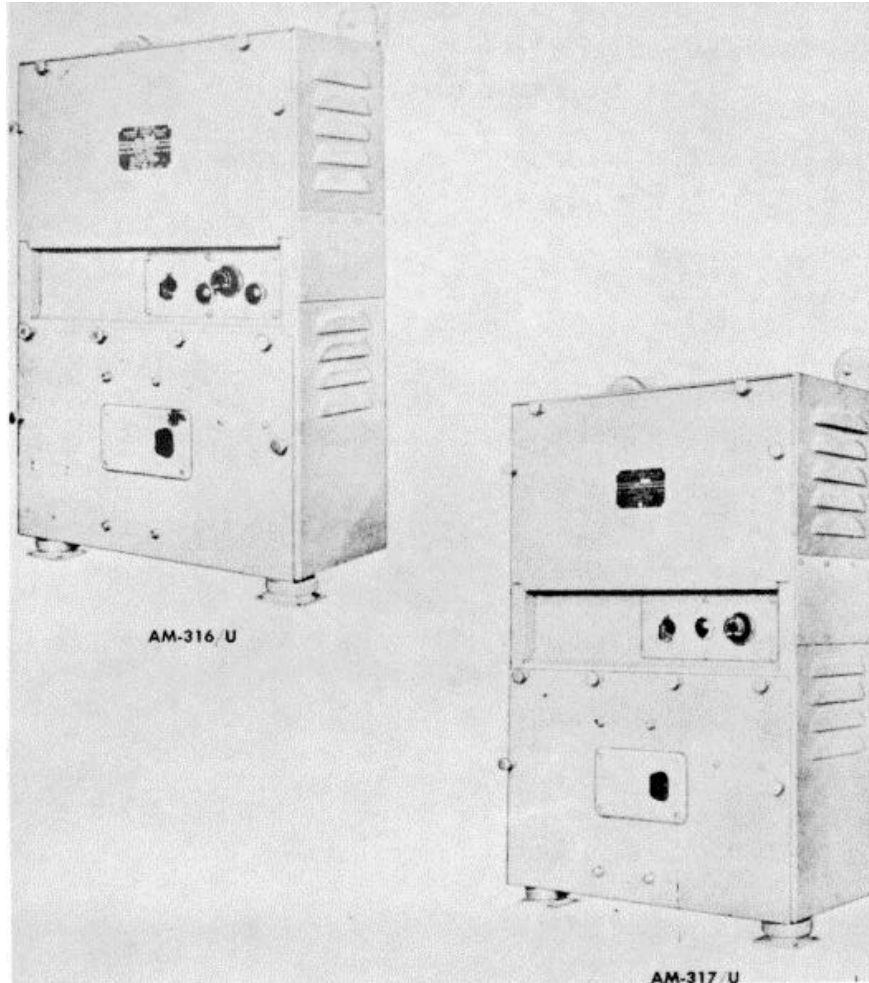

**FUNCTIONAL DESCRIPTION**

The AM-316/U and AM-317/U are self-contained units used as auxiliary items to shipboard synchro systems. The AM-316/U is a torque amplifier and data transmitter of synchro signals normally used to isolate a

heavy synchro load from the source generator. The synchro data output is an exact replica of the synchro data input, except that it will lag in phase relationship by the amount of the error voltage.

The AM-317/U is a differential mixer of two synchro signals and data transmitter of

**AM-316/U: 1**

**ITEM NAME:** ELECTRONIC CONTROL AMPLIFIER

**TYPE:** AM-316/U, AM-317/U

a composite synchro signal normally used to mix antenna bearing data and own ship's course bearing data for a composite data known as true bearing data. The synchro data output is a composite of two synchro data inputs which will be transmitted as a sum or difference of the two signals.

60 cps plus or minus 10%, single ph  
Power Requirements  
Normal Operation  
AM-316/U: 290 va at 80% pf  
AM-317/U: 70 va at 95% pf  
Heat Dissipation  
AM-316/U: 230w  
AM-317/U: 65w

**RELATION TO SIMILAR EQUIPMENT**

None.

**INSTALLATION CONSIDERATIONS**

**TECHNICAL DATA**

Power Supply: 110v plus or minus 10%,

Not available.

**PRINCIPAL COMPONENTS AND PHYSICAL DATA  
SHIPPING DATA**

COMPONENT	BOXES (NR)		OVERALL DIMENSIONS (Inches)	UNIT WT. (Pounds)
	AM-316/U	317/U		
Electronic Control Amplifier AM-316/U	1			142
Electronic Control Amplifier AM-317/U		1		149

**EQUIPMENT SUPPLIED DATA**

COMPONENT	QTY (NR)		OVERALL DIMENSIONS (Inches)	UNIT WT. (Pounds)
	AM-316/U	317/U		
Electronic Control Amplifier AM-316/U	1		10-1/8 x 18 x 29-3/16	102
Electronic Control Amplifier AM-317/U		1	10-1/8 x 18 x 29-3/16	109
Set of Equipment Spares	1	1	5 x 8 x 8	*
Technical Manual NAVSHIPS 91347	2	2	1/4 x 8-3/4 x 11-1/4	

**NOTE:** \* Included in weight of Amplifier.

**REFERENCE DATA AND LITERATURE**

Technical Manuals:  
NAVSHIPS 91347 for Electronic Control Amplifier AM-316/U and AM-317/U

DATE: 1 July 1964

ITEM NAME: ELECTRONIC CONTROL AMPLIFIER

COGNIZANT SERVICE: USN

TYPE: \*AM-420/U, \*\*AM-421/U

FEDERAL STOCK NUMBER: \*6110-507-9548 \*\*5990-369-5195  
\*6110-518-2934 W/S \*\*5990-566-8755 W/S

	USA	USN	USAF	USMC
STATUS OR TYPE CLASSIFICATION				
Mfg(s) Name or Code Number: Radio Corp. of America, RCA Victor Div., Camden, N. 3.				

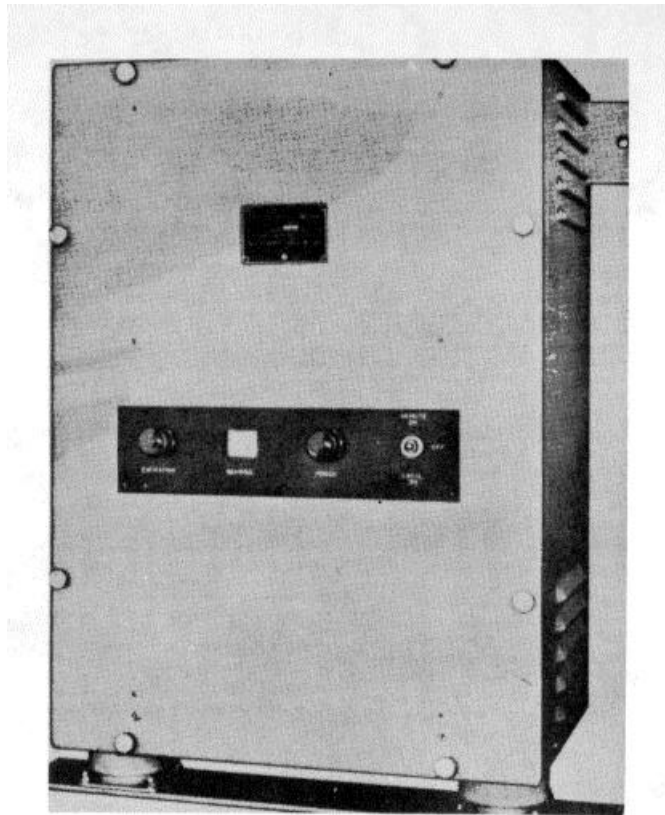

### FUNCTIONAL DESCRIPTION

The AM-420/U and AM-421/U are designed to isolate a high synchro-load requirement from a source having a limited output. They are single self-contained units which receives one or two-speed and 36-speed synchro

intelligence voltages. These voltages are applied to two synchro control transformers, and error voltages developed energize a servo motor which drives the control transformers to zero the error.

They also drive synchro differential generators which provide the output voltages of



**ITEM NAME:** ELECTRONIC CONTROL AMPLIFIER

**TYPE:** AM-420/U, AM-421/U

the unit and permit insertion of such additional intelligence as compass readings or the like. They incorporate a bearing dial which is also driven by the servo motor.

AM-420/U: 1 or 2-speed and/or 36-speed synchro, coarse-speed synchro generator.

AM-421/U: 1 or 2-speed and/or 36-speed synchro, coarse and fine-speed synchro generator.

**RELATION TO SIMILAR EQUIPMENT**

The AM-420/U and AM-421/U are basically similar. The AM-420/U has a coarse speed synchro generator only, while the AM-421/U has both coarse and fine speed synchro generators.

Accuracy  
Dynamic: plus or minus 5 minutes.  
Static: plus or minus 3 minutes.  
Power Requirements: 115v, 60 cps plus or minus 10%, 23w reference, 123w supply.  
Heat Dissipation  
AM-420/U: 156w  
AM-421/U: 168w

**TECHNICAL DESCRIPTION**

Input: 1 or 2-speed and/or 36-speed synchro.  
Output

**INSTALLATION CONSIDERATIONS**

Not available.

**PRINCIPAL COMPONENTS AND PHYSICAL DATA**

COMPONENT UNIT WT.	SHIPPING DATA BOXES		OVERALL DIMENSIONS (Pounds)
	(NR)	(Inches)	
Electronic Control Amplifier AM/420/U	1	21-1/4 x 30-1/4 x 37-3/4	264
Electronic Control Amplifier AM-421/U	1	21-1/4 x 30-1/4 x 37-3/4	273
Set of Equipment Spares	1	8-3/8 x 12-1/2 x 14-1/2	30

COMPONENT	QTY	EQUIPMENT SUPPLIED DATA	
		OVERALL DIMENSIONS (Inches)	UNIT WT. (Pounds)
AM-420/U Electronic Control Amplifier AM-420/U	1	14-1/4 x 21-1/8 x 26	128
Set of Equipment Spares	1	6 x 9 x 12	11
Technical Manual NAVSHIPS 91517	2	3/8 x B-3/4 x 11-1/2	
AM-421/U Electronic Control Amplifier AM-421/U	1	14-1/2 x 21-1/8 x 26	140
Set of Equipment Spares	1	6 x 9 x 12	11
Technical Manual NAVSHIPS 91518	2	3/8 x 8-3/4 x 11-1/2	

**REFERENCE DATA AND LITERATURE**

Technical Manuals:  
NAVSHIPS 91519 for Electronic Control Amplifier AM-420/U.  
NAVSHIPS 91518 for Electronic Control Amplifier AM-421/U.

**DATE:** 1 July 1964

**ITEM NAME:** AMPLIFIER ASSEMBLY

**COGNIZANT SERVICE:** USN

**TYPE:** AM-518/SSA

**FEDERAL STOCK NUMBER:** 5845-665-1564

	USA	USN	USAF	USMC
STATUS OR TYPE CLASSIFICATION				
Mfg(s) Name or Code Number: Pacific Division, Bendix Aviation Corp., North Hollywood, Calif.				

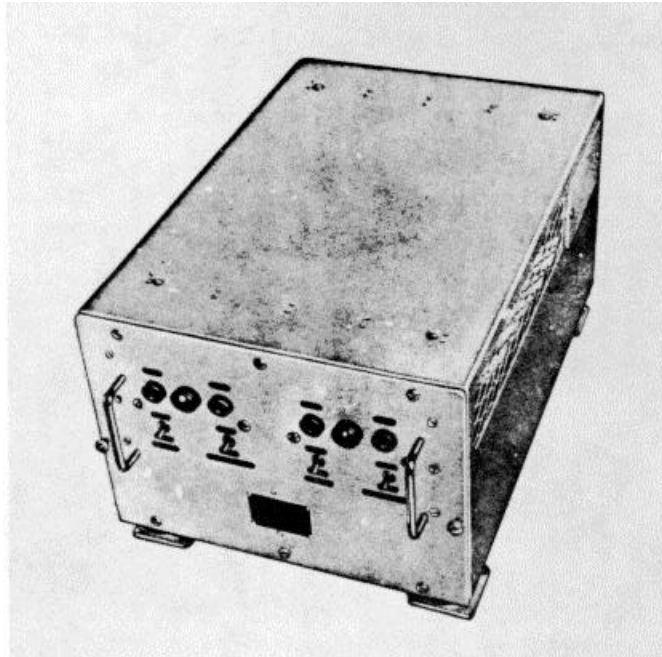

**FUNCTIONAL DESCRIPTION**

The AM-518/SSA is a Video Amplifier Assembly designed to distribute video data from one radar to eight banks of ten switches or from two radars to four banks of

ten switches. Two video inputs from each radar are provided to prevent operational failures due to battle damage or output tube failure. It maintains signal level from single input to a maximum of forty remote indicators.

**AM-518/SSA: 1**

**ITEM NAME:** AMPLIFIER ASSEMBLY

**TYPE:** AM-518/SSA

**RELATION TO SIMILAR EQUIPMENT**

None.

Frequency Data

Frequency Range: 100 cycle to 10mc,  
3 db over frequency range

Operating Power Requirement: 115v ac, 60  
cps, single ph

**TECHNICAL DESCRIPTION**

Input Data

Number of Channels: 2 channels  
Impedance: 70 ohms ea channel

Output Data

Number of Channels: 2 channels  
Impedance: 50 ohms ea channel

Over-all Gain: 1 to 4v

**INSTALLATION CONSIDERATIONS**

Related Equipment: The AM-S1B/SSA is de-  
signed to be used with but not part of  
Radio Frequency Switching Group (A-266/ SSA)  
The AM-51B/SSA is designed as part of  
Data Distribution Group for Naval Vessels.

**PRINCIPAL COMPONENTS AND PHYSICAL DATA**

<b>COMPONENT</b>	<b>QTY</b>	<b>OVERALL DIMENSIONS (Inches)</b>	<b>UNIT WT. (Pounds)</b>
Amplifier Assy AM-51B/SSA	1	13.5 x 17.31 x 26.	53

**REFERENCE DATA AND LITERATURE**

Technical Manuals:

NAVSHIPS 91639(A) for Data Switch Group  
0--266/SSA, OA-266A/SSA and OA-266B/SSA.

Nomenclature Card for Amplifier Assembly

AM-518/SSA.

AM-51B/SSA: 2

**AM-518/SSA: 2**

DATE: 1 September 1964

ITEM NAME: TRIGGER PULSE AMPLIFIER

COGNIZANT SERVICE: USN

TYPE: AM-1913A/UP

FEDERAL STOCK NUMBER: 2F5840-823-6080

	USA	USN	USAF	USMC
STATUS OR TYPE CLASSIFICATION		Used by		
Mfg(s) Name or Code Number: General Instrument Corp., Radio Receptor Division (05828)				

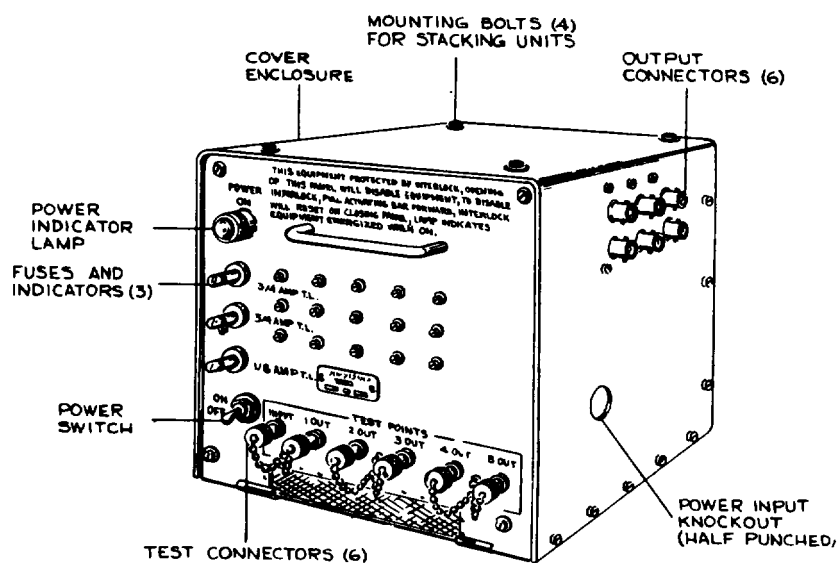

### FUNCTIONAL DESCRIPTION

Trigger Pulse Amplifier AM-1913A/UP is designed to provide from one to five simultaneous and identical triggering pulses for radar indicating equipments when a

proper input pulse is present. The AM-1913A/UP can accept trigger pulses from a radar receiver, radar signal distribution switchboard, or similar equipments, and distribute an output pulse to as many as five indicators.

AM-1913A/UP: 1

**ITEM NAME:** TRIGGER PULSE AMPLIFIER

Trigger Amplifier Assembly Output Signal  
Impedance: 75 ohms (output)

**TYPE:** AM-1913A/UP

Pulse Polarity: Pos

**RELATION TO SIMILAR EQUIPMENT**

Peak Pulse Amplitude: 20 plus or minus 5v

None.

Duration: 1 to 10 usec at 50% peak

Rise Time: 0.2 usec or less

Power Supply Assy

Input: 115v, 60 cyc, 1-ph

Output: 105v dc (B plus); 6.3v, 60 cyc,  
1-ph (fill)

**TECHNICAL DESCRIPTION**

Trigger Pulse Amplifier Input Signal

Impedance: 75 ohms (input)

Pulse Polarity: Pos

Peak Pulse Amplitude: 5v min, 55v max

Repetition Rate: 10 to 5000 pps

**INSTALLATION CONSIDERATIONS**

Not available.

**PRINCIPAL COMPONENTS AND PHYSICAL DATA**

<b>COMPONENT</b>	<b>QTY</b>	<b>OVERALL DIMENSIONS (Inches)</b>	<b>UNIT WT. (Pounds)</b>
Trigger Pulse Amplifier AM-1913A/UP	1	8-1/4 x 9-3/4 x 12	13

**SHIPPING DATA**

<b>COMPONENT</b>	<b>PKGS</b>	<b>OVERALL DIMENSIONS (Inches)</b>	<b>UNIT WT. (Pounds)</b>
	1	18.1	17

**REFERENCE DATA AND LITERATURE**

Technical Manuals:  
NAVSHIPS 94621

**AM-1913A/UP: 2**

DATE: 1 September 1964

ITEM NAME: TRIGGER PULSE AMPLIFIER

COGNIZANT SERVICE: USN

TYPE: AM-1913B/UP

FEDERAL STOCK NUMBER: 2F5840-957-4600

	USA	USN	USAF	USMC
STATUS OR TYPE CLASSIFICATION		Used by		
Mfg(s) Name or Code Number: Electro International Incorporated				

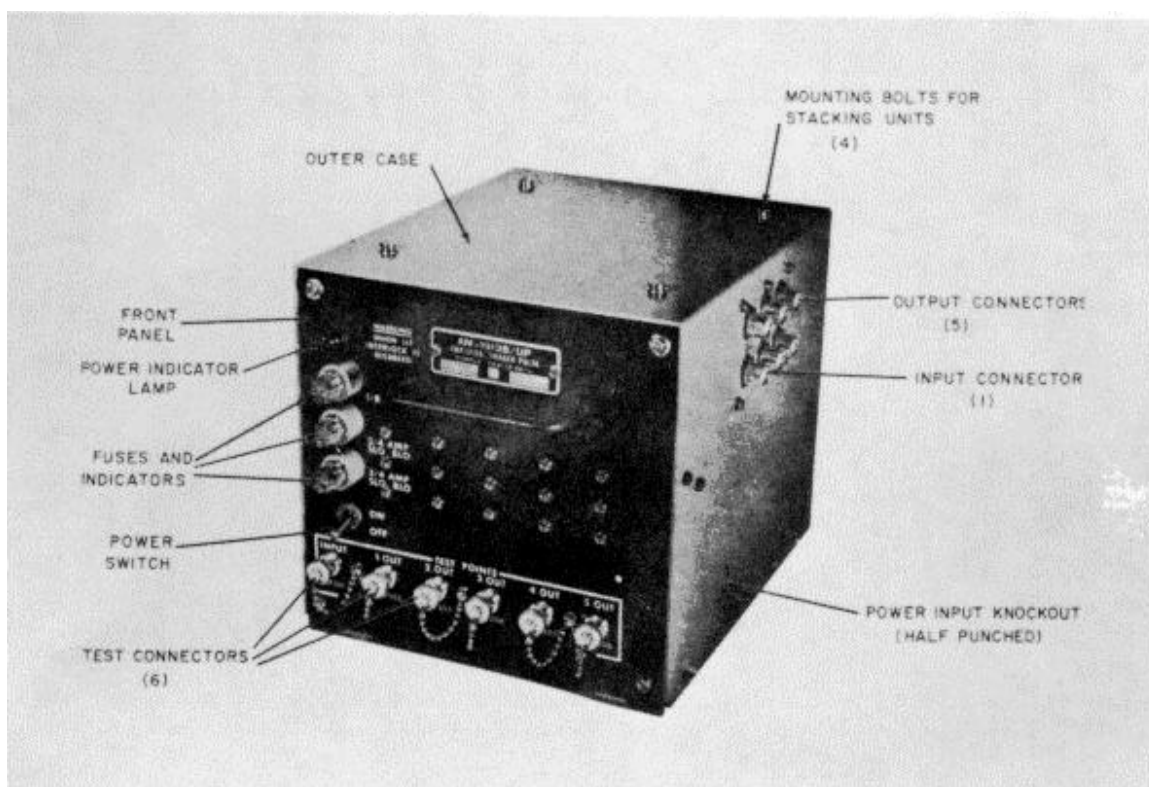

### FUNCTIONAL DESCRIPTION

Trigger Pulse Amplifier AM-1913B/UP is designed to provide from one to five simultaneous and identical triggering pulses for radar indicating equipments when a

proper input pulse is present. The AM-1913B/UP can accept trigger pulses from a radar receiver, radar signal distribution switchboard, or similar equipments, and distribute an output pulse to as many as five indicators.

AM-1913B/UP: 1

**ITEM NAME:** TRIGGER PULSE AMPLIFIER

**TYPE:** AM-1913B/UP

**RELATION TO SIMILAR EQUIPMENT**

None.

Delay: 0.5 to 2.5 usec can be made between input and output signals  
Power Supply Assy  
Input: 115v, 60 cyc, 1-ph, 33w  
Output: 105v dc (B plus); 6.3v, 60 cyc, 1-ph (fill)  
Ambient Temperature  
Storage: -62 to plus 750C (-79 to plus 1670F)  
Operating: 0 to plus 500C (plus 32 to plus 1220F)

**TECHNICAL DESCRIPTION**

Trigger Pulse Amplifier Input Signal  
Impedance: 75 ohms (input)  
Pulse Polarity: Pos  
Peak Pulse Amplitude: 5.0 to 55v max  
Duration: 0.3 to 25 usec  
Repetition Rate: 10 to 5000 pps  
Trigger Regenerator Output Signal  
Impedance: 75 ohms (output)  
Pulse Polarity: Pos  
Peak Pulse Amplitude: 20 plus or minus 5v  
Duration: 2 to 5 usec  
Repetition Rate: 10 to 5000 pps

**INSTALLATION CONSIDERATION**

Not available.

**PRINCIPAL COMPONENTS AND PHYSICAL DATA**

<b>COMPONENT</b>	<b>QTY</b>	<b>OVERALL DIMENSIONS (Inches)</b>	<b>UNIT WT. (Pounds)</b>
Trigger Pulse Amplifier AM-1913B/UP	1	8-13/16 x 9-5/8 x 12	13

**SHIPPING DATA**

<b>COMPONENT</b>	<b>PKGS</b>	<b>VOLUME (CU FT)</b>	<b>UNIT WT. (Pounds)</b>
	1	18.1	17

**REFERENCE DATA AND LITERATURE**

Technical Manuals:  
NAVSHIPS 95760

DATE: 1 September 1964

ITEM NAME: TRIGGER PULSE AMPLIFIER

COGNIZANT SERVICE: USN

TYPE: AM-1913/UP

FEDERAL STOCK NUMBER: 2F5840-539-7919

	USA	USN	USAF	USMC
STATUS OR TYPE CLASSIFICATION		Used by		
Mfg(s) Name or Code Number: Admiral Corporation (70117)				

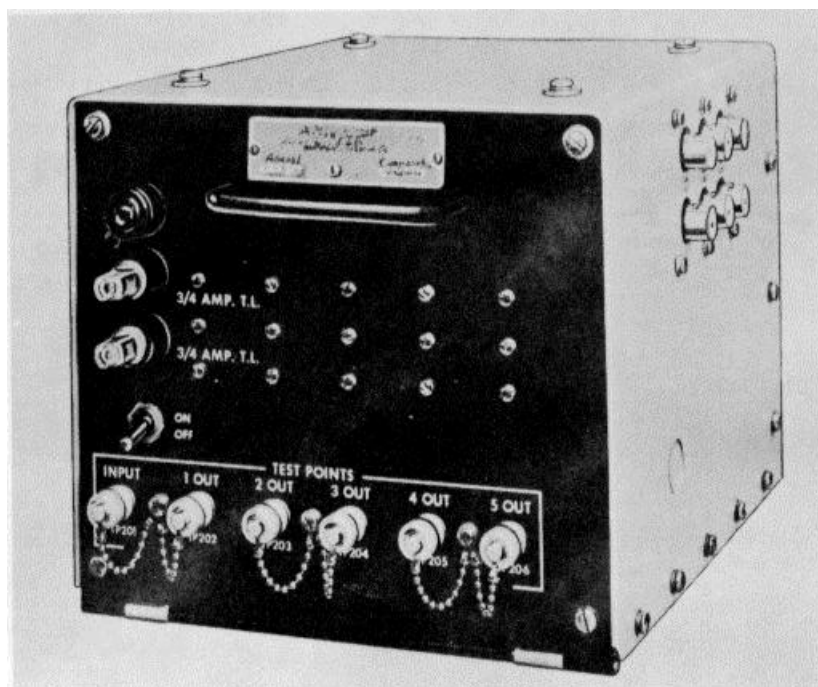

### FUNCTIONAL DESCRIPTION

Trigger Pulse Amplifier AM-1913/UP is designed to provide from one to five simultaneous and identical triggering pulses for radar indicating equipments when a

proper input pulse is present. The AM-1913/UP can accept trigger pulses from a radar receiver, radar signal distribution switchboard, or similar equipments, and distribute an output pulse to as many as five indicators.

AM-1913/UP: 1



**ITEM NAME:** TRIGGER PULSE AMPLIFIER

**TYPE:** AM-1913/UP

**RELATION TO SIMILAR EQUIPMENT**

None.

**TECHNICAL DESCRIPTION**

Trigger Pulse Amplifier Input Signal  
Impedance: 75 ohms (input); 75 ohms  
(output)  
Pulse Polarity: Pos  
Peak Pulse Amplitude: 10v min  
Repetition Rate: 20 to 4100 pps  
Trigger Regenerator Output Signal  
Impedance: 75 ohms (input); 75 ohms  
(output)

Pulse Polarity: Pos  
Peak Pulse Amplitude: 20 plus or minus 5v  
Duration: 2 to 5 usec at 50% nom peak  
Rise Time: 0.2 usec or less  
Delay: 0.5 to 2.5 usec can be made be-  
tween the input and output signals  
Power Supply Assy  
Input: 115v, 60 cyc, 1-ph  
Output: 105v dc (B plus); 6.3v, 60 cyc,  
1-ph (fil)

**INSTALLATION CONSIDERATION**

Not available.

**PRINCIPAL COMPONENTS AND PHYSICAL DATA**

<b>COMPONENT</b>	<b>QTY</b>	<b>OVERALL DIMENSIONS (Inches)</b>	<b>UNIT WT. (Pounds)</b>
Trigger Pulse Amplifier AM-1913/UP	1	8-3/16 x 9-1/2 x 11-7/8	19

**SHIPPING DATA**

<b>COMPONENT</b>	<b>PKGS</b>	<b>OVERALL DIMENSIONS (Inches)</b>	<b>UNIT WT. (Pounds)</b>
	1	18.	1 28

**REFERENCE DATA AND LITERATURE**

Technical Manuals:  
NAVSHIPS 93222

DATE: 1 September 1964

ITEM NAME: VIDEO AMPLIFIER

COGNIZANT SERVICE: USN

TYPE: AM-1914A/UP

FEDERAL STOCK NUMBER: 2F5840-823-6081

	USA	USN	USAF	USMC
STATUS OR TYPE CLASSIFICATION		Used by		
Mfg(s) Name or Code Number: General Instrument Corp., Radi Receptor Div., (05828)				

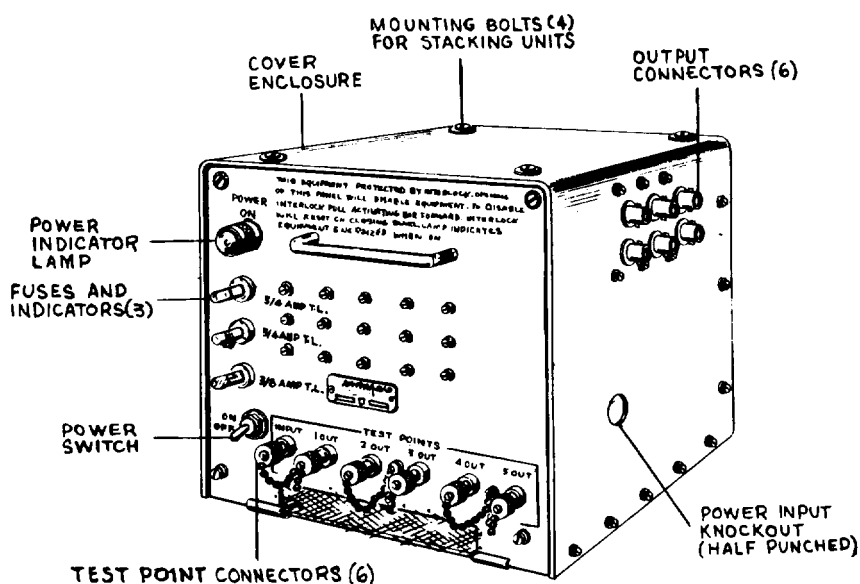

### FUNCTIONAL DESCRIPTION

Video Amplifier AM-1914A/UP is designed to distribute pulsed radar video information. It can accept video signals from a radar receiver, radar signal distribution switchboard, or other similar equipment; and

distribute the signals with minimum loss and distortion to as many as five separate indicators. The distribution function is accomplished by paralleling the high impedance inputs of five identical plug-in video amplifier subassemblies across a video signal input, and obtaining the

**ITEM NAME:** VIDEO AMPLIFIER

**TYPE:** AM-1914A/UP  
reproduced signal from each plug-in amplifier subassembly output.

**RELATION TO SIMILAR EQUIPMENT**

None.

**TECHNICAL DESCRIPTION**

Input and Output Characteristics  
 Number of Channels: 1 radar video input;  
 5 radar video outputs  
 Impedance: 75 ohm non-inductive resistor  
 input line termination; ext. dc resistance of 75 ohms read at end of ea output cable.  
 Pulse Polarity: Pos video input; pos video output  
 Peak Pulse Amplitude: 0.2 to 3.0v input (2.0v nom) voltage; output voltage of ea channel is the same value as the input voltage plus or minus 5%  
 Input Signal Pulse Duration: 1500 usec max  
 Bandpass: Within plus or minus 0.5 db from 1000 cps to 4 mc, within 3 db from 60 cps to 10 mc, and 6 db up to 13 mc referenced to response at 1 mc  
 Maximum Duty Cycle for Distortion-Free

Amplification: 70% duty cycle  
 Input-Voltage to Output Voltage Gain: 1:1 nom; ea output channel gain ratio is adjustable from 0.8:1 to 1.2:1  
 Input Signal Connection Facilities: 1 coaxial cable connector for ea input chan.  
 Output Signal Connection Facilities: 1 coaxial cable connector for ea output channel  
 Video Output: Pos video signals across 75 ohms non-inductive resistive load are equal to the amplitude of the input signal  
 Power Supply Assy  
 Input: 115v, 60 cyc, 1-ph, 55w  
 Output: 105v dc (B plus); 6.3v, 60 cyc, 1-ph (fil)  
 Ambient Temperature  
 Storage: -62 to plus 75°C (-79 to plus 167°F)  
 Operating: 0 to plus 50°C (plus 32 to 122°F)

**INSTALLATION CONSIDERATION**

Not available.

**PRINCIPAL COMPONENTS AND PHYSICAL DATA**

COMPONENT	QTY	OVERALL DIMENSIONS (Inches)	UNIT WT. (Pounds)
Video Amplifier AM-1914A/UP	1	8-1/4 x 9-3/4 x 12	16

**SHIPPING DATA**

COMPONENT	PKGS	OVERALL DIMENSIONS (Inches)	UNIT WT. (Pounds)
	1	18.1	17

**REFERENCE DATA AND LITERATURE**

Technical Manuals:  
 NAVSHIPS 94622

DATE: 1 September 1964

ITEM NAME: VIDEO AMPLIFIER

COGNIZANT SERVICE: USN

TYPE: AM-1914B/UP

FEDERAL STOCK NUMBER: 2F5840-957-4601

	USA	USN	USAF	USMC
STATUS OR TYPE CLASSIFICATION		Used by		
Mfg(s) Name or Code Number. Electro International Incorporated				

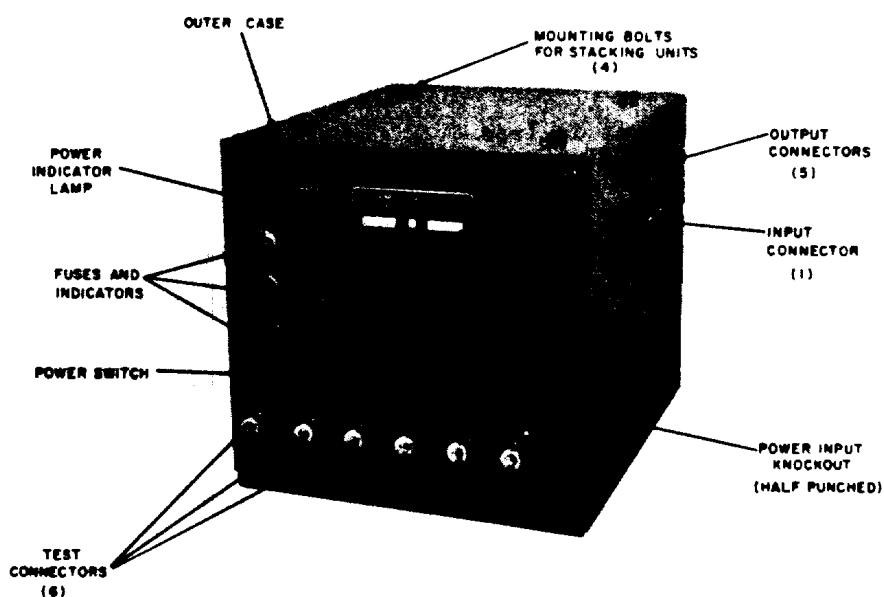

### FUNCTIONAL DESCRIPTION

Video Amplifier AM-1914B/UP is designed to distribute pulsed radar video information. It can accept video signals from a radar receiver, radar signal distribution switchboard, or other similar equipment; and

distribute the signals with minimum loss and distortion to as many as five separate indicators. The distribution function is accomplished by paralleling the high impedance inputs of five identical plug-in video amplifier subassemblies across a video signal input, and obtaining the reproduced signal from

AM-1914B/UP: 1

**ITEM NAME:** VIDEO AMPLIFIER

**TYPE:** AM-1914B/UP

each plug-in amplifier subassembly output.

**RELATION TO SIMILAR EQUIPMENT**

None.

**TECHNICAL DESCRIPTION**

Input and Output Characteristics  
 Number of Channels: 1 radar video input;  
 5 radar video outputs  
 Impedance: 75 ohm non-inductive resistor input line termination; ext dc resistance of 75 ohms reed at end of ea output cable  
 Pulse Polarity: Pos video input; pos video output  
 Peak Pulse Amplitude: 0.2 to 3.0v input (2.0v nom) voltage; output voltage of ea channel is the same value as the input voltage plus or minus 5%  
 Input Signal Pulse Duration: 0.1 to 1500 usec  
 Bandpass  
 Upper Frequency: 3 db point exceeds 10 mc  
 Lower Frequency: 3 db point is less than 60 cyc; flat within plus or

minus 0.5 db from 1 kc to 6 mc  
 Maximum Duty Cycle for Distortion-Free Amplification: 70% duty cycle  
 Input-Voltage to Output-Voltage Gain Ratio: 1:1 nom, ea output channel gain ratio is adjustable from 0.85:1 to 1.2:1  
 Input Signal Connection Facilities: 1 coaxial cable connector for input channel  
 Output Signal Connection Facilities: 1 coaxial cable connector for ea output channel  
 Video Output: Pos video signals across 75 ohm non-inductive resistive load are equal to the amplitude of the input load  
 Power Supply Assy  
 Input: 115v, 60 cyc- 1-ph, 62w  
 Output: 105v dc (B plus); 6.3v, 60 cyc, 1-ph (fill)  
 Ambient Temperature  
 Storage: -62 to plus 750C (-79 to 167UF)  
 Operating: 0 to plus 500C (plus 32 to plus 1220F)

**INSTALLATION CONSIDERATION**

Not available.

**PRINCIPAL COMPONENTS AND PHYSICAL DATA**

COMPONENT	QTY	OVERALL DIMENSIONS (Inches)	UNIT WT. (Pounds)
Video Amplifier AM-1914B/UP	1	8-13/16 x 9-5/8 x 12	22.50

**SHIPPING DATA**

COMPONENT	PKGS	OVERALL DIMENSIONS (Inches)	UNIT WT. (Pounds)
	1	18.1	25.5

**REFERENCE DATA AND LITERATURE**

Technical Manuals:  
NAVSHIPS 95761

**AM-1914B/UP: 2**

DATE: 1 September 1964

ITEM NAME: VIDEO AMPLIFIER

COGNIZANT SERVICE: USN

TYPE: AM-1914/UP

FEDERAL STOCK NUMBER: 2F5895-627-8404

	USA	USN	USAF	USMC
STATUS OR TYPE CLASSIFICATION		Used by		
Mfg(s) Name or Code Number: Admiral Corporation (70117)				

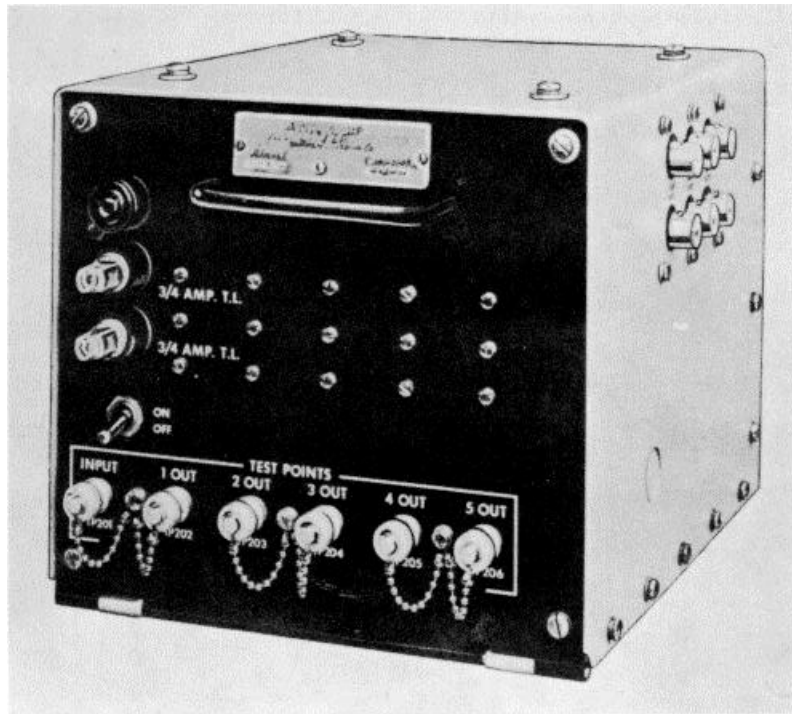

### FUNCTIONAL DESCRIPTION

Video Amplifier AM-1914/UP is designed to distribute pulsed radar video information. It can accept video signals from a radar receiver, radar signal distribution switchboard, or other similar equipment; and distribute

the signals with minimum loss and distortion to as many as five separate indicators. The distribution function is accomplished by paralleling the high impedance inputs of five identical plug-in video amplifier subassemblies across a video signal input, and obtaining the re

AM-1914/UP: 1

**ITEM NAME:** VIDEO AMPLIFIER

**TYPE:** AM-1914/UP

produced signal from each plug-in amplifier subassembly output.

minus 0.5 db from 1 kc to 6 mc  
Maximum Duty Cycle for Distortion-Free Amplification: 65% duty cycle  
Input-Voltage to Output-Voltage Gain Ratio: 1:1 nom; ea output channel gain ratio is adjustable from 0.85:1 to 1.2:1

**RELATION TO SIMILAR EQUIPMENT**

None.

**TECHNICAL DESCRIPTION**

Input and Output Characteristics  
Number of Channels: 1 radar video input; 5 radar video outputs  
Impedance: 75 ohm non-inductive resistor input line termination; ext dc resistance of 75 ohms read at end of ea output cable  
Pulse Polarity: Pos video input; pos video output  
Peak Pulse Amplitude: 0.2 to 3.0v input (2.0v nom) voltage; output voltage of ea channel is the same value as the input voltage plus or minus 5%  
Input Signal Pulse Duration: 0o.15 to 1000 usec  
Bandpass  
Upper Frequency: 3 db point exceeds 10 mc  
Lower Frequency: 3 db point is less than 60 cyc; flat within plus or

Input Signal Connection Facilities: 1 coaxial cable connector for input channel  
Output Signal Connection Facilities: 1 coaxial cable connector for ea output channel  
Video Output: Pos video signals across 75 ohms non-inductive resistive load are equal to the amplitude of the input signal  
Power Supply Assy  
Input: 115v, 60 cyc, 1-ph, 55w  
Output: 105v dc (B plus); 6.3v, 60 cyc, 1-ph (fil)  
Ambient Temperature  
Storage: -62 to plus 750C (-79 to plus 167UF  
Operating: 0 to plus 500C (plus 32 to plus 122°F)

**INSTALLATION CONSIDERATION**

Not available.

**PRINCIPAL COMPONENTS AND PHYSICAL DATA**

COMPONENT	QTY	OVERALL DIMENSIONS (Inches)	UNIT WT. (Pounds)
Video Amplifier AM-1914/UP	1	8-1/4 x 9-3/4 x 11-23/3'2	19

**SHIPPING DATA**

COMPONENT	PKGS	OVERALL DIMENSIONS (Inches)	UNIT WT. (Pounds)
	1	18	.1 28

**REFERENCE DATA AND LITERATURE**

Technical Manuals:  
NAVSHIPS 93219

DATE: 1 July 1964

ITEM NAME: ANTENNA GROUP

COGNIZANT SERVICE: USN

TYPE: AN/BPA-5

FEDERAL STOCK NUMBER:

	USA	USN	USAF	USMC
STATUS OR TYPE CLASSIFICATION				
Mfg(s) Name or Code Number: Philco Corporation				

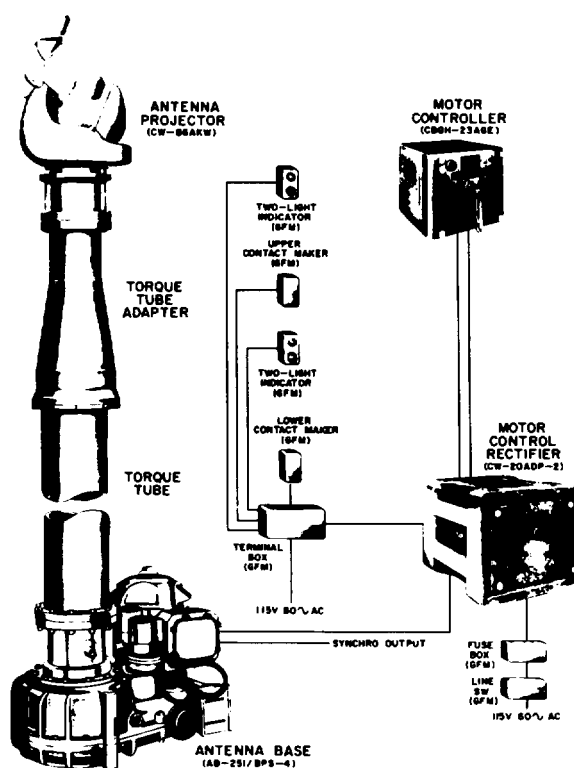

**FUNCTIONAL DESCRIPTION**

Antenna Group AN/BPA-5 provides a retractable antenna positioning system for submarine search radars SS-a, SS-1, SS-2 and AN/ BPS-4. The antenna

extends through a standard periscope housing and permits search operation while the submarine is submerged. The antenna may be rotated through 360 degrees at 6 rpm or may be used for sector scanning.



**ITEM NAME:** ANTENNA GROUP

**TYPE:** AN/BPA-5

**RELATION TO SIMILAR EQUIPMENT**

None.

db down  
Scanning Rate: 0 to 6 rpm, cw and ccw  
Bearing Accuracy: plus or minus 1 deg  
in azimuth  
Synchro Outputs: 1X speed and 36X speed.  
R-F Operating Frequency: 8740 to 8890 mc  
Peak R-F Power: 75 to 110 kw  
Operating Power Requirements: 115v ac,  
60 cps, single ph, 325w

**TECHNICAL DESCRIPTION**

R-F Lines  
Type: Waveguide type RG-51/U  
Outside Dimensions: 5/8 x 1-1/4 in.  
Thickness: 1/16 in.  
Antenna Projector  
Type: CW-66AKW  
Beam Width  
Horizontal: 2.6 deg  
Vertical: 16 deg  
Polarization: Horizontal  
Minor Lobes (SS): 21 db down (one way)  
at 5 deg ea side; all other over 25

**INSTALLATION CONSIDERATIONS**

Related Equipment: (Required but not  
Supplied) (1) Torque Tube (7-1/2 or  
9 in. Overall Dimensions approx 38  
ft); (1) Technical Manual for Radar  
Equipments Navy Model SS-a, SS-1, and  
SS-2 NAVSHIPS 91513.

**PRINCIPAL COMPONENTS AND PHYSICAL DATA**

COMPONENT	QTY	OVERALL DIMENSIONS (Inches)	UNIT WT. (Pounds)
Antenna Base AB-251/BPS-5	1	18-3/4 x 24-3/16 x 28	675
Antenna Projector CW-66AKW	1	17-1/8 x 28-13/32 x 30	200
Motor Control Rectifier CW-20ADP-2	1	17-3/8 x 19-3/8 x 26-3/4	340
Motor Controller 1 13-1/16 x 13-1/8 x 14 50 CBGH-23AGE			

**SHIPPING DATA**

COMPONENT	PKGS	OVERALL DIMENSIONS (Inches)	UNIT WT. (Pounds)
AB-251/BPS-5	1		735
CW-66AKW	1		300
CW-20ADP-2	1		440
CBGH-23AGE	1		100

**REFERENCE DATA AND LITERATURE**

Technical Manuals:  
NAVSHIPS 93169

DATE: 1 July 1964

ITEM NAME: ANTENNA GROUP

COGNIZANT SERVICE: USN

TYPE: AN/BPA-4

FEDERAL STOCK NUMBER:

	USA	USN	USAF	USMC
STATUS OR TYPE CLASSIFICATION				

Mfg(s) Name or Code Number: Philadelphia Naval Shipyard, Philadelphia, Pa.

No Illustration Available.

**FUNCTIONAL DESCRIPTION**

The AN/BPA-4 provides a retractable positioning system for submarine search radars SS-A, SS-1, and SS-2. It permits search operation while submerged

(with two (2) vertical antenna positions). The antenna group does not include the antenna or below decks consoles. The group extends through a standard periscope housing. A rotation of 360 deg (continuous) at six (6) rpm or sector scan is provided.

**AN/BPA-4: 1**

**ITEM NAME:** ANTENNA GROUP

**TYPE:** AN/BPA-4

**RELATION TO SIMILAR EQUIPMENT**

None.

**TECHNICAL DESCRIPTION**

Not available.

**INSTALLATION CONSIDERATIONS**

Related Equipment: The AN/BPA-4 is designed to be used with, but not part of, Radar Set SS-A, SS-1, SS-2.

**PRINCIPAL COMPONENTS AND PHYSICAL DATA**

<b>COMPONENTS</b>	<b>QTY</b>	<b>OVERALL DIMENSIONS (Inches)</b>	<b>UNIT WT. (Pounds)</b>
Drive Mechanism for Radar Model SV-3	1		
Adapter, Antenna to SV-3 Waveguide	1		
Adapter, SS below-decks equipment to SV-3 Waveguide	1		

**REFERENCE DATA AND LITERATURE**

Technical Manuals:  
NAVSHIPS 93400

**AN/BPA-4: 2**

DATE: 1 July 1964

ITEM NAME: RADAR SET

COGNIZANT SERVICE: USN

TYPE: AN/BPS-4

FEDERAL STOCK NUMBER: F5840-548-7666  
F5840-669-8067 W/S

	USA	USN	USAF	USMC
STATUS OR TYPE CLASSIFICATION Ltd Std				

Mfg(s) Name or Code Number: Westinghouse Electric Corp., Baltimore, Maryland

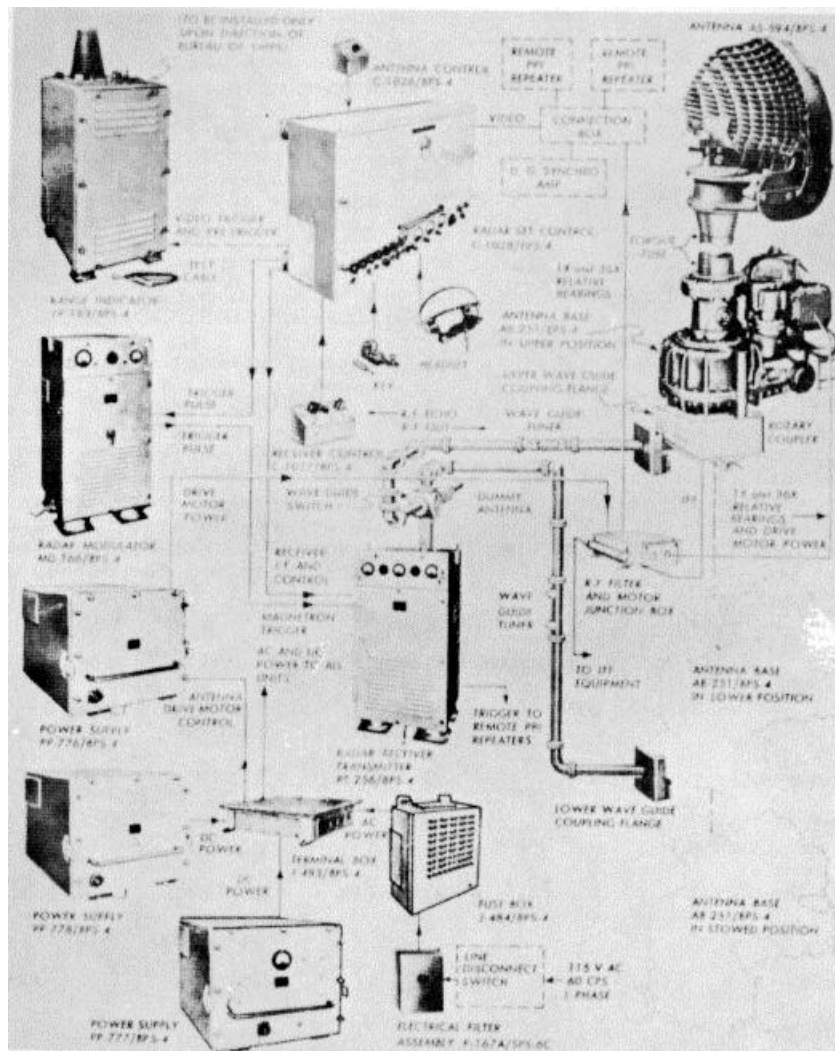

**FUNCTIONAL DESCRIPTION**

The AN/BPS-4 is a short range air and surface search radar designed primarily for installation on submarines. The primary objective is to detect aircraft targets and provide range and bearing information at

ranges up to 30,000 yards at altitudes up to 10,000 feet. The secondary objective is to detect and give range and bearing information on surface targets at any range up to 30,000 yards when the submarine is fully surfaced. It may also be used as a keyed communications transmitter.

**ITEM NAME:** RADAR SET

**TYPE:** AN/BPS-4

The AN/BPS-4 provides the necessary trigger pulses, intermediate frequency (IF) output and synchro bearing information to present its radar display on the Radar Set AN/BPS-1 or Model SS-1.

The antenna feed system on Radar Set AN/BPS-4 is capable of operating with Radar Recognition Set AN/UPX-( ). A synchronizing output is provided for triggering the radar recognition equipment. It is also designed to provide one speed and 36 speed azimuth bearing, video, and synchronizing signals, to two Navy Model VK series repeaters.

**RELATION TO SIMILAR EQUIPMENT**

None.

**TECHNICAL DESCRIPTION**

**Antenna**

**Beam Width**

Horizontal: 5.3 deg

Vertical: 50 deg (cosecant squared type pattern)

Feed: One 50 ohm coaxial, one waveguide.

Type: Parabolic

Polarization: Vertical one frequency, horizontal second frequency.

Gain: 23.5 db (approx)

Scanning: Vertical beam width of 60 deg and continuously through an azimuth angle of 360 deg

Inherent Bearing Accuracy: plus or minus 1% in azimuth

Inherent Range Accuracy: plus or minus

3% of indicated range plus 200 yds  
Range and Bearing: Up to 30, 000 yds at altitudes up to 10, 000 ft.

Type of Receiver: Superheterodyne, employing automatic frequency control and anti-jamming protection.

Receiver Output: Provides video outputs for the VK indicating units and Range Indicator IP-183/BPS-4; a 400 cps audio output is supplied when employed for keyed MCW communication; a 60 mc output is supplied for auxiliary equipment.

Peak Power Output: 500 kw

Pulse Width: 1 usec

Pulse Repetition Rate: 400 pps plus or minus 5%

Intermediate Frequency: 60 mc

Operating Frequency Range: 3400 to 3700 mc

Power Source Required: 115v plus or minus 5%, 60 cps plus or minus 2 cycles, 1 ph; the primary power source should have a max capacity of 5 kva for proper operation exclusive of the antenna drive motor.

**INSTALLATION CONSIDERATIONS**

Related Equipment: (Required but not Supplied) (1) Torque Tube Mast, 2 to 4 PPI Repeaters VK series, (1) Gyro Compass Synchro Amplifier Mark 2 Mod 1 or equivalent, (1) Connection Box, (1) Line Disconnect Switch NT-24899 or equivalent, Cables and Waveguides as required. (1) Range Indicator IP-183/BPS as required by direction from the Bureau of Ships.

**PRINCIPAL COMPONENTS AND PHYSICAL DATA**

COMPONENT	QTY	HEIGHT (Inches)	WIDTH (Inches)	DEPTH (Inches)	UNIT WT. (Pounds)
Radar Receiver-Transmitter RT-256/BPS-4	1	38-15/16	21-3/8	18-29/32	303
Radar Set Control C-1028/BPS-4	1	31-3/4	21-3/16	11-5/8	122
Radar Modulator MD-166/BPS-4	1	38-15/16	20-1/4	17-13/32	380
Antenna Base AB-251/BPS-4	1	28	24-3/16	18-3/4	675
Antenna AS-594/BPS-4	1	48-5/16	37-21/32	26-29/32	300
Power Supply PP-776/BPS-4	1	23-11/16	18-1/2	16-3/4	240
Power Supply PP-777/BPS-4	1	23-11/16	18-1/2	16-3/4	154
Power Supply PP-778/BPS-4	1	23-11/16	18-1/2	16-3/4	134
Antenna Control C-1026/BPS-4	1	4-3/8	4	3-1/2	3
Receiver Control C-1072/BPS-4	1	5-1/2	4	2-9/16	2

ITEM NAME: RADAR SET

TYPE: AN/BPS-4

PRINCIPAL COMPONENTS AND PHYSICAL DATA (Cont.)

COMPONENT	QTY	HEIGHT (Inches)	WIDTH (Inches)	DEPTH (Inches)	UNIT WT. (Pounds)
Range Indicator IP-183/BPS-4	*1				

**NOTE: \*Accessories not supplied as part of Radar Set AN/BPS;  
supplied on as required by the Bureau of Ships.**

SHIPPING DATA

COMPONENTS	BOXES (NR)	OVERALL DIMENSIONS (Inches)	UNIT WT. (Pounds)
Radar Set Control C-1028/BPS-4 and Instruction Books	1	16 x 26 x 37-1/2	206
Radar Modulator MD-156/BPS-4	1	23-1/2 x 25 x 45	455
Antenna Base AB-251/BPS-4	1	23 x 30 x 32	735
Antenna AS-594/BPS	1	32 x 42 x 52	365
Radar Receiver Transmitter RT-256/B PS-4	1	24 x 26 x 43	378
Power Supply PP-776/BPS-4	1	22 x 22 x 28	290
Power Supply PP-777/BPS-4	1	22 x 22-1/2 x 28-1/2	204
Power Supply PP-778/BPS-4	1	22 x 22 x 28	184
Fuse Box J-484/BPS-4	1	14 x 21 x 25	103
Rotary Coupler	1	17 x 21 x 27	75
Waveguide Switch	1	15 x 15 x 18	82
Accessories	2	26 x 26 x 47	170
Maintenance Parts Kit	2	17 x 21 x 41	200
Range Indicator IP-183/BPS-4	.1	17 x 21 x 41	141

**NOTE: \*Accessories not Supplied as part of Radar Set AN/BPS-4.**

REFERENCE DATA AND LITERATURE

Technical Manuals:  
NAVSHIPS 91621

AN/BPS-4: 3

DATE: 1 September 1964

ITEM NAME: RADAR SET

COGNIZANT SERVICE: USN

TYPE: AN/BPS-5

FEDERAL STOCK NUMBER:

	USA	USN	USAF	USMC
STATUS OR TYPE CLASSIFICATION		Used by		

Mfg(s) Name or Code Number: Lockheed Electronics Co., (87557); Western Electric Co, Inc. (64959)

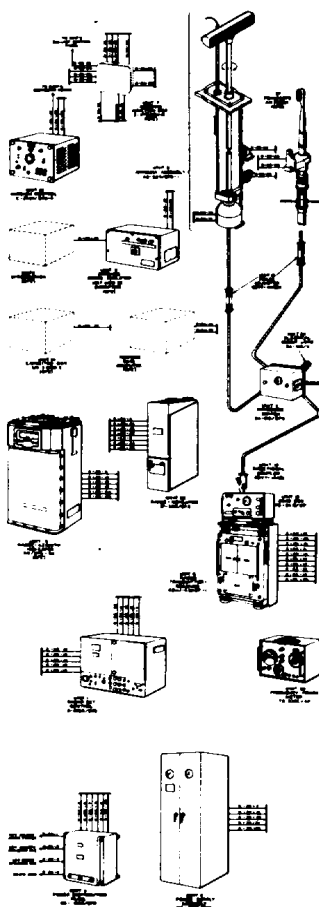

### FUNCTIONAL DESCRIPTION

Radar Set AN/BPS-5 is a conventional short range surface-search radar designed for installation on Class SSN593 submarine. This radar set has a max range of 80 nautical miles and provides target range and bearing information on Range-Azimuth Indicator AN/SPA-4A.

This indicator provides a PFI, or polar map presentation, of the area surrounding the submarine with the center of the screen presenting own ship's position. Normal radar operation is performed from the radar set control and range indicator located in the Combat Information Center.

**ITEM NAME:** RADAR SET  
**TYPE:** AN/BPS-5

This unit together with the PPI unit compose the central control station of the equipment. The transmitter generates RF energy which is shaped into a narrow beam by the radar antenna and radiated toward the area being searched. Radar targets in the area reflect a minut amount of RF energy (echoes) back to the antenna. These echoes are amplified and detected by the receiver. The target echoes appear as bright spots on the PPI screen; distances from the center of the screen represent target range and the angular position of the target represents it's bearing. The "area search" type of operation just described generally is performed with the submarine surfaced and using the raised radar antenna. Another tactical use of the radar is "target track" operation in which the submarine is submerged and the "ST" (periscope) antenna is used to avoid detection. Range of targets within 20 miles can be measured precisely and is automatically applied to the ship's torpedo data computer. Target bearing is obtained by optically tracking the target with periscope. The radar also has capabilities for cw communications operation with another similarly equipped station. During this type of operation, the radar functions just as in search operation except that the radar antenna is pointed at the second station and the operator controls the radar transmissions with a telegraph key. A headset is used to aurally monitor the transmissions. The operator sends messages in international Morse Code (or other similar system) by operating the key. Other conventional features of the radar set are automatic frequency control of the 60 megacycle intermediate frequency, sensitivity time control of the receiver sensitivity, and anti-jam to suppress extraneous signals.

RELATION TO SIMILAR EQUIPMENT

Radar Set AN/BPS-5 is a modernized version of Radar Sets SS-1, SV-1, AN/BPS-1, AN/BPS-4, and AN/BPS-9A. Radar Set AN/BPS-5 is similar to Radar Set AN/BPS-11 except for differences in antenna drive configuration. These differences exist because of the intended installation of each radar.

**TECHNICAL DESCRIPTION**

**Overall Systems**

Maximum Range: 160, 000 yds (80 mi)  
Minimum Range: 200 yds  
Bearing Accuracy: plus or minus 0.25°

**Range Accuracy**

0 to 60, 000 Yds: 25 yds plus or minus 0.1% of measured range  
60, 000 to 160, 000 Yds: plus or minus 2% of measured range

**Power Requirements**

General Power: 115v, 60 cyc, 1-ph  
Standby: 1852 va  
Operate: 2367 va  
Trans-On: 3072 va

Synchro Excitation: 115v, 60 cyc,  
1-ph, 600 va and 115 va

Synchronizing and Transmitting Systems  
Repetition Rate: 600 pps adjustable  
plus or minus 30 pps  
Pulse Width: 0.5 usec  
Pulse Shape: Rectangular  
Frequency: 8740 to 8890 mc  
Magnetron Stability: plus or minus  
45 mc  
Peak RF Power: 75 to 10 kw  
Duty Cycle: 0.03%  
Average Power: 22.5 to 30w  
RF Lines RG-51/U: Waveguide  
VSWR: 1.1:1 max

Radar Antenna  
Horizontal Beamwidth: 2.6°  
Vertical Beamwidth: 16°  
Antenna Gain: 29.3 db  
Polarization: Horizontal  
Sidelobes: 23 db down (one way) at 6°  
ea side all others over 25 db down

ST (Periscope) Antenna  
Horizontal Beamwidth: 30°  
Vertical Beamwidth: 10°  
Antenna Gain: 14 db  
Sidelobes Horizontal  
Vertical: 14 db down at 20° ea side  
Horizontal: 16 db down at 60° ea  
side

Receiving System  
Antenna Coupling: Duplex converter,  
TR and ATR tube detector  
Bearing Oscillator: Klystron, type  
2K25  
First Detector: Crystal, type 1N23B  
Second Detector: Electron tube, type  
6AL5  
IF. Frequency: 60 mc  
Pre-IF. Bandwidth: 3.5 to 4 mc at 3 db  
down point  
IF. Bandwidth: 9 mc at 3 db down point  
Video Bandpass: 3.5 mc at 3 db down  
point  
Noise Figure: 17.db  
Frequency Control: Manual and AFC  
Gain Control: Manual, STC, FTC and AGC

Indicating System  
Range Indicator  
Display Size: 5 in.  
Presentation: Type A  
Sweep Ranges: 0 to 4, 10, and 20 mi  
Sweeps: Normal-A sweep with range



DATE: 1 September 1964

ITEM NAME: RADAR SET

COGNIZANT SERVICE: USN

TYPE: AN/BPS-SA

FEDERAL STOCK NUMBER: 2F5840-884-8234

	USA	USN	USAF	USMC
STATUS OR TYPE CLASSIFICATION		Used by		

Mfg(s) Name or Code Number: Lockheed Electronics Co., (64959); Western Electric Co., Inc. (87557)

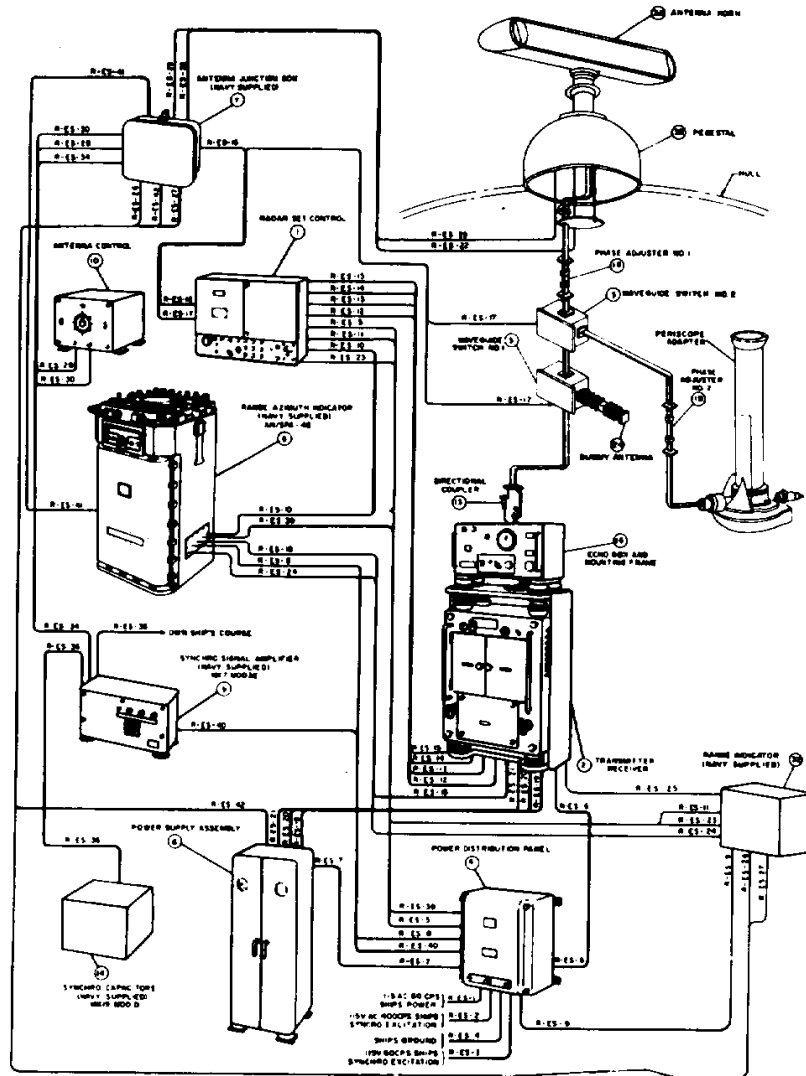

**FUNCTIONAL DESCRIPTION**

Radar Set AN/BPS-SA is a conventional short range surface-search radar designed for installation on Class SSN593 Submarine. This radar set has a maximum range of 80 nautical miles and provides target range and bearing information on Range Azimuth Indicator

AN/SPA-4A. This indicator provides a PPI or polar map presentation of the area surrounding the submarine with the center of the screen presenting own ship's position. Normal radar operation is performed from the radar set control and range indicator located in the Combat Information Center.

**ITEM NAME:** RADAR SET

**TYPE:** AN/BPS-5A

range indicator located in the Combat Information Center. This unit together with the PPI unit compose the central control station of the equipment.

The transmitter generates RF energy which is shaped into a narrow beam by the radar antenna and radiated toward the area being searched. Radar targets in the area reflect a minute amount of RF energy (echoes) back to the antenna. These echoes are amplified and detected by the receiver. The target echoes appear as bright spots on the PPI screen; distances from the center of the screen represent target range and the angular position of the target represents its bearing.

The "area search" type of operation just described generally is performed with the submarine surfaced and using the raised radar antenna. Another tactical use of the radar is "target track" operation in which the submarine is submerged and the "ST" (periscope) antenna is used to avoid detection. Range of targets within 20 miles can be measured precisely and is automatically applied to the ship's torpedo data computer. Target bearing is obtained by optically tracking the target with periscope.

The radar also has capabilities for cw communications operation with another similarly equipped station. During this type of operation, the radar functions just as in search operation except that the radar antenna is pointed at the second station and the operator controls the radar transmissions with a telegraph key. A headset is used to aurally monitor the transmissions. The operator sends messages in international Morse Code or other similar systems by operating the key.

Other conventional features of the radar set are automatic frequency control of the 60 mc intermediate frequency, sensitivity time control of receiver sensitivity, and anti-jam to suppress extraneous signals.

**RELATION TO SIMILAR EQUIPMENT**

None.

**TECHNICAL DESCRIPTION**

**Over-all Systems**

Maximum Range: 160, 000 yds (80 mi)

Minimum Range: 200 yds

Bearing Accuracy: plus or minus 0.250

**Range Accuracy**

0 to 60, 000 Yds: 25 yds plus or minus 0.1% of measured range

60, 000 to 160, 000 Yds: plus or minus 2% of measured range

**Power Requirements**

General Power: 115v, 60 cyc, 1-ph

Standby: 1852 va

Operate: 2367 va

Trans-On: 3072 va

Synchro Excitation: 115v, 60 cyc,

1-ph, 600 va and 115 va

**Synchronizing and Transmitting Systems**

Repetition Rate: 600 pps adjustable

plus or minus 30 pps

Pulse Width: 0.5 usec

Pulse Shape: Rectangular

Frequency: 8740 to 8890 mc

Peak RF Power: 75 to 100 kw

Duty Cycle: 0.03%

Average Power: 22.5 to 30w

RF Lines RG-51/U: Waveguide

VSWR: 1.1:1 max

**Radar Antenna**

Horizontal Beamwidth: 2.6°

Vertical Beamwidth: 16°

Antenna Gain: 29.3 db

Polarization: Horizontal

Sidelobes: 23 db down (one way) at 6° ea side all others over 25 db down

**ST (Periscope) Antenna**

Horizontal Beamwidth: 30°

Vertical Beamwidth: 10°

Antenna Gain: 14 db

Sidelobes Horizontal: 16 db down at 6° ea side

Sidelobes Vertical: 14 db down at 20° ea side

**Receiving System**

Antenna Coupling: Duplex converter, TR and ATR tubes Detector

Bearing Oscillator: Klystron, Type 2K25

First Detector: Crystal, Type 1N23B

Second Detector: Electron tube, Type 6AL5

IF. Frequency: 60 mc

Pre-IF. Bandwidth: 3.5 to 4 mc at 3 db down point

IF. Bandwidth: 9 mc at 3 db down point

Video Bandpass: 3.5 mc at 3db down point

Gain Control: Manual, STC, FTC and AGC

Noise Figure: 17 db

Frequency Control: Manual and AFC

**Indicating System**

**Range Indicator**

Display Size: 5 in.

Presentation: Type A

Sweep Ranges: 0 to 4, 10 and 20 mi

Sweeps: Normal - A sweep with range step expanded 1000 yds after range step

Range Readout: Counters in yds and mi

Min Increment of Yds Counter: 100 yds

Min Increment of Mi Counter: 0.1 mi

Electrical Range Output: Synchros at 2000, 72, 000 and 1, 296, 000 yds revolution

**ITEM NAME:** RADAR SET

**TYPE:** AN/BPS-5A

**INSTALLATION CONSIDERATION**

Related Equipment

Required but not Supplied: (1) Antenna Junction Box-2-4TB20M-2; (1) Range-Azimuth Indicator AN/SPA-4B; (1) Instruction Book for Range-Azimuth Indicator AN/SPA-4B NAVSHIPS 91825(A); (1)Capacitor Box (Synchro Capacitors) MK 19 Mod O; (1) Synchro Signal Amplifier MK 7 Mod 3E; (1) Instruction Book for Synchro Signal Amplifier MK 7 Mode 3E NAVSHIPS 324-0315; and (1) Range Indicator IP-599/BPS.

PPI Indicator: Range Azimuth Indicator  
AN/SPA-4B (Govt furnished)  
Antenna Position System  
Vertical Control  
Positions: Raised and stow  
Drive: GFE hydraulic system  
Radar Set AN/BPS-5A  
Azimuth Control  
Automatic: cw or ccw continuous 3600 scan, 0 to 11 rpm  
Manual: Point  
Antenna Drive: Motor driven transmission controlled by magnetic clutches

**PRINCIPAL COMPONENTS AND PHYSICAL DATA**

COMPONENTS	QTY	OVERALL DIMENSIONS (Inches)	UNIT WT. (Pounds)
Radar Set Control C-3725/BPS	1	16-5/8 x 18-1/2 x 26	175
Radar Transmitter Receiver CW-43ADF-1	1	17-1/16 x 22-1/2 x 34	250
Antenna Assy AS-527/BPS-1	1		
Power Distribution Panel SB-1325/BPS	1	9-3/4 x 18 x 20-5/8	84
Waveguide Switch SA-834/BPS	1	4-1/2 x 5-1/2 x 7	4
Power Supply Assy PP-3031/BPS	1	17 x 22-5/8 x 46-23/32	450
Antenna Control C-1376/BPS	1	14-1/8 x 15-3/4 x 21-3/4	75
Headset Assy CW-49985-A	1	6 x 6 x 8	4.5
Key Assy BL-61136	1		
Directional Coupler CW-14ABL	1	2-7/16 x 3-5/8 x 8-1/32	5
Echo Box TS-311B/UP	1	8-1/2 x 8-15/16 x 16	23.5
Instruction Book NAVSHIPS 92004	1		
Phase Adjuster CW-14ABM-1	1	2-13/32 x 2-5/8 x 9-1/4	5
Frequency Power Meter TS-230C/AP	1	10-1/2 x 10-3/4 x 18-1/2	30
Dummy Antenna TS-321/AP	1	1-3/4 x 2 x 7-9/32	3
Range Indicator IP-599/BPS	1	8 x 24-7/16 x 32-1/2	120

**AN/BPS-5A: 3**

ITEM NAME: RADAR SET

TYPE: AN/BPS-5A

PRINCIPAL COMPONENTS AND PHYSICAL DATA (Continued)

SHIPPING DATA

COMPONENT	PKGS	VOLUME (CU FT)	UNIT WT. (Pounds)
	1	10.2	228
	1	14.7	510
	1	3.3	155
	1	18.4	525
	1	6.6	138
	1	4.0	65
	1	17.4	650
	1	6.0	168
	1	3.3	72
	1	5.9	88

REFERENCE DATA AND LITERATURE

Technical Manuals:

- NAVSHIPS 94224(A): for Radar Sets AN/BPS-5A and AN/BPS-11A.
- NAVSHIPS 94224.21: Operators Instruction Charts.
- NAVSHIPS 94224.32: Performance Standard Sheet.
- NAVSHIPS 94224.42: Maintenance Standard Book.
- NAVSHIPS 94224.11: Lubrication Charts.

Specifications: MIL-R-22178

AN/BPS-5A: 4

**ITEM NAME:** RADAR SET

**TYPE:** AN/BPS-5

step expanded-1000 yds after range step  
Range Readout: Counters in yds and mi  
min increment of yds, counter-10 yds  
min increment of mi counter-0.1 mi  
Electrical Range Output: Synchros at  
2000, 72, 000 and 1, 296, 000 yds revolution  
PPI Indicator: Range Azimuth Indicator  
AN/SPA-4A (Govt furnished)  
Vertical Control  
Positions: Raised and stow  
Drive: GFE hydraulic system  
Radar Set AN/BPS-5  
Azimuth Control  
Automatic: cw or ccw continuous 360° scan, 0 to 11 rpm  
  
Manual: Point

Antenna Drive: Motor-driven transmission controlled by magnetic clutches

**INSTALLATION CONSIDERATION**

Related Equipment

Required but not Supplied: (1) Antenna Junction Box-2-4TB20M-2; (1) Range-Azimuth Indicator AN/SPA-4A; (1) Instruction Book for Range-Azimuth Indicate AN/SPA-4A, NAVSHIPS 91825(A); (1) Synchro Signal Amplifier MK 7 Mod 3E; (1) Instruction Book for Synchro Signal Amplifier MK 7 Mod 3E, NAVSHIPS 324-0315; (1) Capacitor Box MK3 Mod O, and Range Indicator IP-599/BPS.

**PRINCIPAL COMPONENTS AND PHYSICAL DATA**

<b>COMPONENTS</b>	<b>QTY</b>	<b>OVERALL DIMENSIONS (Inches)</b>	<b>UNIT WT. (Pounds)</b>
Radar Set Control C-3728/BPS	1	16-5/8 x 18-1/2 x 26	175
Radar-Transmitter-Receiver 43ADF-1	1	17-1/16 x 22-1/2 x 34	250
Antenna Assy AS-527/BPS-1	1		
Power Distribution Panel SB-1325/BPS	1	9-3/4 x 18 x 20-5/8	84
Waveguide Switch SA-B16/BPS	1	9 x 10-5/8 x 13-7/8	26
Power Supply Assy PP-3031/BPS	1	17 x 22-5/8 x 46-23/32	450
Antenna Control C-3729/BPS-5	1	14-13/32 x 17-1/8 x 21-3/8	130
Headset Assy 49985-A	1	6 x 6 x 8	4.5
Key Assy	1		
Directional Coupler 14ABL	1	2-7/16 x 3-5/8 x 8-1/32	5
Echo Box TS-311B/UP	1	8-1/2 x 8-15/16 x 16	23.5
Instruction Book NAVSHIPS 91111			
Phase Adjuster 14ABM	1	2-5/8 x 2-13/32 x 9-1/4	5
Frequency-Power Meter TS-230C/AP	1	10-1/2 x 10-3/4 x 18-1/2	30
Instruction Book NAVSHIPS 91669			
Electrical Dummy Load DA-14B/U	1	1-3/4 x 2 x 7-13/16	1
Range Indicator IP-599/BPS	1	8 x 24-7/16 x 32-1/2	120

**AN/BPS-5: 3**

ITEM NAME: RADAR SET

TYPE: AN/BPS-5

PRINCIPAL COMPONENTS AND PHYSICAL DATA (Continued)

SHIPPING DATA

COMPONENT	PKGS	VOLUME (CU FT)	UNIT WT. (Pounds)
	1	10.7	205
	1	13.7	437
	1	3.8	157
	1	19.9	412
	1		
	1		
	1		
	1		
	1		
	1		
	1	4.9	127
	1	2.5	52
	1	18.6	536
	1	1.8	28
	1	1.8	19
	1	9.9	305
	1	5.9	174

REFERENCE DATA AND LITERATURE

Technical Manuals:

- NAVSHIPS 94224(A): for Radar Sets AN/BPS-5 and AN/BPS-11.
- NAVSHIPS 94224.21: Operator's Instruction Charts.
- NAVSHIPS 94224.32: Performance Standard Sheet.
- NAVSHIPS 94224.42: Maintenance Standard Book.
- NAVSHIPS 94224.11: Lubrication Charts

Specification: MIL-R-22178

AN/BPS-5: 4

DATE: 1 July 1964

ITEM NAME: RADAR SET

COGNIZANT SERVICE: USN

TYPE: AN/BPS-9

FEDERAL STOCK NUMBER: F5840-818-1621  
F5840-543-1899 W/S

	USA	USN	USAF	USMC
STATUS OR TYPE CLASSIFICATION Sub Std				

Mfg(s) Name or Code Number: Western Electric Company, Inc., New York, N. Y.

No Illustration Available.

**FUNCTIONAL DESCRIPTION**

Radar Set AN/BPS-9 is designed for installation on submarines for obtaining search and torpedo launching information against surface vessels. The equipment is also capable of providing warning information on low

flying aircraft. Target data is displayed in range and bearing on A-, B-, and PPI-scope presentations, and provision is also made for IFF operation. This equipment may also be used for radio telegraphic communication as well as for radar operation.

**AN/BPS-9: 1**

Volume 1  
Section 3

**MIL-HDBK-162A**  
15 December 1965

**ITEM NAME:** RADAR SET

**TYPE:** AN/BPS-9

**RELATION TO SIMILAR EQUIPMENT**

This equipment is similar to Radar Equipment SS-a, SS-1 and SS-2.

**TECHNICAL DESCRIPTION**

**Transmitter**

Frequency: 8740 to 8890 mc  
Peak R-F Output: 75 to 110 kw  
Pulse Rate: 600 pps, adjustable plus or minus 10%  
Pulse Length: 0.5 usec  
Pulse Shape: Square

**Antenna**

Beam: 2.6 deg (horizontal), 16 deg (vertical), 26 db (gain).  
Scanning Rate: 0 to 8 rpm  
Polarization: Horizontal  
Antenna Drive: 3/4 hp manually-reversible dc motor

**Receiver**

Type: Double detector  
Pre-IF. Band Pass: 3.5 to 4 mc  
IF. Frequency: 60 mc  
IF. Bandwidth: 8 to 9 mc  
Frequency Control: afc and manual  
Video Band Pass: 3.5 mc  
Noise Figure: 17 db

**Plan Position Indicator**

Size: 5 in.

Presentation: True bearing

**Markers**

Range: Electrical Line  
Bearing: Mechanical

**Scales**

Fixed: True bearing scale ring  
Movable: Relative bearing scale ring  
Range: 4000, 8000, 20, 000, 40, 000 yds, 80 mi, and 8000 yd precision

**Accuracy**

Bearing: plus or minus 1 deg  
Range to 60, 000 Yds: plus or minus (50 yds plus 0.1%) of measured range.  
Range 60, 000 Yds to 80 Miles: Plus or minus (200 yds plus or minus 2%) of measured range.

**A-Scan Presentation**

Range: 8000, 20, 000, 40, 000 yds, 80 mi, and 4000 yds precision.

Marker: Step.

Accuracy: Range plus or minus (25 plu or minus 0.1% of measured range) to 60, 000 yds and plus or minus (200 plus 2% of measured range) to 80 mi.

**B-Scan Presentation**

Range: 4000 yds deep 25 deg sector, precision sweep.

**Markers**

Range: Electrical Line (horizontal)  
Bearing: Electrical Lines (vertical) at 0 deg, plus or minus 5 deg, plus or minus 10 deg.

**Range Indications**

Local: Counters on console.  
Remote: Synchro output (1- and 36-speed).

**Bearing Indications**

Local: PPI scales (plus or minus 1 deg)  
Remote: Synchro output (1- and 36-speed) for remote indicators (plus or minus 0.25 deg)

Power Requirements: 115v, 60 or 400 cycle, single ph

**INSTALLATION CONSIDERATIONS**

Related Equipment: (Required but not Supplied) Bulk cables as required: RG-13/U, MSCA-10, MCOS-4, MSCA-14, MSCA-7.

**PRINCIPAL COMPONENTS AND PHYSICAL DATA (Continued)**

**SHIPPING DATA**

<b>COMPONENT</b>	<b>BOXES (NR)</b>	<b>OVERALL DIMENSIONS (Inches)</b>	<b>UNIT WT. (Pounds)</b>
Accessory Kit including: Dummy Antenna TS-231/AP (2) Phase Adjuster 14ABM-1 Directional Coupler 14ABL Headset Assy Key Assy Waveguide Stop 23ALJ Sensitivity Time Control 23AJG-2 Frequency Power Meter TS-230C/AP	1	20 x 22 x 46	200
Torque Tube Drive 10AFX	1	18 x 20 x 25	175
Synchro Unit 21ADF-1	1	16 x 17 x 27	150
Motor Drive Gear Unit NT-10723	1	20 x 28	150
Set of Waveguide Parts D-152697	1	6 x 10 x 137	125

**AN/BPS-9: 2**



ITEM NAME: RADAR SET

TYPE: AN/BPS-9

PRINCIPAL COMPONENTS AND PHYSICAL DATA (Continued)

SHIPPING DATA

COMPONENT	BOXES	OVERALL DIMENSIONS (Inches)	UNIT WT. (Pounds)
Antenna Projector 66AKW	1	23 x 34 x 38	300
Radar Set Console CA-1928/BPS-9	1	35 x 48 x 62	1570
Transmitter-Receiver 43ADF-1	1	25 x 28 x 38	500
Antenna Assy 66AKX-2			
Power Distribution Unit 23AGS-1	1	17 x 27 x 30	140
Junction Box NT-62217 including: Set of Interconnecting Cables	1	18 x 23 x 23	125
High Voltage Rectifier 20ADW-1	1		
Regulated Rectifier 20ADN-1	1		
Auxiliary Rectifier 20ADO-1	1		
Servo Power Unit 20ADX-1	1		
Motor Controller 23AGE incl: Waveguide Switching Unit 24AAN	1	16 x 19 x 24 140	
Motor Control Rectifier 20ADP-3	1	22 x 23 x 31	440
Control Motor PD-64/U	1	13 x 17 x 27	195
Echo Box & Frame TS-311B/UP	1	15 x 17 x 23	60
Periscope Adapter 14ABH-2	*	20 x 20 x 52	425
Waveguide Switching Unit 24AAN	*	11 x 15 x 17	30

NOTE: \*Auxiliary Equipment for ST-a, ST-1 operation.

EQUIPMENT SUPPLIED DATA

COMPONENTS	QTY	OVERALL DIMENSIONS (Inches)	UNIT WT. (Pounds)
Radar Set Console OA-1928/BPS-9	1	22-3/4 x 40-7/8 x 51-1/4	1067
Transmitter-Receiver 43ADF-1	1	17-1/16 x 22-1/2 x 33-31/32	387
Antenna Assy 66AKX-2 including:	1		
Antenna Projector 66AKW	1	17-1/8 x 28-13/32 x 30	200
Torque Tube Drive 10AFX	1	11-13/32 x 13-3/4 x 16-1/4	100
Synchro Unit 21ADF-1	1	10-1/16 x 11-13/32 x 17	100
Motor Drive Gear Unit NT-10723	1	10-3/32 x 17-15/32 x 19-13/16	125
Set of Waveguid Parts D-152697 (Mfr's Desig)	1		
Power Distribution Unit 23AGS-1	1	9-3/4 x 18 x 21-1/16	90
Junction Box NT-62217	1	4-17/32 x 18-1/4 x 18-5/8	50

AN/BPS-9: 3

ITEM NAME: RADAR SET

TYPE: AN/BPS-9

PRINCIPAL COMPONENTS AND PHYSICAL DATA

EQUIPMENT SUPPLIED DATA (Cont.)

COMPONENTS	QTY	OVERALL DIMENSIONS (Inches)	UNIT WT. (Pounds)
High Voltage Rectifier 20ADW-1	1	17-3/8 x 19-3/8 x 26-3/4	325
Regulated Rectifier 20ADN-1	1	17-3/8 x 19-3/8 x 26-7/8	310
Auxiliary Rectifier 20ADO-1	1	17-3/8 x 19-3/8 x 26-7/8	250
Servo Power Unit 20ADX-1	1	17-3/8 x 19-3/8 x 26-7/8	250
Motor Control Rectifier 20ADP-3	1	17-3/8 x 19-3/8 x 26-3/4	340
Motor Controller 23AGE	1	13-1/16 x 13-1/8 x 14	50
Control Motor PD-64/U	1	8-7/8 x 9-5/16 x 18-1/2	85
Waveguide Switching Unit 24AAN	1	5-1/32 x 12-5/16 x 12-5/8	23
Directional Coupler 14ABL	1	2-7/16 x 3-5/8 x 8-1/32	5
Echo Box & Mounting Frame TS-311B/UP	1	9 x 9-1/4 x 17-3/4	20
Phase Adjuster 14ABM-1	2	1-7/8 x 2 x 8	5
Waveguide Stop 23ALJ	1	6-1/2 x 6-1/2 x 8-9/16	30
Frequency Power Meter TS-230C/AP	1	6 x 10 x 12	10.5
Set of Interconnecting Cables D-152306 (Mfr's Desig)	1		
Sensitivity Time Control 23AJG-2	1	5-29/32 x 7-3/4 x 8-5/8	10
Dummy Antenna TS-231/AP	1	1-3/4 x 2 x 7-13/16	8
Head Set Assy	1		
Key Assy	1		
Waveguide Switching Unit 24AAN	1*	5-1/32 x 12-5/16 x 12-5/8	23
Periscope Adpater 14AB-2	1*	14-3/4 x 14-3/4 x 47-1/4	300
Set Equipment Maintenance Parts	1		
Technical Manual for TS-230A/AP	2	3/8 x 9 x 11-1/2	1
Technical Manual NAVSHIPS 91513	2	6-1/2 x 9 x 11-1/2	7
Set of Permanent Change 1 Sheets	2	1 x 8-1/2 x 11	2

NOTE: \*Auxiliary Equipment for ST-a, ST-1 operation.

REFERENCE DATA AND LITERATURE

Technical Manuals:  
NAVSHIPS 91513

AN/BPS-9: 4

**DATE:** 1 July 1964

**ITEM NAME:** RADAR SET

**COGNIZANT SERVICE:** USN

**TYPE:** AN/BPS-9A

**FEDERAL STOCK NUMBER:** F5840-672-6322

	USA	USN	USAF	USMC
STATUS OR TYPE CLASSIFICATION		Sub Std		

Mfg(s) Name or Code Number: Western Electric Co., Inc, New York, N. Y.

No Illustration Available.

**FUNCTIONAL DESCRIPTION**

Radar Set AN/BPS-9A is designed for installation on submarines for obtaining search and torpedo launching information against surface vessels. The equipment is also capable of providing warning information on low

flying aircraft. Target data is displayed in range and bearing on A-, B-, and PPI-scope presentations, and provision is also made for IFF operation.

This equipment may also be used for radio telegraphic communication as well as for radar operation.

**AN/BPS-9A: 1**

**ITEM NAME:** RADAR SET

**TYPE:** AN/BPS-9A

**RELATION TO SIMILAR EQUIPMENT**

None.

**TECHNICAL DESCRIPTION**

**Transmitter**

Frequency: 8740 to 8890 mc  
Peak R-F Output: 75 to 110 kw  
Pulse Rate: 600 pps, adjustable plus or minus 10%  
Pulse Length: 0.5 usec  
Pulse Shape: Square

**Antenna**

Beam: 2.6 deg (horizontal), 16 deg (vertical), 26 db (gain)  
Scanning Rate: 0 to 8 rpm  
Polarization: Horizontal  
Antenna Drive: 3/4 hp manually-reversible dc motor

**Receiver**

Type: Double detector  
Pre-IF. Bandpass: 3.5 to 4 mc  
IF. Frequency: 60 mc  
IF. Bandwidth: 8 to 9 mc  
Frequency Control: afc and manual  
Video Bandpass: 3.5 mc  
Noise Figure: 17 db

**Plan Position Indicator**

Size: 5 in.  
Presentation: True bearing Markers  
Range: Electrical line  
Bearing: Mechanical cursor Scales  
Fixed: True bearing scale ring  
Movable: Relative bearing scale ring  
Ranges: 8000, 20, 000, and 40, 000 yds, 80 mi and 8000 yds precision Accuracy  
Bearing: Approx plus or minus 1 deg  
Range to 60, 000 Yards: plus or minus (50 yds plus 0.1%) of measured range.

Range 60, 000 Yards to 80 Miles: plus or minus (200 yds plus 2%) of measured range

**A-Scan Presentation**

Ranges: 8000, 20, 000 and 40, 000 yds, 80 mi, and 4000 yds precision.  
Marker: Step  
Accuracy: Range plus or minus (25 plus 0.1% of measured range) to 60, 000 yds, and plus or minus (200 plus 2% of measured range) to 80 mi

**B-Scan Presentation**

Range: 4000 yds deep 25 deg sector, precision sweep.  
Markers  
Range: Electrical line (horizontal)  
Bearing: Electrical lines (vertical) at 0 deg, plus or minus 5 deg and plus or minus 10 deg

Prime Uses: Accurate range and bearing settings.

**Accuracy**

Range: plus or minus (25 plus 0.1% of measured range) to 60, 000 yds  
Bearing: plus or minus 0.25 deg

**Range Indications**

Local: Counters on console  
Remote: Synchro output (1- and 36-speed) for remote indicators.

**Bearing Indications**

Local: PPI scales (plus or minus 1 deg)  
Remote: Synchro output (1- and 36-speed) for remote indicators (plus or minus .25 deg)

Power Requirements: 115v, 60 or 400 cy, single ph

**INSTALLATION CONSIDERATIONS**

Related Equipment: (Required but not Supplied) Bulk Cables (as required) RG-13/U, MSCA-10, MCOS-4, MSCA-14, MSCA-7.

**PRINCIPAL COMPONENTS AND PHYSICAL DATA**

<b>COMPONENTS</b>	<b>QTY</b>	<b>OVERALL DIMENSIONS (Inches)</b>	<b>UNIT WT. (Pounds)</b>
Radar Set AN/BPS-9A includes:	1		
Radar Set Console 0A-1928/BPS-9	1	22-3/4 x 40-7/3 x 51-1/4	1067
Transmitter-Receiver 43ADF-1	1	17-1/16 x 22-1/2 x 33-31/32	382
Antenna AS-996/BPS-9A	1		
Power Distribution Unit 23AGS-1	1	9-3/4 x 18 x 21-11/16	90
Junction Box NT-62217	1	4-17/32 x 18-1/4 x 18-5/8	50
High Voltage Rectifier 20ADW-1	1	17-3/8 x 19-3/8 x 26-3/4	325
Regulated Rectifier 20ADN-1	1	17-3/8 x 19-3/8 x 26-7/8	310
Auxiliary Rectifier 20ADO-1	1	17-3/8 x 19-3/8 x 26-7/8	250

**AN/BPS-9A: 2**

ITEM NAME: RADAR SET

TYPE: AN/BPS-9A

PRINCIPAL COMPONENTS AND PHYSICAL DATA

COMPONENTS	QTY	OVERALL DIMENSIONS (Inches)	UNIT WT. (Pounds)
Servo Power Unit 20ADX-1	1	17-3/8 x 19-3/8 x 26-7/8	250
Motor Control Rectifier 20ADP-3	1	17-3/8 x 19-3/8 x 26-3/4	340
Motor Controller 23AGE	1	13-1/16 x 13-1/8 x 14	50
Control Motor PD-64/U	1	8-7/8 x 9-5/16 x 18-1/2	85
Waveguide Switching Unit 24AAN	1	5-1/32 x 12-5/16 x 12-5/8	23
Directional Coupler 14ABL	1	2-7/16 x 3-5/8 x 8-1/32	5
Echo Box and Mounting Frame TS-311B/UP	1	9 x 9-1/4 x 17-3/4	20
Phase Adjuster 14ABM-1	2	1-7/8 x 2 x 8	5
Waveguide Stop 23ALJ	1	6-1/2 x 6-1/2 x 8-9/16	30
Frequency Power Meter TS-230C/AP	1	6 x 10 x 12	10.5
Set of Interconnecting Cables D-152306 (Mfr's Design)	1		
Sensitivity Time Control 23AJG-2	1	5-29/32 x 7-3/4 x 8-5/8	10
Dummy Antenna TS-231/AP	1	1-3/4 x 2 x 7-13/16	8
Head Set Assembly	1		
Key Assembly	1		
Waveguide Switching Unit 24AAN	1*	5-1/32 x 12-5/16 x 12-5/8	23
Periscope Adapter 14ABM-2	1*	14-3/4 x 14-3/4 x 47-1/4	300
Set of Equipment Maintenance Parts	1		
Technical Manual for TS-230A/AP (NAVSHIPS 91105)	2	3/8 x 9 x 11-1/2	1
Technical Manual NAVSHIPS 91513	2	6-1/2 x 9 x 11-1/2	7

NOTE: \*Auxiliary Equipment for ST-1 operation.

REFERENCE DATA AND LITERATURE

Technical Manuals:  
NAVSHIPS 91513

AN/BPS-9A: 3

DATE: 1 July 1964

ITEM NAME: RADAR SET

COGNIZANT SERVICE: USN

TYPE: AN/BPS-9B

FEDERAL STOCK NUMBER:

	USA	USN	USAF	USMC
STATUS OR TYPE CLASSIFICATION		Sub Std		

Mfg(s) Name or Code Number: Western Electric Company, New York, N. Y.

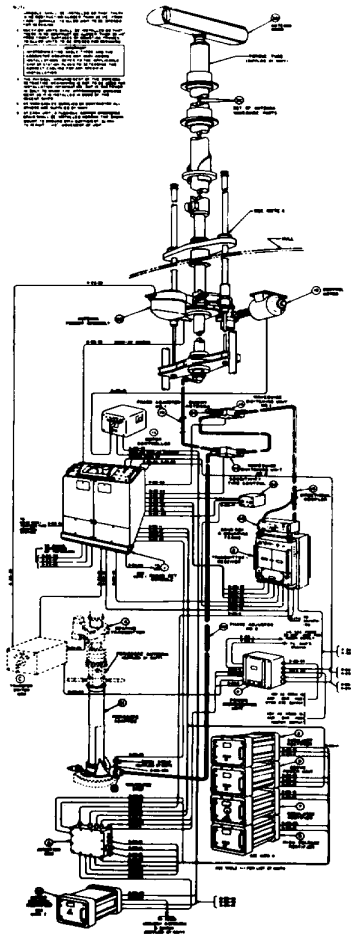

**FUNCTIONAL DESCRIPTION**

The AN/BPS-9B is designed for special use in seaborne installations aboard submarines. It is a search

and missile fire-control radar which also provides early warning of low flying aircraft. The range unit gear assembly and bearing gear assembly may utilize either 60 cycle or 400 cycle synchros.

**AN/BPS-9B: 1**

**ITEM NAME:** RADAR SET

**TYPE:** AN/BPS-9B

**RELATION TO SIMILAR EQUIPMENT**

The AN/BPS-9B is similar to Radar Sets AN/BPS-9 and AN/BPS-9A except for the antenna assemblies which are electrically and functionally interchangeable but they require different maintenance parts.

**TECHNICAL DESCRIPTION**

**Transmitting System**

- Number of Bands: 1 band
- Number of Channels: 1 channel
- Pulse Rate: 600 pps, adjustable plus or minus 10%
- Pulse Length: 0.5 usec
- Pulse Shape: Square
- Type of Modulator: Non-linear coil
- Peak R-F Power: 75 to 110 kw
- Frequency Range: 8740 to 8890 mc

**Receiving System**

- Type of Antenna Coupling: Duplexer w/TR and ATR tubes.
- Type of Receiver: Double detector

- Type First Detector: Crystal, 1N23B
- BO Type: Klystron, integral cavity
- Pre-IF. Band Pass: 3.5 to 4 mc (at 3 db down point).
- IF. Frequency: 60 mc
- IF. Bandwidth: 8 to 9 mc
- Type of Frequency Control: afc and manual
- Video Band Pass: 3.5 mc (at 3 db down point).
- Receiver Noise Figure: 17 db
- Type Second Detector: Type 6AL5 electron tube in IF. amplifier.
- Number of Bands: 1 band
- Number of Channels: 1 channel
- Frequency Range: 8740 to 8890 mc
- Operating Power Requirements: 115v ac, 60 cps, single ph.

**INSTALLATION CONSIDERATIONS**

Not available.

**PRINCIPAL COMPONENTS AND PHYSICAL DATA  
SHIPPING DATA**

<b>COMPONENTS</b>	<b>QTY</b>	<b>OVERALL DIMENSIONS (Inches)</b>	<b>UNIT WT. (Pounds)</b>
Accessory Kit includes:	1	20 x 22 x 46	200
Dummy Antenna TS-231/AP	1		
Phase Adjuster CW-14ABM-1	2		
Directional Coupler CW-14ABL	1		
Headset Assembly (N17-H-52031-1552)	1		
Key Assembly (N17-K-45B94-2451)	1		
Waveguide Stop CW-23ALJ	1		
Sensitivity Time Control CW-23A3G-2	1		
Frequency Power Meter TS-230C/AP	1		
Antenna Assy AS-996/BPS-98 including:	2		
Torque Tube Drive CW-10AFX	1	18 x 20 x 25	175
Synchro Unit CW-21ADF-1	1	16 x 17 x 27	150
Motor Drive Gear Unit CW-10723	1	20 dia x 28 lg	150
Set of Waveguide Parts D-152697	1	6 x 10 x 137	125
Horn Antenna AT-294/BPS-1	1	15 x 18 x 44	200
Radar Set Console OA-1928/BPS-9	1	35 x 48 x 62	1570
Transmitter-Receiver CW-43ADJ-1	1	25 x 28 x 38	500
Power Distribution Unit CW-23AGS-1	1	17 x 27 x 30	140
Junction Box Set of Inter- Connecting Cables CW-62217	1	18 x 23 x 23	125

**AN/BPS-9B: 2**

ITEM NAME: RADAR SET  
TYPE: AN/BPS-9B

PRINCIPAL COMPONENTS AND PHYSICAL DATA  
SHIPPING DATA

COMPONENTS	BOXES	OVERALL DIMENSIONS (Inches)	UNIT WT. (Pounds)
High Voltage Rectifier CW-20ADW-1	1	22 x 23 x 31	425
Regulated Rectifier CW-20ADN-1	1	22 x 23 x 31	410
Auxiliary Rectifier CW-20ADO-1	1	22 x 23 x 31	445
Servo Power Unit CW-20ADX-1	1	22 x 23 x 31	350
Motor Controller CW-23AGE including: Waveguide Switching Unit 1 (1) CW-24AAN	1	16 x 19 x 24	140
Motor Control Rectifier CW-20ADP-3	1	22 x 23 x 31	440
Control Motor PD-64/U	1	13 x 17 x 27	195
Echo Box and Frame TS-311B/UP	1	15 x 17 x 23	60
Periscope Adapter CW-14ABH-2	*1	20 x 20 x 52	425
Waveguide Switching Unit (1) CW-24AAN	*1	11 x 15 x 17	30
Radar Set AN/BPS-9 complete	1		6420

NOTE: \*Auxiliary equipment for ST-1 operation.

EQUIPMENT SUPPLIED DATA

COMPONENTS	QTY	OVERALL DIMENSIONS (Inches)	UNIT WT. (Pounds)
Radar Set Console OA-1928/BPS-9 including: Control Panel D-15420T	1	22-3/4 x 40-7/8 x 51-1/4	1067
Radar, Transmitter-Receiver CW-43ADF-1	1	17-1/16 x 22-1/2 x 34	382
Mast Section GS-16452	1		
Power Distribution Unit CW-23AGS-1	1	9-3/4 x 18 x 21-1/16	90
Junction Box CW-62217	1	4-17/32 x 18-5/8 x 18-3/4	50
High Voltage Rectifier CW-20ADW-1	1	17-3/8 x 19-3/8 x 26-3/4	325
Regulated Rectifier CW-20ADN-1	1	17-3/8 x 19-3/8 x 26-3/4	310
Auxiliary Rectifier CW-20ADO-1	1	17-3/8 x 19-3/8 x 26-3/4	250
Servo Power Unit CW-20ADX-1	1	17-3/8 x 19-3/8 x 26-3/4	250
Pedestal AB-200/BPS-1	1	13-3/8 h x 19-1/2 dia	
Antenna Junction Box (Navy Supplied)	1		
Horn, Antenna AT-294/BPS-1	1	7 x 8-3/4 x 39-1/2	130
Directional Coupler CW-14ABL	1	3-5/8 x 2-7/16 x 8-1/32	5
Echo Box Test Set and Mounting Frame	1		
Echo Box Test TS-311B/UP	1	15 x 17 x 23	60

AN/BPS-9B: 3



**ITEM NAME:** RADAR SET

**TYPE:** AN/BPS-9B

**PRINCIPAL COMPONENTS AND PHYSICAL DATA**

<b>COMPONENTS</b>	<b>QTY</b>	<b>OVERALL DIMENSIONS (Inches)</b>	<b>UNIT WT. (Pounds)</b>
Phase Adjuster CAVX-14ABM-1	2	1-7/8 x 2 x 8	5
Frequency Power Meter TS-230C/AP	1	6 x 10 x 12	10.5
Waveguide Switching Unit CW-24AAN	1	5-1/32 x 12-5/16 x 12-5/8	23
Sensitivity Time Control CW-23AJG-2	1	5-29/32 x 7-3/4 x 8-5/8	10
Dummy Antenna TS-231/AP	1	1-3/4 x 2 x 7-1/2	8
Control, Antenna C-1376/BPS	1	14-1/8 x 15-3/4 x 21-3/4	
Waveguide Stop CW-23ALJ	1	6-1/2 x 6-1/2 x 8-9/16	30

**REFERENCE DATA AND LITERATURE**

Technical Manuals:  
NAVSHIPS 93400

**AN/BPS-9B: 4**

DATE: 1 September 1964

ITEM NAME: RADAR SET

COGNIZANT SERVICE: USN

TYPE: AN/BPS-11

FEDERAL STCCK NUMBER: 2F5840-897-6887

	USA	USN	USAF	USMC
STATUS OR TYPE CLASSIFICATION		Std		

Mfg(s) Name or Code Number: Western Electric Co., Inc. (87557); Lockheed Electronics Co. (64959)

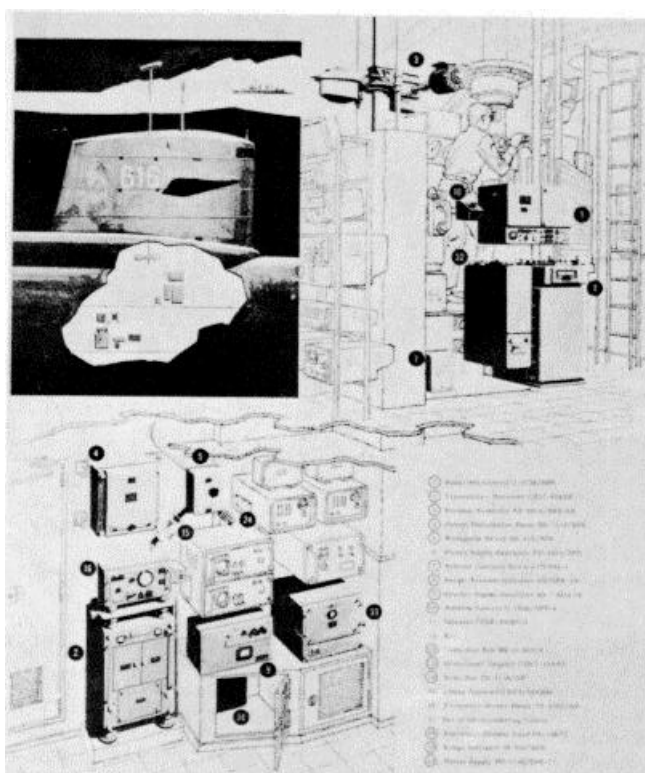

**FUNCTIONAL DESCRIPTION**

Radar Set AN/BPS-11 is a conventional short range surface-search radar designed for installation on Class SSB 616 Submarine. This radar set has a maximum range of 80 nautical miles and provides target range and bearing

information on Range-Azimuth Indicator AN/SPA-4A. This indicator provides a PPI, or polar map presentation of the area surrounding the submarine with the center of the screen presenting own ship's position. Normal radar operation is performed from the radar set control and

**ITEM NAME:** RADAR SET  
**TYPE:** AN/BPS-11

range indicator located in the Combat Information Center. This unit together with the PPI unit compose the central control station of the equipment.

The transmitter generates RF energy which is shaped into a narrow beam by the radar antenna and radiated toward the area being searched. Radar targets in the area reflect a minute amount of RF energy (echoes) back to the antenna. These echoes are amplified and detected by the receiver. The target echoes appear as bright spots on the PPI screen; distance from the center of the screen represents target range and the angular position of the target represents its bearing.

The "area search" type of operation just described generally is performed with the submarine surfaced and using the raised radar antenna. Another tactical use of the radar is "target track" operation in which the submarine is submerged and the "ST" (periscope) antenna is used to avoid detection. Range of target within 20 miles can be measured precisely and is automatically applied to the ship's torpedo data computer, target bearing is obtained by optically tracking the target with periscope.

The radar also has capabilities for cw communications operation with another similarly equipped station. During this type of operation, the radar functions just as in search operation except that the radar antenna is pointed at second station and the operator controls the radar transmissions with a telegraph key. A headset is used to aurally monitor the transmissions. The operator sends messages in international Morse Code for other similar systems by operating the key.

Other conventional features of the radar set are automatic frequency control of the 60 mc intermediate frequency, sensitivity time control of receiver sensitivity, and anti-jam to suppress extraneous signals.

#### **RELATION TO SIMILAR EQUIPMENT**

Radar Set AN/BPS-11 is a modernized version of Radar Sets SS-1, SV-1, AN/BPS-1, AN/BPS-4, and AN/BPS-9A. Radar Set AN/BPS11 is similar to Radar Set AN/BPS-5 except for differences in antenna drive configurations. These differences exist because of the intended installation of each radar.

#### **TECHNICAL DESCRIPTION**

##### Over-All Systems

Maximum Range: 160, 000 yds (80 mi)

Minimum Range: 200 yds

Bearing Accuracy: plus or minus 0.25°

##### Range Accuracy

0 to 60, 000 Yds: 25 yds plus or minus 0.1% of measured range

60, 000 to 160, 000 yds: plus or minus 2% of measured range

##### Power Requirements

General Power: 115v, 60 cyc, 1-ph

Standby: 1852 va

Operate: 2367 va

Trans-On: 3072 va

Synchro Excitation: 115v, 60 cyc, 1-ph  
600 va and 115 va

##### Synchronizing and Transmitting Systems

Repetition Rate: 600 pps, adjustable  
plus or minus 30 pps

Pulse Width: 0.5 usec

Pulse Shape: Rectangular

Frequency: 8740 to 8890 mc

Magnetron Stability: plus or minus 45 mc

Peak RF Power: 75 to 100 kw

Duty Cycle: 0.03%

Average Power: 22.5 to 30w

RF Lines RG-51/U: Waveguide

VSWR: 1.1:1 max

##### Radar Antenna

Horizontal Beamwidth: 2.60°

Vertical Beamwidth: 16°

Antenna Gain: 29.3 db

Polarization: Horizontal

Sidelobes: 23 db down (one way) at 6°  
ea side all others over 25 db down

##### ST (Periscope) Antenna

Horizontal Beamwidth: 30°

Vertical Beamwidth: 10°

Antenna Gain: 14 db

Sidelobes

Horizontal: 16 db down at 60° ea side

Vertical: 14 db down at 20° ea side

##### Receiving System

Antenna Coupling: Duplex converter, TR  
and ATR tube detector

Bearing Oscillator: Klystron, type 2K25

First Detector: Crystal, type 1N23B

Second Detector: Electron, tube type 6AL5

IF. Frequency: 60 mc

Video Bandpass: 3.5 mc at 3 db down point

IF. Bandwidth: 9 mc at 3 db down point

Noise Figure: 17 db

Frequency Control: Manual and AFC

Gain Control: Manual, STC, FTC, and AGC

Pre-IF. Bandwidth: 3.5 to 4 mc at 3 db down point

##### Indicating System

Range Indicator

Display Size: 5 in.

Presentation: Type A

Sweep Ranges: 0 to 4, 10, and 20 mi

Sweeps: Normal-A sweep with range  
step expanded-1000 yds after range step

Range Readout: Counters in yds and

mi min increment of yds counter-100

yds min increment of mi counter-0.1 mi

Electrical Range Output: Synchros at

2000, 72, 000 & 1, 296, 00 yds revolution

**ITEM NAME:** RADAR SET

**TYPE:** AN/BPS-11

**INSTALLATION CONSIDERATION**

PPI Indicator: Range Azimuth Indicator  
AN/SPA-4A (Govt furnished)  
Antenna Positioning System  
Vertical Control  
Positions: Raised and stow  
Drive: GFE hydraulic system  
Radar Set AN/BPS-11  
Azimuth Control  
Automatic: cw or ccw continuous 360°  
scan, 0 to 8 rpm  
Mechanical Coupling: Clutch between  
antenna mast and torque tube drive  
assy disengages, prevents azimuth  
drive, except at full antenna eleva-  
tion.  
Antenna Drive: Adjustable speed, re-  
versible, dc motor.

**Related Equipment**

Required but not Supplied: (1) Antenna  
Junction Box 4-4TB2OM3; (1) Range-  
Azimuth Indicator AN/SPA-4A; (1) In-  
struction Book for Range-Azimuth In-  
dicator AN/SPA-4A NAVSHIPS 91825(A);  
(1) Synchro Signal Amplifier ME 7 Mod  
3E; (1) Instruction Book for Synchro  
Signal Amplifier MK 7 Mod 3E NAVSHIPS  
324-0315; (1) Antenna Control C-1026/  
BPS-4; (1) Capacitor Box MK 19 Mod 0;  
(1) Power Supply PP-3198/BPS-11; and  
(1) Range Indicator IP-599/BPS.

**PRINCIPAL COMPONENTS AND PHYSICAL DATA**

<b>COMPONENTS</b>	<b>QTY</b>	<b>OVERALL DIMENSIONS (Inches)</b>	<b>UNIT WT. (Pounds)</b>
Radar Set Control C-3728/BPS	1	16-5/8 x 18-1/2 x 26	175
Radar Transmitter Receiver 43ADF-1	1	17-1/16 x 22-1/2 x 34	250
Antenna AS-996A/BPS-9A	1		
Power Distribution Panel SB-1325/BPS	1	9-3/4 x 18 x 20-5/8	84
Waveguide Switch SA-816/BPS	1	9 x 10-5/8 x 13-7/8	26
Power Supply Assy PP-3031/BPS	1	17 x 22-5/8 x 46-23/32	450
Headset Assy 49985-A	1	6 x 6 x 8	4.5
Key Assy	1		
Control Motor PD-64/U	1		
Directional Coupler 14ABL	1	2-7/16 x 3-5/8 x 8-1/32	5
Echo Box TS-311B/UP	1	8-1/2 x 8-15/16 x 16	23.5
Antenna Control C-1026/BPS-4	1	7 x 8 x 9	6
Phase Adjuster 14ABM	1	2-13/32 x 2-5/8 x 9-1/4	5
Electrical Dummy DA-148/U	1	1-3/4 x 2 x 7-13/16	1
Range Indicator IP-599/BPS	1	8 x 24-7/16 x 33-1/2	120
Power Supply PP-3198/BPS-11	1		

**AN/BPS-11: 3**

**ITEM NAME:** RADAR SET

**TYPE:** AN/BPS-11

**PRINCIPAL COMPONENTS AND PHYSICAL DATA (Continued)**  
**SHIPPING DATA**

COMPONENT	PKGS	VOLUME (CU FT)	UNIT WT. (Pounds)
	1	10.7	205
	1	13.7	437
	1	3.8	157
	1	2.6	127
	1		
	1		
	1		
	1		
	1		
	1		
	1	2.5	133
	1	2.5	47
	1	2.5	95
	1	4.9	127
	1	2.5	52
	1	18.6	536
	1	1.8	28
	1	1.8	19
	1	9.9	305
	1	5.9	174

**REFERENCE DATA AND LITER**

Technical Manuals:

- NAVSHIPS 94224(A): for Radar Sets AN/BPS-5 and AN/BPS-11.
- NAVSHIPS 94224.21: Operators instruction Charts.
- NAVSHIPS 94224.32: Performance Standard Sheet.
- NAVSHIPS 94224.42: Maintenance Standard Book.
- NAVSHIPS 94224.11: Lubrication Charts.

Specifications: MIL-R-22178

**AN/BPS-11: 4**

DATE: 1 September 1964

ITEM NAME: RADAR SET

COGNIZANT SERVICE: USN

TYPE: AN/BPS-11A

FEDERAL STOCK NUMBER: 2F5840-884-8235

	USA	USN	USAF	USMC
STATUS OR TYPE CLASSIFICATION		Std		

Mfg(s) Name or Code Number: Lockheed Electronics Company (64959)

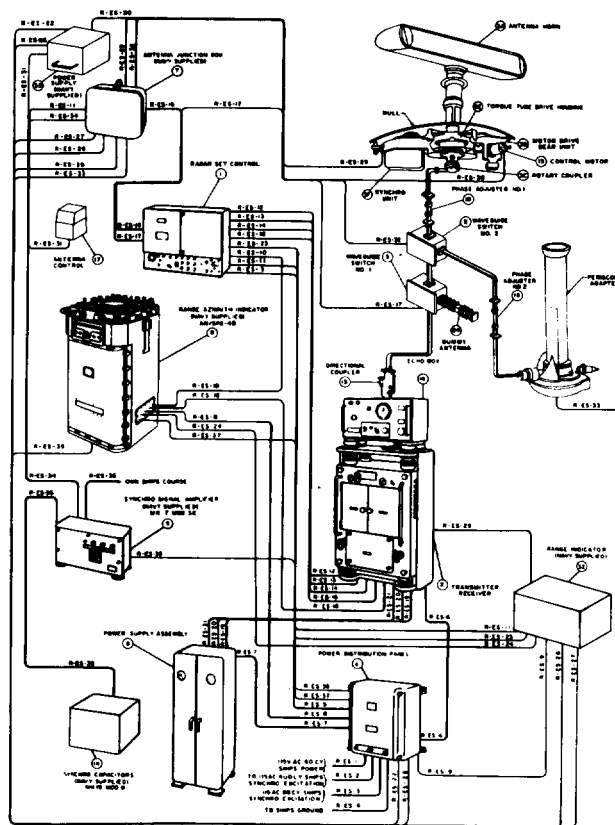

**FUNCTIONAL DESCRIPTION**

Radar Set AN/BPS-11A is a conventional short range surface-search radar designed for installation on class SSB-616 submarine. This radar set has a maximum range of 80 nautical miles and provides target range and bearing information on

Range Azimuth Indicator AN/SPA-4A. This indicator provides a PPI or polar map presentation of the area surrounding the submarine with the center of the screen presenting own ship's position. Normal radar operation is performed from the radar set control and range indicator located

**ITEM NAME:** RADAR SET

**TYPE:** AN/BPS-11A

in the Combat Information Center. This unit together with the PPI unit compose the central control station of the equipment.

The transmitter generates RF energy which is shaped into a narrow beam by the radar antenna and radiated toward the area being searched. Radar targets in the area reflect a minute amount of RF energy (echoes) back to the antenna. These echoes are amplified and detected by the receiver. The target echoes appear as bright spots on the PPI screen, ; distances from the center of the screen represent target range and the angular position of the target represents it's bearing.

The "area search" type of operation just described generally is performed with the submarine surfaced and using the raised radar antenna. Another tactical use of the radar is "target track" operation in which the submarine is submerged and the "ST" (periscope) antenna is used to avoid detection. Range of targets within 20 miles can be measured precisely and is automatically applied to the ship's torpedo data computer. Target bearing is obtained by optically tracking the target with periscope.

The radar also has capabilities for cw communication operations with another similarly equipped station. During this type of operation, the radar functions just as in search operation except that the radar antenna is pointed at the second station and the operator controls the radar transmissions with a telegraph key. A headset is used to aurally monitor the transmissions. The operator sends messages in international Morse Code or other similar system by operating the key.

Other conventional features of the radar set are automatic frequency control of the 60 mc intermediate frequency, sensitivity time control of receiver sensitivity, and anti-jam to suppress extraneous signals.

**RELATION TO SIMILAR EQUIPMENT**

None.

**TECHNICAL DESCRIPTION**

**Over-All Systems**

Maximum Range: 160, 000 yds (80 mi)  
Minimum Range: 200 yds  
Bearing Accuracy: plus or minus 0.25°  
Range Accuracy: 0 to 60, 000 yds, 25 yds  
plus or minus 0.1% of measured range;  
60, 000 to 160, 000 yds plus or minus 2%  
of measured range

**Power Requirements**

General Power: 115v, 60 cyc, 1-ph  
Standby: 1852 va Operate: 2367 va  
Trans-On: 3072 va  
Synchro Excitation: 115v, 60 cyc, 1-ph,  
600 va and 115 va

**Synchronizing and Transmitting Systems**

Repetition Rate: 600 pps adjustable  
plus or minus 30 pps  
Pulse Width: 0.5 usec  
Pulse Shape: Rectangular  
Frequency: 8740 to 8890 mc  
Peak RF Power: 75 to 100 kw  
Duty Cycle: 0.03%  
Average Power: 22.5 to 30w  
RF Lines RG-51/U: Waveguide  
Volts Standard Wave Ratio: 1.1:1 max

**Radar Antenna**

Horizontal Beamwidth: -.6°  
Vertical Beamwidth: 16  
Antenna Gain: 29.3 db  
Polarization: Horizontal  
Sidelobes: 23 db down (one way) at 6°  
ea side all others over 25 db down

**ST (Periscope) Antenna**

Horizontal Beamwidth: 30°  
Vertical Beamwidth: 10°  
Antenna Gain: 14 db  
Sidelobes

Horizontal: 16 db down at 60° ea side  
Vertical: 14 db down at 20° ea side

**Receiving System**

Antenna Coupling: Duplex converter, TR  
and ATR tube detector  
Bearing Oscillator: Klystron type 2K25  
First Detector: Crystal type 1N23B  
Second Detector: Electron type type 6AL5  
IF. Frequency: 60 mc  
Pre-IF. Bandwidth: 3.5 to 4 mc at 3 db down point  
IF. Bandwidth: 9 mc at 3 db down point  
Video Bandpass: 3.5 mc at 3 db down point  
Noise Figure: 17 db  
Frequency Control: Manual, STC, FTC, and AGC

**Indicating System**

Display Size: 5 in.  
Presentation: Type A  
Sweep Ranges: 0 to 4, 10, and 20 mi  
Sweeps: Normal-A sweep with range step  
expanded 1000 yds after range step  
Range Readout: Counters in yds and mi  
min increment of yds counter 100 yds  
min increment of mi counter 0.1 mi  
Electrical Range Output: Synchros at  
2000, 72, 000 and 1, 296, 000 yds revolution  
PPI Indicator: Range Azimuth Indicator  
AN/SPA-4B (Govt furnished)  
Antenna Positioning System  
Vertical Control  
Positions: Raised and stow  
Drive: GFE hydraulic system

**ITEM NAME:** RADAR SET

**TYPE:** AN/BPS-11A

Radar Set AN/BPS-11A  
Azimuth Control  
Automatic: cw or ccw continuous 360°  
scan, 0 to 8 rpm  
Manual: Point  
Antenna Drive: Motor driven transmis-  
sion controlled by magnetic clutches

Junction Box; (1) Range Azimuth Indicator AN/SPA-4B;  
(1) Instruction Book for Range-Azimuth Indicator  
AN/SPA4B NAVSHIPS 91825(A); (1) Synchro Signal  
Amplifier MK 7 Mod 3E; (1) Instruction Book for Synchro  
Signal Amplifier MK 7 Mod 3E NAVSHIPS 324-0315; (1)  
Antenna Control C-1026/BPS-4; (1) Capacitor Box  
(Synchro Capacitors) MK 19 Mod 0; (1) Range Indicator  
IP599/BPS; (1) Power Supply PP-3198A/ BPS-11 and  
PP-3198B/BPS-11; and (1) Power Supply PP-776/BPS-  
4.

**INSTALLATION CONSIDERATION**

Related Equipment  
Required but not Supplied: (1) Antenna

**PRINCIPAL COMPONENTS AND PHYSICAL DATA**

COMPONENTS	QTY	OVERALL DIMENSIONS (Inches)	UNIT WT. (Pounds)
Radar Set Control C-3728/BPS	1	16-5/8 x 18-1/2 x 26	175
Radar Transmitter Receiver CW-43ADF-1	1	17-1/16 x 22-1/2 x 34	250
Antenna AS-996A/BPS-9A	1		
Power Distribution Panel SB-1325/BPS	1	9-3/4 x 18 x 20-5/8	84
Waveguide Switch SA-834/BPS	1	4-1/2 x 5-1/2 x 7	4
Power Supply Assy PP-3031/BPS	1	17 x 22-5/8 x 46-23/32	450
Headset Assy CW-49985-A	1	6 x 6 x 8	4.5
Key Assy BL-61136	1		
Control Motor PD-64/U	1		
Directional Coupler CW-14ABL	1	2-7/16 x 3-5/8 x 8-1/32	5
Echo Box TS-311B/UP	1	8-1/2 x 8-15/16 x 16	23.5
Instruction Book NAVSHIPS 92004	1		
Antenna Control C-1026/BPS-4	1	7 x 8 x 9	6
Phase Adjuster CW-14ABM-1	1	2-13/32 x 2-5/8 x 9-1/4	5
Frequency-Power Meter TS-230C/AP	1	10-1/2 x 10-3/4 x 18-1/2	30
Dummy Antenna TS-231/AP	1	1-3/4 x 2 x 7-13/16	1
Range Indicator IP-599/BPS	1	8 x 24-7/16 x 32-1/2	120
Power Supply PP-3198/BPS-11 and PP-3198A/BPS-II	1		
Power Supply PP-3198B/BPS-II	1	21 x 23 x 28	240

**AN/BPS-11A: 3**



**ITEM NAME:** RADAR SET

**TYPE:** AN/BPS-11A

**PRINCIPAL COMPONENTS AND PHYSICAL DATA (Continued)**

**SHIPPING DATA**

COMPONENT	PKGS	VOLUME (CU FT)	UNIT WT. (Pounds)
	1	10.2	228
	1	14.7	510
	1	3.3	155
	1	5.9	120
	1	6.6	138
	1	6.6	131
	1	17.4	650
	1	4.5	120
	1	3.3	72
	1	5.9	88
		3.8	129
		10.0	320

**REFERENCE DATA AND LITERATURE**

Technical Manuals:

- NAVSHIPS 94224(A): for Radar Sets AN/BPS-5A and AN/BPS-11A.
- NAVSHIPS 94224.21: Operators Instruction Charts for Radar Set AN/BPS-SA.
- NAVSHIPS 94224.32: Performance Std Sheet for Radar Set AN/BPS-5A.
- NAVSHIPS 94224.42: Maintenance Std Book for Radar Set AN/BPS-5A.
- NAVSHIPS 94224.11: Lubrication Charts for Radar Set AN/BPS-5A.

Specifications: MIL-R-22178

**AN/BPS-11A: 4**

DATE: 1 July 1964      ITEM NAME: RADAR SET

COGNIZANT SERVICE: USN      TYPE: AN/CPT-2

FEDERAL STOCK NUMBER:

	USA	USN	USAF	USMC
STATUS OR TYPE CLASSIFICATION	Used By	Used By		
Mfg(s) Name or Code Number: Vendo Company (79079)				

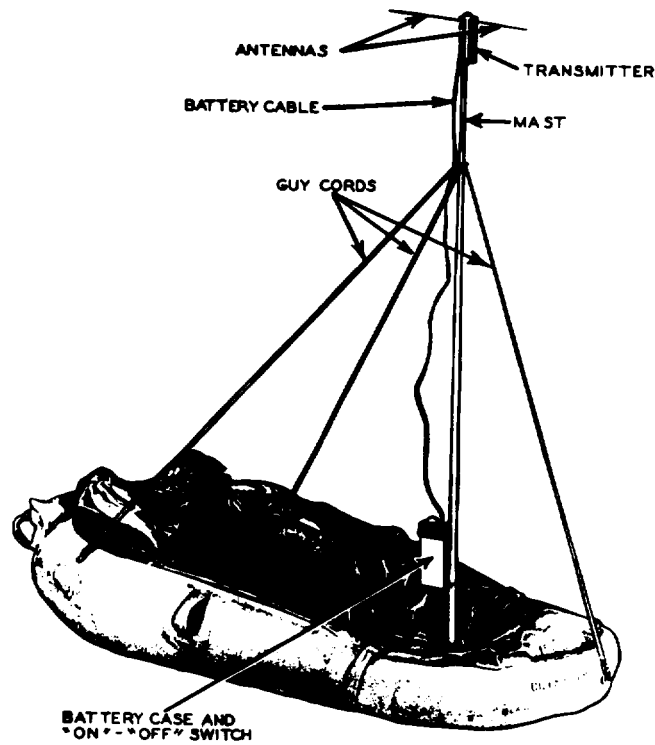

**FUNCTIONAL DESCRIPTION**

The Radar Set AN/CPT-2 is a self-contained, light-weight beacon transmitter for use in a one (1) man life raft. The radar set has as

effective range of from 12 to 18 miles. It operates in the frequency of 176 megacycle (mc).

AN/CPT-2: 1

**ITEM NAME:** RADAR SET  
**TYPE:** AN/CPT-2

**RELATION TO SIMILAR EQUIPMENT**

None.

**TECHNICAL DESCRIPTION**

Type of Transmitter: Squegging oscillator  
Type of Signal: Pulse modulated  
(squegging).  
Pulse Rate: 45 kc per sec  
Frequency: 176 mc  
Effective Operating Range: 12 to 18 mi  
Operating Power Requirements: Two (2)  
1.5v, BA-30 batteries in parallel and  
one (1) 103.5v, BA-38 or BA-38B.

**INSTALLATION CONSIDERATIONS**

Siting: One (1) man life raft.

Related Equipment: The AN/CPT-2 is de-  
signed to operate with such equipments  
as Radio Set SCR-729-A, Radar Set AN/  
APN-12, Radar Set AN/APN-10, Radio Set  
SCR-521, Navy ASE, British MK 11.  
(Equipment Required but not Supplied)  
(1) Frequency Meter BC-96-C or BC-906-D;  
(1) Test Set TS-35; (1) Cathode Ray  
Oscillograph RCA-158 or equivalent;  
(2) Battery BA-30 (1.5v); (1) Battery  
BA-38 or BA-38B (103.5v or 93.6v).

**PRINCIPAL COMPONENTS AND PHYSICAL DATA**

<b>COMPONENTS</b>	<b>QTY</b>	<b>OVERALL DIMENSIONS (Inches)</b>	<b>UNIT WT. (Pounds)</b>
Radar Set AN/CPT-2	1	2 x 4-1/2 x 15	3-1/4

**REFERENCE DATA AND LITERATURE**

Technical Manuals:  
AN16-30CPT2-2

DATE: 1 July 1964

ITEM NAME: RANGE-AZIMUTH INDICATOR

COGNIZANT SERVICE: USN

TYPE: AN/SPA-4, \* -4A, \*\* -4B\*\*\*

FEDERAL STOCK NUMBER: F5840-665-3686\*  
F5840-644-4626\*\*  
F5840-552-1903\*\*\*

	USA	USN	USAF	USMC
Ltd Std*, ** STATUS OR TYPE CLASSIFICATION Sub .Std*** General Electric Company*; Radio Corporation of America **; Mfg(s) Name or Code Number: Bendix Aviation Corporation***				

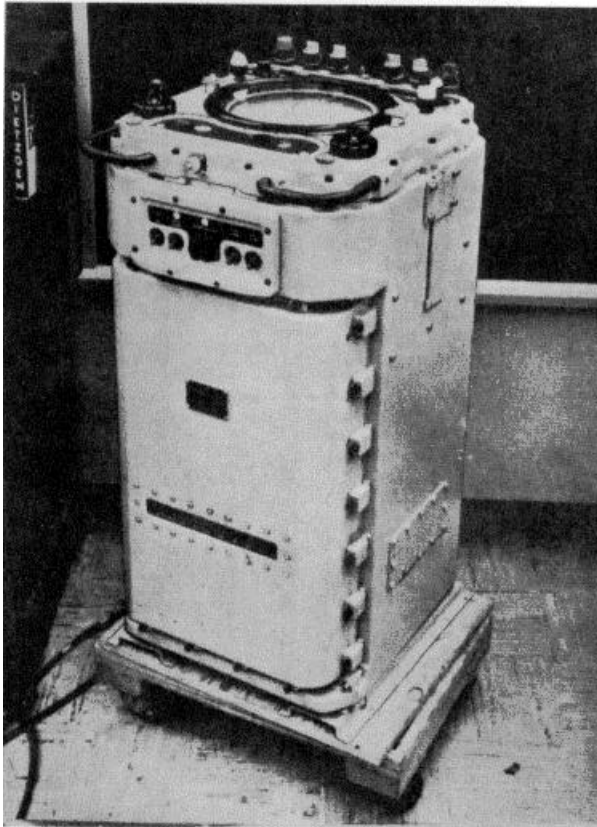

### FUNCTIONAL DESCRIPTION

Range-Azimuth Indicators AN/SPA-4, -4A, and -4B provide PPI type presentations of target range and azimuth when supplied with video and trigger signals from any one of eight search radars. Azimuth is determined by means of a mechanical cursor. The target presentation is the result of two alternately generated electronic sweeps -- the PPI sweep and the cursor sweep. The PPI sweep is rotated through 360 degrees on the screen in synchronism with the associated radar antenna, and the cursor sweep traces a single, controlled radius. A spot-of-light range strobe appears on the screen during the cursor sweep and can be superimposed on any target in the PPI display, thus permitting a highly accurate measurement of the target range. Field changes to the AN/SPA-4 and AN/SPA-4A provide an indication of true bearing which is incorporated in the design of the AN/SPA-4B.

### RELATION TO SIMILAR EQUIPMENT

None.

### TECHNICAL DESCRIPTION

Video Input:

AN/SPA-4 - +1 to +2.5v

AN/SPA-4A, -4B - +2 ±0.5v

Trigger Input: +5 to +50v

Pulse Repetition Rate:

AN/SPA-4 - 140 to 3, 000 pps

AN/SPA-4A, -4B - 60 to 3, 000 pps

Operating Voltages and Power Requirements:

AN/SPA-4 - 115v ±10%, 60 ±2 cps, 1-ph, 14.2 amp, 97% pf, 715 va, 690w

AN/SPA-4A, -4B - 115v ±10%, 60 cps, 1-ph, amp ±10%, 90% pf, 1, 110 va

Type of Presentation: One 10-in. PPI

Range Marks:

AN/SPA-4 - 0.5, 1, 5, 20, and 50 mi

AN/SPA-4A, -4B - 0.5, 1, 2, 5, 10, 20, and 50 mi

AN/SPA-4, -4A, -4B

Range Strobe Accuracy:  $\pm 1\%$  of range scale  
Azimuth Accuracy: 2 deg for 1-speed;  
1 deg for 1- and 36-speed  
Sweep Accuracy:  $\pm 1\%$  from 1- to 20-mi range;  
 $\pm 2\%$  from 20- to 250- or 300-mi range

**INSTALLATION CONSIDERATIONS**

Siting: If open bridge or weather exposed site is used, Air Exchange Valve MX- 1478/SPA-4A is needed.  
Vertical Mounting: Bottom shock mounts must be bolted to a horizontal deck or surface. If practical, further secure equipment to bulk-

head by means of two shock mounts at the upper rear of the unit.  
Tilted Mounting: As much as 45 deg forward slanting allowed. Equipment must be permanently attached to a support tilted the same angle as the equipment.  
Cabling Requirements: Video and trigger cables must have a characteristic impedance of 75 ohms. The rear cable entrance hole is not available when Air Exchange Valve MX- 1478/SPA-4A is used.  
Related Equipment: Designed for use with any standard Navy search radar system having a prf between 140 and 3, 000 pps.

**PRINCIPAL COMPONENTS AND PHYSICAL DATA**

COMPONENT	QTY	HEIGHT (Inches)	WIDTH (Inches)	DEPTH (Inches)	UNIT WT. (Pounds)
Range-Azimuth Indicator ID-302/SPA-4	1	37-15/16	21-3/4	18	342
Range-Azimuth Indicator AN/SPA-4A	1	38	21	19	366
Range-Azimuth Indicator AN/SPA-4B	1	39	21	19	400

**REFERENCE DATA AND LITERATURE**

Technical Manuals:  
NAVSHIPS 91659  
NAVSHIPS 91825(B)  
NAVSHIPS 92942(A)

DATE: 1 July 1964

ITEM NAME: INDICATOR GROUP

COGNIZANT SERVICE: USN

TYPE: AN/SPA-8, \*-8A, \*-8B\*, -9\*\*

FEDERAL STOCK NUMBER: See Note 1

	USA	USN	USAF	USMC
STATUS OR TYPE CLASSIFICATION		Std * Sub. Std **		
Crosley Division, AVCO Mfg. Co. (AN/SPA-8B)				
Mfg(s) Name or Code Number: Hazeltine Electronics Corp. (AN/SPA-8, -8A, -9)				

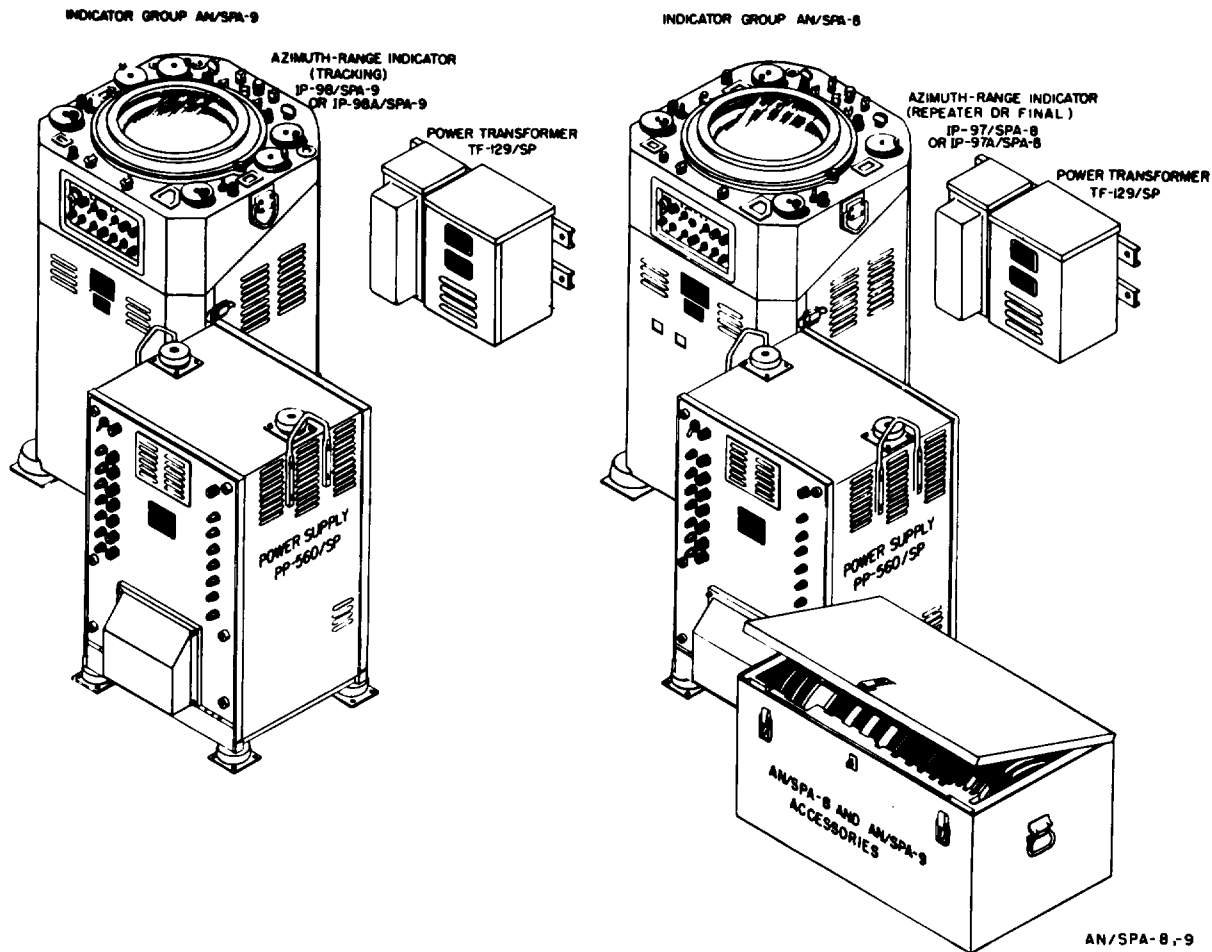

**FUNCTIONAL DESCRIPTION**

indicator Groups AN/SPA-8, -8A, -8B, and -9 are general purpose PPI's for ship or submarine

installation. They can be used as master or remote radar PPI repeaters, as radar relay search tracking indicators, or as radar relay search-repeat indicators. They are frequently used as track-

AN/SPA-8, -8A, -8B, -9  
ing and repeat indicators with Radio Receiving Set  
AN/SRR-4, which is the shipborne section of the AEW  
system.

This equipment features continuous range variation  
without loss of target, time sharing of the electronic  
cursor and tracking strobe, and sweep and off-centering  
controls which make target magnification possible  
without geographic distortion. The AN/SPA-8A, -8B are  
single indicators used as either a tracking indicator or a  
repeater, while the AN/SPA-8 and the AN/SPA-9 consist  
of separate tracking and repeater indicators.

**RELATION TO SIMILAR EQUIPMENT**

None.

**TECHNICAL DESCRIPTION**

Type of Presentation: Ten-in. PP[ with elec-  
tronic cursor and with range at 1, 2, 5, 10,  
and 50 mi

Range:

AN/SPA-8, -9 -

4 to 250 mi continuously variable

AN/SPA-8A, -8B -

4 to 300 mi continuously variable

Pulse Repetition Rate:

AN/SPA-8, -9 - 60 to 2, 000 pps

AN/SPA-8A, -8B - 60 to 3, 000 pps

Range Accuracy:

AN/SPA-8, -9 - 300 to 10, 000 yd, +100 yd

10, 000 to 40, 000 yd, ±1% of actual range

40, 000 to 100, 000 yd, ±2% of actual range

100, 000 yd to 250 mi, ±3% of actual range

AN/SPA-8A, -8B - 300 to 10, 000 yd, +100 yd

10, 000 to 72, 000 yd, ±1% of actual range

72, 000 yd to 300 mi, ±2% of actual range

Azimuth Accuracy:

Within 2 deg at all antenna speeds

Video Input: 1 to 2.5v

Trigger Input: 5 to 50v

Antenna Trace and Rotation Speed:

AN/SPA-8, -9 - 0 to 30 rpm

AN/SPA-8A, -8B - 0 to 40 rpm

Operating Voltages and Power Requirements:

115v 10%, 60 ±2 cps, 1-ph, 1, 620w, 0.83 pf

**INSTALLATION CONSIDERATIONS**

Siting: Allow room for servicing and ventilation.

Space must be available for the indicator to  
tilt forward and rest on its side for servicing.

Mounting: Vertical or 3 deg forward tilt of

indicator unit. Both require bolting to deck  
and bulkhead. Tilted installation r e q u i r e s  
base mount and bulkhead for permanent fas-  
tening.

Cabling Requirements: Radius of curvature of  
cable bends should be more than ten times  
the diameter of the cable.

Related Equipment: Radio Receiving Set AN/  
SRR-4.

**PRINCIPAL COMPONENTS AND PHYSICAL DATA**

COMPONENT	QTY	HEIGHT (Inches)	WIDTH (Inches)	DEPTH (Inches)	UNIT WT. (Pounds)
AN/SPA-8 Azimuth-Range Indicator IP-97/SPA-8 or IP-97A/SPA-8	1	38	25-1/2	24	438
Power Supply PP-560/SP	1	30-13/32	22-1/4	20-13/32	316
Power Transformer TF-129/SP	1	23-45/64	12-29/32	8-7/64	96
AN/SPA-8A Azimuth-Range Indicator 1 38 26 25-1/2 472 IP-97B/SPA-8	1	38	25-1/2	24	472
Power Supply PP-560A/SP	1	30-13/32	22-1/4	20-13/32	320
Power Transformer TF-129/SP or TF-129A/SP	1	23-45/64	12-29/32	8-1/4	96

AN/SPA-8, -8A, -8B, -9

**PRINCIPAL COMPONENTS AND PHYSICAL DATA (cont'd)**

<b>COMPONENT</b>	<b>QTY</b>	<b>HEIGHT (Inches)</b>	<b>WIDTH (Inches)</b>	<b>DEPTH (Inches)</b>	<b>UNIT WT. (Pounds)</b>
AN/SPA- 8B					
Azimuth-Range Indicator IP-97C/SPA-8	1	38	26	25-1/2	472
Power Supply PP-560B/SP	1	30-13/32	22-1/4	20-13/32	320
Power Transformer TF-129/SP or TF-129A/SP	1	23-45/64	12-29/32	8-1/4	96
AN/SPA-9					
Azimuth-Range Indicator IP-98/SPA-9 or IP-98A/SPA-9	1	38	25-1/2	24	438
Power Supply PP-560/SP	1	30-13/32	22-1/4	20-13/32	316
Power Transformer TF-129/SP	1	23-45/64	12-29/32	8-7/64	96

**REFERENCE DATA AND LITERATURE**

**Note 1. Federal Stock Numbers**

Technical Manuals:  
NAVSHIPS 91411(A)  
NAVSHIPS 91737  
F5840-316-8444

F5840-665-2572  
F5840-316-8443  
F5840-556-9558

**AN/SPA-8: 3**



DATE: 1 July 1964

ITEM NAME: INDICATOR GROUP

COGNIZANT SERVICE: USN

TYPE: AN/SPA-8C

FEDERAL STOCK NUMBER:

	USA	USN	USAF	USMC
STATUS OR TYPE CLASSIFICATION				

Mfg(s) Name or Code Number: Hazeltine Electronics Div., Hazeltine Corp., Little Neck, N. Y.

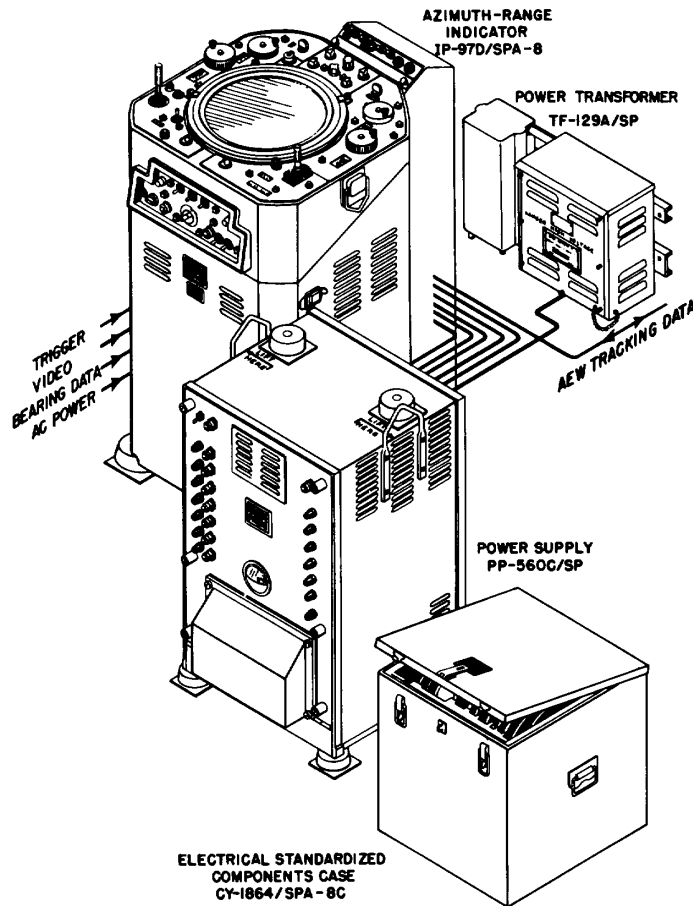

**FUNCTIONAL DESCRIPTION**

The AN/SPA-8C is a general purpose plan position indicator designed to be used as an ordinary PPI, as an AEW tracking indicator, or as an AEW repeater indicator. It incorporates continuous range variation,

time sharing of the electronic cursor and tracking strobe with the sweep, off-centering and magnification. The range strobe can be switched to the video sweep so that it appears as an adjustable range ring, concentric with the regular range rings. Its radius as a range ring can be changed with

**ITEM NAME:** INDICATOR GROUP

**TYPE:** AN/SPA-SC

the regular range strobe control. Another feature is that a switch can be set to present the range rings either in the usual position on the video display sweep, on the cursor where they appear as range markers, or in both places simultaneously.

It has provisions, when used with the AN/SRR-4 or AN/WRR-1 equipment as an AEW tracking indicator, to place either the AEW aircraft or its own ship at the origin of the electronic cursor so that the operator can read directly the range and bearing of targets from either the AEW aircraft or his own ship.

**RELATION TO SIMILAR EQUIPMENT**

The AN/SPA-8C is similar to, but not completely interchangeable with the AN/SPA-BA.

**TECHNICAL DESCRIPTION**

Presentation: 10 in CR tube.  
Pulse Repetition Frequency: 60 to 3000 pps.  
Input  
Video: 1 to 2.5v, positive

Trigger: 5 to 50v, positive  
Antenna and Trace Rotation: 0 to 40 rpm  
Range Selection  
Centered PPI: 4 to 300 mi, continuously variable.  
Off-Centered PPI: 4 to 300 mi, continuously variable.  
Range Accuracy  
300 to 10, 000 Yds: plus or minus 100 yds.  
10, 000 to 72, 000 Yds: plus or minus 1% of actual range.  
72, 000 Yds to 300 Mi: plus or minus 2% of actual range.  
Bearing Accuracy: Within 2 deg at all antenna speeds.  
Power Requirements: 115v plus or minus 10%, 60 plus or minus 3 cps, single ph, 1650 va, 97% pf

**INSTALLATION CONSIDERATIONS**

Related Equipment: (Required but not Supplied) Interconnecting Cables as required, Terminal Tubes as required, Synchros as required, Test Equipment as required.

**PRINCIPAL COMPONENTS AND PHYSICAL DATA  
SHIPPING DATA**

COMPONENT	BOXES (NR.)	OVERALL DIMENSIONS (Inches)	UNIT WT. (Pounds)
Azimuth-Range Indicator IP-97D/SPA-8	1	35 x 39-1/2 x 46-3/4	700
Power Supply PP-560C/SP	1	27-1/2 x 33 x 36-3/4	465
Power Transformer TF-129A/SP	1	10-3/4 x 17-1/2 x 30-3/4	150
Set of Indicator Accessories	1		
Components Case CY-1B64/SPA-BC	1	18-1/8 x 20-1/8 x 21-5/8	
Set of Shock Mounts including: (2) Technical Manual NAVSHIPS 93133 (2) Maintenance Standards NAVSHIPS 93133.42	1		

**EQUIPMENT SUPPLIED DATA**

COMPONENT	BOXES (NR.)	OVERALL DIMENSIONS (Inches)	UNIT WT. (Pounds)
Azimuth-Range Indicator IP-97D/SPA-8	1	25-1/2 x 29-1/4 x 39-3/4	460
Power Supply PP-560C/SP	1	20-1/2 x 22-5/16 x 30-3/8	309
Power Transformer TF-129A/SP	1	8-1/4 x 12-7/8 x 23-11/16	112
Components Case CY-1864/SPA-BC	1	15-1/2 x 15-1/2 x 18-3/4	76

**AN/SPA-SC: 2**

**ITEM NAME:** INDICATOR GROUP

**TYPE:** AN/S PA-BC

**PRINCIPAL COMPONENTS AND PHYSICAL DATA**

**EQUIPMENT SUPPLIED DATA (Cont.)**

<b>COMPONENTS</b>	<b>QTY</b>	<b>OVERALL DIMENSIONS (Inches)</b>	<b>UNIT WT. (Pounds)</b>
Set of Indicator Accessories	1		
Set of Equipment Spares	1		
Technical Manual NAVSHIPS 93133	2		
Maintenance Standards Manual NAVSHIPS 93133.42	2		
Operator's Chart NAVSHIPS 93133.21	2		

**REFERENCE DATA AND LITERATURE**

Technical Manuals:  
NAVSHIPS 93133

**AN/S PA-8C: 3**

**DATE:** 1 July 1964

**ITEM NAME:** INDICATOR GROUP

**COGNIZANT SERVICE:** USN

**TYPE:** AN/SPA-9

**FEDERAL STOCK NUMBER:** F5840-316-8444

	USA	USN	USAF	USMC
STATUS OR TYPE CLASSIFICATION Sub Std				

Mfg(s) Name or Code Number: Hazeltine Electronics Corporation

Description for Indicator Group AN/SPA-9 is found on Indicator Group AN/SPA-8 data sheets, pages AN/SPA-8: 1 through AN/SPA-8: 3.

**AN/S PA-9: 1**

DATE: 1 July 1964

ITEM NAME: COMPUTER-RECORDER GROUP

COGNIZANT SERVICE: USN

TYPE: AN/SPA-14(XN-1)

FEDERAL STOCK NUMBER:

	USA	USN	USAF	USMC
STATUS OR TYPE CLASSIFICATION				

Mfg(s) Name or Code Number: Electronics Associates, Inc., Long Branch, N. J.

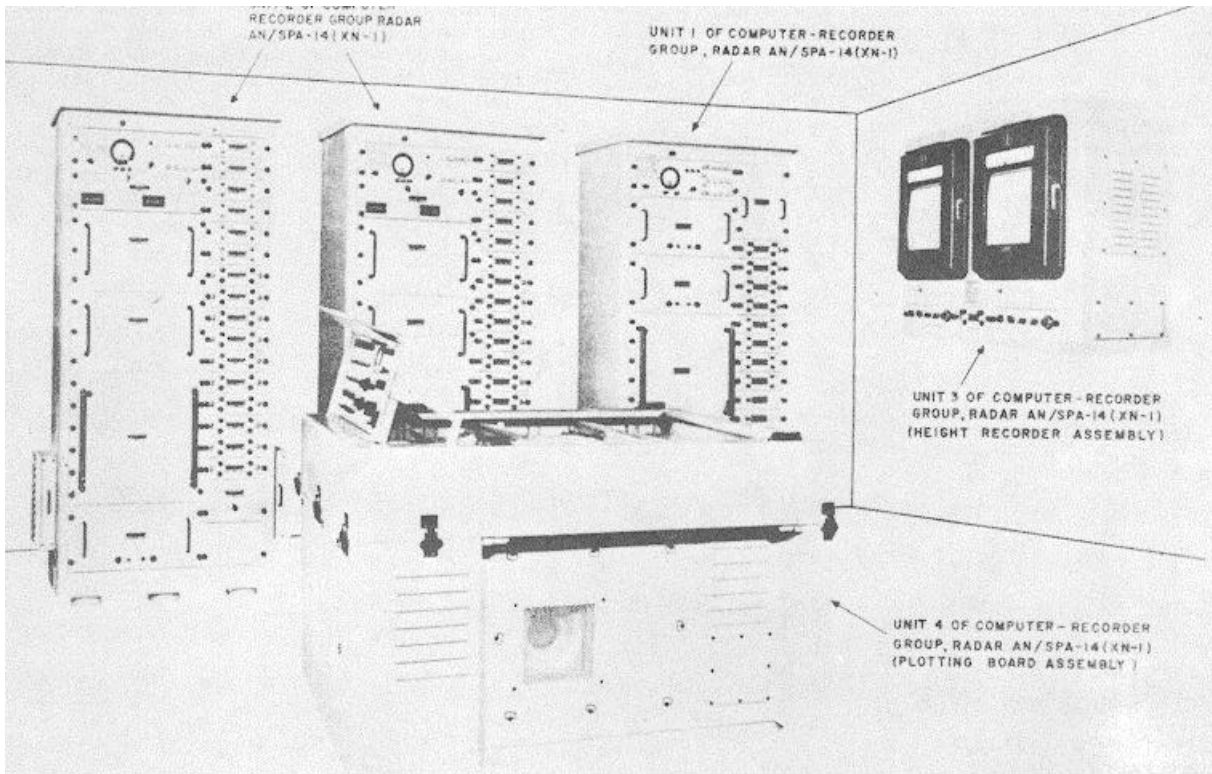

### FUNCTIONAL DESCRIPTION

The AN/SPA-14(XN-1) is an electro-mechanical device that automatically computes and records in an x, y, and z coordinate system the activities of two radars. One radar tracks a target and the other tracks a beacon.

There are four radars, any two of which can be utilized to feed information into the computer-recorder group. In addition to the input data from the radars, additional input signals are derived from the ship and are called Own Ship's Course 1 and 36

AN/SPA-14(XN-1): 1

**ITEM NAME:** COMPUTER-RECORDER GROUP  
**TYPE:** AN/SPA-14(XN-1)

speed and Own Ship's Motion. The resulting plot on the plotting board shows the path over a horizontal reference plane of both the target and beacon relative to a fixed set of axis.

**RELATION TO SIMILAR EQUIPMENT**

Power Requirements: 115V, 60 cps, single ph, 30 amps for Unit 1, 20 amps for Unit 4.

Heat Dissipation

Unit 1: Approx 1000w (57 BTU per min).

Unit 2: Approx 1300w per rack (73 BTU per min).

Unit 3: Approx 300w (18 BTU per min).

Unit 4: Approx 180w (105 BTU per min).

Presentation: Permanently inked record on plotting board of X vs. Y coordinates vs. height plot on height recorder.

Computer Accuracy: Output voltage within plus or minus 9.4% of theoretically correct voltages, electro-mechanical resolving element and their driving servos within 0.5% of range and linear angles and 0.1% for resolved azimuth and elevation angles.

Angular Speed of Target: 30 deg per sec in relation to ship can be computed.

Plotter Accuracy: 0.015 of theoretically correct positions.

Acceleration

Pen: 200 in. per sec

Arm: 100 in. per sec

Plotting Velocity: 3 in. per sec in any direction without exceeding accuracy tolerance limit.

Arm Transfer: Pen can be relocated completely across board in 2 sec upon transfer of arm plotting functions.

Height Recorder

Type: 2 pen instrument for recording

2 independent variables simultaneously.

Paper Speed: 1, 3, 5, or 15, in. per minute.

Scale Factors (Plotting Board): 2, 4, 8, and 12 mi per in. to give max ranges of 30, 60, 120, and 180 mi for long limit. Divide by 4 for short limit (50 mi max).

Parallax and Own Ship's Motion: Own ship can be off-centered from 0 to 180 mi from center of plotting area (long limit).

**INSTALLATION CONSIDERATIONS**

Not available.

**PRINCIPAL COMPONENTS AND PHYSICAL DATA**

COMPONENTS	QTY	OVERALL DIMENSIONS (Inches)	UNIT WT. (Pounds)
Unit 1 Computer	1	23-7/8 x 35-3/4 x 71-7/8	1300
Unit 2 Computer	2	23-7/8 x 35-3/4 x 71-7/8	1200
Unit 3 Height Recorder	1	23-5/8 x 34-5/16 x 45-1/2	400
Unit 4 Plotting Board Assy	1	41-7/16 x 48-3/8 x 63-7/16	1250
Set of Accessories	1		

**REFERENCE DATA AND LITERATURE**

Technical Manuals:  
NAVSHIPS 92925

DATE: 1 July 1964

ITEM NAME: INDICATOR GROUP

COGNIZANT SERVICE: USN

TYPE: AN/SPA- 18

FEDERAL STOCK NUMBER: F5840-644-4553

	USA	USN	USAF	USMC
STATUS OR TYPE CLASSIFICATION		Std		

Mfg(s) Name or Code Number: The Austin Company, Special Devices Division

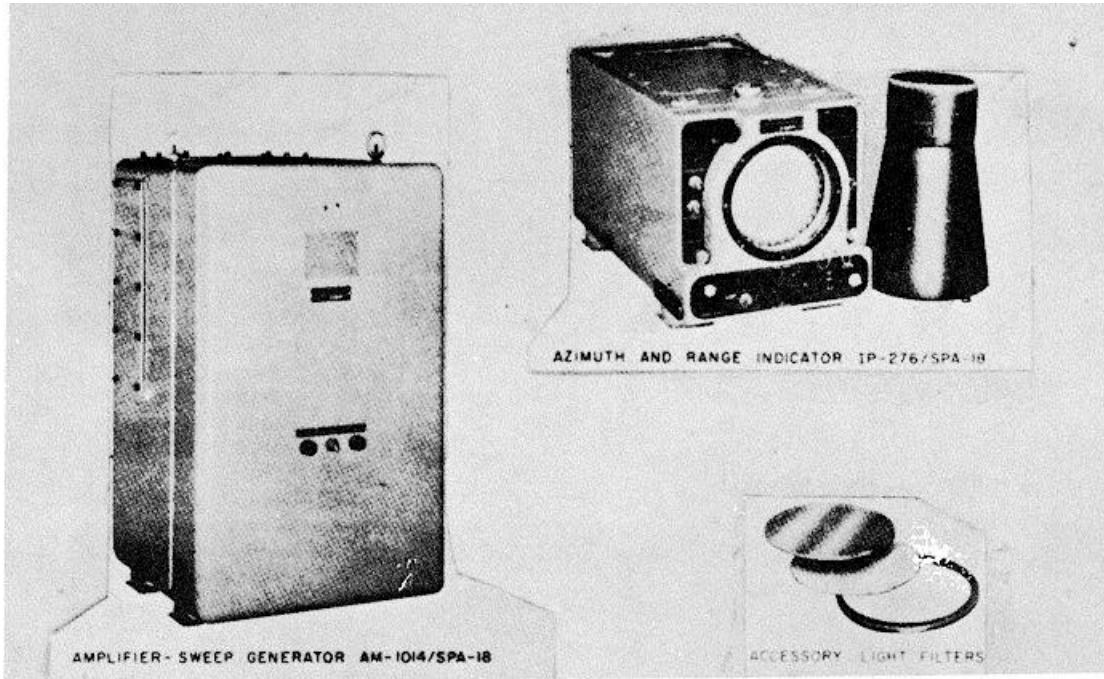

### FUNCTIONAL DESCRIPTION

Indicator Group AN/SPA- 18 p r o v i d e s remote PPI indication at locations where size and weight are controlling factors.

### RELATION TO SIMILAR EQUIPMENT

None.

### TECHNICAL DESCRIPTION

Video Input: +1 to +2.5v  
Trigger Input: +5 to +50v peak

Trigger Pulse Duration: 10  $\mu$  sec max  
Pulse Repetition Rate: 57 to 3, 000 pps  
Range: 2 to 30 mi continuous  
Operating Voltages and Power Requirements:  
115v  $\pm$ 10%, 60  $\pm$ 2 cps, 1-ph, 605w, 0.93 pf  
Type of Presentation: One 7-in. PP[  
Range Mark Intervals: 0.5, i, 2, 5, 10, 20, and 50 mi

### INSTALLATION CONSIDERATIONS

Siting:  
Mounting: Each unit is provided with shock mounts to permit shelf or bulkhead mounting.  
Cabling Requirements:  
Related Equipment:

**AN/SPA- 18**

**PRINCIPAL COMPONENTS AND PHYSICAL DATA**

<b>COMPONENT</b>	<b>QTY</b>	<b>HEIGHT (Inches)</b>	<b>WIDTH (Inches)</b>	<b>DEPTH (Inches)</b>	<b>UNIT WT. (Pounds)</b>
Amplifier-Sweep Generator AM- 1014/SPA- 18	1	30-3/4	18-27/32	19-7/32	198
Azimuth-Range Indicator IP-276/SPA- 18	1	14-3/4	13-1/8	37-3/4	107

**REFERENCE DATA AND LITERATURE**

Technical Manual:  
NAVSHIPS 92344



DATE: 1 July 1964  
COGNIZANT SERVICE: USN

ITEM NAME: ANTENNA GROUP  
TYPE: AN/SPA-21(XN-1)

FEDERAL STOCK NUMBER:

	USA	USN	USAF	USMC
STATUS OR TYPE CLASSIFICATION				

Mfg(s) Name or Code Number: The Gabriel Laboratories Div. of Gabriel Co., Needham Heights, Mass.

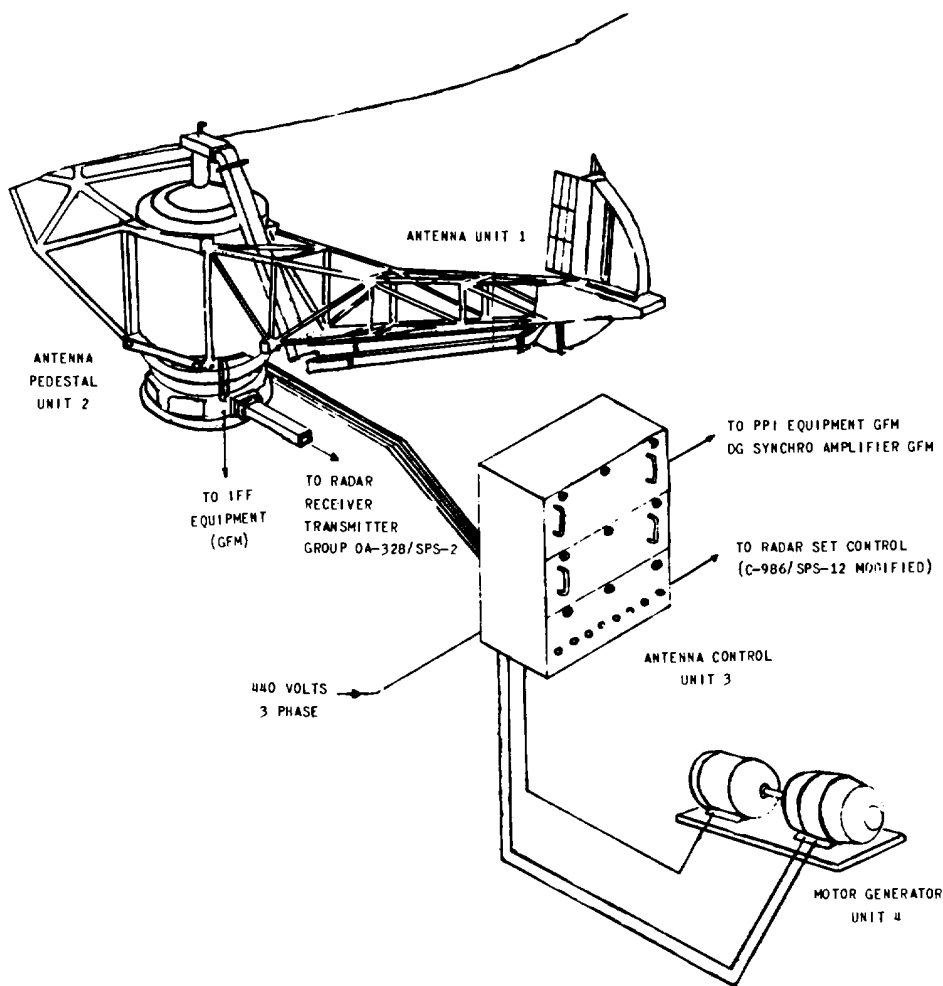

### FUNCTIONAL DESCRIPTION

The AN/SPA-21(XN-1) was developed to improve Radar Set AN/SPS-12 from a medium range to a long-range high altitude surveillance radar system. An additional six (6) db gain over the old system was realized by

incorporating a larger reflector element, fed by a point-source hog horn. Provision is also made to connect IFF equipment to Radar Set AN/SPS-12, and display the received signals from this equipment together with the reflected radar signals on the same Plan Position Indicator (PPI) scope of other associated

**ITEM NAME:** ANTENNA GROUP

**TYPE:** AN/SPA-21(XN-1)

equipment. The power handling capacity of the feed system is increased to two megawatts (peak Power) and the antenna and pedestal is constructed to withstand a heavier ice and wind loading without impairing the normal operation of the equipment.

cps, 3 ph, 15.5 kw max and 5.0 kw normal

**INSTALLATION CONSIDERATIONS**

**RELATION TO SIMILAR EQUIPMENT**

None.

**TECHNICAL DESCRIPTION**

Heat Dissipation: 250w  
Operating Frequency: 1250 to 1350 mc  
Peak Power Output: 2 megw  
Operating Power Requirements: 440v ac, 60

Related Equipment: The AN/SPA-21(XN-1) is designed to be used with but not part of the AN/SPS-12 or possibly the AN/SPS-6. (Equipment Required but not Supplied):  
(1) Radar Set AN/SPS-12 excluding the following units: (1) Control-Power Supply C-1100/SPS-12, (1) Antenna Pedestal AB-276/SPS-12, (1) Rotary Coupler CU-603/SPS-12, (1) Antenna AS-603/SPS-11  
(1) Master PPI and Instruction Book, (1) DG Synchro Amplifier and Instruction Book AM-421/U, (1) Range Calibrator and Instruction Book, (1) PPI Repeater and Instruction Book.

**PRINCIPAL COMPONENTS AND PHYSICAL DATA**

**SHIPPING DATA**

<b>COMPONENT</b>	<b>BOXES</b>	<b>OVERALL DIMENSIONS (Inches)</b>	<b>UNIT WT. (Pounds)</b>
Antenna Pedestal Unit 2	1	42 x 46 x 92	2610
Antenna Feedhorn and Support P/O Unit 1	1	32 x 62 x 146	425
Antenna Reflector Support P/O Unit 1	1	44 x 55 x 59	210
Antenna Reflector Section (Right End) P/O Unit 1	1	42 x 98 x 118	370
Antenna Reflector Section (Left End) P/O Unit 1	1	42 x 98 x 118	370
Antenna Reflector Section (Middle) P/O Unit 1	1	50 x 102 x 110	450
Antenna Control Unit 3	1	27 x 29 x 43	285
Motor-Generator Unit 4	1	30 x 30 x 59	1225
Motor-Generator Maintenance Parts	1	13 x 18 x 29	85
Antenna Pedestal & Antenna Control Maintenance Parts	1	24 x 24 x 36	75
Antenna Pedestal Maintenance Parts	1	13 x 16 x 23	63
Radar Set Control Modification Kit	1	12 x 12 x 18	50

**AN/S PA-21(XN-1): 2**

**ITEM NAME:** ANTENNA GROUP

**TYPE:** AN/SPA-21(XN-1)

**PRINCIPAL COMPONENTS AND PHYSICAL DATA (Cent.)**

<b>COMPONENTS</b>	<b>QTY</b>	<b>OVERALL DIMENSIONS (Inches)</b>	<b>UNIT WT. (Pounds)</b>
Antenna Reflector & Support Unit 1 & Feedhorn Support	1	66 x 150 x 296-1/4 30 x 60 x 140	500 300
Antenna Pedestal Unit 2	1	36-1/8 x 36-1/8 x 86-5/8	1700
Antenna Control Unit 3	1	21-1/8 x 22-3/4 x 37-1/4	205
Motor Generator Unit 4	1	22-1/8 x 25-3/8 x 52-1/4	1030
Field Change Kit to modify Radar Set Control C-986/SPS-12 for use with Antenna Group AN/SPA-21(XN-1)	1		
Technical Manual NAVSH[PS 92616(A)	2	1-1/2 x 9-1/2 x 11-1/2	

**REFERENCE DATA AND LITERATURE**

Technical Manuals:  
NAVSHIPS 92616(A)

**AN/SPA-21(XN-1): 3**

DATE: 1 July 1964

ITEM NAME: INDICATOR GROUP

COGNIZANT SERVICE: USN

TYPE: AN/SPA-23(XN-1)

FEDERAL STOCK NUMBER:

	USA	USN	USAF	USMC
STATUS OR TYPE CLASSIFICATION				
Mfg(s) Name or Code Number: Stromberg-Carlson Company				

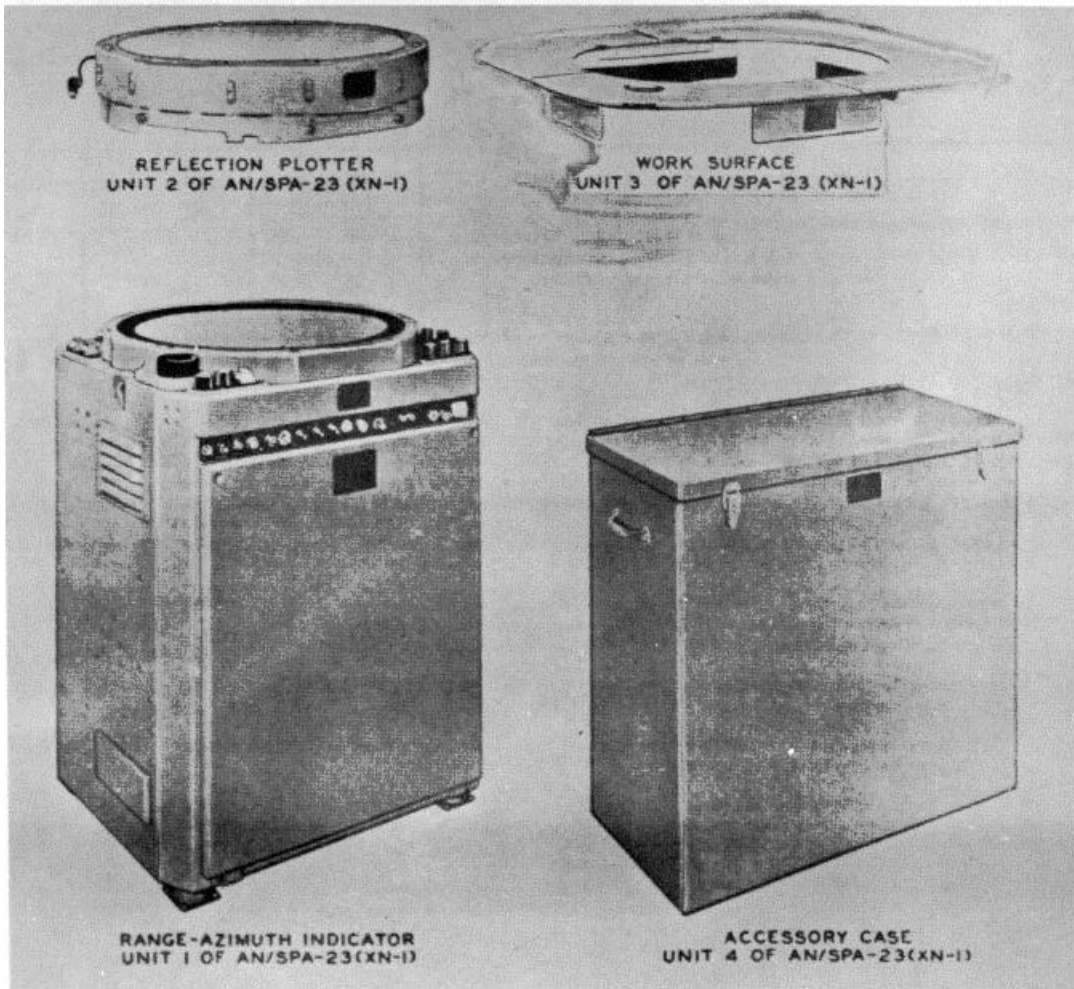

AN/SPA-23(XN-1): 1

AN/SPA-23(XN- 1)

**FUNCTIONAL DESCRIPTION**

Indicator Group AN/SPA-23(XN-1) is a general purpose PPI that provides a large, direct-view range and azimuth plot. The equipment may be used with any standard Navy search radar system.

The equipment is made simpler to operate and yet retain its useful, reliable and stable operation by excluding extra features. Continuously variable sweep range, electronic range rings, position counters and transmitters, and off-center operation from Airborne Early Warning or Dead Reckoning Analyzer are not included in this group.

**RELATION TO SIMILAR EQUIPMENT**

None.

**TECHNICAL DESCRIPTION**

Pulse Repetition Rate: 60 to 3, 000 cps  
Video Input No. 1: +1 to +2.5v  
Video Input No. 2: +1 to +2.5v  
Trigger Input: +5 to +50v  
Pulse Width: 10 µsec max  
Antenna and Trace Rotation Speed: 0 to 60 rpm  
Bearing Accuracy: Within 2 deg at all antenna speeds  
Range Selection:  
4, 10, 20, 40, 80, 200, and 300 mi  
Type of Presentation: One 22-in. PPI  
Operating Voltages and Power Requirements:  
115 vac, 60 cps, 1-ph, 800w

**INSTALLATION CONSIDERATIONS**

Not available.

**PRINCIPAL COMPONENTS AND PHYSICAL DATA**

COMPONENT	QTY	HEIGHT (Inches)	WIDTH (Inches)	DEPTH (Inches)	UNIT WT. (Pounds)
Range-Azimuth Indicator	1	39-1/4	29-3/4	27	512
Accessory Case	1	30-1/2	30-1/4	15-11/16	118

**REFERENCE DATA AND LITERATURE**

Technical Manual:  
NAVSHIPS 92457(A)

DATE: 1 July 1964

ITEM NAME: INDICATOR GROUP

COGNIZANT SERVICE: USN

TYPE: AN/SPA-25

FEDERAL STOCK NUMBER: 5840-448-0051

	USA	USN	USAF	USMC
STATUS OR TYPE CLASSIFICATION		Std		
Mfg(s) Name or Code Number: Motorola, Inc.				

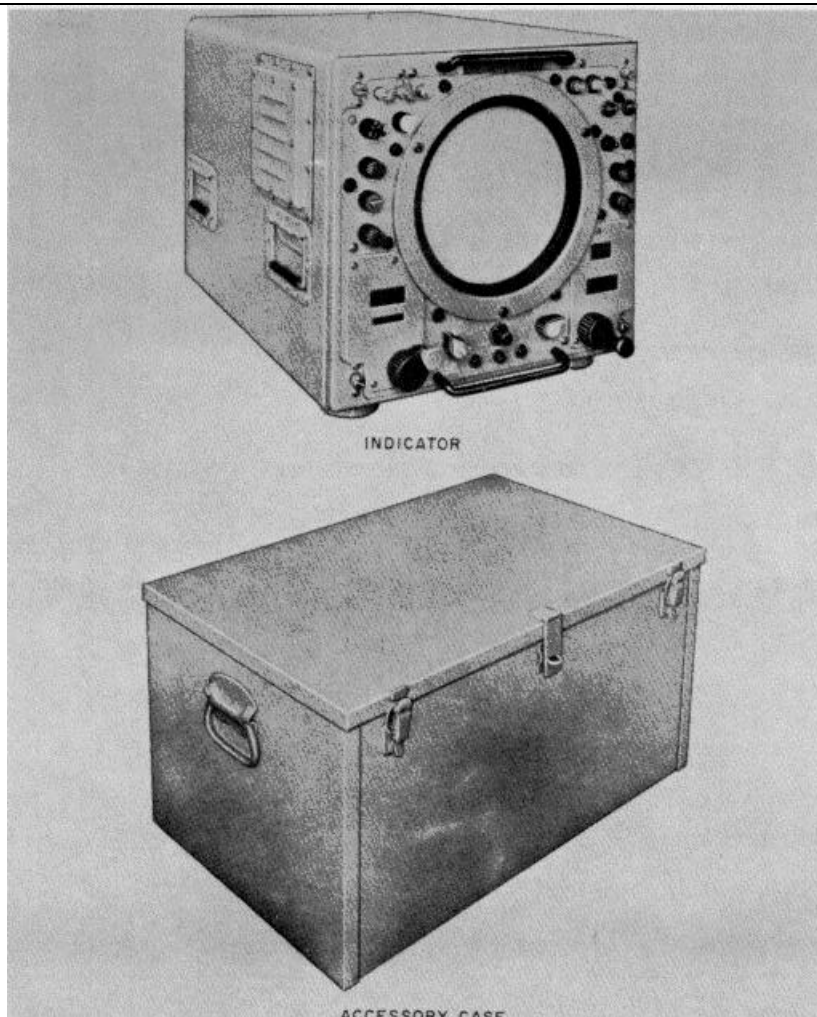

#### FUNCTIONAL DESCRIPTION

Indicator Group AN/SPA-25 is a plan position radar indicator that is used as a repeater for search radars having maximum ranges of 300 miles or less. The indicator is transistorized except for one stage, the

sweep driver tubes. The use of transistors in place of electron tubes allows a reduction in unit size, simpler circuitry, and increased reliability.

Detected radar targets are illuminated on the CRT for measurement of range and azimuth. Range is measured by range marks and

**ITEM NAME:** INDICATOR GROUP

**TYPE:** AN/SPA-25

a range strobe. Range marks appear on the cathode-ray tube as concentric rings spaced at intervals that represent distance from the radar antenna. The range strobe appears as an expanding concentric ring whose expansion is mechanically controlled by the operator. When the range strobe ring passes through a target, the target range is shown on a range-window on the front panel. The range of a target at a distance of 28 miles or less is expressed in yards in the range yards window. The range of a target beyond 28 miles is expressed in miles in a rangemiles window.

Bearing is measured by an electronic bearing cursor. The cursor appears as a sweep whose azimuth is mechanically controlled by the operator. When the bearing cursor is activated, normal video is blanked from the presentation. The cursor crank control is then hand-operated to make the cursor pass through the target on the indication CRT. The bearing thus determined is shown on the cursor bearing window. The electronic cursor provides accurate bearing measurements since parallax, a fault common to mechanical cursors, is eliminated.

**RELATION TO SIMILAR EQUIPMENT**

This equipment replaces Radar Indicating

Equipments VC, VD, VE, VF series, VH, V3 and VJ-1.

**TECHNICAL DESCRIPTION**

Type of Presentation: 1g-in. PPI  
 Range, Max: 300 mi  
 Range, Min: 4 mi  
 Sweep Rate: 40 rpm max  
 Sweep Linearity: 1%  
 Range Marker Intervals: 1, 2, 5, 10, 25 and 50 mi  
 Range Marker Pulse Width: 0.25 usec  
 Range Marker Accuracy: 1%  
 Range Strobe Pulse Width: 0.25 usec  
 Range Strobe Accuracy: 0.15 to 5 mi, 0.05 mi; 5 to 36 mi, 1%; 26 to 300 mi, 2%.  
 Input Trigger Pulse Width: 1 to 10 usec  
 Input Trigger Amplitude: 5 to 50v  
 Pulse Repetition Rate: 6 to 3000 pps  
 Video Input: 1 to 2.5v pos  
 Operating Voltages and Power Requirements: 115v, 60 cps, 1-ph, 180w

**INSTALLATION CONSIDERATIONS**

Not available.

**PRINCIPAL COMPONENTS AND PHYSICAL DATA**

COMPONENT	QTY	HEIGHT (Inches)	WIDTH (Inches)	DEPTH (Inches)	UNIT WT. (Pounds)
Indicator AN/SPA-25	1	17-1/16	18-23/32	23-53/64	180
*DRA Unit	1				
Accessory Case	1	19-1/4	31	15-1/8	

**NOTE:** \*Mounts on side of Indicator.

**REFERENCE DATA AND LITERATURE**

Technical Manuals:  
NAVSHIPS 92981

DATE: 1 July 1964

ITEM NAME: INDICATOR GROUP

COGNIZANT SERVICE: USN

TYPE: AN/SPA-25(XN-1)

FEDERAL STOCK NUMBER:

	USA	USN	USAF	USMC
STATUS OR TYPE CLASSIFICATION				
Mfg(s) Name or Code Number: Westinghouse Electric Corporation, Electronics Div., Baltimore, Md.				

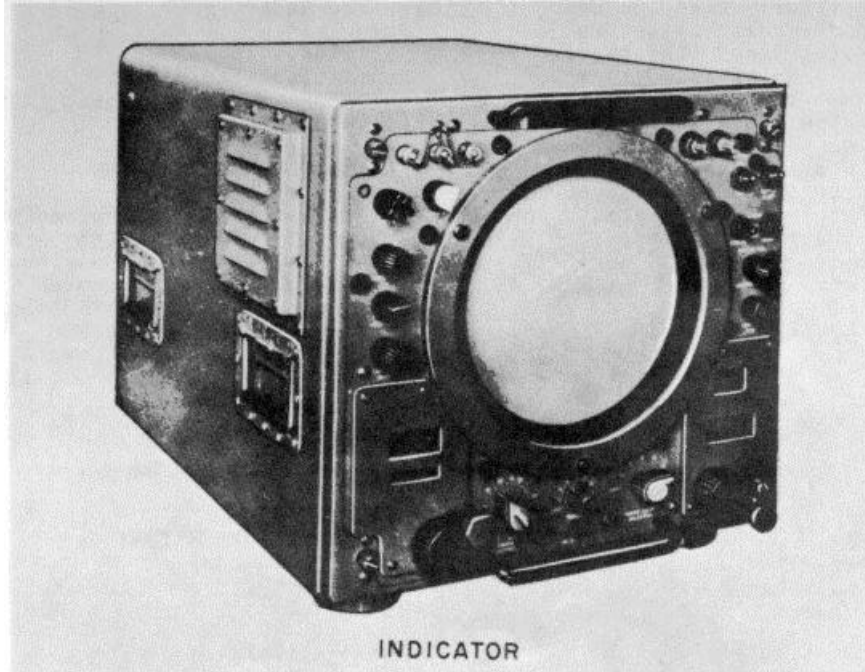

**FUNCTIONAL DESCRIPTION**

Indicator Group AN/SPA-25(XN-1) is a plan position radar indicator that is intended for use as a repeater for search radars having maximum ranges of 300 miles or less. The PPI information is displayed on a 10-inch

cathode ray tube. The indicator is transistorized except for one stage, the sweep drive tubes. The use of transistors in place of electron tubes provides a smaller overall size of the unit, simplicity of circuits and increased reliability of operation.

AN/SPA-25(XN-1): 1



**ITEM NAME:** INDICATOR GROUP

**TYPE:** AN/SPA-25(XN-1)

Detected radar targets are illuminated on the cathode ray tube for measurement of range and azimuth. Range is measured by means of range marks and a range strobe. Range marks appear on the cathode ray tube as concentric rings spaced at accurate intervals to represent distance from the radar antenna. The range strobe appears as an expanding concentric ring, the expansion of which is mechanically controlled by the operator. When the range strobe ring is made to pass through a target, the target range is shown on a range-window on the front panel. The range of a target at a distance of twenty-eight miles or less is expressed in yards in a range-yards window. The range of a target beyond twenty-eight miles is expressed in miles in a rangemiles window.

Bearing is measured by means of an electronic bearing cursor. The cursor appears as a sweep whose azimuth is mechanically controlled by the operator. When the bearing cursor is activated, normal video is blanked from the presentation. The cursor crank control is then hand-operated to make the cursor pass through the target while the target is still glowing on the cathode ray tube. The bearing thus determined is shown on the cursor-bearing window. The use of an electronic cursor provides accurate bearing measurements since parallax, a fault common to mechanical cursors, is eliminated.

**RELATION TO SIMILAR EQUIPMENT**

None.

**TECHNICAL DESCRIPTIONS**

Power Requirements: 180w, 115v, 60 cycles, single ph

Range of Indicator

Maximum: 300 mi

Minimum: 4 mi

Sweep Rate

Maximum: 40 rpm

Sweep Linearity: 1%

Range Marks

Spacing in Miles: 1, 2, 5, 10, 25 and 50

Pulse Width: 1 plus or minus 1/4 usec

Accuracy between Marks: 1%

Range Strobe

Pulse Width: 1.5 plus or minus 1/4 usec

Accuracy

0.15 - 5 Miles: 0.05 mi

5 - 36 Miles: 1%

36 - 300 Miles: 2%

Cranking Ratio: Approx 20 turns per 300 mi

Required Radar Input Trigger

Pulse Width: 1 to 10 usec

Amplitude: 5 to 50v

Repetition Rate: 6 to 3000

Required Radio Video Input: 1 to 2.5v

pos polarity.

**INSTALLATION CONSIDERATIONS**

Related Equipment: (Required but not Supplied) (1) Radar Set, AEW or DRA Radar Relay Receiver (as required) Shipboard, Multiple Armored Cable MSCA-10; (as required) Shipboard Multiple Armored Cable MSCA-14 or MSCA-7; (as required) Coaxial Cable RG-10/U; (2) Connector UG-111/U.

**PRINCIPAL COMPONENTS AND PHYSICAL DATA**  
**SHIPPING DATA**

<b>COMPONENTS</b>	<b>QTY</b>	<b>OVERALL DIMENSIONS (Inches)</b>	<b>UNIT WT. (Pounds)</b>
Indicator	1	23-7/8 x 29 x 32	229
Accessory Case consisting of:	1	15-1/8 x 19-1/4 x 31	
Reflector Plotter	1		
Spray-Type Baffles	3		
Patch Cable	1		
Equipment Spares	1		

**EQUIPMENT SUPPLIED DATA**

<b>COMPONENTS</b>	<b>QTY</b>	<b>OVERALL DIMENSIONS (Inches)</b>	<b>UNIT WT. (Pounds)</b>
Indicator	1	17-1/16 x 18-23/32 x 23-53/64	180
Accessory Case consisting of:	1	15-1/8 x 19-1/4 x 31	
Reflector Plotter	1		
Spray-Type Baffles	3		
Patch Cable	1		

**ITEM NAME:** INDICATOR GROUP

**TYPE:** AN/S PA-25(XN-1 )

**PRINCIPAL COMPONENTS AND PHYSICAL DATA  
EQUIPMENT SUPPLIED DATA (Cent.)**

<b>COMPONENTS</b>	<b>QTY</b>	<b>OVERALL DIMENSIONS (Inches)</b>	<b>UNIT WT. (Pounds)</b>
Equipment Spares	1		
Technical Manual NAVSHIPS 92981(A)	2		

**REFERENCE DATA AND LITERATURE**

Technical Manuals:  
NAVSHIPS 9398(A)

**AN/SPA-25(XN-1): 3**

DATE: 1 July 1964

ITEM NAME: INDICATOR GROUP

COGNIZANT SERVICE: USN

TYPE: AN/SPA-31

FEDERAL STOCK NUMBER:

	USA	USN	USAF	USMC
STATUS OR TYPE CLASSIFICATION		Std		
Mfg(s) Name or Code Number: Hughes Aircraft Company				

**Illustration Not Available**

**FUNCTIONAL DESCRIPTION**

The AN/SPA-31 is a range and height indicator that displays the scalar distance between a reference point and a target, and the vertical distance between a reference point and a target.

Range Limits: 0 to 160 mi  
Height Limits: 0 to 75, 000 ft  
Operating Voltages and Power Requirements:  
115v, 58 to 62 cps, 1-ph, 8.6 amp, 990 va,  
0.96 pf  
Presentation: Range and height indicator

**RELATION TO SIMILAR EQUIPMENT**

The AN/SPA-31 is similar to, but not interchangeable with, the Navy Model VL-1.

**INSTALLATION CONSIDERATIONS**

Siting:  
Mounting: Deck mounted.  
Cabling Requirements:  
Related Equipment:

**TECHNICAL DESCRIPTION**

Pulse Repetition frequency: 470 to 2, 800 pps

**PRINCIPAL COMPONENTS AND PHYSICAL DATA**

COMPONENT	QTY	HEIGHT (Inches)	WIDTH (Inches)	DEPTH (Inches)	UNIT WT. (Pounds)
Height Indicator IP-499/SPA-31	1	40-3/8	19-1/2	24-3/8	489
Correlator-Indicator SN-237/SPA-31	1	28-3/8	11-3/4	24-1/2	165

**REFERENCE DATA AND LITERATURE**

Technical Manuals:  
NAVSHIPS 91511A  
NAVSHIPS 92969A

DATE: 1 July 1964

ITEM NAME: INDICATOR GROUP

COGNIZANT SERVICE: USN

TYPE: AN/SPA-31(XN-1)

FEDERAL STOCK NUMBER:

	USA	USN	USAF	USMC
STATUS OR TYPE CLASSIFICATION				
Mfg(s) Name or Code Number: Hughes Aircraft Company				

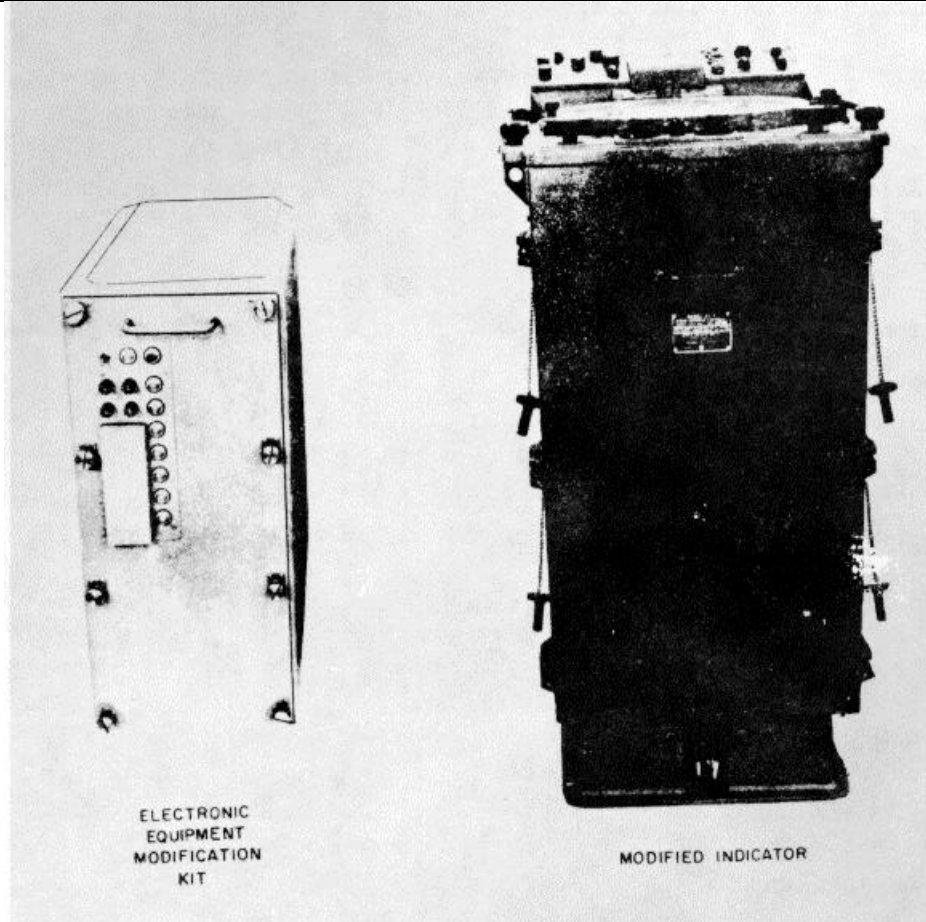

**FUNCTIONAL DESCRIPTION**

The Indicator Group AN/SPA-31(XN-1) is designed as a range and height indicator, which presents visually the scalar distance

between a reference point and a target, and the vertical distance between a reference point and a target.

AN/SPA-31(XN-1): 1

**ITEM NAME:** INDICATOR GROUP

**TYPE:** AN/SPA-31(XN-1)

**RELATION TO SIMILAR EQUIPMENT**

The AN/SPA-31(XN-1) is similar to, but not interchangeable with Navy Model VL-1 Radar Repeater, modified by Hughes Aircraft Company for use with Radar Set AN/SPS-26.

**TECHNICAL DESCRIPTION**

Pulse Repetition Frequency: 470 to 2800 pps  
Video Input: 1 to 2.5v (pos)  
Trigger Input: 5 to 50v (pos)  
Range Selection: 20, 40, 70 and 160 mi  
Screen Diameter: 12 in.  
Viewing Diameter: 10 in.  
Range Accuracy: Plus or minus 1.0% of

total scale.  
Power Factor: 96%  
Power Supply Characteristics  
Input: 115v plus or minus 10%, 60 cps, single ph  
Current Consumption: Modified indicator proper, 690 va; Modification Kit 2.60 amps; total current consumption 8.60 amps  
Power Consumption: Modified indicator proper, 690 va; Modification Kit 300 va; total power consumption 990 va

**INSTALLATION CONSIDERATIONS**

Not available.

**PRINCIPAL COMPONENTS AND PHYSICAL DATA**

<b>COMPONENTS</b>	<b>QTY</b>	<b>OVERALL DIMENSIONS (Inches)</b>	<b>UNIT WT. (Pounds)</b>
Modified Indicator CG-55AKD-1 complete w/tubes, fuses and Modified VL-1 X506265-100	1	19-1/2 x 24-3/8 x 40-3/8	489
Viewing Hood	1	14 lg x 14-3/8 dia	3
Shock Mount (Top) Assy	1	5-1/4 x 5-5/8 x 16-5/8	26
Set of Equipment Spares	1	12 x 15 x 24	57
Modification Kit Electronic Equipment X506071-100	1	11.75 x 24.50 x 25.38	165
Technical Manual NAVSHIPS 91511(A)	2	1 x 9 x 11.5	3
Complementary Technical Manual	2	1/4 x 9-1/8 x 11-1/2	1.5

**SHIPPING DATA**

<b>PKGS (NR)</b>	<b>UNIT WT. (Pounds)</b>
1	618
1	57
1	B5
1	257

**REFERENCE DATA AND LITERATURE**

Technical Manuals:  
NAVSHIPS 92969(A)

**AN/SPA-31(XN-1):**

**DATE:** 1 July 1964

**ITEM NAME:** INDICATOR GROUP

**COGNIZANT SERVICE:** USN

**TYPE:** AN/S PA-31A

**FEDERAL STOCK NUMBER:**

	USA	USN	USAF	USMC
STATUS OR TYPE CLASSIFICATION				
Mfg(s) Name or Code Number: Hughes Aircraft Company, Fullerton, California				

Illustration not Available.

**FUNCTIONAL DESCRIPTION**

The Indicator Group AN/SPA-31A is a standard, government-furnished, height-range indicator (VL-1) modified for use with Hughes Aircraft Company's hemispheric scan radar,

which visually presents the scalar and vertical distance between a reference point and a target. It is designed to serve as a remote range-height indicator.

**AN/SPA-31A: 1**

**ITEM NAME:** INDICATOR GROUP

**TYPE:** AN/SPA-31A

**RELATION TO SIMILAR EQUIPMENT**

None.

Power Factor: 96%

Pulse Repetition Frequency: 470 to 2800  
per sec

Operating Power Requirements: 115v ac,  
60 cps, single ph, 8.6 amps, 990 va  
at 96% pf.

**TECHNICAL DESCRIPTION**

Video Input: 1 to 2.5v (pos)

Trigger Input: 5 to 50v (pos)

Range Selection: 0 to 160 mi

Screen Diameter: 12 in.

Viewing Diameter: 10 in.

Range Accuracy: Plus or minus 1.0% of  
total scale.

**INSTALLATION CONSIDERATIONS**

Related Equipment: The AN/SPA-31A is  
mechanically and electrically inter-  
changeable with Indicator Group AN/  
SPA-31. Two-way interchangeable.

**PRINCIPAL COMPONENTS AND PHYSICAL DATA**

Not Available.

**REFERENCE DATA AND LITERATURE**

Technical Manuals:

NAVSHIPS 93400

NAVSHIPS 93279

Nomenclature Card for Indicator Group

AN/S PA-31A.

DATE: 1 July 1964

ITEM NAME: INDICATOR GROUP

COGNIZANT SERVICE: USN

TYPE: AN/SPA-32

FEDERAL STOCK NUMBER:

	USA	USN	USAF	USMC
STATUS OR TYPE CLASSIFICATION		Std		
Mfg(s) Name or Code Number: Hughes Aircraft Company				

Illustration Not Available

#### FUNCTIONAL DESCRIPTION

The AN/SPA-32 is an azimuth and range indicator that visually presents the scalar distance between a reference point and a target in a horizontal plane.

#### RELATION TO SIMILAR EQUIPMENT

The AN/SPA-32 is similar to, but not interchangeable with, the AN/SPA-8A. AN/SPA-32 is basically a modified AN/SPA-8A with lowered repetition rates.

#### TECHNICAL DESCRIPTION

Range, Max: 160 mi  
Azimuth Coverage: 360 deg  
Type of Presentation: Azimuth and range indicator  
Operating Voltages and Power Requirements:  
115 vac, 60 cps, 1-ph, 1, 620w, 0.83 pf

#### INSTALLATION CONSIDERATIONS

Not available.

#### PRINCIPAL COMPONENTS AND PHYSICAL DATA

COMPONENT	QTY	HEIGHT (Inches)	WIDTH (Inches)	DEPTH (Inches)	UNIT WT. (Pounds)
Azimuth-Range Indicator [P- 502/SPA- 32	1	38	25-1/2	26	472
Indicator-Correlator SN-236/SPA-32	1				
Power Supply PP-560A/SP	1	30-2/5	22-1/4	20-2/5	320
Power Transformer TF-129/SP or TF-129A/SP	1	23-7/10	12-9/10	8-1/4	66

#### REFERENCE DATA AND LITERATURE

Technical Manuals:  
NAVSHIPS 91737  
NAVSHIPS 92970A

AN/SPA-32: 1



DATE: 1 July 1964

ITEM NAME: INDICATOR GROUP

COGNIZANT SERVICE: USN

TYPE: AN/SPA-32(XN-1)

FEDERAL STOCK NUMBER:

	USA	USN	USAF	USMC
STATUS OR TYPE CLASSIFICATION				
Mfg(s) Name or Code Number: Hughes Aircraft Company				

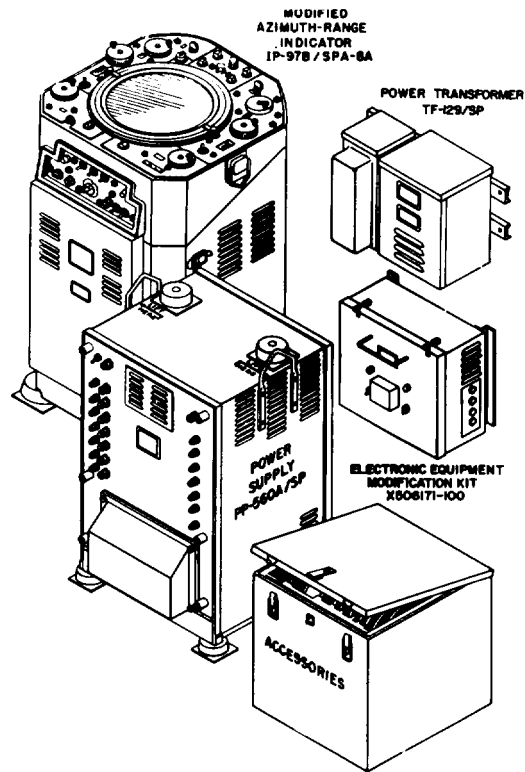

### FUNCTIONAL DESCRIPTION

The Indicator Group AN/SPA-32(XN-1) is designed as a range and azimuth indicator, which presents visually the scalar distance

between a reference point and a target, and the angle between a reference point and a target in a horizontal plane.

AN/SPA-32(XN-1): 1

**ITEM NAME:** INDICATOR GROUP

**TYPE:** AN/SPA-32(XN-1)

**RELATION TO SIMILAR EQUIPMENT**

The AN/SPA-32(XN-1) is similar to, but not interchangeable with AN/SPA-8A, modified by Hughes Aircraft Company for use with Radar Set AN/SPS-26( ).

1% of actual range.  
72, 000 Yards to 160 Miles: plus or minus 2% of actual range.  
Bearing Accuracy: Within 2 deg at all antenna speeds.  
Antenna and Trace Rotation Speed: 15 and 30 rpm  
Trigger Input: 5 to 50v (pos)  
Video Input: 1 to 4v (pos)  
Pulse Repetition Frequency: 485 to 3550 pps  
Power Factor: Approx 83%  
Power Demand: 1950 va, 1620w (approx)  
Operating Power Requirements: 115v ac, 60 cps, single ph

**TECHNICAL DESCRIPTION**

Type of Indicator: Cathode ray tube type.  
Type of Scanning: Azimuth and range  
Type of Measurement Reading  
Azimuth: 0 to 360 deg  
Range: Marked in yds and mi  
Range Selection  
Centered PPI: 10 to 160 mi, continuously var.  
Off-Centered PPI: 10 to 160 mi, continuously var.  
Range Accuracy  
300 to 10, 000 Yards: plus or minus 100 yds  
10, 000 to 72, 000 Yards: plus or minus

**INSTALLATION CONSIDERATIONS**

Related Equipment: (Required but not Supplied) (2) Cable Type MSCA-10 (Length as required); (2) Cable Type MeSGA-3 (Length as required).

**PRINCIPAL COMPONENTS AND PHYSICAL DATA**

<b>COMPONENTS</b>	<b>QTY</b>	<b>OVERALL DIMENSIONS (Inches)</b>	<b>UNIT WT. (Pounds)</b>
Azimuth-Range Indicator IP-97B/SPA-8A (w/modified AN/SPA-BA Unit)	1	25.5 x 26.6 x 38	497
Power Supply PP-56OA/SP	1	20.4 x 22.25 x 30.4	320
Power Transformer TF-129/SP	1	8.25 x 12.9 x 23.7	96
Electronic Equipment Modification Kit MX-506171-100	1	12.67 x 18 x 19.34	75
Indicator Accessories	1	15.4 x 16.9 x 17.8	102
Set of Equipment Spares	1	12.1 x 15.69 x 36.93	212
Technical Manual NAVSHIPS 91737	2	1.5 x 9 x 11.5	5
Technical Manual NAVSHIPS 92970(A)	2	0.88 x 9.4 x 11.5	3

**SHIPPING DATA**

<b>PKGS (NR)</b>	<b>UNIT WT. (Pounds)</b>
1	1880
1	632
1	463
1	158
1	156
1	40
1	107
1	15
1	310

**AN/SPA-32(XN-1): 2**

**ITEM NAME:** INDICATOR GROUP

**TYPE:** AN/S PA-32(XN-1)

**REFERENCE DATA AND LITERATURE**

Technical Manuals;  
NAVSHIPS 92970(A)

**AN/SPA-32(XN-1): 3**

DATE: 1 July 1964

ITEM NAME: INDICATOR GROUP

COGNIZANT SERVICE: USN

TYPE: AN/SPA-33

FEDERAL STOCK NUMBER: 5840-538-7170 W/S  
5840-583-0147

	USA	USN	USAF	USMC
STATUS OR TYPE CLASSIFICATION				
Mfg(s) Name or Code Number: Hazeltine Electronic Div. of Hazeltine Electronic Corp.				

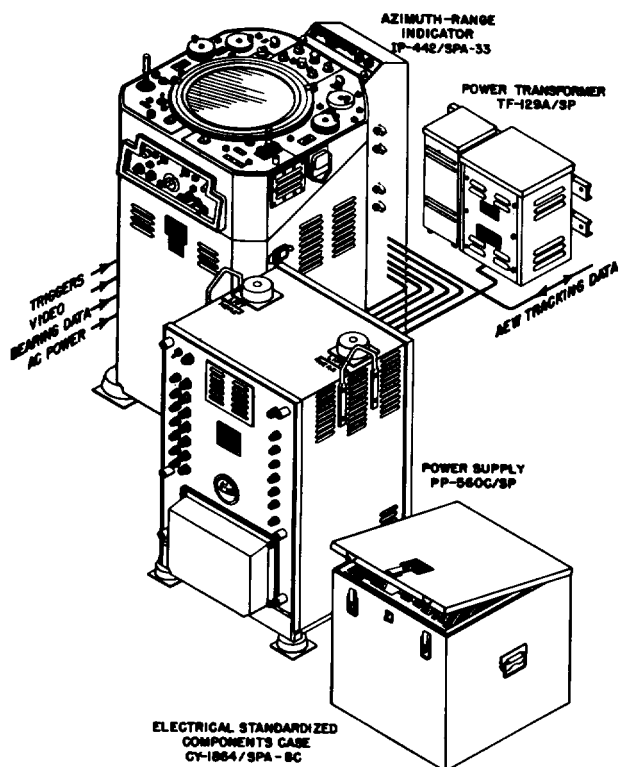

### FUNCTIONAL DESCRIPTION

The AN/SPA-33 is a general purpose Plan Position Indicator (PPI). By means of a front panel function control switch, it can be used as an ordinary PPI, or, as an Airborne Early Warning(AEW) tracking in

dicator, or as an AEW repeat (final) indicator. In addition, as an ordinary PPI, the indicator can accept azimuth information in the form of two (2) rectangular coordinate voltages instead of synchro voltages when the Radar Selector switch is in position 2.

AN/SPA-33: 1

**ITEM NAME:** INDICATOR GROUP

**TYPE:** AN/SPA-33

**RELATION TO SIMILAR EQUIPMENT**

The AN/SPA-33 is designed to be used with but not part of the AN/SPS-26( ), and is similar to but not functionally interchangeable with Indicator Group AN/SPA-8 Series due to the elimination of the "Dead Reckoning Analyzer".

**TECHNICAL DESCRIPTION**

Bearing Accuracy: Within 2 deg at all antenna speeds.  
 Antenna and Trace Rotation: 0 to 40 rpm  
 Trigger Input: 5 to 50v (pos)  
 Video Input: 1 to 231/2v (pos)  
 Pulse Repetition Frequency: 60 to 3000 pps  
 Power Factor: 0.934 (approx)  
 Power Demand: 1755 va, 1640w approx  
 Range Selection  
     Centered PPI: 4 to 300 mi, continuously var  
     Off-Centered PPI: 4 to 300 mi, continuously var  
 Range Accuracy

300 to 10, 000 Yards: plus or minus 100 yds  
 10, 00 to 72, 000 Yards: plus or minus 1% of actual range  
 72, 000 Yards to 300 Miles: plus or minus 2% of actual range.  
 Operating Power Requirements: 115v ac, 60 cps, single ph

**INSTALLATION CONSIDERATIONS**

Related Equipment: (Required but not Supplied) (1) Oscilloscope OS-5/U or AN/USM-25; (1) Oscilloscope OS-8/U or TS-239/U; (1) Multimeter AN/PSM-4 or TS-352/U; (1) Multimeter AN/PSM-6 or ME-25( )/U; (1) Electronic Switch TS-433A/U; (1) Signal Generator SG-18/U; (1) Voltmeter, A.C. SNSN G17-V-1000; (1) Synchro type 5G; (1) Synchro type 6G; (1) Cable type DSGA-9; (1) Cable type DSGA-23; (2) Cable type MSCA-10; (2) Cable type MSCA-7; (1) Cable type MSCA-14; (1) Cable type MSCA-19; (1) Cable type TSGA-9; (7) Cable type RG-12A/U; (1) Cable type RG-27/U.

**PRINCIPAL COMPONENTS AND PHYSICAL DATA**

COMPONENTS	QTY	OVERALL DIMENSIONS (Inches)	UNIT WT. (Pounds)
Azimuth-Range Indicator IP-442/SPA-33	1	25-1/2 x 29-1/4 x 39-3/4	460
Power Supply PP-560C/SP	1	20-3/8 x 22-1/4 x 30-3/8	309
Power Transformer TF-129A/SP	1	8-1/8 x 12-7/8 x 23-11/16	112
Electrical Equipment Case CY-1864/SPA-8C	1	15-1/2 x 16 x 19	76
Set of Shockmounts	1	10-3/4 x 18-1/2 x 31-3/4	
Set of Accessories	1		45
Technical Manuals NAVSHIPS 93156	2	4 x 9-1/2 x 11-1/2	
Maintenance Manual NAVSHIPS 93156.42	1	1/2 x 8-7/8 x 11-1/8	

**SHIPPING DATA PKGS**

PKGS	UNIT WT. (Pounds)
1	685
1	474
1	156
1	124
1	50
2	
1	
1	

**AN/SPA-33: 2**

**MIL-HDBK-162A**  
15 December 1965

Volume 1  
Section 3

**ITEM NAME:** INDICATOR GROUP

**TYPE:** AN/S PA-33

**REFERENCE DATA AND LITERATURE**

Technical Manuals:  
NAVSHIPS 93156

**AN/SPA-33: 3**

DATE: 1 July 1964

ITEM NAME: INDICATOR GROUP

COGNIZANT SERVICE: USN

TYPE: AN/SPA-34

FEDERAL STOCK NUMBER: 5840-473-7881

	USA	USN	USAF	USMC
STATUS OR TYPE CLASSIFICATION				
Mfg(s) Name or Code Number: Philco Corporation, Philadelphia, Pa.				

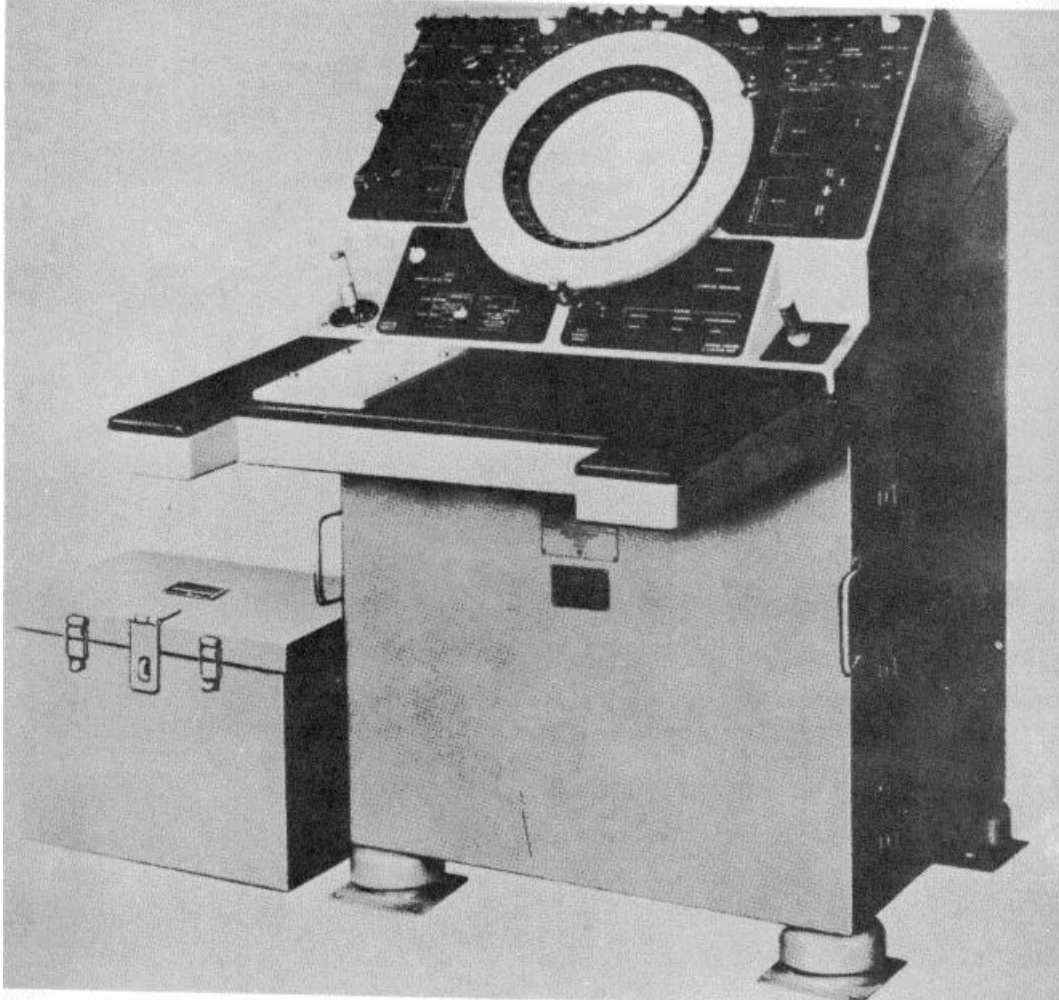

**FUNCTIONAL DESCRIPTION**

Indicator Group AN/SPA-34 receives video, trigger, and azimuth information from the radar set selected by the RADAR SELECTOR switch and displays the video information on the screen of the cathode-ray tube. The

selected radar set can be either shipboard or airborne; if it is a shipboard set, the radar information is cabled directly to the indicator; if it is an airborne set, the radar information is transmitted through an Airborne Early Warning (AEW) system to the indicator. The radar selected for presenta

**ITEM NAME:** INDICATOR GROUP

**TYPE:** AN/SPA-34  
tion by the RADAR SELECTOR switch depends upon the particular installation.

**RELATION TO SIMILAR EQUIPMENT**  
None.

**TECHNICAL DESCRIPTION**  
Power Requirements: 115v plus or minus 10%, 60 cycles plus or minus 3 cycles, single ph, 485w, 0.91 pf  
Pulse Repetition Frequency: 10 to 5000 pps  
Video Input: 2v pos (plus or minus 0.5v)  
Trigger Input: 5 to 50v (pos)  
Azimuth Scan Speed: Up to 60 rpm  
Range Selection  
Centered Display: 4 to 400 mi, continuously var.

Off-Centered Display: 5 radii (but not more than 300 mi)  
Range Accuracy  
300 to 10, 000 Yards: plus or minus 100 yds  
10, 000 to 72, 000 Yards: plus or minus 1% of actual range  
72, 000 Yards to 400 Miles: plus or minus 2% of actual range  
Bearing Accuracy: plus or minus 2 deg  
Cathode-Ray Tube: Type 10AMP7  
Modes of Operation: General purpose PPI; AEW tracking indicator; AEW repeat (final) indicator

**INSTALLATION CONSIDERATIONS**  
Related Equipment: (Required but not Supplied) (15) Cables; (8) Terminal Tubes; (2) Synchro 5F.

**PRINCIPAL COMPONENTS AND PHYSICAL DATA  
SHIPPING DATA**

<b>COMPONENTS</b>	<b>QTY</b>	<b>OVERALL DIMENSIONS (Inches)</b>	<b>UNIT WT. (Pounds)</b>
Indicator, Azimuth-Range IP-539/SPA-34	1	32 x 36-1/4 x 52	550
Electrical Standardized Components Case CY-2753/SPA-34	1	16-1/2 x 19 x 21	83
Technical Manual NAVSHIPS 93813	1		

**EQUIPMENT SUPPLIED DATA**

<b>COMPONENTS</b>	<b>QTY</b>	<b>OVERALL DIMENSIONS (Inches)</b>	<b>UNIT WT. (Pounds)</b>
Indicator, Azimuth-Range IP-539/SPA-34	1	24* x 27 x 45	523
Case, Components, Standardized, Electrical CY-2753/SPA-34	1	13 x 15 x 17-1/2	73
Technical Manual NAVSHIPS 93813	1		

**NOTE: \*Depth is 38 in. with operator shelf installed.**

**REFERENCE DATA AND LITERATURE**

Technical Manuals:  
NAVSHIPS 93813



DATE: 1 July 1964

ITEM NAME: INDICATOR GROUP

COGNIZANT SERVICE: USN

TYPE: AN/SPA-36

FEDERAL STOCK NUMBER:

	USA	USN	USAF	USMC
STATUS OR TYPE CLASSIFICATION				
Mfg(s) Name or Code Number: Westinghouse Electric Corporation, Baltimore, Md.				

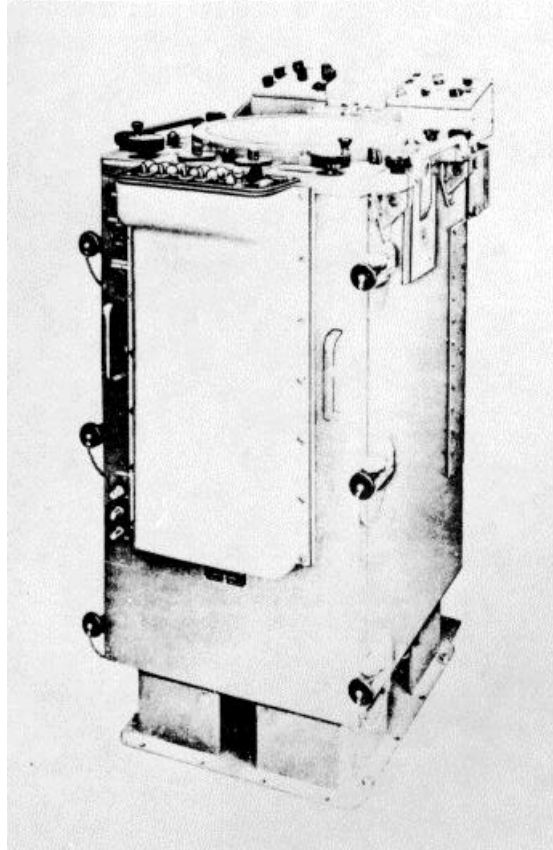

**FUNCTIONAL DESCRIPTION**

The Indicator Group AN/SPA-36 is designed to give visual display of the radar echo, thereby enabling range and height to be determined. It can be

gated in range and bearing by the position data stored by Intercept Tracking and Control Group AN/SPA-22. The unit is a converted VL-1. Conversion is accomplished by kit.

AN/SPA-36: 1

**ITEM NAME:** INDICATOR GROUP

**TYPE:** AN/SPA-36

**RELATION TO SIMILAR EQUIPMENT**

None.

Operating Power Requirements: 115v ac, 60 cps, single ph, 662w

**TECHNICAL DESCRIPTION**

Type of Display: Visual  
Output Signal Characteristics: 60 - 3000 pps  
Range: 0 to 20 mi

**INSTALLATION CONSIDERATIONS**

Related Equipment: The AN/SPA-36 is designed to be used with, but not part of Indicator Control Group AN/SPA-22 and AN/SPS-6.

**PRINCIPAL COMPONENTS AND PHYSICAL DATA**

<b>COMPONENTS</b>	<b>QTY</b>	<b>OVERALL DIMENSIONS (Inches)</b>	<b>UNIT WT. (Pounds)</b>
Indicator, Height-Range IP-458/SPA-36	1	19-1/2 x 24-3/8 x 40-3/8	474
General Electric Accessory Kit Viewing Hood and Control- Storer C-2472/SPA-36	1	14 x 14-3/8 dia	3

**REFERENCE DATA AND LITERATURE**

Technical Manuals:  
NAVSHIPS 93180(A)

**AN/SPA-36: 2**

DATE: 1 July 1964

ITEM NAME: INDICATOR GROUP

COGNIZANT SERVICE: USN

TYPE: AN/SPA-37

FEDERAL STOCK NUMBER:

	USA	USN	USAF	USMC
STATUS OR TYPE CLASSIFICATION				

Mfg(s) Name or Code Number. Motorola Incorporated, Chicago, Illinois

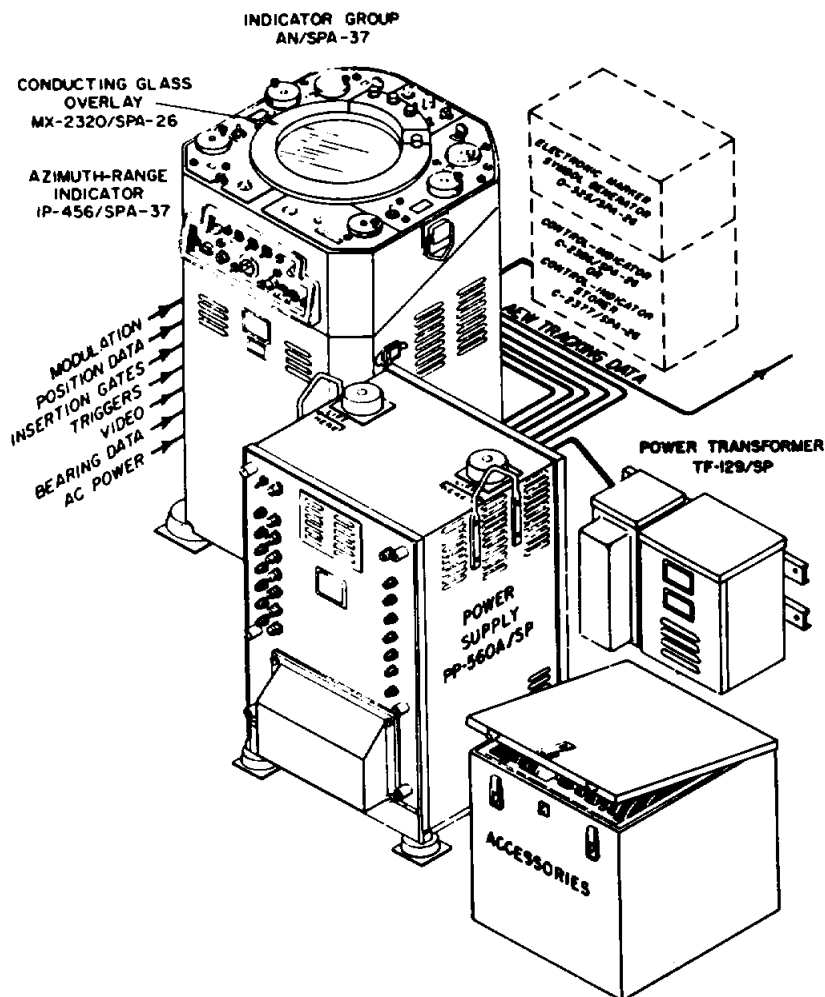

**FUNCTIONAL DESCRIPTION**

The Indicator Group AN/SPA-37 is designed to give a visual display of the radar echo, thereby, enabling range

and height to be determined. It presents scalar distance and vertical distance between reference point(s) and a target. It can be gated in range and bearing by the position data stored by the AN/SPA-26(V).

**ITEM NAME:** INDICATOR GROUP

**TYPE:** AN/SPA-37

**RELATION TO SIMILAR EQUIPMENT**

None.

Negative Gate: 90v neg pulse, 90 usec wide  
Fast Scan Trigger: 155v pos pulse, 100 usec wide  
Count Down Trigger: 60v pos pulse, 10 usec wide  
Time Sharing Gate: 100v neg pulse, 500 usec wide  
Screen Diameter: 12 in.  
Viewing Diameter: 10 in.  
Range Accuracy: plus or minus 1.C% of total scale.  
Power Supply: Self contained.  
Operating Power Requirements: 115v ac plus or minus 10%, 60 cps, single ph

**TECHNICAL DESCRIPTION**

**Input Data**

X-Modulation: Sine wave, 6v peak-to-peak; Sine wave, 14v peak-to-peak; saw tooth, 0 to plus or minus 100v  
Y-Modulation: Sine wave, 90 deg ph shifted from x-modulation on 6v peak-to-peak; Sine wave, 90 deg ph shifted from x-modulation, 14v peak-to-peak; saw tooth, 0 to plus or minus 100v  
X-Position: dc analog between plus or minus 50v  
Y-Position: dc analog between plus or minus 50v  
Positive Gate: 90v pos pulse, 90 usec wide

**INSTALLATION CONSIDERATIONS**

Related Equipment: The AN/SPA-37 is designed to be used with but not part of AN/SPA-26(V), AN/SPS-6 and AN/SPS-29.

**PRINCIPAL COMPONENTS AND PHYSICAL DATA**

<b>COMPONENTS</b>	<b>QTY</b>	<b>OVERALL DIMENSIONS (Inches)</b>	<b>UNIT WT. (Pounds)</b>
Indicator, Azimuth-Range IP-456/SPA-37	1	0.38 x 25-1/2 x 29	
Power Supply PP-560A/SP	1	20-3/8 x 22-1/4 x 30-3/8	
Power Transformer TF-129/SP or TF-129A/SP	1	8-1/8x 12-7/8 x 23-11/16	
Overlay, Conducting Glass MX-2320/SPA-26	1	4-1/2 x 14-3/8 dia	2
Accessory Kit	1		

**REFERENCE DATA AND LITERATURE**

Technical Manuals:  
NAVSHIPS 93342

**AN/SPA-37: 2**

DATE: 1 July 1964

ITEM NAME: INDICATOR GROUP

COGNIZANT SERVICE: USN

TYPE: AN/SPA-38

FEDERAL STOCK NUMBER:

	USA	USN	USAF	USMC
STATUS OR TYPE CLASSIFICATION				

Mfg(s) Name or Code Number: Motorola Incorporated, Chicago, Illinois

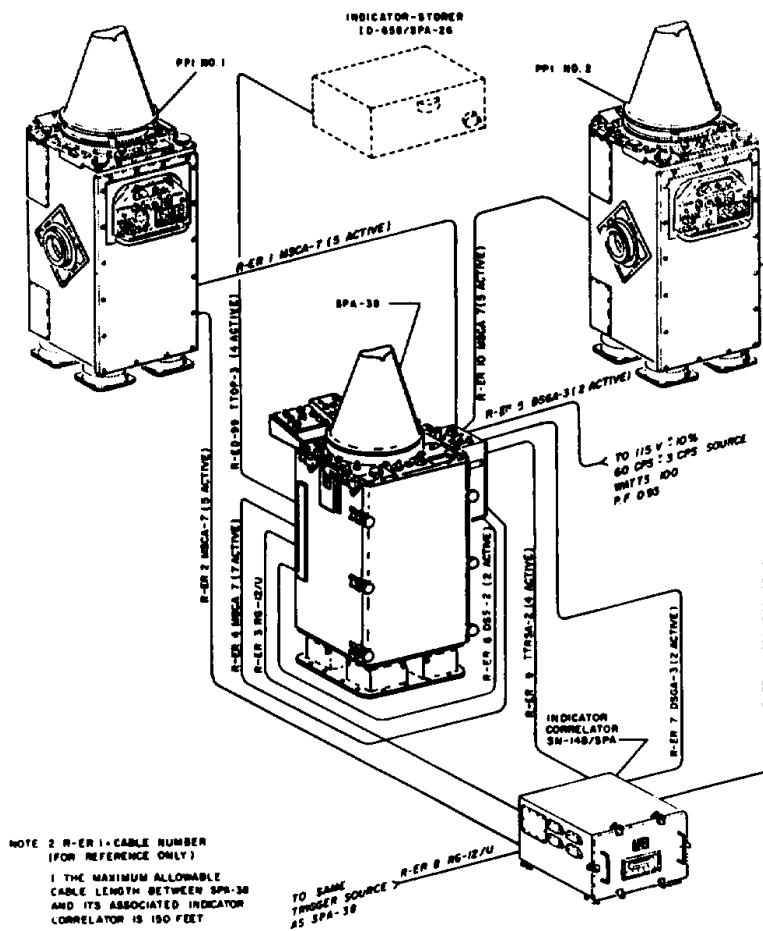

**FUNCTIONAL DESCRIPTION**

The Indicator Group AN/SPA-38 is designed to give a visual display of the radar echo, thereby enabling range and height to be determined. It presents a scalar

distance and vertical distance between reference point(s) and a target. It can be gated in range and bearing by the position data stored by the AN/SPA-26(V).

**ITEM NAME:** INDICATOR GROUP

**TYPE:** AN/SPA-38

**RELATION TO SIMILAR EQUIPMENT**

The AN/SPA-38 is a modified Radar Repeater Equipment Navy Model VL-1.

Screen Diameter: 12 in.  
Viewing Diameter: 10 in.  
Range Accuracy: plus or minus 1.0% of total scale  
Power Supply: Self-contained.  
Operating Power Requirements: 115v ac plus or minus 10%, 60 cps, single ph

**TECHNICAL DESCRIPTION**

Pulse Repetition Frequency: 60 to 3000 pps  
Video Input: 1 to 2.5v (pos)  
Trigger Input: 5 to 50v (pos)  
Range Selection: 20, 40, 70 and 140 mi ranges;  
sweep may be delayed up to 180 mi. Max  
undistorted sweep range approx 270 mi

**INSTALLATION CONSIDERATIONS**

Related Equipment: The AN/SPA-38 is designed to be used with, but not part of the AN/SPA-26(V), AN/SPS-6 and AN/SPS-30.

**PRINCIPAL COMPONENTS AND PHYSICAL DATA**

<b>COMPONENTS</b>	<b>QTY</b>	<b>OVERALL DIMENSIONS (Inches)</b>	<b>UNIT WT. (Pounds)</b>
Height-Range, Indicator IP-359/SPA-38	1	19-1/2 x 24-3/8 x 40-3/8	474
Viewing Hood	1	14 x 14-3/8 dia	3
Shock Mount (Top) Assy	1	5-1/4 x 5-5/8 x 16-5/8	26
Set of Equipment Spares	1	12 x 15 x 24	57

**SHIPPING DATA**

<b>PKGS (NR)</b>	<b>UNIT WT. (Pounds)</b>
1	625
1	48
1	90

**REFERENCE DATA AND LITERATURE**

Technical Manuals:  
NAVSHIPS 93246

**DATE:** 1 July 1964

**ITEM NAME:** RANGE HEIGHT INDICATOR

**COGNIZANT SERVICE:** USN

**TYPE:** AN/SPA-40

**FEDERAL STOCK NUMBER:**

	USA	USN	USAF	USMC
STATUS OR TYPE CLASSIFICATION				

Mfg(s) Name or Code Number: General Electric Company, Syracuse, New York

**Illustration not Available.**

**FUNCTIONAL DESCRIPTION**

The AN/SPA-40 is a console type range height

indicator for use with the AN/SPS-8 and AN/SPS-30 height finding radar systems.

**AN/SPA-40: 1**

**ITEM NAME:** RANGE HEIGHT INDICATOR

**TYPE:** AN/SPA-40

**RELATION TO SIMILAR EQUIPMENT**

None.

Range in Feet: 0 to 100,000 ft high  
Operating Power Requirements: 115v, 60 cps, single  
ph

**TECHNICAL DESCRIPTION**

Type of Indicator: Cathode ray tube type.  
Type of Scan: "E" scan.  
Type of Counter: Veeder Root.  
Mileage Range: 0 to 300 mi

**INSTALLATION CONSIDERATIONS**

Related Equipment: The AN/SPA-40 is designed to  
be used with but not part of the AN/SPS-8 and  
AN/SPS-30.

**PRINCIPAL COMPONENTS AND PHYSICAL DATA**

<b>COMPONENTS</b>	<b>QTY</b>	<b>OVERALL DIMENSIONS (Inches)</b>	<b>UNIT WT. (Pounds)</b>
Range Height Indicator	1	25 x 38 x 45	525

**REFERENCE DATA AND LITERATURE**

Technical Manuals:  
NAVSHIPS 4457 (Rev. 11-56)

**AN/SPA-40: 2**



DATE: 1 July 1964

ITEM NAME: ANTENNA GROUP

COGNIZANT SERVICE: USN

TYPE: AN/SPA-45

FEDERAL STOCK NUMBER:

	USA	USN	USAF	USMC
STATUS OR TYPE CLASSIFICATION				

Mfg(s) Name or Code Number: Hughes Aircraft Co., Fullerton, Calif.

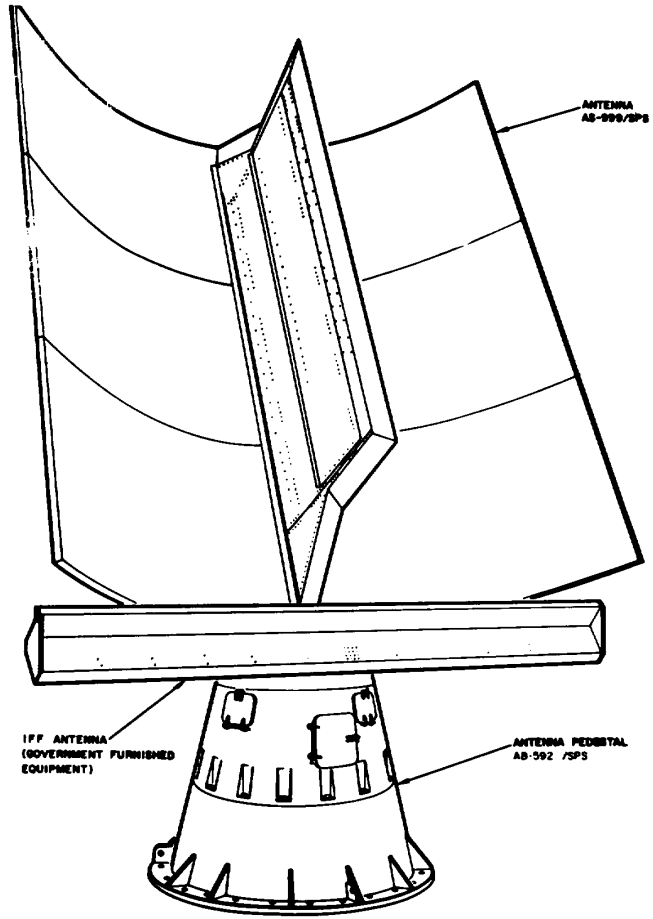

**FUNCTIONAL DESCRIPTION**

Antenna Group AN/SPA-45 is designed to radiate and

receive rf energy and to rotate the antenna for azimuth surveillance.

**ITEM NAME:** ANTENNA GROUP

**TYPE:** AN/SPA-45

**RELATION TO SIMILAR EQUIPMENT**

None.

Transit Time For rf Energy Between First and Last Slots: 0.166 usec  
 Broadside Frequency: 3000 mc  
 Gain: 33.5 db relative to an isotropic radiator at 3050.6 mc  
 Beamwidth in Elevation: 3 deg  
 Beamwidth in Azimuth: 2.4 deg  
 Side Lobes in Elevation: -20 db with respect to the main beam  
 Side Lobes in Azimuth: -16 db for the first pair; -20 db for all others.  
 Ambient Temperature: -55 deg to plus or minus 150 deg C (-67 deg to plus 302 deg F).

**TECHNICAL DESCRIPTION**

Antenna Rotation Rate  
 Normal: 15 rpm  
 With MTI: 11.5 rpm  
 For Testing: 30 rpm  
 For Coincident Video: 4.8 rpm  
 Antenna  
 Reflector: Parabolic cylinder section tilted 25 dog from the vertical.  
 Primary Feed: Folded rectangular waveguide.

**INSTALLATION CONSIDERATIONS**

Not available.

**PRINCIPAL COMPONENTS AND PHYSICAL DATA**

COMPONENT	BOXES (NR.)	OVERALL DIMENSIONS (Inches)	UNIT WT. (Pounds)
Antenna AS-999/SPS	1	95 x 124 x 152	3000
Antenna Pedestal AB-592/SPS	1	55 x 60 x 60	1600

**EQUIPMENT SUPPLIED DATA**

COMPONENTS	QTY	OVERALL DIMENSIONS (Inches)	UNIT WT. (Pounds)
Antenna Group AN/SPA-45 including:	1	92 x 110 x 184	2475
Antenna AS-999/SPS	1	92 x 110 x 141	
Antenna Pedestal AB-592/SPS	1		
Assembly, Rotary Coupler and Wave-Guide Segments Hughes Part No. 518509	1		
Elbow-Lower Rotating Joint Hughes Part No. 517996	1		
Tube, Waveguide Antenna Feed Hughes Part No. 585278	1		
Connector and Cable Hughes Part No. 585610	1		

**REFERENCE DATA AND LITERATURE**

Technical Manuals:  
 NAVSHIPS 93273(A)

DATE: 1 July 1964

ITEM NAME: ANTENNA GROUP

COGNIZANT SERVICE: USN

TYPE: AN/SPA-45A

FEDERAL STOCK NUMBER: 5840-678-0970

	USA	USN	USAF	USMC
STATUS OR TYPE CLASSIFICATION				

Mfg(s) Name or Code Number. Hughes Aircraft Company, Fuller, California

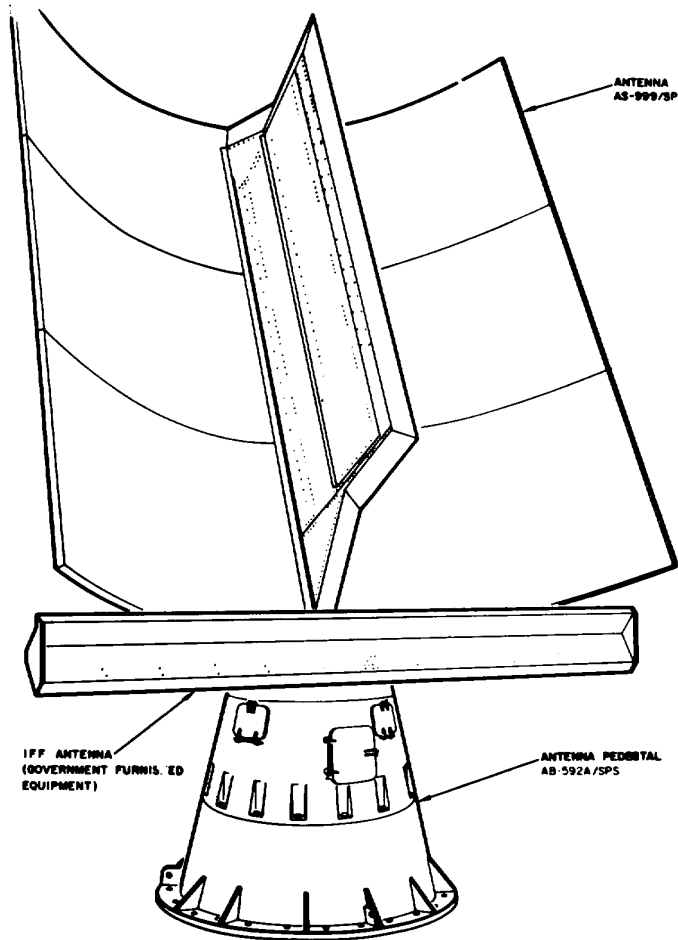

**FUNCTIONAL DESCRIPTION**

Antenna Group AN/SPA-45A is designed to radiate

and receive rf energy and to rotate the antenna for azimuth surveillance.

**ITEM NAME:** ANTENNA GROUP

**TYPE:** AN/SPA-45A

**RELATION TO SIMILAR EQUIPMENT**

None.

Broadside Frequency: 3000 mc  
Gain: 33.5 db relative to an isotropic radiator at 3050.6 mc  
Beamwidth in Elevation: 3 deg  
Beamwidth in Azimuth: 2.4 deg  
Side Lobes in Elevation: -20 db with respect to the main beam.  
Side Lobes in Azimuth: -16 db for the first pair; -20 db for all others.  
Ambient Temperature: -55 deg to plus 150 deg C (-67 deg to plus 302 deg F).

**TECHNICAL DESCRIPTION**

Antenna Rotation Rate

- Normal: 15 rpm
- With MTI: 11.5 rpm
- For Testing: 30 rpm
- For Coincident Video: 4.8 rpm

Antenna

- Reflector: Parabolic cylinder section tilted 25 deg from the vertical.
- Primary Feed: Folded rectangular waveguide.
- Transit Time For rf Energy Between First and Last Slots: 0.166 usec

**INSTALLATION CONSIDERATIONS**

Not available.

**PRINCIPAL COMPONENTS AND PHYSICAL DATA**

COMPONENT	BOXES (NR.)	OVERALL DIMENSIONS (Inches)	UNIT WT. (Pounds)
Antenna AS-999/SPS	1	95 x 124 x 152	3000
Antenna Pedestal AB-592A/SPS	1	55 x 60 x 60	1600

**EQUIPMENT SUPPLIED DATA**

COMPONENTS	QTY	OVERALL DIMENSIONS (Inches)	UNIT WT. (Pounds)
Antenna Group AN/SPA-45A includes:	1	92 x 110 x 184	2475
Antenna AS-999/SPS	1	92 x 110 x 141	
Antenna Pedestal AB-592A/SPS	1	43 x 54 x 54	
Assembly, Rotary Coupler & Waveguide Segments Hughes Part No. 517623	1		
Elbow-Lower Rotating Joint Hughes Part No. 517996	1		
Tube, Waveguide Antenna Feed Hughes Part No. 585178	1		
Connector and Cable Hughes Part No. 585610			

**REFERENCE DATA AND LITERATURE**

Technical Manuals:  
NAVSHIPS 93273(A)

DATE: 1 July 1964

ITEM NAME: ANTENNA GROUP

COGNIZANT SERVICE: USN

TYPE: AN/SPA-45B

FEDERAL STOCK NUMBER:

	USA	USN	USAF	USMC
STATUS OR TYPE CLASSIFICATION				

Mfg(s) Name or Code Number: Hughes Aircraft Company, Fullerton, California

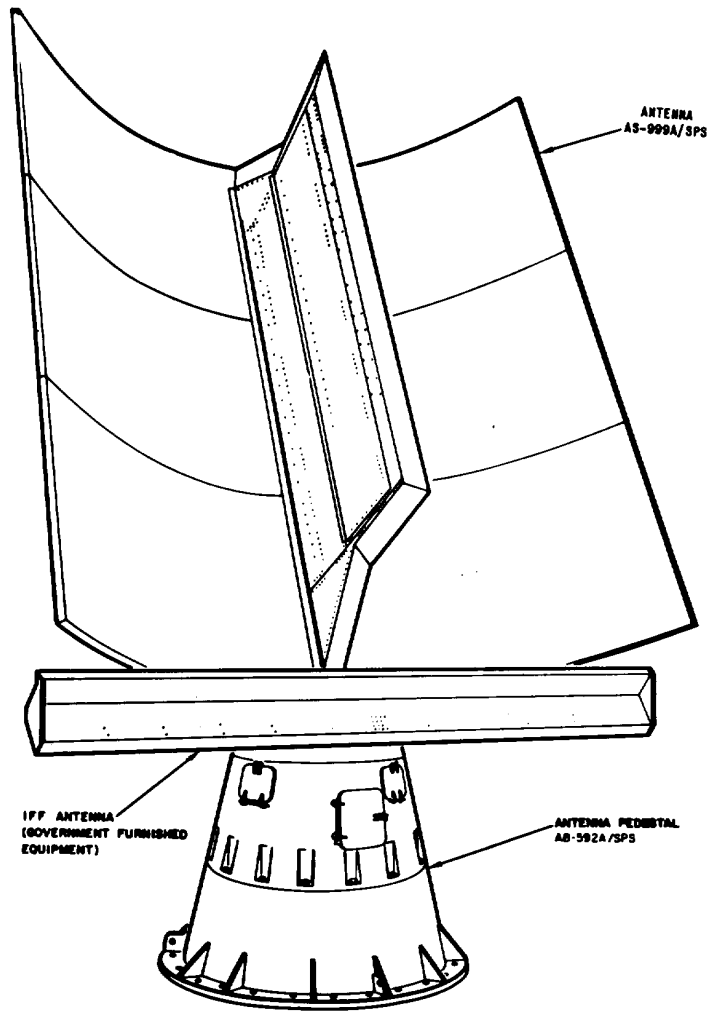

**FUNCTIONAL DESCRIPTION**

Antenna Group AN/SPA-45B is designed to radiate

and receive rf energy and to rotate the antenna for azimuth surveillance.

AN/SPA-45B: 1

**ITEM NAME:** ANTENNA GROUP

**TYPE:** AN/SPA-45B

**RELATION TO SIMILAR EQUIPMENT**

None.

Transit Time for rf Energy Between First and Last Slots: 0.166 usec  
 Broadside Frequency: 3000 mc  
 Gain: 33.5 db relative to an isotropic radiator at 3050.6 mc  
 Beamwidth in Elevation: 3 deg  
 Beamwidth in Azimuth: 2.4 deg  
 Side Lobes in Elevation: -20 db with respect to the main beam.  
 Side Lobes in Azimuth: -16 db for the first pair; -20 db for all others.  
 Ambient Temperature: -55 deg to plus 150 deg C (-67 deg to plus 302 deg F).

**TECHNICAL DESCRIPTION**

Antenna Rotation Rate  
 Normal: 15 rpm  
 With MTI: 11.5 rpm  
 For Testing: 30 rpm  
 For Coincident Video: 4.8 rpm  
 Antenna  
 Reflector: Parabolic cylinder section tilted 25 deg from the vertical.  
 Primary Feed: Folded rectangular waveguide.

**INSTALLATION CONSIDERATIONS**

Not available.

**PRINCIPAL COMPONENTS AND PHYSICAL DATA**

**SHIPPING DATA**

COMPONENT	BOXES (NR.)	OVERALL DIMENSIONS (Inches)	UNIT WT. (Pounds)
Antenna AS-999A/SPS	1	95 x 124 x 152	3000
Antenna Pedestal AB-592A/SPS	1	55 x 60 x 60	1600

**EQUIPMENT SUPPLIED DATA**

COMPONENTS	QTY	OVERALL DIMENSIONS (Inches)	UNIT WT. (Pounds)
Antenna Group AN/SPA-45B includes:	1	92 x 110 x 184	2475
Antenna AS-999A/SPS	1	92 x 110 x 141	
Antenna Pedestal AB-592A/SPS	1	43 x 54 x 54	
Assembly, Rotary Coupler & Waveguide Segments Hughes Part No. 517623	1		
Elbow-Lower Rotating Joint Hughes Part No. 517996	1		
Tube, Waveguide Antenna Feed Hughes Part No. 585278	1		
Connector and Cable Hughes Part No. 585610			

**REFERENCE DATA AND LITERATURE**

Technical Manuals:  
NAVSHIPS 93390

**DATE:** 1 July 1964

**ITEM NAME:** WAVEFORM CONVERTER GROUP

**COGNIZANT SERVICE:** USN

**TYPE:** AN/SPA-46

**FEDERAL STOCK NUMBER:**

	USA	USN	USAF	USMC
STATUS OR TYPE CLASSIFICATION				

Mfg(s) Name or Code Number: Hughes Aircraft Company, Fullerton, California

**Illustration not Available.**

**FUNCTIONAL DESCRIPTION**

range signals to slant range output signals.

The AN/SPA-46 is designed to convert input ground

**AN/SPA-46: 1**

**ITEM NAME:** WAVEFORM CONVERTER GROUP

**TYPE:** AN/SPA-46

**RELATION TO SIMILAR EQUIPMENT**

None.

single ph; 6.3v ac, 60 cps, single ph; 300v dc, plus  
150v dc, -250v dc.

**INSTALLATION CONSIDERATIONS**

**TECHNICAL DESCRIPTION**

Operating Power Requirements: 115v ac, 60 cps,

Related Equipment: The AN/SPA-46 is de- signed to  
be used with but not part of AN/SPS-42.

**PRINCIPAL COMPONENTS AND PHYSICAL DATA**

<b>COMPONENTS</b>	<b>QTY</b>	<b>OVERALL DIMENSIONS (Inches)</b>	<b>UNIT WT. (Pounds)</b>
Waveform Converter Group AN/SPA-46 consists of:	1	25 x 32 x 37	500
Converter, Signal Data CV-765/SP	1	11.13 x 24.5 x 35.76	
Power Supply PP-2275/SP	1	6 x 22 x 24.44	
Power Supply PP-2276/SP	1	8 x 22 x 24.44	
Electrical Equipment Cabinet CY-2573/S P	1	24 x 25 x 36.52	

**REFERENCE DATA AND LITERATURE**

Technical Manuals:  
    NAVSHIPS 93400  
    NAVSHIPS 93273A



**DATE:** 1 July 1964

**ITEM NAME:** WAVEFORM CONVERTER GROUP

**COGNIZANT SERVICE:** USN

**TYPE:** AN/SPA-49

**FEDERAL STOCK NUMBER:**

	USA	USN	USAF	USMC
STATUS OR TYPE CLASSIFICATION				

Mfg(s) Name or Code Number: Hughes Aircraft Co., Fullerton, California

**Illustration not Available.**

**FUNCTIONAL DESCRIPTION**

signals to slant range signals.

The AN/SPA-49 is designed to convert ground range

**AN/SPA-49: 1**

**ITEM NAME:** WAVEFORM CONVERTER GROUP

**TYPE:** AN/SPA-49

**RELATION TO SIMILAR EQUIPMENT**

None.

single ph; 6.3v ac, 60 cps, single ph; 300v dc, plus  
or minus 150v dc, -250v dc.

**INSTALLATION CONSIDERATIONS**

**TECHNICAL DESCRIPTION**

Operating Power Requirements: 115v ac, 60 cps,

Related Equipment: The AN/SPA-49 is de- signed to  
be used with but not part of Radar Set AN/SPS-  
39.

**PRINCIPAL COMPONENTS AND PHYSICAL DATA**

<b>COMPONENTS</b>	<b>QTY</b>	<b>OVERALL DIMENSIONS (Inches)</b>	<b>UNIT WT. (Pounds)</b>
Waveform Converter Group AN/SPA-49 consists of:	1	25 x 32 x 36.5	644
Converter, Signal Data CV-765/SP	1	11 x 24 x 25	
Power Supply PP-2275/SP	1	9 x 23 x 24	
Power Supply PP-2276/SP	1	9 x 24 x 24	
Cabinet, Electrical Equipment CY-2707/SP	1	25 x 32 x 36.5	

**REFERENCE DATA AND LITERATURE**

Technical Manuals:  
NAVSHIPS 93400  
NAVSHIPS 93273A

DATE: 1 July 1964

ITEM NAME: INDICATOR GROUP

COGNIZANT SERVICE: USN

TYPE: AN/SPA-51

FEDERAL STOCK NUMBER:

	USA	USN	USAF	USMC
STATUS OR TYPE CLASSIFICATION				

Mfg(s) Name or Code Number: Hazeltine Electronics Div., Hazeltine Corp., Little Neck, N. Y.

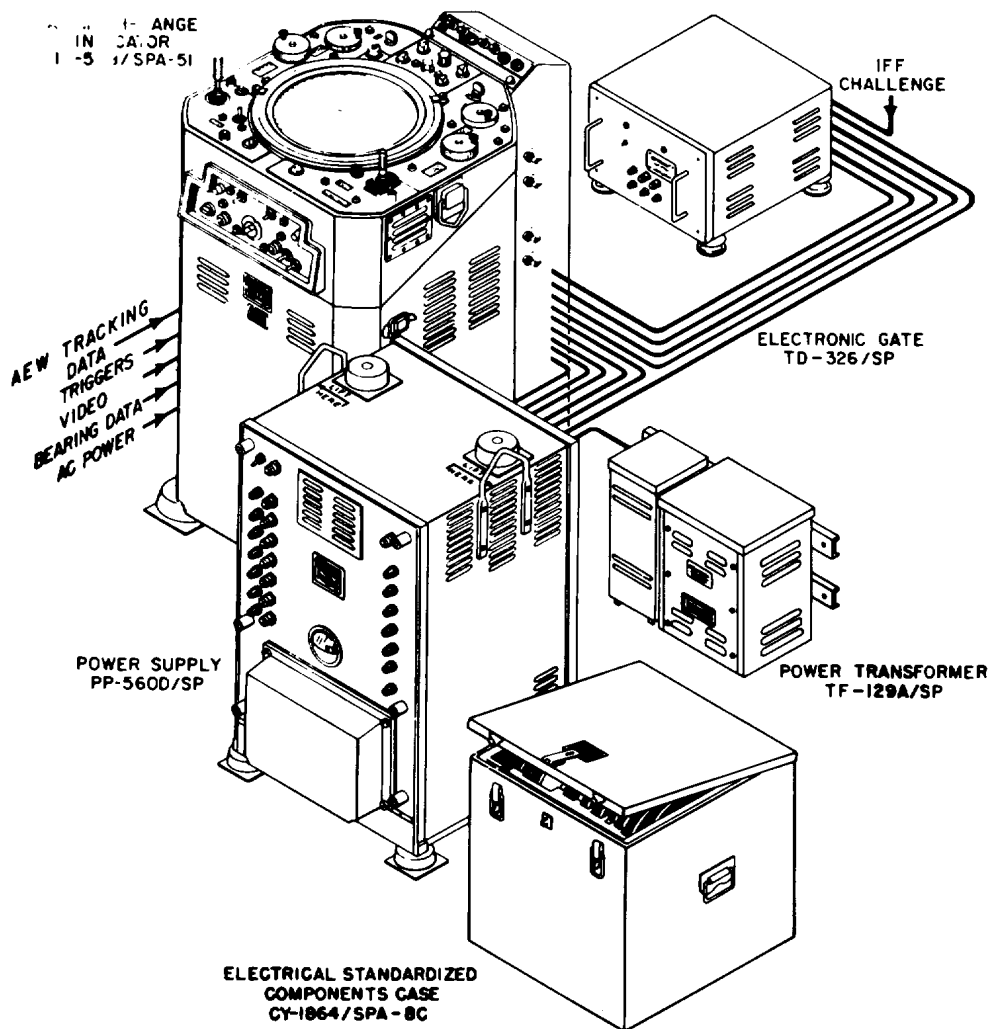

### FUNCTIONAL DESCRIPTION

Indicator Group AN/SPA-51 is a general purpose plan position indicator intended for shipboard use. It is adaptable to a variety of radar equipments. A front panel function control switch permits it to be used as an

ordinary PPI, as an AEW tracking indicator, or as an AEW repeat (final) indicator. In addition, when used as an ordinary PPI, the indicator group has as special features the ability to accept azimuth information in the form of two rectangular coordinate voltages instead of

**ITEM NAME:** INDICATOR GROUP

**TYPE:** AN/SPA-51

synchro voltages and the ability to display AN/SPS-32 radar video and IFF target responses. The mode of operation of the indicator group is chosen by a RADAR SELECTOR switch mounted on the front panel.

Bearing Accuracy: Within 2 deg at all antenna speeds  
Cathode-Ray Tube Diameter (PPI): 10-1/2 in.  
Number of Operators Required: 1

**RELATION TO SIMILAR EQUIPMENT**

Indicator Group AN/SPA-51 is essentially the same as Indicator Group AN/SPA-33 except that AN/SPS-32 radar video (and IFF target responses) can also be displayed by selecting positions 4 or 10 of the RADAR SELECTOR switch. Other differences are: an extension of range from 300 to 400 miles, deletion of external cursor bearing information transfer, elimination of the range and bearing buzzer, and the display of AN/SPS-26 radar in positions 2, 3, or 9 of the RADAR SELECTOR switch.

**INSTALLATION CONSIDERATIONS**

Siting: Azimuth-Range Indicator IP-538/ SPA-51 and Electrical Standardized Components Case CY-1864/SPA-BC; Combat Information Center. Power Supply PP-560D/SP; where convenient, up to 150 feet (maximum cable length) from the indicator. Power Transformer TF-129A/SP; where convenient, up to 60 feet (maximum cable length) from the power supply. Electronic Gate TD-326/SP; where convenient, up to 75 feet (maximum cable length) from the indicator and the power supply.

**TECHNICAL DESCRIPTION**

Pulse Repetition Frequency: 60 to 3000 per sec  
Power Requirements: 115v plus or minus 10%; 60 cycles plus or minus 3 cycles, single ph  
Power Demand: 1847 va  
Power Dissipation: 1700w (approx)  
Power Factor: 0.93 pf (approx)  
Video Input: 1 to 2-1/2v (pos)  
Trigger Input: 5 to 50v (pos)  
Antenna and Trace Rotation: 0 to 40 rpm  
Range  
Centered PPI: 4 to 400 mi continuously var  
Off-Centered PPI: 4 to 400 mi continuously var  
Range Accuracy  
300 to 10,000 Yards: plus or minus 100 yds  
10,000 to 72,000 Yards: plus or minus 1% of actual range  
72,000 Yards to 400 Miles: plus or minus 2% of actual range

Mounting: All units except Electrical Standardized Components Case CY-1864/SPA-BC are shock mounted and bolted into place.

Mounting Dimensions: length by width by depth.  
Azimuth Range Indicator  
IP-538/SPA-51: 63 in. 41 in. 45 in.  
Power Supply PP-560D/SP: 40 in. 28 in. 31 in.  
Power Transformer TF-129A/SP: 9 in. 24 in. 13 in.  
Electronic Gate TD-326/SP: 41 in. 15 in. 16 in.  
Components Case CY-1864/SPA-BC: 16 in. 19 in. 16 in.

Related Equipment: (Required, but not Supplied)  
Video Decoder KY-80/UPA-24, Radar Set Control C-1008/UPA-24, 5G synchro, 6G synchro interconnecting cables, and terminal tubes.

**PRINCIPAL COMPONENTS AND PHYSICAL DATA  
SHIPPING DATA**

COMPONENT	BOXES (NR.)	OVERALL DIMENSIONS (Inches)	UNIT WT. (Pounds)
Azimuth-Range Indicator IP-53B/SPA-51	1	35 x 39-1/2 x 46-3/4	685
Power Supply PP-560D/SP	1	33 x 27-1/2 x 36-3/4	474
Power Transformer TF-129A/SP	1	30-3/4 x 17-1/2 x 10-3/4	156
Electrical Standardized Components Case CY-1864/SPA-BC	1	21-5/8 x 20-1/8 x 18-1/8	124
Electronic Gate TD-326/SP	1		

ITEM NAME: INDICATOR GROUP

TYPE: AN/SPA-51

**PRINCIPAL COMPONENTS AND PHYSICAL DATA  
SHIPPING DATA (Cont.)**

COMPONENT	BOXES (NR.)	OVERALL DIMENSIONS (Inches)	UNIT WT. (Pounds)
Shockmounts for IP-538/SPA-51	1	31-3/4 x 18-1/2 x 10-3/4	50
Hardware			
NAVSHIPS 93526 - Complementary Technical Manual for Indicator Group AN/SPA-51			
NAVSHIPS 93156 - Technical Manual for Indicator Group AN/SPA-33			
NAVSHIPS 93156.42 - Maintenance Standards Book for Indicator Group AN/SPA-33			
NAVSHIPS 93156.32 - Performance Standards Sheet			
NAVSHIPS 93156.21 - Operator's Chart for Indicator Group AN/SPA-33			
Maintenance Parts Kit	1		

**EQUIPMENT SUPPLIED DATA**

COMPONENTS	QTY	OVERALL DIMENSIONS (Inches)	UNIT WT. (Pounds)
Azimuth-Range Indicator IP-538/SPA-51	1	29-1/4 x 25-1/2 x 39-3/4	460
Power Supply PP-56OD/SP	1	20-1/8 x 22-1/4 x 30-3/8	309
Power Transformer TF-129A/SP	1	8-1/8 x 23-11/16 x 12-7/8	112
Electrical Standardized Components Case CY-1864/SPA-8C (Incl IP-538/SPA-51 accessories)	1	19 x 16 x 15-1/2	76
Electronic Gate TD-326/SP	1	17 x 14-1/2 x 10-3/4	50
Shockmounts Set	1	31-3/4 x 18-1/2 x 10-3/4	
Maintenance Parts Kit	1		
Box of Hardware			
Technical Manual for Indicator Group AN/SPA-33 - NAVSHIPS 93156	2	11-1/2 x 9-1/2 x 4	
Technical Manual for Indicator Group AN/SPA-51 - NAVSHIPS 93526	2	11-1/2 x 9-1/2	
Maintenance Standards Book for Indicator Group AN/SPA-33 - NAVSHIPS 93156.42	1	11-1/8 x 8-7/8 x 1/2	
Performance Standards Sheet - NAVSHIPS 93156.32	1		
Operator's Chart for Indicator Group AN/SPA-33 - NAVSHIPS 93156.21	1	11-1/2 x 8-1/2 x 1/4	

**AN/SPA-51: 3**

**ITEM NAME:** INDICATOR GROUP

**TYPE:** AN/SPA-51

**REFERENCE DATA AND LITERATURE**

Technical Manuals:

NAVSHIPS 93526: Complementary Technical Manual  
for Indicator Group AN/SPA-51.

NAVSHIPS 93156: Technical Manual for Indicator  
Group AN/SPA-33.

NAVSHIPS 93156.42: Maintenance Standards Book  
for Indicator Group AN/SPA-33.

NAVSHIPS 93156.32: Performance Standards Sheet.

NAVSHIPS 93156.21: Operator's Chart for Indicator  
Group AN/SPA-33.

**AN/SPA-51: 4**

**DATE:** 1 July 1964

**ITEM NAME:** ANTENNA

**COGNIZANT SERVICE:** USN

**TYPE:** AN/SPA-54

**FEDERAL STOCK NUMBER:** F5840-448-0049

	USA	USN	USAF	USMC
STATUS OR TYPE CLASSIFICATION				

Mfg(s) Name or Code Number: Hughes Aircraft Company, Fullerton, California

**Illustration not Available.**

**FUNCTIONAL DESCRIPTION**

Radio Frequency (RF) energy and it rotates the antenna for azimuth surveillance.

The AN/SPA-54 is designed to radiate and receive

**AN/SPA-54: 1**

**ITEM NAME:** ANTENNA

**TYPE:** AN/S PA-54

**RELATION TO SIMILAR EQUIPMENT**

None.

**INSTALLATION CONSIDERATIONS**

Related Equipment: The AN/SPA-54 is designed to be used with, but is not part of AN/SPS-39 and AN/SPS-39A.

**TECHNICAL DESCRIPTION**

Not available.

**PRINCIPAL COMPONENTS AND PHYSICAL DATA**

<b>COMPONENTS</b>	<b>QTY</b>	<b>OVERALL DIMENSIONS (Inches)</b>	<b>UNIT WT. (Pounds)</b>
Antenna AS-1109/SPS	1		
Pedestal AB-657/SPS	1		
Assembly, Antenna Rotary Coupler, Slipping, & Waveguide	1		
Elbow, Lower Rotating Joint	1		
Tube, Waveguide Antenna Feed	1		
Connector & Cable	1		

**REFERENCE DATA AND LITERATURE**

Technical Manuals:  
NAVSHIPS 93400



**DATE:** 1 July 1964

**ITEM NAME:** CONTROL INDICATOR GROUP

**COGNIZANT SERVICE:** USN

**TYPE:** AN/SPA-55(XN-1)

**FEDERAL STOCK NUMBER:**

	USA	USN	USAF	USMC
STATUS OR TYPE CLASSIFICATION				

Mfg(s) Name or Code Number. Motorola Incorporated, Chicago, Illinois

**Illustration not Available.**

**FUNCTIONAL DESCRIPTION**

The AN/SPA-55(XN-1) interchanges analog voltages between Indicator Control Group AN/SPA-26(V) and Intercept Tracking and Control Group AN/SPA-22. Pilot lights indicate the status of AN/SPA-22 channels. An

assembly of four indicator lights is mounted at each of two air controller positions in the AN/SPA-22. The AN/SPA55(XN-1) displays interceptor status from the AN/SPA-22. It transfers analog voltage position data from the AN/SPA-22 via scale change amplifiers to the

**AN/SPA-55(XN-1): 1**

**ITEM NAME:** CONTROL INDICATOR GROUP

**TYPE:** AN/SPA-55(XN-1)

AN/SPA-26(V). It transfers analog voltage position and velocity data via scale change amplifiers to the AN/SPA-22. It pairs a selected target with an interceptor and alerts air controllers. The status indicator for the pairing-panel control unit lights and controls the pairing-panel main unit. Analog voltages transferred are: eight-channels (two circuits per channel) input from AN/SPA-22, output to AN/SPA26(V); and two channels (two circuits per channel) input from AN/SPA-26(V), output to AN/SPA-22.

**TECHNICAL DESCRIPTION**

Output Signal Characteristics: Analog voltages.  
Operating Power Requirements: 115v ac, 60 cps, single ph.

**INSTALLATION CONSIDERATIONS**

Related Equipment: The AN/SPA-55(XN-1) is designed to be used with, but is not part of Indicator Control Group AN/SPA-26(V), Intercept Tracking and Control Group AN/SPA-22, and Plotting Group, Radar Data AN/SPA-15( ).

**RELATION TO SIMILAR EQUIPMENT**

None.

**PRINCIPAL COMPONENTS AND PHYSICAL DATA**

<b>COMPONENTS</b>	<b>QTY</b>	<b>OVERALL DIMENSIONS (Inches)</b>	<b>UNIT WT. (Pounds)</b>
Pairing Panel Main Unit	1		
Pairing Panel Control Unit	1		
Indicator Light	2		

**REFERENCE DATA AND LITERATURE**

Technical Manuals:  
NAVSHIPS 93400

**AN/S PA-55(XN-1): 2**

DATE: 1 July 1964

ITEM NAME: RADAR TRAINING SET

COGNIZANT SERVICE: USN

TYPE: AN/S PG-T10

FEDERAL STOCK NUMBER: 6940-597-2626

	USA	USN	USAF	USMC
STATUS OR TYPE CLASSIFICATION				

Mfg(s) Name or Code Number: Stavid Engineering Inc., Plainfield, New Jersey

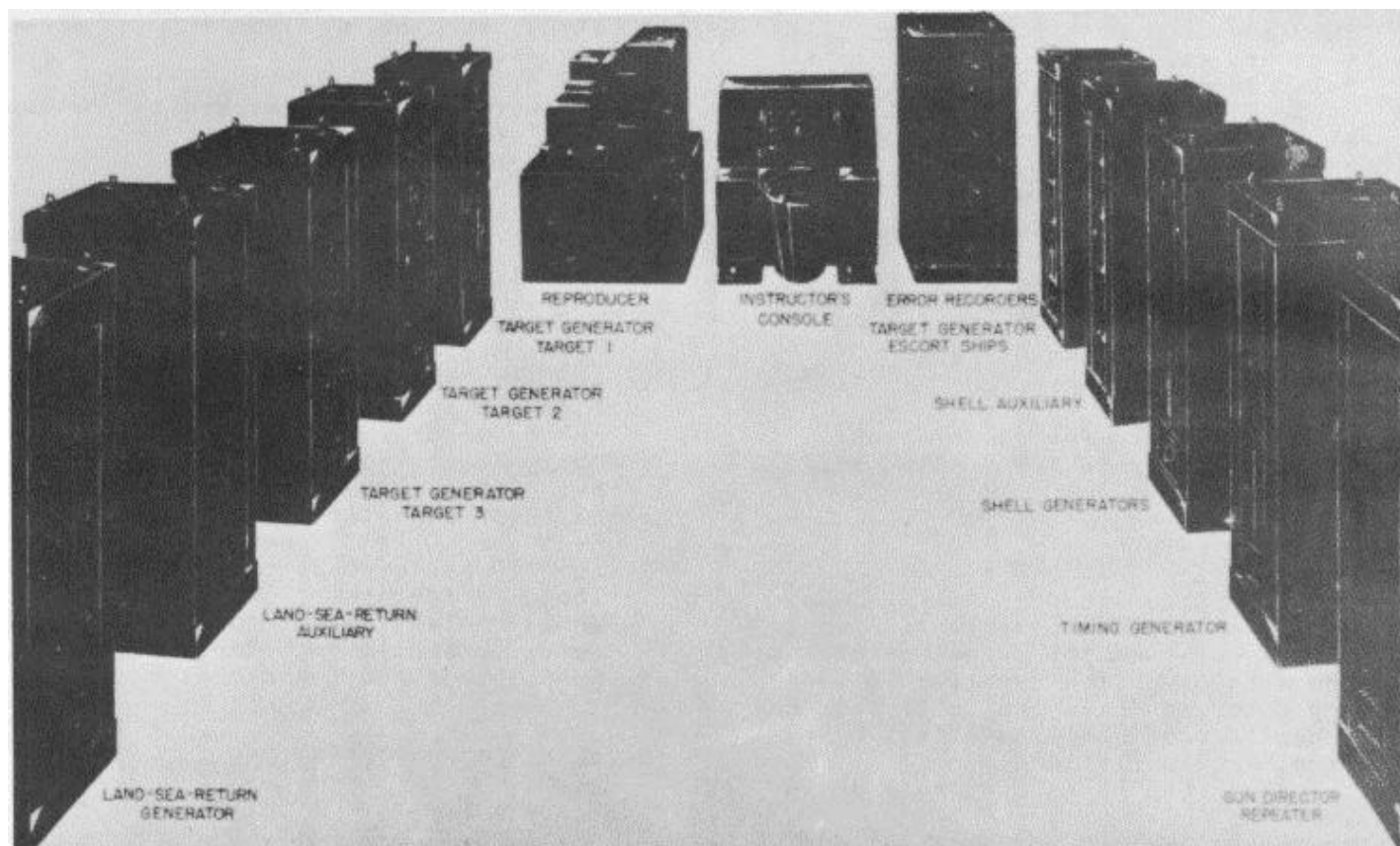

### FUNCTIONAL DESCRIPTION

AN/SPG-T10 is designed to be used with Radars Mk 25 or Mk 35 to provide simulated signals for standardized training of radar operators. Problems are provided on film, making it possible to grade and

compare the relative proficiencies of various students on the same problem. Recording error meters provide a permanent record of the student's progress.

Signals representing three aircraft or surface targets, six escort ships, and a land mass are provided.

AN/SPG-T10: 1

**ITEM NAME:** RADAR TRAINING SET

**TYPE:** AN/SPG-T10

Additional signals simulate sea-return, jamming, and shells. Range, bearing, and elevation of the three targets are controlled by signals recorded on a film. Range and bearing of the escort ships, bearing and attitude of the land mass, and type and origin of jamming signals are also controlled entirely by the instructor.

**RELATION TO SIMILAR EQUIPMENT**

None.

**TECHNICAL DESCRIPTION**

Reproducer

Number of Channels: 13 (10 channels are only used).

Signal Data

Number of Signals: 3

Type: Target Range controlled by variable frequency signal varying between 1000 and 5000 cps; Bearing and Elevation are controlled by 400 cycle signals; Jamming type and origin are controlled by coded interruptions of a 3500 cycle signal.

Output Level: 20 my

Impedance: 700 ohms

Timing Generator

Power Supply Data

Quantity: 2

Type: 300v regulated rectifiers, 0.5 amp

Impedance: less than 0.2 ohms

Oscillator Data

Quantity: 2

Type: 2000 cycle for range synchronization; 400 cycle for bearing and elevation test.

Target Generators (3)

Power Supply Data

Quantity: 2

Type: 300v regulated rectifiers, 360 ma. One supplies positive voltages to all units of the target generator; the other supplies negative voltages for power and bias applications.

Shell Generator and Shell Auxiliary

Number of Shells Provided: 3

Firing Data: May be fixed singly or in salvo.

Control Data: May be adjusted to cause the shell to miss the target by any desired amount up to plus or minus 1.5 deg in bearing and elevation and plus or minus 1000 yards in range.

Land-Sea-Return Generator and Land-Sea-Return Auxiliary

Operational Data: Returns are generated using scale models to obtain realistic echoes.

Land Range: Set at 10,000 yds. Bearing is controlled by signals from the film. Land attitude is also controlled by the film to make it appear as though the ship were sailing a circular course around an island.

Error Recorders

Operational Data: Error meters provide permanent records of the student's proficiency in tracking targets. Separate records are made for errors in range, bearing and elevation.

Range: Measures errors up to plus or minus 500 yds and records these on a moving paper strip. Errors in excess of plus or minus 800 yds cause max deflection of the error meter in the proper direction to indicate whether radar range is greater or less than actual target range.

Instructors Console

Operational Data: Console contains a PPI repeater which permits the instructor to see all targets simultaneously and to designate one to the student operators.

Control Data: Gain controls for all targets; spotting controls in range; bearing, and elevation for shells; identification switches to permit identifying any particular target on the PPI scope. Tally lights notify which target is being jammed and nature of jamming.

Gun Director Repeater

Operational Data: Repeater consists largely of servo systems which repeat the director orders of the radar equipment. Servo systems position control transformers in accordance with the position of the gun director.

**INSTALLATION CONSIDERATIONS**

Not available.

**ITEM NAME:** RADAR TRAINING SET

**TYPE:** AN/SPG-T10

**PRINCIPAL COMPONENTS AND PHYSICAL DATA**

<b>COMPONENT</b>	<b>QTY</b>	<b>OVERALL DIMENSIONS (Inches)</b>	<b>UNIT WT. (Pounds)</b>
Reproducer	1		
Timing Generator	1		
Target Generator	3		
Shell Generator	1		
Shell Auxiliary	1		
Land and Sea Return Generator	1		
Land and Sea Return Auxiliary	1		
Error Recorder	1		
Instructor's Console	1		
Gun Director Repeater	1		

**REFERENCE DATA AND LITERATURE**

Technical Manuals:  
OP 1739

**AN/SPG-T10: 3**

DATE: 1 July 1964

ITEM NAME: TRAINER

COGNIZANT SERVICE: USN

TYPE: AN/S PN-T1

FEDERAL STOCK NUMBER:

	USA	USN	USAF	USMC
STATUS OR TYPE CLASSIFICATION	Used By	Used By		

Mfg(s) Name or Code Number: U. S. Navy Electronics Laboratory (89199)

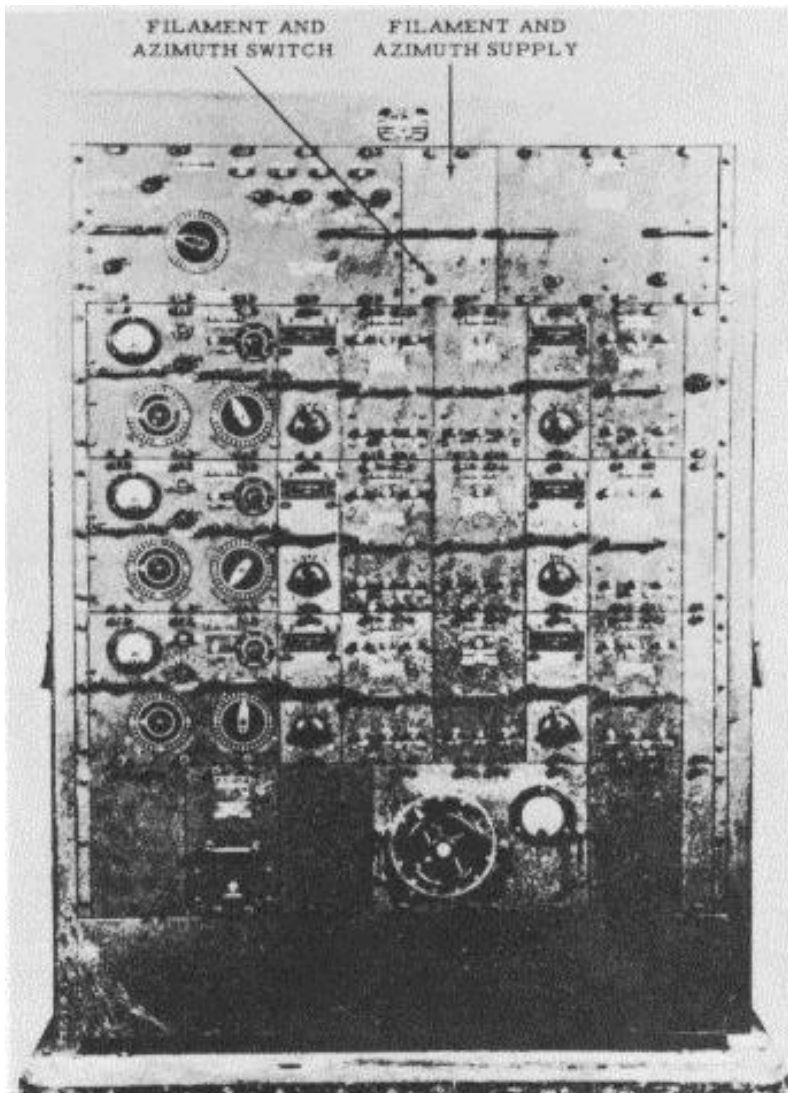

**FUNCTIONAL DESCRIPTION**

The Trainer AN/SPN-T1 is designed to provide team training of naval personnel in shore bombardment and ship navigation exercises.

The AN/SPN-T1 is a combination of three modified equipments; Radar Training Set AN/APS-T3; Training Equipment Radar Navy Model OBJ; and Radar Equipment Navy Model SG. Land mass and ship's targets are displayed on a modified Navy Model TSG radar which has been altered to permit enlargement of the map scale by factor of two.

**ITEM NAME:** TRAINER

**TYPE:** AN/SPN-T1

**RELATION TO SIMILAR EQUIPMENT**

None.

OBJ: Generates five maneuverable Surface Ships Targets and solves their position with respect to own ship.

SG: Presents "A" and "PPI" scope presentations of simulated CIC maneuvers.

Operating Power Requirements: 120v ac, 60 cps, single ph, 43 amps

**TECHNICAL DESCRIPTION**

Effective Ranges

Land: 30 mi max range viewable. Navigable:  
Approx 650 yds min range of own ship with respect to land.

Type of Signals

AN/APS-T3: Produces land mass signals with respect to own-ships motion.

**INSTALLATION CONSIDERATIONS**

Not available.

**PRINCIPAL COMPONENTS AND PHYSICAL DATA**

<b>COMPONENT</b>	<b>QTY</b>	<b>OVERALL DIMENSIONS (Inches)</b>	<b>UNIT WT. (Pounds)</b>
Modified Ultrasonic Trainer AN/APS-T3 (Device 15z-1)	1		
Modified Radar Training Equipment OBJ	1		
Modified Radar Equipment SG-lb	1		
Indicator VH and VD-2	1		
Modified NEL Annapolis-Type Conning Unit	1		

**REFERENCE DATA AND LITERATURE**

Technical Manuals:  
NAVSHIPS 91350

**AN/SPN-T1: 2**

DATE: 1 July 1964

ITEM NAME: REMOTE PPI

COGNIZANT SERVICE: USN

TYPE: 55ACD

FEDERAL STOCK NUMBER: F5840-260-4623

	USA	USN	USAF	USMC
STATUS OR TYPE CLASSIFICATION				

Mfg(s) Name or Code Number: General Electric Company

master PPI, and each remote PPI may be connected to as many as five master PPI units.

#### RELATION TO SIMILAR EQUIPMENT

None.

#### TECHNICAL DESCRIPTION

Pulse Repetition Rate: 60, 200, 400, or 800 to 1,000 pps

Range Scales: 7.5, 20, 75, and 200 naut mi

Presentation: One 7-in. PPI

Ambient Temperature Range: -20 to +50 deg C

Synchronizing Input: 5 to 40v

Video Input: 1v r/in

Field Excitation (yoke driving motor) Input: 115v, 60 cps ship's supply or gyro excitation bus

Synchro Excitation (5 CT) Input: From stator terminal connections on antenna bearing synchro generator

Operating Voltages and Power Requirements: 115 vac, 60 cps, 0.935 pf

Operational Power Consumption: 275w

Stand-By Power Consumption: 100w

Operational Current Consumption: 2.7 amps

Stand-By Current Consumption: 0.86 amps

#### INSTALLATION CONSIDERATIONS

Siting:

Mounting: Deck mounted. .

Cabling Requirements:

Related Equipment: The 55ACD operates in conjunction with radar and PPI systems using pulse rates of 60, 200, 400, or 800 to 1,000 pps, such as Navy Model SC and SK series radar equipment.

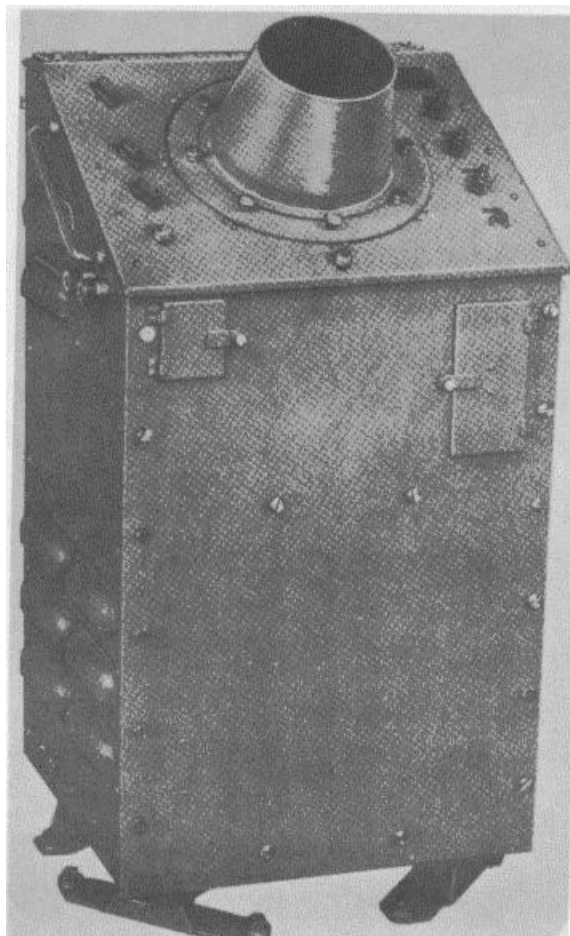

#### FUNCTIONAL DESCRIPTION

Remote PPI 55ACD reproduces the oscillographic pattern of a master PPI at remote positions on a ship. As many as 12 of these units may be connected to one



**55ACD**

**PRINCIPAL COMPONENTS AND PHYSICAL DATA**

<b>COMPONENT</b>	<b>QTY</b>	<b>HEIGHT (Inches)</b>	<b>WIDTH (Inches)</b>	<b>DEPTH (Inches)</b>	<b>UNIT WT. (Pounds)</b>
Remote Plan Position Indicator NT-55ACD	1	45-1/2	24-5/8	23-1/2	375
Selector Switch NT-24168	1	15-5/8	11-1/4	6	17

**REFERENCE DATA AND LITERATURE**

Technical Manual:  
ENG 203(A)

**DATE:** 1 July 1964

**ITEM NAME:** MISTER PPI

**COGNIZANT SERVICE:** USN

**TYPE:** 55ADP

**FEDERAL STOCK NUMBER:** F5840-372-2941

	USA	USN	USAF	USMC
STATUS OR TYPE CLASSIFICATION				

Mfg(s) Name or Code Number: Radio Corporation of America

Description for Master PPI 55ADP is found on Bearing Amplifier Converter 50ACU data sheet, pages 50ACU: 1 through 50ACU: 2.

**55ADP: 1**

DATE: 1 July 1964

ITEM NAME: IFF COORDINATOR-RANGE  
INDICATOR

COGNIZANT SERVICE: USN

TYPE: 55AHP-1

FEDERAL STOCK NUMBER: F5840-325-6314

	USA	USN	USAF	USMC
STATUS OR TYPE CLASSIFICATION				

Mfg(s) Name or Code Number: Radio Corporation of America

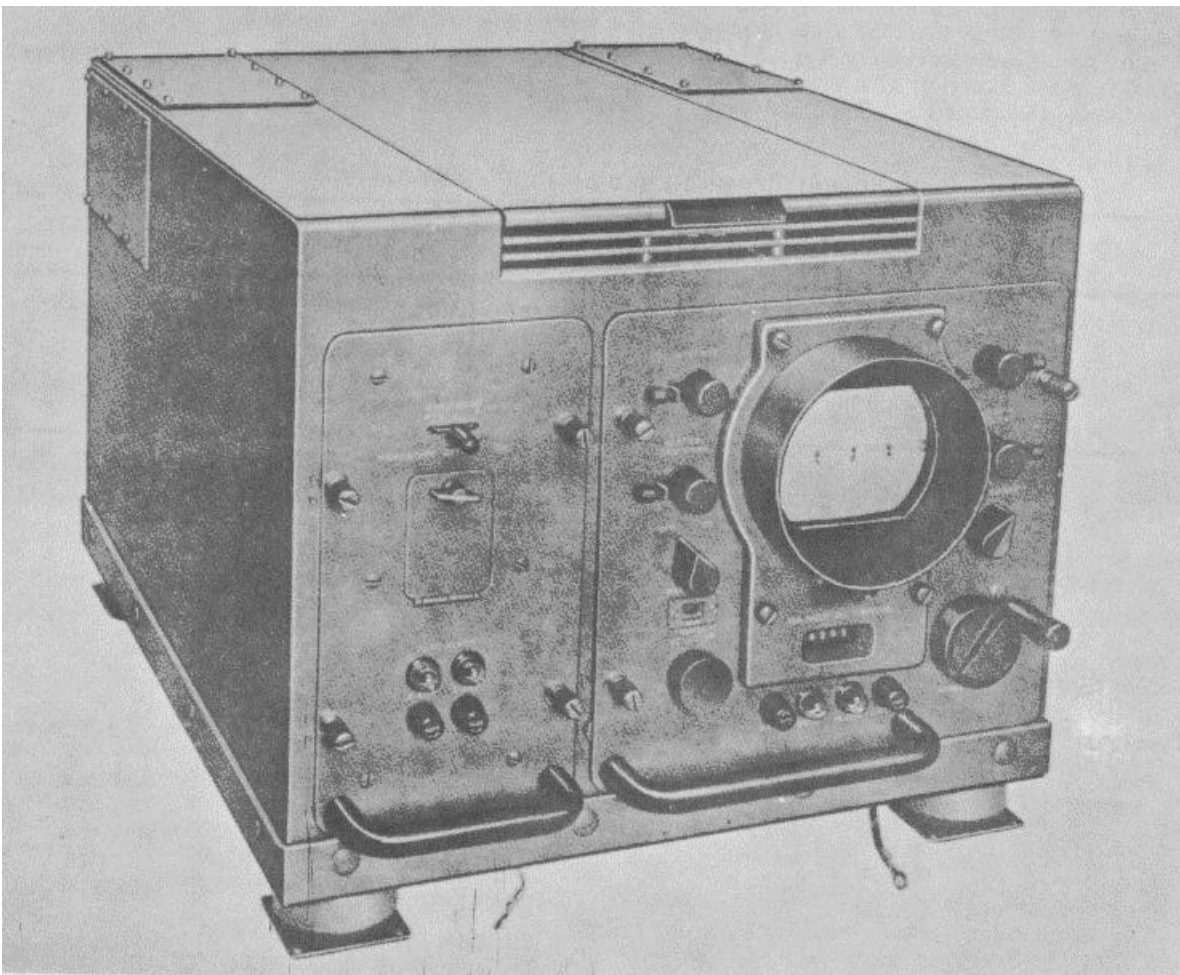

55AHP-1: I

**55AHP- 1**

**FUNCTIONAL DESCRIPTION**

The Navy Type 55AHP-1 is a shipboard installation used with existing radar and IFF systems to provide a means for the received radar and IFF signals to be displayed simultaneously on the screen of a CRT. The information displayed indicates the range and identity of remote objects.

It is used in conjunction with radar transmitting and receiving systems which have a repetition rate of 180 or 600 pulses per second and which supply synchronization, video IFF, and radar signals to the console for presentation on the A-scope.

Field Change 1 applies to all Navy Type 55AHP-1 equipments used with Radar Equipments AN/SPS-4, Navy Model SG-6, and Navy Model SG-6b. Option 1 to the field change removes the IFF Coordinator Navy Type 23AGG-1 from the cabinet and places a blanking plate over the opening left by removal of the coordinator. Option 2 to the field change removes the IFF Coordinator Navy Type 23AGG-1, and authorizes

construction of a new cabinet to house the Range Indicator Navy Type 55AGJ-1.

**RELATION TO SIMILAR EQUIPMENT**

The Navy Type 55AHP-1 is the same as Navy Type 55AHP except for minor components used.

**TECHNICAL DESCRIPTION**

Presentation: One 5-in. A-scope  
Range Scales: 4, 20, 80, and 200 mi  
Trigger Pulse: +5 to +50w  
Video Signals: +1.0 to +2.5v  
Operating Voltages and Power Requirements: 104 to 126 vac, 58 to 62 cps, 1-ph, 300w

**INSTALLATION CONSIDERATIONS**

Siting:  
Mounting: Shelf mounted.  
Cabling Requirements:  
Related Equipment:

**PRINCIPAL COMPONENTS AND PHYSICAL DATA**

COMPONENT	QTY	HEIGHT (Inches)	WIDTH (Inches)	DEPTH (Inches)	UNIT WT. (Pounds)
Cabinet NT-16104-A	1	18-1/32	21-3/8	31-9/32	195
IFF Coordinator NT-23AGG-1	1	12-1/16	6-7/8	29-9/16	31
Range Indicator NT-55AGJ-1	1	12-1/16	12-7/8	29-9/16	90

**REFERENCE DATA AND LITERATURE**

Technical Manual:  
NAVSHIPS 900827

DATE: 1 July 1965

ITEM NAME: ANTENNA ASSEMBLY

COGNIZANT SERVICE: USN

TYPE: 66ACG

FEDERAL STOCK NUMBER:

	USA	USN	USAF	USMC
STATUS OR TYPE CLASSIFICATION				

Mfg(s) Name or Code Number: Hazeltine Electronics

### FUNCTIONAL DESCRIPTION

The 66ACG antenna is suitable for use on small and medium-size Naval ships where space aloft is limited. The 66ACG is part of the BL, BM, and BN series IFF equipment installations, but may be used with any low-power radio receiver and transmitter operating in the frequency range of 157 to 187 mc.

### RELATION TO SIMILAR EQUIPMENT

None.

### TECHNICAL DESCRIPTION

Frequency: 157 to 187 mc  
Type: Vertical half-wave dipole mounted on, but insulated from, a horizontal steering wheel type ground plane.  
Polarization: Vertical  
Input Impedance: 50 ohms  
Feed: RG-10/U, coaxial cable with NT-49195 plug  
Horizontal Radiation Pattern: Omnidirectional  
Vertical Radiation Pattern: Low angle

### INSTALLATION CONSIDERATIONS

Siting:  
Mounting: Supported on 1-in. diameter iron pipe 14 or 29 inches long.  
Cabling Requirements:  
Related Equipment:

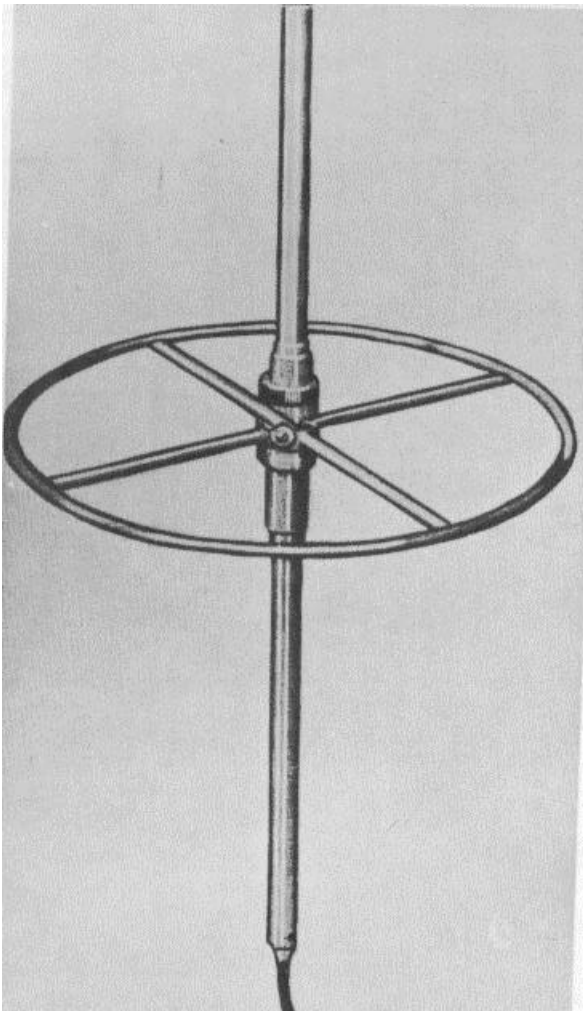

**66ACG**

**PRINCIPAL COMPONENTS AND PHYSICAL DATA**

<b>COMPONENT</b>	<b>QTY</b>	<b>HEIGHT (Inches)</b>	<b>WIDTH (Inches)</b>	<b>DEPTH (Inches)</b>	<b>UNIT WT. (Pounds)</b>
Antenna Assembly 66ACG	1	24	4-3/4	21-1/2	8

**REFERENCE DATA AND LITERATURE**

Technical Manual:  
NAVSHIPS 95439

**66ACG: 2**

DATE: 1 July 1965

ITEM NAME: ANTENNA ASSEMBLY

COGNIZANT SERVICE: USN

TYPE: 66AHQ

FEDERAL STOCK NUMBER: F5985-644-3306

	USA	USN	USAF	USMC
STATUS OR TYPE CLASSIFICATION				

Mfg(s) Name or Code Number: General Electric Company

**FUNCTIONAL DESCRIPTION**

Antenna Assembly 66AHQ is used with Radar Equipment SP for surface search and aircraft detection.

**RELATION TO SIMILAR EQUIPMENT**

The 66AHQ is identical to Antenna Assembly 66AFP except for differences in lobe motor and in cross-level gear ratio.

**TECHNICAL DESCRIPTION**

Type: Parabolic; also 6 folded dipoles for IFF  
 Rotation Speed: 6 rpm  
 Antenna Feed: Waveguide  
 Frequency: 2800 mc  
 Vertical Cross Level Limit: +66 to -31 deg  
 Horizontal Cross Level Limit: +30 to -30 deg  
 Vertical Beam Width: 3.6 deg  
 Horizontal Beam Width: 3.6 deg  
 Stabilization Type: 3-ax:  
 Roll Limit:  $\pm 30$  deg  
 Pitch Limit:  $\pm 01$  deg

**INSTALLATION CONSIDERATIONS**

Not available.

**PRINCIPAL COMPONENTS AND PHYSICAL DATA**

COMPONENT	QTY	HEIGHT (Inches)	WIDTH (Inches)	DEPTH (Inches)	UNIT WT. (Pounds)
Antenna Assembly NT-66AHQ	1	115	73	73	1790

**REFERENCE DATA AND LITERATURE**

Technical Manual:  
NAVSHIPS 95440

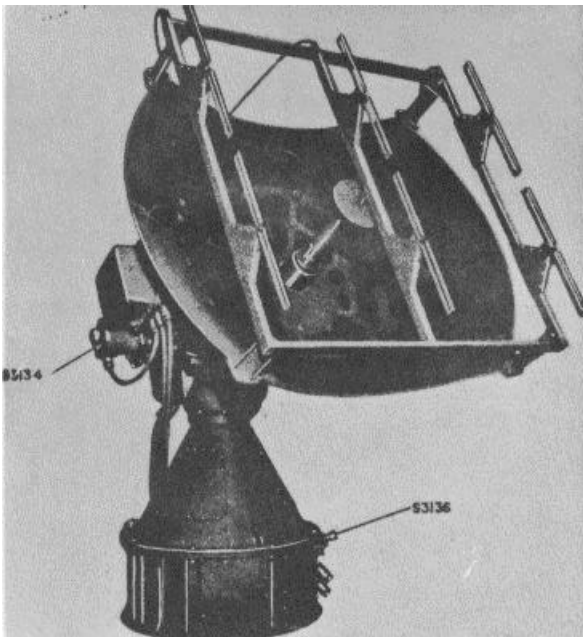

APPENDIX A

EXPLANATION OF THE JOINT ELECTRONICS  
TYPE DESIGNATION SYSTEM (JETDS)

The JOINT ELECTRONICS TYPE DESIGNATION SYSTEM (JETDS), and its procedures, are mandatory for use in type designating of all electronic material as defined in MIL-STD-196B. The military department may use this system for allied classes of material where such usage is in accordance with standard DEPARTMENT OF DEFENSE procedures.

The System is explained and illustrated by the following chart.

THE JOINT ELECTRONICS TYPE DESIGNATION SYSTEM (JETDS)

TABLE OF UNIT (COMPONENT) INDICATORS

COMP. IND	FAMILY NAME	EXAMPLES OF USE (Not to be construed as limiting the application of the unit indicator)
AB	Supports, antenna .....	Antenna mounts, mast bases, mast sections, towers, etc.
AM	Amplifiers.....	Power, audio, interphone radio frequency, video, electronic control, etc.
AS	Antennae, simple and complex.....	Arrays, parabolic type, masthead, whip or telescopic loop, dipole, reflector, etc.
*AT	Antennae, simple.....	For new assignments use AS
BA	Battery, primary type .....	B batteries, battery packs, etc.
BB	Battery, secondary type .....	Storage batteries, battery packs, etc.
BZ	Signal devices, audible .....	Buzzers, gongs, horns, etc.
C	Controls .....	Control box, remote tuning control, etc.
CA	Commutator assemblies, sonar .....	Peculiar to sonar equipment.
CB	Capacitor bank.....	Used as a power supply.
CG	Cable assemblies, RF .....	RF cables, waveguides, transmission lines, etc., with terminals.
CH	Chassis, drawer, door.....	A framework designed to accept plug-in modules. May include circuitry and/or receptacles. Does not include the plug-in module(s). It is not a storage facility or blank chassis.
.CK	Crystal kits .....	A kit of crystals with holders.
CM	Comparators .....	Compares two or more input signals.
CN	Compensators.....	Electrical and/or mechanical compensating regulating or attenuating apparatus.
CP	Computers .....	A mechanical and/or electronic mathematical calculating device.
CR	Crystals.....	Crystal in crystal holder.
CU	Couplers .....	Impedance coupling devices, directional couplers, etc.
CV	Converters (electronic) .....	Electronic apparatus for changing the phase, frequency, or from "one" medium to "another".
CW	Covers .....	Cover, bag, roll, cap, radome, nacelle, etc.
CX	Cable Assemblies, nonRF .....	NonRF cables with terminals, test leads, also composite cables of RF and nonRF conductors.
CY	Cases and cabinets .....	Rigid and semirigid structure for enclosing or carrying equipment.
D	Dispensers .....	Chaff, leaflet, flare, napalm, bomblet, etc.
DA	Load, dummy .....	RF and nonRF test loads.
DT	Detecting heads .....	Magnetic pickup device, search coil, hydrophone, etc., (see RF).
DY	Dynamotors .....	Dynamotor power supply.
E	Hoists.....	Sonar hoist assembly, etc.
F	Filters.....	Band-pass, noise, telephone, wave traps, etc.



## TABLE OF UNIT (COMPONENT) INDICATORS (cont'd)

COMP. IND	FAMILY NAME	EXAMPLES OF USE
FN	Furniture .....	Chairs, desks, tables, etc.
FR	Frequency measuring device .....	Frequency meters, tuned cavity, etc.
G	Generators, power.....	Electrical power generators without prime movers, (see PU & PD).
GO	Goniometers .....	Goniometers of all types.
GP	Ground rods .....	Ground rods, stakes, etc.
H	Head, hand, and chest sets .....	Includes earphone.
HC	Crystal holder.....	Crystal holder less crystal.
HD	Environmental apparatus.....	Heating, cooling, dehumidifying, pressure, vacuum devices, etc.
ID	Indicators, noncathode-ray tube.....	Calibrated dials and meters, indicating lights, etc., (see IP).
IL	Insulators .....	Strain, standoff, feed-through, etc.
IM	Intensity measuring devices.....	Includes SWR gear, field intensity and noise meters slotted lines, etc.
IP	Indicators, cathode ray tube .....	Azimuth, elevation, panoramic, etc.
J	Junction devices.....	Junction, jack and terminal boxes, etc.
KY	Keying devices .....	Mechanical, electrical and electronic keyers, coders, interrupters, etc.
LC	Tools, line construction.....	Includes special apparatus such as cable plows, etc.
LS	Loudspeakers.....	Separately housed loudspeakers, inter-communication station.
M	Microphones.....	Radio, telephone, throat, hand, etc.
MA	Magazines.....	Magnetic tape or wire, etc.
MD	Modulators, demodulators, discrimators .....	Device for varying amplitude, frequency or phase.
ME	Meters.....	Multimeters, volt-ohm-milliammeters, vacuum tube voltmeters, power meters, etc.
MF	Magnets or magnetic field generators .....	Magnetic tape or wire eraser, electromagnet, permanent magnet, etc.
MK	Miscellaneous kits .....	Maintenance, modification, etc., except tool and crystal, (see CK, TX).
ML	Meteorological devices .....	Barometer, hygrometer, thermometer, scales, etc.
MT	Mountings .....	Mountings, racks, frames, stands, etc.
MX	Miscellaneous .....	Equipment not otherwise classified, includes subassemblies. Do not use if better indicators available.
MU	Memory units .....	Memory units.
O	Oscillators.....	Master frequency, blocking, multibrators, etc. (for test oscillators, see SG).
OA	Operating assemblies.....	Assembly of operating units not otherwise covered, used with or part of one set or set series.
OC	Oceanographic devices .....	Bathythermographs, etc.
OS	Oscilloscope, test .....	Test Oscilloscopes for general test purposes.
PD	Prime Drivers. ....	Gasoline engines, electric motors, synchros, diesel motors, etc.
PF	Fittings, pole .....	Cable hanger, clamp, protectors, etc.
PG	Pigeon articles.....	Container, loft, vest, etc.
*PH	Photographic articles.....	Camera, projector, sensitometer, etc.
PL	Plug-in modules .....	Plug-in modules not otherwise classified. Do not use if more specific indicators, such as AM, R, T, apply.
PP	Power supplies.....	Nonrotating machine type such as vibrator pack rectifier, thermoelectric, etc.
PT	Plotting equipments.....	Except meteorological, Boards, maps, transparent maps, plotting table, etc.

## TABLE OF UNIT (COMPONENT) INDICATORS (cont'd)

COMP. IND	FAMILY NAME	EXAMPLES OF USE
PU	Power equipments.....	Rotating power equipment except dynamotors, motor-generator, etc.
R	Receivers.....	Receivers, all types except telephone.
RC	Reels.....	All types, (see RL).
RD	Recorder-reproducers.....	Sound, graphic, tape, wire, film, disc, facsimile, magnetic, mechanical, etc.
RE	Relay assemblies.....	Electrical, electronic, etc.
RF	Radio Frequency component.....	Composite component of RF circuits. Do not use if better indicator is available.
RG	Cables, RF, Bulk.....	RF cable, waveguides, transmission lines, etc. without terminals.
RL	Reeling machines.....	Mechanisms for dispensing and rewinding antenna or field wire, recording wire or tape etc.
RO	Recorders.....	Sound, graphic, tape, wire, film, disc, facsimile, magnetic, mechanical, etc.
RP	Reproducers.....	Sound, graphic, tape, wire, film, disc, facsimile, magnetic, mechanical, etc.
RR	Reflectors.....	Target, confusion, etc. Except antenna reflectors, (see AS).
RT	Receiver and transmitter.....	Radio and radar transceivers, composite transmitter and receiver, etc.
S	Shelters.....	House, tent, protective shelter, etc.
SA	Switching devices.....	Manual, impact, motor driven, pressure operated, etc.
SB	Switchboards.....	Telephone, fire control, power, panel, etc.
SG	Generators, signal.....	Test oscillators, noise generators, etc., (see O).
SM	Simulators.....	Flight, aircraft, target, signal, etc.
SN	Synchronizers.....	Equipment to coordinate two or more functions.
ST	Straps.....	Harness, straps, etc.
SU	Optical device.....	Telescopes, periscopes, projectors, and bore-sighting scopes.
T	Transmitters.....	Transmitters, all types, except telephone.
TA	Telephone apparatus.....	Miscellaneous telephone equipment
TB	Towed body.....	Towed underwater body or fish, paravance, etc.
TC	Towed cable.....	Articulated towing strut, faired cable, etc.
TD	Timing devices.....	Mechanical and electronic timing devices, range device, multiplexers, electronic gates, etc.
TF	Transformers.....	Transformers when used as separate items.
TG	Positioning device;.....	Tilt and/or train assemblies.
TH	Telegraph apparatus.....	Miscellaneous telegraph apparatus.
TK	Tool kits.....	Miscellaneous tool assemblies.
TL	Tools.....	All types except line construction (see LC).
TN	Tuning units.....	Receiver, Transmitter, antenna, tuning units, etc
TR	Transducers.....	Magnetic heads, phonopickups, sonar transducers, vibration pickups, etc., (see H, LS, and M).
TS	Test items.....	Test and measuring equipment not otherwise included; boresighting and alignment equipment.
TT	Teletypewriter and facsimile apparatus.....	Miscellaneous tape, teletype, facsimile equipment, etc.
TV	Tester, tube.....	Electronic tube tester.
TW	Tapes and recording wires.....	Recording tape and wire, splicing, electrical insulating tape, etc.
U	Connectors, audio and power.....	Unions, plugs, sockets, adapters, etc.

**TABLE OF UNIT (COMPONENT) INDICATORS (cont'd)**

COMP. IND	FAMILY NAME	EXAMPLES OF USE
UG	Connectors, RF .....	Unions, plugs, sockets, choke couplings, adapters, elbows, flanges, etc.
V	Vehicles .....	Carts, dollies, trucks, trailers, etc.
VS	Signaling equipment, visual .....	Flag sets, serial panels, signal lamp equipment.
WD	Cables, two conductor .....	NonRF wire, cable and cordage in bulk (see RG).
WF	Cables, four conductor .....	NonRF wire, cable and cordage in bulk (see RG).
WM	Cables, multiple conductor .....	NonRF wire, cable and cordage in bulk (see RG).
WS	Cables, single conductor .....	NonRF wire, cable and cordage in bulk (see RG).
WT	Cables, three conductor .....	NonRF wire, cable and cordage in bulk (see RG).
ZM	Impedance measuring devices .....	Used for measuring Q, C, L, R, or PF, etc.

**NOTE: \*Not for U.S. use except for assigning modification letters to previously type designated items.**

**TABLE OF EQUIPMENT INDICATOR LETTERS**

INSTALLATION	TYPE OF	EQUIPMENT PURPOSE
A - Piloted aircraft	A - Invisible light, heat radiation	A - Auxiliary assemblies (not complete operating sets used with or part of two or more sets or sets series).
B - Underwater mobile, submarine	B - Pigeon (do not use)	B - Bombing
C - Air transportable (inactivated, do not use)	C - Carrier	C - Communications (receiving)
D - Pilotless carrier	D - Radiac	D - Direction finder, reconnaissance, and/or surveillance
F - Fixed ground	E - Nupac	G - Fire-control, or searchlight directing
G - General ground use	*F - Photographic and transmitting)	H - Recording and/or reproducing (graphic meteorological and sound)
K - Amphibious address	G - Telegraph or teletype	K - Computing
M - Ground, mobile	I - Interphone and public	L - Searchlight control (inactivated, use G)
P - Portable	E - Ejection and/or release	M - Maintenance and/or test assemblies (including tools)
S - Water surface	J - Electromechanical or Inertial wire covered	N - Navigational aids (including altimeters, beacons, compasses, racons, depth, sounding approach, and landing)
T - Ground, transportable	K - Telemetry	P - Reproducing (inactivated, use light H)
U - General utility	L - Countermeasures	Q - Special, or combination of purposes
V - Ground, Vehicular	M - Meteorological	R - Receiving, passive detecting
W - Water surface and underwater combination	N - Sound in air	S - Detecting and/or range and bearing, search
	P - Radar	T - Transmitting
	Q - Sonar and underwater sound	W - Automatic flight or remote control
	R - Radio	X - Identification and recognition
	S - Special types, magnetic, etc, or combinations of types	
	T - Telephone (wire)	
	V - Visual and visible	
	W - Armament (peculiar to armament, not otherwise covered)	
	X - Facsimile or television	
	Y - Data processing	

**NOTE: \*Not for U.S. use except for assigning modification letters to previously type designated items.**

**EXAMPLES OF JETDS TYPE NUMBERS****TYPE NUMBER INDICATES**

AN/SRC-3( ).....	General reference set nomenclature for water surface radio communication set No. 3
AN/SRC-3.....	Original procurement set nomenclature applied against
AN/SRC-3A.....	Modification set nomenclature applied against AN/SRC-3.
AN/APQ-13-T1( ).....	General reference training set nomenclature for the AN/APQ-13 set
A/APQ-13-T1.....	Original procurement training set nomenclature applied against AN/APQ-13-T1( ).
AN/APQ-13-TIA.....	Modification training set nomenclature applied against AN/APQ-13-T1.
AN/UPT-T3( ).....	General reference training set nomenclature for general utility radar transmitting training set No. 3.
AN/UPT-T3.....	Original procurement training set nomenclature applied against AN/UPT-T3( ).
AN/UPT-T3A.....	Modification training set nomenclature applied against AN/UPT-T3.
T-51( )/ARQ-8.....	General reference component nomenclature for transmitter No. 51, part of or used with airborne radio special set No. 8.
T-51/AIRQ-8.....	Original procurement component nomenclature applied against T-51( )/ARQ-8.
T-51A/ARQ-8.....	Modification component nomenclature applied against T-51/ARQ-8.
RD-31( )/U.....	General reference component nomenclature for recorder-reproducer No. 31 for general utility use, not part of a specific set.
RD-31/U.....	Original procurement component nomenclature applied against RD-31( )/U.
RD-31A/U.....	Modification component nomenclature applied against RD-31/U.

**NOTES**

1. This chart was formerly titled **SUMMARY OF 3OINT NOMENCLATURE SYSTEM ("AN" SYSTEM) FOR COMMUNICATION-ELECTRONIC EQUIPMENT.**

2. The system indicator "AN" does not mean that the Army, Navy, and Air Force use the equipment but simply that the type number was assigned in the JETDS System.

3. In the JETDS nomenclature system, nomenclature consists of a name followed by a type number. The type number will consist of indicator letters shown on this chart and an assigned number.

4. The type number of an independent major unit not part of or used with a specific set will consist of a component indicator, a number, the slant and such of the set or equipment indicator letters as apply. Example: SB-5/PT would be the type number of a portable telephone switchboard for independent use.

5. Requests for nomenclature assignments will be submitted on the Department of Defense Form DD-1 and prepared in accordance with the item names and description patterns promulgated by the office of the Assistant Secretary of Defense (Supply and Logistics).

**MODIFICATION LETTERS**

Component modification suffix letters will be assigned for each modification of a component when detail parts and subassemblies used therein are no longer interchangeable, but the component itself is interchangeable physically, electrically, and mechanically.

**MODIFICATION LETTERS (cont' d)**

Set modification letters will be assigned for each modification not affecting interchangeability of the sets or equipment as a whole, except that in some special cases they will be assigned to indicate functional interchangeability and not necessarily complete electrical and mechanical interchangeability. Modification letters will only be assigned if the frequency coverage of the unmodified equipment is maintained.

The suffix letters X, Y, and Z will be used only to designate a set or equipment modified by changing the power input voltage, phase or frequency. X will indicate the first change, Y the second, Z the third, XX the fourth etc., and these letters will be in addition to other modification letters applicable. (For examples see MIL-STD-196B).

**ADDITIONAL INDICATORS**

Experimental Sets. In order to identify a set or equipment of an experimental nature with the development organization concerned, the following indicators will be used with the parenthesis:

- XA - RTD/ASD, Wright-Patterson Air Force Base, Ohio.
- XB - Naval Research Laboratory, Washington, D.C.
- XC - U.S. Army Signal Engineering Laboratories, The Hexagon, Fort Monmouth, N.J. (inactivated, use XE).
- XD - Electronic Systems Division, Laurence G. Hanscom Field, Bedford, Massachusetts.
- XE - U.S. Army Electronics Laboratories, Fort Monmouth, N.J.
- XF - Frankford Arsenal, Philadelphia, Pa.
- XG - U.S.N. Electronics Laboratory, San Diego, California.
- \*XH - Aerial Reconnaissance Laboratory, Wright-Patterson Air Force Base, Ohio.
- XI - Det 4, RTD, Eglin Air Force Base, Florida.
- XJ - Naval Air Development Center, Johnsville, Pa.
- \*XK - Flight Control Laboratory, Wright-Patterson Air Force Base, Ohio
- XL - U.S. Army Signal Electronics Research Unit, Mountain View, Calif.
- XM - U.S. Army Signal Engineering Laboratories, The Hexagon, Fort Monmouth, N.J. (inactivated, use XE)
- XN - Department of the Navy, Washington, D.C.
- XO - U.S. Army Missile Command, Redstone Arsenal, Alabama.
- XP - Canadian Department of National Defense, Ottawa, Canada.
- \*XQ - Aeronautical Accessories Laboratory, Wright-Patterson Air Force Base, Ohio.
- XR - National Security Agency, Fort George G. Meade, Maryland.
- \*XS - Electronic Components Laboratory, Wright-Patterson Air Force Base, Ohio.
- XT - U.S. Army Security Agency, Arlington Hall Station, Arlington, Va.
- XU - U.S. No Underwater Sound Laboratory, Fort Trumbell, New London, Conn.
- XV - Air Force Weapons Laboratory, Kirtland Air Force Base, New Mexico.
- XW - Rome Air Development Center, Rome, New York
- \*XY - Weapons Guidance Laboratory, Wright-Patterson Air Force Base, Ohio.
- XZ - U.S.N. Bureau of Naval Weapons Activities.
- XAA - Air Force Ballistic Systems Division, Norton Air Force Base, Calif.
- XAE - U.S. Army Electronics Research and Development Activity, Fort Huachuca, Arizona.
- XAN - Naval Avionics Facility, Indianapolis, Ind.
- XBB - U.S. Army Electronics Command, Proc and Prod Dir., Fort Monmouth, N.J.
- XCC - Air Force Missile Test Center, Patrick Air Force Base, Florida.
- XDD - U.S. Army Signal Air Defense Engineering Agency, Fort George G. Meade, Maryland.
- XLW - U.S. Army Limited War Laboratory, Aberdeen Proving Ground, Maryland.
- XPM - U.S. Army, Project Michigan, Ypsilanti, Michigan.

**NOTE: \*Not for Air Force use except for assigning additional developmental designations to previously type designated items. Use XA for all new equipments.**

**ADDITIONAL INDICATORS (cont'd)**

Example. Radio Set AN/ARC-3( ) might be assigned for a new airborne radio communication set under development. The cognizant development organization might then assign AN/ARC-3 (XA-1), AN/ARC-3(XA-2), etc., type numbers to the various sets developed for test. When the set was considered satisfactory for use, the experimental indicator would be dropped and procurement nomenclature AN/ARC-3 would be officially assigned thereto.

Training Sets. A set or equipment designed for training purposes will be assigned type numbers as follows:

1. A set to train for a specific basic set will be assigned the basic set type number followed by a dash, the letter T, and a number. Example: Radio Training Set AN/ARC6A-T1 would be the first training set for Radio Set AN/ARC-6A.

2. A set to train for general types of sets will be assigned the usual set indicator letters followed by a dash, the letter T, and a number. Example: Radio Training Set AN/ARC-T1 would be the first training set for general airborne radio communications sets.

Parenthesis Indicator. A nomenclature assignment with parenthesis, ( ) following the basic type number is made to identify an article generally, when a need exists for a more general identification than that provided by nomenclature assigned to specific designs of the article. Examples: AN/GRC-5( ), AM-6( )/GRC-5, SB-9( )/GG. A specific design is identified by the plain basic type number, the basic type number with a suffix letter, or the basic type number with an experimental symbol in parenthesis. Examples: AN/GRC-5, AN/GRC5A, AN/GRC-5(XC-1), AM-6B/GRC-5, SB-9(XE-3)/GG. The letter V within the parenthesis is used to identify systems with varying parts list.

**NOMENCLATURE POLICY  
(See MILSTD-196B for Statement of Policies)**

1. JETDS type designation shall be assigned to:
  - (a) Complete systems, subsystems, centrals, sets, groups, units (components), and subassemblies of military design either definitive or variable in configuration.
  - (b) Material of either commercial or military design, which are grouped for a military purpose.
  - (c) Electronic materiel of military design which are part of, or used with, an end item not identified in the JETDS.
  - (d) Commercial materiel requiring military identification for use by the U. S. Government.
  - (e) Electronic materiel of military design which are not part of, or used with, a set.
2. JETDS type designation will not be assigned to:
  - (a) Materiel cataloged commercially, except in accordance with commercial materiel requiring military identification for use by the U. S. Government.
  - (b) Parts such as capacitors, electron tubes, and resistors, except if required to facilitate military identification.
  - (c) Materiel having other identification in coordinated (joint) military specifications or type designation systems.

**NOMENCLATURE POLICY (cont'd)**

3. Nomenclature assignments will remain unchanged regardless of later changes in installation and/or applications.

4. All officially assigned JETDS nomenclatures shall be unclassified in order to provide a ready means of identification, in correspondence and other means of communication, in the clear.

**Important. - All personnel are cautioned against originating or changing any part of any nomenclature assignment, including modification letters, without authorization.**

**EXPLANATION OF THE SIGNAL CORPS NOMENCLATURE SYSTEM**

Signal Corps Nomenclature consists of a name and a type number. Example: Radio Receiver BC-301-A. The prefix letters, such as "BC" in the above example, designate classes of equipment as shown in the following list. The suffix letters, such as "A" in the above example, designate different versions or models of similar equipments.

In some cases, a nomenclature assignment with parenthesis, ( ), following the basic type number is made to identify an article generally, when a need exists for a more general identification than that provided by nomenclature assigned to specific designs of the article. Example: Radio Transmitter BC-325-( ).

**LIST OF PREFIX LETTERS USED WITH TYPE NUMBERS**

A .....	Phantom antennas.
AH.....	Guy anchors.
AL.....	Aerial communication.
AN.....	Antenna aeriels. Made up of a definite length of antenna wire having the ends prepared for attaching to masts or other supports.
AP .....	Aerial communication panel sets.
AR.....	Lightning arresters.
BA .....	Primary batteries, wet and dry.
BB .....	Storage batteries, lead and Edison.
BC.....	Radio receivers, radio transmitters, control boxes, etc.
BD.....	Power boards, switchboards, and panels for electrical control.
BE .....	Starting boxes, apparatus boxes, cabinets, outlet boxes and the like with electrical internal components (other than radio boxes).
BG.....	Bags, carrying cases, empty tool rolls, tool cases, and fabric covers.
BK.....	Circuit breakers and relays (other than telegraph).
BL.....	Connecting blocks.
BR.....	Brushes, motor and generator.
BX .....	Boxes, smaller than chests.
BZ .....	Buzzers.
C .....	Induction coils, transformers (other than power transformers - See TF) linking and coupling coils.
CA.....	Capacitors, variable and fixed.
CB.....	Cording sets and cording equipments (usually they are not part of radio sets).
CC (1 to 49).....	Telephone switchboard transmitter and receiver cords.

## LIST OF PREFIX LETTERS USED WITH TYPE NUMBERS (cont'd)

CC (50 to 99) .....	Telephone switchboard connecting cords, but not including plugs.
CC (100 to 299) .....	Telephone cords for fixed telephone equipment.
CC (300 to 399) .....	Cords for telephone equipment of tactical organization.
CD .....	Electrical extension cords complete with plugs, etc., all kinds of complete connection cords.
CE .....	Pack animal equipments
CF .....	Telephone and telegraph carrier equipment.
CH .....	Chests and boxes larger than "BX" boxes.
CN .....	Contacts, contact points and screws but does not include plugs.
CO .....	Electrical extension cords without plugs (other than telephone cords) or cordage.
CP .....	Counterpoise made up of definite lengths of wire with ends prepared for connecting to radio sets.
CS .....	Carry cases.
CT .....	Conduit.
DC .....	Crystals and crystal units.
DM .....	Dynamotors.
DR .....	Spools for wire and reels which are the equivalent of spools but are larger than 16 inches in diameter.
E .....	Radio compasses, binoculars.
EE .....	Electrical engineering sets and equipments, including telephones, telegraph outfits, signal lamp sets, etc., when no other classification is appropriate.
F .....	Fairleads.
FL .....	Filters.
FM .....	Frames, supporting.
FT .....	Fittings, clamps, mountings, or other accessories adapted to fastening detachable apparatus to a frame, support, or other apparatus.
FU .....	Fuses.
FX .....	Facsimile transceivers.
GA .....	Spark gaps.
GC .....	Hand cranks for generators, reels, etc.
GE .....	Gasoline engines.
GN .....	Generators other than motor-generators.
GP .....	Ground pins, ground rods, etc. (A device driven into the ground which serves as an electrical connection.)
GR .....	Ground ranging, sound ranging, and flash ranging sets.
GS .....	Generator stands.
GY .....	Guys.
HB .....	Headbands.
HK .....	Hooks.
HM .....	Hammers.
HO .....	Shelters.
HS .....	Headsets.
HY .....	Hydrometers.
I .....	Instruments both electrical, as ammeters, voltmeters, etc., and mechanical, as clocks, compasses, etc. (usually portable).
IC .....	Insulating compounds.
IE .....	Instrument equipments.
IF .....	Electrical instruments, front-of-board or surface type.
IN .....	Insulators.
IS .....	Electrical instruments, flush or mounted in the board.
IW .....	Telephone accessories for interior wiring.
J .....	Transmitting keys.
JB .....	Jack boxes.
JK .....	Jacks, receptacles for plugs.
JM .....	Jack mountings and outlets.
K .....	Carts, trucks, trailers, and other vehicles.
KE .....	Mobile radio equipments.
KN .....	Knives.



## LIST OF PREFIX LETTERS USED WITH TYPE NUMBERS (cont'd)

LC .....	Telephone line construction tools and apparatus.
LG .....	Legs.
LM .....	Lamps and bulbs, illuminating.
LP .....	Loops.
LS .....	Loudspeakers.
M .....	Miscellaneous.
MA .....	Masts, radio complete but does not include antenna wires or counterpoise.
MC .....	Same as "M" except usually larger or more complicated. An "MC" might contain an "M".
ME .....	Maintenance and other miscellaneous equipments.
MG .....	Motor-generator.
ML .....	Meteorological apparatus.
MM .....	Miscellaneous mechanical repair parts.
MO .....	Motors.
MP .....	Mast plates and caps.
MS .....	Mast sections.
MT .....	Ground mats.
OC .....	Oil cans and oil-can equipments.
P .....	Headsets.
PA .....	Public address equipment.
PD .....	Protectors.
PE .....	Power Units, dynamotor units, etc.
PF .....	Pole fittings, including all small parts used in pole-line construction.
PG .....	Pigeon articles.
PH .....	Photographic articles.
PL .....	Plugs.
PN .....	Panels for mounting on relay racks or frames.
PO .....	Poles and pike poles.
R .....	Telephone receivers. A single receiver without headband assembly as differentiated from headset or handset.
RA .....	Rectifiers.
RC .....	Accessory equipments for use with radio sets, to extend their utility.
RL .....	Reel mechanisms to rotate spools or reels which are the equivalent of spools except of larger diameter.
RM .....	Remote control units.
RP .....	Rope and nonelectrical cord.
RS .....	Resistors.
RU .....	Cooling system.
SCM .....	Meteorological sets and equipment.
SCR .....	Radio sets and other complete assemblages.
SCS .....	Extensive communication systems.
SE .....	Signal equipments or sets.
SG .....	Shafts and gears including worms and pinions.
SO .....	Sockets, plug, and radio tube.
ST .....	Straps, carrying, etc.
SW .....	Switches.
SY .....	Stationary sets.
T .....	Telephone transmitters and microphones. Single transmitter without assembly in breastplate or other unit.
TC .....	Telephone or telegraph control office sets.
TD .....	Chest sets.
TE .....	Tool equipments and tool sets.
TF .....	Transformers, power.
TG .....	Telegraph instruments.
TL .....	Tools.
TM .....	Terminals, terminal lugs, connectors, binding posts, etc.
TP .....	Telephones, desk sets, etc.
TR .....	Towers.

**LIST OF PREFIX LETTERS USED WITH TYPE NUMBERS (cont'd)**

TS .....	Handsets, including transmitter, receiver, and appropriate mounting, but not including apparatus box, etc.
TU .....	Transmitter tuning units.
VA .....	Variometers.
VB .....	Vibrators.
VO .....	Oscillators.
VT .....	Radio tubes
W .....	Wire.
WC (1 to 200).....	Submarine cables.
WC (201 to 300).....	Rubber-insulated subterranean cables.
WC (301 to 400).....	Paper-insulated armored cables.
WC (401 to 500).....	Paper-insulated unarmored cables.
WC (501 to 600).....	Special types of cables.
WC (601 to 700).....	Power cables.
WRS.....	Wire Repair Stations - Field.
WT .....	Weights (for antenna or other purposes).

**EXPLANATION OF THE NAVY TYPE DESIGNATION SYSTEM**

Navy type designations are assigned to denote major units and also to most component parts likely to require replacement during the normal life of the equipment involved. There are two systems of type designations the Numerical System of Navy Type Designations, and the Alphabetical System of Navy Type Designations.

The Numerical System. In the numerical system the designation is composed of a Navy type number (e.g. 21426), a group of prefix letters to indicate the manufacturer of the item (e.g. CZZ) and when necessary, a suffix letter. The prefix letters and the Navy type number are separated by a dash to form the complete Navy type designation (e.g. CZZ-21426). Once prefix letters are assigned to a manufacturer the same designating letters remain the permanent identification of the company and shall precede the Navy type numbers of all material manufactured by him. Preliminary models of major units are identified by a special description consisting of the Navy type number assigned for the corresponding unit of the production equipment prefixed by the letter 'X' i.e., CRV-X52041. The numerical portion of the Navy type designation is assigned in order of receipt of request, the last three or four numbers being the order, the first two being the "class". The significance of the first two digits in each type number is shown in the table below.

The suffix letter is assigned to differentiate units of improved or different manufacture which are entirely interchangeable as units but, due to difference in construction, are not necessarily interchangeable with respect to their integral parts. The suffix letter is separated from the numerical portion by a dash. For example:

1. Navy Type -61046-A insulator is identical to 61046 except the glaze is changed from white to chocolate color.
2. Navy Type -21426-A motor-generator set is identical to -21426 except that steel has replaced cast-iron throughout.

The Alphabetical System. The alphabetical system, which is used for units peculiar to radar equipments and special apparatus, is analogous to the numerical system except the last three or four numbers of the numerical portion are replaced with alphabetical letters starting with AAA and progressing alphabetically; such as, AAA, AAB, AAC --- AAZ, ABA, ABB -- etc. Also, the suffix letter is replaced by a suffix number; the first modification being indicated by the number "1", etc. A few examples of this system are CZZ-21AAA, CRV-46ABK, CRV-66ACY, CRV-66ACY-1, etc. The fundamental principles governing the application of both systems of Navy type designations are the same.

## EXPLANATION OF THE NAVY TYPE DESIGNATION SYSTEM (cont'd)

Class No.	Material
10	Miscellaneous: To be used when a definite class is not available.
14	Special RF Devices (Not covered by any other classification). (Electronic switching, etc.)
18	Prime Movers and Accessories: All types except electrical.
19	Batteries: All types; parts and accessories.
20	Rectifier Power Units - Voltage Regulators - Copper Oxide Rectifiers: All types. A20 crystal detectors.
21	Motors - Generators - Synamotors - Motor Generators - Rotary Converters, etc. Motor controllers.
22	Instruments - Electrical Indicating and Recording.
23	Control Panels and Control Units. (Except motor controllers).
24	Switches: Manually operated.
25	Shields and Shielding Mater1A1: Finishes.
26	Keys - Telegraph: Manually operated.
28	Protective Devices: Static types.
29	Electromagnetic Contact Devices: All types.
30	Transformers and Reactors: Power and audio.
35	Oscillators - Complete Units (Audio or RF).
36	Ranging Equipment - Radio (Localizer, rotating beacons, etc.)
38	Vacuum Tubes - Photo - Electric Cells: AUI types.
40	Piezo - Electric Crystals and Holders - Thermometers and Thermostats.
41	Compensators - Underwater Sound.
43	Transmitter - Receiver Units (Combined): Equipment in which the transmitter and receiver are not separable as units.
46	Receiver Units and Converters (RF to IF, etc) - Radio and Sound.
47	RF Transformers - Inductors - Chokes.
48	Capacitors: All types.
49	Head Telephones - Telephone Cords - Patch Cords - Loudspeakers - Plugs - Jacks - Sockets - Receptacles: All types.
50	Amplifier, Modulator and Coupler Units - Electronic Converters - Mixing Panels: All types (Complete duplex and duplex units.) See 14 for electronic switching.
51	Microphones - Hydrophones - Underwater Sound Electrical Pickup Devices - Combination Handsets: All types.
52	Radio Transmitter Units: includes RF drivers for underwater sound equipment, etc.
53	Filter Units: All electrical types.
54	Sound Receiving Devices - Acoustical.
55	Indicators and Recorders: Radio, radar and underwater sound. (Indicating instruments under class 22.)
56	Wave Propagation.
59	Television - Photo - Radio.
60	Test Equipment (Integral instruments under Class 22.) A60 Training Equipment (Operator trainers and instruction devices.)
61	Insulators and Insulating Mater1A1: Phenolic and ceramic.
62	Wires and Conductors - Junction Boxes. A62 RF Transmission lines and RF cables, etc.
63	Resistors: All types.
64	Static Recorders and Eliminators.
65	Remote Control Systems by Wire: Repeater systems, etc.
66	Antennas - Antenna Assemblies. (Dummy and phantom antennas.)
67	Automatic Systems, Facsimile, Tele-Automatic: Automatic keyers and recorders.
68	Secrecy Systems: Sending and receiving. (Speech scrambling.)
69	Direction Finding Equipment: Radio.
70	Distance Finding: A70 Radio Altimeters.
72	Portable Equipment - Field Sets.
73	Combined Gas Engine Generator Sets.
74	Precision Calibration and Measuring Equipment.
75	Standards: (Including standardization notices, etc).
78	HF Underwater Sound Projector (above 10 kc) and supporting parts.

**EXPLANATION OF THE NAVY TYPE DESIGNATION SYSTEM (cont'd)**

<b>Class No.</b>	<b>Material</b>
79	LF Underwater Sound Projector (10 kc or below).
83	Frequency Control Systems.
84	Control by Radio.
85	Interference Reduction.
87	Experimental Superfrequency Equipment.
88	Instrument Landing Equipments.
89	Radio Recognition and Identification Devices.
90	Visual Signalling Apparatus (This classification for type number assignments only).

**EXPLANATION OF THE NAVY MODEL LETTER SYSTEM**

Items in the Navy Model Letter System are designated by two or three basic letters - sometimes supplemented by prefix or suffix letters and/or numerals.

Equipments identical in all respects and purchased from the same contractor bear the same model designation. Additional equipment obtained for service use by additional purchase is designated by a numeral following the original model letters. For example, on subsequent orders for the Model TAQ transmitting equipment, the equipment is identified by the designations TAQ-1, TAQ-2, etc. Additionally, if after acceptance by the Navy Department, the Bureau of Ships authorizes a modification of the equipment, a lower case alteration letter is assigned to follow the model letters. For example, if a Model TAB-1 transmitter is modified after delivery by the addition of a harmonic suppressing circuit or unit, the model designation would be changed to a TAB-1A. An additional modification of the TAB-1a or a modification of the TAB-1 differing from the "a" modification, would be indicated by "b" and the equipment designated known as TAB-1b.

Equipments of an experimental nature are assigned model letters beginning with "X" if manufactured by a Naval organization (e.g., XA, XB, etc.), or with "CX" if manufactured by a commercial company (e.g., CXA, CXB, CXAA, CXAB, etc.)

Preliminary models of equipments, subsequently to become the property of the Navy, as required by the terms of a contract or similar authorization are given an "X" prefix letter, separated from the basic designation by a dash. The preliminary (test) model of "Model TBU" was therefore designated 'Model X-TBU.' The Navy Model Letter series is shown in the following table.

**NAVY MODEL LETTER SYSTEM**

<b>Model Letter Series</b>	<b>Model Subseries</b>	<b>Type Equipment</b>	<b>Remarks</b>
		Airborne Radio and Radar Equipment	All new assignments to Airborne Equipments shall be in the "AN" (Army-Navy) Nomenclature System
A -----	----- AB----- -- AI----- AM----- ----- AR----- - AS----- -- AT----- AY----- -	Airborne IFF Airborne Radar Intercept Airborne Radio Transmitting and Receiving. Airborne Radio Receiving. Airborne Search Radar. Airborne Radio Transmitting. Airborne Radar Altimeters.	
B -----	-----	Ship-Shore IFF Equipment.	
C -----	CX -----	All Commercial Experimental Equipment.	
D -----	----- -----	Ship-Shore Radio and Radar Direction Finding Equipment.	

NAVY MODEL LETTER SYSTEM (cont'd)

Model Letter Series	Model Subseries	Type Equipment	Remarks
-----	DX-----	Assembled Direction Finder Equipments----	DF assemblies which when used with a standard receiver form a complete DF equipment.
E-----	-----	Emergency Power Equipment-----	Gasoline or Diesel Engine Generator Sets.
F-----	-----	Radar Fire Control Equipment-----	"F" Series superseded by the BUORD RADAR MARK-MOD-Series.
	-----	-----	Subseries of "F" Series in use for other than Fire Control Radar.
	FP-----	Facsimile Recording Equipment -----	
	FQ-----	Facsimile Scanning Equipment -----	
	FR-----	Frequency Shift Receiver Converter Equipment-----	
G-----	FS-----	Frequency Shift Keying Equipment-Airborne Radio Transmitting Equipment	Classification cancelled- Reassigned "AT" Series.
H-----	-----	Hoist Train Mechanism-----	Canceled - Hoist Train Mechanism considered as part of an equipment.
I-----	-----	Intercept Radar- -----	
J-----	-----	Sonar-Sound Listening (Receiving)	
L-----	-----	Precision Calibrating Equipment-----	
M-----	-----	Radio Transmitting and Receiving Equipment	
Radar----- Equip. Mark-- Mod--	-----	Radar Fire Control Equipment-----	
N-----	-----	Sonar Echo Sounding	
	NA-----	Sonar Beacon.	
	NG-----	Echo Sounding (Rochelle Salt).	
	NK-----	Portable Echo Sounding Recording.	
	NJ-----	Lightweight Echo Sounding Recording.	
	NM-----	Echo Sounding (Magnetostriction).	
O-----	-----	Measuring, Test and Operator Trainer Equipments for Models OA to OCZ inclusive. For Models OCZ, on the subseries breakdown is as follows:	
	OE-----	Xmtr and/or Rec. Analyzers. Vacuum Tube Voltmeters. Volt-Ohm-Milliammeters. Multimeters.	
	OF-----	Echo Boxes, Wavemeters, Frequency Meters (Non-Precision).	

NAVY MODEL LETTER SYSTEM (cont'd)

Model Letter Series	Model Subseries	Type Equipment	Remarks
	OG----- -----	Signal Generators (Non-Precision), Test Oscillators.	
	OK-----	Sonar Computers.	
	OM-----	Test Monitor Equipment.	
	OP-----	Signal and Sound Wave Measuring Equipment, Noise Meters.	
	OS-----	Oscilloscopes.	
	OT-----	Radar Operator Trainers.	
	OV-----	Vacuum Tube Analyzers or Testers.	
	OW-----	Sonar Test Equipment.	
	OZ-----	Impedance Measuring Equipment.	
P -----	-----	Automatic Transmitting and Receiving Equipment Coding Equipment.	
Q -----	-----	Sonar Echo-Ranging-Listening Equipments: E/R/L (Quartz). E/R/L (Rochelle Salt). E/R (Magnetostriction) with L (Rochelle Salt).	
	QD-----	Depth Determining Equipment.	
	QF-----	Teacher & Training Equipment	
	QG-----	Console Version of "QC" Series.	
	QJ-----	Console Version of "QB" Series.	
	QK-----	Scanning Sonar-Crystal.	
	QL-----	Frequency Modulated Sonar.	
	QX-----	Auxiliary Equipments to Echo Ranging Gear.	
R -----	-----	Radio Receiving Equipment-----	Panoramic Radio Adapters were in- cluded in this class up through Model REZ.
	RP-----	Panoramic Radio Adapters-----	
S -----	-----	Search Radar Equipment.	
T -----	-----	Radio Transmitting Equipment:	
	TP-----	Power Amplifiers.	
U -----	-----	Remote Control:	
	UX-----	Mobile Remote Control.	
V -----	-----	Visual - PPI Repeaters.	
W -----	-----	Sonar - Combined Ranging and Sounding:	
	WA-----	Combined Sounding-Ranging (Magnetostriction).	
	WB-----	Combined Sounding-Ranging (Rochelle Salt).	
	WC-----	Combined Sounding-Ranging (R/S Sounding) (M/S & R/S Ranging and Listening).	
	WD-----	Combined Sounding-Ranging (R/S -- Sounding) (M/S & R/S Ranging and Listening).	
	WE-----	Combined Lightweight M/S Echo --- Ranging with sounding feature removed.	
	WF-----	Combined Ranging-Sounding- --- Listening (Sonic & Supersonic --- Listening using ADP crystals).	

## NAVY MODEL LETTER SYSTEM (cont'd)

Model Letter Series	Model Subseries	Type Equipment	Remarks
X -----	-----	Experimental (Navy Designed).	
Y -----	-----	Navigation and Landing Equipment: (Other than Direction Finders). (Beacons).	
Z -----	-----	Airborne Navigation and Landing. -----	Classification canceled - Reassigned "AY" Series.

**APPENDIX B  
GLOSSARY OF ABBREVIATIONS**

**A**

ac..... alternating current  
AEW ..... Aircraft Early Warning  
af ..... audio frequency  
arc ..... automatic frequency control  
agc..... automatic gain control  
Alt Std..... Alternate Standard  
AM ..... Amplitude Modulation  
amp ..... ampere(s)  
amp hr ..... ampere-hour(s)  
ant ..... antenna  
approx..... approximately  
assy ..... assembly  
ASW ..... Anti-Submarine Warfare  
aux..... auxiliary  
avg..... average  
avc..... automatic volume control  
AWG ..... American Wire Gage

**B**

bfo ..... beat-frequency oscillator  
BuAer..... Bureau of Aeronautics  
BuOrd ..... Bureau of Ordnance  
BuShips ..... Bureau of Ships  
BuWeaps ..... Bureau of Weapons

**C**

C..... Centigrade  
c to c..... center to center  
cap..... capacity  
CB ..... Common Battery  
ccw ..... counterclockwise  
cem..... cubic feet per minute  
cm..... centimeters  
Co..... Company  
c/o..... Consists of  
coml..... commercial  
Corp..... Corporation  
cp..... candlepower  
cpm..... cycles per minute  
cps..... cycles per second  
cu ft..... cubic foot (feet)  
CRT ..... Cathode-Ray Tube  
cu in..... cubic inch(es)  
cur ..... current  
cyc ..... cycle(s)  
cw ..... continuous wave, clockwise

**D**

db ..... decibel(s)  
dbm ..... decibels referred to 1 milliwatt  
dbw ..... decibels referred to 1 watt  
dc..... direct current  
deg..... degrees (angular)  
devt..... development  
DF..... Direction Finder (Finding)  
dia..... diameter

**E**

ea ..... each  
eff ..... efficiency  
eg ..... for example  
ehf ..... extremely high frequency  
elec..... electric(al)  
emf ..... electromotive force  
equip..... equipment  
exp..... experimental  
ext..... external  
est..... estimate

**F**

f ..... farad(s)  
F ..... Fahrenheit  
fax ..... facsimile  
Fed ..... Federal  
fig ..... figure(s)  
FM ..... Frequency Modulation  
fpm ..... feet per minute  
fps..... feet per second  
freq ..... frequency (frequencies)  
fsk ..... frequency-shift keying  
ft ..... foot (feet)  
ft lb ..... foot pounds  
FTC ..... fast time constant

**G**

g ..... gravity  
gal..... gallon  
GCA..... Ground-Controlled Approach  
GGI o ..... Ground-Controlled Interception  
gen..... generator  
grd ..... ground (electric)  
gph..... gallons per hour  
gpi..... ground position indicator  
gpm ..... gallons per minute  
gps..... gallons per second

**H**

h ..... altitude  
hf ..... high frequency  
Hg..... Mercury  
horiz..... horizontal  
hp ..... horsepower  
hr ..... hour(s)

**I**

icw ..... interrupted continuous wave  
IF ..... Intermediate Frequency  
IFF ..... Identification, Friend or Foe  
ILS ..... Instrument Landing System  
in..... inch(es)  
Inc..... Incorporated  
incl ..... inclusive (including)  
instl ..... install (installation)



GLOSSARY OF ABBREVIATIONS (Contd)

**J**  
JAN..... Joint Army-Navy  
jct..... junction

**K**  
kc..... kilocycles  
km..... kilometer(s)  
kv..... kilovolts  
kva..... kilovolt-ampere(s)  
kw..... kilowatt(s)  
kwh..... kilowatt-hour(s)

**L**  
lb..... pound(s)  
lg..... length, long  
lf..... low frequency  
Loran..... Long-range navigation  
Ltd Std..... Limited Standard

**M**  
m..... meter(s)  
ma..... milliamperes(s)  
MarC..... Marine Corps  
max..... maximum  
mb..... millibar(s)  
mc..... megacycle(s)  
mcw..... modulated continuous wave  
mego..... megohm(s)  
megw..... megawatts  
mf..... medium frequency  
Mfg..... Manufacturing  
mfr..... manufacture(r)  
mi..... mile(s)  
mike..... microphone  
min..... minimum  
MLI..... Main Lobe Indicator  
mm..... milliammeter  
mo..... month(s)  
mod..... modified; modification  
mph..... miles per hour  
ms..... millisecond  
MTI..... Moving-Target Indicator  
mv..... millivolt(s)  
mw..... milliwatt(s)

**N**  
neg..... negative  
nom..... nominal  
norm..... normal  
NA..... Not Applicable  
naut..... nautical  
nav..... navigation (navigational)  
Nav Aid..... Navigational Aid  
nag..... negative  
No..... number  
NT..... Navy Type

**O**  
obs..... obsolete

obsoles..... obsolescent  
opm..... operations per minute  
opp..... opposite  
osc..... oscillator

**P**  
p..... page  
pc..... piece(s)  
pct (%).)..... percent  
pf..... power factor  
ph..... phase  
PM..... Pulse Modulation  
P/N..... Part Number  
p/o..... part of  
porm (+)..... ps or Minus  
pos..... positive  
PPI..... Plan Position Indicator  
pps..... pulses per second  
pr..... pair(s)  
press..... pressure  
pr..... pulse repetition rate  
p std..... planned standard  
pt..... pint(s)  
prf..... pulse repetition frequency

**Q**  
qt..... quart(s)  
qty..... quantity

**R**  
RDF..... Radio Direction Finder (Finding)  
rcvr..... receiver(s)  
ref..... refer (reference)  
rag..... regulate (regulated)  
req..... require (required)  
rf..... radio frequency  
RHI..... Range Height Indicator  
rms..... root mean square  
rpm..... revolutions per minute  
rps..... revolutions per second  
RSI..... Raid Size Indicator  
RSRU..... Raid Size Remote Unit

**S**  
sec..... second(s)  
sect..... section(s)  
shf..... super-high frequency  
Shora..... Short-range navigation  
SIF..... Selective Identification Feature  
SigC..... Signal Corps  
Spec..... Specification  
spkr..... speaker  
sq..... square  
sta..... station(s)  
Std..... Standard  
sub..... substitute  
sub std..... substitute standard  
sw..... switch  
swbd..... switchboard  
swr..... standing wave ratio

**GLOSSARY OF ABBREVIATIONS (Cont'd)**

sync ..... synchronize (synchronizer)  
sys ..... system(s)

**T**

tech ..... technical  
temp ..... temperature  
Tent. Std ..... Tentative Standard  
term ..... terminal  
TM ..... Technical Manual  
T.O ..... Technical Order  
TR ..... Transmit-Receive  
TRF ..... Tuned Radio Frequency

**U**

uhf ..... ultra-high frequency  
USAF ..... United States Air Force  
usec ..... microsecond(s)  
uuf ..... micro-microsecond(s)  
USN ..... United States Navy  
uv ..... microvolt(s)  
u/w ..... used with

**V**

v ..... volt(s)

V ..... Velocity  
va ..... volt-ampere(s)  
var ..... variable  
vert ..... vertical  
vf ..... voice frequency  
vfo ..... variable frequency oscillator  
vhf ..... very high frequency  
viz ..... namely  
vol ..... volume  
VSWR ..... Voltage Standing Wave Ratio  
vu ..... volume unit

**W**

w ..... watts  
whr ..... watt-hour(s)  
wpm ..... words per minute  
w-s ..... with spares  
wt ..... weight

**Y**

yd ..... yard(s)  
yr ..... year(s)

INDEX OF ITEMS BY NAME

Nomenclature	Vol	Sect.	Pages
<b>A</b>			
Aircraft Alarm System, AN/FPS-23 .....	2	1	AN/FPS-23: 1-3
Aircraft Approach Control Central, AN/SPN-35.....	1	3	AN/SPN-35: 1-4
Aircraft Guidance Central			
AN/MSN-1 .....	1	1	AN/MSN-1: 1-2
AN/MSN-2 .....	1	1	AN/MSN-2: 1-2
Aircraft Radar Equipment			
AN/APA-17, -17A, -17B.....	1	2	AN/APA-17: 1-2
AN/APS-2G .....	1	2	AN/APS-2G: 1-3
AN/APS-3 .....	1	2	AN/APS-3: 1-2
AN/APS-4A.....	1	2	AN/APS-4A: 1-3
AN/APS-6 .....	1	2	AN/APS-6: 1-2
AN/APS-15A, -15B.....	1	2	AN/APS-15A: 1-4
ASA.....	1	2	ASA: 1-3
ASB-5 .....	1	2	ASB-5: 1-2
ASB-6, -7 .....	1	2	ASB-6: 1-3
ASC, ASC-1.....	1	2	ASC: 1-2
Air Traffic Control Group			
AN/SPA-13(XN-1).....	2	3	AN/SPA-13(XN-1): 1-2
AN/SPA-13(XN-2).....	2	3	AN/SPA-13(XN-2): 1-2
Air Traffic Display Group, AN/FSA-29(XN-1).....	1	1	AN/FSA-29(XN-1): 1-2
Amplifier Assembly, AM-518/SSA .....	1	3	AM-518/SSA: 1-2
Amplifier-Indicator Group, AN/GPA-26 .....	1	1	AN/GPA-26: 1-3
Analog To Digital Converter, CV-1054(XN-1)/SPS-32.....	2	3	CV-1054(XN-1)/SPS-32: 1-2
Antenna			
AN/SPA-54 .....	1	3	AN/SPA-54: 1-2
AS-501/SPN .....	1	3	AS-501/SPN: 1-2
AS-766(XN-1)/FP .....	2	3	AS-766(XN-1)/FP: 1-2
AS-767(XN-1)/W.P .....	2	3	AS-767(XN-1)/WP: 1-1
AS-1065/UPX .....	1	1	AS-1065/UPX: 1-2
AS-1161/SPS .....	1	3	AS-1161/SPS: 1-2
AS-1288/BPX.....	1	3	AS-1288/BPX: 1-2
AT-309/GPX, AT-309A/GPX, AT-309B/GPX, AT-309C/GPX .....	1	1	AT-309/GPX: 1-3
AT-1090/B .....	1	3	AT-1090/B: 1-2
Antenna Assembly			
AS-45A/APR-6.....	1	3	AS-45A/APR-6: 1-2
AS-177/UPX, AS-177A/UPX.....	1	3	AS-177/UPX: 1-2
AS-177(XN-21)/UPX.....	1	3	AS-177(XN-21)/UPX: 1-2
AS-295/UP, AS-295A/UP, AS-295B/UP .....	1	1	AS-295/UP: 1-2
AS-468/B, AS-522/BPX, AS-522A/BPX, AS-522B/BPX, AS-523/BPX, AS-524/BPX, AS-525/BPX, AS-535/B.....	2	3	AS-468/B: 1-3
AS-523B/BPX .....	1	3	AS-523B/BPX: 1-2
AS-606/U .....	2	1	AS-606/U: 1-2
AS-1201/BPX.....	1	3	AS-1201/BPX: 1-2
66ACG .....	1	3	66ACG: 1-2
66AHQ .....	1	3	66AHQ: 1-1
Antenna Group			
AN/APA-137 .....	1	2	AN/APA-137: 1-2
AN/BPA-2 .....	2	3	AN/BPA-2: 1-2
AN/BPA-2(XN-1).....	2	3	AN/BPA-2(XN-1): 1-2
AN/BPA-4 .....	1	3	AN/BPA-4: 1-4
AN/BPA-5 .....	1	3	AN/BPA-5: 1-2
AN/BPA-6 .....	2	3	AN/BPA-6: 1-3
AN/GPA-8.....	1	1	AN/GPA-8: 1-2
AN/SPA-21(XN-1).....	1	3	AN/SPA-21(XN-1): 1-3
AN/SPA-45 .....	1	3	AN/SPA-45: 1-2
AN/SPA-45A.....	1	3	AN/SPA-45A: 1-2
AN/SPA-45B.....	1	3	AN/SPA-45B: 1-2
AN/UPA-22, AN/UPA-23. AN/UPA-23A.....	1	3	AN/UPA-22: 1-2

Nomenclature	Vol	Sect.	Pages
OA-493/APS-20.....	1	2	OA-493/APS-20: 1-2
OA-1124/FPS.....	1	1	OA-1124/FPS: 1-3
Antenna Pedestal Group, AN/UPA-43.....	1	3	AN/UPA-43: 1-2
Antenna Stabilizing Group, OA-1375/APS-62.....	1	2	OA-1375/APS-62: 1-2
Attenuator Assembly			
AN/APA-22.....	1	2	AN/APA-22: 1-2
AN/APA-26.....	1	2	AN/APA-26: 1-2
Azimuth Range Indicator			
IP-199(XN-1)/SP.....	2	3	IP-199(XN-1)/SP: 1-2
IP-281/UP.....	1	3	IP-281/UP: 1-2
IP-281A/UP.....	1	3	IP-281A/UP: 1-2
IP-281B/UP.....	1	3	IP-281B/UP: 1-2
Azimuth Stabilization Assembly, AN/APA-14.....	1	2	AN/APA-14: 1-2
<b>B</b>			
Beacon Transmitter Receiver, AN/TPN-3.....	1	1	AN/TPN-3: 1-2
Bearing Amplifier Converter, SOACU.....	1	3	50ACU: 1-2
Bomb Director Set			
AN/ASB-1.....	2	2	AN/ASB-1: 1-3
AN/ASB-1A.....	2	2	AN/ASB-1A: 1-3
<b>C</b>			
Central Computer Display Set, AN/FSA-43.....	1	1	AN/FSA-43: 1-2
Close Cooperation Set, AN/MPQ-2A.....	1	1	AN/MPQ-2A: 1-3
Close Support Control Set			
AN/MSQ-1.....	1	1	AN/MSQ-1: 1-3
AN/MSQ-1A.....	1	1	AN/MSQ-1A: 1-2
AN/MSQ-2.....	1	1	AN/MSQ-2: 1-3
Coder-Decoder Group			
AN/GPA-T8.....	1	1	AN/GPA-78: 1-2
AN/GPA-97.....	1	1	AN/GPA-97: 1-2
AN/TPX-25.....			AN/TPX-25: 1-2
Coder Monitor Group, AN/WPA-2.....	2	3	AN/WPA-2: 1-2
Combat Control Central, AN/FSQ-8.....	1	1	AN/FSQ-8: 1-3
Command Control Console, AN/WPA-1.....	2	3	AN/WPA-i: 1-2
Computer, Ti8.....	2	1	Ti8: 1-2
Computer Assembly, AN/APA-30.....	1	2	AN/APA-30: 1-2
Computer Indicator Group, AN/TPA-5.....	2	1	AN/TPA-5: 1-3
Computer Recorder Group AN/SPA-14(XN-1).....	1	3	AN/SPA-14(XN-1): 1-2
Computer Tracking, AN/TPA-2.....	2	1	AN/TPA-2: 1-2
Control Group, OA-1162/TXQ-1.....	2	1	OA-1162/TXQ-1: 1-2
Control Indicator			
C-191B(XN-1)/SPS-18.....	2	3	C-1918(XN-1)/SPS-18: 1-2
C-3039/SPS-BA.....	1	3	C-3039/SPS-8A: 1-2
Control Indicator Group, AN/SPA-55(XN-i).....	1	3	AN/SPA-55(XN-1): 1-2
Control Monitor Group			
AN/FPA-1(XN-1).....	1	1	AN/FPA-1(XN-1): 1-2
AN/FSA-4.....	1	1	AN/FSA-4: 1-2
AN/FSA-4A.....	1	1	AN/FSA-4A: 1-2
Control Monitor Set, AN/FSW-1.....	1	1	AN/FSW-1: 1-2
Coordinate Data Monitor			
OA-947/FPS-1.....	1	1	OA-947/FPS-1: 1-2
OA-1163/FST.....	1	1	OA-1163/FST: 1-2
Coordinate Data Transmitter			
OA-682/GPA-29, OA-6B2A/GPA-29.....	1	1	OA-682/GPA-29: 1-2
Coordinate Data Transmitting Set			
AN/FST-1.....	1	1	AN/FST-1: 1-2
AN/FST-2, -2A, -2B.....	1	1	AN/FST-2: 1-4
Correlator Indicator, SN-148/SPA.....	1	3	SN-148/SPA: 1-2
Countermeasures Control Console, OA-i892/FPS.....	2	1	OA-1B92/FPS: 1-2
Countermeasures Set, AN/TLQ-11.....	2	1	AN/TLQ-11: 1-2
Countermeasures Signals Similar Group, AN/GPA-98.....	1	1	AN/GPA-98: 1-2
Course Data Computer Generator, CP-87/U.....	1	3	CP-87/U: 1-2

Nomenclature	Vol	Sept.	Pages
<b>D</b>			
Data Distribution Group, AN/SSA-7 .....	2	3	AN/SSA-7: 1-3
Data Processing Group, AN/GPA-88.....	1	1	AN/GPA-88: 1-2
Data Switching Group			
OA-266/SSA, OA-266A/SSA, OA-266B/SSA .....	1	3	OA-266/SSA: 1-2
OA-496/SSA.....	1	3	OA-496/SSA: 1-2
Dead Reckoning Tracer, AN/ASA-14.....	1	2	AN/ASA-14: 1-2
Decoder Group			
AN/GPA-60, -60A .....	1	1	AN/GPA-60: 1-2
AN/GPA-64.....	1	1	AN/GPA-64: 1-3
AN/TPA-3 .....	1	1	AN/TPA-3: 1-1
AN/UPA-24 .....	1	3	AN/UPA-24: 1-2
AN/UPA-24A.....	1	3	AN/UPA-24A: 1-3
AN/UPA-24B.....	1	3	AN/UPA-24B: 1-2
AN/UPA-49(XN-1) .....	1	3	AN/UPA-49(XN-1): 1-3
AN/UPA-50(XN-1) .....	1	3	AN/UPA-49(XN-1): 1-3
OA-3369/APX-7.....	1	2	OA-3369/APX-7: 1-2
Delay Line Set, AM-1796/FPS.....	1	1	AM-1796/FPS: 1i-2
Destination Preset Computer Group, OA-i213/wPQ .....	2	3	OA-1213/WPQ: 1-2
Detecting Set, AN/ASQ-8.....	1	2	AN/ASQ-8: 1-4
Digital to Digital Converter, CV-105S(XN-i)/SPS-33 .....	2	3	CV-105S(XN-1)/SPS-33: 1-2
Direction Data Converter			
PU-155/SP PU-155A/SP, PU-155B/SP, PU-155(XN-1)/SP.....	1	3	PU-155/SP: 1-3
Direction Finder, CXGH .....	1	1	CXGH: 1-3
Direction Finder Group			
AN/APA-69 .....	2	2	AN/APA-69: 1-3
AN/APA-69A.....	2	2	AN/APA-69A: 1-3
AN/APA-69C.....	2	2	AN/APA-69C: 1-3
Directional Antenna Assembly			
AN/UPA-3 .....	2	3	AN/UPA-3: 1-3
AN/UPA-4 .....	1	3	AN/UPA-4: 1-2
AN/UPA-6.....	2	3	AN/UPA-3: 1-3
Displacement Gyroscope, CN-611/APS-80A.....	1	2	CN-611/APS-80A: 1-2
Display Plotting Board Group			
AN/GPA-29.....	1	1	AN/GPA-29: 1-2
AN/GPA-29A .....	1	1	AN/GPA-29A: 1-2
AN/GSA-12.....	1	1	AN/GSA-12: 1-2
AN/SPA-39(XN-1).....	2	3	AN/SPA-39(XN-1): 1-2
Doppler Drift Attachment, AN/APA-52A.....	1	2	AN/APA-52A: 1-2
<b>E</b>			
Electrical Synchronizer Group			
AN/SPA-20 .....	2	3	AN/SPA-28: 1-2
AN/SPA-28A.....	2	3	AN/SPA-28A: 1-2
Electronic Altimeter Set			
AN/APN-42A.....	1	2	AN/APN-42A: 1-2
AN/APN-133.....	1	2	AN/APN-133: 1-2
AN/APN-141 .....	1	2	AN/APN-141: 1-2
AN/APN-141A.....	1	2	AN/APN-141A: 1-2
AN/APN-150(V).....	1	2	AN/APN150(V): 1-2
Electronic Control Amplifier			
AM-316/U, AM-317/U .....	1	3	AM-316/U: 1-2
AM-420/U, AM-421/U .....	1	3	AM-420/U: 1-2
AM-1600/APN.....	1	2	AM-1600/APN: 1-2
AM-1600A/APN .....	1	2	AM-1600A/APN: 1-2
AM-2209/AJA-3 .....	1	2	AM-2209/AJA-3: 1-2
AM-2370/APN-129 .....	1	2	AM-2370/APN-129: 1-2
Electronic Gate, TD-94/GPX.....	1	1	TD-94/GPX: 1-2
Electronic Mapping Group, AN/GPA-5.....	1	1	AN/GPA-5: 1-2
Electronic Reconnaissance Set, AN/APR-7.....	2	2	AN/APR-17: 1-3

Nomenclature	Vol	Sect.	Pages
<b>F</b>			
Flight Control Group			
AN/GKA-1 .....	2	1	AN/GKA-1: 1-2
AN/GKA-4 .....	2	1	AN/GKA-4: 1-2
Frequency Converter, CV-95A/U .....	1	3	CV-95A/U: 1-2
<b>G</b>			
Ground Position Indicator			
AN/APA-44A .....	1	2	AN/APA-44A: 1-3
AN/APA-57 .....	1	2	AN/APA-57: 1-2
<b>H</b>			
Height Range Data Converter, CV-601/FPS-6A .....	1	1	CV-601/FPS-6A: 1-2
Homing Equipment, AN/APA-48 .....	1	2	AN/APA-48: 1-2
IFF Coordinator Range Indicator, 55AHP-1 .....	1	3	55AHP-1: 1-2
Indicator Adapter			
MX-1339/UP .....	1	3	MX-1339/UP: 1-2
MX-1618/UP .....	1	3	M-1618/UP: 1-2
Indicator Assembly, AN/APA-56, -56A, -56B .....	1	2	AN/APA-56: 1-3
Indicator Control, C-2456/SP .....	1	3	C-2456/SP: 1-2
Indicator Control Group			
AN/SPA-26(V) .....	2	3	AN/SPA-26(V): 1-2
AN/SPA-26(XN-1) .....	2	3	AN/SPA-26(XN-1): 1-2
Indicator Correlator, SN-206/SP .....	1	3	SN-206/SP: 1-2
Indicator Equipment, AN/APA-5 .....	1	2	AN/APA-5: 1-2
Indicator Group			
AN/APA-81 .....	1	2	AN/APA-81: 1-2
AN/APA-82 .....	1	2	AN/APA-82: 1-3
AN/APA-90 .....	1	2	AN/APA-90: 1-2
AN/APA-113 .....	1	2	AN/APA-113: 1-2
AN/APA-125, -125A1 .....	1	2	AN/APA-125: 1-2
AN/APA-138(XN-3) .....	2	2	AN/APA-138(XN-3): 1-2
AN/GPA-118 .....	1	1	AN/GPA-118: 1-2
AN/SPA-8, -8A, -8B, AN/SPA-9 .....	1	3	AN/SPA-8: 1-3
AN/SPA-8C .....	1	3	AN/SPA-8C: 1-3
AN/SPA-9 .....	1	3	AN/SPA-8: 1-3
AN/SPA-12(XN-1) .....	2	3	AN/SPA-12(XN-1): 1-2
AN/SPA-18 .....	1	3	AN/SPA-18: 1-2
AN/SPA-23(XN-1) .....	1	3	AN/SPA-23(XN-1): 1-2
AN/SPA-25 .....	1	3	AN/SPA-25: 1-2
AN/SPA-25(XN-1) .....	1	3	AN/SPA-25(XN-1): 1-3
AN/SPA-31 .....	1	3	AN/SPA-31: 1-1
AN/SPA-31A .....	1	3	AN/SPA-31A: 1-2
AN/SPA-31(XN-1) .....	1	3	AN/SPA-31(XN-1): 1-2
AN/SPA-32 .....	1	3	AN/SPA-32: 1-1
AN/SPA-32(XN-1) .....	1	3	AN/SPA-32(XN-1): 1-3
AN/SPA-33 .....	1	3	AN/SPA-33: 1-3
AN/SPA-34 .....	1	3	AN/SPA-34: 1-2
AN/SPA-36 .....	1	3	AN/SPA-36: 1-2
AN/SPA-37 .....	1	3	AN/SPA-37: 1-2
AN/SPA-38 .....	1	3	AN/SPA-38: 1-2
AN/SPA-41(XN-) .....	2	3	AN/SPA-41(XN-1): 1-3
AN/SPA-50 .....	2	3	AN/SPA-50: 1-2
AN/SPA-51 .....	1	3	AN/SPA-51: 1-4
AN/UPA-T2 .....	1	1	AN/UPA-T2: 1-2
AN/UPA-25 .....	1	1	AN/UPA-25: 1-3
AN/UPA-26(XN-1) .....	1	1	AN/UPA-26(XN-1): 1-2
AN/UPA-35 .....	1	1	AN/UPA-35: 1-2
AN/UPA-45 .....	1	3	AN/UPA-45: 1-1
AN/UPA-48 .....	1	1	AN/UPA-48: 1-2

Nomenclature	Vol	Sect.	Pages
OA-1040/GPS.....	1	1	OA-1040/GPS: 1-2
Inflight Positioning Set, AN/APA-129:.....	2	2	AN/APA-129: 1-2
Intercept Tracking and Control Group			
AN/SPA-22.....	2	3	AN/SPA-22: 1-3
AN/S PA-43(XN-1).....	2	3	AN/SPA-43(XN-i): 1-3
Interconnecting Group, AN/GPA-45A.....	1	1	AN/GPA-45A: 1-2
Interference Blanker Group			
AN/GPA-28.....	1	1	AN/GPA-28: 1-2
AN/GPA-101.....	1	1	AN/GPA-101: 1-2
AN/GPX-27.....	1	1	AN/GPX-27: 1-3
Interrogation Set			
AN/UPX-9.....	1	3	AN/UPX-9: 1-1
AN/UPX-11.....	1	3	AN/UPX-11: 1-1
Interrogator Responder, BN, BN-1 BN-2.....	1	3	BN: 1-3
Interrogator Set			
AN/APX-26.....	1	2	AN/APX-26: 1-2
AN/APX-26B.....	1	2	AN/APX-26B: 1-2
AN/APX-28( ).....	1	2	AN/APX-28( ): 1-2
AN/APX-29A.....	1	2	AN/APX-29A: 1-2
AN/APX-49.....	1	2	AN/APX-49: 1-2
AN/GPX-8A.....	1	1	AN/GPX-8A: 1-3
AN/GPX-17A.....	1	1	AN/GPX-17A: 1-2
AN/GPX-18B.....	1	1	AN/GPX-18B: 1-2
AN/GPX-18C.....	1	1	AN/GPX-18C: 1-2
AN/GPX-20B.....	1	1	AN/GPX-20B: 1-2
AN/GPX-29(XN-1).....	1	1	AN/GPX-29(XN-1): 1-2
AN/GPX-30.....	1	1	AN/GPX-30: 1-2
AN/TPX-17, -17A.....	1	1	AN/TPX-17: 1-2
AN/TPX-17C.....	1	1	AN/TPX-17C: 1-3
AN/TPX-18A.....	1	1	AN/TPX-18A: 1-2
AN/TPX-19.....	2	1	AN/TPX-19: 1-3
AN/TPX-21.....	2	1	AN/TPX-21: 1-2
AN/TPX-22.....	2	1	AN/TPX-22: 1-2
AN/TPX-26.....	2	1	AN/TPX-26: 1-2
AN/TPX-27.....	2	1	AN/TPX-27: 1-2
AN/TPX-28.....	1	1	AN/TPX-28: 1-2
AN/UPX-14.....	2	1	AN/UPX-14: 1-3
AN/UPX-21.....	1	1	AN/UPX-21: 1-2
<b>L</b>			
Landing Control Central			
AN/MPN-13.....	1	1	AN/MPN-13: 1-4
AN/MPN-14.....	1	1	AN/MPN-14: 1-6
AN/MPN-15.....	1	1	AN/MPN-15: 1-4
AN/MPN-16.....	1	1	AN/MPN-16: 1-6
Landing Control Set AN/MPN-11A, -11B, -11C, -11D.....	1	1	AN/MPN-11A: 1-4
<b>M</b>			
Magnetic Detecting Set, AN/ASQ-10.....	1	2	AN/ASQ-10: 1-1
Marine Radar Equipment, MU.....	1	3	MU: 1-2
Master PPI, 55ADP.....	1	3	50ACU: 1-2
Missile Guidance and Tracking Set, AN/SPG-55.....	2	3	AN/SPG-55: 1-4
Missile Impact Predictor Set, AN/FSQ-28.....	1	1	AN/FSQ-28: 1-2
Missile Range Instrumentation Set			
AN/FPQ-6.....	1	1	AN/FPQ-6: 1-2
AN/S PQ-7.....	1	3	AN/SPQ-7: 1-2
AN/TPQ-18.....	1	1	AN/TPQ-18: 1-2
Moving Target Indicator Group, AN/GP A-7, -7A.....	1	1	AN/GPA-7: 1-2
Multiplexer, TD-285/FST.....	1	1	TD-285/FST: 1-2

Nomenclature	Vol	Sect.	Pages
<b>N</b>			
Navigational Computer			
CP-98(XN-1)/UPW .....	2	3	CP-98(XN-1)/UPW: 1-2
CP-98(XN-2)/UPW .....	2	3	CP-98(XN-1)/UPW: 1-2
CP-376A/APA-127.....	2	2	CP-376A/APA-127: 1-2
CP-376B/APA-127.....	2	2	CP-376B/APA-127: 1-2
CP-438/WP .....	2	3	CP-438/WP: 1-2
CP-450/UPW.....	2	3	CP-540-UPW: 1-2
Navigational Computer Group, AN/ASA-13.....	1	2	AN/ASA-13: 1-2
<b>O</b>			
Operations Central, AN/MSQ-16.....	1	1	AN/MSQ-16: 1-2
<b>P</b>			
Panoramic Data Receiving Set, AN/APR-14.....	2	2	AN/APR-14: 1-2
Performance Indicator Group, AN/SPA-27(XN-1).....	2	3	AN/SPA-27(XN-1): 1-2
Position Indicating Radar Beacon Set, AN/APN-136. 2.....	2	2	AN/APN-136: 1-2
Power Unit, PU-26A/U .....	1	1	PU-26A/U: 1-2
Pulse Analyzer Group, AN/APA-64 64A .....	1	2	AN/APA-64: 1-2
Pulse Trigger Generator, 0-329/SP.....	1	3	0-329/SP: 1-3
<b>R</b>			
Radar Beacon			
AN/APN-11 .....	1	2	AN/APN-11: 1-2
AN/APN-63 .....	1	2	AN/APN-63: 1-2
AN/CPN-6.....	1	1	AN/CPN-6: 1-3
AN/DPN-3A .....	1	2	AN/DPN-3A: 1-2
AN/DPN-17 .....	2	2	AN/DPN-17: 1-2
AN/DPN-17A .....	1	2	AN/DPN-17A: 1-2
AN/DPN-17B .....	1	2	AN/DPN-17B: 1-2
AN/DPN-25.....	1	2	AN/DPN-25: 1-2
AN/FPN-10(XN-1).....	1	1	AN/FPN-10(XN-1): 1-2
AN/FPN-13 .....	1	1	AN/FPN-13: 1-2
AN/MPN-, N/MPN-8 .....	1	1	AN/MPN-2: 1-3
AN/TPN-9(XN-1) .....	2	1	AN/TPN-9(XN-1): 1-2
AN/TPQ-7 .....	2	1	AN/TPQ-7: 1-2
AN/UPN-2.....	1	1	AN/UPN-2: 1-2
AN/UPN-3.....	1	1	AN/UPN-3: 1-2
AN/UPN-4.....	1	1	AN/UPN-4: 1-2
AN/UPN-7.....	1	3	AN/UPN-7: 1-2
Radar Beacon Equipment YQ.....	2	3	PO: 1-2
Radar Beacon Set, AN/PPN-16.....	1	1	AN/PPN-16: 1-2
Radar Blanking Receiver, CXKA.....	1	3	CXKA: 1-2
Radar Bomb Scoring Central			
AN/MSQ-35 .....	1	1	AN/MSQ-35: 1-6
AN/MSQ-39, -39A.....	1	1	AN/MSQ-39: 1-2
Radar Booster Amplifier Assembly, AN/APA-8 .....	1	2	AN/APA-8: 1-2
Radar Cloud Detecting Set, AN/TPQ-11.....	1	1	AN/TPQ-11: 1-2
Radar Compensating Assembly, AN/APA-16.....	1	2	AN/APA-16: 1-2
Radar Control Center, AN/FSA-41.1.....	1	1	AN/FSA-41: 1-2
Radar Course Directing Central			
AN/BPQ-1 .....	2	2	AN/BPQ-1: 1-3
AN/BPQ-1(XN-1, -2, -3).....	2	3	AN/BPQ-1(XN-1): 1-4
AN/BPQ-2 .....	2	3	AN/BPQ-2: 1-5
AN/MPQ-14, -14A.....	1	1	AN/MPQ-14: 1-3
AN/TPQ-10( .....	2	1	AN/TPQ-10( ): 1-3
Radar Course Directing Group			
AN/GPA-37 .....	2	1	AN/GPA-37: 1-4
AN/GPA-37(V) .....	2	1	AN/GPA-73(V): 1-2
AN/GSA-51 .....	1	1	AN/GSA-51: 1-2



Nomenclature	Vol	Sect.	Pages
Radar Data Distribution Group			
AN/GPA-106( )	1	1	AN/GPA-106( ) 1-2
AN/GPA-107(V)	1	1	AN/GPA-107(V): 1-2
Radar Data Distribution Set			
AN/FSA-40	1	1	AN/FSA-40: 1-2
AN/FSA-42	1	1	AN/FSA-42: 1-2
Radar Data Group, AN/SSA-B(XN-2), AN/SSA-i9(XN-2)	1	3	AN/SSA-1B(XN-2): 1-2
Radar Data Plotting Group, AN/SPA-15	2	3	AN/SPA-1: 1-2
Radar Data Relay Set, AN/TXQ-1	1	1	AN/TXQ-1: 1-4
Radar Distribution Switchboard			
23AFL	1	3	23AFL: 1-2
23AGU	1	3	23AGU: 1-2
Radar Equipment			
AN/APX-1	1	2	AN/APX-1: 1-2
CXBR-2	1	3	CXBR-1: 1-2
MK 12 MOD 1	1	3	MK 12 MOD 1: 1-2
MK 25 MOD 3	2	3	M 25 MOD 3: 1-2
M 35 MOD 2	2	3	MK 35 MOD 2: 1-2
SA, SA-1, SA-2, SA-3	1	3	SA: 1-2
SC	1	3	SC: 1-2
SC-2	1	3	SC-1: 1-2
SC-3	1	3	SC-3: 1-2
SC-4	1	3	SC-4: 1-2
SC-5	1	3	SC-5: 1-2
SD, SD-a, SD-2, -3, -4, -5	1	3	SD: 1-5
SF, SF-1	1	3	SF: 1-2
SG-a, -b, -c, -d, -1, -1b, -1c -1d, -2S, -2Sb	1	3	SG-a: 1-7
SG-3	1	3	SG-3:1-2
SG-6, SG-6B	1	3	SG-6: 1-3
SJ	1	3	SJ: 1-2
SJ-1	1	3	SJ-1-1:1-2
SK-1M	1	1	SK-1M: 1-3
SO, SOa, SO-1, -2, -3, -4, -5, -6, -8, -8a, -9, -10, -13	1	3	SO: 1-8
SO-7N	1	1	SO-7N: 1-3
SP, SP-2	1	3	SP: 1-3
SP-1M	1	1	SP-1M: 1-3
SR, SR-a, SR-b	1	3	SR: 1-2
SR-3, SR-3a, SR-3b, SR-3c	1	3	SR-3: 1-3
SR-6	1	3	SR-6: 1-2
SR-6a, SR-6b	1	3	SR-6a: 1-2
SS, SS-a, SS-1, SS-2	1	3	SS: 1-4
ST	1	3	ST: 1-3
ST-1	1	3	ST-1:1-1
SU, SU-1, SU-1A	1	3	SU: 1-4
SU-2	1	3	SU-2: 1-2
SV, SV-1	1	3	SV: 1-5
SV-3	2	3	SV-3: 1-5
SX	1	3	SX: 1-3
SX- Z	1	3	SX1: 1-3
Radar Identification Set			
AN/APX-6	1	2	AN/APX-6: 1-2
AN/GPX-6	1	1	AN/GPX-6: 1-2
AN/GPX-6A	1	1	AN/GPX-6A: 1-3
AN/GPX-7	1	1	AN/GPX-7: 1-2
AN/GPX-7A	1	1	AN/GPX-7A: 1-3
AN/GPX-8	1	1	AN/GPX-8: 1-3
AN/GPX-9, -9A, -9B	1	1	AN/GPX-9: 1-3
AN/MPX-7	1	1	AN/MPX-7: 1-2
AN/MPX-7A	1	1	AN/MPX-7A: 1-2
AN/UPX-5, -5A, -5B	1	3	AN/UPX-5: 1-2
Radar Indicating Equipment			
VC, VC-1	1	3	VC:1-2
VE, VE-1, VE-1 a	1	3	VE: 1-3
VF, VF-a, VF-1	1	3	VF: 1-2
VG, VG-1, VG-2	1	3	VG: 1-2
VG-3	1	3	VG-3: 1-2

Nomenclature	Vol	Sect.	Pages
Radar Indicator Assembly, AN/APA-11.....	1	2	AN/APA-11: 1-2
Radar Interconnecting Assembly, AN/UPA-16(XN-21), AN/UPA-20(XN-21).....	2	3	AN/UPA-16(XN-21): 1-2
Radar Meteorological Set			
AN/FPS-41(XN-1).....	1	1	AN/FPS-41(XN-1): 1-2
AN/FPS-77(V).....	1	1	AN/FPS-77(V): 1-2
Radar Monitoring Set			
AN/FSQ-53.....	1	1	AN/FSQ-53: 1-2
AN/FSQ-54.....	1	1	AN/FSQ-54: 1-
Radar Navigation Set			
AN/APN-82.....	1	2	AN/APN-82: 1-3
AN/APN-130.....	1	2	AN/APN-130: 1-2
AN/APN-153(V).....	1	2	AN/APN-153(V): 1-2
Radar Operator Training Equipment, OU.....	1	2	OU: 1-2
Radar Receiver			
R-223/SPR.....	1	3	R-223/SPR: 1-2
46ACJ.....	1	2	46ACJ: 1-1
46ACQ-1.....	1	3	46ACQ-1: 1-1
Radar Receiving Equipment			
AN/APR-2.....	1	2	AN/APR-2: 1-2
PO.....	2	3	PO: 1-2
Radar Receiving Set			
AN/APR-12.....	1	2	AN/APR-12: 1-1
AN/APR-13.....	2	2	AN/APR-13: 1-2
AN/APS-54.....	2	2	AN/APS-54: 1-2
AN/APS-54A.....	2	2	AN/APS-54A: 1-2
Radar Recognition Set			
AN/APX-7.....	1	2	AN/APX-7: 1-2
AN/UPX-1, -1A.....	1	3	AN/UPX-1: 1-3
AN/UPX-4.....	1	3	AN/UPX-4: 1-2
AN/UPX-6.....	1	1	AN/UPX-6: 1-2
AN/UPX-6X.....	1	1	AN/UPX-6X: 1-2
Radar Repeater Equipment			
VH.....	1	3	VH: 1-2
VJ, VJ-a, -b, -1.....	1	3	V3: 1-3
VK, VK-2, -3, -3a, -4, -4a -5.....	1	3	VK: 1-3
VL, VL-1.....	1	3	VL: 1-2
Radar Set			
AN/APG-30, -30A.....	1	2	AN/APG-30: 1-3
AN/APG-32A.....	1	2	AN/APG-32A: 1-2
AN/APG-41B.....	1	2	AN/APG-41B: 1-3
AN/APG-51.....	2	2	AN/APG-51: 1-3
AN/APG-51A.....	2	2	AN/APG-S1A: 1-3
AN/APG-51B, -51C.....	2	2	AN/APG-51B: 1-3
AN/APG-56.....	2	2	AN/APG-56: 1-3
AN/APN-1, -1B, -1X.....	1	2	AN/APN-1: 1-2
AN/APN-1A.....	1	2	AN/APN-1A: 1-2
AN/APN-12, -12A.....	1	2	AN/APN-12: 1-2
AN/APN-22.....	1	2	AN/APN-22: 1-2
AN/APN-59.....	1	2	AN/APN-59: 1-3
AN/APN-59B.....	1	2	AN/APN-59B: 1-2
AN/APN-81.....	1	2	AN/APN-81: 1-3
AN/APN-97.....	1	2	AN/APN-97: 1-2
AN/APN-99A.....	1	2	AN/APN-99A: 1-3
AN/APN-100.....	1	2	AN/APN-100: 1-1
AN/APN-102.....	1	2	AN/APN-102: 1-2
AN/APN-105.....	1	2	AN/APN-105: 1-2
AN/APN-107.....	1	2	AN/APN-107: 1-2
AN/APN-108.....	1	2	AN/APN-108: 1-3
AN/APN-117.....	1	2	AN/APN-117: 1-2
AN/APN-120.....	1	2	AN/APN-120: 1-2
AN/APN-122.....	1	2	AN/APN-122: 1-2
AN/APN-131.....	1	2	AN/APN-131: 1-2
AN/APN-144.....	1	2	AN/APN-144: 1-2
AN/APN-147.....	1	2	AN/APN-147: 1-2
AN/APQ-20.....	1	2	AN/APQ-20: 1-2

Nomenclature	Vol	Sect.	Pages
AN/APQ-23D	1	2	AN/APQ-23D: 1-3
AN/APQ-35, -35A	1	2	AN/APQ-35: 1-3
AN/APQ-35B	1	2	AN/APQ-35B: 1-2
AN/APQ-41	1	2	AN/APQ-41: 1-3
AN/APQ-50	2	2	AN/APQ-50: 1-2
AN/APQ-51	2	2	AN/APQ-51: 1-3
AN/APQ-72	2	2	AN/APQ-72: 1-3
AN/APQ-72(XN-2)	2	2	AN/APQ-72(XN-2): 1-3
AN/APQ-74(XN-1)	2	2	AN/APQ-74(XN-1): 1-3
AN/APQ-83	2	2	AN/APQ-83: 1-3
AN/APQ-86	2	2	AN/APQ-86: 1-3
AN/APQ-94	2	2	AN/APQ-94: 1-3
AN/APR-7	1	2	AN/APR-7: 1-2
AN/APR-9, -9A, -9B	2	2	AN/APR-9: 1-3
AN/APS-2	1	2	AN/APS-2: 1-2
AN/APS-19, -19A, -19B, -19C	1	2	AN/APS-19: 1-4
AN/APS-20A, -20C	1	2	AN/APS-20A: 1-4
AN/APS-20E	1	2	AN/APS-20E: 1-4
AN/APS-20F	1	2	AN/APS-20F: 1-2
AN/APS-23A	1	2	AN/APS-23A: 1-3
AN/APS-27	2	2	AN/APS-27: 1-3
AN/APS-30	1	2	AN/APS-30: 1-1
AN/APS-31, -31B	1	2	AN/APS-31: 1-3
AN/APS-31A	1	2	AN/APS-31A: 1-3
AN/APS-31C	2	2	AN/APS-31C: 1-2
AN/APS-33	1	2	AN/APS-33: 1-4
AN/APS-33A	1	2	AN/APS-33A: 1-4
AN/APS-33B	2	2	AN/APS-33B: 1-3
AN/APS-33C	1	2	AN/APS-33C: 1-4
AN/APS-33D	1	2	AN/APS-33D: 1-4
AN/A PS-33F	1	2	AN/APS-33F: 1-4
AN/APS-38, -38A	2	2	AN/APS-38: 1-5
AN/APS-42	1	2	AN/APS-42: 1-3
AN/APS-42A	1	2	AN/APS-42A: 1-2
AN/APS-42B	1	2	AN/APS-42B: 1-2
AN/APS-44, -44A	2	2	AN/APS-44: 1-4
AN/APS-45, -45A	1	2	AN/APS-45: 1-4
AN/APS-62	2	2	AN/APS-62: 1-3
AN/APS-63	2	2	AN/APS-63: 1-3
AN/APS-64	2	2	AN/APS-64: 1-3
AN/APS-66	2	2	AN/APS-66: 1-2
AN/APS-67	2	2	AN/APS-67: 1-3
AN/APS-69	1	2	AN/APS-69: 1-2
AN/APS-70	2	2	AN/APS-70: 1-2
AN/APS-80	1	2	AN/APS-80: 1-3
AN/APS-§8	1	2	AN/APS-88: 1-2
AN/APS-95	1	2	AN/APS-95: 1-3
AN/APW-11	2	2	AN/APW-11: 1-2
AN/BPS-1	2	3	AN/BPS-1: 1-3
AN/BPS-2	2	3	AN/BPS-2: 1-3
AN/BPS-2(XN-1)	2	3	AN/BPS-2(XN-1): 1-3
AN/BPS-3	2	3	AN/BPS-3: 1-2
AN/BPS-4	1	3	AN/BPS-4: 1-3
AN/BPS-5	1	3	AN/BPS-5: 1-4
AN/BPS-5A	1	3	AN/BPS-5A: 1-4
AN/BPS-9	1	3	AN/BPS-9: 1-4
AN/BPS-9A		3	AN/BPS-9A: 1-3
AN/BPS-9B	1	3	AN/BPS-9B: 1-4
AN/BPS-11	1	3	AN/BPS-11: 1-4
AN/BPS-11A	1	3	AN/BPS-11A: 1-4
AN/CPN-4, -4A, -4B	1	1	AN/CPN-4: 1-5
AN/CPN-18, -18A, -18C, -18D	1	1	AN/CPN-18: 1-3
AN/CPS-6B	1	1	AN/CPS-6B: 1-4
AN/CPS-9	1	1	AN/CPS-9: 1-3
AN/CPT-2	1	3	AN/CPT-2: 1-2
AN/FPN-1A	1	1	AN/FPN-1A: 1-5
AN/FPN-1(XN-2)	1	1	AN/FPN-1(XN-2): 1-6

Nomenclature	Vol	Sect.	Pages
AN/FPN-16.....	1	1	AN/FPN-16: 1-4
AN/FPN-28, -28A.....	1	1	AN/FPN-28: 1-8
AN/FPN-29(XN-1).....	1	1	AN/FPN-29(XN-1): 1-2
AN/FPN-47.....	1	1	AN/FPN-47: 1-3
AN/FPS-3, -3A.....	1	1	AN/FPS-3: 1-3
AN/FPS-4.....	1	1	AN/FPS-4: 1-3
AN/FPS-6.....	1	1	AN/FPS-6: 1-3
AN/FPS-6A.....	1	1	AN/FPS-6A: 1-3
AN/FPS-6B.....	1	1	AN/FPS-6B: 1-3
AN/FPS-7, -7A, -7B, -7C, -7D.....	2	1	AN/FPS-7: 1-5
AN/FPS-8.....	1	1	AN/FPS-8: 1-3
AN/FPS-10.....	1	1	AN/FPS-10: 1-3
AN/FPS-11.....	1	1	AN/FPS-14: 1-3
AN/FPS-16.....	1	1	AN/FPS-16: 1-7
AN/FPS-16(V).....	1	1	AN/FPS-16(V): 1-10
AN/FPS-17(V).....	2	1	AN/FPS-17(V): 1-2
AN/FPS-18, -18A.....	1	1	AN/FPS-18: 1-3
AN/FPS-19.....	1	1	AN/FPS-19: 1-2
AN/FPS-20.....	2	1	AN/FPS-20: 1-4
AN/FPS-20A.....	2	1	AN/FPS-20A: 1-4
AN/FPS-20B.....	2	1	AN/FPS-20B: 1-3
AN/FPS-24, -24A.....	2	1	AN/FPS-24: 1-6
AN/FPS-26, -26A.....	2	1	AN/FPS-26: 1-7
AN/FPS-27.....	2	1	AN/FPS-27: 1-7
AN/FPS-30.....	1	1	AN/FPS-30: 1-3
AN/FPS-35.....	2	1	AN/FPS-35: 1-8
AN/FPS-36.....	1	1	AN/FPS-36: 1-3
AN/FPS-37.....	1	1	AN/FPS-37: 1-2
AN/FPS-49.....	2	1	AN/FPS-49: 1-2
AN/FPS-49A.....	2	1	AN/FPS-49A: 1-2
AN/FPS-50(V).....	2	1	AN/FPS-50(V): 1-3
AN/FPS-64, -64A.....	2	1	AN/FPS-64: 1-3
AN/FPS-65, -65A.....	2	1	AN/FPS-65: 1-3
AN/FPS-66, -66A.....	2	1	AN/FPS-66: 1-3
AN/FPS-67.....	2	1	AN/FPS-67: 1-3
AN/FPS-67A, -67B.....	2	1	AN/FPS-67A: 1-4
AN/FPS-78.....	1	1	AN/FPS-78: 1-2
AN/FPS-79.....	1	1	AN/FPS-79: 1-2
AN/FPS-82.....	2	1	AN/FPS-82: 1-2
AN/FPS-85.....	2	1	AN/FPS-85: 1-2
AN/FPS-87.....	2	1	AN/FPS-87: 1-2
AN/FPS-87A.....	2	1	AN/FPS-87: 1-2
AN/FPS-88(V)1, -88(V)2.....	2	1	AN/FPS-88(V)1: 1-4
AN/FPS-89.....	1	1	AN/FPS-89: 1-2
AN/FPS-90, -507.....	1	1	AN/FPS-90: 1-3
AN/FPS-91, -91A.....	2	1	AN/FPS-91: 1-3
AN/FPS-93, -93A.....	1	1	AN/FPS-93: 1-2
AN/FPS-100.....	1	1	AN/FPS-100: 1-5
AN/FPS-100A.....	1	1	AN/FPS-100: 1-5
AN/FPS-507.....	1	1	AN/FPS-90: 1-3
AN/GPN-2.....	1	1	AN/GPN-2: 1-3
AN/GPN-6.....	1	1	AN/GPN-6: 1-3
AN/GPS-3.....	1	1	AN/GPS-3: 1-3
AN/GPS-4, -4A.....	2	1	AN/GPS-4: 1-4
AN/GPX-2.....	1	1	AN/GPX-2: 1-1
AN/KPQ-1.....	2	1	AN/KPQ-1: 1-2
AN/MPG-1.....	1	1	AN/MPG-1: 1-3
AN/MPN-1A.....	1	1	AN/MPN-1A: 1-4
AN/MPN-3.....	1	1	AN/MPN-3: 1-2
AN/MPN-5, -5A.....	1	1	AN/MPN-5: 1-8
AN/MPQ-4A.....	1	1	AN/MPQ-4A: 1-2
AN/MPQ-10, -10A.....	1	1	AN/MPQ-10: 1-3
AN/MPQ-16.....	1	1	AN/MPQ-16: 1-2
AN/MPQ-22.....	1	1	AN/MPQ-22: 1-2
AN/MPQ-25.....	2	1	AN/MPQ-25: 1-2
AN/MPQ-29.....	1	1	AN/MPQ-29: 1-2
AN/MPQ-33(XO).....	2	1	AN/MPQ-33(XO): 1-2

Nomenclature	Vol	Sect.	Pages
AN/MPQ-34(XO)	2	1	AN/MPQ-34(XO): 1-2
AN/MPQ-35(XO)	2	1	AN/MPQ-35(XO): 1-2
AN/MPS-4B, -4C	1	1	AN/MPS-4B: 1-3
AN/MPS-7	1	1	AN/MPS-7: 1-3
AN/MPS-8	1	1	AN/MPS-8: 1-3
AN/MPS-11	1	1	AN/MPS-11: 1-3
AN/MPS-11A	1	1	AN/MPS-11A: 1-2
AN/MPS-14	1	1	AN/MPS-14: 1-3
AN/MPS-16, -16A, -16B	1	1	AN/MPS-16: 1-3
AN/MPS-21	2	1	AN/MPS-21: 1-2
AN/MPX-2(XN-21)	1	1	AN/MPX-2(XN-21): 1-2
AN/MSG-1	1	1	AN/MG-1: 1-3
AN/PPS-4	1	1	AN/PPS-4: 1-2
AN/SPG-34	2	3	AN/SPG-34: 1-2
AN/SPG-48	2	3	AN/SPG-48: 1-2
AN/SPG-49	2	3	AN/SPG-49: 1-3
AN/SPG-50	2	3	AN/SPG-50: 1-5
AN/SPG-52	2	3	AN/SPG-52: 1-2
AN/SPG-53	2	3	AN/SPG-53: 1-3
AN/S PN-4	1	3	AN/SPN-4: 1-2
AN/SPN-5, -5SX -SY, -5Z	1	3	AN/SPN-5: 1-3
AN/SPN-SA, -SAX, -SAY, -SAZ, -5B	1	3	AN/SPN-5A: 1-3
AN/SPN-6	1	3	AN/SPN-6: 1-3
AN/SPN-8 -8A1	1	1	AN/SPN-8: 1-3
AN/SPN-11, -11X, -11Y, -11Z	2	3	AN/SPN-11: 1-4
AN/SPN-12	2	3	AN/SPN-12: 1-2
AN/SPN-12(XN-4)	2	3	AN/SPN-12(XN-4): 1-2
AN/SPN-13	1	3	AN/SPN-13: 1-2
AN/SPN-18, -18X	1	3	AN/SPN-18: 1-3
AN/SPN-21	1	3	AN/SPN-21: 1-2
AN/SPN-22	1	3	AN/SPN-22: 1-2
AN/SPN-23	1	3	AN/SPN-23: 1-2
AN/SPQ-2	2	3	AN/SPQ-2: 1-2
AN/SPQ-5	2	3	AN/SPQ-5: 1-5
AN/SPQ-6()	3	3	AN/SPQ-6(): 1-1
AN/SPQ-6(XN-1)	2	3	AN/SPQ-6(XN-1): 1-2
AN/SPQ-8	2	3	AN/SPQ-8: 1-4
AN/SPS-2	2	3	AN/SPS-2: 1-3
AN/SPS-3(XN-1)	2	3	AN/SPS-3(XN-1): 1-2
AN/SPS-4	1	3	AN/SPS-4: 1-2
AN/SPS-5, -5A, -5B	1	3	AN/SPS-5: 1-3
AN/SPS-5C	1	3	AN/SPS-5C: 1-2
AN/S PS-5D	1	3	AN/SPS-5D: 1-2
AN/SPS-6, -6A, -6B, -6C	1	3	AN/SPS-6: 1-3
AN/SPS-7	2	3	AN/SPS-7: 1-3
AN/SPS-B, -8A, -8B	1	3	AN/SPS-8: 1-3
AN/SPS-8D	1	3	AN/SPS-8D: 1-2
AN/SPS-10, -10B, -10C, -10D	1	3	AN/SPS-10: 1-3
AN/SPS-10	1	3	AN/SPS-10E: 1-3
AN/SPS-12, -12A	1	3	AN/SPS-12: 1-3
AN/SPS-13(XN-1)	3	2	AN/SPS-13(XN-1): 1-3
AN/SPS-16	1	3	AN/SPS-16: 1-3
AN/SPS-16(XN-1)	1	1	AN/SPS-16(XN-1): 1-3
AN/SPS-17	2	3	AN/SPS-17: 1-6
AN/SPS-18(XN-1)	2	3	AN/SPS-18(XN-1): 1-2
AN/SPS-18(XN-2)	2	3	AN/SPS-18(XN-2): 1-2
AN/SPS-21	1	3	AN/SPS-21: 1-2
AN/SPS-21A	1	3	AN/SPS-21A: 1-2
AN/SPS-21B	1	3	AN/SPS-21B: 1-2
AN/SPS-21C	1	3	AN/SPS-21C: 1-2
AN/SPS-21D	1	3	AN/SPS-21D: 1-2
AN/SPS-23, -23A -23X, -23XX, -23Y, -23Z	1	3	AN/SPS-23: 1-4
AN/S PS-27	2	3	CXRX: 1-4
AN/SPS-28	1	3	AN/SPS-28: 1-2
AN/SPS-29	2	3	AN/SPS-29: 1-5
AN/SPS-29D	2	3	AN/SPS-29D: 1-5
AN/SPS-30	2	3	AN/SPS-30: 1-3

Nomenclature	Vol	Sect	Page
AN/SPS-30(XN-1).....	2	3	AN/SPS-30(XN-1):1-4
AN/SPS-32().....	2	3	AN/SPS-32(): 1-1
AN/SPS-33().....	2	3	AN/SPS-33(): 1-1
AN/SPS-35, -35A.....	1	3	AN/SPS-35: 1-3
AN/SPS-36.....	1	3	AN/SPS-36: 1-2
AN/SPS-37.....	2	3	AN/SPS-37: 1-4
AN/SPS-37A.....	2	3	AN/SPS-37A: 1-4
AN/SPS-39.....	2	3	AN/SPS-39: 1-3
AN/SPS-39(XN-1).....	2	3	AN/SPS-39(XN-1): 1-5
AN/SPS-40.....	2	3	AN/SPS-40: 1-4
AN/SPS-41.....	1	3	AN/SPS-41: 1-2
AN/SPS-42.....	2	3	AN/SPS-42: 1-4
AN/SPS-43.....	2	3	AN/SPS-43: 1-4
AN/SPS-43A.....	3	3	AN/SPS-43A: 1-5
AN/SPS-46.....	1	3	AN/SPS-46: 1-2
AN/SPS-46X.....	3	3	AN/SPS-46X: 1-2
AN/SPS-51.....	1	3	AN/SPS-51: 1-2
AN/SPW-2.....	2	3	AN/SPW-2: 1-3
AN/SPW-2A.....	2	3	AN/SPW-2A: 1-3
AN/SPW-2B.....	2	3	AN/SPW-2B: 1-3
AN/SPX-2(XN-21).....	2	3	AN/SPX-2(XN-21): 1-4
AN/TPG-2.....	1	1	AN/TPG-2: 1-3
AN/TPN-B.....	1	1	AN/TPN-8: 1-4
AN/TPN-12.....	1	1	AN/TPN-12: 1-3
AN/TPQ-12(XN-1).....	2	1	AN/TPQ-12(XN-1): 1-1
AN/TPS-10D.....	1	1	AN/TPS-10D: 1-1
AN/TPS-15, -15A, -15X.....	1	1	AN/TPS-15: 1-2
AN/TPS-21.....	1	1	AN/TPS-21: 1-4
AN/TPS-22, -22.....	2	1	AN/TPS-22: 1-4
AN/TPS-25.....	1	1	AN/TPS-25: 1-2
AN/TPS-26( ).....	2	1	AN/TPS-26(): 1-1
AN/TPS-27.....	2	1	AN/TPS-27: 1-5
AN/TPS-28.....	2	1	AN/TPS-28: 1-
AN/TPS-32( ).....	2	1	AN/TPS-32(): 1
AN/TPS-37.....	1	1	AN/TPS-37: 1-
AN/TPS-40.....	1	1	AN/TPS-40: 1-2
AN/TPS-44.....	1	2	AN/TPS-44: 1-2
AN/TPX-1.....	1	1	AN/TPX-1: 1-3
AN/TPX-3.....	1	1	AN/TPX-3: 1-2
AN/UPS-1, -1A.....	2	1	AN/UPS-1: 1-2
AN/UPX-7.....	1	1	AN/UPX-7: 1-2
AN/UPX-7A.....	1	1	AN/UPX-7A: 1-2
CXR.....	2	3	CXR: 1-4
E-34.....	2	2	E-34: 1-2
MK-34 MOD 17.....	2	3	MK-34 MOD 17: 1-2
<b>Radar Set Group</b>			
AN/APA-127.....	2	2	AN/APA-127: 1-2
AN/APA-12.....	2	2	AN/APA-128: 1-2
AN/GPA-27, -27A, -57, -57A, -58, -58A.....	1	1	AN/GPA-27: 1-7
AN/GPA-33.....	1	1	AN/GPA-33: 1-3
AN/GPA-49.....	1	1	AN/GPA-49: 1-3
AN/GPA-50.....	1	1	AN/GPA-50: 1-3
AN/GPA-57, -57A.....	1	1	AN/GPA-27: 1-7
AN/GPA-58 -58A.....	1	1	AN/GPA-27: 1-7
AN/GPA-59A.....	1	1	AN/GPA-59A: 1-2
AN/GPA-80.....	1	1	AN/GPA-80: 1-2
AN/GPA-11B.....	1	1	AN/GPA-118: 1-2
Radar Set Transfer Control, C-1604/GP.....	1	1	C-1604/GP: 1-2
<b>Radar Signal Distribution Switchboard</b>			
SB-440/SP, SB-441/SP, SB-442/SP.....	1	3	SB-440/SP: 1-2
SB-594(XN-1)/BP.....	1	3	SB-594(XN-1)/BP: 1-2
SB-640(XN-1)/BP.....	1	3	SB-640(XN-1)/BP: 1-2
SB-990(XN-1)/SP.....	2	3	SB-990(XN-1)/SP: 1-2
SB-1108/SP.....	2	3	SB-1108/SP: 1-3
SB-1109/SP.....	2	3	SB-1109/SP: 1-3
SB-1229/SP.....	2	3	SB-1229/SP: 1-2

Nomenclature	Vol	Sect	Page
Radar Signal Processing Group			
AN/FSA-30 .....	1	1	AN/FSA-30: 1-2
AN/FSA-31 .....	1	1	AN/FSA-31: 1-2
Radar Surveillance Central			
AN/GSS-1 .....	2	1	AN/GSS-1: 1-2
AN/MSQ-4 .....	2	1	AN/MSQ-4: 1-3
AN/TPS-31 .....	1	1	AN/TPS-31: 1-7
AN/TPS-31(XN-1).....	1	1	AN/TPS-31(XN-1): 1-3
Radar Surveillance System			
AN/TPS-39(V)2, -39(V)4, -39(V)4A, -39(V)4B, -39(V)4C, -39(V)5, -39(V)5A, -39(V)5B.....	1	1	AN/TPS-39(V)2: 1-4
Radar Target Simulator, SM-42()/U .....	1	1	SM-42()/U: 1-2
Radar Trainer			
AN/GPN-T2, -T2A .....	1	1	AN/GPN-T2: 1-3
AN/SPS-T1 .....	1	3	AN/SPS-T1: 1-2
AN/SPS-T2 .....	1	3	AN/SPS-T2: 1-2
AN/SPS-T2A .....	1	1	AN/SPS-T2A: 1-2
AN/UPS-T4 .....	1	1	AN/UPS-T4: 1-3
Radar Training Equipment			
OBJ .....	1	3	OBJ: 1-2
OCJ, OCJ-1 .....	1	3	OCJ: 1-3
OCZ .....	1	3	OCZ: 1-2
OCZ-1 .....	1	3	OCZ-1: 1-2
Radar Training Set			
AN/APQ-T22 .....	1	2	AN/APQ-T2: 1-2
AN/GPS-T1A .....	1	1	AN/GPS-T1A: 1-2
AN/SPG-T10 .....	1	3	AN/SPG-T10: 1-3
AN/UPT-T3 .....	1	1	AN/UPT-T3: 1-2
AN/UPT-T4 .....	1	2	AN/UPT-T4: 1-2
Radar Transponder Beacon			
AN/APN-7 .....	1	2	AN/APN-7: 1-2
AN/APN-13 .....	1	2	AN/APN-13: 1-2
Radio Beacon Set			
AN/TPN-7, -7() .....	2	1	AN/TPN-7: 1-2
AN/WPN .....	1	3	AN/WPN-1: 1-1
Radio Beacon System, AN/UPN-14 .....	1	3	AN/UPN-14: 1-3
Radio Equipment			
BL-1, -2, -3, -4, -5, -6 .....	1	3	BL-1: 1-4
Y3 .....	1	1	YJ: 1-3
YJ-2 .....	1	3	YJ-2: 1-2
Radio Interference Filter Unit, CY-1913/UJ .....	1	3	CY-1913/U: 1-2
Radio Interrogator Set			
AN/GPX-17 .....	1	1	AN/GPX-17: 1-2
AN/GPX-18 .....	1	1	AN/GPX-18: 1-2
AN/GPX-18A .....	1	1	AN/GPX-18A: 1-3
AN/GPX-20 .....	1	1	AN/GPX-20: 1-2
AN/GPX-20A .....	1	1	AN/GPX-20A: 1-3
Radio Receiving Set, AN/ARR-27, -27A .....	1	2	AN/ARR-27: 1-2
Radio Set			
AN/APN-4 .....	1	2	AN/APN-4: 1-2
AN/APQ-13 .....	1	2	AN/APQ-13: 1-3
AN/APX-2 .....	1	2	AN/APX-2: 1-2
AN/CPN-3 .....	1	1	AN/CPN-3: 1-3
AN/MPN-1B .....	1	1	AN/MPN-1B: 1-5
AN/PPS-1 .....	1	1	AN/PPS-1: 1-2
AN/TPS-1 .....	1	1	AN/TPS-1: 1-2
AN/TPS-1B .....	1	1	AN/TPS-1B: 1-2
AN/TPS-1D .....	1	1	AN/TPS-1D: 1-3
AN/TPS-1G .....	1	1	AN/TPS-1G: 1-3
AN/TPS-2 .....	1	1	AN/TPS-2: 1-2
Radio Transmitting Set, AN/ART-26 .....	1	2	AN/ART-26: 1-2
Radome Group			
AN/TPA-1 .....	1	1	AN/TPA-1: 1-3
AN/TPA-1(XN-1).....	1	1	AN/TPA-1(XN-1): 1-4
Radome Tower Group, AN/GPA-89 .....	1	1	AN/GPA-89: 1-2
Range Azimuth Indicator, AN/SPA-4, -4A, -4B .....	1	3	AN/SPA-4: 1-2

Nomenclature	Vol	Sect.	Pages
Range Height Indicator			
AN/SPA-7 .....	2	3	AN/SPA-7: 1-2
AN/SPA-40 .....	1	3	AN/SPA-40: 1-2
Range Indicator			
IP-99/SP, IP-99A/SP .....	1	3	IP-99/SP: 1-3
IP-374/SPG .....	2	3	IP-374/SPG: 1-2
Receiver Group, AN/GPA-68 .....	1	1	AN/GPA-68: 1-1
Receiving Equipment, AN/APR-4 .....	1	2	AN/APR-4: 1-2
Recording Assembly, AN/APA-23 .....	1	2	AN/APA-23: 1-2
Reflectoscope, MX-969/SPA-4A .....	1	3	MX-969/SPA-4A: 1-2
Remote Control Monitor Group			
AN/APA-65 .....	1	2	AN/APA-65: 1-2
AN/APA-66 .....	1	2	AN/APA-66: 1-2
AN/APA-67 .....	1	2	AN/APA-67: 1-2
Remote PPI, 55ACD .....	1	3	55ACD: 1-2
Rendezvous Radar Beacon Set			
AN/APN-134 .....	2	2	AN/APN-134: 1-2
AN/APN-135 .....	1	2	AN/APN-135: 1-2
Repeater Indicator Equipment, AN/APA-1 .....	1	2	AN/APA-1: 1-2
Rigid Radome, CW-396/GPS, CW-396A/GPS .....	1	1	CW-396/GPS: 1-3
Rotary Switch, SA-213/U, SA-233/U, SA-234/U .....	1	1	SA-213/U: 1-3
<b>S</b>			
Sector Scan Assembly, AN/APA-12A .....	1	2	AN/APA-12A: 1-2
Ships Motion Recording Set, AN/SPN-1O(XN-1) .....	1	3	AN/SPN-1O(XN-1): 1-2
Signal Analyzer Group, AN/APA-74 .....	2	2	AN/APA-74: 1-2
Signal Data Converter, CV-1246/SPS-T .....	1	3	CV-1246/SPS-T: 1-2
Signal Data Converter Group, AN/WSA-1 .....	1	3	AN/WSA-1: 1-2
Simulator-Radar Selector Group, AN/GPA-112(V) .....	1	1	AN/GPA-112(V): 1-3
Situation Display Projection Set, AN/GPA-114 .....	1	1	AN/GPA-114: 1-2
Stabilization Data Set			
AN/SSQ-4 .....	1	3	AN/SSQ-4: 1-2
AN/SSQ-14 .....	1	3	AN/SSQ-14: 1-2
Stable Element, MK 8 MO 2, MK 8 1MO 4 .....	1	3	MK. 8 .MOD 2: 1-2
Status Display Set			
AN/FPA-20 .....	1	1	AN/FPA-20: 1-2
AN/FPA-21 .....	1	1	AN/FPA-21: 1-2
Supersonic Radar Reflective Aerial Tow Target,			
TDU-21/B .....	1	2	TDU-21/B: 1-2
Suppression Generator, O-30/CPN .....	1	1	O-30/CPN: 1-2
Switchboard Group, AN/TPA-4 .....	1	1	AN/TPA-4: 1-2
Synchronizer Group			
AN/FSA-24 .....	1	1	AN/FSA-24: 1-3
AN/FSA-27 .....	1	1	AN/FSA-27: 1-4
AN/FSA-28 .....	1	1	AN/FSA-28: 1-4
<b>T</b>			
Tactical Evaluator Group, AN/SPA-29(XN-1) .....	2	3	AN/SPA-29(XN-1): 1-3
Target Data Distribution Group, AN/SSA-21(XN-1) .....	2	3	AN/SSA-21(XN-1): 1-2
Test Set Simulator, SM-117/BPQ-2 .....	2	3	SM-117/BPQ-2: 1-2
Tilt Stabilization Assembly, AN/APA-15 .....	1	2	AN/APA-15: 1-2
Trailer Mounted Landing Control Set			
AN/MPN-1 .....	1	2	AN/MPN-17: 1-3
AN/MPN-17A .....	1	2	AN/MPN-17: 1-3
Trainer, AN/SPN-T1 .....	1	3	AN/SPN-T1: 1-2
Training Set, AN/TPQ-T .....	1	1	AN/TPQ-T1: 1-2
Training Transmitter Equipment, AN/UPT-T1 .....	1	2	AN/UPT-T1: 1-2
Transponder Set			
AN/APX-25 .....	1	2	AN/APX-25: 1-2
AN/APX-25A .....	1	2	AN/APX-25A: 1-2
AN/APX-27B .....	1	2	AN/APX-27B: 1-2
AN/APX-34() .....	2	2	AN/APX-34(): 1-2
AN/APX-35() .....	1	2	AN/APX-35(): 1-2



Nomenclature	Vol	Sect.	Pages
AN/APX-37 .....	1	2	AN/APX-37: 1-2
AN/APX-46(V) .....	1	2	AN/APX-46(V): 1-2
AN/DPN-32 .....	1	2	AN/DPN-32: 1-2
AN/DPN-37, -38 .....	2	2	AN/DPN-37: 1-2
AN/DPN-66 .....	1	2	AN/DPN-66: 1-3
AN/DPW-9 .....	1	2	AN/DPW-9: 1-2
AN/UPX-8 .....	1	3	AN/UPX-8: 1-2
AN/UPX-12, -1A, -12B .....	1	3	AN/UPX-12: 1-2
AN/UPX-17 .....	1	3	AN/UPX-17: 1-1
Trigger Mixer, MX-1369/UPX .....	1	3	MX-1369/UPX: 1-2
Trigger Pulse Amplifier			
AM-1913/UP .....	1	3	AM-1913/UP: 1-2
AM-1913A/UP .....	1	3	AM-1913A/UP: 1-2
AM-1913B/UP .....	1	3	AM-1913B/UP: 1-2
Trigger Video Amplifier, AM-1379/FPS .....	1	1	AM-1379/FPS: 1-2
<b>V</b>			
Video Amplifier			
AM-299/UP .....	1	1	AM-229/UP: 1-2
AM-1914/UP .....	1	3	AM-1914/UP: 1-2
AM-1914A/UP .....	1	3	AM-1914A/UP: 1-2
AM-1914B/UP .....	1	3	AM-1914B/UP: 1-2
Video Coder Group, AN/UPA-38 .....	1	3	AN/UPA-38: 1-2
Video Conditioning Group, AN/GPA-11O(V) .....	1	1	AN/GPA-11O(V): 1-2
Video Decoder			
KY-71/UPX .....	1	3	KY-71/UPX: 1-2
KY-145/DPW .....	2	2	KY-145/DPW: 1-2
Video Display Height Size Console,			
OA-3075(XN-1)/SPS-33 .....	2	3	OA-3075(XN-1)/SPS-33: 1-2
Video Distributor, SA-220/UPX, SA-220A/UPX .....	1	1	SA-220/UPX: 1-2
Video Mapping Group			
AN/GPA-30 .....	1	1	AN/GPA-30: 1-2
AN/GPA-70 .....	1	1	AN/GPA-70: 1-2
AN/GPA-91 .....	1	1	AN/GPA-91: 1-3
P-14X .....	2	3	P-14X: 1-2
<b>W</b>			
Wave Trap, F-20/UPR.1 .....	1	3	F-20/UPR: 1-2
Waveform Converter Group			
AN/SPA-46 .....	1	3	AN/SPA-46: 1-2
AN/SPA-49 .....	1	3	AN/SPA-49: 1-2

By Order of the Secretary of the Army:

**HAROLD K. JOHNSON,**  
*General, United States Army,*  
*Chief of Staff.*

**Official:**

**J. C. LAMBERT,**  
*Major General, United States Army,*  
*The Adjutant General.*

**Distribution:**

**Active Army:**

USASA (2)	USAMOCOM (15)	USAAVNC (1)
CNGB (1)	USAWECOM (15)	USAADCEN (1)
CC-E (5)	USAMUCOM (15)	USASPTCP (11)
Dir of Trans (1)	USATECOM(15)	Instl (2) except
CofEngrs (1)	Proc Dist (2)	Ft Monmouth (20)
TSG (1)	MDW (1)	Ft Gordon (5)
CofSptS (1)	Armies (2) except	Ft Huachuca (5)
USAMB (2)	1 <sup>st</sup> USA (4)	WSMR (3)
USAAESWBD (2)	Corps (1)	Ft Carson (5)
USAAVNTBD (2)	USAC (1)	Army Dep (2) except
USABAAR (1)	Div (1) except	LBAD (5)
USAID (1)	11 <sup>th</sup> Air Aslt Div (2)	SAAD (5)
USACDCEA (1)	Bde (1)	TOAD (5)
USACDCCBRA (1)	Regt/Gp/bg (1)	FTWOAD (3)
USACDCCEA (1)	Bn (1)	LEAD (3)
USACDCCEA	USAERDAW (2)	ATAD (3)
Ft Huachuca (1)	Svc Colleges (2)	GENDEP (OS) (2)
USACDCOA (1)	Br Svc Sch (1) except	Sig Sec, GENDEP (OS) (2)
USACDCQMA (1)	USASCS (10)	Sig Dep (OS) (3)
USACDCTA (1)	USASESCS ( 5)	Sig Fld Maint Shops (1)
USACDCADA (1)	USAARMS (4)	USAERDAA (2)
USACDCARMA (1)	USAIS (4)	Lab (2) except
USACDCAVNA (1)	USAAMS (4)	USAELL (24)
USACDCARTYA (1)	USAOC&S (4)	USARPA (2)
USACDCSWA (1)	USAADS (4)	MAAG (1)
USAMC (15)	USMA (2)	USARMIS (1)
USCONARC (4)	USATC AD (1)	USARSG (1)
ARADCOM (2)	USATC Armor (1)	Arsenal (1)
ARADCOM Rgn (1)	USAT Engr (1)	PG (2)
OS Maj Comd (2)	USATC Inf (1)	Units org under fol TOE:
LOGCOMD (2)	USASTC (1)	11-157 (1)
USAMICOM (15)	WRAMC (1)	11-158 (1)
USASMC (20)	USACDCEC (1)	11-587 (1)
USASCC (5)	USAMEC (1)	11-592 (1)
USAECOM (150)	USASPTC (1)	11-597 (1)
	USASPTCM (1)	
	USASPTCO (1)	

NG: State AG (3).

USAR: None.

For explanation of abbreviations used see AR 320-50.

DATE: 1 July 1964

ITEM NAME: RADAR SET

COGNIZANT SERVICE: USN

TYPE: AN/SPN-4

FEDERAL STOCK NUMBER: F5840-642-6701

	USA	USN	USAF	USMC
STATUS OR TYPE CLASSIFICATION				
Mfg(s) Name or Code Number: Raytheon Mfg., Company				

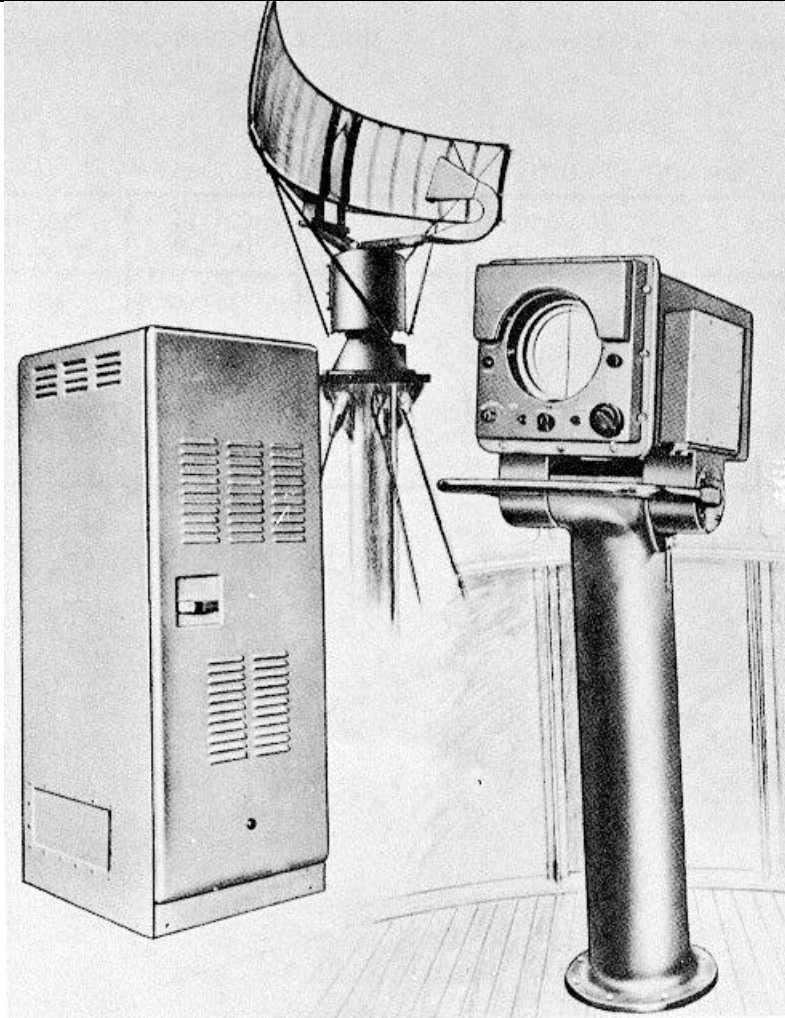

AN/SPN-4: 1

**AN/SPN-4**

**FUNCTIONAL DESCRIPTION**

The AN/SPN-4 is a commercial radar navigational system designed for non-combatant ships.

**RELATION TO SIMILAR EQUIPMENT**

The AN/SPN-4 is identical to Raytheon's Mariners Pathfinder Radar Set Model CX1002 and similar to Model CX-1086 except for a modification kit required for true bearing readings.

**TECHNICAL DESCRIPTION**

Frequency: 3055 ±45 mc  
 Range, Min: 100 yd  
 Peak Power Output: 15 kw  
 Operating Voltages and Power Requirements:  
     115 vac ±10%, 1-ph, 50 to 70 cps,  
     1 kva at 60 cps

Type of Presentation: One 7-in. PPI  
 Range Scales: 1.5, 5, 15, and 50 mi  
 Pulse Repetition Rate: 1, 000 pps ±5%  
 Pulse Width: 0.4 µsec  
 Horizontal Coverage: 360 deg  
 Antenna Rotation Speed: 7 rpm at 60 cps  
 Range Resolution: 100 yd  
 Azimuth Resolution: 5 deg  
 Range Accuracy: 100 yd at 100 to 5, 000 yd;  
     2% at 2.5 to 50 mi  
 Azimuth Accuracy: 2 deg between antenna and  
     indicator  
 Horizontal Beam Width: 3.5 deg  
 Vertical Beam Width: 11.5 deg  
 Receiver Noise Factor: 15 db  
 Tuning: AFC  
 Video Output: Limited at 1.75 to 0.25v across 75  
     ohms to min bandwidth of 3 mc

**INSTALLATION CONSIDERATIONS**

Not available.

**PRINCIPAL COMPONENTS AND PHYSICAL DATA**

<b>COMPONENT</b>	<b>QTY</b>	<b>HEIGHT (Inches)</b>	<b>WIDTH (Inches)</b>	<b>DEPTH (Inches)</b>	<b>UNIT WT. (Pounds)</b>
Receiver-Transmitter Unit RT- 142/SPN-4	1	60	23-1/2	26	525
Antenna AS-404/SPN-4	1	89	53		150
Plan Position Indicator IP-116/SPN-4	1	14	14- ¼	24	50

**REFERENCE DATA AND LITERATURE**

Technical Manual:  
NAVSHIPS 91052

DATE: 1 July 1964

ITEM NAME: RADAR SET

COGNIZANT SERVICE: USA\*  
USN

TYPE: AN/SPN-5\*, -5X, -5Y, -5Z

FEDERAL STOCK NUMBER: 5840-223-4522 (115 vac)  
5840-503-0879 (115 vdc)

	USA	USN	USAF	USMC
STATUS OR TYPE CLASSIFICATION	Std	Std		

Mfg(s) Name or Code Number: Radiomarine Corporation of America

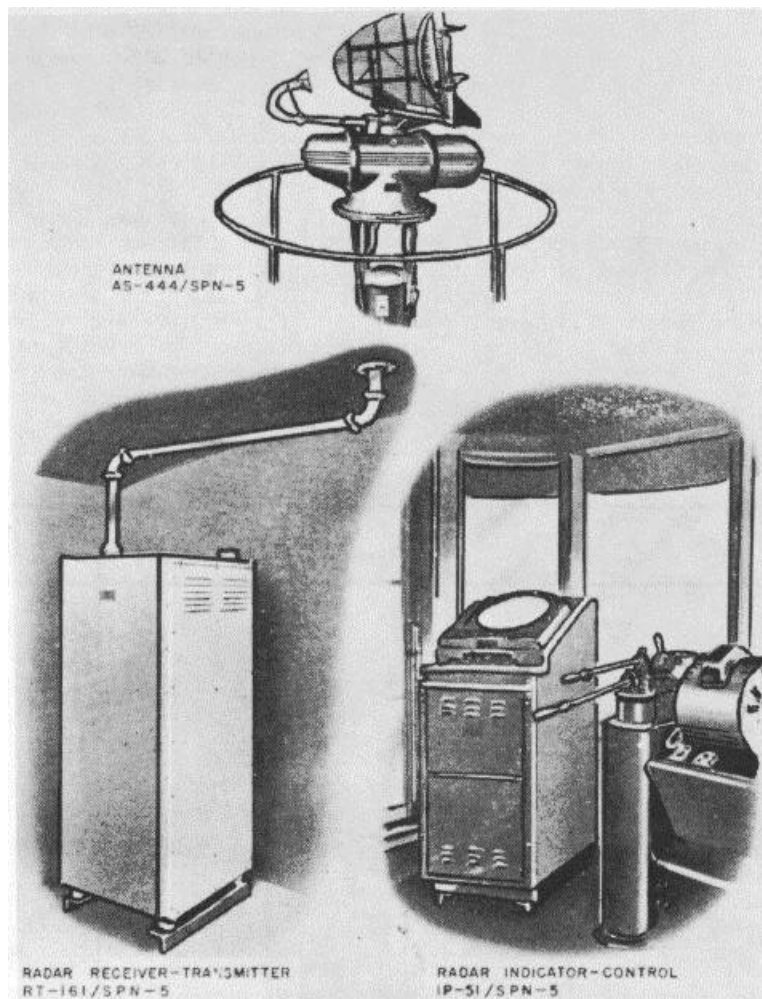

AN/SPN-5: 1

AN/SPN-5, -5X, -5Y, -5Z

**FUNCTIONAL DESCRIPTION**

Radar Sets AN/SPN-5, -5X, -5Y, -5Z are search radar sets, used in a fixed installation on oceangoing vessels. The set is a navigational aid that furnishes position information on other vessels, buoys, channel markers and coast lines. Target position information consists of range and bearing.

**RELATION TO SIMILAR EQUIPMENT**

AN/SPN-5, -5X, -5Y, -5Z is functionally and electrically interchangeable (as a whole) with AN/ SPN-5A, -5AX, -5AY, -5AZ, -5B except the AN/SPN-SB includes de-icing, true bearing, and variable range-marker features.

**TECHNICAL DESCRIPTION**

Frequency: 9320 to 9430 mc  
 Range: 81, 070 yd (max); 80 yd (min)  
 Peak Power Output: 30 kw  
 Operating Voltages and Power Requirements:  
     AN/SPN-5 - 115 vac, 60 cps, 1-ph, 12 amp,  
         0.85 pf  
     AN/SPN-5X - 115 vdc, 20 amp  
     AN/SPN-5Y - 230 vdc, 24 amp  
     AN/SPN-5Z - 230 vac, 60 cps, 1-ph, 6.5 amp,  
         0.85 pf

Type of Presentation: 12-in. PPI  
 Ranges and Intervals of Range Marks:  
     0 to 1.5 mi position - 0.5 ml intervals  
     0 to 4 mi position - 1 mi intervals  
     0 to 8 mi position - 2 mi intervals  
     0 to 20 mi position - 5 mi intervals  
     0 to 40 mi position - 10 mi intervals  
 Duty Cycle: .00075  
 Pulse Repetition Rate:  
     1.5-, 4-, and 8-mi ranges, 3, 000 cps;  
     20- and 40-mi ranges, 750 cps  
 Pulse Width:  
     1.5-, 4-, and 8-mi ranges, 0.25  $\mu$ sec;  
     20- and 40-mi ranges, 1  $\mu$ sec  
 Range Accuracy:  $\pm 1\%$   
 Azimuth Accuracy:  $\pm 2$  deg  
 Beam Width: 1.8 deg at half-power points

**INSTALLATION CONSIDERATIONS**

Siting: If possible, locate the antenna on either side of the ship, rather than amidships. The waveguide run should not exceed 75 ft from the base of the antenna unit to the top of the transmitter-receiver unit.  
 Mounting:  
 Cabling Requirements:  
 Related Equipment:

**PRINCIPAL COMPONENTS AND PHYSICAL DATA**

COMPONENT	QTY	HEIGHT (Inches)	WIDTH (Inches)	DEPTH (Inches)	UNIT WT. (Pounds)
Radar Receiver-Transmitter RT-161/SPN-5	1	53-3/4	19-3/8	20-1/2	326
Radar Indicator Control IP-51/SPN-5	1	47	18	28-1/2	230
Antenna AS-444/SPN-5	1	32	17	18	148.5
Motor Starter SA-166/U (5Y only)	1	9-1/2	6-13/16	6-29/32	13.5
Motor Starter SA-167/U (5X only)	1	11-3/4	7-1/8	8-5/8	18
Circuit Breaker SA-172/SPN-5(5only)	1	8-5/8	4-3/8	6-1/8	6.5
Circuit Breaker SA-173/SPN-5 (5Z only)	1	8-5/8	4-3/8	8-1/8	6.5
Switch Box SA-174/SPN-5 (5X only)	1	7-1/4	4	6-1/2	4.25
Switch Box SA-175/SPN-5 (5, 5Y, 5Z only)	1	11-3/4	5-1/4	9-5/8	9

**PRINCIPAL COMPONENTS AND PHYSICAL DATA (cont'd)**

<b>COMPONENT</b>	<b>QTY</b>	<b>HEIGHT (Inches)</b>	<b>WIDTH (Inches)</b>	<b>DEPTH (Inches)</b>	<b>UNIT WT. (Pounds)</b>
Motor Generator PU-163/U (5Y only)	1	35-7/8	14-1/2	18-1/8	450
Motor Generator PU-164/U (5X only)	1	35-7/8	14-1/2	18-1/8	450
Power Transformer TF-120/U (5Z only)	1	10-1/2	5	8-1/4	9

**REFERENCE DATA AND LITERATURE**

Technical Manuals:

TM 11-1301

TM 11-1501

TM 11-5840-207-12P

TM 11-5840-207-35P

Specification:

SIG 71-2507(USA)

**AN/SPN-5: 3**

DATE: 1 July 1964

ITEM NAME: RADAR SET

COGNIZANT SERVICE: USN

TYPE: AN/SPN-5A, -5AX, -5AY, -5AZ, -5B

FEDERAL STOCK NUMBER: See Note 1

	USA	USN	USAF	USMC
STATUS OR TYPE CLASSIFICATION		Std		

Mfg(s) Name or Code Number: Radiomarine Corporation of America

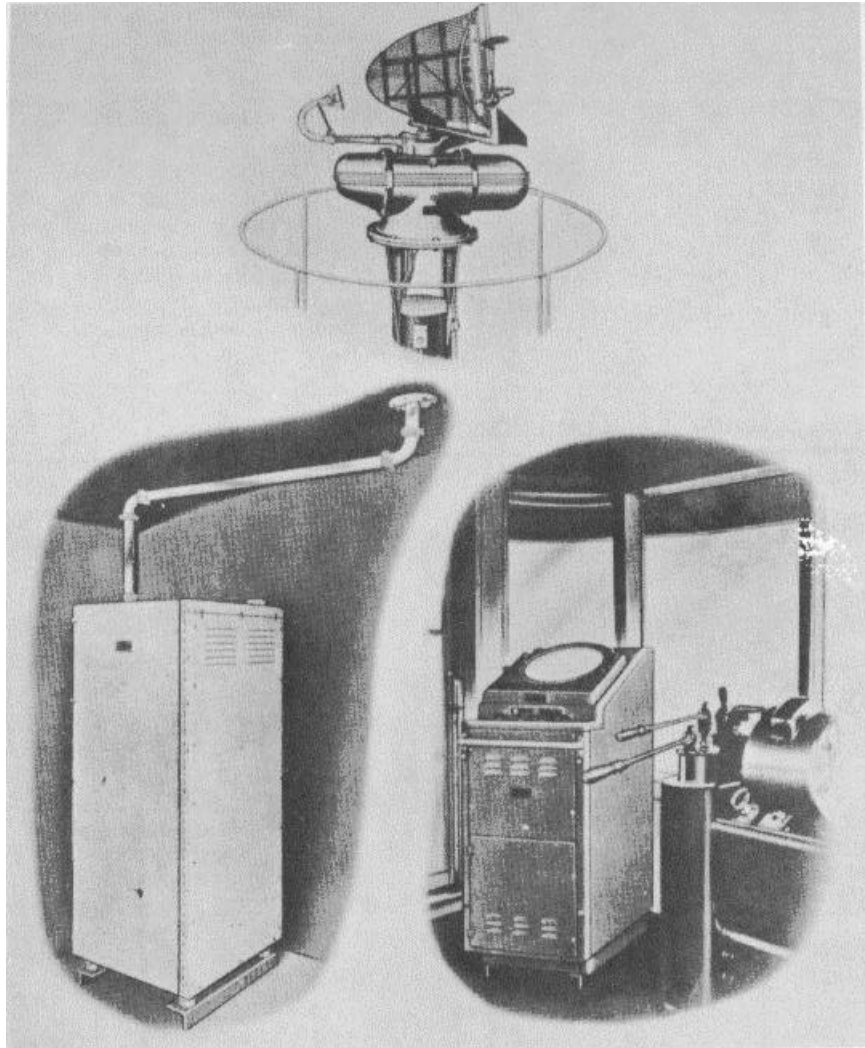

AN/SPN-5A: 1



AN/SPN-5A, -5AX, -5AY, -5AZ, -5B

**FUNCTIONAL DESCRIPTION**

Radar Sets AN/SPN-5A, -5AX, -5AY, -5AZ and -5B are search radar sets, used in fixed installations on ocean-going vessels. The sets are navigational aids that furnish position information on other vessels, buoys, channel markers, and coast lines. Target position information consists of range and bearing.

**RELATION TO SIMILAR EQUIPMENT**

The AN/SPN-5A, -5AX, -5AY, -5AZ, -5B are similar to, and functionally interchangeable (as a whole) with, AN/SPN-5, -5X, -5Y, -5Z except the AN/SPN-5B includes de-icing, true bearing, and variable range-marker features.

**TECHNICAL DESCRIPTION**

Frequency: 9320 to 9430 mc  
 Range: 81, 070 yd (max); 80 yd (min)  
 Power Output: 30 kw (peak); 25w (avg)  
 Pulse Repetition Rate:  
     1.5-, 4-, and 8-mi ranges, 3, 000 pps;  
     20-, and 40-mi ranges, 750 pps  
 Pulse Duration:  
     1.5-, 2-, 4-, and 8-mi ranges, 0.25  $\mu$ sec;  
     20-, and 40-mi ranges, 1  $\mu$ sec  
 Range Accuracy: +1%  
 Azimuth Accuracy:  $\pm$ 2 deg

Range Resolution: 80 yd on ranges using 0.25  $\mu$ sec pulse  
 Azimuth Resolution: 2 deg  
 IF. Frequency: 30 mc  
 Receiver Sensitivity: -92 dbm  
 Receiver Bandwidth: 5.5 mc  
 Operating Voltages and Power Requirements:  
     AN/SPN-5A - 115 vac, 60 cps, 1-ph, 12 amp, 0.85 pf  
     AN/SPN-5AX - 115 vdc, 20 amp  
     AN/SPN-5AY - 230 vdc, 24 amp  
     AN/SPN-5AZ - 230 vac, 60 cps, 1-ph, 6.5 amp, 0.85 pf  
     AN/SPN-5B - 115 vac, 60 cps, 1-ph, 1, 380 va, 0.85 pf  
 Duty Cycle: 0.00083  
 Horizontal Beam Width:  
     1.8 deg at half-power points  
 Vertical Beam Width:  
     19 deg at half-power points  
 Antenna Scanning Rate: 10 rpm or 60 deg per sec

**INSTALLATION CONSIDERATIONS**

Siting: If possible, locate the antenna on either side of the ship, rather than amidships. The waveguide run should not exceed 75 ft from the base of the antenna unit to the top of the transmitter-receiver unit.  
 Mounting:  
 Cabling Requirements:  
 Related Equipment:

**PRINCIPAL COMPONENTS AND PHYSICAL DATA**

COMPONENT	QTY	HEIGHT (Inches)	WIDTH (Inches)	DEPTH (Inches)	UNIT WT. (Pounds)
Radar Receiver-Transmitter RT-161/SPN-5 (5B only)	1	53-3/4	19-3/8	20-1/2	326
Radar Receiver-Transmitter RT-161A/SPN-5 (5A, 5AX, 5AY, 5AZ only)	1	53-3/4	19-3/8	20-1/2	326
Control Indicator C-1091/SPN-5A (5A, 5AX, 5AY, 5AZ only)	1	52-1/2	18	28-3/4	230
Range Computer CP-142/SPN-5A	1	17-1/2	5-1/4	6	
Radar Indicator-Control IP-51/SPN-5 (5B only)	1	47	18	28-1/2	230
Azimuth Indicator ID-333/SPN-5A	1	14-1/2	4-3/4	11-3/8	

AN/SPN-5A, -5AX, -5AY, -5AZ, -5B

**PRINCIPAL COMPONENTS AND PHYSICAL DATA (cont'd)**

COMPONENT	QTY	HEIGHT (Inches)	WIDTH (Inches)	DEPTH (Inches)	UNIT WT. (Pounds)
Motor Starter SA-166/U(5AY only)	1	9-1/2	6-13/16	6-29/32	13.5
Motor Starter SA-167/U(5AX only)	1	11-3/4	7-1/8	8-5/8	18
Circuit Breaker SA-172/U (5A, 5AX, 5AY, 5AZ only)	1	8-5/8	4-3/8	6-1/8	6.5
Switch Box SA-174/SPN-5 (5AX only)	1	7-1/4	4	6-1/2	4.25
Switch Box SA-175/SPN-5 (5A, 5AY, 5AZ only)	1	11-3/4	5-1/4	9-5/8	9
Circuit Breaker SA-300/SPN-5AZ (5AZ only)	1	8-5/8	4-3/8	6-3/16	
Motor Generator PU-163/U (5AY only)	1	35-7/8	14-1/2	18-1/8	450
Motor Generator PU-164/U (5AX only)	1	35-7/8	14-1/2	18-1/8	450
Power Transformer TF-120/U (5AZ only)	1	10-1/2	5	8-1/4	9

**REFERENCE DATA AND LITERATURE**

Technical Manuals:  
TM 11-1301  
TM 11-1501  
TM 11-5510

**Note 1. Federal Stock Numbers**

AN/SPN-5A: 5840-642-6715  
AN/SPN-5AX: 5840-642-6697  
AN/SPN-5AY: 5840-642-6705  
AN/SPN-5AZ: 5840-642-6716  
AN/SPN-5B:

**AN/SPN-5A: 3**

DATE: 1 July 1964

ITEM NAME: RADAR SET

COGNIZANT SERVICE: USN

TYPE: AN/SPN-6

FEDERAL STOCK NUMBER: 5840-642-6687  
5840-642-8231 w-s

	USA	USN	USAF	USMC
STATUS OR TYPE CLASSIFICATION		Ltd Std		

Mfg(s) Name or Code Number: Raytheon Mfg. Company

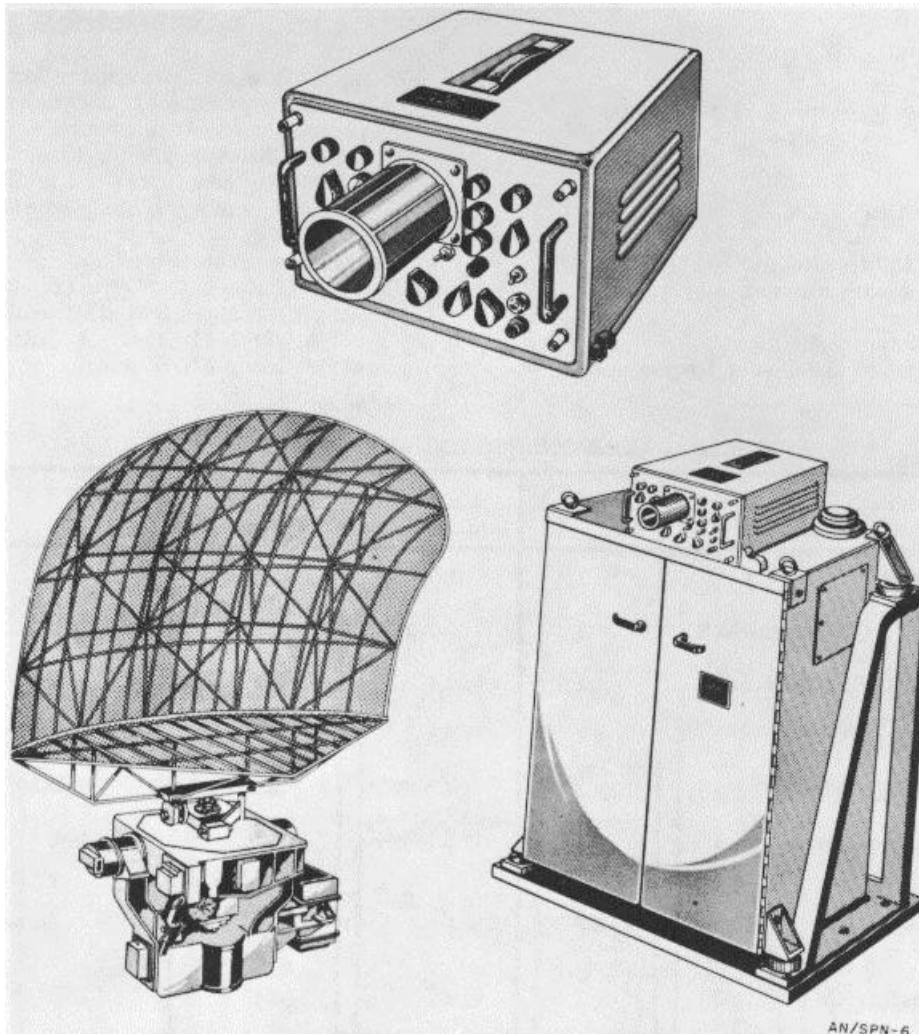

AN/SPN-6: 1

AN/SPN-6

**FUNCTIONAL DESCRIPTION**

Radar Set AN/SPN-6 is control-approach equipment for medium and large aircraft carriers. The set is keyed by a thyratron and offers a choice of two pulse widths and two bandwidths. Components include a standard receiver and a linear-log receiver. Both have anti-jam circuits. Aircraft and surface targets are presented on the indicator of Radar Repeater VK-4 or of Indicator Group AN/ SPA-8A.

Repeaters other than the VK-4 may be used. Radar Set Control C-799/SPN-6, Amplifier Control C-979/SPN-6, and the master indicator of the associated equipment serve as a control center.

115 vac 10%, 60  $\bar{n}$ 2 cps, 3-ph, 2 kva  
Type of Presentation: PPI of associated indicator  
RF Power Source: Magnetron  
Pulse Repetition Rate: 685 to 760 pps  
Pulse Width: 0.33 or 1.25  $\mu$ sec  
Horizontal Beam Width: 2 deg, cosecant squaring to +15 deg  
Vertical Beam Width: 2.5 deg  
Receiver Bandwidth: 1 or 5 mc  
IF. Frequency: 30 mc  
Horizontal Coverage: 360 deg  
Vertical Coverage: -2 to +10 deg (from horizon)

**RELATION TO SIMILAR EQUIPMENT**

The AN/SPN-6 is similar to and replaces the AN/SPN-6(XN-1).

**TECHNICAL DESCRIPTION**

Frequency: 3550 to 3700 mc  
Range: Varies with antenna height and size of target  
Peak Power Output: 500 kw  
Operating Voltages and Power Requirements:

440 vac  $\bar{n}$ 10%, 60  $\bar{n}$ 2 cps, 3-ph, 10 kva;

**INSTALLATION CONSIDERATIONS**

Siting: Allow sufficient space for operating and servicing personnel. Location should provide protection from the weather and ample ventilation. Allow room for external connections and locate units to insure a minimum of interference from or to other equipments.

Mounting:

Cabling Requirements:

Related Equipment: Gyro-compass, Synchro-Amplifier Mark 2 Mod 1B; Stabilization Data Set AN/SSQ-14; Radar Repeater VK-4; Indicator Group AN/SPA-8A.

**PRINCIPAL COMPONENTS AND PHYSICAL DATA**

COMPONENT	QTY	HEIGHT (Inches)	WIDTH (Inches)	DEPTH (Inches)	UNIT WT. (Pounds)
Antenna AS-538/SPN-6	1	180	144-3/4	144-3/4	2385
Antenna Stabilizer CN-144/SPN-6	1	30-7/8	18-1/4	21-1/2	200
Antenna Control C-851/SPN-6	1	16	27-1/2	39-3/4	285
Box Switch SA-244/U	2	13-1/4	6-1/2	5-1/4	14
RF Filter Unit CTD-53225	1	15-1/2	22-3/8	6-1/2	54
Power Distribution Transformer TF-160/U	1	11-3/4	12-3/4	11-3/4	89
Line Voltage Regulator CRP-301498	2	31	20	15	340
Transformer-Filter Unit CRP-301499	2	37	14	14	321
Radar Modulator MD-160/SPN-6	1	68	33	19-5/8	1129

**PRINCIPAL COMPONENTS AND PHYSICAL DATA (cont'd)**

<b>COMPONENT</b>	<b>QTY</b>	<b>HEIGHT (Inches)</b>	<b>WIDTH (Inches)</b>	<b>DEPTH (Inches)</b>	<b>UNIT WT. (Pounds)</b>
Radar Receiver-Transmitter RT-179/SPN-6	1	53-3/4	39-1/8	20	705
Monitor Scope CRP-55AGM-1	1	10-1/2	16-1/2	18-7/8	64
Video Amplifier CRP-5AJW-1	1	28	15-3/4	16-1/8	134
Intermediate Frequency Amplifier AM-607/SPN-6	1	26	19-1/2	12-5/8	139
Radar Set Control C-799/SPN-6	1	38-1/2	14-7/8	18-5/8	102

**REFERENCE DATA AND LITERATURE**

Technical Manual:  
NAVSHIPS 91810(B)

**AN/SPN-6: 3**

DATE: 1 July 1964

ITEM NAME: RADAR SET

COGNIZANT SERVICE: USN

TYPE: AN/SPN-8, \* -8A\*\*

FEDERAL STOCK NUMBER: 5840-665-3699\*  
5840-642-6699\*\*

	USA	USN	USAF	USMC
STATUS OR TYPE CLASSIFICATION		Ltd Std		

Mfg(s) Name or Code Number: Bendix Radio Division of Bendix Aviation Company

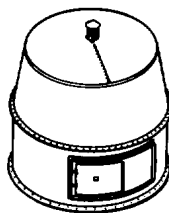

RADOME  
CW-205/SPN-8

\* USED ONLY IN RADAR SET AN/SPN-8  
\*\* USED ONLY IN RADAR SET AN/SPN-8A  
ALL OTHER UNITS COMMON TO BOTH SYSTEMS.

HOUSING FOR



TUNED CAVITY  
FR-68/UP

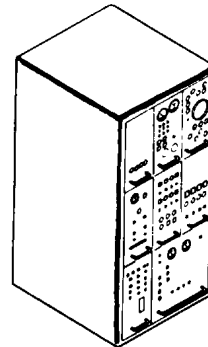

RECEIVER-TRANSMITTER  
GROUP  
OA-364/SPN-8

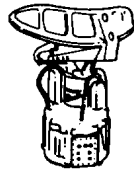

ANTENNA  
AS-477/SPN-8

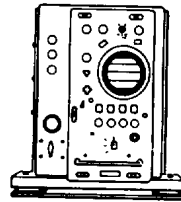

SYNCHROSCOPE  
OS-14/SPN-8

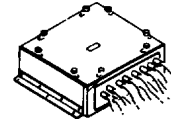

\*\* INTERCONNECTING BOX  
J-582/SPN-8A

\*\* ELECTRICAL EQUIPMENT CABINET  
CY-1502/SPN-8A



INDICATOR CONTROL  
C-1063/SPN-8 C-1063/SPN-8 C-1082/SPN-8



SOLENOID RELAY  
RE-127/SPN-8



LINE FREQUENCY METER

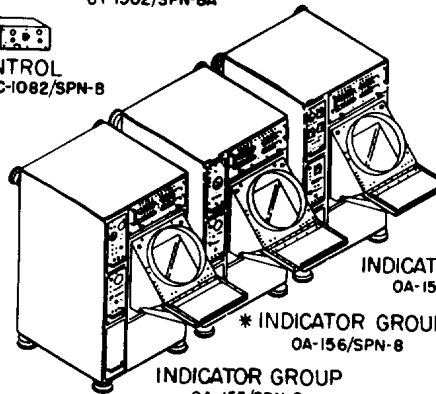

INDICATOR GROUP  
OA-155/SPN-8

\* INDICATOR GROUP  
OA-156/SPN-8

INDICATOR GROUP  
OA-157/SPN-8

AN/SPN-8: 1

AN/SPN-8, -8A

**FUNCTIONAL DESCRIPTION**

The AN/SPN-8 and AN/SPN-8A are carrier-controlled approach systems used when visibility approaches zero. The systems will guide aircraft from a position as far as six miles away to a position as close as 200 feet from touchdown on the aircraft carrier. PPI's display the aircraft's position in relation to an ideal approach path. The AN/SPN-8 and -8A include units to compensate or correct for deviations from the roll, pitch, and yaw of the carrier. Eleven radio channels and ten intercommunications channels are available. The radio channels transmit instructions to, and receive responses from, the pilot of the aircraft. The intercommunications channels provide contact with other stations aboard the carrier. The AN/SPN-8 or -8A controllers direct the pilot along an ideal approach path until the aircraft is visible to the landing signal officer. If the pilot does not receive directions from the landing signal officer at the 200-foot minimum range, a wave-off is given by the final controller.

Type of Emission: Pulse  
 Peak Power Output: 40 to 60 kw  
 Pulse Rate: 4, 000 pps  
 Pulse Width: 0.25  $\mu$ sec  
 Nominal Carrier Output: 25 kw peak power for each type of emission  
 Frequency Stability:  $\pm$ 0.5 mc for receiver local oscillator, AFC, and magnetron  
 Receiver Output: 5v peak into 70-ohm line IF. Frequency: 60 mc  
 Operating Voltages and Power Requirements:  
 115v, 60 cps, 1-ph, 4.6 kva, 0.5 amp max starting current; 115v, 40 cps  $\pm$ 4%, 3-ph, 4.5 kva delta-connected negative phase sequence  
 Antenna Type: Searchlight beam  
 Antenna Feed: X-band horn  
 Antenna Gain: 33 db  
 Horizontal Beam Width: 1.5 deg  
 Vertical Beam Width: 6 deg (between half-power points)  
 Tilt Angle: 5 deg above and 2 deg below horizontal  
 Scanning Data: 100 deg arc in azimuth with 3 oscillations per second

**RELATION TO SIMILAR EQUIPMENT**

None.

**TECHNICAL DESCRIPTION**

Frequency: 9000 to 9180 mc continuously variable

Range: 6 naut mi (max); 200 ft (min)

**INSTALLATION CONSIDERATIONS**

Not available.

**PRINCIPAL COMPONENTS AND PHYSICAL DATA**

COMPONENT	QTY	HEIGHT (Inches)	WIDTH (Inches)	DEPTH (Inches)	UNIT WT. (Pounds)
Receiver-Transmitter Group OA-3 64/SPN-8	1	50.25	21.0	26.88	620
Indicator Group OA-155/SPN-8	1	44.50	25.5	26	466
Indicator Group OA-156/SPN-8	1	44.50	25.25	26	477
Indicator Group OA-157/SPN-8	1	44.50	25.25	26	472
Antenna AS-477/SPN-8	1	42	32.38	36.12	535
Radome CW-205/SPN-8	1	102	32.38	82	410
Tuned Cavity FR-68/UP	1	20.26	15.06	19.59	15
Indicator Control C-1063/SPN-8	1	7.76	3.50	4.56	3

**PRINCIPAL COMPONENTS AND PHYSICAL DATA (cont'd)**

<b>COMPONENT</b>	<b>QTY</b>	<b>HEIGHT (Inches)</b>	<b>WIDTH (Inches)</b>	<b>DEPTH (Inches)</b>	<b>UNIT WT. (Pounds)</b>
Indicator Control C-1082/SPN-8	1	7.76	3.50	4.56	4
Line Frequency Meter	1	5.89			
Solenoid Relay RE-127/SPN-8	1	14.94	8.44	9.19	28

**REFERENCE DATA AND LITERATURE**

Technical Manual:  
NAVSHIPS 91879(A)

**AN/SPN-8: 3**



DATE: 1 July 1964

ITEM NAME: SHIPS MOTION RECORDING SET

COGNIZANT SERVICE: USN

TYPE: AN/SPN-10(XN-1)

FEDERAL STOCK NUMBER:

	USA	USN	USAF	USMC
STATUS OR TYPE CLASSIFICATION		P Std		

Mfg(s) Name or Code Number: See NOTE #2.

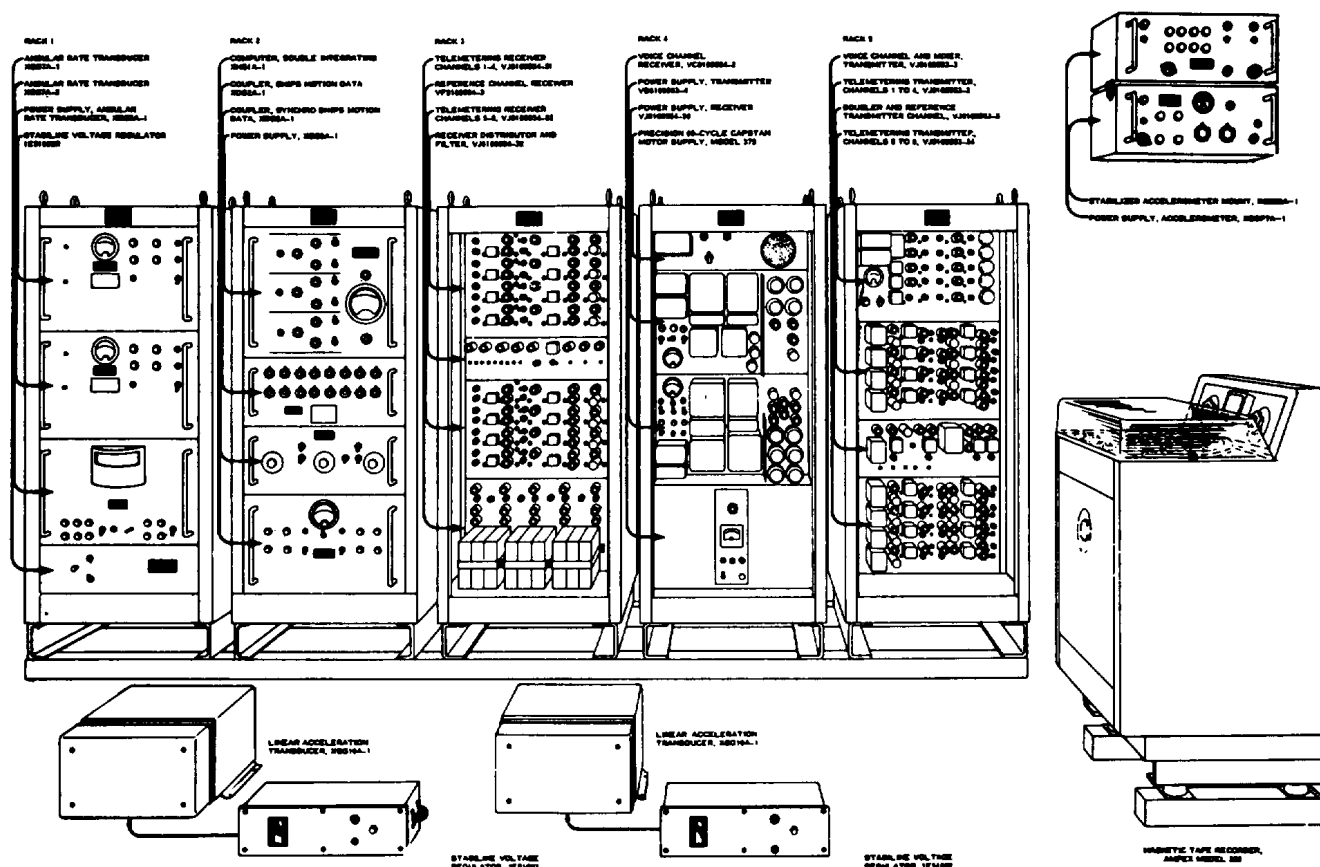

## FUNCTIONAL DESCRIPTION

The Ships Motion Recording Set is a specialized equipment for shipboard use. It is designed to sense roll, pitch yaw, roll rate, pitch rate and vertical

acceleration at three locations, to compute velocity and displacement from each acceleration channel and to record simultaneously any eight of these components and operator's verbal data on a standard magnetic tape.

AN/SPN-10(XN-1): 1

**ITEM NAME:** SHIPS MOTION RECORDING SET

**TYPE:** AN SPN-10(XN-1)

**RELATION TO SIMILAR EQUIPMENT**

None.

**TECHNICAL DESCRIPTION**

**Power Requirements**

Main Sensing & Computing Units (Racks 1, 2 and Stabilized Accelerometer):

100 to 125v, 60 plus or minus 6 cps, 800 va; 100 to 125v, 400 plus or minus 20 cps, 27 va

Recording and Playback Equipment (Racks 3, 4, 5 and Magnetic Tape Recorder):

100 to 125v, 60 plus or minus 6 cps, 1250 va.

Each Remote Linear Acceleration Transducer (With Stabiline Voltage Regulator):

100 to 125v, 60 plus or minus 6 cps, 100 va.

**Data Inputs to Main Unit**

3 stator and reference ph from 36-speed synchro of Stable Element (oriented to indicate roll).

3 stator ph and reference ph from 72-speed synchro of Stable Element (oriented to indicate pitch).

3 stator ph and reference ph from compass 36-speed output

3 stator ph and reference ph from compass single speed output

**Sensing Channels:** 14 channels, any eight of which may be recorded.

**Telemetering Transmitter Channels:** Consists of eight carrier frequency between 4930 to 14, 770 cps. Frequency below these bands are used for single voice channel, permitting the recording of pertinent information.

**Calibrating Voltages**

**Sensing Equipment**

Translatory Motion: 5v equals 25 ft; 5v equals 25 ft per sec; 5v equals 25 ft per sec 2.

Stabilized Accelerometer: 5v equals 5,

10, 20 or 40 ft (after double integration Angular Displacements

Roll: 5v equals 10 deg

Pitch: 5v equals 3 deg or 10 deg

Yaw: 5v equals 10 deg or 360 deg

**Angular Rates**

Roll Rate: 5v equals 0.1 radius per sec

Pitch Rate: 5v equals 0.1 radius per sec

**Magnetic Tape Recorder**

Tape Speed: 15 and 7.5 cps

Frequency Response: At 15 in., plus or minus 2 db, 50 to 15, 000 cps; at 7.5 in. plus or minus 2 db, 50 to 7500 cps.

Signal to Noise Ration: Over 60 db

Starting Time: Instantaneous (full speed in less than 1/10 sec).

Stopping Time: At 15 rps movement less than 2 in after stop button is depressed.

Flutter and WOW: At 15 cps, less than 0.1 % root-mean-square, measuring all flutter components from 0 to 300 cps, using a tone of 3000 cps. At 7.5 in, under 0.2%.

Monitoring of Tape: Separate record and playback heads and amplifiers.

Playback Timing Accuracy: 0.2%

Playing Time: 33 min. at 15 in speed on standard 10-1/2 in NAB reel, 66 min at 7.5 in speed. The recorder will also accommodate the standard RMA reel in various thicknesses.

Rewind Time: 1 min for full NAB reel.

Record Amplifier: Budging input, normally set up for plus 4 vu in.

Playback Amplifier: Normal plus 4 vu output. Rated to deliver 20 dbm without exceeding 1% total harmonic distortion from 30 to 15, 000 cps.

**INSTALLATION CONSIDERATIONS**

Not available.

**PRINCIPAL COMPONENTS AND PHYSICAL DATA**

<b>COMPONENTS</b>	<b>QTY</b>	<b>OVERALL DIMENSIONS (Inches)</b>	<b>UNIT WT. (Pounds)</b>
Linear Acceleration Transducer XGG10A-1	2	8-3/4 x 12-3/4 x 13-3/4	24
Stabilized Accelerometer Mount XQG22A-1	1	8-3/4 x 15-3/4 x 19-7/8	45
Accelerometer Power Supply XBG17A-1	1	8-5/8 x 15-3/8 x 20-3/4	29
Double Integrating Computer XHG1A-1	1	14 x 16-1/4 x 19	39
Angular Rate Transducer XGGTA-1	1	12 x 16-1/4 x 19	35
Angular Rate Transducer XGG7A-2	1	12 x 16-1/4 x 19	35
Ships Motion Data Coupler XDG2A-1	1	8 x 16-1/8 x 19	15
Ships Motion Data Synchro Coupler XDGBA-1	1	8 x 16-1/8 x 19	42

**ITEM NAME:** SHIPS MOTION RECORDING SET

**TYPE:** AN/SPN-10(XN-1)

**PRINCIPAL COMPONENTS AND PHYSICAL DATA (Cont.)**

<b>COMPONENTS</b>	<b>QTY</b>	<b>OVERALL DIMENSIONS (Inches)</b>	<b>UNIT WT. (Pounds)</b>
Power Supply XBG3A-1	1	12 x 16-1/4 x 19	60
Angular Rate Transducer Power Supply XBG5A-1	1	12 x 16-1/4 x 19	110
"Stabiline" Voltage Regulator	1	5-1/4 x 13-3/4 x 19	48
"Stabiline" Voltage Regulator	2	5-3/4 x 14 x 20	45
D.C. Signal Generator XUG20A-1	1	4-1/2 x 7-1/2 x 8-1/4	4.5
Cabinet, Racks 1 and 2 XQG10A-1	2	18 x 22-1/2 x 51	48
Voice Channel and Mixer-Transmitter	1		
Telemetry Channels 1 to 4 Transmitter	1		
Double and Reference Channel-Transmitter	1		
Telemetry Channels 5 to 8-Transmitter	1		
Telemetry Channels 1 to 4-Receiver	1		
Reference Channel-Receiver	1		
Telemetry Channels 5 to 8-Receiver	1		
Distributor and Filter-Receiver	1		
Voice Channel-Receiver	1		
Power Supply-Transmitter	1		
Power Supply-Receiver	1		
Precision 60-Cycle Capstan Motor Supply	1		
Magnetic Tape Recorder	1		
Cabinets, Racks 3, 4 and 5	3		
7.51.P.S. Filters-Receivers	*1		
Cabinet, Rack 6	*1		
Oscilloscope RCA WO-57B	1		
Vacuum Tube Volt-Ohmmeter Simpson 303	1		
Recorder Sanborn 127	1		
D.C. Amplifier Sanborn 126	1		

**NOTE #1: \*Supplied with set Serial No. 3 and 4 for playback use only.**

**REFERENCE DATA AND LITERATURE**

Technical Manuals:  
NAVSHIPS 92667

**NOTE #2: Minneapolis-Honeywell Regulator Co., Minneapolis, Minn.  
Bell Aircraft Corp., Buffalo, N. Y.**

**AN/SPN-10(XN-1): 3**

DATE: 1 July 1964

ITEM NAME: RADAR SET

COGNIZANT SERVICE: USA  
USN

TYPE: AN/SPN-11, -11X, \* -11Y, -11Z\*\*

FEDERAL STOCK NUMBER: 5840-642-8237 w-s \*  
5840-665-1211 \*\*

	USA	USN	USAF	USMC
STATUS OR TYPE CLASSIFICATION	Alt Std**	See Note 1		

Mfg(s) Name or Code Number: Radiomarine Corporation of America

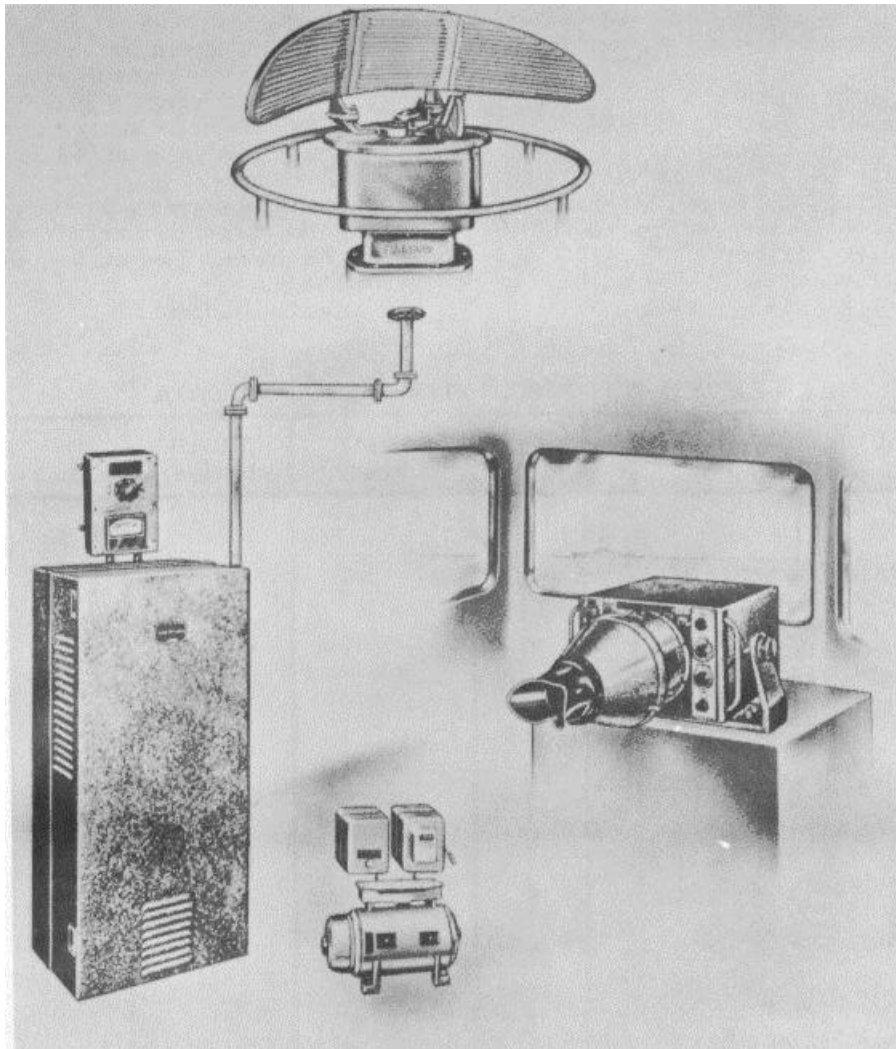

AN/SPN-11: 1

AN/SPN-11, - 11X, - 11Y, - 11Z

**FUNCTIONAL DESCRIPTION**

Radar Sets AN/SPN-11, -11X, -11Y, and -11Z are shipboard radar navigational aids for small craft. They provide position data on ships and landmarks at ranges of from 75 yards to 20 nautical miles. The sets provide anticollision data by observing positions and courses of ships on the open sea; piloting information by observing positions of buoys and other markers in channels and harbors; bearings and ranges of known landmarks to plot the position of the radar-equipped craft; and storm warning data by observing and plotting movements of heavy rain or snow squalls.

Duty Cycle: 0.004  
Pulse Repetition Rate: 1, 000 pps  
Pulse Width: 0.4  $\mu$ sec  
Horizontal Beam Width: 1.9 deg  
Vertical Beam Width: 20 deg  
Range Resolution: 75 yd  
Bearing Resolution: 2 deg  
Range Scales: 1, 3, 8, and 20 naut mi  
IF. Frequency: 30 mc  
IF. Bandwidth: 5 mc  
Receiver Sensitivity: -90 dbm  
Antenna Feed: Horn type, 400 to 500 ohms input impedance  
Antenna Speed: 17 rpm

**RELATION TO SIMILAR EQUIPMENT**

None.

**INSTALLATION CONSIDERATIONS**

**TECHNICAL DESCRIPTION**

Frequency: 9320 to 9430 mc  
Range: 20 naut mi (max); 75 yd (min)  
RF Power Source: Magnetron  
Power Output: 30 kw (peak); 12w (avg)  
Operating Voltages and Power Requirements:  
AN/SPN-11 - 115 vac, 400 cps, 1-ph  
AN/SPN-11X - 115 vdc, 1, 000w  
AN/SPN-11Y - 32 vdc  
AN/SPN-11Z - 24 vdc, 1, 000w  
Type of Presentation: One 7-in. PPI

Siting: The antenna should be high enough to permit the radar beam to clear large shipboard structures. The front end of the antenna base must face directly ahead and be accurately aligned in a fore and aft direction.  
Mounting:  
Cabling Requirements: The waveguide run from the base of the antenna to the receiver-transmitter must be as short and straight as possible.  
Related Equipment:

**PRINCIPAL COMPONENTS ANC PHYSICAL DATA**

COMPONENT	QTY	HEIGHT (Inches)	WIDTH (Inches)	DEPTH (Inches)	UNIT WT. (Pounds)
AN/SPN-11					
Radar Receiver-Transmitter RT-268( )/SPN-11	1				
Azimuth and Range Indicator IP-193( )/SPN-11	1				
Antenna AS-599( )/SPN-11	1				
Resistance Element HD-123( )/SPN-11	1				
Motor Generator (AC)	1				
Motor Generator (DC)	1				
Circuit Breaker	1				
Starter Motor	1				
Switch Box SA-284( )/SPN-11	1				
Voltage Regulator CN-192( )/SPN-11	1				

AN/SPN-11, - 11X, - 11Y, - 11Z

**PRINCIPAL COMPONENTS AND PHYSICAL DATA (cont'd)**

<b>COMPONENT</b>	<b>QTY</b>	<b>HEIGHT (Inches)</b>	<b>WIDTH (Inches)</b>	<b>DEPTH (Inches)</b>	<b>UNIT WT. (Pounds)</b>
AN/SPN-11X					
Radar Receiver-Transmitter RT-268/SPN-11	1	43-5/8	20-5/8	13-3/4	215
Azimuth and Range Indicator IP-193/SPN-11	1	16-3/8	18	19	60
Antenna AS-599/SPN-11	1	22-1/2	33-3/4	50	155
Motor Generator PU-243/SPN-11	1	9-1/4	13-3/4	19-1/2	170
Motor Starter SA-287/SPN-11	1	9-1/2	6-13/16	6-29/32	13
Voltage Regulator CN-192/SPN-11	1	11-1/2	8-3/8	5-1/2	8
Junction Box J-497/SPN-11	1	14-1/8	6-3/4	3-3/4	5
Switch Box SA-284/SPN-11	1	7	6-3/4	4	4.25
AN/SPN-11Y					
Radar Receiver-Transmitter RT-268/SPN-11	1	43-5/8	20-5/8	13-3/4	215
Azimuth and Range Indicator	1	16-3/8	18	19	60
Antenna AS-599/SPN-11	1	22-1/2	33-3/4	50	155
Motor Generator	1				
Motor Starter	1				
Voltage Regulator	1				
Junction Box	1				
Switch Box	1				
AN/SPN-11Z					
Radar Receiver-Transmitter RT-268/SPN-11	1	43-5/8	20-5/8	13-3/4	215
Azimuth and Range Indicator IP-193/SPN-11	1	16-3/8	18	19	60
Antenna AS-599/SPN-11	1	22-1/2	33-3/4	50	155
Motor Generator PU-244/SPN-11	1	9-1/4	13-3/4	19-1/2	170

**AN/SPN-11: 3**

AN/SPN-11, -11X, -11Y, -11Z

**PRINCIPAL COMPONENTS AND PHYSICAL DATA (cont'd)**

<b>COMPONENT</b>	<b>QTY</b>	<b>HEIGHT (Inches)</b>	<b>WIDTH (Inches)</b>	<b>DEPTH (Inches)</b>	<b>UNIT WT. (Pounds)</b>
Motor Starter SA-285/SPN-11	1	12	7-1/8	8-3/4	19
Voltage Regulator CN-194/SPN-11	1				
Junction Box J-497/SPN-11	1	14-1/8	6-3/4	3-3/4	5
Switch Box SA-283/SPN-11	1	11	10-1/4	5-1/4	8

**REFERENCE DATA AND LITERATURE**

Technical Manuals:

- TM 11-1335
- TM 11-1535
- NAVSHIPS 92487
- NAVSHIPS 91751
- NAVSHIPS 91752

**Note 1: Navy Status of Obsolescent for  
AN/SPN-11, -11X and -11Z.**

**AN/SPN-11: 4**

DATE: 1 July 1964

ITEM NAME: RADAR SET

COGNIZANT SERVICE: USN

TYPE: AN/SPN-13

FEDERAL STOCK NUMBER:

	USA	USN	USAF	USMC
STATUS OR TYPE CLASSIFICATION				

Mfg(s) Name or Code Number: General Electric Company

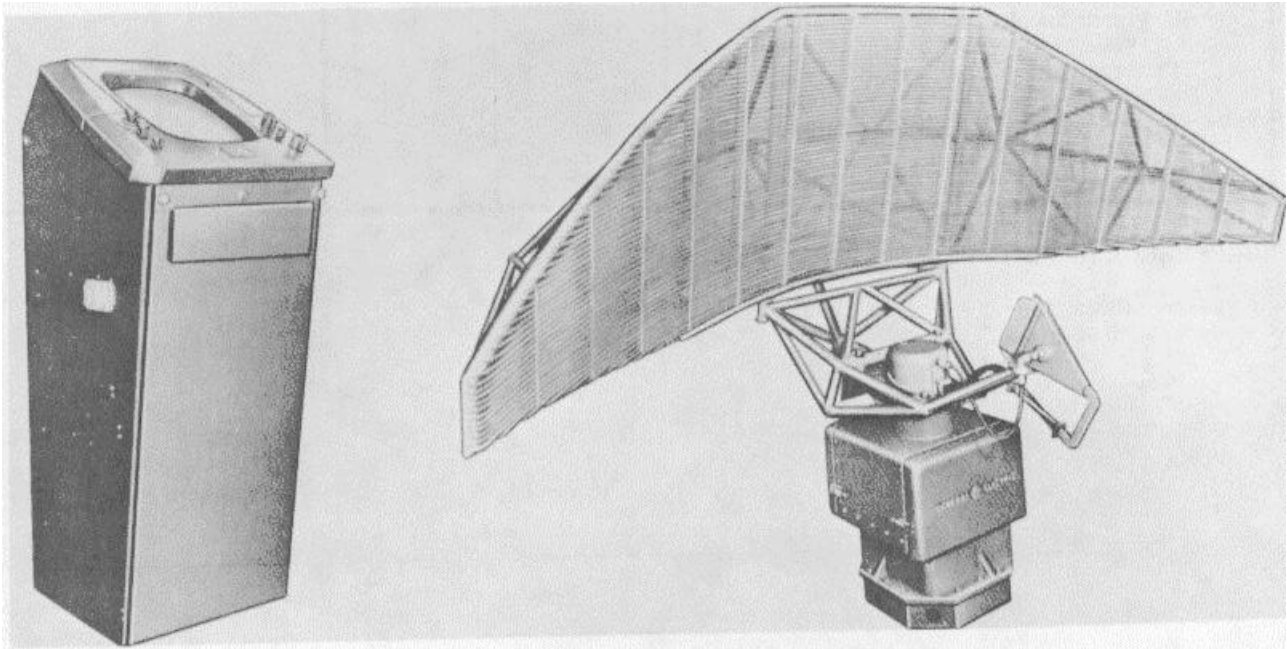

### FUNCTIONAL DESCRIPTION

The AN/SPN-13 is a shipborne dual-frequency navigational radar equipment. Both 3070 and 9375 mc operations are combined in a single set.

The equipment is comprised of two major units; a single antenna which is used for both frequencies; and a compact console which contains all controls, a 17-in. PPI, indicator chassis, transmitter chassis, and power supplies.

oscillator (automatic or manual control)  
Presentation: One 17-in. PPI  
Range Scales: 1.5, 5, 10, 25, and 50 mi  
Pulse Repetition Rate: 1, 200 cps  
Antenna Type: Horn, slotted line  
Antenna Polarization: Horizontal  
Operating Voltages and Power Requirements:  
115v, 60 cps, 1-ph, 700w

### RELATION TO SIMILAR EQUIPMENT

None.

### TECHNICAL DESCRIPTION

Frequency: 3070 and 9375 mc  
Frequency Control: 3-cm and 10-cm klystron

### INSTALLATION CONSIDERATIONS

Siting:  
Mounting: Antenna pedestal requires a mounting base 17 inches square or 18 inches in diameter. The console is deck mounted on bridge and requires a space 16.5 inches by 18.5 inches.  
Cabling Requirements:  
Related Equipment:



AN/SPN-13

**PRINCIPAL COMPONENTS AND PHYSICAL DATA**

<b>COMPONENT</b>	<b>QTY</b>	<b>HEIGHT (Inches)</b>	<b>WIDTH (Inches)</b>	<b>DEPTH (Inches)</b>	<b>UNIT WT. (Pounds)</b>
Console (including) (1) Transmitter T-352/SPN-13 (1) Indicator and Azimuth Range IP-195/SPN-13 (1) Control Receiver C-1080/SPN-13 (1) RF Amplifier AM-690/SPN-13 (1) IF Amplifier AM-691/SPN-13 (1) Video Amplifier AM-689/SPN-13 (2) Power Supply PP-819/SPN-13, PP-181/SPN-13 (1) Trigger Amplifier AM-688/SPN-13 (1) Control Indicator C-1079/SPN-13	1	51-1/4	23-1/2	22-1/8	310
Antenna AS-601/SPN-13	1	104	43	42	226

**REFERENCE DATA AND LITERATURE**

Technical Manual:  
NAVSHIPS 91653.2

**AN/SPN-13: 2**

DATE: 1 July 1964

ITEM NAME: RADAR SET

COGNIZANT SERVICE: USA\*\*  
USN\*

TYPE: AN/SPN-18\*, -18X\*\*

FEDERAL STOCK NUMBER:

	USA	USN	USAF	USMC
STATUS OR TYPE CLASSIFICATION				

Mfg(s) Name or Code Number: Radiomarine Corporation of America

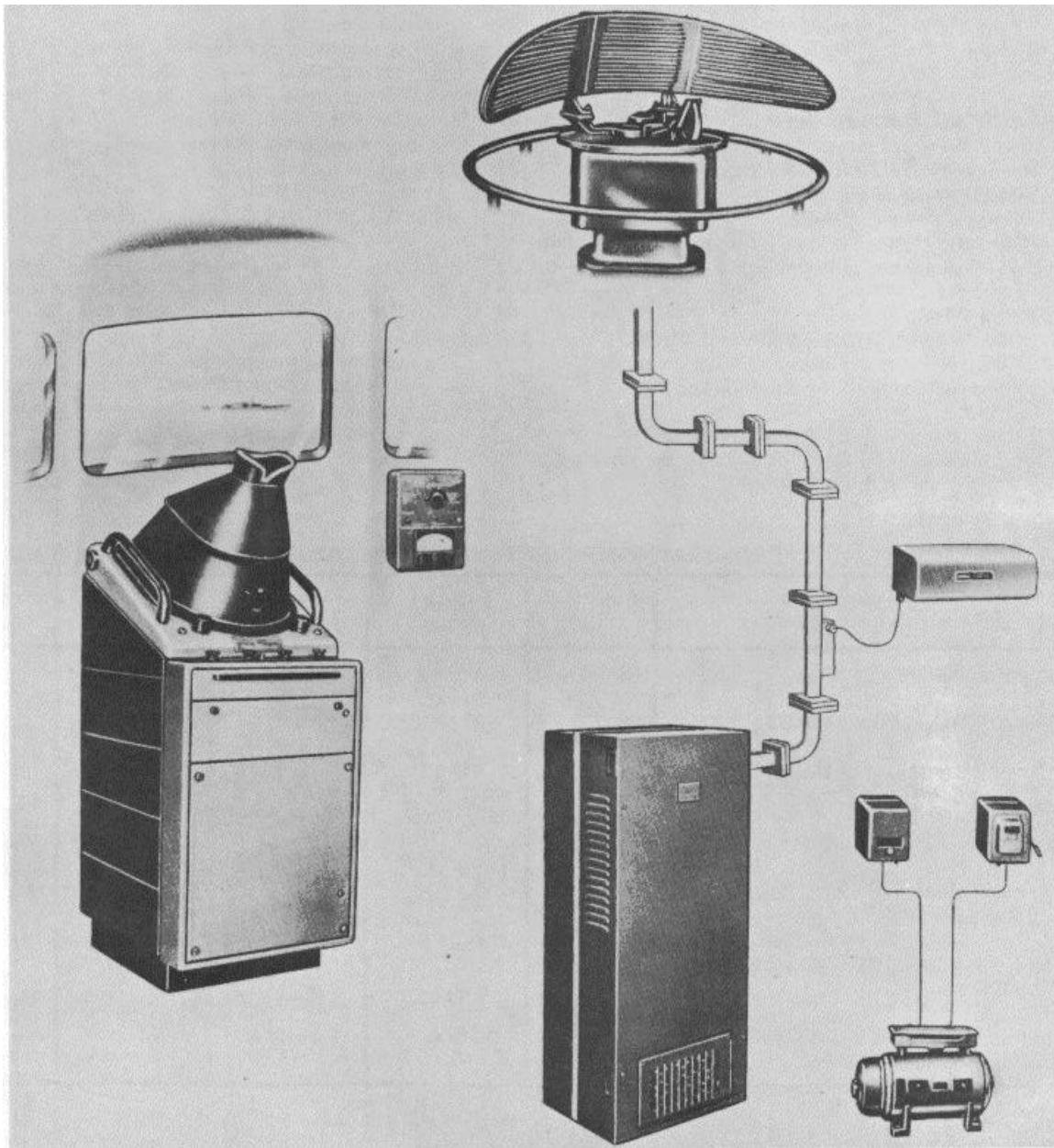

AN/SPN-18: 1

AN/SPN-18, -18X

**FUNCTIONAL DESCRIPTION**

Radar Set AN/SPN-18 and -18X are shipboard equipments that supply position data of ships and landmarks. These equipments provide anticollision data; piloting information through observation of shorelines, buoys, and channel markers; and storm warning data by tracking heavy rain or snow squalls.

The AN/SPN-18 is operated from a dc power source, while the AN/SPN-18X is operated from an ac source.

**RELATION TO SIMILAR EQUIPMENT**

None.

**TECHNICAL DESCRIPTION**

Frequency: 9320 to 9430 mc  
 Peak Power Output: 40 kw  
 Average Power: 20w  
 Pulse Repetition Rate: 2, 000 pps for 1-, 2-, and 4-mi ranges; 800 pps for 8-, 20-, and 40-mi ranges  
 Pulse Width:  
 25  $\mu$ sec for 1-, 2-, and 4-mi ranges;  
 65  $\mu$ sec for 8-, 20-, and 40-mi ranges  
 Type of Presentation: One 16-in. PPI  
 Ranges:  
 Searching - 1, 2, 4, 8, 20, and 40 mi  
 Tracking - 1, 2, 4, 8, and 20 mi, and up to 20 mi on 40-mi range

**Operating Voltages and Power Requirements:**

AN/SPN-18 - 115 vdc  
 AN/SPN-18X - 115v, 60 cps, 1-ph  
 Receiver Type: Superheterodyne  
 IF. Frequency: 30 mc  
 Bandwidth: 8 mc for 1-, 2-, and 4-mi ranges;  
 2.5 mc for 8-, 20-, and 40-mi ranges  
 Azimuth Coverage: 360 deg continuous rotation  
 Range Accuracy: 2% on all ranges  
 Azimuth Accuracy: 1 deg  
 Range Resolution:  
 5 yd on 1-, 2-, and 4-mi ranges  
 Azimuth Resolution: 1.5 deg  
 Antenna Type: Parabolic reflector with feed horn  
 Horizontal Beam Width: 1.9 deg  
 Vertical Beam Width: 20 deg  
 Sidelobe Attenuation: 30 db  
 Rotation Speed: 9 rpm  
 Antenna Feed: Waveguide

**INSTALLATION CONSIDERATIONS**

Siting: The antenna should be positioned so that the radar beam will clear large shipboard structures.  
 Mounting:  
 Cabling Requirements: The waveguide run from the base of the antenna to the receiver-transmitter must be made as short and straight as possible.  
 Related Equipment:

**PRINCIPAL COMPONENTS AND PHYSICAL DATA**

COMPONENT	QTY	HEIGHT (Inches)	WIDTH (Inches)	DEPTH (Inches)	UNIT WT. (Pounds)
Antenna AS-659/SPN-18	1	50	33-3/4	22-1/2	160
Control Indicator C-1261/SPN-18	1	47-3/8	23-1/4	20-1/2	235
Circuit Breaker SA-369/SPN-18X (18X only)	1	9-3/16	6-1/16	5-1/8	8
Duplexer CU-311/SPN-11	1				
Frequency Mixer Stage CV-239/SPN-11	1				
Motor Generator PU-243A/SPN-11 (18 only)	1	20-1/2	13-3/4	9-1/4	170
Motor Generator PU-288/SPN-18X (18X only)	1	29-1/2	14-3/4	12-9/16	250

**PRINCIPAL COMPONENTS AND PHYSICAL DATA (cont'd)**

<b>COMPONENT</b>	<b>QTY</b>	<b>HEIGHT (Inches)</b>	<b>WIDTH (Inches)</b>	<b>DEPTH (Inches)</b>	<b>UNIT WT. (Pounds)</b>
Motor Starter SA-342/SPN-18 (18 only)	1	9-1/8	7	6-13/16	13
Powergraph Position Tracker Radiomarine Type RM-182	1	18-3/4	18-1/2	17-1/4	17.5
Radar Receiver R-572/SPN-18	1				
Radar Receiver-Transmitter RT-290/SPN-18	1	43-5/8	30-5/8	13-3/4	255
Resistance Element HD-124/SPN-11	1				
Switch Box SA-284/SPN-11 (18 only)	1	7-1/2	7-1/8	4-1/8	4.25
Switch Box SA-368/SPN-18X (18X only)	1	7-1/2	7-1/8	4-1/8	4.25
Voltage Regulator CN-255/SPN-18	1	11-5/8	7-1/2	7-1/8	14
Electrical Synchronizer SN-119/SPN-18	1				
Video Amplifier AM-874/SPN-18	1				
Tuned Cavity TN-224/SPN-18	1	13-7/8	6-1/2	6-1/8	20
Directional Coupler CU-356/SPN-18	1				

**REFERENCE DATA AND LITERATURE**

Technical Manual:  
TM 11-1330

**AN/SPN-18: 3**

**MIL-HDBK-162A**  
15 December 1965

Volume 1  
Section 3

**DATE:** 1 July 1964

**ITEM NAME:** RADAR SET

**COGNIZANT SERVICE:** USN

**TYPE:** AN/SPN-21

**FEDERAL STOCK NUMBER:**

	<b>USA</b>	<b>USN</b>	<b>USAF</b>	<b>USMC</b>
<b>STATUS OR TYPE CLASSIFICATION</b>				

Mfg(s) Name or Code Number: Raytheon Manufacturing Company, Waltham, Massachusetts

Illustration not Available.

**FUNCTIONAL DESCRIPTION**

The AN/SPN-21 is designed as a small boat

surface search navigational Radar Set.

**AN/SPN-21: 1**

**ITEM NAME:** RADAR SET

**TYPE:** AN/SPN-21

**RELATION TO SIMILAR EQUIPMENT**

None.

Operating Power Requirements: 105v, 115v  
or 125v, 57 to 63 cps, single ph.

**TECHNICAL DESCRIPTION**

Operating Frequency Data  
Transmitter and Receiver: 9335 to 9405  
mc.

**INSTALLATION CONSIDERATIONS**

Not available.

**PRINCIPAL COMPONENTS AND PHYSICAL DATA**

<b>COMPONENTS</b>	<b>QTY</b>	<b>OVERALL DIMENSIONS (Inches)</b>	<b>UNIT WT. (Pounds)</b>
Radar Set AN/SPN-21 including:	1		
Antenna Unit No. 1953C	1		
Control-Indicator Unit No. 1954A	1		
Installation Kit, Electronic Equipment Unit No. 1956A	1		
Set of Equipment Spares	1		

**REFERENCE DATA AND LITERATURE**

Nomenclature Card AN/SPN-21 for Radar Set.

**AN/S PN-21: 2**

**DATE:** 1 July 1964

**ITEM NAME:** RADAR SET

**COGNIZANT SERVICE:** USN

**TYPE:** AN/SPN-22

**FEDERAL STOCK NUMBER:**

	USA	USN	USAF	USMC
<b>STATUS OR TYPE CLASSIFICATION</b>				

Mfg(s) Name or Code Number: Radiomarine Corporation of America, New York, N. Y.

Illustration not available.

**FUNCTIONAL DESCRIPTION**

The AN/SPN-22 is designed as a small

boat surface search navigational Radar Set.

**AN/SPN-22: 1**

**ITEM NAME:** RADAR SET

**TYPE:** AN/SPN-22

**RELATION TO SIMILAR EQUIPMENT**

None

Transmitter and Receiver: 9320 to 9430  
mc  
Operating Power Requirements: 115 or 230v,  
60 cps, single ph.

**TECHNICAL DESCRIPTION**

Type of Emission: PO type  
Operating Frequency Range

**INSTALLATION CONSIDERATIONS**

Not available.

**PRINCIPAL COMPONENTS AND PHYSICAL DATA**

<b>COMPONENTS</b>	<b>QTY</b>	<b>OVERALL DIMENSIONS (Inches)</b>	<b>UNIT WT. (Pounds)</b>
Radar Set AN/SPN-22 including:	1		
Azimuth and Range Indicator IP-371/SPN-22	1		
Antenna AS-320/SPN-22	1		
Interconnecting Box J-767/SPN-22	1		
Multimeter ME-109/SPN-22	1		
Reflection Plotter, Radar Data PT-408/S PN-22	1		
Indicator Cover CW-415/SPN-22	1		

**REFERENCE DATA AND LITERATURE**

Nomenclature Card AN/SPN-22 for Radar Set.



DATE: 1 July 1964

ITEM NAME: RADAR SET

COGNIZANT SERVICE: USN

TYPE: AN/SPN-23

FEDERAL STOCK NUMBER:

	USA	USN	USAF	USMC
STATUS OR TYPE CLASSIFICATION		Std		

Mfg(s) Name or Code Number: Edo Corporation

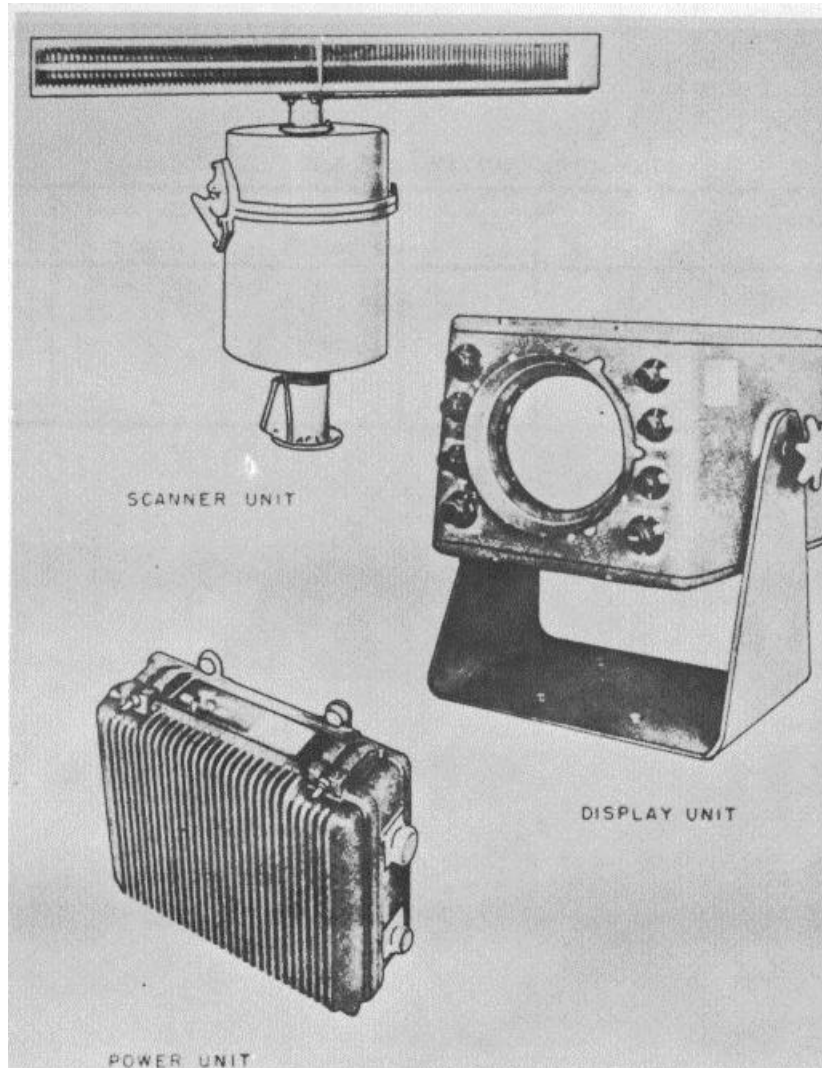

AN/SPN-23: 1

AN/SPN-23

**FUNCTIONAL DESCRIPTION**

Radar Set AN/SPN-23 is a small-boat surface search navigational radar equipment designed to display visually the ranges and bearings of surface objects at ranges up to 20 nautical miles.

**RELATION TO SIMILAR EQUIPMENT**

Same as Edo Corp. Radar Model 320, except that the AN/SPN-23 is equipped with a 24 vdc inverter.

**TECHNICAL DESCRIPTION**

Frequency: 9345 to 9405 mc  
Power Output: 7 to 10 kw

Pulse Repetition Rate: 1,000 pps  
Pulse Width: 0.15 to 0.25  $\mu$ sec on 1-, 2-, and 5-mi range; 0.4 to 0.5  $\mu$ sec on 10- and 20-mi ranges  
IF. Frequency: 30 mc  
Bandwidth: 8 mc  
Type of Presentation: One 7-in. PPI  
Ranges: 1 2, 5, 10, and 20 mi  
Inverter Output: 115v, 1,000 cps, 1-ph, 260w  
Operating Voltages and Power Requirements: 24 vdc  
Horizontal Beam Width: 1.8 deg  
Vertical Beam Width: 25 deg  
Antenna Rotation Speed: 15 rpm

**INSTALLATION CONSIDERATIONS**

Not available.

**PRINCIPAL COMPONENTS AND PHYSICAL DATA**

<b>COMPONENT</b>	<b>QTY</b>	<b>HEIGHT (Inches)</b>	<b>WIDTH (Inches)</b>	<b>DEPTH (Inches)</b>	<b>UNIT WT. (Pounds)</b>
Antenna-Scanner Unit	1	14	24	24	
Display Unit	1	16	13	10	
Power Supply and Receiver	1	16	14	6	
					Total Wt. 260

**REFERENCE DATA AND LITERATURE**

Technical Manual:  
NAVSHIPS 92721

DATE: 15 September 1964

ITEM NAME: AIRCRAFT APPROACH CONTROL  
CENTRAL

COGNIZANT SERVICE: USN

TYPE: AN/SPN-35

FEDERAL STOCK NUMBER:

	USA	USN	USAF	USMC
STATUS OR TYPE CLASSIFICATION		Std		

Mfg(s) Name or Code Number: Gilfillan Corporation (24930)

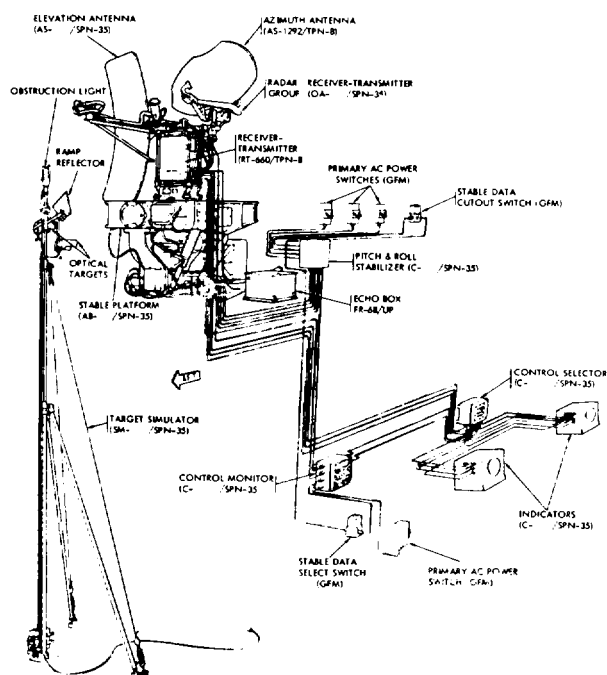

## FUNCTIONAL DESCRIPTION

Aircraft Approach Control Central AN/SPN-35 is a carrier controlled approach radar system used for precision landing approaches to an aircraft carrier during adverse weather conditions. This system is used in

conjunction with an optical landing system for carrier landing operations. The radar system displays both azimuth and elevation data on each radar indicator (up to four indicators may be used), which enables the radar operator to direct the pilot along a predetermined glidepath and azimuth courseline to a transition point

**ITEM NAME:** AIRCRAFT APPROACH CONTROL CENTRAL

**TYPE:** AN/SPN-35

one mile from the ship. The radar system may also be used for air traffic control, height finding, and radar surveillance of aircraft.

**RELATION TO SIMILAR EQUIPMENT**

None.

**TECHNICAL DESCRIPTION**

IF. Delay Line  
Delay: 0.24 usec Impedance: 50 ohms  
Attenuation: 8 db

Control Indicator Group  
General  
Number of Indicators: 2, 3 or 4  
Indicator Presentation: PPI or beta  
can be displayed in indicators in search and PREC modes respectively; PPI display or beta display on any indicator when master indicator is in SIMULT mode  
Remoting: 500 ft or less

Surveillance: (Search)  
Type Display: PPI (10 in.)  
Ranges: Linear (5-, 10-, 20- and 40-mi sweeps)  
Offset Ranges: Full radius (except 40-mi)  
Range Marks: i-mi spacing on 5- and 10-mi sweeps; 5-mi spacing on 20- and 40-mi sweeps; one 1/4 mi range mark, separately selected and separately adjustable on 5- and 10-mi ranges  
Range Mark Accuracy: plus or minus 1%  
Azimuth Display: 300 or 600 sector scan or 360° in SIMULT mode, within a -1° to plus 10° elevation sector  
Elevation Display: -1° to plus 10° or -1° to plus 35 within a 300 azimuth section scan  
Date Rate: One azimuth and elevation picture every sec in NORM code; one azimuth and one elevation picture every 2 sec in 600 AZ mode; approx 16 azimuth and 24 elevation pictures every 60 sec on precision display in SIMULT mode; od{ azimuth and one elevation picture every sec in 35° EL mode  
Glideslope Cursors: Adjustable to any glideslope from plus 1° to 45° in elevation  
Runway (Canted Deck) Cursors: 2 electronic preset cursors adjustable to any heading within the siting criteria

Service Conditions  
Ambient Temperature  
Operating: -40°C (-40°F) to plus 50°C (plus 122°F)  
Non-Operating: -62°C (-800F) to plus 75°C (plus 167°F)  
Relative Humidity: No adverse effects up to 95% relative humidity (operating and non-operating)  
Altitude

Operating: Sea level to 6000 ft Non-Operating: Sea level to 25,000 ft

Winds  
Operating: 40 knots Non-Operating: 100 knots  
Sand and Dust: As encountered in arid regions (particles 10-20 microns in size)

Elevation Antenna  
Beamwidth: 1/2 power  
Vertical: 1.1u max  
Horizontal: 3.5° max csc2 to -15°  
Gain: 35 db  
Polarization: Vert or circular  
Scan Coverage: Scan -1° to plus 10°, or -1° to plus 35°  
Horizontal Servo: plus or minus 15°  
Vertical Height: 8 ft  
Horizontal Width: 2 ft

Azimuth Antenna  
Beamwidth: 1/2 pwr  
Vertical: 3.5°max csc 2 to 30°  
Horizontal: 1.3° max  
Gain: 37 db  
Polarization: Horiz or circular  
Scan Coverage: 30°, 60°, and 360°  
Tilt: -1° to plus 25°  
Vert Ht.: 4.5 ft; Horiz Width: 6.5 ft

Transmitter  
Operating Frequency: X-band (9.0 to 9.16 giga cyc)  
Pulse Width: 0.2 or 0.8 usec  
PRF: 1200 pps  
Peak Power Output: 200 kw nom

Receiver  
Minimum Detectable Signal: -101 db  
Receiver IF. Bandwidth: 2 mc for 0.8 usec pulse; 7 mc for 0.2 usec pulse  
Receiver FTC: Selected by operator  
Receiver STC: Selected by operator  
Receiver Tuning: Local oscillator tune from operator's position  
RF Noise Figure: 10.5 db

IF. Preamplifier  
Gain: Var (plus 27 db to -13 db)  
Bandwidth: 13 mc  
Center Frequency: 60 mc  
Noise Figure: 2.8 db

IF. Amplifier  
Gain: Var (plus 84 db to plus 34 db, narrow band); var (plus 79 db to plus 28 db, wide band)  
Bandwidth: 2 mc or 7 mc  
Center Frequency: 60 mc  
Dynamic Range: 30 db

Log IF. Amplifier  
IF. Gain: 70 db  
Bandwidth: 8 mc

**ITEM NAME:** AIRCRAFT APPROACH CONTROL  
CENTRAL

**TYPE:** AN/SPN-35

Center Frequency: 60 mc  
Dynamic Range: 50 db  
Video Amplifier  
Gain: 10 db  
Bandwidth: 500 cps to 3 mc  
Dynamic Range: 17v  
Vibration and Shock: No damage or impairment to operation when subjected to sinusoidal vibration from 5 cps to 33 cps, or random-type shock encountered during overload transport or helicopter pick up, flight, or landing  
Transport: Cargo transport helicopter (HRS-1 or equivalent) or 2-1/2 ton M-35 truck  
Gross Weight: 3186 lbs  
Power Source: 120 to 208v, 400 cyc, 3-ph 4-wire, 4 kw primary source. Capable of operating within pwr source variations of plus or minus 10% and freq variations of plus or minus 5%, and will not be damaged by a transient v of a duration not greater than one sec  
Radar Set AN/SPN-6 Stabilization Components (Modified)  
Stabilization Planes: Pitch and roll  
Pitch Plane Excursions  
Electrical: plus or minus 4.5° plus or minus 3 milliradians  
Hydraulic: plus or minus 7°  
Mechanical: plus or minus 9°

Roll Plane Excursions  
Electrical: plus or minus 15.5°  
Hydraulic: plus or minus 18°  
Mechanical: plus or minus 20°  
Synchro Data Input: 400 cyc 2X and 36X (pitch and roll)  
Synchro Data Source: Ships MK 19 Gyrocompass equip. or equivalent  
Hydraulic System  
Pressure: 1350 psi max  
Fluid Type: MIL-H-5606A  
Fluid Capacity: 3 qt  
Power Requirements: 440v, 60 cyc, 3-ph, 3-wire, 5 amp per ph 120 to 208v, 400 cyc, 3-ph, 4-wire, 15 amp per ph, 115v, 60 cyc, 1-ph, 2-wire, 10 amp

**INSTALLATION CONSIDERATIONS**

Not available.

**PRINCIPAL COMPONENTS AND PHYSICAL DATA**

<b>COMPONENTS</b>	<b>QTY</b>	<b>OVERALL DIMENSIONS (Inches)</b>	<b>UNIT WT. (Pounds)</b>
Azimuth Antenna AS-1292/TPN-8	1		
Elevation Antenna	1		
Obstruction Light	1		
Radar Receiver-Transmitter Group	1		
Ramp Reflector	1		
Receiver-Transmitter RT-660/TPN-8	1		
Primary ac Power Switches (GFM)	3		
Stable Data Cutout Switch (GFM)	1		
Optical Target	1		
Pitch and Roll Stabilizer	1		
Stable Platform	1		
Echo Box FR-68/UP	1		
Target Simulator	1		

**ITEM NAME:** AIRCRAFT APPROACH CONTROL CENTRAL

**TYPE:** AN/S PN-35

**PRINCIPAL COMPONENTS AND PHYSICAL DATA**

<b>COMPONENTS</b>	<b>QTY</b>	<b>OVERALL DIMENSIONS (Inches)</b>	<b>UNIT WT. (Pounds)</b>
Control Selector	1		
Control Monitor	1		
Stable Date Select Switch (GFM)	1		
Primary ac Power Switch (GFM)	1		
Indicators	2		

**REFERENCE DATA AND LITERATURE**

Technical Manuals:  
NAVSHIPS 91810

**AN/SPN-35: 4**

DATE: 15 January 1964  
INSTRUMENTATION

ITEM NAME: MISSILE RANGE  
SET  
TYPE: AN/SPQ-7

COGNIZANT SERVICE: USN

FEDERAL STOCK NUMBER:

	USA	USN	USAF	USMC
STATUS OR TYPE CLASSIFICATION			Tent. Std	

Mfg(s) Name or Code Number: Radio Corporation of America, Moorestown, New Jersey

No Illustration Available.

**FUNCTIONAL DESCRIPTION**

Missile Range Instrumentation Set is a ship installed long-range precision tracking set used for tracking intercontinental ballistic missiles and satellites. Because of the ship dynamics and deck space, a 16

foot diameter reflector antenna is used. A 3 megawatt klystron transmitter is used to increase antenna gain. The set shall be capable of obtaining signal level and space position data on a primary target (trans-sponder) and two secondary (skin) targets simultaneously for target cross section measurements.

**AN/SPQ-7: 1**

**ITEM NAME:** MISSILE RANGE INSTRUMENTATION SET

**TYPE:** AN/SPQ-7

**RELATION TO SIMILAR EQUIPMENT**

AN/SPQ-7 is similar to AN/FPQ-6 and AN/TPQ-18.

input; 203v, 120v ac, 60 cycles, 3-ph,  
4-wire, 225 kva

**TECHNICAL DESCRIPTION**

Frequency Data:  
Transmitter; 5400 - 5900 mc  
Receiver; 5400 - 5900 mc  
Power Requirements:

**INSTALLATION CONSIDERATIONS**

Siting: The AMR Shipboard Instrumentation Radar, AN/SPQ-7, requires about 2500 square feet of area below deck installation of equipment cabinets and control consoles. A 16 foot parabolic hydraulic-driven antenna group, specially adapted for shipboard use, is mounted on the deck.

**PRINCIPAL COMPONENTS AND PHYSICAL DATA**

<b>COMPONENT</b>	<b>QTY</b>	<b>HEIGHT (Inches)</b>	<b>WIDTH (Inches)</b>	<b>DEPTH (Inches)</b>	<b>UNIT WT. (Pounds)</b>
Radar Set AN/FPS-16 (less building, heading system, standard boresight tower, air conditioner systems, standard range group, standard antenna group and standard transmitter).	1				
16 feet diameter parabolic hydraulic - driven antenna group	1				
Low Noise Receiver Group	1				
Acquisition and Control Console Group	1				
Digital Range Group	1				
Real Time Digital Data Corrector	1				
High-Powered Tunable Transmitter	1				
Circular Polarization Adapter Group	1				
Boresight Tower and Equipment Group	1				

**REFERENCE DATA AND LITERATURE**

Nomenclature Card and AF Form 81 for AN/SPQ-7



DATE: 15 July 1964

ITEM NAME: RADAR TRAINER

COGNIZANT SERVICE: USN

TYPE: AN/SPS-T1

FEDERAL STOCK NUMBER: 6940-724-8128

	USA	USN	USAF	USMC
STATUS OR TYPE CLASSIFICATION				

Mfg(s) Name or Code Number: Aeromotive Equipment Corp., Kansas City, Missouri

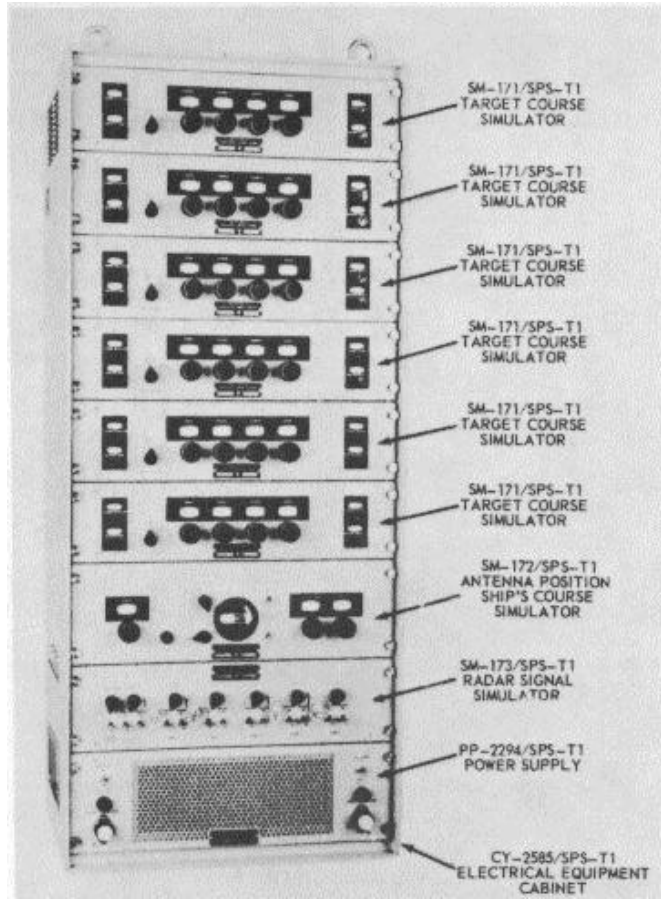

**FUNCTIONAL DESCRIPTION**

Radar Trainer AN/SPS-T1 is used to provide simulated moving target radar pulses and simulated beacon response pulses for presentation on the plan position indicator of search radar. Up to six target pulses

can be produced simultaneously and are controllable as to range, azimuth, course, speed and rate of turn. Two or more radar trainers can be interconnected to provide for any number of additional targets. Relative target motion, with respect to the ship is provided by applying "own" ship's course, speed and rate of turn.

**AN/SPS-T1: 1**

**ITEM NAME:** RADAR TRAINER  
**TYPE:** AN/SPS-T1

**RELATION TO SIMILAR EQUIPMENT**

None.

Sweep Circuit: 240 mi sweep, min range for sweep is 2 mi  
Beam Width: Adjustable horizontal width of from 1.5 to 8 deg plus or minus 1/2 deg.

Beacon Signal: Beacon video pulse has same characteristics as target video pulse.

Beacon Return: Adjustable horizontal beam width from 4.5 to 47 deg plus or minus 25% of setting.

Bearing Rotation: Capable of synchronization with radar having single speed synchro outputs with antenna rotation speeds of 0 to 20 rpm in either direction. Also capable of supplying single speed synchro bearing information with speeds continuously variable from 1 to 10 rpm.

Power Requirements: 115v, 60 cycles, single ph.

**TECHNICAL DESCRIPTION**

Trigger Pulse: 20 plus or minus 5v peak measured across 75 ohms, pos polarity, 2 to 10 usec duration at 150 to 250 pps

External Trigger: 55v peak measured across 75 ohms, pos polarity, 0.3 to 25 usec duration at 60 to 2000 pps

Video Output: Pos video pulses, limited to 5 plus or minus 0.5v across 75 ohms. Output controllable to a peak amplitude of 2.0 plus or minus 0.5v to indicator unit.

Target Pulse Width: 1.5 to 4 usec plus or minus 0.25 usec

Range Accuracy: Plus or minus 2% of range setting above 4 mi

Azimuth Accuracy: Plus or minus 2% of setting in course.

**INSTALLATION CONSIDERATIONS**

Not available.

**PRINCIPAL COMPONENTS AND PHYSICAL DATA**

COMPONENTS	QTY	OVERALL DIMENSIONS (Inches)	UNIT WT. (Pounds)
Electrical Equipment Cabinet CY-2585/SPS-T1	1	14-1/2 x 20-1/2 x 49-3/8	98
Target Course Simulator SM-171/SPS-T1	6	4-7/8 x 13-1/8 x 19-7/8	30
Antenna Position - Ship's Course Simulator SM-172/SPS-T1	1	4-1/4 x 13-1/4 x 19-7/8	45
Radar Signal Simulator SM-173/SPS-T1	1	5-1/4 x 13-1/4 x 19-7/8	25
Power Supply PP-2294/SPS-T1	1	6-1/8 x 12-3/8 x 19-7/8	64

**REFERENCE DATA AND LITERATURE**

Technical Manuals:  
NAVSHIPS 93435  
NAVSHIPS 93435.21: Operating Instruction Charts  
NAVSHIPS 93435.32: Performance Standards Sheet  
NAVSHIPS 93435.42: Maintenance Standards Book

**DATE:** 1 July 1964

**ITEM NAME:** RADAR TRAINER

**COGNIZANT SERVICE:** USN

**TYPE:** AN/SPS-T2

**FEDERAL STOCK NUMBER:** 6940-679-3025  
694-542-2286 W/S

	USA	USN	USAF	USMC
<b>STATUS OR TYPE CLASSIFICATION</b>				

Mfg(s) Name or Code Number: Servonics Inc., Alexandria, Virginia

Illustration not Available.

### FUNCTIONAL DESCRIPTION

Radar Trainer AN/SPS-T2 is a 3-dimensional moving target simulator furnishing speed, course and altitude information, speed correction for climb and dive, sea

return and random target fading, and supplying all necessary signals to energize standard PPI and RHI for simulated targets and mixed real and simulated targets.

**AN/SPS -T2: 1**

**ITEM NAME:** RADAR TRAINER

**TYPE:** AN/SPS-T2

**RELATION TO SIMILAR EQUIPMENT**

None.

Power Requirements: 115v plus or minus  
10%, 60 cycles, single ph, 1200w

**INSTALLATION CONSIDERATIONS**

Not available.

**TECHNICAL DESCRIPTION**

Video Impedance: 72 ohms

**PRINCIPAL COMPONENTS AND PHYSICAL DATA**

<b>COMPONENTS</b>	<b>QTY</b>	<b>OVERALL DIMENSIONS (Inches)</b>	<b>UNIT WT. (Pounds)</b>
Radar Trainer AN/SPS-T2 includes:	1		660
Simulator Group OA-2062/SPS-T2	2	16-1/4 x 21-1/8 x 35-1/4	190
Simulator Group Power Supply OA- 201/SPS-T2	1	16-1/4 x 21-1/8 x 35-1/4	190
Amplifier Power Supply AM-2102/SP	1	13-1/8 x 16-1/4 x 21-1/8	90

**REFERENCE DATA AND LITERATURE**

Technical Manuals:  
NAVSHIPS 93259  
NAVSHIPS 93259.21  
NAVSHIPS 93259.32  
NAVSHIPS 93259.42

**AN/SPS-T2: 2**

DATE: 1 July 1964

ITEM NAME: RADAR TRAINER

COGNIZANT SERVICE: USN

TYPE: AN/SPS-TA

FEDERAL STOCK NUMBER: 6940-677-9862

	USA	USN	USAF	USMC
STATUS OR TYPE CLASSIFICATION				

Mfg(s) Name or Code Number: Servonics Inc., Alexandria, Virginia

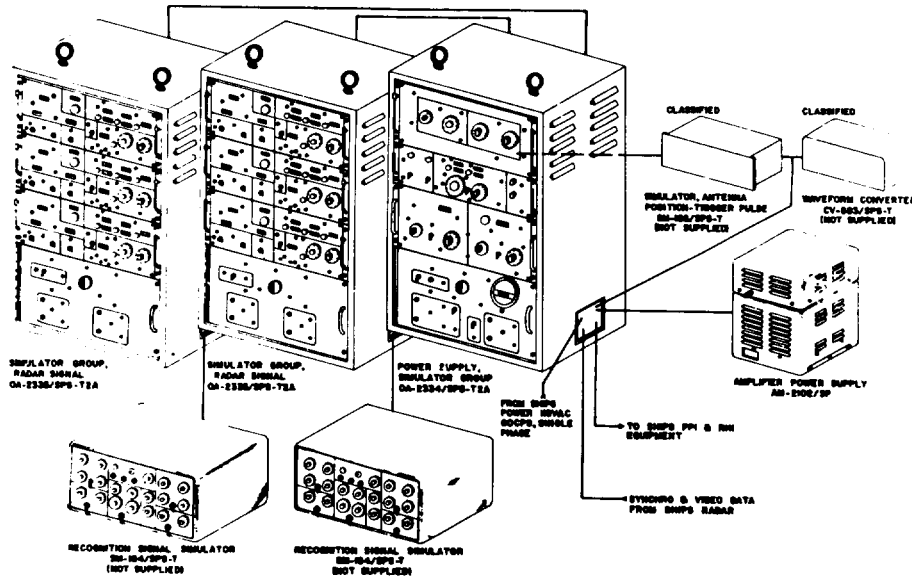

**FUNCTIONAL DESCRIPTION**

The Radar Trainer AN/SPA-T2A is designed as an electromechanical analog computing device which completely simulates radar data normally supplied by Surface Search Radar (SSR), Air Search Radar (ASR),

and Height Finding Radar (HFR). Data supplied by the AN/SPS-T2A provides a radar display of moving targets, integrated with the operational characteristics of radar equipments. The output of the AN/SPS-T2A is displayed directly on Plan Position Indicators (PPI), and Range-Height Indicators (RHI).

AN/SPS-T2A: 1

**ITEM NAME:** RADAR TRAINER

**TYPE:** AN/SPS-T2A

**RELATION TO SIMILAR EQUIPMENT**

The AN/SPS-T2A is designed to be used with, but not part of AN/SPS-6, -8, -12, -39, -42 and AM-2102/SP and CV-883/SPS-T2. The AN/SPS-T2A is functionally interchangeable with Radar Trainer AN/SPS-T2.

Course: 0 to 360 deg  
Own Ship Speed: 0 to 500 knots  
Own Ship Position: 250 mi max from origin  
Antenna Simulation Characteristics  
ASR Antenna Speed: 0 to 50 rpm  
HFR Antenna Speed: 0 to 50 rpm  
HFR Scan Rate: Off, 5, 10, 20 scans per sec  
HFR Sector Control: 0 to 36 deg in horizontal plane  
Radar Characteristics Simulation Data  
Range: 0.5 mi min to 250 mi max  
Azimuth Beam Width: 1 deg to 6 deg max  
Signal Output from OA-2334/SPS-T2A to Ship's Equipment  
Trigger Signal-PPI: 20v, 2 usec  
Trigger Signal-RHI: 20v, 2 usec  
Video Signal-PPI: 2.5v  
Video Signal-RHI: 2.5v  
Operating Power Requirements: 115v ac, 60 cps, single ph.

**TECHNICAL DESCRIPTION**

Pulse Repetition Frequency (ASR and HFR)  
Simulated Mode: 100 to 1200 pps  
Mixed Mode: Synchronized to PRF of radar system.  
Simulated Target Characteristics  
Speed: 0 to 3000 knots air speed; 0 to 300 knots surface speed  
Course: 0 to 360  
Turn Rate: 0 to 10 deg per sec port; 0 to 10 deg per sec starboard.  
Climb-Dive Rate: 0 to 25,000 ft min climb; 0 to 25,000 ft min dive.  
North-South Miles: 250 mi North to 250 mi South  
East-West Miles: 250 mi East to 250 mi West  
Slant Range: 0 to 250 mi  
Altitude: 0 to 100,000 ft  
Elevation Angle: 0 to 90 deg  
Own Ship Simulation Characteristics

**INSTALLATION CONSIDERATIONS**

Related Equipment: (Required, but not Supplied) (19) Cable RG-12A/U; (2) Cable MSCA-14; (1) Cable MSCA-19; (2) Cable DSGA-3; (2) Cable TTRS-2; (1) Cable DSGA-9.

**PRINCIPAL COMPONENTS AND PHYSICAL DATA**

COMPONENTS	QTY	OVERALL DIMENSIONS (Inches)	UNIT WT. (Pounds)
Simulator Group, Radar Signal OA-2335/S PS -T2A	2	17-1/2 x 19-1/8 x 35-1/4	190
Power Supply, Simulator Group OA-2334/SPS-T2A	1	17-1/2 x 19-1/8 x 35-1/4	190
Amplifier Power Supply AM-2102/SP	1	10-5/16 x 13-25/32 x 15-3/16	60

**SHIPPING DATA**

BOXES (NR.)	UNIT WT. (Pounds)
2	295
1	295
1	170

**REFERENCE DATA AND LITERATURE**

Technical Manuals:  
NAVSHIPS 93426  
NAVSHIPS 93426.21: Operating Instruction Chart

DATE: 1 July 1964

ITEM NAME: RADAR SET

COGNIZANT SERVICE: USN

TYPE: AN/SPS-4

FEDERAL STOCK NUMBER: F5840-665-3517

	USA	USN	USAF	USMC
STATUS OR TYPE CLASSIFICATION		Ltd Std		

Mfg(s) Name or Code Number: Raytheon Mfg. Co.

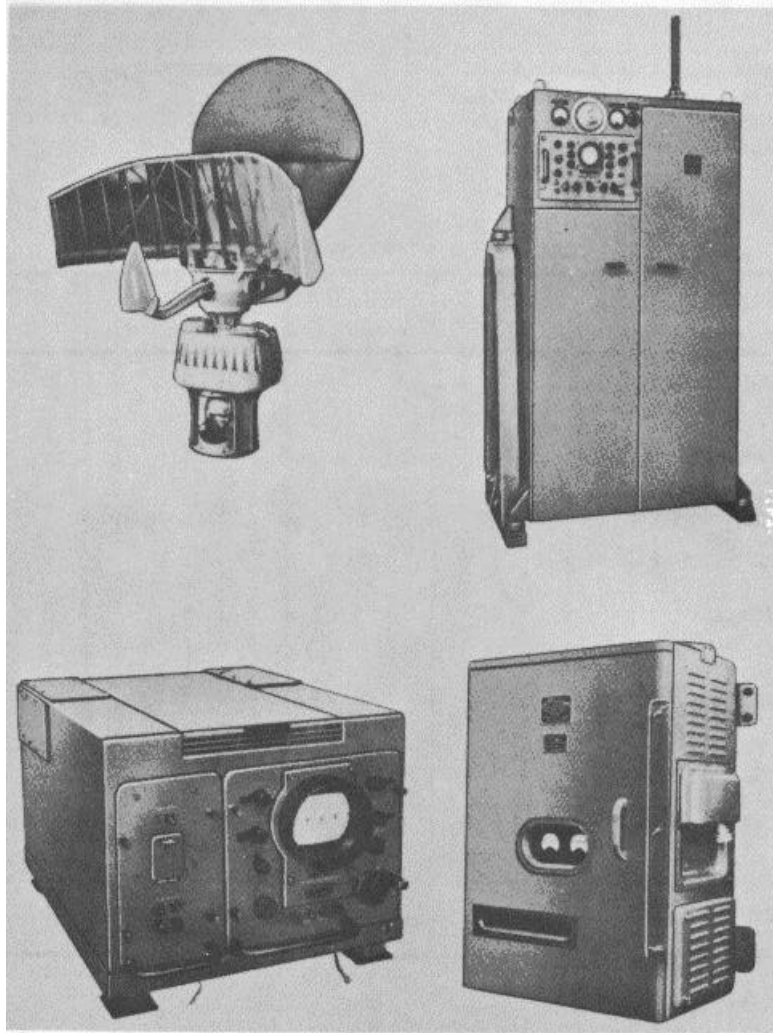

AN/SPS-4: 1

**AN/SPS-4**

**FUNCTIONAL DESCRIPTION**

Radar Set AN/SPS-4 is a medium power surface and zenith search radar equipment which may be operated at any frequency in the 5450 to 5825 mc range. It has a special dual antenna which permits the operator to observe targets either on and near the surface of the water or approaching from overhead.

Targets are presented on the screens of a range indicator and a range repeater as well as on other repeaters in the system. Both 1 and 36-speed information is required to operate the synchro signal amplifier while the rest of the system requires only 1-speed information.

**RELATION TO SIMILAR EQUIPMENT**

The AN/SPS-4 is similar to Navy Model SG-6b except for changes in the antenna, the transmitter, and the receiver to permit operation on lower frequencies and at a higher power output.

**TECHNICAL DESCRIPTION**

Frequency: 5450 to 5825 mc  
 Power Output: 180 kw (min)  
 Pulse Repetition Rate: 625 to 650 pps  
 Pulse Width: 0.37 to 1.3 μsec  
 IF. Frequency: 30 mc  
 Narrow Bandwidth: 1 mc approx  
 Broad Bandwidth: 5 mc approx  
 Operating Voltages and Power Requirements:  
 115, 220, or 440v ±10%, 60 ±2 cps, 1-ph, 4.5 kva max, 89% pf  
 Antenna Rotation Speed: 5 and 15 rpm or manual  
 Horizontal Beam Width:  
 Surface Reflector - 1.7 to 2.3 deg  
 Zenith Reflector - 3 deg approx  
 Vertical Beam Width:  
 Surface Reflector - 14 to 16 deg  
 Zenith Reflector - Max radiation at 21 deg above horizon

**INSTALLATION CONSIDERATIONS**

Not available.

**PRINCIPAL COMPONENTS AND PHYSICAL DATA**

COMPONENT	QTY	HEIGHT (Inches)	WIDTH (Inches)	DEPTH (Inches)	UNIT WT. (Pounds)
Radar Receiver-Transmitter RT- 197/SPS-4	1	65	39	22	800
Range Indicator NT-55AGJ	1	32	21	18	182
Radar Modulator MD-132/SPS-4	1	40	30	17	345
Antenna Assembly AS-508/SPS-4	1	106	84	69	476
Training Control Amplifier NT-50AJN	1	30	25	16	275
Power Transformer NT-303880	1	16	13	11	167
Synchro Signal Amplifier Mk 2 Mod 2B or Mk 27 Mod 4G	1	22	15	11	150
Indicator Unit NT-55AGU-1	1	33	21	20	258
Driver Unit NT-50AKX	1	36	18	15	281
Delay Unit NT-50AGG	1	25	22	13	155

**REFERENCE DATA AND LITERATURE**

Technical Manual:  
NAVSHIPS 91724(A)



DATE: 1 July 1964

ITEM NAME: RADAR SET

COGNIZANT SERVICE: USN

TYPE: AN/SPS-5\*, -5A\*\*, -5B\*\*\*

FEDERAL STOCK NUMBER: F5840-664-4909\*  
F5840-351-9995\*\*  
F5840-665-2532\*\*\*

	USA	USN	USAF	USMC
STATUS OR TYPE CLASSIFICATION		Ltd Std		

Mfg(s) Name or Code Number: Raytheon Mfg. Co.

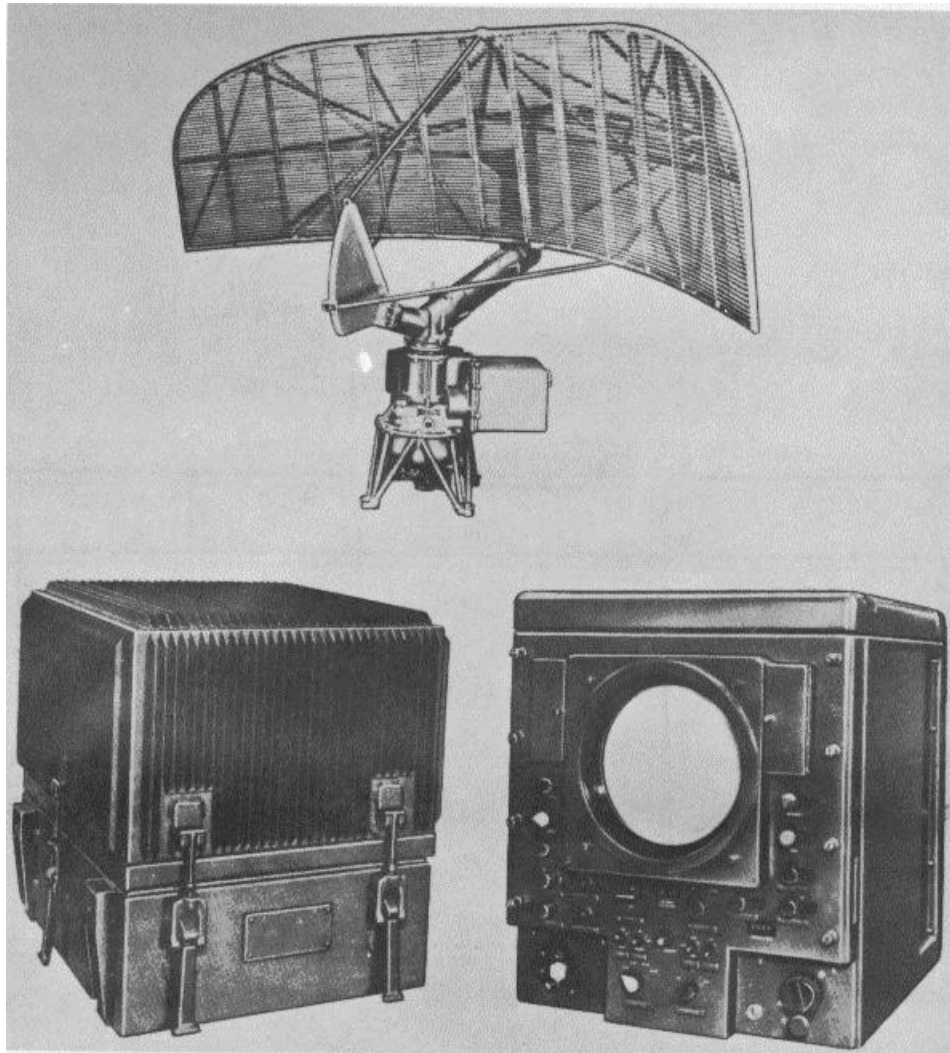

AN/SPS-5: 1

AN/SPS-5, -5A, -5B

**FUNCTIONAL DESCRIPTION**

Radar Sets AN/SPS-5,-5A, and -5B are medium power, lightweight, surface search equipments. These equipments feature high power output, narrow pulse width, thyatron keying, a low noise receiver with a sensitivity time control and a fast time constant to clarify target presentation, a large lightweight antenna reflector that provides simultaneous surface search and modified (low altitude) air search, and a regulated high voltage power supply which maintains constant power input to the magnetron oscillator.

In the AN/SPS-SA and -5B the antenna weight has been further reduced by the replacement of Antenna AS-511/SPS-5 with Antenna AS-651/SPS-5B.

There is no provision for elevation of the antenna reflector in the AN/SPS-5A and -5B. The azimuth synchro system of the AN/SPS-5 is normally a 2x system while the synchro system of the AN/SPS-5A and -5B is a 1x system.

**RELATION TO SIMILAR EQUIPMENT**

None.

**TECHNICAL DESCRIPTION**

Frequency: 6275 to 6575 mc  
Frequency Control: Pulse modulated magnetron oscillator

Pulse Width: 0.37  $\mu$ sec  
Pulse Repetition Rate: 683.06 pps  
Peak Power Output: 285 kw  
IF. Frequency: 30 mc  
Bandwidth: 5 mc  
Antenna Type: Pyramidal horn with slotted parabolic reflector  
Antenna Feed: Waveguide  
Horizontal Beam Width: 1.5 deg  
Vertical Beam Width: -7.5 to +7.5 deg and from +7.5 deg to +22 deg  
Antenna Rotation Speed: 17 rpm  
Operating Voltages and Power Requirements: 104 to 126v, 60 cps, 1-ph

**INSTALLATION CONSIDERATIONS**

Siting: Allow space for ventilation, servicing, and interunit cabling. Locate for short cabling, protection from weather, and operating convenience.

Mounting: Antenna bolts to standard mast cap. Receiver-transmitter is mounted on special shelf. Power supply, radar modulator, tuned cavity, and antenna control mounted on bulk-head. Azimuth-range indicator table mounted.

Cabling Requirements: Minimum crossovers; continuous cabling between units; large cables bent on 7-in. radius or greater; small cables on 5-in. radius or greater. Separate rf cables if possible, or run parallel 6 to 12 inches away from other cabling.

Related Equipment:

**PRINCIPAL COMPONENTS AND PHYSICAL DATA**

COMPONENT	QTY	HEIGHT (Inches)	WIDTH (Inches)	DEPTH (Inches)	UNIT WT. (Pounds)
AN/SPS-5, -5A					
Receiver-Transmitter RT-202/SPS-5	1	21-3/4	21-3/16	20-7/16	108
Radar Modulator MD-133/SPS-5	1	19-1/4	16-9/16	13	67
Azimuth-Range Indicator IP-120/SPS-5	1	25-1/4	25	22	234
Power Supply PP-601/SPS-5	1	28-5/16	22	11-13/16	160
Antenna AS-511/SPS-5	1	59-3/4	89	89	166
Control Antenna C-787/SPS-5	1	22	18-1/2	13-3/16	108

**PRINCIPAL COMPONENTS AND PHYSICAL DATA (cont'd)**

<b>COMPONENT</b>	<b>QTY</b>	<b>HEIGHT (Inches)</b>	<b>WIDTH (Inches)</b>	<b>DEPTH (Inches)</b>	<b>UNIT WT. (Pounds)</b>
AN/SPS- 5B					
Receiver-Transmitter RT-301/SPS-5B	1	21-3/4	21-3/16	20-7/16	108
Radar Modulator MD-133/SPS-5	1	19-1/4	16-9/16	13	67
Azimuth-Range Indicator IP-249/SPS- 5B	1	25-1/2	25-5/16	24-1/8	228
Power Supply PP-1026/SPS-5B	1	28-15/16	22	11-13/16	160
Antenna AS-651/SPS-5B	1	56-7/8	90	90	102
Antenna Control C-1263/SPS-5B	1	22	18-3/16	13-3/4	92

**REFERENCE DATA AND LITERATURE**

Technical Manuals:  
NAVSHIPS 91634(A)  
NAVSHIPS 92752  
NAVSHIPS 91958(A)

**AN/S PS-5: 3**



**ITEM NAME:** RADAR SET

**TYPE:** AN/SPS-5C

**RELATION TO SIMILAR EQUIPMENT**

The AN/SPS-5C is similar to Radar Sets AN/SPS-5 and -5A except it is modified by Radar Set Group OA-2237/SPS-SC, which provides new operating features, increased performance and a new frequency range 5450 to 5285.

The AN/SPS-5C has the same performance features and operational characteristics as Radar Set AN/SPS-SD.

Intermediate Frequency: 30 mc  
Antenna Gain: 29.0 db  
Antenna Horizontal Beamwidth: 1.7 deg  
Antenna Vertical Beamwidth: 15 deg  
High Angle Coverage: Approx Cosecant Squared plus 7 to 22 deg  
Polarization: Horizontal  
Antenna Rotation Speed: 17 rpm  
Power Supply Characteristics  
Voltage: 103 - 127v ac  
Frequency: 60 cps plus or minus 3 cycles.  
Maximum Starting Current: 57 amps  
Standby Current: 10 amps  
Operating Current: 16.5 amps  
Estimated Power: 1.7 kw  
Power Factor: 87%

**TECHNICAL DESCRIPTION**

Peak Power Output: 250 to 350 kw  
Pulse Duration: 0.5 usec  
Pulse Repetition Frequency: 683.06 pps  
Frequency Range: 5450 to 5825 mc  
Noise Factor: 8.5 db  
Type of Receiver: Superheterodyne  
Receiver Bandwidth: 3.0 mc

**INSTALLATION CONSIDERATIONS**

Not available.

**PRINCIPAL COMPONENTS AND PHYSICAL DATA**

<b>COMPONENTS</b>	<b>QTY</b>	<b>OVERALL DIMENSIONS (Inches)</b>	<b>UNIT WT. (Pounds)</b>
*Radar Receiver-Transmitter RT-510/SPS-SC	1	20-7/16 x 20-13/16 x 21-3/4	158
*Radar Modulator MD-352/SPS-5C	1	13 x 16-9/16 x 19-1/4	132
**Control-Indicator C-2B08/SPS-5C	1	24-1/4 x 25-5/16 x 25-1/2	234
**Power Supply PP-2289/SPS-SC	1	11-13/16 x 22 x 28-15/16	160
*Antenna AS-1002/SPS-5C	1	52-1/2 x 101 Swing Circle	106
**Antenna Control C-2B06/SPS-5C	1	13-3/16 x 18-1/8 x 22	108
*Directional Coupler CU-735/SPS-5C	1	4-1/4 x 6 x 6-5/16	2
*Tuned Cavity FR-133/SPS-SC	1	8 x 8-1/8 x 17-1/4	27
*Voltage Standing Wave Ratio Indicator IM-152/SP	1	6 x 15-1/2 x 16	7
*Switch Box SA-633/S	1	5-13/16 x 5-13/16 x 13-1/4	2

**NOTE:** \*Supplied as new units with Radar Set Group OA-2237/SPS-5C.

\*\*Modified by addition of Radar Set Group OA-2237/SPS-5C.

**REFERENCE DATA AND LITERATURE**

Technical Manuals:  
NAVSHIPS 93477  
NAVSHIPS 93477.11: Lubrication Chart

DATE: 1 July 1964

ITEM NAME: RADAR SET

COGNIZANT SERVICE: USN

TYPE: AN/SPS-5D

FEDERAL STOCK NUMBER:

	USA	USN	USAF	USMC
STATUS OR TYPE CLASSIFICATION		S td		
Mfg(s) Name or Code Number: Raytheon Manufacturing Company				

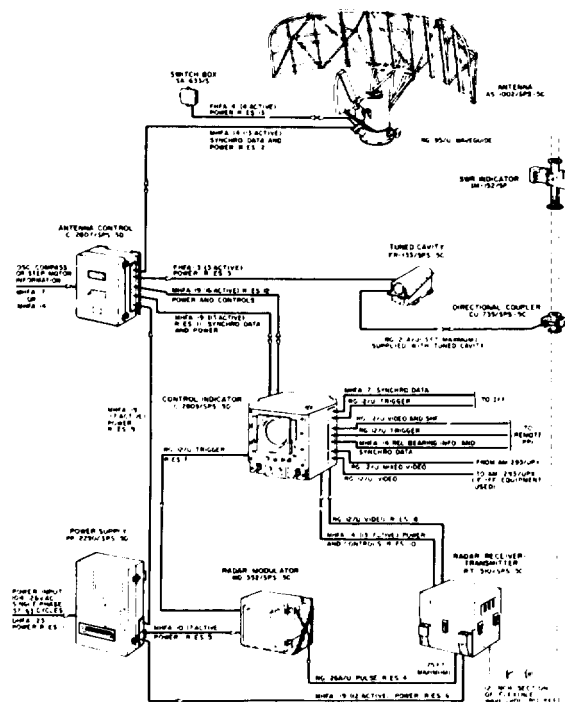

**FUNCTIONAL DESCRIPTION**

The Radar Set AN/SPS-5D is designed as a medium-power, light-weight, surface-search equipment which operates in the range of

5450 5825 megacycles (mc), and is installed on vessels having a 115 volt, 60 cycle power source.

**AN/SPS-5D: 1**

ITEM NAME: RADAR SET

TYPE: AN/SPS-5D

**RELATION TO SIMILAR EQUIPMENT**

The AN/SPS-5D is similar to AN/SPS-5B, except it has been modified to provide new operating features, increased performance, and a new frequency range. Performance features and operational characteristics are the same as for Radar Set AN/SPS-5C.

Antenna Gain: 29.0 db  
 Antenna Horizontal Beamwidth: 1.7 deg  
 Antenna Vertical Beamwidth: 15 deg  
 High Angle Coverage: Approx Coscant Squared plus 7 to 22 deg  
 Polarization: Horizontal  
 Antenna Rotation Speed: 17 rpm  
 Relative Bearing Data: 1 speed  
 Power Supply Characteristics  
 Voltage: 103 to 127v ac  
 Frequency: 60 plus or minus 3 cycles  
 Phase: Single  
 Maximum Starting Current: 57 amps  
 Standby Current: 10 amps  
 Operating Current: 16.5 amps  
 Estimated Power: 1.7 kw  
 Power Factor: 87%

**TECHNICAL DESCRIPTION**

Number of Bands: 1 band  
 Number of Channels: 1 channel  
 Peak Power Output: 250 to 350 kw  
 Pulse Repetition Frequency: 683.06 pps  
 Frequency Range: 5450 to 5825 mc  
 Noise Factor: 8.5 db  
 Type of Receiver: Superheterodyne  
 Receiver Bandwidth: 3.0 mc  
 Intermediate Frequency: 30 mc

**INSTALLATION CONSIDERATIONS**

Not available.

**PRINCIPAL COMPONENTS AND PHYSICAL DATA**

COMPONENT	QTY	OVERALL DIMENSIONS (Inches)	UNIT WT. (Pounds)
*Radar Receiver-Transmitter RT-510/SPS-5C	1	20-7/16 x 20-13/16 x 21-3/4	158
*Radar Modulator MD-352/SPS-5C	1	13 x 16-9/16 x 19-1/4	132
**Control-Indicator C-2809/SPS-5D	1	24-1/4 x 25-5/16 x 25-1/2	234
**Power Supply PP-2290/SPS-5D	1	11-13/16 x 22 x 28-15/16	160
*Antenna AS-1002/SPS-5C	1	52-1/2 x 101 Swing Circle	106
**Antenna Control CU-2807/SPS-5D	1	13-3/16 x 8-1/8 x 22	106
*Directional Coupler CU-735/SPS-5C	1	4-1/4 x 6 x 6-5/16	2
*Tuned Cavity FR-133/SPS-5C	1	8 x 8-1/8 x 17-1/4	27
*Voltage Standing Wave Ratio Indicator IM-152/SP	1	6 x 15-1/2 x 16	7
*Switch Box SA-633/S	1	5-13/16 x 5-13/16 x 13-1/4	2

**NOTE: \*Supplied as new units with Radar Set Group OA-2237/SPS-5C.  
 \*\*Modified by addition of Radar Set Group OA-2237/SPS-5C.**

**REFERENCE DATA AND LITERATURE**

Technical Manuals:  
 NAVSHIPS 93521  
 NAVSHIPS 93521.11: Lubrication Chart

DATE: 1 July 1964

ITEM NAME: RADAR SET

COGNIZANT SERVICE: USN

TYPE: AN/SPS-6 , -6A, -6B, -6C

FEDERAL STOCK NUMBER: See Note 1

	USA	USN	USAF	USMC
STATUS OR TYPE CLASSIFICATION		See Note 2		
Mfg(s) Name or Code Number: Westinghouse Electric Corporation				

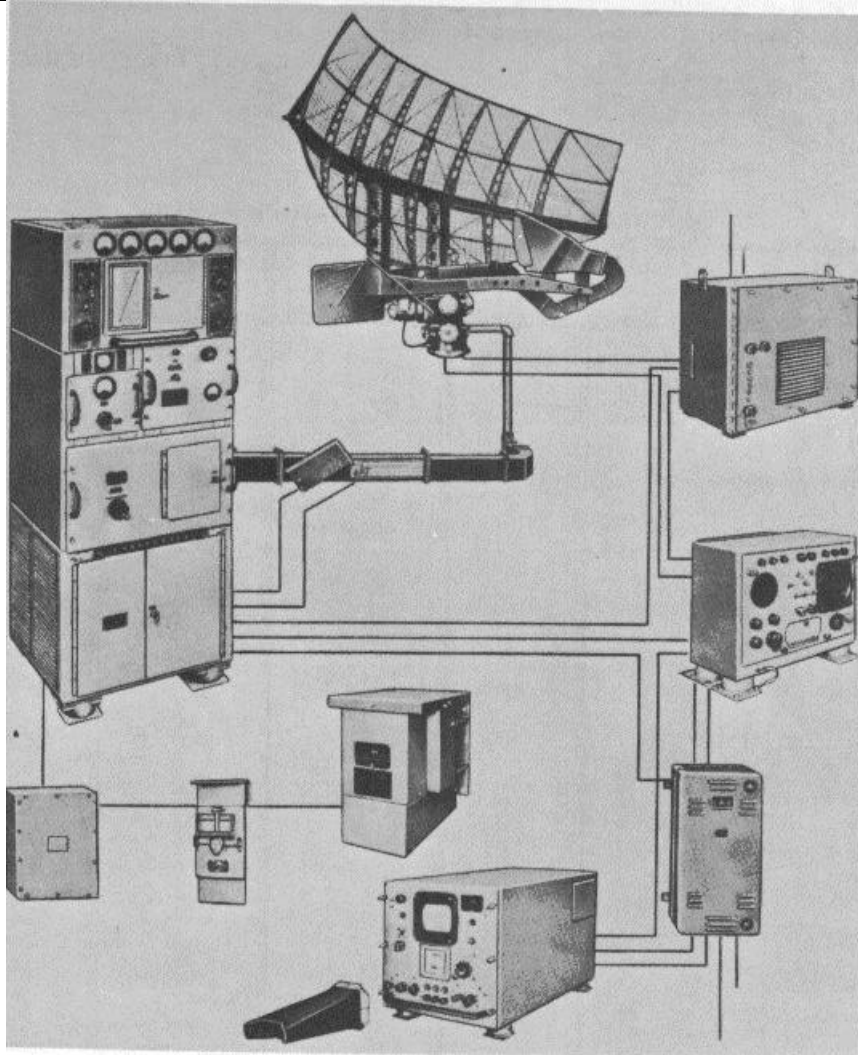

AN/SPS-6: 1



**AN/SPS-6, -6A, -6B, -6C**

**FUNCTIONAL DESCRIPTION**

Radar Sets AN/SPS-6, -6A, -6B, and -6C are shipboard, air and surface, search radar equipments that supply target bearing and range data to PPI and A-scope indicators. These radars provide sweep trigger, video voltage, and bearing data for as many as four external PPI indicators of the VE, VJ, and VK or similar types. They are designed for either local or remote operation, and a dual feedhorn radiator on the antenna propagates and receives both radar and IFF signals.

These radar sets are essentially similar, the major difference being the antenna used with each model.

**RELATION TO SIMILAR EQUIPMENT**

The AN/SPS-6, -6A, -6B, and -6C are similar to Navy Models SR-3 and SR-6 series equipments.

**TECHNICAL DESCRIPTION**

Frequency: 1250 to 1350 mc

Peak Power Output: 750 kw  
 Pulse Repetition Rate: 150 to 600 pps  
 Pulse Width: 4  $\mu$ sec at 150 pps;  
 1  $\mu$ sec at 600 pps  
 IF. Frequency: 30 mc  
 Operating Voltages and Power Requirements:  
 115, 198, 210, 220, 396, 420, or 440v, 60 cps,  
 1-ph, 5.5 kva  
 Antenna Type: Unidirectional, parabolic type reflector  
 Horizontal Beam Width: 3.5 deg  
 Vertical Beam Width:  
 AN/SPS-6 - 10 deg  
 AN/SPS-6A - 20 deg  
 AN/SPS-6B - 30 deg  
 AN/SPS-6C - 30 deg  
 Antenna Rotation Speed: Automatic, 5 to 15 rpm;  
 Manual, 0 to 2.5 rpm

**INSTALLATION CONSIDERATIONS**

Not available.

**PRINCIPAL COMPONENTS AND PHYSICAL DATA**

COMPONENT	QTY	HEIGHT (Inches)	WIDTH (Inches)	DEPTH (Inches)	UNIT WT. (Pounds)
AN/SPS-6					
Radar Receiver-Transmitter RT-141A/SPS-6	1	72	28	25	1060
Antenna AS-402A/SPS-6	1	93	210	77	557
Video Amplifier NT-50AJW	1	28-7/16	16-1/16	15-11/16	136
Radar Set Control C-490A/SPS-6	1	14-7/16	17-3/4	13-1/4	44
Antenna Control C-491A/SPS-6	1	27-9/16	29-1/8	13-5/8	252
Antenna Mounting AB-146/SPS-6	1	41-7/8	26-15/16	18	267
Power Transformer TF-115/U	1	14-3/8	10-7/8	12-11/16	104
AN/SPS-6A					
Radar Receiver-Transmitter RT- 141A/SPS-6	1	72	28	25	1060
Antenna AS-492A/SPS-6A	1	93	204	82- 1/4	586
Video Amplifier NT-SOAJW	1	28-7/16	16-1/16	15-11/16	136
Radar Set Control C-490A/SPS-6	1	14-7/16	17-3/4	13-1/4	44
Antenna Control C-491A/SPS-6	1	27-9/16	29-1/8	13-5/8	252

PRINCIPAL COMPONENTS AND PHYSICAL DATA (cont'd)

COMPONENT	QTY	HEIGHT (Inches)	WIDTH (Inches)	DEPTH (Inches)	UNIT WT. (Pounds)
Antenna Mounting AB- 146/SPS-6	1	41-7/8	26-15/16	18	267
Power Transformer TF-115/U	1	14-3/8	10-7/8	12-11/16	104
AN/SPS- 6B					
Radar Receiver-Transmitter RT- 141A/SPS-6	1	72	28	25	1060
Antenna AS-430A/SPS-6B	1	95-5/8	204	95	626
Video Amplifier NT-50AJW	1	28-7/16	16-1/16	15-11/16	136
Radar Set Control C-490A/SPS-6	1	14-7/16	17-3/4	13-1/4	44
Antenna Control C-491A/SPS-6	1	27-9/16	29-1/8	13-5/8	252
Antenna Mounting AB-146/SPS-6	1	41-7/8	26-15/16	18	267
Power Transformer TF-115/U	1	14-3/8	10-7/8	12-11/16	104
AN/SPS- 6C					
Radar Receiver-Transmitter RT-267/SPS-6C	1	72	28	25	1063
Antenna Control C-1056/SPS-6C	1	25-5/8	27-1/8	18-9/32	317
Antenna AS-430B/SPS-6B	1	153-5/8	204	95-7/8	591
Video Amplifier NT-50AJW	1	28-7/16	16-1/16	15-11/16	136
Radar Set Control C-1074/SPS-6C	1	14-11/16	17-3/4	10-1/2	47
Antenna Pedestal AB-274/SPS-6C	1	35-5/8	29-3/4	18	333
Power Transformer TF-115/U	1	14-3/8	10-7/8	12-11/16	104

REFERENCE DATA AND LITERATURE

Technical Manuals:  
NAVSHIPS 91081  
NAVSHIPS 91620(A)

Note 1. Federal Stock Numbers

AN/SPS-6 - F5840-263-0146  
AN/SPS-6A - F5840-644-3371  
AN/SPS-6B - F5840-644-4916  
AN/SPS-6C- F5840-644-4915

Note 2. Navy Status or Type Classification.

AN/SPS-6A - Ltd Std  
AN/SPS-6B - Sub Std  
AN/SPS-6C - Std (Small Surface Ship)  
AN/SPS-6C - Sub Std (Large Surface Ship)

DATE: 1 July 1964

ITEM NAME: RADAR SET

COGNIZANT SERVICE: USN

TYPE: AN/SPS-8\*, -8A\*\*, -8B

FEDERAL STOCK NUMBER: F5840- 644-4906\*  
 F5840-665-1965\*\*

	USA	USN	USAF	USMC
STATUS OR TYPE CLASSIFICATION		See Note 1		
Mfg(s) Name or Code Number: General Electric Company				

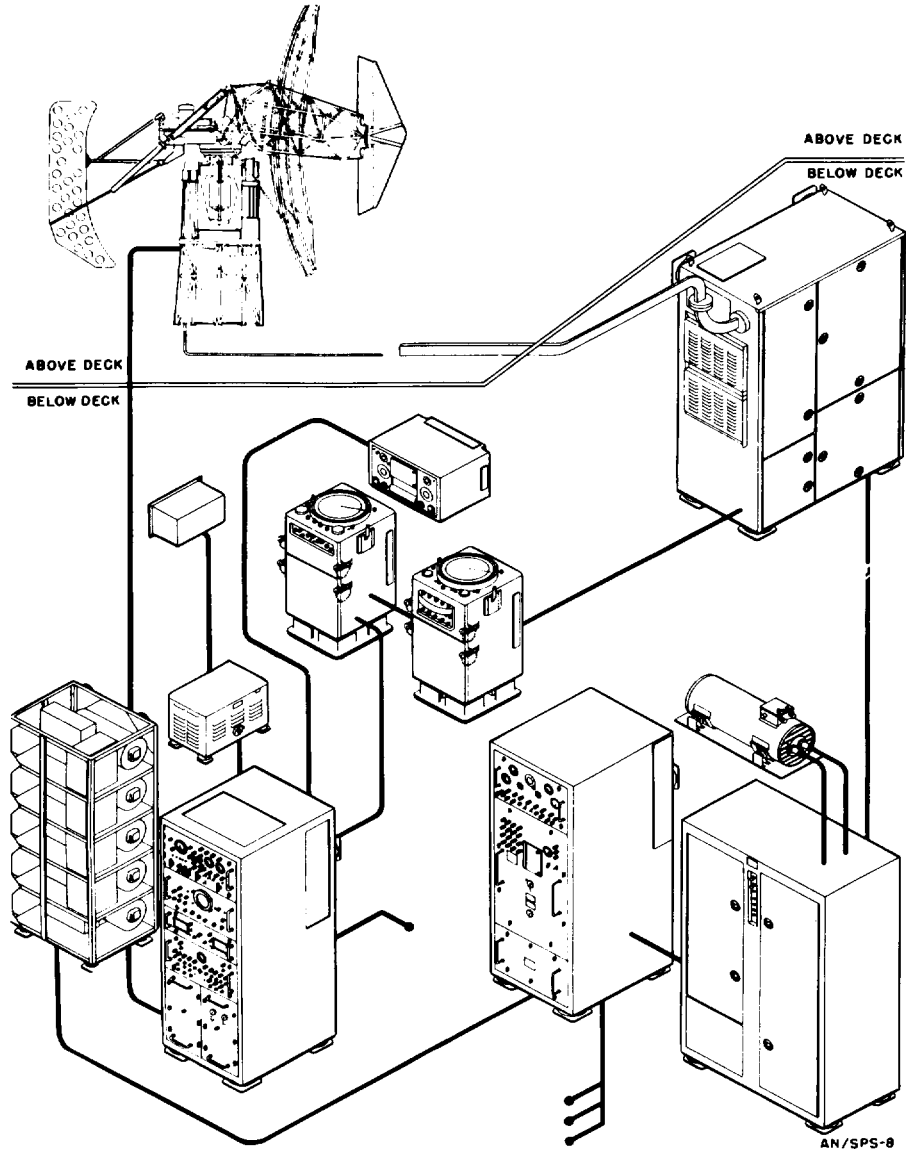

AN/S PS-8: 1

**AN/SPS-8, -8A, -8B**

**FUNCTIONAL DESCRIPTION**

Radar Sets AN/SPS-8, -8A, and -8B are shipboard integrated search and height-finding radar systems used for the detection and surveillance of aircraft. It presents target height, slant range, bearing, and beacon information on Radar Repeater Equipments VK and VL.

The antenna is precisely stabilized by use of a stable element and the roll and pitch servo loops.

**RELATION TO SIMILAR EQUIPMENT**

None.

**TECHNICAL DESCRIPTION**

Frequency: 3430 to 3570 mc

Peak Power Output:

AN/SPS-8 - 650 kw

AN/SPS-8A, -8B - 1 megw

Pulse Repetition Rate:

AN/SPS-8 - 500 and 1,000 pps

AN/SPS-8A, -8B - 450 and 700 pps

Pulse Width:

AN/SPS-8 - 1 and 2  $\mu$ sec

AN/SPS-8A, -8B - 2  $\mu$ sec

IF. Frequency: Radar 30 mc; beacon, 60 mc

Range, Max:

AN/SPS-8 - 60 naut mi on two F2H fighter planes at 1,000 pps and 5 rpm

AN/SPS-8A, -8B - 72 naut mi on two F2H fighter planes at 700 pps and 5 rpm

Antenna Feed:

AN/SPS-8, -8A - Robinson horn scanner

AN/SPS-8B - Organ pipe scanner

Horizontal Beam Width:

AN/SPS-8, -8A - 3.5 deg

AN/SPS-8B - 1.5 deg

Vertical Beam Width:

AN/SPS-8, -8A - 1.1 deg

AN/SPS-8B - 1.2 deg

Antenna Gain:

AN/SPS-8, -8A - 37.5 db

AN/SPS-8B - 41 db

Antenna Speed 1, 2, 3, 5, and 0 rpm, or manual

Azimuth Coverage: 30 to 200 deg

Elevation Coverage:

AN/SPS-8, -8A - Any 11 deg sector between 0 and 36 deg

AN/SPS-8B - Any 12 deg sector between 0 and 36 deg

Scan Rate:

AN/SPS-8, -8A - 1,200, 600, and 300 rpm or manual

AN/SPS-8B - 970, 720, and 360 rpm or manual

Reflector Elevation:

AN/SPS-8, -8B - 4 to 29 deg

AN/SPS-8B - 6 to 30 deg

**INSTALLATION CONSIDERATIONS**

Siting: To ease servicing and maintenance, place units as close together as possible. Receiver transmitter unit must be no more than 125 feet from antenna to avoid excessive moding and pulling of magnetron. 300 ft is the maximum recommended distance apart for other units. Place modulator close to transmitter to avoid loss through pulse cables. Place Radar Set Control C-1176/SPS-8A or C-677/ SPS-8 above the master VK and VL indicators.

Mounting: Bolt base shock mounts to deck and rear shock mounts to bulkhead. Bond each equipment cabinet to deck or bulkhead to protect personnel and prevent stray electric fields.

Cabling Requirements: Special procedure for assembling the high voltage pulse cables is given in Section 3 of NAVSHIPS 91988(A) or 91522(A).

Related Equipment: Navy Model VK Plan Position Indicator; Navy Model VL Range-Height Indicator.

AN/SPS-8, -8A, -8B

PRINCIPAL COMPONENTS AND PHYSICAL DATA

COMPONENT	QTY	HEIGHT (Inches)	WIDTH (Inches)	DEPTH (Inches)	UNIT WT. (Pounds)
AN/SPS-8					
DG Synchro Amplifier Mk 3 Mod 1A	1	12	14	20-1/4	104
Synchro Signal Amplifier Mk 7 Mod 2C	1	14-1/4	15-3/4	22-3/4	467
Antenna AS-484/SPS-8					3985
Radar Receiver-Transmitter Group OA- 160/SPS-8	1	31-7/32	45-1/2	70-3/16	1272
Capacitor Assembly CB-4/SPS-8	1	10	11	16	97
Radar Modulator MD-122/SPS-8	1	24	46	70	2243
AN/SPS-8A, -8B					
DG Synchro Amplifier Mk 3 Mod 1A or Mk 7 Mod 2C	1	12	14	20- 1/4	104
Antenna AS-484A/SPS-8					5400
Antenna AS-828/SPS					4431
Radar Receiver-Transmitter Group OA-461/SPS-8A	1	31-7/32	45-1/2	70-3/16	1192
Capacitor Assembly CB-4/SPS-8	1	10	11	16	97
Radar Modulator MD-217/SPS-8A	1	24	46	70	2243

REFERENCE DATA AND LITERATURE

Technical Manual:  
NAVSHIPS 91522(A)  
NAVSHIPS 91988(A)

Note 1. Navy Status or Type Classification.  
AN/SPS-B - Ltd Std  
AN/SPS-8A - Sub Std  
AN/SPS-8B - Std

AN/S PS -8: 3

DATE: 1 July 1964

ITEM NAME: RADAR SET

COGNIZANT SERVICE: USN

TYPE: AN/SPS-8D

FEDERAL STOCK NUMBER:

	USA	USN	USAF	USMC
<b>STATUS OR TYPE CLASSIFICATION</b>				
Mfg(s) Name or Code Number: General Electric Company, Syracuse, New York				

Illustration not available.

**FUNCTIONAL DESCRIPTION**

The AN/SPS-BD Radar Set is a shipborne three-coordinate radar used for search, detection, height finding and control of intercepts. Has continuous scanning in elevation and azimuth, presenting any 120

degrees elevation sector between 0 degrees and 36 degrees elevation for the full 360 degrees in azimuth at 2, 3, 5 or 10 rpm or manual search lighting or sector scanning, with 41 db high-gain fully stabilized antenna. It consists of Radar Set AN/SPS-BA and AS-828A/SPS Antenna.

**AN/SPS-8D: 1**

ITEM NAME: RADAR SET

TYPE: AN/SPS-BD

**RELATION TO SIMILAR EQUIPMENT**

The AN/SPS-BD is functionally interchangeable with AN/SPS-8, -8A, -8B, -8C except uses different units.

Repetition Rate: 450 and 700 pps  
Power Input: 3 ph, 20 kva  
Type of Emission: Pulse

**TECHNICAL DESCRIPTION**

Pulse Data  
Width: 2 usec

**INSTALLATION CONSIDERATIONS**

Not available.

**PRINCIPAL COMPONENTS AND PHYSICAL DATA**

COMPONENT	QTY	OVERALL DIMENSIONS (Inches)	UNIT WT. (Pounds)
Antenna AS-828A/SPS	1		
Radar Receiver Transmitter Group OA-461/SPS-BA	1	31-1/4 x 48-7/16 x 64-1/16	1135
Radar Modulator MD-217/SPS-BA	1	24 x 46 x 70	2243
Dummy Load DA-37/U	1		
Power Control Group OA-460/SPS-BA	1	29 x 32 x 70	1503
Radar Control Group OA-659/SPS-BA	1		
Motor Generator Group OA-167/SPS-8	1	20 x 23-9/16 x 65	1288
Radar Set Control C-1176/SPS-8A	1	16-5/16 x 18-15/16 x 31-5/8	320

**REFERENCE DATA AND LITERATURE**

NAVSHIPS Form 4457  
Nomenclature Card for Radar Set AN/SPS-8D.

AN/SPS-8D: 2

DATE: 1 July 1964  
COGNIZANT SERVICE: USN

ITEM NAME: RADAR SET  
TYPE: AN/SPS-10, -10B, -10C, -10D

FEDERAL STOCK NUMBER: F5840- 642-6690

	USA	USN	USAF	USMC
STATUS OR TYPE CLASSIFICATION		See Note 1		
Mfg(s) Name or Code Number: Sylvania Electric Products, Inc.				

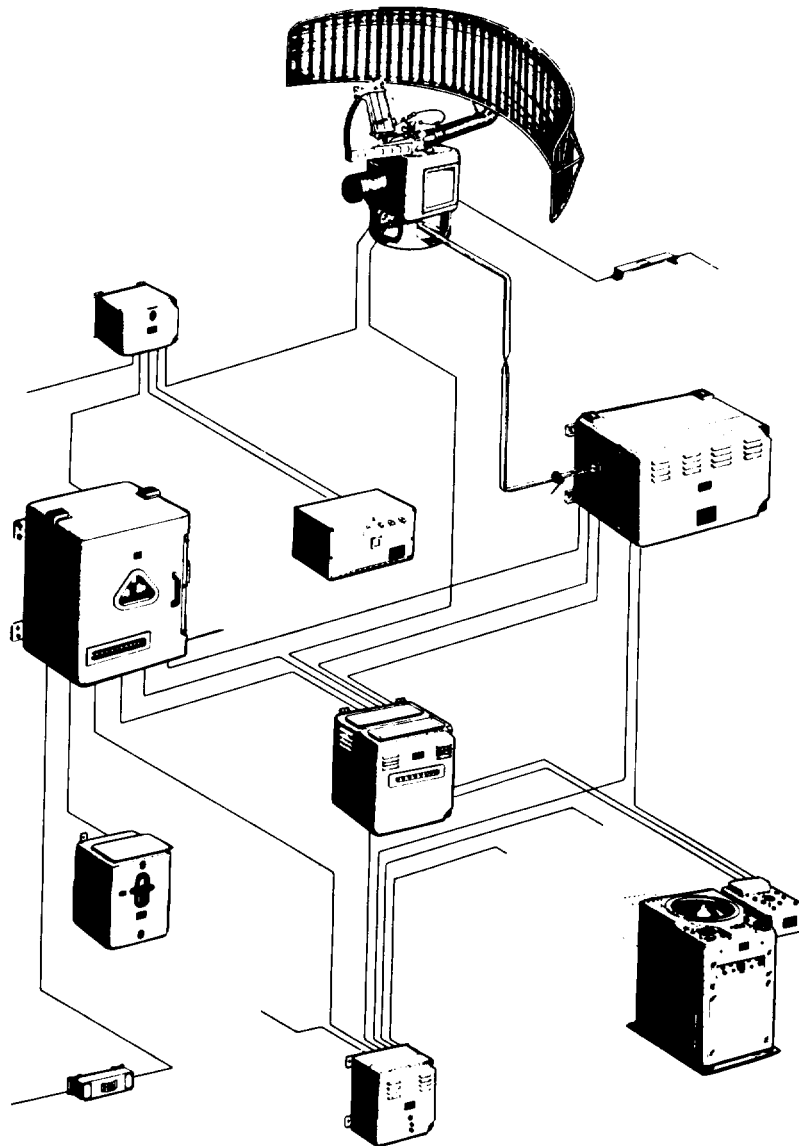

AN/SPS-10: 1



**AN/SPS-10, -10B, -10C, -10D**

**FUNCTIONAL DESCRIPTION**

Although primarily designed for shipboard installation, the AN/SPS-10 may be used at a shore station. The AN/SPS-10 is employed for the detection, ranging, and tracking of surface targets and, to a limited extent, of air targets. Provisions are made to supply target range and azimuth intelligence to a standard PPI. Means are provided for beacon and IFF operation.

**RELATION TO SIMILAR EQUIPMENT**

The AN/SPS-10 is similar to the Radar Equipment SO series, except for the voltage regulator and modulator.

**TECHNICAL DESCRIPTION**

Frequency: 5450 to 5825 mc  
(beacon receiver - 5450 ±2 mc)  
Type Frequency Control: AM (pulsed) magnetron oscillator  
Pulse Width:  
Radar - 0.25 or 1.3 μsec ±10%  
Beacon - 2.25 -μsec ±10%  
Peak Power Output: 285 kw  
Pulse Repetition Rate:  
Radar - 625 to 650 pps  
Beacon - 312 to 325 pps  
Type of Receiver: Superheterodyne  
IF. Frequency: 30 mc  
Receiver Bandwidth: Narrow, 1 mc; broad, 5 mc  
Operating Voltages and Power Requirements:

115 vac ±10%, 60 cps, 1-ph, 3.5 kva, 0.9 pf

Antenna Rotation Speed:

16 ±1 rpm up to 60-knot load

Horizontal Beam Width:

Radar - 1.5 deg approx

IFF - 6 deg approx

Vertical Beam Width:

Radar - 12 to 16 deg

IFF - 22 deg approx

Resolution:

Azimuth - Less than 1 deg

Range - Short pulse, 50 yd; long pulse, 275 yd

**INSTALLATION CONSIDERATIONS**

Siting: Allow sufficient space for operating and servicing personnel. Location should provide protection from the weather and ample ventilation. Allow room for external connections and locate units to insure a minimum of interference from or to other equipment.

Mounting: Each cabinet must be grounded to bulkhead for safety and elimination of stray electric fields. All units are shock mounted except Band Suppression Filter F-188/SPS10, Power Supply PP-886/SPS10, and Slotted Line IM-82/UP.

Cabling Requirements: High-voltage pulse cable that connects the modulator to the receiver transmitter unit must be bonded to the bulkhead at 18-inch intervals. Coaxial cables should be secured with double-toe loose fitting straps. Waveguide and cable runs should be short and direct.

Related Equipment:

**PRINCIPAL COMPONENTS AND PHYSICAL DATA**

COMPONENT	QTY	HEIGHT (Inches)	WIDTH (Inches)	DEPTH (Inches)	UNIT WT. (Pounds)
Antenna Assembly AS-615/SPS-10	1	76	126	126	324
Power Supply PP-866/SPS-10	1	28	19.13	14.13	133
Interconnecting Box J-510/SPS-10	1	13.88	14.59	9.63	43
Filter, Band Suppression F- 188/SPS- 10	1	6.53	14.13	3.47	11.5
Filter, Band Suppression F- 189/SPS- 10	1	2.5	20.75	2.75	1.5
Slotted Line IM-82/UP	1	3.63	3.63	14.5	4.5

AN/SPS-10, -10B, -10C, -10D

**PRINCIPAL COMPONENTS AND PHYSICAL DATA (cont'd)**

<b>COMPONENT</b>	<b>QTY</b>	<b>HEIGHT (Inches)</b>	<b>WIDTH (Inches)</b>	<b>DEPTH (Inches)</b>	<b>UNIT WT. (Pounds)</b>
Radar Receiver-Transmitter RT-272/SPS- 10	1	25.38	32.81	20.19	260
Radar Modulator MD-176/SPS-10	1	40.38	30.25	19.06	325
Voltage Regulator 30AAP-1	1	23.86	14.06	11.63	88
Radar Set Control C-1134/SPS-10	1	13.94	9.25	14.19	18
Radar Repeater Equipment VJ-1 or AN/SPA-4A	1				
Synchro Amplifier Mk 2 Mod 2A	1				
Indicator Adapter MX-1399/SPS-10	1	20.19	17.06	11	50

**REFERENCE DATA AND LITERATURE**

Technical Manual:  
NAVSHIPS 91921(A)

Note 1. Navy Status or Type Classification.

AN/SPS-10 - Sub Std  
AN/SPS-10B - Sub Std  
AN/SPS-10C - Std  
AN/SPS-10D - Std

**AN/SPS-10: 3**

DATE: 1 September 1964

ITEM- NAME: RADAR SET

COGNIZANT SERVICE: USN

TYPE: AN/SPS-10E

FEDERAL STOCK NUMBER:

	USA	USN	USAF	USMC
STATUS OR TYPE CLASSIFICATION		Used by		
Mfg(s) Name or Code Number: Raytheon Manufacturing Company (10011)				

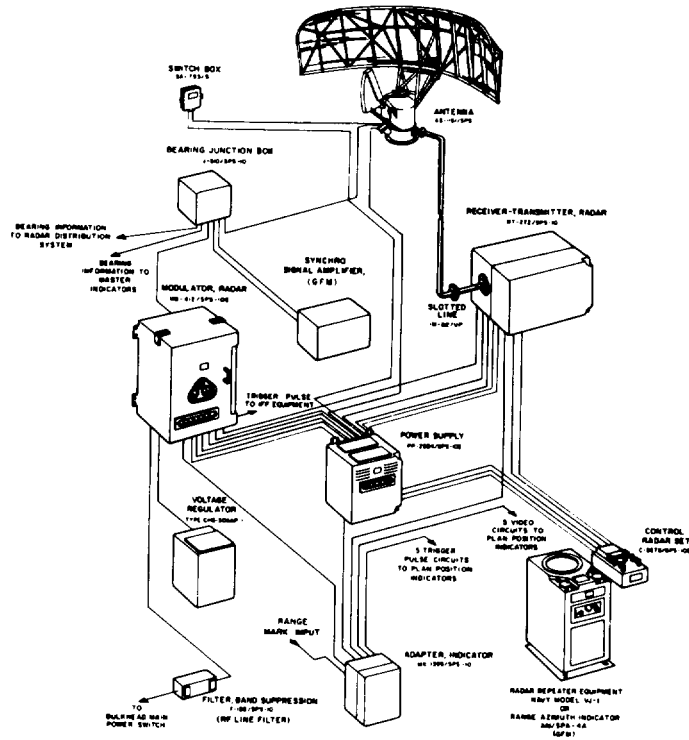

**FUNCTIONAL DESCRIPTION**

Radar Set AN/SPS-10E is designed for shipboard installation primarily; it may also be employed at a shore station. It is used for the detection, ranging and tracking of surface targets and, to a limited extent, of air targets.

Provisions are made to supply target range and bearing intelligence to a standrd Navy plan position indicator Means are provided for Beacon and IFF operation.

**ITEM NAME:** RADAR SET

**TYPE:** AN/SPS-10E

**RELATION TO SIMILAR EQUIPMENT**

Radar Set AN/SPS-10E is similar to AN/SPS10 with the exception of major change between the two is the use of Antenna AS-1161 in AN/SPS-10E. In addition minor changes have resulted in new nomenclature.

**TECHNICAL DESCRIPTION**

**Transmitter Frequency Band**

Radar and Beacon: 5450 to 5825 mc  
Receiver Frequency Band and Radar Receiver Frequency Band: 5450 to 5825 mc  
Beacon: 5450 plus or minus 2 mc

Type of Frequency Control: Amplitude-Modulated (pulsed) magnetron oscillator

**Type of Emission**

Radar Pulse: 0.25 to 1.3 usec plus or minus 10%  
Beacon Pulse: 2.25 usec plus or minus 10%

Type of Receiver: Superheterodyne

Intermediate Frequency: 30 mc

**Bandwidth**

Narrow Band: 1 mc  
Wide Band: 5 mc

**Power Supply**

Voltage: 115v ac plus or minus 10%  
Frequency: 60 plus or minus 2 cyc  
Phase: Single  
Estimated Power: 3.5 kva  
Estimated Power Factor: 0.9

Radar Resolution (Effect of Indicator Not Considered)

Bearing: Less than 10  
Range Short Pulse: 50 yds  
Range Long Pulse: 275 yds

Humidity: Up to 95% relative

Ambient Temperature (Except Antenna): 0 to 50°C (32 to 122°F)

Ambient Temperature Antenna: -35 to plus 60°C (-31 to plus 1400F)

Construction (Except Antenna): Dripproof

Construction Antenna: Watertight

**Antenna**

Frequency of Operation: 5450 to 5825 mc

Antenna Gain: 30.0 db

Antenna Horizontal Beamwidth: 1.9°

Antenna Vertical Beamwidth: 16°

High Angle Coverage: Approx  $\text{csc}^2$  plus 7 to 22°

Polarization: Horizontal

Rotation Speed: 17 rpm

Relative Bearing Data: 1 speed

Power Source: 115v, 60 cyc

**INSTALLATION CONSIDERATIONS**

Not available.

**PRINCIPAL COMPONENTS AND PHYSICAL DATA**

<b>COMPONENT</b>	<b>QTY</b>	<b>OVERALL DIMENSIONS (Inches)</b>	<b>UNIT WT. (Pounds)</b>
Antenna AS-1161/SPS	1		
Adapter Indicator MX-1399/SPS-10	1		
Control Radar Set 1 C-3678/SPS-10E			
Filter Band Suppression F-188/SPS-10	1		
Filter Band Suppression F-189/SPS-10	1		
Indicator Standing Wave Ratio IM-127/SPS-10	1		
Interconnecting Box J-510/SPS-10E	1		
Modulator Radar MD-412/SPS-10E	1		
Power Supply PP-2984/SPS-10E	1		

**AN/SPS-10E: 2**

ITEM NAME: RADAR SET

TYPE: AN/SPS-10E

COMPONENT	QTY	OVERALL DIMENSIONS (Inches)	UNIT WT. (Pounds)
Receiver-Transmitter Radar RT-272/SPS-10	1		
Slotted Line IM-82/UP	1		
Synchro Signal Amplifier (GFM) Mark 2 Mod 2A	1		
Voltage Regulator CHS-30AAP-1	1		
Switch Box SA-793/S			
Radar Repeater Equipment (GFM) Navy Model VJ-1	1		

#### REFERENCE DATA AND LITERATURE

Technical Manuals:

NAVSHIPS 91921(A): for Radar Set AN/SPS-10

NAVSHIPS 94120: Complementary Technical Manual for Radar Set AN/SPS-10E

AN/SPS-10E: 3

DATE: 1 July 1964

ITEM NAME: RADAR SET

COGNIZANT SERVICE: USN

TYPE: AN/SPS-12, AN/SPS-12A\*

FEDERAL STOCK NUMBER: F5840-642-6706

	USA	USN	USAF	USMC
<b>STATUS OR TYPE CLASSIFICATION</b>		Sub Std * Std		

Mfg(s) Name or Code Number: Radio Corporation of America

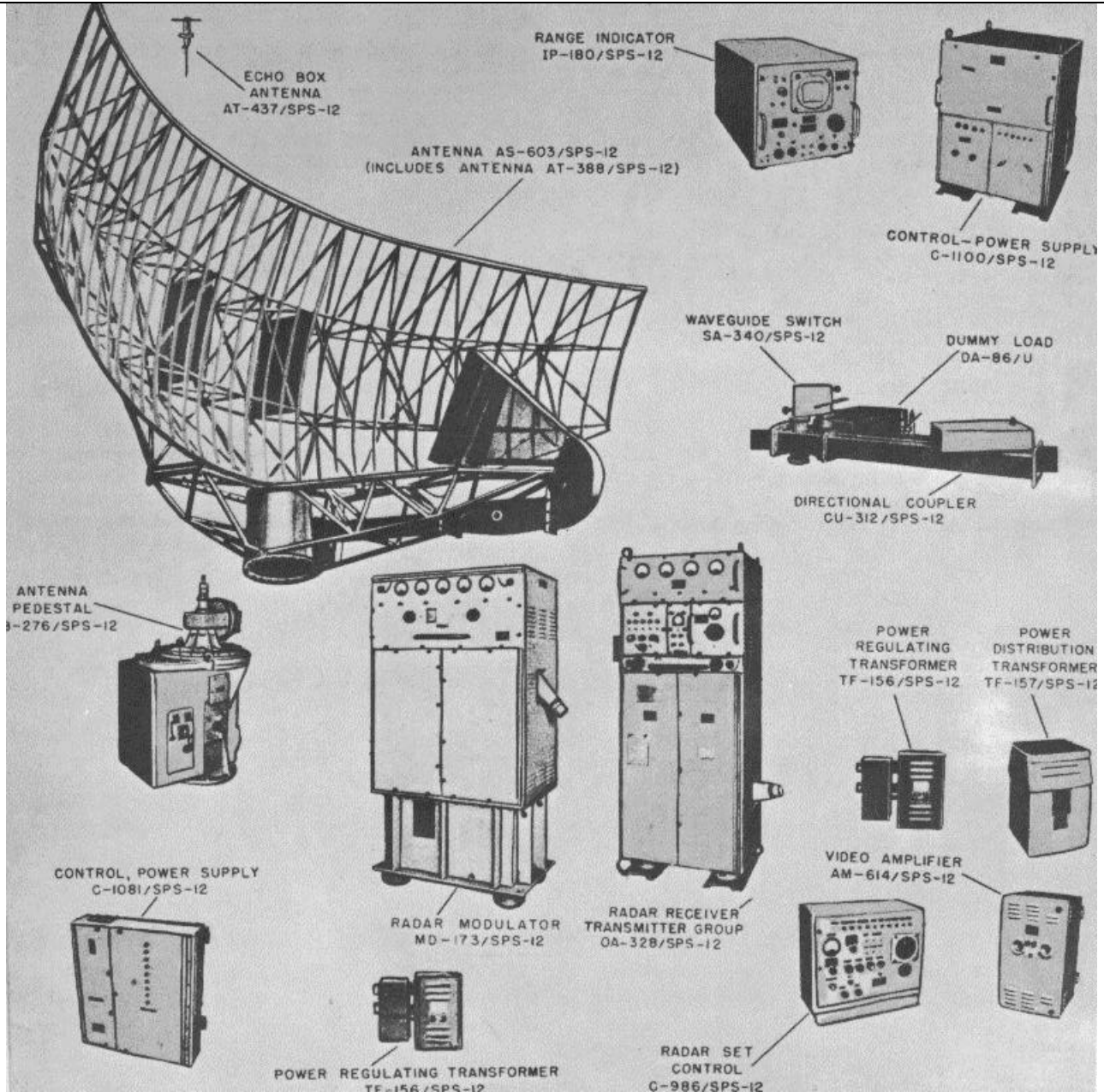

**AN/SPS-12, AN/SPS-12A**

**FUNCTIONAL DESCRIPTION**

The AN/SPS12 is a medium-range surveillance radar that detects aircraft and surface ships. It presents target range on an A-type indicator and provides target range and azimuth data for presentation on associated PPI's. Provision is made to connect AN/UPX-1A equipment and display the received signals from this equipment together with the reflected radar signals on the PPI of other associated equipment.

The fundamental pulse repetition frequencies may be varied by  $\pm 5\%$  for anti-jamming purposes. Local or remote selection of long or short pulses is possible. Facilities for making radar performance checks while at sea are provided. Sufficient space is available to permit a modification that increases the peak power output to two megawatts.

When Antenna Group AN/SPA-21(XN-1) is installed, the AN/SPS12 is converted to a long range surveillance radar equipment.

**RELATION TO SIMILAR EQUIPMENT**

Functionally similar to, but not interchangeable with, Radar Sets AN/SPS-6,-6A,-6B series equipments. The AN/SPS-12A is functionally interchangeable with the AN/SPS-12, only difference is the addition of roll stabilization to the antenna.

**TECHNICAL DESCRIPTION**

Frequency: 1250 to 1350 mc  
Peak Power Output: 500 kw  
Pulse Repetition Rate: 300 and 600 pps, variable  
by  $\pm 5\%$ - for anti-jamming  
Pulse Duration: 4  $\mu$ sec for 300 pps and 1  $\mu$ sec  
for 600 pps

IF. Frequency: 30 mc  
Operating Voltages and Power Requirements:  
440v, 60 cps, 3-ph, 9 kva max, 19.6 amp operating  
current, 9.3 amp standby current,  
0.92 pf (lagging)  
Antenna Type: Parabolic  
Antenna Feed: L-band waveguide  
Antenna Beam Pattern, Vertical Plane:  
30 deg cosecant squared  
Antenna Beam Pattern, Horizontal Plane:  
Sharp 3 deg beam

**INSTALLATION CONSIDERATIONS**

Siting: Locate Radar Modulator MD173/SPS12 and Radar Receiver-Transmitter Group OA-328/SPS-12 close together in compartment near mast. Locate Control-Power Supply C-1100/SPS-12 and Electronic Control Amplifier AM-420/U (GFE) near Radar Receiver Transmitter Group OA-328/SPS-12. Allow clearance on all sides of units for removal of panels and servicing.  
Mounting: Radar Receiver-Transmitter Group OA-328/SPS-12, Radar Modulator MD-173/ SPS-12, and Control-Power Supply C-1100/ SPS-12 mounted upright with shock mounts to steel plates on deck and shock mounts to bulkhead. Power Supply Control C-1081 must be mounted in an upright position for relays to function properly.  
Cabling Requirements: Cables should not run through battery charging compartments, galleys, uptake spaces or machinery spaces. Solid coaxial cables should be kept away from steam pipes, hot-air intakes, and stack gases.  
Related Equipment: AN/UPX( ).

PRINCIPAL COMPONENTS AND PHYSICAL DATA

COMPONENT	QTY	HEIGHT (Inches)	WIDTH (Inches)	DEPTH (Inches)	UNIT WT. (Pounds)
Radar Receiver-Transmitter Group OA-328/SPS-12	1	22-7/16	28	72	700
Radar Modulator MD-173/SPS-12	1	72	37-1/16	28-9/16	1650
Radar Set Control C-986/SPS-12	1	14-7/16	22-3/4	22-3/4	81
Range Indicator IP-180/SPS-12	1	18-1/4	19	42-1/2	143
Control Power Supply C-1100/SPS-12	1	34-3/16	25-1/4	30-1/4	550
Antenna Pedestal AB-276/SPS-12	1	52-1/2	24	31-1/4	590
Antenna AS-603/SPS-12	1	121	205	92	400
Video Amplifier AM-614/SPS-12	1	26-1/4	15-1/2	15-5/16	107
Control Power Supply C-1081/SPS-12	1	26-1/2	24-3/8	9-5/16	102
Power Regulating Transformer TF-156/SPS- 12	1	14-1/8	18	7-5/16	69
Power Distribution Transformer TF- 157/SPS- 12	1	20-11/16	13-13/16	13-7/8	188
Switch Waveguide SA-340/SPS-12	1	14-1/8	10-5/6	11-11/16	20
Dummy Load DA-86/U	1	7-5/8	26-7/8	10-7/8	48
Coupler Directional CU-312/SPS-12	1	9-9/32	33-1/2	12-7/8	36
Antenna AT-437/SPS-12	1	6	4-7/8	1/4	1

REFERENCE DATA AND LITERATURE

Technical Manual:  
NAVSHIPS 91949(A)

AN/SPS-12: 3



DATE: 1 July 1964

ITEM NAME: RADAR SET

COGNIZANT SERVICE: USN

TYPE: AN/SPS-16

FEDERAL STOCK NUMBER: 5840-573-4422 W/S

	USA	USN	USAF	USMC
STATUS OR TYPE CLASSIFICATION				
Mfg(s) Name or Code Number: Westinghouse Electric Corporation				

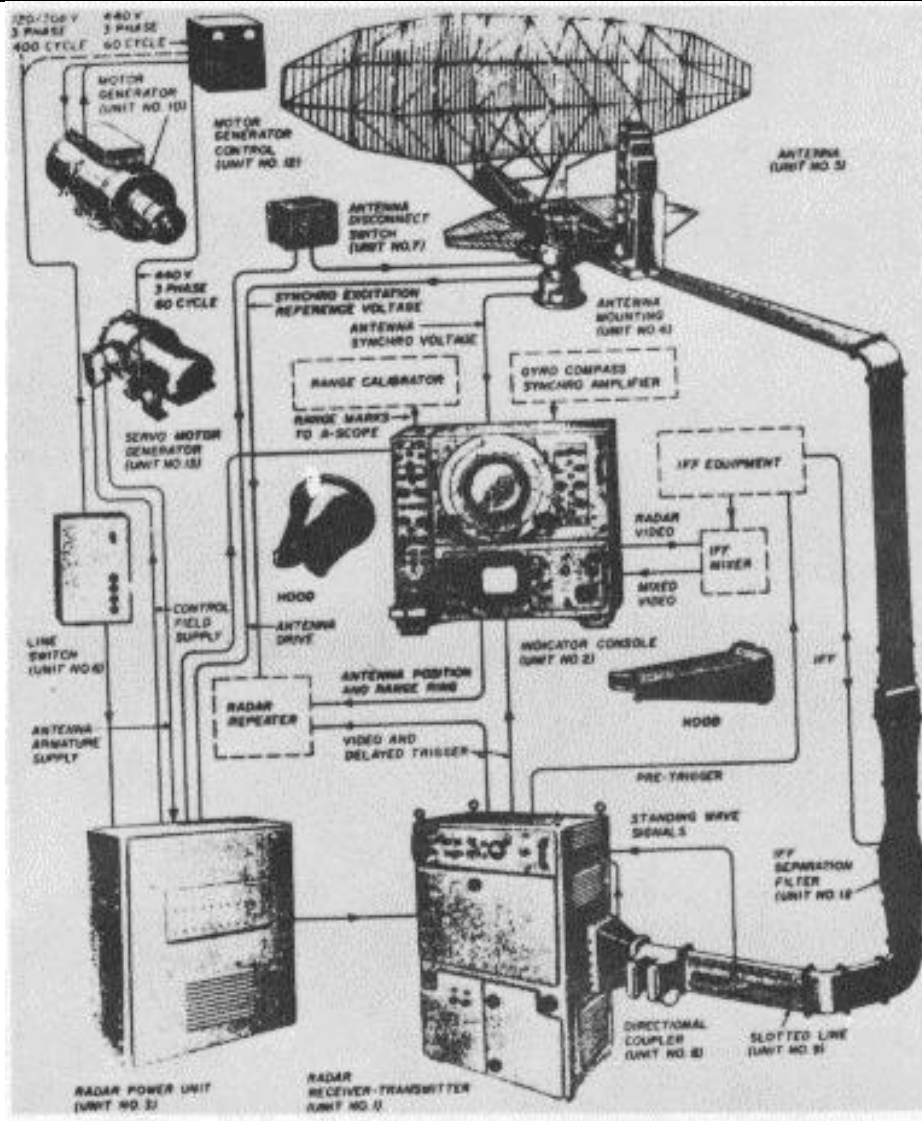

**FUNCTIONAL DESCRIPTION**

The Radar Set AN/SPS-16 is designed as a shipborne air and surface search radar set to operate with IFF equipment and to

display target bearing and range data on the Plan Position Indicator (PPI) and "A" scope indicators.

**ITEM NAME:** RADAR SET

**TYPE:** AN/SPS-16

**RELATION TO SIMILAR EXUIPMENT**

The AN/SPS-16 is mechanically and electrically interchangeable with the AN/SPS16(XN-1); it differs in minor curcuit changes; tube and semi-conductor type and numbers also differ.

Operating Power Requirements: 440v ac, 60 cps, 3 ph; or 120 to 208v ac, 400 cps, 3 ph, 4-wire.

**INSTALLATION CONSIDERATIONS**

Related Equipment: (Required but not Supplied) (1) PPI-Repeater and Technical Manual Model VK or equivalent; (1) Gyro Compass Synchro Amplifier and Technical Manual MK 3 Mod 1 or MK 2 Mod 1; (1) Range Calibrator and Technical Manual TS-358/UP or equivalent; (1) IFF Equipment and Technical Manual.

**TECHNICAL DESCRIPTION**

Frequency Range: 1250 to 1350 mc  
Peak Power Output: 500 kw  
Pulse Repetition Range: 400 pps  
Intermediate Frequency: 30 mc  
Type of Receiver: Superheterodyne  
Power Factor: 90% lagging

**PRINCIPAL COMPONENTS AND PHYSICAL DATA**

<b>COMPONENT</b>	<b>QTY</b>	<b>OVERALL DIMENSIONS (Inches)</b>	<b>UNIT WT. (Pounds)</b>
Radar Receiver Transmitter Unit #1	1	19-3/4 x 27 x 43	375
Indicator Console Unit #2	1	22-3/8 x 23-1/8 x 25-9/16	140
Radar Power Unit, Unit #3	1	14 x 25-11/16 x 30-1/2	153
Antenna Mounting Unit #4	1	25 x 25-1/2 x 33-3/4	302
Antenna Unit #5	1	81-3/32 x 100-7/8 x 192-7/8	208
Line Switch Unit #6	1	6 x 12-1/16 x 18-9/16	12.5
Antenna Disconnect Switch Unit #7	1	4-1/2 x 5 x 5-1/2	1.5
Directional Coupler Unit #8	1	6-1/2 x 6-3/4 x 8	3.5
Slotted Line Unit #9	1	6-1/2 x 8 x 22-5/8	9
Motor Generator Unit #10	1	15-1/2 x 18-5/8 x 42	610
IFF Separation Filter Unit #11	1	7-1/2 x 9-1/2 x 62-7/8	34.5
Servo Motor Generator Unit #13	1	16-1/2 x 19-1/2 x 32-3/4	430
Motor Generator Unit #12	1	11-1/2 x 13-1/2 x 14-1/2	20
Waveguide Assy and Accessories	1		170.5

**AN/SPS-16: 2**

ITEM NAME: RADAR SET

TYPE: AN/SPS-16

PRINCIPAL COMPONENTS AND PHYSICAL DATA  
SHIPPING DATA

COMPONENT	PKGS (NR.)	UNIT WT. (Pounds)
	1	484
	1	48
	1	257
	1	230
	1	460
	1	458
	1	
	1	275
	1	
	1	
	1	
	1	
	1	760
	1	75
	1	
	1	508
	1	156
	2	200
	6	120

REFERENCE DATA AND LITERATURE

Technical Manuals:

NAVSHIPS 91991: for Radar Set AN/SPS-16(XN-1).

NAVSHIPS 93400: Preliminary Data Form.

AN/SPS-16: 3



**ITEM NAME:** RADAR SET

**TYPE:** AN/SPS-16(XN-1)

on the Indicator Console. Antenna rotation is controlled in manual operation by the handslew wheel and in automatic operation by a potentiometer on the Radar Set Control chassis, both of which are located on the Indicator Console. Seven feed horn radiators on the Antenna propagate and receive both radar and IFF signals. The radar signals from Radar-Receiver Transmitter may be tuned to any frequency in the L-band between 1250 and 1350 mc. The IFF Signals originate in Radar Recognition Set AN/UPX( ) and are coupled to the waveguide through the IFF separation filter.

**RELATION TO SIMILAR EQUIPMENT**

None.

**TECHNICAL DESCRIPTION**

Frequency Range: 1250 to 1350 mc  
Peak Power Output: 500 kw  
Pulse Repetition Rate: 400 pps  
Receiver Type: Superheterodyne  
Power Factor: 90% lagging.  
Power Source Required: 440v, 60 cps, 3 ph  
or 120 to 208v, 400 cps, 3 ph, 4-wire.

**INSTALLATION CONSIDERATIONS**

Related Equipment: (Required but not Supplied) VK PPI Repeaters or equivalent, (1) Gyro Compass Synchro Amplifier Mark 3 Mod 1 or Mark 2 Mod 1, (1) Range Calibrator TS-358/UP or equivalent and (1) IFF Equipment.

**PRINCIPAL COMPONENTS AND PHYSICAL DATA**

**SHIPPING DATA**

<b>COMPONENT</b>	<b>BOXES (NR.)</b>	<b>OVERALL DIMENSIONS (Inches)</b>	<b>UNIT WT. (Pounds)</b>
Receiver-Transmitter	1	31-1/4 x 34-1/8 x 45-1/2	484
Magnetron	1	10-1/4 x 15 x 22-1/2	48
Indicator Console	1	31-1/8 x 31-1/4 x 34	257
Radar Power Unit	1	23-1/8 x 35-1/4 x 38-3/4	230
Antenna Mounting	1	35-1/8 x 35-1/4 x 48-1/8	460
Antenna (Reflectors and Ground Plane)	1	43-1/2 x 83 x 198	458
Antenna (Wye Beam)	1	40-1/4 x 50-3/4 x 106	
Accessories:	1		
Line Switch			
Antenna Disconnect Switch			
Direct Coupler			
Slotted Line			
Waveguide Components		31-1/8 x 31-1/4 x 55-1/8	275
Motor Generator and Motor Generator Controller	1	20-1/4 x 43-1/4 x 45-1/8	760
IFF Separator	1	11-1/4 x 13-1/4 x 65-1/4	75
Servo Motor Generator	1	23-1/4 x 25-3/8 x 43-3/8	506
Synchro Amplifier	1	17-3/8 x 21-5/8 x 29-1/2	156
Maintenance Parts	2	18 x 22 x 34	200
Maintenance Parts	6	14 x 16 x 22	120

**AN/SPS-16(XN-1): 2**

ITEM NAME: RADAR SET

TYPE: AN/SPS-16(XN-1)

**PRINCIPAL COMPONENTS AND PHYSICAL DATA  
EQUIPMENT SUPPLIED DATA**

<b>COMPONENT</b>	<b>QTY</b>	<b>OVERALL DIMENSIONS (Inches)</b>	<b>UNIT WT. (Pounds)</b>
Radar Receiver-Transmitter	1	19-3/4 x 27 x 43	375
Indicator Console	1	22-3/8 x 23-1/8 x 25-9/16	140
Radar Power Unit	1	14 x 25-11/16 x 30-1/2	153
Antenna Mounting	1	25 x 25-1/2 x 33-3/4	302
Antenna	1	81-3/32 x 100-7/8 x 192-7/8	208
Line Switch	1	6 x 12-1/16 x 18-9/16	12-1/2
Antenna Disconnect Switch	1	4-1/2 x 5 x 5/12	1-1/2
Directional Coupler	1	6-1/2 x 6-3/4 x 8	3-1/2
Slotted Line	1	6-1/2 x 8 x 22-5/8	9
Motor Generator	1	15-1/2 x 18-5/8 x 42	610
IFF Separation Filter	1	7-1/2 x 9-1/2 x 62-7/8	34-1/2
Motor Generator Control	1	11-1/2 x 13-1/2 x 14-1/2	20
Servo Motor Generator	1	16-1/2 x 19-1/2 x 32-3/4	430
Waveguide Assembly	1		170-1/2

**REFERENCE DATA AND LITERATURE**

Technical Manuals:  
NAVSHIPS 91991

**AN/SPS-16(XN-1) : 3**

DATE: 1 July 1964

NAME: RADAR SET

COGNIZANT SERVICE: USN

TYPE: AN/SPS-21

FEDERAL STOCK NUMBER: 5840-669-8729

	USA	USN	USAF	USMC
STATUS OR TYPE CLASSIFICATION-		Sub Std		
Mfg(a) Name or Code Number: Raytheon Manufacturing Company				

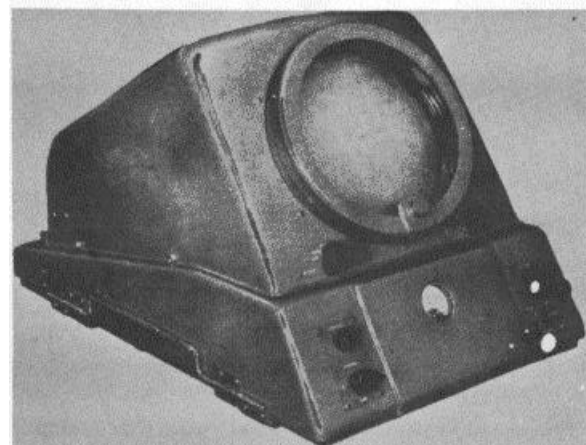
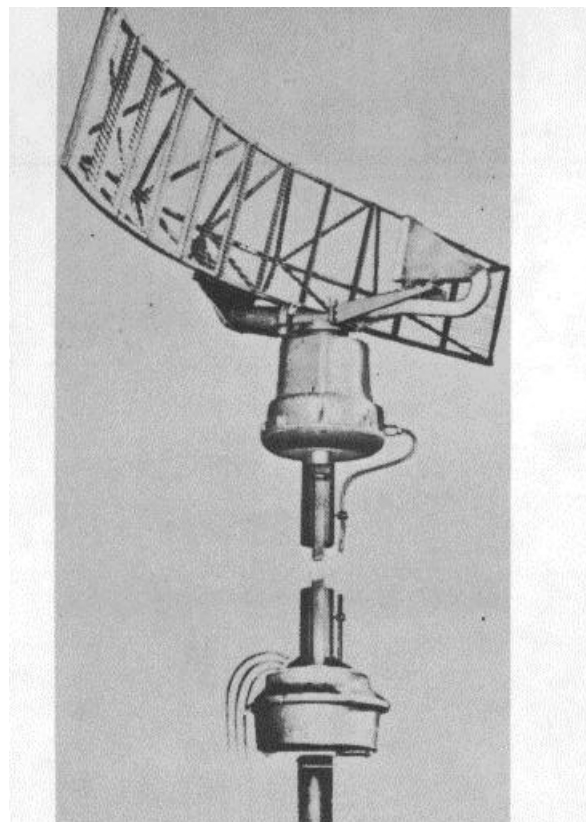

### FUNCTIONAL DESCRIPTION

AN/SPS-21 is a surface scanning, short range, low-power, lightweight equipment. It is designed for installation in small vessels where space is at a premium and on larger vessels where a second radar is needed as a standby navigational aid.

### RELATION TO SIMILAR EQUIPMENT

None.

### TECHNICAL DESCRIPTION

Frequency: 5500 to 5600 mc  
 Range, Max: 16 mi  
 Range, Min: 75 yd  
 Peak Power Output: 10 kw  
 Pulse Repetition Rate: 1,500 pps  
 Pulse Duration: 0.19  $\mu$ sec  
 Type of Presentation: PPI (10-in. CRT)  
 Operating Voltages and Power Requirements:  
 104 to 126v, 58 to 62 cps, 1-ph, 10 amp starting current, 2 amp standby current, 6.5 amp operating current, 607w, 0.804 pf

Antenna Type: Parabolic  
 Antenna Input Impedance: 466 ohms  
 Antenna Feed: Waveguide  
 Horizontal Beam Width: 2 deg 3 db down  
 Vertical Beam Width: 15 deg 3 db down  
 IF. Frequency: 45 mc

Number and Interval of Range Markers:

Range Scale (miles)	No. of Markers	Interval (miles)
1	2	0.5
2	4	0.5
4	4	1.0
8	4	2.0
16	4	4.0

### INSTALLATION CONSIDERATIONS

Siting: The antenna and radar receiver-transmitter are watertight and may be sited in exposed

AN/SPS-21

locations. The indicator is drip-proof and should be sheltered from the weather.

Mounting: The antenna and radar receiver-transmitter maybe mounted together as one unit or installed

as two units with a waveguide between them.

Cabling Requirements:

Related Equipment:

**PRINCIPAL COMPONENTS AND PHYSICAL DATA**

<b>COMPONENT</b>	<b>QTY</b>	<b>HEIGHT (Inches)</b>	<b>WIDTH (Inches)</b>	<b>DEPTH (Inches)</b>	<b>UNIT WT. (Pounds)</b>
Antenna AS-710/SPS-21	1	31	18	48	122
Reflector	1	20	98	26	47
Radar Receiver-Transmitter RT-321/SPS-21	1	19	20	20	53
Control Indicator C-1438/SPS-21	1	16	17	23	103

**REFERENCE DATA AND LITERATURE**

Technical Manual:  
NAVSHIPS 92284(A)



**DATE:** 1 July 1964

**ITEM NAME:** RADAR SET

**COGNIZANT SERVICE:** USN

**TYPE:** AN/SPS-21A

**FEDERAL STOCK NUMBER:** 5840-542-7153

	USA	USN	USAF	USMC
STATUS OR TYPE CLASSIFICATION		Std		
Mfg(s) Name or Code Number: Raytheon Manufacturing, Waltham, Massachusetts				

Illustration not Available.

**FUNCTIONAL DESCRIPTION**

The AN/SPS-21A is a short-range, compact, lightweight equipment of low power consumption. It is a surface scanning 5500 to 5600 megacycle (mc) radar

designed for installation on small vessels where space is at a premium and on large vessels where a second radar is needed for use as a standby navigational aid for complete protection. The radar set operates from a 115 volt, 60 cycle power source.

**AN/SPS-21A: 1**

**ITEM NAME:** RADAR SET

**TYPE:** AN/SPS-21A

**RELATION TO SIMILAR EQUIPMENT**

The AN/SPS-21A is similar to and interchangeable with Radar Set AN/SPS-21 except each unit has minor modifications.

Number of Bands: 1 band  
Operating Frequency Range  
Transmitter and Receiver: 5550 to 5600 mc.  
Power Supply Characteristics  
Voltage: 104 to 126v  
Frequency: 58 to 62 cycles.  
Phase: Single.  
Maximum Starting Current: 10 amps  
Standby Current: 2 amps  
Running Current: 6.56 amps  
Estimated Power: 607w  
Power Factor: 80.4%

**TECHNICAL DESCRIPTION**

Type of Frequency Control: Pulse-Modulated  
Magnetron Oscillator.  
Peak Power Output: 10 kw  
Type of Emission: Pulse (0.19 usec).  
Pulse Rate: 1500 pps  
Type of Receiver: Superheterodyne  
Intermediate Frequency: 45 mc  
Bandwidth: 11 mc

**INSTALLATION CONSIDERATIONS**

Not available.

**PRINCIPAL COMPONENTS AND PHYSICAL DATA**

**SHIPPING DATA**

<b>COMPONENT</b>	<b>BOXES (NR)</b>	<b>OVERALL DIMENSIONS (Inches)</b>	<b>UNIT WT. (Pounds)</b>
Antenna Pedestal AS-710A/SPS-21	1	26 x 36 x 37	237
Reflector	1	36 x 39 x 104	298
Radar Receiver-Transmitter RT-321A/SPS-21	1	23 x 26 x 31	107
Control Indicator C-1438A/SPS-21	1	25 x 28 x 41	217
Set of Miscellaneous Interconnection Material	1	18 x 21 x 32	93
Waveguide RG-49/U	1	5 x 5 x 174	72
Set of Equipment Spares	1	24 x 24 x 36	83
Set of Equipment Spares	1	25 x 28 x 41	207

**EQUIPMENT SUPPLIED DATA**

<b>COMPONENTS</b>	<b>QTY</b>	<b>OVERALL DIMENSIONS (Inches)</b>	<b>UNIT WT. (Pounds)</b>
Antenna Pedestal AS-710A/SPS-21	1	16 x 19 x 27	122
Reflector	1	33 x 48 x 93	47
Radar Receiver-Transmitter RT-321A/SPS-21	1	19 x 20 x 20	53
Control Indicator C-1438A/SPS-21	1	16 x 17 x 28	103
Waveguide RG-49/U	1		50

**REFERENCE DATA AND LITERATURE**

Technical Manuals:  
NAVSHIPS 92284(A): for Radar Set AN/SPS-21.  
Nomenclature Card for Radar Set AN/SPS-21A.

**DATE:** 1 July 1964

**ITEM NAME:** RADAR SET

**COGNIZANT SERVICE:** USN

**TYPE:** AN/S PS-21B

**FEDERAL STOCK NUMBER:** 5840-542-7154

	USA	USN	USAF	USMC
STATUS OR TYPE CLASSIFICATION		Std		
Mfg(s) Name or Code Number: Raytheon Manufacturing Company, Waltham, Massachusetts				

Illustration not Available.

**FUNCTIONAL DESCRIPTION**

The AN/SPS-21B is a short-range, compact, lightweight equipment of low power consumption. It is a surface scanning 5500 to 5600 megacycle (mc) radar

designed for installation on small vessels where space is at a premium and on larger vessels where a second radar is needed for use as a standby navigational aid for complete protection. The radar operates from 115 volts, 60 cycle power source.

**AN/SPS-21B: 1**

**ITEM NAME:** RADAR SET

**TYPE:** AN/SPS-21B

**RELATION TO SIMILAR EQUIPMENT**

The AN/SPS-21B is similar to and interchangeable with Radar Set(s) AN/SPS-21 and AN/SPS-21A except Control Indicator C-143BB/SPS-21 is modified to include variable range marker.

Intermediate Frequency: 45 mc  
Bandwidth: 11 mc  
Power Supply Characteristics  
Voltage: 104 to 126v  
Frequency: 58 to 62 cycles  
Phase: Single  
Maximum Starting Current: 10 amps  
Standby Current: 2 amps  
Running Current: 6.56 amps  
Estimated Power: 607w  
Power Factor: 80.4%.

**TECHNICAL DESCRIPTION**

Type of Frequency Control: Pulse-Modulated  
Magnetron Oscillator.  
Type of Emission: Pulse (0.19 usec).  
Peak Power Output: 10 kw  
Pulse Rate: 1500 pps  
Type of Receiver: Superheterodyne

**INSTALLATION CONSIDERATIONS**

Not available.

**PRINCIPAL COMPONENTS AND PHYSICAL DATA**

**SHIPPING DATA**

<b>COMPONENT</b>	<b>BOXES (NR)</b>	<b>OVERALL DIMENSIONS (Inches)</b>	<b>UNIT WT. (Pounds)</b>
Antenna Pedestal AS-710A/SPS-21	1	26 x 36 x 37	237
Reflector	1	36 x 39 x 104	298
Radar Receiver Transmitter RT-321A/SPS-21	1	23 x 26 x 31	107
Control Indicator C-1438B/SPS-21	1	25 x 28 x 41	217
Set of Miscellaneous Interconnection Material	1	18 x 21 x 32	93
Set of Equipment Spares	1	24 x 24 x 36	83
Set of Equipment Spares	1	25 x 28 x 41	207
Waveguide RG-49/U	1	5 x 5 x 174	72

**EQUIPMENT SUPPLIED DATA**

<b>COMPONENTS</b>	<b>QTY</b>	<b>OVERALL DIMENSIONS (Inches)</b>	<b>UNIT WT. (Pounds)</b>
Antenna Pedestal AS-710A/SPS-21	1	16 x 19 x 27	122
Reflector	1	33 x 48 x 93	47
Radar Receiver Transmitter RT-321A/SPS-21	1	19 x 20 x 20	53
Control Indicator C-1438B/SPS-21	1	16 x 17 x 28	103
Waveguide RG-49/U	1		50

**REFERENCE DATA AND LITERATURE**

Technical Manuals:  
NAVSHIPS 922B4(A): for Radar Set AN/SPS-21.  
Nomenclature Card for Radar Set AN/SPS-21B.

DATE: 1 July 1964

ITEM NAME: RADAR SET

COGNIZANT SERVICE: USN

TYPE: AN/SPS-21C

FEDERAL STOCK NUMBER: 5840-726-3961

	USA	USN	USAF	USMC
STATUS OR TYPE CLASSIFICATION		Std		
Mfg(s) Name or Code Number: Voi-Shaun Mfg Co., Div of Pheoll Mfg Co., Culver City, Calif.				

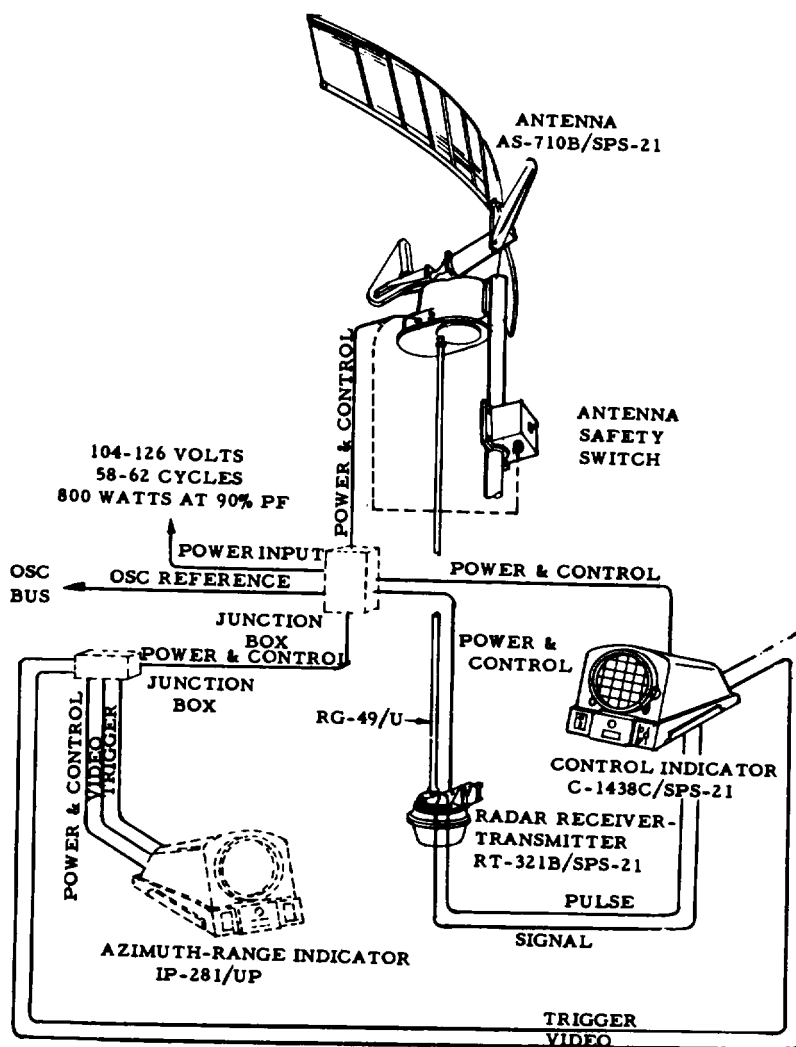

**FUNCTIONAL DESCRIPTION**

Radar Set AN/SPS-21C is a short-range, compact, lightweight equipment of low power consumption. It is a

surface scanning radar designed for installation on small vessels where space is at a premium and on larger vessels where a second radar is needed for use as a standby navigation aid for complete protection.

**ITEM NAME:** RADAR SET

**TYPE:** AN/SPS-21C

**PRINCIPAL COMPONENTS AND PHYSICAL DATA  
SHIPPING DATA**

<b>COMPONENT</b>	<b>BOXES (NR)</b>	<b>OVERALL DIMENSIONS (Inches)</b>	<b>UNIT WT. (Pounds)</b>
Antenna Pedestal AS-710B/SPS-21	1	26 x 36 x 37	237
Reflector	1	36 x 53 x 104	298
Receiver-Transmitter, Radar RT-321B/SPS-21	1	23 x 26 x 31	107
Control-Indicator C-1438C/SPS-21	1	25 x 28 x 41	217
Misc. and Interconnecting Material	1	1B x 21 x 32	93
Waveguide RG-49/U	1	5 x 5 x 174	72
Equipment Maintenance Parts	1	24 x 24 x 36	83
Equipment Maintenance Parts	1	25 x 28 x 41	207

**EQUIPMENT SUPPLIED DATA**

<b>COMPONENTS</b>	<b>QTY</b>	<b>OVERALL DIMENSIONS (Inches)</b>	<b>UNIT WT. (Pounds)</b>
Radar Set AN/SPS-21C includes:	1		427
Antenna Assy AS-710B/SPS-21 c/o	1		169
Antenna Pedestal	1	16 x 19 x 27	122
Reflector	1	33 x 48 x 93	47
Receiver-Transmitter, Radar RT-321B/SPS-21	1	19 x 20 x 20	53
Control-Indicator C-1438C/SPS-21	1	16 x 17 x 28	103
Waveguide RG-49/U	1		50

**REFERENCE DATA AND LITERATURE**

Technical Manuals:  
NAVSHIPS 00000

**AN/SPS-21C: 2**

**DATE:** 1 July 1964

**ITEM NAME:** RADAR SET

**COGNIZANT SERVICE:** USN

**TYPE:** AN/SPS-21D

**FEDERAL STOCK NUMBER:** 5840-810-8591

	USA	USN	USAF	USMC
STATUS OR TYPE CLASSIFICATION		Std		
Mfg(s) Name or Code Number: Sperry Piedmont Company, Charlottesville, Virginia				

Illustration not Available.

**FUNCTIONAL DESCRIPTION**

Radar Set AN/SPS-21D is a short range, compact, lightweight equipment of low power consumption. It is a surface scanning radar designed for installation on small vessels where space is at a premium and on larger vessels where a second radar is needed for use as a standby navigation aid for complete protection.

**AN/SPS-21D: 1**

**ITEM NAME:** RADAR SET

**TYPE:** AN/SPS-21D

**RELATION TO SIMILAR EQUIPMENT**

This equipment is functionally interchangeable with and can replace Radar Sets AN/SPS-21, -21A, -21B, -21C, except parts differ.

Voltage: 104 to 126v  
Frequency: 58 to 62 cycles  
Phase: Single  
Estimated Power: 510w  
Power Factor: 0.815

**TECHNICAL DESCRIPTION**

Frequency Band: 5500 to 5600 mc  
Power Supply Characteristics

**INSTALLATION CONSIDERATIONS**

Not available.

**PRINCIPAL COMPONENTS AND PHYSICAL DATA**

<b>COMPONENTS</b>	<b>QTY</b>	<b>OVERALL DIMENSIONS (Inches)</b>	<b>UNIT WT. (Pounds)</b>
Antenna Assy AS-710C/SPS-21	1	52-3/8 x 98 (swing circle)	168
Receiver-Transmitter, Radar RT-321C/SPS-21	1	19-1/4 x 19-5/8 x 20-5/16	53
Control-Indicator C-1438D/SPS-21	1	17-1/4 x 20-3/4 x 29	168

**REFERENCE DATA AND LITERATURE**

Technical Manuals:  
NAVSHIPS 00000

**AN/SPS-21D: 2**



**DATE:** 1 July 1964

**ITEM NAME:** RADAR SET

**COGNIZANT SERVICE:** USN

**TYPE:** AN/SPS-23, -23A, -23X, -23Y, -23Z, -23XX

**FEDERAL STOCK NUMBER:**

	USA	USN	USAF	USMC
STATUS OR TYPE CLASSIFICATION		Std		
Mfg(s) Name or Code Number: Radiomarine Corporation of America				

No Illustration Available.

**FUNCTIONAL DESCRIPTION**

Radar Sets AN/SPS-23, -23A, -23X, -23Y, -23Z, and -23XX are medium power, lightweight, surface scanning X-band sets for installation on small ships. The equipments display range and azimuth information as well as Ramark beacon signals.

**RELATION TO SIMILAR EQUIPMENT**

None.

**TECHNICAL DESCRIPTION**

Frequency: 9320 to 9500 mc  
Range: 40 mi (max); 55 yd (rnin)  
Power Output: 50 kw (rnin)  
Operating Voltages and Power Requirements:  
AN/SPS-23, -23A -  
220/440 vac, 60 cps, 3-ph, 1.42 kw  
AN/SPS-23X -  
115/230 vac, 60 cps, 1.89 kw  
AN/SPS-23Y, -23XX -  
115 vdc, 1.5 kw

**AN/SPS-23: 1**

AN/SPS-23, -23A, -23X, -23Y, -23Z, -23XX

AN/SPS-23Z  
32 vdc, 1.73 kw  
Type of Presentation:  
Two 10-in. and one 5-in. CRT  
Range Scales: 1, 2, 4, 8, 20, and 40 mi  
Pulse Repetition Rate: 1,000 pps  
Pulse Width:  
0.25  $\mu$ sec on 1, 2, 4, and 8 mi scales;  
1  $\mu$ sec on 20, and 40 mi scales  
Horizontal Coverage: 360 deg  
Antenna Rotation Speed: 17 or 20 rpm (depends  
on antenna type)  
Range Resolution: 50 yd  
Bearing Resolution: 1.9 deg at 1 mi range  
Range Accuracy: 30 yd  
Bearing Accuracy:  $\pm 1.5$  deg  
Sweep Linearity: 2% or 50 yd

Horizontal Beam Width: 1.9 deg  
Vertical Beam Width: 20 deg  
Receiver Bandwidth: 1.5 or 10 mc  
IF. Frequency: 30 mc  
Receiver Noise Figure: 12 db

#### INSTALLATION CONSIDERATIONS

Siting: Consistent with physical limitations of ship, units should be placed so as not to cause undue stress on existing structure.  
Mounting: Units should be mounted so as to allow sufficient space for servicing and upkeep.  
Cabling Requirements: Waveguide run should be as short and direct as possible.  
Related Equipment:

#### PRINCIPAL COMPONENTS AND PHYSICAL DATA

COMPONENT	QTY	HEIGHT (Inches)	WIDTH (Inches)	DEPTH (Inches)	UNIT WT. (Pounds)
AN/SPS-23, -23A, -23X, -23Y, -23Z, and -23XX					
Radar Receiver-Transmitter RT-341/SPS	1	33-7/8	24	29-1/4	304
Control Indicator C-1543/SPS	1	25-3/4	24	47	210
Remark Receiver R-640/SPS	1	12-1/8	16-13/16	10-11/16	25
Azimuth Indicator ID-444/SPS	1	12-1/8	16-13/16	10-11/16	25
Azimuth Indicator ID-445/SPS	1	12-1/8	16-13/16	10-11/16	25
Terminal Box J-659/SPS	1				
AN/SPS-23, -23A, -23XX only Azimuth and Range Indicator IP-306/SPS	1	25-3/4	24	47	210
Range Indicator IP-307/SPS	1	16-3/4	22	30-1/8	160
Interconnecting Box J-656/SPS	1	24-5/8	21-7/8	10-7/8	66
AN, SPS-23, -23XX only Interconnecting Box J-663/SPS	1	25-1/8	15	7	26
Terminal Box J-660/SPS	1	14-3/4	12-15/16	4-5/8	14

AN/SPS-23, -23A, -23X, -23Y, -23Z, -23XX

**PRINCIPAL COMPONENTS AND PHYSICAL DATA (cont'd)**

COMPONENT	QTY	HEIGHT (Inches)	WIDTH (Inches)	DEPTH (Inches)	UNIT WT. (Pounds)
AN/SPS-23, -23A only					
Generator Control C-1544/U	1	24-1/4	21-9/16	7-1/2	53
Motor Generator PU-310/U	1	17-1/8	36	16-1/16	485
Switch Box SA-409/U	1	15	10-1/4	6-7/8	17
Switch Box SA-410/U	1	9-5/8	8-1/4	6-7/8	10
AN/SPS-23 only					
Antenna AS-744/SPS-23	1	36	56	25-1/2	319
AN/SPS-23A, -23X, -23Y only					
Interconnecting Box J-657/SPS	1	25-1/8	15	7	26
AN/SPS-23A, -23X only					
Antenna AS-745/SPS-23X	1	33-3/4	54	22-1/2	156
AN/SPS-23A, -23X, -23Y, -23Z only					
Tuned Cavity FR-86/U	1	9-3/8	14-3/4	7-3/8	14
Directional Coupler CU-356/SPN-18	1	2-3/4	6	2-i3/16	1
AN/SPS-23X only					
Generator Control C-1545/U	1	24-1/4	21-1/2	7-9/16	55
Motor Generator PU-311/U	1	12-7/16	20-1/8	17	210
AN/SPS-23X, -23XX, -23Y only					
Switch Box SA-411/U	1	15 10-1/4	8-1/4	18	
AN/SPS-23XX only					
Generator Control C-1548/U	1	24-1/4	21-1/2	7-9/16	55
Motor Generator PU-314/U	1	17-1/8	42	16-1/2	510
Antenna AS-748/SPS-23XX	1	36	56	25-1/2	319
AN/SPS-23Y only					
Generator Control C-1546/U	1	24-1/4	21-1/2	7-9/16	55
Motor Generator PU-312/U	1	17-1/2	39	16-1/8	460
Antenna AS-746/SPS-23Y	1	33-3/4	54	22-1/2	156

AN/SPS-23, -23A, -23X, -23Y, -23Z, -23XX

**PRINCIPAL COMPONENTS AND PHYSICAL DATA (cont'd)**

<b>COMPONENT</b>	<b>QTY</b>	<b>HEIGHT (Inches)</b>	<b>WIDTH (Inches)</b>	<b>DEPTH (Inches)</b>	<b>UNIT WT. (Pounds)</b>
AN/SPS-23Z only Interconnecting Box J-658/SPS	1	25-3/16	15	7	35
Generator Control C-1547/U	1	30-1/16	21-1/4	8-3/16	71
Motor Generator PU-313/U	1	17-1/2	39	16-1/8	490
Switch Box SA-412/U	1	25	19-3/8	9	57
Antenna AS-747/SPS-23Z	1	33-3/4	54	22-1/2	156

**REFERENCE DATA AND LITERATURE**

Technical Manual:  
CG-273-31

**AN/SPS-23: 4**

DATE: 1 July 1964

ITEM NAME: RADAR SET

COGNIZANT SERVICE: USN

TYPE: AN/SPS-28

FEDERAL STOCK NUMBER: F5840-569-1429 w-s

	USA	USN	USAF	USMC
STATUS OR TYPE CLASSIFICATION		Std		
Mfg(s) Name or Code Number: Westinghouse Electric Corporation				

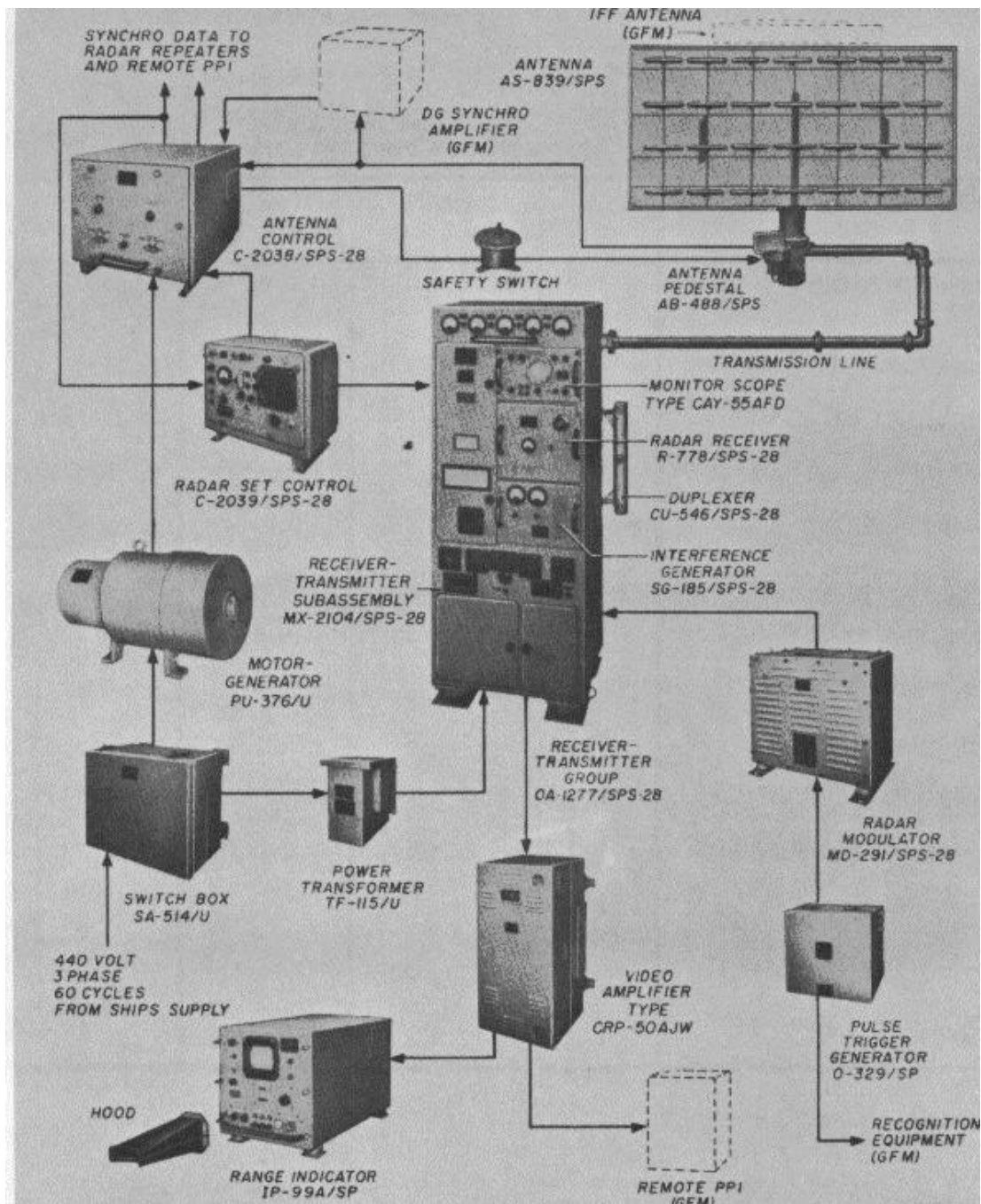

AN/SPS-28: 1

AN/SPS-28

**FUNCTIONAL DESCRIPTION**

Radar Set AN/SPS-28 is a shipborne air-search radar that determines the range and bearing of remote targets.

**RELATION TO SIMILAR EQUIPMENT**

Individual units only are similar to corresponding units of radar equipments SR, SRa, SR-6(), and AN/SPS-6().

**TECHNICAL DESCRIPTION**

Frequency: Variable from 215 to 225 mc  
Range: 4, 20, 80, and 200 mi

Operating Voltages and Power Requirements:

440 vac, 3-ph, 60 cps, 3.64 kw, 0.56 pf (lagging)  
Peak Power Output: 750 kw  
IF. Frequency: 30 mc  
Minimum Discernible Signal: 0.6  $\mu$ v  
Pulse Repetition Rate: 120 to 1,000 pps in two ranges  
Receiver Noise Figure: Less than 6 db  
Range Accuracy:  
 $\pm$ 100 yd on ranges up to 20,000 yd  
Antenna Feed Assembly: 28 folded dipoles

**INSTALLATION CONSIDERATIONS**

Not available.

**PRINCIPAL COMPONENTS AND PHYSICAL DATA**

COMPONENT	QTY	HEIGHT (Inches)	WIDTH (Inches)	DEPTH (Inches)	UNIT WT. (Pounds)
Receiver-Transmitter Group OA- 1277/SPS-28	1	72	33-9/16	25	1235
Pulse Trigger Generator 0-329/SP	1	16-3/4	16-3/8	14	53
Radar Modulator MD-291/SPS-28	1	23-1/2	27-1/4	15-7/16	168
Video Amplifier Type CRP-50AJW	1	28-7/16	15-11/16	16-1/16	136
Range Indicator IP-99A/SP	1	18	17	32	160
Radar Set Control C-2039/SPS-28	1	15-11/16	18-3/8	13-1/4	50
Antenna Control C-2038/SPS-28	1	17-1/2	19-5/8	29-7/8	125
Motor Generator PU-376/U	1	20	17	33-1/4	565
Antenna Pedestal AB-488/SPS	1	77-7/8	44-1/2'	36	596
Antenna AS-839/SPS	1	102	210	47-1/4	588
Directional Coupler CU-570/SPS-28	1	5-9/16	5-3/16	11	8
Radio Frequency Monitor IP-411/SPS-28	1	24	25	22	125
Power Transformer TF-11S/U	1	14-3/8	10-7/8	12-11/16	110
Switch Box SA-514/U	1	17-7/16	19-7/8	15-5/16	60

**REFERENCE DATA AND LITERATURE**

Technical Manual:  
NAVSHIPS 92896(A)

DATE: 1 July 1964

ITEM NAME: RADAR SET

COGNIZANT SERVICE: USN

TYPE: AN/SPS-35, AN/SPS-35A\*

See Note 3.

5840-679-2830\*  
5840-725-8313 (Motor Generator not Included)

FEDERAL STOCK NUMBER: 5840-725-8314 (Includes Motor Generator PU-421/U)  
5840-725-8315 (Includes Motor Generator PU-420/U)

	USA	USN	USAF	USMC
STATUS OR TYPE CLASSIFICATION	Std-A	Sub Std Sub Std*		
Mfg(s) Name or Code Number: Raytheon Manufacturing Company, Waltham, Massachusetts				

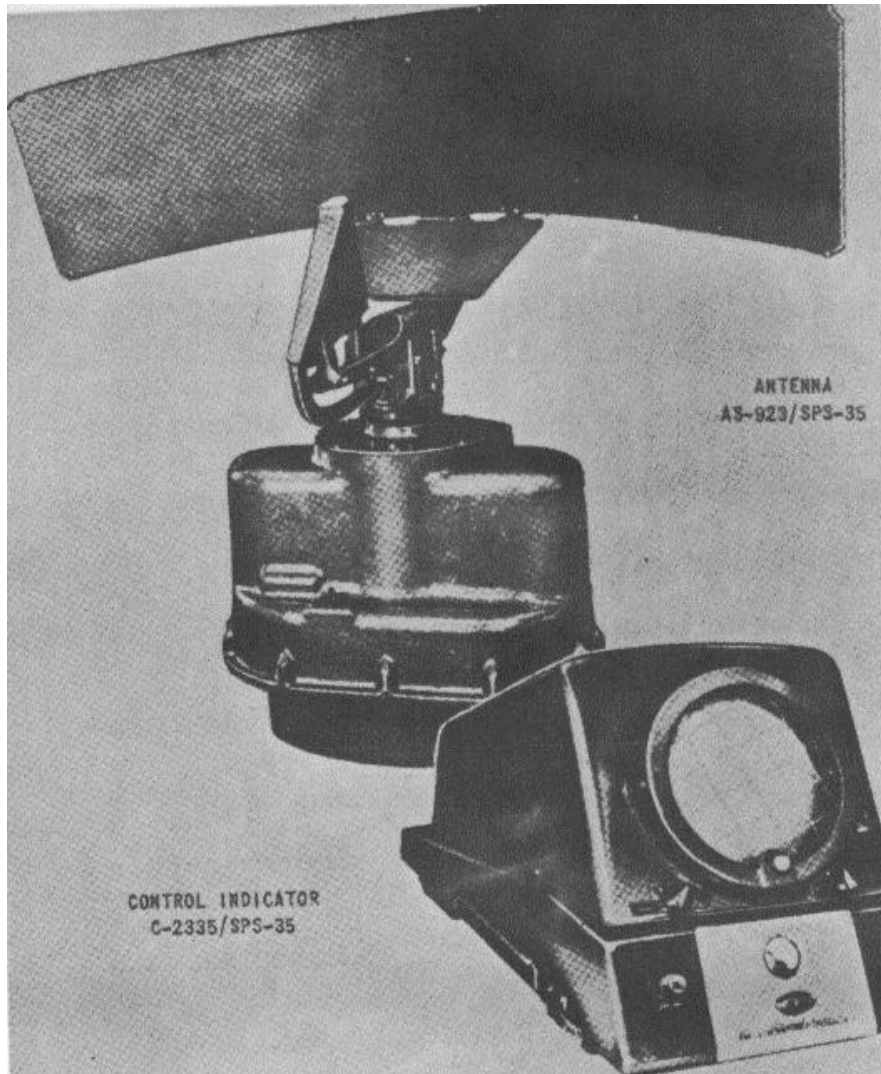

**FUNCTIONAL DESCRIPTION**

Radar Set AN/SPS-35 is a compact, lightweight equipment of low power consumption designed especially for use on small vessels, where space is at a

premium. It is also suitable for use on larger vessels where a high-performance radar at a minimum cost is required or where a second radar is needed for use as a standby for complete protection.

**ITEM NAME: RADAR SET**

**TYPE: AN/SPS-35, AN/SPS-35A**

**RELATION TO SIMILAR EQUIPMENT**

The AN/SPS-35A is a modified AN/SPS-35 with an additional PPI (remote) and minor changes. AN/SPS-35 and AN/SPS-35A are similar to, but not mechanically interchangeable with AN/SPN-21 and AN/SPS-36. The antenna and indicator units also have some component part differences. AN/SPS-35, -35A are modified military versions of the Raytheon Pathfinder, Raytheon Model 1500.

**TECHNICAL DESCRIPTION**

Frequency: 9335 to 9405 mc  
 Type of Frequency Control: Amplitude  
 Modulated magnetron oscillator.  
 Peak Power Output: 7 kw  
 Pulse Length: 0.2 usec  
 Pulse Repetition Frequency  
     1500 pps for 1, 2, 4, 8, and 16 mi ranges  
     750 pps for 32 mi range  
 Type of Receiver: Superheterodyne  
 IF. Frequency: 45 mc  
 IF. Bandwidth: 10 mc  
 Antenna: Truncated paraboloidal reflector  
 Horizontal Beam Width: 3°  
 Vertical Beam Width: 15° with 3 db point

not less than 6° from mechanical horizon.  
 Rotation: 20 rpm (avg).  
 Radar Resolution  
     Azimuth: 2.5°  
     Range: 50 yds  
 Local Oscillator: 2K25 or QK391 klystron  
 Power Requirements  
     Standby: 207w  
     Radiate: 565w at 5.41 amp  
 Voltage Requirements:  
     24v dc (when used with Motor Generator  
         PU-420/U)  
     11Sv dc (when used with Motor Generator  
         PU-421/U)  
     115v ac, 60 cycles, 1-ph

**INSTALLATION CONSIDERATIONS**

Mounting: Receiver-Transmitter is in a weatherproof mounting in the antenna housing. The Indicator is drip-proof but must be sheltered from the weather. Control-Indicator is designed for 3position mounting. Antenna is sideclamp instead of usual base or pedestal bolt mounting.

**PRINCIPAL COMPONENTS AND PHYSICAL DATA**

**SHIPPING DATA**

<b>COMPONENT</b>	<b>BOXES (NR)</b>	<b>OVERALL DIMENSIONS (Inches)</b>	<b>UNIT WT. (Pounds)</b>
Antenna Receiver-Transmitter AS-923/SPS-35	1	32 x 50 x 56	274
Control Indicator C-2335/SPS-35	1	28 x 33 x 44	294
Cathode Ray Tube10WP7	1	17 x 19 x 29	54
IKEE	1	18 x 18 x 29	45
Equipment Maintenance Parts	1	14 x 21 x 26	62
Equipment Maintenance Parts	1	14 x 21 x 24	54
Equipment Maintenance Parts	1	14 x 21 x 24	61
Equipment Maintenance Parts	1	19 x 21 x 33	51
Compensator, Power Factor CN-469/U			
*Motor-Generator PU-420/U			
**Motor-Generator PU-421/U			



ITEM NAME: RADAR SET

TYPE: AN/SPS-35, AN/SPS-35A

**PRINCIPAL COMPONENTS AND PHYSICAL DATA (Cont.)**

**EQUIPMENT SUPPLIED DATA**

<b>COMPONENT</b>	<b>QTY</b>	<b>HEIGHT (Inches)</b>	<b>WIDTH (Inches)</b>	<b>DEPTH (Inches)</b>	<b>UNIT WT. (Pounds)</b>
Antenna Receiver-Transmitter AS -923/S PS -35	1	42-7/16	49	24	150
Control Indicator C-2335/SPS-35	1	27-15/16	17-1/4	19	300
*Motor Generator PU-420/U	1	10	27-3/4	13-1/4	210
**Motor Generator PU-421/U	1	10	27-3/4	13-1/4	210
Compensator, Power Factor CN-469/U	1	9-5/8	6-3/8	3-7/8	10

**NOTE 1: \*AN/SPS-35 will have 24v dc power requirements when used with Motor Generator PU-420/U.**

**\*\*AN/SPS-35 will have 115v dc power requirements when used with Motor Generator PU-421/U.**

**NOTE 2: AN/SPS-35 with power requirements of 115v ac requires no Motor Generator.**

**REFERENCE DATA AND LITERATURE**

Technical Manuals:  
NAVSHIPS 93081(A)

**NOTE 3. USA LINE ITEM NUMBER: 634465 (AN/SPS-35 only)**

**AN/SPS-35: 3**

DATE: 1 July 1964

ITEM NAME: RADAR SET

COGNIZANT SERVICE: USN

TYPE: AN/SPS-36

FEDERAL STOCK NUMBER: F5840-543-1355 w-s

	USA	USN	USAF	USMC
STATUS OR TYPE CLASSIFICATION		Sub Std		
Mfg(s) Name or Code Number: Edo Corporation				

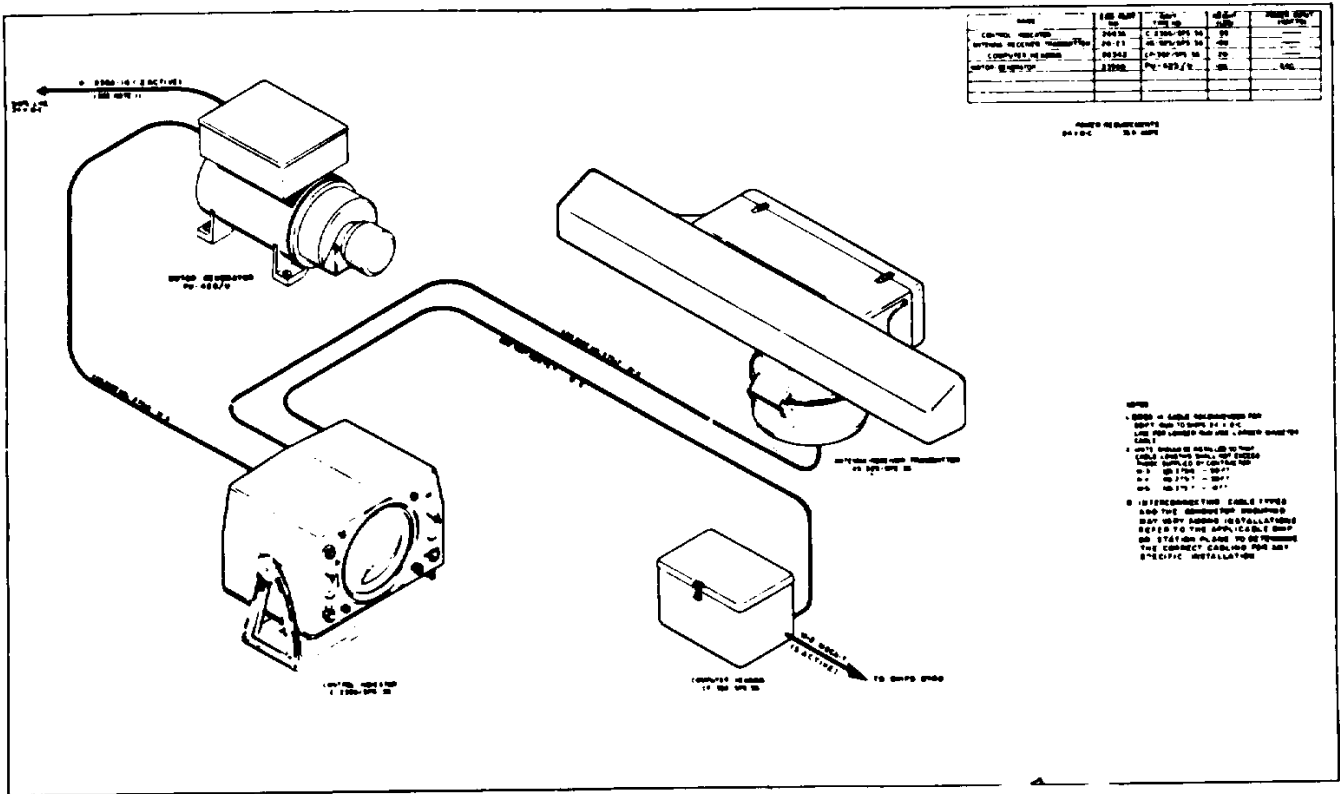

AN/SPS-36

**FUNCTIONAL DESCRIPTION**

Radar Set AN/SPS-36 is a surface scanning, low power equipment that is installed in small craft where space and generator capacity are limited. The equipment displays range and azimuth information.

4-mi scale, 0.5 mi  
8- and 16-mi scales, 2 mi  
Peak Power Output: 10 kw  
Pulse Repetition Rate: 1,000 pps  
Pulse Width: 0.15  $\mu$ sec on the 0.5-, 2-, and 4-mi scales; 0.5  $\mu$ sec on the 8- and 16-mi scales  
Operating Voltages and Power Requirements:  
24 vdc  $\pm$ 10%, 35 amp  
Display: PPI, 10-in. CRT  
Antenna Rotation Speed: 17 rpm  
Antenna Beam Width: 2 x 28 deg  
Receiver Type: Superheterodyne  
IF. Frequency: 30 mc  
Receiver Bandwidth: 8 mc

**RELATION TO SIMILAR EQUIPMENT**

None.

**TECHNICAL DESCRIPTION**

Frequency: 9350 to 9400 mc  
Range Scales: 0.5, 2, 4, 8, and 16 mi  
Range, Max: 16 mi  
Range, Min: 25 yd  
Range Marker Intervals:  
0.5- and 2-mi scales, 0.25 mi

**INSTALLATION CONSIDERATIONS**

Not available.

**PRINCIPAL COMPONENTS AND PHYSICAL DATA**

COMPONENT	QTY	HEIGHT (Inches)	WIDTH (Inches)	DEPTH (Inches)	UNIT WT. (Pounds)
Control-Indicator C-2366/SPS-36	1	18-3/32	20- 1/2	18-9/16	95
Antenna Receiver-Transmitter AS-925/SPS-36	1	19	53	20-5/16	100
Heading Computer CP-382/SPS-36	1	6	13	10-3/4	20
Motor-Generator PU-423/U	1	12-9/16	8	19-7/16	105

**Note: Motor-Generator PU-423/U is used with, but not a part of, AN/SPS-36.**

**REFERENCE DATA AND LITERATURE**

Technical Manual:  
NAVSHIPS 93101(A)

DATE: 1 July 1964

ITEM NAME: RADAR SET

COGNIZANT SERVICE: USN

TYPE: AN/SPS-41

FEDERAL STOCK NUMBER:

	USA	USN	USAF	USMC
STATUS OR TYPE CLASSIFICATION		Ltd Std		
Mfg(s) Name or Code Number: Bendix-Pacific Division of Bendix Aviation Corporation				

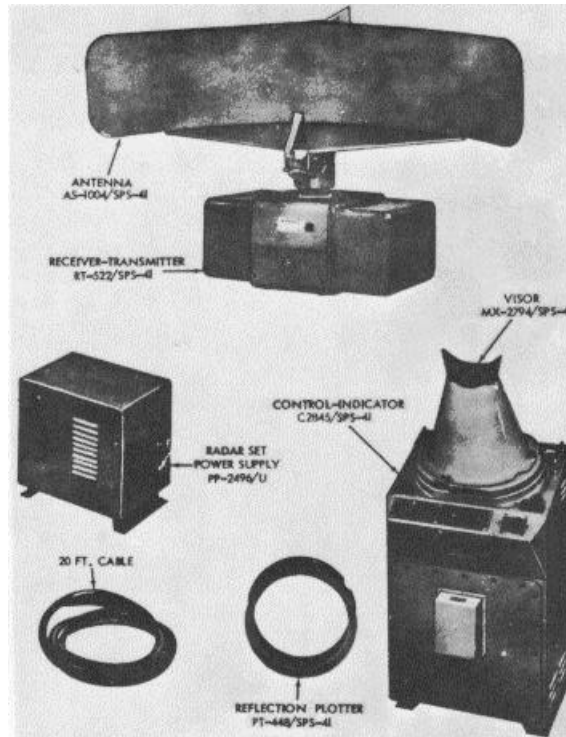

### FUNCTIONAL DESCRIPTION

The Radar Set AN/SPS-41 is designed as a surface search radar which provides a Plan Position Indicator (PPI) type display of shorelines, buoys, ships, and such navigation targets. The operating range is from 25

yards to 32 nautical miles. The PPI screen is a 10 inch diameter cathode ray tube. Range rings and a variable marker enables precise range determination of targets presented.

AN/SPS-41: 1

**ITEM NAME:** RADAR SET

**TYPE:** AN/SPS-41

**RELATION TO SIMILAR EQUIPMENT**

None.

Minimum Range: 75 ft  
Antenna Rotation: 21 rpm  
Horizontal Beam Width: 1.B deg  
Vertical Beam Width: 20 deg  
Bearing Accuracy: 2 deg  
Maximum Range: 32 naut mi  
Sweep Ranges: 1/2, 2, 4, 8, 16, 32 naut mi  
Fixed Range Rings: 1/4, 1/2, 1, 2, 4, 8 naut mi

**TECHNICAL DESCRIPTION**

Frequency X Band: 9375 mc  
Number of Bands: 1 band  
Peak Power: 7 to 10 kw  
Type of Indicator: 10 in. PPI  
Pulse Length: (1/2, 2 and 4 mi ranges)  
0.1 usec; (8, 16 and 32 mi ranges) 0.4 usec  
Repetition Rates: (1/2, 2 and 4 mi ranges)  
1600 cps; (8, 16 and 32 mi ranges) 625 cps

**INSTALLATION CONSIDERATIONS**

Not available.

**PRINCIPAL COMPONENTS AND PHYSICAL DATA**

<b>COMPONENTS</b>	<b>QTY</b>	<b>OVERALL DIMENSIONS (Inches)</b>	<b>UNIT WT. (Pounds)</b>
Antenna AS-1004/SPS-41	1	23 x 31-3/4 x 37-1/2	20
Receiver-Transmitter RT-522/SPS-41	1	10-1/2 x 14-1/2 x 22-1/4	99
Control-Indicator C-2d45/SPS-41	1	16-1/2 x 17-1/2 x 27	115
Radar Set Power Supply PP-2496/U	1	9-1/2 x 14 x 14-1/2	45
Receiver-Transmitter Indicator Cable	1	240 lg	5
Reflection Plotter PT-44B/SPS-41	1	3-1/2 lg x 11-3/4 dia	4-3/4
CRT Grid Scale MX-2393/SPS-41	1	3/4 h x 12 dia	1-3/5
Visor MX-2794/SPS-41	1	11-3/4 x 12 dia	1-1/2

**REFERENCE DATA AND LITERATURE**

Technical Manuals:  
NAVSHIPS 93314

**AN/SPS-41: 2**

**DATE:** 1 July 1964

**ITEM NAME:** RADAR SET

**COGNIZANT SERVICE:** USN

**TYPE:** AN/SPS-46

**FEDERAL STOCK NUMBER:** 5840-801-6126

	USA	USN	USAF	USMC
STATUS OR TYPE CLASSIFICATION		Std		
Mfg(s) Name or Code Number: Lavoic Laboratories Inc., Morganville, New Jersey				

Illustration not Available.

**FUNCTIONAL DESCRIPTION**

for water surface craft. It is used for surface search and navigation.

The AN/SPS-46 is a seaborne installation designed

**AN/SPS-46: 1**

**ITEM NAME:** RADAR SET

**TYPE:** AN/SPS-46

**RELATION TO SIMILAR EQUIPMENT**

None.

**TECHNICAL DESCRIPTION**

Type of Emission: PO type  
Cable Limitations: 50 ft max  
Waveguide Limitations: 25 ft max  
Beam Pattern  
    Horizontal: 2.2 deg  
    Vertical: 15 deg  
Power Output: 7 kw (Peak) min  
Output Signal Characteristics: 1500 pps  
    (option of 750 pps on 32-mi range) 0.2 usec  
Frequency Data

Transmitter

Frequency Range: 9345 to 9405 mc  
Number of Bands: 1 band  
Number of Channels: 1 channel

Receiver

Frequency Range: 9345 to 9405 mc  
Number of Bands: 1 band  
Number of Channels: 1 channel  
Operating Power Requirements: 115v ac,  
60 cps, single ph.

**INSTALLATION CONSIDERATIONS**

Siting: Seaborne for water surface craft.

**PRINCIPAL COMPONENTS AND PHYSICAL DATA**

<b>COMPONENTS</b>	<b>QTY</b>	<b>OVERALL DIMENSIONS (Inches)</b>	<b>UNIT WT. (Pounds)</b>
Control-Indicator C-3142/SPS-46	1	7-1/2 x 18-5/16 x 21-3/4	96
Antenna AS-1066/SPS-46	1	27-3/4 x 48-1/2 dia	88
Receiver-Transmitter, Radar RT-560/S PS-46	1	9-15/16 x 20-9/16 x 25-7/8	107

**REFERENCE DATA AND LITERATURE**

Technical Manuals:  
    NAVSHIPS 93400: Preliminary Data Form

**MIL-HDBK-162A**  
15 December 1965

Volume 1  
Section 3

**DATE:** 1 July 1964

**ITEM NAME:** RADAR SET

**COGNIZANT SERVICE:** USN

**TYPE:** AN/SPS-46X

**FEDERAL STOCK NUMBER:** 5840-801-6127

	USA	USN	USAF	USMC
STATUS OR TYPE CLASSIFICATION		Std		
Mfg(s) Name or Code Number: Lavoic Laboratories Inc., Morganville, New Jersey				

Illustrations not Available.

**FUNCTIONAL DESCRIPTION**

The AN/SPS-46X is a seaborne installation designed for water surface craft. It is used for surface search and navigation.

**AN/SPS-46X: 1**



**ITEM NAME:** RADAR SET

**TYPE:** AN/SPS-46X

**RELATION TO SIMILAR EQUIPMENT**

The AN/SPS-46X is similar to the AN/SPS-46 except that it differs in equipment supplied and the operating power required.

Vertical: 15 deg  
Frequency Data  
Transmitter  
Frequency Range: 9345 to 9405 mc  
Number of Bands: 1 band  
Number of Channels: 1 channel  
Receiver  
Frequency Range: 9345 to 9405 mc  
Number of Bands: 1 band  
Number of Channels: 1 channel  
Operating Power Requirements: 24 dc, 700w

**TECHNICAL DESCRIPTION**

Type of Emission: PO type  
Cable Limitations: 50 ft max  
Waveguide Limitations: 25 ft max  
Power Output: 7 kw (Peak) min  
Output Signal Characteristics 1500 pps  
(option of 750 pps on 32-mi range) 0.2 usec.  
Beam Pattern  
Horizontal: 2.2 deg

**INSTALLATION CONSIDERATIONS**

Siting: Seaborne installation designed for water surface craft.

**PRINCIPAL COMPONENTS AND PHYSICAL DATA**

<b>COMPONENTS</b>	<b>QTY</b>	<b>OVERALL DIMENSIONS (Inches)</b>	<b>UNIT WT. (Pounds)</b>
Control-Indicator C-3143/SPS-46X	1	7-1/2 x 18-5/16 x 21-3/4	96
Antenna AS-1067/SPS-46X	1	27-3/4 x 48-1/2 dia	88
Receiver-Transmitter, Radar RT-561/SPS-46X	1	9-15/16 x 20-9/16 x 25-7/8	107

**REFERENCE DATA AND LITERATURE**

Technical Manuals:  
NAVSHIPS 93400: Preliminary Data Form

**AN/SPS-46X: 2**

**DATE:** 15 February 1965

**ITEM NAME:** RADAR SET

**COGNIZANT SERVICE:** USN

**TYPE:** AN/SPS-51

**FEDERAL STOCK NUMBER:**

	USA	USN	USAF	USMC
STATUS OR TYPE CLASSIFICATION Sub. Std				
Mfg(s) Name or Code Number: Lavoie Laboratories, Inc., Morganville, New Jersey				

Illustration not Available.

**FUNCTIONAL DESCRIPTION**

Radar Set AN/SPS-51 is a 75 kw peak power X-band, surface search radar providing high resolution capabilities. The unit is made up of a transmitter-receiver, a control indicator, and azimuth-range

indicator and antenna. Ranges are: 1/2, 1, 2, 3, 4, 20, 40 miles. Facilities for project plotting are provided in both the control indicator and azimuth range indicator, will also furnish sweep trigger, bearing servo information, and video to an additional standard Navy radar repeater.

**AN/SPS-51: 1**

**ITEM NAME:** RADAR SET

**TYPE:** AN/SPS-51

**RELATION TO SIMILAR EQUIPMENT**

None.

Receiver: 9375 plus or minus 30 mc, 1  
band, 1 channel  
Operating Power Requirements: 115v ac,  
60 cyc, 1-ph

**TECHNICAL DESCRIPTION**

Frequency Data  
Transmitter: 9375 plus or minus 30 mc,  
1 band, 1 channel

**INSTALLATION CONSIDERATIONS**

Not available.

**PRINCIPAL COMPONENTS AND PHYSICAL DATA**

<b>COMPONENTS</b>	<b>QTY</b>	<b>OVERALL DIMENSIONS (Inches)</b>	<b>UNIT WT. (Pounds)</b>
Control-Indicator C-4485/SPS-51	1		
Azimuth-Range Indicator IP-681/SPS-51	1		
Radar Receiver-Transmitter RT-688/SPS-51	1		
Antenna AS-1373/SPS-51	1		
Electrical Dummy Load DA-325/SPS-51	1		
Directional Coupler CU-11B/SPS-51	1		

**REFERENCE DATA AND LITERATURE**

Nomenclature Card for AN/SPS-51 dated 12 October 1962.

DATE: 1 July 1964

ITEM NAME: RADAR DATA GROUP

COGNIZANT SERVICE: USN

TYPE: AN/SSA-18(XN-2), AN/SSA-19(XN-2)

FEDERAL STOCK NUMBER:

	USA	USN	USAF	USMC
STATUS OR TYPE CLASSIFICATION				
Mfg(s) Name or Code Number: Skiatron Electronics and Television Corp., New York, New York				

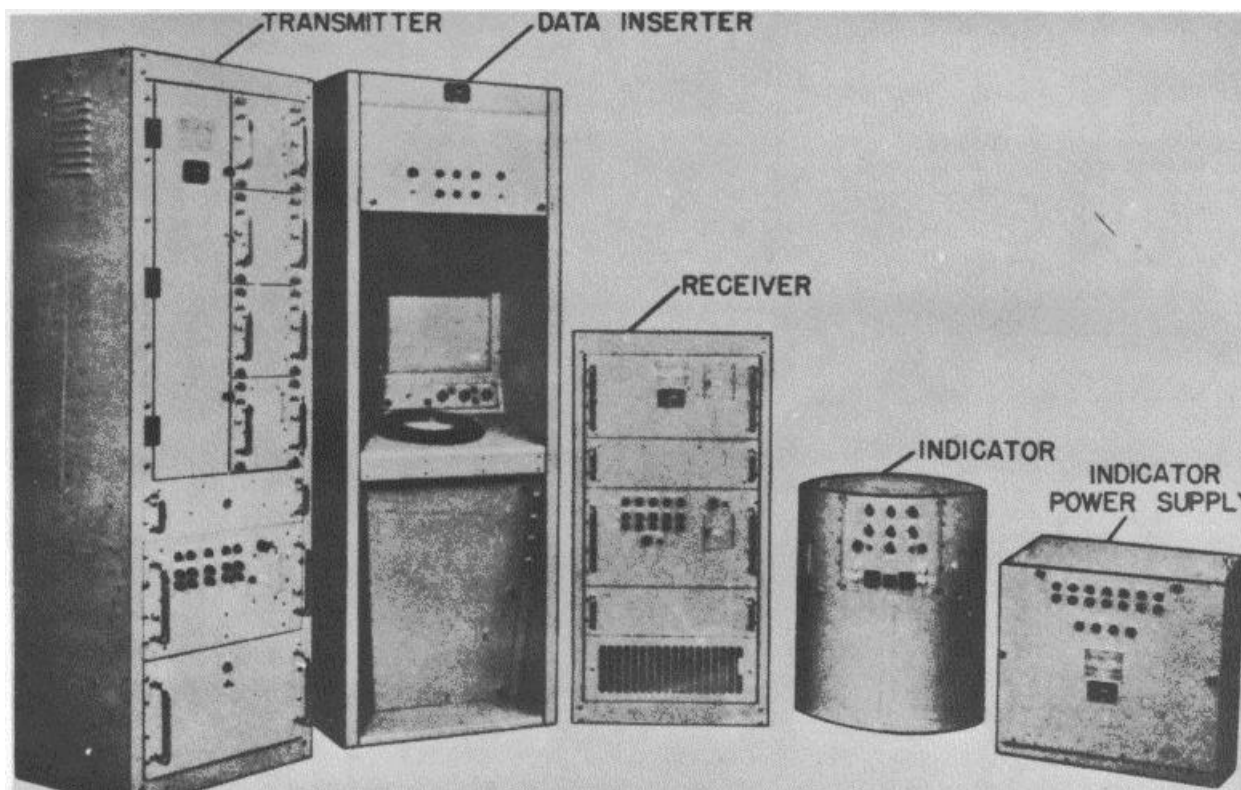

### FUNCTIONAL DESCRIPTION

The AN/SSA-18(XN-2) and AN/SSA-19(XN-2) together function as a Radar Data Band width Compression equipment designed for the transmission of radar signals derived from radar equipment such as Radar Set Navy Model SG-2S by compression of video

bandwidth from approximately one megacycle to approximately one kilocycle.

The AN/SSA-18(XN-2) accepts antenna rotational data in the form of one-speed synchro signals as well as wide band radar trigger and range video signals from a radar and converts the data for transmission via a narrow band wire or radio communication facility to a remote indicator.

AN/SSA-18(XN-2): 1

**ITEM NAME:** RADAR DATA GROUP

**TYPE:** AN/SSA-18(XN-2), AN/SSA-19(XN-2)

The AN/SSA-19(XN-2) receives and converts narrow band radar data to signals which will operate a standard radar repeater unit and cause it to display a facsimile of the original radar PPI presentation.

Synchro Data: 5-wire, one-speed, 60 cps, 2 to 20 rpm  
 Transmitter Output Signal: 0 to 2v peak-to-peak, 200 to 6000 cps  
 Receiver Input: 0.05 to 20v peak-to-peak, 600 ohms impedance  
 Indicator Signal Requirements  
 Radar Trigger: 5 to 50v, pos polarity, 60 to 3400 pps, 75 ohms  
 Radar Video and Radar Range Marks: 1 to 5v, pos polarity, 75 ohms  
 IFF Video: 1 to 5v, pos polarity, 75 ohms  
 Synchro Data: 5-wire, one-speed, 60 cps synchro voltages.  
 Radar Video: 30v, pos polarity, amplitude stabilized.  
 Radar Trigger: 10v, pos polarity, 30 pps  
 Presentation  
 Transmitter: 5 in. CR tube  
 Data Inserter: 7 in. CR tube  
 Indicator: 16 in. CR tube  
 Power Requirements: 115v plus or minus 10%, 60 plus or minus 2 cps, single ph, 2460w

**RELATION TO SIMILAR EQUIPMENT**

The AN/SSA-18(XN-2) and AN/SSA-19(XN-2) are similar to the AN/SSA-18(XN-1) and AN/SSA-19(XN-1) respectively.

**TECHNICAL DESCRIPTION**

Transmitter Input Requirements

Trigger

Amplitude: 5 to 50v  
 Polarity: Positive  
 Impedance: 75 ohms  
 Pulse Rate: 600 to 100 pps

Video

Amplitude: 1 to 5v  
 Polarity: Positive  
 Impedance: 75 ohms  
 Pulse Width: 1 usec

**INSTALLATION CONSIDERATIONS**

Not available.

**PRINCIPAL COMPONENTS AND PHYSICAL DATA**

COMPONENTS	QTY	OVERALL DIMENSIONS (Inches)	UNIT WT. (Pounds)
Transmitting Group AN/SSA-18(XN-2) consisting of:	1		1500
Transmitter Unit	1	18 x 22 x 66	
Data Inserter Unit	2	18 x 24 x 66	
Receiving Group AN/SSA-19(XN-2) consisting of:	1		1000
Receiver Unit 1		18 x 22 x 42	
Indicator Group IF-403(XN-1)/SSA-19			

**REFERENCE DATA AND LITERATURE**

Technical Manuals:  
NAVSHIPS 92953

**AN/SSA-18(XN-2): 2**

DATE: 1 July 1964

ITEM NAME: STABILIZATION DATA SET

COGNIZANT SERVICE: USN

TYPE: AN/SSQ-4

FEDERAL STOCK NUMBER: F5840-553-0446

	USA	USN	USAF	USMC
STATUS OR TYPE CLASSIFICATION				
Mfg(s) Name or Code Number: General Electric Company				

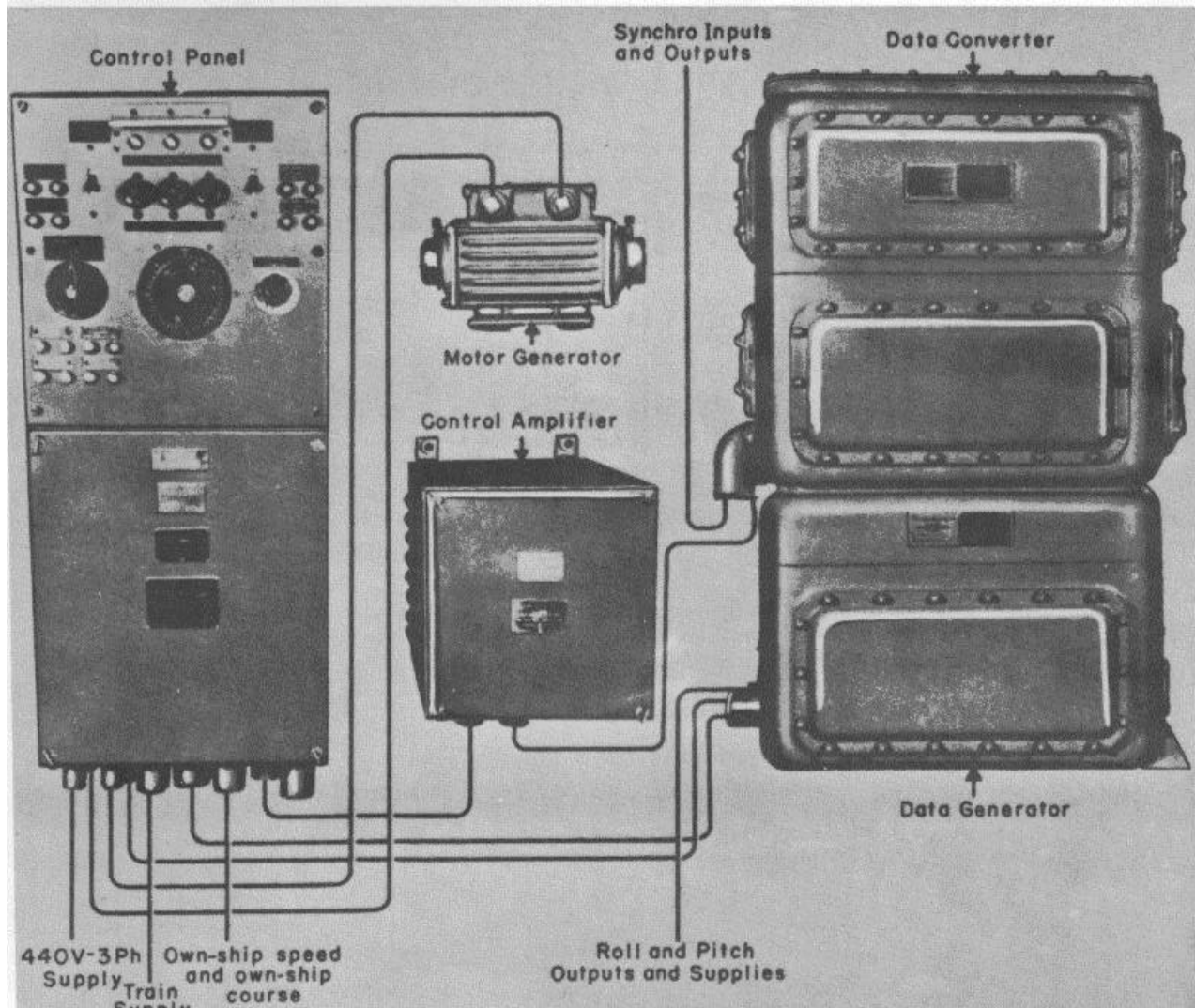

AN/SSQ-4: 1

AN/SSQ-4

**FUNCTIONAL DESCRIPTION**

The AN/SSQ-4 is used to stabilize radar antennas. It determines the roll and pitch angles, and converts roll and pitch to level and cross level signals. Roll, pitch, level, cross level and deck train (deck tilt correction) signals are transmitted to other units of the stabilizing system. The set has an alternate arrangement whereby it can either receive relative bearing and transmit deck train, or receive train and transmit deck tilt correction. Input and outputs are received and transmitted entirely by synchro signals.

**RELATION TO SIMILAR EQUIPMENT**

None.

**TECHNICAL DESCRIPTION**

Operating Voltages and Power Requirements:  
440v, 60 cps, 3-ph; 115v, 60 cps, 1-ph  
Servo Roll Limits:  $\pm 30\%$   
Servo Pitch Limits:  $\pm 12\%$   
Own-Ship Speed Synchro Input: 40 knots per revolution for turn corrector  
Own-Ship Course Synchro Input: 1-speed for latitude correction of gyro  
Relative Bearing Synchro Input: 1- and 36-speed for data converter  
Roll and Pitch Angle Output: 2- and 36-speed  
Level and Cross-Level Angle Output: 2- and 36-speed  
Deck Train Signal Output: 1- and 36-speed

**INSTALLATION CONSIDERATIONS**

Not available.

**PRINCIPAL COMPONENTS AND PHYSICAL DATA**

COMPONENT	QTY	HEIGHT (Inches)	WIDTH (Inches)	DEPTH (Inches)	UNIT WT. (Pounds)
Stabilization Data Generator PU-168/SSQ-4 including Stabilization Data Converter CV-73/SSQ-4	1	42-7/8	29	24	675
Control Panel C-526/SSQ-4	1	42	16-1/4	15-3/4	315
Electronic Control Amplifier AM-254/SSQ-4	1	15-1/2	13	18	60
Motor-Generator PU-167/U	1	18	30	18	60

**REFERENCE DATA AND LITERATURE**

Technical Manual:  
NAVSHIPS 91354

DATE: 1 July 1964

ITEM NAME: STABILIZATION DATA SET

COGNIZANT SERVICE: USN

TYPE: AN/SSQ-14

FEDERAL STOCK NUMBER:

	USA	USN	USAF	USMC
STATUS OR TYPE CLASSIFICATION		Std		
Mfg(s) Name or Code Number: Control Engineering Corporation				



AN/SSQ-14: 1



AN/SSQ-14

**FUNCTIONAL DESCRIPTION**

The AN/SSQ-14 provides roll and pitch signals to external stabilized equipments, keeping them stabilized with respect to a horizontal plane regardless of the ship's motion. The pendulum unit, in conjunction with the two single degree of freedom gyroscope units, provides a true horizontal reference for the measurement of roll and pitch angle and operates the servosystem which positions the roll and pitch gimbals with respect to the horizon. All electrical circuits are controlled by a single master control switch, which has three positions, STAND-BY, OFF, and OPERATE. This switch should be in either OPERATE or STAND-BY at all times when the vessel is at sea or under any conditions where less than 20 minutes notice is given before stabilization data is desired.

None.

**TECHNICAL DESCRIPTION**

Operating Voltages and Power Requirements:  
115v, 3-ph, 60 cps, 500w  
Own Ship's Course Input: 1- and 36-speed  
Roll Output: 2- and 36-speed  
Pitch Output: 2- and 36-speed  
Accuracy: -12 min (with roll up to 40 deg and pitch up to 20 deg)

**INSTALLATION CONSIDERATIONS**

Not available.

**RELATION TO SIMILAR EQUIPMENT**

**PRINCIPAL COMPONENTS AND PHYSICAL DATA**

<b>COMPONENT</b>	<b>QTY</b>	<b>HEIGHT (Inches)</b>	<b>WIDTH (Inches)</b>	<b>DEPTH (Inches)</b>	<b>UNIT WT. (Pounds)</b>
Stabilization Data Generator PU-252/SSQ-14	1	36	29	24	484
Motor-Generator PU-251/U	1	12	10	7	36
REFERENCE DATA AND LITERATURE					

Technical Manual:  
NAVSHIPS 91664(A)

DATE: 1 July 1964

ITEM NAME: DIRECTIONAL ANTENNA ASSEMBLY

COGNIZANT SERVICE: USN

TYPE: AN/UPA-4

FEDERAL STOCK NUMBER:

	USA	USN	USAF	USMC
STATUS OR TYPE CLASSIFICATION	Used By	Used By		
Mfg(s) Name or Code Number: Palmer-Bee Company (45510)				

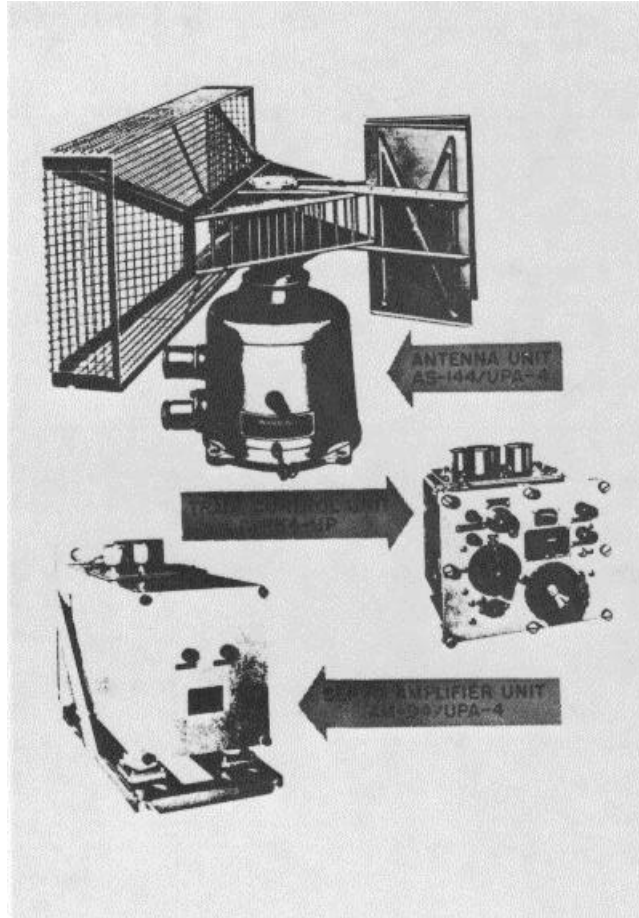

**FUNCTIONAL DESCRIPTION**

The Directional Antenna Assembly AN/UPA-1 serves a distinct purpose, differing from conventional radar systems since it is exclusively a means for identifying as friend or foe all ships or planes within its range. It may be operated with equal facility on ship or land, and as

occasion demands, may be manually operated or driven remotely in synchronism, with a radar antenna. Like all radar systems it makes use of pulse transmission, but unlike other radar, its beam is not reflected back from the target but enters a receiver on a friendly ship or plane where an identifying signal is automatically transmitted back to the inquiring source.

**ITEM NAME:** DIRECTIONAL ANTENNA ASSEMBLY

**TYPE:** AN/UPA-4

Friendly ships or planes are equipped with receivers and transmitters in resonance with each other. When necessary, identifying signals may be changed quickly and frequently.

Type of Control: Synchro control transformer  
Type of Drive: dc, drive motor  
Frequency Operates in Mark 5 frequency Servo Amplifier AM-94/UPA-4 Data  
Unit Function: Amplifies synchro error voltage from antenna pedestal to drive antenna in train. Operates a pilot light to indicate errors of less than 3 deg  
Input: 115/180/230v ac, 50/60/400/500 cps, 1-ph  
Operating Power Requirements: 90 to 115v ac, 50/60/400/500 cps, 1-ph

**RELATION TO SIMILAR EQUIPMENT**

None.

**TECHNICAL DESCRIPTION**

Type of Operation: Manually or driven in synchronism with a radar antenna.

Train Control Unit C-234/UP Data

Unit Function: Control train angle and rotation of a directional antenna; feeds 3 wire synchro position voltage to antenna pedestal of antenna assy

Input: 115/180/230v ac, 50/60/400/500 cps, 1-ph

Antenna Assembly AS-144/UPA-4 Data

**INSTALLATION CONSIDERATIONS**

Siting: Ship or land.

Related Equipment: The AN/UPA-4 is designed to be used with, but not part of Radar Set AN/CPX-3, AN/CPX-4 and other MK V, IFF equipment.

**PRINCIPAL COMPONENTS AND PHYSICAL DATA**

<b>COMPONENTS</b>	<b>QTY</b>	<b>OVERALL DIMENSIONS (Inches)</b>	<b>UNIT WT. (Pounds)</b>
Servo Amplifier Unit AM-94/UPA-4	1	10 x 12-7/8 x 14	40
Antenna Unit AS-144/UPA-4	1	16-5/8 x 29-3/8 x 30	45
Train Control Unit C-234/UP	1	10-1/2 x 13-5/8 x 15-5/8	78

**REFERENCE DATA AND LITERATURE**

Technical Manuals:  
NAVSHIPS 91015

**AN/UPA-4: 2**

DATE: 1 July 1964

ITEM NAME: ANTENNA GROUP

COGNIZANT SERVICE: USN

TYPE: AN/UPA-22\*, -23\*\*, -23A\*\*\*

FEDERAL STOCK NUMBER: F5985-665-0921\*  
F5985-316-2458\*\*

	USA	USN	USAF	USMC
STATUS OR TYPE CLASSIFICATION				
Sterling Precision Instrument Corp.**				
Mfg(8) Name or Code Number: Maryland Electronics Mfg. Corp.*, Hazeltine Electronic Corp.***				

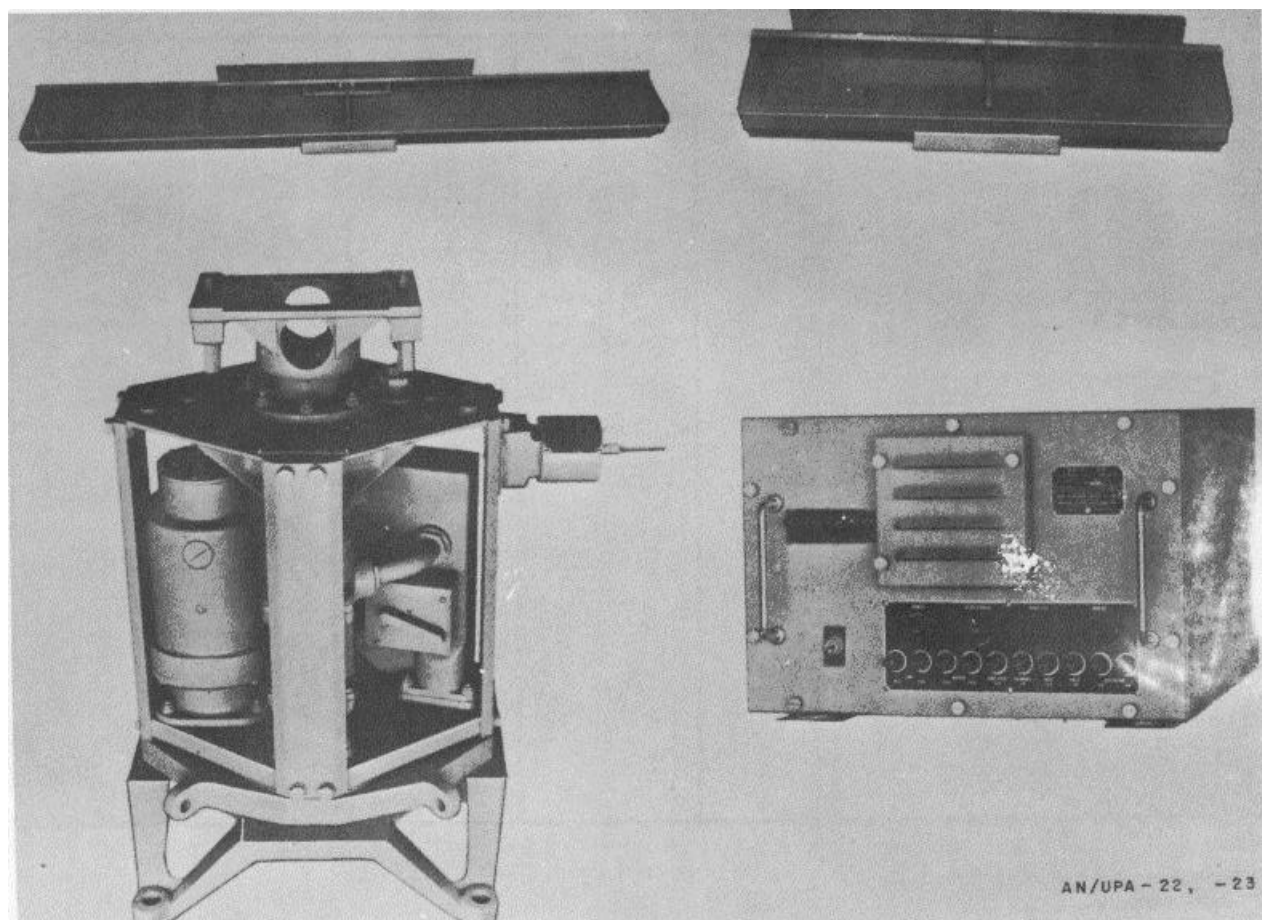

### FUNCTIONAL DESCRIPTION

Antenna Group AN/UPA-22, AN/UPA-23, and AN/UPA-23A transmit and receive vertically polarized waves in the 1010 to 1110 mc frequency band. The antennas are rotated in continuous synchronism with a separate radar antenna. The equipments include an electronic control amplifier that reduces the error

between the actual antenna bearing and the desired bearing, with reliable bearing indication provided by means of a pilot lamp.

The AN/UPA-22, AN/UPA-23, and AN/UPA-23A are identical except that the AN/UPA-22 has a 10-foot antenna while the AN/UPA-23 has a 5-foot antenna. The AN/UPA-23A has a greater speed of rotation and increased strength.

AN/UPA-22: 1

AN/UPA-22, -23, -23A

**RELATION TO SIMILAR EQUIPMENT**

None.

AT-353/UPA-23, AT-353A/UPA-23 - Broad-  
side array of 6 full-wave slot radiators  
Polarization: Vertical  
Input Impedance: 51 ohms  
Operating Voltages and Power Requirements:  
117v ±10%, 60 cps ±7.5%, 1-ph, 600w avg, 200w  
idling, 1,500w peak; 115 or 230v, 50 to 60  
cps, 1-ph, 100 va, or 115 or 230 vdc

**TECHNICAL DESCRIPTION**

Frequency: 1010 to 1110 mc  
RF Power Input Capability: 10 kw peak at duty  
cycle of 0.25%  
Antenna Type:  
AT-352/UPA-22 - Broadside array of 12 full-  
wave slot radiators

**INSTALLATION CONSIDERATIONS**

Not available.

**PRINCIPAL COMPONENTS AND PHYSICAL DATA**

COMPONENT	QTY	HEIGHT (Inches)	WIDTH (Inches)	DEPTH (Inches)	UNIT WT. (Pounds)
AN/UPA-22					
Antenna Pedestal AB-238/UPA	1	20-5/16	13-7/8	12-15/16	80
Antenna AT-352/UPA-22	1	111-3/8	15-1/2	12-1/8	55
Electronic Control Amplifier AM-582/UPA	1	19-9/16	19	12-25/32	84
AN/UPA-23					
Antenna Pedestal AB-238/UPA	1	20-5/16	13-7/8	12-15/16	80
Antenna AT-353/UPA-23 or AT-353A/UPA-23	1	55-7/8	15-1/2	11-7/8	25
Electronic Control Amplifier AM-582/UPA	1	19-9/16	19	11-25/32	84
AN/UPA-23A					
Antenna Pedestal AB-447/UP	1				
Antenna AT-353A/UPA-23	1				
Electronic Control Amplifier AM-1369/UP	1				

**REFERENCE DATA AND LITERATURE**

Technical Manual:  
NAVSHIPS 91516(B)

**AN/UPA-22: 2**

DATE: 1 July 1964

ITEM NAME: DECODER GROUP

COGNIZANT SERVICE: USN

TYPE: AN/UPA-24

5840-699-4003

FEDERAL STOCK NUMBER: 5840-347-9143 W/S

	USA	USN	USAF	USMC
STATUS OR TYPE CLASSIFICATION		Sub. Std		
Mfg(s) Name or Code Number: Brubaker Mfg., Co., Capehart-Farnsworth Co.				

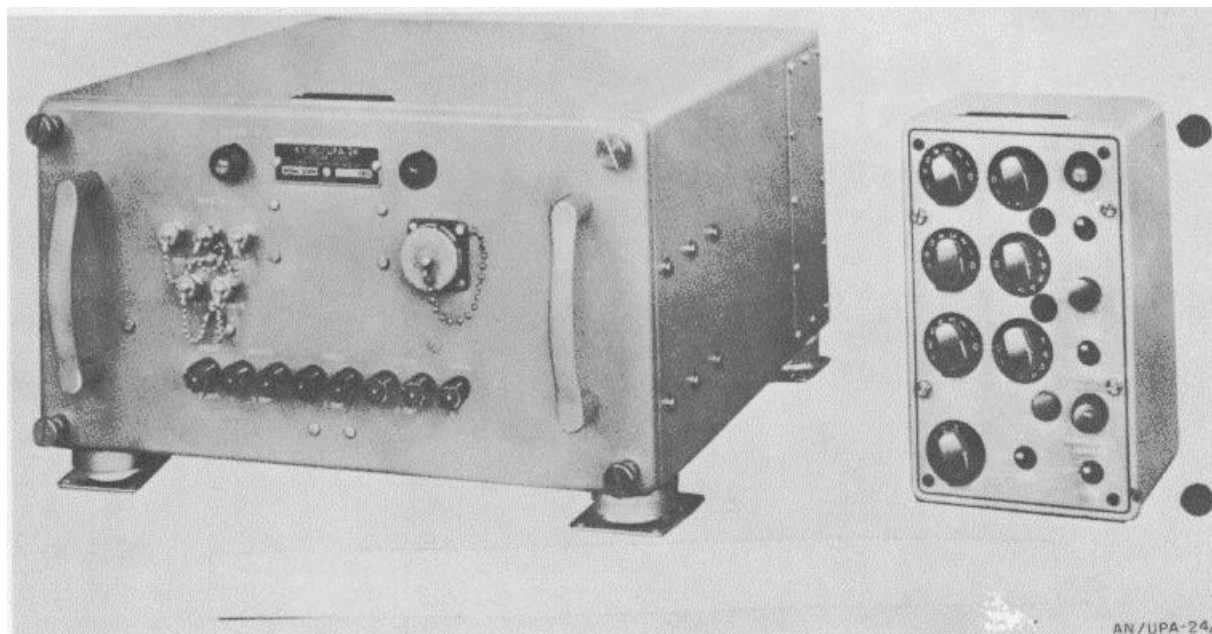

### FUNCTIONAL DESCRIPTION

Decoder Group ANAJPA-24, when interconnected with a radar recognition set, facilitates the interpretation of coded IFF signals. The equipment selects a coded video pulse-train in one of three modes from a recognition set. The coded pulse-train is presented to the decoder circuitry. If the pulse-train is correctly coded, an indication in the form of a single decoded pulse is available for presentation on a radar indicator. If the pulse-train is not correctly coded, a decode pulse is not available for presentation. The equipment also permits the presentation of the coded or decoded identification signal alone, the radar signal alone, or the radar signal mixed with either the coded or decoded identification signal.

### RELATION TO SIMILAR EQUIPMENT

Similar to the AN/UPA-24A.  
**TECHNICAL DESCRIPTION**

Operating Voltages and Power Requirements:  
117v, 60 or 400 cps, 1-ph  
Video Input and Output Impedances: 70 ohms nom

### INSTALLATION CONSIDERATIONS

Siting:  
Mounting: All units should be mounted so that it will not be necessary to dismantle the mounting brackets in order to remove the units.  
Cabling Requirements: Sufficient slack should be left in the interconnecting cabling to permit removal of the chassis from its case without placing undue strain on the connections.  
Related Equipment: AN/UPX-1, -1A

AN/UPA-24:-1

AN/UPA-24

**PRINCIPAL COMPONENTS AND PHYSICAL DATA**

<b>COMPONENT</b>	<b>QTY</b>	<b>HEIGHT (Inches)</b>	<b>WIDTH (Inches)</b>	<b>DEPTH (Inches)</b>	<b>UNIT WT. (Pounds)</b>
Video Decoder KY-80/UPA-24	1	9-3/4	17-11/32	19-1/32	56-3/4
Radar Set Control C-1008/UPA-24	1	9-1/16	5-3/4	6-3/16	4-1/2

**REFERENCE DATA AND LITERATURE**

Technical Manual:  
NAVSHIPS 92119(A)

**AN/UPA-24: 2**

DATE: 1 September 1964

ITEM NAME: DECODER GROUP

COGNIZANT SERVICE: USN

TYPE: AN/UPA-24A

FEDERAL STOCK NUMBER: 2F5840-713-8567

	USA	USN	USAF	USMC
STATUS OR TYPE CLASSIFICATION		Std		
Mfg(s) Name or Code Number: Telecomputing Corp., Electronic System Div. (91000)				

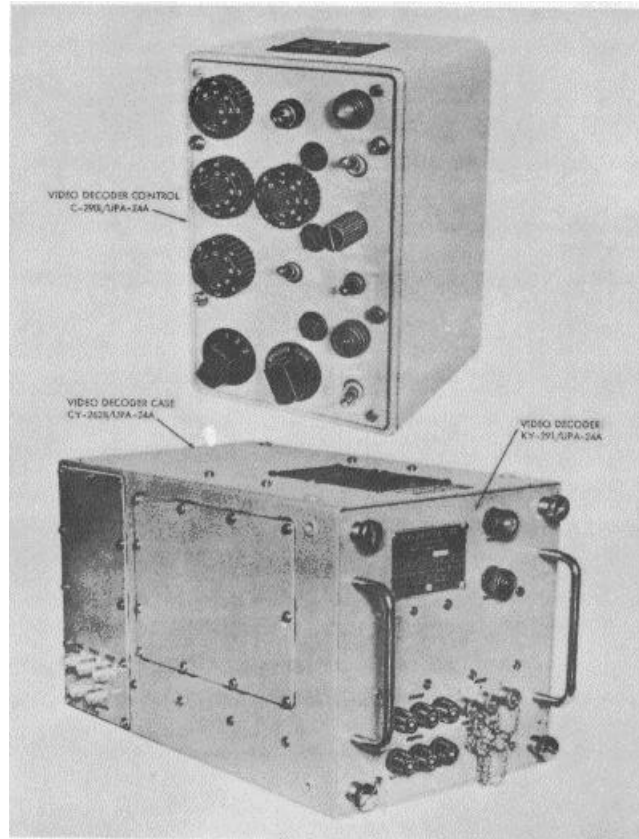

**FUNCTIONAL DESCRIPTION**

Decoder Group AN/UPA-24A functions with associated radar and radar recognition sets to decode and identify pulse-coded IFF-SIF signals received from the identification equipment in an aircraft or ship which is being tracked and identified. Both the radar video,

which contains the tracking information, and the IFF-SIF video, which contains the identifying information, are routed through the components of the Decoder Group on their way to the radar indicator. A composite signal is then displayed on the indicator, giving course and position of the target and, also, identifying the target as friend or foe.

**AN/UPA-24A: 1**



**ITEM NAME:** DECODER GROUP

**TYPE:** AN/UPA-24A

**RELATION TO SIMILAR EQUIPMENT**

None.

**TECHNICAL DESCRIPTION**

Video Input and Output Impedances: 75 ohms  
 IFF Video Pulse Train Input  
 Source: Radar Recognition Set  
 Number of Pulses in Train  
 Mode 1: 2 to 7  
 Mode 2: 2 to 14  
 Mode 3: 2 to 8  
 Spacing (Pulse Trains with 6 Information Pulses): First information pulse 2.90 plus or minus 0.05 usec from start pulse, succeeding pulses 2.90 plus or minus 0.05 usec apart  
 Spacing (Pulse Trains with 12 Information Pulses): First information pulse 1.45 plus or minus 0.05 usec from start pulse, succeeding pulses 1.45 plus or minus 0.05 usec apart  
 Pulse Input Polarity: Pos  
 Allowable Undershoot: Less than 5%  
 Pulse Train Duration: 20.3 plus or minus 0.1 usec  
 Pulse Amplitude: 2.0 plus or minus 0.5v  
 Individual Pulse Duration: 0.30 to 1.0 usec (0.45 nom)  
 Pulse Rise Time: 0.08 to 0.20 usec  
 Pulse Decay Time: 0.08 to 0.30 usec  
 Amplitude Variation Between All Pulses: plus or minus 1.0 db max  
 Duty Cycle: 25% max (signal plus noise)  
 Noise Only: 2v max and up to 20% max duty cyc

Radar Video Input  
 Source: Associated radar set  
 Pulse Polarity: Pos going  
 Amplitude: 2.0 plus or minus 0.5v max  
 Pulse Width: 0.30 to 1500 usec  
 Duty Cycle During Signal Time: 0.0 to 60.0% (at .100 pulse repetition freq)  
 Noise: 2.0v max and up to 60% duty cyc  
 Acceptable Signal Time Duration: 20.0 to 5000 usec  
 Repetition Rate: 10.0 to 5000 pps  
 Decode Video Output Pulse  
 Destination: Radar indicator of associated radar  
 Pulse Duration: 0.30 to 1.0 usec (0.45 usec nom)  
 Pulse Rise Time: 0.08 to 0.20 usec  
 Pulse Decay Time: 0.05 to 0.30 usec  
 Pulse Amplitude: 2 plus 0.5v nom  
 Primary Power Requirements: 115v plus or minus 10%, 60 or 400 cyc, 1-ph, 60w  
 Heater Power Requirements: 115v ac or dc, or 230v ac or dc, 20w  
 Heat Dissipation: 60w total  
 Ambient Operating Temperature  
 Operating: -28 to plus 65±C (-18.4 to plus 149±F)  
 Non-Operating: -62 to plus 75±C (-79.2 to plus 167±F)

**INSTALLATION CONSIDERATIONS**

Related Equipment  
 Required but not Supplied: (1) Cable MSCA-14; (4) Cable MSCA-19; (2) Cable DSGA-3; (5) Cable RG-12/U.

**PRINCIPAL COMPONENTS AND PHYSICAL DATA**

<b>COMPONENTS</b>	<b>QTY</b>	<b>OVERALL DIMENSIONS (Inches)</b>	<b>UNIT WT. (Pounds)</b>
Decoder, Video KY-291/UPA-24A	1	9 x 9-3/4 x 17-1/2	24.75
Control, Video Decoder C-2901/UPA-24A	1	5-1/1 x 5-13/16 x 9	5.25
Case, Video Decoder CY-2628/UPA-24A	1	5-13/16 x 7-3/16 x 9	7.25
Technical Manual NAVSHIPS 93876(A)	2	1/2 x 8-1-1/2 x 11	1.0
Operating Instruction Chart NAVSHIPS 93876.21	1	8-1/2 x 11	

**AN/UPA-24A: 2**

ITEM NAME: DECODER GROUP

TYPE: AN/UPA-24A

**PRINCIPAL COMPONENTS AND PHYSICAL DATA (Continued)**

COMPONENTS	QTY	OVERALL DIMENSIONS (Inches)	UNIT WT. (Pounds)
Performance Standards Sheet NAVSHIPS 93876.32	1	8-1/2 x 11	
Maintenance Standards Book NAVSHIPS 93876.42	1	1/4 x 8-1/2 x 11	0.2

**SHIPPING DATA**

COMPONENTS	PKGS	VOLUME (CU FT)	UNIT WT. (Pounds)
	1	1.86	47

**REFERENCE DATA AND LITERATURE**

Technical Manuals:

- NAVSHIPS 93876(A)
- NAVSHIPS 93876.21: Operating Instruction Chart
- NAVSHIPS 93876.32: Performance Standards Sheet
- NAVSHIPS 93876.42: Maintenance Standards Book

**AN/UPA-24A: 3**

DATE: 1 September 1964

ITEM NAME: DECODER GROUP

COGNIZANT SERVICE: USN

TYPE: AN/UPA-24B

FEDERAL STOCK NUMBER:

	USA	USN	USAF	USMC
STATUS OR TYPE CLASSIFICATION		Std		
Mfg(s) Name or Code Number: Hoffman Electronics Corp., Military Products Div. (28959)				

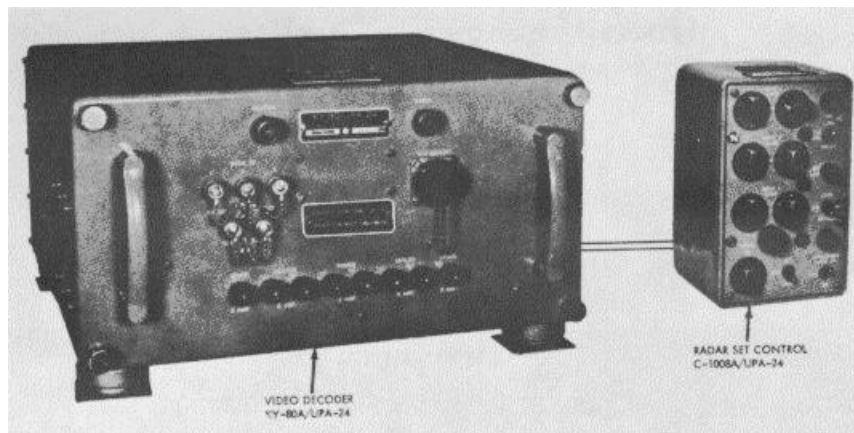

**FUNCTIONAL DESCRIPTION**

Decoder Group AN/UPA-24B processes coded IFF signals and radar signals from external equipment, such as Radar Recognition Set AN/UPX-1, and delivers a single output for presentation on an external radar indicator. The AN/UPA-24B produces this presentation

by selecting a coded video pulse-train, in one of three modes, from the radar recognition set. This coded pulse-train is presented to a decoder network. If the pulse-train is correctly coded, an indication in the form of a single "decode" pulse is available for presentation on the radar indicator.

**AN/UPA-24B: 1**

**ITEM NAME:** DECODER GROUP

**TYPE:** AN/UPA-24B

If the pulse-train is not correctly coded, a decode pulse is not available for presentation unless the bracket decode capability is chosen. Bracket decoding produces a decode pulse from any properly timed pulse-train, regardless of code content. The AN/UPA-24B also permits the presentation of the coded or decoded IFF signal alone, the radar signal alone, or the radar signal mixed with either coded or decoded IFF signals. Data on this Sheet reflects the following field changes: Fc 1 through 4 (AN/UPA-24).

nally 70 ohms  
Primary Power Voltage: 115v, 60 or 400 cyc, 1-ph  
Space Heater Power Voltage: 115v or 220v, 60 or 400 cyc, 1-ph  
Heat Dissipation: 92w max  
Space Heater Dissipation: 300w max

**RELATION TO SIMILAR EQUIPMENT**

None.

**TECHNICAL DESCRIPTION**

Video Input and Output Impedances: Nomi-

**INSTALLATION CONSIDERATIONS**

Related Equipment  
Required but not Supplied: (1) Radar Test Set TS-1253/UP; (1) Oscilloscope AN/USM-32 or AN/USM-105A; (as reqd) Armored Cable DSGA-3; (as reqd) Armored Cable MSCA-7; (as reqd) Armored Cable MSCA-10; (as reqd) Armored Cable MSCA-24; (as reqd) Coaxial Cable RG-12/U.

**PRINCIPAL COMPONENTS AND PHYSICAL DATA**

COMPONENTS	QTY	OVERALL DIMENSIONS (Inches)	UNIT WT. (Pounds)
Decoder, Video KY-80A/UPA-24	1	9-3/4 x 17-11/32 x 19-1/32	56.75
Control, Radar Set C-1008A/UPA-24	1	5-3/4 x 6-3/16 x 9-1/16	4.50
Technical Manual NAVSHIPS 94257	2	1/4 x 8-1/2 x 11	

**SHIPPING DATA**

COMPONENTS	PKGS	VOLUME (CU FT)	UNIT WT. (Pounds)
	1	7.2	150

**REFERENCE DATA AND LITERATURE**

Technical Manuals:  
NAVSHIPS 94257  
NAVSHIPS 94257.32: Performance Standards Sheet.  
NAVSHIPS 94257.42: Maintenance Standards Book

**AN/UPA-24B: 2**

DATE: 1 July 1964

ITEM NAME: VIDEO CODER GROUP

COGNIZANT SERVICE: USN

TYPE: AN/UPA-38

FEDERAL STOCK NUMBER: F5840-669-6836

	USA	USN	USAF	USMC
STATUS OR TYPE CLASSIFICATION		Sub. Std		
Mfg(s) Name or Code Number: Raytheon Mfg. Co.				

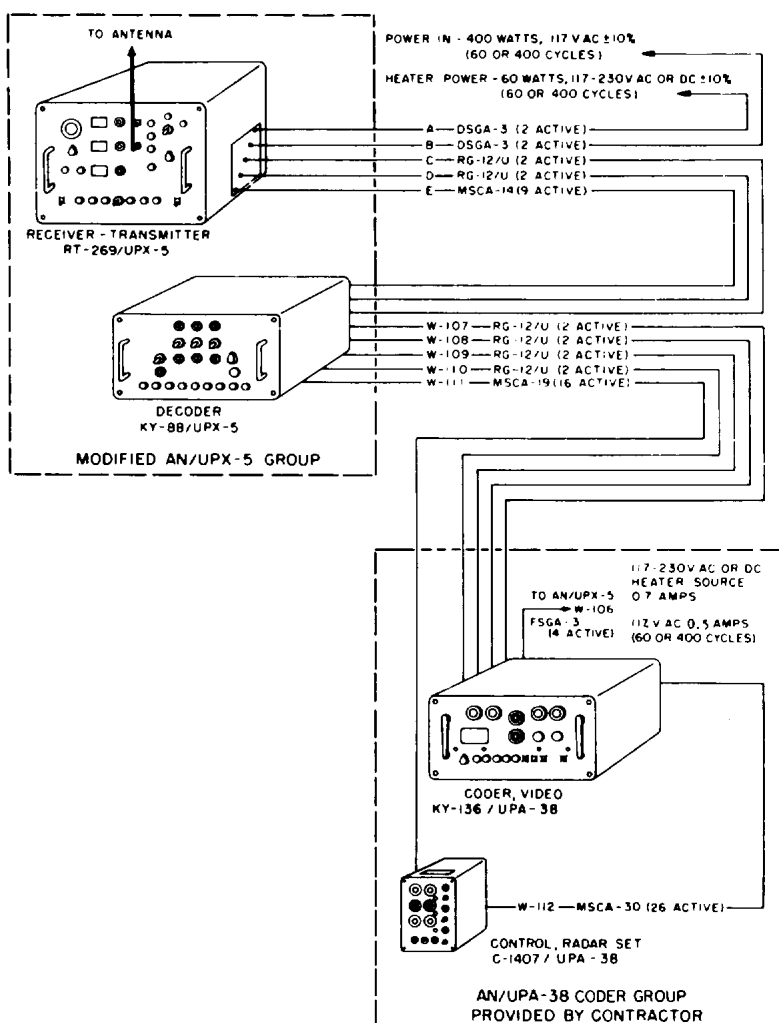

AN/UPA-38: 1

AN/UPA-38

**FUNCTIONAL DESCRIPTION**

Video Coder Group AN/UPA-38 is an IFF coding equipment designed for use with Radar Identification Set AN/UPX-5. Its purpose is to provide coded pulse-train replies for transmission by the AN/UPX-5.

**RELATION TO SIMILAR EQUIPMENT**

None.

**TECHNICAL DESCRIPTION**

Operating Voltages and Power Requirements:

117v  $\pm$ 10%, 60  $\pm$ 3 cps or 400  $\pm$ 40 cps, 1-ph, 91.6 pf

**INSTALLATION CONSIDERATIONS**

Siting:

Mounting: The video coder is designed for table or shelf mounting only; the radar set control is designed for shelf, table, rack or bulkhead mounting. Clearance for operation and servicing is required at the front only.

Cabling Requirements:

Related Equipment: AN/UPX-5.

**PRINCIPAL COMPONENTS AND PHYSICAL DATA**

<b>COMPONENT</b>	<b>QTY</b>	<b>HEIGHT (Inches)</b>	<b>WIDTH (Inches)</b>	<b>DEPTH (Inches)</b>	<b>UNIT WT. (Pounds)</b>
Video Coder KY-136/UPA-38	1	10	17	20	47
Radar Set Control C-1407/UPA-38	1	9	6	7	4-1/2

**REFERENCE DATA AND LITERATURE**

Technical Manual.  
NAVSHIPS 92650

DATE: 1 September 1964

ITEM NAME: ANTENNA PEDESTAL GROUP

COGNIZANT SERVICE: USN

TYPE: AN/UPA-43

FEDERAL STOCK NUMBER: 2F5985-957-3660

	USA	USN	USAF	USMC
STATUS OR TYPE CLASSIFICATION		Used by		
Mfg(s) Name or Code Number: ITE Circuit Breaker Company (30086)				

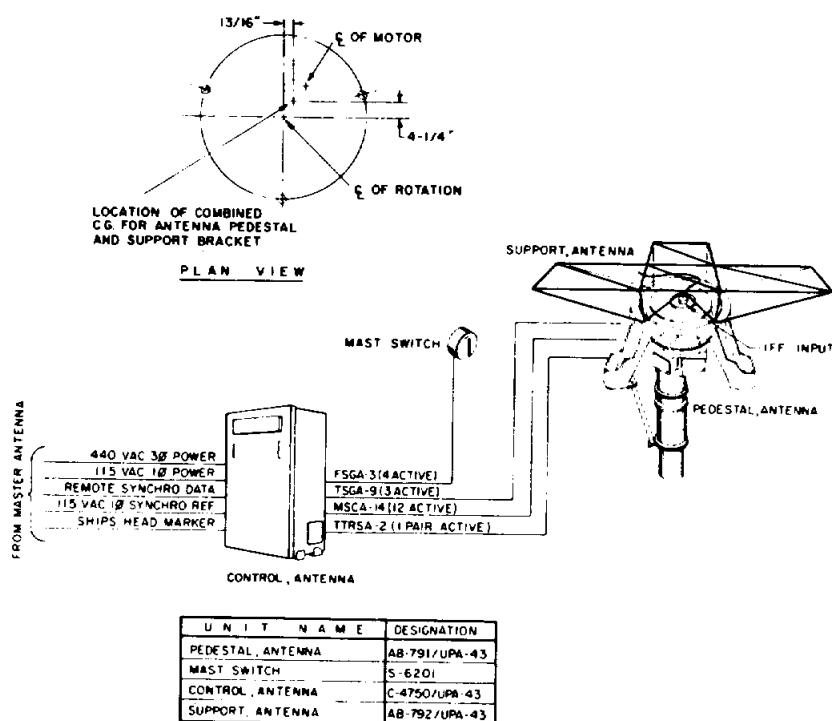

FUNCTIONAL DESCRIPTION

Antenna Pedestal Group AN/UPA-43 is a slaved pedestal group designed to support and position an AS-1065/UPX IFF interrogator antenna in synchronism to a remote command unit.

AN/UPA-43: 1

**ITEM NAME:** ANTENNA PEDESTAL GROUP

**TYPE:** AN/UPA-43

**RELATION TO SIMILAR EQUIPMENT**

None.

per sq ft  
Acceleration: 30/sec<sup>2</sup> max rotation; 320  
per sec<sup>2</sup> max rate-sector scan  
Scan: Sinusoidal sector scan-min angle  
of plus or minus 15°  
Rotary Joint Duty Cycle: 0.25% in the  
1010-1110 mc freq band

**TECHNICAL DESCRIPTION**

Frequency Range: 1010 to 1110 mc  
Power Source Required: 440v, 3-ph, 60 cyc  
and 115v, 1-pb, 60 cyc  
Power Output: 15 kw  
Voltage Standing Wave Ratio: 1.5:1 max  
over 360 pedestal rotation  
Standard Rotation: 15 rpm ccw; 30 rpm ccw  
Wind Velocity  
Normal: 75 knots with 4.5 lbs ice per sq ft  
on top surface of antenna  
Survival: 100 mph wind with 7 lbs ice

**INSTALLATION CONSIDERATION**

Related Equipment  
Required but not Supplied: (1) Elec-  
tronic Volt-Ohm-Ammeter AN/USM-116;  
(1) Oscilloscope AN/USM-105A; (1)  
Variac CN/16A/U; (1) Test Set TS-  
1100A/U; (1) Technical Manual  
NAVSHIPS 93560.

**PRINCIPAL COMPONENTS AND PHYSICAL DATA**

COMPONENTS	QTY	OVERALL DIMENSIONS (Inches)	UNIT WT. (Pounds)
Antenna Pedestal Group AN/UPA-43 includes:	1	29-5/8 x 33-7/8 x 34-3/4	719
Antenna Pedestal AB-791/UPA-43	1	29-5/6 x 33-7/8 x 34-3/4	318
Antenna Support AB-792/UPA-43	1	12 x 32-1/4 x 84	36
Antenna Control C-4750/UPA-43	1	23-7/16 x 29 x 42-7/16	358
Mast Switch S-6201	1	4-1/32 x 5-11/16 x 5-11/16	6
Technical Manual NAVSHIPS 94927	1	1/2 x 8-1/4 x 10-3/4	1

**SHIPPING DATA**

COMPONENTS	PKGS	VOLUME (CU FT)	UNIT WT. (Pounds)
	1	52.76	523
	1	34.50	136
	1	29.70	458

**REFERENCE DATA AND LITERATURE**

Technical Manuals:  
NAVSHIPS 94927

**AN/UPA-43: 2**



DATE: 1 July 1964

ITEM NAME: INDICATOR GROUP

COGNIZANT SERVICE: USN (USMC)

TYPE: AN/UPA-45

**FEDERAL STOCK NUMBER:**

	USA	USN	USAF	USMC
STATUS OR TYPE CLASSIFICATION				

Mfg(s) Name or Code Number: U. S. Army, Ft. Monmouth, N. J.

Illustration Not Available

**FUNCTIONAL DESCRIPTION**

Indicator Group AN/UPA-45 is designed for general purpose use. It provides remote PP[ presentation when supplied by video from ground-based radar/IFF equipments.

**TECHNICAL DESCRIPTION**

Type of Presentation: PPI with 360 deg azimuth coverage  
Range: 0 to 250 mi  
Operating Voltages and Power Requirements:  
115v, 60 or 400 cps, 1-ph, 500w approx

**RELATION TO SIMILAR EQUIPMENT**

This indicator group was originally known as AN/APA- 125. The group was modified by the USMC for field use and designated as the AN/UPA-45.

**INSTALLATION CONSIDERATIONS**

Not available.

**PRINCIPAL COMPONENTS AND PHYSICAL DATA**

COMPONENT	QTY	HEIGHT (Inches)	WIDTH (Inches)	DEPTH (Inches)	UNIT WT. (Pounds)
Azimuth-Range Indicator IP-( )/UPA-45	1	24	13	31	135
Control Indicator C-( )/UPA-45	1	24	7	9-3/4	12
Power Supply PP-( )/UPA-45	1	22	12	26	115

**REFERENCE DATA AND LITERATURE**

Not available.

DATE: 1 September 1964

ITEM NAME: DECODER GROUP

COGNIZANT SERVICE: USN

TYPE: AN/UPA-49(XN-1)

FEDERAL STOCK NUMBER:

	USA	USN	USAF	USMC
STATUS OR TYPE CLASSIFICATION		Used by		

Mfg(s) Name or Code Number: Admiral Corporation (08128)

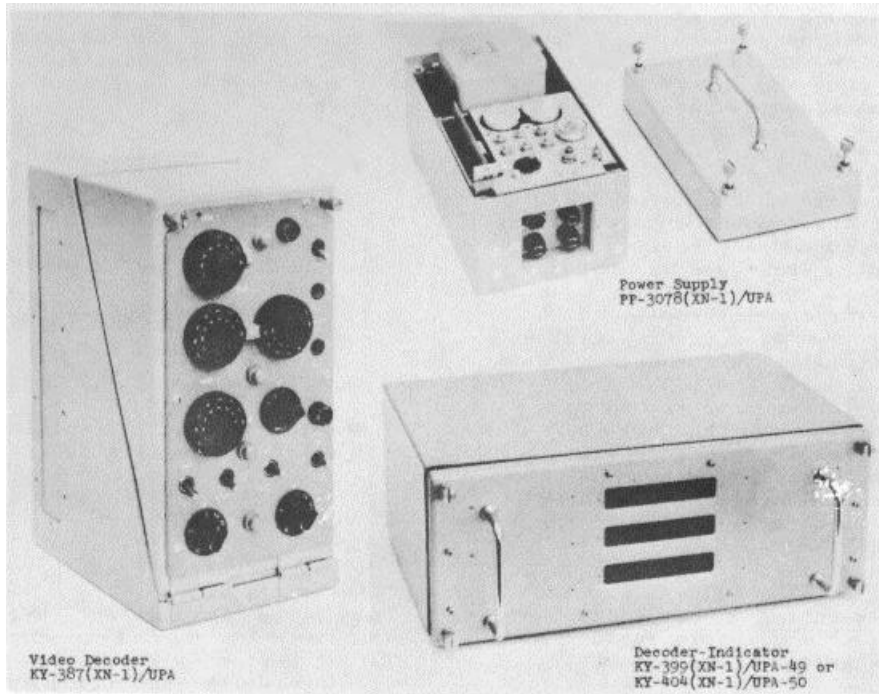

**FUNCTIONAL DESCRIPTION**

Decoder Group AN/UPA-49(XN-1) is comprised of three complementary units, a Video Decoder, a Decoder-Indicator, and a Power Supply, a Decoder Group processes the multiple pulse coded replies of the IFF MK X (SIC)system, in

any one of the three selectable IFF modes. It performs simultaneously a passive decode, a bracket decode, and an active decode function and augments the overall system capability for positive identification of radar-detected aircraft or ships, and for the subsequent tracking

**AN/UPA-49(XN-1): 1**

**ITEM NAME:** DECODER GROUP

**TYPE:** AN/UPA-49(XN-1)

of IFF displayed targets.

The decode functions of the decoder group are (1) to check a target reply code for parity with a preset code (passive decode); (2) to check the reply code for bracket-pulse coincidence (bracket decode); and (3) to translate the reply code, which is in a binary coded octal form, into its equivalent decimal number (active decode). As a result of these functions, output signals are provided for display as the IFF target on an associated radar indicator, and a decimal number is read out on 1 amp indicating devices. The IFF target display and the code readout are performed in synchronism. A three channel device, the code readout presents instantaneously the reply codes of three discrete targets. In addition, a delayed code video output is provided for display and, when interconnected, the surveillance radar video is passed or mixed with IFF video as an output. Selecting an IFF, radar, or mixed output, establishing a preset code and an IFF mode of operation, and enabling the interrogator challenge are functions of operating controls located on the front panel of the video decoder.

A sector gate generated by the decoder indicator unit of the decoder group provides a means of selecting and segregating targets for active readout. This gate is applied externally to the video sweep of the associated radar indicator and internally to the code translation circuits. As displayed on a PPI type indicator the sector gate is defined by azimuth radials and range arcs which appear as brightened traces to form essentially a rectangular shape on the screen. This defined area represents in range and azimuth the time during which target replies are enabled for active readout. The placement of the sector gate is a function of the associated radar indicator controls; the area delimited by the gate is adjustable within limits by means of azimuth and range controls on the video decoder unit. The sector gate is also useable for delimiting target challenge to the gated area.

**RELATION TO SIMILAR EQUIPMENT**

Decoder Group AN/UPA-49(XN-1) and Decoder Group AN/UPA-50(XN-1) are functionally identical units. They differ only in their application to particular system complex and in minor circuit variations which are necessary to make each group compatible with the characteristics of associated equipment. The AN/UPA-49 is used in the Navy Tactical Data System. A Video Decoder KY-387(XN-1)UPA and a Power Supply PP-3078(XN-1) are units common to both groups. A Decoder-Indicator is the third unit in a group; the KY-386(XN-1) /UPA-49 is used. Decoder Group AN/UPA-49 is a replacement for the Decoder Group AN/UPA-24.

**TECHNICAL DESCRIPTION**

Inputs

IFF Video: Mode 1, 2, or 3 SIF code train replies  
Polarity: Pos  
Pulse Amplitude: 2v plus or minus 0.5v  
Pulse Width: 0.30 to 1.0 usec (0.45 usec nom)  
Pulse Spacing: 1.45 or 2.90, usec plus or minus 0.50 usec, as measured from pulse leading edges.  
Azimuth Signal: A nom 15v neg polarity, rectangular pulse  
Radar Video: 0.30 to 1500 usec duration of individual pulses; 2v (min) amplitude

Outputs

Radar Video: Output supplied identical to input; or as a mixed output w/IFF video  
Bracket Decode: A single 1.5 usec (nom) pulse  
Polarity: Pos  
Amplitude: Adjustable between 1.5 to 4.0v  
Passive Decode: A single 1.5 usec (nom) pulse  
Polarity: Pos  
Amplitude: Adjustable between 1.5 to 4.0v  
Bracket Decode: Normal bracket pulse; stretched passive decode pulse (10 usec nom)  
Passive Decode: Passive decode pulse (10 usec nom)  
Code Video: Same form as IFF input video, but delayed approx 40.8 usec  
Polarity: Pos  
Amplitude: Adjustable between 1.5 to 4.0v

Target Sector Gate: Series of pulses; pos polarity; amplitude adjustable from 0 to 4v

Power Requirements: 115v ac, 400 cyc, 1-ph, 50w

**INSTALLATION CONSIDERATIONS**

Related Equipment

Required but not Supplied: For Decoder Group AN/UPA-49. Units of a Navy Tactical Data System are required to provide IFF video and azimuth inputs, and to display decoder group outputs.

ITEM NAME: DECODER GROUP

TYPE: AN/UPA-49(XN-1)

PRINCIPAL COMPONENTS AND PHYSICAL DATA

COMPONENTS	QTY	OVERALL DIMENSIONS (Inches)	UNIT WT. (Pounds)
Decoder Group AN/UPA-49(XN-1)	1		45
Video Decoder KY-387(XN-1)/UPA	1	6-3/4 x 10-1/2 x 13	15
Decoder-Indicator KY-388(XN-1 )/UPA-49	1	6-3/8 x 11-7/8 x 16-3/16	18
Power Supply PP-3078(XN-1)/UPA	1	5-11/16 x 7-5/8 x 9-13/16	12
Connector, Plug, Electrical	14		
MS90248	6		
PTO6W-12-10S	2		
PTO6W-14-19S	1		
PTO6W-14-19P	1		
PT06W-16-26P	1		
PT06W-16-26S	1		
PT06W-12-10P	1		
PT06W-12-10S(X)	1		
NAVSHIPS 94374 Technical Manuals	2		

SHIPPING DATA

COMPONENT	PKGS	VOLUME (CU FT)	UNIT WT. (Pounds)
	1	9	136

REFERENCE DATA AND LITERATURE

Technical Manuals:  
NAVSHIPS 94374

AN/UPA-49(XN-1): 3

DATE: 1 September 1964

ITEM NAME: DECODER GROUP

COGNIZANT SERVICE: USN

TYPE: AN/UPA-50(XN-1)

FEDERAL STOCK NUMBER:

	USA	USN	USAF	USMC
STATUS OR TYPE CLASSIFICATION		Used by		

Mfg(s) Name or Code Number: Admiral Corporation (08128)

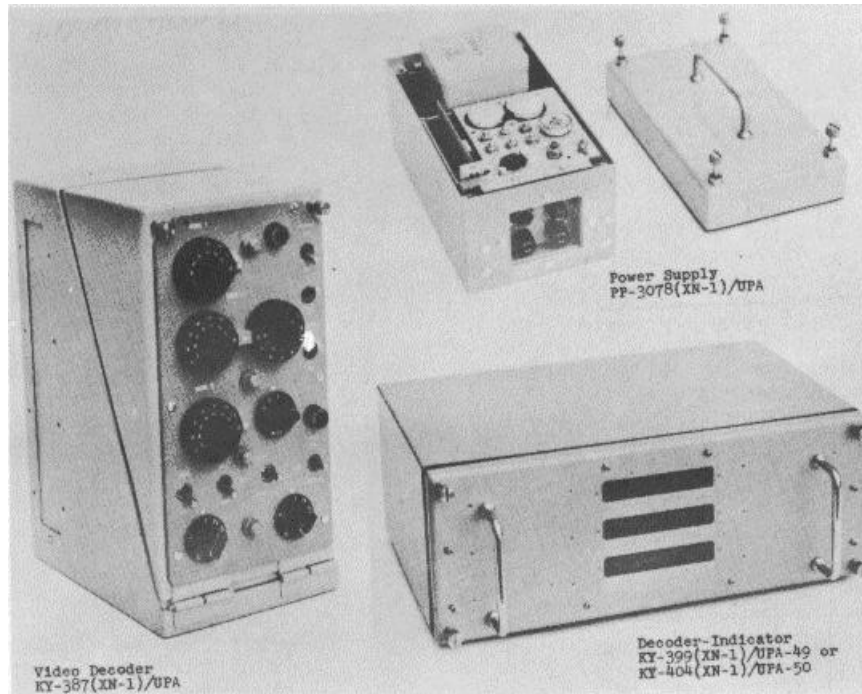

**FUNCTIONAL DESCRIPTION**

Decoder Group AN/UPA-50(XN-1) is comprised of three complementary units, a Video Decoder, A Decoder Indicator, and a Power Supply, a decoder group processes the multiple pulse coded replies of the IFF

MK-X (SIF) system in any one of the three selectable IFF modes. It performs simultaneously a passive decode, a bracket decode, and an active decode function and augments the over-all system capability for positive identification of radar-detected aircraft or ships, and for the subsequent tracking of IFF

**AN/UPA-50(XN-1): 1**

**ITEM NAME:** DECODER GROUP  
**TYPE:** AN/UPA-50(XN-1)

displayed targets.

The decode functions of the decoder group are (1) to check a target reply code for parity with a preset code (passive decode); (2) to check the reply code for bracket pulse coincidence (bracket decode); and (3) to translate the reply code, which is in a binary coded octal form, into its equivalent decimal number (active decode). As a result of these functions, output signals are provided for display as the IFF target on an associated radar indicator, and a decimal number is read out on lamp indicating devices. The IFF target display and the code readout are performed in synchronism. A three channel device, the code readout presents instantaneously the reply codes of three discrete targets. In addition, a delayed code video output is provided for display and, when interconnected, the surveillance radar video is passed or mixed with IFF video as an output. Selecting and IFF, radar or mixed output, establishing a preset code and an IFF mode of operation, and enabling the interrogator challenge are functions of operating controls located on the front panel of the video decoder.

A sector gate generated by the decoder indicator unit of the decoder group provides a means of selecting and segregating targets for active readout. This gate is applied externally to the video sweeps of the associated radar indicator and internally to the code translation circuits. As displayed on a PPI type indicator the sector gate is defined by azimuth radials and range areas which appear as brightened traces to form essentially a rectangular shape on the screen. This defined area represents in range and azimuth the time during which target replies are enabled for active readout. The placement of the sector gate is a function of the associated radar indicator controls; the area delimited by the gate is adjustable within limits by means of azimuth and range controls on the video decoder unit. The sector gate is also useable for delimiting target challenge to the gated area.

#### RELATION TO SIMILAR EQUIPMENT

Decoder Group AN/UPA-49(XN-1) and Decoder Group AN/UPA-50(XN-1) are functionally identical units. They differ only in their application to particular system complex and in minor circuit variations which are necessary to make each group compatible with the characteristics of associated equipment. The AN/UPA-50 is used with Radar Recognition Set AN/UPX-1A and Radar Indicator AN/SPA-BA. A Video Decoder KY-3B7(XN-1)/UPA and a Power Supply PP-3078(XN-1) are units common to both groups. A Decoder-Indicator is the third unit in a group; the KY-404(XN-1)/UPA50 is used. Decoder Group AN/UPA-50 is a replacement for the Decoder Group AN/UPA-24.

#### TECHNICAL DESCRIPTION

##### Inputs

IFF Video: Mode 1, 2, or 3 SIF code train replies

Polarity: Pos

Pulse Amplitude: 2v plus or minus 0.5v

Pulse Width: 0.30 to 1.0 usec (0.45 usec

nom)

Pulse Spacing: 1.45 to 2.90, usec plus or minus 0.50 usec as measured from pulse leading edges

Pulse Spacing: 1.45 to 2.90, usec plus or minus 0.50 usec as measured from pulse leading edges

Azimuth Signal: Three ph cursor-bearing antenna synchro v from a modified AN/SPA-IA; a 6.3v ac, 60 cyc reference v

Range Trigger: 12v nom amplitude; pos polarity; at a repetition rate which is the same as AN/SPA-IA range strobe generator

Radar Video: 0.30 to 1500 usec duration of individual pulses; 2v (min) amplitude

##### Input and Output

Impedance: 75 ohms (terminated) Outputs

Radar Video: Output supplied identical to input; or as a mixed output w/IFF video

Bracket Decode: A single 1.5 usec (nom) pulse

Polarity: Pos

Amplitude: Adjustable between 1.5 to 4.0v

Passive Decode: A single 1.5 usec (nom) pulse.

Polarity: Pos

Amplitude: Adjustable between 1.5 to 4.0v

Bracket Decode: Normal bracket pulse; stretched passive decode pulse (10 usec nom)

Passive Decode: Passive decode pulse (10 usec nom)

Code Video: Same form as IFF input video, but delayed approx 40.8 usec

Polarity: Pos

Amplitude: Adjustable between 1.5 to 4.0v

Target Sector Gate: Series of pulses; pos polarity amplitude adjustable from 0 to 4v

Power Requirements: 115v ac, 400 cyc, 1-ph, 50w

#### INSTALLATION CONSIDERATION

##### Related Equipment

Required but not Supplied: For Decoder Group AN/UPA-50. One Radar Recognition Set AN/UPX-1A which supplies IFF video inputs and one Radar Indicator AN/SPA-BA which provides cursor/ant-

**ITEM NAME:** DECODER GROUP

**TYPE:** AN/UPA-50(XN-1)

enna bearing information and range strobe pulses, and displays the outputs of the decoder group are requir-

ed. The Radar Indicator is modified specifically for operation with this decoder group.

**PRINCIPAL COMPONENTS AND PHYSICAL DATA**

<b>COMPONENTS</b>	<b>QTY</b>	<b>OVERALL DIMENSIONS (Inches)</b>	<b>UNIT WT. (Pounds)</b>
Decoder Group AN/UPA-50(XN-1)	1		45
Video Decoder KY-387(XN-1)/UPA	1	6-3/4 x 10-1/2 x 13	15
Decoder-Indicator KY-404(XN-1 )/UPA-50	1	6-3/8 x 11-7/8 x 16-3/16	18
Power Supply PP-3078(XN-1)/UPA	1	5-11/16 x 7-5/8 x 9-13/16	12
Connector Plug, Electrical c/o: MS90248	14		
Pt06W-12-10S	6		
Pt06W-14-19S	2		
Pt06W-14-19P	1		
Pt06W-16-26P	1		
Pt06W-16-26S	1		
Pt06W-12-10P	1		
Pt06W-12-10S(X)	1		
Field Change Kit 16-AN/SPA-8A	1		
Technical Manuals NAVSHIPS 94374	2		

**SHIPPING DATA**

<b>COMPONENT</b>	<b>PKGS</b>	<b>VOLUME (CU FT)</b>	<b>UNIT WT. (Pounds)</b>
	1	9	136

**REFERENCE DATA AND LITERATURE**

Technical Manuals:  
NAVSHIPS 94374

**AN/UPA-50(XN-1): 3**

**DATE:** 1 July 1964

**ITEM NAME:** RADAR BEACON

**COGNIZANT SERVICE:** USN

**TYPE:** AN/UPN-?

FEDERAL STOCK NUMBER: 5825-665-1463

	USA	USN	USAF	USMC
STATUS OR TYPE CLASSIFICATION		Std		
Mfg(s) Name or Code Number: Melpar, Incorporated				

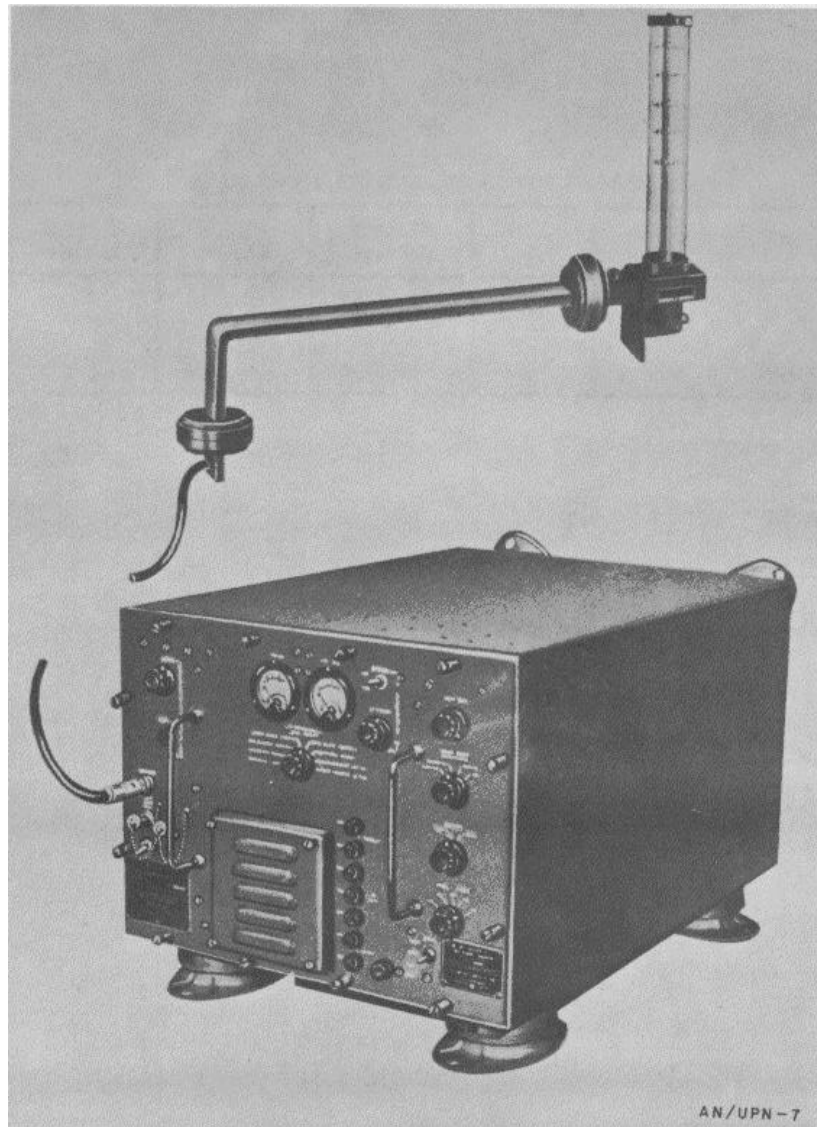

**AN/UPN-7: 1**



**AN/UPN-7**

**FUNCTIONAL DESCRIPTION**

Radar Beacon AN/UPN-7 provides ship's position data for display on the aircraft radar and the shipboard repeater of an AEW system.

The AN/UPN-7 may also be used as a navigational beacon. It accepts the beacon pulses of suitable radar equipment and replies with a series of coded pulses that provide the interrogating radar equipment with the range, bearing, and identification of the beacon.

**RELATION TO SIMILAR EQUIPMENT**

None.

**TECHNICAL DESCRIPTION**

Frequency: Transmitter, 2819 to 2821 mc; re-

ceiver, 2850 to 2910 mc  
Peak Power Output: 1.0 kw  
Pulse Width: 1.1 to 1.15 msec  
Horizontal Beam Width: Omnidirectional  
Vertical Beam Width: Main lobe 5 deg from horizontal; side lobes give coverage up to 50,000 ft altitude at elevation angles up to 75 deg from horizon  
Antenna Feed: RG-48/U waveguide (less than 100 ft)  
Standing Wave Ratio: Less than 1.3:1  
Polarization: Vertical

**INSTALLATION CONSIDERATIONS**

Not available.

**PRINCIPAL COMPONENTS AND PHYSICAL DATA**

COMPONENT	QTY	HEIGHT (Inches)	WIDTH (Inches)	DEPTH (Inches)	UNIT WT. (Pounds)
Receiver-Transmitter RT- 186/UPN-7	1	31-9/16	20-7/8	17-5/8	330
Antenna AT-244/UPN-7	1	25-5/16	9-3/16	5-5/16	35

**REFERENCE DATE AND LITERATURE**

Technical Manual:  
NAVSHIPS 91602

**DATE:** 1 July 1964    **ITEM NAME:** BEACON SYSTEM, RADIO

**SERVICE:** USN    **TYPE:** AN/UPN-14

**FEDERAL STOCK NUMBER:** 5825-552-0092 W/S

	USA	USN	USAF	USMC
STATUS OR TYPE CLASSIFICATION Used By		Used By		

Mfg((S) Name or Code Number: Litton Industries, Maryland Electronics Mfg. Corp. (82699)

Illustration not Available.

**FUNCTIONAL DESCRIPTION**

The Beacon System Radio AN/IUPN-14 is designed for shipboard installation. It is an "inverted" Loran type equipment used as an automatic electronic positioning indicator system. Its function is to interrogate

the Radio Beacon Set AN/TPN-11 equipments installed at each of two (2) shore stations, display the returned signals on the screen of a cathode-ray tube and indicate the range to each shore station on direct reading range counters.

**AN/UPN-14: 1**

**ITEM NAME:** BEACON SYSTEM, RADIO

**TYPE:** AN/UPN-14

**RELATION TO SIMILAR EQUIPMENT**

None.

**TECHNICAL DESCRIPTION**

Type of Indicator: Cathode-ray tube type.  
 Effective Range Coverage: Up to 500 mi at sea (distance of ship from 2 shore stations suitably seperated).  
 Accuracy: Better than 0.2 usec for 95% of readings under normal conditions.  
 Repetition Rate: 41-2/3 and 33-1/3 pps, switch selectable.  
 Transmitter Characteristics  
 Type: Pulsed oscillator, self-excited.  
 Frequency Range: Fixed tunable, 1700 to 2000 kc  
 Frequency: 1850 and 1950 kc  
 Output Pulse: 70 usec duration at 50% amplitude.  
 Rise Time: 8 plus or minus 2 usec from 10 to 90% amplitude.  
 Maximum Peak Power: At least 18 kw  
 Output Impedance: 50 ohms resistive.  
 Spurious Radiation: 60 db down from radiated power.  
 Antenna (Not supplied): 25-100 ft T-type.  
 Receiver Characteristics  
 Type: Superheterodyne, wide band.

Frequency: 2 channels, switched select able, 1850 and 1950 kc  
 Bandwidth: 80 kc plus or minus 5 kc to 6 db down from center freq.  
 Video Response: Flat within plus or minus 2 db from 150 to 20, 000 cycles.  
 Local Oscillator  
 Type: Crystal  
 Frequency: 2950 and 3050 kc  
 Intermediate Frequency: 1100 kc  
 Signal to Internal Noise at Minimum Signal: 10:1.  
 Input Impedance: 50 ohms  
 Output Impedance: 50 ohms  
 Operating Power Requirements: 115v ac, 60 cycles, 1-ph  
 Transmitter Power Output: 275w (at 20 kw output).  
 Receiver-Indicator: 595w

**INSTALLATION CONSIDERATIONS**

Related Equipment:  
 Required but not Supplied  
 (300 ft) Antenna Wire, Bronze, stranded No. 10; (200 ft) Power Cable, Armored, 2 conductor, No. 8 copper; (4) Antenna Insulators (12 inch); (1) Lead-in-Insulator for AN/SPN-24; (1) Antenna System for AN/SPN-24; (1) Radio Receiver & Instruction Manual; (1) Radio Transmitter & Instruction Manual.

**PRINCIPAL COMPONENTS AND PHYSICAL DATA**

COMPONENTS	QTY	OVERALL DIMENSIONS (Inches)	UNIT WT. (Pounds)
Transmitting Group OA-1521/SPN-24	1		
consists of:			
Radar Transmitter T-638/SPN-24	1	16 x 20-1/4 x 25-3/4	133
Power Supply PP-1756/SPN-24	1	16 x 20-1/4 x 25-3/4	133
Receiver Group OA-1523/SPN-24	1		
consists of:			
Power Supply Receiver PP-175B/SPN-24	1	16 x 20-1/4 x 25-3/4	185
Range Indicator IP-426/SPN-24	1	16 x 20-1/4 x 25-3/4	140
Antenna Coupler CU-468/SPN-20	1	9 x 14-1/2 x 19-3/8	14
Line Regulator CN-481/SPN-24	1	8-3/4 x 12-3/16 x 21-3/8	40
Angle Connectors UG-913/U	12		
Connectors UG-8BC/U	2		
Connectors UG-925A/U	2		

**AN/UPN-14: 2**

**ITEM NAME:** BEACON SYSTEM, RADIO

**TYPE:** AN/UPN-14

**PRINCIPAL COMPONENTS AND PHYSICAL DATA (Cont.)**

**SHIPPING DATA**

PKGS	UNIT WT. (Pounds)
1	205
1	230
1	107
1	240
1	298
1	105

**REFERENCE DATA AND LITERATURE**

Technical Manuals:  
NAVSHIPS 93554

**AN/UPN-14: 3**

DATE: 1 July 1964

ITEM NAME: RADAR RECOGNITION SET

COGNIZANT SERVICE: USN

TYPE: AN/UPX-1, \* -1A\*\*

FEDERAL STOCK NUMBER: F5859-669-8059\*  
 5895-501-0873\*\*

	USA	USN	USAF	USMC
STATUS OR TYPE CLASSIFICATION		Sub. Std		

Mfg(s) Name or Code Number: General Communications Co., \*; Admiral Corporation \*\*

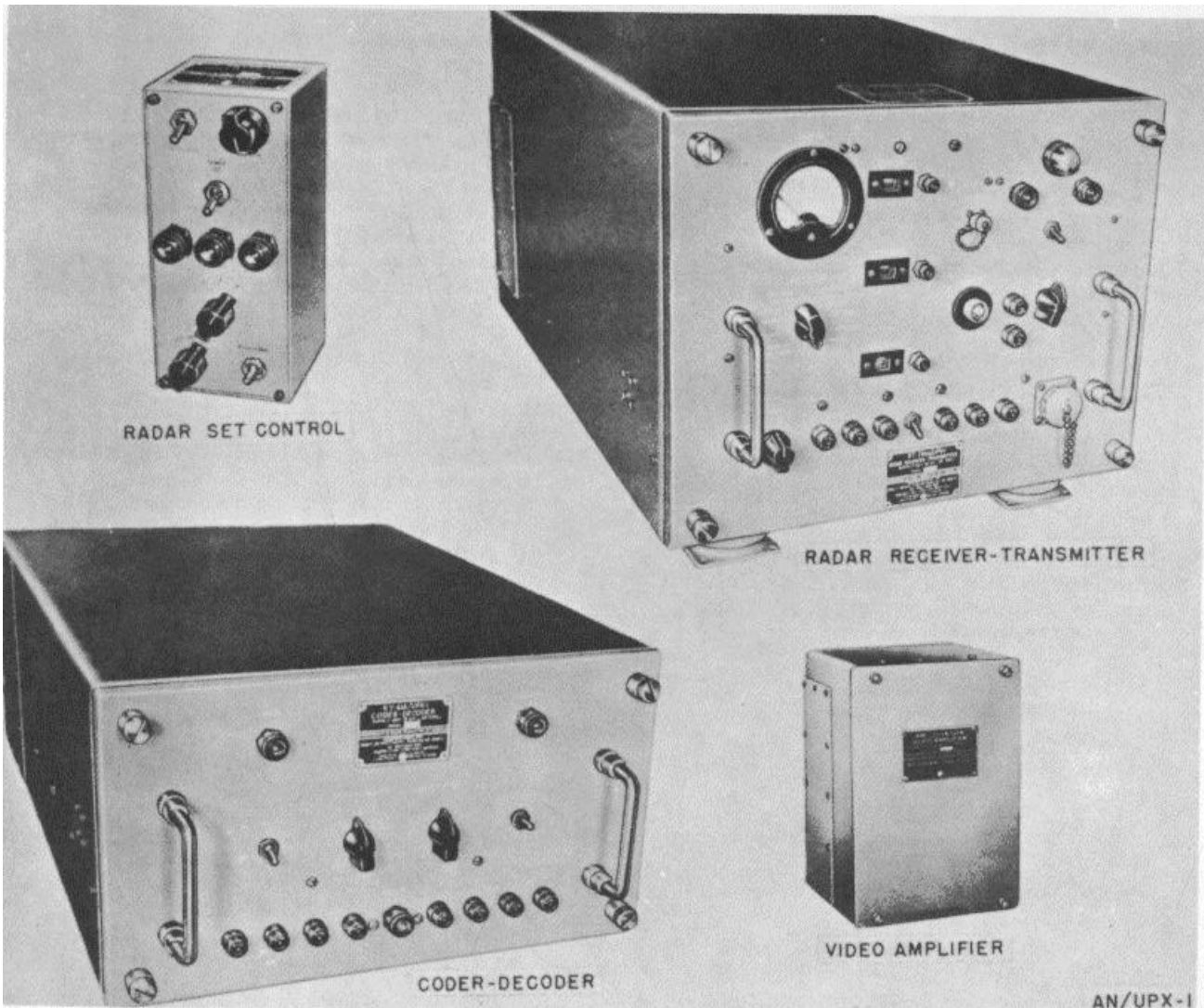

## AN/UPX-1, -1A

### FUNCTIONAL DESCRIPTION

Radar Recognition Sets AN/UPX-1 and -1A are used primarily for the recognition of friendly radar targets. A supplementary use of the equipment is to provide a more detailed recognition of friendly radar targets for additional security and tactical information. The sets are operated in conjunction with shipboard and fixed ground station radar equipment. They normally use the radar display for the presentation of IFF data, and their antennas are either an integral part of, or are slaved with, the associated radar antenna.

### RELATION TO SIMILAR EQUIPMENT

None.

### TECHNICAL DESCRIPTION

#### Transmitter

Frequency: 1010 to 1030 mc  
IF. Frequency: 59.5 +1.5 mc  
Pulse Repetition Rate: 50 to 410 pps  
Pulse Spacing:  
Mode 1 - 3  $\mu$  sec  
Mode 2 - 5  $\mu$  sec  
Mode 3 - 8  $\mu$  sec

GTC Gate Duration: 300 to 2, 500  $\mu$  sec

#### Receiver

Frequency: 1090 to 1110 mc  
Sensitivity: 80 db below 1v or better  
Bandwidth:  
8 to 11 mc at 6 db down  
24 mc at 40 db down  
IF. Pickup: 6 db below signal level  
Positive Video Output: 10 to 12v high dynamic range with 0.03v rms noise. 4 to 5 low dynamic range with 1v rms noise.

#### Coder Decoder

##### Input Pulse -

Polarity: Positive  
Repetition Rate: 50 to 410 pps  
Duration: 0.3 to 25  $\mu$  sec at 50% amplitude  
Voltage: 5 to 50v peak across 75 ohm resistor  
Rise Time: 0.01 to 1  $\mu$  sec, 0 to 70% amplitude  
Display Trigger -  
Polarity: Positive  
Repetition Rate: 5 to 100 pps  
Duration: 10  $\mu$  sec at 85% peak amplitude  
Voltage: 10v across 75 ohm resistor, under display trigger

Rise Time: 0.25  $\mu$  sec

Jitter: 0.05  $\mu$  sec

##### Suppressor Pulse -

Rise Time: 0.25  $\mu$  sec

Duration: 1 to 2  $\mu$  sec

Amplitude: 20 to 50v

Self Trigger: 150 to 410 pulse pairs per sec

#### Video Amplifier

IFF Input Signal: 1 to 5v

Radar Input Signal: 1 to 5v 0.75v rms noise

Video Output Signal Polarity: Positive

Operating Voltages and Power Requirements:

105 to 125v, 60 to 400 cps, 1-ph, 865w

### INSTALLATION CONSIDERATIONS

#### Siting:

#### Mounting:

Cabling Requirements: No cables should exceed 300 ft in length

Related Equipment: When used for other than a single system installation, auxiliary equipment Video Distributor SA-220/UPX, Selector Switch SA-213/U, Radar Set Controls C-814/UPX-1, C-815/UPX-1, and C-816/UPX-1 are also required.

AN/UPX-1, -1A

PRINCIPAL COMPONENTS AND PHYSICAL DATA

COMPONENT	QTY	HEIGHT (Inches)	WIDTH (Inches)	DEPTH (Inches)	UNIT WT. (Pounds)
AN/UPX-1 Receiver-Transmitter RT-194/UPX-I	1	16-3/4	18-3/8	27-3/4	135
Coder-Decoder KY-61/UPX-1	1	10	18-3/8	27-1/8	75
Video-Amplifier AM-293/UPX-1	1	10-1/4	6-1/2	6-5/8	13
Radar Set Control C-731/UPX-1	1	8	3-1/2	4-5/8	3
AN/UPX- 1A Receiver-Transmitter RT- 194A/UPX- 1	1	16-3/4	18-3/8	27-3/4	135
Coder-Decoder KY-61A/UPX-1	1	10	18-3/8	27-1/8	75
Video Amplifier AM-293A/UPX-1	1	10-1/4	6-1/2	6-5/8	13
Radar Set Control C-731/UPX-1	1	8	3-1/2	4-5/8	3

REFERENCE DATA AND LITERATURE

Technical Manuals:  
NAVSHIPS 91343  
NAVSHIPS 91765

AN/UPX-1: 3

**DATE:** 1 July 1964

**ITEM NAME:** RADAR RECOGNITION SET

**COGNIZANT SERVICE:** USN

**TYPE:** AN/UPX-4

**FEDERAL STOCK NUMBER:**

	USA	USN	USAF	USMC
STATUS OR TYPE CLASSIFICATION	Used By	Used By		

Mfg(s) Name or Code Number: Federal Telecommunications Laboratories (90348)

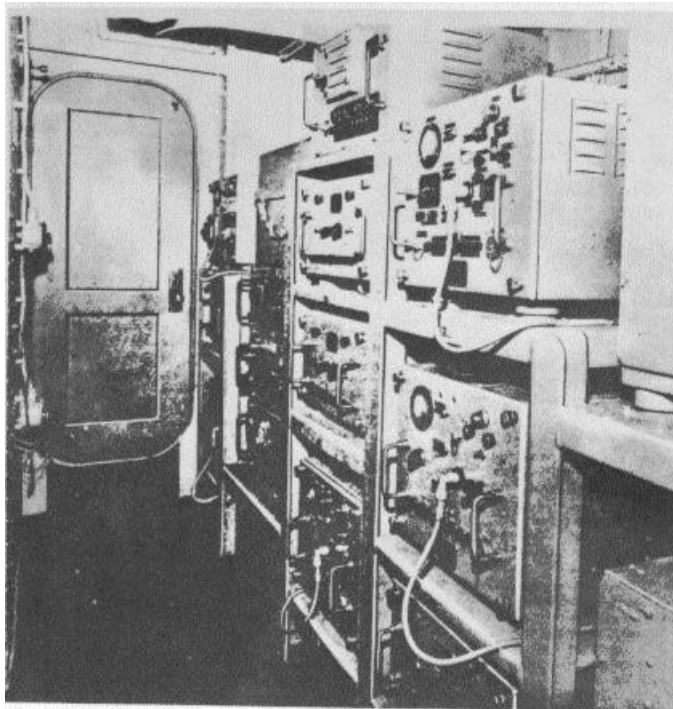

**FUNCTIONAL DESCRIPTION**

The Radar Recognition Set is designed as a shipboard interrogator set installed and operated in fixed or mobile ground units. This equipment transmits in the frequency band of 990 to 10.10 megacycles, three (3)

types of one-microsecond, double-pulse challenge signals, synchronized with radar transmission. It receives single-pulse, double-pulse, or 5-pulse sequences of one microsecond pulses in the 1080 to 1130 megacycle band, and provides video for display on any commonly used PPI. The display

**AN/UPX-4: 1**



**ITEM NAME:** RADAR RECOGNITION SET

**TYPE:** AN/UPX-4

is coordinated with radar information, to provide the range and azimuth of the target identified.

**RELATION TO SIMILAR EQUIPMENT**

None.

Receiver Data  
Number of Bands: 3 bands.  
Type of Frequency Control: Direct crystal controlled.  
Frequency Range: 1080 to 1130 mc  
Peak Power Output: 20 kw peak  
Operating Power Requirements: 117v ac, 60 or 400 cps, 1-ph, 1500w

**TECHNICAL DESCRIPTION**

Type of Emission: Pulse type.  
Type of Frequency Control: Crystal  
Type of Indicator: Visual, PPI  
Transmitter Data  
Number of Bands: 3 bands  
Type of Frequency Control: afc crystal controlled.  
Frequency Range: 990 to 1040 mc

**INSTALLATION CONSIDERATIONS**

Siting: Fixed or mobile units.  
Related Equipment:  
Required but not Supplied  
(1) ac/dc Voltmeter (20, 000 ohms/volt or better); (1) Radar Test Set AN/UPM-4A; (1) Radar Test Set AN/UPM-6B.

**PRINCIPAL COMPONENTS AND PHYSICAL DATA**

COMPONENTS	QTY	OVERALL DIMENSIONS (Inches)	UNIT WT. (Pounds)
Video Amplifier AM-293/UPX		3 x 5 x 7	
Receiver-Transmitter RT-194/UPX-1			
Coder-Decoder KY-61/UPX-1		Approx 14-3/4 x 18 x 26-1/8	115
Radar Set Control C-731/UPX-1		6-1/2 x 7-1/2 x 12	5
Radar Set Control C-814/UPX-1		6-1/2 x 7-1/2 x 12	5

**REFERENCE DATA AND LITERATURE**

Technical Manuals:  
NAVSHIPS 92176: for Basic IFF Radar Identification System of which Radar Recognition Set AN/UPX-4 is a part of.

**AN/UPX-4: 2**

DATE: 1 July 1964

ITEM NAME: RADAR IDENTIFICATION SET

COGNIZANT SERVICE: USN

TYPE: AN/UPX-5, \* -5A, \*\* -5B

FEDERAL STOCK NUMBER: 5895-501-4927\*\*

	USA	USN	USAF	USMC
STATUS OR TYPE CLASSIFICATION		Ltd Std		

Mfg(s) Name or Code Number: General Electric Co.\*; Radio Receptor Co, Inc.\*\*

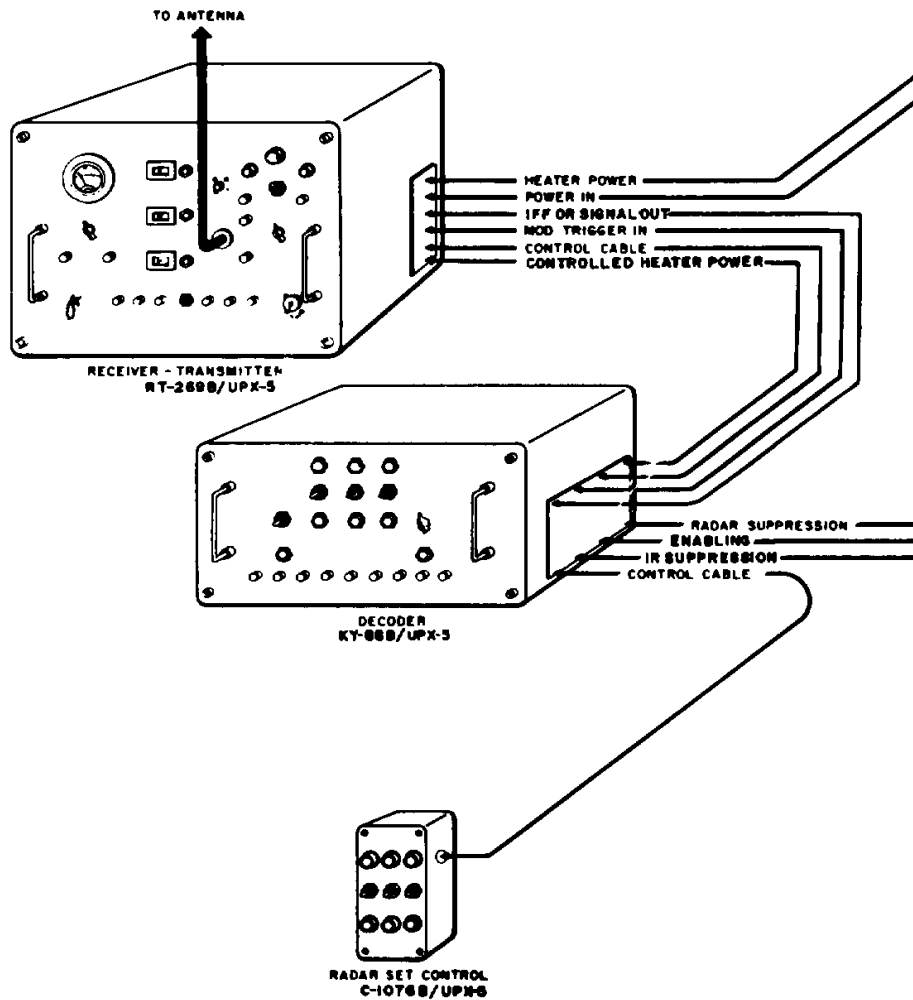

**AN/UPX-5, -5A, -5B**

**FUNCTIONAL DESCRIPTION**

Radar Identification Sets AN/UPX-5, -5A, and -5B respond to interrogations from radar recognition sets for the purpose of self-identification. They receive paired-pulse interrogation signals and transmit single-pulse identifying replies. Interrogations are pulse-pairs in one or more of three modes as determined by the spacing of the pulses in a pair. Replies to all modes are single, one-microsecond pulses.

IF. Frequency: 59.5 ±1.5 mc  
Bandwidth: 6 db, 8 to 11 mc  
Duty Cycle: 0.1% while carrying rf pulses of 10-kw peak power  
Minimum Output: 300 watts at 500 pps  
Pulse Width: 0.9 to 1.3 μ sec at 50% peak amplitude  
Operating Voltages and Power Requirements: 105 to 125v, 57 to 63 cps, or 360 to 440 cps, 1-ph, 398w approx

**RELATION TO SIMILAR EQUIPMENT**

When changes as directed by NAVSHIPS 98825 have been performed, these equipments become Transponder Sets AN/UPX-12, AN/UPX-12A, and AN/UPX-12B, respectively.

**INSTALLATION CONSIDERATIONS**

Siting:  
Mounting:  
Cabling Requirements: Cables must enter the cases without excessive sharp bends. Interconnecting cables between receiver-transmitter and decoder must not exceed 20 feet. The antenna cable must not exceed 150 feet, and other cables should not exceed 300 feet in length.  
Related Equipment:

**TECHNICAL DESCRIPTION**

Frequency: Receiver, 1010 to 1030 mc;  
transmitter, 1090 to 1110 mc

**PRINCIPAL COMPONENTS AND PHYSICAL DATA**

COMPONENT	QTY	HEIGHT (Inches)	WIDTH (Inches)	DEPTH (Inches)	UNIT WT. (Pounds)
AN/UPX- 5 Receiver-Transmitter RT-269/UPX- 5	1	15-1/2	18	28-3/8	141
Decoder KY-88/UPX-5	1	10	18	26-5/8	101
Radar Set Control C-1076/UPX-5	1	8	3-1/2	5-5/16	3
AN/UPX-5A Receiver-Transmitter 1 15- 1/2 18 28-3/8 141 RT-269A/UPX-5					
Decoder KY-88A/UPX-5	1	10	18	26-5/8	101
Radar Set Control C-1076A/UPX-5	1	8	3-1/2	5-5/16	3
AN/UPX- SB  Receiver-Transmitter 1 15- 1/2 18 28-3/8 141 RT-269B UPX-5					
Decoder KY-88B UPX-5	1	10	18	26-5/8	101
Radar Set ControlC-1076B, UPX-5	1	8	3-1/2	5-5 16	3

**REFERENCE DATA AND LITERATURE**

Technical Manual:  
NAVSHIPS 91836(A)

**DATE:** 15 March 1965

**ITEM NAME:** TRANSPONDER SET

**COGNIZANT SERVICE:** USN

**TYPE:** AN/UPX-8

**USA LINE ITEM NUMBER:** 692500

**FEDERAL STOCK NUMBER:**

	USA	USN	USAF	USMC
STATUS OR TYPE CLASSIFICATION		Std		

Mfg(s) Name or Code Number: The Philco Corporation, Philadelphia, Pennsylvania.

Illustration not Available.

**FUNCTIONAL DESCRIPTION**

The AN/UPX-8 is an IFF transmitter-receiver used for challenging and recognizing distant targets or those targets which

have been detected by an associated radar equipment.

**AN/UPX-8: 1**

**ITEM NAME:** TRANSPONDER SET

**TYPE:** AN/UPX-8

**RELATION TO SIMILAR EQUIPMENT**

None.

Operating Power Requirements: 105 to 125v  
ac, 57 to 63 cps, single ph; 105 to 125v  
ac, 360 to 440 cps, single ph

**TECHNICAL DESCRIPTION**

Frequency Data  
Transmitted Signal  
Frequency Range: 1090 to 1110 mc  
Received Signal  
Frequency Range: 1010 to 1030 mc  
Number of Bands: 1 band.

**INSTALLATION CONSIDERATIONS**

Siting: Shipboard, in trailers or fixed  
ground stations.

**PRINCIPAL COMPONENTS AND PHYSICAL DATA**

<b>COMPONENTS</b>	<b>QTY</b>	<b>OVERALL DIMENSIONS (Inches)</b>	<b>UNIT WT. (Pounds)</b>
Receiver-Transmitter RT-293/UPX-8	1		
Decoder, Transponder Set KY-114/UPX-8	1	9-25/32 x 18-1/8 x 27-3/8	
Remote Control Box	1		

**REFERENCE DATA AND LITERATURE**

Nomenclature Card for Transponder Set  
AN/UPX-8.

**AN/UPX-8: 2**

DATE: 1 July 1964

ITEM NAME: INTERROGATION SET

COGNIZANT SERVICE: USN

TYPE: AN/UPX-9

USA LINE ITEM NUMBER: 621432

FEDERAL STOCK NUMBER: 5895-548-7568

	USA	USN	USAF	USMC
STATUS OR TYPE CLASSIFICATION		Std		

Mfg(s) Name or Code Number: Radio Receptor Company, Inc.

Illustration Not Available

**FUNCTIONAL DESCRIPTION**

Interrogator Set AN/UPX-9 is an IFF transmitter-receiver used for challenging and recognizing targets. The set is used with a remote PPI which displays the IFF reply signals from the target as broken, illuminated arcs that are delayed outward along the sweep to appear after the radar signals.

A coder-decoder receives trigger pulses from the associated radar, processes them for triggering, and separates transponder replies for distribution to video units.

**RELATION TO SIMILAR EQUIPMENT**

None.

**TECHNICAL DESCRIPTION**

Frequency: Transmitter, 1005 to 1035 mc;  
receiver, 1085 to 1115 mc  
Peak Power Output: 1 kw  
Frequency Control: Crystal  
Modes of Operation: 3  
Operating Voltages and Power Requirements:  
105, 117, or 125v, 60 or 400 cps, 1-ph

**INSTALLATION CONSIDERATIONS**

Not available.

**PRINCIPAL COMPONENTS AND PHYSICAL DATA**

COMPONENT	QTY	HEIGHT (Inches)	WIDTH (Inches)	DEPTH (Inches)	UNIT WT. (Pounds)
Receiver-Transmitter RT-288/UPX-9	1				
Coder-Decoder KY-109/UPX-9	1	27-3/8	18-1/8	9-25/32	

**REFERENCE DATA AND LITERATURE**

Not available.

AN/UPX-9: 1

DATE: 1 July 1964

ITEM NAME: INTERROGATION SET

COGNIZANT SERVICE: USN

TYPE: AN/UPX-11

FEDERAL STOCK NUMBER:

	USA	USN	USAF	USMC
STATUS OR TYPE CLASSIFICATION		Std		

Mfg(s) Name or Code Number: General Communications Company

Illustration Not Available

### FUNCTIONAL DESCRIPTION

Interrogator Set AN/UPX-11 transmits coded interrogations and is used in conjunction with a search radar for the identification of targets. An external coder may be used in place of the three internal channels to drive the modulator. The AN/UPX-11 contains provisions for monitoring the transmitted signal and measuring the SWR of the antenna circuits.

sponding subassemblies used in Radar Set AN/UPX-17.

### TECHNICAL DESCRIPTION

Frequency: Transmitter, 1010 to 1040 mc;  
receiver, 1090 to 1110 mc  
Operating Voltages and Power Requirements:  
105 to 125v, 57 to 63 cps, 1-ph;  
105 to 125v, 360 to 440 cps, 1-ph

### RELATION TO SIMILAR EQUIPMENT

The if. amplifier subassembly and modulator subassembly are interchangeable with the corre-

### INSTALLATION CONSIDERATIONS

Not available.

### PRINCIPAL COMPONENTS AND PHYSICAL DATA

COMPONENT	QTY	HEIGHT (Inches)	WIDTH (Inches)	DEPTH (Inches)	UNIT WT. (Pounds)
Receiver-Transmitter 1 RT-326/UPX- 11					

### REFERENCE DATA AND LITERATURE

Not available.

AN/UPX-11: 1

DATE: 1 July 1964

ITEM NAME: TRANSPONDER SET

COGNIZANT SERVICE: USN

TYPE: AN/UPX-12, \* -12A, \*\* -12B\*\*\*

FEDERAL STOCK NUMBER:

	USA	USN	USAF	USMC
STATUS OR TYPE CLASSIFICATION		Sub. Std		

Mfg(s) Name or Code Number: General Electric Company\*; Radio Receptor Company, Inc.\*\*

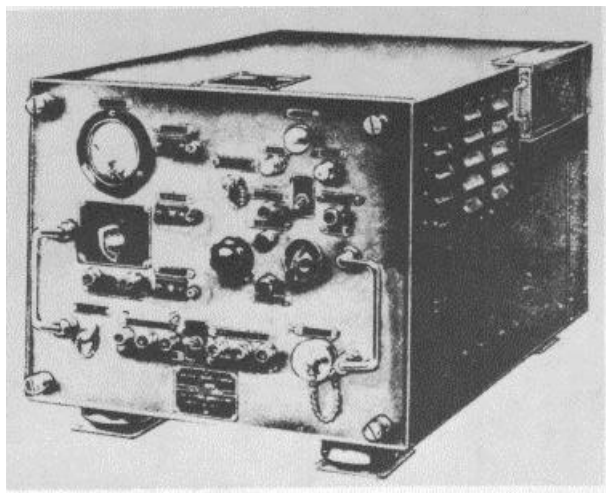

Receiver-Transmitter RT-38?()/uPI-12

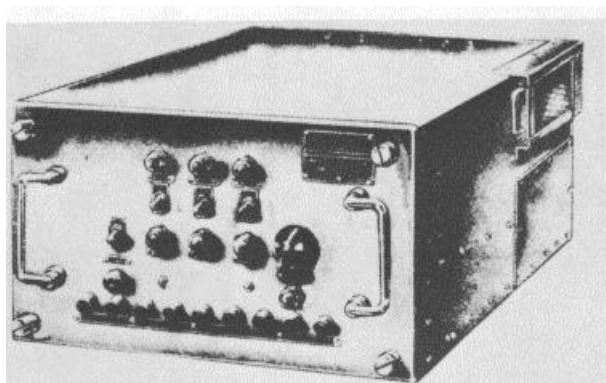

Decoder KT-200()/UPY-12

### FUNCTIONAL DESCRIPTION

Transponder Sets AN/UPX-12, -12A, and -12B respond to appropriate interrogations from Radar Recognition Sets for the purpose of self-identification. They receive paired-pulse interrogation signals and transmit single-pulse identifying replies. Interrogations are pulse-pairs in one or more of three modes as determined by the spacing of the pulses in a pair. Replies to all modes are single, one-microsecond pulses.

### RELATION TO SIMILAR EQUIPMENT

Similar to the AN/UPX-5, -5A, and -5B equipments.

### TECHNICAL DESCRIPTION

Frequency: Receiver, 1010 to 1030 mc;  
transmitter, 1090 to 1110 mc  
IF. Frequency: 59.5 +1.5 mc  
Bandwidth: 8 to 11 mc at 6 db down  
Duty Cycle: 0.1% while carrying pulses of 10-kw peak power  
Minimum Output: 300w at 500 pps  
Pulse Width: 0.9 to 1.3 -sec (50% of peak amplitude)  
Operating Voltages and Power Requirements:  
105 to 125v, 57 to 63 cps or 360 to 440 cps,  
1-ph, 398w approx

### INSTALLATION CONSIDERATIONS

Siting:  
Mounting:  
Cabling Requirements: Cables must enter the cases without sharp bends. Interconnecting cables between receiver-transmitter and decoder must not exceed 20 feet. The antenna cable must not exceed 150 feet and other cables should not exceed 300 feet in length.  
Related Equipment:



**AN/UPX-12, -12A, -12B**

**PRINCIPAL COMPONENTS AND PHYSICAL DATA**

<b>COMPONENT</b>	<b>QTY</b>	<b>HEIGHT (Inches)</b>	<b>WIDTH (Inches)</b>	<b>DEPTH (Inches)</b>	<b>UNIT WT. (Pounds)</b>
AN/UPX- 12					
Receiver-Transmitter RT-387/UPX- 12	1	15-1/2	18	28-3/8	141
Decoder KY-200/UPX-12	1	10	18	26-5/8	101
Video Coder KY-136/UPA-38	1				
Radar Set Control C-1047/UPA-38	1				
AN/UPX- 12A					
Receiver-Transmitter RT-387A/UPX- 12	1				
Decoder KY-200A/UPX-12	1				
Video Coder KY-136/UPA-38	1				
Radar Set Control C- 1047/UPA-38	1				
AN/UPX- 12B					
Receiver-Transmitter RT-387B/UPX-12	1				
Decoder KY-200B/UPX-12	1				
Video Coder KY-136/UPA-38	1				
Radar Set Control C-1047/UPA-38	1				

**REFERENCE DATA AND LITERATURE**

Technical Manual:  
NAVSHIPS 92820

DATE: 1 July 1964

ITEM NAME: TRANSPONDER SET

COGNIZANT SERVICE: USN

TYPE: AN/UPX-17

FEDERAL STOCK NUMBER:

	USA	USN	USAF	USMC
STATUS OR TYPE CLASSIFICATION		Std		

Mfg(s) Name or Code Number: General Communications Company

Illustration Not Available

**FUNCTIONAL DESCRIPTION**

The AN/UPX-17 is a general purpose transponder set. The equipment receives paired pulse challenging signals and transmits identifying reply signals for the purpose of self-identification.

Operating Voltages and Power Requirements:  
105 to 125 vac, 57 to 63 cps, 1-ph;  
105 to 125 vac, 360 to 440 cps, 1-ph  
Coded Channels: 3  
Type of Presentation: Indicator not included.  
Designed for use with remote indicator.

**RELATION TO SIMILAR EQUIPMENT**

None.

**INSTALLATION CONSIDERATIONS**

Siting:  
Mounting:  
Cabling Requirements:  
Related Equipment: The if. amplifier and modulator subassemblies used in the AN/UPX-17 are interchangeable with the if. amplifier and modulator units used in Interrogator Set AN/UPX-11.

**TECHNICAL DESCRIPTION**

Frequency: Transmitter, 1090 to 1110 mc;  
receiver, 1010 to 1040

**PRINCIPAL COMPONENTS AND PHYSICAL DATA**

COMPONENT	QTY	HEIGHT (Inches)	WIDTH (Inches)	DEPTH (Inches)	UNIT WT. (Pounds)
Transponder Part No. 53822	1				
Antenna AS-177A/UPX	2				
Radar Set Control C-1407A/UPA-38	1				

**REFERENCE DATA AND LITERATURE**

Technical Manual:  
NAVSHIPS 92642  
Specification:  
MIL-T-17963(SHIPS)

DATE: 1 July 1964

ITEM NAME: RADIO BEACON SET

COGNIZANT SERVICE: USN

TYPE: AN/WPN-1

FEDERAL STOCK NUMBER:

	USA	USN	USAF	USMC
STATUS OR TYPE CLASSIFICATION		P Std		

Mfg(s) Name or Code Number: Maryland Electronics Mfg., Co.; Amerac Mfg. Company

Illustration Not Available

**FUNCTIONAL DESCRIPTION**

Radio Beacon Set AN/WPN-1 is a shipboard beacon used to determine range and azimuth to interrogating airborne radio equipment transmitting in the 2850- to 2910-mc band. Provisions are incorporated for coincidence triggering via radio link between plane and ship. The beacon is triggered automatically and replies with from 2 to 4 pulses per interrogation at 2820 mc.

The equipment may be installed aboard surface vessels or submarines.

**RELATION TO SIMILAR EQUIPMENT**

None.

**TECHNICAL DESCRIPTION**

Frequency: 2820 mc

Peak Power Output: 1 kw

Operating Voltages and Power Requirements:  
110v, 60 cps, 1-ph

**INSTALLATION CONSIDERATIONS**

Not available.

**PRINCIPAL COMPONENTS AND PHYSICAL DATA**

COMPONENT	QTY	HEIGHT (Inches)	WIDTH (Inches)	DEPTH (Inches)	UNIT WT. (Pounds)
Receiver-Transmitter OA-1769/WPN-1	1				
Power Supply PP-1922/WPN-1	1				
Radio Beacon RT-440/WPN-1	1				
Antenna AT-244A/UPN-7	1				

**REFERENCE DATA AND LITERATURE**

Specification:  
MIL-B-21125(SHIPS)

AN/WPN-1: 1

DATE: 1 September 1964

ITEM NAME: SIGNAL DATA CONVERTER GROUP

COGNIZANT SERVICE: USN

TYPE: AN/WSA-1

FEDERAL STOCK NUMBER: 2F5840-779-0913

	USA	USN	USAF	USMC
STATUS OR TYPE CLASSIFICATION		Used by		

Mfg(s) Name or Code : Minneapolis-Honeywell Regulator Company (01534)

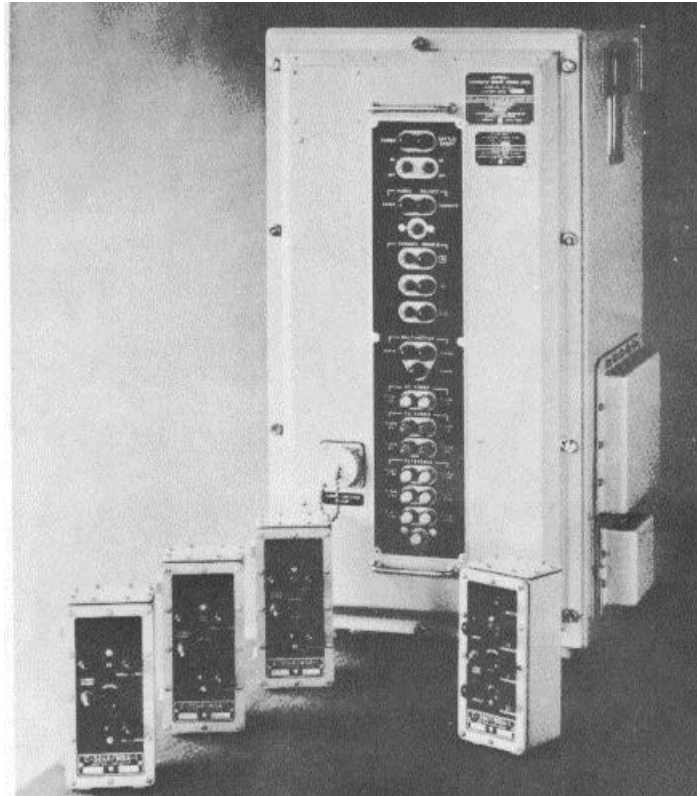

**FUNCTIONAL DESCRIPTION**

Signal Data Converter AN/WSA-1 accepts range and azimuth data in three channels from computing or

tracking devices and generates distinctive video symbols to present the computed or tracked position of the three targets superimposed upon a PPI display of search radar output.

**AN/WSA-1: 1**

**ITEM NAME:** SIGNAL DATA CONVERTER GROUP

**TYPE:** AN/WSA-1

**RELATION TO SIMILAR EQUIPMENT**

None.

(3-wire, 1-speed, 60 or 400 cps synchro v); (5) three channels of target range data (3-wire, i-speed, 60 or 400 cps synchro v)

**TECHNICAL DESCRIPTION**

Power Requirements: 103.5 to 126.5v, 57 to 63 cyc, 2 amp  
Output: Digital, symbol-forming pulses of 1.5 to 2.5v, amplitude mixed w/radar video or radar video alone  
Inputs: (1) Radar video; (2) radar trigger /20 plus or minus 5v, amplitude; 3) radar antenna azimuth (3-wire, 1-speed, 60 or 400-cps synchro v); (4) three channels of target azimuth data

Video Input Impedance: 75 ohms  
Video Output Impedance: Not rated  
Ambient Temperature Limitations  
Operating: 0 to plus 50°C (32 to 122°F)  
Non-Operating: -62 to plus 75°C (79.8 to 167°F)

**INSTALLATION CONSIDERATIONS**

Not available.

**PRINCIPAL COMPONENTS AND PHYSICAL DATA**

COMPONENTS	QTY	OVERALL DIMENSIONS (Inches)	UNIT WT. (Pounds)
Signal Data Converter Group AN/WSA-1	1		
Converter Signal Data CV-933/WSA-1	1	23 x 23-5/8 x 36-1/4	300
Control Indicator C-3247/WSA-1	1	4-3/8 x 4-1/2 x 9-1/4	6
Control Indicator C-3248/WSA-1	1	4-3/8 x 4-1/2 x 9-1/4	6

**SHIPPING DATA**

COMPONENTS	PKGS	VOLUME (CU FT)	UNIT WT. (Pounds)
	1	31.6	450

**REFERENCE DATA AND LITERATURE**

Technical Manuals:  
NAVSHIPS 94231

**AN/WSA-1:**

DATE: 1 July 1964

ITEM NAME: ANTENNA ASSEMBLY

COGNIZANT SERVICE: USN

TYPE: AS-45A/APR-6

FEDERAL STOCK NUMBER: F5985-257-3211

	USA	USN	USAF	USMC
STATUS OR TYPE CLASSIFICATION				

Mfg(s) Name or Code Number: Galvin Manufacturing Corporation, Chicago, Illinois

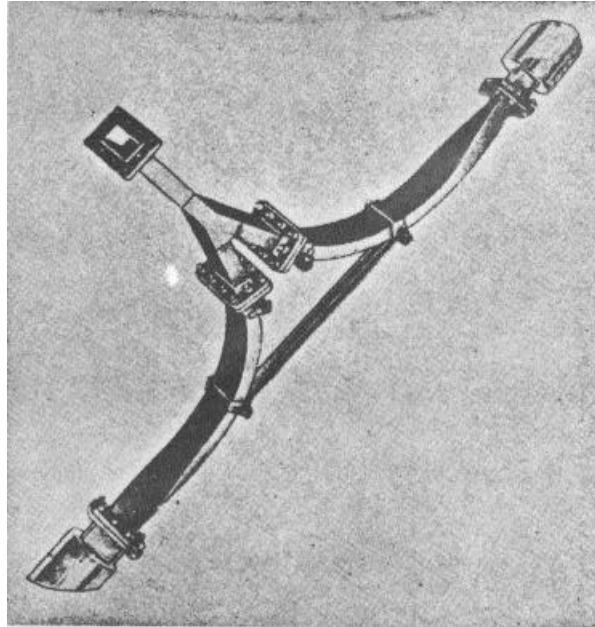

**FUNCTIONAL DESCRIPTION**

The AS-45A/APR-6 is used with Radar Receiver AN/SPR-2 which is designed for shipboard

countermeasure installations. It is a "Y" shaped antenna composed of a single section of waveguide which branches into two sections of waveguide bending over a large radius of an angle of 180 degrees from each other.

**AS-45A/APR-6: 1**

**ITEM NAME:** ANTENNA ASSEMBLY

**TYPE:** AS-45A/APR-6

**RELATION TO SIMILAR EQUIPMENT**

Polarization: horizontal or vertical.

None.

**INSTALLATION CONSIDERATIONS**

**TECHNICAL DESCRIPTION**

Not available.

Frequency Range: 3000 to 6000 mc

**PRINCIPAL COMPONENTS AND PHYSICAL DATA**

<b>COMPONENTS</b>	<b>QTY</b>	<b>OVERALL DIMENSIONS (Inches)</b>	<b>UNIT WT. (Pounds)</b>
Antenna Assembly AS-45A/APR-6	1	6-1/4 x 35-3/4 x 70-3/8	55-1/2

**REFERENCE DATA AND LITERATURE**

Technical Manuals:  
NAVSHIPS 900121(A): for Shipboard Antenna Details  
Chapter 5, Antenna Data Sheets.

**AS-45A/APR-6: 2**

DATE: 1 July 1964

ITEM NAME: ANTENNA ASSEMBLY

COGNIZANT SERVICE: USN

TYPE: AS-177/UPX, \*AS-177A/UPX

FEDERAL STOCK NUMBER: F5985-296-1978  
\*F5985-510-0013

	USA	USN	USAF	USMC
STATUS OR TYPE CLASSIFICATION				

Mfg(s) Name or Code Number: See Note 1

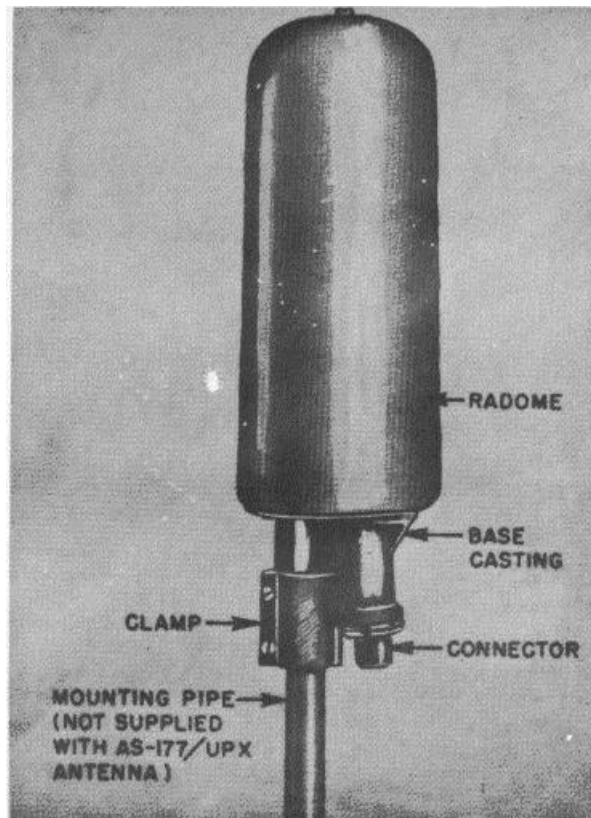

FUNCTIONAL DESCRIPTION

The AS-177/UPX and AS-177A/UPX are omni-directional shipboard radar antenna, although they may be used with other types of equipment.

AS-177/UPX: 1



**ITEM NAME:** ANTENNA ASSEMBLY

**TYPE:** AS-177/UPX, AS-177A/UPX

**RELATION TO SIMILAR EQUIPMENT**

None.

Feed: 52 ohms coaxial transmission line.  
Polarization: Vertical  
Beamwidth: 47-1/2° plus or minus 12-1/2°  
at 3 db down from max.  
Gain: 2.5 db

**TECHNICAL DESCRIPTION**

Frequency Range: 1010 to 1110 mc  
RF Power Input: Must not exceed 10 kw  
peak at 0.1% duty cycle.  
Windloading: Center of radome.

**INSTALLATION CONSIDERATIONS**

Not available.

**PRINCIPAL COMPONENTS AND PHYSICAL DATA  
SHIPPING DATA**

COMPONENTS	BOXES (NR.) AS-177 /UPX A/UPX	OVERALL DIMENSIONS (Inches)	UNIT WT. (Pounds)
Antenna Assembly AS-177/UPX	1	12 x 13-1/2 x 28-7/8	38
Antenna Assembly AS-177A/UPX	1	9 x 9 x 21	12

**EQUIPMENT SUPPLIED DATA**

COMPONENTS	QTY AS-177 /UPX A/UPX		
Antenna Assembly AS-177/UPX	1	5-15/16 x 8-9/16 x 21	8
Antenna Assembly AS-177A/UPX	1	6-1/2 x 6-1/2 x 20-1/8	7

**REFERENCE DATA AND LITERATURE**

Technical Manuals:

NAVSHIPS 91597: for Antenna Assembly AS-177/UPX  
NAVSHIPS 92642: for Antenna Assembly AS-177A/UPX

NOTE 1: (AS-177/UPX) General Electric Company, Syracuse, New York  
(AS-177A/UPX) I-T-E Circuit Breaker Company, Philadelphia, Pa.

**AS/177/UPX: 2**

DATE: 1 July 1964

ITEM NAME: ANTENNA ASSEMBLY

COGNIZANT SERVICE: USN

TYPE: AS-177(XN-21)/UPX

FEDERAL STOCK NUMBER:

	USA	USN	USAF	USMC
STATUS OR TYPE CLASSIFICATION				

Mfg(s) Name or Code Number: Hazeltine Electronics Corporation, New York, N. Y.

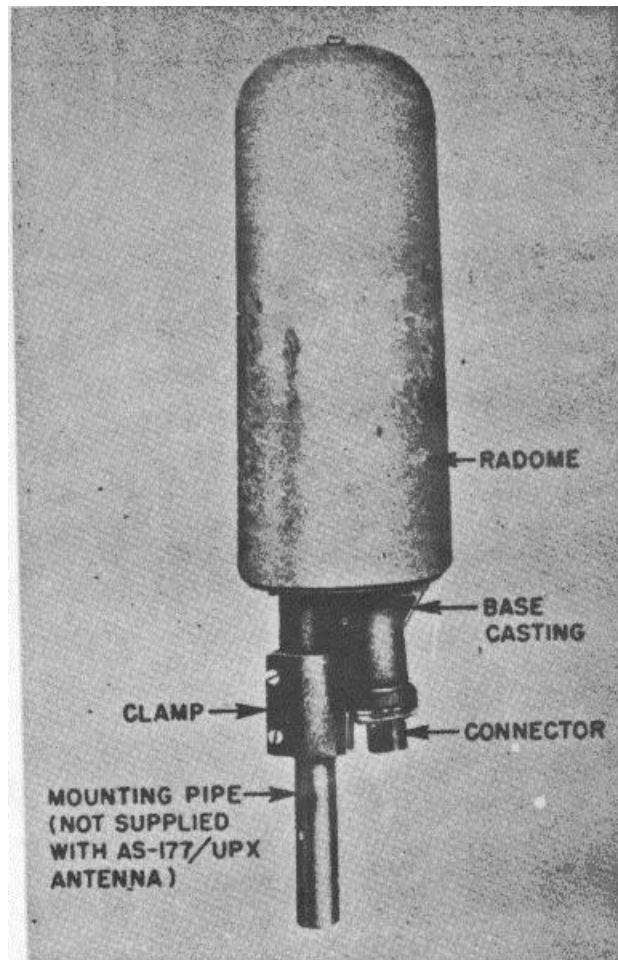

**FUNCTIONAL DESCRIPTION**

The AS-177(XN-21)/UPX is an omni-directional antenna for shipboard and land-base installations,

designed to permit operation over the Mark 5 IFF frequency band. An "Sband" filter is included as an integral part of the antenna.

**AN-177(XN-21)/UPX: 1**

**ITEM NAME:** ANTENNA ASSEMBLY

**TYPE:** AS-177(XN-21)/UPX

**RELATION TO SIMILAR EQUIPMENT**

None.

Gain: 2.5 db plus or minus 0.5 over a half-wave dipole.

**TECHNICAL DESCRIPTION**

Feed: Coaxial transmission line.  
Polarization: Vertical.  
Beamwidth: 47-1/2° plus or minus 12-1/2° at 3 db down from max.

**INSTALLATION CONSIDERATIONS**

Related Equipment: AS-177(XN-21)/UPX is primarily intended for use with the AN/SPX-1 and AN/SPX-2 radio equipments although it may also be used with other equipments.

**PRINCIPAL COMPONENTS AND PHYSICAL DATA  
SHIPPING DATA**

<b>COMPONENTS</b>	<b>BOXES (NR.)</b>	<b>OVERALL DIMENSIONS (Inches)</b>	<b>UNIT WT. (Pounds)</b>
Antenna Assembly AS-177(XN-21)/UPX	1	8 x 15-1/4 x 26-3/8	20

**EQUIPMENT SUPPLIED DATA**

<b>COMPONENTS</b>	<b>QTY</b>	<b>OVERALL DIMENSIONS (Inches)</b>	<b>UNIT WT. (Pounds)</b>
Antenna Assembly AS-177(XN-21)/UPX	1	6 x 8-5/8 x 19-1/2	8

**REFERENCE DATA AND LITERATURE**

Technical Manuals:  
NAVSHIPS 900, 954

**4S-177(XN-21)/UPX: 2**

DATE: 1 July 1964

ITEM NAME: ANTENNA

COGNIZANT SERVICE: USN

TYPE: AS-501/SPN

FEDERAL STOCK NUMBER:

	USA	USN	USAF	USMC
STATUS OR TYPE CLASSIFICATION				

Mfg(s) Number or Code Number: Andrew Alford, consulting Engineers, Boston, Massachusetts

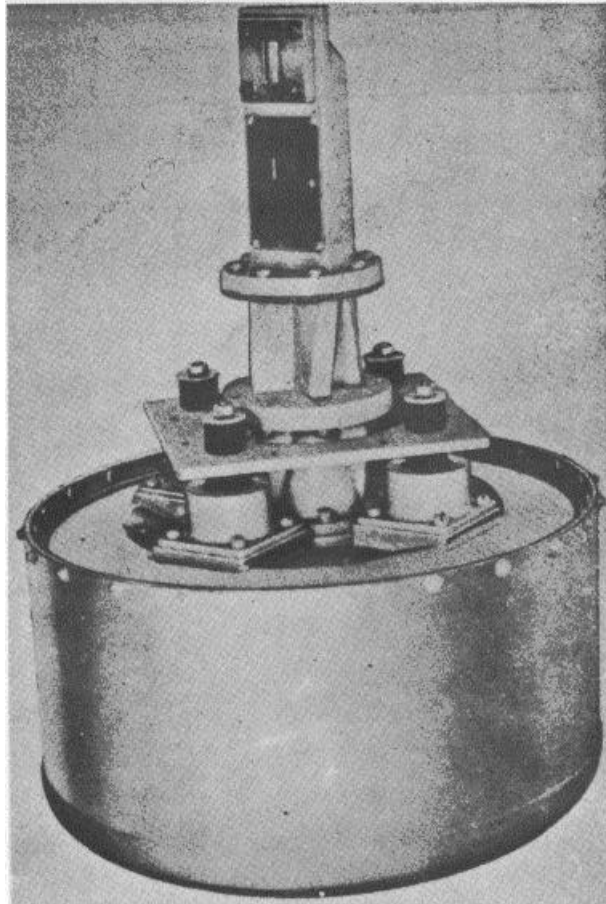

**FUNCTIONAL DESCRIPTION**

The AS-501/SPN is for use with Radar Beacon AN/UPN-11. It is designed to provide omni-directional transmission or reception of horizontal polarized

radiation within the frequency range from 7250 to 10,750 mc. When used with Radar Beacon AN/UPN-11 Antenna AS-501/SPN operates over the frequency range from 0900 to 9400 mc. Two antennas are used in this case; one is for transmitting, the other for receiving.

**AS-501/SPN: 1**

**ITEM NAME:** ANTENNA

**TYPE:** AS-501/SPN

**RELATION TO SIMILAR EQUIPMENT**

None.

Input Impedance: swr of 1.4: 1 with respect to RG-52/U waveguide.

**INSTALLATION CONSIDERATIONS**

Related Equipment:  
Required but not Supplied.  
(1) Radar Beacon AN/UPN-11.

**TECHNICAL DESCRIPTION**

Frequency: 7250 to 10, 750 mc  
Power Input: 1 kw cw, 40 kw peak.

**PRINCIPAL COMPONENTS AND PHYSICAL DATA**

**SHIPPING DATA**

<b>COMPONENTS</b>	<b>BOXES (NR.)</b>	<b>OVERALL DIMENSIONS (Inches)</b>	<b>UNIT WT. (Pounds)</b>
Antenna AS-501/SPN	2	12-1/2 x 19 x 26	61

**EQUIPMENT SUPPLIED DATA**

<b>COMPONENTS</b>	<b>QTY</b>	<b>OVERALL DIMENSIONS (Inches)</b>	<b>UNIT WT. (Pounds)</b>
Antenna AS-501/SPN	1	13-5/8 x 13-5/8 x 19-7/8	17
Flexible Waveguide	1	1-5/8 x 1-5/8 x 24-1/4	1

**REFERENCE DATA AND LITERATURE**

Technical Manuals:  
NAVSHIPS 91950: for Antenna AS-501/SPN(XN-1) &  
Antenna AS-501/SPN.

**AS-501/SPN: 2**

**DATE:** 1 July 1964

**ITEM NAME:** ANTENNA ASSEMBLY

**COGNIZANT SERVICE:** USN

**TYPE:** AS-523B/BPX

**FEDERAL STOCK NUMBER:** F5985-688-B993

	USA	USN	USAF	USMC
STATUS OR TYPE CLASSIFICATION				

Mfg(s) Name or Code Number: Lieco Inc., Freeport, Long Island, N. Y.

Illustration not Available.

**FUNCTIONAL DESCRIPTION**

Antenna Assembly AS-523B/BPX is an omni-directional antenna designed for IFF and UHF purposes. It is designed to be mounted primarily on submarines.

**AS-523B/BPX: 1**

**ITEM NAME:** ANTENNA ASSEMBLY

**TYPE:** AS-523B/BPX

**RELATION TO SIMILAR EQUIPMENT**

Output Impedance: 50 ohms

This equipment is electrically and mechanically interchangeable with Antenna As-523A/BPX and AS-523/BPX, except that the AS-523B/BPX is more pressure-proof.

**INSTALLATION CONSIDERATIONS**

Not available.

**TECHNICAL DESCRIPTION**

Frequency Range: 225 to 390 mc; 960 to 1050 mc

**PRINCIPAL COMPONENTS AND PHYSICAL DATA**

<b>COMPONENTS</b>	<b>QTY</b>	<b>OVERALL DIMENSIONS (Inches)</b>	<b>UNIT WT. (Pounds)</b>
Antenna Assembly AS-523B/BPX consists of:	1	7-3/4 dia x 33	
Antenna AS-522C/BPX	1		
Antenna AS-46BA/B	1		
Antenna Base AB-234A/B	1		

**REFERENCE DATA AND LITERATURE**

Technical Manuals:  
NAVSHIPS 93400: Preliminary Data Sheet.

**AS-523B/BPX: 2**

DATE: 1 September 1964

ITEM NAME: ANTENNA

COGNIZANT SERVICE: USN

TYPE: AS-1161/SPS

FEDERAL STOCK NUMBER:

	USA	USN	USAF	USMC
STATUS OR TYPE CLASSIFICATION		Used by		

Mfg(s) Name or Code Number: Raytheon Manufacturing Company (10011)

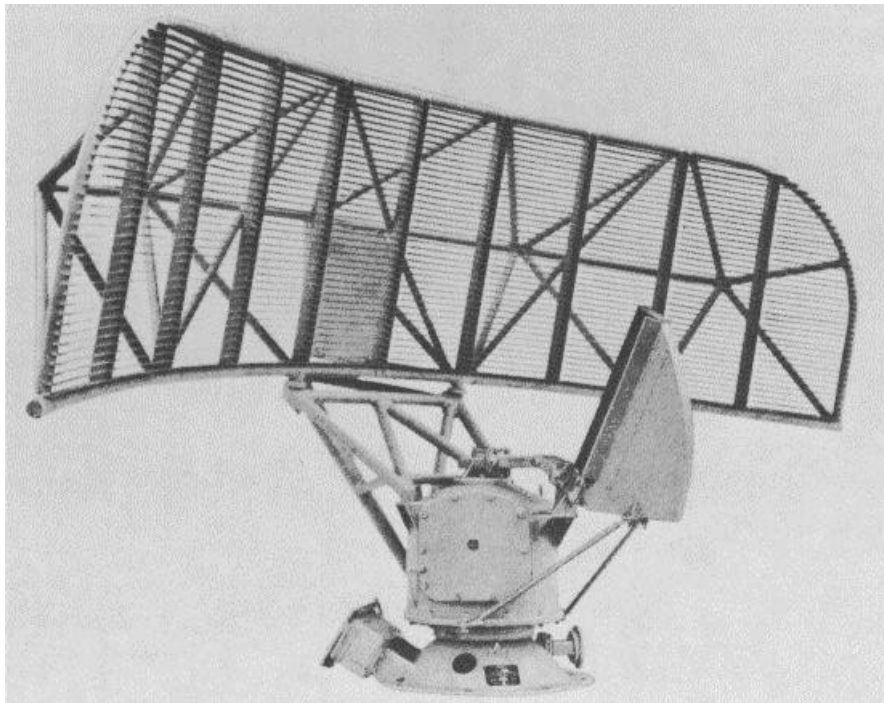

**FUNCTIONAL DESCRIPTION**

Antenna AS-1161/SPS includes a truncated parabolic reflector, feed horn waveguide steptwist, rotary joint, and an antenna drive mechanism. The drive mechanism is comprised of a 1/5 hp drive motor and a gear train that rotate the radiation elements of the

antenna at 17 rpm. Also included with the drive mechanism is a one-speed synchro transmitter and two cam-actuated micro-switches that operate the ship's heading marker circuit. The antenna is designed for mast mounting, and provides simultaneous surface and limited air search.

**AS-1161/SPS: 1**



**ITEM NAME:** ANTENNA

**TYPE:** AS-1161/SPS

**RELATION TO SIMILAR EQUIPMENT**

Antenna AS-1161/SPS is part of Radar Set AN/SPS-10E.

High Angle Coverage: Approx  $\csc^2$  plus 7 to 22°  
Polarization: Horiz  
Antenna Rotation Speed: 17 rpm  
Relative Bearing Data: 1 speed  
Power Source Data: 115v, 60 cyc

**TECHNICAL DESCRIPTION**

Frequency of Operation: 5450 to 5825 mc  
Antenna Gain: 30.0 db  
Antenna Horizontal Beamwidth: 1.90  
Antenna Vertical Beamwidth: 16°

**INSTALLATION CONSIDERATION**

Related Equipment  
Required but not Supplied: (1) Instruction Book for AN/SPS-10 NAVSHIPS 91921(A).

**PRINCIPAL COMPONENTS AND PHYSICAL DATA**

COMPONENTS	QTY	OVERALL DIMENSIONS (Inches)	UNIT WT. (Pounds)
Antenna AS-1161/SPS includes:	1	52-1/2 x 101	110
Switch Box SA-793/S	1	5-3/16 x 5-13/16 x 13-1/4	2

**SHIPPING DATA**

COMPONENTS	PKGS	VOLUME (CU FT)	UNIT WT. (Pounds)
	1	20.4	105
	1	113.5	100

**REFERENCE DATA AND LITERATURE**

Technical Manuals:  
NAVSHIPS 94120: for Radar Set AN/SPS-10E.

DATE: 1 September 1964

ITEM NAME: ANTENNA ASSEMBLY

COGNIZANT SERVICE: USN

TYPE: AS-1201/BPX

FEDERAL STOCK NUMBER: 2F5985-856-4270

	USA	USN	USAF	USMC
STATUS OR TYPE CLASSIFICATION		Used by		

Mfg(s) Name or Code Number: Granite State Machine Co., Inc. (82005)

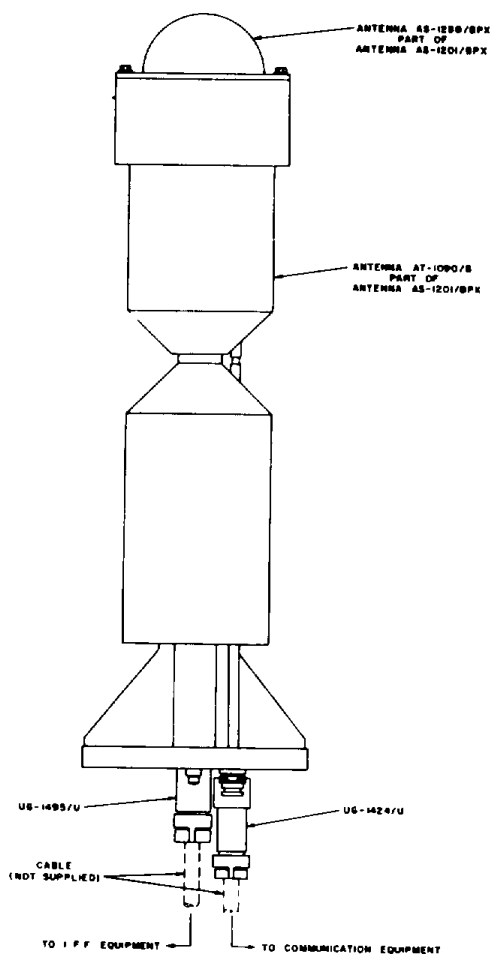

### FUNCTIONAL DESCRIPTION

Antenna Assembly AS-1201/BPX is composed of uhf communications Antenna AT-1090/B and IFF Antenna AS-1288/BPX mounted together, with dome-enclosed

AS-1288/BPX mounted on top. Each antenna component operates independently of the other, and each has its own cabling. If desired each antenna can be installed and operated as a separate equipment.

AS-1201/BPX: 1

**ITEM NAME:** ANTENNA ASSEMBLY

**TYPE:** AS-1201/BPX

**RELATION TO SIMILAR EQUIPMENT**

None.

Radiation Pattern: Circular  
Polarization: Vert  
Mounting: Mast, usually on submarine mast

**TECHNICAL DESCRIPTION**

Frequency Range: 225 to 390 mc and 960 to 1050 mc  
Output Data: RF signals, modulated or unmodulated  
Nominal Impedance: 50 ohms

**INSTALLATION CONSIDERATION**

Related Equipment  
Required but not Supplied: (1) Communication Equipment; (1) IFF Equipment.

**PRINCIPAL COMPONENTS AND PHYSICAL DATA**

COMPONENTS	QTY	OVERALL DIMENSIONS (Inches)	UNIT WT. (Pounds)
Antenna Assy AS-1201/BPX includes:	1	7-3/4 x 7-3/4 x 29-11/16	55
Antenna AS-1288/BPX	1	2-1/16 x 6 x 6	15
Antenna AT-1090/B	1	7-3/4 x 7-3/4 x 27-9/16	40
Connector, Receptacle, Electrical UG-1495/U	1		
Connector, Plug, Electrical UG-1424/U			
Technical Manual NAVSHIPS 9475U	2	1/4 x 8-1/2 x 11	

**SHIPPING DATA**

COMPONENTS	PKGS	VOLUME (CU FT)	UNIT WT. (Pounds)
	1	17.5	65

**REFERENCE DATA AND LITERATURE**

Technical Manuals:  
NAVSHIPS 9175B: For Antenna Assembly AS-1201/BPX, Antenna AS-1288/BPX, and Antenna AT-1090/B.

**AS-1201/BPX: 2**

DATE: 1 September 1964

ITEM NAME: ANTENNA

COGNIZANT SERVICE: USN

TYPE: AS-1288/BPX

FEDERAL STOCK NUMBER: 2F59B5-064-1427

	USA	USN	USAF	USMC
STATUS OR TYPE CLASSIFICATION		Used by		
Mfg(s) Name or Code Number: Granite State Machine Co., Inc. (82005)				

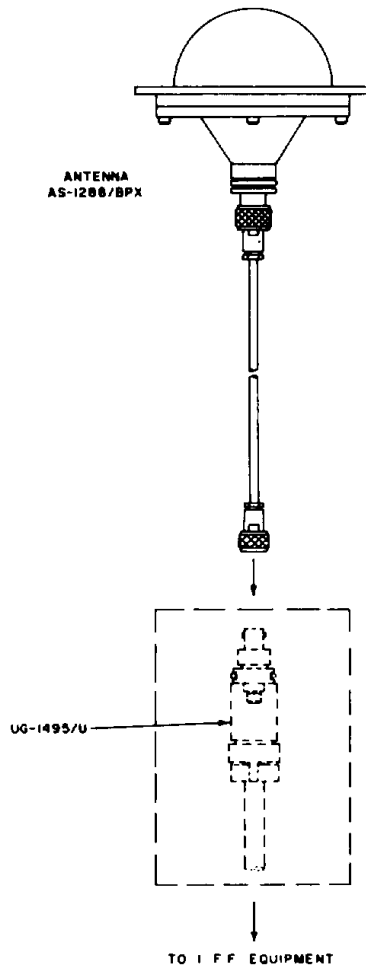

**FUNCTIONAL DESCRIPTION**

Antenna AS 1288/BPX is a vertically polarized, 3rmiidirectional recessed cone, designed to operate as

both a receiving and transmitting antenna in the frequency range of 960 to 1050 mc, and functioning a part of an IFF set

**AS-1288/BPX: 1**

**ITEM NAME:** ANTENNA

**TYPE:** AS-1288/BPX

**RELATION TO SIMILAR EQUIPMENT**

None.

in polyethelene dome brass holder  
Enclosure: Pressure-proof when installed  
with AT-1090/B and appropriate connec-  
tors.

Mounting: Atop Antenna AT-1090/B on sub-  
marine mast.

**TECHNICAL DESCRIPTION**

Frequency Range: 960 to 1050 mc  
Output Data: RF signals, modulated or  
unmodulated  
Nominal Impedance: 50 ohms  
Voltage Standing Wave Ratio : 2:1 max  
Radiation Pattern: Circular  
Polarization: Vert  
Construction: Aluminum cone impregnated

**INSTALLATION CONSIDERATION**

Related Equipment  
Required but not Supplied: (1) IFF  
Equipment.

**PRINCIPAL COMPONENTS AND PHYSICAL DATA**

<b>COMPONENTS</b>	<b>QTY</b>	<b>OVERALL DIMENSIONS (Inches)</b>	<b>UNIT WT. (Pounds)</b>
Antenna AS-12b/BPX includes:	1	2-1/16 x 6 x 6	15
Technical Manual NAVSHIPS 94756	2	1/4 x 8-1/2 x 11	

**REFERENCE DATA AND LITERATURE**

Technical Manuals:  
NAVSHIPS 94756: for Antenna Assy AS-1201/BPX, Antenna AS-1288/BPX  
and Antenna AT-1090/B.

**AS-1288/BPX: 2**

DATE: 1 September 1964

ITEM NAME: ANTENNA

COGNIZANT SERVICE: USN

TYPE: AT-1090/B

FEDERAL STOCK NUMBER: 2F5985-856-4269

	USA	USN	USAF	USMC
STATUS OF TYPE CLASSIFICATION		Used by		
Mfg(s) Name or Code Number: Granite State Machine Co., Inc. (82005)				

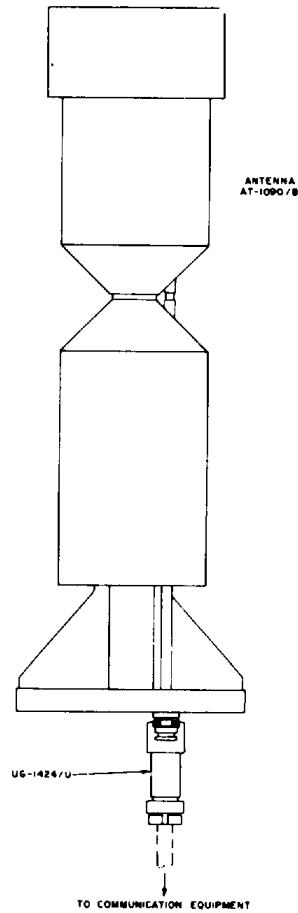

**FUNCTIONAL DESCRIPTION**

Antenna AT-1090/B is a vertically polarized, omnidirectional coaxial dipole, designed to operate as a transmitting and receiving antenna in the uhf communications frequency range of 225 to 390 mc.

**AT-1090/B: 1**

**ITEM NAME:** ANTENNA

**TYPE:** AT-1090/B

**RELATION TO SIMILAR EQUIPMENT**

None.

Construction: Brass tubing, with stainless steel mast and flange  
Enclosure: Pressure-proof when installed with appropriate connector  
Mounting: Mast, usually on submarine mast

**TECHNICAL DESCRIPTION**

Frequency Range: 225 to 390 mc  
Output Data: RF signals, modulated or unmodulated  
Nominal Impedance: 50 ohms  
Radiation Pattern: Circular  
Polarization: Vert

**INSTALLATION CONSIDERATION**

Related Equipment  
Equipment Required but not Supplied:  
(1) Communications Equipment.

**PRINCIPAL COMPONENTS AND PHYSICAL DATA**

<b>COMPONENTS</b>	<b>QTY</b>	<b>OVERALL DIMENSIONS (Inches)</b>	<b>UNIT WT. (Pounds)</b>
Antenna AT-1090/B includes:	1	7-3/4 x 7-3/4 x 27-9/16	40
Connector, Plug, Electrical UG-1424/U	1		
Technical Manual NAVSHIPS 94758	2	1/4 x 8-1/2 x 11	

**SHIPPING DATA**

<b>COMPONENTS</b>	<b>PKGS</b>	<b>VOLUME (CU FT)</b>	<b>UNIT WT. (Pounds)</b>
	1	15.9	50

**REFERENCE DATA AND LITERATURE**

Technical Manuals:  
NAVSHIPS 9475d: for Antenna Assy AS-1201/BPX, Antenna AS-1288/BPX and Antenna AT-1090/B.

DATE: 1 July 1964

ITEM NAME: RADIO EQUIPMENT

COGNIZANT SERVICE: USN

TYPE: BL-1 thru BL-6

FEDERAL STOCK NUMBER:

	USA	USN	USAF	USMC
STATUS OR TYPE CLASSIFICATION				

Mfg(s) Name or Code Number: Hazeltine Electronics Corporation, New York, N. Y.

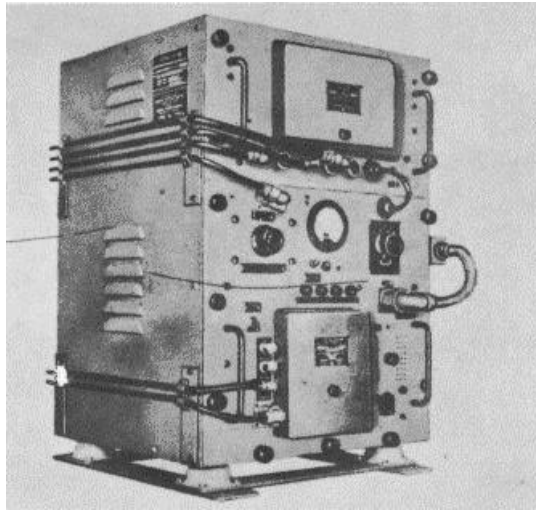

*Radio Equipment Model BL-3*

**FUNCTIONAL DESCRIPTION**

The Navy Models BL-1 thru BL-6 are shipboard and shore-based interrogator-responser components designed for use with radars equipped to receive IFF

pulses. They interrogate Radar Equipment AN/APX-1 and Radio Sets AN/APX-2, SCR-595, and SCR-695 from which a coded reply is received and displayed on a radar A-scope.

**BL-1: 1**



**ITEM NAME:** RADIO EQUIPMENT

**TYPE:** BL-1 thru BL-6

**RELATION TO SIMILAR EQUIPMENT**

The Models BL-1 thru BL-6 are basically similar, differing mainly in the components used.

The Models BL-1 thru -6 are similar to the Model BL, but the Model BL has a slightly higher frequency range.

**TECHNICAL DESCRIPTION**

Frequency Range: 157 to 187 mc

Peak Power Output: 1.5 kw

Emission: Pulse

Pulse Data

Repetition Rate: 25 to 500 pps

Length

BL-1 thru -5: 10 usec

BL-6: 6.7 usec

Receiver Data

Type: Superheterodyne

Reception: Pulse

Pulse Length: 5 to 100 usec

IF. : 11 mc

Band-Pass: 4 mc

Power Requirements: 100 to 230v, 50 to 60 cps, 1-ph, 350w

Antenna Data

Type

NT-66ACF: Stovepipe, vertical array of two half-wave radiators.

NT-66ACG, NT-66AFJ: Rod with wheel type ground plane.

Impedance: 50 ohms

Radiation: Nondirectional

Polarization: Vertical

**INSTALLATION CONSIDERATIONS**

Related Equipment: BL-1 thru BL-6 are used with associated series Radar Equipments Navy Model SA, SC, SK, SP, SM and CXAM.

**PRINCIPAL COMPONENTS AND PHYSICAL DATA**

**SHIPPING DATA**

<b>COMPONENTS</b>	<b>BOXES (NR.)</b>	<b>OVERALL DIMENSIONS (Inches)</b>	<b>UNIT WT. (Pounds)</b>
Radar Transmitter including: Receiver	1	25 x 26 x 34-1/2	342
Impedance Matching Unit	1	2-1/4 x 2-1/2 x 30-1/2	4
Duplexing Unit	1	3-1/2 x 8-1/2 x 48	21
Antenna NT-66ACF	1	16-1/2 x 16-1/2 x 77-1/2	106
Antenna NT-66ACG	1	4-3/4 x 21-1/2 x 24	8
Antenna NT-66AFJ	1	8-3/4 x 21-3/4 x 21-3/4	12
Set of Equipment Spares	1	11 x 18 x 23	80

**EQUIPMENT SUPPLIED DATA**

<b>COMPONENTS</b>	<b>QTY</b>	<b>OVERALL DIMENSIONS (Inches)</b>	<b>UNIT WT. (Pounds)</b>
BL-1			
Radar Transmitter NT-52ABC	1	17-3/4 x 19 x 19-1/2	117
Receiver NT-46AAZ	1	9-7/8 x 15 x 19-1/2	59
Impedance Matching Unit NT-62ABA	1	1-1/2 x 5-3/4 x 18-3/4	2.4
Duplexing Unit NT-50ABS or NT-50ABS-1	1	3 x 8 x 47-1/2	20
Antenna NT-66ACF or NT-66ACG or	i	12 x 12 x 12	52
NT-66AF3		19 x 19 x 20-3/8	5
		19 x 20 x 20	8
Ventilating Panel NT-10185	1	4-1/4 x 19-1/4 x 27-1/4	

ITEM NAME: RADIO EQUIPMENT

TYPE: BL-1 thru BL-6

PRINCIPAL COMPONENTS AND PHYSICAL DATA  
EQUIPMENT SUPPLIED DATA (Cent.)

COMPONENTS	QTY	OVERALL DIMENSIONS (Inches)	UNIT WT. (Pounds)
Set of Accessories	1		
Set of Equipment Spares	1	9 x 15 x 18	53
BL-2			
Radar Transmitter NT-52ABF	1	17-3/4 x 19 x 19-1/2	117
Receiver NT-46ABE	1	9-7/8 x 15 x 19-1/2	59
Impedance Matching Unit NT-62ABA	1	1-1/2 x 5-3/4 x 1B-3/4	2.4
Duplexing Unit NT-50ABS or NT-50ABS-1	1	3 x 8 x 47-1/2	20
Antenna NT-66ACF or NT-66ACG or NT-66AFJ	1	12 x 12 x 12 19 x 19 x 20-3/8 19 x 20 x 20	52 5 8
Ventilating Panel NT-10185	1	4-1/2 x 19-1/4 x 27-1/4	
Set of Accessories	1		
Set of Equipment Spares	1	9 x 15 x 18	53
BL-3			
Radar Transmitter NT-52ABF	1	17-3/4 x 19 x 19-1/2	117
Receiver NT-46ABF	1	9-7/8 x 15 x 19-1/2	59
Impedance Matching Unit NT-62ABA	1	1-1/2 x 5-3/4 x 18-3/4	2.4
Duplexing Unit NT-50ABS or NT-50ABS-1	1	3 x 8 x 47-1/2	20
Antenna NT-66ACF or NT-66ACG or NT-66AFJ	1	12 x 12 x 72 19 x 19 x 20-3/8 19 x 20 x 20	52 5 8
Ventilating Panel NT-10185	1	4-1/2 x 19-1/4 x 27-1/4	
Set of Accessories	1		
Set of Equipment Spares	1	9-1/2 x 13 x 19-1/4 60	
BL-4			
Radar Transmitter NT-52ABP or NT-52ABQ	1	20-21/64 x 20-5/8 x 29-21/32	117
Receiver NT-46ABZ	1	9-7/8 x 15 x 19-1/2	59
Duplexing Unit NT-50ABS or NT-50ABS-1	1	3 x 8 x 47-1/2	20
Antenna NT-66ACF or NT-66ACG or NT-66AFJ	1	12 x 12 x 72 19 x 19 x 20-3/8 19 x 20 x 20	52 5 8
Set of Accessories	1		
Set of Equipment Spares	1	9-1/2 x 13 x 19-1/4	60

**ITEM NAME: RADIO EQUIPMENT**

**TYPE: BL-1 thru BL-6**

**PRINCIPAL COMPONENTS AND PHYSICAL DATA  
EQUIPMENT SUPPLIED DATA (Cont.)**

<b>COMPONENTS</b>	<b>QTY</b>	<b>OVERALL DIMENSIONS (Inches)</b>	<b>UNIT WT. (Pounds)</b>
<b>BL-5</b>			
Radar Transmitter NT-52ABQ	1	20-21/64 x 20-5/8 x 29-21/32	117
Receiver NT-46ACH	1	9-7/8 x 15 x 19-1/2	59
Duplexing Unit NT-50ABS or NT-50ABS-1	1	3 x 8 x 47-1/2	20
Antenna NT-66ACF or NT-66ACG or NT-66AFJ	1	12 x 12 x 72 19 x 19 x 20-3/8 19 x 20 x 20	52 5 8
Set of Accessories	1		
Set of Equipment Spares	1	9-1/2 x 13 x 19-1/4 60	
<b>BL-6</b>			
Radar Transmitter NT-52ABR	1	17-3/4 x 19 x 19-1/2	117
Receiver NT-46ACF	1	9-7/8 x 15 x 19-1/2	59
Duplexing Unit NT-50ABS or NT-50ABS-1	1	3 x 8 x 47-1/2	20
Antenna NT-66ACF or NT-66ACG or NT-66AFJ	1	12 x 12 x 72 19 x 19 x 20-3/8 19 x 20 x 20	52 5 8
Set of Accessories	1		
Set of Equipment Spares	1	9 x 15 x 18	53

**REFERENCE DATA AND LITERATURE**

Technical Manuals:

- SHIPS 273: for Navy Model BL-1 and BL-2 Radio Equipments.
- ENG 176: for Navy Model BL-3 Radio Equipment.
- ENG 234: for Navy Model BL-4 Radio Equipment.
- ENG 229: for Navy Model BL-5 Radio Equipment.
- ENG 230A: for Navy Model BL-6 Radio Equipment.

DATE: 1 July 1964

ITEM NAME: INTERROGATOR RESPONSOR

COGNIZANT SERVICE: USN

TYPE: \*BN, BN-1, BN-2

FEDERAL STOCK NUMBER: \*5895-665-3591  
\*5895-644-3384 W/S

	USA	USN	USAF	USMC
STATUS OR TYPE CLASSIFICATION				

Mfg(s) Name or Code Number: Farnsworth Television and Radio Corp., Fort Wayne, Indiana

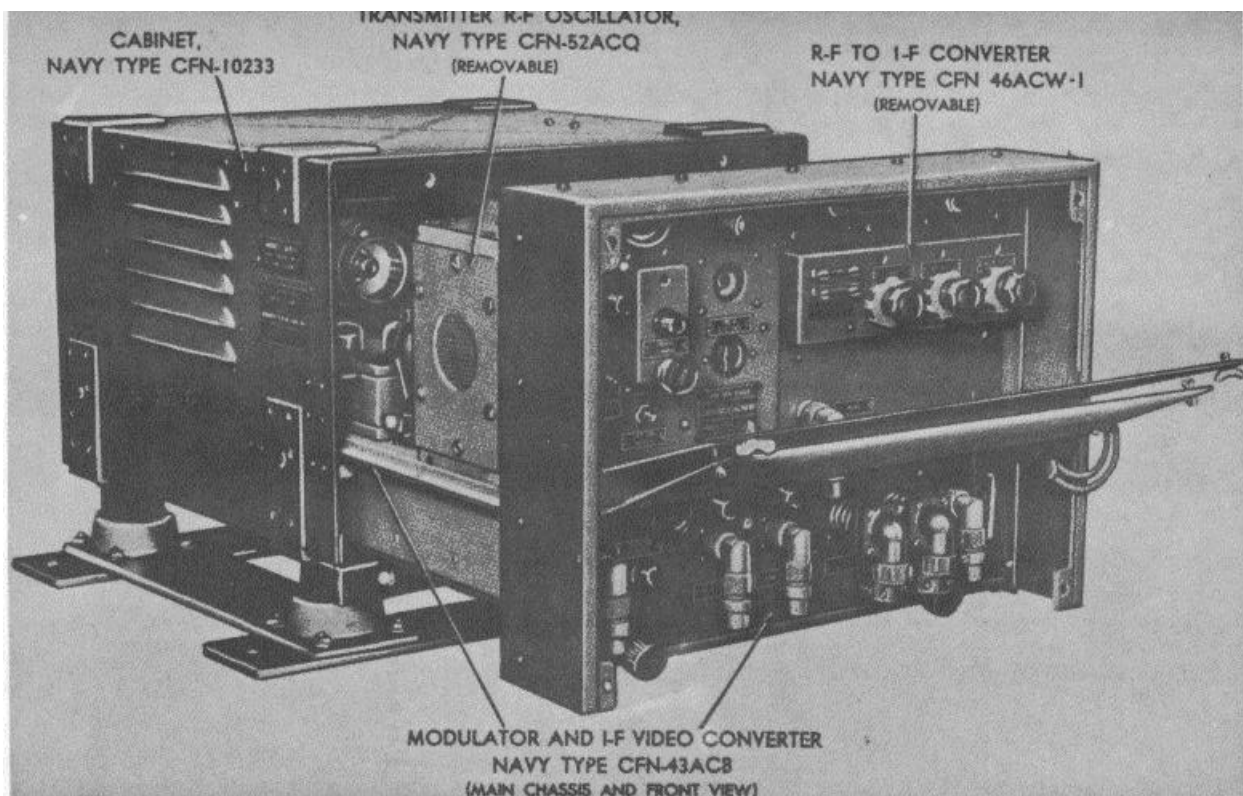

### FUNCTIONAL DESCRIPTION

The BN, BN-i and BN-2 IFF Interrogator Respondors are challenging and identifying units of the Mark III IFF System. Operation involves a signal emitted from the interrogator-responzor which serves to trigger a

transponder in a challenged craft, and in turn receives an appropriately coded reply from the transponder. The equipment then properly forms the reply for display on the associated radar indicator, thus establishing the craft's friendly identity. The BN is designed for operation

BN: 1

**ITEM NAME:** INTERROGATOR RESPONSOR

**TYPE:** BN, BN-1, BN-2

with all surface detection radars, with radar equipments SD, SP-1M and SK-1M and with fire control radars Mark 4 and Mark II.

**RELATION SIMILAR EQUIPMENT**

The BN-1 is similar to the BN except that it employs an improved high-gain receiver and an antenna mast and carrying case. The BN-2 is similar electrically to the BN and BN-1, however, it is a ground transportable equipment for use in the field.

**TECHNICAL DESCRIPTION**

Transmitter  
Frequency Range: 157 to 187 mc  
Power Output  
BN, BN-1: 1.0 kw  
BN-2: 500w  
Pulse Rate: 0 to 550 pps

Pulse Width: 5.0 to 9.0 usec  
Receiver  
Type: Superheterodyne  
IF: 2B to 32 mc  
Band-Pass: 4 mc IF.  
Signal to Noise Ratio: 3 to 1  
Sensitivity  
BN, BN-2: 96 to 100 db below 1.0v  
BN-1: Greater than 100 db below 1.0  
Power Source Required: 115v, 50 to 425  
cps, 225w  
Antenna  
BN: Inverted T-type  
BN-2: Vertical rod type

**INSTALLATION CONSIDERATIONS**

Not available.

**PRINCIPAL COMPONENTS AND PHYSICAL DATA**

**SHIPPING DATA**

COMPONENT	BOXES (NR)	OVERALL DIMENSIONS (Inches)	UNIT WT. (Pounds)
IFF Interrogator-Responsor BN-1 including:	1		
Equipment spare parts and duplexer		20-1/8 x 26-1/2 x 42	304
Accessories for BN-1	3	45-3/4 x 62-3/16 x 82-1/2	435

**NOTE:** Shipping data not available for BN and BN-2.

**EQUIPMENT SUPPLIED DATA**

COMPONENTS	QTY	OVERALL DIMENSIONS (Inches)	UNIT WT. (Pounds)
Cabinet CFN-10233* containing: Transmitter RF Oscillator CFN-52ACQ RF to IF Converter CFN-46ACW-1 Modulator and IF to Video Converter CFN-43ACB	1	14-3/8 x 20-1/16 x 20-11/16	156
Cabinet CFN-10367** containing: Transmitter-Receiver	1		86
Duplexing Unit CTZ-50ACW***	1	4-5/8 x 21 x 4-3/4 18	
Antenna Mast Assy CFN-10370**	1	20 x 2 dia	
Antenna Assy CTZ-66AFJ**	1	18 x 20 dia	8
Antenna Carrying Case CFN-10372**	1	27-9/16 x 25-5/8 x 28-1/4	

**ITEM NAME:** INTERROGATOR RESPONOR

**TYPE:** BN, BN-1, BN-2

**PRINCIPAL COMPONENTS AND PHYSICAL DATA**

**EQUIPMENT SUPPLIED DATA (Cont.)**

<b>COMPONENTS</b>	<b>QTY</b>	<b>OVERALL DIMENSIONS (Inches)</b>	<b>UNIT WT. (Pounds)</b>
Mast Carrying Case CFN-10373*	1	81 x 25 x 2-1/4	
Equipment Carrying Case CFN-10371**	1	30-5/8 x 27-9/16 x 28-1/4	
Set of Accessories	1	39-1/2 x 66-1/4 x 50-1/4	227
Set of Equipment Spares	1	9 x 18 x 12	40

**NOTE:** \*BN and BN-1 only.

\*\*BN-2 only.

\*\*\*Supplied for BN-1 and BN-2. Supplied for BN by Hazeltine.

**REFERENCE DATA AND LITERATURE**

Technical Manuals:

SHIPS 232A: for Navy Model BN Radar Equipment.

SHIPS 323A: for Navy Model BN-1.

AN16-45-82: for Navy Model BN Equipment.

**BN: 3**

DATE: 1 July 1964

ITEM NAME: INDICATOR CONTROL

COGNIZANT SERVICE: USN

TYPE: C-2456/SP

FEDERAL, STOCK NUMBER.

	USA	USN	USAF	USMC
STATUS OR TYPE CLASSIFICATION				

Mfg(s) Name or Code Number: Polarad Electronics Corp., Long Island City, New York

Description for INDICATOR CONTROL  
C-2456/SP is found on INDICATOR  
CORRELATOR SN-206/SP data sheet,  
pages SN-206/SP: 1, SN-206/SP: 2.

C-2456/SP: 1

**DATE:** 1 July 1964

**ITEM NAME:** CONTROL-INDICATOR

**COGNIZANT SERVICE:** USN

**TYPE:** C-3039/SPS-8A

**FEDERAL STOCK NUMBER:**

	USA	USN	USAF	USMC
STATUS OR TYPE CLASSIFICATION				

Mfg(s) Name or Code Number: Philadelphia Naval Shipyard

**Illustration not Available.**

**FUNCTIONAL DESCRIPTION**

The Control-Indicator C-3039/SPS-BA is designed to provide for remote control of Radar Set AN/SPS-8A. It contains switches and indicators for turning power on and off and regulating power input to radar set.

**C-3039/SPS-8A: 1**



**ITEM NAME:** CONTROL-INDICATOR

**TYPE:** C-3039/SPS-BA

**RELATION TO SIMILAR EQUIPMENT**

None.

Type of Indication: Meter movement type.  
Dial Size: 2 in. dia

**INSTALLATION CONSIDERATIONS**

**TECHNICAL DESCRIPTION**

Principle Control Function:  
Remote control of power input to radar.  
Type of Indicator: Indicator light indication.

Related Equipment: The C-3039/SPS-8A is used in conjunction with Radar Set AN/SPS-BA as a result of Field Change 11.

**PRINCIPAL COMPONENTS AND PHYSICAL DATA**

<b>COMPONENTS</b>	<b>QTY</b>	<b>OVERALL DIMENSIONS (Inches)</b>	<b>UNIT WT. (Pounds)</b>
Control-Indicator C-3039/SPS-BA	1	6 x 8 x 8	

**REFERENCE DATA AND LITERATURE**

Nomenclature Card for Control-Indicator C-3039/SPS-BA.

DATE: 1 July 1964

ITEM NAME: COURSE DATA COMPUTER-  
GENERATOR

COGNIZANT SERVICE: USN

TYPE: CP-87/U

FEDERAL STOCK NUMBER: F5840-642-8083

	USA	USN	USAF	USMC
STATUS OR TYPE CLASSIFICATION				

Mfg(s) Name or Code Number: Airplane and Marine Instruments, Inc., Clearfield, Pa.

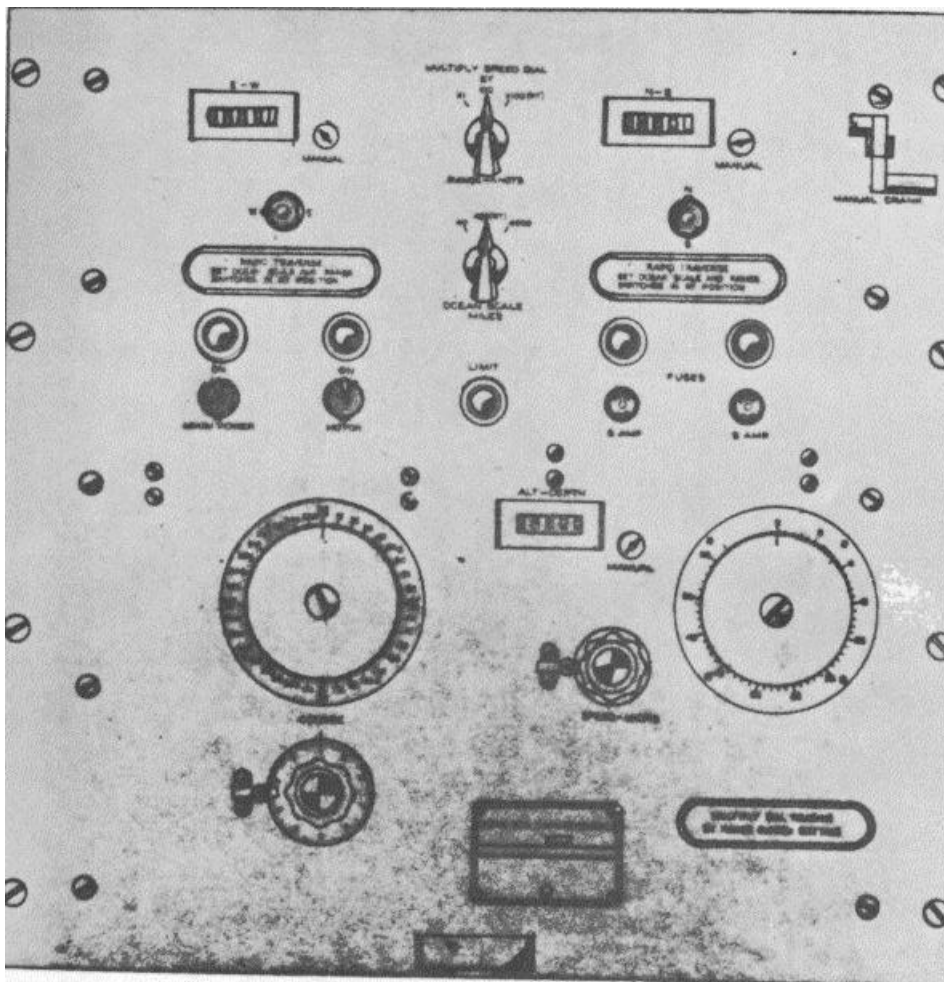

**FUNCTIONAL DESCRIPTION**

The CP-87/U is designed to generate rectangular coordinate data from course and speed data sent in by means of manually positioned local controls or from

course and speed synchro data supplied from a remote point. Altitude or depth synchro data may be inserted by means of a local control. Remote indication data of the target may be given in speed, course, position, and altitude or depth.

**ITEM NAME:** COURSE DATA COMPUTER-GENERATOR

**TYPE:** CP-87/U

**RELATION TO SIMILAR EQUIPMENT**

None.

Output Data: X and Y coordinate step-by-step transmitter position data. X and Y coordinate helipot resistance position data, X and Y coordinate 5G synchro position data.

Heat Dissipation: 415w

Power Source Required: 100 to 130v, 60 cps, 1-ph 415w, 0.93 pf

**TECHNICAL DESCRIPTION**

Input Data: 5F synchro speed information, 5-G synchro course information, and 5-G synchro altitude or depth information.

**INSTALLATION CONSIDERATIONS**

Not available.

**PRINCIPAL COMPONENTS AND PHYSICAL DATA**

**SHIPPING DATA**

<b>COMPONENT</b>	<b>BOXES (NR)</b>	<b>OVERALL DIMENSIONS (Inches)</b>	<b>UNIT WT. (Pounds)</b>
Course Data Computer-Generator CP-87/U	1	23-1/2 x 24 x 28	301
Equipment Spares	1	9 x 13 x 15-3/4	30.5
Cabinet CY-997/G*	1	25 x 32 x 93	522

**NOTE: \*One supplied for each group of four CP-b7/U's.**

**EQUIPMENT SUPPLIED DATA**

<b>COMPONENTS</b>	<b>QTY</b>	<b>OVERALL DIMENSIONS (Inches)</b>	<b>UNIT WT. (Pounds)</b>
Course Data Computer-Generator CP-87/U	1	19 x 19-1/4 x 23	200
Set of Equipment Spares	1	6-1/2 x 10-1/4 x 13-1/b	15.75
Cabinet CY-997/G*	1	22-1/2 x 26 x 88	300

**NOTE: \*One supplied for each group of four CP-87/U's.**

**REFERENCE DATA AND LITERATURE**

Technical Manuals:

NAVSHIPS 91387: for Course Data Computer-Generator CP-b7/U and Cabinet CY-997/G.

DATE: 1 July 1964

ITEM NAME: FREQUENCY CONVERTER

COGNIZANT SERVICE: USN

TYPE.: CV-95A/U

FEDERAL STOCK NUMBER: 5840-665-3310

	USA	USN	USAF	USMC
STATUS OR TYPE CLASSIFICATION				

Mfg(s) Name or Code Number: Decimeter, Incorporated

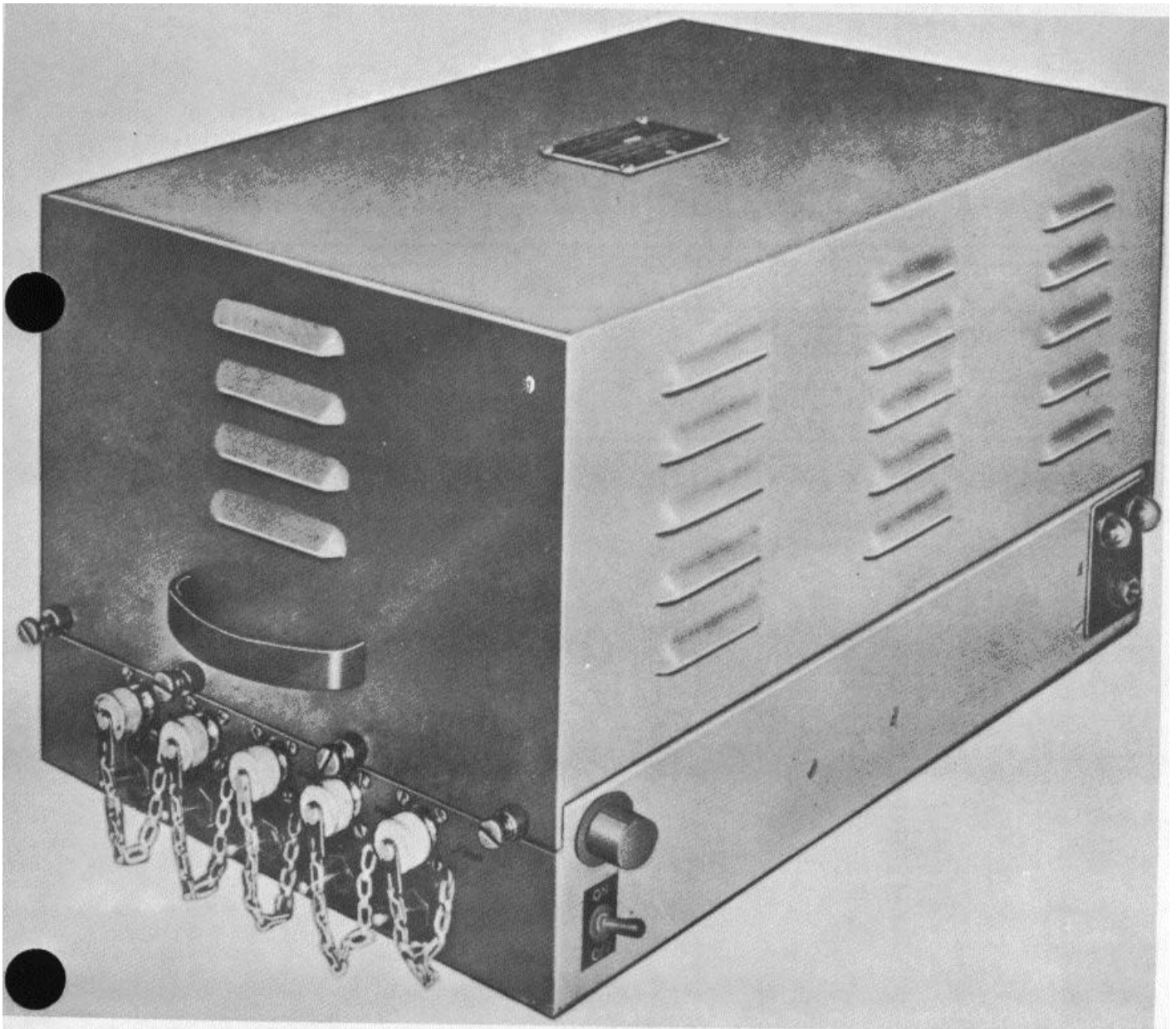

CV-95A/U: 1

CV-95A/U

**FUNCTIONAL DESCRIPTION**

Frequency Converter CV-95A/U is designed to (1) amplify the if. output of any radar or other system containing a 15-mc if. channel, (2) detect and amplify any audio or video modulation from the associated radar or other 15-mc if. system, and (3) furnish a peak video output of two volts. The CV95A/U provides additional video channels for equipments that do not have enough video outputs or whose video outputs are too low. Each CV-95A/U will combine one to four sets of 15-mc if. range data and supply video range data to a maximum of five PPI repeaters. More than one CV-95A/U may be used with a single system.

**RELATION TO SIMILAR EQUIPMENT**

The CV-95A/U and CV-95/U are electrically and mechanically interchangeable except for minor modifications.

**TECHNICAL DESCRIPTION**

IF. Input: 15 mc  
 Impedance: 75 ohms  
 Video Output: 1 to 3v  
 Frequency Response: Flat within 1 db from 250 cps to 2.5 mc  
 Sensitivity: A i-mv if. input at any of four input channels provides five video outputs of 2v peak into resistive loads of 75 ohms  
 Operating Voltages and Power Requirements: 100 to 130v, 58 to 62 cps, 1-ph, 95% lagging pf, 205w

**INSTALLATION CONSIDERATIONS**

Siting:  
 Mounting:  
 Cabling Requirements:  
 Related Equipment: Radar Console SR, Radar Training Equipment OCZ, OCZ-1, and PPI Repeater VG.

**PRINCIPAL COMPONENTS AND PHYSICAL DATA**

COMPONENT	QTY	HEIGHT (Inches)	WIDTH (Inches)	DEPTH (Inches)	UNIT WT. (Pounds)
Frequency Converter CV-95A/U	1	10-1/4	12-3/4	20-5/8	43
Coaxial Connector NT-49190	9				
Power Connector NT-49639	1				

**REFERENCE DATA AND LITERATURE**

Technical Manual:  
NAVSHIPS 92068

DATE: 1 September 1964

ITEM NAME: SIGNAL DATA CONVERTER

COGNIZANT SERVICE: USN

TYPE: CV-1246/SPS-T

FEDERAL STOCK NUMBER:

	USA	USN	USAF	USMC
STATUS OR TYPE CLASSIFICATION		Used by		

Mfg(s) Name or Code Number: Servonics Inc. (05885)



**FUNCTIONAL DESCRIPTION**

Signal Data Converter CV-1246/SPS-T is an electromechanical device designed to convert dual speed (1:1 and 36:1) 400 cycle per second synchro data to single speed (1:1) 60 cycles per second synchro data.

**ITEM NAME:** SIGNAL DATA CONVERTER

**TYPE:** CV-1246/SPS-T

**RELATION TO SIMILAR EQUIPMENT**

None.

Power Consumption From External Radar 400  
Cycles Synchros: 100w  
Bearing Accuracy: plus or minus 1°

**TECHNICAL DESCRIPTION**

Signal Inputs: Dual speed 400 cyc synchro data  
Outputs: Single speed 60 cyc synchro data  
Power Supply: Self contained  
Power Supply Operating Characteristics  
Inputs: 115 plus or minus 1v, 60 plus or minus 3  
cyc, 1-ph  
Power Consumption: 100w  
Power Factor: 0.90  
Output: 300v de, 6.3v ac

**INSTALLATION CONSIDERATION**

Related Equipment  
Required but not Supplied: (1) Radar Trainer  
AN/SPS-T2A; (1) Technical Manual  
NAVSHIPS 93426(A) for Radar Trainer  
AN/SPS-T2A; (1) Radar Set AN/MPS-16; (1)  
Technical Manual AF31P3-2MPS16-1, 2, 3, 4  
for Radar Set AN/MPS-16; (1) Set  
Interconnecting Cables

**PRINCIPAL COMPONENTS AND PHYSICAL DATA**

COMPONENTS	QTY	OVERALL DIMENSIONS (Inches)	UNIT WT. (Pounds)
Signal Data Converter CV-1246/SPS-T includes:	1	7-1/4 x 13-1/4 x 15	21
Technical Manuals	2		
Set Connector Plugs for interconnecting cables includes:	1		
Connector MS3106A-16S-4S	1		
Connector MS3106A-20-29S	1		
Connector MS3106A-20-29SW	1		
Clamp, Connector MS3057-0	1		
Clamp, Connector MS3057-12	1		

**SHIPPING DATA**

COMPONENT	PKGS	OVERALL DIMENSIONS (Inches)	UNIT WT. (Pounds)
	1	1.33	25

**REFERENCE DATA AND LITERATURE**

Technical Manuals:  
NAVSHIPS 94442

DATE: 1 July 1964

ITEM NAME: RADAR EQUIPMENT

COGNIZANT SERVICE: USN

TYPE: CXBR-1

FEDERAL STOCK NUMBER:

	USA	USN	USAF	USMC
STATUS OR TYPE CLASSIFICATION				

Mfg(s) Name or Code Number: General Electric Company

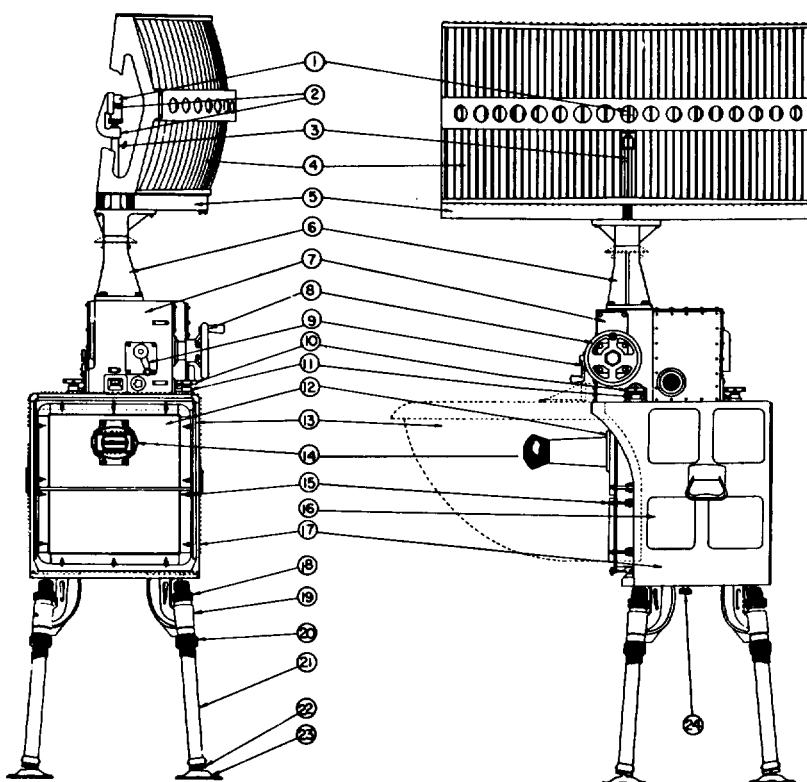

SQ and CXBR-1 Radar Equipment

Ref	DESCRIPTION	Ref	DESCRIPTION
1	Antenna Assembly	13	Weather Hood
2	Back Reflector and Socket	14	Viewing Hood and Face Mask
3	Antenna Shaft	15	Wing Nut
4	Parabolic Reflector	16	Chassis Case
5	Reflector Support Frame	17	Frame
6	Antenna Pedestal	18	Upper Capstan Nuts
7	Antenna Control L-it	19	Leg Socket
8	Antenna Rotation Hand Wheel	20	Lower Capstan Nuts
9	Drive Selector Handle	21	Leg
10	Ant. Control Unit Capstan Screw	22	Ball and Socket Joint
11	Antenna Control Unit Foot	23	Mounting Foot
12	Front Panel	24	Shock Mount Bolts



CXBR-1

**FUNCTIONAL DESCRIPTION**

The CXBR-1 is a compact, low-power, portable radar equipment used as an auxiliary equipment in large vessels, a deck installation on small vessels, or an emergency installation at any location where minimum installation time is desired. Provisions are made for synchronizing the Output of an IFF receiver into this unit and presenting the IFF data on all three types of presentation available.

**RELATION TO SIMILAR EQUIPMENT**

In the general appearance and use, the CXBR-1 resembles the SN, SQ, and CXBR radar equipments.

**TECHNICAL DESCRIPTION**

Presentation: 3-in. CRT  
 Type of Presentation: A, B, and PPI  
 Pulse Rate: 800 cps, variable  $\pm 40$  cps  
 Pulse Width: 1  $\mu$ sec  
 Peak Power Output: 500 and 1,000w  
 Range, Max: 45 mi  
 Range, Min: 300 yd  
 Range Scales: 3, 15, and 45 mi  
 Minimum Readable Range: A-scope - 300 yd,  
 B-scope - 300 yd, PPI - 300 yd  
 Range Accuracy:  $\pm 500$  yd on 3-mi A-scale  
 Bearing Accuracy:  $\pm 5$  deg  
 Operating Voltages and Power Requirements: 90 to  
 130 vac, 60 cps, 1-ph, 320w, 0.85 pf

**INSTALLATION CONSIDERATIONS**

Not available.

**PRINCIPAL COMPONENTS AND PHYSICAL DATA**

COMPONENT	QTY	HEIGHT (Inches)	WIDTH (Inches)	DEPTH (Inches)	UNIT WT. (Pounds)
Antenna Control Unit NT-X23ADS	1				
Antenna Assembly NT-266AFG	1				
Radar Transmitter-Receiver NT-X43ABV	1				

**REFERENCE DATA AND LITERATURE**

Technical Manual:  
SHIPS 257

**DATE:** 1 July 1964

**ITEM NAME:** RADAR BLANKING RECEIVER

**COGNIZANT SERVICE:** USN

**TYPE:.** CXKA

**FEDERAL STOCK NUMBER:**

	USA	USN	USAF	USMC
STATUS OR TYPE CLASSIFICATION				

Mfg(s) Name or Code Number: Warwick Manufacturing Corporation, Chicago, Illinois

**Illustration not Available.**

**FUNCTIONAL DESCRIPTION**

The CXKA is a companion piece of equipment to be used with RDO, AN/SPR-1, AN/ SPR-2 or similar type radar intercept receivers. It operates from 40 to 3000 mc without any tuning controls. In essence, it samples

the pulses coming into an intercept receiver and rejects all those pulses above a preset voltage level (friendly radars), but allows the intercept receiver to pass all those signals below this same level (enemy and weaker friendly signals). Thus, since it will reject any radar

**CXKA: 1**

**ITEM NAME:** RADAR BLANKING RECEIVER

**TYPE:** CXKA

signal strong enough to cause spurious responses, it eliminates the loss of intercept, the decrease in range of an intercept or an error in bearing due to the presence of high intensity local radar signals.

**RELATION TO SIMILAR EQUIPMENT**

None.

**TECHNICAL DESCRIPTION**

Frequency Range: 40 to 3000 mc  
Sensitivity: 1 mv  
Type of Circuit: Crystal detector and untuned video amplifier.  
Power Source Required: 115v, 60 cps, 1-ph  
Power Consumption: 70w

**INSTALLATION CONSIDERATIONS**

Not available.

**PRINCIPAL COMPONENTS AND PHYSICAL DATA**

<b>COMPONENTS</b>	<b>QTY</b>	<b>OVERALL DIMENSIONS (Inches)</b>	<b>UNIT WT. (Pounds)</b>
Blanking Radio Receiver CXKA	1		
Shock Mounting	1		
Video Cable	1		
R.F. Cable	1		
Power Cable plug AN-3106-22-45	1		
Power Cable Clamp AN3057-12	1		

**REFERENCE DATA AND LITERATURE**

Technical Manuals:  
NAVSHIPS 95070

**CXKA: 2**

DATE: 1 July 1964

ITEM NAME: RADIO INTERFERENCE  
FILTER UNIT

COGNIZANT SERVICE: USN

TYPE: CY-1913/U

FEDERAL STOCK NUMBER:

	USA	USN	USAF	USMC
STATUS OR TYPE CLASSIFICATION				

Mfg(s) Name or Code Number. Aerovox Corp., Pacific Coast Div., Monrovia, California

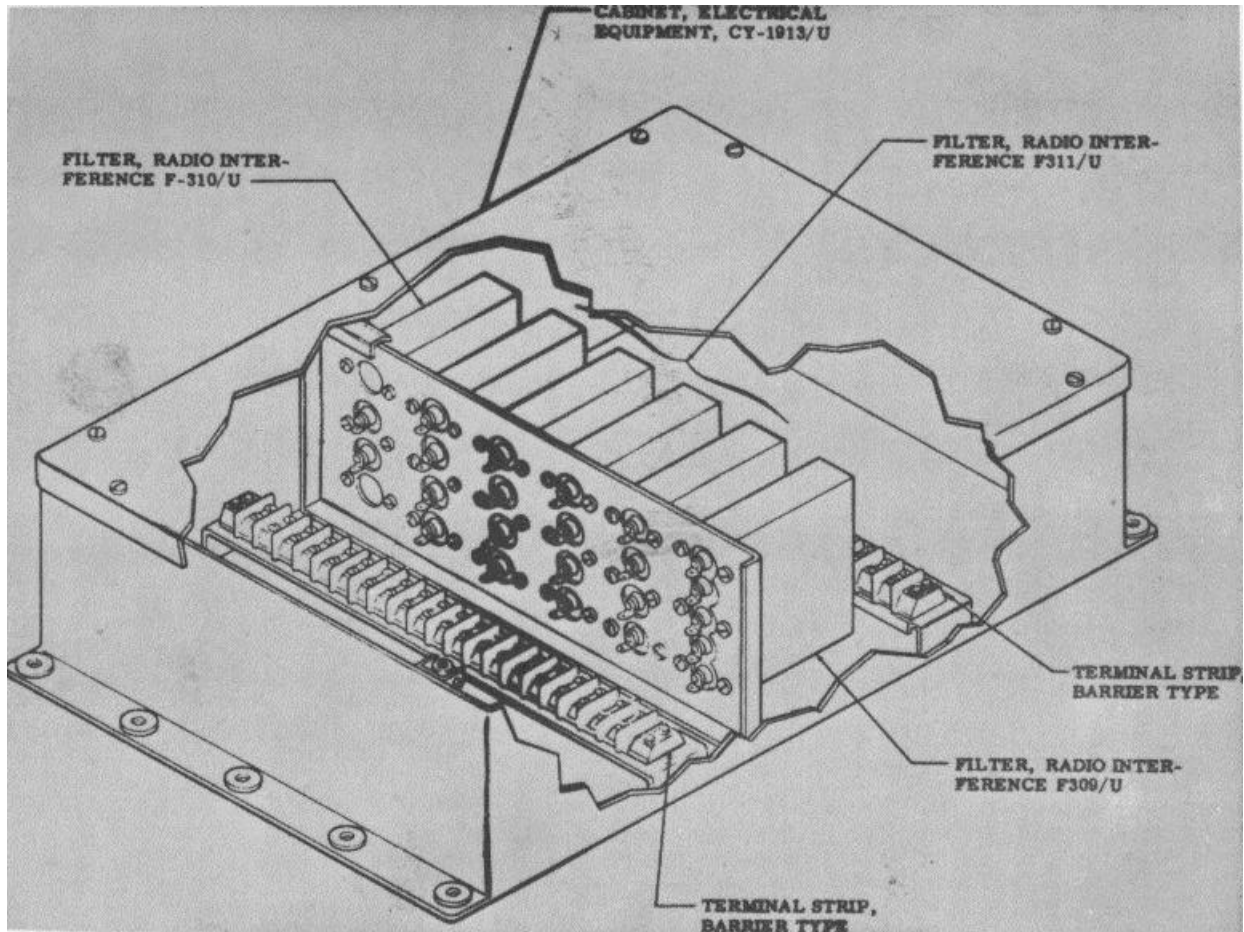

**FUNCTIONAL DESCRIPTION**

The Radio Interference Filter Assembly is an unattended equipment designed for shipboard use as a

radio interference filter box for a number of radar systems. It will normally be connected within the power and control cables between the radar antenna and the associated below deck components.

**ITEM NAME:** RADIO INTERFERENCE FILTER UNIT

**TYPE:** CY-1913/U

**RELATION TO SIMILAR EQUIPMENT**

None.

F-310/U: 250v ac/dc, 12 amp, 0.1 to 1000 mc, 2 circuit.  
F-311/U: 250v ac/dc, 3 amp, 0.1 to 1000 mc, 4 circuit.

**TECHNICAL DESCRIPTION**

Filter Ratings

F-309/U: 250v ac/dc, 1.6 amp, 0.1 to 1000 mc, 5 circuit.

**INSTALLATION CONSIDERATIONS**

Related Equipment:

Required but not Supplied. (10) Screw, No. 76 Wire per MIL-W-16878B as Required.

**PRINCIPAL COMPONENTS AND PHYSICAL DATA**

**SHIPPING DATA**

<b>COMPONENT</b>	<b>BOXES (NR)</b>	<b>OVERALL DIMENSIONS (Inches)</b>	<b>UNIT WT. (Pounds)</b>
Electrical Equipment Cabinet CY-1913/U (3)	1	14-3/8 x 20-1/16 x 21-3/8	68.5
Radio Interference Filters F-309/U(1), F-310/U(1), and F-311/U(4)	3	6-3/4 x 7-1/8 x 10-3/4	10.3

**EQUIPMENT SUPPLIED DATA**

<b>COMPONENTS</b>	<b>QTY</b>	<b>OVERALL DIMENSIONS (Inches)</b>	<b>UNIT WT. (Pounds)</b>
Radio Interference Filter Assy including:	1	5 x 13 x 20-3/16	27
Electrical Equipment Cabinet CY-1913/U	1	5 x 13 x 20-3/16	18
Radio Interference Filter F-309/U	1	1-7/8 x 4 x 4-3/4	1.2
Radio Interference Filter F-310/U	1	1-7/8 x 4 x 4-3/4	1.5
Radio Interference Filter F-311/U	4	1-7/8 x 4 x 4-3/4	1.4

**REFERENCE DATA AND LITERATURE**

Technical Manuals:

NAVSHIPS 92762: for Radio Interference Filter Assembly including Electrical Equipment Cabinet CY-1913/U; Radio Interference Filter Units F-309/U, F-310/U, F-311/U.

DATE: 1 July 1964

ITEM NAME: WAVE TRAP

COGNIZANT SERVICE: USN

TYPE: F-20/UPR

FEDERAL STOCK NUMBER: F5915-246- 1435

	USA	USN	USAF	USMC
STATUS OR TYPE CLASSIFICATION		Obsoles		

Mfg(s) Name or Code Number: Designers For Industry, Inc.

### FUNCTIONAL DESCRIPTION

The F-20/UPR is designed to determine the carrier frequency of radar signals from 300 to 3,400 mc and distinguishes true signals from harmonic or spurious responses in the receiver. Provision for blackout operation is provided as the red-paint filled calibrated scales will fluoresce if ultraviolet illumination is provided.

### RELATION TO SIMILAR EQUIPMENT

None.

### TECHNICAL DESCRIPTION

Frequency: 300 to 3,400 mc

### INSTALLATION CONSIDERATIONS

Siting:

Mounting:

Cabling Requirements:

Related Equipment: The F-20/UPR is designed for use with the AN/SPR- 1, AN/APR- 1, RDO and similar receivers.

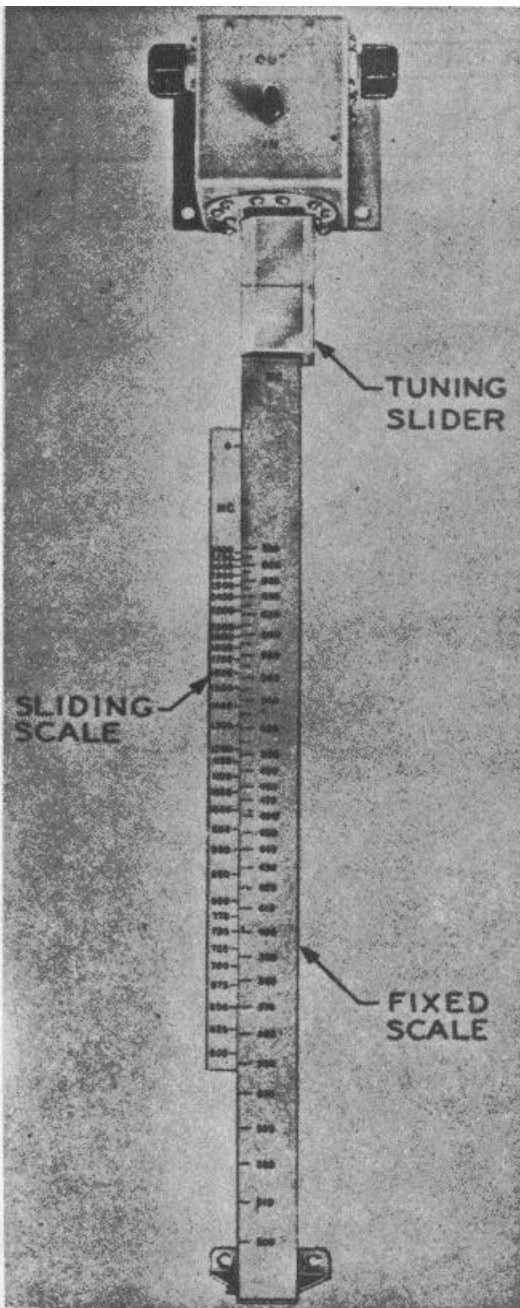

**F-20/UPR**

**PRINCIPAL COMPONENTS AND PHYSICAL DATA**

<b>COMPONENT</b>	<b>QTY</b>	<b>HEIGHT (Inches)</b>	<b>WIDTH (Inches)</b>	<b>DEPTH (Inches)</b>	<b>UNIT WT. (Pounds)</b>
Wave Trap F-20/UPR	1	20-3/4	6	3-3/16	3.2

**REFERENCE DATA AND LITERATURE**

Technical Manual:  
NAVSHIPS 900582

**F-20/UPR: 2**

DATE: 1 July 1964

ITEM NAME: RANGE INDICATOR

COGNIZANT SERVICE: USN

TYPE: IP-99/SP, IP-99A/SP\*

FEDERAL STOCK NUMBER: 5840-665-1274  
5840-644-4624 W/S  
5840-569-0413\*  
5840-552-9007 W/S\*

	USA	USN	USAF	USMC
STATUS OR TYPE CLASSIFICATION				

Mfg(s) Name or Code Number: Westinghouse Electric Corp., Baltimore, Maryland

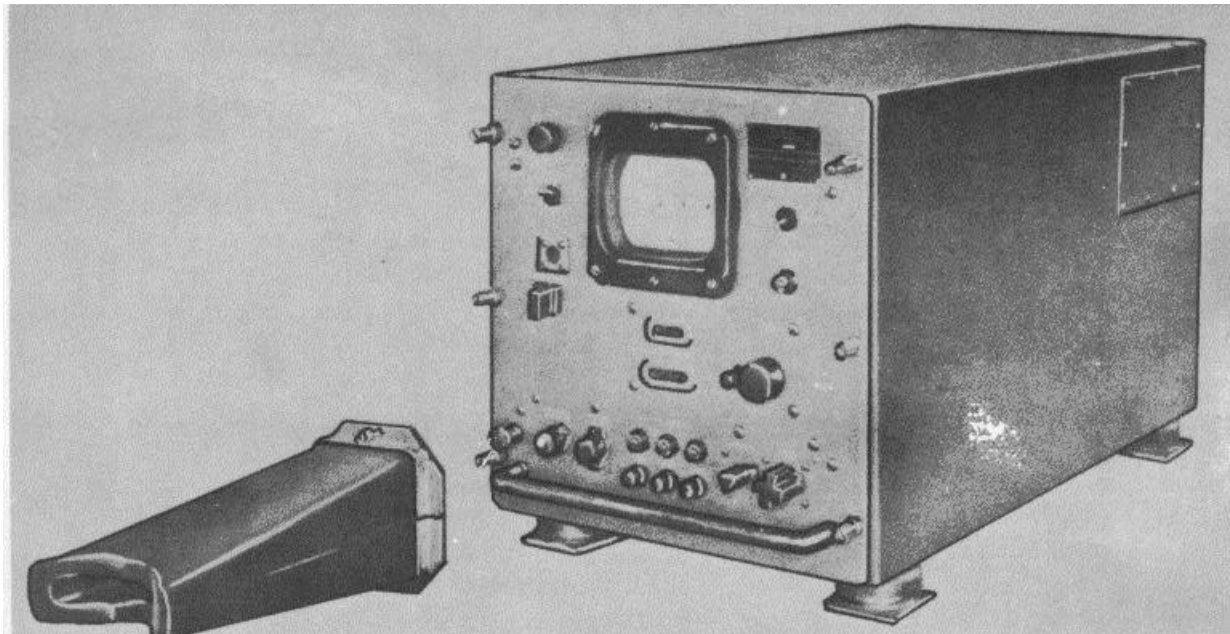

**FUNCTIONAL DESCRIPTION**

The IP-99/SP and IP-99A/SP are designed for use with an associated search radar set. The radar system must supply synchronization, received radar video signals, and a fixed range marker pulse to Range Indicator for presentation on the type A-scope. The

luminescent spot on the scope screen of Range Indicator travels horizontally from left to right across the screen every time the radar set generates a pulse. A received echo pulse produces a sharp vertical pip extending upward on the horizontal trace at the moment the pulse

IP-99/SP: 1



**ITEM NAME:** RANGE INDICATOR

**TYPE:** IP-99/SP, IP-99A/SP

is received. The time interval between the main bang and the target pip is proportional to the distance between the radar set and the left-hand origin of the trace is proportional to the time interval, the trace can be calibrated for the direct measurement of the target range.

Scan: 5 in. A-Scope  
Heat Dissipation: 180w  
Ambient Temperature: -20OC to plus 65OC  
Power Source Required  
IP-99/SP: 115v, 60 cps, i-ph, 100w  
IP-99A/SP: 115v, 60 cps, 1-ph, 200w

**RELATION TO SIMILAR EQUIPMENT**

None.

**INSTALLATION CONSIDERATIONS**

Related Equipment:  
Required but not Supplied. (1) Radar Set, (as required) Cable, Coaxial RG-10/U, (as required) Cable, Coaxial RG-12/U, (as required) Cable, Single Conductor SHFA-3, (as required) Cable, Double Conductor DHFA-3.

**TECHNICAL DESCRIPTION**

Sweep Ranges: 4, 20, 80, and 200 mi  
Video Bandwidth: 3 mc

**PRINCIPAL COMPONENTS AND PHYSICAL DATA**

**SHIPPING DATA**

<b>COMPONENT</b>	<b>BOXES (NR)</b>	<b>OVERALL DIMENSIONS (Inches)</b>	<b>UNIT WT. (Pounds)</b>
IP-99/SP			
Range Indicator IP-99/SP	1	20 x 20 x 33	174.0
Visor Hood	1	7 x 7 x 13	8.0
Tubes	1	8 x 16 x 16	10.0
Maintenance Spares	1	13 x 13-1/2 x 14-1/2	90.0
IP-99A/SP			
Range Indicator IP-99A/SP	1	26 x 27 x 39	250
CR Tube and Visor Hood	1	19-7/8 x 19-7/8 x 26-1/2	56

**EQUIPMENT SUPPLIED DATA**

<b>COMPONENTS</b>	<b>QTY</b>		<b>OVERALL DIMENSIONS (Inches)</b>	<b>UNIT WT. (Pounds)</b>
	<b>IP-99/SP</b>	<b>IP-99A/SP</b>		
Range Indicator IP-99/SP	1		17 x 18 x 32	150
Range Indicator IP-99A/SP		1	17 x 18 x 32	160
Visor Hood	1	1	5-7/8 x 6-1/4 x 12-5/16	2.0
Technical Manual	2			4
Box Maintenance Spares	1		12 x 12 x 12	75
Set Maintenance Prints	1			2
Set Test Data	1	1		9
Set Tubes	1			

**MIL-HDBK-162A**  
15 December 1965

Volume 1  
Section 3

**ITEM NAME:** RANGE INDICATOR

**TYPE:** IP-99/SP, IP-99A/SP

**REFERENCE DATA AND LITERATURE**

Technical Manuals:  
NAVSHIPS 91443

**IP-99/SP: 3**

DATE: 1 July 1964

ITEM NAME: AZIMUTH-RANGE INDICATOR

COGNIZANT SERVICE: USN

TYPE: IP-281/UP

FEDERAL STOCK NUMBER: 5840-510-5751

	USA	USN	USAF	USMC
STATUS OR TYPE CLASSIFICATION:				

Mfg(s) Name or Code Number: Raytheon Co., Waltham, Massachusetts

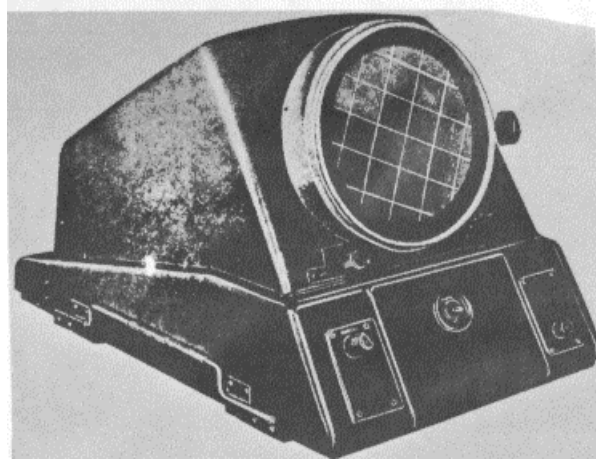

### FUNCTIONAL DESCRIPTION

Azimuth-Range Indicator IP-281/UP is a remote plan position indicator (PPI) designed to repeat information obtained from any standard search radar. Its purpose is

to repeat, at a remote point, target information appearing at the search radar.

Targets are presented on an electrostatic-focus, magnetic-deflection, 10-inch cathode-ray tube (CRT). Five range settings are available: 2, 4, 16, 40, and 80 miles. Four fixed range-markers are provided on each range setting, each marker representing one-fourth the

IP-281/UP: 1

**ITEM NAME:** AZIMUTH-RANGE INDICATOR

**TYPE:** IP-281/UP

distance of the range setting used. The unit consists of one self-contained unit.

Power Requirements: 115v plus or minus 11v, 60 cycle plus or minus 2 cycle, 1-ph, 200 va, 90% pf  
Pulse Repetition Frequency: 57 to 2000 cps  
Video Input: 1 to 2.5v pos  
Trigger Input: 5 to 50v pos  
Azimuth Rotation Speed: 0 to 20 rpm

**RELATION TO SIMILAR EQUIPMENT**

None.

**TECHNICAL DESCRIPTION**

**INSTALLATION CONSIDERATIONS**

Not available.

**PRINCIPAL COMPONENTS AND PHYSICAL DATA**

<b>COMPONENTS</b>	<b>BOXES (NR.)</b>	<b>OVERALL DIMENSIONS (Inches)</b>	<b>UNIT WT. (Pounds)</b>
Azimuth-Range Indicator IP-281/UP	1	25 x 28 x 41	207

**EQUIPMENT SUPPLIED DATA**

<b>COMPONENTS</b>	<b>QTY</b>	<b>OVERALL DIMENSIONS (Inches)</b>	<b>UNIT WT. (Pounds)</b>
Azimuth-Range Indicator IP-281/UP	1	16-1/4 x 17-1/4 x 29	93

**REFERENCE DATA AND LITERATURE**

Technical Manuals:  
NAVSHIPS 92285(A): for Azimuth-Range Indicators IP-281/UP, IP-281A/UP, IP-281B/UP.

**DATE:** 1 July 1964

**ITEM NAME:** AZIMUTH-RANGE INDICATOR

**COGNIZANT SERVICE:** USN

**TYPE** IP-281A/UP

**FEDERAL STOCK NUMBER:**

	USA	USN	USAF	USMC
STATUS OR TYPE CLASSIFICATION				

Mfg(s) Name or Code Number: Raytheon Co., Waltham, Massachusetts

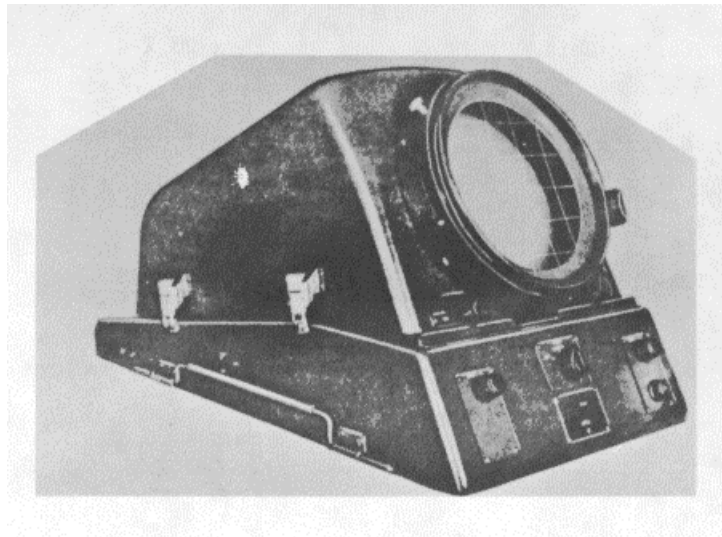

**FUNCTIONAL DESCRIPTION**

Azimuth Range Indicator IP-281A/UP is a remote plan position indicator (PPI) designed to repeat information obtained from any standard search radar. Its purpose is to repeat, at a remote point, target information appearing at the search radar.

Targets are presented on an electrostatic-focus, magnetic-deflection, 10-inch cathode-ray tube (CRT). Five range settings are available: 2, 4, 16, 40 and 80 miles. Four fixed range markers are provided on each range setting, each marker representing one-fourth the distance of the range setting used. The equipment consists of one self-contained unit.

**IP-281A/UP: 1**

**ITEM NAME:** AZIMUTH-RANGE INDICATOR

**TYPE:** IP-281A/UP

**RELATION TO SIMILAR EQUIPMENT**

IP-281A/UP is mechanically and electrically interchangeable with Indicator IP281/UP, except for component parts.

Pulse Repetition Frequency: 57 to 2000 cps.  
Video Input: 1 to 2.5v pos  
Trigger Input: 5 to 50v pos  
Azimuth Rotation Speed: 0 to 20 rpm

**TECHNICAL DESCRIPTION**

Power Requirements: 115v plus or minus 11v- 60 cycles plus or minus 2 cycles, 200 va, 90% pf.

**INSTALLATION CONSIDERATIONS**

Related Equipment: IP-281A/UP is used with but not part of AN/SPS-21A, AN/SPS-21B.

**PRINCIPAL COMPONENTS AND PHYSICAL DATA**

<b>COMPONENTS</b>	<b>QTY</b>	<b>OVERALL DIMENSIONS (Inches)</b>	<b>UNIT WT. (Pounds)</b>
Azimuth-Range Indicator IP-261A/UP	1	16-1/4 x 17-1/4 x 29	93

**SHIPPING DATA**

<b>COMPONENTS</b>	<b>BOXES (NR.)</b>	<b>OVERALL DIMENSIONS (Inches)</b>	<b>UNIT WT. (Pounds)</b>
Azimuth-Range Indicator IP-281A/UP	1	25 x 28 x 41	207
PPI Tube 10WP7A	1	17 x 19 x 29	54
Equipment Maintenance Parts	1	9 x 11 x 14	15
Viewing Hood	1	11 x 11 x 13	3

**REFERENCE DATA AND LITERATURE**

Technical Manuals:  
NAVSHIPS 92285(A): for Azimuth-Range Indicators IP-281/UP,  
IP-281A/UP, IP-281B/UP.

DATE: 1 July 1964

ITEM NAME: AZIMUTH-RANGE INDICATOR

COGNIZANT SERVICE: USN

TYPE: IP-281B/UP

FEDERAL STOCK NUMBER: 5840-633-7805

	USA	USN	USAF	USMC
STATUS OR TYPE CLASSIFICATION				

Mfg(s) Name or Code Number: Raytheon Co., Waltham, Massachusetts

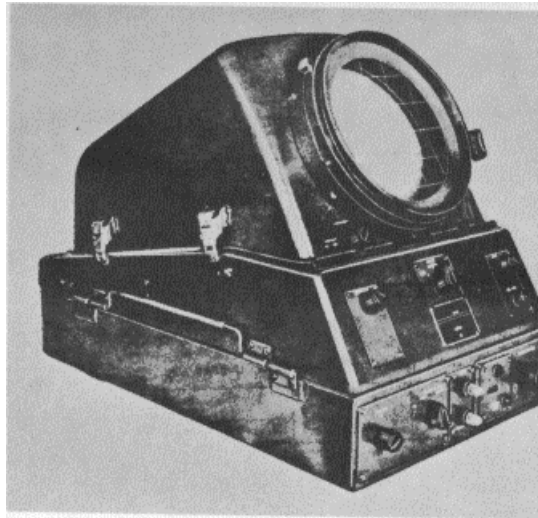

### FUNCTIONAL DESCRIPTION

Azimuth-Range Indicator IP-281B/UP is a remote plan position indicator (PPI) designed to repeat information obtained from any standard search radar. Its purpose is to repeat, at a remote point, target information appearing at the search radar.

Targets are presented on an electrostatic-focus, magnetic-deflection, 10-inch cathode-ray tube (CRT). Five range settings are available: 2, 4, 16, 40, and 80 miles. Four fixed range markers are provided on each range setting, each marker representing one-fourth the distance of the range setting used. The equipment consists of one self-contained unit.

IP-281B/UP: 1

**ITEM NAME:** AZIMUTH-RANGE INDICATOR

**TYPE:** IP-281B/UP

**RELATION TO SIMILAR EQUIPMENT**

IP-281B/UP is similar to IP-281A/UP except the IP-281B/UP has a variable range marker. They are interchangeable.

Pulse Repetition Frequency: 57 to 2000 cps  
Video Input: 1 to 2.5v pos  
Trigger Input: 5 to 50v pos  
Azimuth Rotation Speed: 0 to 20 rpm

**INSTALLATION CONSIDERATIONS**

Related Equipment: IP-281B/UP is used with but not part of AN/SPS-21A, AN/SPS-21B.

**TECHNICAL DESCRIPTION**

Power Requirements: 115v plus or minus 11v, 60 cycles plus or minus 2 cycles, 1-ph, 200 va, 90% pf.

**PRINCIPAL COMPONENTS AND PHYSICAL DATA**

**SHIPPING DATA**

<b>COMPONENT</b>	<b>BOXES (NR.)</b>	<b>OVERALL DIMENSIONS (Inches)</b>	<b>UNIT WT. (Pounds)</b>
Azimuth-Range Indicator IP-281B/UP	1	28 x 33 x 44	263
PPI Tube 10WP7A	1	17 x 19 x 29	54
Equipment Maintenance Parts	1	9 x 11 x 14	15
Viewing Hood	1	11 x 11 x 13	3

**EQUIPMENT SUPPLIED DATA**

<b>COMPONENTS</b>	<b>QTY</b>	<b>OVERALL DIMENSIONS (Inches)</b>	<b>UNIT WT. (Pounds)</b>
Azimuth-Range Indicator IP-281B/UP	1	17-1/4 x 20-1/4 x 29-1/4	124

**REFERENCE DATA AND LITERATURE**

Technical Manuals:  
NAVSHIPS 92285(A): for Azimuth-Range Indicators IP-281/UP, IP-2BIA/UP, IP-281B/UP.



DATE: 1 July 1964

ITEM NAME: VIDEO DECODER

COGNIZANT SERVICE: USN

TYPE: KY-71/UPX

FEDERAL STOCK NUMBER:

	USA	USN	USAF	USMC
STATUS OR TYPE CLASSIFICATION		Sub Std		

Mfg(s) Name or Code Number: Hazeltine Electronics Corporation

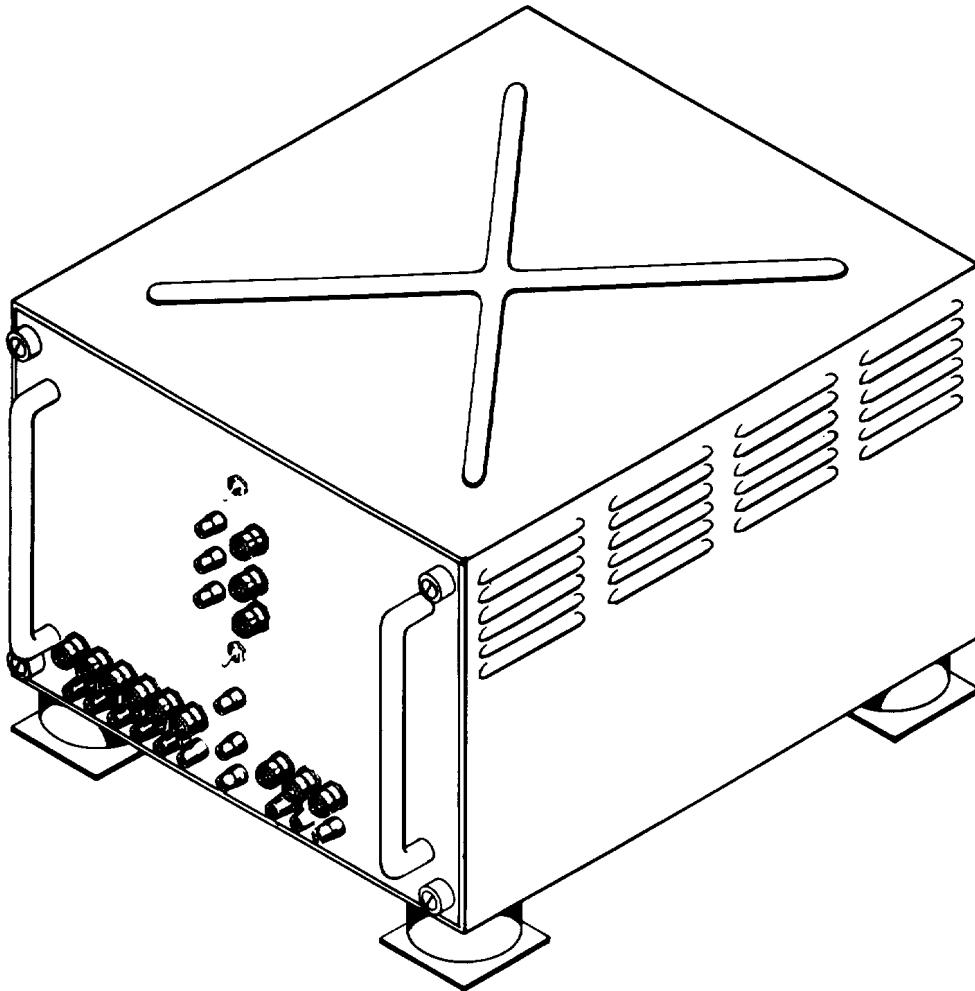

**FUNCTIONAL DESCRIPTION**

Video Decoder KY-71/UPX is a video separator for use on board ship in conjunction with Radio Receiving Set AN/SRR-4 to separate radar data from identification data. After the radar and identification data are transmitted on a common link, the KY-71/UPX separates them into their proper circuits.

**RELATION TO SIMILAR EQUIPMENT**

None.

**TECHNICAL DESCRIPTION**

Operating Voltages and Power Requirements: 115v,  
1-ph, 60 cps, 250 va  
Heat Dissipation: 240w

KY-71/UPX

**INSTALLATION CONSIDERATIONS**

Siting:  
Mounting: Provided with shock mounts, designed for either deck or rack mounting.  
Cabling Requirements:

Related Equipment: Video Decoder KY-71/UPX is used with Radio Receiving Set AN/SRR-4, and Video Distributor SA-220/UPX or Data Distribution Group AN/SSA-7.

**PRINCIPAL COMPONENTS AND PHYSICAL DATA**

<b>COMPONENT</b>	<b>QTY</b>	<b>HEIGHT (Inches)</b>	<b>WIDTH (Inches)</b>	<b>DEPTH (Inches)</b>	<b>UNIT WT. (Pounds)</b>
Video Decoder KY-71/UPX	1	14-3/4	18	26-1/8	115

**REFERENCE DATA AND LITERATURE**

Technical Manual:  
NAVSHIPS 91565

**KY-71/UPX: 2**

DATE: 1 July 1964

ITEM NAME: STABLE ELEMENT

COGNIZANT SERVICE: USN

TYPE: MK 8 MOD 2\*, MOD 4\*\*

FEDERAL STOCK NUMBER: F5840-568-2689\*  
F5840-303-4358\*\*

	USA	USN	USAF	USMC
STATUS OR TYPE CLASSIFICATION				

Mfg(s) Name or Code Number: Westinghouse Electric Company

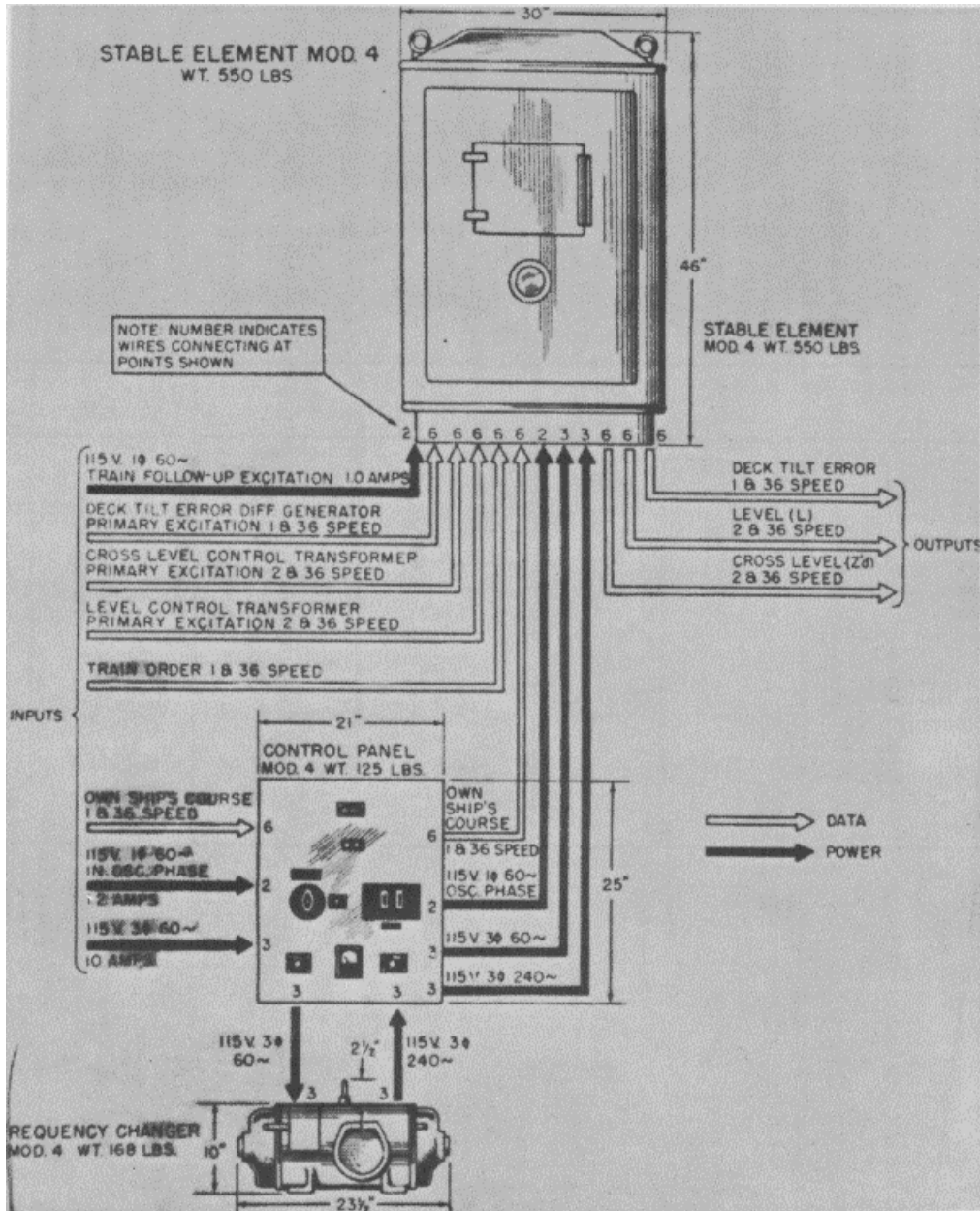

MK 8 MOD 2, MOD 4

**TECHNICAL DESCRIPTION**

The Mk 8 Mod 2 and Mk 8 Mod 4 are gyro-controlled instruments used to measure electrical values of level and cross-level with respect to the line-of-sight to the target. This information is transmitted to a stabilized instrument, such as a radar antenna, to keep it aimed at the target in spite of the ship's pitch and roll.

The stable element is an auxiliary equipment necessary to the installation of the larger radar equipments such as Radar Equipments SM,SP, and SX series. Mk8 Mod2 is furnished with conversion kit for 2- and 36-speed and for 2- and 72-speed.

**RELATION TO SIMILAR EQUIPMENT**

None.

**TECHNICAL DESCRIPTION**

Mod 2 Data Input:

Own Ship's Course - 1- and 36-speed  
Relative Target Bearing - 1- and 36-speed  
Mod 2 Data Output: Level- 2- and 36-speed,  
Cross-Level- 2- and 36-, or 2- and 72-speed,  
Train Order - 1- and 36-speed  
Mod 4 Data Input:  
Own Ship's Course - 1- and 36-speed  
Train Order - 1- and 36-speed  
Mod 4 Data Output: Level- 2- and 36-speed,  
Cross-Level - 2- and 36-speed, Deck Tilt  
Correction - 1- and 36-speed  
Mod 2 Operating Voltages and Power Requirements:  
115v,3-ph,60 cps, 10 amp; 115v, 1-ph 60 cps, 2.5  
amp; 115v, 1-ph, 60 cps, 3.8 or 0.5 amp  
Mod 4 Operating Voltages and Power Requirements:  
115v, 3-ph, 60 cps, 10 amp; 115v, 1-ph, 60 cps,  
1.0 amp

**INSTALLATION CONSIDERATIONS**

Determined by the equipment with which the stable element is associated.

**PRINCIPAL COMPONENTS AND PHYSICAL DATA**

COMPONENT	QTY	HEIGHT (Inches)	WIDTH (Inches)	DEPTH (Inches)	UNIT WT. (Pounds)
Mk 8 Mod 2					
Stable Element	1	45-7/8	31-1/4	31-1'4	535
Frequency Converter CAV-211531	1	19-1/4	23-3/4	12-5/8	280
Control Panel	1	25-1/16	21-11/16	15-13/16	
Mk 8 Mod 4					
Stable Element	1	46	30	30	550
Frequency Changer Mod 4	1	10	23-1/2	10	168
Control Panel	1	25	21	15	

**REFERENCE DATA AND LITERATURE**

Technical Manual:  
NAVSHIPS 900967

DATE: 1 July 1964

ITEM NAME: RADAR EQUIPMENT

COGNIZANT SERVICE: USN

TYPE: MK 12 MOD 1

FEDERAL STOCK NUMBER:

	USA	USN	USAF	USMC
STATUS OR TYPE CLASSIFICATION				

Mfg(s) Name or Code Number: Western Electric Company

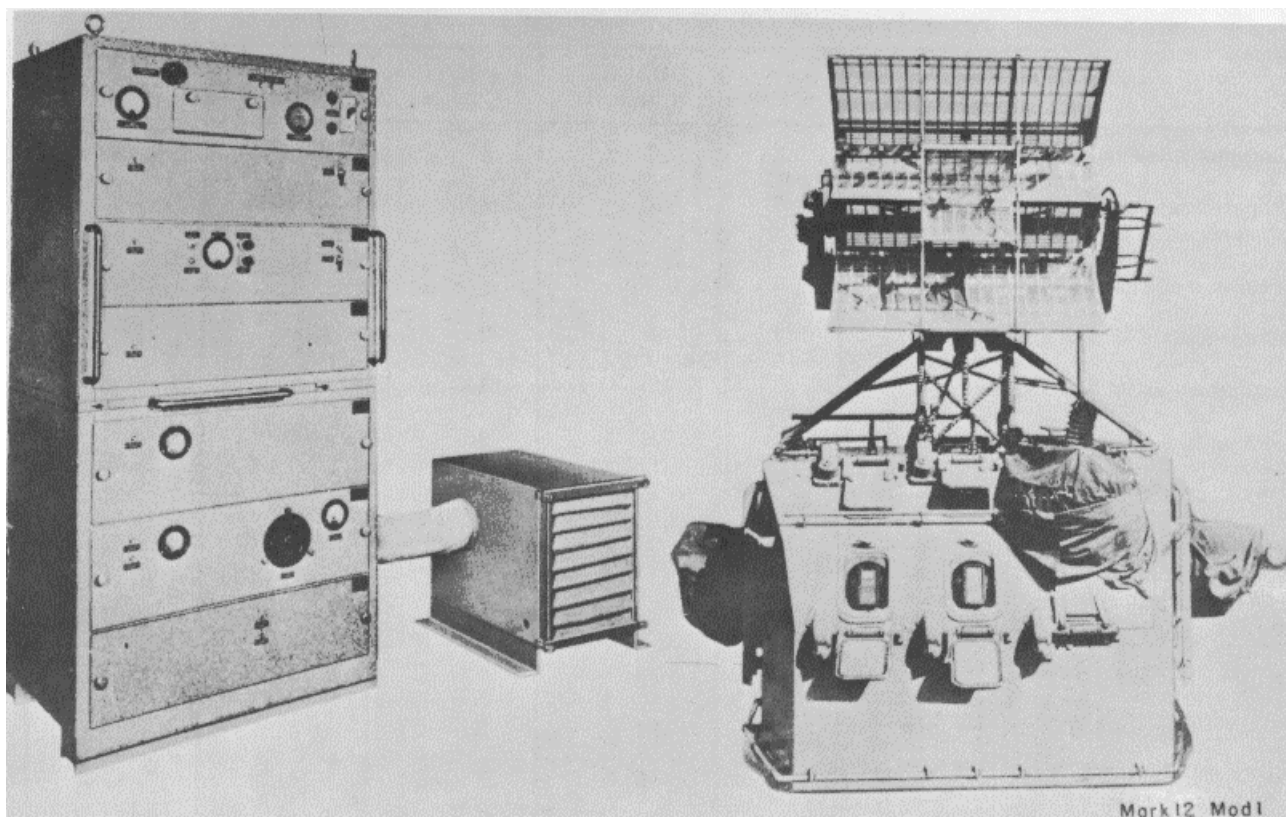

### FUNCTIONAL DESCRIPTION

The Mk 12 Mod 1 is a shipboard fire control radar which provides the means for locating aircraft and surface craft and providing range, azimuth, and elevation data for fire control. It is associated with Gun Director Mk 37. Radar equipment Mk 22 may be used with the Mk 12 to provide accuracy at low level elevation.

### RELATION TO SIMILAR EQUIPMENT

The Mk 12 Mod 1 is similar to Radar Equipment Mk 12, except that the latter has only one range control unit.

The Mk 12 Mod 1 is also similar to Radar Equipment Mk 12 Mod 3, but the latter includes improved automatic range tracking circuits and anti-jamming features.

### TECHNICAL DESCRIPTION

Range, Max: Air - 45,000 yd; surface - 40,000 yd  
 Range, Min: 400 yd  
 Range Resolution: 300 yd  
 Azimuth Resolution: 7 deg  
 Elevation Resolution: 7 deg  
 Range Accuracy:  $\pm 25$  yd

**MK 12 MOD 1**

Azimuth Accuracy:  $\pm 3$  mils  
 Elevation Accuracy:  $\pm 3$  mils  
 Operating Voltages and Power Requirements: 110,  
 220, or 440v, 1-ph, 60 cps, 2.5 kw  
 Frequency: 920 to 970 mc  
 RF Power: 100 kw peak, 0.048 kw avg  
 Pulse Repetition Rate: 480 pps  
 Pulse Duration: 1  $\mu$ sec  
 IF. Frequency: 30 mc  
 Receiver Sensitivity: 3  $\mu$ v noise factor, 16 db

Antenna Feed: 8 dipoles per section of double  
 cylindrical parabola  
 Antenna Gain: 22 db  
 Horizontal Beam Width: 10 deg at half-power points  
 Vertical Beam Width: 10 deg at half-power points  
 Type of Presentation: Four 3-in. CRT

**INSTALLATION CONSIDERATIONS**

Not available.

**PRINCIPAL COMPONENTS AND PHYSICAL DATA**

COMPONENT	QTY	HEIGHT (Inches)	WIDTH (Inches)	DEPTH (Inches)	UNIT WT. (Pounds)
Antenna Assembly CW-66AFF	1	75	75	58	460
Radar Transmitter-Receiver Assembly CS-43ABU	1	51	24	16	400
Train or Elevation Meter CW-22AAD	2	6	7	5	20
Range Unit CW-23AFB	1	38	22	12	225
Indicator Unit CW-55ADN	5	21	15	8	200
Indicator Power Unit CW-20ACF	1	21	20	10	106
Operator's Control Unit CW-23ADO	1	14	13	7	20
Power Control-Amplifier Assembly CW-50ACP	1	36	37	26	575
Power Supply Assembly CW-20ACC	1	36	36	26	815
Range Control Unit CW-23AFC	1	15	13	11	65
Blower-Filter Assembly CW-10213	1	22	24	22	140
Cathode-Ray Oscillograph CDU-60064	1	9	15	16	49
Portable Sweep Unit CW-50147	1	7	23	9	15

**REFERENCE DATA AND LITERATURE**

Technical Manual:  
 SHIPS 270A  
 Ordnance Pamphlet  
 OP 1076

DATE: 1 July 1964

ITEM NAME: MARINE RADAR EQUIPMENT

COGNIZANT SERVICE: USN

TYPE: MU

FEDERAL STOCK NUMBER: 5840-647-7070

	USA	USN	USAF	USMC
STATUS OR TYPE CLASSIFICATION				

Mfg(s) Name or Code Number: Westinghouse Electric Corporation, Baltimore, Maryland

**Illustration not Available.**

#### FUNCTIONAL DESCRIPTION

The Model MU is designed for Marine use to serve as a collision warning device by giving an indication of the presence of other vessels or objects that protrude above the surface of the water. Sufficient accuracy is incorporated in the equipment so that it may be used as

a navigational aid even in congested areas such as in rivers, in narrow straits, or in the entrance to a busy harbor. Signals representing other vessels, buoys, break waters, and shore lines are clearly presented in the living indicator picture of the surrounding area, at distances from less than 100 yards to 40 miles.

**MU: 1**

**ITEM NAME:** MARINE RADAR EQUIPMENT

**TYPE:** MU

**RELATION TO SIMILAR EQUIPMENT**

None.

Antenna Data

Rotation: 4.5 sec a revolution.

Beam Width

Horizontal: 2°

Vertical: 15°

**TECHNICAL DESCRIPTION**

Frequency Range: 9320 to 9430 mc

Distance Ranges: 1.5, 4, 16 and 40 mi

Presentation: 7 in. CR tube.

Power Requirements: 115v, 50 or 60 cps, 1-ph or  
115v dc or 230v dc.

**INSTALLATION CONSIDERATIONS**

Not available.

**PRINCIPAL COMPONENTS AND PHYSICAL DATA**

<b>COMPONENTS</b>	<b>QTY</b>	<b>OVERALL DIMENSIONS (Inches)</b>	<b>UNIT WT. (Pounds)</b>
Indicator Console	1	20 x 20 x 51-1/8	240
Viewing Hood	1		
Pedestal Transmitter	1	22-1/4 x 25-15/16 x 38	
Antenna Dome Assy	1	33-1/2 x 64-1/16 dia	200
Pedestal Mast	1	18 dia x 24	
Pedestal Cover Assy	1		
Terminal Kit	1		
Coaxial Cable RG-12/U	3		
Interconnection Cable	2		
Waveguide RG-51/U	1		
Set of Waveguide Fittings	1		
Azimuth Stabilization Unit	1		30
Motor Generator, 115v dc or 230v dc	1	12-7/8 x 16-1/4 x 28	225
Line Starter, 115v dc or 230v dc	1	10-1/4 x 12 x 19-5/16	55
De-icing Kit	1		
Kit of Special Tubes	1		

**REFERENCE DATA AND LITERATURE**

Technical Manuals:  
NAVSHIPS 91121



DATE: 1 July 1964

ITEM NAME: REFLECTOSCOPE

COGNIZANT SERVICE: USN

TYPE: MX-969/SPA-4A

FEDERAL STOCK NUMBER: 5840-315-2855  
5840-316-8748 W/S

	USA	USN	USAF	USMC
STATUS OR TYPE CLASSIFICATION				

Mfg(s) Name or Code Number: Radio Corp. of America, RCA Victor Div., Camden, N. J.

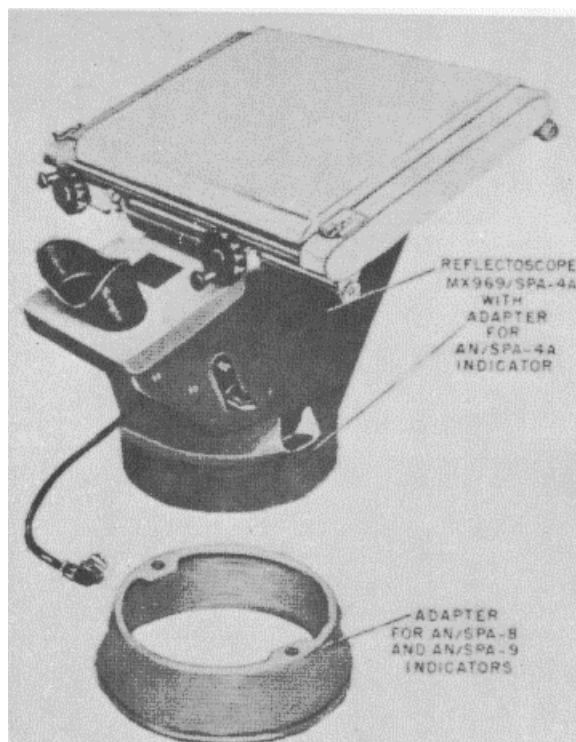

### FUNCTIONAL DESCRIPTION

The MX-969/SPA-4A is designed for use with Range-Azimuth Indicators AN/SPA-4A, AN/SPA-8, and AN/SPA-9 to present an optically superimposed view of the PPI

display and a navigation chart of the area under radar search. This direct correlation of radar echo signals and chart positively fixes the position of the ship and/or any targets with respect to the chart.

It employs a system of mirrors that coincidentally reflect

MX-969/SPA-4A: 1

**ITEM NAME:** REFLECTOSCOPE

**TYPE:** MX-969/SPA-4A

a view of a movable illuminated chart and a PPI display and presents them at a common viewing point. The chart The chart can be positioned manually to bring any desired area into view at the eyepiece. A dichroic mirror in the viewing path of the chart introduces the reflection of the PPI display to provide the combined view. The intensity of illumination of the chart and the brilliancy of the PPI display may be independently regulated to allow inspection of either presentation alone or in conjunction with the other.

**TECHNICAL DESCRIPTION**

Power Requirements: 6.3v ac or dc, 0.1 to 3.2w, 100% pf.  
Heat Dissipation: 0.1 to 3.2w

**INSTALLATION CONSIDERATIONS**

Related Equipment:  
Required but not Supplied. (1) Range-Azimuth Indicator AN/SPA-4A or AN/SPA-8 or AN/SPA-9.

**RELATION TO SIMILAR EQUIPMENT**

None.

**PRINCIPAL COMPONENTS AND PHYSICAL DATA**

**SHIPPING DATA**

<b>COMPONENT</b>	<b>BOXES (NR.)</b>	<b>OVERALL DIMENSIONS (Inches)</b>	<b>UNIT WT. (Pounds)</b>
Reflectoscope MX-969/SPA-4A including: Adapter Rings Set of Equipment Spares Technical Manuals Chart Rolls	1	31 x 31 x 32-1/2	80

**EQUIPMENT SUPPLIED DATA**

<b>COMPONENTS</b>	<b>QTY</b>	<b>OVERALL DIMENSIONS (Inches)</b>	<b>UNIT WT. (Pounds)</b>
Reflectoscope MX-969/SPA-4A	1	21-5/8 x 23 x 23	45
Adapter Ring for AN/SPA-4A	1	3 x 24-3/4	
Adapter Ring for AN/SPA-8, -9	1	3-3/8 x 28-1/4 dia	
Technical Manual NAVSHIPS 91588	2	1/4 x 9 x 11-1/2	
Set of Equipment Spares	1		
Chart Roll	2		

**REFERENCE DATA AND LITERATURE**

Technical Manuals:  
NAVSHIPS 91588

DATE: 1 July 1964

ITEM NAME: INDICATOR ADAPTER

COGNIZANT SERVICE: USN

TYPE: MX-1339/UP

FEDERAL STOCK NUMBER: F5840-665-3628

	USA	USN	USAF	USMC
STATUS OR TYPE CLASSIFICATION				

Mfg(s) Name or Code Number: The Austin Company

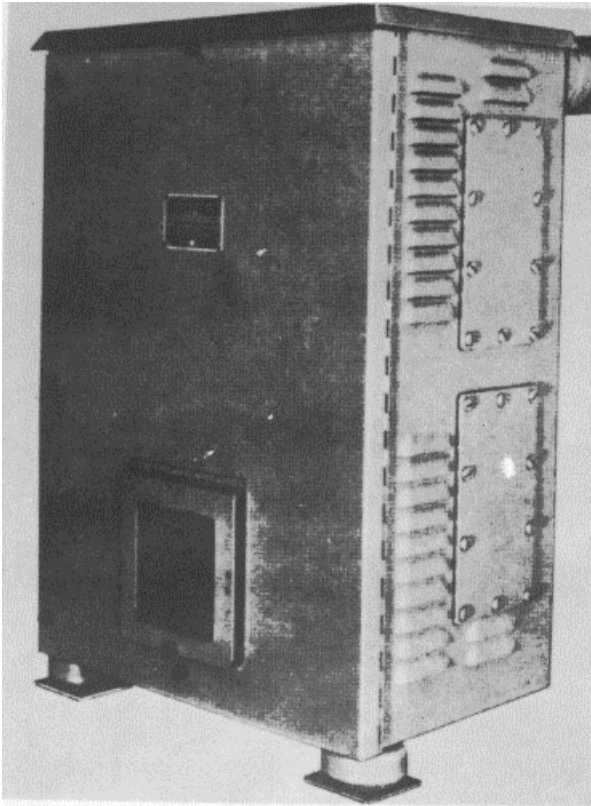

### FUNCTIONAL DESCRIPTION

The MX-1339/UP provides five remote radar PPI repeaters with trigger and video signals derived from any standard Navy search radar set. It isolates the radar set from the repeaters, amplifies the radar video signal, and regenerates the radar trigger pulse with an adjustable time delay. There are five separate, identical video and trigger outputs, with provisions to furnish the negative input signal as a sixth video output. Each output is independent of the other outputs and can be shorted with

no adverse effect on the remaining outputs. In addition, there is provision for accepting range mark pulses of positive polarity for range calibration of the remote repeater units.

### RELATION TO SIMILAR EQUIPMENT

None.

### TECHNICAL DESCRIPTION

Video Input:  $-0.75$  to  $-0.9v$  or  $2 \pm 0.5v$   
Video Output: 5 channels individually adjustable from 0 to 5v across 75 ohms  
Range Mark Input: 2v max  
Bandwidth:  $\pm 3$  db from 60 cps to 6 mc,  $\pm 1$  db from 10 kc to 4 mc  
Video Input Impedance: 75 ohms  
Range Mark Input Impedance: 51 ohms  
Trigger Input: 25 to 50v at 57 to 2,000 pps  
Trigger Delay: 0 to 2.5  $\mu$ sec in 0.05  $\mu$ sec steps  
Trigger Output: Approx 30v across 75 ohms for each of 5 channels  
Trigger Input Impedance: 75 ohms  
Operating Voltages and Power Requirements: 115v  $\pm 10\%$ , 60  $\pm 2$  cps, 1-ph, 215w, 0.96 pf

### INSTALLATION CONSIDERATIONS

Siting: Dependent upon the installation and type of radar equipment with which used.  
Mounting: Shock mounted against deck and bulk-head.  
Cabling Requirements:  
Related Equipment:

MX-1339/UP

**PRINCIPAL COMPONENTS AND PHYSICAL DATA**

<b>COMPONENT</b>	<b>QTY</b>	<b>HEIGHT (Inches)</b>	<b>WIDTH (Inches)</b>	<b>DEPTH (Inches)</b>	<b>UNIT WT. (Pounds)</b>
Indicator-Adapter MX-1339/UP	1	27	18	15	100

**REFERENCE DATA AND LITERATURE**

Technical Manual:  
NAVSHIPS 91703

**MX-1339/UP: 2**

DATE: 1 July 1964

ITEM NAME: TRIGGER MIXER

COGNIZANT SERVICE: USN

TYPE: MX-1369/UPX

FEDERAL STOCK NUMBER: 5840-301-6819

	USA	USN	USAF	USMC
STATUS OR TYPE CLASSIFICATION				

Mfg(s) Name or Code Number: Brubaker Mfg Co., Inc., Los Angeles, California



#### FUNCTIONAL DESCRIPTION

The MX-1369/UPX is comprised of mixer circuits which enable a transponder to be suppressed by several different trigger inputs. This equipment combines IFF (Identification Friend or Foe) suppression triggers from

interrogator sets into one output, and the triggers from radar or other interrogator sets into another output. These two outputs are connected to the two suppression inputs of a transponder. The equipment is fully shielded and may be operated in close proximity to high-power radar equipment without interaction.

MX-1369/UPX: 1

**ITEM NAME:** TRIGGER MIXER

**TYPE:** MX-1369/UPX

**RELATION TO SIMILAR EQUIPMENT**

None.

**TECHNICAL DESCRIPTION**

Input Characteristics

Quantity: 6 trigger inputs, singly or in combination.  
Amplitude: plus 15 to plus 50v into a 75 ohm load.  
Pulse Duration: 0.3 to 25 usec  
Rise Time: Not more than 0.25 usec  
Overshoot: Less than 25% of pos amplitude.  
Max Voltage Input: 250v dc  
Pulse Interval: 15 usec max

Output Characteristics

Quantity: 2 combined trigger outputs.  
Amplitude Min: plus 4.0v  
Duration Increase: 2 usec max  
Rise Time Increase: 0.5 usec max  
Normal Output Termination: 75 ohms  
Overshoot: Less than 25% of pos amplitude when working into a 75 ohms load.  
External Power Source Required: None.  
Features  
Case: Aluminum.  
Cover: Gasketed.

**INSTALLATION CONSIDERATIONS**

Not available.

**PRINCIPAL COMPONENTS AND PHYSICAL DATA**

**SHIPPING DATA**

<b>COMPONENT</b>	<b>BOXES (NR.)</b>	<b>OVERALL DIMENSIONS (Inches)</b>	<b>UNIT WT. (Pounds)</b>
Trigger Mixer MX-1369/UPX	1	6-9/16 x 7-1/2 x 12-1/8	6.5

**EQUIPMENT SUPPLIED DATA**

<b>COMPONENTS</b>	<b>QTY</b>	<b>OVERALL DIMENSIONS (Inches)</b>	<b>UNIT WT. (Pounds)</b>
Trigger Mixer MX-1369/UPX	1	4.78 x 5.31 x 8.12	3

**REFERENCE DATA AND LITERATURE**

Technical Manuals:  
NAVSHIPS 91753

**MX-1369/UPX: 2**

DATE: 1 July 1964

ITEM NAME: INDICATOR ADAPTER

COGNIZANT SERVICE: USN

TYPE: MX-1618/UP

FEDERAL STOCK NUMBER: F5840-693-4871

	USA	USN	USAF	USMC
STATUS OR TYPE CLARIFICATION		Std		

Mfg(m) Name or Code Number: Dynamic Electronics, Inc.

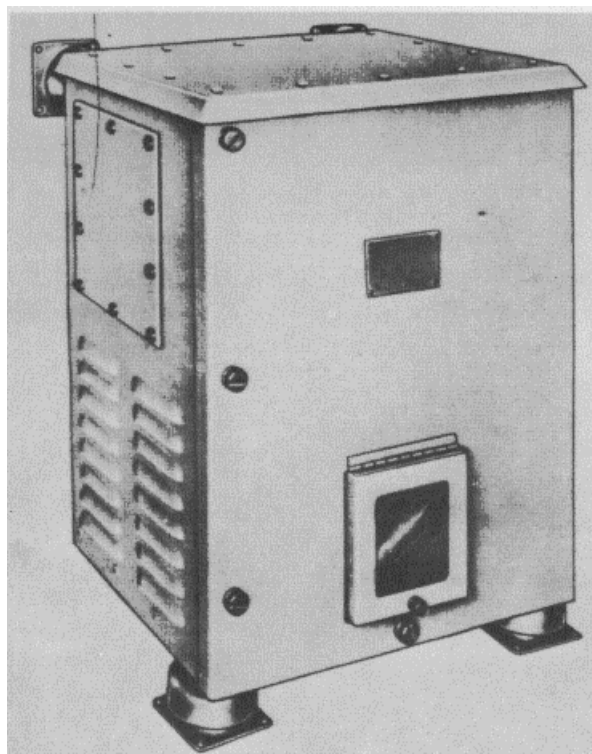

### FUNCTIONAL DESCRIPTION

The MX-1618/UP provides five remote radar PPI repeaters with trigger and video signals derived from any standard Navy radar search set. The Indicator Adapter serves to isolate the radar set from the repeaters. In addition, it amplifies the radar video signal and regenerates the radar trigger pulse with an adjustable time delay.

### RELATION TO SIMILAR EQUIPMENT

None.

### TECHNICAL DESCRIPTION

Operating Voltages and Power Requirements: 115v, 60 cps, 1-ph, 185w  
 Video Input: 2.0  $\pm$ 0.5v  
 Video Output: 5 outputs, each adjustable from 0 to 2.5v across 75 ohms  
 Video Bandwidth Stability: +3 db from 60 cps to 6 mc;  $\pm$ 1 db from 10 kc to 4 mc;  $\pm$ 6 db at 10 mc  
 Trigger Input: 25 to 50v  
 Pulse Repetition Rate: 57 to 2,000 pps  
 Trigger Delay: 0 to 2.5  $\mu$ sec in 0.05  $\mu$ sec steps  
 Trigger Output: 5 outputs, each approx 30v across 75 ohms

**MX-1618/UP**

Trigger Input Impedance: 75 ohms  
Current Drain: 1.6 amp  
Power Factor: 97%  
Heat Dissipation: 10.52 btu per min

Mounting: Upright shock mounting on bulkhead or shelf. Shock mounts are provided, but mounting brackets are not.

Cabling Requirements: Cable entrance plates are adequate to handle all cables. Run cables according to standard Navy practices.

Related Equipment: Standard Navy search radar equipments and PPI repeaters.

**INSTALLATION CONSIDERATIONS**

Siting: Locate in weather-protected area such as a compartment or an enclosed passageway.

**PRINCIPAL COMPONENTS AND PHYSICAL DATA**

<b>COMPONENT</b>	<b>QTY</b>	<b>HEIGHT (Inches)</b>	<b>WIDTH (Inches)</b>	<b>DEPTH (Inches)</b>	<b>UNIT WT. (Pounds)</b>
Indicator Adapter MX-1618/UP	1	21-7/16	16-1/8	13-3/4	75

**REFERENCE DATA AND LITERATURE**

Technical Manual:  
NAVSHIPS 92384



DATE: 1 July 1964

ITEM NAME: PULSE TRIGGER GENERATOR

COGNIZANT SERVICE: USN

TYPE: 0-329/SP

FEDERAL STOCK NUMBER: 5840-665-1264  
5840-519-5268 W/S

	USA	USN	USAF	USMC
STATUS OR TYPE CLASSIFICATION				

Mfg(s) Name or Code Number: Westinghouse Electric Corporation, Baltimore, Maryland

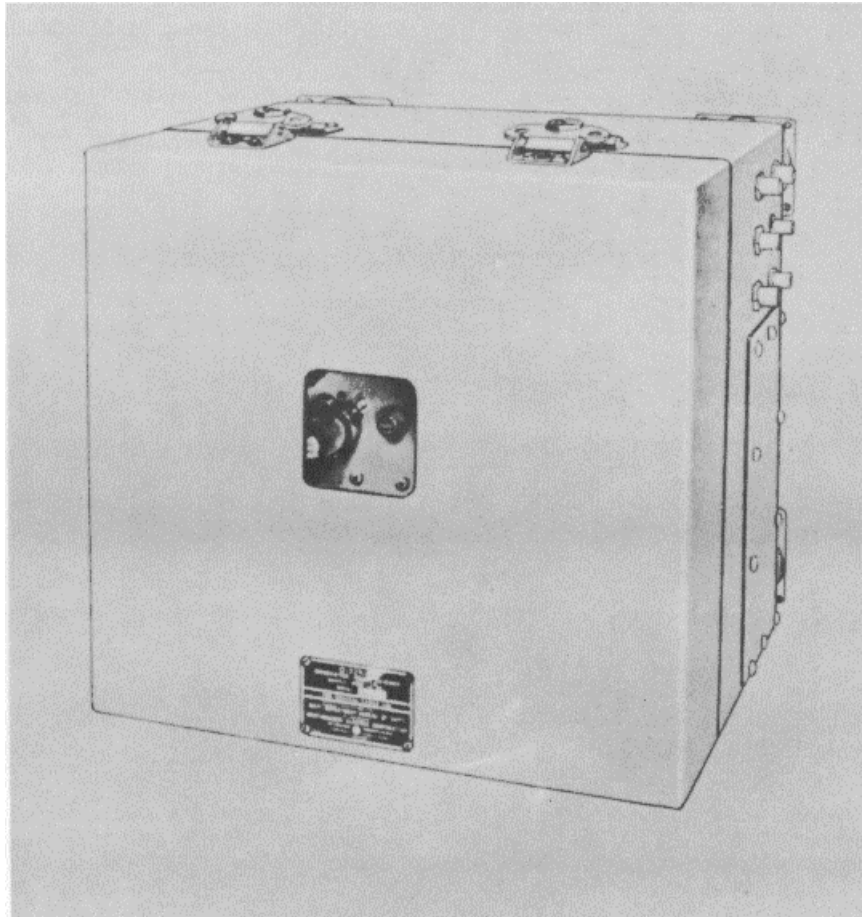

### FUNCTIONAL DESCRIPTION

The 0-329/SP is designed to supply trigger pulses for air and surface search radar sets and their remote indicators, and to supply pre-trigger pulses for associated IFF equipment. It synchronizes a search radar set and its remote indicators with their associated

IFF equipment, providing the necessary delay between the IFF trigger pulses and the radar and indicator trigger pulses.

The 0-329/SP is used with Radar Equipment SR-6b and Radar Sets AN/SP-6, -6A, -6B and -6C when the radar sets external trigger input circuits are modified in accordance with Field Change NAVSHIPS 98607.

**ITEM NAME:** PULSE TRIGGER GENERATOR

**TYPE:** 0-329/SP

Data on this sheet reflects the following field changes,  
FC-1.

**RELATION TO SIMILAR EQUIPMENT**

None.

**TECHNICAL DESCRIPTION**

Pulse Rate

Band 1: 120 to 500 pps  
Band 2: 500 to 1000 pps

Pre-Trigger Pulse Data

Adjustment: 50 usec plus or minus 10% ahead of  
radar trigger (before shipment).

Polarity: positive

Peak Voltage: 20 to 50v nom across a 75 ohm  
plus or minus 5% terminating resistor.

Rise Time: 9.93 to 25 usec at 50% amplitude.

Radar Trigger Pulse Data

Polarity: positive

Peak Voltage: 50 to plus or minus 10% nom  
across a 75 ohm plus or minus 5% terminating  
resistor.

Duration: 10 usec max at 85% nom peak voltage.

Rise Time: Within 20% of nom pulse duration, but  
no less than 40v per usec.

Overshoot (Positive and Negative): 10% max of  
nom peak voltage.

Heat Dissipation: 88w

Power Requirements: 115v plus or minus 10%, 60  
cps plus or minus 2 cps

Rectification: Full-wave type (power supply).

**INSTALLATION CONSIDERATIONS**

Related Equipment:

Required but not Supplied. (1) Radar Set; (6)  
Connector, Cable; Cable, Coaxial RG-12/U as  
Required; Cable, Armored RSGA-3 as  
Required.

**PRINCIPAL COMPONENTS AND PHYSICAL DATA**

**SHIPPING DATA**

<b>COMPONENT</b>	<b>BOXES (NR.)</b>	<b>OVERALL DIMENSIONS (Inches)</b>	<b>UNIT WT. (Pounds)</b>
Pulse Trigger Generator 0-329/SP including:  (2) Technical Manuals NAVSHIPS 92567  Equipment Spares  *Field Change Kit Parts  *Field Change Bulletins  *Temporary Corrections	1	22-3/4 x 22-3/4 x 28-5/8	98

**NOTE: \*Omitted when Pulse Trigger Generator 0-329/SP is not a part of Field Change Kit.**

**0-329/SP: 2**

**ITEM NAME:** PULSE TRIGGER GENERATOR

**TYPE:** O-329/SP

**PRINCIPAL COMPONENTS AND PHYSICAL DATA (Cont.)**

**EQUIPMENT SUPPLIED DATA**

**PRINCIPAL COMPONENTS AND PHYSICAL DATA**

<b>COMPONENTS</b>	<b>QTY</b>	<b>OVERALL DIMENSIONS (Inches)</b>	<b>UNIT WT. (Pounds)</b>
Pulse Trigger Generator O-329/SP	1	14 x 16-3/8 x 16-3/4	53
Technical Manuals NAVSHIPS 92567	2		0.5
Equipment Spares	1		7
F.C. Bulletins NAVSHIPS 98607	*2		
Temporary Corrections, T-10 to NAVSHIPS 900, 989(A)	*2		
Temporary Corrections, T-18 to NAVSHIPS 91081	*2		
Temporary Corrections, T-9 to NAVSHIPS 91620(A)	*2		

**NOTE: \*Supplied only when Pulse Trigger Generator O-329/SP is shipped as part of Field Change Kit.**

**REFERENCE DATA AND LITERATURE**

Technical Manuals:  
NAVSHIPS 92567

**O-329/SP: 3**

DATE: 1 July 1964

ITEM NAME: DATA SWITCHING GROUP

COGNIZANT SERVICE: USN

TYPE: OA-266/SSA, OA-266A/SSA, OA-266B/SSA4

FEDERAL STOCK NUMBER: 5820-501-0429'

	USA	USN	USAF	USMC
STATUS OR TYPE CLASSIFICATION				
Mfg(s) Name or Code Number: Pacific Div., Bendix Aviation Corp., North Hollywood, California				

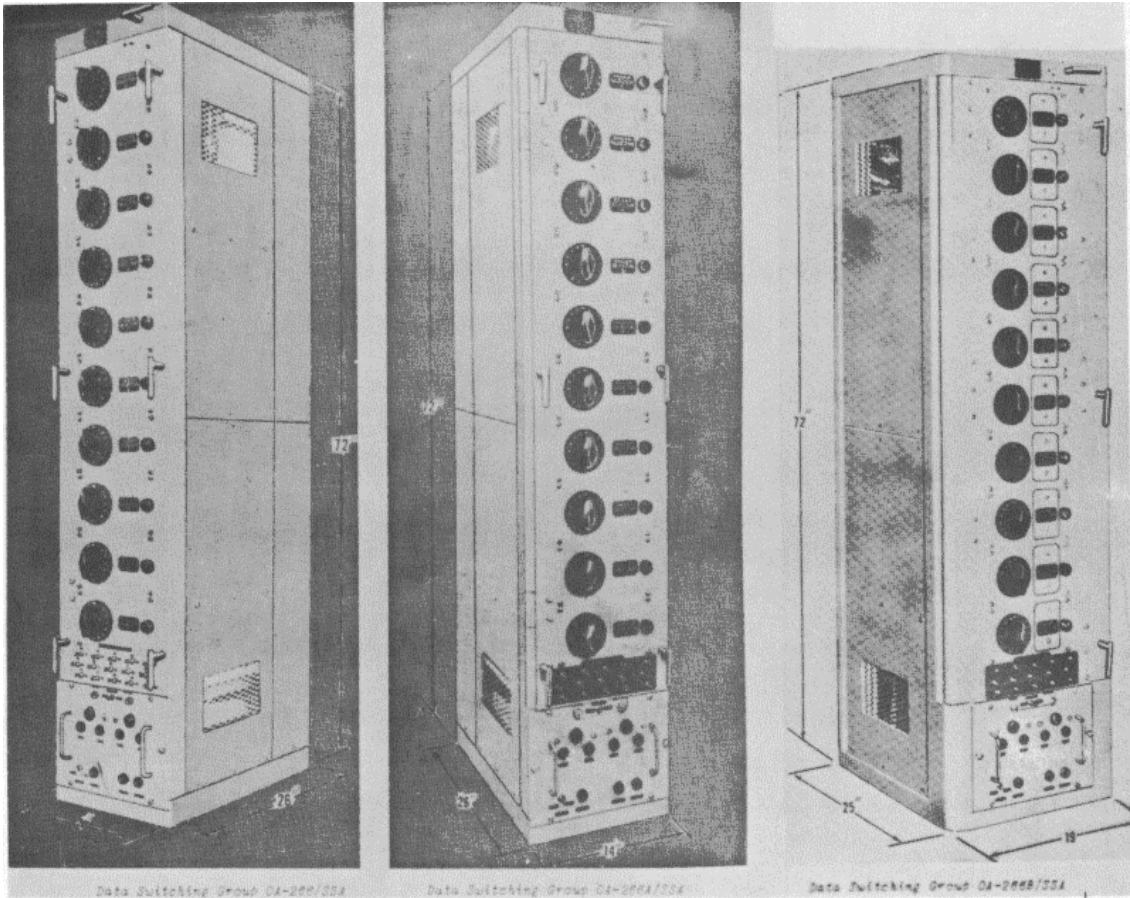

**FUNCTIONAL DESCRIPTION**

The OA-266/SSA, OA-266A/SSA and OA-266B/SSA provide for the distribution of single speed and 36 speed synchro, trigger, video, blanking, sine and cosine and relative bearing data from 15 radar equipments to 10

radar repeaters located at remote stations. In the OA-266A/SSA and OA-266B/SSA although provisions are made for 15 information sources only 10 are wired.

By operating Order Switches SA-242/SSA located adjacent to remote repeater stations the desired output is automatically selected

**OA-266/SSA: 1**

**ITEM NAME:** DATA SWITCHING GROUP

**TYPE:** G9-266/SSA, OA-266A/SSA, OA-266B/SSA

from the data switching group. Ten radar selector switches and their associated servo systems are mounted to the door of the cabinet. A clutch arrangement permits the selector switches at the data switching unit to be manually operated.

The equipment forms a part of a Data Distribution Group for naval vessels.

Data on this sheet reflects the following Field changes, No. 2.

**RELATION TO SIMILAR EQUIPMENT**

The OA-266A/SSA and OA-266/SSA are electrically and mechanically interchangeable except for mechanical fabrication and assembly changes in a minor degree not affecting space configuration of the unit nor major subassemblies. The OA-266B/SSA is functionally but not mechanically interchangeable with the OA-266A/SSA and OA-266/SSA and was used unofficially by the contractor.

**TECHNICAL DESCRIPTION**

Frequency Range: 100 cps to 10 mc

Input Impedance  
Video Output Cathode Follower: 50 ohms  
Trigger Output Cathode Follower: 70 ohms  
Output Impedance  
Video: 70 ohms  
Trigger: 70 ohms  
Master Radar Inputs: 15; OA-266A/SSA and OA-266B/SSA wired for 10.  
Remote PPI Outputs: 10  
Operating Power Requirements: 115v, 60 cps, 3-ph at 15 amp; 115v, 60 cps, 1-ph at 5 amp.  
Heat Dissipation: 300w  
Ambient Temperature Range: -28°C to 65°C.

**INSTALLATION CONSIDERATIONS**

Related Equipment:  
Required but not Supplied.  
(1) Amplifier Assembly AM-518/SSA,  
(1) Switch Rotary SA-242/SSA1 (1)  
Switch, Rotary SA-243/SSA and (1)  
Switch, Rotary SA-247/SSA and (1)  
Voltmeter, Electronic ME-55/SSA.

**PRINCIPAL COMPONENTS AND PHYSICAL DATA**

**SHIPPING DATA**

COMPONENT	BOXES (NR.)	OVERALL DIMENSIONS (Inches)	UNIT WT. (Pounds)
Data Switching Group OA-266/SSA or		22.2 x 38.5 x 81.5	970
Data Switching Group OA-266A/SSA or		22.2 x 38.5 x 81.5	955
Data Switching Group OA-266B/SSA		22 x 39 x 80.7	1090

**EQUIPMENT SUPPLIED DATA**

COMPONENTS	QTY	OVERALL DIMENSIONS (Inches)	UNIT WT. (Pounds)
Data Switching Group OA-266/SSA or	1	14 x 28.6 x 74.2	740
Data Switching Group OA-266A/SSA or	1	14 x 28.6 x 74.2	725
Data Switching Group OA-266B/SSA	1	19 x 27.68 x 74.2	850

**REFERENCE DATA AND LITERATURE**

Technical Manuals:  
NAVSHIPS 91639(A)

DATE: 1 July 1964

ITEM NAME: DATA SWITCHING GROUP

COGNIZANT SERVICE: USN

TYPE: OA-496/SSA

FEDERAL STOCK NUMBER: 5895-644-4470  
5895-644-4708 W/S

	USA	USN	USAF	USMC
STATUS OR TYPE CLASSIFICATION				
Mfg(s) Name or Code Number: Pacific Div., Bendix Aviation Corp., North Hollywood, California				

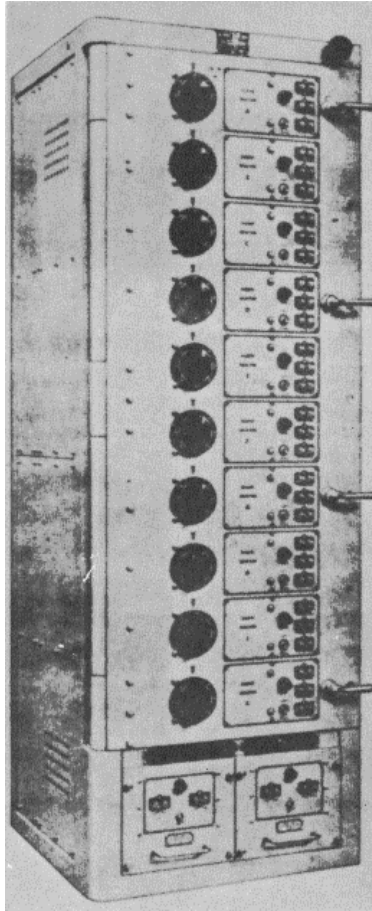

### FUNCTIONAL DESCRIPTION

The OA-496/SSA receives seven sources of radar data and permits the automatic selection of the desired source of information by the operation of remote rotary switches located adjacent to repeater stations. A

potential-matching servo system, partially in the selector switch, positions the radar selector switch in the data switching group to coincide with the position of the remote selector switch. An "AUTO-MANUAL" switch permits manual operation of the selector switch at the data switching unit.

OA-496/SSA: 1

**ITEM NAME:** DATA SWITCHING GROUP

**TYPE:** OA-496/SSA

Ten radar selector switches with amplifiers supplying video and trigger signals to remote repeater stations and two power supplies are mounted in each data switching group cabinet.

The equipment serves as part of a radar data distribution group for naval vessels.

**RELATION TO SIMILAR EQUIPMENT**

None.

**TECHNICAL DESCRIPTION**

Frequency Range: 20 cps to 15 mc  
Input Impedance  
Video Amplifiers: 70 ohms  
Trigger Amplifiers: 70 ohms

Output Impedance  
Video Amplifiers: 70 ohms  
Trigger Amplifiers: 70 ohms  
Operating Power Requirements: 115v, 60 cps, 3-ph at 10 amp; 115v, 60 cps, 1-ph at 4 amp.  
Ambient Temperature Range: -28°C to plus 65°C.  
Heat Dissipation: 300w

**INSTALLATION CONSIDERATIONS**

Related Equipment: Used in conjunction with Amplifier Assembly AM-518/SSA, Rotary Switch SA-243/SSA and Rotary Switch SA-247/SSA.

**PRINCIPAL COMPONENTS AND PHYSICAL DATA**

**SHIPPING DATA**

<b>COMPONENT</b>	<b>BOXES (NR.)</b>	<b>OVERALL DIMENSIONS (Inches)</b>	<b>UNIT WT. (Pounds)</b>
Data Switching Group OA-496/SSA		42 x 51.4 x 84	1515

**EQUIPMENT SUPPLIED DATA**

<b>COMPONENT</b>	<b>BOXES (NR.)</b>	<b>OVERALL DIMENSIONS (Inches)</b>	<b>UNIT WT. (Pounds)</b>
Data Switching Group OA-496/SSA	1	23.5 x 25.6 x 71.49	925

**REFERENCE DATA AND LITERATURE**

Technical Manuals:  
NAVSHIPS 92256(A): for Data Switching Group OA-496/SSA, OA-496A/SSA and Associated Units:  
Amplifier Assembly AM-518/SSA  
Rotary Switch SA-243/SSA  
Rotary Switch SA-247/SSA

**OA-496/SSA: 2**

DATE: 1 July 1964

ITEM NAME: RADAR TRAINING -EQUIPMENT

COGNIZANT SERVICE: USN

TYPE: OBJ

FEDERAL STOCK NUMBER:

	USA	USN	USAF	USMC
STATUS OR TYPE CLASSIFICATION				
Mfg(s) Name or Code Number: Sentinel Radio Corporation, Evanston, Illinois				

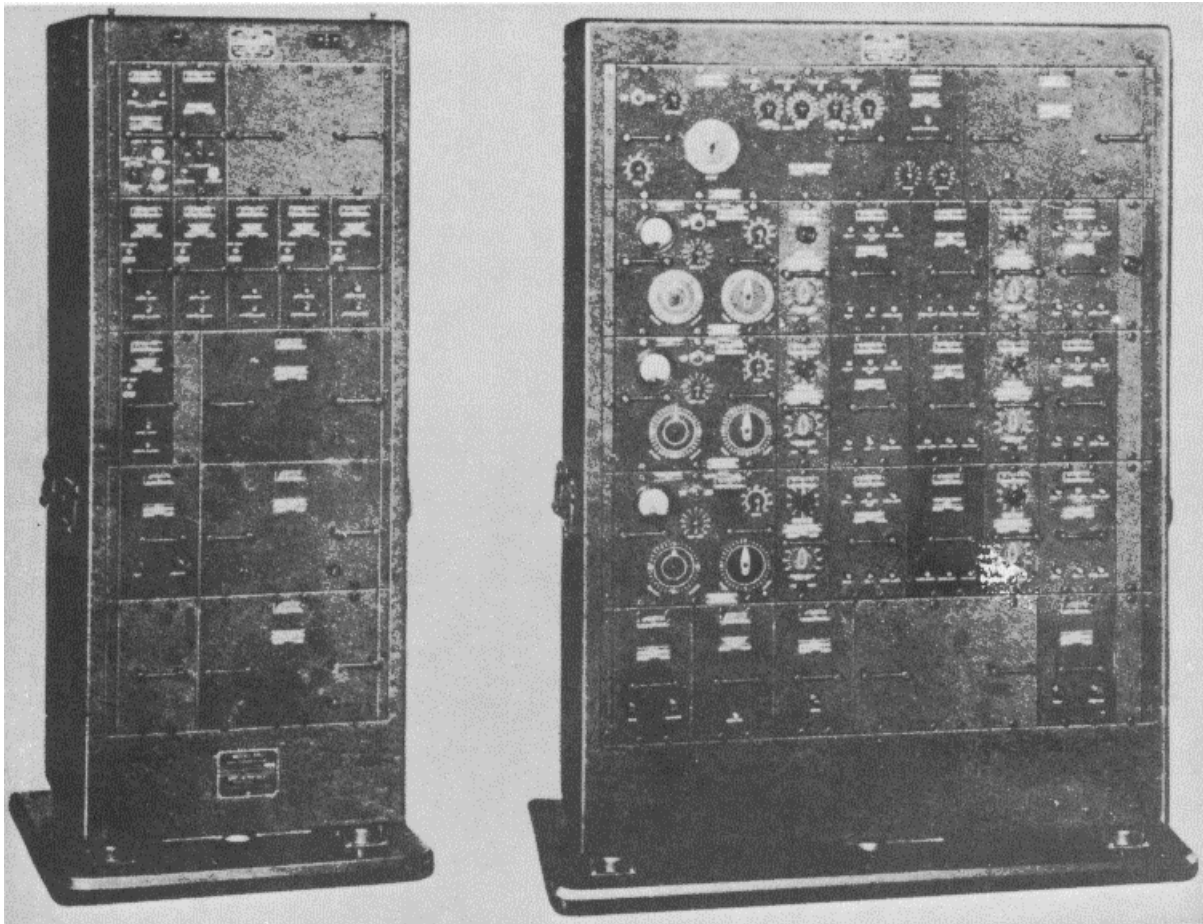

**FUNCTIONAL DESCRIPTION**

The OBJ is designed to train students in the operation of standard surface search radar equipment such as the SG, SU, SF or SL without requiring the student to be on shipboard.

The equipment consists of two units, the signal generator cabinet and control console; it simulates actual problems encountered on shipboard.

Data on this sheet reflects the following field changes, MOD Kits A and B.

OBJ: 1



**ITEM NAME:** RADAR TRAINING EQUIPMENT

**TYPE:** OBJ

**RELATION TO SIMILAR EQUIPMENT**

None.

**INSTALLATION CONSIDERATIONS**

Not available.

**TECHNICAL DESCRIPTION**

Power Source Required: 115v ac, 60 cps,  
1-ph.

**PRINCIPAL COMPONENTS AND PHYSICAL DATA**

<b>COMPONENTS</b>	<b>QTY</b>	<b>OVERALL DIMENSIONS (Inches)</b>	<b>UNIT WT. (Pounds)</b>
Signal Generator Assy NT-6OACH	1		
Control Console NT-23AES	1		

**REFERENCE DATA AND LITERATURE**

Technical Manuals:  
NAVSHIPS 900, 241

**OBJ: 2**

**DATE:** 1 July 1964

**ITEM NAME:** RADAR TRAINING EQUIPMENT

**COGNIZANT SERVICE:** USN

**TYPE:** OCJ, OCJ-1

**FEDERAL STOCK NUMBER:**

	USA	USN	USAF	USMC
STATUS OR TYPE CLASSIFICATION				
Mfg(s) Name or Code Number: Raytheon Manufacturing Co., Waltham, Massachusetts				

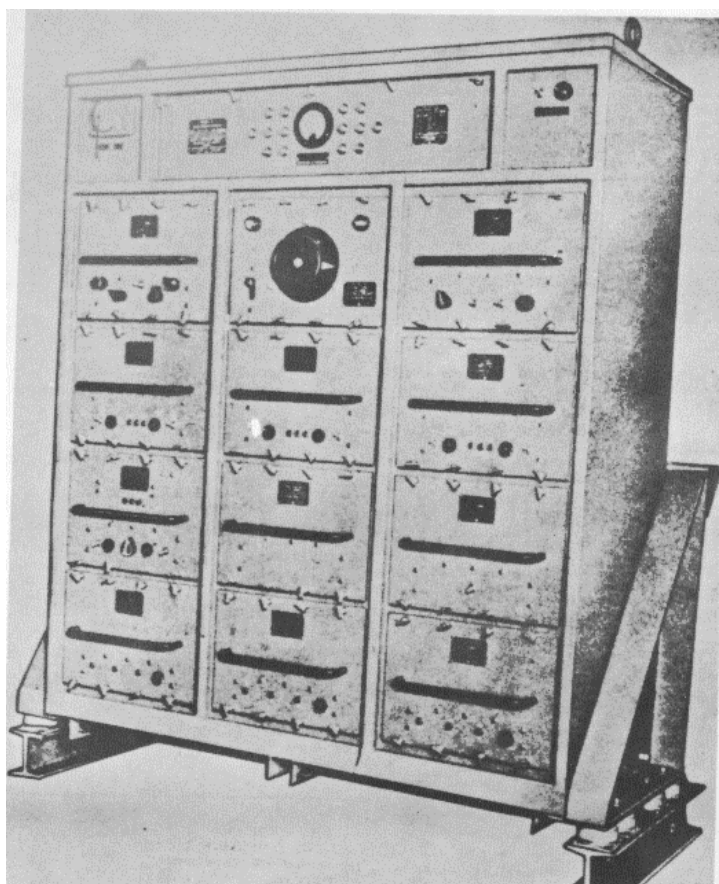

### FUNCTIONAL DESCRIPTION

The OCJ and OCJ-1 is an electromechanical system which, when used in conjunction with the console of an air-search radar equipment, simulates actual operating

conditions encountered with air-search radar. The simulation of six targets, which are individually in range, bearing, and intensity is achieved by the use of electromechanical systems.

**OCJ: 1**

**ITEM NAME:** RADAR TRAINING EQUIPMENT

**TYPE:** OCJ, OCJ-1

**RELATION TO SIMILAR EQUIPMENT**

OW-1 is similar to Radar Training Equipment OCJ.

**TECHNICAL DESCRIPTION**

Simulated

- Number Simulated Targets: 6
- Range: 150 mi max, 1000 yd min
- Bearings: 0 to 360
- Antenna Horizontal Beamwidth: Adjustable from 4 to 250
- Target Echo Pulse Length: 1, 2 or 4 usec
- Noise
  - High, Random Frequency: 13.5 to 16.5 mc
  - Low, Random Frequency: 0 to 10 cps
- Interference
  - Wildcatting: 60 to 200 pps plus or minus 10%.
  - Continuous Wave: 15 mc
  - Noise, Random Frequency
    - Sine Wave AM: 8 cps, 5 kc or 250 kc plus or minus 10%.

Program Duration: 30 to 60 min  
External Trigger

- Amplitude: 9 to 12v
- Polarity: positive
- Repetition Rate: 60 to 600 pps.
- Internal Trigger
  - Amplitude: 40v (across 75 ohms).
  - Polarity: positive
  - Repetition Rate: 60, 150, 200, 300, 400 or 600 pps
- IF Output
  - Radar Modulator: 15 mc
  - Frequency Converter: 30 and 60 mc
- Heat Dissipation
  - Target Simulator: 300w
  - Radar Signal Simulator: 855w
  - Electronic Control Amplifier: 85w
- Operating Power: 104 to 126v, 58 to 62 cps, 1-ph, 78.5% pf.

**INSTALLATION CONSIDERATIONS**

- Related Equipment  
Required but not Supplied.
- (1) Radar Console SR, SA, SC, or SK;
  - (2) Main Line Switch; (1) Instruction Book for applicable to Radar used.
  - (1) 5G or 5CT Synchro (as required).

**PRINCIPAL COMPONENTS AND PHYSICAL DATA**

**SHIPPING DATA**

COMPONENT	BOXES		OVERALL DIMENSIONS (Inches)	UNIT WT. (Pounds)
	OCJ	(NR.) OCJ-1		
Target Simulator NT-S2ADY	1		29 x 42-1/2 x 43	705
Target Simulator NT-S2AEA		1	29 x 42-1/2 x 43	705
Radar Signal Simulator NT-52ADZ	1		30 x 59 x 70	1437
Radar Signal Simulator NT-52AEB		1	30 x 59 x 70	1437
Electronic Control Amplifier NT-50AKW		1		
Case NT-10690	1	1	16-3/4 x 25 x 35	198
Case NT-10743		1		
Equipment Spares	5	1		

**OCJ: 2**

**ITEM NAME:** RADAR TRAINING EQUIPMENT

**TYPE:** OCJ, OCJ-1

**PRINCIPAL COMPONENTS AND PHYSICAL DATA (Cont.)**

**EQUIPMENT SUPPLIED DATA**

COMPONENT	QTY		OVERALL DIMENSIONS (Inches)	UNIT WT. (Pounds)
	OCJ	OCJ-1		
Target Simulator NT-52ADY	1		20 x 36 x 37	500
Target Simulator NT-52AEA		1	20 x 36 x 37	500
Radar Signal Simulator NT-52ADZ	1		24 x 55 x 63	1037
Radar Signal Simulator NT-5.AEB		1	24 x 55 x 63	1037
Electronic Control Amplifier NT-SOAKW		1	12-5/8 x 16 x 28	
Case NT-10690	1	1	13-1/4 x 22-3/8 x 30-1/4	331
Case NT-10743		1	5-5/8 x 12-1/4 x 21-1/2	36
Spare Parts	5	*		

**NOTE:** \* Information not available.

**REFERENCE DATA AND LITERATURE**

Technical Manuals:  
 NAVSHIPS 900, 996: for Navy Model OCJ.  
 NAVSHIPS 91332(A): for Navy Model OCJ-1.

**OCJ: 3**

DATE: 1 July 1964

ITEM NAME: RADAR TRAINING EQUIPMENT

COGNIZANT SERVICE: USN

TYPE: OCZ

FEDERAL STOCK NUMBER: 6940-375-9164  
6940-664-B486 W/S

	USA	USN	USAF	USMC
STATUS OR TYPE CLASSIFICATION				
Mfg(s) Name or Code Number: Airplane and Marine Instrument, Inc., Clearfield, Pa.				

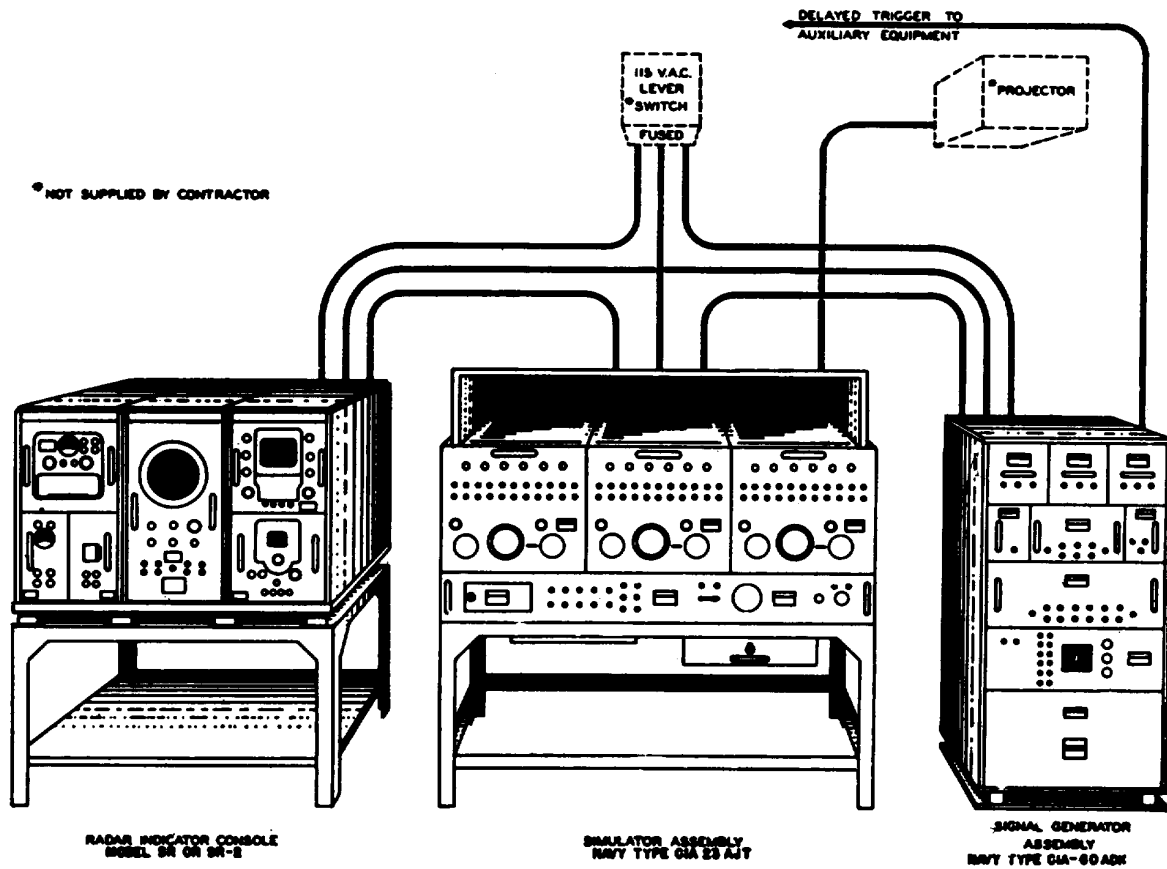

**FUNCTIONAL DESCRIPTION**

The OCZ generates three synthetic aircraft target echoes which are independently positioned in space by

means of individual calibrated controls for target speed, course, and rate of climb. The synthetic echoes are delivered to the intermediate frequency stages of a standard Navy shipboard air search radar and displayed on the indicator tubes of the radar equipment used.

OCZ: 1

**ITEM NAME:** RADAR TRAINING EQUIPMENT

**TYPE:** OCZ

**RELATION TO SIMILAR EQUIPMENT**

None.

Operating: 10.5 amp  
Standby: 2.0 amp  
Operating Power: 100 to 130v, 58 to 60  
cps, 1-ph  
Power Factor: 68%

**TECHINCAL DESCRIPTION**

IF Output Frequency: 15 or 30 mc  
Repetition Rate: 60 or 200 cps  
Trainer Input Power  
Starting: 4 kva  
Operating: 1.2 kva  
Standby: 0.2 kva  
Current Signal Generator Assembly  
Starting: 5.3 amp  
Operating: 5.4 amp  
Standby: 2.0 amp  
Current Simulator Assembly  
Starting: 34.5 amp

**INSTALLATION CONSIDERATIONS**

Related Equipment:  
Required but not Supplied.  
(as required) Cable DCOP-4, (as required) Cable DCOS-4, (as required) Cable RG-58/U, (as required) Cable MCOP-7, (as required) Cable MCOP-10, (1) Radar SR or SR-2, (1) SR or SR-2 Technical Manual, (1) Switch (SR-2 only), (1) Switch (optional).

**PRINCIPAL COMPONENTS AND PHYSICAL DATA**

**SHIPPING DATA**

<b>COMPONENT</b>	<b>BOXES (NR.)</b>	<b>OVERALL DIMENSIONS (Inches)</b>	<b>UNIT WT. (Pounds)</b>
Antenna Position Simulator NT-23AJS Radar Target Simulator (3 Units) NT-23AJR	1	31 x 32 x 64-1/2	998
Frame NT-10635 Light Shield (Part of NT-23AJT)	1	28-1/2 x 32 x 63	297
Jumper Cable and Accessories Signal Generator Assy NT-6OADK	1	23 x 28 x 63	640
Equipment Spares	1	15-1/4 x 20 x 41	236
Equipment Spares	1	15-1/4 x 20 x 41	250
Equipment Spares	1	15-1/4 x 20 x 41	168

**EQUIPMENT SUPPLIED DATA**

<b>COMPONENTS</b>	<b>QTY</b>	<b>OVERALL DIMENSIONS (Inches)</b>	<b>UNIT WT. (Pounds)</b>
Simulator Assembly NT-23AJT	1	27 x 60 x 65	742
Signal Generator Assy NT-6OADK	1	18 x 25 x 57	418
Jumper Cables	12		
Cable Connectors	39		

**REFERENCE DATA AND LITERATURE**

Technical Manuals:  
NAVSHIPS 900,955

DATE: 1 July 1964

ITEM NAME: RADAR TRAINING EQUIPMENT

COGNIZANT SERVICE: USN

TYPE: OCZ-1

FEDERAL STOCK NUMBER: 6940-200-3205

	USA	USN	USAF	USMC
STATUS OR TYPE CLASSIFICATION				
Mfg(s) Name or Code Number: Airplane and Marine Instrument, Inc., Clearfield, Pa.				

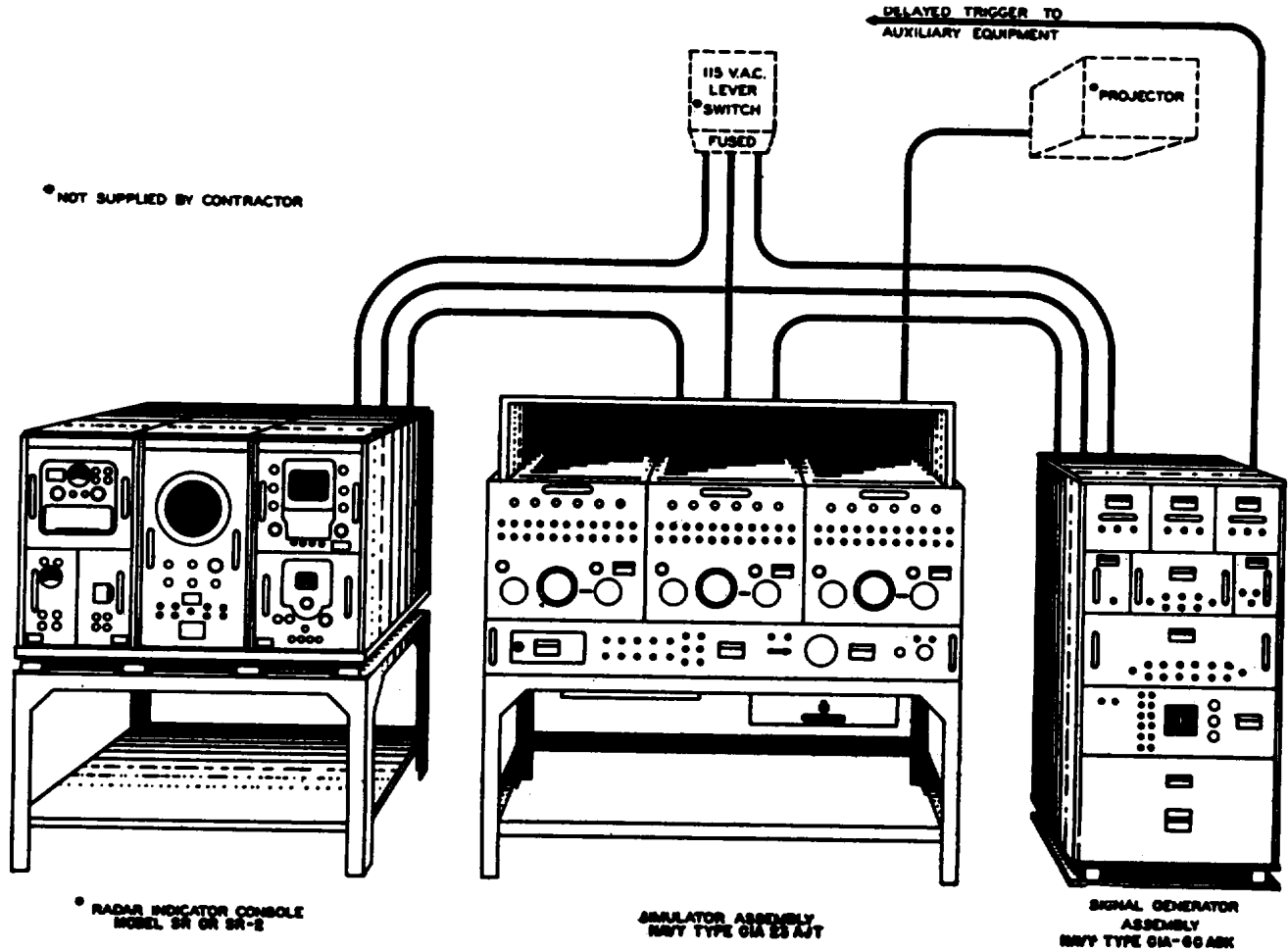

**FUNCTIONAL DESCRIPTION**

The OCZ-1 generates three synthetic aircraft target echoes which are independently positioned in space by means of calibrated controls for target speed, course,

and rate of climbs. The synthetic echoes are delivered to the intermediate frequency stages of a standard Navy shipboard air-search radar and displayed on the indicator tubes of the radar equipment used.

**ITEM NAME:** RADAR TRAINING EQUIPMENT

**TYPE:** OCZ-1

**RELATION TO SIMILAR EQUIPMENT**

None.

Current Requirements, Simulator Assembly  
Starting: 34.5 amp  
Operating: 10.5 amp  
Standby: 2.0 amp  
Operating Power: 100 to 130v, 1-ph, 58  
to 62 cps.  
Power Factor: 86%

**TECHNICAL DESCRIPTION**

IF Output Frequency: 15, 30, or 60 mc  
Repetition Rate: 60, 150, 200, 300, 400,  
and 600 cps.  
Pulse Width: .1, 2, or 4 usec  
Trainer Input Power  
Starting: 4 kva  
Operating: 1.2 kva  
Standby: 0.2 kva  
Current Requirements, Signal Generator  
Assembly  
Starting: 5.3 amp  
Operating: 5.2 amp  
Standby: 2.0 amp

**INSTALLATION CONSIDERATIONS**

Related Equipment:  
Required but not Supplied.  
(as required) Cable DCOP-4, (as re-  
quired) Cable DCOS-4, (as required)  
Cable RG-58/U, (as required) Cable  
MCOP-7, (as required) Cable MCOP-10,  
(1) Radar w/Applicable Technical Man-  
ual, (2) Switch.

**PRINCIPAL COMPONENTS AND PHYSICAL DATA**

**SHIPPING DATA**

<b>COMPONENT</b>	<b>BOXES (NR.)</b>	<b>OVERALL DIMENSIONS (Inches)</b>	<b>UNIT WT. (Pounds)</b>
Antenna Position Simulator NT-23A3S-1 Radar Target Simulator (3 Units) NT-23A3R-1	1	31 x 32 x 64-1/2	1010
Frame NT-10635-A Light Shield NT-23AJT-1 Calculator NT-10AHF-1 Jumper Cables and Accessories	1	28-1/2 x 32 x 63	297
Signal Generator Assy NT-6OADK-1 Equipment Spares	1 1	23 x 28 x 63 16-1/2 x 16 x 27	640 195

**EQUIPMENT SUPPLIED DATA**

<b>COMPONENTS</b>	<b>QTY</b>	<b>OVERALL DIMENSIONS (Inches)</b>	<b>UNIT WT. (Pounds)</b>
Simulator Assy NT-23AJT-1	1	27 x 60 x 65	755
Signal Generator Assy NT-60ADK-1	1	19 x 25 x 57	418
Jumper Cables Completely Assembled with Connectors	12		
Cable Connectors	39		

**REFERENCE DATA AND LITERATURE**

Technical Manuals:  
NAVSHIPS 91215



DATE: 1 July 1964

ITEM NAME: DIRECTION DATA CONVERTER

COGNIZANT SERVICE: USN

TYPE: PU-155/SP, PU-155(XN-1)/SP,  
PU-155A/SP, PU-155B/SP

FEDERAL STOCK NUMBER: See Note 1

	USA	USN	USAF	USMC
STATUS OR TYPE CLASSIFICATION				
Mfg(s) Name or Code Number: See Note 2				

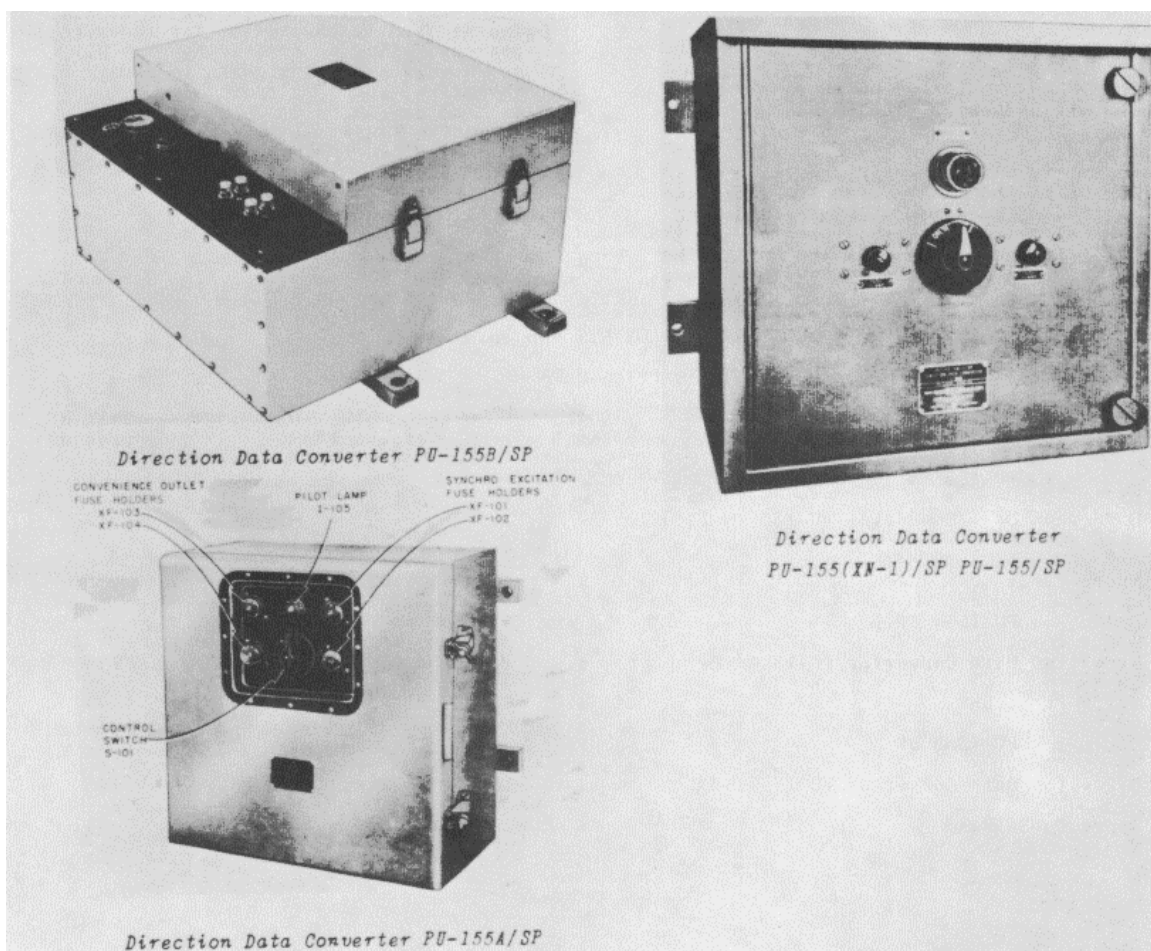

**FUNCTIONAL DESCRIPTION**

The PU-155/SP, PU-155(XN-1)/SP, PU-155A/SP and PU-155B/SP are electromechanical devices to convert step-by-step position signals into corresponding synchro signals. It is used as an intermediate unit between a Dead Reckoning Analyzer which supplies

step-by-step position data and a radar repeater which has a synchro-controlled provision for offsetting the origin of a PPI display. The dead reckoning analyzer supplies two step-by-step signals which represent respectively the north-south and east-west components of ship's movement.

**ITEM NAME:** DIRECTION DATA CONVERTER

TYPE: PU-155/SP, PU-155(XN-1)/SP,  
PU-155A/SP, PU-155B/SP

The Direction Data Converter translates these signals into two synchro signals which represent the same components. The synchro signals are used in the radar repeater to offset the origin of the PPI display in the north-south and east-west directions in proportion to the ships movement indicated by the signals. In this manner the display, when once centered on a given reference point, remains centered on the same point regardless of own ships movement.

**RELATION TO SIMILAR EQUIPMENT**

The PU-155(XN-1)/SP and PU-155/SP have four sets of gears. The PU-155A/SP and PU-155B/SP have three. Intermediate gear ratios differ but the final results are the same in terms of gear reduction ratio. With the PU-155(XN-1)/SP and PU-155/U the direction of rotation of remotely driven synchros is the opposite of that which the PU-155A/SP and the PU-155B/SP, but can be made the same by an interchange of connections either at the step-motor or at the synchro generator.

**TECHNICAL DESCRIPTION**

Power Supply: 115v, 1-ph, 60 cps, 4 to 16 amps (depending on the number of repeaters fed).  
Input Signals: Two 115v dc, 4-wire step-by-step signals from Dead Reckoning Analyzer; max power 26w. Total Dead Reckoning Analyzer speed 750 rpm.  
Outputs: Synchro excitation for radar repeaters, 115v, 60 cps, 1-ph. Two 90v ac; 3-wire synchro signals to radar repeaters; speed, 1 rpm.  
Heat Dissipation  
PU-155(XN-1)/SP: 125w, max  
PU-155/SP, PU-155A/SP, PU-155B/SP: 88w

**INSTALLATION CONSIDERATIONS**

Not available.

**PRINCIPAL COMPONENTS AND PHYSICAL DATA**

**SHIPPING DATA**

COMPONENT	BOXES (NR.)	OVERALL DIMENSIONS (Inches)	UNIT WT. (Pounds)
PU-155(XN-1)/SP, PU-155/SP Direction Data Converter PU-155(XN-1)-P or PU-155/SP	1		212
Spare Parts Box PU-155A/SP	1	10 x 16 x 22	75
Direction Data Converter PU-155A/SP	1	16-3/4 x 22-1/2 x 27	170
Spare Parts Box	1	9 x 17 x 25	42
PU-155B/SP Direction Data Converter PU-155B/SP	1	16-1/2 x 23 x 27-1/2	145
Spare Parts Box	1	3-5/8 x 4-3/8 x 7-3/4	4.0

**PU-155/SP: 2**

**ITEM NAME:** DIRECTION DATA CONVERTER

**TYPE:** PU-155/SP, PU-155(XN-1)/SP,  
PU-155A/SP, PU-155B/SP

**PRINCIPAL COMPONENTS AND PHYSICAL DATA (Cont.)**

**EQUIPMENT SUPPLIED DATA**

<b>COMPONENTS</b>	<b>QTY</b>	<b>OVERALL DIMENSIONS (Inches)</b>	<b>UNIT WT. (Pounds)</b>
PU-155(XN-1)/SP, PU-155/SP			
Direction Data Converter PU-155(XN-1)/SP or PU-155/SP	1	11-11/16 x 18-7/8 x 22-1/4	120
Spare Parts Box	1	6 x 12 x 18	34
Technical Manuals NAVSHIPS 91197 PU-155A/S P	2		
Direction Data Converter PU-155A/SP	1	11-7/8 x 19-3/8 x 21-3/4	122
Spare Parts Box	1	6 x 12 x 18	25
Technical Manuals NAVSHIPS 91197 PU-155B/SP	2		
Direction Data Converter PU-155B/SP	1	11-1/8 x 17-3/4 x 20-1/2	100
Spare Parts Box	1	3-5/8 x 4-3/8 x 7-3/4	3.3
Technical Manuals NAVSHIPS 92172	2		

**REFERENCE DATA AND LITERATURE**

Technical Manuals:

NAVSHIPS 91100: for Direction Data Converter PU-155(XN-1)/SP.  
NAVSHIPS 91197: for Direction Data Converter PU-155A/SP.  
NAVSHIPS 92172: for Direction Data Converter PU-155B/SP.

NOTE 1. PU-155/SP : 5840-642-7967  
5840-665-2073  
PU-155A/SP: 5840-642-7968  
5840-665-2064  
PU-155B/SP: 5840-665-1894

NOTE 2. PU-155(XN-1)/SP: General Electric Co., Schenectady, N. Y.  
PU-155A/SP: Raytheon Mfg Co., Waltham, Mass.  
PU-155B/SP: Ultrasonic Corp., Cambridge, Mass.

**PU-155/SP: 3**

DATE: 1 July 1964

ITEM NAME: RADAR RECEIVER

COGNIZANT SERVICE: USN

TYPE: R-223/SPR

FEDERAL STOCK NUMBER: 5840-238-9880  
5840-669-6805 W/S

	USA	USN	USAF	USMC
STATUS OR TYPE CLASSIFICATION				
Mfg(s) Name or Code Number: General Communication Company, Boston, Massachusetts				

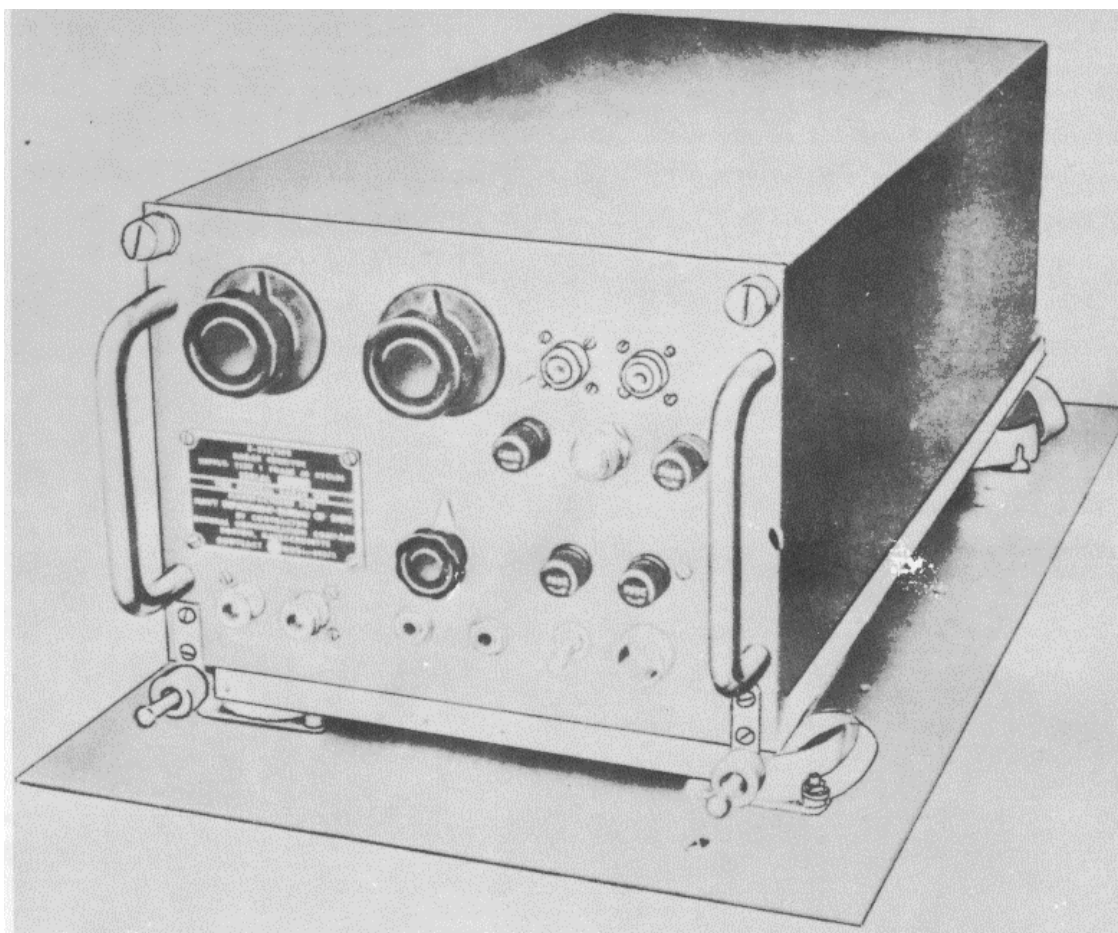

**FUNCTIONAL DESCRIPTION**

The R-223/SPR is designed to operate with any of the models RDO, AN/APR-1, AN/SPR-1, AN/SPR-2 series of radar intercept receivers similarly, its antenna requirements are the same as those of the receiver with

which it is employed. Thus, to add the R-223/SPR to any of the above sets, no additional equipment except for the short pieces of antenna and video cable is necessary. Data on this sheet reflects the following field changes, FC-1.

R-223/SPR: 1

**ITEM NAME:** RADAR RECEIVER

**TYPE:** R-223/SPR

**RELATION TO SIMILAR EQUIPMENT**

None.

Operating Power: 115v, 69 cps, 1-ph,  
115w.

**TECHNICAL DESCRIPTION**

Frequency Range: 40 to 3000 mc, without  
any tuning controls.

Type Circuit: Crystal detector and un-  
tuned video amplifier.

**INSTALLATION CONSIDERATIONS**

Related Equipment:

Required but not Supplied.

(1) Power Cable MCOS-2, (1) Video Cable  
RG-8/U (3 ft long), (1) Antenna Jumper  
Cable RG-8/U (3 ft lg).

**PRINCIPAL COMPONENTS AND PHYSICAL DATA**

<b>COMPONENTS</b>	<b>QTY</b>	<b>OVERALL DIMENSIONS (Inches)</b>	<b>UNIT WT. (Pounds)</b>
Radar Receiver R-223/SPR	1	7-5/8 x 10-1/4 x 21-1/2	38
Equipment Spare Parts Box consists of:	1		
Right Angle Adapters NT-49192	2	25/64 dia x 1-1/4 x 1-1/4	
Plugs NT-49190	2	23/64 dia x 1-5/8	
Right Angle Adapters UG-27/U	2	25/32 dia x 1-7/16 x 1-7/16	
Plugs UG-21/U	2	13/16 dia x 1-3/4	
Power Plug ac AN3102-14S-7P	1	29/32 x 1-3/16 x 1-3/16	
Cable Clamp AN-3057-6	1	15/16 dia x 1-5/16	
Technical Manual	2		

**REFERENCE DATA AND LITERATURE**

Technical Manuals:  
NAVSHIPS 900, 991

**R-223/SPR: 2**

DATE: 1 July 1964

ITEM NAME: RADAR EQUIPMENT

COGNIZANT SERVICE: USN

TYPE: SA, SA-1, SA-2, SA-3

FEDERAL STOCK NUMBER: SA - F5840-665-3728; SA-1 - F5840-644-4636  
SA-2 - F5840-644-4656; SA-3 - F,840-665-2256

	USA	USN	USAF	USMC
STATUS OR TYPE CLASSIFICATION		Obsoles		
Mfg(s) Name or Code Number: RCA Victor				

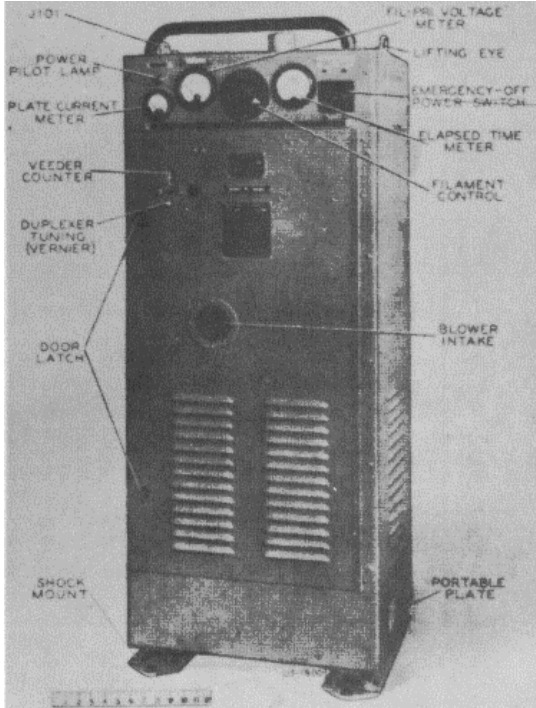

### FUNCTIONAL DESCRIPTION

Radar Equipments SA, SA-1, SA-2, and SA-3 are lightweight, short range air-search radars that may also be used for surface search. They are used in both ship and shore installations.

The SA and SA-1 are similar. The SA-1 employs equivalent but slightly modified units. The SA-1 and SA-2 differ principally in that the SA-2 employs, in addition to a receiver-indicator, a PPI. A PPI is added to the SA in the field. The SA-3 is identical to the SA-2 except for differences in the antenna train system.

### RELATION TO SIMILAR EQUIPMENT

None.

### TECHNICAL DESCRIPTION

#### Maximum Reliable Range:

- Bombers - 50 mi at 30,000 ft;  
40 mi at 10,000 ft
- Fighters - 30 mi at 10,000 ft
- Battleships - 20 mi
- Cruisers - 20 mi
- Destroyers - 10 mi
- Submarines - 3 mi

Range Resolution: 500 yd

Azimuth Resolution: 15 deg

Range Accuracy:  $\pm 50$  yd

Azimuth Accuracy: 1 deg

Range, Min: 1.25 mi

#### Operating Voltages and Power Requirements:

- SA-1 - 110 to 120 +5v, 69 cps, 1-ph, 1,340 kw
- SA, SA-2, SA-3 - 110 to 1.;)  $\pm 5v$ , 60 cps, 1-ph, 3.73 kw

#### Range Presentation:

- SA, SA-1 - 5-in. A-scope; 15-, 75-, and 375-mi ranges with range stop and dial

- SA-2, SA-3 - 5-in. A-scope; 20-, 80-, and 400-mi ranges with range stop; 2-in. CRT for calibrating

Azimuth Presentation: Relative and true bearing with rotating "bug"; true bearing of antenna on inner dial, relative bearing on outer dial.

Frequency: 175 to 225 mc

Peak Power Output: 100 kw

Pulse Repetition Rate: 60 pps

Pulse Width: 5  $\mu$ sec

IF. Frequency: 15 mc

Bandwidth: SA - 1 mc if.; SA-2 - 0.7 mc if.

Noise Figure: 7 db

Antenna Reflector: Rectangular mattress

Antenna Feed: 50 ohm coaxial

Antenna Polarization: Horizontal

Horizontal Beam Width: SA-1 - 45 deg; SA-2 and SA-3 - 30 deg

Vertical Beam Width: 52 deg

SA, SA-1, SA-2, SA-3

Antenna Gain: 13.5 db  
Antenna Scan: Continuous, 360 deg at 2.5 or 5 rpm by motor or manually; fixed elevation at 5 deg left-right lobe switching is optional; sector sweep thru 90 deg

for access and cables. Receiver-indicator should be below deck, but does not have to be close to transmitter. Train indicator-control unit should be on the right side of and adjacent to the receiver indicator.  
Mounting: Transmitter is shock mounted to deck and bulkhead; receiver-indicator and train indicator-control units are shock mounted to table.  
Cabling Requirements: Most all interconnecting cables must be fabricated. Cable lengths are not critical, but normally should not be more than 100 feet long.  
Related Equipment:

**INSTALLATION CONSIDERATIONS**

Siting: Transmitter may be placed at any convenient location below decks where there is additional space

**PRINCIPAL COMPONENTS AND PHYSICAL DATA**

COMPONENT	QTY	HEIGHT (Inches)	WIDTH (Inches)	DEPTH (Inches)	UNIT WT. (Pounds)
Antenna Assembly 66ABQ (SA)	1	104	60	26-3/4	209
66ABR (SA-1)	1	72	59-1/2	29-1/2	65
66AEW (SA-2, -3)	1	104	60	26-3/4	228
Radar Transmitter 52ABD (SA, SA-1)	1	51-3/4	20-15/16	17-1/8	285
52ABD-2 (SA-2, SA-3)	1	52-3/8	20-15/16	17-5/16	285
Radar Receiver-Indicator					
46ABA (SA)	1	25-21/32	22-1/4	21-1/2	150
46ABB (SA-1)	1	25-21/32	22-1/4	21-1/2	150
46ACG-2 (SA-2, -3)	1	25-5/16	22-1/4	21-1/2	150
Train-Indicator-Control Unit					
55ABK (SA)	1	25-21/32	24-23/32	14-11/32	181
55ABM (SA-1)	1	25-21/32	24-23/32	14-11/32	114
55ABL (SA-2, -3)	1	25-21/32	24-23/32	14-11/32	181
Antenna Pedestal 10AEE (SA-1)	1	23-7/8	6-1/2	6-1/2	35
10ACH (SA-2)	1	42	19	19	288
10AEQ (SA-3)	1	42	19	19	288

**REFERENCE DATA AND LITERATURE**

Technical Manuals:  
SHIPS 210  
SHIPS 211  
SHIPS 276  
SHIPS 283  
NAVSHIPS 900,733

DATE: 1 July 1964

ITEM NAME: RADAR SIGNAL DISTRIBUTION  
SWITCHBOARD

COGNIZANT SERVICE: USN

TYPE: SB-440/SP\*, SB-441/SP\*\*, SB-442/SP\*\*\*

FEDERAL STOCK NUMBER: F5840-504-9949\*  
F5840-504-9948\*\*  
F5840-504-9947\*\*\*

	USA	USN	USAF	USMC
STATUS OR TYPE CLASSIFICATION				
Mfg(s) Name or Code Number: Admiral Corporation				

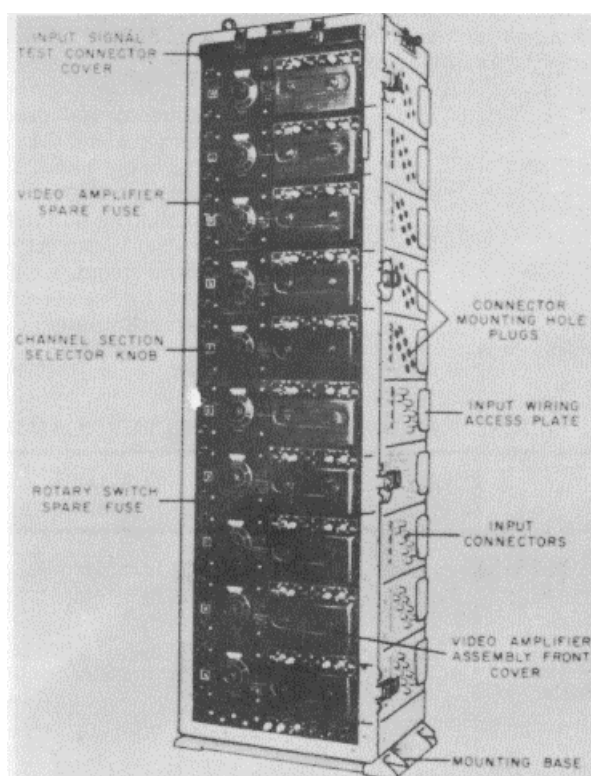

*Radar Signal Distribution  
Switchboard SB-442/SP*

**SB-440/SP: 1**



SB-440/SP, SB-441/SP, SB-442/SP

**FUNCTIONAL DESCRIPTION**

Radar Signal Distribution Switchboards SB-440/ SP, SB-441/SP, and SB-442/SP distribute video and trigger data to indicating equipments. Each switchboard accepts information from as many as seven radar and four IFF sets. The differences between the SB-440/SP, SB-441/SP, and SB-442/SP are in the number of master-control switches and the corresponding number of indicating equipments that can be handled. The number of master control switches equals the number of indicator equipments a switchboard can handle. The SB-440/SP handles five indicating equipments; the SB-441/SP handles seven indicating equipments; the SB-442/SP handles ten indicating equipments. All master control switches are identical. Switchboard inputs connect to rotary switch assemblies. The switch assemblies allow a single input to connect to any or all of the available indicating equipments.

**RELATION TO SIMILAR EQUIPMENT**

None.

**TECHNICAL DESCRIPTION**

Input and Output Impedance: 75 ohms

Peak Pulse Amplitude of Video Input and Output Signals: 0.2 to 3v  
Polarity of Input and Output Signals: Positive  
Peak Pulse Amplitude of Trigger Regenerator Input Signal: 5v (min)  
Peak Pulse Amplitude of Trigger Regenerator Output Signal: 20 ±5v  
Pulse Duration of Trigger Regenerator Output Signal: 3.5 to 4 µsec at 85% nom peak  
Rise Time of Trigger Regenerator Output Signal: 0.2 µsec or less

Operating Voltages and Power Requirements:  
SB-440/SP - 115 vac, 60 cps, 1-ph, 200w  
SB-441/SP - 115 vac, 60 cps, 1-ph, 280w  
SB-442/SP - 115 vac, 60 cps, 1-ph, 400w

**INSTALLATION CONSIDERATIONS**

Siting: Allow space on sides of switchboard to connect and disconnect input and output cabling; allow 21 inches in front of equipment for front panel assembly to be opened.

Mounting: Fasten securely to deck through six mounting holes; fasten at top of case according to instructions in NAVSHIPS 92903(A).

Cabling Requirements: Input and output cabling shall not exceed 300 feet.

Related Equipment: Standard Navy IFF and radar equipments.

**PRINCIPAL COMPONENTS AND PHYSICAL DATA**

COMPONENT	QTY	HEIGHT (Inches)	WIDTH (Inches)	DEPTH (Inches)	UNIT WT. (Pounds)
Radar Signal Distribution Switchboard SB-440/SP (Includes 5 Remote Master Control Switches)	1	39-7/8	21-1/2	15-5/8	176
Radar Signal Distribution Switchboard SB-441/SP (Includes 7 Remote Master Control Switches)	1	51-7/8	21-1/2	15-5/8	245
Radar Signal Distribution Switchboard SB-442/SP (Includes 10 Remote Master Control Switches)	1	69-7/8	21-1/2	15-5/8	356

**REFERENCE DATA AND LITERATURE**

Technical Manual:  
NAVSHIPS 92903(A)

**DATE:** 1 July 1964

**ITEM NAME:** RADAR SIGNAL DISTRIBUTION  
SWITCHBOARD

**COGNIZANT SERVICE:** USN

**TYPE:** SB-594(XN-1)/BP

**FEDERAL STOCK NUMBER:**

	USA	USN	USAF	USMC
STATUS OR TYPE CLASSIFICATION				
Mfg(s) Name or Code Number: Stavid Engineering, Inc.				

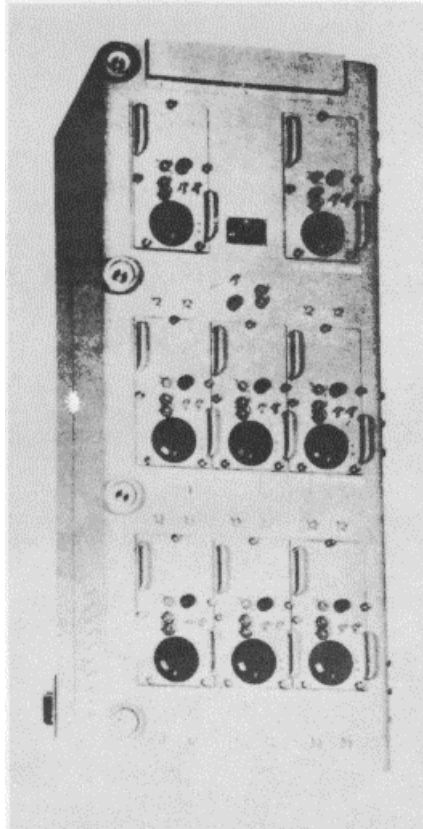

**FUNCTIONAL DESCRIPTION**

Radar Signal Distribution Switchboard SB-594(XN-1)/BP is an automatic switching equipment which provides for the selection of various ship's radar signals

and IFF information for presentation on remote repeaters.

**SB-594(XN-1)/BP: 1**

**ITEM NAME:** RADAR SIGNAL DISTRIBUTION SWITCHBOARD

**TYPE:** SB-594(XN-1)/BP

**RELATION TO SIMILAR -EQUIPMENT**

None.

Typical Information Channels: 1x synchro, 36x synchro, synchro excitation, IFF controls, IFF video, radar trigger, radar video.

**Outputs**

Maximum Number of Remote Indicator Repeaters: 8  
Maximum Total Number of Pulse Outputs: 38

**TECHNICAL DESCRIPTION**

Power Requirements: 115v, 60 cycle, 1-ph, 320w

**Inputs**

Maximum Number of Radars: 8  
Maximum Total Number of Pulse Inputs: 22

**INSTALLATION CONSIDERATIONS**

Not available.

**PRINCIPAL COMPONENTS AND PHYSICAL DATA**

**SHIPPING DATA**

<b>COMPONENT</b>	<b>PKGS</b>	<b>OVERALL DIMENSIONS (Inches)</b>	<b>UNIT WT. (Pounds)</b>
	1		450

**EQUIPMENT SUPPLIED DATA**

<b>COMPONENT</b>	<b>QTY</b>	<b>OVERALL DIMENSIONS (Inches)</b>	<b>UNIT WT. (Pounds)</b>
Radar Signal Distribution Switchboard SB-594(XN-1)/BP	1	20-1/2 x 23-1/8 x 54-3/8	270

**REFERENCE DATA AND LITERATURE**

Technical Manuals:  
NAVSHIPS 92899(A)

**SB-594(XN-1)/BP: 2**

ITEM NAME: RADAR EQUIPMENT

TYPE: SV, SV-1

PRINCIPAL COMPONENTS AND PHYSICAL DATA

EQUIPMENT SUPPLIED DATA (Cont.)

COMPONENTS	QTY	OVERALL DIMENSIONS (Inches)	UNIT WT. (Pounds)
66ALW**			
Waveguide Switching Unit 24AAK	1	9 x 13 x 20	75
Dummy Antenna 66AJW	1	20	11
Frequency Power Meter TS-295/UP	1	9 x 9 x 10	12
Spline Shaft	1	168 x 2.25 dia	100
Set of Waveguide Parts	1		
Set of Special Cables	1		
Echo Box 14ABG	1	7 x 8 x 16	10
Adapter Control Unit 23ABX*	1	5 x 6 x 10	7
Set of Equipment Maintenance Parts	1		

NOTE: \*Supplied w/SV only.  
\*\*Supplied w/SV-1 only.

REFERENCE DATA AND LITERATURE

NAVSHIPS 900548(A): for Radar Equipment Navy Model SV.  
SHIPS 341: for Radar Equipment Navy Model SV-1.

SV: 5

DATE: 1 July 1964

ITEM NAME: RADAR EQUIPMENT

COGNIZANT SERVICE: USN

TYPE: SX

FEDERAL STOCK NUMBER: 5840-642-7812 W/S

	USA	USN	USAF	USMC
STATUS OR TYPE CLASSIFICATION				
Mfg(s) Name or Code Number: General Electric Company, Syracuse, New York				

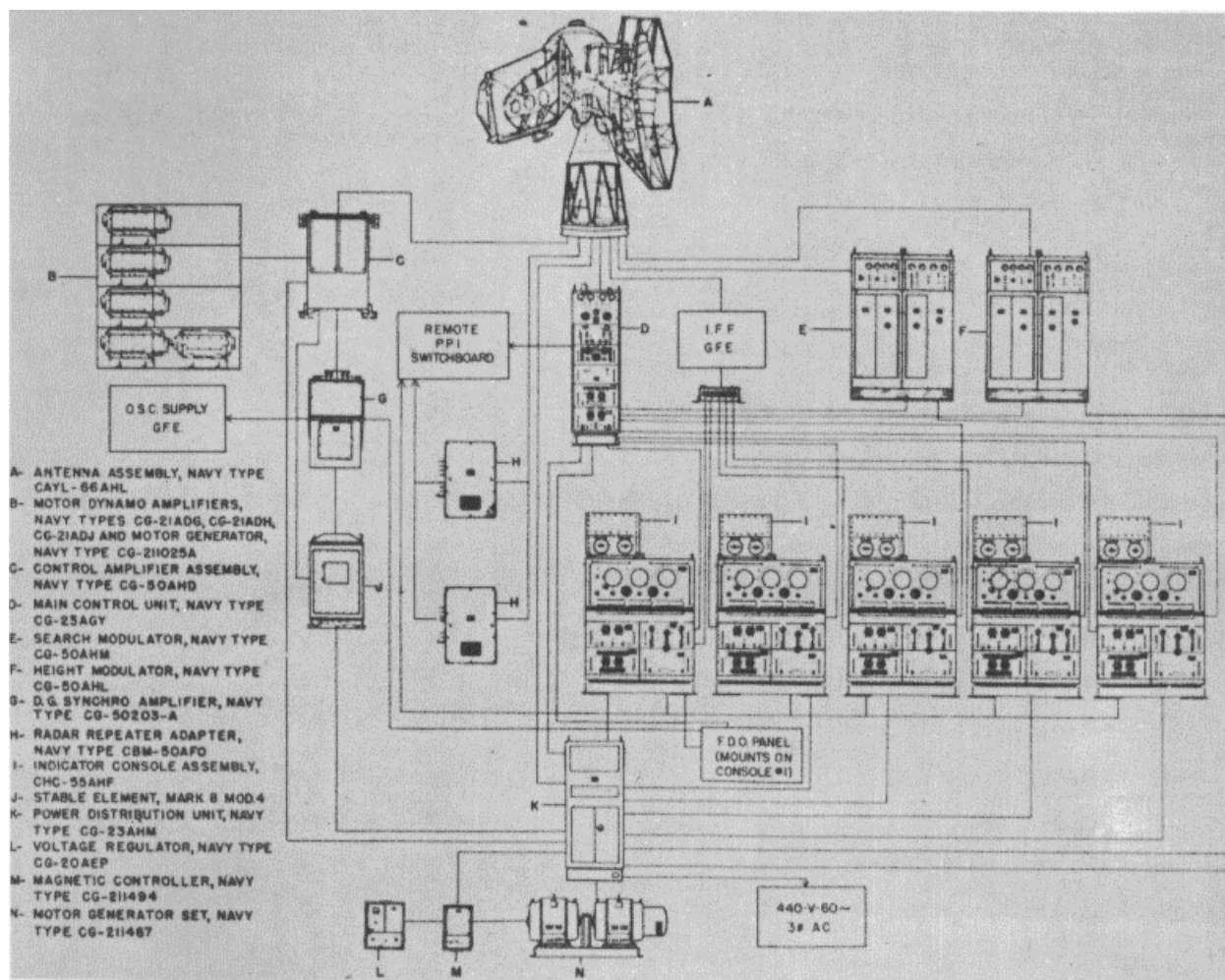

**FUNCTIONAL DESCRIPTION**

The SX is a high-power micro-wave radar system which performs the functions of long-range air and surface search and height determination of aircraft. The equipment is capable of indicating height, range, and

bearing information on a large number of targets with continuous train scan of the antenna. This feature allows the equipment to provide height and bearing data on several targets, and at the same time, provide unimpaired air and surface search. This is accomplished effectively by dividing the equipment into two major

**ITEM NAME:** RADAR EQUIPMENT

**TYPE:** SX

portions; namely, a search system and a height system.  
Data on this sheet reflects the following field changes:  
FC-1 to 10.

usec pw.  
Receiver  
Type: Superheterodyne.  
IF: 30 mc  
Power Supply  
Power Factor: 85% full load.  
Input: 440v, 3-ph 60 cps.  
Output: 440v, 3-ph, 60 cps, 31.3 kva,  
Ambient Temperature: 50°C

**RELATION TO SIMILAR EQUIPMENT**

None.

**TECHNICAL DESCRIPTION**

Frequency  
Search System Using  
4J31: 2860 to 2900 mc  
4J32: 2820 to 2860 mc  
4J33: 2780 to 2820 mc  
Height System Using 4J39: 3500 mc to 3550.  
Type Modulation: Pulse Modulated.  
Peak Power Output  
Search: 0.8 meqw at 390 pps and 1.0  
usec pw.  
Height: 0.5 meqw at 1170 pps and 1.0

**INSTALLATION CONSIDERATIONS**

Related Equipment:  
Required but not Supplied.  
(1) Stable Element Mark 8 Mod 4, (1)  
Stable Element Mark 8 Mod 4, (1) Stable  
Element Control Panel Mark 18 Mod 4, (1)  
Radar Distribution Switch Board, (5) Radar  
Order Switch, (1) IFF Equipment, (2)  
Echo Box TS-270/UP.

**PRINCIPAL COMPONENTS AND PHYSICAL DATA**

<b>COMPONENTS</b>	<b>QTY</b>	<b>OVERALL DIMENSIONS (Inches)</b>	<b>UNIT WT. (Pounds)</b>
Antenna Assy 66ALH-1	1		5885
Radar Transmitter-Receiver Assy 43ADH	1	22 x 22 x 48	620
Power Distribution Cabinet 23AHM	1	24 x 28-5/8 x 69	1600
Search Modulator 50AHM	1	24 x 57-3/4 x 72-1/B	2255
Height Modulator 50AHL	1	24 x 57-3/4 x 72-1/B	2770
Main Control Unit 23AGY	1	28 x 33-1/4 x 72	1106
Radar Repeater Adapter 50AFU	3	15 x 20 x 31-1/2	172
Indicator Console Assy 5SAHF-1	5	27 x 46 x 56	1458
Receiver Control 23AKD	1	6 x 12-7/8 x 16	
Communication Switch 24AAQ	5	10-3/B x 18-3/4 x 19-3/8	225
Attenuator NT-633453	1	2 x 3-1/4 x 7-3/4	3
Antenna Control Unit 23AHD	1	9-1/2 x 21-1/2 x 24-1/2	266
Control Amplifier Assy 50AHD	1	19-1/2 x 39 x 52-1/2	450
D. G. Synchro Amplifier NT-50203-A	1	16-1/2 x 25-1/2 x 45	345
Motor-Dynamo Amplifier (Train) 21ADG	1	12-1/4 x 14-1/2 x 22-1/8	185
Motor-Dynamo Amplifier (Elevation) 21ADH	1	12-1/4 x 14-1/2 x 22-1/8	220
Motor-Dynamo Amplifier (Cross-level) 21ADH	1	12-1/4 x 14-1/2 x 22-1/2	220
Motor-Dynamo Amplifier (Scanner) 21AD3	1	9-7/B x 12-1/4 x 19-3/8	450
Motor Generator Unit (dc) NT-211025-A	1	12-1/4 x 14-1/2 x 21-3/8	185

**SX: 2**

ITEM NAME: RADAR EQUIPMENT

TYPE: SX

PRINCIPAL COMPONENTS AND PHYSICAL DATA (Cont.)

COMPONENTS	QTY	OVERALL DIMENSIONS (Inches)	UNIT WT. (Pounds)
Motor Generator Set NT-211487	1	28 x 34 x 72	2330
Voltage Regulator 20AEP	1	18-1/2 x 27 x 33	300
Magnetic Controller NT-211494	1	11 x 20 x 22	110
Dummy Load 14ACN		11-3/4 x 13-1/4 x 26	44

REFERENCE DATA AND LITERATURE

Technical Manuals:  
NAVSHIPS 900, 950

SX: 3

DATE: 1 July 1964

ITEM NAME: RADAR EQUIPMENT

COGNIZANT SERVICE: USN

TYPE: SX-1

FEDERAL STOCK NUMBER: 5840-665-1911 W/S

	USA	USN	USAF	USMC
STATUS OR TYPE CLASSIFICATION				
Mfg(s) Name or Code Number: General Electric Company, Syracuse, New York				

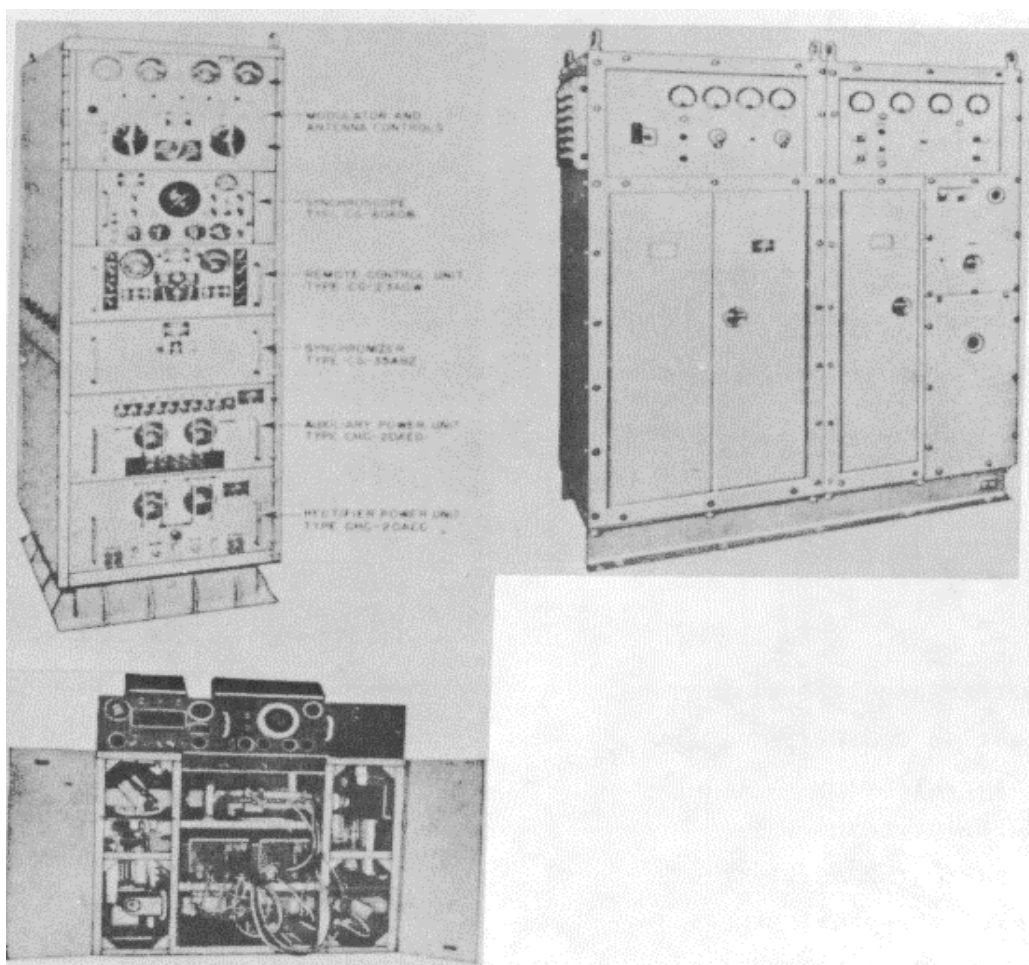

**FUNCTIONAL DESCRIPTION**

The Navy Model SX-1 Radar Equipment is a high powered microwave radar system designed to perform the functions of long range air and surface search and height determination of aircraft. The equipment is

capable of indicating height, range and bearing information on a large number of targets with continuous train scan of the antenna. This feature allows the equipment to provide height and bearing data on several targets, and, at the same time, provide unimpaired air and surface search. This is accomplished effectively by

SX-1: 1



**ITEM NAME:** RADAR EQUIPMENT

**TYPE:** SX-1

dividing the equipment into two major portions; namely, a search system and a height system.

Power Supply: Motor Generator Set NT-211487  
Power Factor Limits: 85% full load.  
Motor Input: 440v, 60 cps, 3-ph, 290 amp-starting, 49 amp-full load, 25 amp-standby.  
Continuous Output: 440v, 60 cps, 3-ph, 31.3 kva, 25 kw.  
Ambient Temperature: 50°C (122°F).  
Temperature Rise: 40°C (1040F).  
Heat Dissipation: 9.9 kw approx  
Echo Box Ringtime  
Search System: 7000 yd.  
Height System: 4000 yd.

**RELATION TO SIMILAR EQUIPMENT**

None.

**TECHNICAL DESCRIPTION**

Search System Frequency  
Using 4531: 2860 to 2900 mc  
Using 4332: 2820 to 2860 mc  
Using 4533: 2780 to 2820 mc  
Height System Frequency: 3500 to 3550 mc  
Peak Power Output (Search): 0.8 megw at 390 pps and 1 usec pw.  
Peak Power Output (Height): 0.5 megw at 1170 pps and 1 usec pw  
Type of Modulation: Pulse modulated.  
Type of Receiver: Superheterodyne.  
Intermediate Frequency: 30 mc.  
Type of IF Control: Automatic.

**INSTALLATION CONSIDERATIONS**

Related Equipment:  
Required but not Supplied.  
(1) Radar Distribution Switch Board, (5)  
Radar Order Switch, (1) IFF Equipment,  
(2) Echo Box TS/270-UP, (10) Junction Box.

**PRINCIPAL COMPONENTS AND PHYSICAL DATA**

**SHIPPING DATA**

<b>COMPONENT</b>	<b>BOXES (NR)</b>	<b>OVERALL DIMENSIONS (Inches)</b>	<b>UNIT WT. (Pounds)</b>
Navy Model SX-1 Radar Equipment	122		57, 692 approx

**EQUIPMENT SUPPLIED DATA**

<b>COMPONENTS</b>	<b>QTY</b>	<b>OVERALL DIMENSIONS (Inches)</b>	<b>UNIT WT. (Pounds)</b>
Antenna Assy NT-66ALH	1		5885
Radar Transmitter-Receiver Assy NT-43ADH		22 x 48 x 48	620
Power Distribution Cabinet NT-23AHM	1	24 x 28-5/8 x 69	1600
Search Modulator NT-50AHM	1	24 x 57-3/4 x 72-1/8	2255
Height Modulator NT-50AHL	1	24 x 57-3/4 x 72-1/8	2770
Main Control Unit NT-23AGY-1	1	28 x 33-1/4 x 72	1106
Indicator Console Assy NT-55AHF-1	1	27 x 46 x 56	1458
Radar Repeater Adapter NT-50AFO-2	3	15 x 20 x 31-1/2	172
Communications Switch NT-24AAQ	5	10-3/8 x 18-3/4 x 19-3/8	225
Attenuator NT-633453	1	2 x 3-1/4 x 7-3/4	3
Antenna Control Unit NT-23AHD	1	9-1/2 x 21-1/2 x 24-1/2	266
Control Amplifier Assy NT-50AHD	1	19-1/2 x 39 x 52-1/2	450
Motor Dynamo Amplifier (Train) NT-21ADG	1	12-1/4 x 14-1/2 x 22-1/8	236

ITEM NAME: RADAR EQUIPMENT

TYPE: SX-1

PRINCIPAL COMPONENTS AND PHYSICAL DATA

EQUIPMENT SUPPLIED DATA (Cont.)

COMPONENTS	QTY	OVERALL DIMENSIONS (Inches)	UNIT WT. (Pounds)
Motor Dynamo Amplifier (Elevation) NT-21ADH	1	12-1/4 x 14-1/2 x 22-1/8	220
Motor Dynamo Amplifier (Cross-level) NT-21ADH	1	12-1/4 x 14-1/2 x 22-1/8	220
Motor Dynamo Amplifier (Scanner) NT-21ADJ	1	9-7/8 x 12-1/4 x 19-3/8	150
Motor Generator Unit (dc) NT-211025-A	1	12-1/4 x 14-1/2 x 21-3/8	220
Motor Generator Set NT-211487	1	28 x 34 x 72	2330
Voltage Regulator NT-20AEP	1	18-1/2 x 27 x 33	300
Magnetic Controller NT-211494	1	11 x 20 x 22	110
Dummy Load	1	12 x 13-1/4 x 26	44
Dummy Load Spares NT-14ACN		9-1/2 x 16-1/2 x 20-1/2	67
Power Transformer NT-304764	3	18-1/2 x 18-1/2 x 33-1/4	425
Receiver Control Unit NT-23AKD	1	6 x 15 x 17-1/2	70

REFERENCE DATA AND LITERATURE

Technical Manuals:  
NAVSHIPS 91174

**DATE:** 1 July 1964

**ITEM NAME:** RADAR INDICATING EQUIPMENT

**COGNIZANT SERVICE:** USN

**TYPE:** VC, VC-1\*

**FEDERAL STOCK NUMBER:** \*5840-260-4613  
\*5840-665-2071 W/S

	USA	USN	USAF	USMC
STATUS OR TYPE CLASSIFICATION				
Mfg(s) Name or Code Number: General Electric Company, Bridgeport, Connecticut				

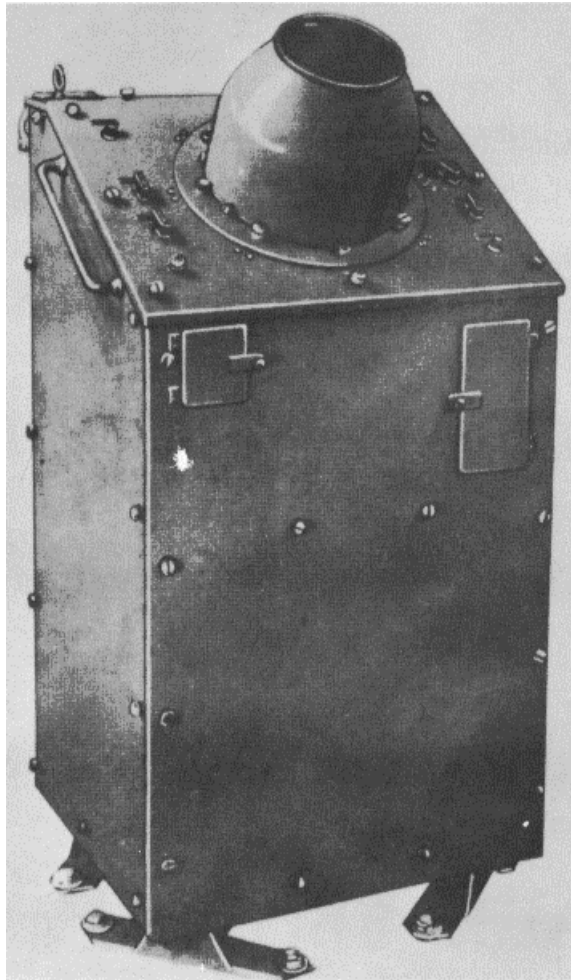

**FUNCTIONAL DESCRIPTION**

The VC (NT-55ACD) and VC-1 are shipboard PPI's which present a map-like display of the area searched by the associated radar, giving target range and bearing information. They may be used to repeat the master indicator information at a remote point or as master

indicators themselves. When used as master indicators, they must receive PPI video and trigger from the radar, range and bearing synchro information from the radar antenna, own-ship's course synchro information from the ship's gyro-compass, and IFF video from the interrogator-responzor.

**VC: 1**

**ITEM NAME:** RADAR INDICATING EQUIPMENT

**TYPE:** VC, VC-1

**RELATION TO SIMILAR EQUIPMENT**

The VC and VC-1 may be used with radars having pulse repetition rates from 60 to 1000 pps. They require one speed range and one speed bearing synchro data.

The VC-1 differs from the VC in that the pulse-rate switch used with the VC has been removed, and a calibrator unit has been added, eliminating use of the master radar system for calibration points.

**TECHNICAL DESCRIPTION**

Range

VC: 7.5, 20, 75, and 200 naut mi

VC-1: 4, 20, 80, and 200 mi

Ambient Temperature Range: -20° to plus 50°C.

Video Bandwidth: 2.5 mc

Scan: PPI, 7 in. CR tube

Pulse Rate: 60, 200, 400 and 800 to 1000 pps.

Power Source Required: 115v, 60 cps, 1-ph, 275w, 0.935 pf.

**INSTALLATION CONSIDERATIONS**

Not available.

**PRINCIPAL COMPONENTS AND PHYSICAL DATA**

COMPONENTS	QTY	OVERALL DIMENSIONS (Inches)	UNIT WT. (Pounds)
PPI Repeater CG-55ACD*	1	45-1/2 x 24-5/8 x 23-1/2	375
PPI Repeater CG-55ADT**	1	45-1/2 x 25 x 23-1/2	380
Selector Switch CG-24168*	1	11-1/4 x 6 x 15-5/8	17
CG-24168-A**		8-1/2 x 8-1/2 x 18	41
Set of Equipment Spares	1		64
Set of Equipment Spares	1		

**NOTE:** \*VC.  
\*\*VC-1.

**REFERENCE DATA AND LITERATURE**

Technical Manuals:

ENG 203A: for Navy Type 55ACD Remote Plan Position Indicator.

SHIPS 220: for Navy Type 55ADT PPI Repeater with Navy Type 24168A Selector Switch.

**VC: 2**

DATE: 1 July 1964

ITEM NAME: RADAR INDICATING EQUIPMENT

COGNIZANT SERVICE: USN

TYPE: \*VE, VE-1, VE-1a

FEDERAL STOCK NUMBER: \*5840-665-0147  
\*5840-644-4628 W/S

	USA	USN	USAF	USMC
STATUS OR TYPE CLASSIFICATION				
Mfg(s) Name or Code Number: Westinghouse Electric Corporation, Baltimore, Maryland				

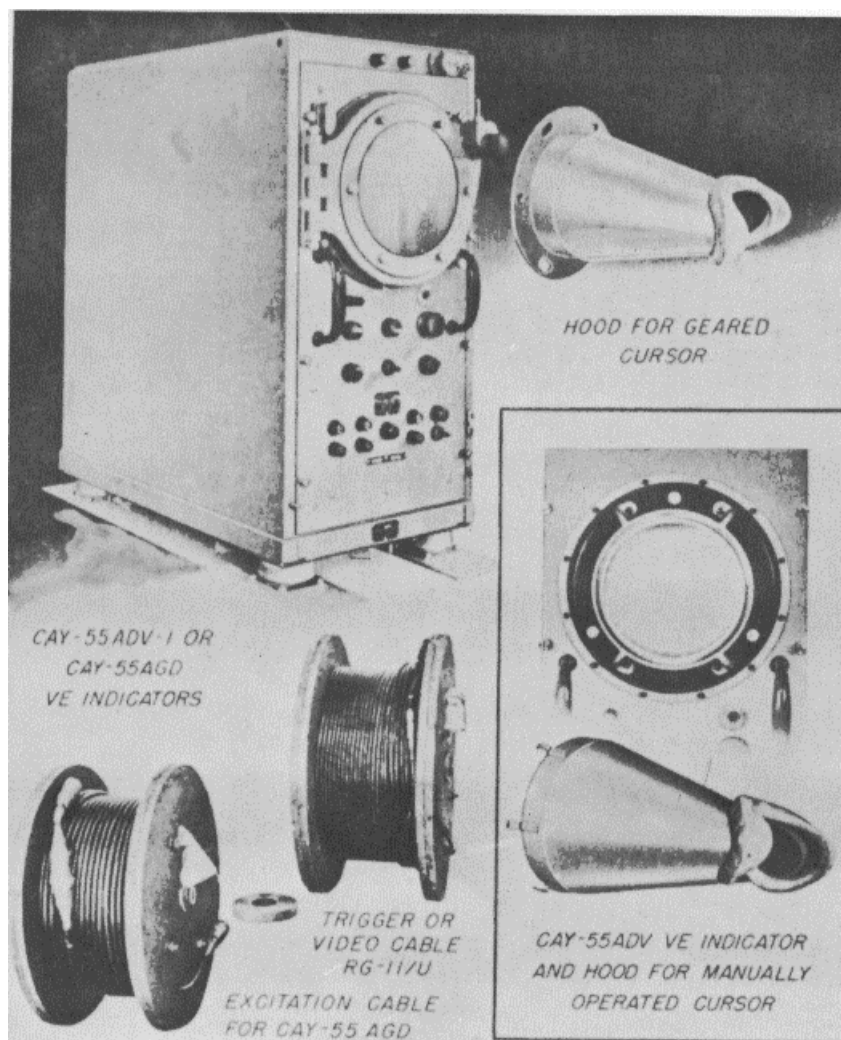

### FUNCTIONAL DESCRIPTION

The VE, VE-1 and VE-1a are Plan Position Indicator, which present a map-like display of the area searched by the associated radar, giving target range and bearing information. They may be used as master indicators, or

in a remote location, as a repeater, repeating the display as shown by the master Indicator. When used as a master indicator each must receive PPI video and trigger from the radar, range and bearing synchro information from the radar antenna, own-ships-course synchro information from the ships gyro-compass, and IFF video

VE: 1

**ITEM NAME:** RADAR INDICATING EQUIPMENT

**TYPE:** VE, VE-1, VE-1a

from the interrogator-responder. These equipments are used only with radars having pulse repetition rates from 60 to 1600 pulses per second, and require one speed range and one speed bearing synchro data.

The VE-1 and VE-1a are Marine Corps versions of the VE. The Indicators 55ADV and 55ADV-1 used with the VE are identical, except that the 55ADV-1 has a new panel and a gear driven cursor.

Data on this sheet reflects the following Field Changes: FC-1, 2, 3 for VE and FC-1 for VE-1

**RELATION TO SIMILAR EQUIPMENT**

None.

**TECHNICAL DESCRIPTION**

Range: 4, 20, 80 and 200 mi  
Presentation  
VE, VE-1: 7 in. CR tube.  
VE-1a: 12 in. CR tube.  
Video Input: Pos signals, 2v plus or minus 0.5v  
Trigger Input: Pos pulses, 7.5 to 40v, 60 to 1600 cps.  
Synchro: 5 wire, one speed, synchro system.  
Type Of Data: PPI, azimuth and range.  
Power Requirements: 115v, 60 cps, 1-ph.

**INSTALLATION CONSIDERATIONS**

Not available.

**PRINCIPAL COMPONENTS AND PHYSICAL DATA**

COMPONENT	SHIPPING DATA		UNIT WT. (Pounds)
	BOXES (NR)	OVERALL DIMENSIONS (Inches)	
VE			
Indicator NT-55ADV or NT-55ADV-1	1	19 x 35 x 38	287
Tube Type 7BP7	1	12 x 13 x 21	23
Spare Tubes	1	20 x 20 x 24	58
Spare Parts	1	18 x 19 x 21	167
VE-1, VE-1a			
Indicator NT-55AGD with Carrying Case	1	27 x 42 x 43	503
Excitation Cable with Carrying Case NT-1009	3	28 x 34 x 40	307
Trigger Cable with Carrying Case NT-10409	1	28 x 34 x 40	307
Spare Parts	1	18 x 19 x 29	167
Set Spare Tubes with Carrying Case	1	22 x 25 x 39	157
Modification Kit	1.		

**NOTE:** \*This Modification Kit changes Indicator to NT-5SAHR with 12 in. CR Tube. When modification is made, Equipment becomes VE-1a.

**EQUIPMENT SUPPLIED DATA**

COMPONENTS	QTY	OVERALL DIMENSIONS (Inches)	UNIT WT. (Pounds)
VE			
Indicator NT-55ADV or NT-55ADV-1	1	4-1/32 x 27-3/16 x 29-3/4	180
Set of Spare Parts	1		0

**VE: 2**

**ITEM NAME:** RADAR INDICATING EQUIPMENT

**TYPE:** VE, VE-1, VE-1a

**PRINCIPAL COMPONENTS AND PHYSICAL DATA**

**EQUIPMENT SUPPLIED DATA (Cont.)**

<b>COMPONENTS</b>	<b>QTY</b>	<b>OVERALL DIMENSIONS (Inches)</b>	<b>UNIT WT. (Pounds)</b>
VE (Cont.)			
Set of Spare Tubes	1		20
VE-1			
Indicator NT-55AGD with Carrying Case	1*	21-1/2 x 35-1/2 x 35-1/2	370
Excitation Cable & Carry Case NT-10409	3	22-1/8 x 31 x 34	100
Trigger Cable & Carrying Case NT-10409	3	22-1/8 x 31 x 34	100
Set of Spare Parts	1		130
Set of Spare Tubes with Carrying Case	1	19-1/2 x 22-1/8 x 34-1/2	12
Modification Kit	1.		

**NOTE: \*This Modification Kit changes Indicator to NT-55AHR with 12 in. CR Tube. When modification is made, Equipment becomes VE-1a.**

**REFERENCE DATA AND LITERATURE**

Technical Manuals:

SHIPS 375: for VE Indicator & VE-1 Indicator.  
FIELD CHANGE 1: for VE-1 Remote Indicator  
(conversion of VE-1 to VE-1a).

**VE: 3**

DATE: 1 July 1964

ITEM NAME: RADAR INDICATING EQUIPMENT

COGNIZANT SERVICE: USN

TYPE: VF\*, VF-a\*\*, VF-1\*\*\*

FEDERAL STOCK NUMBER: F5840-665-1943\*  
F5840-665-0562\*\*  
F5840-665-3811\*\*\*

	USA	USN	USAF	USMC
STATUS OR TYPE CLASSIFICATION		Obsoles*,***		
Mfg(s) Name or Code Number: Raytheon Manufacturing Company				

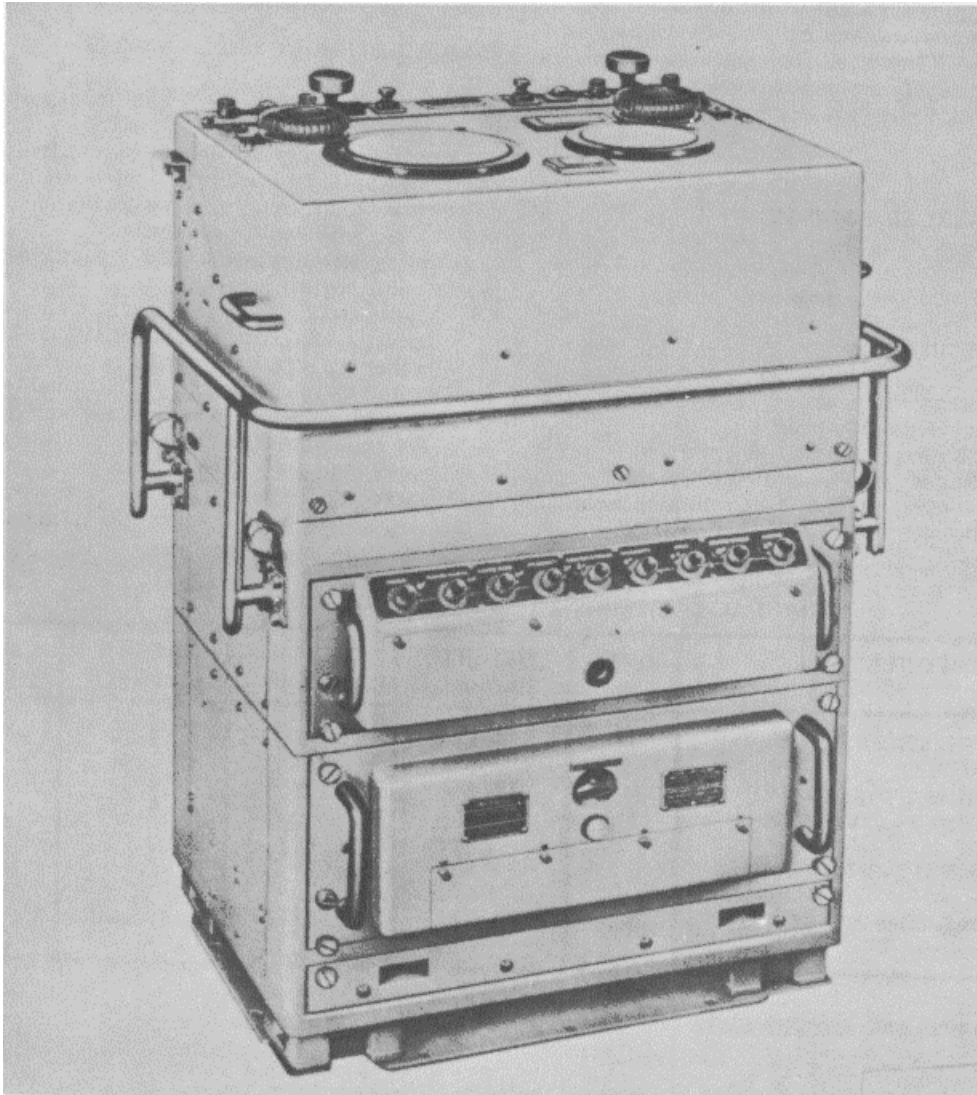

VF: 1



VF, VF-a, VF-1

**FUNCTIONAL DESCRIPTION**

Radar Indicating Equipments VF, VF-a, and VF-1 are repeaters used with any search radar equipment capable of transmitting PPI information. Their purpose is to repeat, at a remote point, accurate target information appearing at any selected master radar. Provision is made to transmit this information to other remote points. Targets are presented on two CRT's, one of which is a PPI used for search and coordination and the other, a B-scope used for accurate determination of range and bearing. This information is of sufficient accuracy to be used for fire control and torpedo direction. Operation of the equipment requires that a master radar system and gyro supply it with video and trigger signals, azimuth data, and range indications. The VF-a is a VF modified for operation from a 400-cycle power supply instead of from a 60-cycle supply. The Model VF-1 is a later reorder of the VF.

**RELATION TO SIMILAR EQUIPMENT**

None.

**TECHNICAL DESCRIPTION**

Video Input: +1 to +3v peak  
 Trigger Input: +5 to +50v peak  
 Pulse Repetition Rate: 60 to 1,000 pps  
 Operating Voltages and Power Requirements:  
 VF, VF-1 - 115v, 60 cps, 1-ph, 15 amp max  
 VF-a - 120v, 400 cps, 1-ph, 15 amp max

Type of Presentation: One 5-in. PPI and one 5-in. B-scope  
 Ranges: 4, 20, 80, and 200 mi  
 Range Marker Intervals:  
 PPI - each 1/4 of full scale  
 B-scope - each 1,000 yd  
 Range Accuracy:  
 B-scope - :25 yd on 4,000 to 50,000 yd scale;  
 ±100 yd on 600 to 4,000 yd scale  
 PPI - range is estimated  
 Azimuth Accuracy:  
 B-scope - ±0.15 deg on 1- and 36-speed;  
 ±1 deg on 1-speed  
 PPI - ±1 deg of master radar  
 Bearing Indication: True and relative

**INSTALLATION CONSIDERATIONS**

Siting: Units may be located in any order convenient to the installing yard.  
 Mounting: Precision Plan Position Indicator Repeater CRP-55AEF mounted on metal plate fastened to deck; other units fastened to bulkhead with angle brackets.  
 Cabling Requirements: Use standard armored cable for all interunit connections. All interunit wiring should conform to the interconnection diagram in NAVSHIPS 900,858. All other wiring should conform to diagrams supplied by the Navy. Allow extra cable so units can be removed for servicing and cables can be repaired. Do not bend coaxial cables on less than a six inch radius.  
 Related Equipment: Search radar equipments capable of transmitting PPI information.

**PRINCIPAL COMPONENTS AND PHYSICAL DATA**

COMPONENT	QTY	HEIGHT (Inches)	WIDTH (Inches)	DEPTH (Inches)	UNIT WT. (Pounds)
PPI Repeater NT-55AEF	1	43	32	24	989
Auxiliary Rectifier NT-20ADA(VF only)	1	18-1/2	18-1/4	13	41
or NT-20ADD(VF-a, VF-1 only)	1	14-3/4	13	7-3/4	36
Selector Switch NT-24298	1	24- 1/4	12- 1/4	12	50
Line Voltage Regulator NT-301407 (VF, VF-1 only)	1	37	20- 1/4	13	318

**REFERENCE DATA AND LITERATURE**

Technical Manuals:  
 NAVSHIPS 900,858 (VF)  
 NAVSHIPS 91486 (VF-a)  
 NAVSHIPS 91478 (VF-1)

DATE: 1 July 1964

ITEM NAME: RADAR INDICATING EQUIPMENT

COGNIZANT SERVICE: USN

TYPE: VG\*, VG-1\*\*, VG-2\*\*\*

FEDERAL STOCK NUMBER: 5840-644-4630\*  
5840-665-3810\*\*  
5840-548-7251\*\*\*

	USA	USN	USAF	USMC
STATUS OR TYPE CLASSIFICATION		Obsoles		
Mfg(s) Name or Code Number: General Electric Company				

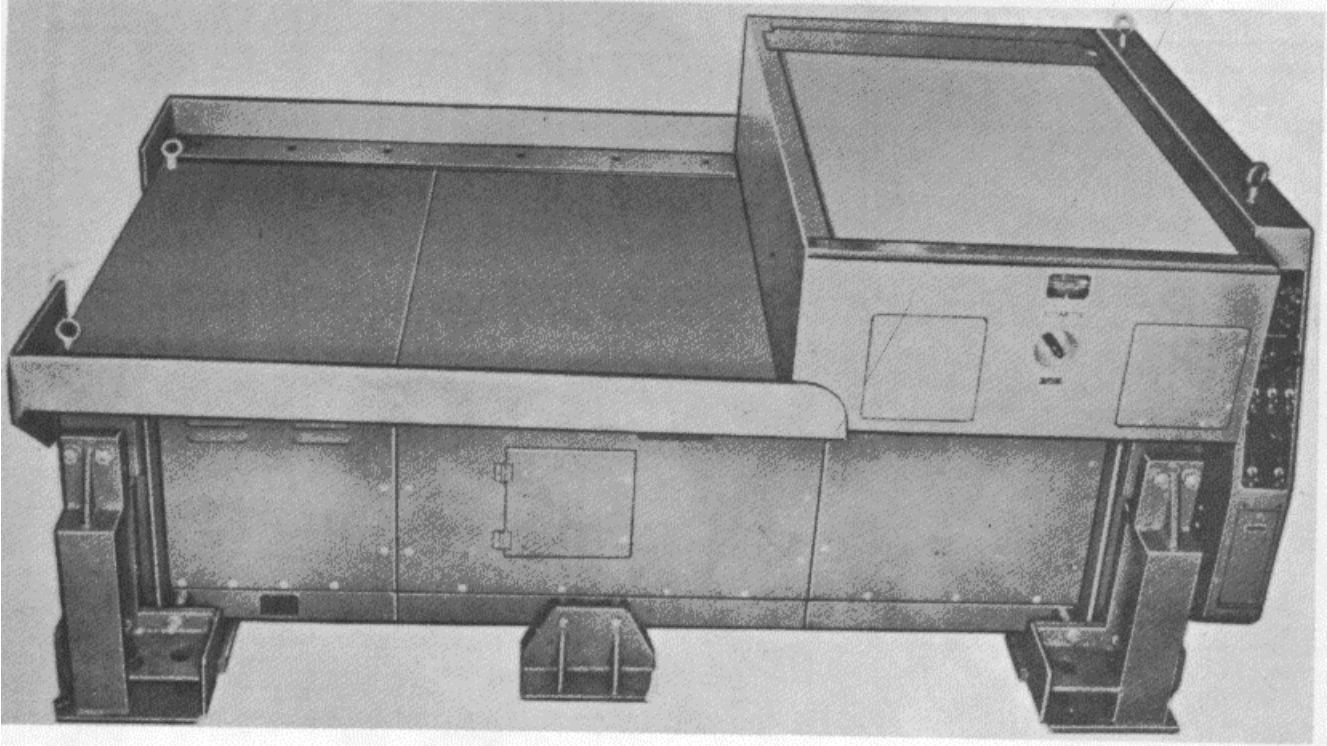

### FUNCTIONAL DESCRIPTION

Radar Indicating Equipment VG, VG1, and VG-2 are used aboard ship to project the PPI pattern of associated radar equipment upon a flat-top viewing screen of opal glass or tracing paper. Tactical calculations can be made directly upon the plot.

A range selector switch provides a 4-, 10-, 20-, 80-, or 200-mile radius, with concentric range marks. The equipment also projects two concentric dials (using an O.S.C. dial projector), each marked with a 360-degree calibration. The inner dial is fixed and is adjustable for true or relative bearing; the outer dial rotates and presents the ship's heading.

### RELATION TO SIMILAR EQUIPMENT

None.

### TECHNICAL DESCRIPTION

Trigger Pulse: 5 to 40v peak  
Video Pulse: 3v peak  
Range: 4, 10, 20, 80, and 200 mi  
Pulse Repetition Rate:  
4-, 10-, 20-mi ranges - 60 to 1,050 pps  
80-mi range - 60 to 850 pps  
200-mi range - 60 to 325 pps

VG: 1

VG, VG-1, VG-2

Presentation: 24 in. flat top viewing screen  
Image Visibility: Image on viewing screen may be observed in the presence of 1 foot-candle of indirect lighting  
Bearing Accuracy: Within 0.75 deg  
Operating Voltages and Power Requirements: 115v, 60 cps, 1-ph

**INSTALLATION CONSIDERATIONS**

Siting: Dependent upon the type of naval craft in which the equipment is installed. Sufficient clearance must be provided for personnel to utilize the flat-top viewing screen.  
Mounting: Deck mounted.  
Cabling Requirements:  
Related Equipment:

**PRINCIPAL COMPONENTS AND PHYSICAL DATA**

COMPONENT	QTY	HEIGHT (Inches)	WIDTH (Inches)	DEPTH (Inches)	UNIT WT. (Pounds)
VG, VG-1 Projection PPI Repeater Unit 55AEB or 55AEC	1	37-3/4	58-3/4	34	1260
VG-2 Projection PPI Repeater Unit 55AFL	1	41	89	40	1700

**REFERENCE DATA AND LITERATURE**

Technical Manual:  
NAVSHIPS 91563

**VG: 2**

DATE: 1 July 1964

ITEM NAME: RADAR INDICATING EQUIPMENT

COGNIZANT SERVICE: USN

TYPE: VG-3

FEDERAL STOCK NUMBER: 5840-501-1958  
5840-644-4821 W/S

	USA	USN	USAF	USMC
STATUS OR TYPE CLASSIFICATION				
Mfg(s) Name or Code Number: General Electric Co., Bridgeport, Connecticut				

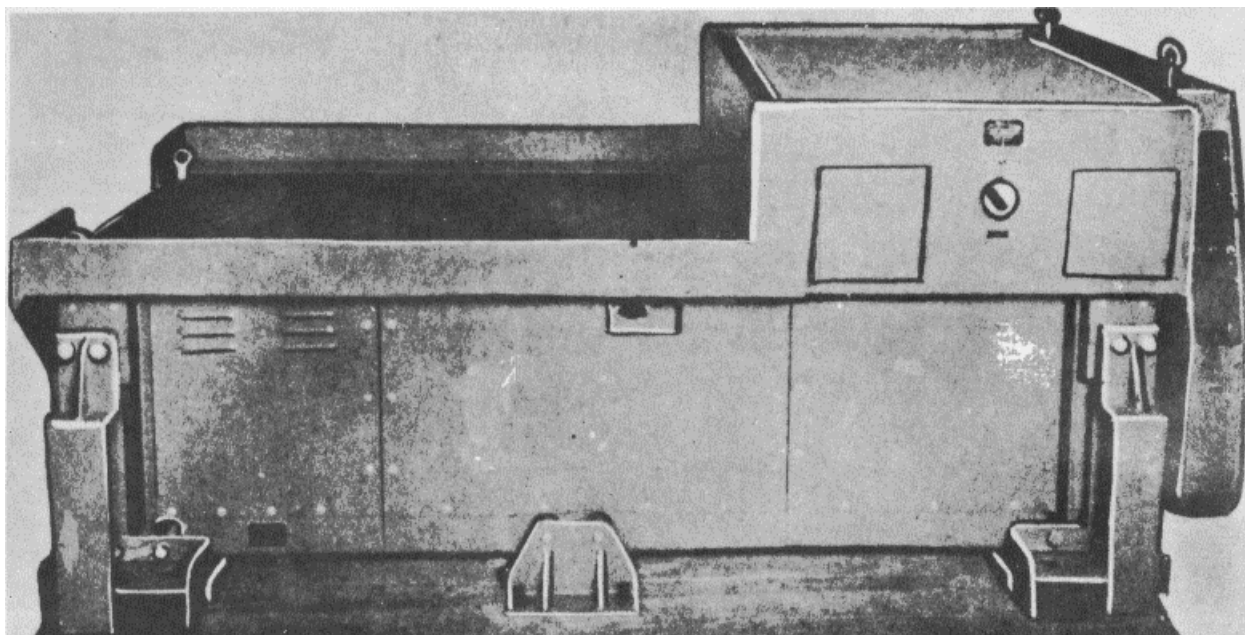

### FUNCTIONAL DESCRIPTION

The VG-3 is designed for shipboard use in projecting the PPI pattern of associated radar equipment upon a flat-top viewing screen of opal glass or tracing paper. It offers a plotting table on which the actual map-in motion

is portrayed and on which tactical calculations can be made directly.

A range selector switch provides a 4, 10, 20, 80 or 200 mi radius, with 4 concentric range mark rings for ranging purposes. The equipment also projects two concentric circular dials (Target Designation) each marked with a 360 deg calibration.

VG-3: 1

**ITEM NAME:** RADAR INDICATING EQUIPMENT

**TYPE:** VG-3

The inner dial is fixed and is adjustable for true or relative bearing, the outer dial rotates and presents the target designation.

Ranges: 4, 10, 20, 80, 200 mi.  
Pulse Rate  
4, 10, 20 Mile Ranges: 60 to 1050 cps  
80 Mile Range: 60 to 850 cps  
200 Mile Range: 60 to 325 cps  
Picture Diameter: 24 in. (screen dia) 25 in.  
Image Visibility: Image on viewing screen may be observed in the presence of 1 foot-angle of direct lighting.  
Bearing Accuracy: Within 3/4 of 1 deg  
Operating Power: 115v, 1-ph, 60 cps.

**RELATION TO SIMILAR EQUIPMENT**

Similar to VG, VG-1, VG-2 except for a few mechanical changes.

**TECHNICAL DESCRIPTION**

Signal Input  
Trigger Pulse Voltage: 5 to 40v peak.  
Video Pulse Voltage: 3v peak.  
O.S.C. Synchro: S1, S2, S3, R1, R2.  
Radar Bearing: S1, S2, S3, R1, R2.

**INSTALLATION CONSIDERATIONS**

Not available.

**PRINCIPAL COMPONENTS AND PHYSICAL DATA**

<b>COMPONENTS</b>	<b>QTY</b>	<b>OVERALL DIMENSIONS (Inches)</b>	<b>UNIT WT. (Pounds)</b>
Projection PPI Repeater NT-55AFN Complete with all tubes, lamps & fuses	1	34 x 25 x 59	1000
Selector Switch NT-24168-	1	9-1/2 x 9-1/2 x 16-1/2	20
Roll of Tracing Paper (CELO-VEL #316)	1	27 x 30 yds	
Mounting for Computer MC316-A	1		
Air Exhaust pipe fitting plate (furnished in spare parts box)	1		
Terminal Tubes, Mounted on bottom panel mounting plate	3		
Armored Coaxial Cable RG/12U	2	7 ft.	
Equipment, Stock, and Mobile Spare Parts for ea Projection PPI Repeater & Selector Switch			

**REFERENCE DATA AND LITERATURE**

Technical Manuals:  
SHIPS 261

DATE: 1 July 1964

ITEM NAME: RADAR REPEATER EQUIPMENT

COGNIZANT SERVICE: USN

TYPE: VH

FEDERAL STOCK NUMBER: 5840-665-0133  
5840-644-4627 W/S

	USA	USN	USAF	USMC
STATUS OR TYPE CLASSIFICATION				

Mfg(s) Name or Code Number: Raytheon Mfg Company, Waltham, Massachusetts

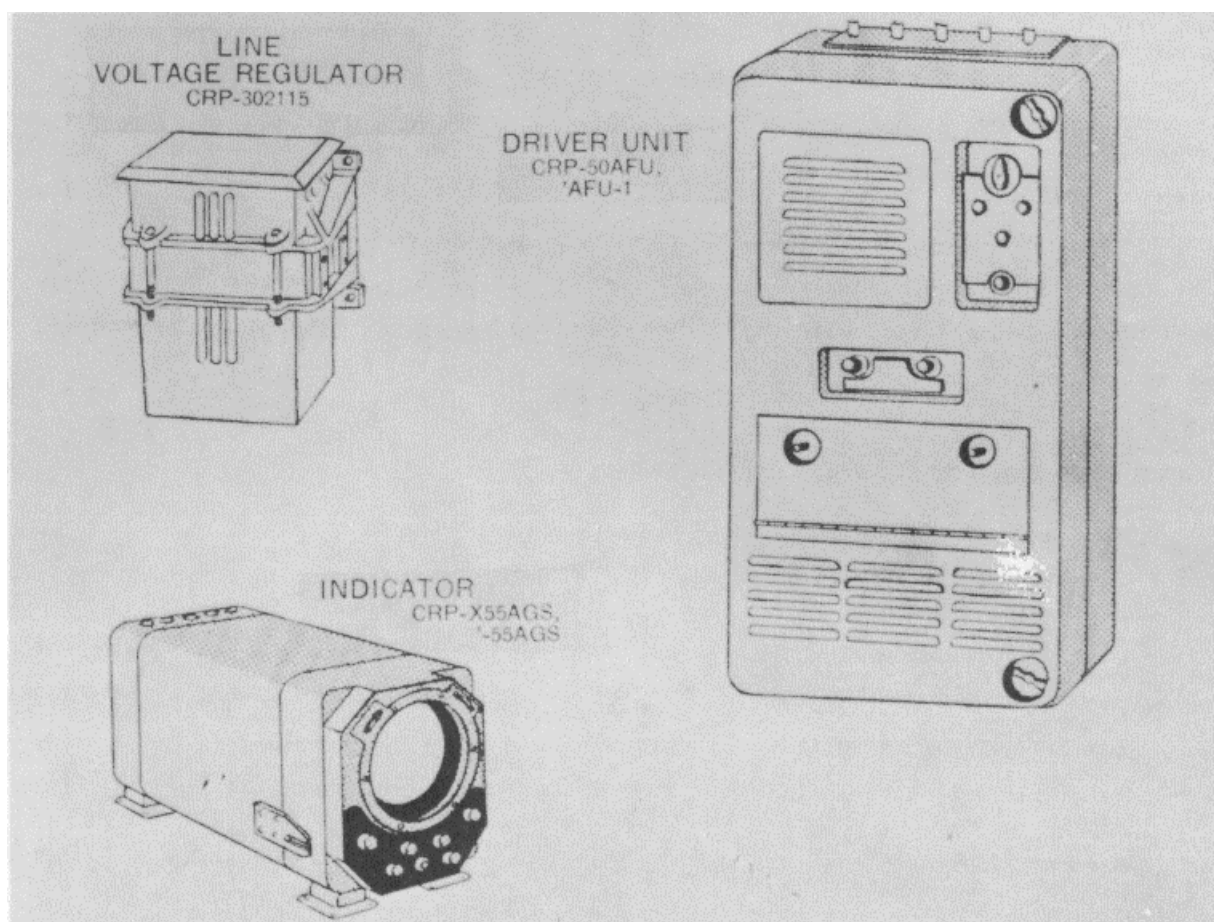

**FUNCTIONAL DESCRIPTION**

The VH is a remote indicator for use with any type of search radar equipment capable of transmitting PPI information. It repeats, at a remote point, target information appearing at any selected master radar

system. Six range settings are available: 2, 4, 10, 20, -0, and 200 miles. Four fixed range markers are provided on each range setting, each marker representing one-fourth of the distance of the range setting used. The special feature of this equipment is the compactness of the indicator unit, permitting it to be

**ITEM NAME:** RADAR REPEATER EQUIPMENT

**TYPE:** VH

used in locations where space is limited.

**RELATION TO SIMILAR EQUIPMENT**

None.

**TECHNICAL DESCRIPTION**

Ranges: 2, 4, 10, 20, 80 and 200 mi.  
Range Indication: Range markers at 1/4 full range indicated.  
Presentation: 5 in. CR tube.  
Bearing: True.  
Bearing Accuracy: plus or minus 2.2%.  
Signal Requirements

Video: Pos, 1 to 2.5v  
Trigger: Pos, 5 to 50v  
Trigger Frequency  
Up to 200 Miles: 57 to 300 cps  
80 Miles: 57 to 800 cps  
20 Miles: 57 to 1000 cps  
Input Impedance: 75 ohms  
Trigger Duration: 0.25 to 20 usec.  
Power Requirements: 115v plus or minus 10%, 60 plus or minus 12 cps, 1-ph, 40w

**INSTALLATION CONSIDERATIONS**

Not available.

**PRINCIPAL COMPONENTS AND PHYSICAL DATA  
SHIPPING DATA**

<b>COMPONENT</b>	<b>BOXES (NR)</b>	<b>OVERALL DIMENSIONS (Inches)</b>	<b>UNIT WT. (Pounds)</b>
Driver Unit NT-50AFU or NT50AFU-1	1	20-1/2 x 27 x 47	435
Indicator Unit NT-55AGS or NT-X55AGS	1	17-1/2 x 17-1/2 x 32	170
Line Voltage Regulator NT-302115	*1	15-3/4 x 16-5/8 x 20-7/8	90
Maintenance & Installation Material	1	14-1/4 x 25 x 29-1/2	152
Set of Spare Parts	2	14-1/4 x 18-3/4 x 29-1/2	
Set of Spare Tubes	1	20 x 20 x 24	67

**NOTE: \*Supplied with Preproduction Models only.**

**EQUIPMENT SUPPLIED DATA**

<b>COMPONENTS</b>	<b>QTY</b>	<b>OVERALL DIMENSIONS (Inches)</b>	<b>UNIT WT. (Pounds)</b>
Driver Unit NT-50AFU or NT-50AFU-1	1	14-5/8 x 19-1/2 x 37	281
Indicator Unit NT-55AGS or NT-X55AGS	1	8-1/4 x 11-1/2 x 22-1/4	117
Line Voltage Regulator NT-302115	*1	8-1/2 x 9-3/4 x 13-3/4	59
Set of Maintenance & Installation Materials	1		101
Box of Equipment Spares	1	12-1/4 x 15-1/2 x 24-1/2	124
Box of Equipment Spares	1	12-1/4 x 15-1/2 x 24-1/2	90
Set of Spare Tubes	1		37

**NOTE: \*Supplied with Preproduction Models only.**

**REFERENCE DATA AND LITERATURE**

Technical Manuals:  
NAVSHIPS 900, 934

**DATE:** 1 July 1964

**ITEM NAME:** RADAR REPEATER EQUIPMENT

**COGNIZANT SERVICE:** USN

**TYPE:** VJ, VJ-a, VJ-b, VJ-1

**FEDERAL STOCK NUMBER:** See Note 1

	USA	USN	USAF	USMC
STATUS OR TYPE CLASSIFICATION		See Note 2		
Mfg(s) Name or Code Number: Raytheon Manufacturing Company				

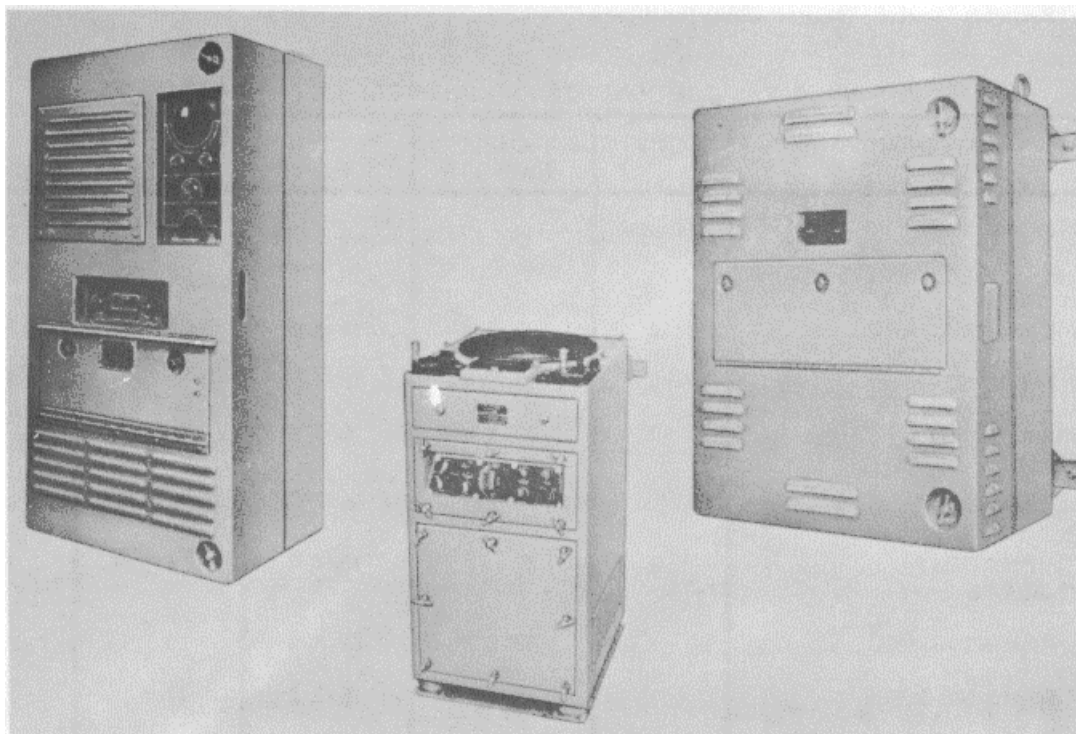

**FUNCTIONAL DESCRIPTION**

Radar Repeater Equipments VJ, VJ-a, VJ-b, and VJ-1 are remote indicators for use with any type of search radar equipment capable of transmitting PPI information. Its purpose is to repeat, at a remote point, target information from any selected master radar system. Provision is made for transmission of range and bearing information of chosen targets to other remote points. Targets are presented on a conventional 12-in. PPI.

Provision is made for a delayed sweep which permits enlargement of portions of the search area for closer examination. Six range settings are available with range markers representing 1/4 of the range setting being used.

**RELATION TO SIMILAR EQUIPMENT**

None.

**VJ: 1**



VJ, VJ-a, VJ-b, VJ-1

**TECHNICAL DESCRIPTION**

Ranges:  
 VJ, VJ-a, VJ-1 - 2, 4, 10, 20, 80, and 200 mi  
 VJ-b - 2, 4, 10, 25, 60, 100, 160, and 240 mi  
 Range Marks: At intervals of 1/4 of full scale  
 Range Accuracy:  $\pm 1\%$   
 Bearing Indication: True or relative  
 Video Input:  $\pm 1$  to  $\pm 2.5v$   
 Trigger Input:  $\pm 5$  to  $\pm 50v$ , 57 to 300/820/1,000 cps  
 Delay: 20 and 40 mi  
 Operating Voltages and Power Requirements:  
 VJ, VJ-b, VJ-1 - 115v, 60 cps, 1-ph  
 VJ-a - 120v, 400 cps, 1-ph, 70w approx

**INSTALLATION CONSIDERATIONS**

Siting: Selector switch, trigger delay unit and driver unit should be mounted close together.  
 Unit locations should be planned for short cabling. Indicator unit is weatherproof. All other units must be located in protected areas.  
 Mounting: Indicator unit is designed for four point deck mounting, but two-point top rear mounts are also provided for tilted installations.  
 Cabling Requirements: One RG-27/U cable is supplied. Standard Navy armored cable is used for all interunit connections. Bending radius of coaxial cables should be at least ten times the cable diameter.  
 Related Equipment: All search radars capable of transmitting PPI information.

**PRINCIPAL COMPONENTS AND PHYSICAL DATA**

COMPONENT	QTY	HEIGHT (Inches)	WIDTH (Inches)	DEPTH (Inches)	UNIT WT. (Pounds)
VJ					
Driver Unit NT-SOAFU-1	1	37	19-1/2	14-5/8	281
Indicator Unit NT-55AGU	1	32-3/8	21-3/8	20	258
Selector Switch NT-24786	1	17	12-1/2	19	64
Line Voltage Regulator NT-302115	1	13-3/4	9-3/4	8-1/2	59
VJ-a					
Driver Unit NT-50AFU or NT-50AFU-I	1	37	19-1/2	14-5/8	281
Indicator Unit NT-55AGU	1	32-3/8	21-3/8	20	258
Selector Switch NT-24786	1	17	12-1/2	19	64
VJ-b					
Driver Unit NT-50ALB	1	37	19-1/2	14- 5/8	281
Indicator Unit NT-55AKP	2	32-3/8	21-3/8	20	258
Selector Switch NT-24786	1	17	12-1/2	19	64
Line Voltage Regulator NT-302115	1	13-3/4	9-3/4	8-1/2	59

VJ, VJ-a, VJ-b, VJ-1

**PRINCIPAL COMPONENTS AND PHYSICAL DATA (cont'd)**

<b>COMPONENT</b>	<b>QTY</b>	<b>HEIGHT (Inches)</b>	<b>WIDTH (Inches)</b>	<b>DEPTH (Inches)</b>	<b>UNIT WT. (Pounds)</b>
VJ-1					
Driver Unit NT-50AKX	1	37	20	15	281
Indicator Unit NT-55AGU-1	1	33	21	20	268
Selector Switch NT-24786	1	17	12-1/2	19	64

**REFERENCE DATA AND LITERATURE**

Technical Manuals  
NAVSHIPS 900,829(A)  
NAVSHIPS 91504  
NAVSHIPS 91934

Note 1. Federal Stock Numbers

VJ - 5840-665-3863  
VJ-a -  
VJ-b - 5840-642-8355  
VJ-1 - 5840-644-4632

Note 2. Status

VJ - Obsoles  
VJ-a -  
VJ-b - Ltd Obsoles  
VJ-1 - Obsoles

DATE: 1 July 1964

ITEM NAME: RADAR REPEATER EQUIPMENT

COGNIZANT SERVICE: USN

TYPE: VK, VK-2, -3, 3a,-4, -4a, 5

FEDERAL STOCK NUMBER: See Note 1

	USA	USN	USAF	USMC
STATUS OR TYPE CLASSIFICATION		Obsoles		
Mfg(s) Name or Code Number: See Note 2				

### FUNCTIONAL DESCRIPTION

Radar Repeater Equipment VK, VK-2, VK-3, VK-3a, VK-4, VK-4a, and VK-5 function as standard PPI repeaters, off-centered PPI repeaters, or as expanded off-centered PPI repeaters. They may also serve as plotting centers. These equipments can display target data obtained from an AEW system, information from a dead reckoning analyzer, or target data from a shipboard radar. Service as a radar relay or target designation transmitter, relaying target bearing and range to remote stations, can also be performed.

The VK series equipments are similar, differing slightly in electrical performance.

### RELATION TO SIMILAR EQUIPMENT

None.

### TECHNICAL DESCRIPTION

#### Range Scales:

- VK, VK-2, VK-3 - 4, 10, 20, 40, 80, and 200 mi in centered and off-centered operation
- VK-3a, VK-4 - 4, 10, 20, 40, 80, 150, 200 and 300 mi in centered and off-centered operation
- VK-4a, VK-5 - Fixed, 4, 20, and 150 mi in centered and off-centered operation; variable, 4 to 300 mi in centered and off-centered operation

#### Range Accuracy:

- VK - 0 to 18,000 yd,  $\pm 100$  yd; 18,000 to 100,000 yd,  $\pm 1\%$  of actual range; 0 to 200 mi,  $\pm 5\%$  of actual range
- VK-2, VK-3 - 300 to 10,000 yd;  $\pm 100$  yd; 50 to 200 mi,  $\pm 0.4$  mi

#### Bearing Indication: True and relative

Bearing Accuracy: Within 2.2 deg at all speeds

#### Pulse Repetition Frequency:

- VK - 57 to 2,000 pps
- VK-2, VK-3, VK-3a, VK-4, VK-5 - 57 to 3,000 pps

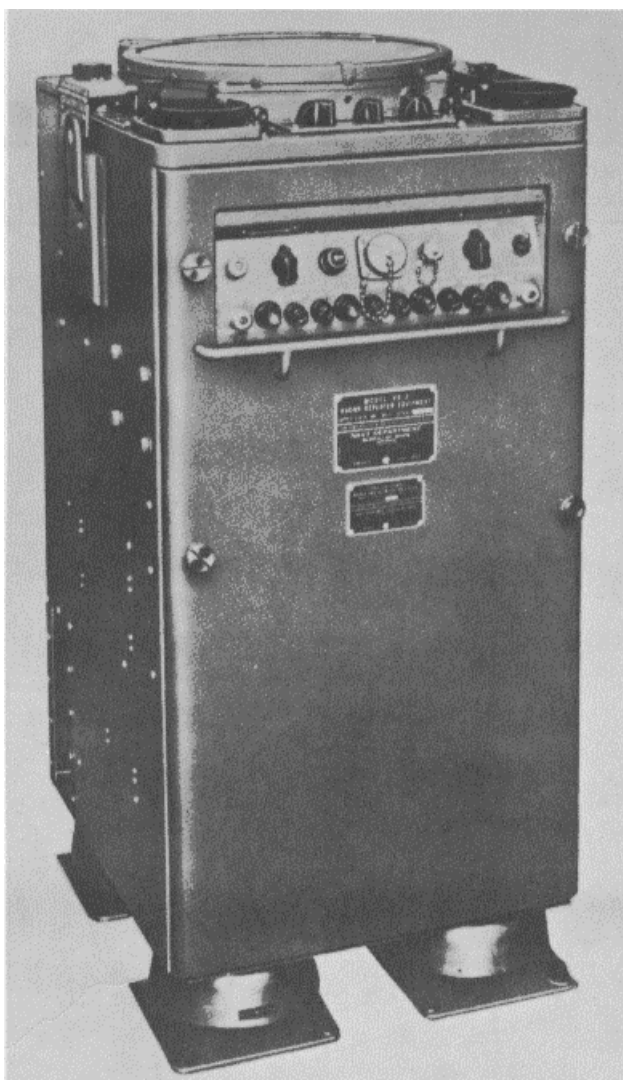

VK: 1

VK, VK-2, -3, -3a, -4, -4a, -5

Video Input:

VK, VK-2, VK-3, VK-4a, VK-5 - +1 to +2.5v  
VK-3a, VK-4 - +1.5 to +3v

Trigger Input:

VK, VK-2, VK-3, VK-4a, VK-5 - +5 to +50v  
VK-3a, VK-4 - +3.5 to +40v

Antenna and Trace Rotation: 0 to 60 rpm

Operating Voltages and Power Requirements:

115v  $\pm$ 10%, 60  $\pm$ 2 cps, 1-ph

Power Factor:

VK, VK-4a - 96% lagging  
VK-2, VK-3, VK-3a, VK-4, VK-5 - 90% lagging

Siting: Locate for freedom of movement of operating and service personnel. Space allowance should be based on dimensions when master chassis is withdrawn.

Mounting: VK shipped with bottom shock mounts attached. An extra shock mount is included to brace VK against bulkhead or vertical partition. Unit secured to foundation through flat steel bedplate. Viewing screen can be sloped toward operator at angle of 0 to 45 deg. (Requires special bedplate).

Cabling Requirements: Unit equipped with three access cover plates for cable entry and exit.

Related Equipment: All standard Navy search radar systems.

**INSTALLATION CONSIDERATIONS**

**PRINCIPAL COMPONENTS AND PHYSICAL DATA**

COMPONENT	QTY	HEIGHT (Inches)	WIDTH (Inches)	DEPTH (Inches)	UNIT WT. (Pounds)
PPI Repeater	1	37-7/16	18-5/16	16-5/8	520
VK-2					
Range-Azimuth Indicator NT-55AKJ	1	40	24	18	445
Power Supply NT-20AGD	1	24-1/2	24	13-1/2	235
VK-3					
Azimuth Indicator NT-55AKK	1	40	24	18	445
Power Supply NT-20AGD	1	24-1/2	24	13-1/2	235
VK-3a					
Azimuth Indicator NT-55AKK-1	1	40	24	18	445
Power Supply NT-20AGD	1	24-1/2	24	13-1/2	235
VK-4					
Azimuth-Range Indicator IP-172/SP	1	38-1/16	22-1/16	17-9/32	378
Power Supply PP-734/SP VK- 4a	1	24-3/16	21-1/2	13-15/16	142
Azimuth-Range Indicator IP-172A/SP	1	38-1/16	23-9/16	17-9/32	392
Power Supply PP-734B/SP	1	24-3/16	23-7/8	13-15/16	143

**VK: 2**

VK, VK-2, -3, -3a, -4, -4a, -5

**PRINCIPAL COMPONENTS AND PHYSICAL DATA (cont'd)**

COMPONENT	QTY	HEIGHT (Inches)	WIDTH (Inches)	DEPTH (Inches)	UNIT WT. (Pounds)
VK-5 Azimuth-Range Indicator IP-226/SP	1	42-5/32	22	21-15/16	471
Power Supply PP-734A/SP	1	24-3/16	23-7/8	13-7/8	145

**REFERENCE DATA AND LITERATURE**

Technical Manuals:

NAVSHIPS 900986 (VK)  
NAVSHIPS 91300 (VK-2)  
NAVSHIPS 91413 (VK-3)  
NAVSHIPS 91563(B) (VK-4)  
NAVSHIPS 91910 (VK-4a)  
NAVSHIPS 91786 (VK-5)

**Note 1. Federal Stock Numbers**

VK - F5840-644-4631  
VK-2 - F5840-642-8346  
VK-3a -  
VK-3 - F5840-260-4622  
VK-4 - F5840-644-4635  
VK-4a - F5840-665-3812  
VK-5 - F5840-644-4629

**Note 2. Manufacturers**

VK, VK-3, -3a - General Electric Company  
VK-2 - Hazeltine Electronics Corporation  
VK-4, -4a, -5 - Westinghouse Electronic Corp.

**VK: 3**

DATE: 1 July 1964

ITEM NAME: RADAR REPEATER EQUIPMENT

COGNIZANT SERVICE: USN

TYPE: VL, VL-1

FEDERAL STOCK NUMBER:

	USA	USN	USAF	USMC
STATUS OR TYPE CLASSIFICATION		Sub. Std		

Mfg(s) Name or Code Number: General Electric Company

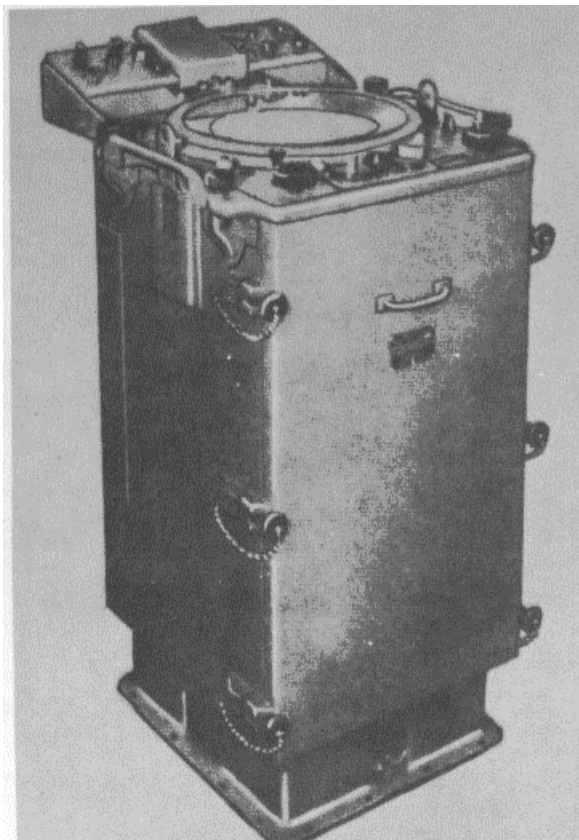

12-inch CRT within ranges of 20, 40, 70, and 140 miles, but contain provisions to change the ranges to 20, 40, 100, and 200 miles, if desired. Selection of a presentation width may be made at the unit or at the remote radar control system. These repeaters are often used in conjunction with VK series repeater equipments which repeat search information.

#### RELATION TO SIMILAR EQUIPMENT

None.

#### TECHNICAL DESCRIPTION

Pulse Repetition Frequency: 60 to 3,000 pps  
 Video Input: +1 to +2.5v  
 Trigger Input: +5 to +50v  
 Range Selection:  
     Normal - 20, 40, 70, and 140 mi  
     Alternate - 20, 40, 100, and 200 mi  
     Sweep Delay - 180 mi max  
     Sweep Range - 270 mi max undistorted  
 Range Accuracy:  $\pm 1\%$  of total scale  
 Range Markers: 5, 10, 20, and 50 mi  
 Sector Width: 10, 30, or 360 deg  
 Operating Voltages and Power Requirements:  
     115v  $\pm 10\%$ , 60  $\pm 2$  cps, 1-ph, 1, 510 va, 96% pf

#### FUNCTIONAL DESCRIPTION

Radar Repeater Equipment VL and VL-1 are compact, self-contained units designed for permanent shipboard installation at a point remote from the radar height-finding units. The equipments are used to repeat visual information obtained from any standard Navy height radar system. They display scope patterns on a

#### INSTALLATION CONSIDERATIONS

Not available.

VL: 1

VL, VL-1

**PRINCIPAL COMPONENTS AND PHYSICAL DATA**

<b>COMPONENT</b>	<b>QTY</b>	<b>HEIGHT (Inches)</b>	<b>WIDTH (Inches)</b>	<b>DEPTH (Inches)</b>	<b>UNIT WT. (Pounds)</b>
RHI Repeater NT-55AKD (VL only)	1	37-7/16	23	16-5/8	453
RHI Repeater NT-55AKD-1 (VL-1 only)	1	40-3/8	24-3/8	19-1/2	474

**REFERENCE DATA AND LITERATURE**

Technical Manuals:  
NAVSHIPS 91177  
NAVSHIPS 91511(A)

**VL:**

DATE: 1 July 1964

ITEM NAME: RADIO EQUIPMENT

COGNIZANT SERVICE: USN

TYPE: YJ-2

FEDERAL STOCK NUMBER:

	USA	USN	USAF	USMC
STATUS OR TYPE CLASSIFICATION				

Mfg(s) Name or Code Number: Hazeltine Electronics Corporation, New York, N. Y.

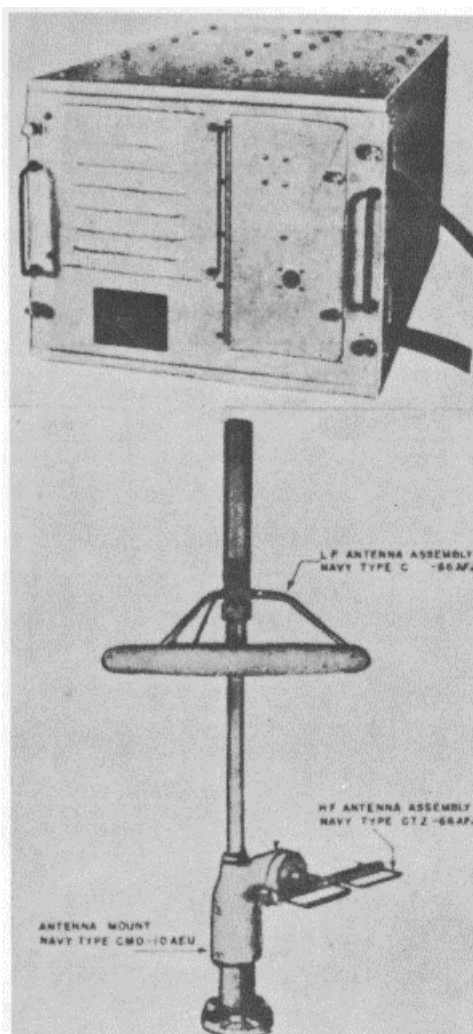

### FUNCTIONAL DESCRIPTION

The Model YJ-2 is a two-channel, automatic-responding radar beacon designed for shipboard installation. It will automatically transmit coded reply signals in response to interrogating signals received

from craft equipped with suitable radar or IFF equipment, and is capable of replying to interrogating signals in the 176 and 515 megacycle bands. It can be used for homing purposes by planes, when the location is not known, or if it is known to be mobile, by using the reply signal of either continuous or frequent interrogation.



**ITEM NAME:** RADIO EQUIPMENT

**TYPE:** YJ-2

The Model YJ-2 is supplied with a frequency conversion kit to permit nominal operating frequencies of 176, 515, 535, and 555 megacycles.

**RELATION TO SIMILAR EQUIPMENT**

The Model YJ-2 is similar to Models YJ and YJ-1, differing in that the Model YJ-2 is the shipboard version of the Models YJ and YJ-i which are designed for shore installation.

**TECHNICAL DESCRIPTION**

**Frequency Data**

Band Designation: 176 and 515 mc  
Range (Receiver)

A Transponder: 171 to 181 mc  
B Transponder: 505 to 535 mc

Range (Transmitter)

A Transponder: 172.5 to 182.5 mc  
B Transponder: 505 to 535 mc

**Interrogation Data**

Normal Pulse Rate: 400 pps

Maximum Pulse Rate (To Which Equipment Will Respond)

A Transponder: 3000 pps.

B Transponder: 4000 pps.

Recovery Time (at 400 pps)

A Transponder: 50 to 120 usec

B Transponder: 100 to 200 usec

Interrogating Pulse Duration: Approx 2 usec or more.

**Reply Data**

Transmitted Pulse Duration: 7 to 10 usec

Pulse Power (at 400 pps)

A Transponder: 15w min

B Transponder: 75w min

Rate of Time Sharing: 15 to 20 cps

Duration of Coding Cycle: 30 sec

Power Requirements: 115v plus or minus 5% or 230v plus or minus 5%, 50 to 60 cps, 350w

**Antenna Data**

Type: Vertically polarized radiator and horizontally polarized folded dipole.

**INSTALLATION CONSIDERATIONS**

Not available.

**PRINCIPAL COMPONENTS AND PHYSICAL DATA**

<b>COMPONENT</b>	<b>BOXES (NR.)</b>	<b>OVERALL DIMENSIONS (Inches)</b>	<b>UNIT WT. (Pounds)</b>
Radio Equipment Navy Model YJ-2	1	26-3/4 x 31-1/8 x 36-1/2	

**EQUIPMENT SUPPLIED DATA**

<b>COMPONENTS</b>	<b>QTY</b>	<b>OVERALL DIMENSIONS (Inches)</b>	<b>UNIT WT. (Pounds)</b>
Cabinet	1	17-1/8 x 22-5/8 x 29-3/4	1.25
Rectifier Power Unit NT-20ACH-2	1	10-11/16 x 12-1/2 x 16	57
RF Unit, A Band NT-43ABW-2	1	7-3/16 x 11 x 12-5/8	13.5
RF Unit, B Band NT-43ABX-2	1	7-11/16 x 11 x 12-5/8	17.5
Antenna NT-66AJL	1	20 x 21-1/2 x 42	17.5

**REFERENCE DATA AND LITERATURE**

Technical Manuals:  
SHIPS 299

DATE: 1 July 1964

ITEM NAME: RADAR DISTRIBUTION  
SWITCHBOARD

COGNIZANT SERVICE: USN

TYPE: 23AFL

FEDERAL STOCK NUMBER: F5840-665-1419

	USA	USN	USAF	USMC
STATUS OR TYPE CLASSIFICATION				

Mfg(s) Name or Code Number: Bendix Aviation Corporation, Marine Division

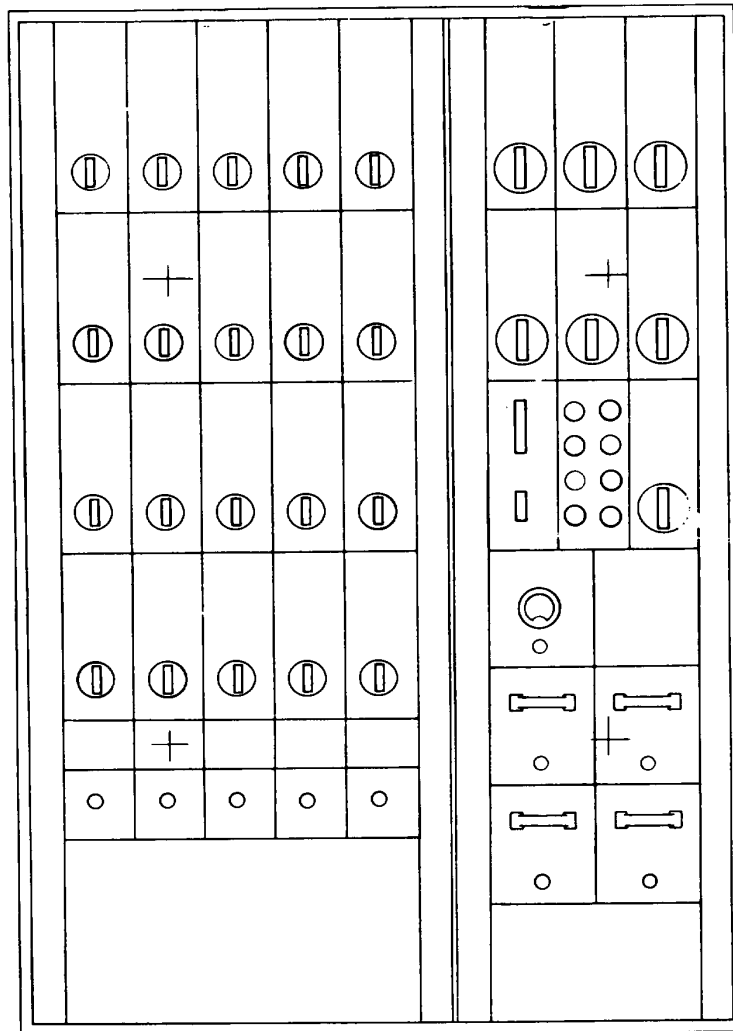

23 AFL

23AFL: 1

23AFL

### FUNCTIONAL DESCRIPTION

The 23AFL Switchboard is the central point for the distribution of radar information from 5 radar systems to 20 remote radar repeaters.

The 23AFL may be used in conjunction with any 5 radar systems and 20 remote repeater units that are capable of transmitting and receiving target range and bearing information.

Master Radar Inputs: 5  
Remote Repeater Outlets: 20  
Video Input Level:  $2 \pm 0.5v$ , 70 ohms  
Trigger Input Level: 25 to 50v, 70 ohms  
Operating Voltages and Power Requirements:  
115 ;ac, 60 cps, 1-ph, 0.94 kva

### RELATION TO SIMILAR EQUIPMENT

None.

### TECHNICAL DESCRIPTION

Video Amplifier Gain: 2:1

### INSTALLATION CONSIDERATIONS

Siting:  
Mounting: Deck mounted, except for the order switches which are bulkhead mounted.  
Cabling Requirements:  
Related Equipment:

### PRINCIPAL COMPONENTS AND PHYSICAL DATA

COMPONENT	QTY	HEIGHT (Inches)	WIDTH (Inches)	DEPTH (Inches)	UNIT WT. (Pounds)
Panel No. 1 NT-23AFL	1	71	29	23	1925
Panel No. 2 NT-23AFL	1	71	19	22	975
Repeater Order Switches NT-24316	20	9	9	6	15

### REFERENCE DATA AND LITERATURE

Technical Manual:  
NAVSHIPS 900653(A)

**23AFL: 2**

DATE: 1 July 1964

ITEM NAME: RADAR DISTRIBUTION  
SWITCHBOARD

COGNIZANT SERVICE: USN

TYPE: 23AGU

FEDERAL STOCK NUMBER: F5840-665-1616

	USA	USN	USAF	USMC
STATUS OR TYPE CLASSIFICATION				

Mfg(s) Name or Code Number: Bendix Aviation Corporation, Marine Division

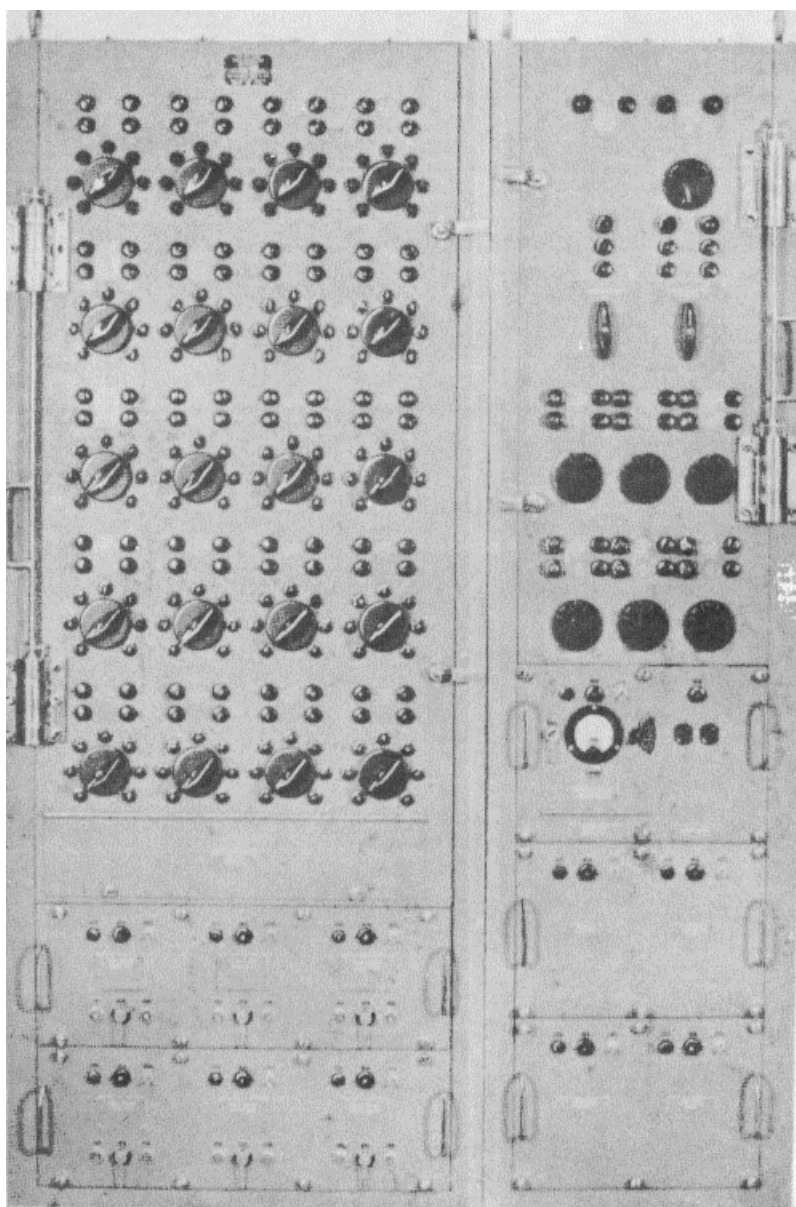

23AGU: 1

23AGU

**FUNCTIONAL DESCRIPTION**

The 23AGU Switchboard is the central point for the distribution of radar information from 6 radar systems to 20 remote radar repeaters.

The 23AGU may be used in conjunction with any 6 radar systems and 20 remote repeater units that are capable of transmitting and receiving target range and azimuth information.

Signal Voltage Response: Flat from 100 cps to 4.5 mc

Master Radar Inputs: 6

Remote Repeater Outputs: 20

Operating Voltages and Power Requirements:  
115 vac, 60 cps, 1.014 kva, 0.897 pf

**RELATION TO SIMILAR EQUIPMENT**

None.

**TECHNICAL DESCRIPTION**

Video Amplifier Gain: 2:1

**INSTALLATION CONSIDERATIONS**

Siting:

Mounting: Deck mounted, except for the order switches which are bulkhead mounted.

Cabling Requirements:

Related Equipment:

**PRINCIPAL COMPONENTS AND PHYSICAL DATA**

<b>COMPONENT</b>	<b>QTY</b>	<b>HEIGHT (Inches)</b>	<b>WIDTH (Inches)</b>	<b>DEPTH (Inches)</b>	<b>UNIT WT. (Pounds)</b>
Panel No. 1 NT-23AGU	1	71	29	23	985
Panel No. 2 NT-23AGU	1	71	19	22	560
Radar Order Switches NT-24645	20	9	9	6	14.5

**REFERENCE DATA AND LITERATURE**

Technical Manual:  
NAVSHIPS 900879(A)

DATE: 1 July 1964

ITEM NAME: RADAR RECEIVER

COGNIZANT SERVICE: USN

TYPE: 46ACQ-1

FEDERAL STOCK NUMBER: F5840-508-1950

	USA	USN	USAF	USMC
STATUS OR TYPE CLASSIFICATION				

Mfg(s) Name or Code Number: General Electric Company

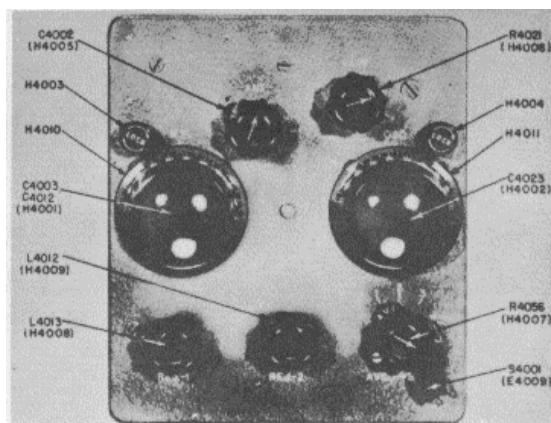

### RELATION TO SIMILAR EQUIPMENT

The 46ACQ-1 is identical to the 46ACQ except for two wire wound resistors.

### TECHNICAL DESCRIPTION

Frequency: 175 to 225 mc  
IF. Frequency: 15 mc  
Operating Voltages and Power Requirements:  
115 vac, 60 cps, 1-ph, 100w

### INSTALLATION CONSIDERATIONS

Siting:  
Mounting: Panel mounted. The 46ACQ-1 requires an auxiliary power supply, but additional space provisions for this supply need not be made since the auxiliary supply may be installed in the space occupied by the pre-amplifier it replaces. The 46ACQ-1 and the receiver it replaces have identical space requirements.  
Cabling Requirements:  
Related Equipment:

### FUNCTIONAL DESCRIPTION

The 46ACQ-1 is a replacement unit for the radar receivers used in Radar Equipments SC, SC-1, -2, and SK. The 46ACQ-1 has improved signal-to-noise ratio, greater sensitivity, and relative freedom from interfering or jamming signals.

### PRINCIPAL COMPONENTS AND PHYSICAL DATA

COMPONENT	QTY	HEIGHT (Inches)	WIDTH (Inches)	DEPTH (Inches)	UNIT WT. (Pounds)
Radar Receiver NT-46ACQ-1	1	21-27/32	19-27/32	21-7/8	
Auxiliary Power Supply Unit NT-20220	1	8-3/4	9-9/16	12-7/16	38

### REFERENCE DATA AND LITERATURE

Technical Manual:  
SHIPS 248

DATE: 1 July 1964

ITEM NAME: MASTER PPI 55ADP\* and  
BEARING AMPLIFIER CONVERTER 50ACU\*\*  
TYPE: 55ADP\* and 50ACU\*\*

COGNIZANT SERVICE: USN

FEDERAL STOCK NUMBER: F5840-372-2941\*  
F5840-308-4573\*\*

	USA	USN	USAF	USMC
STATUS OR TYPE CLASSIFICATION				

Mfg(s) Name or Code Number: Radio Corporation of America

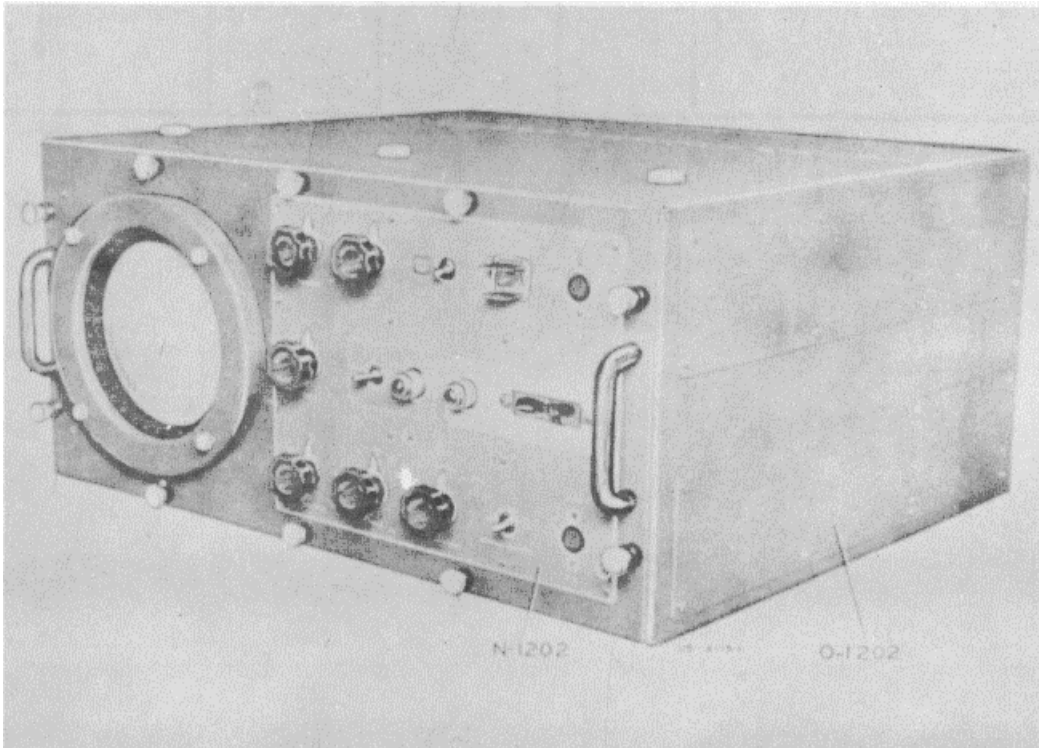

### FUNCTIONAL DESCRIPTION

The 55ADP and 50ACU make up a complete PPI equipment that is used in conjunction with shipboard Radar Equipment Models SA and SA-2.

The 55ADP consists of a PPI; the amplification, deflection, and power circuits associated with the PPI; all operating controls for the entire PPI equipment; and 4 video amplifiers that feed echo pulses to remote indicators. Provisions are included for using the ship's 60-cycle supply voltage instead of the gyro compass voltage, to control the rotation of the indicator tube sweep. When the ship's 60cycle supply voltage is used, the indications are oriented with respect to the ship's lubber line; when the gyro compass voltage is used, indication orientations are with respect to true north.

The 50ACU controls the rotation speed and direction of the servomotor so that it will follow the rotation of the antenna and obtain either relative or true bearing indications on the PPI of the 55ADP. When desired, the 50ACU will limit the exploration field of the system to a 90-degree sector. The 50ACU also includes a PPI bearing repeater synchro generator through which bearing indications may be transmitted to remote positions, and supplies a voltage to the remote indicators for energizing their pilot lights during relative bearing operation.

### RELATION TO SIMILAR EQUIPMENT

None.

50ACU: 1

55ADP and 50ACU

**TECHNICAL DESCRIPTION**

Ranges: 20, 80, and 200 mi  
Type of Presentation: One 7-in. PPI  
Operating Voltages and Power Requirements:  
55ADP, 115 vac, 60 cps, 1-ph, 350w  
55ACU, 115 vac, 60 cps, 1-ph, 110w

**INSTALLATION CONSIDERATIONS**

Siting:  
Mounting: Shelf mounted.  
Cabling Requirements:  
Related Equipment:

**PRINCIPAL COMPONENTS AND PHYSICAL DATA**

<b>COMPONENT</b>	<b>QTY</b>	<b>HEIGHT (Inches)</b>	<b>WIDTH (Inches)</b>	<b>DEPTH (Inches)</b>	<b>UNIT WT. (Pounds)</b>
Master PPI Type 55ADP	1	12-1/2	25-3/4	22-1/2	165.
Bearing Amplifier Converter Type 50ACU	1	16-5/8	27-9/16	20-1/8	159

**REFERENCE DATA AND LITERATURE**

Technical Manual:  
SHIPS 354

**50ACU: 2**



**MIL-HDBK-162A**  
15 December 1965

Volume 1  
Section 3

**DATE:** 1 July 1964

**ITEM NAME:** RADAR SIGNAL DISTRIBUTION  
SWITCHBOARD

**COGNIZANT SERVICE:** USN

**TYPE:** SB-640(XN-1)/BP

**FEDERAL STOCK NUMBER:**

	<b>USA</b>	<b>USN</b>	<b>USAF</b>	<b>USMC</b>
STATUS OR TYPE CLASSIFICATION				

Mfg(s) Name or Code Number: Portsmouth Naval Shipyard

Illustration not available.

**SB-640(XN-1)/BP: 1**

SB-640(XN-1)/BP

### FUNCTIONAL DESCRIPTION

The SB-640(XN-1)/BP is designed to switch radar information from five radar sets to nine remote repeaters. Switching is accomplished by use of identical switch and amplifier assemblies, each assembly supplying information to one repeater, and selection of radar information is accomplished by remotely controlling the position of the switch in each assembly.

Separate video amplifier, power supply, and trigger regeneration circuits are provided for each repeater. Consequently, failure of any assembly in the switchboard affects only one repeater. One section of the frame is specially wired to permit presentation of AN/BPS-4 radar information on SS series radar indicator console in addition to the normal SS/ST presentation. Provisions are also included for the distribution of selected IFF from three radar sets.

The SB-640(XN-1)/BP is intended for radar repeater system on submarine installations.

### RELATION TO SIMILAR EQUIPMENT

None.

### TECHNICAL DESCRIPTION

Impedance: 75 ohms input and output

Heat Dissipation: 300w

Current Consumption:

Total - 13.5 amp

Switch Unit (each) - 1.2 amp

Amplifier Unit (each) - 0.3 amp

Operating Voltages and Power Requirements:

115v, 60 cps, 3-ph

### INSTALLATION CONSIDERATIONS

Not available.

### PRINCIPAL COMPONENTS AND PHYSICAL DATA

COMPONENT	QTY	HEIGHT (Inches)	WIDTH (Inches)	DEPTH (Inches)	UNIT WT. (Pounds)
Radar Signal Distribution Switch- 1 75-1/2 board SB-640(XN- 1)/BP	15	25	650		

### REFERENCE DATA AND LITERATURE

Technical Manual:  
NAVSHIPS 92729

SB-640(XN-1)/BP: 2

DATE: 1 July 1964

ITEM NAME: RADAR EQUIPMENT

COGNIZANT SERVICE: USN

TYPE: SC

FEDERAL STOCK NUMBER: F5840-644-4804

	USA	USN	USAF	USMC
STATUS OR TYPE CLASSIFICATION		Obsoles		

Mfg(s) Name or Code Number: General Electric Company

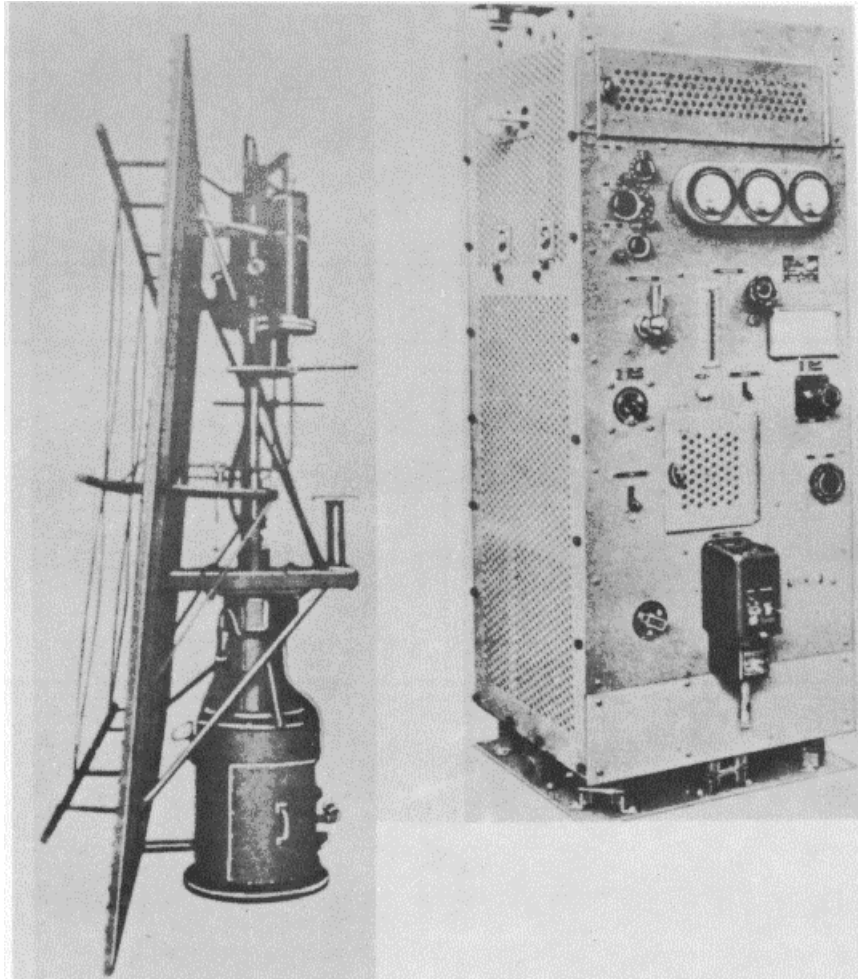

**FUNCTIONAL DESCRIPTION**

Radar Set SC is an air search radar installed on destroyers and larger vessels. A preamplifier has been added to the original SC equipment to supply additional gain and to improve the signal-to-noise ratio of the received signal.

SC: 1

SC

**RELATION TO SIMILAR EQUIPMENT**

Radar Equipments SC, SC-1, -2, -3, -4, and -5 are general detection equipments. All of these equipments have different frequency ranges. The SC uses only a type A presentation, whereas later equipments in the series use a type A presentation, a PPI scope, and a remote indicator adaptor.

Operating Voltages and Power Requirements:  
110v, 60 cps, 2 kva; 220/440v, 60 cps supplies may be used in conjunction with Power Transformer NT-30ABB  
Type of Presentation: A-scope  
Presentation Ranges: 15, 75, and 375 mi  
Antenna Type: 12 end-fed half-wave dipoles, screen reflector  
Antenna Feed: Coaxial  
Antenna Polarization: Horizontal

**TECHNICAL DESCRIPTION**

Frequency: 175 to 225 mc  
Peak Power Output: 100 kw  
Pulse Width: 5  $\mu$ sec  
IF. Frequency: 31 mc  
Bandwidth: 1.5 mc  
Maximum Detection Range: 150 mi

**INSTALLATION CONSIDERATIONS**

Siting:  
Mounting: Radar should not be mounted on outboard bulkheads. Inboard bulkhead mounting is satisfactory when bulkhead is braced to prevent vibration from ship's gunfire.  
Cabling Requirements: Cables must have enough slack to allow units to slide in and out of case.

**PRINCIPAL COMPONENTS AND PHYSICAL DATA**

COMPONENT	QTY	HEIGHT (Inches)	WIDTH (Inches)	DEPTH (Inches)	UNIT WT. (Pounds)
Control Unit NT-23AAF	1	21-1/8	13-1/2	19-11/16	
Control Unit NT-23AAG	1	21-1/8	13-1/2	19-11/16	
Transmitter NT-52AAG	1	50-3/8	21-15/16	22-9/16	
Antenna Assembly NT-66AAJ or NT-66AAK	1	9	2	8-1/2	
Receiver-Indicator NT-46AAE	1	22	19-5/8	20	
Preamplifier NT-50ABM	1	11-3/4	7-3/4	8	

**REFERENCE DATA AND LITERATURE**

Technical Manual:  
ENG 125

**SC: 2**

DATE: 1 July 1964

ITEM NAME: RADAR EQUIPMENT

COGNIZANT SERVICE: USN

TYPE: SC-2

FEDERAL STOCK NUMBER: F5840-644-4653

	USA	USN	USAF	USMC
STATUS OR TYPE CLASSIFICATION		Obsoles		

Mfg(s) Name or Code Number: General Electric Company

Illustration Not Available

### FUNCTIONAL DESCRIPTION

Radar Equipment SC-2 is a shipboard radar search equipment used on destroyers and larger vessels. It employs a master PPI from which a maximum of 16 radar repeaters may be fed. Provisions are made for use of Mk III IFF equipment.

Range Resolution: 500 yd  
Bearing Resolution: 10 deg  
Range Accuracy:  $\pm 100$  yd  
Bearing Accuracy:  $\pm 3$  deg  
Range, Min: 1, 200yd  
Operating Voltages and Power Requirements:  
230/460v, 60 cps, 1-ph, 3.5 kva; or 115 vdc,  
3.5 kva; or 230 vdc, 3.5 kva

### RELATION TO SIMILAR EQUIPMENT

Radar Equipments SC-3 and SC-4 are similar to the SC-2 but have an improved antenna pedestal. In addition, the SC-3 provides an anti-jam feature, video balance, back bias, if. rejection filter, and avc. The SC-5 has an improved intercept PPI cursor.

Type of Presentation:  
Range - 5-in. A-scope; 15-, 75-, and 375-mi ranges  
PPI - 12-in.; 20-, 75-, and 200-mi ranges  
Azimuth - True and relative dials  
Antenna Type: Dipole, end-fed half-wave  
Antenna Feed: Coaxial  
Reflector: Rectangular mattress  
Antenna Gain: 13.5 db  
Polarization: Horizontal  
Horizontal Beam Width: 17 deg  
Vertical Beam Width: 60 deg

### TECHNICAL DESCRIPTION

Frequency: 175 to 225 mc  
Peak Power Output: 200 kw  
Pulse Repetition Rate: 60 pps  
Pulse Width: 3 to 6  $\mu$ sec  
IF. Frequency: 31 mc  
Maximum Reliable Range:  
Bombers - 90 mi at 30, 000 ft;  
60 mi at 10, 000 ft  
Fighters - 40 mi at 10, 000 ft  
Battleships - 12 mi  
Cruisers - 12 mi  
Destroyers - 10 mi  
Submarines - 3 mi when surfaced

### INSTALLATION CONSIDERATIONS

Siting:  
Mounting: Radar units should not be mounted on outboard bulkheads. Inboard bulkheads may be used for mounting if they are braced to prevent vibration from gunfire.  
Cabling Requirements: Cables must have enough slack to allow units to slide in and out of case.  
Related Equipment:

SC-2: 1

SC-2

**PRINCIPAL COMPONENTS AND PHYSICAL DATA**

<b>COMPONENT</b>	<b>QTY</b>	<b>HEIGHT (Inches)</b>	<b>WIDTH (Inches)</b>	<b>DEPTH (Inches)</b>	<b>UNIT WT. (Pounds)</b>
Control Unit NT-23ACD	1	35-23/32	20	23-7/8	125
Radar Transmitter NT-52ABH	1	54-3/8	18-1/2	20-1/4	350
Antenna and Pedestal NT-66ACB, NT-66ACC, NT-66ACD, or NT-66ACE	1				556
Radar Receiver-Indicator NT-46ABJ	1	22	19-5/8	20	240
Plan Position Indicator NT-55ACC	1	40-15/32	33-1/4	40-3/8	690
Transformer NT-30AAK	1	20-1/4	7-9/16	9	135

**REFERENCE DATA AND LITERATURE**

Technical Manual:  
ENG 157 Vol II

**SC-2: 2**

DATE: 1 July 1964

ITEM NAME: RADAR EQUIPMENT

COGNIZANT SERVICE: USN

TYPE: SC-3

FEDERAL STOCK NUMBER: F5840-644-4657

	USA	USN	USAF	USMC
STATUS OR TYPE CLASSIFICATION Obsoles				

Mfg(s) Name or Code Number: General Electric Company

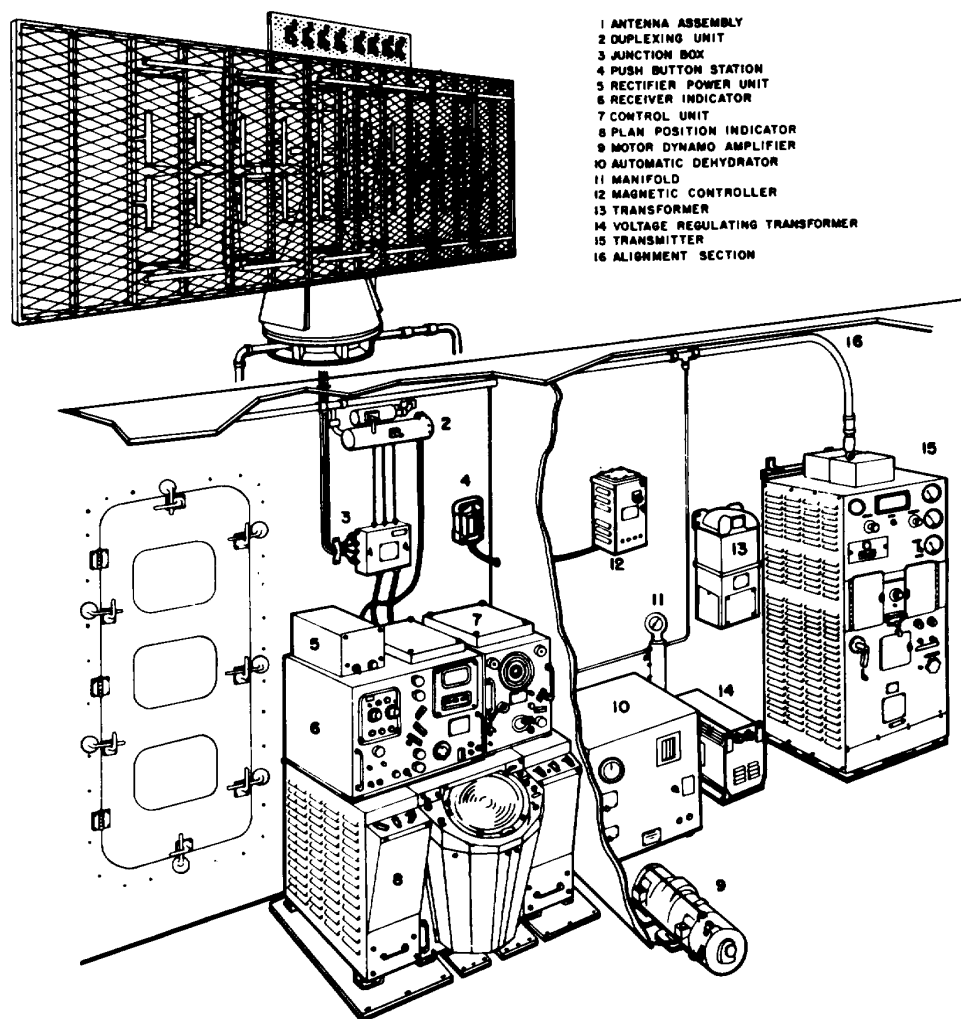

### FUNCTIONAL DESCRIPTION

Radar Equipment SC-3 is a shipboard search radar equipment that operates within a frequency range of approximately 195 to 225 mc.

Anti-jam controls and circuits are incorporated in this equipment to permit operation in a variety of jamming conditions. Provisions are also made for using the SC-3 with IFF radar equipment.

**ITEM NAME:** RADAR EQUIPMENT

**TYPE:** SC-3

**RELATION TO SIMILAR EQUIPMENT**

The SC-3 is similar to the SC-2, SC-4 and SC-5. The SC-3 provides improved anti-jam video balance, back bias, IF. rejection filter, and avc features not found on earlier models.

**TECHNICAL DESCRIPTION**

Frequency: 195 to 205 mc and 215 to 225 mc  
Power Output: 80w  
Pulse Repetition Rate: 60 pps  
Pulse Width: 6 to 30 usec  
Operating Voltages and Power Requirements:  
230 or 460v, 60 cps, 1-ph  
Range, Max: 200 mi  
Range Resolution: 500 yd  
Azimuth Resolution: 10 deg

**INSTALLATION CONSIDERATIONS**

Siting: Housed in spaces protected from bomb splinters, shell fragments and weather. Unit location conforms to latest BuShips type plan.

Mounting: Plates and brackets are needed for mounting, but are not supplied. Out-board bulkheads should not be used for mounting. Inboard bulkheads may be used if they are braced to prevent vibration from gunfire.

Cabling Requirements: Coaxial cable that connects duplexer to receiver should be as short as possible and never exceed 300 feet.

**PRINCIPAL COMPONENTS AND PHYSICAL DATA**

<b>COMPONENT</b>	<b>QTY</b>	<b>HEIGHT (Inches)</b>	<b>WIDTH (Inches)</b>	<b>DEPTH (Inches)</b>	<b>UNIT WT. (Pounds)</b>
Transmitter NT-52ABH-1	1	63-1/16	20-1/4	19-9/16	
Receiver NT-46ACM	1	21-5/16	20	19-15/32	
Plan Position Indicator NT-55ACC-1 NT-55ACC-1	1	33-1/4	29-1/16	27-3/32	600
Control Unit NT-23ADL	1	21-5/16	20	13-1/2	
Antenna Assy NT-66AEU or NT-66AET	1	18	91-1/16	43-1/2	595

**REFERENCE DATA AND LITERATURE**

Technical Manual:  
SHIPS 221A



DATE: 1 July 1964

ITEM NAME: RADAR EQUIPMENT

COGNIZANT SERVICE: USN

TYPE: SC-4

FEDERAL STOCK NUMBER: F5840-665-1979

	USA	USN	USAF	USMC
STATUS OR TYPE CLASSIFICATION		Obsoles		

Mfg(s) Name or Code Number: General Electric Company

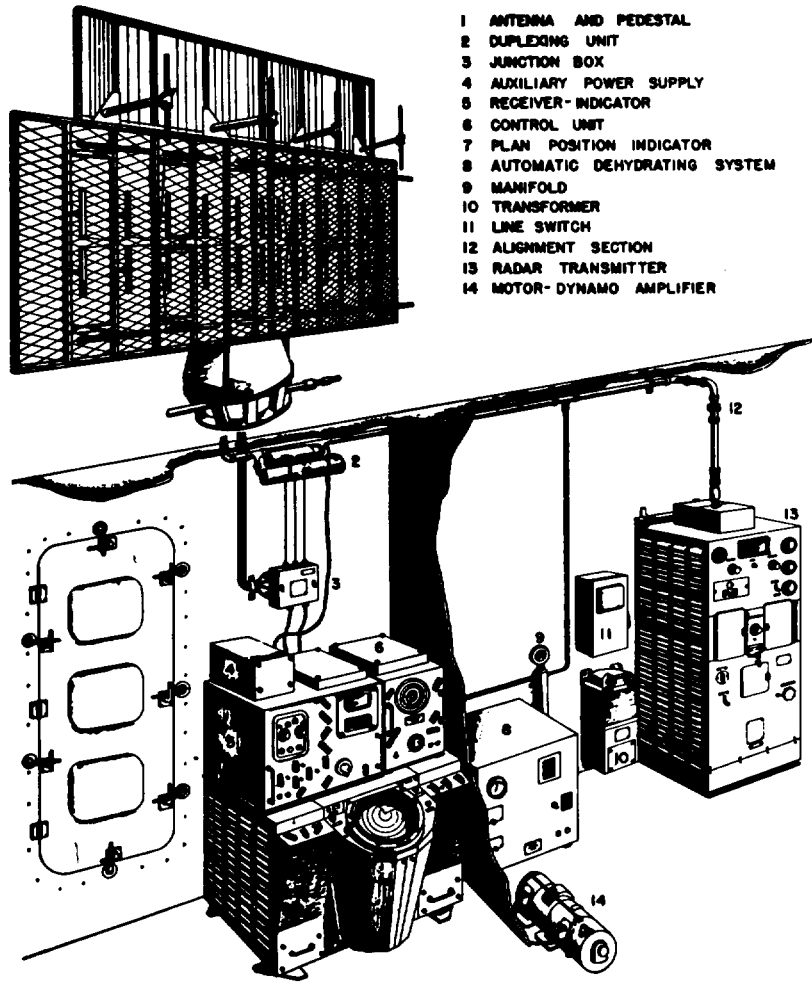

SC-4: 1

SC-4

**FUNCTIONAL DESCRIPTION**

Radar Equipment SC-4 is an early warning or long-range search radar, primarily intended for the detection of aircraft. Data is presented on both an A-scope and a PPI. Provision is made for connection to remote PPI's and to IFF equipment. The SC-4 can be operated from any of the usual ship's power sources.

**RELATION TO SIMILAR EQUIPMENT**

The SC-4 is similar functionally to the SA series equipments, the SK series equipments, and to the other equipments of the SC series. Many of the component units of these equipments are interchangeable.

**TECHNICAL DESCRIPTION**

Frequency: 195 to 205 and 215 to 225 mc  
Peak Power Output: 200 kw  
Pulse Repetition Rate: 60 pps  
Pulse Width: 5  $\mu$ sec  
Operating Voltages and Power Requirements:  
230/460v, 60cps, 1-ph, 3.7kw or 115/230 vdc,  
4.4 kw

Maximum Reliable Range:  
Bombers - 90 mi at 30, 000 ft; 60 mi at 10, 000 ft  
Fighters - 40 mi at 10, 000 ft  
Battleships - 12 mi  
Cruisers - 12 mi  
Destroyers - 10 mi  
Submarines - 3 mi when surfaced  
Range Resolution: 500 yd  
Azimuth Resolution: 10 deg

Range Accuracy: +100 yd  
Sweep Accuracy: 20 mi  
Range, Min: 1, 200 yd  
Type of Presentation:  
Range - 5-in. A-scope, range step and counter scales 20, 80, and 400 mi  
Bearing - True and relative bearing dials  
PPI - 12-in. master, 20, 80, and 200 mi  
IF. Frequency: 15 mc  
IF. Bandpass: 0.43 mc  
Video Bandpass: 0.5 mc  
Receiver Noise: 6 db above theoretical  
Receiver Gain: 160 db  
Receiver Sensitivity: 1  $\mu$ v for 1.1 signal-to-noise ratio; sensitivity time control reduces gain for ranges of 8, 000 to 12, 000 yd  
Antenna Type: Dipole, end-fed half-wave  
Antenna Gain: 13.5 db  
Reflector: Rectangular mattress  
Antenna Feed: Coaxial  
Polarization: Horizontal  
Vertical Beam Width: 60 deg  
Horizontal Beam Width: 17 deg

**INSTALLATION CONSIDERATIONS**

Siting:  
Mounting: Radar units should not be mounted on outboard bulkheads. Inboard bulkheads may be used if they are braced to prevent vibration from gunfire.  
Cabling Requirements: Cables must have enough slack to allow units to slide in and out of case.  
Related Equipment:

**PRINCIPAL COMPONENTS AND PHYSICAL DATA**

COMPONENT	QTY	HEIGHT (Inches)	WIDTH (Inches)	DEPTH (Inches)	UNIT WT. (Pounds)
Transmitter NT-52ADB	1	64-11/16	19-9/16	20-1/4	334
Receiver-Indicator NT-46ADG including Receiver NT-46ACQ-1	1	22-9/16	21-27/32	21-7/8	253
Control Unit NT-23AEZ	1	22-9/16	13-3/8	21-9/16	125
Plan Position Indicator NT-55AEX	1	43	37-1/16	42-13/16	800
Antenna Assembly NT-66AET-1 or NT-66AEU-1	1	180	43-1/2	91-1/16	590
Transformer NT-30AAK	1	20-1/4	7-21/32	9-1/16	135

**REFERENCE DATA AND LITERATURE**

Technical Manual:  
NAVSHIPS 900, 866

DATE: 1 July 1964

ITEM NAME: RADAR EQUIPMENT

COGNIZANT SERVICE: USN

TYPE: SC-5

FEDERAL STOCK NUMBER: F5840-644-4912

	USA	USN	USAF	USMC
STATUS OR TYPE CLASSIFICATION		Obsoles		

Mfg(s) Name or Code Number: General Electric Company

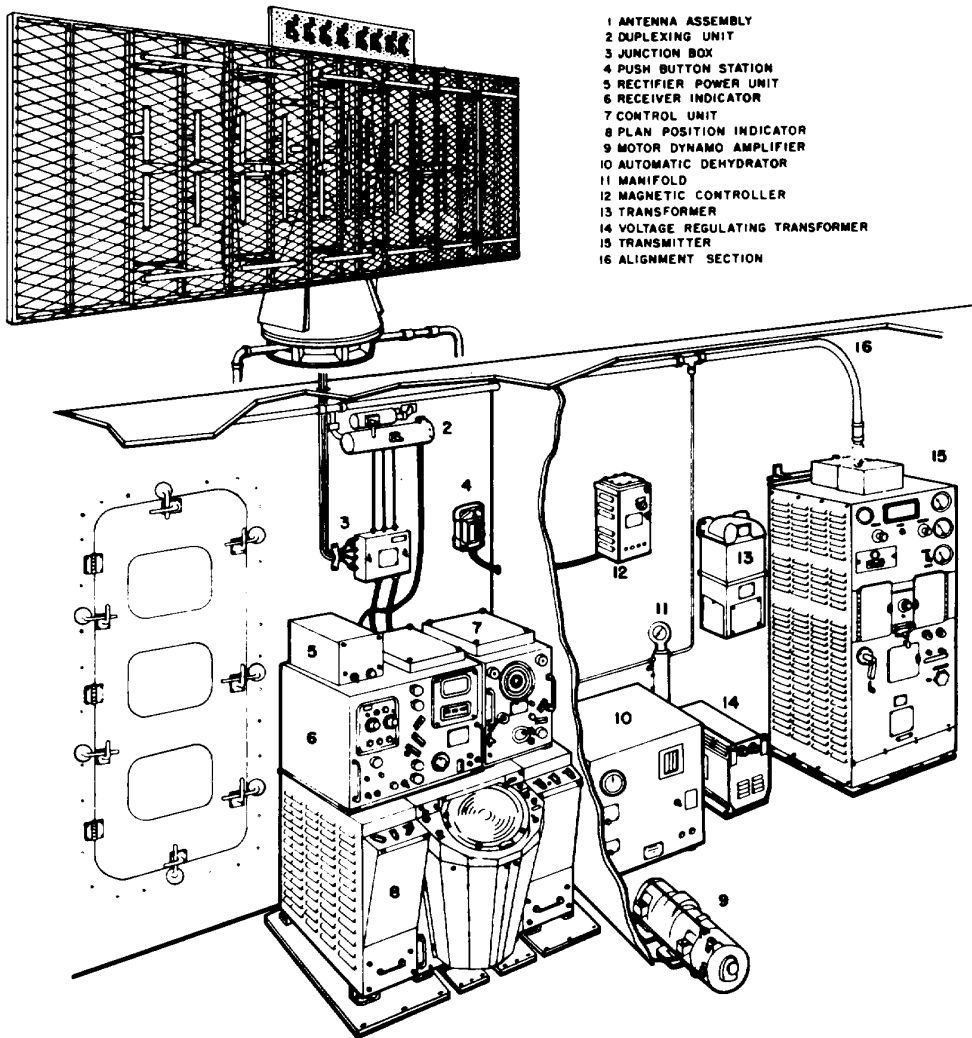

SC-5: 1

SC-5

**FUNCTIONAL DESCRIPTION**

The SC-5 is a medium-range search radar used for early warning against aircraft. It employs a master PPI which will feed as many as 16 radar repeaters. Provision is made for use of Mark III IFF equipment. The SC-5 is installed on destroyers and larger vessels.

**RELATION TO SIMILAR EQUIPMENT**

The SC-5 is similar to Radar Equipments SC, SC-1, SC-2, SC-3, and SC-4, except that the SC-5 has a new antenna drive motor, a selenium rectifier in the control unit, and different transmitter mounting dimensions.

**TECHNICAL DESCRIPTION**

Frequency: Transmitter, 195 to 255 mc;  
receiver, 175 to 225 mc  
Peak Power Output: 200 kw  
Pulse Repetition Rate: 60 pps  
Pulse Width: 5  $\mu$ sec  
IF. Frequency: 15 mc  
IF. Bandwidth: 5 mc  
Receiver Sensitivity: 1  $\mu$ V  
Maximum Overall Gain: 160 db  
Operating Voltages and Power Requirements:  
460v, 60 cps, 1-ph, 3.5 kw; can be converted  
for 230 vac operation with supplied kit.  
Maximum Reliable Range:  
Bombers - 90 mi at 30, 000 ft  
Fighters - 40 mi at 10, 000 ft

Battleships - 12 mi  
Cruisers - 12 mi  
Submarines - 3 mi  
Range Resolution: 500 yd  
Bearing Resolution: 10 deg  
Range Accuracy:  $\pm$ 100 yd  
Bearing Accuracy:  $\pm$ 3 deg  
Range, Min: 1, 200 yd  
Type of Presentation:  
Range - 5-in. A-scope; 20-, 80-, and 400-mi  
ranges  
Bearing - True and relative  
PPI-12-in. master PPI with 20-, 80-, and  
200-mi ranges  
Antenna Type: Dipole array  
Antenna Impedance: 52 ohms  
Reflector: Rectangular mattress  
Horizontal Beam Width: 17 deg at half-power  
points  
Vertical Beam Width: 60 deg at half-power points  
Polarization: Horizontal  
Antenna Gain: 13.5 db

**INSTALLATION CONSIDERATIONS**

Siting:  
Mounting: Radar units should not be mounted on  
outboard bulkheads. Inboard bulkhead mount-  
ing is permitted if bulkheads are braced to  
prevent vibration from gunfire.  
Cabling Requirements: Cables must have enough  
slack to allow units to slide in and out of case

**PRINCIPAL COMPONENTS AND PHYSICAL DATA**

COMPONENT	QTY	HEIGHT (Inches)	WIDTH (Inches)	DEPTH (Inches)	UNIT WT. (Pounds)
Transmitter NT-52ADG	1	64-11/16	20-1/4	22-7/8	334
Receiver-Indicator NT-46ADG-1 including: Receiver NT-46ACQ-2	1	22-9/16	21-27/32	21-7/8	253
Control Unit NT-23AFN	1	22-9/16	13-3/8	21-9/16	125
Plan Position Indicator NT-55AFZ	1	43	37-1/16	42-13/16	800
Antenna Assembly NT-66AJE or NT-66AJF	1	180	43-1/2	91-1/16	590
Transformer NT-30AAK	1	20-1/4	7-21/32	8-7/16	135

**REFERENCE DATA AND LITERATURE**

Technical Manual:  
NAVSHIPS 900, 867

DATE: 1 July 1964

ITEM NAME: RADAR EQUIPMENT

COGNIZANT SERVICE: USN

TYPE: SR-3, SR-3a, SR-3b, SR-3c

FEDERAL STOCK NUMBER: SR-3 - F5840-665-2258;  
SR-3a- F5840 642-6679

	USA	USN	USAF	USMC
STATUS OR TYPE CLASSIFICATION		Obsoles		

Mfg(s) Name or Code Number: Industrial Electronics Div., Westinghouse Electronic Corp.

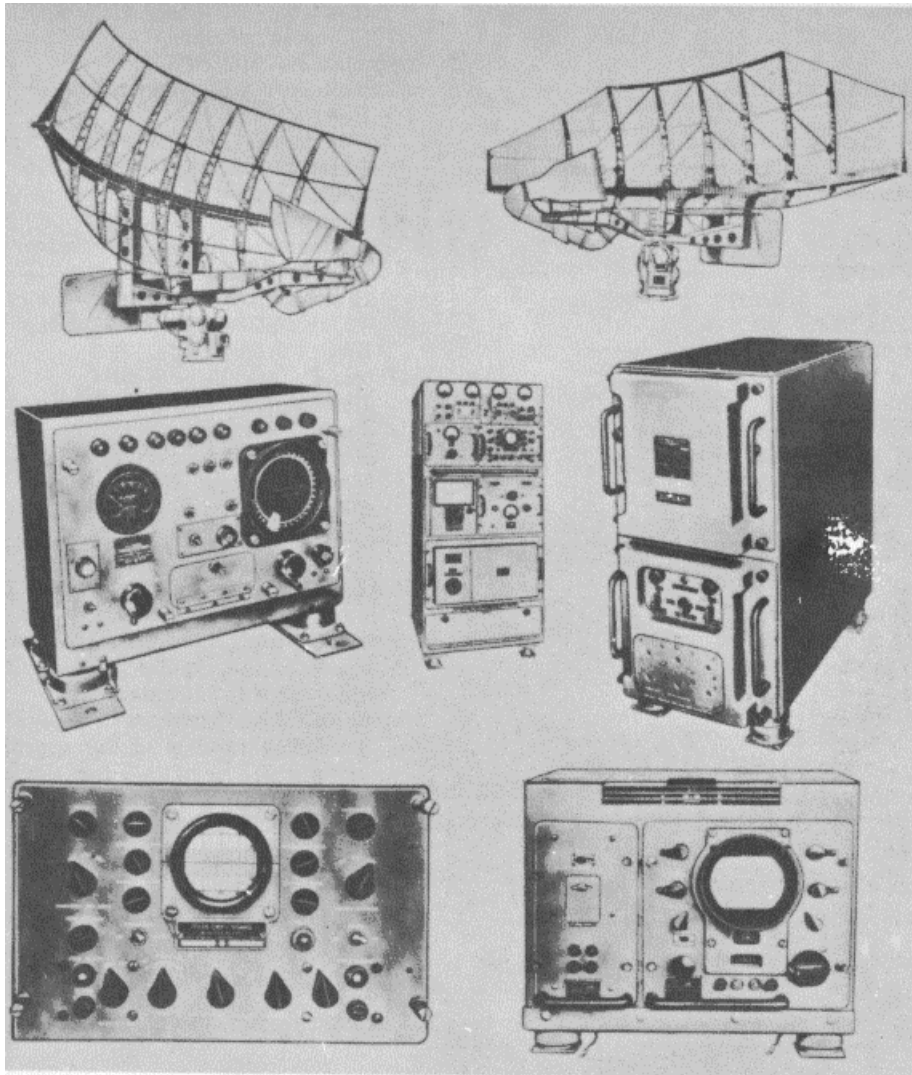

SR-3: 1

SR-3, -3a, -3b, -3c

## FUNCTIONAL DESCRIPTION

Radar Equipments SR-3, -3a, -3b, and -3c are shipboard equipments that operate within the L-band 1250 to 1350 mc. They are capable of detecting surface craft and aircraft at long range. They will supply video and sweep trigger voltages for type A and PPI scopes, as well as one-speed bearing data for PPI use. Provision has been made for operating one master PPI and two remote PPI's of the VE or VJ type. The antenna can be operated either automatically or manually. These equipments include their own echo box, which has a directional coupler and slotted-line assembly. Provision is made for integration with the ship's IFF equipment.

These equipments are similar except for the types of antenna used.

## RELATION TO SIMILAR EQUIPMENT

The SR-3 series radars are similar to the SR-6 series and the AN/SPS-6 series. Many of the components are interchangeable.

## TECHNICAL DESCRIPTION

Frequency: 1250 to 1350 mc  
Peak Power Output: 500 to 750 kw  
Pulse Repetition Rate: 150 to 600 pps  
Pulse Width: 1 and 4  $\mu$ sec  
Operating Voltages and Power Requirements:  
115v, 60 cps, 1-ph, 5 kva, 92% pf  
Sensitivity: 0.5 to 1  $\mu$ V  
IF. Frequency: 30 mc  
IF. Bandpass: 0.5 and 2.0 mc  
Receiver Noise: 14 db above theoretical  
Maximum Reliable Range:  
Bombers - 100 mi at 10, 000 ft  
Fighters - 80 mi at 10, 000 ft  
Battleships - 20 mi  
Cruisers - 20 mi  
Destroyers - 15 mi  
Submarines - 5 mi  
Range Resolution: 200 yd  
Azimuth Resolution: 1.5 deg  
Range Accuracy: 100 yd  
Azimuth Accuracy:  $\pm 2$  deg  
Range, Min: 600 yd

### Type of Presentation:

Range - 5-in. A-scope; 4, 20, 80, 400 mi; step expansion is provided except on 400 mi sweep

Bearing - Relative and true

Other - A monitor A-scope is provided on 20-mi and 80-mi ranges; provision is made for radar repeaters

### Antenna 66AMD:

Reflector - V-shaped, stainless steel waveguide 210 in. long

Feed - Waveguide and dipole

Horizontal Beam Width - 4 deg

Vertical Beam Width - 30 deg

Polarization- Horizontal

Gain - 24 db

Rotation - 360 deg at 2.5 and 5.0 rpm, automatic or manual

### Antenna AS-402/SPS-6:

Reflector - Slotted parabolic

Feed - Horn-fed

Horizontal Beam Width - 3.5 deg

Vertical Beam Width - 10 deg

SWR- 1.1 to 1.0

### Antenna AS-429A/SPS- 6A:

Reflector - Slotted parabolic

Feed - Horn-fed

Horizontal Beam Width - 3.5 deg

Vertical Beam Width - 20 deg

SWR - 1.1 to 1.0

### Antenna AS-430A/SPS-6B

Reflector - Slotted parabolic

Feed - Horn-fed

Horizontal Beam Width - 3.5 deg

Vertical Beam Width - 30 deg

SWR - 1.1 to 1.0

## INSTALLATION CONSIDERATIONS

Siting: Siting of individual components is governed by the type of Naval craft in which the equipment is installed.

Mounting: Components are designed for deck or bulkhead mounting, as appropriate. Shock mounts are provided for those components susceptible to casualty from mechanical shock.

Cabling Requirements:

Related Equipment:

SR-3, -3a, -3b, -3c

**PRINCIPAL COMPONENTS AND PHYSICAL DATA**

<b>COMPONENT</b>	<b>QTY</b>	<b>HEIGHT (Inches)</b>	<b>WIDTH (Inches)</b>	<b>DEPTH (Inches)</b>	<b>UNIT WT. (Pounds)</b>
Modulator CAY-50AHE	1	63	28	24-11/16	905
Transmitter-Receiver CAY-43ADL	1	62-7/8	28	24-13/16	815
Range Indicator CRP-55AHP	1	18-7/16	21	32-9/32	226
General Control Unit CAY-23AHW (SR-3 only)	1	30-7/8	17-31/32	27-3/4	168
Antenna Pedestal CAPZ-21ADK (SR-3 only)	1	44-5/8	42	22-5/8	455
Antenna Mounting AB-146/SPS-6 (SR-3a, -3b, -3c only)	1				
Transmitter Oscillator CAY-35ACJ	1	27-7/8	14-7/16	21-1/8	210
Antenna Assembly CAY-66ALN (SR-3 only)	1	210	39-1/4	16-3/4	193
Mk III IFF Antenna 66AMD (SR-3 only)	1	14-1/8	36	120-1/4	120
Antenna AS-402/SPS-6 (SR-3a only) or	1	77-1/2	140	210	686
Antenna AS-429A/SPS-6A (SR-3b only) or	1	84-5/8	152-7/8	204	686
Antenna AS-430A/SPS-6B (SR-3c only)	1	94-5/8	153-5/8	204	626
Radar Set Control C-924/SPS	1	13-1/4	15-7/16	17-1/2	44
Antenna Control C-491B/SPS-6 (SR-3a, -3b, -3c only)	1	13-5/8	27-9/16	29-1/8	221,

**REFERENCE DATA AND LITERATURE**

Technical Manuals:  
NAVSHIPS 900, 539  
NAVSHIPS 900, 539(A)

DATE: 1 July 1964

ITEM NAME: RADAR EQUIPMENT

COGNIZANT SERVICE: USN

TYPE: SR-6

FEDERAL STOCK NUMBER: F5840-665-1669

	USA	USN	USAF	USMC
STATUS OR TYPE CLASSIFICATION		Obsoles		

Mfg(s) Name or Code Number: Westinghouse Electric Company

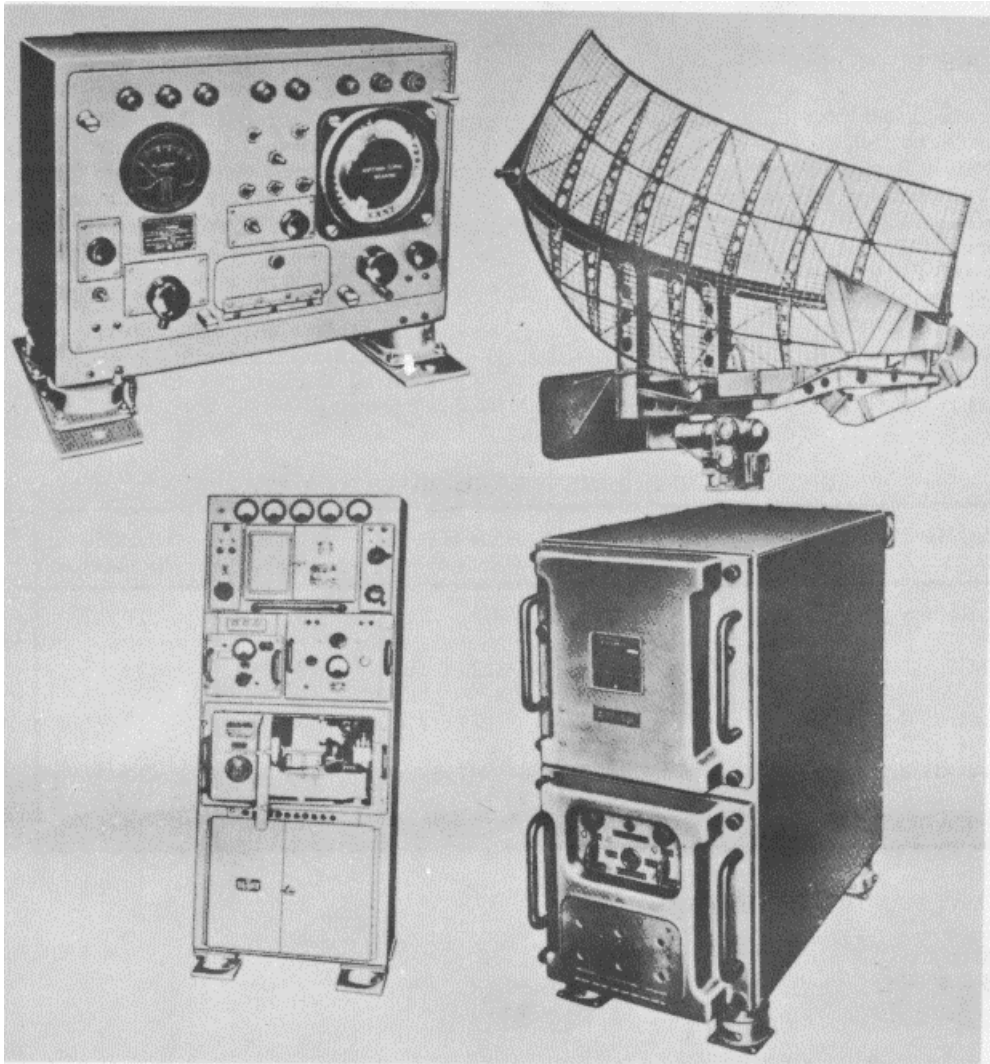

SR-6: 1



SR-6

**FUNCTIONAL DESCRIPTION**

Radar Equipment SR-6 is a medium range search equipment for shipboard installation. The SR-6 is used to detect surface vessels and aircraft and to supply range and bearing data. No PPI or A-scopes are supplied with the SR-6, but provision is made for use of all types of standard repeaters. IFF equipments for the SR-6 are Radar Equipments Mark 3 and Mark 5.

Azimuth Accuracy:  $\pm 1$  deg  
 Range, Min: 800 yd  
 Type of Presentation:  
     Range- 5-in. A-scope (not supplied) 4, 20, 80, and 200 mi  
     Bearing- Relative and true shown on dial; provision is made for radar repeaters  
 Reflector: V-shaped, 112-3/16 in. long  
 Antenna Feed: Waveguide and dipole  
 Antenna Turning Radius: 5 ft  
 Horizontal Beam Width: 8 deg  
 Vertical Beam Width: 30 deg  
 Antenna Polarization: Horizontal  
 Antenna Gain: 21 db  
 Antenna Rotation: 360 deg; 5 to 15 rpm, automatic or manual

**RELATION TO SIMILAR EQUIPMENT**

Radar Equipment SR-6 is a lightweight version of the SR-3 and is similar to Radar Equipments AN/SPS-6( ) and SR-3c.

**TECHNICAL DESCRIPTION**

Frequency: 1250 to 1350 mc  
 Peak Power Output: 750 kw  
 Pulse Repetition Rate: 300 pps  
 Operating Voltages and Power Requirements:  
     110/220/440v i5%, 60 cps, 1-ph, 4.5 kva  
 IF. Frequency: 30 mc  
 Bandwidth: 0.5 and 2 mc  
 Noise: 14 db above theoretical  
 Range Resolution: 400 yd  
 Azimuth Resolution: 8 deg  
 Range Accuracy: 4-mi sweep,  $\pm 100$  yd; 20-mi sweep,  $\pm 100$  yd; 80-mi sweep,  $\pm 2,000$  yd

**INSTALLATION CONSIDERATIONS**

Siting: Locate IFF coordinator-range indicator, master PPI indicator and radar set control in CIC room. Locate radar receiver-transmitter near antenna mast for short straight waveguide run. Locate antenna control, gyro-compass synchro amplifier, and synchro capacitor unit near the radar receiver-transmitter.  
 Mounting: Deck and bulkhead. Shock mounts to deck; brackets to bulkhead.  
 Cabling Requirements:  
 Related Equipment: Standard Navy radar repeaters.

**PRINCIPAL COMPONENTS AND PHYSICAL DATA**

COMPONENT	QTY	HEIGHT (Inches)	WIDTH (Inches)	DEPTH (Inches)	UNIT WT. (Pounds)
Transmitter-Receiver Unit 43ADV	1	72	25	28	954
Antenna 66AMV	1	112-3/16	19-5/8	23	80
Radar Set Control C-645/SPS	1	17-1/2	13-1/4	14-7/16	40
Antenna Pedestal 21ADS	1	26-15/16	18	25-3/4	233
Transformer CAY-303936	1	16	11-3/8	13-11/16	168

**REFERENCE DATA AND LITERATURE**

Technical Manual:  
NAVSHIPS 900989

DATE: 1 July 1964

ITEM NAME: RADAR EQUIPMENT

COGNIZANT SERVICE: USN

TYPE: SR-6a, SR-6b\*

FEDERAL STOCK NUMBER:

	USA	USN	USAF	USMC
STATUS OR TYPE CLASSIFICATION		Obsoles *		

Mfg(s) Name or Code Number: Westinghouse Electric Company

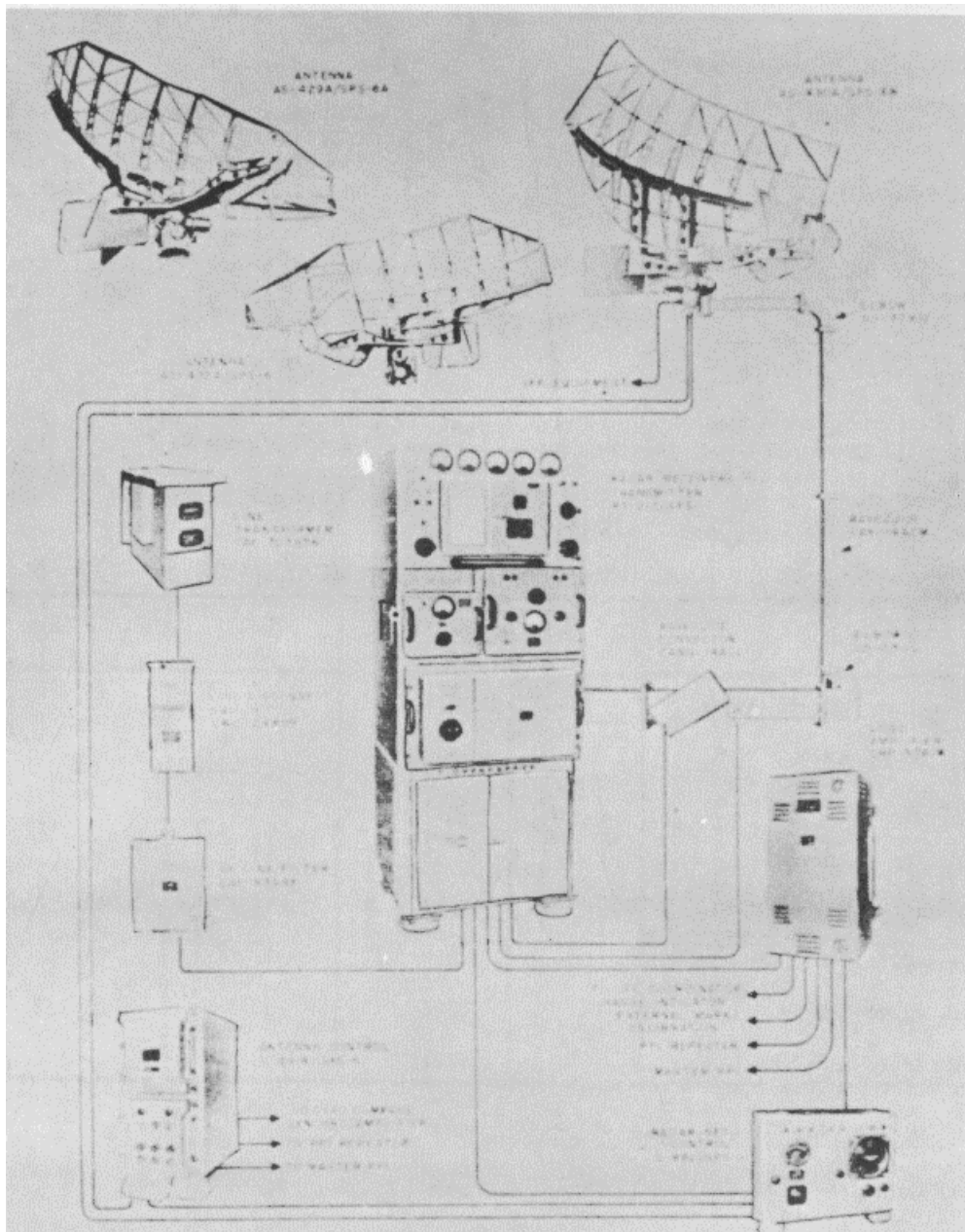

SR-6a: 1

SR-6a, SR-6b

**FUNCTIONAL DESCRIPTION**

Radar Equipments SR-6a and SR-6b are shipboard search radars that provide accurate range-azimuth data and early warning of approaching surface craft and aircraft. They provide line-of-sight range information that is displayed on the A-scope and the range counter of the associated range indicator, while relative and true bearing data is displayed on any PPI scopes being operated with the equipment.

The SR-6a and SR-6b are identical, differing only in the type of antenna reflector used.

**RELATION TO SIMILAR EQUIPMENT**

None.

**TECHNICAL DESCRIPTION**

Frequency: 1244 to 1350 mc  
 Power Output: 500 to 750 kw  
 Pulse Repetition Rate: 300 pps  
 Pulse Width: 2  $\mu$ sec  
 Operating Voltages and Power Requirements:  
 110 to 120v, 60 cps, 1-ph  
 IF. Frequency: 30 mc  
 Antenna Rotation Speed: Automatic, 5 to 10 rpm  
 cw, 10 to 15 rpm cw, 10 rpm cw emergency;  
 manual, 2.5 rpm max cw or ccw  
 Antenna Feed: Horn

Antenna Polarization: Vertical for IFF antenna,  
 horizontal for radar antenna  
 Horizontal Beam Width: 3.5 deg  
 Vertical Beam Width:  
 AS-402A/SPS-6 - 10 deg  
 AS-429A/SPS-6A - 20 deg, cosecant squared  
 AS-430A/SPS-6B - 30 deg, cosecant squared

**INSTALLATION CONSIDERATIONS**

Siting: As a general rule, locate the IFF coordinator-range indicator, master PPI indicator, and Radar Set Control C-882/SPS in CIC room; Receiver-Transmitter RT-217/SPS in a compartment near the mast; Antenna Control C-491B/SPS-6, gyro-compass synchro amplifier, and synchro capacitor unit near RT-217/SPS, so they can be observed by the operator. Allow space for servicing equipment. Follow installation drawings of NAVSHIPS 900989.1(A) for slide-out chassis clearances and ventilation requirements.

Mounting: Mounting holes are drilled at dimensions shown in the outline drawings of NAVSHIPS 900989.1(A).

Cabling Requirements: Most coaxial lines go directly to terminal boards. Keep solid coaxial cables away from steam pipes, hot-air intakes and stack gases. Do not run cables through battery charging compartments, galleys, uptake spaces or machinery spaces.

Related Equipment:

**PRINCIPAL COMPONENTS AND PHYSICAL DATA**

COMPONENT	QTY	HEIGHT (Inches)	WIDTH (Inches)	DEPTH (Inches)	UNIT WT. (Pounds)
Transmitter-Receiver RT-217/SPS	1	77	35	31	1260
Antenna Control C-491B/SPS-6	1	36	35	21	355
Radar Set Control C-882/SPS	1	25	21	18	100
Range Indicator NT-55AHP-1	1	39	33	24	340
Antenna Mounting AB-146/SPS-6	1	44	34	23	480
Antenna AS-402A/SPS-6	1	210	93	77	396
Antenna AS-429A/SPS-6A	1	204	153-5/8	95-7/8	626
Antenna AS-430A/SPS-6B	1	204	152-13/16	90-1/8	586

**REFERENCE DATA AND LITERATURE**

Technical Manual:  
 NAVSHIPS 900, 989(A)  
 NAVSHIPS 92381

MIL-HDBK-162A  
15 December 1965

Volume 1  
Section 3

DATE: 1 July 1964

ITEM NAME: RADAR EQUIPMENT

COGNIZANT SERVICE: USN

TYPE: SS, SS-a, SS-1, SS-2

FEDERAL STOCK NUMBER: See Note 1

	USA	USN	USAF	USMC
STATUS OR TYPE CLASSIFICATION		Ltd Std		

Mfg(s) Name or Code Number: Western Electric Company

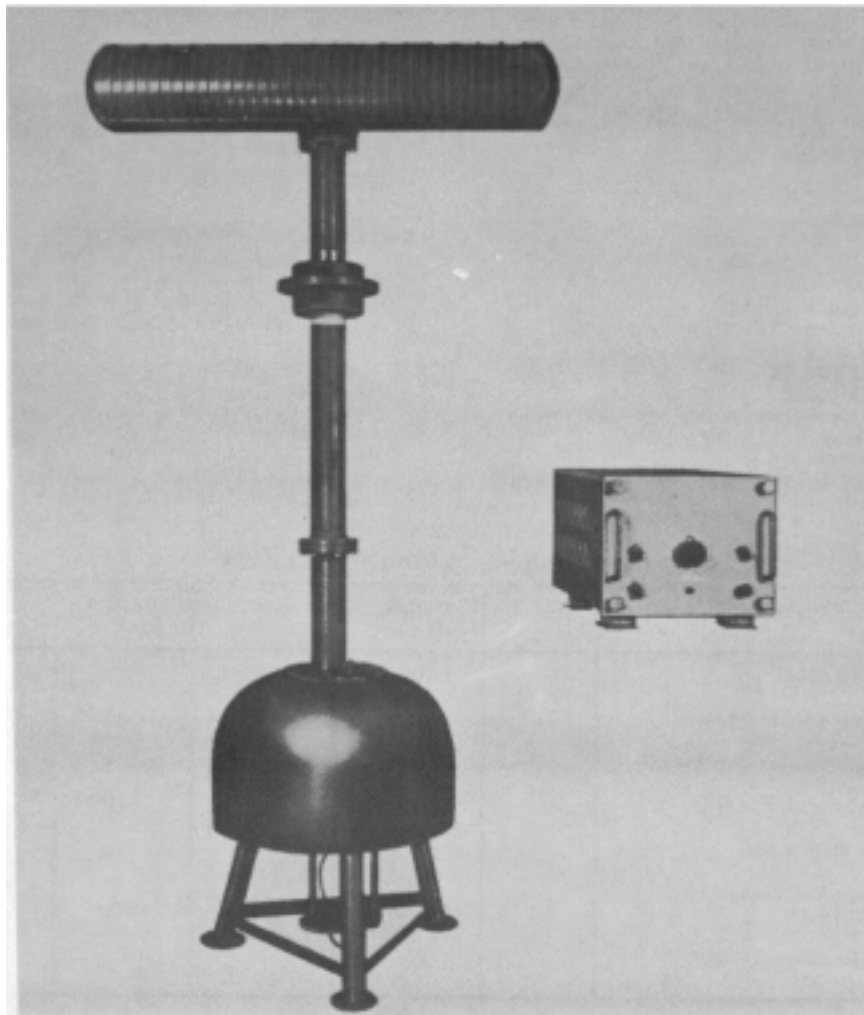

SS: 1

SS, SS-a, SS-1, SS-2

**FUNCTIONAL DESCRIPTION**

Radar Equipments SS, SS-a, SS-1, and SS-2 are installed in submarines to search for, and obtain torpedo launching information about, surface ships. These equipments also provide warning information on low-flying aircraft. Provision is made for IFF operation.

**RELATION TO SIMILAR EQUIPMENT**

The SS and SS-a are similar to Radar Equipment SS-1 and SS-2 except that the latter have interconnections for a target designation computer. Radar Equipment SS, SS-a, SS-1, and SS-2 may be used to replace the SJ, SJ-a, SJ-1, and ST radars and may be used with an ST antenna.

**TECHNICAL DESCRIPTION**

Frequency: 8740 to 8890 mc  
 Maximum Reliable Range:  
     Bombers - 7.5 mi at 500 ft  
     Battleships - 15 mi  
     Cruisers - 15 mi  
     Destroyers - 12.5 mi  
     Submarines - 10 mi (when surfaced)  
 Range, Min: 300 yd  
 Power Output: 75 to 110 kw (peak);  
     0.045 kw (avg)  
 Operating Voltages and Power Requirements:  
     115 vac, 60 cps, 1-ph, 3.8 kva  
 Type of Presentation:  
     Range - 3-in. A- or B-scope at ranges of 4,  
         10, 20, and 80 mi

Bearing - B-scope at 4, 000 yd and 30 deg

sector  
 PPI - 5-in. scope with provision for four PPI repeaters at ranges of 4, 10, 20, and 80 mi  
 Other - IFF may be displayed on A-scope  
 RF Power Source: Type 2J50 magnetron  
 Pulse Repetition Rate: 600 cps ±10i  
 Pulse Width: 0.5 μsec  
 Horizontal Coverage: 360 deg  
 Antenna Rotation Speed: 0 to 8 rpm (motor or manual)  
 Reflector Type: Solid, truncated parabola  
 Antenna Feed: Waveguide  
 Horizontal Beam Width: 2.6 deg  
 Vertical Beam Width: 16 deg  
 Antenna Gain: 26 db  
 Range Resolution: 85 yd  
 Bearing Resolution: 3 deg  
 Range Accuracy: ±25 yd plus 1% of range on 0- to 20-mi scale; ±200 yd plus 2% of range on 0- to 80-mi scale  
 Receiver Bandwidth: 5 mc  
 IF. Frequency: 60 mc

**INSTALLATION CONSIDERATIONS**

Siting: Control units, transmitter-receiver, and units included in the waveguide line should be installed in the conning tower; power supply rectifiers and junction box should be installed in control room.  
 Mounting:  
 Cabling Requirements: Only high voltage cable is supplied.  
 Related Equipment: ST periscope antenna; Gyro Compass Mk7 Mod 4; Torpedo Data Computer Mk 4 Mods 1 thru 12; SV Radar Equipment.

**PRINCIPAL COMPONENTS AND PHYSICAL DATA**

COMPONENT	QTY	HEIGHT (Inches)	WIDTH (Inches)	DEPTH (Inches)	UNIT WT. (Pounds)
Junction Box 62217	1	4-17/32	18-1/4	18-5/8	50
Antenna Drive Motor 211388	1	8-3/4	8-27/32	17-3/16	120
Waveguide Switching Unit 24AAN	1	5-1/32	12-5/16	12-5/8	23
Directional Coupler 14ABL	1	2-7/16	3-5/8	8-1/32	5
Waveguide Stop 23AGO	1	4-5/16	6-1/2	6-1/2	15
High Voltage Rectifier 20ADW* or 20ADW-1**	1	17-3/8	19-3/8	26-3/4	325
Auxiliary Rectifier 20ADO* or 20ADO-1**	1	17-3/8	19-3/8	26-7/8	250

SS, SS-a, SS-1, SS-2

PRINCIPAL COMPONENTS AND PHYSICAL DATA (cont'd)

COMPONENT	QTY	HEIGHT (Inches)	WIDTH (Inches)	DEPTH (Inches)	UNIT WT. (Pounds)
Regulated Rectifier 20ADN* or 20ADN-1**	1	17-3/8	19-3/8	26-7/8	310
Servo Power Unit 20ADX* or 20ADX-1**	1	17-3/8	19-3/8	26-7/8	250
Servo Amplifier 50AGO (SS, SS-1 only)	2	5-11/16	6-3/8	13-3/8	10
Motor Controller Unit 23AGE* or CBGH**	1	13-1/16	13-1/8	14	50
Motor Control Rectifier 20ADP* or 20ADP-1**	1	17-3/8	19-3/8	26-7/8	340
Echo Box TS-311/UP* or TS-311A/UP**	1	9	9-1/4	17-3/4	20
Radar Transmitter Receiver 43ADF* or 43ADF-1**	1	17-1/16	22-1/2	34	250
Indicator Console 55AGV* or 55AGV-1(SS-a only)	1	17-1/2	20-7/8	51-1/8	750
or 55AGV-2(SS-1 only)	1	22	40-7/8	51	825
or 55AGV-3(SS-2 only)	1	22-3/4	40-1/8	51-1/4	825
Antenna Assembly 66AKX* or 66AKX-1(SS-1 only)	1	17-1/8	28-13/32	30	425
or 66AKX-2(SS-2 only)	1	17-1/8	28-13/32	30	425
Power Distribution Unit 23AGS* or 23AGS-1**	1	9-3/4	18	21-1/16	90
Phase Adjuster 14ABM*** or 14ABM-1(SS-2 only)	1	1-7/8	2	8	5
Electronic Control Amplifier Assembly 50AKK(SS-a, SS-1 only)	2	1-7/8	2	8	5
or 50AKK-1(SS-2 only)	1	14-1/2	21-1/16	50	300
Sensitivity Time Control Unit 23AJG-1(SS-1 only)	1	14-1/2	21-1/16	50	300
23AJG-2(SS-2 only)	1	5-15/16	7-3/4	8-5/8	10
Dummy Antenna TS-231/AP**	1	5-15/16	7-3/4	8-5/8	10
Frequency Power Meter TS-230/AP* or TS-230A/AP**	1	1-3/4	2	7-13/16	8
	1	2	6	10	10.5
	1	2	6	10	10.5

SS: 3

SS, SS-a, SS-l, SS-2

**PRINCIPAL COMPONENTS AND PHYSICAL DATA (cont'd)**

<b>COMPONENT</b>	<b>QTY</b>	<b>HEIGHT (Inches)</b>	<b>WIDTH (Inches)</b>	<b>DEPTH (Inches)</b>	<b>UNIT WT. (Pounds)</b>
Error Voltage Monitor ID-303/BPS-1 (SS-2 only)	1	3-3/4	4-5/8	6-1/2	5
Set of Interconnecting Cables and Accessories					

\* SS, SS-a only

\*\* SS-1, SS-2 only

\*\*\* SS, SS-a, SS-1 only

**REFERENCE DATA AND LITERATURE**

**Note 1. Federal Stock Numbers**

Technical Manuals:  
NAVSHIPS 335  
NAVSHIPS 335-1  
NAVSHIPS 91513, Vol 1  
NAVSHIPS 91281

SS - 5840-642-6708  
SS-a -  
SS-1 - 5840-642-7060  
SS-2 - 5840-352-0085

**SS: 4**

DATE: 1 July 1964

ITEM NAME: RADAR EQUIPMENT

COGNIZANT SERVICE: USN

TYPE: ST

FEDERAL STOCK NUMBER: 5840-642-7055

	USA	USN	USAF	USMC
STATUS OR TYPE CLASSIFICATION		Obsoles		

Mfg(s) Name or Code Number: Western Electric Company

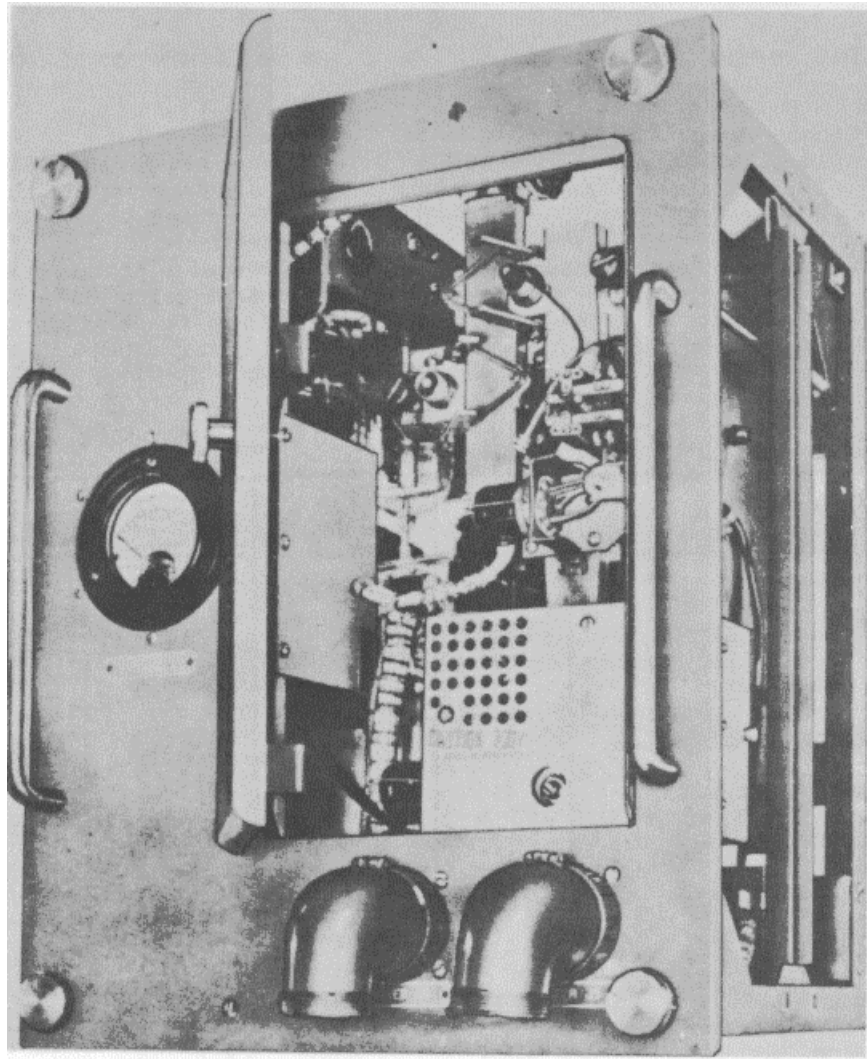

ST: 1



ST

**FUNCTIONAL DESCRIPTION**

Radar Equipment ST is installed in submarines and is used in conjunction with Radar Equipment SJ for detecting surface objects. The antenna is mounted in the periscope for use at periscope depth. Provision is made for the ST to operate into a dummy antenna during submerged operations or when radar silence is desired with the equipment operating.

Other - Provisions for IFF display  
 RF Power Source: Type 2J50 magnetron  
 Pulse Repetition Rate:  
 1, 500 pps 10% and 600 pps ±10%  
 Pulse Width: 0.3 μsec  
 Horizontal Coverage: 360 deg  
 Antenna Feed: 2- by 6-in. horn in periscope  
 Horizontal Beam Width: 25 deg  
 Vertical Beam Width: 12 deg  
 Antenna Gain: 15 db  
 Range Resolution: 75 yd  
 Bearing Resolution: 20 deg  
 Range Accuracy: 15 yd ±0.1% of range  
 Bearing Accuracy: ±5 deg  
 IF. Frequency: 60 mc

**RELATION TO SIMILAR EQUIPMENT**

Radar Equipment SS, SS-a, SS-1, or SS-2 may be used to replace Radar Equipment ST.

**TECHNICAL DESCRIPTION**

Frequency: 10, 000 mc  
 Maximum Reliable Range:  
 Battleships and Cruisers - 5 mi  
 Destroyers and Submarines - 3 mi  
 Range, Min: 250 yd  
 Peak Power Output: 30 kw (0.03 kw avg)  
 Operating Voltages and Power Requirements:  
 115 vac, 60 cps, 1-ph, 1.5 kva  
 Type of Presentation:  
 Range - 5-in. A-scope of SJ at ranges of 1,  
 10, and 30 mi

Bearing - Bearing dial

**INSTALLATION CONSIDERATIONS**

Siting:  
 Mounting:  
 Cabling Requirements:  
 Related Equipment: Radar Equipment SJ; Radar Equipment ST-a or ST-1 periscope antenna assembly. ST-a or ST-1 radar components needed to provide rf interconnection of the SS-2 radar to the periscope antenna can be supplied separately. The components are Periscope Adapter CGP-14ABH and Waveguide Switching Unit CW-24AAN.

**PRINCIPAL COMPONENTS AND PHYSICAL DATA**

COMPONENT	QTY	HEIGHT (Inches)	WIDTH (Inches)	DEPTH (Inches)	UNIT WT. (Pounds)
Selector Unit 24AAH	1	14-3/4	16-3/16	16-9/16	95
Transmitter-Receiver 43ACU	1	13	15-11/16	19-1/2	150
Selector Control Unit 23AFP	1	3-1/2	4-5/8	7-7/8	15
Periscope Adapter 14ABB	1	48	14-3/4	14-3/4	220
Waveguide Switching Unit 24AAF	1	3-7/8	10	11-1/8	20
Echo Box 14AAX	1	15	16-1/4	18-7/8	40
Waveguide Pick-up I4ABC	1	3-7/8	8-1/8	11-1/8	16
Junction Box 62ABK	1	4-7/8	13-1/4	17-9/16	40
Dummy Antenna 66AHT	1	1-3/4	2	7-13/16	8

**PRINCIPAL COMPONENTS AND PHYSICAL DATA (cont'd)**

<b>COMPONENT</b>	<b>QTY</b>	<b>HEIGHT (Inches)</b>	<b>WIDTH (Inches)</b>	<b>DEPTH (Inches)</b>	<b>UNIT WT. (Pounds)</b>
Transmitter Mounting Frame 10376	1	13-19/32	19-1/8	27-15/16	80
Modification Kit	1				
Set of Waveguides	1				
Set of Conversion Parts	3				

**REFERENCE DATA AND LITERATURE**

Technical Manual:  
NAVSHIPS 900, 336

**ST: 3**

DATE: 1 July 1964

ITEM NAME: RADAR EQUIPMENT

COGNIZANT SERVICE: USN

TYPE: ST-1

FEDERAL STOCK NUMBER:

	USA	USN	USAF	USMC
STATUS OR TYPE CLASSIFICATION		Sub. Std		
Mfg(s) Name or Code Number: Western Electric Company				

Illustration Not Available

FUNCTIONAL DESCRIPTION

Radar Equipment ST-1 is the submarine antenna assembly for Radar Equipment ST. The assembly includes a periscope adapter and a waveguide switching unit.

RELATION TO SIMILAR EQUIPMENT

The ST-1, ST-2, and ST-3 are functionally identical.

TECHNICAL DESCRIPTION

Not available.

INSTALLATION CONSIDERATIONS

Siting:  
Mounting:  
Cabling Requirements:  
Related Equipment: Radar Equipment ST, SS-2, and modified SS or SS-1. ST-1 (or ST-a) components needed to provide rf interconnection of the SS-2 radar can be supplied separately. The components are Periscope Adapter CGP-14-ABH and Waveguide Switching Unit CW-24AAN.

PRINCIPAL COMPONENTS AND PHYSICAL DATA

COMPONENT	QTY	HEIGHT (Inches)	WIDTH (Inches)	DEPTH (Inches)	UNIT WT. (Pounds)
Periscope Adapter CGP-14ABH-1	1	48	14-3/4	14-3/4	220
Waveguide Switching Unit NT-24AAF	1	11-1/8	10	3-7/8	16

REFERENCE DATA AND LITERATURE

Technical Manual:  
NAVSHIPS 900, 336

ST-1: 1

DATE: 1 July 1964

ITEM NAME: RADAR EQUIPMENT

COGNIZANT SERVICE: USN

TYPE: \*SU, \*\*SU-1, SU-1A

FEDERAL STOCK NUMBER: \*5840-642-7069 \*\*5840-642-7065  
\*5840-644-4650 W/S \*\*5840-644-4651 W/S

	USA	USN	USAF	USMC
STATUS OR TYPE CLASSIFICATION		Obsoles		

Mfg(s) Name or Code Number: Submarine Signal Co., Boston, Massachusetts

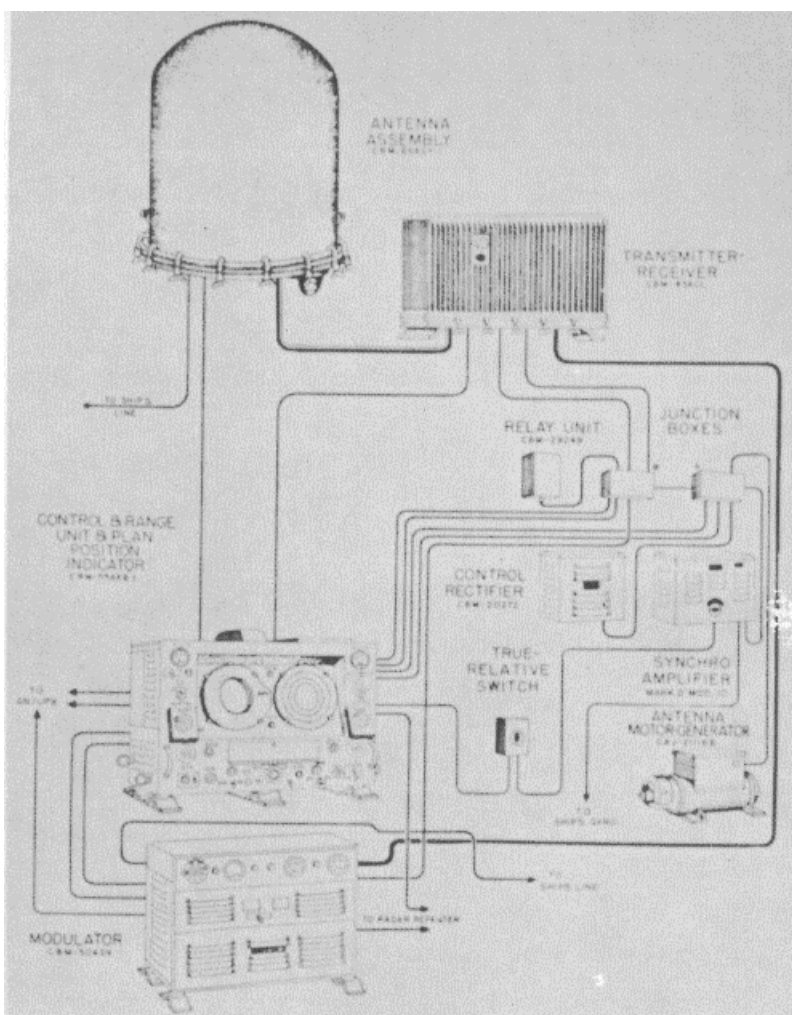

**FUNCTIONAL DESCRIPTION**

The SU, SU-1 and SU-1A are medium-power surface scanning equipments for installation on surface vessels.

Target indications are displayed on both PPI and range scope presentations.

Data on this sheet reflects the following Field Changes: FC-45 (SU), FC-43 (SU-1), and FC-3 (SU-1A).

SU: 1

**ITEM NAME:** RADAR EQUIPMENT

**TYPE:** SU, SU-1, SU-1A

**RELATION TO SIMILAR EQUIPMENT**

None.

Pulse Duration: 1 usec for general use  
and 1/2 usec for greater definition of  
target.

Pulse Rate: 600 pps

Pulse Output: 18 kw when using 2J36 Magne-  
tron and 60 kw when using 2J49 Magnetron.

Receiver

Type: Superheterodyne, local oscilla-  
tor.

IF Bandwidth: 30 mc

Frequency Stability: afc

Power Source Required

SU and SU-1A: 115v, 60 cps, 1-ph.

SU-1: 115v dc, 4 kw, motor-generator.

**TECHNICAL DESCRIPTION**

Frequency: 9000 mc

Accuracy

Range: plus or minus 5.0 yd at 8000 yd,  
plus or minus 250 yd at 40, 000 yd,  
plus or minus 1/2 mi at 80 mi.

Bearing: plus or minus 1 deg

Resolution

Range: 250 yd

Bearing: 3 deg

Indication: 5 in. PPI scan and 5 in.  
range oscilloscope.

Bearing Presentation: Relative and true,  
simultaneously.

**INSTALLATION CONSIDERATIONS**

Not available.

**PRINCIPAL COMPONENTS AND PHYSICAL DATA**

**SHIPPING DATA**

COMPONENT	BOXES (NR.)			OVERALL DIMENSIONS (Inches)	UNIT WT. (Pounds)
	SU	SU-1	SU-1A		
Antenna Motor-Generator NT-211168	1	1	1	18 x 20 x 27	182
Modulator 50 ADV	1	1	1	22 x 32 x 39	360
Transmitter Receiver 43ACL	1	1	1	23 x 25 x 33	230
Antenna Assy 66AGY-1	1	1	1	33-1/2 x 33-1/2 x 57	383
Control & Range Unit-PPI 55AEZ-1		1	1	29 x 32-1/2 x 35	553
Control Rectifier NT-20272	1		1	18 x 22 x 36	155
Relay Unit NT-29249 incl tubes	1	1	1	21 x 28 x 43	98
Synchro Amplifier Mark 2 Mod 1C	1	1	1		
Voltage Regulator NT-20271, Con- trol Rectifier NT-20272		1		18 x 22 x 36	155
Magnetic Controller NT-211167		1		19 x 20 x 27	90
Motor-Generator Set NT-211169		1		24 x 26 x 62	825
Control & Range Unit-PPI 55AEY-1	1			29 x 32-1/2 x 35	553
Bearing & Syro Switch 23AER	1				
Waveguide Tubing & Fitting		1	1	7 x 11 x 149	150
Spare Tubes		1	1	12 x 24 x 34	52
Spare Tubes		1	1	32 x 33-1/2 x 35	195
Spare Parts (Box 1 & 2)		1	1	19 x 25 x 36	195
Spare Parts (Box 3 & 4)		1	1	19 x 25 x 35	200

**SU: 2**

DATE: 1 July 1964

ITEM NAME: RADAR EQUIPMENT

COGNIZANT SERVICE: USN

TYPE: SU-2

FEDERAL STOCK NUMBER: 5840-642-7066

	USA	USN	USAF	USMC
STATUS OR TYPE CLASSIFICATION		Obsoles		

Mfg(s) Name or Code Number: Submarine Signal Company

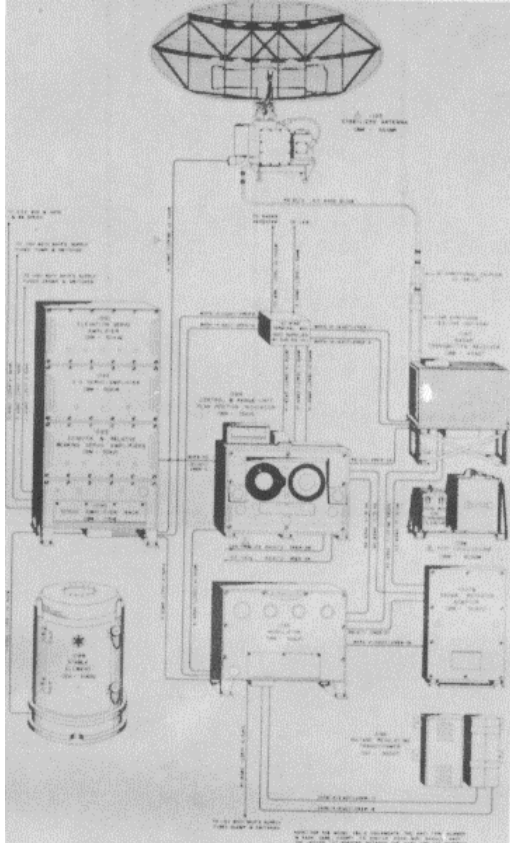

### FUNCTIONAL DESCRIPTION

Radar Equipment SU-2 is a medium-range surface-search radar for use on medium size and smaller vessels (larger than a PC). The antenna is stabilized for line-of-sight only. The stable element is mounted near the metacenter of the ship. A recognition set adapter is included for IFF coordination.

### RELATION TO SIMILAR EQUIPMENT

The SU-2 is identical to Radar Equipment SU-4 except that the SU-4 uses a larger stable base antenna. The SU-2 and SU-3 have an optional shorter pulse,

broader band, and anti-jam features not in the SU and SU-1. The SU-2 gives better resolution and more consistent ranges than the SU.

### TECHNICAL DESCRIPTION

- Frequency: 9000 mc
- Range, Max: 80 mi
- Range, Min: 100 yd
- Peak Power Output: 50 kw
- Operating Voltages and Power Requirements:  
115 vac, 60 cps, 1-ph
- Type of Presentation:
  - Range - 5-in. A-scope with range step and dials at ranges of 4, 20, and 80 mi
  - Bearing - True and relative indicator
  - PPI - 5-in. A-scope with range- marker spot; 2, 4, 20, and 80 mi ranges
  - Other - Provision for IFF display
- RF Power Source: Type 2J49 magnetron
- Pulse Repetition Rate: 600 pps
- Pulse Width: 0.25  $\mu$ sec or 1  $\mu$ sec
- Repeater Adapter Output Video Signal Lines:  
4 lines at  $\pm 2 \pm 0.5v$  amplitude
- Repeater Adapter Trigger Lines: 4 lines at +55v; amplitude may vary between +25 and +75v
- Horizontal Coverage: 360 deg
- Range Resolution: 0.25  $\mu$ sec pulse, 100 yd;  
1  $\mu$ sec pulse, 250 yd
- Azimuth Resolution: 1 deg
- Range Accuracy:  $\pm 50$  yd at 8, 000 yd;  $\pm 250$  yd at 40, 000 yd; and 1/2 mi at 80 mi
- Horizontal Beam Width: 1.9 deg
- Vertical Beam Width: 3.8 deg
- Antenna: Slotted paraboloidal; horn waveguide fed into reflector; horizontal polarization
- Receiver Bandwidth: 3.8 mc
- IF. Frequency: 30 mc

### INSTALLATION CONSIDERATIONS

Siting: Sheltered areas (shipboard).

SU-2

Mounting: Deck-fastened equipments are shock mounted.

Waveguide Requirements: Waveguide between radar transmitter-receiver and antenna

should be no longer than 75 feet.  
Related Equipment: Test Oscilloscope CBM-60ADM.

**PRINCIPAL COMPONENTS AND PHYSICAL DATA**

<b>COMPONENT</b>	<b>QTY</b>	<b>HEIGHT (Inches)</b>	<b>WIDTH (Inches)</b>	<b>DEPTH (Inches)</b>	<b>UNIT WT. (Pounds)</b>
Stable Element 21ADQ	1	24	24	34-1/8	300
Modulator 50AJP	1	19	28-3/4	36-3/4	280
Radar Receiver-Transmitter 43ADT	1	17-3/8	23-1/2	24-3/4	185
Test Oscilloscope 60ADM	1	10-15/16	14-11/16	22-1/2	68
Control and Range Unit PPI 55AJG	1	26-3/4	27-13/16	34-1/2	512
Stabilized Antenna 66AMR	1	30-1/16	43-7/16	55	180
Servo Amplifier Rack 10618	1	22-13/16	28-7/8	67-1/8	625
Radar Repeater Adaptor 50AFO-1	1	15-1/4	21-13/16	37-7/16	175
Voltage Regulating Transformer 303107	1	9-3/4	16-7/8	23-1/2	176
Echo Box TS-218/UP	1	6-1/32	11-3/8	18-1/4	10
Set of Waveguides and Accessories	1				
Set of Equipment Spares					

**REFERENCE DATA AND LITERATURE**

Technical Manual:  
NAVSHIPS 90083 1(A)

ITEM NAME: RADAR EQUIPMENT

TYPE: SU, SU-1, SU-1A

PRINCIPAL COMPONENTS AND PHYSICAL DATA (Cont.)

SHIPPING DATA (Cont.)

COMPONENT	BOXES (NR.)			OVERALL DIMENSIONS (Inches)	UNIT WT. (Pounds)
	SU	SU-1	SU-1A		
Spare Parts (Box 5)		1	JA	23 x 27 x 35	230
Spare Parts (Box 6)		1	1	23 x 27 x 35	250
Spare Parts (Box 7 & 8)		1	1	19 x 25 x 35	225
Spare Parts (Box 9 & 10)		1	1	19 x 25 x 35	175
Spare Parts (Box 11 & 12)		1	1	19 x 25 x 35	205
Spare Parts (Box 13 & 14)		1	1	15 x 18 x 33	137
Spare Parts (Box 14) incl spare Transmitter-Receiver 43ACL		1	1	23 x 25 x 35	228

EQUIPMENT SUPPLIED DATA

COMPONENTS	QTY			OVERALL DIMENSIONS (Inches)	UNIT WT. (Pounds)
	SU	SU-1	SU-1A		
Antenna Motor-Generator NT-21116B	1	1	1	8-3/4 x 12-3/4 x 20-1/8	125
Modulator 50ADV	1	1	1	17-1/2 x 25-5/8 x 31-1/2	230
Transmitter Receiver 43ACL	1	1	1	17-3/8 x 18-1/4 x 23-1/2	135
Antenna Assy 66AGY-1	1	1	1	31-1/2 x 31-1/2 x 49-1/2	210
Control & Range Unit & Plan	1			25-1/2 x 28 x 30	425
Position Indicator 55AEY-1		1	1	25-1/2 x 28 x 30	425
Control Rectifier NT-20272	1	1	1	10-13/16 x 12 x 15-5/8	50
Voltage Regulator NT-20271		1			
Relay Unit NT-29249	1	1	1	4-3/8 x 5-3/4 x 7-1/4	10
Bearing & Syro Switch 23AER	1			10-7/8 x 12-1/4 x 15-1/2	40
Synchro Amplifier Mark 2 Mod 1C	1	1	1		
Magnetic Controller NT-211167		1		9-7/8 x 10-1/8 x 16	30
Motor-Generator Set NT-211169 c/o:		1		20 x 22-3/16 x 55-1/8	700
Motor, dc NT-211170		1			
Generator, ac NT-211171		1			
Set Spare Parts	1	1	1		

SU: 3



**ITEM NAME:** RADAR EQUIPMENT

**TYPE:** SU, SU-1, SU-1A

**REFERENCE DATA AND LITERATURE**

Technical Manuals:

SHIPS 313: for Radar Equipment SU.

NAVSHIPS 900, 882: for Radar Equipment SU-1 and SU-1A.

**SU: 4**

DATE: 1 July 1964

ITEM NAME: RADAR EQUIPMENT

COGNIZANT SERVICE: USN

TYPE: SV, \*SV-1

FEDERAL STOCK NUMBER: 5840-263-5508 \*5840-665-3767 W/S  
5840-644-4654 W/S \*5840-642-7052

	USA	USN	USAF	USMC
STATUS OR TYPE CLASSIFICATION				

Mfg(s) Name or Code Number: Western Electric Co., Inc., New York, N. Y.

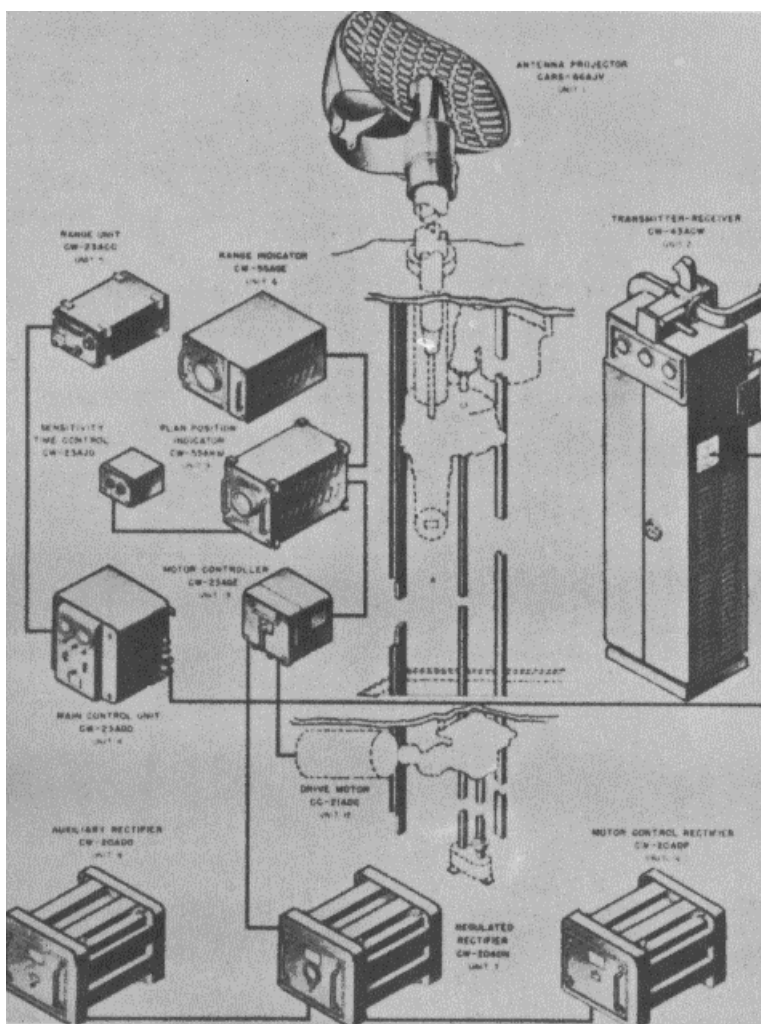

**FUNCTIONAL DESCRIPTION**

The SV and SV-1 are designed for installation on submarines as aircraft warning equipments. They may

also be used for search purposes and for torpedo fire control.

Data on this sheet reflects the following Field Changes: No. 4, 5 8, 43, 56, 60 for SV and No. 8, 12 for SV-f.

**ITEM NAME:** RADAR EQUIPMENT

**TYPE:** SV, SV-1

**RELATION TO SIMILAR EQUIPMENT**

The Models SV and SV-1 replace Radar Equipment SD. The SV-1 is similar to the SV but has instantaneous automatic volume control, a fast time constant, and uses the indicating unit of Radar Equipment SS with provision for true bearings; the SV uses the Radar Equipment SJ-1 indicator.

**TECHNICAL DESCRIPTION**

General

Maximum Reliable Range

Bombers at 2500 to 15, 000 Ft: 22 mi

Bombers at 300 Ft: 15 mi

Fighters at 10, 000 Ft: 11 mi

Fighters at 200 Ft: 14 mi

Minimum Range: 400 yd

Resolution

Range. 5.7 yd

Bearing: 5 deg

Accuracy

Range: SV, plus or minus (50 yd to 0.1%); SV-1, 15 yd plus or minus 1%.

Bearing: SV, plus or minus 2 deg; SV-1, 0.5 deg

Power Source Required: 115v, 60 cps, 1-ph, 6 kva.

Transmitter

Frequency Range: 3400 to 3700 mc

RF Source: Magnetron

RF Lines: Waveguide.

RF Peak Power: 500 kw

RF Average Power: 0.2 kw

Pulse Rate: 400 pps plus or minus 5%.

Pulse Width: 1.0 usec

Receiver

Type: Superheterodyne, double detector.

IF: 60 mc

Bandwidth: 2 mc IF, 3 mc video.

Frequency Control: Manual or automatic.

Indication Data

Range

SV: 5 in. "A" scope, 10 and 30 mi ranges and 1.5 mi precision sweep.

SV-1: 3 in. "A" scope, 4, 20 and 80 mi ranges and 2.0 mi precision sweep.

Accuracy: plus or minus (25 yd plus 0.1% of measured range) to 30 mi and plus or minus (200 yd plus 2% of measured range) to 80 mi.

Bearing

SV-1: 3 in. "B" scope, 2 mi precision sweep.

Accuracy: Plus or minus 0.5 deg

PPI

Type: 5 in. CR tube, provision for four repeaters.

Ranges: SV; 4, 10, 20, and 80 mi.

SV-1; 4, 10, 20, and 80 mi. Both with 4 mi precision sweep.

Markers: Range in electrical line; bearing, mechanical cursor.

Scales: Relative bearing scale ring (SV, SV-1); true bearing scale ring (SV-1).

Other: Provision of IFF trigger and display.

Antenna

Feed: Waveguide

Reflector: 2 by 4 ft slotted parabola.

H.P. Beamwidth

Horizontal: 5.5 deg

Vertical: 60 deg

Polarization: Horizontal

Gain: 30 db

Scan: 3600 at 0 to 6 rpm by motor.

**INSTALLATION CONSIDERATIONS**

Related Equipment:

Required but not Supplied.

Interconnecting Cables and straight sections of waveguide.

**PRINCIPAL COMPONENTS AND PHYSICAL DATA**

**SHIPPING DATA**

<b>COMPONENT</b>	<b>BOXES (NR.)</b>	<b>OVERALL DIMENSIONS (Inches)</b>	<b>UNIT WT. (Pounds)</b>
Indicator Console 55AHN**	1	23 x 47 x 62	1200
Torque Tube Drive Unit 10AFB	1	24 x 27 x 28	550
Spline Shaft Drive Unit 10AFC	1	18 x 22 x 26	280
Spline Shaft Upper Bearing 10AFE			
Synchro Unit 21ADE-SV or -21ADF-SV-1			
Motor Drive Shaft	1	4 x 5 x 68	30
Power Distribution Unit 23AGS**	1	15 x 27 x 28	175
Junction Box 62217**	1	8 x 20 x 22	100

**SV: 2**

ITEM NAME: RADAR EQUIPMENT

TYPE: SV, SV-1

PRINCIPAL COMPONENTS AND PHYSICAL DATA

SHIPPING DATA (Cont.)

COMPONENT	BOXES (NR.)	OVERALL DIMENSIONS (Inches)	UNIT WT. (Pounds)
Antenna Projector 66AJV	1	23 x 45 x 55	570
Regulated Rectifier 20ADN	1	22 x 23 x 31	460
Auxiliary Rectifier 20ADO	1	22 x 23 x 31	400
Servo Power Unit 2OADX**	1	22 x 23 x 31	400
Motor Controller 23AGE	1	16 x 16 x 18	85
Motor Control Rectifier 2OADP	1	22 x 23 x 31	490
Waveguide Switching Unit 24AAK	1	14 x 17 x 23	110
Dummy Antenna 66AJW	1	11 x 15 x 26	45
Frequency Power Meter TS-295/UP	1	15 x 15 x 17	40
Set of Waveguide Parts	1		225
Main Control Unit 23AGD*	1	22 x 23 x 25	205
Range Unit 23ACC*	1	11 x 15 x 26	95
Range Indicator 55AGE*	1	17 x 21 x 28	165
Plan Position Indicator 55AHM*	1	17 x 18 x 27	155
Phase Adjusters 14ABT*	1	11 x 16 x 18	50
Set of Sway Braces for Transmitter Receiver*	1	10 x 16 x 20	105
Rotary Joint Assy	1	13 x 16 x 17	100
Antenna Drive Motor 21ADC*	1	16 x 20 x 24	195
Antenna Drive Motor 211389**	1		
Synchro Unit 21ADE*	1	18 x 22 x 26	280
Adaptor Control Unit 23ABX*	1		
Set of Equipment Spare Parts			

NOTES: \* Supplied w/SV only.

\*\*Supplied w/SV-1 only.

EQUIPMENT SUPPLIED DATA

COMPONENTS	QTY	OVERALL DIMENSIONS (Inches)	UNIT WT. (Pounds)
Range Unit 23ACC	1*	7 x 10 x 19	60
Range Transmitter 52ADJ	*	10-25/32 x 9-1/2 x 10-5/16	
Plan Position Indicator 55AHM	1*	15 x 12 x 20	135
PPI Assy 55AHC	1**	12-13/16 x 9-3/8 x 9-3/8	

SV: 3

ITEM NAME: RADAR EQUIPMENT

TYPE: SV, SV-Z

PRINCIPAL COMPONENTS AND PHYSICAL DATA

EQUIPMENT SUPPLIED DATA (Cent.)

COMPONENTS	QTY	OVERALL DIMENSIONS (Inches)	UNIT WT. (Pounds)
Range Indicator 55AGE	1*	13 x 17 x 21	110
Indicator Console 55AHN	1**	52 x 41 x 18	750
Range Unit Gear Assy 10AGF	1**	8-1/4 x 7-7/8 x 17-13/16	45
Transmitter-Receiver 43ACW	1	70 x 21 x 22	800
IF. Amplifier 50AGP	1**	3-5/16 x 14-1/2 x 2-7/8	
Bearing Gear Assy 10AGD	1**	17-1/2 x 12-5/6 x 18-1/16	
Motor Drive Gear Unit 10AFD	1*	13 x 18 x 11	125
Switching IF. Amplifier 50AJE	1*	5-29/32 x 7-3/4 x 6-17/32	
Torque Tube Drive Unit 10AFB	1	30 x 22 x 16	500
Spline Shaft Drive Unit 10AFC	1	9 x 17 x 11	50
Spline Shaft Upper Bearing 10AFE	1	8 x 6 x 8	25
Synchro Unit 21ADE	1*	11 x 17 x 12	90
Synchro Unit 21ADF	1**	11 x 17 x 12	90
Motor Drive Shaft	1	Cut to length 1.5 dia	14
Main Control Unit 23AGD	1*	18 x 21 x 18	100
Power Distribution Unit 23AGS	1**	18 x 22 x 10	90
Coaxial Junction Box 62315	1	1-3/4 x 2-1/2 x 3-3/8	
Junction Box 62217	1**	19 x 19 x 5	50
Antenna Projector 66A3W	1	36 x 48 x 27	400
Sensitivity Time Control Unit 23AJG	1*	5-29/32 x 7-3/4 x 8-5/8	10-1/2
Regulated Rectifier 20ADN	1	18 x 20 x 27	310
Auxiliary Rectifier 20ADO	1	18 x 20 x 27	250
Servo Power Unit 20ADX	1	18 x 20 x 27	250
Servo Amplifier 50AGQ	1**	5-11/16 x 13-3/8 x 6-3/8	10
Motor Controller 23AGE	1	14 x 12 x 12	50
Motor Control Rectifier 20ADP	1	18 x 20 x 27	340
Motor-Drive Gear Unit 10AGC	1**	10-3/32 x 17-15/32 x 19-13/16	
Antenna Drive Motor 21ADC*	1	11 x 11 x 21	160
-211389**		9-11/16 x 13-9/32 x 17-3/8	
Antenna Drive Assy 66AKA*	1		

SV: 4

PRINCIPAL COMPONENTS AND PHYSICAL DATA (cont'd)

COMPONENT	QTY	HEIGHT (Inches)	WIDTH (Inches)	DEPTH (Inches)	UNIT WT. (Pounds)
Radar Repeater Equipment VJ Includes:					
Driver Unit NT-50AFU-1	1	37	20	15	281
Indicator Unit NT-55AGU	1	33	21	20	258
Delay Unit NT-50AGG	1	25	22	13	155

REFERENCE DATA AND LITERATURE

Technical Manuals:  
NAVSHIPS 900861(A)  
NAVSHIPS 91491  
NAVSHIPS 91384

**ITEM NAME:** RADAR EQUIPMENT

**TYPE:** SG-a, -b, -c, -d, -1, -1b, -1c,  
-1d, -2S, -2Sb

## REFERENCE DATA AND LITERATURE

### Technical Manuals:

NAVSHIPS 900531: for Radar Equipments Navy Models SG-a, SG-b, SG-c, SG-d, SG-1, SG-1b, SG-1c, SG-1d, SG-2S and SG-2Sb.

NAVSHIPS 900532: for Radar Equipment Navy Model SG-2S, Tower and Antenna.

**NOTE 1. SG-a:** 5840-642-6680  
5840-642-7801 W/S  
**SG-1:** 5840-642-6691  
5840-665-2261 w/S  
**SG-2S:** 5840-642-6683  
5840-644-4638 W/S  
**SG-2Sb:** 5840-303-1326  
5840-665-3770 W/S

**NOTE 2.** Navy Status of Obsolescent for SG-1, SG-1b.

**SG-a: 7**

DATE: 1 July 1964

ITEM NAME: RADAR EQUIPMENT

COGNIZANT SERVICE: USN

TYPE: SG—6,\* SG-6B\*\*

FEDERAL STOCK NUMBER: F5840-665-1115\*  
F5840-642-7057\*\*

	USA	USN	USAF	USMC
STATUS OR TYPE CLASSIFICATION		Ltd Std		

Mfg(s) Name or Code Number: Raytheon Mfg. Company

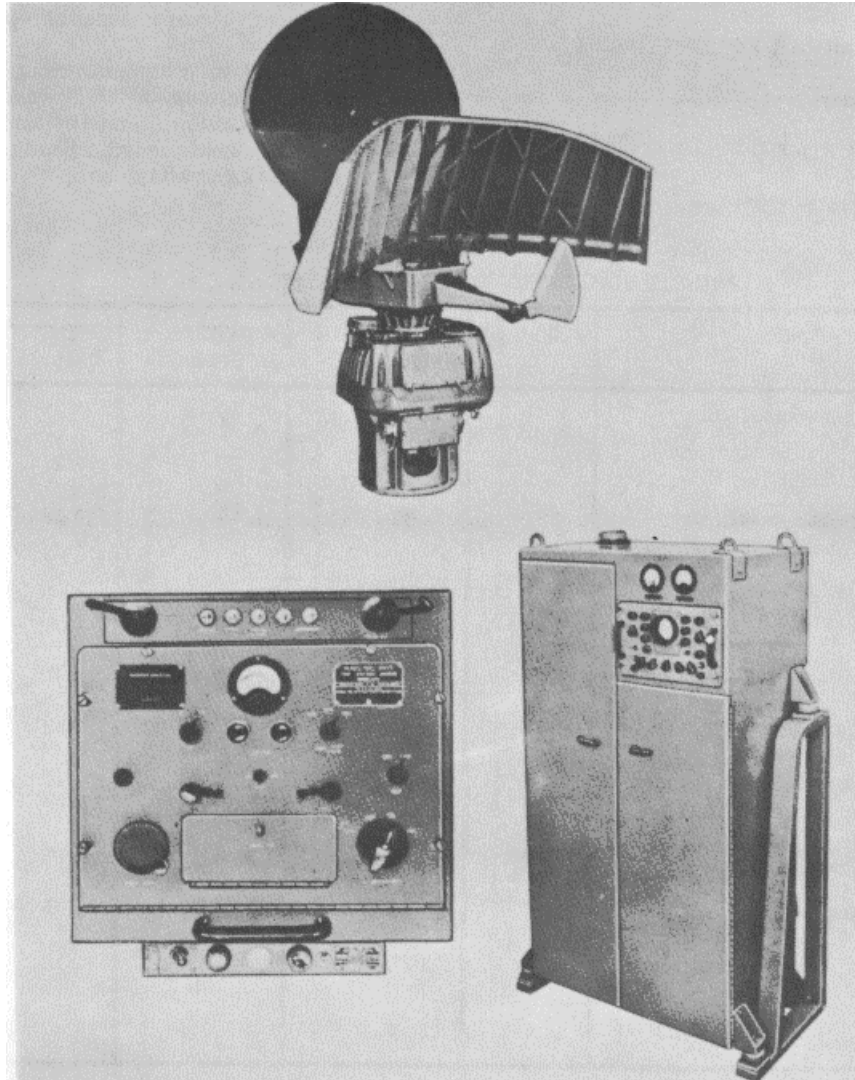

SG-6: 1



SG-6, SG-6B

**FUNCTIONAL DESCRIPTION**

The SG-6 and SG-6B are high-powered, shipboard, surface search and zenith scanning equipments. Targets are presented on a range scope, on radar repeater equipment VJ or VJ-1, and on any other repeaters in use. Both sweeps may be delayed for close examination of distant targets.

The SG-6, and SG-6B are similar. The SG-6B incorporates the following improvements to the SG-6: new antenna design, RG-49/U instead of RG50/U transmission lines between the transmitter and antenna, automatic radiation restoring circuitry, an additional 50- $\mu$ sec sweep position on the monitor scope, additional filtering, and modified crystal mounts.

**RELATION TO SIMILAR EQUIPMENT**

Lightweight equivalent of SG-5.

**TECHNICAL DESCRIPTION**

Frequency: 6275 to 6574 mc

Peak Power Output: 125 kw  
Pulse Repetition Rate: 625 to 650 pps  
Pulse Width: 0.37 or 1.3  $\mu$ sec  
IF. Frequency: 30 mc  
IF. Bandwidth: 1 mc or 5 mc  
Type of Presentation: One 5-in. range scope  
Range Scales: 4, 20, 80 mi  
Range Accuracy: 40 yds, 4-mi scale; 300 yds, 20-mi scale; 0.45 mi, 80-mi scale

**INSTALLATION CONSIDERATIONS**

Siting: Refer to BUSHIPS arrangement plan for standard layout to suit type of vessel.  
Mounting: Mount antenna on a plate fitted to the mast. Provide a suitable servicing platform below.  
Cabling Requirements: Max length of interconnecting cables, 300 ft (except high voltage pulse cables limited by allowable reflections); power cable lengths limited to maximum permissible voltage drop.

**PRINCIPAL COMPONENTS AND PHYSICAL DATA**

COMPONENT	QTY	HEIGHT (Inches)	WIDTH (Inches)	DEPTH (Inches)	UNIT WT. (Pounds)
Radar Transmitter-Receiver NT-43ADS-2 or NT-43ADS-3	1	62	39	23	750
IFF Coordinator-Range Indicator Assembly NT-55AHP	1	33	22	19	213
General Control Unit NT-23AJH or NT-23AJH-1	1	18	17	9	60
Modulator NT-50AJM	1	40	30	19	345
Dual Antenna Assembly NT-66AMQ-3	1	55	37	23	548
Training Control Amplifier NT- 50AJN	1	31	26	17	240
RF Filter Unit NT-53414	1	19	9	6	50
Switch Box NT-241066	1	15	6	5	13
Gyro-Compass Synchro-Amplifier Mk 2 Mod 1B	1	21	12	12	60
Power Transformer NT-303880	1	16	13	11	167

DATE: 1 July 1964

ITEM NAME: RADAR EQUIPMENT

COGNIZANT SERVICE: USN

TYPE: SJ

FEDERAL STOCK NUMBER: 5840-303-1328  
5840-347-9190 W/S

	USA	USN	USAF	USMC
STATUS OR TYPE CLASSIFICATION				

Mfg(s) Name or Code Number: Western Electric Co., New York, N. Y.

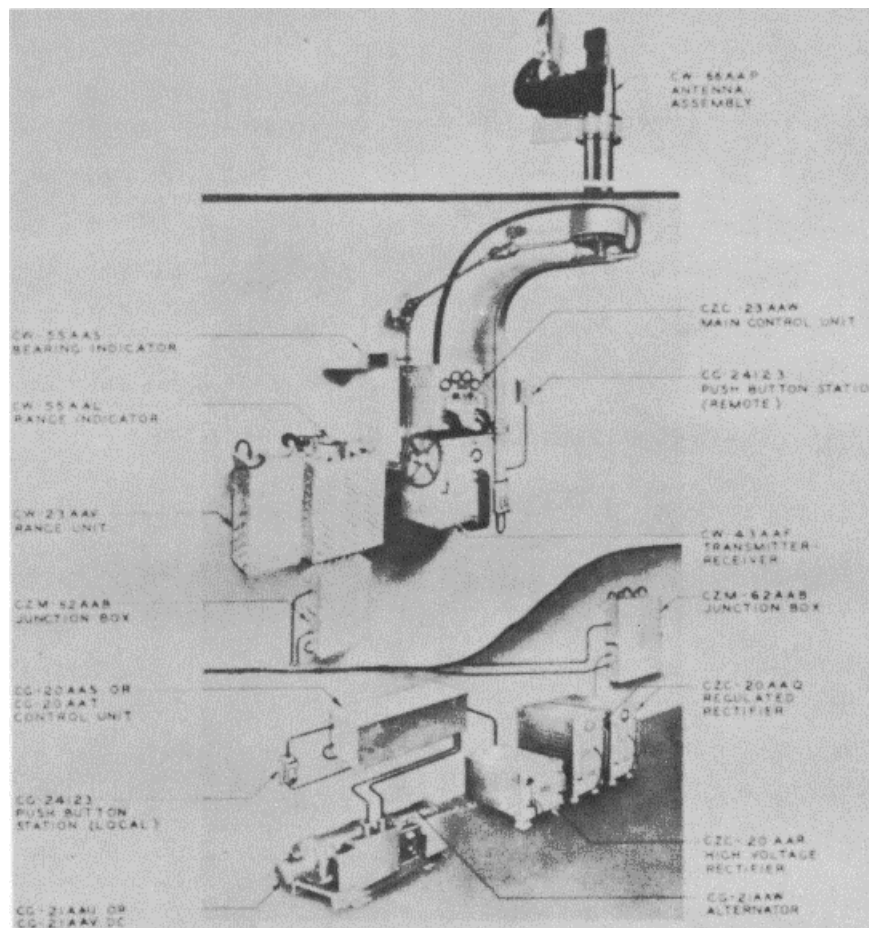

### FUNCTIONAL DESCRIPTION

The SJ is a radio detection and ranging equipment designed for use on submarines to detect the presence of surface objects such as ships or submarines

and to indicate the distance and direction of such objects.

SJ: 1

**ITEM NAME:** RADAR EQUIPMENT

**TYPE:** SJ

**RELATION TO SIMILAR EQUIPMENT**

None.

**TECHNICAL DESCRIPTION**

Accuracy

Bearing: plus or minus 0.3 deg

Range: plus or minus 15 yds

Minimum Range: 250 yd

Indication and Data Output

Presentation: 5 in. CR tube.

Main Sweep: 60,000 yd

Extended Sweep: 20,000 yd

Precision Sweep: 40,000 yd

Transmitter

Frequency: 3000 mc

Pulse Rate: 600 and 1800 pps

Receiver

Intermediate Frequency: 60 mc

Bandwidth: 5 mc

Operating Power: 120v, 60 cps, 1-ph,  
1.4 kva.

**INSTALLATION CONSIDERATIONS**

Related Equipment:

Required but not Supplied.

(1) Antenna Handwheel Drive and Shafting,

(1) Antenna Torque Tube, Flanges and

Stuffing Box, (1) Antenna Brackets and

Collars, (1) Coaxial Cable, (1) Set

Standard Cables.

**PRINCIPAL COMPONENTS AND PHYSICAL DATA**

<b>COMPONENT</b>	<b>QTY</b>	<b>OVERALL DIMENSIONS (Inches)</b>	<b>UNIT WT. (Pounds)</b>
Antenna Assy NT-66AAP or	1		350
Antenna Assy NT-66ADH			330
Transmitter-Receiver NT-43AAF	1	12-7/8 x 18-7/8 x 24-5/8	160
Range Indicator NT-S5AAL	1	12-3/16 x 16-3/4 x 21-1/8	110
Range Unit NT-23AAV	1	6-9/16 x 9-1/2 x 21-17/32	60
High Voltage Rectifier NT-2OAAAR	1	10-5/16 x 12 x 18-7/16	100
Regulated Rectifier NT-2OAAQ	2	10-21/32 x 17-5/8 x 18-5/8	115
Main Control Unit NT-23AAW	1	J3-5/32 x 14-1/4 x 15-1/4	120
Bearing Indicator NT-55AAS	1	4 x 6-3/4 x 11	11
Junction Box NT-62AAB or	2	4-5/8 x 14 x 17-9/16	25
Junction Box NT-62AAB-S		4-5/8 x 14 x 17-9/16	32
Adapter Control Unit NT-23ABX	1	4-5/8 x 5-3/4 x 5-3/4	6.5
Motor Generator Set NT-21AAS or	1	13-7/16 x 15-1/8 x 42-1/2	565
Motor Generator Set NT-21AAT			565
Set Spare Parts	1		

**REFERENCE DATA AND LITERATURE**

Not available.

DATE: 1 July 1964

ITEM NAME: RADAR EQUIPMENT

COGNIZANT SERVICE: USN

TYPE: SJ-1

FEDERAL STOCK NUMBER: 5840-303-1332  
5840-347-9192 W/S

STATUS OR TYPE CLASSIFICATION	USA	USN	USAF	USMC

Mfg(s) Name or Code Number: Western Electrical Co., Inc., New York, N. Y.

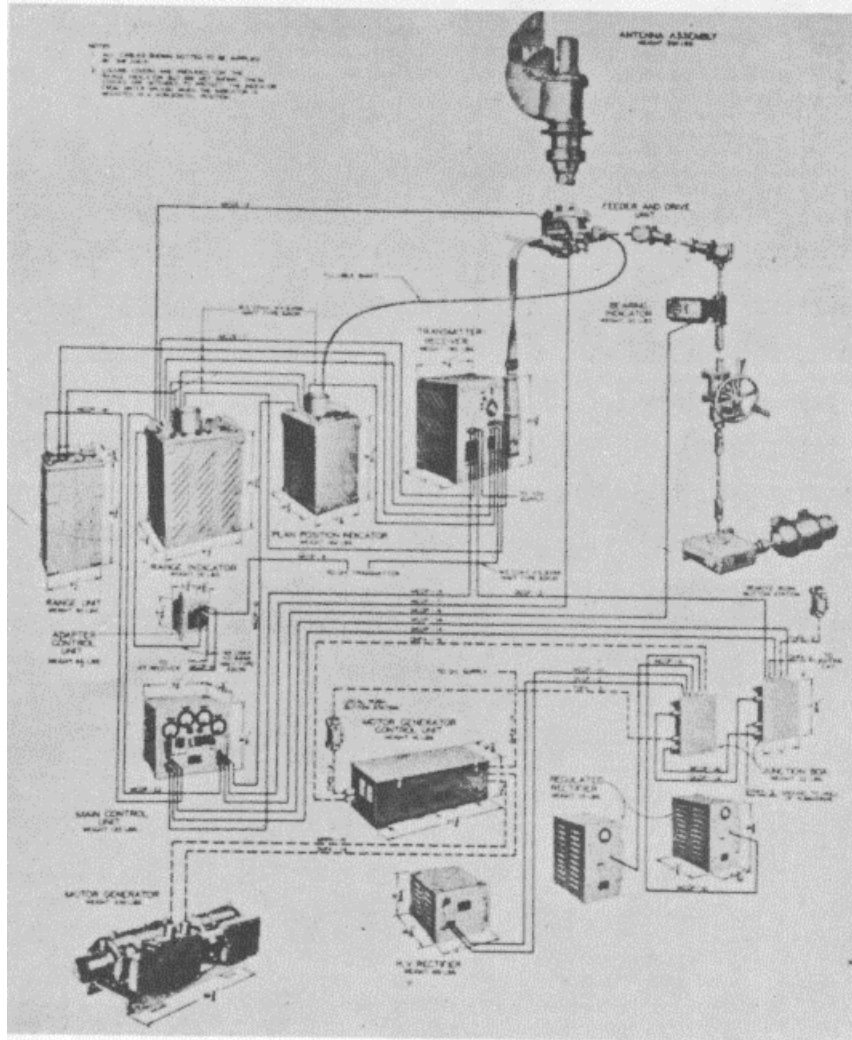

**FUNCTIONAL DESCRIPTION**

The SJ-1 is a radio detection and ranging equipment designed for use on submarines to detect the presence

of surface objects such as ships or submarines, and to indicate the distance and direction of such objects.

**ITEM NAME:** RADAR EQUIPMENT

**TYPE:** SJ-1

**RELATION TO SIMILAR EQUIPMENT**

Similar to SJ.

**TECHNICAL DESCRIPTION**

Maximum Reliable Range  
 Bombers 500 Ft: 5 mi  
 Battleships: 12 mi  
 Cruiser: 12 mi  
 Destroyers: 8 mi  
 Submarines (Surfaced): 6 mi  
 Resolution

Range: 50 yd  
 Bearing: 5 deg  
 Accuracy  
 Range: 15 yd  
 Bearing: 0.3 deg  
 Minimum Ranges: 250 yds  
 Frequency: 3000 mc  
 PPI Ranges: 8,000, 20,000, 80,000 yds;  
 160,000 yd, delayed sweep.

**INSTALLATION CONSIDERATIONS**

Not available.

**PRINCIPAL COMPONENTS AND PHYSICAL DATA**

<b>COMPONENT</b>	<b>QTY</b>	<b>OVERALL DIMENSIONS (Inches)</b>	<b>UNIT WT. (Pounds)</b>
Antenna Assy NT-66AFC	1		350
Transmitter-Receiver NT-43AAF-1	1	13 x 18-7/8 x 20-5/8	190
Range Indicator NT-55AAL-i	1	11-3/8 x 16-3/4 x 20-3/4	110
Plan Position Indicator NT-55ADE	1	12-1/8 x 14-3/8 x 19-7/8	120
Range Unit NT-23ACC	1	6-9/16 x 9-1/2 x 18-3/4	90
High Voltage Rectifier NT-20AAR-1	1	10-5/16 x 12 x 18-7/16	100
Regulated Rectifier NT-20AAQ	2	10-21/32 x 17-5/8 x 18-5/8	115
Main Control Unit NT-23ADH	1	13-5/32 x 14-1/4 x 15-1/4	125
Bearing Indicator NT-SSADD	1	7-13/16 x 8-11/16 x 12-1/16	20
Adapter Control Unit NT-23ABX	1	4-5/8 x 5-3/4 x 5-3/4	6-1/2
Junction Box NT-62AAB	2	4-5/8 x 14 x 17-9/16	32
Motor Generator Set NT-21AAS	1	13-7/16 x 15-1/8 x 44-3/8	565

**REFERENCE DATA AND LITERATURE**

Technical Manuals:  
SHIPS 258

DATE: 1 July 1964

ITEM NAME: RADAR EQUIPMENT

COGNIZANT SERVICE: USN

TYPE: SN-148/SPA

FEDERAL STOCK NUMBER: 5840-503-1332  
5840-669-9192 W/S

	USA	USN	USAF	USMC
STATUS OR TYPE CLASSIFICATION				

Mfg(s) Name or Code Number: The Emerson Electric Mfg. Company, Missouri

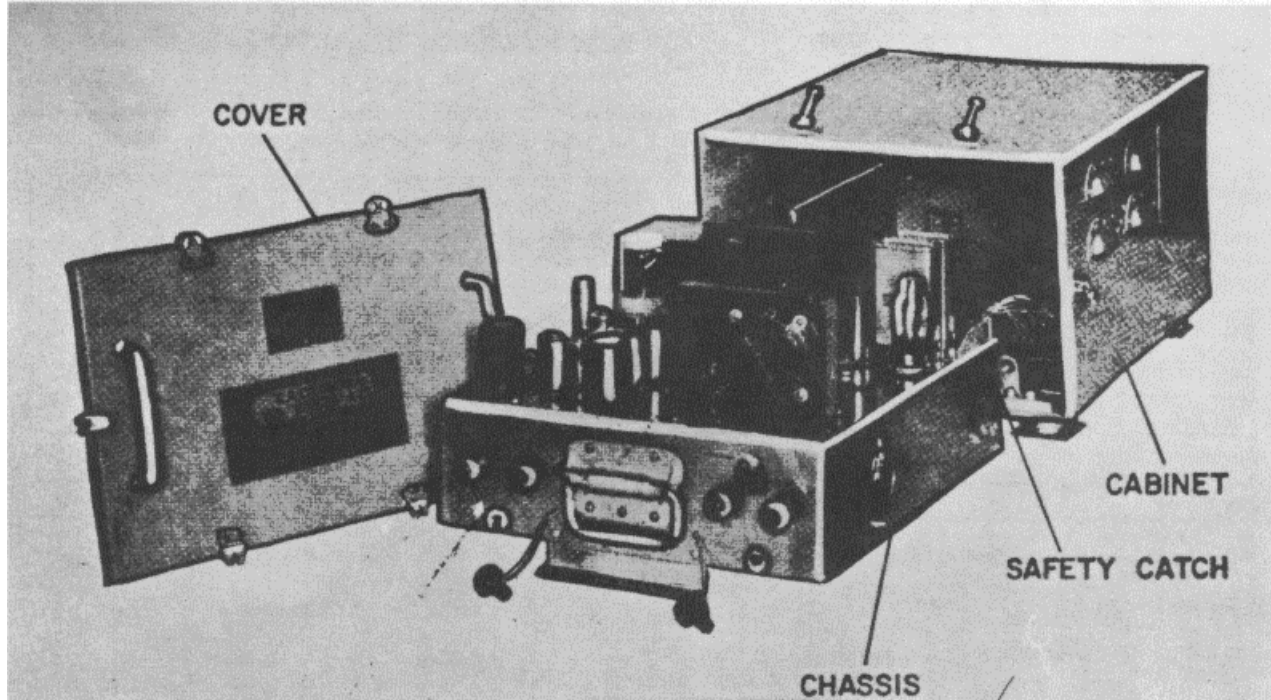

### FUNCTIONAL DESCRIPTION

The SN-148/SPA is designed for use with Radar Repeater Equipment VL-1. The indicator correlator assists the VL-1 operator in identifying, on his VL-1 display, a target selected by the operator of one of two

adjacent plan position indicators. The indicator correlator generates a range line marker which appears automatically on the desired target in the VL-1 display and a delayed range voltage which automatically delays the range sweep of the VL-1 without using the manually operated delay control on the VL-1. The automatic

SN-148/SPA: 1

**ITEM NAME:** CORRELATOR INDICATOR

**TYPE:** SN-148/SPA

delay feature of the indicator correlator causes the range line to remain centered on a 20-mile sweep. The automatic delay may be switched in and out by a Range Delay Switch on the modified VL-1 Indicator Control C-1600/SPA. As long as automatic delay operation is switched in, the range delay control on the VL-1 remains ineffective.

Trigger Input: 5 to 50v pos  
Range Accuracy: 1% or 400 yds  
Power Input: 115v, 60 cps 1 1-ph.  
Power Factor: 0.93  
Power Consumption: 100w

**INSTALLATION CONSIDERATIONS**

Related Equipment  
Required but not Supplied.  
(1) Radar Repeater Equipment VL-1,  
(2) Radar Repeater Equipment VK-5.

**RELATION TO SIMILAR EQUIPMENT**

None.

**TECHNICAL DESCRIPTION**

Pulse Repetition Frequency: 60 to 3000 cps.

**PRINCIPAL COMPONENTS AND PHYSICAL DATA**

<b>COMPONENT</b>	<b>BOXES (NR.)</b>	<b>OVERALL DIMENSIONS (Inches)</b>	<b>UNIT WT. (Pounds)</b>
Indicator Correlator SN-14B/SPA Maintenance Spare Parts Technical Manuals Maintenance Prints NAVSHIPS 92439.51 Loose Parts	1	18 x 21-1/2 x 32-1/2	133

**EQUIPMENT SUPPLIED DATA**

<b>COMPONENT</b>	<b>QTY</b>	<b>OVERALL DIMENSIONS (Inches)</b>	<b>UNIT WT. (Pounds)</b>
Indicator Correlator SN-148/SPA	1	11-3/4 x 16-1/4 x 21-5/8	58
Set Maintenance Spare Parts	1	5 x 13 x 13	22.15
Set Loose Parts	1	3-1/4 x 5 x 6-3/4	1.0
Technical Manuals NAVSHIPS 92439	2	1 x 9 x 11-1/2	3.25
Set Maintenance Prints	2	1/2 x 9 x 11-1/2	1.25

**REFERENCE DATA AND LITERATURE**

Technical Manuals:  
NAVSHIPS 92439

**SN-148/SPA: 2**

DATE: 1 July 1964

ITEM NAME: INDICATOR CORRELATOR

COGNIZANT SERVICE: USN

TYPE: SN-206/SP

FEDERAL STOCK NUMBER:

	USA	USN	USAF	USMC
STATUS OR TYPE CLASSIFICATION				

Mfg(s) Name or Code Number: Polarad Electronics Corporation, Long Island City, New York

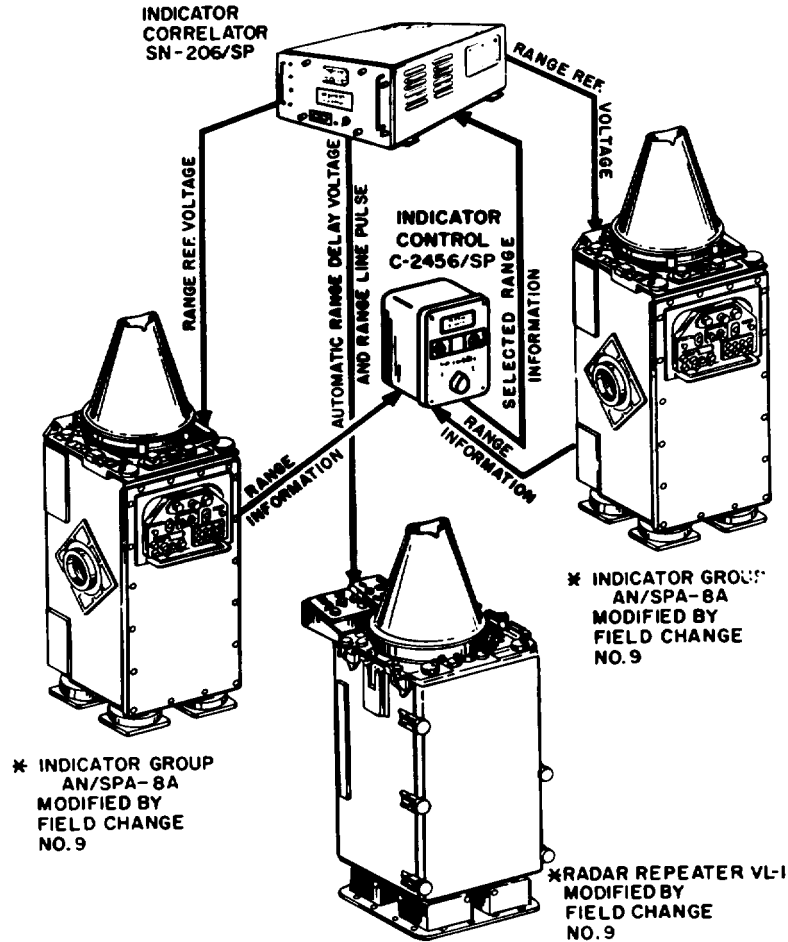

**FUNCTIONAL DESCRIPTION**

Indicator Correlator SN-206/SP is designed for use with Navy Model VL-1 Radar Repeater Equipment (modified by Field Change No. 9) and two adjacent Indicator Groups AN/SPA-1A (modified by Field Change No. 9). The indicator correlator assists the VL-1

operator in identifying, on his VL-1 display, a target selected by the operator of one of two adjacent plan position indicators (PPIs). The indicator correlator generates a range line marker which appears automatically on the desired target in the VL-1 display,



**ITEM NAME:** INDICATOR CORRELATOR

**TYPE:** SN-206/SP

and a delayed range voltage which automatically delays the range sweep of the VL-1 without using the manually operated delay control on the VL-1. The automatic delay feature of the indicator correlator causes the range line marker to remain centered on a 20-mile sweep (10 miles from the left-hand edge of the VL-1 display, regardless of the VL-1 range switch setting used). The automatic delay may be switched in and out by a RANGE DELAY switch, located on the associated Indicator Control C-2456/SP. As long as automatic delay operation is switched in, the RANGE DELAY control on the VL-1 remains ineffective.

**TECHNICAL DESCRIPTION**

Pulse Repetition Frequency: 60 to 3000 cycles.  
Trigger Input: 5 to 50v pos  
Range Accuracy: 1% or 400 yds  
Power Supply: Self-contained.  
Power Supply Input: 115v plus or minus 1v, 60 cycles, 1-ph, 100w  
0.90 pf

**INSTALLATION CONSIDERATIONS**

Related Equipment:  
Required but not Supplied.  
(1) Radar Repeater Equipment VL-1 modified by FC 9; (1) Technical Manual NAVSHIPS 91511(A) revised to F.C. 9; (2) Indicator Group AN/SPA-BA modified by F.C. 9; Technical Manual NAVSHIPS 91737 revised to F.C. 9; (1) Set Interconnecting Cables.

**RELATION TO SIMILAR EQUIPMENT**

None.

**PRINCIPAL COMPONENTS AND PHYSICAL DATA  
SHIPPING DATA**

COMPONENT	BOXES (NR.)	OVERALL DIMENSIONS (Inches)	UNIT WT. (Pounds)
Indicator Correlator SN-206/SP	1	17 x 20 x 26	90
Field Change No. 9 (VL-1 and AN/SPA-BA)	1	10-1/4 x 13 x 14	15
Maintenance Spare Parts	1*	6 x 8 x 20	25

**NOTE:** \*Supplied only with equipments bearing Serial Numbers 1 through 75.

**PRINCIPAL COMPONENTS AND PHYSICAL DATA**

COMPONENT	QTY	OVERALL DIMENSIONS (Inches)	UNIT WT. (Pounds)
Indicator Correlator SN-206/SP	1	11-1/4 x 14-1/4 x 20-1/2	51
Field Change No. 9 (VL-1)	1**		3.5
Field Change No. 9 (AN/SPA-8A)	2		2

**NOTE:** \*\*Field Change No. 9(VL-1) contains Indicator Control C-2456/SP.

**REFERENCE DATA AND LITERATURE**

Technical Manuals:  
NAVSHIPS 93232: for Indicator Correlator SN-206/SP and Indicator Control C-2456/SP.

DATE: 1 July 1964

ITEM NAME: RADAR EQUIPMENT

COGNIZANT SERVICE: USN

TYPE: SO, Soa, SO-1, -2, -3, -4, -5, -6, -8, -8a, -9, -10, -13

FEDERAL STOCK NUMBER: See Note 1

	USA	USN	USAF	USMC
STATUS OR TYPE CLASSIFICATION		Obsoles		

Mfg(s) Name or Code Number: Raytheon Mfg. Co.

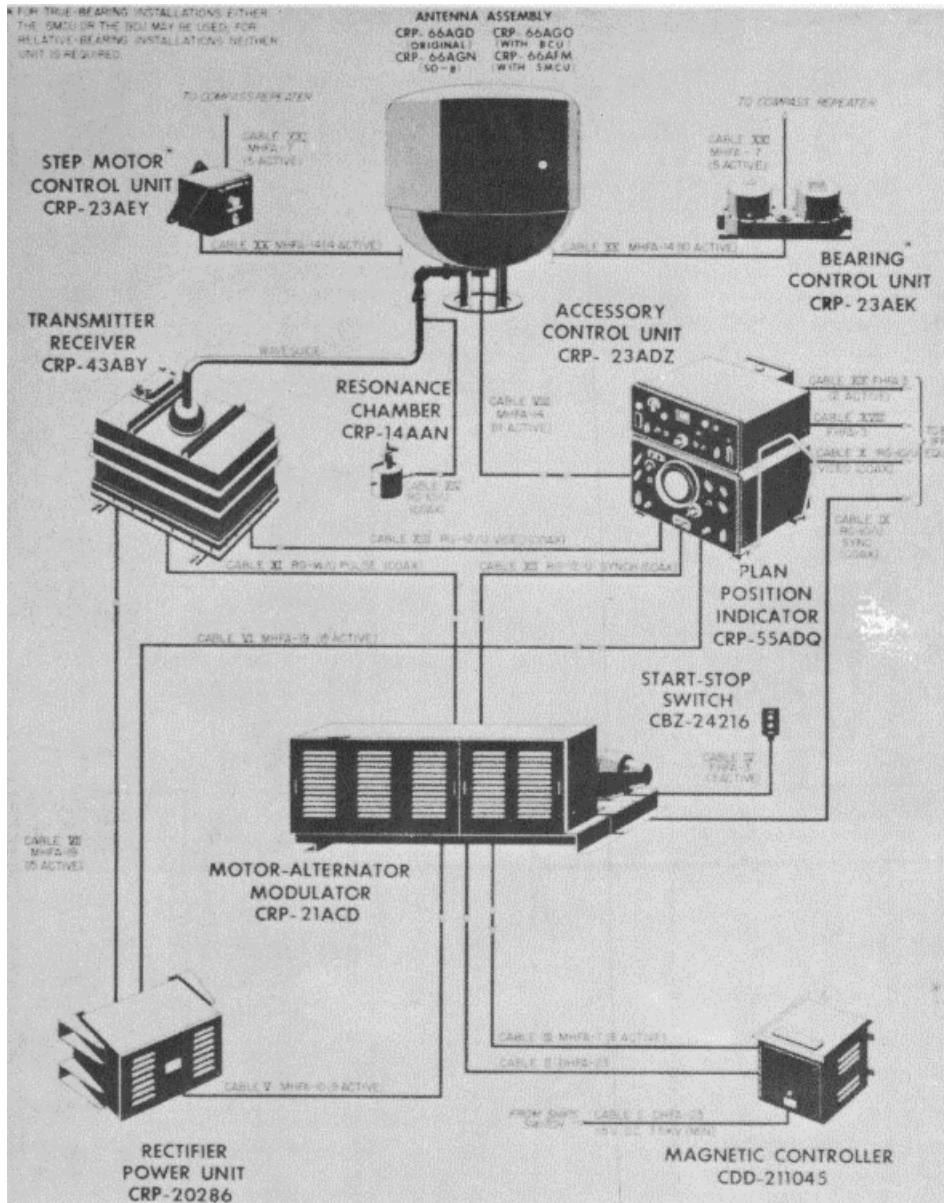

SO: 1

SO, SOa, SO-1, -2, -3, -4, -5, -6, -8, -8a, -9, -10, -13

**FUNCTIONAL DESCRIPTION**

The SO radar equipments are lightweight, medium-power surface search radars for use on patrol, auxiliary and landing craft. Provision is made for IFF. All these equipments are similar in purpose. However, the SO, SOa, SO-1, -2, -3, -4, -8, -9, and 13 are used almost exclusively for surface scanning. The SO-5, -6, and -10 are used for both surface and air scanning.

**RELATION TO SIMILAR EQUIPMENT**

None.

**TECHNICAL DESCRIPTION**

Operating Voltages and Power Requirements:

- SO, SO-13 - 24 or 30 vdc, 1.51 kw
- SOa - 24 vdc, 2.7 kw
- SO-1, -8, -8a - 115 vdc, 3.0 kw
- SO-2, -10 - 115 vac, 60 cps, 1-ph, 4.0 kw
- SO-3 - 24 vdc, 2.0 kw
- SO-4 - 115 vdc, 1.64 kw
- SO-5, -6 - 115 vdc, 4.25 kw
- SO-9 - 32 vdc, 1.8 kw

Frequency:

- SO, SOa, SO-1, -2, -8, -8a, -9, -13 - 2900 to 3100 mc
- SO-5, -6, -10 - 6275 to 6575 mc
- SO-3, -4 - 9000 to 9160 mc

Range, Max: 20 mi approx

Range, Min: 400 yd

Peak Power Output:

- SO, SOa, SO-9, -13 - 60 kw
- SO-1, -2, -8, -8a - 75 kw
- SO-3 - 20 kw
- SO-4 - 50 kw
- SO-5, -6, -10 - 91 to 285 kw

Pulse Repetition Rate:

- SO, SOa, SO-1, -2, -3, -4, -5, -8, -9, -13- 400 pps
- SO-6, -10 - 650 pps
- Pulse Width: SO, SOa, SO-1, -2, -3, -4, -8, -9, -13 - 1.00 -sec
- SO-5, -6, -10 - 0.37 μsec

Range Accuracy: ±60 yd on 4 mi range, ±300 yd on 20 mi range

Azimuth Accuracy: 1 deg

IF. Frequency: 30 mc

Receiver Gain: 120 db

Type of Presentation: 5-in. CRT, provision for IFF

Range Marks: 1, 5, and 20 mi on PPI, movable range markers

Antenna Type: Parabolic

Antenna Feed: Waveguide and nozzle

Antenna Polarization: Horizontal

**INSTALLATION CONSIDERATIONS**

Siting: Transmitter-receiver unit is waterproof and may be installed without shelter. All other units require shelter. Layouts vary with type of craft. Standard layouts are available at most Navy installation bases and at BuShips.

Mounting: Supports along with housings are shown on the Navy Yard plans.

Cabling Requirements: Standard Navy armored cable is used for all interunit connections except the pulse cable. Cables are run according to standard Navy wiring practices. Extra cabling is left at terminal connections to permit units to be removed without disconnecting and to permit repair of cable ends.

Related Equipment:

**PRINCIPAL COMPONENTS AND PHYSICAL DATA**

COMPONENT	QTY	HEIGHT (Inches)	WIDTH (Inches)	DEPTH (Inches)	UNIT WT. (Pounds)
SO Antenna Assembly 66ADN	1	43	26-1/4	26-1/4	59
Radar Receiver Transmitter 43ABK or 43ABY	1 1	23-1/2 24	18-5/16 19	14-13/16 16	85 93
Motor Alternator and Modulator Assembly 21ACB	1	24	14-7/16	14-5/16	93
Rectifier Power Unit CRP-20178	1	20-1/2	10-7/8	9-7/8	30
Plan Position Indicator 55ACD	1	22-5/16	21-3/16	13-1/2	80

SO, SOa, SO-1, -2, -3, -4, -5, -6, -8, -8a, -9, -10,  
-13

PRINCIPAL COMPONENTS AND PHYSICAL DATA (cont'd)

COMPONENT	QTY	HEIGHT (Inches)	WIDTH (Inches)	DEPTH (Inches)	UNIT WT. (Pounds)
SO (cont'd) Resonance Chamber 14AAN	1	9-1/2	5-1/2	5-1/2	5
IFF Control Unit 23ADD SOa	1	8-1/16	8	6-3/4	9
Antenna Assembly 66AFK w/Tripod CRP-10207	1	38	158	38	231
Radar Receiver Transmitter 43ABK or 43ABY	1 1	23-1/2 24	18-5/16 19	14-13/16 16	85 93
Motor Alternator Modulator 2 ACJ	1	24	22	14	124
Voltage Regulator CRP-20226	1	9	6	6	8
Rectifier Power Unit CRP-20178	1	20-1/2	10-7/8	9-7/8	30
Plan Position Indicator 55ACD or 55ADS or 55ADQ	1 1 1	22-5/16 24-1/2 23-1/2	21-3/16 13-1/2 19-1/2	13-1/2 13-1/2 13	80 93 84
Resonance Chamber 14AAN	1	9-1/2	5-1/2	5-1/2	5
IFF Control Unit 23ADD Accessory Control Unit 23ADZ SO- 1	1 1	8-1/16 23-1/2	8 10	6-3/4 19-1/2	9 63
Antenna Assembly 66AGE, 66AFL, 66AGQ or 66AHS	1	39-1/2	24	46	279
Radar Receiver Transmitter 43ABY	1	24	19	16	93
Motor Alternator Modulator 21ACD or 21ACD-1	1	47-1/2	19	21	465
Rectifier Power Unit CRP-20225 or CRP-20286	1	21-1/2	11	10-1/2	26
Magnetic Controller CDD-211045	1	15	13	13	54
Junction Box CRP-62108	1	16	20	9	60
Plan Position Indicator 55ADQ	1	19-1/2	13	23-1/2	84
Resonance Chamber 14AAN	1	9-1/2	5-1/2	5-1/2	5
IFF Control Unit 23ADD	1	8-1/16	8	6-3/4	9
Accessory Control Unit 23ADZ	1	23-1/2	10	19-1/2	63
Bearing Control Unit 23AEK	1	23	10	11	62

SO, SOa, SO-1, -2, -3, -4, -5, -6, -8, -8a, -9, -10, -13

**PRINCIPAL COMPONENTS AND PHYSICAL DATA (cont'd)**

<b>COMPONENT</b>	<b>QTY</b>	<b>HEIGHT (Inches)</b>	<b>WIDTH (Inches)</b>	<b>DEPTH (Inches)</b>	<b>UNIT WT. (Pounds)</b>
SO-2					
Antenna Assembly 66AFN	1	37	33-1/4	38	95
Radar Receiver Transmitter 43ABK-1	1	24	19	16	93
Motor Alternator and Modulator Assembly 21ACE or 21ACE-1	1	47-1/2	19	21	465
Rectifier Power Unit CRP-20286, 20237, or 20287	1	21-1/2	11	10-1/2	26
Auxiliary Rectifier CRP-20238	1	21-1/2	11	10-1/2	26
Magnetic Controller CDD-211059 or 211085	1	15	13	13	54
Junction Box CRP-62108A	1	16	20	9	60
Plan Position Indicator 55ADQ	1	19-1/2	13	23-1/2	84
Resonance Chamber 14AAN	1	9-1/2	5-1/2	5-1/2	5
IFF Control Unit 23ADD	1	8-1/16	8	6-3/4	9
Accessory Control Unit 23ADZ	1	23-1/2	10	19-1/2	63
SO-3					
Antenna Assembly 66AGF	1	47	30	30	125
Radar Receiver Transmitter 43ACD	1	18	21	24	134
Motor Alternator CQR-211095	1	21-1/2	15-1/2	17	139
Modulator 50AEM	1	24-1/4	10-5/8	13	255
Rectifier Power Unit CRP-20247	1	20	16	12	38
Voltage Regulator CRP-20248	1	8	6	7	7
Plan Position Indicator 55ADQ or 55AEM	1 1	19-1/2 19-1/2	13 13	23-1/2 23-1/2	84 84
Resonance Chamber 14AAT	1	10	10	8	20
Accessory Control Unit 23AEE	1	24	10	20	70
Bearing Control Unit 2-EJ	1	10	10	8	23

SO, SOa, SO-1, -2, -3, -4, -5, -6, -8, -8a, -9, -10,  
-13

PRINCIPAL COMPONENTS AND PHYSICAL DATA (cont'd)

COMPONENT	QTY	HEIGHT (Inches)	WIDTH (Inches)	DEPTH (Inches)	UNIT WT. (Pounds)
SO-4					
Antenna Assembly 66AGS	1	52	48	48	185
Radar Receiver Transmitter 43ACO or 43ACN	1 1	24 23-1/2	24 18-7/8	18 17-7/8	140 140
Motor Alternator Unit CDD-21141	1	25	16	17	280
Modulator 50AEQ-1	1	24	31	17	255
Rectifier Power Unit 2OACU	1	23	25	14	170
Magnetic Controller CDD-211242	1	31	26	16	280
Plan Position Indicator 55AEM	1	19-1/2	13	23-1/2	84
Junction Box CRP-62152	1	17	15	8	60
Resonance Chamber 14AAT	1	10	10	8	20
Accessory Control Unit 23AFD	1	23-1/2	9-7/16	19	70
Bearing Control Unit 23AFK SO-5	1	18	10	19	55
Antenna Assembly 66ALZ	1	50-1/4	50	50	220
Radar Receiver Transmitter 43ADN	1	25-1/16	21-1/16	20-1/4	155
Motor Alternator Unit 21ADM	1	17-3/16	7	11-5/8	52
Modulator and Rectifier Power Unit 5OAHN	1	19-1/2	16-5/16	33-5/8	150
Rectifier Power Unit 2OAEQ	1	10-9/16	10-1/4	12-1/2	41
Plan Position Indicator 55AHJ	1	19-7/16	12	24	93
Auxiliary Plan Position Indicator 55AHK	1	15-3/16	12-1/4	22	85
Junction Box 62ABQ	1	17-11/16	23-3/8	7-1/8	44.5
Resonance Chamber 14ABX	1	11-3/4	11-7/16	8	15.5
Accessory Control Unit 23AHQ	1	23-1/2	9-7/16	17-1/2	54
Bearing Control Unit 23AEJ	1	10	10	8	23

SO: 5

SO, SOa, SO-1, -2, -3, -4, -5, -6, -8, -8a, -9, -10, -13

**PRINCIPAL COMPONENTS AND PHYSICAL DATA (cont'd)**

<b>COMPONENT</b>	<b>QTY</b>	<b>HEIGHT (Inches)</b>	<b>WIDTH (Inches)</b>	<b>DEPTH (Inches)</b>	<b>UNIT WT. (Pounds)</b>
SO-6					
Antenna Assembly 66AMP	1	50-1/4	50	50	220
Radar Receiver Transmitter 43ADR	1	25-1/8	21-11/16	20-7/16	186
Motor Alternator CDD-211792	1	28-1/8	16-3/16	14-13/16	294
Modulator 5OAJL	1	30	17	42-1/2	425
Rectifier Power Unit 20AFF	1	21	27-1/2	13-7/16	124
Plan Position Indicator 55AJE	1	19-7/16	12	23-7/16	93
Auxiliary Plan Position Indicator 55AHK	1	15-3/16	12-1/4	22	85
Junction Box 62ABR	1	18	20	7	44
Magnetic Controller CDD-211793	1	30-1/2	25-5/8	17-1/16	284
Resonance Chamber 14ACF	1	11-7/16	8	11-3/4	15.5
Accessory Control Unit 23AJC	1	23-1/2	9-7/16	23-1/2	54
Bearing Control Unit 23AJD	1	20-1/8	18-5/16	12	80
SO-8, -8a					
Antenna Assembly 66AGD (SO-8, -8a) or 66AGO, AFM, AGN (SO-8)	1	37	34	38	105
Radar Receiver Transmitter 43ABY	1	24	19	16	93
Motor Alternator and Modulator Assembly 21ACD or 21ACD-1	1	47-1/2	19	21	465
Rectifier Power Unit CRP-20225	1	11	10-1/2	21-1/2	26
Plan Position Indicator 55ADQ	1	19-1/2	13	23-1/2	84
Junction Box CRP-62018A	1	16	20	9	60
IFF Control Unit 23ADD	1	8-1/16	8	6-3/4	9
Resonance Chamber 14AAN	1	9-1/2	5-1/2	5-1/2	5
Magnetic Controller CDD-211045	1	15	13	13	54
Accessory Control Unit 23ADZ	1	23-1/2	10	19-1/2	63
Bearing Control Unit 23AEK	1	23	11	10	62

SO, SOa, SO-1, -2, -3, -4, -5, -6, -8, -8a, -9, -10,  
-13

PRINCIPAL COMPONENTS AND PHYSICAL DATA (cont'd)

COMPONENT	QTY	HEIGHT (Inches)	WIDTH (Inches)	DEPTH (Inches)	UNIT WT. (Pounds)
SO-9					
Antenna Assembly 66AHR	1	39	35	35	88
Radar Receiver Transmitter 43ACP	1	23-1/2	19	15	93
Motor Alternator Unit CRP-211240	1	23-1/4	18	18	120
Rectifier Power Unit 20ACU	1	11	10-1/2	21-1/2	26
Plan Position Indicator 55ADQ	1	19-1/2	13	23-1/2	84
IFF Control Unit 23ADD	1	8-1/16	8	6-3/4	9
Resonance Chamber 14AAN	1	9-1/2	5-1/2	5-1/2	5
SO-10					
Antenna Assembly 66AMP	1	50-1/4	50	50	220
Radar Receiver Transmitter 43ADR	1	25-1/8	21-11/16	20-7/16	186
Motor Alternator Unit CRP-211792	1	28-1/2	16-3/16	14-13/16	294
Modulator 50AJL	1	30	17	42-1/2	425
Rectifier Power Unit 20AFF	1	21	27-1/2	13-7/16	124
Junction Box 62ABR	1	18	20	7	44
Plan Position Indicator 55AJE	1	19-7/16	12	23-7/16	93
Auxiliary Plan Position Indicator 55AHK	1	15-3/16	12-1/4	22	85
Resonance Chamber 14ACF	1	11-7/16	8	11-3/4	15.5
Magnetic Controller CDD-211793	1	30-1/2	25-5/8	17-1/16	284
Accessory Control Unit 23AJC	1	23-1/2	9-7/16	23-1/2	54
Bearing Control Unit 23AJD	1	20-1/8	18-5/16	12	80
Voltage Regulator 30AAP	1	17	24	12	100

SO: 7



SO, SOa, SO-1, -2, -3, -4, -5, -6, -8, -8a, -9, -10, -13

**PRINCIPAL COMPONENTS AND PHYSICAL DATA (cont'd)**

COMPONENT	QTY	HEIGHT (Inches)	WIDTH (Inches)	DEPTH (Inches)	UNIT WT. (Pounds)
SO- 13					
Antenna Assembly 66AFK w/Tripod CRP- 10207	1	38	158	38	231
Radar Receiver Transmitter 43ABK or 46ACA	1	23-1/2	18-5/16	14-13/16	85
Motor Alternator Unit CRP-211095	1	21-1/2	15-1/2	17	139
Rectifier Power Supply CRP-20269	1	21-1/2	11	10-1/2	26
Junction Box CRP-62108A	1	16	20	9	60
Plan Position Indicator 55ACP or 55ADS or 55ADQ	1 1 1	13-1/2 13-1/2 19-1/2	21-3/16 13-1/2 13	22-5/16 24-1/2 23-1/2	80 93 84
Resonance Chamber 14AAN	1	9-1/2	5-1/2	5-1/2	5
IFF Control Unit 23ADD	1	8-1/16	8	6-3/4	9
Accessory Control Unit 23ADZ	1	23-1/2	10	19-1/2	63
Voltage Regulator CRP-20248	1	9	6	6	8

**REFERENCE DATA AND LITERATURE**

Technical Manuals:  
ENG 195  
NAVSHIPS 91190  
NAVSHIPS 91193  
NAVSHIPS 91129  
NAVSHIPS 900321(A)  
NAVSHIPS 900970  
NAVSHIPS 900860  
SHIPS 260  
SHIPS 259L  
SHIPS 237

**Note 1. Federal Stock Numbers**

SO:  
SOa:  
SO-1: F5840-642-7046  
SO-2: F5840-642-7040  
SO-3: F5840-642-7063  
SO-4: F5840-642-7064  
SO-5: F5840-642-7058  
SO-6: F5840-642-7056  
SO-8: F5840-669-7030  
SO-8a:  
SO-9:  
SO-10: F5840-642-6709  
SO-13:

**SO: 8**

DATE: 1 July 1964

ITEM NAME: RADAR EQUIPMENT

COGNIZANT SERVICE: USN

TYPE: SP\*, SP-2

FEDERAL STOCK NUMBER: F5840-642-7039\*

	USA	USN	USAF	USMC
STATUS OR TYPE CLASSIFICATION				

Mfg(s) Name or Code Number: General Electric Company

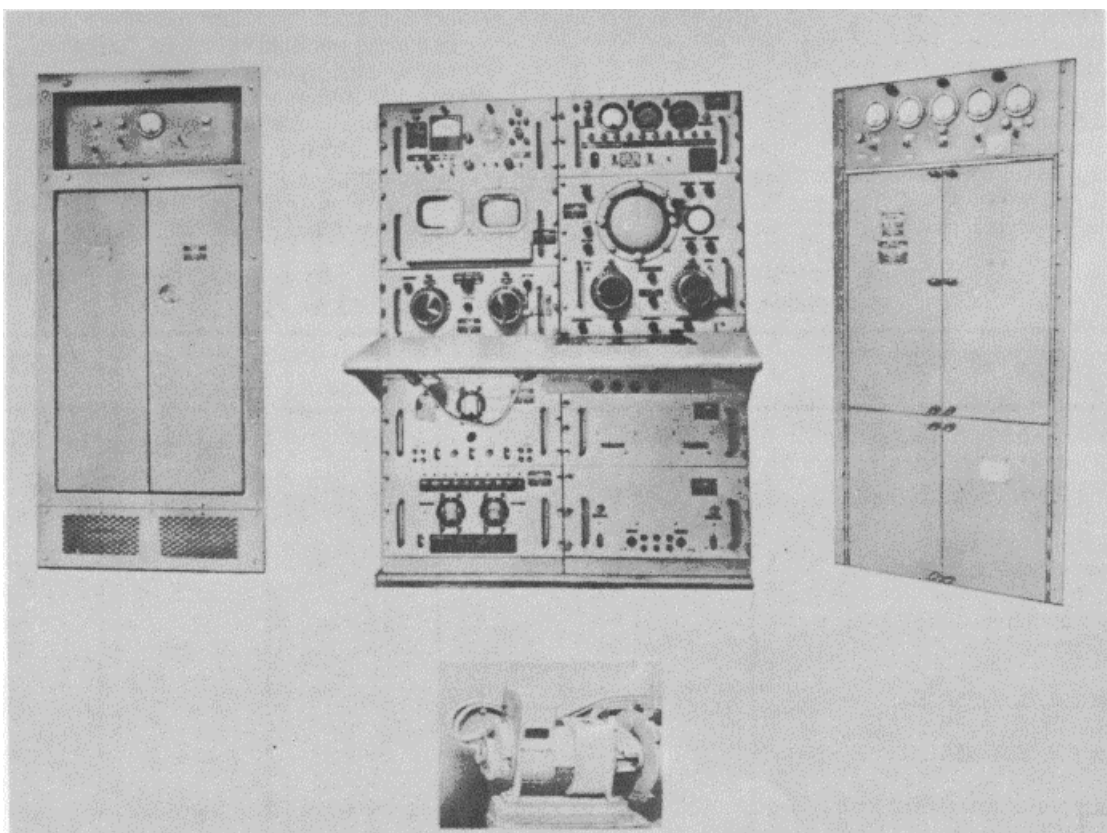

### FUNCTIONAL DESCRIPTION

The SP and SP-2 are high-powered radar equipments used for fighter aircraft direction and surface search. The SP and SP-2 are designed for shipboard installation. Target indications are displayed on PPI, A- and R-scope presentations, and, in the SP-2, on a

range-height indicator. Accurate altitude, range, and bearing information is furnished. Provision is made for radar repeaters and IFF display.

### RELATION TO SIMILAR EQUIPMENT

None.

SP: 1

SP, SP-2

**TECHNICAL DESCRIPTION**

Frequency: 2800 mc  
 Range, Max:  
     PBV - 20 mi at 500 ft, 40 mi at 10,000 ft  
     Battleships - 30 mi  
     Heavy Cruisers - 30 mi  
     Destroyers - 20 mi  
     Submarines - 10 mi (surfaced)  
     Beacons - Line of Sight  
 Range, Min: 500 yd  
 Peak Power Output: 700 kw  
 Pulse Repetition Rate: 600 and 120 pps  
 Pulse Width: 1 or 5 µsec  
 IF. Frequency: 30 mc  
 Receiver Bandwidth: 4 mc, IF.; 2 mc, video  
 Receiver Sensitivity: 14 db above noise level  
 Range Resolution: 200 yd  
 Bearing Resolution: 1.5 deg  
 Elevation Resolution: 500 yd  
 Range Accuracy: 200 yd  
 Bearing Accuracy: 0.5 deg  
 Elevation Accuracy: ±1,300 ft at 30 mi  
 Operating Voltages and Power Requirements:  
     220/440 vac, 60 cps, 3-ph, or 115/230 vdc  
 Type of Presentation: 5-in. A-scope with 100 mi

range; 5-in. R-scope showing any 5-mi portion of A-scope expanded; 7-in. true bearing PPI with relative bearing shown on dial; elevation and altitude meter.  
 PPI Range: 4, 20, 50, 100, and 200 mi  
 Range-Height Indicator (SP-2 only):  
 Type of Presentation - 12 in. RHI scope  
 Range - 20, 40, 80, and 200 mi  
 Elevation - 12,000 to 60,000 ft

**INSTALLATION CONSIDERATIONS**

Siting: Radar console must be located in an area free from noise and distraction. Free space must be provided in front of radar console panel for operator's seating and access to equipment.  
 Mounting: Radar console must be disassembled and reassembled to mount. Size and weight of the console make this necessary.  
 Waveguide Requirements: Smooth interior surface from end to end similar to a one-piece continuous pipe (excepting bolted choke joints and expansion joints).  
 Related Equipment: Type "LAD" Radar Generator, Navy Type CYK-60ACE.

**PRINCIPAL COMPONENTS AND PHYSICAL DATA**

COMPONENT	QTY	HEIGHT (Inches)	WIDTH (Inches)	DEPTH (Inches)	UNIT WT. (Pounds)
Antenna Assembly CG-66AHP	1	136	106	106	2200
or CG-66AHQ	1	115	73	73	1790
or CG-66AHQ-1	1	73	90	75	1788
or CG-66AKV-1	1	98	132	84	2808
Console Assembly CG-23AEN	1	62	46	25-1/2	1410
Control Amplifier Assembly CG-50AEN	1	59-1/4	23-3/8	19-1/4	355
Modulator A CG-35ABD	1	28	63	24	910
Modulator B CG-35ABE	1	28	63	24	1170
Motor Alternator and Spark Gap NT-21ACU	1	18-1/4	36-1/2	16-1/2	360
Signal Generator CYK-60ACE	1	10-1/8	16-7/8	13-1/8	38
Motor Dynamo Amplifier CG-21ACN	3	12-1/4	21-1/2	14-1/4	197
Power Transformer NT-301232	3	20-3/8	11-5/8	9-7/8	185

**PRINCIPAL COMPONENTS AND PHYSICAL DATA (cont'd)**

<b>COMPONENT</b>	<b>QTY</b>	<b>HEIGHT (Inches)</b>	<b>WIDTH (Inches)</b>	<b>DEPTH (Inches)</b>	<b>UNIT WT. (Pounds)</b>
Voltage Regulating Transformer NT-301233	1	20-1/8	22-5/8	17-1/8	345
Motor Alternator Set NT-211250 or NT-211249	1 1	29-3/8 29-3/8	72-3/4 72-3/4	23-3/8 23-3/8	1732 1800
Magnetic Controller NT-211211 or NT-211210	1 1	58-3/4 63	22-7/8 23-3/4	29 30	420 570
SXS to SYN Converter CG-21ACF	1	18-1/4	17-3/4	13-1/4	104
Range-Height Indicator CG-55AKA	1	51-7/16	18-5/16	16-5/8	420
Cursor Bearing Transmitter	1	3-1/8	3-3/16	6-13/16	2
Sine-Cosine Converter	1	4-3/16	7-3/8	13-7/8	1.5
Range Line Generator	1	2-3/4	4-11/16	6	0.5

**REFERENCE DATA AND LITERATURE**

Technical Manuals:  
NAVSHIPS 900534  
NAVSHIPS 91160

DATE: 1 July 1964

ITEM NAME: RADAR EQUIPMENT

COGNIZANT SERVICE: USN

TYPE: SR\*, SR-a\*\*, SR-b\*\*\*

FEDERAL STOCK NUMBER: F5840-665-2533\*  
F5840-642-7811\*\*

	USA	USN	USAF	USMC
STATUS OR TYPE CLASSIFICATION		*Obs **Ltd Std		

Mfg(s) Name or Code Number: Westinghouse Electric Co.\*, \*\*, U.S. Repair Facility, Naval Station\*\*\*

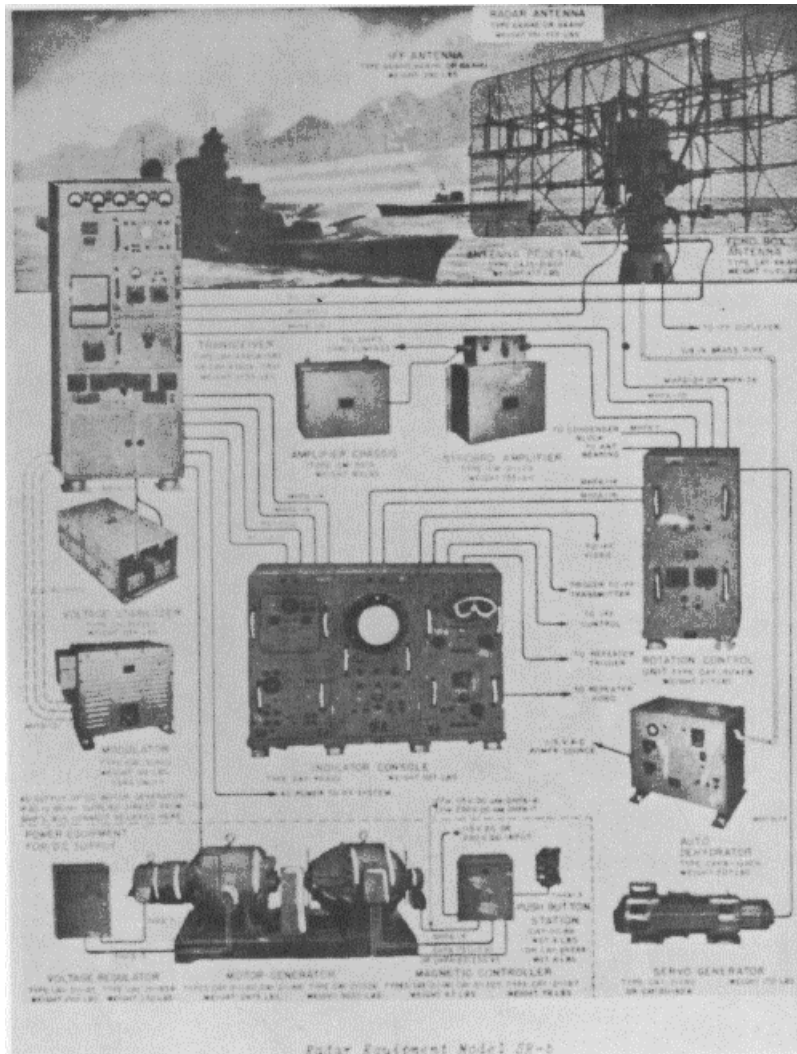

### FUNCTIONAL DESCRIPTION

Radar Equipments SR, SR-a, and SR-b are basically identical in design. They function as searching, ranging, and direction finding devices for ship installations.

The SR was originally designed to search within a radius of 400 nautical miles but was later modified in the field to reduce the maximum range to 200 miles.

SR: 1

**ITEM NAME:** RADAR EQUIPMENT

**TYPE:** SR, SR-a, SR-b

**RELATION TO SIMILAR EQUIPMENT**

The SR-a is an SR that has been modified by replacing the keyer unit with a modulator. The SR-b is a sophisticated version of the SR-a, providing a more sensitive receiver and added T-R protection. This resulted in increased range capability and added reliability.

**TECHNICAL DESCRIPTION**

Frequency: 175 to 225 mc  
Peak Power Output: 300 kw  
Pulse Repetition Rate: 60 and 200 pps  
Pulse Width: 1, 4, or 20 usec  
Operating Voltages and Power Requirements:  
115/230v, 60 cps, 1-ph  
IF. Frequency: 15 mc

Type of Presentation:

Range - A-scope, 4, 20, 80 and 400 mi  
Bearing - PPI, 4, 20, 80 and 200 mi

**INSTALLATION CONSIDERATIONS**

Siting: Locate indicator where average temperature is moderate; transceiver and synchro amplifier near antenna; motor generator near main bus; magnetic controller, voltage regulator, and controller disconnect line switch near motor generator; and pushbutton station near transceiver.

Mounting: Synchro amplifier supports welded to bulkhead; most units are shock mounted.

<b>COMPONENT</b>	<b>QTY</b>	<b>HEIGHT (Inches)</b>	<b>WIDTH (Inches)</b>	<b>DEPTH (Inches)</b>	<b>UNIT WT. (Pounds)</b>
Keyer Unit CAY-67AAD (SR only)	1	11-1/4	14-5/8	18-7/8	62
Monitor Receiver CAY-46ADK	1	13-1/4	14-5/8	20-5/16	53
Monitor Scope CAY-55AFD	1	9-1/4	14-5/8	19-9/32	59
Indicator Console CAY-46ADJ	1	29-13/16	41-3/4	31-13/16	527
Rotation Control Unit CAY-SOAEB	1	30	14-1/4	31-5/16	217
Auto Dehydrator CAKB-10AEK	1	21-5/8	24-3/4	18	207
Modulator CAY-5OAGU (SR-a, -b only)	1	23-1/2	18	27-1/4	168
Motor Generator CAY-211182	1	33-15/16	30-3/16	86-3/4	2975
Antenna Pedestal CA3S-21ACP	1	78-3/4	22-7/8	54-5/8	477
Antenna Assy CLP-66AHE	1	152	69	31-11/16	251
Antenna Assy CLP-66AHF	1	180	72	32-13/16	272
Mark III Dipole CLP-66AHG	1	47-3/8	2	2	5.5
Mark III Dipole CLP-66AHH	1	52	39	16-1/2	292
Mark IV Dipole Group CLP-66AH3	1	52	39	16-1/2	292

**REFERENCE DATA AND LITERATURE**

Technical Manuals:  
NAVSHIPS 900, 946  
NAVSHIPS 92524

DATE: 1 July 1964

ITEM NAME: RADAR EQUIPMENT

COGNIZANT SERVICE: USN

TYPE: SD, SD-a, SD-2 THRU SD-5

FEDERAL STOCK NUMBER:

	USA	USN	USAF	USMC
<b>STATUS OB TYPE CLASSIFICATION</b>				
Mfg(s) Name or Code Number: RCA Victor Div., Radio Corp. of America, Camden, New Jersey				

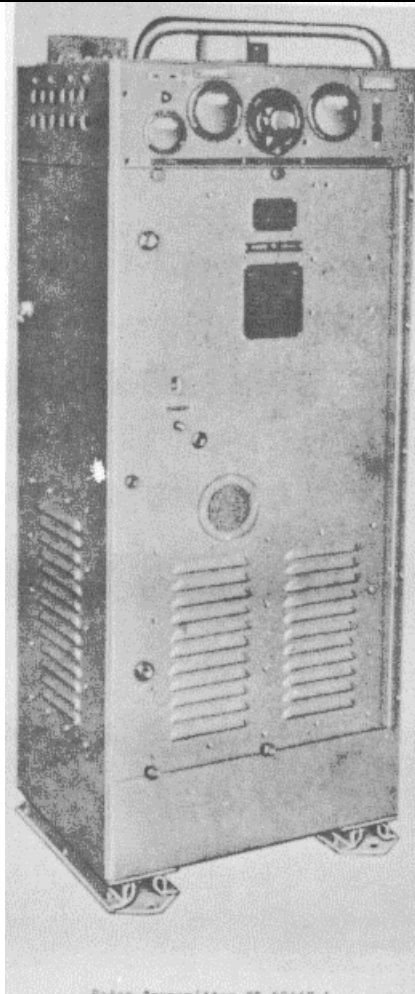

### FUNCTIONAL DESCRIPTION

The Navy Model SD Series equipments are designed to provide warning of the proximity of aircraft and are capable of detecting the presence of remote aerial, marine and land objects, and of determining their

distance with respect to the antenna. They are intended for installation in submarines, excepting the Model SD-3 which is intended for use on small surface vessels, and employ an omnidirectional antenna on the mast to permit operation of the radar while submerged.

SD: 1

**ITEM NAME:** RADAR EQUIPMENT

**TYPE:** SD, SD-a, SD-2 THRU SD-5

Data on this sheet reflects the following field changes: FC-1 -4 thru -7, -10, -11, -12 (SD); FC-2, -3 thru -7, -9 thru -12 (SD-a); FC-3 thru -7, -9, -11, -12 (SD-1); FC-3 thru -7, -9 thru -12 (SD-2); FC-4, -5, -7, -8, -11, -12 (SD-3); FC-4, -6, -8 thru -12 (SD-4); FC-10 thru -13 (SD-5).

**RELATION TO SIMILAR EQUIPMENT**

The Model SD series equipments are similar, differing only in improvements added in latest models.

**TECHNICAL DESCRIPTION**

**Frequency Range**

SD, SD-a, SD-2: 109 to 119 mc  
SD-3, -4, -5: 111 to 117 me

**Power Output:** 100 kw

**Emission:** Pulse

**Pulse Data**

Width: 8.5 usec  
Rate: 60 pps

**Presentation:** 5 in. CR tube

**Receiver Data**

Type: Superheterodyne

IFF: 15 mc

Sensitivity: 5 uv input for lv output across detector load resistor.

**Power Requirements**

SD, SD-, SD-2, -4, -5: 115v, 60 cps, 1-ph.

SD-3: 115v, 60 cps, 1-ph and 110v dc.

**Power Consumption**

SD, SD-a, SD-2: 1130w

SD-3: 1277w ac, 150w dc

SD-4: 1180w

SD-5: 1363w

**Antenna**

SD: 100 ohm J-type dipole, 3/4 wavelength, vertically polarized.

SD-a: Omnidirectional, 100 ohm horizontal U-type dipole with 1/4 wavelength coaxial matching section.

SD-2: 35 ohm omnidirectional U-type.

SD-3: Unidirectional array of 4 radiator sets.

SD-4, -5: Omnidirectional, 100 ohm horizontal U-type dipole with 1/4 wave coaxial matching stub.

**INSTALLATION CONSIDERATIONS**

Not available.

**PRINCIPAL COMPONENTS AND PHYSICAL DATA**

COMPONENT	SHIPPING DATA		UNIT WT. (Pounds)
	BOXES (NR.)	OVERALL DIMENSIONS (Inches)	
SD, SD-a, SD-2			
NOT AVAILABLE			
SD-3			
Radar Transmitter NT-55AAY	1	23 x 26 x 58-1/2	408
Radar Reciever-Indicator NT-55ACL	1	19-1/2 x 26-1/2 x 29	128
Antenna Assy NT-66ADB	1	13 x 31-1/2 x 87	206
Antenna Pedestal NT-10132 including: Set of Accessories	1	16-1/2 x 17-1/2 x 33-1/2	112
Train Indicator NT-55ACM	1	16-1/2 x 25 x 33	136
Frequency Meter Test Set NT-60ABA	1	9-3/4 x 14 x 15-1/4	33
Test Equipment Antenna NT-66ADC	1	5 x 5 x 41	11
Dehydrator Unit	1	18-1/2 x 20-1/2 x 28	99
Equipment Spares	2		
SD-4			
Radar Transmitter NT-52AAY-1	1	23 x 26 x 58-1/2	408
Radar Receiver-Indicator NT-55ACL	1	19-1/2 x 26-1/2 x 29	128



ITEM NAME: RADAR EQUIPMENT

TYPE: SD, SD-a, SD-2 THRU SD-5

PRINCIPAL COMPONENTS AND PHYSICAL DATA

COMPONENT	SHIPPING DATA		UNIT WT. (Pounds)
	BOXES (NR.)	OVERALL DIMENSIONS (Inches)	
SD-4 (Cent.)			
Duplexing Unit NT-5OAAU-1	1	16 x 22-1/4 x 27	100
Antenna Assy NT-66AFE	1	10-3/4 x 30-1/8 x 30-1/4	42
Set of Accessories	1		
Set of Equipment Spares	1		
SD-5			
Radar Transmitter NT-S2AAY-1	1	23 x 26 x 58-1/2	408
Radar Receiver NT-46ADC	1	17-3/8 x 31-5/8	94
Radar Indicator NT-55AEL	1	19 x 26-3/8 x 32-1/2	174
Duplexing Unit NT-5OAAU-1	1	16 x 22-1/4 x 27	100
Antenna Assy NT-66AFE	1	10-3/4 x 30-1/8 x 30-1/4	42
Set of Accessories	1		
Set of Equipment Spares	1		

EQUIPMENT SUPPLIED DATA

COMPONENT	QTY	OVERALL DIMENSIONS (Inches)		UNIT WT. (Pounds)
SD				
Radar Transmitter NT-52AAH	1	18-3/4 x 20-15/16 x 51-3/4		300
Radar-Receiver-Indicator NT-46AAF	1	9-9/16 x 18-3/4 x 22-11/32		58
Duplexing Unit NT-SOAAH	1	12 x 26 x 34		40
Antenna Assy NT-66AAG	1	5 x 5 x 102		50
Set of Accessories	1			
Set of Equipment Spares	1			
Technical Manual ENG 126	2	1 x 8-1/2 x 11		
SD-a				
Radar Transmitter NT-52AAH	1	18-3/4 x 20-15/16 x 51-3/4		300
Radar Receiver-Indicator NT-46AAF-1	1	9-9/16 x 18-3/4 x 22-11/32		58
Duplexing Unit NT-5OAAU	1	8-5/8 x 12-1/4 x 16		44
Antenna Assy NT-66AAR	1			34
Video Amplifier NT-SOAAW	1	6-3/8 x 7-3/4 x 9-1/8		10
Set of Accessories	1			

SD: 3

ITEM NAME: RADAR EQUIPMENT

TYPE: SD, SD-a, SD-2 THRU SD-5

PRINCIPAL COMPONENTS AND PHYSICAL DATA

EQUIPMENT SUPPLIED DATA (Cont.)

COMPONENT	QTY	OVERALL DIMENSIONS (Inches)	UNIT WT. (Pounds)
SD-a (Cont.)			
Set of Equipment Spares	1		
Technical Manual ENG 126	2	1 x 8-1/2 x 11	
SD-2			
Radar Transmitter NT-52AAY	1	15-5/8 x 20-15/16 x 51-3/4	300
Radar Receiver-Indicator NT-46AAW	1	9 x 18-3/4 x 25	63
Duplexing Unit NT-50AAU	1	8-5/8 x 12-1/4 x 16	44
Antenna Assy NT-66AAR or NT-66AFE	1	8-1/2 x 23-5/8 x 30-1/8	34 ea
Set of Accessories	1		
Set of Equipment Spares	1		63
Technical Manual SHIPS 204	2	3/4 x 8-1/2 x 11	
SD-3			
Radar Transmitter NT-55AAY	1	17-5/16 x 20-15/16 x 51-3/4	300
Radar Receiver-Indicator NT-55ACL	1	9-3/4 x 18-3/4 x 25	63
Antenna Assy NT-66ADB	1	28-1/2 x 81-25/32 x 104	50
Antenna Pedestal NT-10132	1	7-1/8 x 7-5/8 x 9	28
Train Indicator NT-55ACH	1	10 x 18-3/4 x 22-5/8	55
Frequency Meter Test Set NT-60ABA	1	6-5/8 x 12 x 12	23
Test Equipment Antenna NT-66ADC	1	1-1/2 dia x 36-1/8	2
Dehydrator Unit	1	12 x 14-1/2 x 22	62
Set of Accessories	1		
Set of Equipment Spares	1		
Technical Manual SHIPS 218	2	3/4 x 8-1/2 x 11	
SD-4			
Radar Transmitter NT-52AAY-1	1	17-5/16 x 20-15/16 x 52-3/8	300
Radar Receiver-Indicator NT-55ACL	1	9-3/4 x 18-3/4 x 25	63
Duplexing Unit NT-50AAU-1	1	9-1/4 x 12-1/4 x 16-1/2	44
Antenna Assy NT-66AFE	1	8-1/2 x 12-1/4 x 23-5/8	13.5
Set of Accessories	1		
Set of Equipment Spares	1		
Technical Manual SHIPS 203A	2	3/4 x 8-1/2 x 11	

SD: 4

ITEM NAME: RADAR EQUIPMENT

TYPE: SD, SD-a, SD-2 THRU SD-5

**PRINCIPAL COMPONENTS AND PHYSICAL DATA**

**EQUIPMENT SUPPLIED DATA (Cont.)**

<b>COMPONENT</b>	<b>QTY</b>	<b>OVERALL DIMENSIONS (Inches)</b>	<b>UNIT WT. (Pounds)</b>
SD-5			
Radar Transmitter NT-52AAY-1	1	18-1/8 x 20-15/16 x 52-1/4	300
Radar Receiver NT-46ADC	1	11-3/8 x 11-9/16 x 21-1/8	40
Radar Indicator NT-55AEL	1	12-5/8 x 20-3/8 x 20-5/8	75
Duplexing Unit NT-50AAU-1	1	9-1/4 x 12 x 16-1/2	44
Antenna Assy NT-66AFE	1	7-5/8 x 22-3/4 x 26	34
Set of Accessories	1		
Set of Equipment Spares	1		
Technical Manual SHIPS 268(A)	2	3/4 x 8-1/2 x 11	

**REFERENCE DATA AND LITERATURE**

Technical Manuals:

- ENG 126: for Navy Models SD and SD-a Radar Equipment.
- SHIPS 204: for Navy Model SD-2 Radar Equipment.
- SHIPS 218: for Navy Model SD-3 Radar Equipment
- SHIPS 203A: for Navy Model SD-4 Radar Equipment.
- SHIPS 268(A): for Radar Equipment Model SD-5.

**SD: 5**

DATE: 1 July 1964

ITEM NAME: RADAR EQUIPMENT

COGNIZANT SERVICE: USN

TYPE: SF\*, SF-1\*\*

FEDERAL STOCK NUMBER: F5840-669-7837\*  
 F5840-642-8838\*\*(115 vdc)  
 F5840-642-7802\*\*(440 vac)

	USA	USN	USAF	USMC
STATUS OR TYPE CLASSIFICATION		Obsoles		

Mfg(s) Name or Code Number: Submarine Signal Company

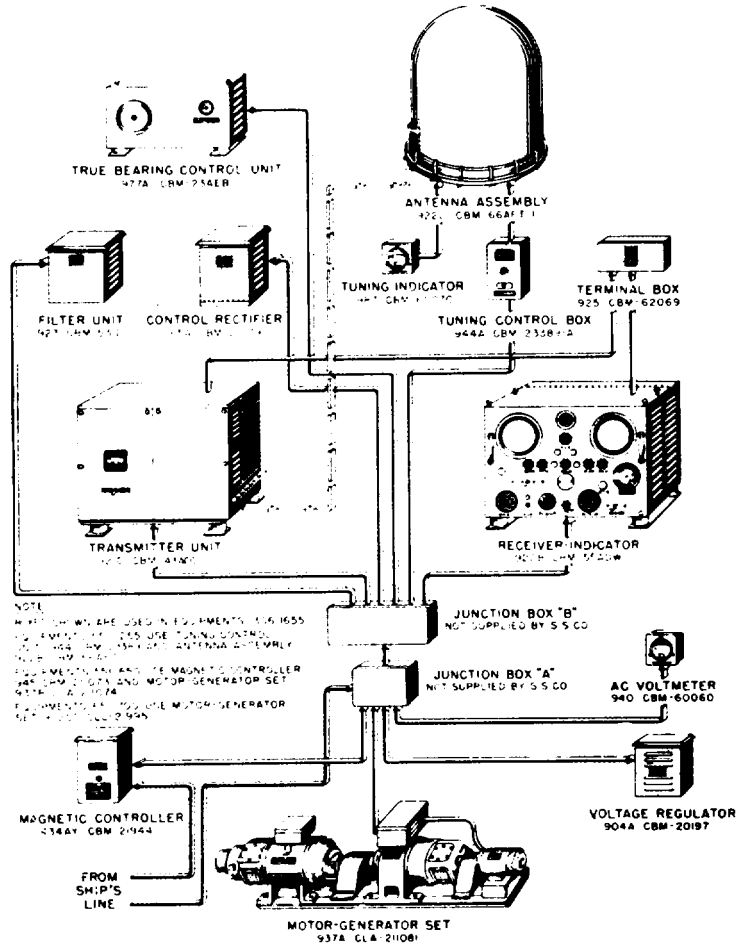

SF: 1

SF, SF-1

**FUNCTIONAL DESCRIPTION**

Radar Equipment SF and SF-1 are compact, medium-power surface search equipments installed on small vessels to detect the presence of ships and low flying aircraft.

These radars are similar except that the SF has provisions for remote PPI operation, employs a true bearing kit, magic-eye tuning, a warning light on the receiver-indicator panel, and differs slightly in circuitry

**RELATION TO SIMILAR EQUIPMENT**

None.

**TECHNICAL DESCRIPTION**

Frequency: 1550 to 5200 mc

Peak Power Output: 80 kw

Pulse Repetition Rate: 400 pps

Pulse Width: 1  $\mu$ sec

Operating Voltages and Power Requirements:  
115 vdc, 26 amp, 2.99 kw; or 440v, 60 cps,  
3-ph

Type of Presentation:

Range - 5-in. A-scope with range step; range circles plus dot on PPI; range scales, 400 yd to 8 mi and 600 yd to 24 mi

Bearing - SF-1, true and relative;  
SF, relative

Antenna Type: Dipole, parabolic reflector

**INSTALLATION CONSIDERATIONS**

Not available.

**PRINCIPAL COMPONENTS AND PHYSICAL DATA**

COMPONENT	QTY	HEIGHT (Inches)	WIDTH (Inches)	DEPTH (Inches)	UNIT WT. (Pounds)
Receiver-Indicator 55ADW	1	22-1/2	18	24-3/4	170
Transmitter 43ACC	1	24-1/2	19	21	215
Antenna Assembly 66AFT-1	1	36-1/4	30-3/4	30-3/4	140

**REFERENCE DATA AND LITERATURE**

Technical Manuals:  
SHIPS 314  
SHIPS 363

DATE: 1 July 1964

ITEM NAME: RADAR EQUIPMENT

COGNIZANT SERVICE: USN

TYPE: SG-a, -b, -c, -d, -1, -1b, -1c, -1d, -25, -2Sb

FEDERAL STOCK NUMBER: See Note 1

	USA	USN	USAF	USMC
STATUS OH TYPE CLASSIFICATION		See Note 2		
Mfg(s) Name or Code Number: Raytheon Mfg Company, Waltham, Massachusetts				

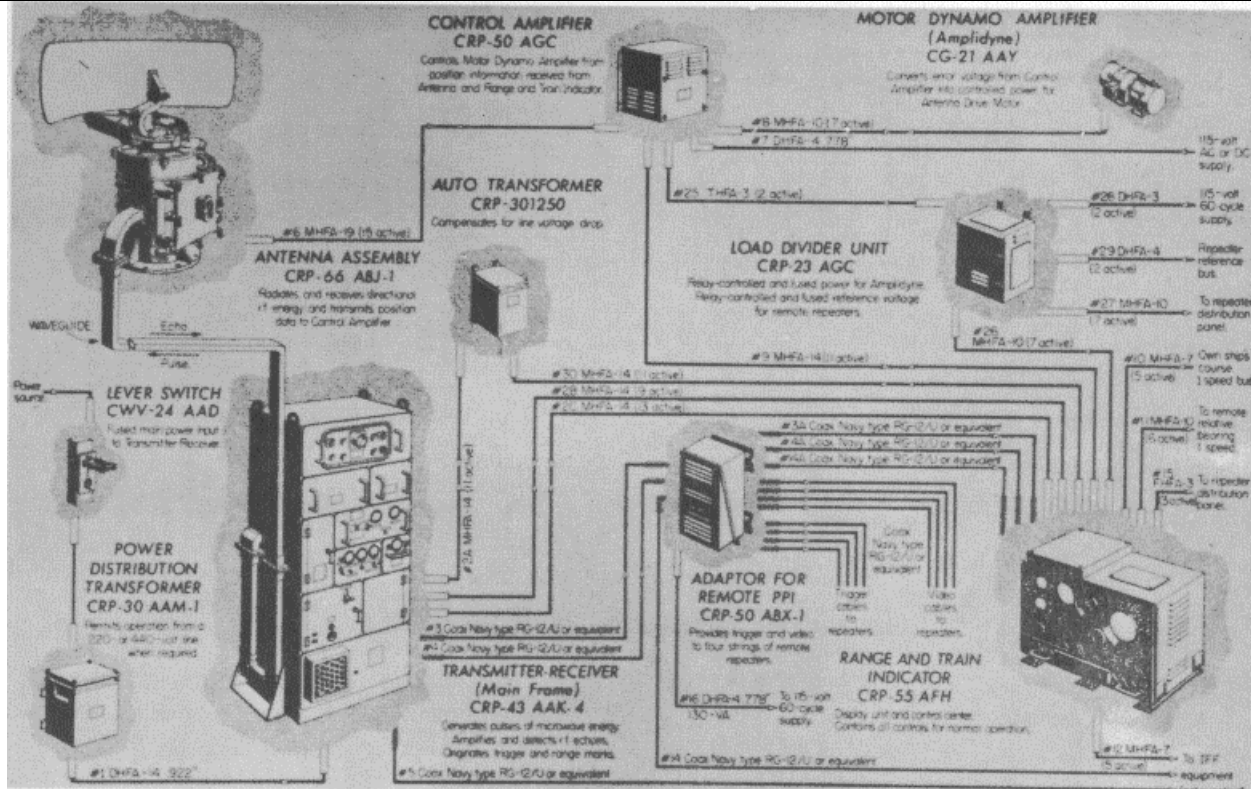

**FUNCTIONAL DESCRIPTION**

The Model SG Series Radar are medium-power pulse-modulated search equipments which continuously provide the accurate range and bearing of objects either in the air or on the surface of the water within the circular

area of search. The equipment is designed for either ship or shore installation to operate from a power source of 115 volts, 60 cycles.

Data on this sheet reflects the following Field Changes: FC-14, 23, 26, 27, 29, 30, 32 thru 48, 50, 53 thru 56, 59, 60 thru 66.

SG-a: 1

**ITEM NAME:** RADAR EQUIPMENT

**TYPE:** SG-a, -b, -c, -d, -1, -b, -1c,  
-1d, -2S, -2Sb

**RELATION TO SIMILAR EQUIPMENT**

The SG-a is the SG converted in the field and is the same electrically as the SG-1. The SG-b is the SG-a modernized by Field Change 50. The SG-c is the SG-a adapted for zenith watch per Field Change 54. The SG-d is the SG-b adapted for zenith watch per Field Change 54. The SG-1 is a production equipment and the same electrically as the SG-a. The SG-1b is the SG-1 modernized per Field Change 50. The SG-1c is the SG-1 adapted for zenith watch per Field Change 54. The SG-1d is the SG-1b adapted for zenith watch per Field Change 54. The SG-2S is similar to the SG-a and SG-1 but is designed for shore installation and includes a tower for the new type antenna. The SG-2Sb is the SG-2S modernized by Field Change 54.

Unmodernized equipments are those that have Field Changes up to and including 49 incorporated, while modernized equipments incorporate Field Change 50.

Field Change 65 to SG-b, SG-1b, SG-d, and SG-2Sb is to enable those equipments to be used with AN/UPX( ) recognition equipments.

Field Change 60 for SG-b and SG-1b equipments provides a choice of normal or MTI presentation and improves system performance by reduction of side lobes and increase of antenna gain.

**TECHNICAL DESCRIPTION**

Frequency Range: 3000 to 3100 mc  
Peak Power Output: Approx 60 kw  
Frequency Control: Self-excited oscillator.  
Emission: Pulse  
Pulse Data  
Width: 2 usec, 1 or 2 usec for equipment

converted by Field Change 62.

Repetition Rate: 750 to 850 pps (this rate changed by Field Change 27.

Type Receiver: Superheterodyne

IF: 30 mc

Bandwidth: 1.5 mc

Power Requirements: 115v plus or minus 5%, 60 cps plus or minus 2%, 1-ph, 2.8 kva or 220 or 440v ac or 7.5 kw output gasoline engine-driven alternator set.

Antenna Data

NT-66ABJ-1

Type: Parabolic

Feed: Waveguide

Beamwidth: 5 deg horizontal, 15 deg vertical at 1/2 power points.

Rotation: 8 or 16 rpm

NT-66AMS

Type: Slatted parabolic

Feed: Waveguide

Beamwidth: 2.5 deg horizontal, 5 deg vertical at 1/2 power points.

Rotation: 8 or 16 rpm

NT-66AKZ

Type: Parabolic

Feed: Waveguide

Horizontal Beamwidth: 5.5 deg

Rotation: 8 or 16 rpm

NT-66AGC

Type: Slatted parabolic

Feed: Waveguide

Beamwidth: 3 deg horizontal, 5 deg vertical.

Rotation: 2 or 4 rpm

**INSTALLATION CONSIDERATIONS**

Related Equipment:

Required but not Supplied.

(1) Load Divider NT-23AGC, (1) Auto-transformer NT-301250.

**PRINCIPAL COMPONENTS AND PHYSICAL DATA**

**SHIPPING DATA**

COMPONENT	BOXES (NR.)	OVERALL DIMENSIONS (Inches)	UNIT WT. (Pounds)
SG-1 INITIAL INSTALLATION			
Transmitter-Receiver NT-43AAK-3	1	30 x 41 x 80	1425
Antenna Pedestal for NT-66AB3-1	1	27 x 41 x 45	476
Antenna Reflector for NT-66ABJ-1	1	18 x 18 x 53	194
Control Amplifier Assy NT-50AAT-1	1	18 x 21 x 32	185
including:			
Motor-Dynamo Amplifier NT-21AAY			
Lever Switch NT-24AAD			

DATE: 1 July 1964

ITEM NAME: RADAR EQUIPMENT

COGNIZANT SERVICE: USN

TYPE: SG-3

FEDERAL STOCK NUMBER: F5840-665-3729

	USA	USN	USAF	USMC
STATUS OR TYPE CLASSIFICATION		Obsoles		
Mfg(s) Name or Code Number: Raytheon Mfg. Co.				

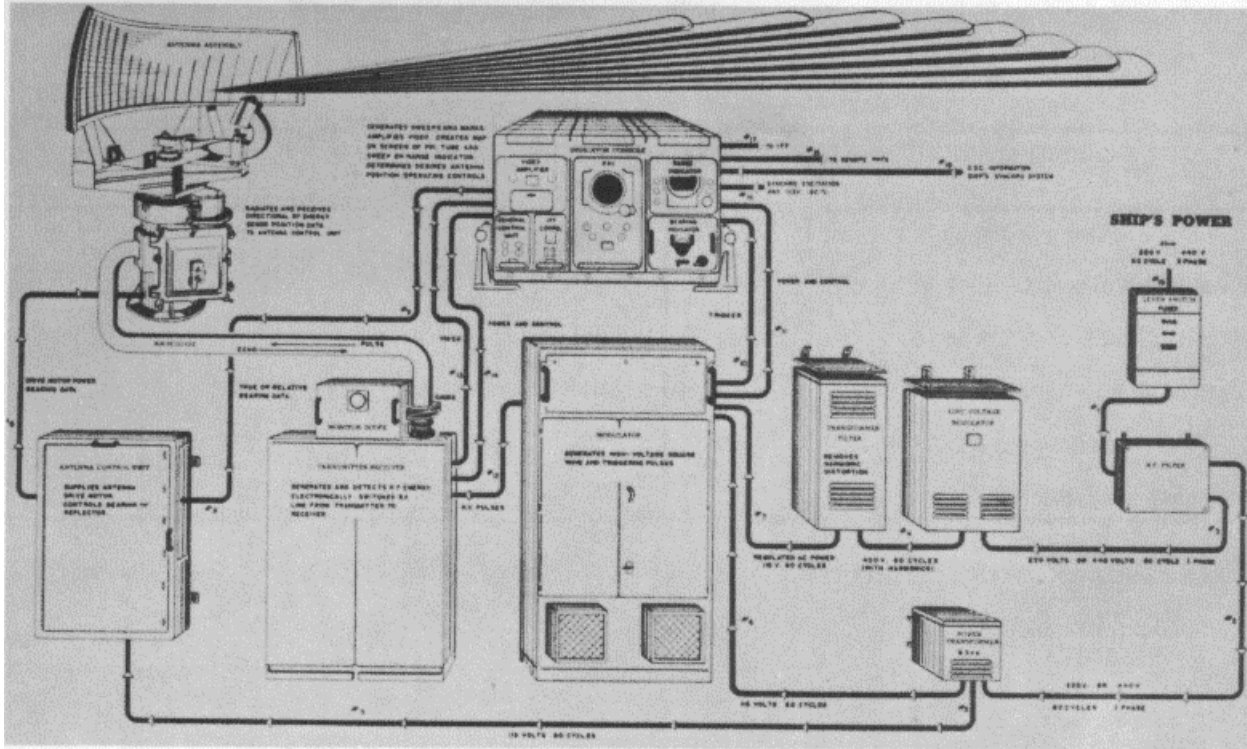

**FUNCTIONAL DESCRIPTION**

Radar Equipment SG-3 is a high-power surfacescanning equipment designed for installation on vessels having a 220or 440-volt, 60 cycle, three phase power supply and a 1- and 36-speed synchro system.

Targets on or near the surface of the water are presented on the screens of a range scope and a PPI. The SG-3 provides anti-jam features, automatic tuning of the local oscillator in the receiver, and a large antenna reflector.

**RELATION TO SIMILAR EQUIPMENT**

The SG-3 is similar to the SG-4, differing only in the antenna used.

**TECHNICAL DESCRIPTION**

Frequency: 3400 to 3700 mc  
Peak Power Output: 300 to 500 kw (approx)  
Pulse Repetition Rate: 750 pps  
Pulse Width: 0.33 or 1.25 µsec

SG-3: 1



**SG-3**

IF. Frequency: 30 mc  
 IF. Bandwidth: 5.5 mc  
 Video Bandwidth: 5 mc  
 Receiver Gain: 120 db  
 Operating Voltages and Power Requirements:  
 220 or 440v, 60 cps, 3-ph, 4 kva, 85% pf  
 Type of Presentation:  
 Range - 5-in. CRT (A-scope)  
 PPI - 7-in. CRT  
 Range Scales: 4, 10, 20, and 80 mi  
 Range Resolution: 200 yd  
 Azimuth Resolution: 2 deg  
 Range Accuracy: +100 yd  
 Azimuth Accuracy: +0.75 deg  
 Reflector Type: Parabolic  
 Antenna Feed: Waveguide

Vertical Beam Width: 10 deg  
 Horizontal Beam Width: 3 deg  
 Polarization: Horizontal  
 Antenna Gain: 30 db  
 Antenna Rotation:  
 360 deg at 2.5 or 5 rpm or manual

**INSTALLATION CONSIDERATIONS**

Siting: Siting of components is dependent upon the Naval craft in which the equipment is installed.  
 Mounting: Components are deck or bulkhead mounted, as appropriate.  
 Cabling Requirements:  
 Related Equipment:

**PRINCIPAL COMPONENTS AND PHYSICAL DATA**

<b>COMPONENT</b>	<b>QTY</b>	<b>HEIGHT (Inches)</b>	<b>WIDTH (Inches)</b>	<b>DEPTH (Inches)</b>	<b>UNIT WT. (Pounds)</b>
Antenna Assembly NT-66AJP	1	67	86	86	469
Antenna Control Unit NT-23AFX	1	41	16	28	350
Indicator Console NT-55AGF	1	49	29	38	958
Modulator NT-50AFN	1	68	20	35	1237
Power Transformer NT-301454	1	13	11	12	90
Transmitter-Receiver NT-43ADA	1	59	20	39	675

**REFERENCE DATA AND LITERATURE**

Technical Manual:  
 SHIPS 367A

ITEM NAME: RADAR EQUIPMENT

TYPE: SG-a, -b, -c, -d, -1, -1b, -1c,  
-1d, -2S, -2Sb

PRINCIPAL COMPONENTS AND PHYSICAL DATA  
SHIPPING DATA (Cont.)

COMPONENT	BOXES (NR.)	OVERALL DIMENSIONS (Inches)	UNIT WT. (Pounds)
Range & Train Indicator NT-55ABC-3	1	30 x 34 x 48	659
Adaptor for Remote PPI NT-50ABX	1	16-1/4 x 19-1/2 x 29-1/2	133
Set of Tubes & Misc Equipment Parts	1	24 x 24 x 36	93
Waveguide Elbows	1	13 x 18 x 29	93
Waveguide Sections	1	10 x 12 x 168	359
Waveguide Flanges	1	14 x 15 x 19	75
Waveguide Hardware	1	9 x 11 x 22	44
Power Distribution Transformer NT-30AAM-1	1	14 x 17 x 21	182
Equipment Spares	1	14-1/2 x 28 x 36-1/4	323
Equipment Spares	1	14-1/2 x 28 x 36-1/4	385
Equipment Spares Tubes	1	24 x 24 x 36	80
Equipment Spares Tubes	1	20 x 20 x 24	39
SG-1b INITIAL INSTALLATION			
Transmitter-Receiver NT-43AAK-4	1	31 x 42 x 81	1650
Antenna Pedestal for NT-66AB3-1	1	28 x 42 x 45	476
Antenna Reflector for NT-66ABJ-1	1	18 x 18 x 53	176
Control Amplifier Assy NT-50AAT-1 incl:	1	15 x 21 x 31	137
Lever Switch NT-24AAD			
Motor-Dynamo Amplifier NT-21AAY	1	15 x 21 x 31	125
Range & Train Indicator NT-55AFH	1	33 x 35 x 47	780
Adaptor for Remote PPI NT-50ABX-1	1	15 x 21 x 31	140
Set of Tubes & Misc Equipment Parts	1	26 x 27 x 31	147
Waveguide Elbows	1	13 x 18 x 29	93
Waveguide Sections	1	10 x 12 x 168	359
Waveguide Flanges	1	14 x 15 x 19	75
Waveguide Hardware	1	9 x 11 x 22	44
Power Distribution Transformer NT-30AAM	1	14 x 17 x 21	182
Equipment Spares	1	14-1/4 x 18-1/2 x 29-1/2	152
Equipment Spares	2	14-1/4 x 18-1/2 x 29-1/2	134
Equipment Spares	1	14-1/4 x 18-1/2 x 29-1/2	127

SG-a: 3

ITEM NAME: RADAR EQUIPMENT

TYPE: SG-a, -b, -c, -d, -1, -1b, -1c,  
-1d, -2S, -2Sb

PRINCIPAL COMPONENTS AND PHYSICAL DATA  
SHIPPING DATA (Cont.)

COMPONENT	BOXES (NR.)	OVERALL DIMENSIONS (Inches)	UNIT WT. (Pounds)
Equipment Spares	1	14-1/4 x 18-1/2 x 29-1/2	150
Equipment Spares	1	14-1/4 x 18-1/2 x 29-1/2	173
Equipment Spares	1	14-1/4 x 18-1/2 x 29-1/2	163
Equipment Spares	1	14-1/4 x 18-1/2 x 29-1/2	162
Antenna Drive Motor with Gear Assy	1	15-1/2 x 20-1/4 x 23-1/2	72
Equipment Spares Tubes	1	24 x 24 x 36	111
Equipment Spares Tubes SG-2S and SG-2Sb	1	24 x 24 x 36	91
Transmitter-Receiver NT-44AAK-3	1	30 x 41 x 80	1425
Antenna Pedestal for NT-66AGC	1	27 x 41 x 45	494
Antenna Reflector for NT-66AGC	1	48 x 73 x 90	800
Control Amplifier NT-5OAT-1 incl: Motor-Dynamo Amplifier NT-21AAV	1		
Range & Train Indicator NT-55ADY	1	30 x 34 x 48	659
Set of Tubes & Misc RF Parts	1	24 x 24 x 36	113
Equipment Spares	1	14 x 28 x 36	299
Equipment Spares	1	14 x 2B x 36	298
Equipment Spares	1	14 x 28 x 36	352
Equipment Spares	1	14 x 28 x 36	273
Equipment Spares Tubes	2	24 x 24 x 36	100
Equipment Spares Tubes	1	24 x 24 x 36	35
Waveguide Sections	4	11 x 16 x 155	320
Waveguide Bends & Flanges	1	11 x 11 x 70	375
Gin Pole	1		173
Set of Tools	1	15 x 20 x 40	171
Paint & Thinner	1	13 x 15 x 20	90
Hoisting Equipment	1	17 x 27 x 39	337
Cable, Cable Clamps, Lugs	1	28 x 28 x 31	379
Antenna Cable	1		760
Antenna Tower NT-66AFO	12		6364

SG-a: 4

ITEM NAME: RADAR EQUIPMENT

TYPE: SG-a, -b, -c, -d, -1, -1b, -1c,  
-1d, -2S, -2Sb

PRINCIPAL COMPONENTS AND PHYSICAL DATA  
SHIPPING DATA (Cont.)

COMPONENT	BOXES (NR.)	OVERALL DIMENSIONS (Inches)	UNIT WT. (Pounds)
Antenna Tower NT-10239	24		6100
Antenna Tower NT-10247	53		14,153
Antenna Tower NT-10253	37		14,757
Gasoline Engine-Driven Alternator Set FIELD CHANGE 60 UNITS	1		
Canceller NT-50A3T	1	19 x 23 x 57	210
Rectifier Power Unit NT-2OAFG	1	18 x 18 x 28	86
Rectifier Power Unit NT-20AFH	1	18 x 18 x 28	86
Radar Receiver NT-46AES incl: Coherent Oscillator NT-35ACN	1	18 x 31 x 34	85
Replacement Antenna Sub-Kits, Mounting	1	17 x 19 x 29	95
Interconnecting & Misc Material	1		
Equipment Spares	1	14-1/4 x 18 x 29-1/2	156
Equipment Spares	1	22 x 23-1/2 x 29-1/2	76

EQUIPMENT SUPPLIED DATA

COMPONENT	BOXES (NR.)	OVERALL DIMENSIONS (Inches)	UNIT WT. (Pounds)
SG SERIES			
Lever Switch NT-24AAD	1	4 x 5 x 15	2
Adaptor for Remote PPI NT-50ABX or NT-50ABX-1	1	11 x 15 x 20	94
Motor-Dynamo Amplifier NT-21AAY	1	8 x 9 x 16	50
Control Amplifier Assy NT-50AAT-1 or NT-50AGC	1	11 x 15 x 16	61
Radar Transmitter-Receiver NT-43AAK-3 or NT-43AAK-4	1	22 x 34 x 71	1425
Range & Train Indicator NT-55ABC-3 or NT-55AFH	1	22 x 25 x 39	480
Load Divider NT-23AGC	*1	10 x 15 x 19	55
Autotransformer NT-301250	*1	8 x 10 x 14	36
Power Distribution Transformer NT-30AAM-1	1	10 x 13 x 15	165

SG-a: 5

ITEM NAME: RADAR EQUIPMENT

TYPE: SG-a, -b, -c, -d, -1, -1b, -1c,  
-1d, -25, -2Sb

PRINCIPAL COMPONENTS AND PHYSICAL DATA

EQUIPMENT SUPPLIED DATA (Cont.)

COMPONENT	QTY	OVERALL DIMENSIONS (Inches)	UNIT WT. (Pounds)
Antenna Assy consisting of:	**1		
Antenna Pedestal		18 x 25 x 29	302
Surface Search Reflector NT-66ABJ-1		15 dia x 49-1/2	144
or			
Zenith Watch Reflector NT-66AKZ		55 x 57 dia	137
or			
Reflector NT-66AMS		29 dia x 66	40
SG-2S or SG-2Sb ONLY			
Transmitter-Receiver NT-44AAK-3	1	20 x 32 x 74	1180
Antenna Assy NT-66AGC	1		670
Control Amplifier NT-50AAT-1	1	11 x 14 x 16	61
Motor-Dynamo Amplifier NT-21AAY	1	6 x 8 x 16	50
Range & Train Indicator NT-55ADY	1	22 x 28 x 39	481
Antenna Tower NT-66AFO or	1		5247
NT-10239 or			5866
NT-10247 or			13,719
NT-10253			14,548
Set of Tubes & Misc RF Parts	1		69
Set of Equipment Spares	1		1172
Set of Waveguide Sections	1		845
Set of Accessories	1		1173
Gasoline Engine-Driven Alternator Set	†1		
FIELD CHANGE 60 UNITS			
Canceller NT-55AJT	1	10-3/16 x 15-15/16 x 48-7/8	115
Rectifier Power Unit NT-20AFG	1	10-1/4 x 11 x 21-13/32	43
Rectifier Power Unit NT-20AFH	1	10-1/4 x 11 x 21-13/32	42
Remote Switch Box NT-241115	1	2-25/32 x 3 x 5-1/4	1.5
Radar Receiver NT-46AES incl:	1	9 x 19-9/16 x 22-5/8	60
Coherent Oscillator NT-35ACN			

**NOTE: \*Not shipped with equipment. Added in conformity  
with Field Changes 47 and/or 48.**

**\*\*Antenna Assy Designator determined by reflector used.**

**Model No. after reflector is for complete Antenna Assy.**

**†Required for some installations.**

**This page only for NON-SOFTWARE-related TM errors/improvements.**

RECOMMENDED CHANGES TO EQUIPMENT TECHNICAL PUBLICATIONS



THEN...JOT DOWN THE DOPE ABOUT IT ON THIS FORM. CAREFULLY TEAR IT OUT. FOLD IT AND DROP IT IN THE MAIL.

**SOMETHING WRONG** WITH THIS PUBLICATION?

FROM: (PRINT YOUR UNIT'S COMPLETE ADDRESS)

DATE SENT

PUBLICATION NUMBER

PUBLICATION DATE

PUBLICATION TITLE

BE EXACT PIN-POINT WHERE IT IS

PAGE NO.

PARA-GRAPH

FIGURE NO.

TABLE NO.

IN THIS SPACE TELL WHAT IS WRONG AND WHAT SHOULD BE DONE ABOUT IT:

TEAR ALONG PERFORATED LINE

PRINTED NAME GRADE OR TITLE AND TELEPHONE NUMBER

SIGN HERE

DA FORM 1 JUL 79 2028-2

PREVIOUS EDITIONS ARE OBSOLETE

P.S.—IF YOUR OUTFIT WANTS TO KNOW ABOUT YOUR RECOMMENDATION MAKE A CARBON COPY OF THIS AND GIVE IT TO YOUR HEADQUARTERS







This fine document...

Was brought to you by me:



## [Liberated Manuals -- free army and government manuals](#)

Why do I do it? I am tired of sleazy CD-ROM sellers, who take publicly available information, slap “watermarks” and other junk on it, and sell it. Those masters of search engine manipulation make sure that their sites that sell free information, come up first in search engines. They did not create it... They did not even scan it... Why should they get your money? Why are not letting you give those free manuals to your friends?

I am setting this document FREE. This document was made by the US Government and is NOT protected by Copyright. Feel free to share, republish, sell and so on.

I am not asking you for donations, fees or handouts. If you can, please provide a link to [liberatedmanuals.com](http://liberatedmanuals.com), so that free manuals come up first in search engines:

<A HREF=<http://www.liberatedmanuals.com/>>Free Military and Government Manuals</A>

– Sincerely  
Igor Chudov  
<http://igor.chudov.com/>