

Everan
FOR OFFICIAL USE ONLY

**ELEMENTARY PRINCIPLES
OF
RADIO TELEGRAPHY
AND TELEPHONY**

**Radio Pamphlet
No. 1**

**Signal Corps, U. S. Army
6-30-18**

3

ERRATA

Radio Pamphlet No. 1.

Page 5, just below
equation should read:

" The self-inductance of a circuit, therefore, is the ... etc."

Page 15, line 13
"aa" should be a/a' .

Page 28, Paragraph 2, Line 9
"current" should read "omf"

Y

io
d.
e-
re

It is expected that the officers and non-commissioned officers better qualified to understand the theory involved in radio will explain the contents of this pamphlet to the enlisted personnel with some knowledge of the work, by enlarging upon the points presented and by giving analogs and in general by going over the pamphlet by sentence, with these men and fully explaining each step and all questions.

ELEMENTARY PRINCIPLES OF RADIO TELEGRAPHY AND TELEPHONY

The Underlying Electrical Theory Involved in Radio Communication Work is Simply and Briefly Covered. The More Common Means of Transmitting and Receiving Radio Employed for Military Purposes are Analyzed in Terms Comprehensible to the Non-Technically Educated but Technically Inclined Personnel.

It is expected that the officers and non-commissioned officers who are better qualified to understand the theory involved in radio work, will explain the contents of this pamphlet to the enlisted personnel who must have some knowledge of the work, by enlarging upon the points presented herein and by giving analogs and in general by going over the pamphlet, sentence by sentence, with these men and fully explaining each step and answering all questions.

PART 1

	Page
CHAPTER I.—THE THEORY UNDERLYING THE RADIO	
SYSTEM OF COMMUNICATION.....	3
General Survey of the Field of Radio Communication...	3
The Electrical Units Pertinent to Radio.....	5
Definitions of Electrical Units.....	6
Three Systems of Units—Table for Changing from One to Another.....	7
Electromagnetic Induction.....	8
The Alternator.....	8
The Inductor Type Alternator.....	10
The Induction Coil.....	10
The Transformer.....	12
Oscillatory Discharge of a Condenser.....	12
Phenomena of Resonance.....	15
Propagation of Electric Waves.....	17
CHAPTER II.—DAMPED WAVE RADIO TELEGRAPHY.....	19
Principles of Transmission.....	19
Types and Characteristics of Antennae.....	20
Transmission by Direct Excitation.....	22
Transmission by Indirect Excitation.....	24
Principles of Reception.....	28
Tuning of Oscillatory Circuits.....	31
Coupling of Oscillatory Circuits.....	31
Sources of Trouble in Reception.....	31
Influence of Topography on Reception.....	32

PART 2

CHAPTER I.—UNDAMPED WAVE RADIO TELEGRAPHY.....	33
Vacuum Tubes in Radio Communication Work.....	33
Electron Flow in Vacuum Tubes.....	34
Operation of Two-Electrode Tubes Under Various Conditions	35
Characteristics of the Three-Electrode Vacuum Tube	36
Detector Action of Vacuum Tubes.....	38
Amplifier Action of Vacuum Tubes.....	40
Oscillator Action of Vacuum Tubes—Undamped Wave Transmission.....	41
Three-Electrode Tubes used by the United States Signal Corps.....	43
Reception of Undamped Waves.....	44
CHAPTER II.—RADIO TELEPHONY.....	46
Modulator Action of Vacuum Tubes.....	46
Radio Telephone Transmission.....	46
Radio Telephone Reception.....	46

PART 1.

CHAPTER I.

THE THEORY UNDERLYING THE RADIO SYSTEM OF COMMUNICATION

General Survey of the Field of Radio Communication

VERY soon after wire telegraphy became of practical usefulness, conditions were encountered in which the desirability of effecting electrical signaling without connecting wires became apparent. As a result of this need, a number of methods of telegraphing without wires were tried out, based on schemes of utilizing the conduction through the ground, magnetic induction, etc., as the means of sending the signals. All of these methods, however, were very limited as to range of transmission and were therefore of little importance and value as a system of communication.

Radio telegraphy, or the transmission of signals by means of unguided electric waves, was first introduced in 1896 by Marconi, after extensive experiments made by himself and with the help of the discoveries and research work of Hertz and others. In 1899 communication was established between Dover and Boulogne, a distance of 32 miles, and shortly after, information between ships was transmitted as far as 80 miles. The importance of radio communication was by that time universally admitted, and from this it has constantly grown and extended its field to commercial, naval and military pursuits. From these early stages, the art has rapidly progressed until in 1916, Arlington Station could hear Japan working with Honolulu, the distance involved being approximately one half the circumference of the earth.

The application of radio to military uses is the one to which this pamphlet is particularly devoted. In this application, its development has likewise been extremely rapid, and at the present time one of the most important means of communication between armies and units is by means of the unguided radio waves, this assuming greater importance as the intensity of destructive shell fire and hence the difficulty of maintaining wire communications increases.

An entire system of radio communication has been established to supplement the wire system for the forwarding of information between the various headquarters of the armies, divisions, brigades and even to and from the front line trenches. In an attack, when the infantry moves forward, one of the most difficult tasks is to maintain communication with headquarters. A certain element of time is involved in carrying forward wire communication systems and they are continually broken down by shell fire. The radio and ground telegraph apparatus, however, are much more simply carried forward and are usually operative unless destroyed by an almost direct hit. Of course, there are many times when the interference of the enemy and other of our own radio sets is so great as to make receiving of signals extremely difficult and at nearly all times the operator must be able to pick out his own signals from a number heard simultaneously.

Another system of radio communication is in existence between airplanes and artillery. This is called the fire-control system and it is perhaps the most extensive and complex of all the radio organizations in operation at the front. The firing of each battery of light, medium, heavy and superheavy artillery is directed to greater or less degree by radio signals sent out from airplanes flying over enemy positions, particularly that of the last three named. This work is extremely important, and the number of airplanes used for the purpose is large. Great as is the value of the airplanes in extending the range of vision of the army, yet their effectiveness in directing artillery fire onto enemy targets is only made possible by the instantaneous means of communication between plane and battery afforded by the radio apparatus. In the early days of the war, even this scheme of communication was so slow, due to the cumbersome signals and natural sluggishness and difficulties incurred in developing and perfecting the practice, that the batteries were not kept busy enough to hold the interest of the men. The intervals between firing and receiving a range correction from the airplanes were so long that not much confidence was had in this method of directing fire. However, the signal system has been greatly simplified and otherwise improved, so that it is now very effective in directing suitable battery fire on enemy gun positions and movements in such a manner as to frequently effectively silence the guns or destroy supply trains, etc.

Radio is also effectively used on reconnaissance and bomb-

ing airplanes, which sometimes are equipped with high power, long range sets. The radio telephone has found some use on battle planes and fighting machines, although this means of communication has not been extensively used up to the present time. It is now undergoing an intensive development and may come in for a more important part in the airplane and other radio work later on.

Not the least important use of the radio apparatus in military operations is that which the alert operator makes of it as a means of anticipating destructive shell fire on his own battery position. It frequently happens that he will hear a hostile plane sending down to the enemy batteries, the map co-ordinates of his position. He will then warn the battery commander not to fire for a period, as this would further prove the position to the hostile aircraft. Or the operator may hear a shell burst at not great distance from his battery position and then hear the hostile plane send down a correction which denotes to the operator that his battery is the target at which the enemy is firing. A timely warning made to the battery commander under these circumstances has saved the lives of many artillery men.

The Electrical Units Pertinent to Radio

Self and Mutual Inductance.--When an electric current is made to flow through a circuit, a magnetic field is established in the space surrounding it. The strength of this field at any given point is proportional to the current flowing in the circuit, and is dependent on the shape of the circuit and on the nature of the medium surrounding it. The value of the ratio of the field flux to the current in a given circuit is called its self-inductance (also called coefficient of self induction). Thus,

$$\text{Self Inductance} = \frac{\text{Electromagnetic Flux}}{\text{Current}}$$

The unit of self inductance, therefore, is the electromagnetic flux around the circuit when unit current is flowing through it.

If unit current is made to flow through one of two independent circuits A and B, (A for instance), the magnetic field due to that current extends around both circuits A and B, if they are near enough together. That part of the flux due to A which interlinks with circuit B is called the mutual inductance of circuit A upon circuit B. This depends on the shape of each of the two circuits and on their relative positions. Their

mutual inductance is therefore greatest when the two circuits are closest together. Whenever a circuit reacts upon another, the two circuits are said to be coupled, the coupling being close or loose according to whether the mutual inductance is large or small.

As the magnetic field builds up around a wire carrying a current, it is possible to obtain a large inductance by winding the wire into a coil so that many turns will be concentrated in small space. By this means, a considerable flux may be produced through the summation of the fluxes due to each turn.

Capacitance.—If an insulated conductor is placed near a grounded conductor, and a charge is given to the former, its potential is found to be proportional to that charge. The value of the ratio of the charge to the potential of the conductor has been called the capacitance (electrostatic capacity) of that conductor. Thus,

$$\text{Capacitance} = \frac{\text{Electrostatic Charge}}{\text{Potential}}$$

A large capacitance may be obtained by placing two sheets of metal very close to each other and insulating them by means of some dielectric (air, mica, glass, etc.). Such a device is called a condenser. Condensers of large capacitance are built by combining a large number of sheets of metal foil separated by glass plates or sheets of mica. All even and all odd numbered sheets are connected together, respectively, each group forming one side of the condenser. The capacitance of a condenser is directly proportional to the area of the plates and inversely proportional to the distance between them.

Condensers of adjustable capacitance are also used. Several semi-circular metal plates are placed parallel and one above the other, and connected by means of metal rods extending through the plates at the two ends of the straight side, and held apart by blocks or washers, the whole group of plates making up one side of the condenser. The other side is made up of a set of similar plates having a semi-circular shape and mounted on a shaft at their centers. By rotating the shaft, the plates move in or out between the stationary plates, and the capacitance of the condenser can thus be continuously varied.

Definitions of Units

Resistance.—The unit of resistance is the international ohm.

It is the resistance of a column of mercury 106.3 cm. high, and weighing 14.4521 grams at a temperature of 0 deg. C.

Current.—The unit of current is the international ampere. It is that unvarying current which, when passed through a neutral solution of silver nitrate, will deposit silver at the rate of .001118 gram per second.

Electromotive Force.—The unit of electromotive force is the international volt. It is the electromotive force which will cause one international ampere to flow through one international ohm.

Inductance.—The unit of inductance or of the coefficient of self-induction is the henry. It is the inductance of a circuit in which a current varying at the uniform rate of one ampere per second will induce an electromotive force of one international volt.

Capacitance.—The unit of capacitance is the farad. It is the capacitance of a condenser, such that a potential of one volt will cause the condenser to store a charge of one coulomb. (A coulomb is the quantity of electricity transported by a current of one ampere flowing for one second).

Three Systems of Units

There are three systems of units commonly used in practice. These are the electrostatic, the electromagnetic and the practical units. A table is given below for changing these units from one system to another.

CAPACITANCE.					
Electrostatic Units (cms.).		Electromagnetic Units (no name).		Practical Units (mfd.).	
To Magnetic.	To Practical.	To Static.	To Practical.	To Static.	To Magnetic.
Divide by 9×10^{20}	Divide by 9×10^9	Multiply by 9×10^{20}	Multiply by 10^{15}	Multiply by 9×10^6	Divide by 10^{15}

INDUCTANCE.					
Electrostatic Units (no name).		Electromagnetic Units (cms.).		Practical Units (henrys).	
To Magnetic.	To Practical.	To Static.	To Practical.	To Static.	To Magnetic.
Multiply by 9×10^{20}	Multiply by 9×10^{11}	Divide by 9×10^{20}	Divide by 10^9	Divide by 9×10^{11}	Multiply by 10^9

CURRENT.

Electrostatic Units (no name).		Electromagnetic Units (no name).		Practical Units (amperes).	
To Magnetic	To Practical.	To Static.	To Practical.	To Static.	To Magnetic.
Divide by 3×10^{10}	Divide by 3×10^9	Multiply by 3×10^{10}	Multiply by 10	Multiply by 3×10^9	Divide by 10

POTENTIAL.

Electrostatic Units (no name).		Electromagnetic Units (no name).		Practical Units (volts).	
To Magnetic.	To Practical.	To Static.	To Practical.	To Static.	To Magnetic.
Multiply by 3×10^{10}	Multiply by 300	Divide by 3×10^{10}	Divide by 10^9	Divide by 300	Multiply by 10^9

RESISTANCE.

Electrostatic Units (no name).		Electromagnetic Units (no name).		Practical Units (ohms).	
To Magnetic.	To Practical.	To Static.	To Practical.	To Static.	To Magnetic.
Multiply by 9×10^{20}	Multiply by 9×10^{11}	Divide by 9×10^{20}	Divide by 10^9	Divide by 9×10^{11}	Multiply by 10^9

It will be noted that in many cases the units have received no name in some of the systems in which they are expressed, so that the name of the system must be given. Thus a current of 1 amp. is a current of 3,000,000,000 units of current in the electrostatic system, or 3,000,000,000 electrostatic units of current.

Electromagnetic Induction

When a conductor is moved across a magnetic field so that it cuts lines of force, an emf. is generated in the conductor. If the conductor is part of a closed circuit, a current will flow in it due to this induced emf. As this induction effect is due to the cutting of lines of force by the conductor, it will be greatest at the instant of the highest rate of cutting the magnetic lines of force (greatest number of lines cut per second). This phenomenon has many practical applications, some of which are studied below.

Alternator.—Consider a loop of wire closed on an ammeter,

and placed near a permanent bar magnet, Fig. 1. If either the magnet or the loop is moved, a current will be observed through the ammeter, the direction of the current depending upon the direction of motion and the polarity of the magnetic pole. If then the loop is held stationary and the magnet rotated around its axis *aa*, the direction of the magnetic field through the loop will be alternately in opposite directions, and an alternating current will be generated in the stationary loop circuit.

As the current is a maximum when the number of magnetic lines of force cutting the wire per unit of time is greatest, this

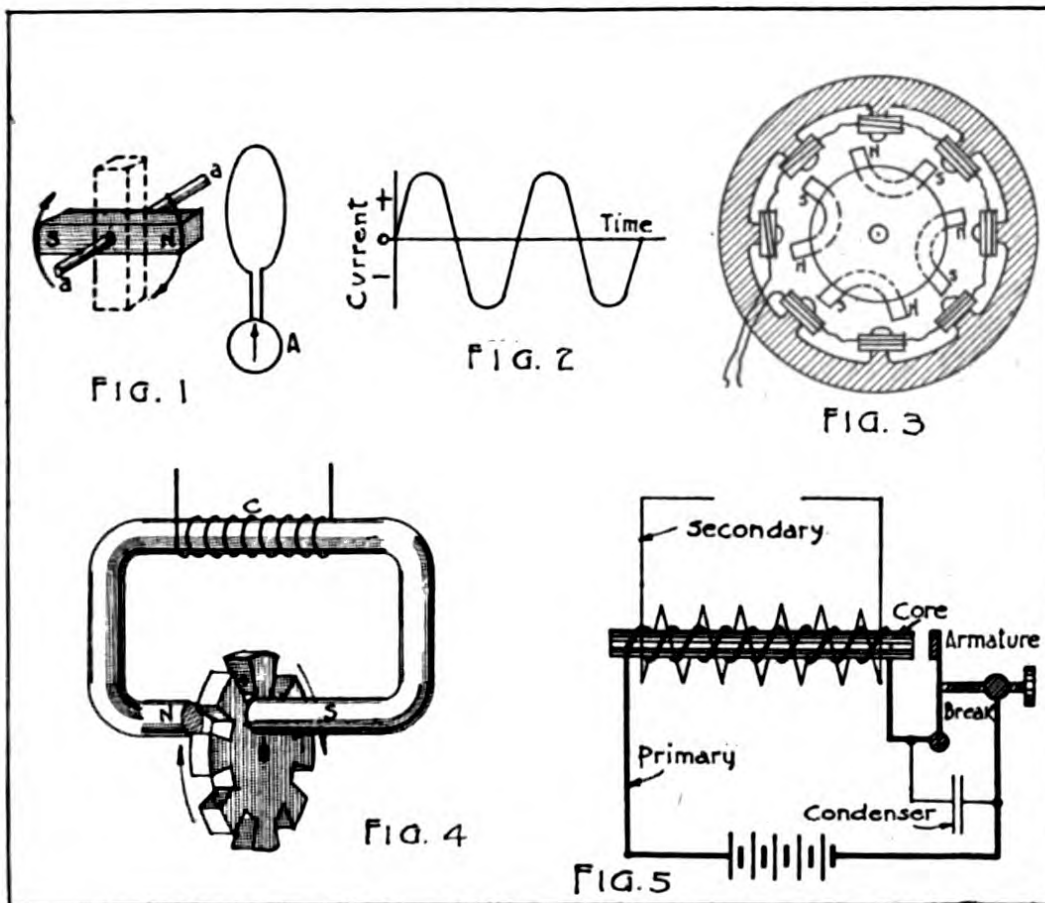

will occur when the magnetic pole passes directly in front of the loop. The current then decreases as the magnet pole is moved away, becomes zero for the position of the magnet shown in dotted lines, and increases again, but in the other direction, as the other pole of the magnet revolves toward the loop. The duration of one complete cycle, that is, of one complete revolution of the magnet, is called the "period" of the alternating current. The number of periods per second is called the "frequency."

A graphical representation of an alternating current may be

obtained by plotting off the value of the current at each instant, time being counted on one axis, and current on the other. This produces what is known as a "sine" curve, as shown in Fig. 2. In order to obtain currents of higher frequency, it is simply necessary to rotate the magnet at a higher speed, or to use a number of magnets mounted on a frame locked to the shaft, Fig. 3. Also, rotating the magnet, Fig. 1, at higher speed, or increasing the number of magnetic fields cut through per revolution, Fig. 3, increases the rate of cutting the lines of force and therefore produces higher voltage.

The permanent magnets may be replaced by electromagnets energized by a direct current derived from an auxiliary dynamo called an exciter, or from a battery. The field magnets, either permanent or electromagnets, may be stationary and the alternating current winding rotary.

The rotating portion of an alternating current generator is called the "rotor" and the stationary portion, the "stator." The more common construction is to make the field windings (d. c.) rotary.

Inductor Type Alternator.—Another method of producing an alternating current is to wind a coil of wire C, Fig. 4, around a magnet of special shape, the two poles of which face each other and are separated by an air gap. A toothed iron disk is then made to rotate between the jaws of the magnet, so that the gap between the poles is alternately open and then practically closed with iron. The result is that the flux between the two poles, and hence the magnetic flux in the entire magnet, alternately increases and decreases. This periodically varies the number of magnetic lines of force inside the coil C where an alternating emf. is thus generated. This type of generator is called an "inductor type alternator." It is quite widely used in supplying high frequency current to airplane radio apparatus. Instead of using a permanent magnet, it is of course possible to use an electromagnet energized by a direct current derived either from a storage battery or from a separate exciter dynamo.

Induction Coil.—Another form of electromagnetic induction is that involved in the operation of the ordinary induction coil, Fig. 5. This consists essentially of an iron core on which are wound two coils of wire. These are called the primary and secondary windings and the latter usually has a much larger number of turns of wire than the primary coil. Inserted in the circuit of the primary coil is a vibrator which, upon closing the circuit through the primary coil, is attracted toward the iron

core of the coil, opening the circuit. It is then immediately released by the demagnetized coil and it returns to its former position to again close the circuit, the operation being very similar to that of the ordinary buzzer. The vibrator thus serves to very rapidly make and break the circuit through the primary coil.

In the induction coil method of producing current by induction, the coils remain stationary, but the function of the vibrator in alternately making and breaking the circuit through the primary, is to produce a rapid change in the number of lines of force resulting from the current in the primary coil. These lines of force also penetrate and surround the secondary coil and induce in it an emf. corresponding in magnitude to the rate of change of the number of lines of force produced by the primary coil. When the circuit of the primary coil is closed, the magnetic field rapidly builds up but is retarded from reaching its maximum value by the counter emf. due to the self-inductance of the primary coil. As this field increases, it induces an emf. in the secondary coil of higher voltage and in the opposite direction than that in the primary. When the current in the primary has reached a certain value, the field becomes strong enough so that the vibrator armature is attracted toward the core, suddenly opening the primary circuit. This is followed by a rapid decrease in the number of lines of force cutting the secondary circuit, this change inducing an emf. of opposite polarity to the first, in the secondary coil. It is important to note that the opening of the primary circuit by the vibrator introduces a condenser in the primary circuit which serves the purpose of causing the primary current to fall to zero value with great rapidity. This is accompanied by a correspondingly high rate of decrease in the magnetic field, with the result that a very much higher emf. is generated in the secondary coil upon opening the primary circuit than upon closing it. This is clearly illus-

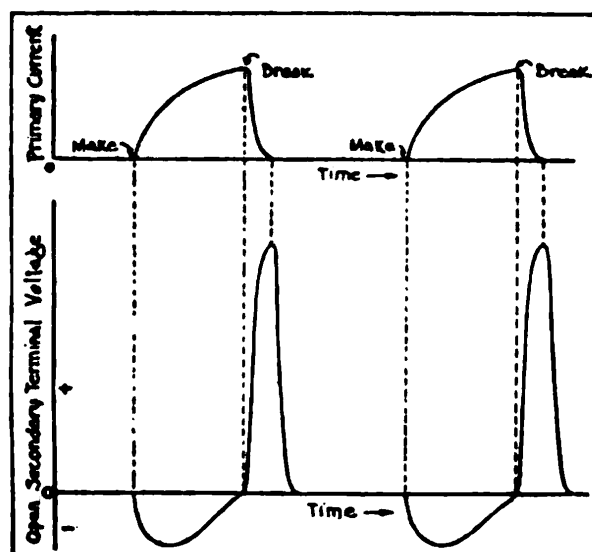

Fig. 6—Current and Voltage Relations in Primary and Secondary of an Induction Coil.

trated by the curves of Fig. 6 where primary current and secondary voltage are plotted against time.

Transformer.—The operation of the alternating current transformer is based on a very similar principle to that of the induction coil. The principal difference between the two is that an alternating current is fed into the primary winding of the transformer instead of a direct current, as in the induction coil, which is broken up by the vibrator to produce a pulsating current.

The current in the primary of the transformer is then periodically reversed in direction. This produces a magnetic field periodically reversing in direction through the primary circuit, and also through the secondary coil which is generally wound over the primary on a common iron core. The reversals of the magnetic field induce in the secondary winding an opposite emf., the polarity of which is reversed at each reversal of the field. If the secondary terminals are connected to some external circuit, an alternating current of frequency equal to that of the primary current will then flow through this circuit. The ratio of the emfs. at the terminals of the two windings (primary and secondary) is equal to the ratio of their number of turns. Thus, if the primary consists of 20 turns of wire and the secondary of 1200 turns, the secondary voltage will be 60 times the primary voltage. The current will be roughly 1/60 as large, assuming unity power factor, since the power induced in the secondary cannot be greater than the power input to the primary. On account of the relative currents carried, the low voltage winding is made of heavy wire, while the high voltage winding is generally made of much finer wire.

Transformers used in radio apparatus are generally for the purpose of transforming a low voltage alternating current into a high voltage alternating current. Such transformers are called "step-up" transformers.

Oscillatory Discharge of a Condenser

As outlined above, currents may be induced in a circuit by another entirely independent circuit in which an alternating or pulsating current is made to flow. As the inductive effect is due to a change of the magnetic flux in the circuits, it increases with increasing rate of change. In other words, the greater the number of reversals of flux per second, the greater the inductive effect at a given point, or the greater the distance

through which this effect may be evidenced. In radio telegraphy, where these effects must be transmitted great distances, it is therefore necessary to generate alternating currents in the transmitting circuit of a very high frequency—something of the order of 30,000 to 3,000,000 cycles per second. A number of methods have been used to attain this result, a very important one being the oscillatory discharge of a condenser. This is explained below.

Consider a condenser C, Fig. 7, with its plates connected to an inductance coil L and a spark gap G. The condenser

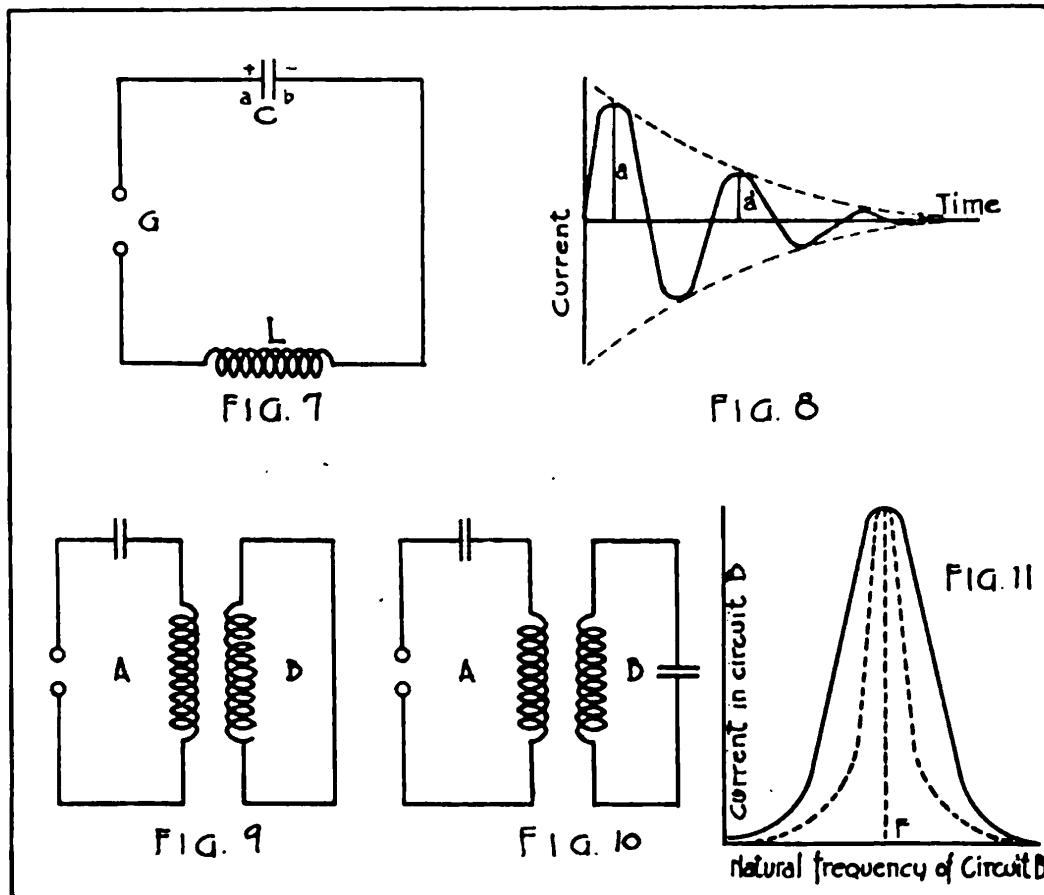

is charged by some outside source of energy; that is, a difference of potential is established between the two plates, giving them opposite polarities. If this potential is made high enough, a spark will jump across the gap, momentarily short-circuiting the condenser through the inductance coil. The condenser will then discharge, and the quantity of electricity which had been accumulated on one of its plates will spread over the circuit in a tendency to equalize the charge on the two plates of the condenser. This will create a current in the circuit, flowing for instance from a to b in the direction aGLb. The

effect of this current is to produce a magnetic field in the coil L. After a very short time, the condenser is entirely discharged, and there is no potential difference between its plates. There being no further charge on the condenser to maintain the current in the circuit, the latter will die out. This is accompanied by the collapse of the electromagnetic field in the coil. This change of magnetic flux, however, generates a current in the coil, in the same direction as the discharge current of the condenser, so that the current in the circuit, instead of dying out suddenly at the moment the condenser is discharged, will continue to flow in the same direction for an instant and accumulate electricity on the condenser plate which was originally at the lower potential. When the current has ceased to flow, the condenser will be charged again, but with a polarity opposite to its original polarity. It will therefore start discharging in the opposite direction, the phenomena occurring as above described, but with the current flowing this time in opposite direction. A series of current reversals will thus take place, the initial energy which was stored in the condenser being alternately stored in the electrostatic and in the electromagnetic fields of the circuit, this producing an alternating current of a frequency depending on the value of the inductance L and capacitance C, in the circuit. The relation between the frequency and the constants of the circuit is

$$f \text{ (cycles per second)} = \frac{159,200}{\sqrt{L \text{ (microhenrys)} C \text{ (microfarads)}}$$

This frequency is called the "natural frequency" of the circuit.

This alternating current would maintain itself indefinitely if there were no energy losses during the cycle. However, the wires making up the circuit have resistance, in which a certain amount of the energy is dissipated in the form of heat. Also, there are heat losses in the spark gap, the radiation losses, and some other losses, generally of less importance, such as leakage losses in the condenser, etc. The result is that at each cycle, the intensity of the current grows less, until after a few cycles, the energy is practically entirely dissipated and the current is consequently "damped" out. These few cycles as a group are called a "train" of oscillations. In order to produce a new train of oscillations, it is then necessary to recharge the condenser by means of some outside

source of potential. Such a train of oscillations may be represented as in Fig. 8 where current is plotted against time.

Decrement.—The number of cycles taking place in the circuit before the current is damped out is dependent on the resistance of the wire making up the circuit, being greatest for circuits of low resistance. The damping varies directly with the resistance of the circuit. The rate of damping of the current of such a discharge may be expressed mathematically by the ratio of the maximum amplitude of two consecutive cycles of a wave train. This ratio is a constant for a given circuit and is called the "arithmetic decrement" of the oscillation. Thus, the arithmetic decrement of the wave shown in Fig. 8, would be $\frac{aa}{aa}$. The greater the value of this decrement, the more rapid the damping of the oscillation. For a true, undamped alternating current, Fig. 2, the decrement is equal to 1.

In practice the arithmetic decrement is of little interest, and the term used most frequently to express the damping is the "logarithmic decrement," which is the Napierian logarithm of the arithmetic decrement. Hence, the logarithmic decrement of an undamped oscillation is zero.

The frequency of oscillation of the condenser discharge may be very great—from 50,000 to 3,000,000 cycles per second, depending on the values of inductance and capacitance in the circuit. But the number of cycles in one train taking place before complete damping out is comparatively small. Hence, by recharging the condenser after each wave train, it is possible to produce a large number of trains of oscillations per second. This may be done by means of an induction coil or an alternator, and will be taken up later.

Phenomena of Resonance

Due to the very high frequency of the discharge oscillations of a condenser through an inductance, the inductive effects are considerable. If an inductance coil B, Fig. 9, is placed near an oscillating circuit A, an alternating emf. is induced in coil B, exactly in the same way as in an ordinary transformer. If the coil is short circuited by means of a piece of wire, an alternating current will flow in the circuit. This will be of the same frequency as the current in circuit A, whatever that frequency may be, as determined by the values of capacitance and inductance in the generating circuit A.

Circuit B is then said to be "aperiodic" as it has no natural oscillation period of its own.

If, however, instead of short circuiting coil B, a condenser is connected across its terminals, Fig. 10, phenomena of a somewhat different nature will take place, so-called resonance phenomena. The alternating current flowing in circuit A, at the natural frequency of that circuit, induces, as before, an alternating emf. of the same frequency in coil B. This emf. produces in circuit B an alternating current of the same frequency. As a result of this alternating current, the condenser of circuit B is charged every half cycle, and will therefore, independently of the current induced by circuit A, discharge through the inductance coil B at the natural frequency of circuit B. Two alternating currents of the natural frequencies of circuits A and B will thus flow in circuit B, and will combine, successively adding and subtracting their effects. If the two frequencies are made equal by a suitable adjustment of the natural period of circuit B, the two currents in that circuit will be in phase and will always add their effects to produce the maximum current in the circuit B. To obtain this condition, it is necessary that the product of the capacitance and inductance of one circuit equal that of the same constants of the other circuit. When this condition prevails, the two circuits are said to be "resonant," or "in tune." Circuit B may be tuned to circuit A by varying the capacitance of the condenser or the inductance of the coil B. Circuits which require a change in frequency are generally equipped with a variable air condenser or a multi-tap inductance coil, or both.

If the current in circuit B is plotted against the natural frequency of that circuit, a "resonance curve," Fig. 11, is obtained which shows that the maximum current exists in B when its frequency is equal to that of circuit A. This curve may in some instances be of a very peaked shape (dotted curve), which means that under certain conditions, circuit A may produce an appreciable current in circuit B only when the latter is almost exactly in tune. Such a result may be attained by loosening the coupling of the two circuits; that is, by separating them so that the induced current in B will not react appreciably on circuit A. Also, the trains of oscillations in circuit A should be damped as little as possible, so that each train will act on circuit B for a comparatively great

length of time. This object is attained by making the circuits of large size copper wire and consequent low resistance.

The fact that the current produced in circuit B by the oscillations of circuit A is considerably greater when the two circuits are in tune, is used in radio telegraphy, as will be shown later, in order to make it possible to receive signals of a given frequency and practically eliminate those of other frequencies.

Propagation of Electric Waves

The flow of electric current in any circuit is accompanied by the existence of interlinked magnetic and static fields which surround the conductors carrying the current and extend throughout space. Whenever the direction of current flow in the circuit is reversed, these fields reverse also. This reversal does not take place, however, throughout space instantaneously. The phenomenon is somewhat similar to the ripples taking place on the surface of water when a pebble is thrown into it. The disturbance gradually propagates itself at a uniform speed, keeping its shape and characteristics until it dies out due to friction losses. The disturbance or reversal in the electric field surrounding a conductor propagates itself in much the same way, but at a speed of 300,000,000 meters (186,500 miles) per second. That is, at a point 300,000,000 meters distant from the circuit under consideration, the reversal of the electric field will occur one second after the reversal of current has been made in the circuit. On account of the similarity with the ripples in the water, this phenomenon has been called an electromagnetic wave. Such waves, however, travel outward not only in one plane as the ripples on the surface of the water, but they radiate out into space in a spherical progression. The medium in which this propagation is assumed to take place is called the "ether." This hypothetical medium is, for theoretical reasons, assumed to be present throughout space, whether matter is present or not; it is the medium in which all electromagnetic disturbances, light waves and heat radiations occur.

If now a frequently reversed current or alternating current is sent through a circuit, the interlinked magnetic and static fields will alternately reverse at the same frequency. This constitutes a series of waves progressing from the current carrying circuit outward into space in all directions. The length of the waves radiated is measured by the distance

between two consecutive points at which the electric field has the same amplitude and direction. This distance is therefore equal to 300,000,000 meters divided by the frequency of the alternating current.

Fluctuations of magnetic and static fields will produce electric currents in any metallic circuit which happens to be within the range of these fields, energy being thus dissipated in these circuits. As this energy is derived from the oscillating circuit, and conveyed to the various other circuits by the electromagnetic waves, the oscillating circuit is shown to "radiate" energy into space. An appreciable amount of energy is not radiated, however, at frequencies of less than about 10,000 cycles per second. The problem is then to generate high frequency alternating currents in a circuit of such shape as to radiate a large amount of energy and produce fields of sufficient strength that the changes in their intensity and direction may be intercepted at great distances. In the following chapters a study will be made of the application of these phenomena to radio telegraphy.

DAMPED WAVE RADIO TELEGRAPHY

Principles of Transmission

From the previous study it has been seen that a radio transmitting set, that is, a set which will emit electromagnetic waves into space, may consist of an oscillatory circuit containing inductance and capacitance, in which trains of damped high frequency oscillations are produced in rapid succession by supplying a certain amount of energy to the system after each wave train. Such a set therefore comprises, in addition to the oscillating circuit, the necessary apparatus to produce the high voltage required for charging the condenser at the beginning of each train of oscillations. This auxiliary apparatus varies greatly with the various sets and is not exclusively applicable to radio work. It comprises ordinary power apparatus used for the production of high potentials and may be an induction coil, transforming the low voltage of a battery into a high pulsating voltage, or an alternator, generating low voltage alternating current which is then stepped up to a high voltage by means of a transformer. This will be studied in a later paragraph.

The oscillatory circuit, however, is a part of the set which is peculiar to radio work. It was seen that such a circuit is made up of an inductance coil, the terminals of which are connected to the plates of a condenser; also, that there are two methods of starting oscillations in such a circuit, one being to introduce a spark gap, charge the condenser, and suddenly close the circuit by producing a spark across the gap, and the other being to couple a circuit without a gap to an oscillating circuit containing a gap. The first may be termed the "direct excitation" and the second, the "indirect excitation" method.

In radio telegraphy it is necessary, in order to increase the range of transmission, to arrange the oscillating circuit so that the electric field will be of suitable shape, and of appreciable strength at great distances. This is accomplished by making either the inductance coil, or (more generally) the condenser of the oscillatory circuit of large physical dimensions. It is then called the "antenna" of the set. The dimensions and shape of the antenna vary greatly in practice and a number of types, some of which are described below are in use at present.

Types and Characteristics of Antennae

In the very great majority of cases, it is the condenser of the radio circuit which is made the antenna, the inductance coil being wound inside the set box. One reason for this is that such a condenser antenna is much more simply installed or repaired under emergency conditions. The simplest type considered here is the so-called "L" type antenna, Fig. 12. This consists of a horizontal wire, called the "aerial" which forms one side of the condenser. This is connected to one side of the inductance of the oscillating circuit. The other side of the con-

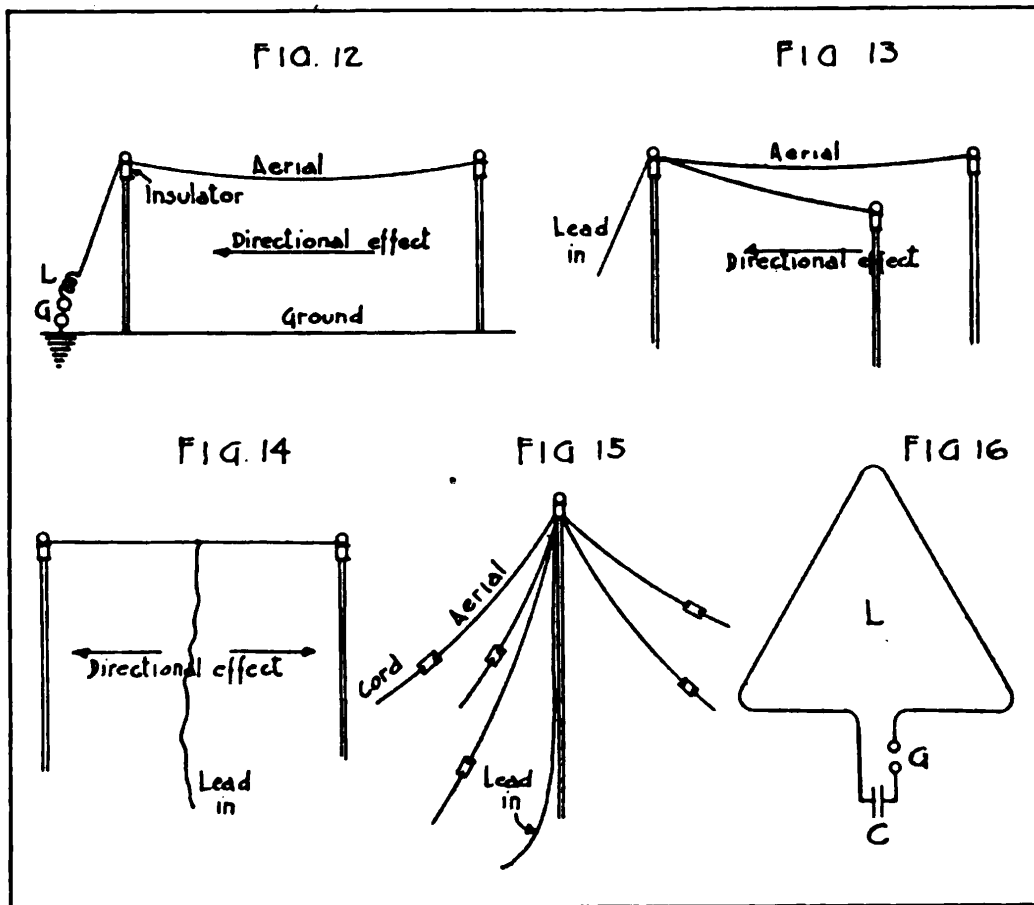

denser is made of a similar wire which is stretched out underneath the aerial wire, either slightly above or laid on the ground. Or the ground itself, if not too dry may be used as the counterpoise side of the condenser. This ground side of the condenser is connected either directly or through a spark gap to the inductance coil, according to the method of excitation used. This is explained below. The connecting wires used to connect the coil and gap to the aerial and the counterpoise (or ground) are called the "lead-in wires." In some cases, no in-

ductance coil is provided with the set, the self inductance of the antenna wire being sufficient.

A very important feature of the antenna is its "directional effect." When the antenna circuit is made to oscillate, the intensity of its electric field and hence the range of transmission is distinctly greater in the direction of the end at which the lead-in wires are connected (direction of the arrow in Fig. 12). Advantage is taken of this characteristic when using such an antenna, by pointing the aerial wire toward the location of the receiving station with which it is desired to communicate, the lead-in wire being connected to that end of the aerial which is nearest the receiving station. It is very important to remember this, since the range of transmission in the other direction is considerably less.

Another type of antenna is the "V" antenna shown in Fig. 13. The aerial consists of two diverging horizontal wires and the lead-in wire is connected at the apex of the "V." If a counterpoise is used, it is generally made of two wires laid on the ground or stretched between masts above ground and underneath the branches of aerial. (See Radio Pamphlet No. 2.) The directional effect of this antenna is toward the point of the "V."

The "T" shaped antenna, Fig. 14, consists of a horizontal wire at the center of which the lead-in wire is connected. The directional effect is in either direction in the vertical plane of the antenna.

The "umbrella" type antenna consists of a number of interconnected wires suspended from the top of a mast and insulated from ground, spreading around the mast like the ribs of an umbrella frame. The free ends are fastened to the ground by means of insulators and ropes, Fig. 15. There is no directional effect with this antenna, the electric waves being radiated with equal strength in all directions.

There are a number of other types in use, but they are generally too difficult to set up in the field for common use. A very important consideration in using antennae is to always well insulate the aerial and lead-in wires from the ground in order to avoid any leakage path which would of course greatly reduce the range and might even completely prevent any radiation.

As was pointed out in the first chapter, the resistance of the oscillating circuit should be as low as possible in order to reduce the heat losses and resulting damping. The lead-in wires con-

necting the counterpoise and antenna to the set should be made as direct and as short as possible. This will also eliminate any superfluous inductance due to possible turns in these wires. If the set is under shelter, the wires should be run through ebonite tubes where they pass through the wall. If these are not available, a bottle may be used, the bottom of which has been broken out.

The ground connection should be made by driving a few metal rods into the ground and interconnecting them, and then connecting them to the set. A ground mat may also be used. This is a small metal netting which is placed on the ground underneath the aerial and connected to the set. It is very useful when the station has to be set up in a short time, and is indispensable when the ground is dry or rocky.

An important use of the counterpoise is to be found on airplane sets where the aerial is generally a single wire let out from a reel on the airplane through an insulating tube, and the counterpoise is all the metallic parts of the airplane motor, gasoline tanks, stay wires, etc., electrically bonded together.

As mentioned before, the antenna sometimes consists of the inductance coil of the set instead of its condenser. The latter is then of small physical size and is mounted within the set box, while the antenna is a loop of wire, Fig. 16, of suitable size and of very few turns, frequently of only one turn, supported on a wooden frame. Such antennae, called "loop antennae," are generally used for short range radio telegraphy and for radiating very short wave lengths—30 to 100-meter waves. They are directional in their plane. This type of antenna is somewhat delicate to repair and is not used very much in the field.

Direct Excitation Transmission

With the direct excitation method of sending radio waves, the radiating oscillatory circuit comprises the aerial and ground (forming the condenser), an inductance coil L , and a spark gap, Fig. 17. The two electrodes of the spark gap are connected to the secondary (high voltage) terminals of a transformer, in the primary of which an alternating current may be made to flow by closing the key placed in series with it. When the key is closed, the primary low tension alternating current induces a high alternating voltage in the secondary of the transformer, and an alternating difference of potential is thus established between the aerial and the ground which causes a storing of

energy in the antenna. If this potential is high enough when the maximum of the cycle is reached, the air gap breaks down and the antenna discharges the stored energy through the inductance L , and a high frequency oscillation is created as explained previously. This is shown in Fig. 18. The upper curve shows the voltage variation in the secondary circuit of the transformer. It rises from zero to the breakdown potential e of the gap, when the condenser discharges and suddenly equalizes the potential of its two electrodes. When the resistance of the gap breaks down, the voltage of the transformer

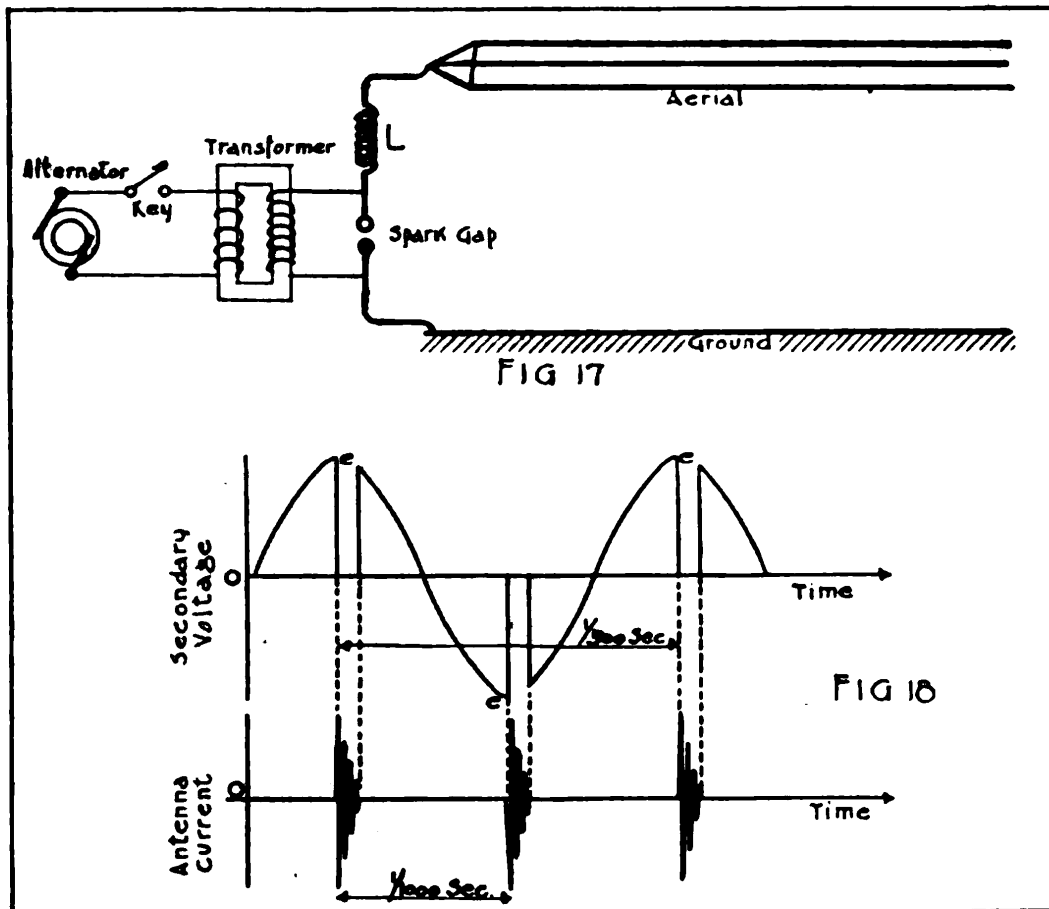

secondary drops practically to zero and a high frequency current oscillates in the antenna circuit, as indicated in the lower curve. When the oscillations have been damped out due to heat losses in the spark, the resistance of the circuit, and the energy losses by radiation, there being no current flow through the gap, the latter opens again, and the voltage of the antenna follows again the cycle of the alternator until the negative maximum is reached, when the same phenomenon takes place. In this way, for every half cycle of the alternator, a high frequency discharge of the antenna takes place which sets up in space, a

train of high frequency oscillations (wave train). The frequency of successive wave trains is thus equal to twice the frequency of the alternator. This, for reasons seen later, is called the "audio" or "wave train" or "spark frequency." The frequency of the oscillations of each individual train is called the "radio frequency" and is entirely independent of the frequency of succession of the sparks or wave trains, as it is determined by the constants (inductance and capacitance) of the antenna circuit. The value of the radio frequency can therefore be regulated by inserting capacitance or inductance in the antenna circuit. Thus, placing an inductance coil in series with the aerial will increase the wave length (decrease the frequency), while a condenser inserted in series with the aerial decreases the wave length (increases the frequency). The frequency of the alternator in practice is of the order of 500 to 1200 cycles per second.

Instead of using an alternator and transformer, an induction coil may be used, as in the SCR-74 trench transmitting set. This supplies a high pulsating voltage at its secondary terminals instead of a high alternating voltage. The operation is the same in principle, the advantage being that such a set is readily portable, and easily set up. However, the wave trains may occur at slightly irregular intervals as the armature does not vibrate regularly as a rule.

The presence of a spark gap in the oscillatory circuit has the disadvantage of introducing quite a high resistance, so that the oscillations are rapidly damped out, and the interval of time between two wave trains, although of the order of 1/1000 second, is very much longer than the duration of the various wave trains. The result is that such sets are of low power and small range, as a great part of the energy of the oscillations, instead of being radiated into space, is wasted away as heat in the antenna circuit. Also, due to the rather high decrement, tuning of the receiving set cannot be made very sharp. For long range sets, this method is then replaced by the indirect excitation method of transmission.

Indirect Excitation Transmission

By this method, oscillations are started in an oscillatory circuit A, Fig. 19, exactly as with the direct excitation method, only this is a so-called closed oscillatory circuit; that is, both the condenser and the inductance coil are of small physical dimensions.

Coupled to this circuit is the antenna circuit, comprising the large aerial-ground condenser and an inductance through which the coupling to circuit A is made. Oscillations are set up in circuit A, as described above, each train of oscillations being rapidly damped out. Through the transformer action of the two inductance coils, these oscillations induce similar oscillations in the antenna circuit. When the oscillations in circuit A have been completely damped out, the antenna circuit, containing no high resistance such as the spark gap, will continue to oscillate for some time, so that for the same power input, a greater

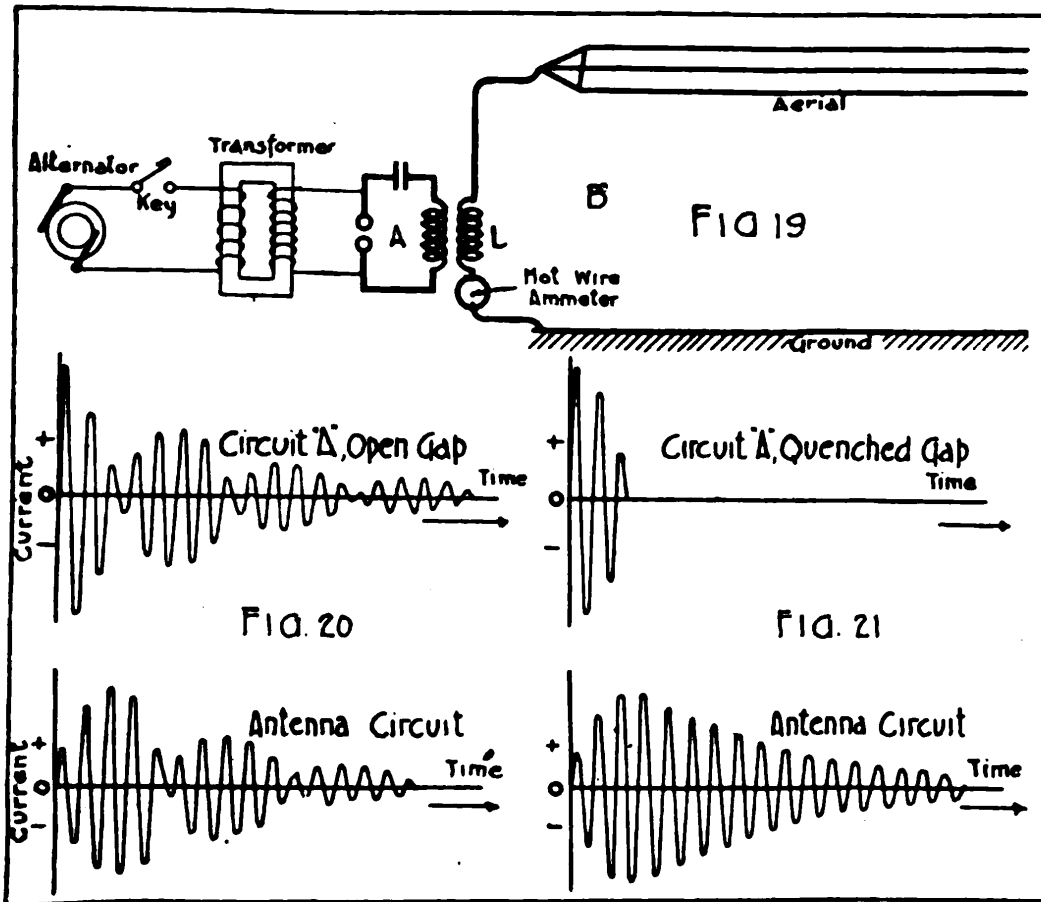

amount of power will be radiated by using this method of exciting the antenna. For the proper operation of such a set it is of course necessary that the antenna circuit be tuned to the period of the closed oscillator circuit A. This is generally done as follows. Circuit A is first given the desired natural period by properly setting its variable condenser and variable inductance. The key is then closed and the antenna circuit adjusted by changing its constants until it is in resonance with circuit A. This condition is indicated by the maximum reading of the hot-wire ammeter inserted in the antenna for this purpose.

As in the previous case, many different arrangements of the circuits are possible. Instead of the alternator and transformer, use may be made of an induction coil. This is done in the SCR-56 airplane transmitting set. In some sets, the coupling of the closed oscillating circuit A to the antenna is made by means of one coil only, Fig. 22. This is called "conductive coupling." The inductance of circuit A is then that part of the coil comprised between the points a and b, the portion of the coil included in the antenna circuit being that between m and n. Such a scheme is used in the SCR-65 airplane transmitter. It will be noticed that this arrangement of one or two inductance coils for effecting the transfer of energy from one circuit to another is, in principle, the same as an ordinary transformer, the only difference being the absence of an iron core. From this similarity, the arrangement has derived the name, "oscillation transformer."

Some auxiliary phenomena take place when indirect excitation is used for setting up oscillations in the antenna. When a train of oscillations is started in a closed oscillatory circuit by the breaking down of the gap, the oscillations quickly damp out, mainly due to energy losses (resistance, gap, etc.) in the circuit itself. However, when such a circuit is coupled to some other oscillating circuit, such as in the case of Fig. 19, the closed oscillator, in addition to wasting away its energy in the usual internal losses, gives up at every cycle a part of it to the other oscillating circuit, so that its damping will be much greater. When the oscillations in the first circuit have died out, the second circuit has then stored a large part of the energy, and high frequency oscillations take place in that circuit. These react on the closed circuit and induce in it an emf. which causes the oscillations to start anew, due to the fact that the conducting gases in the gap were not given time after transfer of energy from the local to the radiating circuit to de-ionize or escape, and open the circuit. The second oscillating circuit thus gives back energy to the first, until it has returned all of it, at which time the first circuit is again in full oscillation. The phenomena then repeat in the same sequence. The result is a series of "beats" in each circuit, as represented in Fig. 20. The practical result is that the antenna circuit, instead of oscillating freely and radiating all its energy into space, feeds back and wastes some of it in the local oscillating circuit A.

To avoid this waste and secure the maximum radiation, it has been found necessary to prevent the transfer of energy

back to the closed oscillating circuit, and a number of methods have been devised, all based on the same principle. The general principle consists of making the spark gap non-conducting after the circuit A has given up all of its energy; that is, after the oscillations taking place in it have been once damped out. If this is done, circuit A is open and an emf. induced back into that circuit by the antenna circuit will be unable to produce any current in it. Excitation by this method is called "impact excitation." This gives conditions shown in Fig. 21, from which it will be seen that after all the energy has been transferred from A to B, it is all spent in circuit B in free oscillations of low damping.

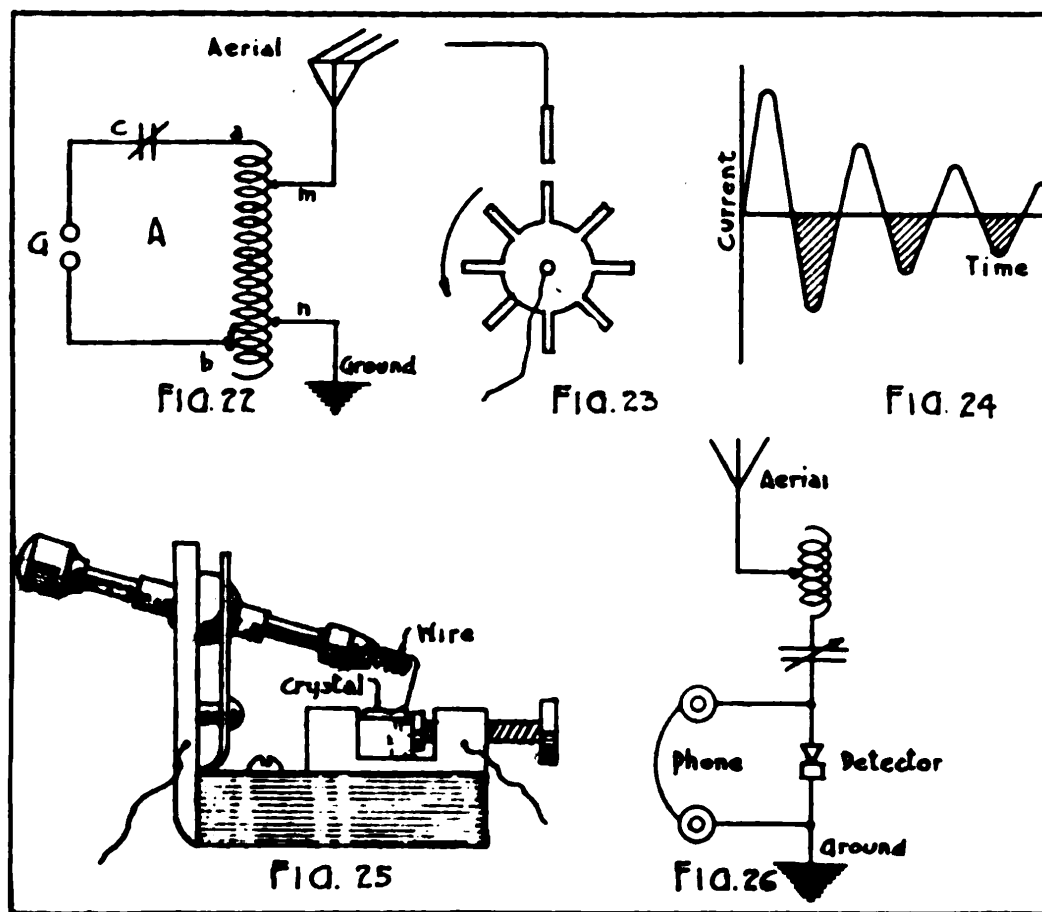

One method of making circuit A non-conducting consists in blowing out the spark in the gap by means of a violent stream of air produced by a blower of some sort. Such an arrangement is called an air blast spark gap. Another method is the use of the "quenched gap," in which the spark occurs in an air tight space between cooled electrodes made of metals such as zinc, aluminum or silver, all of which tend to prevent the spark from maintaining itself after the first energy transfer. A third

method, used on a number of airplane transmitters, is the "rotary spark gap," in which one of the electrodes of the gap is a stationary metal post, at a small distance from which is rotated a toothed metal disk forming the other electrode, Fig. 23. The disk is rotated at high velocity and a spark takes place every time one of the teeth of the disk passes in front of the stationary electrode. Each spark is extinguished very rapidly on account of the increased length of gap as the tooth turns away from the stationary electrode. There are two kinds of rotary gaps, called the "synchronous" and the "non-synchronous" gap. In the former, the disk is driven at such a speed, and has such a number of teeth, that there will be one spark for every cycle of the alternator. In the latter, the disk is driven at a different speed so that there will be more than one spark per cycle, or else one spark in every few cycles. The adjustment of such gaps is somewhat delicate and is not taken up here. While quenched gaps are of use in indirectly excited sets, they should be avoided in directly excited sets, as in this case the oscillations take place only in the antenna circuit and hence want to be prolonged as much as possible.

Principles of Reception

In the previous paragraphs, a study has been made of the production in an antenna, of high frequency damped oscillations. These oscillations, it was pointed out, produce reversals of the electric field throughout space, and if the antenna is of suitable shape, of greater strength in certain directions than in others. Thus a damped oscillation in the antenna will produce a train of electric waves traveling from the source outward. When such a train of waves sweeps over any conductor, it will induce in this conductor an alternating current of proportional amplitude and of the same frequency as the oscillations of the train. If a circuit containing inductance and capacitance is acted upon by the oscillations, the alternating current set up in it will be a maximum when the natural frequency of the circuit is equal to the frequency of the oscillations, or in other words, when the circuit is tuned to the waves received, which means resonant with the transmitting circuit. A radio receiving set then comprises a circuit containing adjustable inductance and capacitance, so that it may be tuned to any frequency within certain limits. As it is of advantage that the receiving set intercept as much as possible of the energy of the incoming waves, it is made to cover as large an area as possible. This

is accomplished by giving large physical dimensions to either the inductance coil or the condenser, in other words, by using an antenna. In such a circuit, for each wave train passing over the antenna there will be induced a train of high frequency oscillations. In order to perceive these oscillations, it is necessary to insert in the circuit some sensitive device which will respond to the extremely small currents induced in the antenna. The telephone receiver forms a very convenient device for this purpose because of its great sensitiveness and ruggedness. Reception of radio telegrams is thus almost universally done by sound.

As the frequency of the oscillations is far beyond the vibration frequency of the telephone receiver diaphragm, no sound would be produced by the latter under the influence of the alternating current induced in the receiving antenna. It is therefore necessary to rectify this current by means of a special device called a "detector." This will conduct electric current fairly well in one direction, but practically not at all in the other. If such a detector is then connected in series with the telephone receivers, a wave train passing over the antenna will induce an alternating current in the circuit, but all the half cycles in one direction will be cut off by the detector, so that instead of a damped alternating current passing through the telephone, a series of unidirectional half-cycle impulses will flow, Fig. 24. As these impulses occur in such rapid succession that the receiver diaphragm will not respond to them, their effect is added, giving one deflection of the diaphragm for each train of waves. When the train of oscillations is damped off, the telephone diaphragm falls back in place until the next wave train arrives at the receiving station. If these trains arrive at a rate (for best results) of 500 to 1200 per second, the successive vibrations of the telephone diaphragm will produce a sound in the operator's ear which will be of a very pure and steady note if the trains arrive regularly, which means that the spark of the transmitting set is occurring at very regular intervals, as determined by the vibrations of the induction coil vibrator, or by the alternating current frequency of the alternator. This wave train frequency is therefore called "audio frequency," as was already pointed out, since it is of a frequency to which the telephone receiver and the ear will respond. The limits of audible frequencies are about 20,000 and 16 cycles per second.

There is quite a large variety of detectors. One used very widely on account of its simplicity is the crystal detector, a

sketch of which is given in Fig. 25. It consists of a crystal of galena (lead sulphite) or iron pyrite (iron sulphite) held in a special support. A fine metal wire is then maintained in position so that its point will rest with a light pressure against a spot of the crystal's surface. Certain points of the crystal surface give better results than others and almost completely stop the current flow in one direction. Such a spot is found by touching the wire point at various points of the surface, until the sound in the telephone receiver is great enough to be readily heard. This adjustment does not have to be repeated often if not disturbed by mechanical vibration. The selection of a good detecting spot on the crystal may be made by exciting the set by means of a small testing buzzer provided for the purpose.

From the previous paragraphs, it may be seen that a receiving set may be constructed by connecting an aerial to ground through an adjustable inductance and condenser, and a telephone receiver shunted by a crystal detector, Fig. 26. The set is tuned by adjusting the inductance and the condenser until maximum response is obtained in the telephone. The high frequency alternating current induced in the antenna will then flow through the receiver in one direction (one half cycle), and through the detector in the other. Such a set, although very simple, has the disadvantage that the detector introduces a high resistance in the antenna, which prevents the latter from oscillating at maximum amplitude.

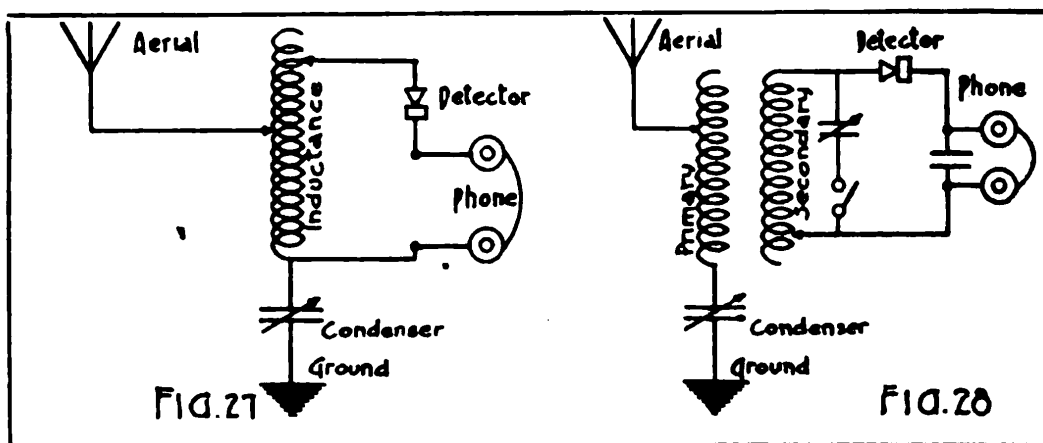

Damped Wave Receiving Circuits. Fig. 27—Inductively and Conductively Coupled. Fig. 28—Inductively Coupled.

A better arrangement is therefore obtained by coupling the telephone and detector circuit to that of the antenna. This coupling may be inductive or capacitive. In case of the former, one of two coils may be used, just as in the case of sending sets. Such sets are shown in Fig. 27 and Fig. 28. With circuits of this kind, the antenna circuit oscillates freely

under the influence of the incoming waves, and induces the high frequency currents in the telephone circuit. The circuit of Fig. 28 is that used in the SCR-54 receiving set, and its operation is fully explained in Radio Pamphlet No. 3.

Tuning.—The waves emitted by transmitting stations are propagated in all directions, so that a receiving station may hear not only the signals of a particular station, but also those of all sets working within a good distance of it. It is evident that the reading of telegraphic signals would be absolutely impossible if it were not possible to weaken or eliminate all of the disturbing signals and on the other hand amplify the ones desired. If the disturbing signals are of wave lengths differing from that of the signals to be received, this selection of signals can be made by proper tuning of the receiving set.

When the resonance is very sharp, the receiving station may be sharply tuned. Reception by coupled circuits is almost always employed on account of the good tuning it affords, due to the possibility of double tuning both the antenna and the local oscillating circuits.

Coupling.—To maintain good tuning, it is necessary to avoid too close coupling, that is to say, to avoid bringing the two coupling coils too near together since in that case, the mutual reaction between the antenna and the oscillating circuits distorts the waves and decreases the sharpness of the tuning.

Care must be taken in the use of radio apparatus, not to put any metallic mass in the vicinity of the coils as this would be the seat of induced currents, the production of which would take energy from the oscillating circuit and damp the oscillations.

Sources of Trouble

It has just been seen that tuning allows the elimination or the weakening of the effect of transmitted waves different in length from the ones to be received. For waves of nearly the same length, this elimination of interference will only be possible when the tuning is very sharp. This depends not alone on the receiving station. If the waves received have high damping, each incoming wave train is made up of only a few oscillations, and does not act very long on the receiving antenna. Sharp tuning requires the rhythmic repetition of the effects of a large number of successive oscillations. Oscillations of the lowest damping should therefore be used when sharp tuning at the receiving station is desired.

If two oscillations have the same or very nearly the same wave length, tuning cannot separate them, but receiving of either is nevertheless possible if the two sending stations have clearly defined tones. This depends on the difference in spark frequency (audio frequency) of the two transmitting sets, the higher this frequency, the higher the pitch of the note heard at the receiving station.

Other causes of serious trouble are electrical atmospheric disturbances, aurora borealis, the passage of electrified clouds, hail storms and drops of electrified rain. The atmospheric electrical discharges produce oscillating currents in the antenna, and the telephone receives them giving a series of mixed sounds. These noises are generally a series of impulses of low tone with the result that the high pitched musical signals are the least disturbed by atmospheric interference. This is often very troublesome in long distance receiving from powerful stations which work with long wave lengths. Although less intense on small field antennae, the atmospheric disturbances sometimes cause serious trouble in reading signals.

Influence of Ground Contour.—On a great plain, the waves are propagated normally in all directions from an antenna. In hilly regions, on the contrary, steep slopes form screens and deflect the waves. Near the foot of a steep hill, there is a region of shadow which is not reached by the waves coming from the opposite side. The waves reflected from the two slopes of a narrow valley, follow the valley. As it is necessary to avoid placing the receiving antenna in a region of shadow, an exposed position is sometimes preferable.

Telegraph lines and metallic conductors used in the construction of houses absorb the waves and their proximity is usually detrimental. In forests, an antenna receives and transmits badly because the sap of the trees conducts electricity and may be the seat of induced currents. When an antenna must be hidden in a wood, it should be placed as close as practicable to the edge from which the waves are coming, or in the middle of a glade. If possible, it is advantageous to install it above the trees. Interference with the waves by trees and houses is greater, the shorter the waves.

It is also necessary to choose a position for the ground connection where the ground is damp and conducting. An antenna in a position not entirely exposed may be good for transmitting and receiving waves in one direction, but not for another.

PART 2.

CHAPTER I.

UNDAMPED WAVE RADIO TELEGRAPHY

The fact that the efficiency of the transmitting sets is greater, and that the tuning of the receiving sets is sharper for the waves having the smallest damping, gives rise to the desirability of using waves that are not damped at all. This means that an alternating current of constant amplitude and of radio frequency must be generated in the transmitting antenna. The use of alternators for this purpose presents very considerable difficulties, and is absolutely impracticable for portable sets such as are needed for military purposes. However, a new method of generation of undamped wave oscillations has come in for a very extensive application in Signal Corps work, consisting in the use of the three-electrode vacuum tube.

Vacuum Tubes in Radio Communication

Upon gaining a general idea of the newer apparatus used in the transmission and reception of communications by radio, one soon becomes impressed with the importance of the vacuum tube, as it occurs in nearly all of the principal types of modern radio apparatus. The same tubes may be used to transmit, to receive, to detect, to amplify, to modulate and to serve other important functions necessary to radio communication as it is now known. Their practical application to these numerous uses is an accomplishment of the last few years and the possibilities for further application are by no means exhausted. In fact, the whole field of radio work has been greatly influenced by the development of vacuum tubes, and by virtue of this it is now possible to effect radio communication through greater range with lower power and with greater selectivity than was formerly possible. Also, the tube has enabled the construction of apparatus for these uses, which is readily portable—a most important feature in connection with military communication systems.

How these tubes work and how they can be made to serve such a multiplicity of purpose, are the questions which most naturally arise in the mind of every student. Answer to these

two questions involves much highly theoretical discussion and more than one way of explaining the action in some instances. The following paragraphs, however, are intended to give an explanation general enough to be easily understood, avoiding much interesting and valuable discussion on functions of the tubes not at present utilized by the U. S. Signal Corps, and also avoiding dual explanations of any particular action.

Electron Flow in Vacuum Tubes

The electron flow in a vacuum tube will first be studied in a bulb containing two metal electrodes; one, a filament which may be heated by a local battery A, and the other, a flat piece of metal, called the plate, Fig. 1. If a battery B is connected across the tube with its negative pole to the filament and its positive pole to the plate, no current will be indicated on the ammeter I inserted in the circuit. However, if a current is passed through the filament by means of a battery A, bringing the filament to a red heat, a current of a few milliamperes will be shown by the ammeter to flow in the circuit BFPIB. Thus, the heating of the filament causes a current to flow across the open space of the bulb. This may be accounted for as follows:

The explanation of phenomena observed in a great number of experiments has led to the assumption that there exist extremely small non-material particles having a definite negative charge of electricity. These particles are called electrons. They move in great numbers between the atoms of any metal. At ordinary room temperatures, they do not escape out of the metal, in most cases, but when the metal is heated, the material atoms vibrate about their mean position of equilibrium with a speed and amplitude which increases with the temperature. The electrons, which follow the atoms in this thermal agitation, likewise acquire increasing speed as the temperature of the metal is raised. When it becomes red hot, the speed of the electrons is so high that they leave the metal. This phenomenon is illustrated by the experiment described above, wherein the filament was made red hot and an electrostatic force was present, due to the connection of the B battery in the plate circuit, which tended to move the negative electrons from the filament to the plate by repulsion from the filament and attraction by the plate. Under these conditions, the electrons travel from the filament to the plate at a speed which may attain tens of thousands of miles per second, and transport negative charges across the space in the bulb from filament to

plate. The passage of electrons, each carrying its charge of electricity from filament to plate, constitutes a flow of electricity which is an electric current. It should be noted that the electron flow is from the negative filament to the positive plate, while the electric current flow is just the opposite—from the positive plate to the negative filament. This is not difficult to explain, as the direction of flow of the electric current from positive to negative poles is a mere assumption which was made before the discovery of the electron flow, and could just as well have been assumed to be in the opposite direction.

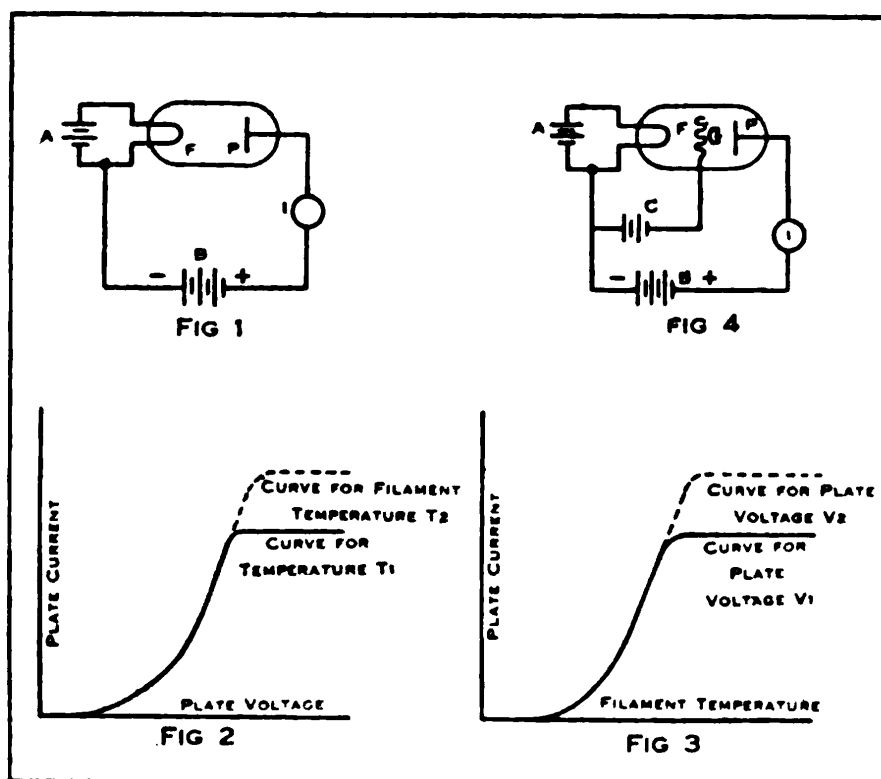

Fig. 1, 2 and 3—Two-Electrode Vacuum Tube and Characteristic Curves
Fig. 4—Three-Electrode Vacuum Tube

If the polarity of the B battery, Fig. 1, is reversed, no electric current will flow through the ammeter, as the plate will be negative and will repel the negatively charged electrons and thus prevent any flow of electricity across the tube.

Operation of Two-Electrode Tubes Under Various Conditions

The two electrode vacuum tube is very frequently called a valve. For a given filament temperature, T_1 , a definite number of electrons is emitted per unit of time. The number of electrons per second which will travel across the tube and reach the plate is the measure of the current in the plate circuit, and it varies

within limits approximately as the square of the voltage across the space between plate and filament. As this voltage is increased, a certain value will be reached at which all electrons emitted by the filament will be absorbed by the plate, so that no increase of current will take place for higher values of the plate voltage. This is shown in Fig. 2, curve for temperature T_1 . In order to increase the plate current, it is then necessary to raise the filament temperature to some higher value, T_2 , when the current curve will rise to a new value before bending over to the horizontal position.

Now, if the plate voltage is kept at a constant value, V_1 , and the filament temperature raised by increasing the current from the battery A, the number of electrons emitted by the filament will vary approximately as the square of the filament temperature figured above the red heat temperature (1600° absolute for tungsten filament) until a point is reached where the electrostatic field, due to the negative charge of the electrons in motion in the tube, will exactly counteract that due to the positive charge of the plate. This condition is called the "space charge effect." Any further increase of filament temperature would then tend to increase the number of electrons in the tube, and therefore the space charge. The latter then outweighing the charge of the plate, would repel some of the electrons back into the filament. A state of equilibrium is thus reached whereby the current remains constant independently of further increase of filament temperature, and the current curve will bend over and remain at a constant value of plate current, Fig. 3. If there is not potential difference between the filament and the plate, the space charge effect will prevent the flow of electrons to the plate.

To increase the current, it is then necessary to increase the plate voltage to some higher value, V_2 . The upper limit to this voltage increase is that which prevails when a blue glow is observed around the plate. On old and defective tubes, this blue glow may appear at normal operating voltages, and then it is an indication of poor vacuum. It causes a hissing noise in the telephones and prevents good operation of the tubes.

The Three-Electrode Vacuum Tube

The three-electrode tube used by the U. S. Signal Corps is a highly evacuated bulb containing a filament and a plate like the two-electrode tube already described, but in addition

having a grid or wire screen supported midway between the plate and the filament. The filament is made of some material, usually tungsten, or platinum coated with oxide, which when heated liberates a quantity of electrons from its surface. The plate electrode is placed near to and usually encloses the filament. It may take various forms, such as two flat plates, a cylinder, a cone, etc. The grid is made up of a network of metal wires, sealed into the tube and supported in such a manner as to be interposed between the filament and the plate so that any passage of electrons or current between these electrodes must pass through the grid.

If the plate is made positive with respect to the heated filament, a flow of electrons will take place from the filament to the plate, as explained in connection with the two electrode tube. In their flow, the electrons must pass through the wire mesh of the grid, which can be made to have a controlling influence on the electrostatic field in the tube. Thus the rate of flow of electrons from filament to plate may be regulated by changing the potential of the grid with respect to the filament. If the grid is given a potential slightly negative to the filament, which may be done by a battery C, Fig. 4, it will repel some of the electrons emitted from the filament, but many of them, due to their high velocity, will pass through the mesh of the grid and reach the plate. Now, as the potential of the grid is made more negative, Fig. 5, the plate current will gradually decrease until the negative grid potential will be great enough to prevent all electrons from leaving the filament, thus stopping the plate current flow entirely. This is due to the action of the field created by the grid which has neutralized that created by the plate.

If the grid is made positive instead of negative, more electrons will be attracted toward the plate than would pass without the influence of the grid potential, and the plate current will be increased until saturation of the tube occurs. This saturation may be explained as follows: As the grid is made more and more positive, the plate current increases at a greater rate than the grid voltage, Fig. 5, so that a grid potential will be reached at which the space charge due to the negative electrons passing across the tube will exactly counteract the influence of the positive grid potential. When this condition prevails, the maximum plate current is obtained. Further increase of grid potential tends to increase the plate

current and therefore the space charge, but the latter, increasing at a greater rate, overbalances the influence of the grid and the plate current thus remains practically constant up to a certain grid voltage, beyond which the plate current slowly decreases. The limitation of plate current is due not only to the space charge effect, but also to the absorption of electrons by the grid in increasing numbers as its positive potential is increased. This absorption gives rise to a current flow in the circuit FGCF, called the grid current.

From the last two paragraphs it can be seen that if the grid is made alternately positive and negative, the plate current will be accordingly increased and decreased about its normal value in the absence of the grid. By means of a small dry battery it is possible to fix the mean potential of the grid at any point on the characteristic curve. The value of this mean potential (which is the grid potential existing when no oscillations are taking place) determines the operation of the tube as a rectifier or as an amplifier. The variations of grid potential modify the plate current, and the tube thus acts as a relay controlled by the very small variations of grid potential. The electrostatic capacity of the grid being very small, the variations of its charge involve correspondingly small amounts of energy. It is therefore very sensitive, and having no inertia, it is able to follow the extremely rapid oscillations encountered in radio telegraphy—oscillations of frequency far beyond the range of mechanical or more common electrical devices.

Detector Action of Vacuum Tubes

A simple connection of the three-electrode tube as a detector is shown in Fig. 6. When a train of damped oscillations strikes the antenna, it produces an alternating voltage in the antenna circuit as represented in Fig. 7-A. This voltage induces a similar voltage in the secondary coil, ab, of the receiving transformer connected in the grid circuit, which is superimposed on the normal grid potential given by the battery C. The component of the grid current due to the alternating voltage will flow only during the positive half cycle of the oscillation, as seen from the grid current characteristic curve, Fig. 5, and indicated in Fig. 7-B. This current flow from grid to filament has a tendency to equalize the potential difference between them, so that the actual grid voltage, instead of

following a symmetrical curve similar to the antenna voltage, will be asymmetrical, the amplitude of the negative half of the wave being greater than that of the positive half, Fig. 7-C, as no current is then flowing.

Referring to the grid current characteristic curve, Fig. 5, again, it will be seen that an asymmetrical change in plate current will result from this asymmetrical change in grid

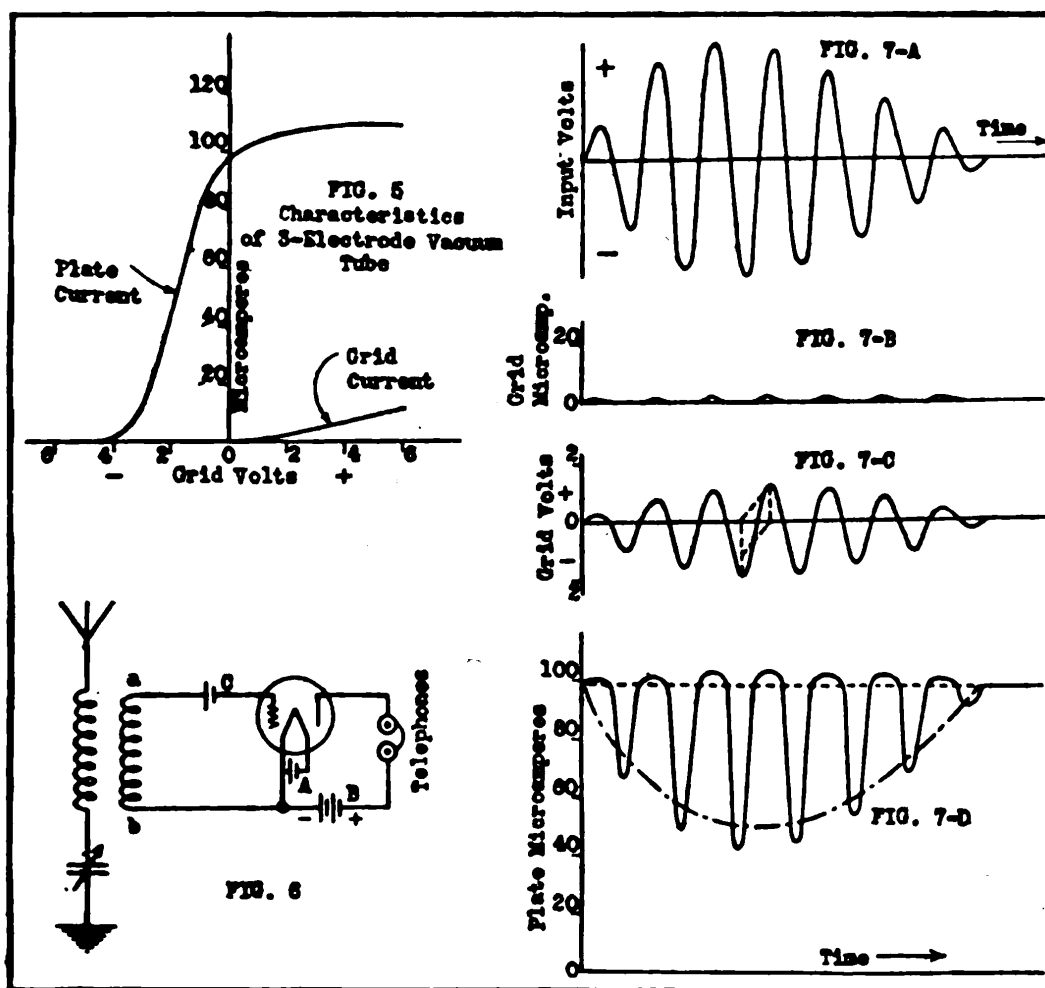

Fig. 5—Characteristics of Three-Electrode Vacuum Tube. Fig. 6—Three-Electrode Tube Used as Detector. Fig. 7—Analysis of Detector Action; (A) Input Voltage Due to Incoming Waves; (B) Resulting Grid Current; (C) Grid Voltage, Resultant of Induced and Counter EMF.; (D) Current in Plate and Telephone Circuit

potential, Fig. 7-D. When flowing through the telephone receivers, this plate current will be smoothed out by the inductance of the telephone into a single unidirectional impulse; and such an impulse being produced for every wave train, a sound will be produced in the telephones at a frequency corresponding to that of the frequency of the trains. The operation of the tube as a detector will be best when the normal grid potential is near the upper bend of the characteristic curve,

and will gradually become less effective as this potential is brought nearer to the lower bend, until a point is reached when rectification does not occur and where the asymmetrical variations of grid voltage produce symmetrical variations of plate current, Fig. 8. This particular part of the curve is used for amplification, as will be explained in a later paragraph. Beyond this point of no detector action, however, the rectifying properties of the tube reappear, so that it may be used as a fair detector on the lower bend of the characteristic curve.*

GRID CONDENSER CONNECTION FOR DETECTOR ACTION.—If the C battery, Fig. 6, is replaced by a small condenser (.0005mfd.), the detector action of the tube is different from that described above. During a period of no oscillations, the plate current assumes a certain value determined by the B battery and the filament temperature. If now an oscillation strikes the antenna, the grid will be made alternately positive and negative. When it is positive, it attracts electrons, and being insulated from the filament, it retains these electrons and acquires a negative charge which lowers the plate current. The negative charge of the grid is then caused to leak off either through the condenser dielectric or through a high resistance shunting the condenser, so that by the time the next train of waves arrives, the grid is again at its normal potential.

Amplifier Action of Vacuum Tubes

The energy of a signal wave at the receiving station is very often so extremely weak that it is necessary or advantageous to amplify the signals to make them more easily read. In radio telephony, this amplification has a special importance. The problem consists in producing changes in the telephone receiver current which are exactly proportional to the amplitude of the incoming waves, and without distortion. As outlined in the explanation of the detector action of the tube, a symmetrical oscillation in the primary (input) circuit induces an asymmetrical oscillation in the secondary or grid circuit, the voltage amplitude being less for the positive half cycle than for the negative. A point may be found on the characteristic curve of the tube, Fig. 8, where the asymmetrical variation of grid potential produces symmetrical variations of plate current, so that the variations of the plate current will reproduce

*The curves of Fig. 7-B, 7-C and 7-D should lag about 180° behind the voltage curve of Fig. 7-A. This has not been shown because of its tendency to confuse.

exactly those in the antenna without distortion. Furthermore, the very slight energy of the wave acting on the grid, produces very large variations of plate current because of the relay action of the tube, and this explains the amplification of the antenna oscillations.

To separate the amplified alternating current from the steady direct current in the plate circuit, the pulsating plate current

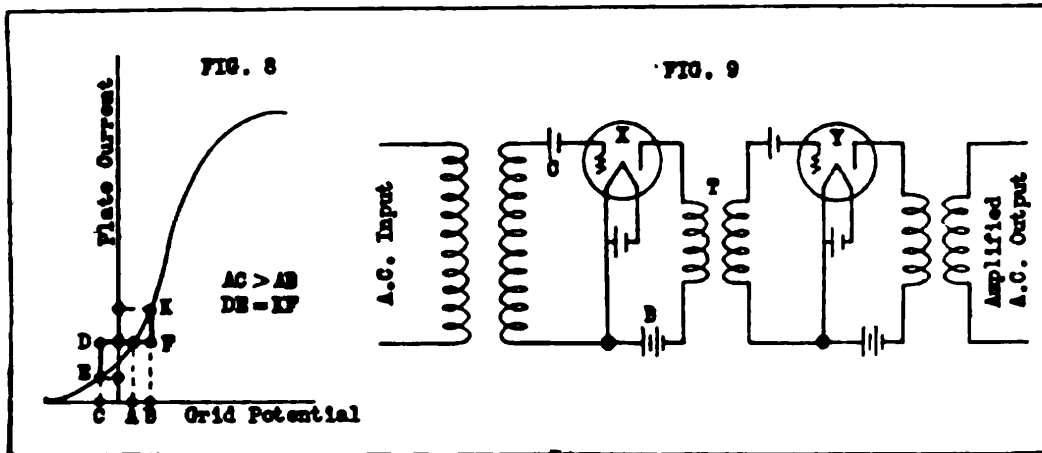

Three-Electrode Vacuum Tube Used as Amplifier. Fig. 8—Point on Characteristic Curve Giving Symmetrical Amplification. Fig. 9—Connection for Cascade Amplification

is passed through a transformer, Fig. 9, which delivers the amplified alternating current at its secondary terminals. A second tube may be used to further amplify this wave if necessary, as tube Y, Fig. 9. When this is done, the process is called cascade amplification. With the VT-1 type vacuum tube, more than two tubes are seldom used for amplification purposes. Two of these tubes give an amplification of about 10,000 times.

Oscillator Action of Vacuum Tubes—Undamped Wave Transmission

As the vacuum tube can be used as an energy amplifier, it can be made to generate and sustain oscillations by feeding back upon the grid circuit the energy amplified in the plate circuit. This can be done by electromagnetically or electrostatically (or both) coupling the grid circuit to the plate circuit. Such an arrangement is shown in Fig. 10, where the grid circuit GL_1FG is coupled electromagnetically to the plate circuit PL_2FP by means of the inductances L_1 and L_2 .

If now a small change is produced in the potential of the

grid, a change in plate current involving a greater amount of energy will result. This plate current, flowing through L_2 , will in turn induce an emf. in L_1 of greater magnitude than the original potential change in the grid circuit. This produces a new change in the potential of the grid so that oscillations

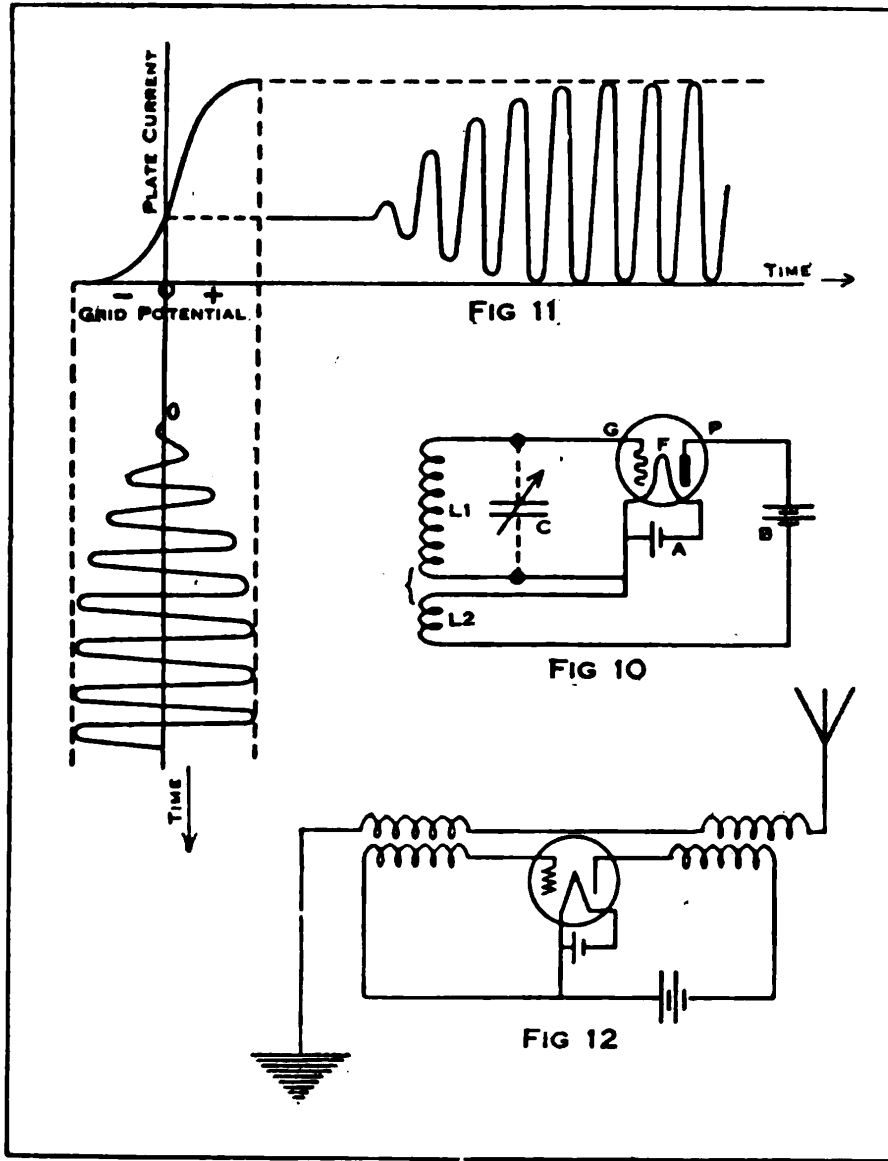

Vacuum Tube Used as Oscillation Generator. Fig. 10—Connection for Undamped Oscillation Generation. Fig. 11—Analysis of Generator Action. Fig. 12—Example of an Undamped Wave Transmitting Set

continue to increase in this manner until the amplitude of the plate current reaches the bends of the characteristic curve of the tube. At this point the oscillations will have reached their final constant amplitude. Fig. 11 is a graphical representation of this phenomenon.

To produce oscillations, it is of course necessary that the values of inductance and capacitance, and the coupling, be chosen of such values that the emf. induced in the grid circuit will be in phase with the alternating component of the plate current. To generate oscillations of any given frequency, it is simply necessary to tune the oscillatory circuit by means of the condenser C, for instance. The circuit L_1C will then oscillate at its natural frequency, and these oscillations will be sustained by the plate current. The oscillator can then be coupled to an antenna and made to induce undamped oscillations in it which will be radiated into space. Such a circuit is shown in Fig. 12, which shows the principle of the SCR-69 set, but there are any number of connections which will enable the use of the three-electrode tube as an oscillation generator. To use such a set as a radio transmitting set, it is simply necessary to insert a sending key at some point of the circuit. Then whenever the key is depressed, the antenna will radiate undamped waves.

Signal Corps Three-Electrode Vacuum Tubes

The three-electrode vacuum tubes used by the Signal Corps have the type numbers VT-1, VT-11, VT-21, VT-14 and VT-2. The first three employ platinum filaments coated with an oxide and they are all used for detection and amplification. They operate at the same constants and have practically the same characteristics, the different designations referring to tubes which have different physical construction and are supplied by three different manufacturers. The VT-2 tube is used for transmitting purposes. The VT-14 tube employs a tungsten filament, and is used for transmitting. It operates with a plate potential of 350 volts, a filament current of 1.75 amp. at 7 to 8 volts, a grid potential of negative 20 volts and delivers 3 watts output.

The detector and amplifier tubes operate with an average filament current of 1.1 amp. at 3.6 volts. The plate voltage averages 20 volts. The grid is maintained at the same potential as the negative filament lead, or slightly more negative.

The VT-2 tube operates with an average filament current of 1.36 amp. at 7 volts, and with a plate voltage of 300 volts. It normally operates with about 20 volts negative potential on the grid. The power output as an oscillation generator is approximately 3 watts.

• The VT-1, VT-2 and VT-14 tubes operate with a dull filament.

The VT-11 and VT-21 tubes operate with extremely bright filaments.

Reception of Undamped Waves

The reception of such signals is different from that of damped wave signals. The principle of damped wave reception is that every wave train, after being rectified, deflects the diaphragm of the telephone receiver, which then between two wave trains, springs back in place. The succession of wave trains then sets the diaphragm into vibration at the spark frequency of the transmitting set.

In undamped wave telegraphy, the oscillations are not divided into wave trains, they are emitted without interruption, and with a constant amplitude, Fig. 13. Hence, the telephone diaphragm is deflected at the beginning of the signal, and so remains until the end of the signal, for the succession of the

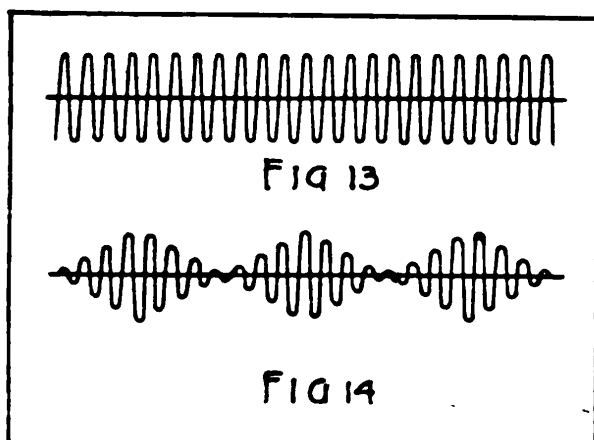

individual waves is so rapid that the diaphragm will not respond to the corresponding high rate of vibration. There is consequently no audible vibration of the diaphragm. However, audible vibrations in the receiver may be obtained by several different methods.

One method consists in utilizing a mechanical interrupter called a "tikker" which is connected in the circuit at the receiving station, in such a way that it periodically interrupts the current through the telephone receivers—the current induced by the incoming radio waves—and thus breaks it up into current-off-and-on periods of a low frequency to which the diaphragm will respond. This method has the disadvantage that all the energy received by the antenna during the current-off periods is lost.

A more recent and better method consists of a scheme for transforming at the receiving station, the continuous waves of constant amplitude into waves the amplitude of which varies periodically, Fig. 14. This end is attained by the application of the phenomenon, familiar in the study of sound wave propa-

gation, called "beats." This is called the "heterodyne" method of reception.

The receiving set is tuned to the frequency of the incoming waves by means of its adjustable inductance coils and condensers. Then, undamped waves of slightly different frequency are generated locally at the receiving station and superimposed upon the oscillations in the detector circuit due to the incoming waves. The result is that the two rectified alternating currents add together algebraically to produce beats in the amplitude of the current through the telephones, of a frequency equal to the difference between the frequencies of the two currents.

Such a set may be constructed by modifying the receiver circuit shown in Fig. 6. It is simply necessary to couple the plate circuit of the detector tube to the grid circuit. The tube then acts simultaneously as a detector for the incoming waves and as a generator for the local undamped oscillations, Fig. 15. Such an arrangement of circuits is called an "autodyne" receiving set.

The frequency of the local oscillations may be changed by adjusting the setting of the condenser C for instance, and this will change the beat frequency and therefore the pitch of the sound in the telephone. A very pure note of any pitch may thus be obtained at the will of the receiving operator. The use of such sets allows exceedingly sharp tuning and practically eliminates all interference from other sending stations.

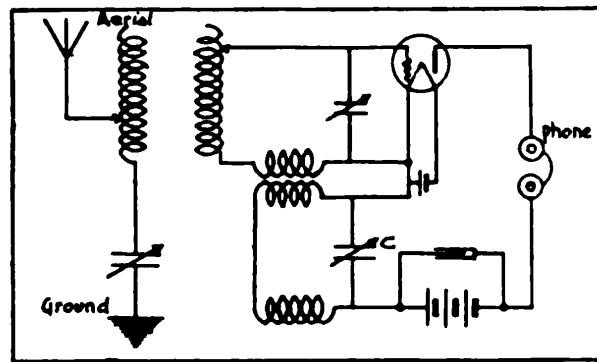

Fig. 15—Schematic Circuit of an Autodyne Receiving Set.

RADIO TELEPHONY

Radio telephony has not thus far been extensively used in the war, although recent developments bid fair to make practical a perhaps very important utilization of this form of radio communication. The principles involved in radio telephonic transmission are the same as for undamped wave telegraphic transmission, except that the sending key is replaced by a device for varying the intensity of the energy radiated to produce sounds at the receiving station corresponding to the inflections and modulations of the voice. The device used for this purpose is the three-electrode vacuum tube so connected in the transmitting oscillatory circuit as to act as a modulator of the outgoing energy. The principles involved in radio telephonic reception are the same as for damped wave telegraphic reception. These principles are explained in the following paragraphs.

Modulator Action of Vacuum Tubes—Radio Telephone Transmission

The three-electrode vacuum tube may be used not only to amplify power, but also to absorb power in a perfectly controllable manner. This may be explained by the characteristic of the tube whereby the space between the plate and filament has a resistance, the magnitude of which is dependent upon the potential of the grid. This was fully shown above in connection with Fig. 5, where, for a given constant plate potential and filament temperature, the plate current was determined by the grid potential. In other words, the action of the vacuum tube may be considered as equivalent to a variable resistance which controls the flow of the current in the plate circuit, the value of this resistance being determined by the potential of the grid.

A common application of this property of the tube is found in radio telephony. For instance, consider the circuit of Fig. 16. The high frequency alternator connected in the antenna circuit generates continuously a high frequency alternating

current of constant amplitude. The antenna is thus made to

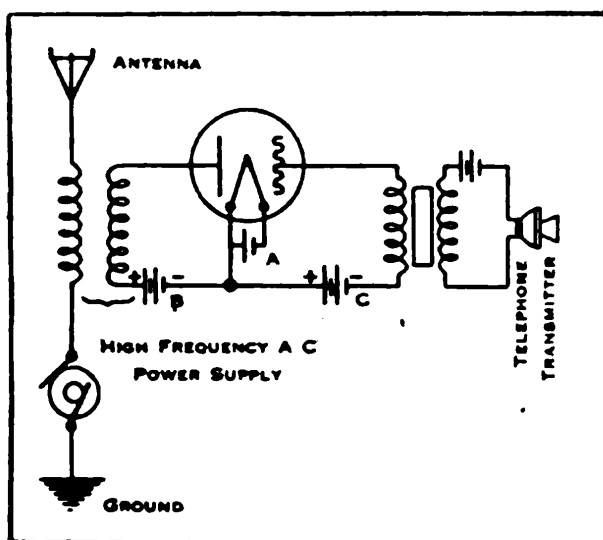

Fig. 16—Three-Electrode Tube Used as Modulator, Showing Connection as Radio Telephone Transmitter

radiate a continuous stream of undamped oscillations. Inductively coupled to the antenna is the plate circuit of a three-electrode vacuum tube, the grid of which is maintained at a considerable negative potential with respect to the filament by means of a battery C. The current passing through the antenna coil induces an emf. in the plate coil coupled to it, and there-

fore a potential difference between the filament and the plate of the tube. But on account of the strongly negative potential of the grid, this emf. produces only a very small current in the plate circuit. In other words, the power transferred from the antenna circuit to the plate circuit of the tube is very small.

Now if the grid is made less negative, or even positive, the same induced emf. in the plate circuit will produce a larger current, so that there will be a larger transfer of energy from the antenna circuit to the tube. The tube will have absorbed power, so to speak, from the antenna circuit. The result of this absorption is that the normal output of the generator is divided between the two circuits in proportion to their impedances, so that part only of the energy normally radiated by the antenna without the reaction of the plate circuit, will now be radiated. The more positive the grid of the tube, the less the resistance to the plate current flow and the greater the power absorbed by the tube, and therefore the less the amount of energy radiated by the antenna.

It is thus possible to modulate the waves radiated by the antenna into any desired shape. By suitably varying the grid potential by means of the voice, through the medium of the ordinary telephone transmitter coupled to the grid circuit, the changes in the instantaneous amounts of energy radiated will be proportional to the inflections of the voice. At the receiving station, the corresponding oscillations, when rectified, will

have a shape or "envelope" molded to the transmitting speech, and they will therefore induce in the telephone receivers a unidirectional pulsating current similar to that in the ordinary wire telephone which will exactly reproduce the sound of the voice at the sending station.

The vacuum tube may be used not only to modulate the a.c. power output of the high frequency a.c. generator, as explained in the previous paragraph, but to modulate the d.c. supply to that generator, thus accomplishing in another way the same final result—the modulation of the antenna output. This is the scheme of modulation commonly used by the U. S. Signal Corps, the a.c. generator being a vacuum tube oscillator. The modulator tube is connected in parallel with the oscillator tube, across the d.c. supply and the telephone transmitter is connected to the primary of a transformer, the secondary of which is connected in the grid circuit of the modulator tube. As the resistance of the modulator tube is changed by the voice, the amount of d.c. power to be transformed into a.c. power by the oscillator tube will be correspondingly modulated. For fuller explanation, see Radio Pamphlet No. 20.

Prepared in the
Office of the Chief Signal Officer
Training Section
Washington
