

623.7  
Un36m  
1905

MANUAL  
OF  
VISUAL SIGNALING  
U. S. SIGNAL CORPS  
—  
1905

Original from  
UNIVERSITY OF ILLINOIS AT  
URBANA-CHAMPAIGN

Digitized by Google



UNIVERSITY OF ILLINOIS  
LIBRARY

BOOK	CLASS	VOLUME
623.7	Un36m	1905

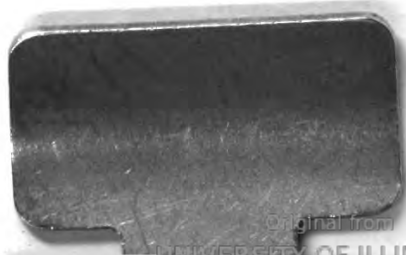

(Manual No. 6)



MANUAL OF VISUAL SIGNALING  
OF THE  
U. S. SIGNAL CORPS



Prepared under the direction of  
BRIGADIER-GENERAL A. W. GREELY  
CHIEF SIGNAL OFFICER, U. S. ARMY

by  
CAPTAIN D. J. CARR  
SIGNAL CORPS

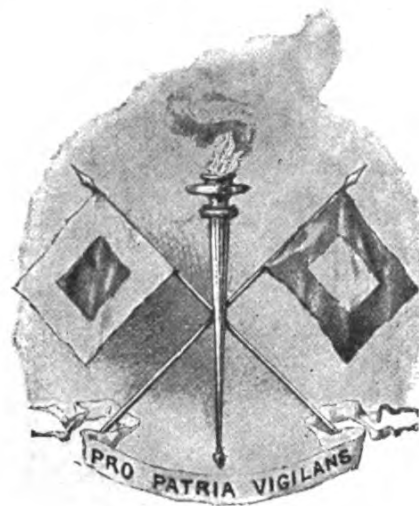

WASHINGTON  
GOVERNMENT PRINTING OFFICE  
1905

623, 7  
Un 36m  
1935

215051222

WAR DEPARTMENT,  
SIGNAL OFFICE,  
*Washington, October 25, 1904.*

The following Manual of Visual Signaling will replace all other pamphlets or similar instructions heretofore issued by this office. Officers and men of the Signal Corps will thoroughly familiarize themselves with the instructions and suggestions contained herein.

It is recognized that the duties devolving upon the Signal Corps of maintaining lines of information pertain very largely to electrical means of intercommunication. There is not, however, a proper realization of the importance of visual signaling as a means of transmitting orders and information. While, as a rule, visual appliances are growing to be subordinate methods of conveying information, yet, in the future, as in the past, the flag, the heliograph, and the lantern must often be indispensable and invaluable methods of signaling.

The Chief Signal Officer of the Army, therefore, enjoins upon the officers and men of the Signal Corps the necessity of acquiring a thorough practical knowledge of visual signaling as the base of signal duty. Every officer and noncommissioned officer should be so trained that he can properly locate signal stations, personally transmit and receive messages by heliograph, flag, lantern, or other method, and devise preconcerted message codes.

(3)

He should also be thoroughly familiar with the use of the War Department and other military codes, so that in critical periods he can insure secrecy in visual messages by suitable use of codes or ciphers.

Military information, whether in the form of reports or orders, is recognized as absolutely indispensable to successful military operations, and the value of such information largely depends on the speed and accuracy of its transmission.

Visual signaling presents a great field for individual and resourceful work in the transmission of such information, and a thorough and careful study of this manual will furnish the theoretical basis on which practical operations may be successfully prosecuted.

A. W. GREELY,  
*Brigadier-General,*  
*Chief Signal Officer, U. S. Army.*

Approved.

ROBERT SHAW OLIVER,  
*Acting Secretary of War.*

## TABLE OF CONTENTS.

---

### CHAPTER I.—*Visual signaling.*

	Page.
Equation of arrangements.....	16
General instructions .....	18
Signal practice.....	19
Selecting location for a signal station.....	20
Concealing the location of a signal station .....	28
Table of distances at which signals may be discerned.....	28
To establish a line of communicating stations .....	30
Finding a station .....	34
The Army and Navy Signal Code .....	41
Flash signals with acetylene lantern, heliograph or search-light.....	42
Order in which a message is transmitted.....	42

### CHAPTER II.—*General instructions for operating stations.*

Duties of each man on a station.....	46
Instructions to signal officers making reports .....	54
To make a reconnaissance of a battlefield.....	56
Repeating back a message.....	57
Repeating stations .....	59
Checking message .....	60
Care of signaling apparatus.....	62

### CHAPTER III.—*Day signaling apparatus.*

The heliograph.....	63
Ranges accomplished .....	66
Setting up and operating the heliograph.....	75
Suggestions for operating and caring for the heliograph....	80
To reduce the intensity of flash for short distances .....	82

CHAPTER III.—*Day signaling apparatus*—Continued.

	Page.
Formula for determining the intervisibility of stations . . . .	84
The flag . . . . .	88
How to place the flagman . . . . .	90
Miscellaneous day signaling . . . . .	91
Smoke signals . . . . .	92
The semaphore . . . . .	93
International Code . . . . .	94
Distant signals . . . . .	95
Example of a signal made by distant signals . . . . .	101
The Continental Telegraph Code . . . . .	102
Chronosemic signals . . . . .	104

CHAPTER IV.—*Night signaling.*

The searchlight . . . . .	106
Methods of gas generation . . . . .	109
Lanterns . . . . .	110
The field lantern . . . . .	111
Description of generator . . . . .	113
Directions for operation and care of the field lantern . . . . .	116
The station signaling lantern . . . . .	120
How the gas is automatically generated . . . . .	125
Directions for operating the lantern . . . . .	128
The torch . . . . .	134
Rockets and bombs . . . . .	140
Rocket signaling . . . . .	142
Miscellaneous night signaling . . . . .	144
The Ardois system . . . . .	145
Special signification of Ardois signals . . . . .	157
Coston signals . . . . .	159
The Very system . . . . .	159

CHAPTER V.—*Compasses.*

Magnetic compasses . . . . .	160
The prismatic compass . . . . .	162

CHAPTER VI.—*Field glasses and telescopes.*

	Page.
Field glasses.....	164
Telescopes.....	172
To determine the power of telescopes .....	173
Telescope holders.....	175
Distance measuring glasses .....	177
The telemeter field glass .....	180
Porro prisms field glasses and telescopes.....	180

CHAPTER VII.—*Codes and cipher.*

Preconcerted message codes .....	183
Cable cipher code.....	192
Cipher key numbers .....	194
Examples of enciphering .....	194
Ciphers .....	196
The cipher disk .....	198
Enciphering by the alphabetical square .....	202
Deciphering messages .....	205



## LIST OF ILLUSTRATIONS.

---

	Page.
Fig. 1. Field signal station .....	21
2. "Initial position" (flag signaling) .....	35
3. Motion "1" (flag signaling) .....	39
4. Motion "2" (flag signaling) .....	40
5. Heliograph station .....	47
6. Mirror and mirror bar case .....	73
7. Heliograph tripods .....	74
8. Heliograph in use with one mirror .....	76
9. Heliograph in use with two mirrors .....	77
10. General alphabetical table for making the inter- national code signals by means of distant signals by fixed semaphore .....	97
11. General alphabetical table for making the inter- national code signals by means of distant signals by shapes .....	98
12. Distant signals .....	99
13. Distant signals .....	99
14. Distant signals .....	99
15. Distant signals .....	100
16. Distant signals .....	100
17. Example of a signal from the International Code made by a fixed semaphore or by distant signals.	101
18. The field lantern .....	111
19. Field signal lantern without tripod .....	112
20. Generator with cartridge in place, sectional view ..	114
21. Lamp showing regulator by-pass valve .....	116
22. Removing top of generator .....	117
23. Placing cartridge in generator .....	117
24. Attaching cartridge to generator .....	118
25. Telegraphic key for signaling with flash lantern ..	118
26. Station signaling lantern, showing telescoping sight- ing tube .....	121

	Page.
Fig. 27. Station signaling lantern, showing insulated handle.	122
28. Station signaling lantern, front view .....	123
29. Station signaling lantern, rear view .....	124
30. Key for station signaling lamp.....	126
31. Cases containing station signaling lantern packed for transportation.....	127
32. Parts of generator.....	128
33. Reading lamp or station lamp.....	129
34. Keyboard for night signal set, Ardois system.....	145
35. Keyboard for night signal set, Ardois system, show- ing receptacles for cables .....	146
36. Keyboard with cover and lamp .....	147
37. Mechanism of keyboard.....	148
38. Diagram of connections of night-signal set.....	149
39. Receptacle and plug .....	150
40. Wiring diagram of truck lights .....	154
41. Truck-light controller .....	155
42. A hoist.....	156
43. Ardois system in use.....	156
44. Telescope holder in position .....	176
45. Prism system.....	181
46. Cipher disk .....	196

---

## P R E F A C E .

---

Attempt has not been made to herein trace the development of the art of visual signaling, records of which reach back to half a century before the Christian era. Instead, the intent has been to succinctly describe methods in use to-day and to offer such suggestions and instructions as experience has shown to be desirable or necessary.

No claim is made for original matter in this manual. It is gleaned from Myer's Manual of Signals, the annual reports of the Chief Signal Officer of the Army, from the International Code of Signals, in fact from all available sources, and is arranged in such a manner as will, it is hoped, be of some aid to those whose duty it is to be skilled in latter-day methods of visual inter-communication.

I desire to express my appreciation of the assistance rendered me by officers of the Signal Corps, and especially to the Chief Signal Officer, Brig. Gen. A. W. Greely, for data and general information regarding the earlier history and development of heliographs and other visual signaling apparatus now in use by the Signal Corps.

D. J. CARR,  
*Captain, Signal Corps.*

(11)

# MANUAL OF VISUAL SIGNALING OF THE U. S. SIGNAL CORPS.

---

## INTRODUCTION.

The comparatively recent development of electrical instruments, materials, and appliances for purposes of communication has materially lessened the need for visual signaling. The cumbersome dial telegraph, which was used on the battlefield for the first time in the civil war in the United States, has given way to the portable kits of the Signal Corps, connected, if need be, by insulated wire slightly thicker than a thread, which answer admirably all requirements over a line hundreds of miles long, lying on the ground or thrown over fences or trees. Contrasting past and present methods, we now have telephonic and telegraphic instruments, used singly and in combination, that increase more than twentyfold the efficiency of the individual. While in consequence of electrical inventions and improvements visual signaling is now less frequently resorted to for the transmission of military messages in time of war, it should be appreciated that the necessity for skilled manipulators and adequate visual signaling apparatus has in no wise diminished. Although relatively greater improvement has been made in instruments for electrical communication, yet

(13)

the heliograph for day and the acetylene for night mark advances nearly as great as are shown in electrical appliances now in use.

While the employment of visual signals is restricted by distance and by atmospheric conditions, there are occasions when no other means of transmitting information is practicable, and where its use will be of the greatest importance. This is especially true in invested positions; between lateral columns on a march; where the terrain is such as to preclude the laying of wires for electrical communication; between outposts and the main body; on reconnaissances, and between detached portions and the main body of a command.

That the visual signaler has had the task of justifying his professional existence under most adverse conditions has been the common experience in the Army of the United States. Like other innovations the system has had incredulity to overcome, while failure to accomplish the impossible has been advanced as an argument against its usefulness. The limitations under which all visual signaling must be conducted should be well understood. For instance, when the sky is overcast the heliograph is of value to transmit messages only so far as artificial light may be reflected by it, yet on a clear day its flash has been read at a distance of 186 miles.

If a light fog prevents the flag being read at a distance of a mile, it should be remembered that messages of vital importance, affecting the success of a campaign, have been transmitted by it over a score of miles. Because a signaler may be given a message of hundreds of words to transmit to a station 5 or 6 miles distant,

the sending of which visually will consume an hour or more, the system should not be held worthless because of the failure of the responsible officer to understand that the message could be delivered at its destination by a mounted orderly in less than half the time required to send it by flag, heliograph, or lantern. Quite as bad judgment would be shown by sending a mounted carrier, over a like distance, with a message of ten words that the flagman could send to its destination in the time needful to saddle and bridle the orderly's horse. The correct and economical use of visual signaling is preeminently one of good judgment, and the efficient signal officer will use always the means available for the most expeditious delivery of information or messages with the transmission of which he is charged.

## CHAPTER I.

### VISUAL SIGNALING.

When it is desired to establish communication between two or more places, and conditions are such as to preclude the use of sound as a transmitting medium, resort must be had to visual signaling in one form or other. Whether each word is to be transmitted letter by letter or words and sentences arbitrarily indicated by some signal, must determine the method to be employed.

When it is necessary or desirable to spell out each word of a message, instruments or appliances for making transient signals are employed, as the heliograph, the flag, flash lantern, the "Ardois," or similar system. These different methods are mentioned as being those

generally distinguishing messages transmitted letter by letter and those expressed by empirical signs. While either of these appliances may be used for transmitting messages by the International Code—which will be described later—flags of different shapes and colors are employed for this purpose when available.

So it may be said that visual signals are either transient or permanent—transient when each signal disappears as soon as made; permanent when the signal remains for a time in view, as when flags are kept hoisted to be read, or a symbol is retained in a certain position. All systems of signals are based upon the principle that having a certain number of elementary signals, each in some way distinguishable from the other, they are made to appear singly or together in all possible arrangements and combinations necessary to form other signals.

It may be necessary to know the number of signals that can be made with any given number of available elementary signals where the elementary signal is used only once in each display or where it may be used repeatedly up to the given number of places in the signal which it is desired to display. Under these conditions the possible number of different signals may be determined from the rules for the equation of arrangements.

#### EQUATION OF ARRANGEMENTS.

A number of elementary signals being given, and it being permitted to use any arrangement of these signals and any repetition of any one or more of them in any signal, to find how many signals of any class,

that is, of a given number of places, can be made with these signals—

*Rule:* Take the whole number of elementary signals and multiply it continually by itself so many times less 1 as there are places in the required signal, or raise the given number of elementary signals to that power of which the number of places to be in the required signals shall be the exponent.

*Example:* Using three elementary signals and repeating any one as often as desired in any combination signal, how many signals of *four places*, or the fourth class, may be made?

*Answer:*  $3 \times 3 \times 3 \times 3 = 81$ , or  $3^4 = 81$ .

Any certain number of elementary signals being given, to find how many different signals of *all classes* can be made, using all of the elements at a time or any one of them, or any repetition of one or more of them in any signal, the limit being fixed only by the largest number of signals to appear in one display—

*Rule:* Find the number of signals of each class which can be made with the given elementary signals up to and including those of the limiting class; add these numbers together and the sum will be the answer.

*Example:* If there are two elementary signals, such as two kinds of motions, one to the right and one to the left from a fixed point, how many signals can be made, using not more than four motions for any signal?

*Answer:*

Of the first class .....	2
Of the second class, $2 \times 2$ .....	4
Of the third class, $2 \times 2 \times 2$ .....	8
Of the fourth class, $2 \times 2 \times 2 \times 2$ .....	16
	30

10495—05—2



The General Service Code alphabet of the Army and Navy of the United States is one of two elements and four places. It will be seen that of the 30 possible signals 28 are used.

#### GENERAL INSTRUCTIONS.

A signal officer should provide himself and the parties working under him with the latest and most accurate topographic maps of the country in which the army is operating. This is especially important when in unfamiliar country.

The United States Coast and Geodetic Survey and the United States Geological Survey issue maps showing points of intervisibility in the United States; these should be closely studied by officers detailed for field work who are unfamiliar with the topography of the country where serving.

A signal officer responsible for the maintenance of communication between the outposts of a command and the main body should familiarize himself with and instruct his subordinates as to the location of each signal station, so that information can be promptly transmitted.

If the topography of the country is such that the advance guard loses sight of the main column, the signal officer on duty should see that intermediate or relay stations are provided, in order that information gathered will suffer the least delay in reaching its destination.

While such information may be of the utmost value, it should be remembered that secrecy in communicating it may be vitally important; for even though the

code used is unknown to the enemy, yet the waving flag—or such other means of visual signaling as may be employed—will inform the enemy that he has probably been observed. This should be avoided, if possible, and stations selected the location of which will be difficult of discovery by the enemy. If there is reason to believe that signals are seen by the enemy, they should be made only upon the expressed authorization of the signal officer charged with the duty of the maintenance of communication, and under such conditions resort should always be had to cipher.

#### SIGNAL PRACTICE.

Full efficiency of the signaler can be maintained only through constant practice, and those in charge of parties should see that men are entirely proficient, and that sufficient practice be had as will insure that accuracy and rapidity in handling messages which is so essential in time of war.

Instructions should commence with the study of the principles of signaling and the theories of their general use, and the pupil should be well grounded in this study before practice is begun. He should so memorize the alphabets to be used that no letter combination will require thought to determine its meaning.

Wand practice is an excellent way in which to acquire proficiency in reading and receiving messages. The wand is a round stick of light wood 18 inches long and one-half inch in diameter, held loosely between the thumb and forefinger, and waved rapidly to the right and left to indicate the “1” and “2” of the code. A few hours' practice each day for a week with the wand

will enable one to read the flag as rapidly as it can be waved, and under very adverse conditions flag signals can be read that without the proficiency gained through wand practice could not be distinguished. This practice should be had at a distance of 10 or 12 feet between the sender and receiver.

One should not be considered proficient in flag-signaling who is unable to correctly read from a 2-foot flag at a distance of 20 yards the letters of the alphabet, numerals, and the authorized abbreviations sent as rapidly as accuracy will permit and without regard to order or sequence. In proportion as this drill is thorough will be the subsequent skill of the student.

Practice should be had in rapidly repeating signals as they are made and in sending and receiving messages by signals in cipher and in using the cipher disk.

The recruit should be drilled in rapidly repeating signals as they are made to him, and very thoroughly in sending and receiving messages by signals in cipher, in using the cipher disk, and in working much more rapidly with the wand or practice flag than is practicable in the field.

#### SELECTING THE LOCATION OF A SIGNAL STATION.

To select a visual signal station, choose a point perfectly in view of the communicating station, or stations, fix the exact position in which the flagman is to stand; so arrange, if possible, that he will have behind him, when viewed from the communicating station, a background of the same color for every position in which the signals may be shown. The color of a background of a station is that against which the signals

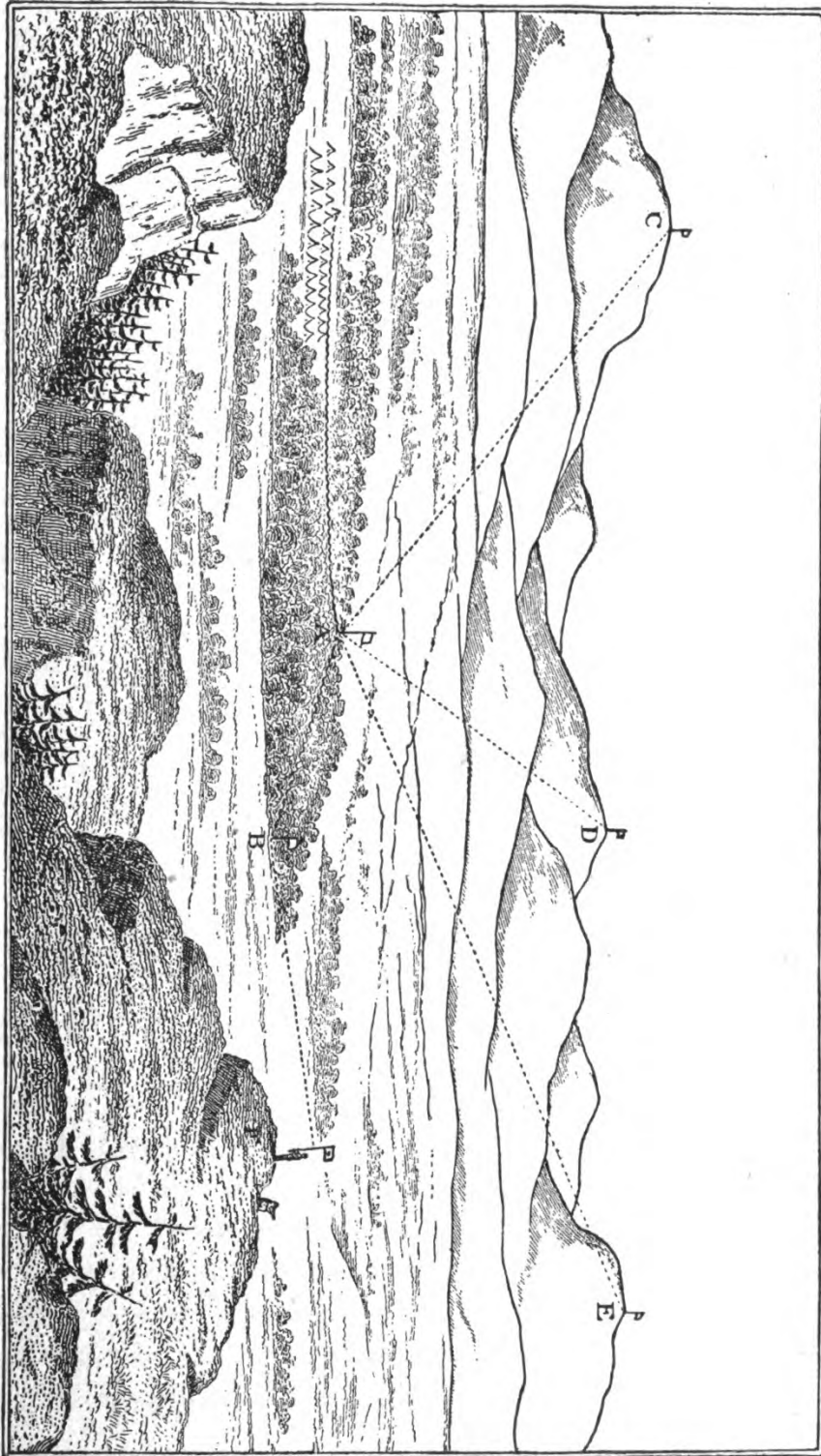

FIG. 1.—Field signal station.

made seem to be displayed when viewed from the communicating station.

To determine the color of the background, take the direction of the communicating station, and, going in front of your station, examine the position from that direction; ascertain whether the communicating station is higher, lower, or on a level with your own. If it is higher, the background for your signals, viewed thence, will be the color of the fields, woods, etc., behind and lower than your flagmen. If it is lower, your background will be the color of the grounds, etc., behind and lying higher than your flagman. If the stations are of equal elevation, then the background for your signals will be that directly behind the flagman.

Or, take a straight pole 18 or 20 feet long, or if a pole is not available stretch taut a string, and at a height of 4 feet above the ground, and from a point where your signals are displayed, direct the far end upon the distant station; then going to the distant end of the pole or string, sight along it and note the background toward which the other end of the pole or string points; this will be the background for the distant station.

Time is frequently lost in an endeavor to open communication with a distant station before determining whether the background is of such character that a signal sent from it will be visible at the distant station. The time given to intelligent selection of a station will be more than made up and compensated for by the fact that subsequent changes will not be required.

Use the white or red flag, or both, as seems best, until the color of the background is determined. Observe whether the background is broken; that is,

whether in part of its motion the flag or other signal displays on light and in part on dark ground, as if, for instance, for half its motion it shows against the trees and for the other half against a white house; or if, for part of the motion, it shows against the sky and for the rest against trees and select, if possible, a background of uniform color.

A signalist, observing from an elevated station and finding his own view of the communicating station uninterrupted, may be led to imagine that the station on which he stands is entirely visible from the communicating station, when in fact it is not. Thus a person from the top of a house may think the whole house is in view from the observing station, when in fact nothing but the roof can be seen. Or located behind a ridge the signalist may think his whole station in good view, when, because of intervening hills, his head only is visible.

Do not presume the background is of the color of the fields near you. It may be that of the woods a long distance, sometimes miles, behind your station. If your station is on a house or an eminence it is still very possible that there are higher grounds somewhere behind it. Backgrounds are generally dark. Sky-exposure backgrounds are rare. They are not often found at long ranges. They can be had only when stations are on the exact crest of ridges or lands which bound the horizon of view from the other station, or on the apex of mountains, etc. At short ranges they may be had by working on the tops of high buildings, steeples, etc.

While it is difficult, especially at long distances, to

procure sky backgrounds, these, when practicable and safe, are desirable; they admit of greater speed and by strong contrast decrease liability of error in reading.

In the same way, when there are temporary interruptions, as often happens from clouds passing the sun, a sky exposure secured for the obscured station will render visible the signals there displayed.

The background being determined, the choice of flags is fixed. The color of the flag must contrast as strongly as possible with that of the background. Upon this contrast the visibility of the signals greatly depends.

With green or dark, or with earth-covered backgrounds, the white flag should be used. With a sky exposure, or with broken or mixed backgrounds, the red flag should be used.

Avoid if you can a station where a camp is located between it and the distant station, as the intervening lights will generally cause annoyance and delay.

If it be desired to conceal the signals on the right or left flanks of the sending stations a shield may be built or constructed of limbs of trees, etc., on either side, 20 or 30 feet from and extending 10 feet beyond and behind the center of the station.

If entire concealment of the station is necessary, give full consideration to the point selected, as failure to do so may be fraught with serious consequences. While it may be necessary, in making the situation of a station known, to temporarily use the sky line for the background, yet in the presence of the enemy or where there is a reason to fear your signals will be seen by him, having established communication, advantage will

be taken of less prominent and visually desirable positions, even at the cost of the difficulty of having signals easily read.

Communicating stations should not, when it can be avoided, be located exactly on an east and west line or the line of the apparent course of the sun. The station, which is in the direction from which the sun shines in any part of its course, is very liable to seem to be enveloped in a haze, and the telescope, if turned upon it, is filled with a dazzling light.

The landscape is often seen as perfectly clear and signals are plainly visible in every direction excepting toward the rising or setting sun. It is better, therefore, that a line connecting the stations should obliquely cross the apparent course of the sun, and care should be taken to so arrange them. If that can not be done, the stations lying in the apparent course of the sun should be so located that they may have a sky exposure when viewed from the communicating station. This obviates, to a very great extent, the difficulty of sun haze; and whenever that difficulty exists, effort should at once be made to secure a sky exposure.

The first essential—complete visibility of signals between stations—being provided, stations should be selected so that messages may be readily carried to them. Do not establish stations far from commonly traveled roads, unless there be reasons in the physical contour of the country or otherwise for such location.

A station should never be located in a camp, or among tents, or where white canvas tents form the background of signals viewed from the other station. The passage of squads of men in an encamp-



ment, the smoke from the numerous cook-fires, the dust thrown up by marching troops or trains, the curiosity of persons not attached to the station make a camp the most unsuitable locality for a signal station. The difficulties are increased at night by the glare of the numerous fires apt to be kindled between the communicating stations; the smoke that, then more heavily than in the day rests over the quarters; and the almost impossibility of distinguishing, at great distances, the signal torches or lights from the changing lights of the encampment. Remember that at a distance of 5 miles between stations lights 25 feet to the right or left of a line connecting the two stations will blend with the light of the lantern or torch, and so prevent signals being read. Avoid as far as possible placing signal stations with traveled roads between them, remembering that smoke, dust, lights, etc., are factors to be considered in determining the visibility of signals. The point chosen ought to be one sufficiently near the headquarters of the general commanding, but outside of camp, and on one side of it, on some clearly visible spot, and with as few encampments between it and the communicating station as possible.

Red lights or rockets should be kept at stations to mark the exact position of that station if the communicating station is very far distant and the officers at it liable to be confused by the number of lights and fires in the vicinity of the station.

Signal stations should be located at as great an altitude as possible, especially when there is difficulty about smoke, haze, or dust. The undulation of the atmosphere noticeable on a hot summer's day is always

less at a distance from the earth's surface. Thus it is sometimes practicable to read signals from a tree or a housetop when it is almost impossible to read from the ground. This air undulation is less also over spots well shaded than in the glare of the sun. This should be borne in mind in all telescopic examinations. Another good reason for locating permanent stations at as great a height as practicable is because the cool night air, the smoke and dust of the day, and heavy mists lie close to the ground, filling the depressions and obscuring low lands, while the higher points remain in view. By careful selections of high ground, stations can often be worked when signals on the lower fields would be inadvisable. For these reasons it is occasionally advantageous to have a station for night work on a housetop or in a tree, while during the day the station is operated from the ground.

It will sometimes be found possible to signal between elevated peaks, when all the landscape of the lower country is deeply buried in a fog; and conversely, a peak will sometimes be wrapped in clouds when lower down the view is unobstructed. In the former case messages may be sent by ascending to mountain summits, and in the latter case, by descending so as to be below the cloud stratum.

When high winds interfere with the proper display of signals the station should be established in the lee of a grove or sheltered by a house or hill.

Under equal conditions, if there be choice between open, conical hills, and flat-topped, gently rising hills, the former should be selected upon which to establish the station, as such location will probably give a

sky background. A station having been decided upon, and communication having been had with other stations, the position of this station will not be changed until information has been given to all other stations with which communication has been had that such change is to be made.

The following table shows the extent of horizon for different heights above the sea level—that is, it shows how far one can see an object which is itself at the level of the sea:

Height of the eye above sea level.	Distance, in statute miles.	Height of the eye above sea level.	Distance, in statute miles.
10 feet .....	4	115 feet .....	14
15 feet .....	5	130 feet .....	15
20 feet .....	6	150 feet .....	16
30 feet .....	7	200 feet .....	18
40 feet .....	8	230 feet .....	20
50 feet .....	9	300 feet .....	23
60 feet .....	10	350 feet .....	25
70 feet .....	11	500 feet .....	30
85 feet .....	12	700 feet .....	35
100 feet .....	13	900 feet .....	40

Hence, an observer whose eye is 30 feet above the sea can distinguish an object 7 miles distant, provided it is at the sea level; but if the object is itself 15 feet above the sea he can make it out  $7 + 5 = 12$  miles off.

#### TO ESTABLISH A LINE OF COMMUNICATING STATIONS.

To establish a line of stations, first choose some prominent position and establish the initial station. The parties for each station should assemble here. At the first station erect a beacon—as a white or other colored signal flag, by which it can be recognized from a distance; the second station is selected in the line

of direction you wish to take. Now, from this first point, determine the compass bearing of the point selected. This second station should be one not only visible from the initial point, but one also in view from positions beyond it. Note should be made of some peculiar house, rock, tree, or other marked object upon it, in order that the exact place may be recognized when it is reached. At the first point now marked by its beacon, station a signal party to reply to signals and to watch the course of the marching party. The others will then move, guided by compass, if need be, toward the second point selected, carrying a signal flag flying, in order that their position may be seen from the first station. The marching party will, from time to time, put itself in communication with the station next in rear, so as to receive directions as to its course, or other information. It will frequently verify its course by compass. On reaching the point chosen for the second station, a beacon or flag will be there erected, and communication will be opened with the first station. Points on either side or to the rear will be examined to see if the second station can be better located than it is, with reference to a third station to be next established. The second station will then be definitely established and marked, and its complement of men stationed to watch the marching party. The point for the third station will be chosen, and the party will proceed toward it with the same general rules as before. These operations will be repeated in the case of each station until the terminal station is reached. Attempts will be afterwards made to reduce the number of inter-

mediate stations by finding other and better points at which to locate some of them.

Should an officer, while establishing a line, and before it is completed, find, on reaching any station, that he is able to communicate over any of the intermediate stations between himself and the first, he will notify the unnecessary station of the fact; not, however, until he has both received and sent messages over it to some other station. Upon receiving orders, the needless station will, after notifying interested stations, abandon it and proceed where ordered.

#### FINDING A STATION.

To find a signaller near any known station, note with the unaided eye some prominent landmark near which the looked-for person or object is supposed to be, and direct the telescope upon the place, as sight is taken over a gun barrel, covering the object; if the eye is now placed at the eyeglass of the telescope, the prominent or directing landmark will be found in the field of view. It will be easy then to scale the country near the marker until the signaller is found. This method is often necessary at night, when only a point of light is seen far off through the darkness, and the telescope must be turned upon it. When the compass bearing of the object sought for is known, the telescope may be aligned by a line drawn with the proper compass bearing. Commencing then with the view at the horizon, the telescope is slowly moved from side to side, taking in fresh fields of view each time a little nearer to the observer, until the whole country shall have been observed from the horizon to quite near the

station. When the general direction only of the object can be given and it is sought for, the whole landscape in that direction to the horizon should be divided into sections by imaginary lines, the limits of these sections being bounded between visible landmarks through which the bounding lines are supposed to pass. Each section should be scrutinized little by little, until the glass has been passed over every spot. Such search will seldom fail to be successful. It must be systematic.

Practice should be had with the telescope in rapidly bringing objects into the field of view, the glass being held in the hands. Great facility in bringing objects within the field of view can soon be acquired as the eye becomes educated to a remarkable keenness of vision by continued practice. Observations can often be made with such rests as the shoulder of a man or over the back of a saddled horse, or with a stick resting on the ground and held in the hand to steady the telescope.

The magnetic bearings of all stations with which another station has worked should be carefully noted and made matter of record in the office directly concerned, so that advantageous use may be made of this data. In addition, guide lines may be established by driving two stakes firmly into the ground and close to each other. A prolongation of a line through the center of one post and marked on the adjacent one will strike the distant station. Under each line should be written the name of the station which it marks.

Detachments carrying only flags and staffs with which to establish communication with home stations have advantageously used common pocket mirrors to attract the attention when the waving flag had failed,

so it should be borne in mind that the station with which it is desired to establish communication may be attracted in various ways, as, for instance, by the use of puffs of smoke.

At times nothing more definite than that a signal station will be opened in some part of the country overlooked from a given station may be known; or that a party has been sent in a certain direction and that he will try, from some points in that direction, to open communication. Such stations must be as prominently placed as possible; on hilltops or in the center of open fields, etc. Endeavor should be made to locate the station near some prominent object which would naturally attract the attention of the observing station.

Signalers upon permanent or semipermanent stations will examine, from time to time, every prominent point within signal distance, to see if communication is attempted therefrom.

A station which has difficulty in making itself visible will probably be discovered if moved near to where the artillery is firing, the attention of the observer being drawn to the report and the smoke of the guns, but the location should be such that the smoke will not hide the signals from view. Under such conditions the largest white and red flags should be displayed together upon the signal staff; and these should be kept in motion, swinging from side to side, near the point from which the smoke rises, while it is rising and for sometime after, in order that the glass at the observing station, turned upon the smoke, may find the flag thus moving in its field of view. When the attempt to attract the attention of the observing station

is to be long continued, a large flag should be fastened to a second staff and kept hoisted in some prominent position, the pole being fastened to a fence corner, or to a stake driven into the ground, or placed in the center of a cache of stones.

At night a camp fire may be used to attract attention by flashing it, and so distinguishing it from other fires. This is done by causing two men to hold a blanket spread before it—that is, between it and the observing station—and to raise and lower this blanket every two seconds, the intermittent light thus made being more readily distinguished than a steady light.

Attempts to attract the attention of a station, in order to be successful, must be persistent. They should never be abandoned until every device has been exhausted, and they should be renewed and continued at different hours of the day and night. It must be remembered that efforts which have failed because the observer's attention has been drawn in another direction may at any other moment be successful if the observing glass chances to bear on the calling signals.

During the whole time that signals are being made to attract attention the calling station must watch closely with the telescope the station called. The watch should not be relaxed until communication is established. It can never be known at what moment the observing station may first have sight of or be ready to reply to the signals seen. Should the efforts of the calling station be successful in attracting the attention of the observing station, the latter should reply at once with signals of recognition and a brief message, as "I see you." The observing station should

10495—05—3



take care to keep a signal flag flying continuously, so as to afford a marked point to the sought-for station and to indicate that some one is on duty and at the glass.

It not infrequently happens that two stations are in quest of each other. In this case each should seek dominant points or places in view of dominant points and thence endeavor to open communication. It should be a general rule in all such cases that at certain agreed hours, as at 6 a. m., 9 a. m., noon, 3 p. m., 6 p. m., 9 p. m., midnight, etc., each party shall be at some prominent point seeking for the other, or shall make signals agreed upon, wherever they may be, for, say, fifteen minutes.

This rule of signaling at predetermined hours applies to all attempts to open communication. Timepieces should, if practicable, be adjusted together.

#### ARMY AND NAVY SIGNAL CODE.

Anything of which the sense of sight may take cognizance may be used as a visual signal. A class of signals is all of those signals to make which the same number of signs must be used; that is, all signals of the same number of places are signals of the same class; "121," "211," "222" are all signals of three places, or the third class.

A combination signal may be an elementary signal repeated several times, or it may be an elementary signal joined to other elementary signals. For instance, in the signal "1121" representing in the General-Service Code "W," there are two elementary signals, the symbols "1" and "2." This signal is therefore one of

two elements. So "2222" is a signal of one element and four places; that is, the one element is made four times.

The waving flag, while one of the most primitive, is, under certain conditions, a very effective means of attracting attention.

If we want to catch the attention of an individual whose station was not connected electrically with our own, and who is so far distant from us that the voice or other ordinary audible sounds could not reach him, recourse would necessarily be had to such means as might be at hand for the purpose. Assuming, then, that the attention of the individual at a distant station has been secured, it is evident that unless we can transmit the letters of the alphabet, and that they will be understood by the distant station, only comparatively few messages can be ex-

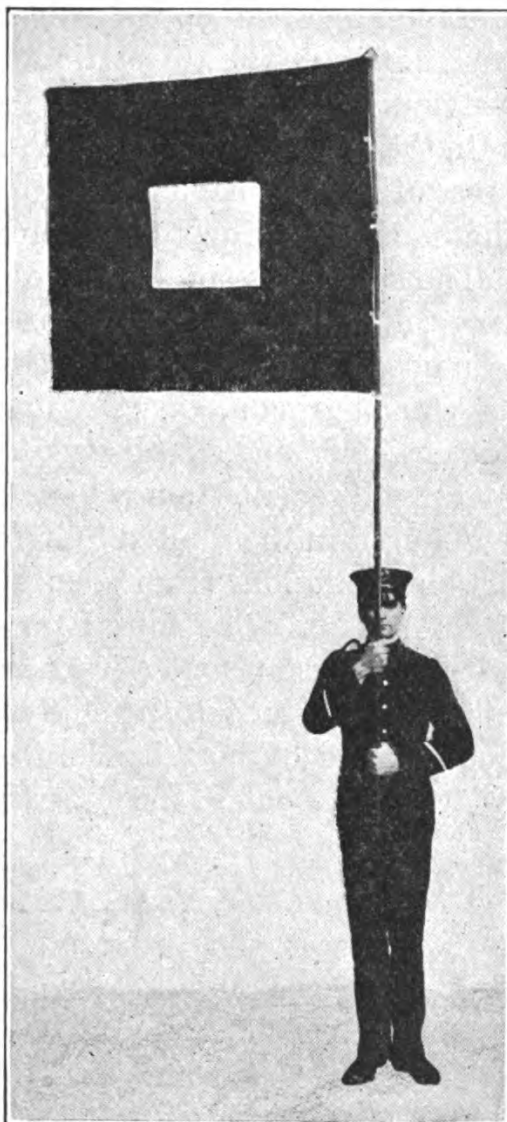

FIG. 2.—“Initial position.”

changed, and these must necessarily be prearranged and preconcerted. If, however, by certain motions of our flag we can represent the letters of the alphabet and the numerals, no difficulty will be experienced in transmitting any information which we may desire to convey.

In the earliest wars of which record exists the importance of the commander being able to communicate with the units of his force has been recognized.

The semaphore of Chappee pointed, since 1740, the way to the solution of the problem, yet until 1858 it was unsolved. In that year Gen. Albert J. Myer, then assistant surgeon, U. S. Army, devised the alphabet, the efficiency and simplicity of which is attested by the fact that it remains to-day, practically, as he then gave it.

As used in the United States Army and Navy, there are three motions from one position for signaling with a single flag. The initial position of the flagman is with the flagstaff held perpendicular and directly above his head, the butt of the staff at the height of the waist and grasped by both hands, the hands separated from each other about 18 inches. (See fig. 2.)

*The Myer system for United States Army and Navy signaling (prescribed by General Orders, No. 32, Adjutant-General's Office, 1895).*

A .....	22	J .....	1122
B .....	2112	K .....	2121
C .....	121	L .....	221
D .....	222	M .....	1221
E .....	12	N .....	11
F .....	2221	O .....	21
G .....	2211	P .....	1212
H .....	122	Q .....	1211
I .....	1	R .....	211

S .....	212	X .....	2122
T .....	2	Y .....	111
U .....	112	Z .....	2222
V .....	1222	tion .....	1112
W .....	1121		

NUMERALS.

1 .....	1111	2 .....	2222
3 .....	1112	4 .....	2221
5 .....	1122	6 .....	2211
7 .....	1222	8 .....	2111
9 .....	1221	0 .....	2112

ABBREVIATIONS.

a .....	after.	t .....	the.
b .....	before.	u .....	you.
c .....	can.	ur .....	your.
h .....	have.	w .....	word.
n .....	not.	wi .....	with.
r .....	are.	y .....	yes.

CONVENTIONAL SIGNALS.

End of a word .....	3
End of a sentence .....	33
End of a message .....	333
Numerals follow (or) numerals end .....	xx3
Signature follows .....	sig 3
Error .....	12 12 3
Acknowledgment, or "I understand" .....	22 22 3
Cease signaling .....	22 22 22 333
Cipher follows, or cipher ends .....	2122 121 3
Wait a moment .....	1111 3
Repeat after (word) .....	121 121 3 22 3 (word)
Repeat last word .....	121 121 33
Repeat last message .....	121 121 121 333
Move a little to right .....	211 211 3
Move a little to left .....	221 221 3
Signal faster .....	2212 3

## CODE CALLS.

International Code use .....	ICU
(Navy) telegraph dictionary use .....	TDU
(Navy) geographical list use .....	GLU
(Navy) general signal use .....	GSU
Navy list use .....	NLU
Vessel's numbers use .....	VNU
Cipher "A" use <sup>a</sup> .....	CAU
Cipher "B" use <sup>a</sup> .....	CBU
Cipher "C" use <sup>a</sup> .....	CCU

## INSTRUCTIONS FOR USING THE CODE.

The whole number opposite each letter or numeral stands for that letter or numeral.

INSTRUCTIONS FOR SIGNALING WITH FLAG OR TORCH,  
HAND LANTERN, AND BEAM OF SEARCHLIGHT.

There is one position and three motions.

The position is with the flag or other appliance held vertically, the signalman facing directly toward the station with which it is desired to communicate.

The first motion ("one" or "1") is to the right of the sender and will embrace an arc of 90°, starting with the vertical and returning to it, and will be made in a plane at right angles to the line connecting the two stations.

The second motion ("two" or "2") is a similar motion to the left of the sender.

The third motion ("front," "three" or "3") is downward directly in front of the sender, and instantly returned upward to the first position.

---

<sup>a</sup> These calls are for preconcerted use in or with the Navy.

To lessen liability of error numerals which occur in the body of a message should be spelled out in full.

The beam of searchlight will be ordinarily used exactly as a flag, the first position being a vertical one.

To break or stop the signals from the sending station, make with the flag or other signal 12 12 12 continuously.

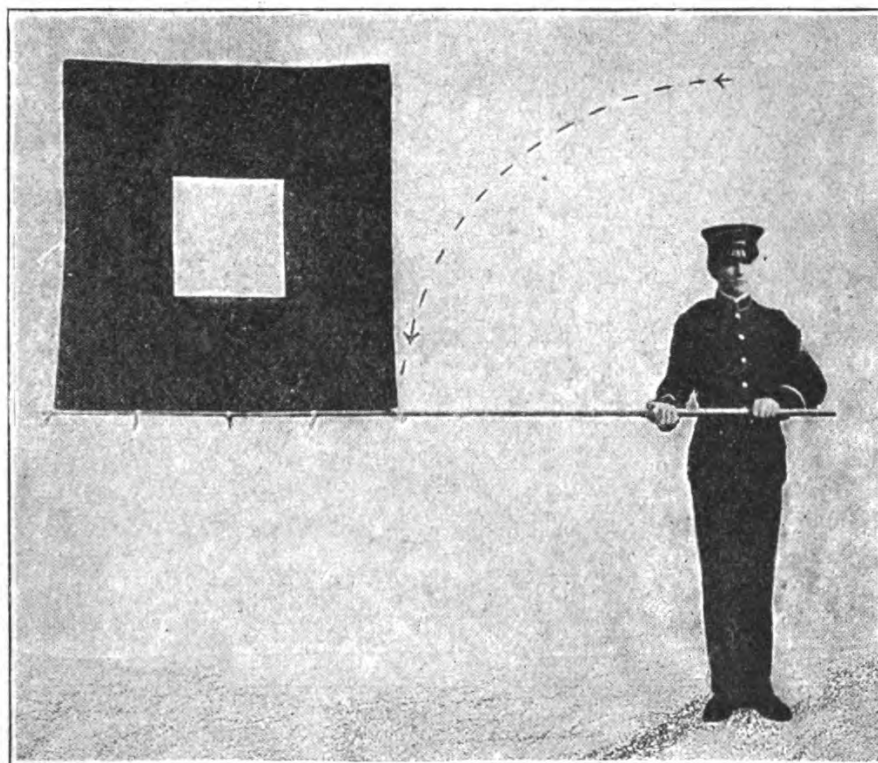

FIG. 3.—Motion "1."

To use the torch or hand lantern, a footlight must be used as a point of reference to the motion. The lantern is more conveniently swung out upward to the right of the footlight for "1" to the left for "2" and raised vertically for "3".

To call a station, signal its call letter until acknowledged; if the call letter be not known, signal "E" until acknowledged. To acknowledge a call, signal "I understand," followed by the call letter of the acknowledging station.

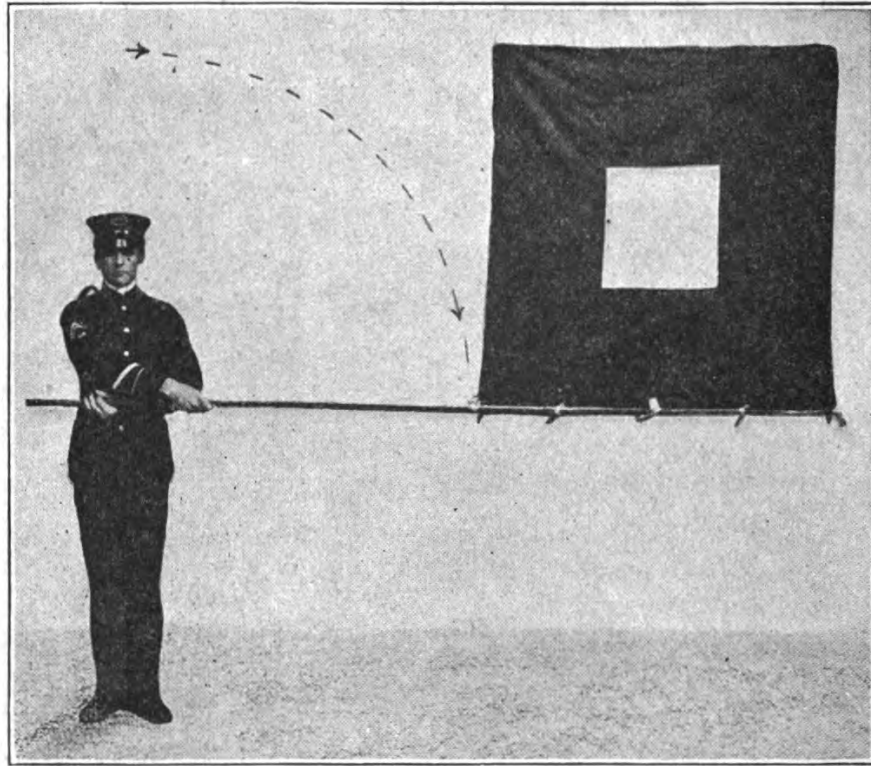

FIG. 4.—Motion "2."

Make a slight pause after each letter and also after "front." If the sender discovers that he has made an error, he should make 3, followed by 12 12 3, after which he begins the word in which the error occurred.

FLASH SIGNALS WITH ACETYLENE LANTERN, HELIOGRAPH,  
OR SEARCHLIGHT.

The first position is to turn a steady flash on the receiving station; the signals are made by alternate obscuration and revelation.

Use short flash for "1," two short flashes in quick succession for "2," and a long steady flash for "3". The elements of a letter should be slightly longer than in sound signals.

To call a station, make the call letter until acknowledged. Each station will then turn on a steady flash and adjust. When the adjustment is satisfactory to the called station, it will cut off its flash, and the calling station will proceed with its message.

If the receiver sees that the sender's mirror needs adjustment, he will turn on a steady flash until answered by a steady flash. When the adjustment is satisfactory the receiver will cut off his flash and the sender will resume his message.

To break the sending station for other purposes, turn on a steady flash and call for "repeat," etc., as occasion requires. All other conventional signals are the same as for the flag, etc.

Each word, abbreviation, and conventional signal is followed by "3."

To start the sending station, signal 121 121 3 22 3, followed by the last word correctly received; the sender will resume his message, beginning with the word indicated by the receiver.

To acknowledge the receipt of a message signal 22 22 3, followed by the personal signal of the receiver. Each station should have its characteristic call letter,



as Washington, W, and each signalist his personal signal, as Jones, Jo.

The full address of a message shall be considered as one sentence and will be followed by the signal "33."

The signal to indicate that "cipher follows" and "cipher ends" is with the flag and torch "XC3," and with other methods, except the International Code, by "XC." It will always precede and follow a cipher message or such part of a plain text message as is enciphered.

#### ORDER IN WHICH A MESSAGE IS TRANSMITTED.

The following will be the order of transmitting the several parts of a message: First, the serial number of the message and the "call letter" of the sending station; second, the operator's personal signal; third, the check; fourth, place from and date; fifth, the address in full; sixth, the address complete; seventh, the body of the message; eighth, sig. (signature follows); ninth, signature.

*Example:* The message—

KENNESAW, GA., *October 6, 1864.*

General CORSE, *Allatoona, Ga.:*

Let the Rome force return at once to Rome and protect the road. I will cover Allatoona.

W. T. SHERMAN, *Major-General.*

Would be sent—

No 1 K Jo 17 O B Kennesaw Ga 6 to General Corse Allatoona Ga. Let the Rome force return at once to Rome and protect the road I will cover Allatoona Sig W T Sherman Major General

## CHAPTER II.

**GENERAL INSTRUCTIONS FOR OPERATING STATIONS.**

The person in charge of a station is responsible for the discipline of his party.

Make signals with regularity; do not send one word rapidly, the next slowly; adopt such a rate of speed as can be read by the distant signaler without causing him to "break" frequently. Make a distinct pause between letters. It is time gained to do so; it is a loss of time and an annoyance to run letters together. Nothing so distinguishes the good from the indifferent operator, visual or telegraph, as this. In the writer's experience no other avoidable cause has occasioned so much delay. When signals are being made with a flag, a fraction of a second will be ample. Using the flash lantern or heliograph, the pause between letters should be relative to the time of display of the elements, longer than with the flag.

Each signal station will have its "call," consisting of one or two letters, and each operator will also have his "signal" of one or two letters, precisely as in the telegraph service. These being once adopted or allotted, will not be changed without due authority.

A signal officer should have a list of the "calls" of each office and the signal of each man under his jurisdiction. This is often of instant value in actual field work. Whenever one's station call is observed the called station should at once respond, making at the close of the response the same particular signal by which it is identified. The calling station should at

intervals give its own call or signal. There is thus established between the parties a mutual knowledge as to the parties with whom each is in communication.

If the call letter of a station be not known, signal "E" until acknowledged. To acknowledge a call signal "I understand," followed by the call letter of the station.

Prevailing atmospheric conditions at or near stations between which communications are desired should be well understood so that if visual communication probably can not be maintained practically uninterruptedly, code signals may be arranged and full advantage taken of brief favorable atmospheric conditions to quickly transmit important messages.

When there is doubt as to the visibility of signals the largest and brightest flags or other symbols should at once be used. After working thus for a short time the signalist becomes accustomed to the range and the smaller flags or signals can be used.

Frequently one's signals may be read by the receiving station, although it may be impossible to determine its exact position; or, it having been found it may be impossible to read its signals, owing to poor light, or smoke, or glare, or haze. Under such conditions important messages should be sent whenever the sending station is in a position from which its signals may be seen by the other station, and especially should this be done if there be a third station in the vicinity which may receive the message and transmit it to its destination. This is, of course, never to be considered as a final sending of the message—a message not being considered sent by signals until it is clearly acknowledged

by signals. There are sometimes intervals of two or three hours when the position of the sun, or a peculiar haze or light, makes one of two communicating stations almost invisible, while the other is seen more clearly than usual. The visible station should utilize favorable intervals to signal its messages with great care and distinctness. When conditions permit intercommunication inquiry should be made as to the receipt of messages thus sent. So one may find himself so close to the enemy that he can not respond to any signals without discovering his position, yet may perfectly read those made from another station.

Again, there may be cases in which messages may be sent when it is known that they can not be either acknowledged or answered by signals. It not infrequently happens, too, that the signals of recognition, "Message understood," and of "Repeat; message not understood"—which signals are sufficient to insure the correct reception of messages—can be seen, when consecutive signals made by that station are invisible. Under such conditions a conventional signal, as a puff of smoke, may be agreed upon to indicate "Message understood." Two puffs to mean "Repeat." So, also before separating and to meet unfavorable atmospheric conditions or locations conventional signals should be adopted to mean "I can not see you. Am going to the top of the mountain;" "Can't see you; look for me on the steeple;" "Can't see you; go to open field on crest of ridge;" "Can't see you; enemy is coming by this road;" "Wait a moment;" "I see you, but can not reply;" "Cease signaling; will call you soon." This rule applies equally to night signals when one

station may distinctly see the signals of another, but can not reply with signals of the same kind, because of broken apparatus, loss of supplies, etc.

With proficient signalmen the word or clause or sentence of a message to be transmitted may be given instead of calling out the numerals representing the letters. When secret or cipher codes, or codes not before used, are employed, or when the officer wishes a message signaled of which he and his correspondent alone shall know the meaning, the message may be reduced to writing before being placed in the hands of the signalist, who then simply becomes a medium for the transmission of the message without the knowledge of its meaning.

At a signal station where continuous operation is required not less than four men should be assigned for duty, and more efficient service will be had if five are provided.

Physical and mental exhaustion follow continuous signal duty; eyes become tired and errors creep into the work. Alertness in mind and body is a prerequisite to the successful carrying on of important signal duties, and this is possible only when frequent reliefs are feasible.

#### DUTIES OF EACH MAN ON A STATION.

On a relay station where the heliograph is used, the number of men should be determined by the number of stations with which it is to communicate. With four men on station and assuming that messages were exchanged by heliograph with a station so distant as to require the use of the telescope to see their flash, the duties of the men would be as follows: No. 1 is the recorder. He calls off the words of the message being

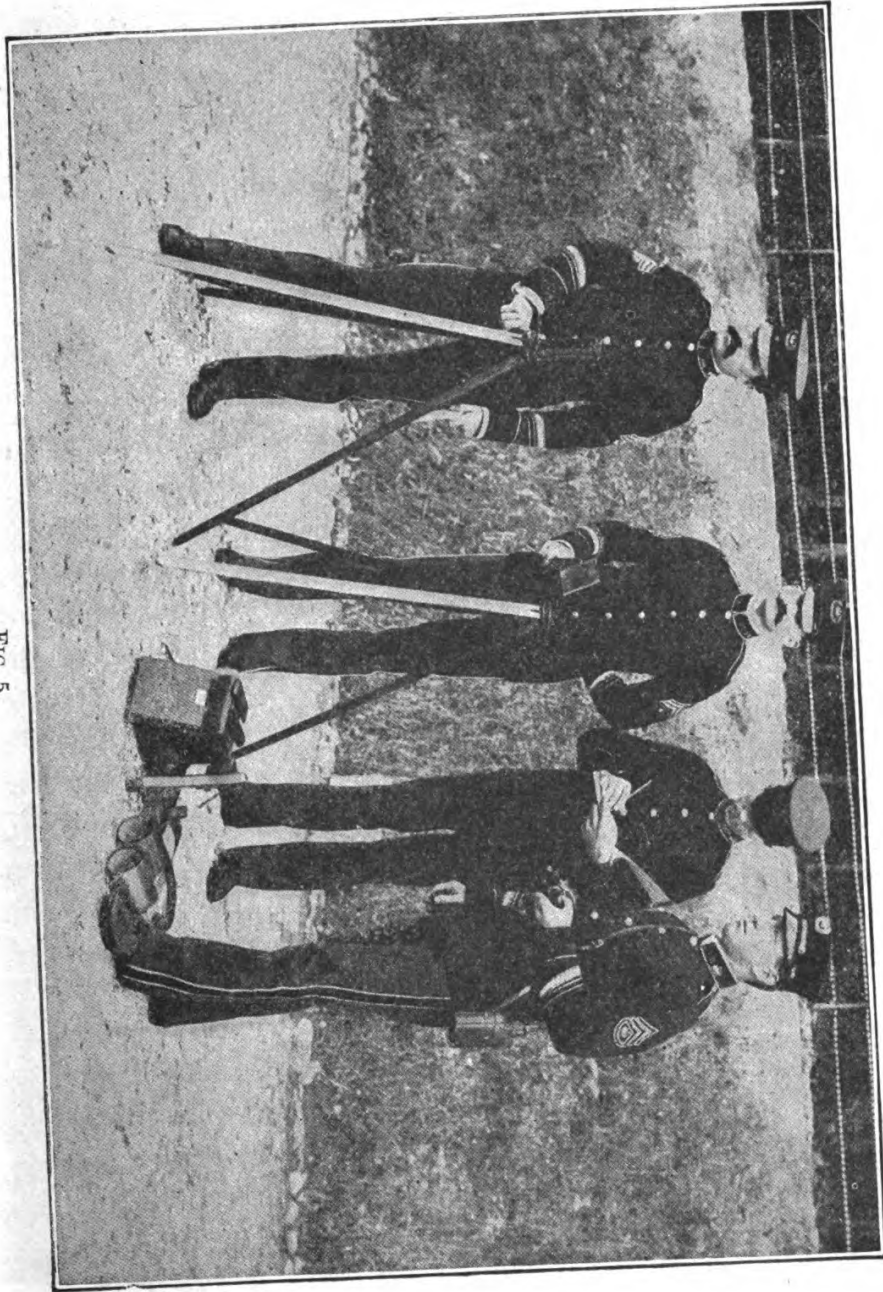

FIG. 5.

sent or records those received by No. 2. The man at the telescope, No. 3, watches for "breaks" and acknowledgment of the receipt of the message (22 22 3) from the distant station; and No. 4 attends to the adjustment and alignment of the heliograph.

In receiving a message the man at the telescope should call out each letter as received, and not wait for the completion of a word.

In flag signaling similar duties will be performed by Nos. 1, 2, and 3, No. 4 not being required.

The officer or noncommissioned officer in charge of a station should require from each man a strict and entire attention to his own immediate duties and permit no conversation that will distract the men at work. He will be careful not to allow persons to loiter about the station or within hearing of the words called out to the signaler.

In receiving messages nothing should be taken for granted, and nothing considered as seen until it has been positively and clearly in view. Do not anticipate what will follow from signals already given. Watch the communicating station until the last signals are made, and be very certain that the signal for the end of the message has been given.

Assignment of men will be made so that a continuous watch for signals may be kept and responsibility for neglect to promptly acknowledge calls determined. These details should be relieved at least every two hours, and if at all practicable every hour. The man on watch should be seated at the glass, and before assuming his duties should, with the aid of the man relieved, make certain that he knows the exact position

of the different stations, and that they are plainly in the field of the glass. This precaution is especially necessary at night when the least movement of the glass may throw a station out of view. Landmarks being then invisible, there is nothing by which to readily detect the error, and signals may be shown long at one station while the glass not bearing upon them is attentively watched at the other. The position of each station should be indicated by a line drawn on the ground from the home to the distant station and the center of the telescope lengthwise should lie in this plane, so that if accidentally deranged the station may be again found at night. Neglect of this care often causes much trouble and delay.

If for any reasons telescopes have not been fixed bearing on the communicating stations during the day, or have been moved from their stands, they must be returned and adjusted before dark.

When a signal station is to communicate with two or more stations, a telescope should be firmly fixed bearing on each when practicable and so far apart that those communicating with one station will not disturb the other.

When a station is found, fix the telescope steadily upon it, and keep it observed while signals are made for its attention. As soon as it is perceived that attention is gained, signal its number or call, or answer any signals it may make.

When a station has sent all messages on hand, the signal "Cease signaling" should invariably be made. When nothing more is to be, for the time, sent from either station, both will make the "Cease signaling"



signal. The observer, or officer, should never leave his station or cease to watch the communicating station until this signal has been exchanged by both stations. It should never be presumed that a station has ceased to work until it has announced this fact by signal.

Stations ceasing to work for a short time only will display a flag flying and stationary. This is a signal that the communicating station may be called at any time. At night the lantern flash will be displayed. So long as this signal is made, an observer will be kept at the glass.

It is sometimes difficult to secure the attention of stations at unexpected hours. The force may not be strong enough for an uninterrupted watch. To provide, so far as possible, for this contingency it may be concerted that if communication is required at unusual time, or is of pressing importance, certain flags shall be displayed, rockets discharged, smokes shown, or other attention-compelling signals used.

When the force is sufficiently strong, these extraordinary signals should not be necessary.

When a number of stations are in view from one station and it is desired to send a message to all or more than one station, some preconcerted signal, as a rocket, a red light, or some peculiar flag or torch signal, should be designated as a signal for general attention. Upon noticing this signal all the called stations reply, and then observe the calling station. This plan is useful when two or more stations can, at the same time, read the signals from the one station, and thus together receive any information to be transmitted from it.

When a number of stations are working in concert, certain fixed hours of the day and night should be especially designated for each by proper authority for the exchange of messages for each station at these hours. All persons on duty should make it a point to be faithfully at their posts at these hours, even if communication may seem to be impossible.

If reply to a call can not at once be made, the signal "Wait a moment" will be sent, and instant report of the fact made to the officer in charge.

Failure to promptly recognize and answer calls, to transmit messages, to notice and report upon movements or other changes visible, may be a neglect of duty.

The officer in charge of stations should, if practicable, visit each in person and see that it actually transmits and receives messages in his presence.

A record of the date and time of the receipt or transmission of every message must be kept.

The original manuscripts of messages received at a station for transmission should be carefully filed.

When two stations are communicating at dusk, or when it is growing dark, and a light is shown at the receiving station, it is a signal to the sending station to use thereafter the flash light instead of the flag or heliograph. A light similarly shown at dawn and then extinguished, or a flag then displayed, indicates to the sending station to cease using lights, and to commence using day signals.

When a message is being transmitted by signals, the sending station should constantly observe the receiving station with the field glass or telescope, in order that

any signals there made to stop the transmission of the message may be instantly seen and heeded. These stop signals may be made necessary by an accident at the receiving station. For instance, the telescope may there be thrown out of adjustment, or a word missing; or there may be one of numerous other causes, which will render a brief cessation of the signaling necessary. A signal to stop should be at once recognized by the sending station, and the further sending of the message should be suspended until the receiving station again announces its readiness for work.

When several messages are to be sent in succession "End of message" signal will be made after the signature of each, to be followed by the abbreviation "ahr," meaning "another," after which commence with the next message.

When stations are certainly in sight of each other, preparation for continuous work should be carefully made before the transmission of official messages is commenced.

During actual conflict officers should, if practicable, use due precautions to locate their men and themselves in unexposed positions if not engaged in sending or receiving messages. When in an exposed position officers and men will lie down, except while transmitting messages. If need be, the flag will be kept flying to indicate the position of the station to the other signal stations with which it may be in communication, or to others seeking for it. The flagman and the man at the telescope may be sheltered by temporary screens, as bales of hay, sand bags, etc. The signal staff and flag alone need project above the screen. At night the

lantern may be set upon the top of the screen or rampart, the signaller being covered.

At times it is necessary or desirable to read messages made by the flagman while facing *away* from the reader. Assume that *you* are sending the message and the signals may be read without difficulty.

Such preparations for night work as can be made during the day should never be neglected. While it may not be necessary to use the telescope or even the field glass to read the flash of the heliograph or the wave of the flag during the daylight, yet to read the flash from the lantern or the wave of the torch at night accurate alignment of the telescope is necessary, and this should, if possible, be done during the day, the telescope being left aligned and focused ready for use when night sets in.

Persons not entitled to be thereat should be kept away from signal stations. In an enemy's country visitors may be spies who come under various pretenses to gather information as to what precise points are in view from the station in order that the enemy may avoid them, and such other items of useful intelligence as they can glean.

Signal stations should be among the last positions to be abandoned when an army is about to move, for events may occur which will delay or even prevent the movement; or again there may be need at the last moment for the immediate transmission of important messages. Except when specific orders obtain, the officer in charge should exercise discretion as to the number and position of stations to be so held.

On a march a certain proportion of signallers should

be mounted, as it may happen that having stopped to communicate with parallel columns, with the advance guard or rear guard, that part of the column to which the party is attached would have so far progressed before the work was completed that his station would be regained only with difficulty. If mounted, signalers can be sent from place to place for temporary duty, and the value of their services greatly enhanced.

The signal officer in the field should always have with him his field glasses, flag, compasses, message book or blanks, and map, being always prepared to work, remembering that occasion may instantly arise when the ability to transmit a message would be invaluable.

When stations are in operation, and the location of one is to be changed, the moving station must inform the observing station of the fact of its intended change, and indicate, when practicable, the position from which communication will be resumed.

If a signal station asks another to move its station either to its right or left, so that its signal will be more distinct, each station will see that a signaller holds a flag or lighted torch above his head. The station asking for the change will lower its flag immediately upon the distant station arriving at a position having a favorable background.

#### INSTRUCTIONS TO SIGNAL OFFICERS MAKING REPORTS.

The numerous brief reports which signal officers must make of their observations should be carefully drawn. They ought to be indicative of the thoroughness and deliberation with which his duty has been performed. Each report should state concisely and

clearly what the officer actually knows or has seen, and what he thinks he sees, being careful to differentiate between known and supposed facts or conditions. When troops, camps, trains, etc., are seen and reported upon, their exact bearing by compass and distance from some village, headquarters, or signal station, certainly known to the officer to whom the report is sent, must be given. Reports should never describe anything as seen on the "right" or "left," but always described by compass points. General terms, as "large forces," "small forces," etc., should be avoided; the exact or estimated number of the force should be given, as should all information that can tend to make the description perfectly intelligible to a person who may not be familiar with the place at which the reporting officer may be, and who may have no further information than the report before him. The report should be drawn up with the aid of a map of the country observed, if one can be had. The study of such a map will often enable a correct report to be made as to where and on what roads forces are seen; without it definite reports would be impossible.

Facts gleaned from citizens should be given in the report; as should also all data that in the opinion of the reporting officer may be of benefit. It is proper for the officer to state briefly what, from all he can see and learn, he believes to be facts, either as to the position, movements, or intentions of the enemy, being careful to state that these are his opinions and deductions from the information he has obtained and the observations he has made and not observed facts. He should do this freely but succinctly, in the knowledge that his report,

with his deductions, will go before an officer who, probably, has information from various sources by which to estimate its correctness and its value. Every report should bear the signature and official rank of the maker.

If an officer or noncommissioned officer in charge of a station himself observes certain movements of the enemy, the facts actually as noted should be at once transmitted to the officer who should have cognizance of the same. The greatest care, however, should be observed between reporting facts as seen and what are opinions or conclusions, so that the officer receiving the report may rely upon what was reported as having been actually seen, and give credence to and place such importance on expressed opinions as he may.

Signal officers, in submitting reports of subordinates, should give their views in reference to the accuracy of its parts, the reliability of the reporting officer, and the concurrence of statements coming from officers observing at different parts of the line.

#### TO MAKE A RECONNAISSANCE OF A BATTLEFIELD.

In a reconnaissance of a field of battle the signal officer should observe and report how many lines of battle there are. Having appliances for so doing, he should closely determine or estimate the direction and distance of prominent objects in the enemy's line from some known point within his own. This should be especially in detail with reference to batteries, reserves, ammunition trains, etc.

The signal officer in charge of a station should not be satisfied with the mere sending and receiving of such messages as he may be called upon to handle. Provided with telescopes, he should have some one con-

stantly watching in the direction of the enemy, who will carefully observe and report to the proper officer the time, compass directions, etc., of the movements of the enemy.

Information of the greatest value, and which could not otherwise be obtained, may thus be secured by intelligent and watchful observation.

The summit of the highest hills should be occupied as observing and signal stations. If they are wooded, axes should be carried, as the felling of a few trees or bushes will often make a station, otherwise of little value, the most useful for observation.

If there is a commanding peak near where the enemy offers battle, signalmen should be hurried to it in advance of the army. The enemy is to be kept constantly in view from the time the position is reached. The knowledge to be gained by witnessing thus the formation of their forces, estimating their strength before their lines are in position, and by witnessing early what preparations are made for the battle, may be invaluable.

#### REPEATING BACK A MESSAGE.

It may happen that very important messages received by signals must be verified by repeating back from the receiving station, signal by signal, each signal used by the sending station in conveying the message. There can be no error in signals thus verified, and the correct transmission of the message is made certain. For such verification each signal must be repeated by the receiving station as soon as it is made at the sending station.

The signalists and their signalmen at each station face toward each other, the signalmen standing each with his flag and staff in the first position for signals.



The chief of each of the corresponding stations has his glass fixed upon the opposite station and takes his post at the glass. The sending of the message is commenced. Each signal is completed by the sending station; the officer in charge orders the same signal made at his own station. The sending signalman pauses after each signal of the message made at his own station until that signal has been correctly repeated at the receiving station.

The symbol numbers at each station must be identical. The signals used may be different, provided they signify the same numbers. Thus, if "1-2" is made at one station, "1-2" must be repeated at the other, though the symbol numbers "1" and "2" may be indicated at one station by different signs from those which indicate the same numbers at the other station. The messages are thus transmitted, signal by signal, the sender pausing after each signal until a similar signal is shown, complete and correct, at the receiving station. It is then certain that his own signal has been seen and noted. A record of the signals shown at each station is kept at the other.

A message may be repeated letter by letter, or word by word, or sentence by sentence; or the whole message is recorded as received and is then repeated back from the receiving station.

The occasions for such exactness as require the trouble of repetition must be determined by the commanding officers, or by the chiefs of stations dispatching the messages. Where cipher is constantly employed, verification insures its accurate receipt and will sometimes prevent the delay in deciphering which may arise from an error in transmission or receipt.

## REPEATING STATIONS.

The repetition of signals through one or more stations to its destination is accomplished as follows:

A warning signal is first given in order that there may be proper attention at the intermediate stations before commencing the message. For instance, a message is to be sent from Washington, D. C., to Frederick, Md. The officer at Washington would first send over the line of stations the warning to "Repeat to Frederick." This warning is repeated from station to station. On receiving it, the officer at Frederick makes the "I understand" signal, which signal is repeated back, from station to station, to Washington. Each station then stands ready to repeat the signal message which is to follow. The station at Washington at once begins its message, and each station repeats each letter signal as received.

When a message is being repeated through a number of stations, the proper person at each station will, as he receives it, call out each letter to his flagman, who, placed *facing from the sending station and toward the station next in line*, makes each letter in its proper order. After signaling from his station each letter, he waits until it is repeated at the next station before he signals another.

If necessary, the two men at each repeating station, who are watching the stations from which the message is being received and to which transmitted, will be provided with telescopes. The former will call out the letters as received, and the latter will repeat it aloud when he notes its receipt by the next distant station. All signals made at the repeating station

will appear to the observers at the sending station reversed.

Long lines of signal stations with a small military force at each, being in communication with the other, may constitute picket lines of great length and importance for holding and keeping under observation lines of communication, rivers, or extensive tracts of country liable to incursion or to be ravaged by predatory bands of the enemy; each station having the power of communicating with those on either side of it, has virtually the advantage of their support, and one can not be attacked without the enemy being exposed to the concentration of forces called for by signals from different stations.

#### CHECKING MESSAGES.

The following rules as to the preparation and counting of messages will be followed in checking all messages sent by signals.

Every address must contain at least two words, and should be sufficient to secure delivery.

All that the sender of a message writes for transmission is counted.

Whenever more than one signature is attached to a message count all initials and names, except the last signature, as a part of the body of a message.

In the body of a message, dictionary words, initial letters, surnames of persons, names of cities, towns, villages, States, and Territories, or names of the provinces, will be counted each as one word. The abbreviations for the names of cities, towns, villages, States, and Territories, and provinces will be counted the same as if written in full.

*Examples.*

Van Dorn .....	1 word.
McGregor .....	1 word.
O'Connor .....	1 word.
De Witt .....	1 word.
Brown, jr .....	2 words.
New York (or N. Y.) .....	1 word.
New York State .....	2 words.
Nova Scotia (or N. S.) .....	1 word.
St. Louis .....	1 word.
East St. Louis .....	1 word.
North Carolina .....	1 word.
Queen Anne County .....	3 words.
New Mexico .....	1 word.
District of Columbia (or D. C.) .....	1 word.
North America .....	2 words.

Figures, decimal points, bars of division, and, in ordinal numbers the affixes "st," "d," "nd," "rd," and "th," will each be counted as one word. Abbreviations of weights and measures in common use, letters and pronounceable groups of letters, when such groups are not improper combinations of dictionary words, will be counted as one word.

Each group of figures or letters in a cipher message is counted as one word.

*Exceptions.*

A. M .....	1 word.
P. M .....	1 word.
Per cent .....	1 word.

If the torch set is used at night it must be cleaned the following morning, which can be done by scouring with ashes or washing it with turpentine. Torch wicks must be examined, trimmed, and renewed. If there is even a slight dripping of turpentine, they are too

loose and should be made tighter by adding new threads to them, or they may be loosened by drawing out strands from the wick if it is so tight that the fluid can not readily flow through it to feed the flame. The torch screws and catches must be examined, and all prepared for the work of the coming night. The torch is not to be filled, however, during the day.

When the torch equipment is to be packed for transportation, the torches must be perfectly emptied of any fluid they contain.

If signal disks are used, keep them in order and clean, the handles well attached, and the disks stored where they will not be damaged.

Where sets of flags, as naval signal flags, are kept on hand, they should be overhauled and if necessary repaired at least once a week.

Lanterns are to be inspected to see that they are wholly clean and in perfect working order.

Each signal flag should be examined. If there are rents or loosened ties they should be repaired. If the flag has become soiled by usage it must be well washed and dried. Flags should be kept clean; a dirty white flag is never read distinctly at any great distance, while a clean flag is seen and read with ease.

#### CARE OF SIGNALING APPARATUS.

Daily inspections should be made to insure that all signaling instruments, appliances, and materials are in readiness for instant use. Defects in the apparatus annoy the sender; to a greater extent they annoy the person to whom the messages are imperfectly sent, and delays result that may have serious consequences.

Signal rockets, bombs, etc., should be packed in waterproof chests or pouches and carefully guarded from moisture. Whenever there are indications that they have been affected by moisture they must be thoroughly aired and fully dried.

The officer in charge of a detachment should satisfy himself of the condition and storage of these articles by personal inspection, and if they are not found to be in serviceable condition he should have them repaired at once; in short, he should see that all articles and appliances needed are on hand and in readiness for immediate use.

Rigid inspection of all equipments and materials will be made by the officer or noncommissioned officer in charge whenever a detachment is about to take the field for service.

### CHAPTER III.

#### DAY SIGNALING APPARATUS.

##### THE HELIOGRAPH.

The advantages of the heliograph for visual signaling are its portability, great range, the comparative rapidity with which it may be worked, and the fact that its flashes can be seen only by those approximately on a right line connecting the stations between which communication is had, and that it can be operated over terrain occupied by the enemy.

Under favorable atmospheric conditions and where signaling is to be continued the heliograph has replaced the flag. With it messages can be more rapidly sent,

while its range is many times greater. Dust and smoke, which would totally obscure even the largest signal flag, are readily penetrated by its flash. Through smoke and haze so dense that the sending station could not be seen, even with a signal telescope of 30 powers, its flashes have been read by the unaided eye at distances of 15 miles.

Experiments with the heliograph for use in the Army of the United States were begun in 1878. Upon the return of Gen. W. T. Sherman from abroad, he made report of the use of this instrument by the English army in India. Upon the recommendation of the present Chief Signal Officer of the Army, Brig. Gen. A. W. Greely (then first lieutenant), two of the heliographs of the Mance pattern were procured. In this method the shutter is not used, the flash being directed on the distant station by moving the mirror itself by means of a key. With these instruments accuracy of adjustment is difficult, as the manipulation of the mirror tends to throw the flash out of alignment. This objection seen and at once appreciated, was overcome through the experiments made under the direction of the Chief Signal Officer of the Army, and the pattern now in use was finally evolved.

The English heliograph consists of a movable mirror, mounted upon a horizontal axis, with an attached finger key, which controls the movement of the mirror. When the key is pressed down the mirror, if properly adjusted, throws a sunflash to the distant station, and when the pressure is removed from the key a spring returns the mirror to its original position, and the direction of the flash is so changed that the signal is no

longer visible at the distant station. This form of heliograph was very satisfactory in many respects, and it proved to be of great utility to the British army during many of their campaigns in India and Africa and later in the Boer war. There are, however, two quite serious objections to this method of operating the mirror: First, very careful attention to the adjustment of the heliograph is necessary in order to direct the flash constantly and steadily upon the receiving station; second, the direction of the flash is liable to be deflected from the out station through the manipulation of the key, causing derangement in the position of the mirror.

The fixed flash method adopted by the Signal Corps of the United States Army was proposed by Maj. F. C. Grugan, U. S. Army (then first lieutenant, U. S. Artillery), to whom may be justly credited the invention of the American heliograph. He devised and submitted a model having the mirrors and screen for intercepting the flash fixed upon separate tripods, so that the quality and direction of the flash are entirely unaffected by the manipulations of the signalman using the key.

In communicating with a distant station after the flash is directed upon it, two tangent screws upon the mirror bars and frame—one screw causing a horizontal motion and the other a vertical motion—give slow and suitable motions to the mirror, so as to constantly and steadily keep the full flash of the sun upon the distant station. The flash is kept accurately adjusted by means of a dark spot arising from an unsilvered point in the center of the mirror. The revelation and obscuration of the flash are effected by the operation

10495—05—5



of a detached screen which is so placed that when closed it entirely obscures the flash and when open permits the free passage of the beams of the reflected light to the receiving station. While the American method of signaling by heliograph requires an additional piece, i. e., the screen, it affords the advantage of rendering communication with the distant station more certain, since the direction of the flash can not possibly be altered by the manipulation of the key.

#### RANGES ACCOMPLISHED.

- By the alternate opening and closing of the screen messages are sent by the General Service Code or American Morse Code of telegraphy. In the latter case a short flash represents the dot and a long flash the dash. The mirror of the standard field heliograph of the Signal Corps of the Army exposes a surface  $4\frac{1}{2}$  inches square, and with this mirror communication can, in sunshine and under usual conditions, be relied upon for distances up to 30 or 40 miles. Messages have been sent with it over a distance of 90 miles and the flash distinguished at 125 miles. For very great distances, however, the station heliograph is used, which is of the same form as the standard field instrument, but is considerably larger, having a mirror 8 inches square. With this instrument, and under favorable atmospheric conditions, the distance over which messages may be visually exchanged is limited only by the convexity of the earth. In 1894 Capt. (now Maj.) W. A. Glassford, Signal Corps, U. S. Army, established stations on Mount Ellen, Utah, and Mount Uncompahgre, Colorado, a distance

of 186 miles, and exchanged a message with a heliograph of this size; that part of his report which treats of the intervisibility of the mountain peaks is incorporated herein. This is the greatest distance over which signals have been exchanged visually. In this experiment the convexity of the surface of the earth intercepted the direct rays of the sun, but the flash was read by refraction.

In May, 1890, during the general practice of the heliograph system of the Department of Arizona, signals were read from the field heliograph, having a mirror  $4\frac{1}{2}$  inches square, at a distance of 125 miles with the aid of the Signal Corps telescope, and during the same practice messages were read at a distance of 100 miles without the aid of the glass.

An important advance lies in the perfection attained in the construction of the mirrors used with the standard heliograph of the Signal Corps. The great distances at which the small mirrors,  $4\frac{1}{2}$  inches square, have been read successfully is directly dependent upon the perfection of the mirror. While, as a general rule, the brightness of the flash of the sun is determined by the size of the mirror, yet it is evident that the flash from the larger mirror, with surfaces not perfectly plane and parallel, will be less brilliant than that from a smaller perfect mirror, since from the imperfect larger surface the sun's rays will be dispersed with resultant diminution of the brightness of the flash.

From a mirror the surface of which is not plane, false images of the sun will be reflected, which, while less bright than the true images, cause unsatisfactory signals which produce delay.

The mirrors used by the Signal Corps in its heliographs must conform to the following specifications:

The mirrors to be of plate glass, free from flaws and other optical defects, to be backed with pure silver, well varnished, and having both surfaces accurately parallel.

Size,  $4\frac{3}{8}$  inches square, so as to insure  $4\frac{1}{2}$  inches square of reflecting surface.

Thickness of glass, not less than one-eighth inch nor more than five thirty-seconds of an inch,

Mirrors to be accurately cut square and ground smooth on the edges, with a slight bevel, so that all mirrors will be interchangeable.

The image of the sun as reflected from the mirror on a plane surface at a distance of about 70 yards shall be clear cut and circular, so as to insure that the surface of the mirror has but one focus of reflection.

A good heliograph mirror will show no distortion of distant objects looked at in it very obliquely.

Many difficulties have been met in the effort to construct a heliograph screen which would permit an almost instantaneous display of an obscuration of the flash.

The original model was not entirely satisfactory, as the distance traveled by the key in moving the screen through an angle of  $90^\circ$  prevented rapid sending. Since this screen was abandoned many different models have been made of one, two, three, or more leaves, the effort being to secure a model which would make rapid and accurate writing possible by removing the screen leaves quickly from the line of sight when the key was pressed down and return them with equal celerity to obscure the flash when the pressure was removed from the key. In some form torsion springs were relied upon, and in others the force of gravity,

by weighting certain parts of the screen. In certain methods the leaves constituted what may be called fan screens, the leaves turning upon horizontal axes; in others the leaves moved vertically. The latter form had two leaves, which, when held closed by springs, shut off all the flash, but when the key was pressed, the upper leaf rising and the lower falling, the flash was quickly revealed. An objection to this screen was the impossibility of preventing the rebounding of the leaves when closed by the spring, which, partly revealing the flash, rendered reading difficult and uncertain.

The screen now used was devised by the late Maj. Charles E. Kilbourne, paymaster, U. S. Army (then captain, Signal Corps). It may be briefly described as follows: A rectangular frame 7.1 inches by 6.4 inches and 0.35 inch thick, made of best quality black lusterless gun metal, having at the center of its base a circular projection 0.9 inch in length, in which is cut a female screw fitting the screw of the heliograph tripod. The frame is cast in two pieces, one piece comprising one vertical and two horizontal sides, and the other one of the vertical sides. The screen has two leaves riveted upon square axles, the round bearing ends of which fit into the vertical sides of the frame and are held firmly in their places when the detachable side is in position. The ends of these axles are fitted on one side of the screen with short arms, held in position by rivets of like size, and their ends are connected by a bar with swivel joints, which control the movement of the leaves, making them open and close simultaneously, the leaves moving in opposite directions. Near the upper end of the connecting bar is a flat-headed screw which holds

fast one end of the long pull string, the other end being attached to a screw on the lower end of the vertical side of the screen frame. Motion is given to the leaves by means of a finger piece attached to the end of the lower axle farthest from spring. The finger piece has a ring through which, when sending, the finger is passed, the ring being large enough to move freely about the finger. The leaves when closed are held firmly in position by means of a spring, and, as the angle made by the arms with the spring is very small, some force is required to start the spring from its position of rest, so there is no rebounding of the leaves, and the obstruction of the flash is perfect when the leaves are closed by the spring. The springs used are best quality phosphor bronze, and their durability is sufficient for months of constant service. When one becomes weakened it can be easily and quickly replaced without tools. If a spring is not available, a coil or two of the weakened one may be cut off, when the increased tension of the remainder will be sufficient to rapidly close the leaves. The extent or amplitude of revolution of the leaves is limited to  $90^{\circ}$  by means of shoulders on the finger piece, which strike a stout pin in the frame of the screen.

The method of manipulating this screen is not altogether satisfactory. In continued use it is tiresome on the hand and fingers of the operator, and therefore militates against correct and accurate sending.

Models have been recently submitted in which the leaves are operated by direct drive, and by a lever movement the latter resembling closely in appearance and action the ordinary telegraph key. These promise

so well that the adoption of one or the other as the standard shutter is probable.

The projection of the rays of the sun upon a screen by reflection from plane mirrors demonstrates that for short distances the figures of the illumination are similar to those of the mirrors used. Removing the mirrors to a greater distance from the screen, it is found that the shapes of the mirrors are no longer reflected, but that all images are circular and of the same diameter. Removing the mirrors to a still greater distance, it is found that the various images are circular as before and of the same diameter, but that this latter diameter is greater than the one previously obtained. Repeating the experiment at increased distances, these results are confirmed with the following conclusions: That up to a certain distance the form of the mirror is reflected upon the screen; that this distance once exceeded, the reflected images obtained from mirrors of various shapes and sizes are all circular and of equal diameters at equal distances; that the greater the distance from the mirror, the greater the diameter of the reflected image; that other things being equal, the larger mirrors produce the brighter images.

It is therefore evident that the advantage derived from the use of a larger mirror consists not in any increase in the size of the flash but in an increase of brightness—i. e., capability of overcoming such obstructions as fog, smoke, haze, and, consequently, distance. The square mirror has about one-fourth more reflecting surface than a round mirror requiring the same packing space, which materially increases its desirability.

Light from the sun is projected upon the surface of

a mirror in a cone of rays and is reflected in a cone of the same dimensions. The angle within which reflection is visible is that subtended by the diameter of the sun. The limit of the lateral extension of the flash at any given distance may therefore be definitely determined, and it is found that, theoretically, the circle of illumination has a diameter which increases about 40 feet for every mile; practically, however, the lateral visibility of the flash will be found to be considerably in excess of the theoretical figures given, due to the mirror not having an absolutely true plane surface, thereby causing dispersion of the rays. So, knowing the diameter of the flash of the far station, the distance between two stations working with each other may be roughly determined. As the diameter of the flash increases directly with the distance between stations, adjustment of the instrument can be as accurately made for great as for short distances.

This diameter of the flash is so small relative to the distance between communicating points that signals are invisible to one far out of the direct line, and therefore not liable to be read by those for whom not intended.

The field heliograph equipment of the Signal Corps consists of—

A sole-leather pouch containing—

1 sun mirror. } Inclosed in a wooden box (X).  
1 station mirror. }

1 screen, 1 sighting rod, 1 screw-driver.

A small pouch, sliding by 2 loops upon the strap of the larger, containing 1 mirror bar (Y).

A skeleton case containing 2 tripods (Z).

A movable spring is placed under each end of the mirror bar for clamping mirrors and sighting rod.

The tripods are similar, the screw of either serving equally well for the attachment of mirror bar or screen. Each is provided with a hook for the suspension of a weight to give greater stability when required.

The sun mirror has an unsilvered spot at its center, the station mirror a paper disk; in other respects they are similar.

The tangent screw attachment to the frame affords the means of revolving the mirror about a horizontal axis. The support to the frame has a conical projection accurately turned to fit the socket of the mirror bar, and grooved to receive the clamping spring.

The screen is provided with a key, by which, in connection with the action of a spring, it is operated to reveal and cut off the flash.

The base of the frame carries a female screw for attachment to the tripod.

The sighting rod is fitted with the socket of the mirror bar, and is clamped in the same manner as the mirrors. It carries at one end a removable disk, which, when turned down, reveals the front sight.

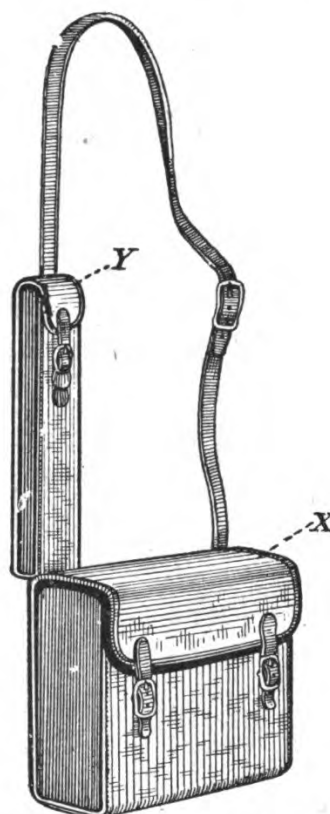

FIG. 6.—Mirror and mirror bar case.



A piece of white paper should be slipped into the disk to receive the "shadow spot," and a slight puncture made therein coincident with the point of the front sight as a guide in adjustment.

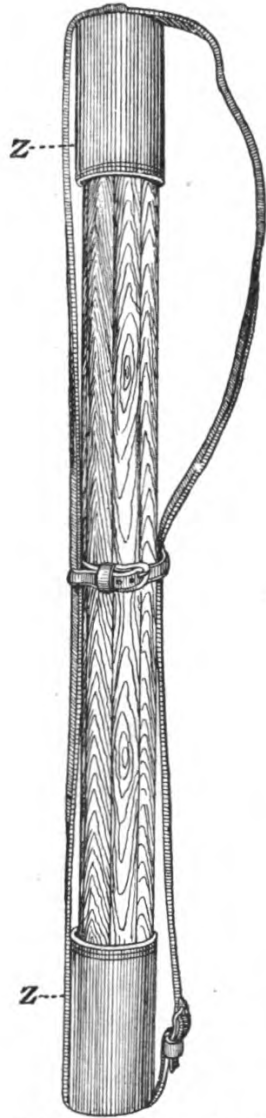

FIG. 7.—Heliograph tripods.

Vertical adjustment of the disk is made possible by loosening the milled slide.

The mirror bar is provided with a clamp, threaded to fit the screw of the tripod. The release of the clamp permits movement of the bar independently of the screw.

In the present model the tangent screw for revolving the mirror about a vertical axis is attached to only one end, and when this model is in use the sun mirror should be clamped to this end while the socket at the other extremity is designed to receive the station mirror or the sighting rod. It is proposed to fit both ends of the mirror bar with the same kind of tangent screw, so that the station mirror may be adjusted with exactness and facility when necessary. This change is proposed as it has been found that frequently the tripod is shaken or the mirror itself changes from its position relative to the sending mirror and the distant station.

At present there is no means other than by turning the mirror with the hand to rearrange adjustments. At

this writing no heliographs have been constructed with the tangent screw at either end; but if the favorable experiments now being conducted continue, it is probable that all mirror bars will be provided with the double tangent screw. This will make no material difference in the instructions as here presented. In the event of one of the tangent screws becoming unserviceable, the sun mirror may be used in the serviceable tangent screw; and the present method of adjustment will be available under new conditions.

#### SETTING UP AND OPERATING THE HELIOGRAPH.

The position of the sun is the guide for determining whether one or two mirrors should be used.

When the sun is in front of the operator—that is, in front of a plane through his position, at right angles to the line joining the stations—the sun mirror only is required; with the sun in rear of this plane both mirrors should be used, although a single mirror may often be used to advantage with the sun well back of the operator. When one mirror is used, the rays of the sun are reflected from the sun mirror direct to the distant station; with two mirrors, the rays are reflected from the sun mirror to the station mirror, thence to the distant observer.

*With one mirror.*—Firmly set the tripod on the ground; attach the mirror bar to the tripod; insert and clamp in their appropriate sockets the sun mirror and the sighting rod, the latter with its disk turned down. Sight through the center of the unsilvered spot in the mirror and turn the mirror bar, and raise or lower the sighting rod until the center of the mirror, the extreme point of the sighting rod, and the distant station are

accurately in line; then firmly clamp the mirror bar to the tripod, taking care not to disturb the alignment. Turn up the disk of the sighting rod.

Move the mirror by means of the slow-motion screws until the "shadow spot" falls upon the paper disk in the sighting rod. The flash will then be visible to the distant observer.

To readily find the "shadow spot," hold a sheet of paper, or the hand, 6 inches in front of the mirror,

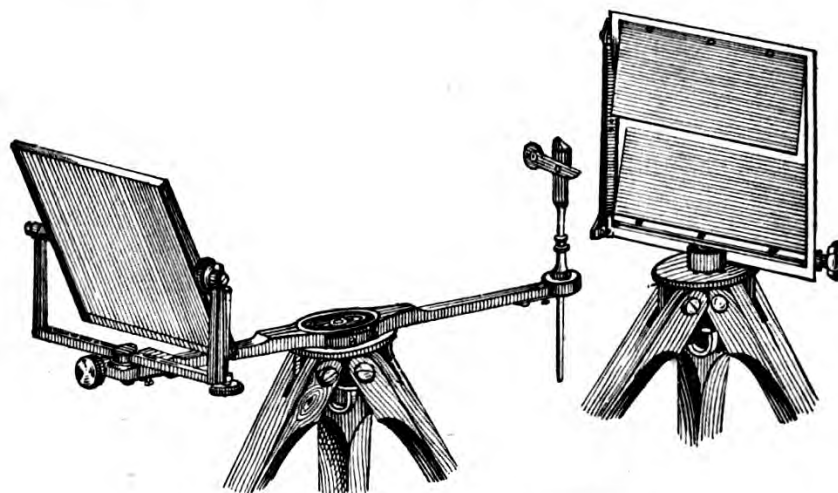

FIG. 8.—Heliograph in use with one mirror.

and the spot may be so kept in view until brought to the disk of the sighting rod.

The "shadow spot" must be kept in the center of the disk while signaling.

Attach the screen to its tripod and place it close to, and in front of, the sighting disk, so as to intercept the flash.

*With two mirrors.*—Firmly set the tripod on the ground; clamp the mirror bar diagonally across the line of vision to the distant station; clamp the sun

mirror, facing the sun, to the end of a mirror bar with tangent screw attachment, and the station mirror facing the distant station to the other socket. Stooping down, the head in rear of and near the station mirror, turn the sun mirror by means of its slow-motion screws until the whole of the station mirror is seen reflected in the sun mirror, and the unsilvered spot and reflection of the paper disk accurately cover each other.

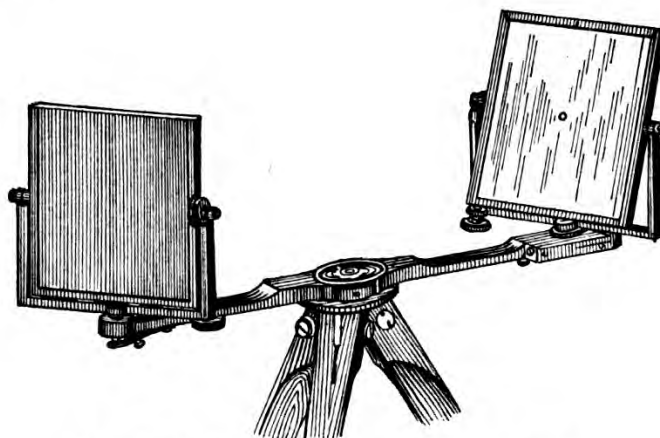

FIG. 9.—Heliograph in use with two mirrors.

Still looking into the sun mirror, turn the station mirror until the reflection of the distant station is brought accurately into line with the top of the reflection of the disk and the top of the unsilvered spot of the sun mirror; after this the station mirror must not be touched.

Now, stepping behind the sun mirror, throw upon the station mirror a full flash from the sun mirror, so that the "shadow spot" falls upon the center of the paper disk. The flash will then be visible at the distant station.

The method of making the adjustment is similar to sighting with a rifle, considering the top of the unsilvered spot of the sun mirror as the rear sight, the top of the reflection of the paper disk of the station mirror as the front sight, and the reflection of the distant station as the target. The "shadow spot" must be kept in the center of the paper disk while signaling.

Attach the screen to its tripod and place it so as to intercept the flash, and in position convenient for maintaining adjustment of the sun mirror while working. In setting up the instrument spread the tripod legs sufficiently to give a good base, and on yielding soil firmly press into the ground, the head approximately level. In a high wind, ballast by hanging a substantial weight to the hook. If the legs become loose at the head joints, tighten the assembling screws with a screw-driver.

See that the screen completely obscures (cuts off) the flash; also, that the flash passes entire when the screen is opened. The spring should sharply return the screen to its normal position when the key is released. If it fails to promptly respond, strengthen or replace the spring.

A dark background should, if practicable, be found for the heliograph. While it may be read with a light background, as the sky, for instance, yet the transmission of messages will be facilitated by securing as great a contrast between the flash and the background as possible.

Extra care bestowed on preliminary adjustment is repaid by increased brilliancy of flash. With alignment absolutely assured and the "shadow spot" at

the center of the disk, the axis of the cone of reflected rays is coincident with the line of sight and the distant station receives the greatest possible intensity of light.

The distant operator is necessarily the best judge as to the flash received; if, therefore, adjustment is called for when the "shadow spot" is at the center of the disk, alignment is probably at fault and should be attended to at once.

Mirrors should fit snugly, but not tightly, in their frames. Great care should be exercised in this, as even a slight pressure destroys the plane surface of the mirror; this produces distortion of the reflection and consequent loss of intensity of the sun flash.

The tendency of the "shadow spot" to move off the disk, due to the apparent motion of the sun, is compensated for, without interrupting signals, by means of the tangent screws of the sun mirror. The movement imparted by these screws to the mirror does not disturb alignment, as its center (the unsilvered spot) is at the intersection of the axes of revolution.

It is of the utmost importance that uniformity in mechanical movement of the screen be cultivated, as lack of rhythm in the signals of the sender entails "breaks" and delay on the part of the receiver.

For the "1" of the General Service Code or that of the Morse Code the flash is almost instantaneous. To avoid continuity of light, release the screen at the moment of depression. "Clipping" should be guarded against by fully opening the screen before releasing the key.

The strain on the eyes, however, from the flash of

the mirrors, in receiving, is often considerable, but may be modified by the use of stained glasses. It will also be occasionally found advantageous to screen the eyes from the glare of surrounding objects.

Ability to read signals from the heliograph may be readily acquired, but may be lost if practice be discontinued before proficiency is attained. It should, therefore, be the endeavor to acquire such facility, not only in sending, but in receiving, that *habit* will come to the aid even after the lapse of considerable time since which the heliograph was last used.

Minor parts of the instrument should be dismantled only to effect repair, for which spare parts are furnished on requisition. All steel should be preserved from rust and tangent screws and bearings from dust and grit. The mirrors should invariably be wiped clean before using. In case of accident to the sun mirror, the station mirror may be made available as such by removing the paper disk.

To find a distant station, its position being unknown, reverse the catch holding the station mirror and with the hand turn the mirror very slowly and full azimuth distance in which the distant station may possibly lie. This should be repeated not less than twice, after which, within a reasonable time, there being no response, the mirror will be directed upon a point nearer the home station and the same process repeated. With care and intelligence it is quite probable that, a station being within range and watching for signals from a distant station with which it may be desired to exchange messages, this method will rarely fail to find the sought-for station.

The exact direction of either station searching for the other being unknown, that station which first perceives that it is being called will adjust its flash upon the distant station to enable it when this light is observed to make proper adjustments. If the position of each station is known to the other, the station first ready for signaling will direct a steady flash upon the distant station to enable it to see not only that it is ready for work, but to enable it to adjust its flash upon the distant station.

Occasionally the receiving station is in cloud while the sun is shining at the sending station. When these conditions obtain—the receiving station can not break, and the sending station should exercise care to transmit each letter slowly and with the utmost distinctness. If the message is important, it should be repeated by the sending station to assist the receiving station to catch any words that may have been missed when first sent. The receiving station will, at the first opportunity, acknowledge, by their numbers and time of receipt, messages so received. In such cases, where it is uncertain that the transmitted message has been correctly and fully received, the facts in each case should be communicated by the sending station to the writer of the message.

No message will be considered sent until its receipt has been acknowledged by the receiving station.

When the exigencies of service are such that but one man is on a station, particular care should be taken by him that his flash falls with full intensity upon the receiving station; he should therefore adjust his mirror with such frequency as will with certainty insure this.

10495—05—6



The "1" of the general service code is represented by a momentary exposition of the flash, and the duration of this exposition constitutes the unit of time.

The "2" is represented by two flashes momentarily exposed.

The "3" is represented by an exposition of the flash for a period of three units of time.

The pause between the elements of a letter is equivalent to the unit of time; that between letters of three such units, and between words of six units.

To call a station, make the "call letter" until acknowledged. Each station will then turn on a steady flash and adjust. When the adjustment is satisfactory to the called station, it will cut off its flash, and the calling station will proceed with its message.

If the receiver sees that the sender's mirror needs adjusting, he will turn on a steady flash until answered by a steady flash. When the adjustment is satisfactory, the receiver will cut off his flash and the sender will resume his message.

To break the sending station for other purposes, turn on a steady flash and call for repeat, etc., as occasion requires. All other conventional signals are the same as for the flag.

When the heliograph is used at distances of 5 miles or less in bright sunshine, the sending mirror may be covered with a piece of cardboard or blotting paper having a square about 2 inches cut out of the center. While the reflected beam of light will be of the same diameter, it will not be so bright, consequently less tiresome on the eyes of the reader, while being sufficiently distinct to be easily read.

When this is not done, dark-colored eyeglasses should be provided and worn.

Under the favorable conditions of sunlight and clearness that obtain in the western country, with a mirror of sufficient area surface, with some modifications of manipulation, long ranges are limited only by the curvature of the earth and intervening mountains and are, within these limitations, as practicable as the shorter ranges.

The interesting problem to be solved in extreme long range signaling from mountain peaks, between which are mountains or plateaus, is to determine before going upon them whether or not the summits are intervisible. The curvature of the earth and intervening elevations are factors which have to be taken into account in the problem. There are two cases of this kind—first, the middle ground may be the highest point, and, second, there may be a mountain on either side of the middle ground, which mountain, though lower in altitude than either of the peaks, may, in view of the curvature of the earth, obstruct the line of sight between the higher mountains. For nearly all parts of the country maps may be had which give the approximate elevation of peaks and plateaus. By consulting these for any indicated range, and if necessary drawing a scale profile for the line joining the two elevated peaks, it can be determined whether any intervening elevations will obstruct the line of vision between the selected peaks. If the middle ground appear high enough to probably obstruct the view, the following formula and computation will determine whether the

right line joining the two peaks penetrates the middle ground:

*Intervisibility.*

$h = \frac{S^2}{2R}$  = height of sea level at middle ground above line joining the bases of the two peaks.

S = the half distance between the ends of a line drawn from the base of one mountain to the base of the other.

R = the earth's mean radius.

To  $h$  add the height above sea level of the surface of the middle ground, which call  $h^1$ .

Now, by taking the sum of the elevations of the two peaks (14,418 and 11,400 for Uncampahgre and Ellen) and dividing by 2 is found the height of the line of vision above  $h$ , the midway point, in the line joining the bases, which call  $H$ . If  $H$  be greater than  $h^1$  the line of vision is above the middle ground; if less, it is below it.

In a case where the elevation is on one side of the middle ground the following formula of Prof. A. W. Phillips, of the Yale College, is applicable:

R = the radius of the earth for the middle latitude.

D = the base of one mountain at end of line.

E = the base of the intervening mountain.

F = the base of the other mountain at end of line.

The distance from peak to peak is, of course, the distance measured on the sea level of the earth; that is, always the circumference D E F.

$h^1$  = the height of the mountain A, whose sea-level base is D.

$h$  = the height of the mountain B, whose sea-level base is E.

$h^2$  = the height of the mountain C, whose sea-level base is F.

and are given as distances above sea level.

Suppose the peaks A and C are those under consideration, and it is required to find whether B—the

mountain (or intervening ground)—is above or below the right line joining the tops of the mountain peaks A and C.

By representing these functions by a diagram lettered as noted and representing the center of the earth as O, and the distance D E—A B, approximately, by a, distance E F—B C, approximately, by b, in the triangle A O C the angle A O C at the earth's center can be found. The arc a b is given in miles, and the radius R is known; A O = R + h<sup>1</sup> and C O = R + h<sup>2</sup> are also known.

Find the angle which the line joining the two peaks makes with the vertical from peak A, or angle C A O is found from

$$\frac{A O + O C}{A O - O C} = \frac{\text{tang. } \frac{1}{2} (C A O + A C O)}{\text{tang. } \frac{1}{2} (C A O - A C O)}$$

$$C A O + A C O = 180^\circ - A O C.$$

In the triangle B A O find A O B in the same way as A O C.

$$A B O = 180^\circ - (A O B + B A O)$$

$$\frac{\text{Sin } A B O}{\text{Sin } B A O} = \frac{A C}{O B}$$

This will give O B on the supposition that O B reaches up to the line joining the summits of the two peaks A C. If O B is greater than R - h, that shows that the summit B will not obstruct the view.

The approximate mean barometer at Mount Uncampahgre is 17.675 inches; at Mount Ellen, 19.750 inches, and upon the table-land intervening, 22.990 inches. The difference in the density of the atmosphere between

Mount Uncampahgre and the middle ground amounts to about one-sixth of the entire atmospheric envelope, and that between the middle ground and Mount Ellen to about one-ninth, the sum of the two being between one-fourth and one-third of the entire atmospheric envelope. A ray of light passing from the rarefied air of Mount Uncampahgre summit to the denser air of the middle ground would be bent downward, while the same ray passing onward would be bent upward through the rarefied strata to Mount Ellen. The trajectory or path of this beam of light, then, is an upward curve that passes above the right line joining the summits of the two peaks.

The angle of refraction for a ray of light from the sun or a star, penetrating the earth's atmosphere, varies with their altitude above the horizon. When the altitude is zero, the refraction is 34 minutes of the arc. At  $90^\circ$  altitude it is zero.

In surveying there has, however, been shown to exist a terrestrial refraction of objects within the same stratum of homogeneous air, which makes them loom above the line of sea-level surfaces. That is to say, upon a level plain, when the atmosphere is in its normal condition, a ray of light from an object to the observer is not straight, but is slightly curved downwards. This curvature of a nearly horizontal ray is not due to the curvature of the earth and of the layers of equal density in the earth's atmosphere, as is often erroneously supposed, but would still exist, and with no sensible change in amount, if the earth's surface were a plane and the directions of gravity everywhere parallel. This is due to the fact that light

travels faster through the rarer air than through the denser media below, so that time is saved by deviating slightly to the upper side of the straight course. The actual amount of curvature is from one-half to one-tenth of the curvature of the earth; that is to say, the radius of curvature of the ray is from two to ten times the earth's radius.

Prof. James Thompson has deduced a general formula for the computation of this curvature of a ray lying in a vertical plane to any point in its length, in the foregoing assumption:

$$\frac{1}{P} = \frac{1}{H} \left(1 - \frac{53}{n}\right) (u-1) \cos. I.$$

In which—

P denotes the radius of curvature.

H, the height of the homogeneous atmosphere, 26,000 feet, or  $\frac{1}{8000}$  of the earth's radius.

n, the number of feet of ascent for decrease of 1° temperature F., or about 300 feet.

u, the index of refraction, 0.0002943, or  $\frac{1}{3400}$  at density sea level and freezing.

I, the inclination of the ray to the horizontal, or the inclination of the wave front to the vertical.

The units P and H may be miles or feet.

By substituting the approximate values,  $\frac{1}{P} = \frac{1}{5}$  about, or  $P = 5$ .

The deflection of the light above the arc of the earth's curvature is about 4,400 feet, which agrees with the facts of observation, for the base of the Henry Mountains was distinctly seen in good light toward evening.

It will be seen that as a result of these refractive

influences heliographic signaling is possible even when the right line joining the summits of two peaks penetrates the intervening ground.

For determining the size of a mirror reflector, to be readily seen by the naked eye during ordinary weather, for any length of time, the United States Coast and Geodetic Survey have found satisfactory the following formula, which was deduced by Prof. George Davidson.

$$n = d \times .046.$$

In which  $n$  = the length in inches of the side of a square mirror;  $d$  = distance in miles.

For smoky or hazy weather the size of the mirror might be well increased, for the intensity of the reflection, or the penetrative power of the flash, multiplies with the area of the reflecting surface of the mirror.

#### THE FLAG.

Signal flags should be of bright colors and clean—the flag used being of a color that will most strongly contrast with the background against which the flags appear when viewed by the person receiving the message; it should be of light and smooth material, which will glide easily through the air, such as cotton or linen; bunting is not desirable.

The motions representative of each letter should be made rapidly. To prevent any entangling of the flag upon its staff, skillful handling, acquired by practice, is necessary. It is accomplished by making a scoop of the flag against the wind, the movement describing an elongated figure 8, thus . The motions should be made so as to display in the lateral waves the whole surface of the flag toward the point of observation.

The 4-foot flags are for general work, and should be used with two or three of the 4-foot joints of staff furnished. The 2-foot, or practice flag, is for use in exceptional cases and over short distances only. A practice flag, as its name indicates, is for use for practice at short distances, and it may also be used to advantage when, during war, firing may compel the signalman to lie down or seek shelter while the signals are being made. It is useful in reconnoissances near the enemy, when—some fixed point being agreed upon from which to report—it can be used with somewhat less danger of attracting the attention of the enemy than can the larger flag.

The red flag should generally be used at sea, where in part of its motion the flag exposes against the woodwork or rigging of the ship and in part against the water or sky, and when snow or a white object forms the background. Generally, however, the white flag will be found best.

When it is difficult to attract attention, two flags are often shown in motion at the same time. When the background is certainly dark, both should be white. If the background is light, dark flags ought to be used. If there is doubt as to the color of the background on which they are displaying, the flags should be of different colors, as white and red.

The sun shining upon a flag increases its visibility; shining behind it, a flag is not rendered more distinct.

The days best suited to the transmission of flag messages are those when, while the atmosphere is clear, the sun is covered with light clouds. The light is then generally diffused. On such days flag messages have been read at the greatest distances.



## HOW TO PLACE THE FLAGMAN.

The position of a signalman transmitting a message by flag or torch must be exactly facing the point to which the message is being sent. The signals must also be shown exactly on the right and left of the sender or they will not be clearly displayed to the observer.

To determine the position of the sender in his relation to the distant station, a line should be sighted over a straight rod direct to the distant station, and a line exactly in this direction should be marked on the ground in front of the signalman. A line drawn at a right angle with this line should be drawn to extend on each side of the signalman, and the points touched by the flag on the right, left, and front should be marked on the ground.

The use of these markers secure the accurate displays of the flag signals by day, and they are even more valuable in torch signaling when the communicating station can not be seen and its exact direction determined. The flagman has then only the markers as guides to determine the direction in which his signals must be shown.

The flagman should stand, one heel on each side of the line connecting the stations, and the flag should be swung in a plane at right angles to this connecting line.

With the flag all motions are determined from its first position, held vertically. The same is true of the torch, but in order that the eye may follow the motions necessary to make the numerals representing the letters of the alphabet, a point of reference is necessary. This is supplied by the "foot torch," a light burning directly on a line between the stations and about 8 feet

in front of the sender, its flame pointing to the distant station. This is the point of reference in relation to which all motions are made.

#### MISCELLANEOUS DAY SIGNALING.

It may be desired to transmit messages to an outlying station, when, because of the proximity of the enemy, it would be unsafe to expose the signaler. Under such conditions the following method may be employed with advantage: An upright rod or standard, projecting 4 or 5 feet above an embankment or other elevation where the signaler may be out of sight, upon which a signal ball or disk may be moved freely up and down by halyards, or by the extension of a rod to where the signaler stands beneath. The moving rod to which the signal ball or disk is attached should extend below the embankment or wall, where it may be worked by being moved up and down; the center of the staff above the embankment or wall being the point of reference and rest.

Held midway on the staff is the first position. To signal "1," the ball is moved rapidly to the top of the signal staff and instantly returned to the first position. To make the signal "2," the signal ball is moved rapidly to the bottom of the signal staff and instantly returned to the first position. To make the signal "3," the signal ball or disk is moved rapidly a little above, then a little below the point of reference and instantly returned to the first position. The pause signal at the point of reference indicates the completion of a signal letter, and three signals "3," indicate the completion of a message. The length of the movement that should

be given to the signal ball when worked by a rod is the length of the arm above the center of the signal staff of the rod, and the same length below that point for the "2."

The signal staff and moving rod should be so proportioned that when the signaler's hand which grasps the rod is at the height of his shoulder, the ball or disk should then be at the point of reference, or first position.

If it be desired that signals should be read from different directions a ball should be used, while if it is desired to prevent the reading of a signal by the flanks, a disk should be used. At night similar vertical motions with a lantern below and above a fixed light may be used, or a horizontal motion to the right and left of a fixed light may be used, the motions to the right being "1" and those to the left "2;" or it may be agreed upon that differing motions may be used, one vertical and one horizontal. If the horizontal motion be to the right, the vertical motion should be the "2;" if the horizontal motion be to the left, the vertical motions should be the "1" and the horizontal "2."

#### SMOKE SIGNALS.

In General Marcy's *Prairie Traveller*, are these suggestions to attract attention and convey prearranged signals:

Very dense smokes may be raised by kindling a large fire with dry wood and piling upon it green boughs of pine, balsam, or hemlock. This throws off a heavy cloud of smoke which can be seen very far.

This method may be used to make the letters of the alphabet, with which certain preconcerted messages may be designated.

During the day an intelligent man should be detailed to keep a vigilant lookout in all directions for smokes, and he should be furnished with a watch, pencil, and paper to make a record of the signals, with their number, and the time of intervals between them.

When puffs of smoke are to be made at designated intervals have small green branches ready in bundles, and at the appointed times spread them upon the fire kept briskly burning. The Indians are said to have signaled by building fires in holes in the ground and confining the dense smoke therein by spreading a blanket over it, which they removed at proper times to make the puffs which, by prearrangement, conveyed their messages.

#### THE SEMAPHORE.

The field semaphore consists of an upright post of moderate height with two movable arms fixed on the same pivot near the top of the post. The arms should be about three feet long and increased one foot for each mile above three over which they are to be employed for signaling. These movable arms are operated by ropes passing over wheels or pulleys. The arms can be displayed in six distinct positions. (See fig. 10.) Each position represents a numeral or numerals, corresponding to the letters of the alphabet, as "a," "1;" "b," "2;" "w," "24;" "z," "26," etc.

An indicator on one side of the post is used to indicate that the "1," "2," and "3" are displayed on that side. When a letter is made it is, if desirable, kept in view until it is seen repeated at the communicating station. This is necessary only with men not well trained, or when the message is of great importance, or when the messages are sent enciphered.

If signal stations are to be permanently, or for any considerable time, occupied, and it is impracticable to electrically connect them, communication may be facilitated by erecting semaphores.

The width of the arm should not exceed one-sixth its length. The indicator should be the same width. The height of the post should be such that movable objects near it will not obscure the indicator or arms when the semaphore is erected in the field.

On one or more vessels of the Navy the semaphore apparatus has been fitted for trial. It consists of four pairs of wooden arms pivoted at the middle of their length to the topmast. These arms have three positions: First, up and down; second, at an angle of  $45^{\circ}$  to the horizontal, and, third, horizontally.

A modification of this apparatus where the signals are read from one direction only, as when the apparatus is erected on shore, may be fitted with but four single arms.

The code consists in regarding the position at an angle of  $45^{\circ}$  as "1" or a red light, and the horizontal position as "2" or a white light, and applying the army and navy code as used in the electrical night system.

Full instructions for the use of the naval semaphore will be furnished to officers when necessary.

#### INTERNATIONAL CODE.

With the International Code of Signals the peoples of different nationalities may speak to each other with a certainty that the message sought to be conveyed will be understood, although neither party has knowledge of any save his native tongue. The code is, as its

name indicates, "international," and every sea-going vessel of every nation is equipped with its flags.

This code of signals consists of 26 flags—one for each letter of the alphabet—and a code pennant. In order of importance, the code is divided as follows: Urgent and important signals are made with two flags; general signals with three flags, and geographical, alphabetical spelling tables, and vessels' numbers, with four flags.

The book as published by the United States Navy is divided into three parts. The first part contains urgent and important signals, money tables, weights, barometric heights, etc., together with a geographical list and a table of phrases formed with the auxiliary verbs.

The second part is an index, consisting of a general vocabulary and a geographical index, arranged alphabetically.

The third part gives lists of the United States storm-warning, life-saving, and time-signal stations, and of Lloyds' signal stations of the world. It also contains semaphore and distant-signal codes, the United States Army and Navy General Service Code, and the Morse Continental Telegraph Code. The International Code with full instructions for its use is furnished to such signal stations as may have occasion to exchange signals with ships.

#### DISTANT SIGNALS.

The following explanation of distant signals and instructions for their use are taken from the International Code of Signals, American edition, 1903:

Distant signals are employed when the distance between stations or the state of the atmosphere is such as to render difficult or impossible the distin-

guishing of colors of the flags of the International Code. These signals provide, also, an alternative system of making the signals in the International Code, which can be adopted when flags can not be employed.

There are three different methods of making distant signals, as follows:

- (a) By cones, balls, and drums.
- (b) By balls, square flags, pennants, and whefts.
- (c) By the fixed coast semaphore.

The last method (fixed coast semaphore) is not necessarily a method of making distant signals, as it can be and is used at close quarters and under conditions when flags could equally be employed, but it has been placed here under the head of distant signals for ease of explanation.

The characteristic of distant signals is the ball, one ball at least appearing in each hoist of the distant code. In the case of the semaphore the ball is replaced by the disk.

Hitherto only three symbols have been required for distant signaling, but the increase made in the number of flags in the International Code makes four symbols necessary in order that it may be possible to provide a distant hoist to represent each of the flags of the code—that is, letters of the alphabet.

Distant signals are made from a ship by hoisting shapes and from the shore by hoisting shapes or by the position of the arms of the semaphore.

The shapes used as symbols are:

- (a) A cone, point upward; a ball; a cone, point downward; a drum. (The drum should be at least one-third greater in height than the ball.)

GENERAL ALPHABETICAL TABLE FOR MAKING THE INTERNATIONAL CODE SIGNALS BY MEANS OF DISTANT SIGNALS BY FIXED SEMAPHORE			
"PREPARATIVE," "ANSWERING," or "STOP" after each complete signal		ANNUL THE WHOLE SIGNAL	
1 1 2	I	2 3 3	Y
B	J	2 3 4	Z
C	K	2 4 1	SPECIAL
D	L	2 4 2	Code Flag Sign
E	M	2 4 3	Alphabetical Sign
F	N	3 1 2	Numeral Sign
G	O	3 2 1	Finishing sign after completion of word or number, when spelling or making numeral signals.
H	P	3 2 2	

FIG. 10.

10495-05-7



GENERAL ALPHABETICAL TABLE FOR MAKING THE INTERNATIONAL CODE SIGNALS BY MEANS OF DISTANT SIGNALS BY SHAPES.			
"PREPARATIVE," "ANSWERING," OR "STOP," after each complete signal.		ANNUL THE WHOLE SIGNAL.	
A 1 1 2	I 2 1 2	Q 2 3 3	Y 3 2 3
B 1 2 1	J 2 1 3	R 2 3 4	Z 3 2 4
C 1 2 2	K 2 1 4	S 2 4 1	SPECIAL SIGNS.
D 1 2 3	L 2 2 1	T 2 4 2	Code Flag Sign. 4 2 1
E 1 2 4	M 2 2 3	U 2 4 3	Alphabetical Sign. 4 2 2
F 1 3 2	N 2 2 4	V 3 1 2	Numeral Sign. 4 2 3
G 1 4 2	O 2 3 1	W 3 2 1	Finishing sign after completion of word or number when spelling or making numeral signals.
H 2 1 1	P 2 3 2	X 3 2 2	

If no cones are available, a square flag may be substituted for the cone point upward, a pennant for the cone point downward, and a wheel for the drum.

FIG. 11.

(b) A square flag may be substituted for the cone, point upward; a ball; a pennant may be substituted for the cone, point downward; a pennant with a fly tied to the halyards or a wheft for the drum. (A wheft is any flag tied in the center.) As in calms, or when the wind is blowing toward or from the observer, it is impossible to distinguish with certainty between a signal flag and a pennant or a wheft, and as flags when hanging up and down may hide one of the balls and so prevent the signals being understood, the system of cones and drums is preferable to that of flags, pennants, and whefts.



FIG. 12.

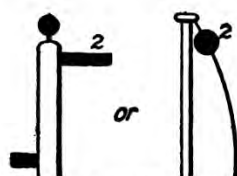

FIG. 13.

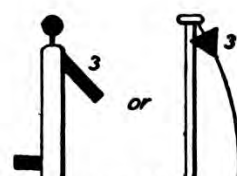

FIG. 14.

(c) In signaling by the semaphore, the positions of the arms represent the shapes.

To simplify the "taking in," "reporting," and "reading off" of the distant signals, the four positions of the semaphore arms and the four symbols have been numbered "1," "2," "3," and "4" (see figs. 12, 13, 14 and 15).

"1" representing the semaphore arm pointing upward on the opposite side to the indicator, a cone with the point upward, or a square flag (see fig. 12).

"2" representing the semaphore arm pointing horizontally on the opposite side to the indicator, or a ball (see fig. 13).

"3" representing the semaphore arm pointing downward on the opposite side to the indicator, a cone with the point downward, or a pennant (see fig. 14).

“4” representing the semaphore arm pointing horizontally on the same side as the indicator, a drum, a pennant with a fly tied to the halyards, or a wheft (see fig. 15).

To facilitate signaling by semaphore or shapes, the signals representing the letters of the alphabet have been arranged in numerical order. Thus “a” is represented by 112, “b” is represented by 121, “c” is represented by 122, etc.

The signals representing the letters from A to G begin with “1;” those from H to U begin with “2;”

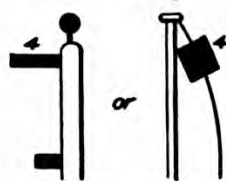

FIG. 15.

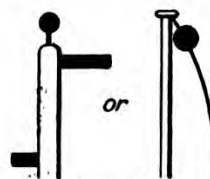

FIG. 16.

those from U to Z begin with “3;” and the special signs—that is, code flag alphabet, numerical and finishing signs—begin with “4.”

The code flag sign 421 is always to be shown before signals taken from the general vocabulary of the International Code are commenced.

When signals are made by the semaphore the disk is always to be kept up until the signals are completed, and the hoist is to be read from the top of the arm downward.

The Stop Signal (see fig. 16) is to be made at the end of each signal.

With two balls, two cones, and one drum every signal in the International Code can be made, each hoist representing one letter of the two, three, or four letters representing signals.

Example of a signal from the International Code, made by fixed semaphore or by distant signals.

(Fig. 17.)

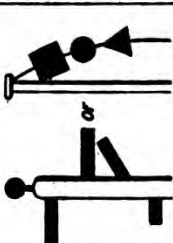
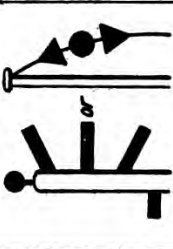
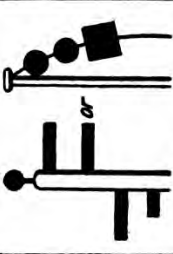
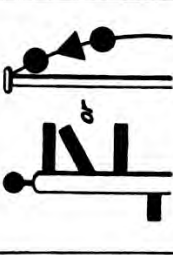
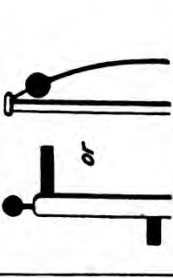
				
4 2 1 Code Flag Signal, indicating that the signal which follows is taken from the General Vocabulary of the International Code.	1 2 3 D	2 2 4 N	2 1 2 I	2 Stop, i. e., Signal is ended.

Looking DNI out in the International Code, we find it to be "Pilot boat is advancing toward you."

*Alphabetical distant signals.*—When it is desired to spell a word by distant signals the alphabetical sign 4 2 2 (see figs. 10 and 11) is to be shown first. All the hoists which follow until the finishing sign 4 3 2 (see figs. 10 and 11) is shown are to be understood as representing the particular letters of the alphabet allotted to them in figures 10 and 11, which, when combined, spell the word which it is desired to signal.

*Numeral distant signals.*—When it is desired to signal numbers by distant signals the numeral sign 4 2 3 (see figs. 10 and 11) is to be shown first. After that sign has been shown and until the finishing sign 4 3 2 (see figs. 10 and 11) is shown, the hoist representing the various letters of the alphabet (see figs. 10 and 11) are to be understood as having the numerical values which are allotted to the particular letters under the system of making numeral signals by flags, which is explained on page 32 of the International Code of Signals.

Thus, after the numeral sign 4 2 3 has been shown the distant signal hoist representing the letter “A” will mean the number 1, that representing B will mean 2, that representing K will mean 11, and so on, as in the numeral table on page 32 of the International Code of Signals.

*Special distant signals.*—As shown in the example above given, signals from the general vocabulary of the International Code require to be made by more than one hoist, which involves loss of time. Arrangements have, however, been adopted by which 37 important signals can be made by one hoist only. These 37 signals are called “special distant signals,” and are represented by the numbers explained in paragraph 7, page 524 of the International Code of Signals, and not by letters.

The special distant signals are distinguished from distant signals taken from the general vocabulary of the International Code by the fact (1) that they are not preceded by the code flag sign, and (2) that stop signal immediately follows the single hoist representing the particular “special distant signal” which is being made.

**THE CONTINENTAL TELEGRAPH CODE.**

The Continental Telegraph Code, used generally throughout the world, differs from the Morse Code in use in the telegraph service in the United States in that the "space" is not used, all letters being made by the dots or dashes or combinations of dots and dashes. The complete alphabet and numerals are as follows:

A	..... - -
B	..... - - - -
C	..... - - - - -
D	..... - - -
E	..... -
F	..... - - - -
G	..... - - - - -
H	..... - - - -
I	..... - -
J	..... - - - - -
K	..... - - - -
L	..... - - - -
M	..... - - - -
N	..... - -
O	..... - - - - -
P	..... - - - - -
Q	..... - - - - -
R	..... - - - -
S	..... - - -
T	..... - - -
U	..... - - - -
V	..... - - - - -
W	..... - - - - -
X	..... - - - - -
Y	..... - - - - -
Z	..... - - - - -
1	..... - - - - -
2	..... - - - - -
3	..... - - - - -
4	..... - - - - -

5	.....	— — — — —
6	.....	— — — — —
7	.....	— — — — —
8	.....	— — — — —
9	.....	— — — — —
0	.....	— — — — —

The dash is represented by a flash of about two seconds duration. The dot is represented by a flash of one second duration. The preparative signal is a series of short flashes.

The answering signal, or "I understand," is a series of alternating long and short flashes.

This code may be used for spelling out each word to be transmitted or the International Code may be used, the letters representative of the alphabetical signals, word phrase, or sentence, being signaled after the signal "I C U" (International Code use) has been made and acknowledged by the answering signal — —

— — — — —

The interval between each flash should be one-half second.

The interval between each letter one second.

The interval between each word two seconds.

#### CHRONOSEMIC SIGNALS.

Chronosemic or time signals may occasionally be advantageously used either in visual or sound signals. The principle upon which time signals are used is this: The intervals between successive signals indicate the meaning of the signal. Thus, an interval of five seconds between signals would represent "1," an interval of ten seconds would represent "2," an interval of fifteen seconds would represent "3," etc. In sending messages

chronosemically the least interval between signals should be five seconds. The determination of the unit intervals must be arrived at upon consideration of all the conditions obtaining at the time it is desired to employ this method. This is necessary because the signals used may require a much greater time interval, as, for instance, displaying a flag from halyards or firing a gun or cannon.

A *base signal* is essential, as from it are counted the seconds of time which represent the signal. A flash being displayed and immediately obscured, and after five seconds again displayed and obscured, would, as above explained, represent "1," etc. The letter "A" of the general service code would be represented by making the base flash, then in ten seconds another flash, and in ten seconds more another flash—"22."

The interval between letters should generally be fifteen seconds or three times as great as the interval representing "1," and between words the interval should be twenty seconds. The end of the message may be indicated by a double signal, or by allowing the flash signal to remain visible for five seconds or more, or in such other way as may be agreed upon. A pendulum to mark the intervals of time, if there be no other method available, may be extemporized from a piece of twine about 30 inches long, and a weight which, being suspended and swung, will give approximately accurate oscillations of one second. The weight should not be more than four or five ounces and the distance from the center of the weight to the point of suspension should be 29 inches. Or the seconds may be told off by counting with the exclamation "ah" between the numerals, as "1" ah "2" ah "3" ah "4."



Chronosemic signals may be used under conditions where it may not be practicable to employ any other method, as, for instance, where it is possible only to raise a flag or disk above an embankment, by sun flash from a hand mirror, or by using bombs and rockets, but one kind of which is available.

Rockets best lend themselves to the chronosemic signaling. The time interval of rockets so used should be computed from the lighting of the rocket. When an interval is of sufficient length, which should always be arranged for, the difference in time between that set for the explosions and its actual occurrence will hardly be sufficient to cause error. Should, however, a rocket fail to explode, or should its explosion be so long delayed as to cause it to be misunderstood, the "annul" signal should be sent up and the message repeated.

## CHAPTER IV.

### NIGHT SIGNALING.

#### THE SEARCHLIGHT.

When an electric searchlight is available its beam of light can frequently be successfully employed for signaling, even when the communicating stations are not in sight of each other. In such cases the shaft or beam of light should be used exactly as is the flag, the first position requiring the beam to be shown vertically; motions to the right of the sender will represent the figure 1; to the left, the figure 2, and directly in front, the figure 3.

For signal stations near sea level or where it is impossible to secure elevation for the stations this method of signaling is of the greatest value. Messages have been communicated between stations at sea level 40

miles apart when no other means of visual communication was at all practicable.

Another method for using the searchlight as a means of signaling is to have some object upon which the beam of light may be displayed, as upon a cloud, a balloon, or other object. To represent "1" the light is flashed for the unit of time upon the object, two similar flashes will represent "2," and an exposure equal to three units of time will represent "3" of the General Service Code.

#### ACETYLENE LANTERNS.

*Acetylene.*—There has been used with very good success over a distance of about 30 miles an acetylene lantern generating its own gas from calcium carbide. This gas, called acetylene, gives when burning, high penetrative power, and is, commercially, comparatively a new discovery.

Acetylene is a pure hydrocarbon gas, which can be produced in various ways. The methods in use by the Signal Corps are (*a*) by dropping calcium carbide into water; (*b*) by dropping water on calcium carbide.

Mr. Edmund Davy, professor of chemistry to the Royal Dublin Society, in 1836 first produced and described acetylene.

The manufacture of calcium carbide, from which is generated acetylene, for commercial purposes, followed its accidental production by Mr. Thomas L. Willson at Spray, N. C., in 1892.

*Calcium carbide.*—In the manufacture of calcium carbide for commercial purposes the best quality of coke and quicklime are used. These two substances are powdered thoroughly, mixed in proper proportions,

and then placed in an electrical furnace. Under the action of the intense heat ( $5,500^{\circ}$  F.) these two refractory substances unite, forming carbide of calcium, commercially known as calcium carbide. Calcium carbide is of a grayish-white color, crystal in appearance, and is nonexplosive and noncombustible, being, except for its affinity for water, an absolutely inert substance. A pound of commercial carbide will produce approximately 5 cubic feet of gas. When water is brought in contact with calcium carbide the generation of acetylene is rapid; owing to its strong affinity for water it will become air slacked and slowly lose its strength if exposed to the action of the moisture in the atmosphere; consequently, when stored or being transported it should be kept in air-tight cans.

When calcium carbide is brought in contact with water the following occurs:

As is known, the principal components of water are oxygen and hydrogen, and calcium carbide is calcium and carbon. When brought in contact the oxygen in the water decomposes the calcium in the carbide, and in this decomposition the hydrogen in the water is liberated and unites with the carbon of the carbide, forming a hydrocarbon gas which is acetylene. It is a pure white light of intense brilliancy and high candle-power. The spectrum analysis of acetylene shows that it is almost identical with sunlight, and, in consequence, delicate shades of color appear according to their true value as under the light of the sun, consequently it penetrates fog to a greater distance than other lights. Acetylene is like other gases—explosive when mixed with air in proper proportions, confined and ignited—and the same precautions should therefore be taken in

its use as would be in the handling of coal or water gas, gasoline vapor, etc. As acetylene is very rich in carbon it will not burn in its pure state without smoking; to avoid this, burners have been constructed so that the gas is mixed with the proper proportion of air at the burner tip, to insure perfect combustion. The burners for acetylene are different from those for other gases. In order to get a flat flame the gas is brought through two perfectly round holes at an angle which causes the two flames to impinge upon each other and thus form a flat flame.

#### METHODS OF GAS GENERATION.

There are two methods for producing acetylene, one in which a limited amount of water is dropped on a mass of calcium carbide, and the other where limited amounts of carbide are dropped into a volume of water. The disadvantage of the water-feed system is that when the water is not in excess and does not entirely surround and touch each piece of carbide the heat of generation will so change the chemical properties of the gas that combustion at the burners is not satisfactory. This change is technically known as "polymerization," or the breaking up of acetylene into other hydrocarbons, such as vapors of benzene, benzole, etc. These form a tarry substance which is apt to condense at the burner tip and clog the openings. Also they deposit carbon on the burners, as they require more air for perfect combustion than does pure acetylene. Another disadvantage of this system is that after the carbide and water are in contact, generation of gas will continue until all the water is absorbed. Where, however,

portability of the generating apparatus is desired and resort to this method is necessary, the objections are not obvious if the apparatus is well constructed and care is taken in its use. This water-feed system is the one used in the field lantern of the United States Signal Corps. When it is essential to have a light of the greatest intensity, several burners in a group are necessary, and this system calls for the other method of generating acetylene, in which limited quantities of carbide are automatically fed to a comparatively large body of water. The water almost instantly absorbs the heat caused by the immediate generation and the acetylene is delivered to the burners nearly pure and free from the by-products of a highly heated gas. This system is used in the station signaling lantern of the United States Signal Corps. By a simple and ingenious device the carbide is automatically fed into the water only as fast as the gas is consumed, there being no over-production, consequently no surplus gas to be stored.

#### LANTERNS.

There are in use by the United States Signal Corps two types of acetylene signaling lanterns—the field signaling lantern and the station signaling lantern. As is indicated by their names, they are designed for special uses; the former, being small, light in weight, very easily transported, and simple to set up and take down, is especially adapted for field work where stations are but temporarily used.

The station signaling lantern is a larger instrument of greater candlepower than the field lantern, and is especially adapted for long-distance work and where stations will be more of a permanent character.

## THE FIELD LANTERN.

(See fig. 18.)

This equipment consists of a signal lantern with cartridge generator attached. The lantern is equipped with a special aplanatic lens mirror, 5 inches in diameter and about 3 inches focus. The lantern is packed complete in a case, and the following extra parts are included, each part having its own receptacle in the case: 2 burners; 1 cover glass; 3 cartridges of calcium carbide of 5 ounces each; 1 pair of gas pliers; 1 tube white lead; 1 extra filter bag; 1 screw-driver.

The lantern is made of brass, all parts of which are riveted. The burner is of the double tip form, consuming three-quarters of a cubic foot per hour. The lantern is fitted with a hood to provide proper ventilation and at the same time pre-

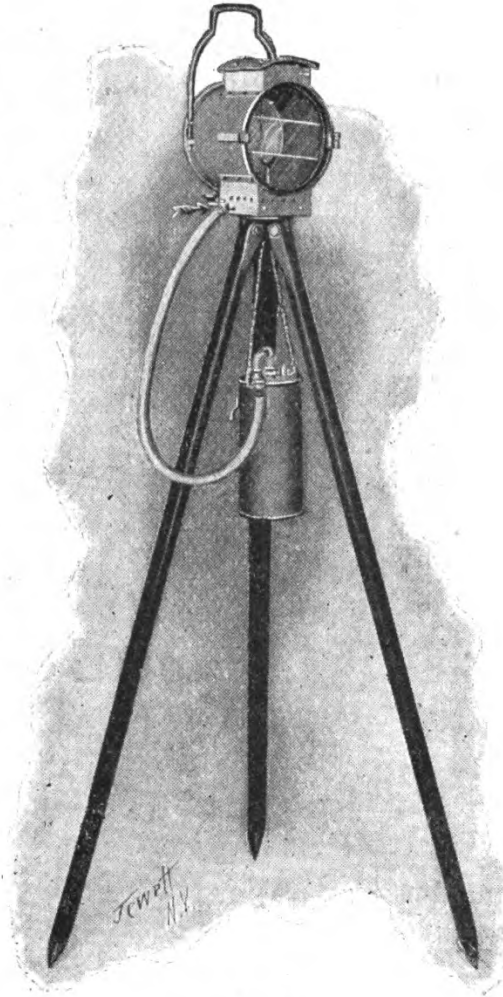

FIG. 18.

vent the flickering of the light by the wind. The front door of the lantern is hinged and fastens with a spring clasp; it is so arranged that it can be entirely removed if necessary. The cover glass is made in three sections and is not affected by the expansion and contraction of the metal due to changes in temperature. The glass is fastened by the aid of a spring wire, so that it can be readily removed if it is necessary to replace a broken section. In the base of the lantern is a key and the ad-

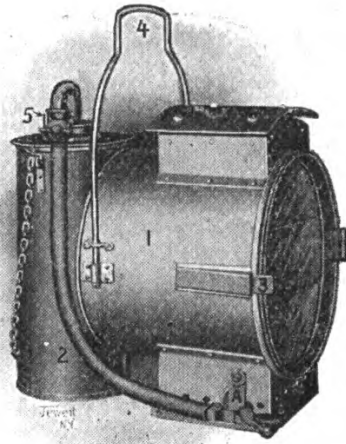

FIG. 19.

justment for regulating the height of the flame. The key is so arranged that when not depressed but little gas is admitted through the bypass to the burner and the flame is low. By depressing the key as much gas as can be entirely consumed is admitted to the burner, which gives a bright flash. At the back of the lantern there is an adjustable handle, so that the equipment

can be used as a hand lantern if desired. This form of lantern can be used with the regular heliograph tripod, the generator being either attached to the back of the lantern or suspended, as shown in fig. 18. When practicable it is better to attach the generator to the lantern, as shown in fig. 19. The candlepower of this lantern is about 1,900.

*The generator.*—This is known as “the cartridge generator,” and while constructed on the water-feed principle, the disadvantages incident to this method are

eliminated as far as possible. It is constructed of brass and has a removable top. Attached to the inside of the top is a flexible frame with a spring latch, the spring latch being hinged. (Fig. 22.) At the top of the frame is a tube or cylinder, the bottom of which is conical in shape and covered by a rubber plug. At the bottom of the frame is a hollow tube, which is the water inlet. The cartridge proper consists of a tin cylinder, having an opening at either end. A small cylinder of wire mesh extends from and connects these openings. The carbide lays around this mesh on the inside of the cartridge. The rubber plug before mentioned fits into the upper opening, and the water tube into the lower opening. (See figs. 21, 22, and 23.) Inside the tube, at the top of the frame, is a filter, the function of which is to remove the dust and moisture from the gas. The outlet from this chamber is by a brass bent tube having a stopcock attached thereto.

#### DESCRIPTION OF GENERATOR.

Fig. 20 gives a sectional view of the generator with the cartridge in place.  $D F G H$  represent the valve frame and  $I$  the cartridge attached. The reservoir  $A$  is filled with water, and when the frame is immersed, with the valve  $R$  closed, the air contained in the cartridge and tubing can not escape, the water seal preventing, while the confined air prevents the water from rising in the tube  $N$ . When the valve at  $R$  is opened and the air is allowed to escape, part of the water from the reservoir rises into the tube  $N$  and then out through the small hole  $O$  to the carbide. Gas is

10495—05—8



immediately generated, the pressure of which prevents further ingress of the water from the tube *N*, and the generation of gas is suspended.

As the gas passes out through the valve at *R* the pressure decreases, permitting the water to again rise in the tube and flow through *O*. Gas is again gener-

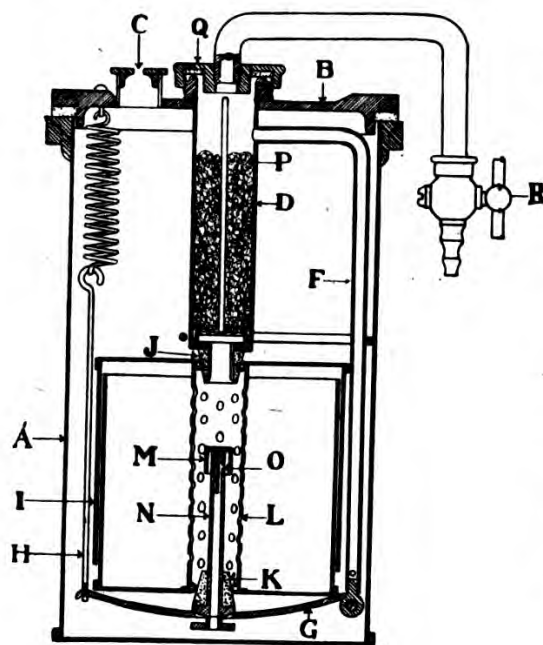

FIG. 20.

ated, which at once exerts its pressure and cuts off the supply of water. This is the automatic action by which water is brought in contact with the calcium carbide. Thus it will be observed that the use or escape of the gas regulates the generation by the simple device of the rise and fall of a water column. There is a cap *M* screwed over the tube *N*. This is used to deflect the course of the water downward, so that the carbide in the lower part of the cartridge is first attacked. There is a needle inside of cap *M*, which can be used for cleaning the hole *O*. When the gas is generated it passes through the filter *D* on its way to the burner through *R*. This filter consists of a tube loosely packed with ordinary nonabsorbent cotton, which should never cover the escape pipe leading to the valve *R*. In pass-

Generated on 2015-11-18 16:36 GMT / http://hdl.handle.net/2027/luug.30112077589635  
Public Domain, Google-digitized / http://www.hathitrust.org/access\_use#pd-google

ing through this cotton filter moisture and dust are removed from the gas. In the latest model a felt filter is used instead of cotton.

The escape pipe  $F$  provides a means for the escape of gas generated and not used or generated more rapidly than consumed. Should an excess be generated, it passes down through the tube  $F$ , and finding its way through some small holes in the bottom of this tube, escapes through the water seal and the opening at  $C$ . It will be noted that if escaping gas at  $C$  should become accidentally lighted, the flame can not strike back into the filter and cartridge because of the water seal. The principal things to observe in the operation of this generator are the following:

(1) To see that the rubber plugs *fit tightly* into the openings of the cartridge.

(2) That the tube  $N$ , the cap  $M$ , and water hole  $O$  are not stopped up.

(3) That the cotton in the filter is changed frequently.

(4) That the *stopcock  $R$  is closed before inserting the frame in the water*. If this latter instruction is not complied with, it can be readily seen that the water will have free access to the carbide and excessive generation will occur.

When the charge is exhausted the entire cartridge is taken out and thrown away. This eliminates the handling of carbide and the disagreeable task of cleaning out the residuum after the gas has been extracted.

Connection is made from the stopcock  $R$  to the hose connection on the lantern proper, and this is the passageway of the gas from the generator to the burner. As soon as the stopcock is opened the water rises through the tube and flows to the carbide. The advan-

tage of the cartridge being submerged in the water is to reduce and absorb as much of the heat liberated by generation as is possible. These lanterns have been tested up to a distance of 10 miles with the naked eye, and under favorable conditions can be used over a range somewhat in excess of this. With a thirty

powers telescope the flash can be read at a distance of 30 miles.

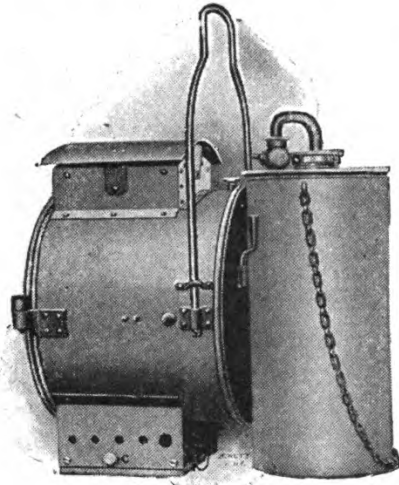

FIG. 21.

#### DIRECTIONS FOR OPERATION AND CARE OF THE FIELD LANTERN.

Take the lamp and generator from the case by aid of the handle attached to the lamp; screw the complete outfit on a heliograph tripod or stand the outfit on a level object; remove

the cover of generator, to which is attached the flexible frame (fig. 4); detach spring from the catch of the flexible frame; tear off flaps from the ends of carbide cartridge (or pry off small caps) and attach the cartridge as shown in fig. 5. Then attach to frame as shown in fig. 6, *being careful to see that both rubber plugs fit tightly into the holes in the cartridge*; fasten the latch of the spring over the metal catch; close stopcock *R* on service pipe; completely fill the outer can of generator with water, the object being to have the generator level full of water when the lamp is in service, then immerse the frame and cartridge, pressing the top of the generator down tight. In doing this the

water will overflow the sides of the generator tank. Now connect by rubber tubing the stopcock with the gas inlet at the bottom of the lamps, as shown in fig. 19; then (1) open front door of the lamp, (2) open stopcock, and (3) light the gas at the burner. In doing this hold the key open. In the new model the key and hose connection are on the *side of bottom of lamp* (fig. 25).

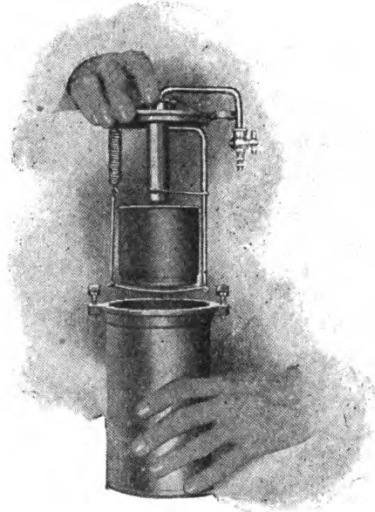

FIG. 22.

When the gas is ignited the lamp is ready for signaling and the key can be operated as is the Morse telegraph instrument, but of course not so rapidly.

In the event of the flame being too high when the

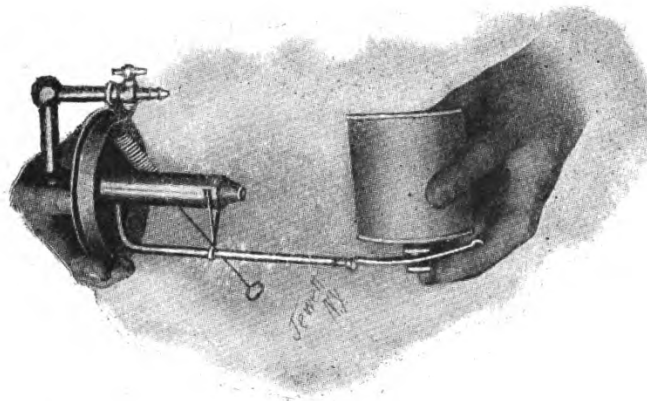

FIG. 23.

key is closed adjustment can be made by loosening the set screw (fig. 18, indicated by an arrow) and adjusting

the light by turning screw *b*. When at the proper height tighten the set screw which locks the by-pass in its proper position.



FIG. 24.

In the new model this is accomplished by aid of the regulator by-pass valve at the *left-hand side of bottom* of lamp. (Fig. 21.) The lamp is properly adjusted when shipped, and should not be changed unless absolutely necessary. Connect the rubber tube to the

burner before opening the stopcock on the generator.

To recharge the generator take the frame and the old cartridge from the case, throw away the old cartridge and replace with a fresh one, proceeding as before. See that fresh water is put in the generator each time a new cartridge is used.

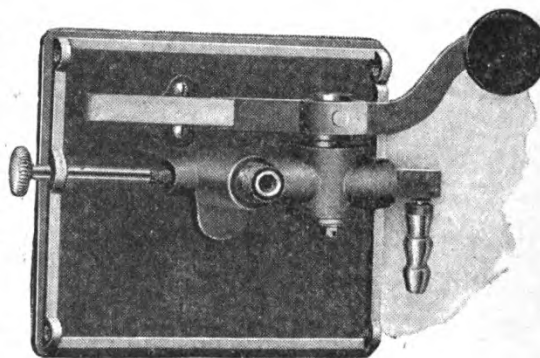

FIG. 25.

In the tube through which the service pipe passes is a felt filter for taking the dust out of the gas. If the filter clogs unscrew the cap to which the service pipe is

attached, clean the felt or replace it with a new filter, binding it in place by a stout thread or string.

If the burner of the lamp does not produce a perfectly flat flame it has become clogged and should be cleaned with the burner cleaner furnished, or a new burner should be substituted, care being taken to put a little white lead on the nipple, if practicable, so as to insure a tight joint.

In repacking the outfit in the case, throw out the water and wipe the can and generator parts dry. You can not be too careful to keep the apparatus clean. This is especially true of the small pipe that passes up through the bottom of the cartridge, with a cap over it. The cap should always be screwed in place, as its object is to prevent the water from squirting to the top of the cartridge.

The back of the lamp can be removed by turning the small thumb screw on the top and drawing out the pin which holds the shell into which is fitted the lens. It is not necessary to take the back out except to replace a lens, as the latter can be cleaned by opening the front door.

If it is desirable to use the lamp as a hand lantern the flame can be turned on full by turning the button in a vertical position; this locks the key open. In the new model depress the key and lock it with the latch above the key.

One charge of calcium carbide will supply gas to burn about one hour with the light turned on full, or for approximately three hours' signaling.

If signaling is to be suspended for some hours, empty the water out of the generator and close valve *R*.

The glass front can be replaced by taking out the wire spring. The glass cuts should be mounted in a horizontal position, and, to prevent breaking, should be protected from rain when the lamp is hot. If a glass should be broken and an extra one is not available to replace it, signaling can be continued by turning the flame on full and using the heliograph shutter, a cap or piece of board in front of the lantern to obscure and reveal the flash. Without the protection of the cover the flame is easily blown out when turned low, but will not be extinguished even in a strong wind if the gas is turned full on.

Old model lamps are serially numbered from 1 to 200, inclusive; the new model lamps are serially numbered from 201 upward.

#### THE STATION SIGNALING LANTERN.

The shell of the lantern is made entirely of brass, being cylindrical in form; the axis of the cylinder is horizontal. Four one-half foot acetylene burners are mounted in this cylinder, in one end of which is a plano convex lens, 5 inches in diameter and of 6-inch focus. The burners are arranged in line on the axis of the lantern and close one to the other. The center of the cluster, permanently adjusted, is mounted in the exact focus of the lens. In the back of the lamp, opposite the lens, is a concave spherical mirror with its center of curvature in the center of the cluster of flames. This arrangement gives the utmost concentration possible for throwing a parallel beam of light with a small portable apparatus. The lens is mounted in an independent brass shell, which fits into a hinged front so

that the front can be swung open and the lens removed or cleaned, or a new one readily substituted. The

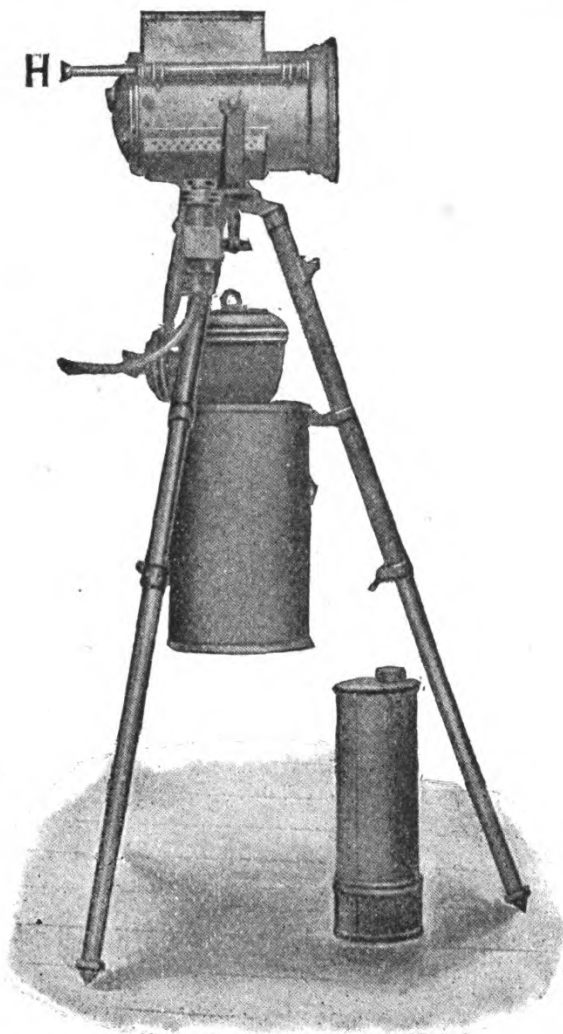

FIG. 26.—Station Signaling Lantern.

Side view of lamp set up ready for use. *H*, Telescoping sighting tube.

reflector is mounted on the hinged back of the lamp which is arranged to fly open by pressing a spring latch. This facilitates the lighting of the lamp.



On top of the lamp is mounted a telescoping sight with adjustable disks, for the purpose of more accu-

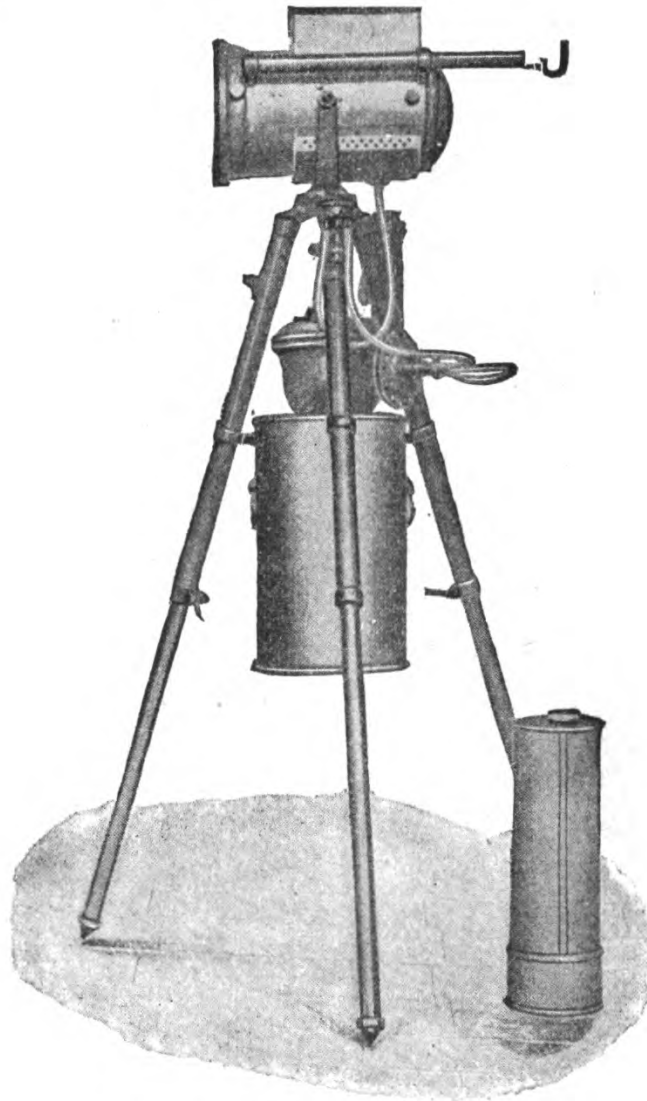

FIG. 27—Station Signaling Lantern.

Side view of lamp set up ready for use. *J*, Insulated handle.

rately directing the beam. The lamp proper is mounted in a fork on trunnions, the fork being mounted so as to

rotate in a horizontal plane. Thus adjustment, both

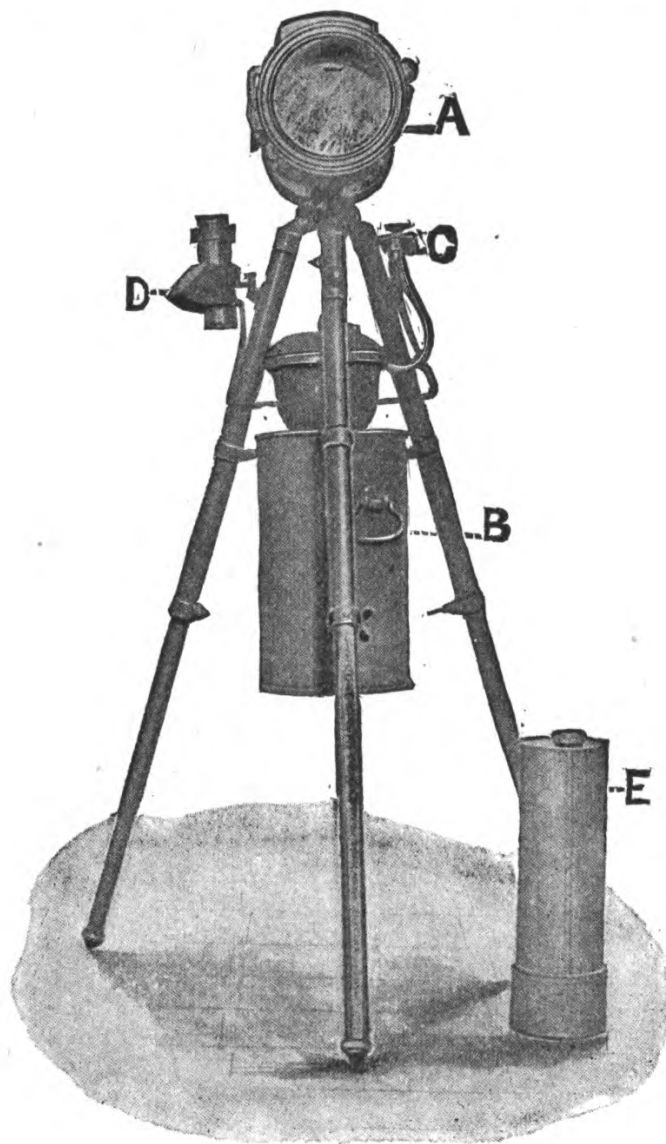

FIG. 28.—Station Signaling Lantern.

Front view of lamp set up ready for use. *A*, Flash lantern; *B*, Acetylene generator; *C*, Signaling key; *D*, Reading lamp *E* Carbide canister.

vertically and horizontally, is provided for. The lan-

tern is pointed on the distant station and a turn of a

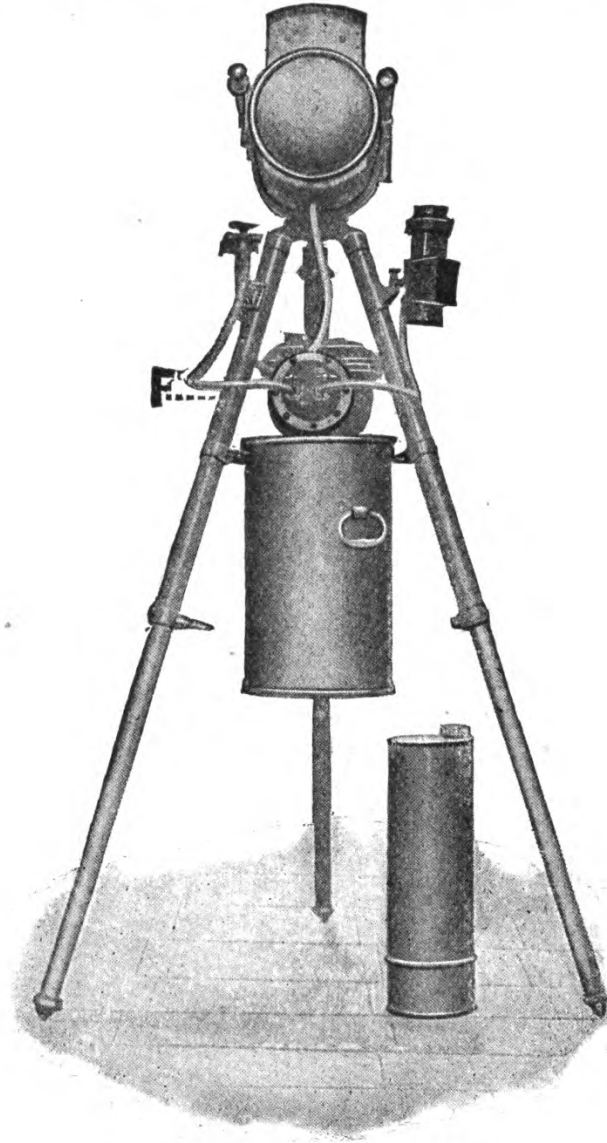

FIG. 29.—Station Signaling Lantern.

Rear view of lamp set up ready for use. *F*, Filter and method of attaching rubber tubes.

thumb screw clamps it in both planes. The lantern is

mounted on a mountain tripod with telescoping legs of bicycle tubing. The tripod is made very rigid by the generator which hangs by hooks on the three legs below the lamp. There are lugs on two of the tripod legs, one for receiving the key and the other to hold the small reading lamp.

#### AUTOMATIC OPERATION.

The carbide in granular form is held in the conical-shaped hopper above the water. The hopper has a hole at the apex. There is a plug or stop on the end of a rod actuated by the diaphragm, which reciprocates vertically through this hole. When the key is opened and the diaphragm descends, the plug is removed from the hole automatically, allowing a little carbide to fall into the water beneath. Gas which is instantly generated passes into the hopper and raises the diaphragm, which lifts the plug, closes the hole in the hopper, and prevents the further dropping of the carbide until the gas which has been generated passes out through the filter to the burners. When the gas so escapes, the diaphragm descends by gravity, the plug is removed from the hole, carbide is dropped, gas is generated, and so this sequence is constantly and automatically repeated.

The generator charged will supply gas for two continuous hours burning, or for about five hours signaling. The generator can be recharged in a few minutes. The tank holds 1 gallon of water, the hopper 1 pound of carbide, so that the gas generated is dry and comparatively cool, the temperature being never higher than 130° F. When, after generation, the gas leaves the

surface of the water, it ascends through the hopper by means of a by-pass, circulates over the carbide in the hopper and thence passes out through a filter before

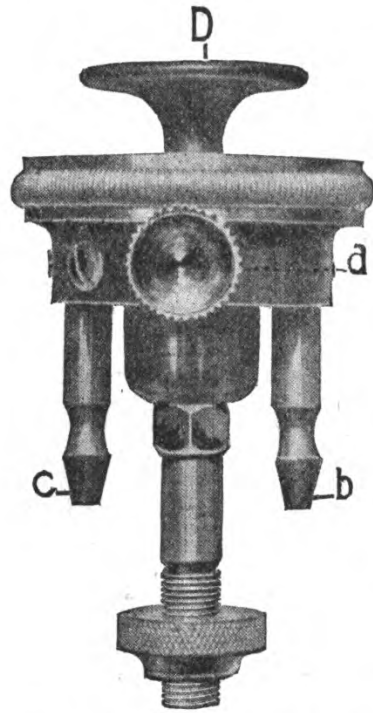

FIG. 30.—Key for Station Signaling Lamp.

*a*, By-pass thumbscrew. *b*, Hose nipple on which is arrow. The connection from the generator to the key should be through this nipple; the direction of the arrow indicates the direction of gas flow. *c*, Hose nipple, connection from key to hose nipple of flash lamp. *D*, Operating key.

going to the burners. This filter consists of a thick felt of fine grain, which is clamped between two brass disks, one of which screws on one side of the hopper; from the other side project two gas cocks, one of which supplies the signaling lantern and the other the reading lamp. The function of the filter is to prevent dust or foreign substance being carried to the burners. It should be inspected occasionally by daylight, and when found coated with lime the felt should be removed and cleaned or new felt substituted. The small reading lamp is equipped with a single-jet acetylene tip. This is for the purpose of supplying light for reading or recording messages, which, of course, can not be conveniently done by the intermittent flashes of the signaling lantern. This

equipment includes a 5-pound canister for the carbide, to one end of which is secured a small funnel for the purpose of easily filling the generator.

Signals are made by turning the gas on and off (or nearly off) intermittently, by means of a "key," or valve, actuated by a button  $1\frac{1}{8}$  inches in diameter, like the but-

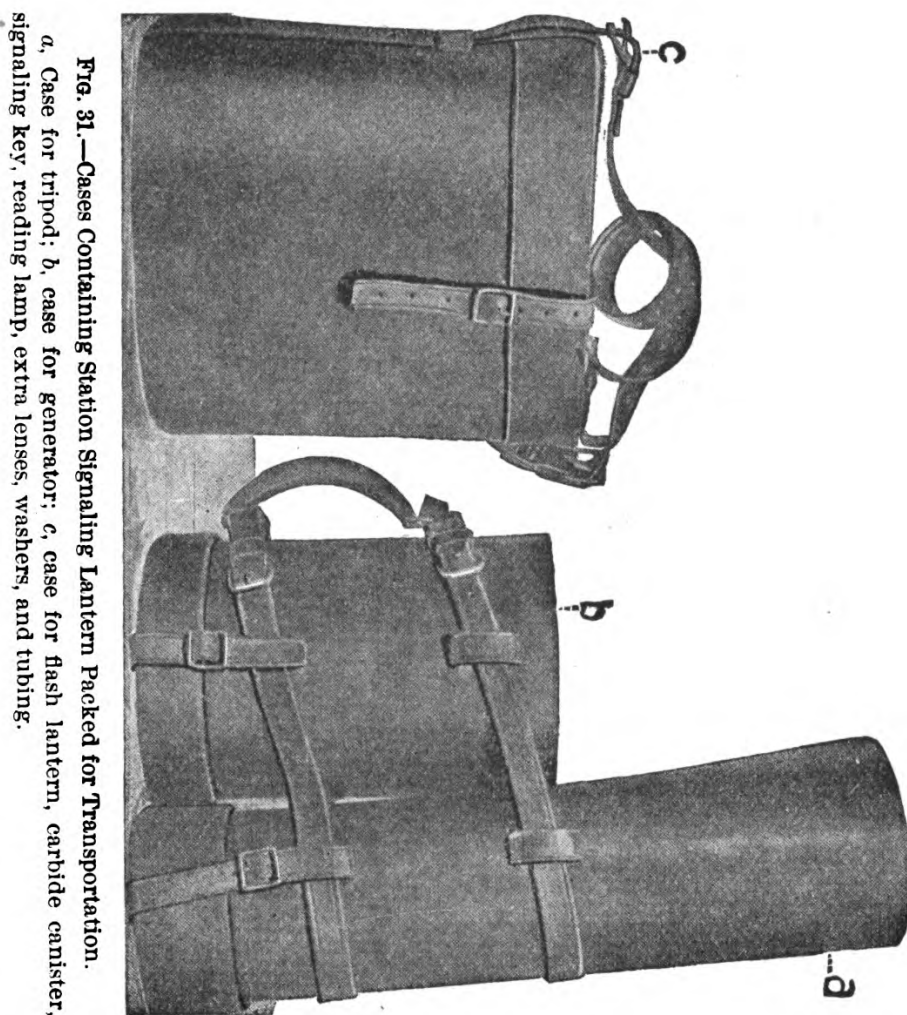

Fig. 31.—Cases Containing Station Signaling Lantern Packed for Transportation.  
 a, Case for tripod; b, case for generator; c, case for flash lantern, carbide canister, signaling key, reading lamp, extra lenses, washers, and tubing.

ton of the standard Morse telegraph key. The action of the key in responding to the touch of the operator is instantaneous. These keys are provided with a by-pass

for supplying a small quantity of gas to the burners to keep them from going out when the pressure is removed

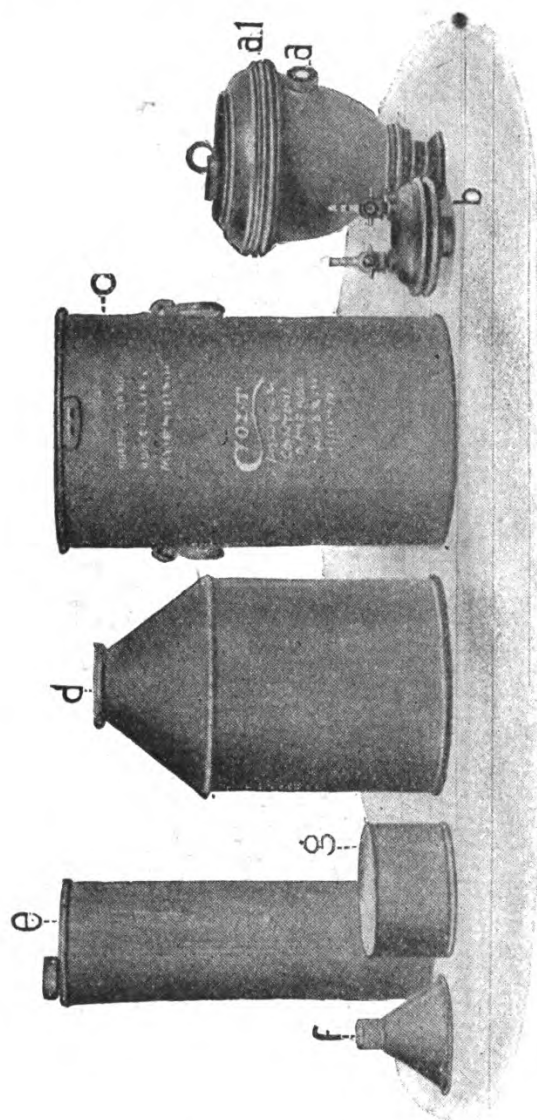

FIG. 32.—Parts of Generator.

*a* 1, Carbide holder or hopper; *a*, where filter is attached to carbide holder; *b*, filter; *c*, outer can of generator; *d*, inner can or gasometer bell; *e*, carbide canister; *f*, funnel for filling carbide holder; *g*, measure for carbide (this holds one full charge). *f* and *g* are packed in bottom of carbide canister (*e*).

from the button. This by-pass is adjustable, so as to enable the operator to regulate the size of the flame.

DIRECTIONS FOR USING THE SIGNAL CORPS STATION  
SIGNALING LANTERN.

Take the tripod from the case and set on the ground with one of its legs toward the distant station. Tighten thumbscrews.

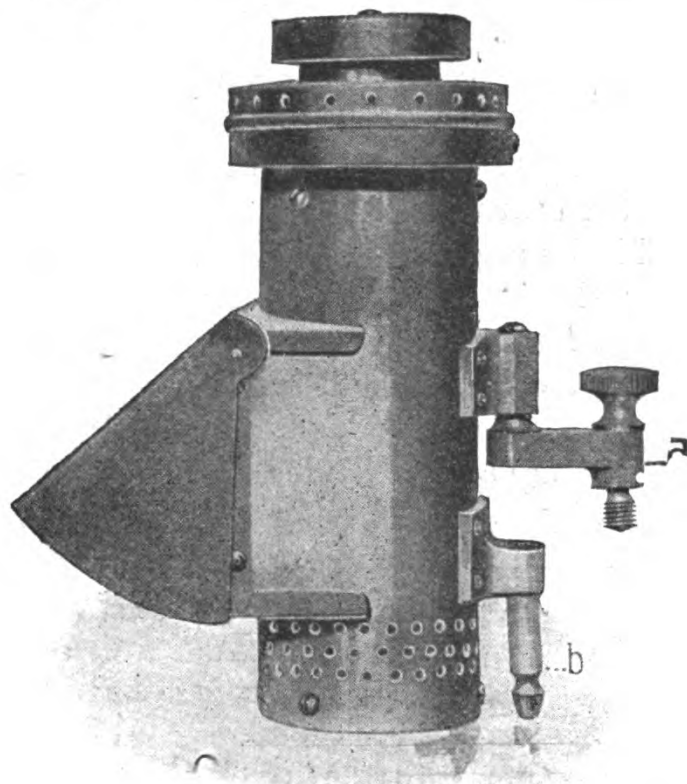

FIG. 33.—Reading Lamp on Station Lamp.

*a*, Screw for attaching to leg of tripod; *b*, hose connection with the cock on filter.

Remove the generator from its case and stand it on level ground. The inner compartment should be filled with water to within one-half inch of the top. The space between the outer and inner walls should be filled to the top. Use only clean water. Clean salt water can be used, if necessary.

10495—05—9



Remove the carbide holder from the inside of the generator bell by unscrewing to the left. Screw it on top of the generator bell.

Be sure that the washer, which makes a gas-tight joint between the carbide holder and the bell, is in place. Screw the gas filter to the carbide holder.

Turn the crossbar on top of hopper so as to allow the diaphragm to descend. See that it works smoothly and then raise it as far as it will go, letting the crossbar rise through the notches in the top of the carbide holder. Then turn the bar so that the diaphragm will be locked in its upper position, closing the feed valve.

Unscrew the filter cap in the top of the diaphragm and fill the hopper with carbide from the measure. Use only one measure full. The measure holds 1 pound. Use only " $\frac{1}{2} \times \frac{1}{8}$ " carbide; i. e., granulated carbide screened through a sieve having 12 meshes to the inch and stopped by a screen having 20 meshes to the inch.

Replace the filter cap and screw it tight.

Open the two hose cocks on the side of the filter to allow the air to escape, and then place the generator bell in the outer tank, *allowing it to descend slowly*.

Now close one of the cocks and, holding the crossbar on the diaphragm with the hand, turn the bar and lower the diaphragm, slowly until some carbide is dropped into the water, which will generate gas and raise the diaphragm, thus automatically closing the valve, when the hand should be removed.

Allow the carbide to feed freely for fifteen seconds to exhaust the air from the generator. If the hopper rises and falls violently, close both cocks. Hang the generator on the hooks inside the legs of the tripod.

Place the lantern on top of the tripod and fasten it, not tightly, by turning the clamping screw to the right.

Attach the signaling key to the lug on the right of the tripod, looking to the distant station, and the reading lamp to the other lug on left of the tripod.

The screw on the stem of the signaling key should be screwed in about seven full turns, then (having the by-pass screw on side of key turned away from the leg of the tripod) clamp it with lock nut on stem of key.

On each side of the stem of the key will be found a hose nipple, one of which is marked with an arrow. This latter is the inlet of the key. Connect it by the rubber hose to one of the hose cocks of the generator. Connect the other nipple of the key to the nipple on the bottom of the signaling lantern. Connect the reading lamp by hose to the cock on the filter of the generator.

To light the gas open the door by pressing the knob on the side at the rear of the signaling lantern. Open the by-pass on side of key by turning to the left one or two turns. Release the diaphragm of the generator and let it descend slowly. Open the hose cock leading to the key, press the button on top of the key, and hold the match over the burners in the lantern.

*Be prepared with the lighted match to hold to the burner immediately upon turning on the gas; otherwise an accumulation of gas in the lantern will cause an explosion when ignited.*

To light the reading lamp, open the glass door in front of the lamp, hold a lighted match over the burner and turn on the gas.

On the right of the lantern is a telescopic sighting

tube. Draw out the tube and, by means of the handle on the left side of the lantern, direct the lantern toward the distant station. The lamp is swung on a horizontal axis. Elevate or depress the lantern until the distant station is seen in the center of the sighting tube, then clamp tight with the thumbscrew. The wooden handle on the left side of the lantern, used for directing the flash, is withdrawn from its sheath by unscrewing to the left until it slides out freely. Draw it out as far as it will go and continue the unscrewing movement, which will fasten it rigidly.

Before signaling, the by-pass on the key should be regulated until the flames are quite low (about a quarter of an inch high). Pressure on the button of the key will admit the full flow of gas instantly and produce a bright flash.

Operate the key in the same manner as a telegraph key, *but slowly*.

At the base of each burner in the signaling lantern will be found a slotted screw head. By turning any one of these to the right with a screw-driver, its respective burner may be turned off and replaced in case the burner is broken or defective.

On the hose nipple just under the burners will be found a knurled head or nut, which, when removed, permits the removal of all the burners.

*Care of the apparatus.*—Keep the washer between the carbide holder and the bell soft and smooth by oil and graphite.

To remove the lens for cleaning, pull button on front of the lantern outward and open the door. The supporting shell of the lens may be slid from the door

frame. The lens shell is in two parts, which, screwed together, clamp the lens between them.

Always fill the generator with clean water every time any carbide is put in the carbide holder. Never run two charges of carbide into the same water.

Do not leave the lamp burning when not in use, thus extending the time the lamp can be used without recharging.

Always empty the unused carbide remaining in the hopper back into the canister when through using. Before packing do not fail to *clean and wipe dry* the plug which automatically opens and closes the hopper valve.

There is a by-pass in the carbide holder of the generator leading from the side of the feed valve upward to allow the gas, when generated, to rise freely from the water and act directly on the diaphragm. Keep this passage clean. Do not invert the carbide holder when it contains carbide or it will get into and clog this by-pass. When charged, the generator, whether the gas is lighted or not, may be safely transported if kept in an upright position and not violently jostled.

Do not allow any light near the lantern except to light the gas at the burners.

Always throw out the residue in the generator after the carbide has run out, and be very careful never to allow any of it to get into the seal between the bucket and the tank.

Do not ram or pack the carbide into the holder. One pound is the maximum charge that should be used.

*Keep the carbide valve clean.*

When through signaling for the night, and the location of the lantern will not be changed materially, the

gas should be turned off from both the key and the reading lamp by closing both the stopcocks; and, as a further precaution, the diaphragm should be raised and the crossbar locked in its position.

#### THE TORCH.

The torch formerly used by the Signal Corps very well met the requirements for active service. It was simple and strong; it could be lighted and used in rainy or stormy weather, and withstood the hard usage incident to field work.

While the torch has been superseded by improved appliances of much greater range for night signaling, and is no longer issued or used by the Signal Corps, yet as the equipment is still in some cases used by the signal corps of the National Guard, it is deemed proper here to give instructions for using it. While disagreeable to work with, cumbersome, and of limited range, the torch is, under favorable atmospheric conditions, entirely reliable to a distance within which the telescope of the Signal Corps renders it visible. If the atmospheric conditions are not unfavorable, the torch may be read with the telescope over 8 or 10 miles with little difficulty.

The set of torch equipments is comprised of the following:

*The canteen*, made of copper, with one seam and soldered, capable of containing one-half gallon of turpentine or other burning fluid.

*The haversack*, in which are packed wicking, shears, and pliers for trimming torch, a small funnel for filling the torch, and the two flame shades, etc.

The canteen and haversack are fitted with shoulder slings or straps by which they may be easily carried.

*The service can* is a strong copper can with rolled seams hard soldered. The nozzle is fitted with a screw cap to prevent leakage. It is capable of containing 5 gallons of burning fluid.

*The flying torch* is a copper cylinder 18 inches long and  $1\frac{1}{2}$  inches in diameter; it is closed at one end, with the exception of a nozzle through which it can be filled and which closes with a screw cap; it is open at the wick end, and on its sides at this end are 4 fenestra or openings 1 inch long, half an inch broad, which open into the wick, so providing that however the flame may be driven by the wind it will find a portion of the wick exposed.

*The foot torch* is a copper cylinder 18 inches long and 2 inches in diameter. It is similar in its structure to the flying torch.

The torches are trimmed by fitting into the mouth a wick of cotton wicking 6 inches long. This must fit closely. The body of the torch is then filled with turpentine or other burning fluid, as petroleum, etc. The flying torch attaches to the staff "third joint" by clamp rings and screws.

*Flame shades.*—Each torch is fitted, when in use, with a flame shade, a ring of thin copper 2 inches wide and fitting by a socket upon the torch in such a way that the ring projects on all sides. This is placed about 1 inch below the fenestra or openings. The use of this shade is to prevent the flame from traveling down the side of the torch and thus overheating it. The flame shade is always detached when the torch is packed. Each torch

is fitted with "wedge strips" below the fenestra. The flame shade can be tightened by pressing it firmly down upon these.

A shade, called a wind shade, is sometimes used in high winds. It consists of fine strips of copper attached to a socket, and is adjusted upon the torch in the same way as the flame shades.

*The funnel, pliers, and shears* are used for filling and trimming the torch.

*A screw or wormer* is placed in the torch case to be used when the wick may, by accident, be drawn so far into the tube of the torch that it can not be seized by the pliers.

Signal torches may be used for any system of signaling in which a light of only one color is needed.

As a general rule, if stations once established are not more than 10 miles distant, the torch light, shown in motion at one station, will be seen at the other through the telescope as a light sufficiently strong to attract attention.

That the wicks of the signal torches are properly adjusted should be carefully observed. If the wicks are too tight the torch will not burn well. If they are too loose the fluid will escape and the torch will burn too violently. The wick of a flying torch is properly trimmed when the flame of the burning torch seems to be about 3 inches in diameter.

If there is even a slight dripping of the fluid, the wick is too loose and it must be made tighter by adding new threads. If the wick is so tight that the fluid can not readily flow through them to feed the flame, draw out a few strands.

One wick properly made will last for a week's work if the torch is kept well filled.

When the torch equipment is to be packed the torches must be perfectly emptied of any fluid they contain.

When the wind blows from such a direction as, by driving back the flame of the foot torch, to render the light of that torch indistinct when viewed from the communicating station, so place the torch as to bring the wind shade upon it in direct opposition to the wind; and if this is not sufficient, build behind the torch a screen about 2 feet high and 2 feet long, of stones, earth, boards, or any other material, and in view of the communicating station, its flame will be in the dead air caused by the screen.

In cases of emergency torches may be improvised from pitch pine, old cordage, or other material saturated with any combustible fluid. Even brands from the fire may be used.

When a flying torch is not in use the wick should be covered with an extinguisher and the torch laid flat on the ground.

Both the flying and foot torch are fitted with an extinguisher. At the conclusion of each message the flying torch should be extinguished. The foot torch or some other light is always left burning in its place so long as signaling is to be carried on, in order that the communicating station may see to what point to direct its signals. A small fire or lantern is often used as a foot light.

If during the transmission of a message the flying torch is lowered to the left at the end of a word and is there extinguished, it indicates that it is extinguished



to be refilled. As soon as refilled light it at the foot torch and bring it thus lighted vertically to the first position and resume the message, beginning the word following that signaled before lowering the torch. One filling of the torch will last for about twenty minutes. The torch should be refilled at the end of a word, after fifteen minutes' use.

The foot or reference torch is to be filled as often as necessary, without stopping signals or extinguishing its light.

Care must be taken that the reference or foot light is certainly within view of the communicating station. If, looking from the level of and over your foot light, the foot light at the communicating station can be seen, your foot light is likewise visible to the far station. If the distant foot light can not be so seen, yours must be raised or moved to a position that, sighting along it, the distant foot light will be visible.

These precautions should be taken by each station. The foot torch, lying close to the ground, is often hidden by bushes or high grass near it, and signals made under such conditions are unintelligible. Signaling should never be commenced at night at any station until, with the head near the ground and in the place at which the foot torch will be, the receiving station has been observed, and it has been made sure that the foot light shown at the home station will be plainly visible there. When a station is occupied and worked during the day all preparations for night signals, such as filling the torches, properly placing them, determining that when lighted they will be in view of the other, etc., should be made before dark.

Learn to swing the torch exactly in a plane at a right angle to a line connecting your own and the station with which you are communicating. The distances between which communication may be maintained is governed by the visibility of your signals, and this visibility is determined by the contrast between the signal and the background and by the radius of the arc described by your signal, and with the flag by its display in its lateral waves of the whole surface toward the point of observation. It is this quality of comparatively prolonged display which produces the vivid impression upon the eye and enables signals to be read at considerable distances.

When signals are made with torches at night the signalman should stand immediately behind the footlight, and the flying torch be so handled that when it is brought to the front to make pause signals its flame, as observed from the communicating station, will seem to mingle with the footlight. When large common fires are burning at or near the station at night, care must be taken that they are so placed as not to confound the view of the torch signals or of other signal lights that may be shown. The signalman must be placed well to one side of the fire, and his signals must be displayed out of the line of sight from the fire of the communicating station.

The light of large fires burning near will often interfere at night with the use of the glass. The best location for the glass is, under these circumstances, in advance of the fire.

Care should also be taken that the glare of the torches or lights will not interfere with the use of the telescope.

To prevent this interference it is sometimes necessary to erect a screen, sheltering the eyes of the observer, or cover the observer's head with a cloth or coat.

For the order in which the several parts of a message are to be transmitted by flag or torch see instructions for the use of the heliograph; the same rules apply when using the flag or torch.

#### ROCKETS AND BOMBS.

Signals made by the explosion of bombs in midair are, within the limits of visibility, not likely to be unseen or misunderstood, and in consequence this method is of much value for preconcerted or code messages. Outposts should, when practicable, be supplied with mortar and bombs, to be used for signaling the approach of the enemy or the happening of unexpected events, the necessity for promptly knowing which is important.

Signal bombs are pasteboard shells, charged with stars which burn brilliantly when ignited. These shells are so fitted with fuses that they can be thrown into the air and exploded at a considerable height. Generally they are fired from mortars—hollow iron cylinders closed at one end, 2 or 3 feet in length, and of sufficient diameter to readily admit the bomb.

Because of the elevation which they attain, rockets and bombs are visible at considerable distances, yet reliance can not be placed upon them beyond a few miles if more than two-color displays are used, unless such colors are used with reference to their number and displayed one at a time, two at a time, three at a time, etc., to indicate different letters, or when made

to throw out clusters of stars of a single color, as all white or all red, or when used as chronosemic or time signals.

When rockets are to be transported the heads should be packed in strong boxes that will protect them from rain, and they should be so packed as to prevent their shaking and being rubbed violently together in transportation. Because of the increased strength of such arrangement, the rocket sticks should be carried bound together in packages. The packages can be easily carried by men on foot. By mounted men they can be carried over the bow of the saddle or with the lower part of the package resting on the stirrup, or in other ways which will suggest themselves. When these packages of sticks are to be carried on a pack saddle they should be attached lengthwise of the animal to prevent contact with other objects on the road. The signalist should always personally inspect rockets before starting on a march. He should notice especially that the paper stretched across the "choke" opening of the rocket, and which covers the match, is unbroken. He should pack in his kit wind matches and slow matches or port fires.

When rockets are to be fired the sticks must be firmly attached, the rockets placed upright in a trough, upon a frame, or against a post. If the fuse is beneath the paper covering the "choke" orifice it is broken, and the rocket is ignited by a port fire. In the rockets now used the fuse extends through the covering and can be lighted direct. If the night be damp the match ought to be exposed only a moment before the rocket is fired. If several rockets are to be fired in

succession it is well to prepare them all at the same time, and to have them all stood upright, but each separated from the other at a distance of at least 6 feet, else one may ignite the other accidentally. In firing for chronosemic signals, one rocket ought to be kept ready upon the frame and in reserve, to be fired in place of one that fails.

If a rocket misses fire it is to be taken from the stand and laid on the ground. Its place is at once supplied by a similar rocket, fired in its stead. The failing rocket is laid on the ground pointed away from the station in order that if it has only hung fire and should afterwards ignite it may not disarrange the signal shown or injure any one of the party. If the wind blows freshly the rocket to be fired should be inclined slightly against the wind.

#### ROCKET SIGNALING.

There have been used with success by the Signal Corps rockets each of which represented in the General Service Code a letter of the alphabet and two letters in succession stood for a certain prearranged phrase.

The numeral "1" is represented by a red star; a white star represents the numeral "2." To send the letter "A," a rocket showing two white stars is sent up. If "B" is to be sent, a rocket showing white-red-red-white is discharged. Each star burns for four to six seconds, and there is a slight interval between the visibility of each star. Between two or more stars of the same color, as "A," "N," "D," "dummies," which

show no light and carry the fire to the next star to be ignited, are employed.

Using the letters of the alphabet in this way a code of 600 phrases is possible, and no phrase will require more than two rockets to represent it. Such a number of preconcerted messages would provide for practically every emergent message that it would be desirable or necessary to transmit.

In the preparation of codes for signals with rockets or bombs there should always be arranged a "preparatory signal," which means "Are you ready?" "Do you see me?" and an "answering signal," which means "Repeat your last signal," "It is not seen," or "It is not understood;" a signal "annul," which means "Disregard last signal;" and a signal to signify the correct receipt of the complete message, or "Signal seen and understood."

The receiving station should promptly acknowledge receipt of each message.

When a line of several stations is established, care should be taken that each station be supplied with copies of instructions and codes exactly alike. These instructions and codes, plainly written, should be carefully compared with each other before they are issued.

There must be indicated in the code, with precision, what color of rocket or bombs is to be used for each numeral appearing in the indices of the code, and, if employed chronosemically, the intervals at which they are to be fired.

Wherever shown in the General Service Code, "red" stands for the numeral "1," and white stands for the numeral "2."

A conventional code of signals between two stations may be formed for representing anticipated duty, as follows:

Burn for "Attention" a red light, or send up a red bomb or rocket.

Burn for "Ready to receive," a white light, or send up a white bomb or rocket.

If not otherwise arranged, the correct receipt of the message should be shown by a white light, bomb, or rocket.

#### MISCELLANEOUS NIGHT SIGNALING.

At night lights may be displayed on the arms of the semaphore to indicate or represent the letters of the alphabet by the different positions of the lights relatively one to the other. One lantern, called a central light, is fixed to the same pivot upon which the arms move. Two other lanterns are attached to the extremities of the arms. A fourth lantern, used as an indicator, is fixed on the same horizontal level with the central light at a distance from it equal to twice the length of the arm and in the same plane nearly in which the arms revolve. Hence the whole apparatus consists of two fixed and two movable lights—four in all.

The central light by night and the post by day are merely guides to the eye. The signs of the semaphore are in reality, therefore, only composed of combinations of two movable bodies by day and two lights by night. It has been ascertained by experiment that the arms for day signals should be about 1 foot in length per mile, increasing proportionately. Therefore, a semaphore arm 6 feet long may suffice for stations 6 miles apart; but it may be well to sometimes add a little to

these dimensions. The width of the arm need not exceed one-sixth of its length. The indicator should be the same width. The height of the post should be such that movable objects near it will not obscure the indicator or arms when the semaphore is erected in the field.

It is occasionally necessary or desirable to use the ordinary hand lantern instead of the torch for night signaling. A method used in the Navy which will occasionally be found very advantageous is to move the lantern outward and upward from a reference lantern to represent "1," and an outward and upward motion to the left to represent "2," and raised vertically and lowered to the point of reference to represent the "3."

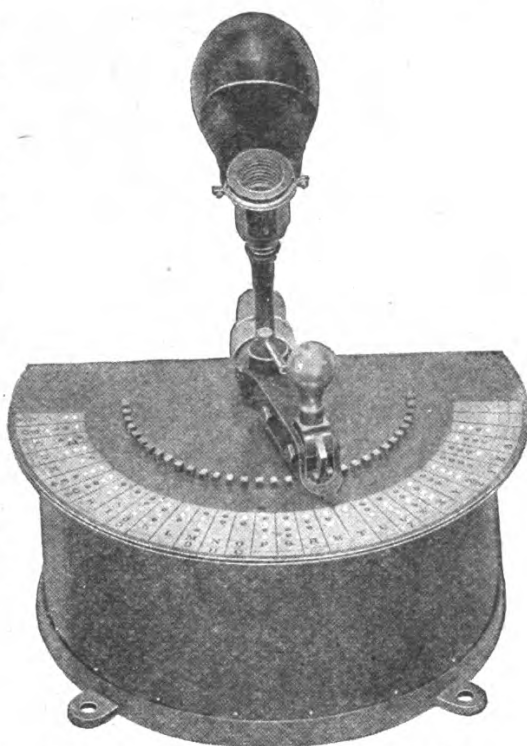

FIG. 34.—Keyboard for night signal set.

#### THE ARDOIS SYSTEM.

The Ardois night signal sets include four parts, namely, keyboard, cable, lanterns, and ladder.

*Keyboard.*—The keyboard consists of a dial and operating handle mounted on a water-tight box containing the mechanism for connecting the lamps in various combinations. The keyboard is illuminated by an incandescent lamp supported on a goose neck, and the

10495—05—10



box has receptacles on the back for the line and the lantern cables. The mechanism consists of a central rotating stud with eight contacts which rest against eight semicircular plates. Each plate is made up of insulating sections of hard rubber and metal sections



FIG. 35.—Ardois system keyboard, showing receptacles for cables.

which connect with a lamp in one of the lanterns. Obviously when one of the contacts of the rotating stud rests on an insulating section, the circuit through the lamp is broken; when on a metal section, the circuit is closed. When the pointer is turned to the position on the dial corresponding to the desired signal,

some contacts rest on the hard rubber sections and others on the metal sections, thus connecting into circuit a certain combination of lamps. The lamps are not actually lighted, however, until the knife switch on the rotating stud is closed by swinging the knob of the handle down toward the operator.

*Connections.*— Current is supplied to the keyboard through two line plugs, one of which is connected to the central contact in the lantern cable receptacle, and the other by means of a brush to the knife switch on the central stud. Each semicircular plate is connected to a contact in the lantern cable recep-



FIG. 36.—Keyboard with cover and lamp.

tacle, into which a plug is fitted to establish connection with the lamps through the lamp cable.

The cable is made up of 16 conductors. One end of each conductor is connected to a lamp and the other end to the plug which fits into the receptacle on the keyboard. Eight conductors run from the 8 outside contacts of the plug to the 8 lamps and the other 8 conductors form the return from the lamps

and are connected to the central contact of the plug. When the lamps are lighted the current flows as follows: From the generator to the line receptacle on the box, to the contact ring, to the switch, to the plunger contacts, to the semicircular plates, to the cable, to the

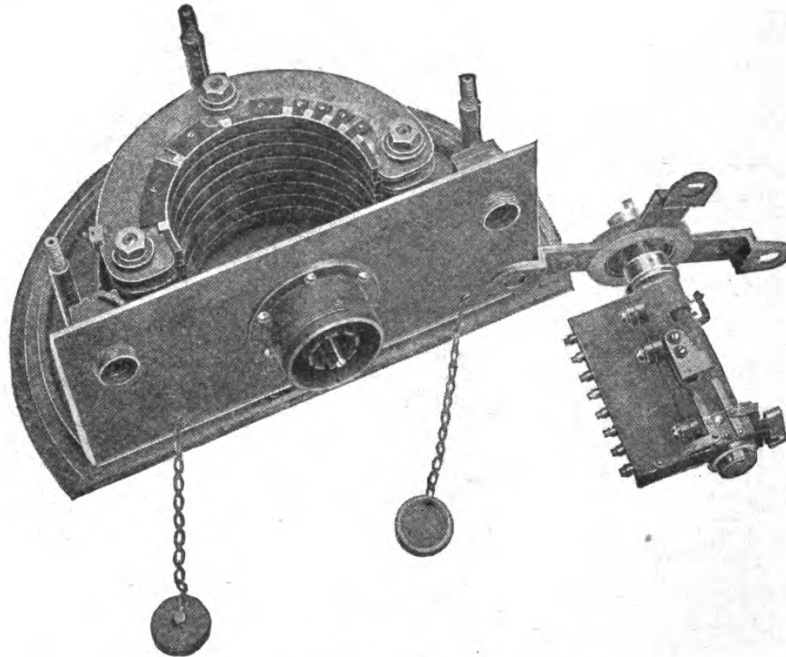

FIG. 37.—Mechanism of Keyboard.

lanterns, back to the cable, to the central contact of the receptacle on the box, to the line receptacle on the box, to the generator.

The circuits are shown in detail in the accompanying diagram. The plug and receptacle are made watertight by means of a soft rubber gasket, and the 16 cables from the plug pass through another gasket in the gland, which makes a tight joint by compressing the soft rubber around them.

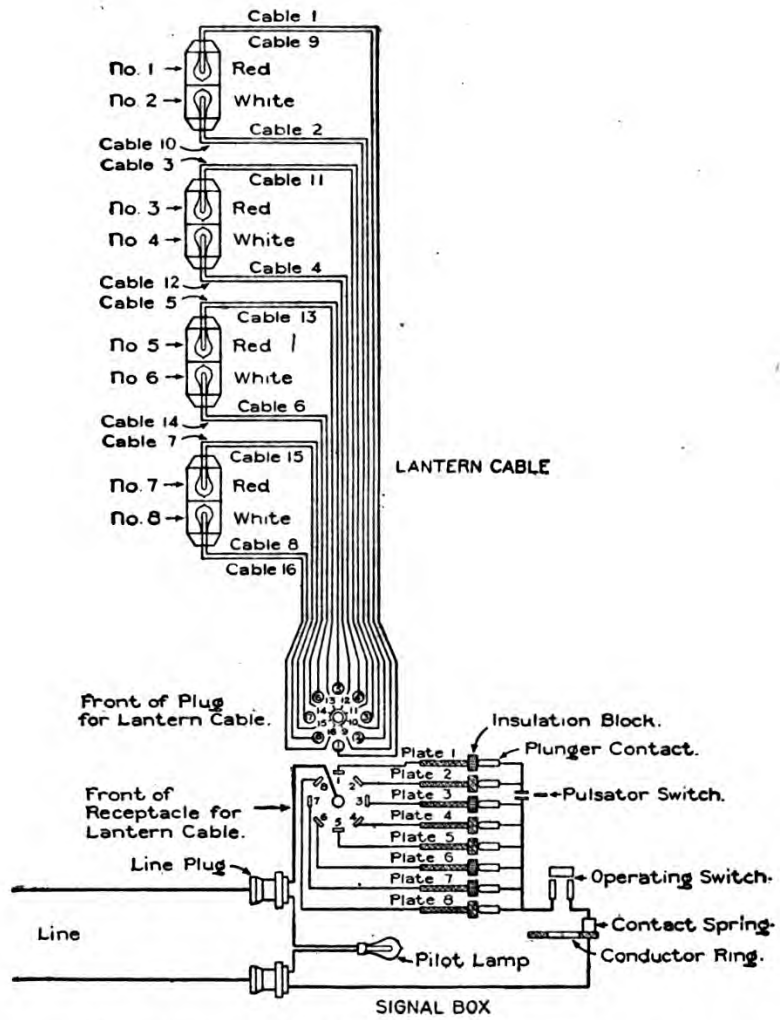

FIG. 38.—Diagram of Connections of Night Signal Set.

*Lanterns and ladder.*—Each of the four lanterns has two compartments, one with a red globe, the other with a white globe. The wires pass through water-tight stuffing boxes in caps which screw on each end of the lantern with a gasket and support standard lamps and sockets.

The ladder is made up of galvanized iron wires with metal cross pieces from which the lanterns are swung.

*Operation.*—After the ladder, lanterns, and keyboard are in place they may be connected as follows:

Connections to the line should go to the two small outside receptacles on the back of the keyboard box,

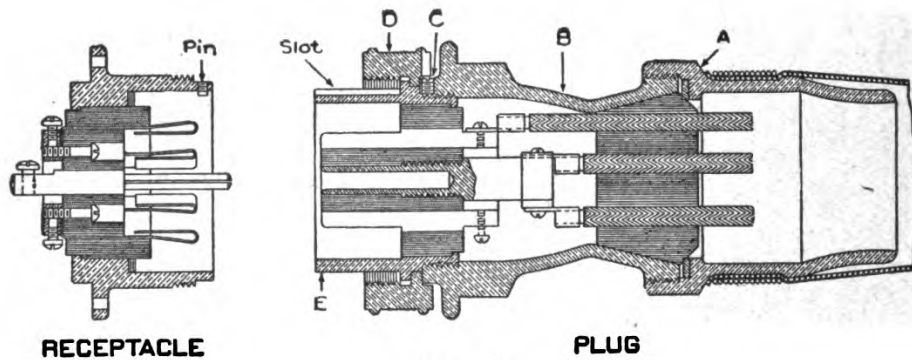

FIG. 39.

and the plug on the end of the lantern cable should be inserted in the receptacle between the line receptacles. This plug can be inserted only one way, as the receptacle has a pin which must fit into a slot on the plug. After the plug is inserted the nut D (see diagram) should be screwed up tightly so as to compress the soft rubber packing. The plug should never be taken from the receptacle when the current is on, as the sparking is apt to injure the contacts, particularly the center

one, which carries the combined current for all the lamps. Therefore, before removing the plug see that the knob on the handle of the keyboard is in an upright position. To operate the keyboard, the arm with the pointer can be swung over the dial to the combination required and the knob depressed. The cam actuated by the knob will then engage with a slot so that the arm can not be moved, and will remain in this position until the knob has been raised again. This arrangement prevents the display of false signals. If pulsating lights are required, they may be produced by means of the pulsator switch on the central shaft. It is a small lever, which extinguishes the lamps in the upper lantern when pushed to one side and lights them again when released. The lamp socket on the keyboard is provided with a switch, and when not in use the lamp should be extinguished to prevent excessive heating when the doors of the cover are closed.

*Repairs.*—The soft rubber packings used about the couplings and cables should be frequently examined and renewed from time to time as the rubber becomes hard and partially vulcanized by the long-continued compression and heat from the metal, which becomes quite hot when in the sun, especially in tropical climates. When worn-out the cables can be replaced, one conductor at a time or all at once. To replace one conductor unscrew the cap at the lantern and disconnect the conductor from the lamp and pull the cable out after loosening the packing in the gland. Cut the sizing about the cable and separate the defective con-

ductor as far as the cable plug on the box and cut away the canvas jacket. With the plug removed from the receptable, unscrew part *A* and slip it up the cable some distance, then unscrew part *B*, after taking out set screw *C*, and work the gasket back on the cables, so that *B* and *E* can be separated. Pull *B* and *E* apart and disconnect the defective conductor from the contact and pull it out through the gasket. Unsolder the terminal on the conductor and solder it to a new conductor; pass the new conductor through *A*, through the gasket, and then through *B*, and connect it to the contact. Screw *B* in place, and after replacing the set screw push the soft rubber gasket down into the gland. As there are 16 conductors the rubber gasket is not easily inserted, but by pulling on one conductor at a time, and changing about, the gasket can be worked into place, and then part *A* can be screwed up and a new canvas jacket put on.

To connect the other end of the conductor to the lamp in the lantern, pass it through the rubber gasket in the gland and connect it to the lamp socket. Screw up the gasket in the gland tightly, replace the cap on the lantern and screw it down hard. When repairing the cable in this manner a good opportunity is offered to put in entirely new gaskets all around. The method of procedure in removing the entire cable is, of course, the same as in removing one strand. The cable should be painted occasionally with some tar compound as a preservative, in the same manner as standing rigging.

*Standard outfit.*—The complete outfit includes:

- 1 keyboard, complete, with cover and lamp.
- 1 ladder and cable, with male half of coupling.
- 1 reel of extra single-conductor cable.
- 5 lanterns (4 for ladder and 1 spare lantern).
- 10 32-candle power 80-volt lamps.
- 1 16-candle power 80-volt lamp for keyboard.
- 1 tool box containing the following:
  - 2 fork wrenches.
  - 1 spanner.
  - 1 grip for male plug and shell.
  - 10 spare gaskets for lantern glands.
  - 1 spare gasket for coupling of 16-conductor cable.
  - 2 spare gaskets for main line plug contacts on keyboard.
  - 2 spare washers for main line plug contacts on keyboard.
  - 10 spare washers for lantern cap.
  - 1 spare washer for coupling.
  - 16 spare copper terminals.

*Truck-light controllers.*—The controlling switch for truck lights is contained in a metal box and connected to the circuit by leads passing through the hollow pedestal on which the box is mounted. The handle on top of the box is used for operating the switch, and the lamp lighted at any one position is indicated by the pointer. The light may be pulsated by moving the pulsator button, on the side of the box, in and out.

When connecting the truck-light controlling switches follow the diagram on page —. The terminals on the inside of the box are marked “*MR*,” “*MW*,” “*FR*,” “*FW*,” those to which the line connections are made are marked “*L*.”



The line wires should be connected to the terminals marked "L;" those from the "Main" red half of the

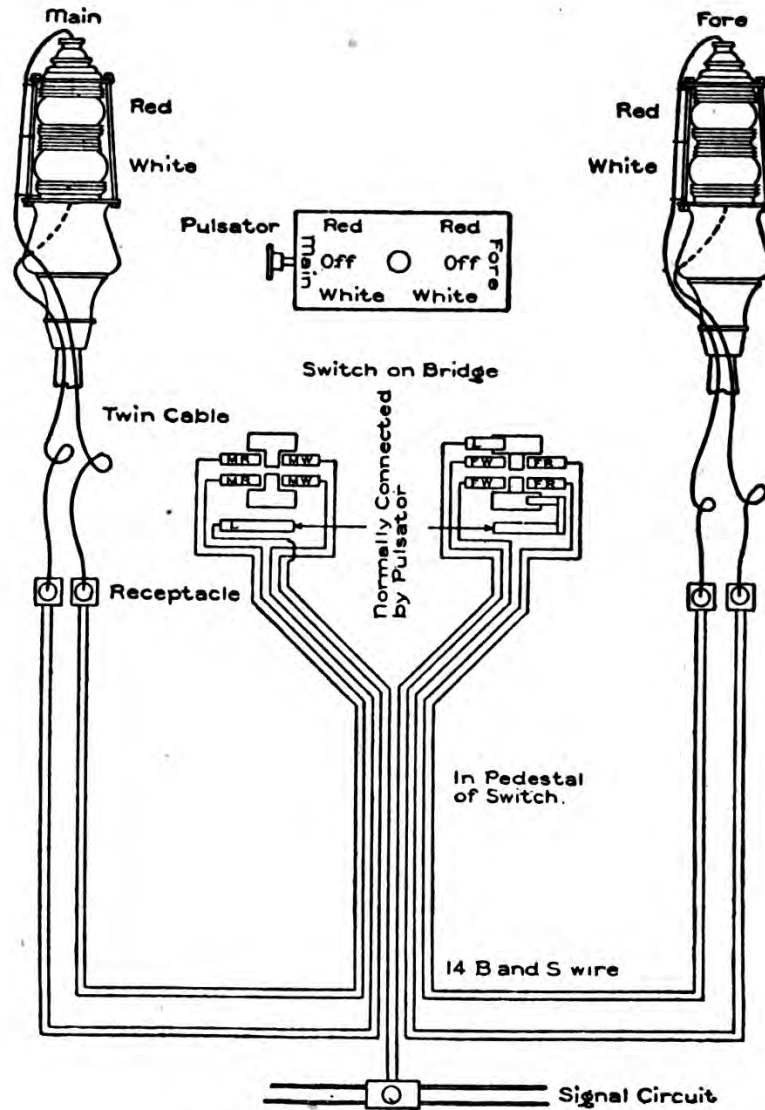

FIG. 40.—Wiring diagram, truck lights.

lantern to "MR," from "Main" white to "MW;" from "Fore" red to "FR," and from "Fore" white to "FW."

Terminals are provided which should be soldered to the ends of the wires and fastened to the contacts with screws.

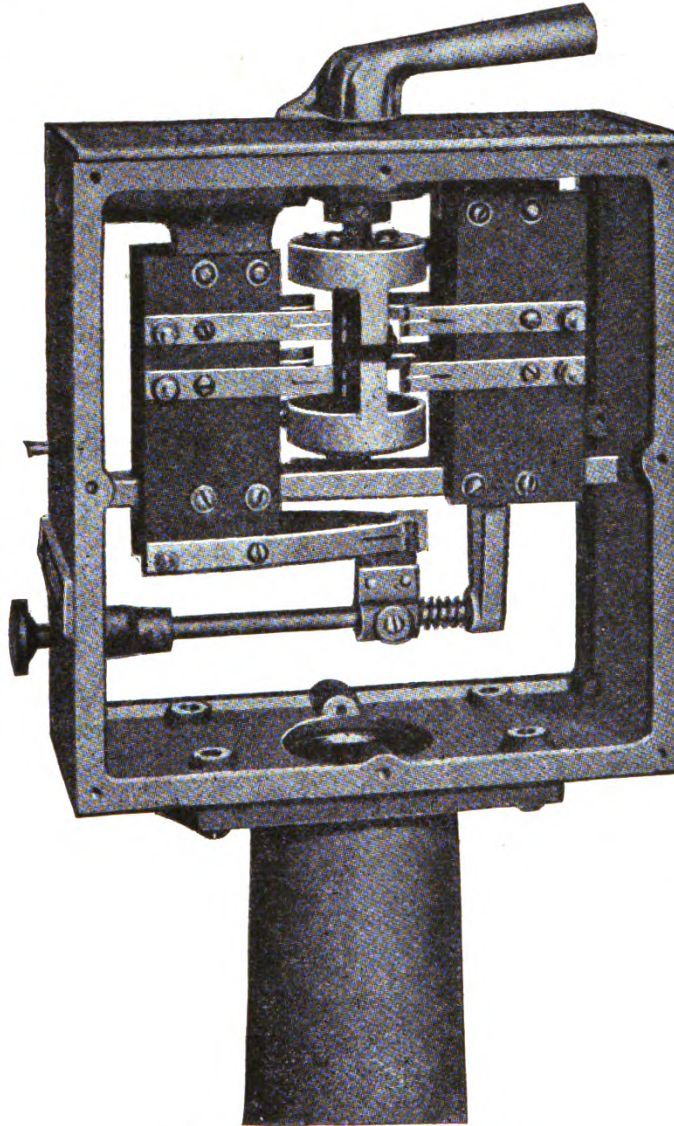

FIG. 41.—Truck-light controller.

The covers on the sides of the box should be removed every three months. If the contacts are dis-

colored they should be polished, and any irregularities or burnt places should be smoothed off with a file.

In the "Ardois" system, used in the United States Army and Navy, the red lamp indicates "1" and the white lamp "2." Four lamps are placed on a vertical staff and electrically illuminated to indicate the numer-

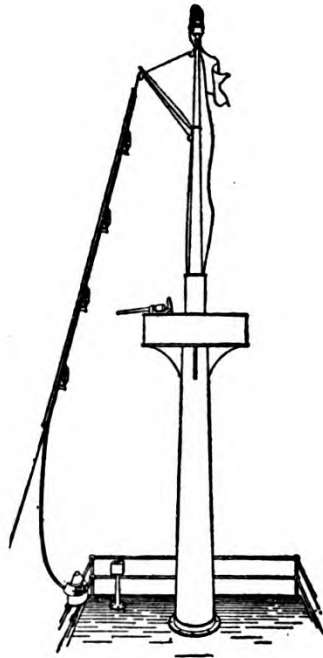

FIG. 42.—A Hoist.

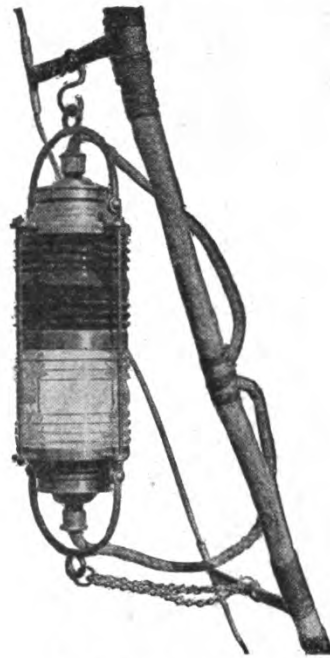

FIG. 43.—Ardois System in Use.

als of the Myer Code, which represent the letters of the alphabet. For instance, white-white, or "22," represents the letter "A," and white-red-red-white, or "2112," represents the letter "B," etc. In this system the lights indicating the letters of the alphabet are read from the top downward.

The full alphabet and numeral code is as follows:

A .....	WW.	S .....	WRW.
B .....	WRRW.	T .....	W.
C .....	RWR.	U .....	RRW.
D .....	WWW.	V .....	RWWW.
E .....	RW.	W .....	RRWR.
F .....	WWWR.	X .....	WRWW.
G .....	WRRR.	Y .....	RRR.
H .....	RWW.	Z .....	WWW.
I .....	R.	1 .....	RRRR.
J .....	RRWW.	2 .....	WWW.
K .....	WRWR.	3 .....	RRRW.
L .....	WWR.	4 .....	WWWR.
M .....	RWWR.	5 .....	RRWW.
N .....	RR.	6 .....	WRRR.
O .....	WR.	7 .....	RWWW.
P .....	RRW.	8 .....	WRRR.
Q .....	RWRR.	9 .....	RWWR.
R .....	WRR.	0 .....	WRRW.

SPECIAL SIGNIFICATION OF ARDOIS SIGNALS.

When the letters of the alphabet are to be used to indicate the meanings set opposite them in the following tabulation, the upper light of the display is pulsated. This is effected by means of a special pulsating key.

Special signification can not be given to "I" and "T," they being represented by a single lamp.

Steady display.	Upper light pulsated.
A .....	Cipher "A" use.
B .....	0 (nought).
C .....	Repeat (following rules for conventional signals under wig-wag code).
D .....	Telegraphic dictionary use.
E .....	Error.
F .....	4.
G .....	6.
H .....	Compass signals use.
I .....	
J .....	5.
K .....	Negative.
L .....	Geographical list use.
M .....	9.
N .....	Cipher "B" use.
O .....	Cipher "C" use.
P .....	Affirmative.
Q .....	Interrogatory.
R .....	International code use.
S .....	General signals use.
T .....	
U .....	Navy list use.
V .....	7.
W .....	Annulling.
X .....	Numerals.
Y .....	Vessels' numbers use.
Z .....	2.
Letters .....	3.
Code call .....	8.
Interval .....	Boat-signals use.

Before numerals are made, the distinctive signal for "numerals" "X" is shown and the upper light is pulsated, which serves still further to distinguish them from letters. The resumption of letters after using numerals will be indicated by the upper light being no longer pulsated, but the display "letters" ("3") will be turned on as an additional indication.

The acknowledgment of the correct receipt of a message will be indicated by the letter "R." If the message has not been fully received, or if it is not understood, indication thereof will be made by signaling the letter "G."

## COSTON SIGNALS.

The letters of the General-Service Code may be represented at night by Coston lights, port fires, or other colored lights, showing the "red" for "1" and the "white" for the "2."

## VERY'S NIGHT SIGNALS.

The Very system employs projected red and green stars, which are shot from pistols held in the hand. The Navy Signal Book is used, to which the following explanation refers.

The letter R stands for red and the letter G for green, and each letter designates a separate star or cartridge. Bracketed stars are a pair of different colors, discharged together from two pistols. The system is based on the Myer Code, red representing "1," and green "2."

1—RRRR.	2—GGGG.
3—RRRG.	4—GGGR.
5—RRGG.	6—GGRR.
7—RGGG.	8—GRRR.
9—RGGR.	10—GRRG.

Affirmative, or "Yes" .....	RGRG
Negative, or "No" .....	GRGR
Numeral .....	GRGG
Interrogatory .....	RGRR
Annulling .....	RRGR
Divisional point, date, designator, or interval .....	GGRG
Telegraphic dictionary, $\left\{ \begin{matrix} R \\ G \end{matrix} \right\}$ bracketed.	
Geographical list, $\left\{ \begin{matrix} R \\ G \end{matrix} \right\}$ followed by a rocket.	
Boat signals, rocket followed by $\left\{ \begin{matrix} R \\ G \end{matrix} \right\}$ .	
Navy list .....	$\left\{ \begin{matrix} R \\ G \end{matrix} \right\} \left\{ \begin{matrix} R \\ G \end{matrix} \right\}$

General call, rocket followed by G.  
 Message call, G without the rocket.  
 The squadron, division, section, or ship's call, the "number" of  
 squadron, division, section, or ship.  
 Answering, or "I understand" .....R  
 Repeating, or "I do not understand" .....G  
 Danger or distress, R repeated several times in quick succession.

## CHAPTER V.

### COMPASSES.

#### MAGNETIC COMPASSES.

The pocket compasses used by signal officers are lettered after the plan of a surveyor's compass. The compass should have fixed upon its case edge, opposite the "N," and also opposite the "S" marks, a small notch or sight, by which to take the range of any observed object.

It is generally the wish of the observing officer to give the compass bearing of any object observed, taken at the point at which he is stationed. In using the compass, the north and south sights on the case edge or on the compass dial are brought to coincide exactly with the north and south point of the needle when at rest. If the object to be viewed be in a southerly direction, it is sighted at over the north sight through the south sight on the case edge; if the object to be viewed be in a northerly direction from the standpoint of the observer, it should be sighted at over the south sight and through the north sight. This being done, the bearing is that reading of the compass card which will appear directly under the "N" or the "S" pole, or point, of the needle, as the case may be. Before the

officer takes the field he should have considerable practice in the use of the compass. This practice can be had simultaneously with that of the telescope, by requiring the student to find, with the telescope, stations in different directions, the compass bearings only being given; and also by requiring him to report the bearings of different-named objects visible at the place from which he is practicing.

The ability to correctly read a map and from it find a distant station, is incumbent upon the signalist. This is essential in many cases, such, for instance, as the determination of the location of stations at different directions and considerable distances from a given point, and so, also, that signalers may expeditiously and surely find their way to designated stations, and ascertain the exact direction from their own toward the station with which they wish to communicate.

In determining the position of a sought-for station, it should be ascertained whether the magnetic or geographic direction has been given. This is essential because the needle of the magnetic compass points not to the true north but to the magnetic north, which, in the western hemisphere, generally speaking, is west of the true north, and in the eastern hemisphere it is east of the true north. If the needle pointed always due north, to exactly determine the position of a station which it is desired to find, it would be necessary only to place the compass with the needle pointing north on a line coincident with the north line of the map, then if the location of the station which we wished to find was  $450^\circ$  west of north, we would, by looking along the projection of a line  $450^\circ$  west of north, or exactly

10495—05—11



northwest, discover the station with which we wish to communicate.

Some compasses are provided with either luminous dials or strips of prepared paper to illuminate the dial. When marching by the aid of the compass, either day or night, do not use the divisions shown on the outer edge of the dial—use instead the divisions on the inner circle. The points of the compass, as NE. or WSW., should be taken rather than the degrees.

Assuming the declination of the magnetic needle at our station to be  $7^{\circ}$  east of north, and it being desired to find a station whose direction from us is given by the compass as NE. Place the compass on the map so that the north end of its needle points north on the map; turn the compass until the *north of its dial* is coincident with the north of the map; then, holding the compass stationary, revolve the map on its axis until its north points  $7^{\circ}$  east of the north of the dial of the compass. The north marked on the map will point to the true north.

If the variation of the needle is east of north, the map should be compensatingly moved toward the west.

For readings requiring great accuracy the prismatic compass should be used.

Being at a certain point and dividing the compass at the north star, the departure of the needle in degrees from the north will represent the magnetic declination; thus the magnetic declination of a place may be determined.

#### THE PRISMATIC COMPASS.

The prism glass is fitted with a prism, a sighting slit, and on the cover a sighting line. In this compass

the dial itself revolves on a needle and, if uninfluenced by adjacent iron, comes to rest with its north pointing to the magnetic north. The circle or dial is divided into  $360^\circ$ , reading from the north by the east to the north.

In addition, the eight points of the compass are marked on the dial.

Facing the objective, the compass bearing of which is desired, bring the compass in line with the eye, checking the movement of the dial by the spring provided for that purpose. When the dial has come to rest, or very nearly so, look at the object through the slit over the prism and bring the sighting line of the glass over the object looked for; read through the prism the degree intersected by the sighting line. This will be the bearing of the object.

The horizontal angle between any distant object and the observing point may be found by taking the difference of the observed bearings. For example: The angular measurements between two distant points, A and B, and your station are required. Following the above directions, A gives a reading of  $60^\circ$  and B  $120^\circ$ . The difference, or  $60^\circ$ , is the angular measurement. So the horizontal angles of any two or more points and your station may be found.

A method of adjusting the prism to a correct focus for the user is generally provided by a screw which enables it to be raised or lowered. When the focus of the user is determined, it should be permanently set in this place.

To set this compass for true north work lay it on a flat surface and allow the dial to settle; then turn the

compass until the white "lubber-line" notch coincides with the number of degrees east or west of the magnetic north and revolve the index line until it is exactly over the north point of the dial; the luminous line in the lid will then point to the true north. Take, for example, that it is required to set the compass to show the true north for Portland, Me. Turn the compass until the "lubber-line" is opposite  $15^{\circ}$  east of the magnetic north point, then revolve the index until it is over the north point. The compass is now ready for "setting" a map.

*Setting a map.*—When the side margins of a map are true north and south the compass, having been set as above, is so placed on the map that the dial coincides with the index which represents the magnetic meridian. The map is thus "set."

*Plane tabling and sketching.*—The compass is placed on the plane table or sketching board and adjusted to a line representing the magnetic meridian by means of the holes in the thumb ring and flap piece, and the table is then turned until the N. and S. points of the dial coincide with it. The table is now "set."

## CHAPTER VI.

### FIELD GLASSES AND TELESCOPES.

#### FIELD GLASSES.

The standard upon which is based the qualities of glasses is found in the human eye, and the properties of a field glass are, therefore, expressed in terms of the power, field, light, etc., of the unaided eye.

The field glass or binocular is, practically, two terrestrial telescopes joined together. They are focused by a screw which simultaneously moves the barrels containing the oculars. In some patterns of glass, especially the Porro prism glass, which is later described, adjustment for each eye is provided, it being well understood that often a person's eyes are unlike in focus.

The lenses of the common, or Galilean, field glass consist of the object glass and the ocular or eyepiece. The object glass is made up of a thin double convex and a thicker plano concave lens. These are joined by balsam and must not be separated for cleaning. The ocular is a double concave lens.

Eyes are of very different capabilities. Some people have short, others far sight; there are normal, excellent, or weak eyes, and the standard is therefore complicated and varying.

For each individual there is a certain distance at which objects may be most distinctly seen. This is called the "visual distance." With short-sighted eyes this distance is from 3 to 6 inches; with normal eyes, from 8 to 14 inches, and with far-sighted eyes, from 16 to 28 inches.

*Power.*—At the "visual distance" all objects appear in their natural size, or, numerically expressed, magnified by one. At a distance less than the visual they are indistinct, blurred, and imperfectly defined; at greater than the "visual distance" objects are clear and well defined, but diminish in size, the more so as they are farther removed.

The common type of field glass has a power of 4 or 5 diameters. A higher power than 10 for use free-hand is impractical.

*Light.*—The illumination of an object when observed with the unaided eye is impressed upon the retina with a brightness in strict proportion to that of the object itself. If an object be viewed under equal illuminating conditions alternately with the naked eye and with a glass, the brightness of the image seen with the naked eye may be represented by 1, while that of the image in the glass will generally differ, being greater or less.

*Field.*—Maintaining head and eyes as motionless as possible, the dimensions of the image which can be held in view corresponds with a visual angle of about  $30^\circ$ ; in other words, the visual field of the naked eye is  $30^\circ$ . That of a field glass is always smaller, while the field of the telescope is still less.

*Definition.*—One of the chief qualities of the eye is its power of defining outlines and details distinctly. Relative characteristics in this respect may be determined in various ways. Thus the distance at which printed matter can be read, or the details of a distant object distinguished, will give a fair measure of the defining power of the eye; but a better method is to express the definition of sight by angular measurement—that is, by the determination of the smallest visual angle giving clear results. Experience teaches that this angle of the normal eye (with good light and favorable color conditions) is about  $40''$ , and it is therefore possible to determine the smallest object which can just be seen, well defined, at an arbitrary distance.

For instance, at a distance of 15 feet an object can be seen which is one-twentieth of an inch high or broad; at 30 feet distance, consequently, the object must be twice the size (one-tenth of an inch) to be seen, and so on relatively, within limits, as distance increases. But as the distance becomes greater sharpness of vision is impaired materially by the interposing atmosphere, while it is also affected by color contrasts and conditions of illumination. It therefore follows that at considerable distances objects which subtend a visual angle of 40'' are no longer clearly defined but become so only as the angle approaches 60'', 120'', 180'', or more.

The capabilities of the normal unassisted eye may therefore be expressed as follows: Power, 1; light, 1; field, 30°; definition, 40'' to 3'.

The most important and essential quality of a glass is definition, i. e., the sharpness, clearness, and the purity of the images seen through it. To obtain good definition it is necessary that spherical and chromatic aberration be overcome, that the polish of the lenses be as perfect as possible, that the cement possess no inequalities, and that the lenses be well focused, that there be no dampness in the interior of the tubes, and, generally, that the instrument be without optical defect.

Faults in this direction are discovered at once by examination of definition, whereas in determining the other constants they are less noticeable. In comparing the definition of any two instruments it is ordinarily necessary only to scan distant objects and observe to what extent details may be distinguished.

The following test may also be used: Focus on printed

matter at a distance just beyond that at which perfect clearness is given and gradually approach until the letters are distinctly defined. The instrument with which the print can be read at the greatest distance has the best definition.

To express definition as an absolute measure, use instead of printed matter, a white sheet of paper upon which a series of heavy lines are drawn at intervals equivalent to their thickness. Focus upon this and gradually approach from a point where the impression of a uniform gray field ceases and the black lines and white intervals begin to appear distinct and defined.

Let the distance thus found be 20 yards and the thickness of the lines and intervals between them one-tenth inch. The circumference of a circle with a radius of 20 yards or 7,200 tenths inches is  $14,400 \times 3.1416$  or 45,240 tenth inches; but a circumference equals  $360^\circ$  or  $(360 \times 60 \times 60)$  1,296,000".

If, therefore, 45,240 tenths inches correspond to 1,296,000", then 1 tenth inch equals 1,296,000 divided by 45,240, or 28.6". The definition is therefore 28.6", or practically half a minute.

The next most important constant of a glass is POWER.

Power may be approximately determined by dividing the diameter of the object glass by that of the circle of light which appears in the eye piece after focusing on a distant object.

This method for low powers gives fairly accurate results, but is not reliable for high power. Another method is as follows:

Observe an object through the glass with one eye and at the same time with the other eye unaided. A

comparison of the two images gives at a glance an idea of the increase in size due to the magnifying power of the glass, and this power may be determined by comparison of the dimensions of the two images after accurate measurement.

Another constant of the glass is the LIGHT of its image. In most cases with instruments of equal quality, differing only as to power, the instrument which shows the brightest image gives the best satisfaction. An exception is found only in observing natural and artificial sources of light which appear sufficiently plain to the naked eye itself.

The light of the field glass is expressed by the number which shows how many times brighter the object appears through the instrument than to the naked eye. Light is a function of the dimensions of the object glass and of the power of the instrument, and is sometimes determined by dividing the square of the objective aperture (expressed in millimeters) by the square of the power; but thus far no absolute and satisfactory rule has been given whereby the proportion of light received through the instrument to that received by the unaided eye may be definitely and reliably expressed, and satisfaction only can be obtained in the selection of a glass for light by actual use of the instrument under both favorable and unfavorable conditions.

In determining the field of a glass, however, i. e., the extent of country that can be observed in any fixed position of the glass, it is possible to arrive at quite definite conclusions. The human eye has of course the greatest field, and as before mentioned is about  $30^{\circ}$  in the normal eye, increased to  $45^{\circ}$  when



both eyes are used; but in obtaining power, field is so intimately related that it can only be done at the expense of the latter, and to this alone is due the fact that no single field glass can be constructed to subserve the purpose of minute examination of details at a distance and at the same time take in sufficient territory to render the glass suitable for general reconnaissance.

The capabilities of glasses, including telescopes, in a general way, lie between the following limits:

(1) Power between 2 and 1,000.

(2) Light may be 0.01 to 200 times that of the unaided eye.

(3) Field measures in most favorable case,  $10^\circ$ ; in the most unfavorable,  $0.1^\circ$ .

(4) Definition varies between  $40''$  and  $0.1''$ .

Thus, as a maximum, an object may be seen by means of a telescope, magnified 1,000 times, 200 times brighter and 400 times sharper than with the naked eye.

If these advantages could be fully utilized for military purposes the use of glasses would be extraordinary, a power of 1,000 practically effecting the same purpose as the approach of the observed object to one-thousandth of the distance. A hostile command 10 miles distant could be seen theoretically as well as if they were only 53 feet away, and the slightest movement of each single man would become visible. Of course no such wonderful effect is physically practicable, and the limiting conditions increase greatly in proportion as either one or the other of the qualities, power, field, etc., is especially sought.

For the mounted man a glass of but 4, or at most 6,

powers, can be used with advantage; on foot, with free hand, instruments of not to exceed 10 powers can be used. If more than 10 powers are desired a holder becomes necessary, and if the holder is intended to be portable, a greater power than 50 is not practicable, as the movement of the air or the slightest touch of the hand sets up vibrations that render clear vision impossible.

Field glasses with low magnifying power, which are usually preferred by ordinary observers, have their chief value in the comparatively extensive field of view; they should be used to observe extensive movements, where large tracts of country must be taken in one field of view or in sweeping the landscape to find the tents of the enemy, their wagons, etc., or other objects, to be afterwards more closely examined with the telescope.

They may be used on shipboard or in boats, where the rolling motion interferes with the use of the telescope; also on horseback or in hasty examination made on foot or in trees, and generally for all observations not critical or those to be made under circumstances where the telescope can not be conveniently handled. The field glass ought to be held by both hands when in use, and to steady it the arms should be kept close to the body.

For reading signals at short ranges, say, up to 5 miles, these glasses are better than the telescope. Flag signals have frequently been read with glasses of this description at a distance of 10 miles.

Glasses which are to be used in the field should have plainly marked on one of the eye-glass slides the focus

mark of the user, so that they may be quickly adjusted without each time being compelled to focus on a distant object. A fine line scratched with a knife will answer.

Field glasses should be used in such a way as to prevent external light entering between the eyepiece and the eye of the observer.

#### TELESCOPES.

While astronomers require only that the telescope be made as capable and perfect as possible in an optical point of view, making all other conditions subordinate to this one, the military, to whom the glass is simply an accessory, make other conditions of the first importance. The glass must have suitable form, small volume, little weight, and that it may be used without support, mounted or dismounted, and the image must appear as looked at by the naked eye—that is, not inverted.

The capability of the instrument, however, is thereby much limited; great powers give plain images only with relatively long tubes; glasses must be held the steadier the more they magnify; and with increasing power all vibrations become more troublesome and render minute observations very difficult or impossible. The additional lenses in terrestrial telescopes somewhat decrease power and affect also light and definition. It is clear therefore that expectations of achieving great power should not be entertained, the function of field glasses being to bring out and define objects which to the naked eye appear indistinct and doubtful.

The distinctness with which anything can be seen through the telescope depends, primarily, upon the number of straight lines of light which are collected by it from every point of the object.

The telescope consists of an object glass which forms the image of the distant object, and an eyepiece which, with the other lenses, perform the duty of a microscope by enlarging the image.

The object glass consists of two lenses, one a thin double convex and the other a plano concave, the convex surface of the former fitting into the hollow or concave surface of the latter; thus the plane or flat surface will be toward the eye and convex side toward the distant object.

The eyepiece consists of four lenses; that is, an object glass diaphragm, an amplifying lens, a field lens, another diaphragm with a larger aperture, and an eye lens.

Telescopes, the object glasses being equal in size, diminish light as a general rule in proportion as their magnifying power is great. The most powerful glasses are therefore to be used for minute observations on the clearest days or when there is a strong light upon the observed object. When the light is fading or there is a little light upon the observed object the clearer view will be had with glasses of large field and low magnifying power.

#### TO DETERMINE THE POWER OF TELESCOPES.

The following is a simple method by which to determine, approximately, the power of a telescope:

When the object glass of a horizontally placed telescope is turned toward the light and all the joints drawn, a luminous point or spot appears on the ocular or eyeglass. Carefully measure the diameter of this spot. Measure then the diameter of the object glass. The power of the glass is that number given as quotient

when the diameter of the object glass is divided by the diameter of the luminous spot. Thus, if  $x$  = diameter of the object glass, and  $y$  = the diameter of the luminous spot, then the power =  $\frac{x}{y}$ .

Experience has demonstrated that the telescope used by the Signal Corps for the past forty years is very well adapted to its needs. This telescope is of nearly thirty powers. It has a focal length of 26 inches. The tube is cased in leather. The draw is of four joints, bronzed black, in order that there may be neither glitter nor glare to disturb the eye of the observer. Leather caps are fitted over both eye and object glasses, and a strong leather strap connecting the caps permits the glass being carried slung over the shoulder. This glass is strong and portable. It has power sufficient for ordinary use, and is of a size to be conveniently handled.

The interior tubes of the telescopes and field glasses are blackened so as to exclude as much as possible the reflection of outside light.

After drawing out the two larger tubes a focus of the telescope is best secured by a slight twisting motion of the first tube in drawing it out or closing it.

It is well, under unfavorable weather conditions, in high winds, bright light, or very warm weather to cover the head of the observer with a dark cloth, coat, or blanket to shut out distracting influences and external light.

When a signal station is to communicate with two or more stations a telescope should be firmly fixed bearing on each and so far apart that the reader at one station will not be in danger of disturbing the reader

at the other station by his movements. At permanent stations telescopes should not be removed from their supports when signaling has ceased for a time. They should be kept in position and carefully covered to protect them from the weather.

Before communication by signals, either in the day or at night, is opened, when possible, the telescope should be placed in a position as accessible as is consistent with its most efficient use, having in mind the necessity for shade or shelter, and in one that is as convenient as is attainable.

#### TELESCOPE HOLDERS.

The stand or support for the telescope may be a heap of stones, two saddles lashed together, a temporary tripod of sticks, a post, a stump, fence, or, in fact, anything furnishing a steady rest. Blankets, thickly folded, or any cloth, as an overcoat, a cushion, or a pillow, placed under the glass, almost entirely prevents vibration. Stones or other heavy bodies should be placed about the glass in order to secure it in its place and to steady it. The brass telescope holder, fitted to screw into trees or other wooden supports, is very useful. Trees having branches and leaves are apt to be shaken by the wind; for this reason a fence corner, a stump, or solitary post or rock should be chosen in preference. A brass post screwing on to the heliograph tripod and having a round head which fits into the sockets of the telescope holder has been employed satisfactorily where trees or other support could not be found. With this, rapid and accurate adjustment is feasible, and when set the telescope remains in position and is not easily deranged.

It is important to so construct a support as to allow the person at the glass a comfortable position while reading, and it should be firm enough to withstand any ordinary gust of wind or other slight disturbing cause.

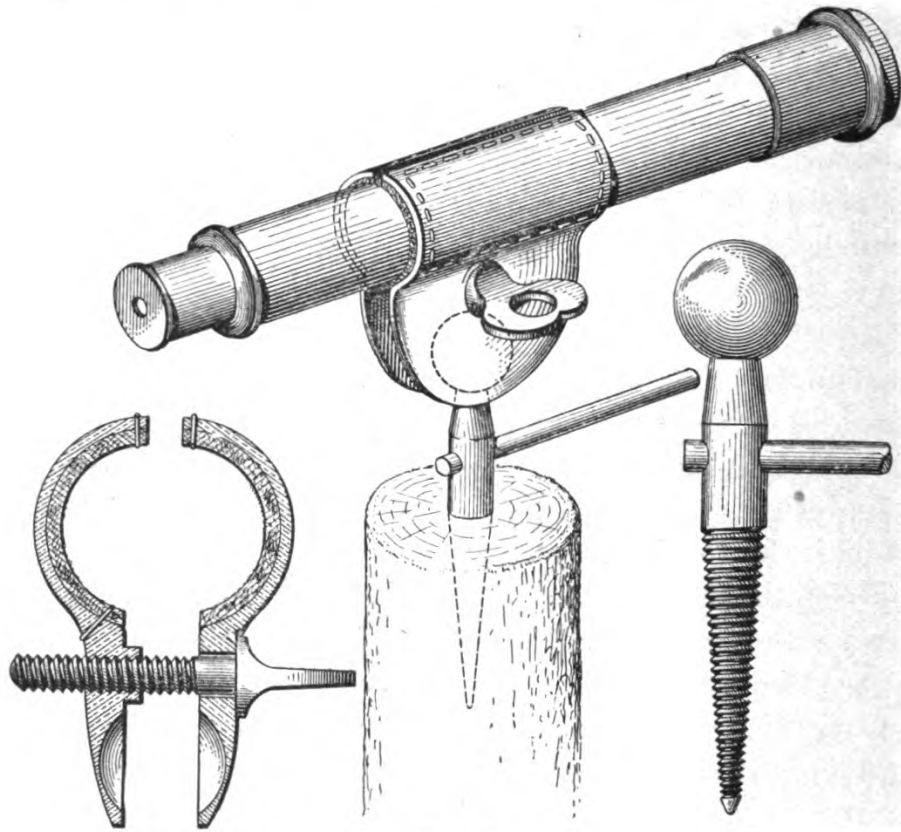

FIG. 45.

At a post or fixed station it is well to construct a permanent stand and to shelter it with a good tent or sentry box.

When the atmosphere is humid and the lenses of the telescope are cold they condense moisture and are covered with a film of mist; this is especially liable to happen at night. If the night seems clear and lights

can be distinctly seen with the naked eye, which are seen with difficulty through the glass, this condition will be found to exist. To remedy this the glass ought to be thoroughly warmed at a fire or with a lamp—care being taken not to overheat it—and made so warm as to retain its heat while it is being used to receive messages. The eyeglass of the telescope is sometimes obscured by the moisture of the breath condensing upon it while the eye is at the glass; this ought to be carefully guarded against.

Old newspapers furnish the best material with which to clean glasses when regular telescope paper provided for this purpose is not on hand. If newspaper is used it should be free from grit or anything to scratch the glass. Soft paper is better than chamois skin. The lenses of the telescope should be kept scrupulously clean, but avoid as much as possible wiping the lenses, even with the softest material, as the polish of the glass will be affected, no matter with what article it may be wiped.

If the telescope is to be carried in the rain a leather cap must always cover the eyepiece end. Without this precaution the glass will be filled with water and may be ruined.

#### DISTANCE MEASURING GLASSES.

Telescopes and field glasses may be prepared for estimating distances without impairing their usefulness for other purposes. A micrometer scale, the distances between the lines of which have been carefully calculated, is engraved on an additional glass. When this glass, so engraved, is adjusted in the focus of one of

10495—05—12



the lenses, it becomes visible to the eye of the observer placed at the eye-piece, while there is at the same time had in the field of view the object it is desired to view, and its distance is indicated by the scale. The scale is computed on the principle that the angle subtended by the rays from any object meeting at the eye is in exact proportion, greater or less, as the object is near or remote. The distance being known at which a certain visual angle is subtended by any object of known height, the distance at which that object is, its location being changed, may be estimated by the measurement of the increased or diminished angle it then subtends. The height of a man—or 5 feet 6 inches—is generally assumed as the unit of measurement. Upon the engraved scale before mentioned one line is marked as the base line. At right angles to and joining this line is a smaller line, by which the base may be distinguished from other lines. Other lines, more or less in number, appear engraved parallel to and above the base line at carefully calculated distances.

For measurement, the telescope is adjusted until the feet of the man to be viewed through it—or the base of any object, if something inanimate has been selected—are brought in the field of view to apparently rest with precision upon the base line.

The first line upon the scale above the base line, then, marks the point upon the glass to which the head of the man thus viewed should seem to reach if he is distant, say, 5 miles. Now, if the man is at a less distance, his figure will seem to cover a greater space and his head reach higher upon the glass; so the second line on the scale above the base may indicate the point

his head will seem to reach if he is distant 4 miles. The next line above may be the scale point if he is distant 3 miles, the next if distant but 2 miles, and the next when he is 1 mile distant. The intervals between the lines may be graduated into smaller intervals. And there may be a scale by which to measure fractional parts of a mile, as hundreds of yards, etc. With proper care distances may in this way be very closely estimated.

To use the "scale glasses" successfully the telescope must be perfectly at rest. An additional difficulty is found in the fact that at great distances the finest scale lines cover too much of the viewed object. These difficulties can be lessened only by practice. Useful approximations to exact distance can, however, be easily made.

Glasses of high magnifying power have been scaled in this way to determine measurements, as to estimate the height of a man at 10 miles distance.

They have also been used to measure the face of a work—to determine its height and its distance; the distance of batteries, ships, etc., and of marked points on the field of battle; or the distances at which bodies of troops are moving, the width of rivers, etc.

Telescopes ought never to be allowed to fall into the hands of the enemy. Officers on dangerous stations should conceal their glasses when not in use. When a glass is to be hidden for precaution, the object lens or one joint of the telescope should be hidden separately from the body of the telescope. A single joint or one lens is so small an object that it can be readily and effectually concealed.

## THE TELEMETER FIELD GLASS.

A field glass has been devised for estimating with more or less accuracy the distance of objects up to 1,800 meters. Between the eye-piece and the objective is inserted a disk the interposition of which gives two images of the object looked at. As the height of the second image is to the first so is the distance of the object from the point from which observed. A scale showing the distances corresponding to the difference in elevation of the images is shown on the barrel of the glass; this is computed and marked for each 100 meters up to 1,800 meters.

## PORRO PRISM FIELD GLASSES AND TELESCOPES.

In 1850 a French engineer, Porro, discovered a combination of prisms which, when inserted between the objective and the eyepiece of an astronomical telescope, showed the image erect or in its natural position, while the same telescope without the prisms showed the image inverted. Practical use of this discovery was not made for many years after. These prisms served a twofold purpose, viz, showing the image of the object looked at in its natural position instead of reversed, and second, the shortening of the telescope by twice turning the ray of light upon itself. Each tube of the prism field glass contains two of these double-reflecting prisms. The ray of light passing through the object glass enters the first prism in such a manner as to be twice totally reflected, each time at an angle of  $90^\circ$ , thus emerging parallel to the entering ray, but in the opposite direction. It is thus

caught by the second prism and is similarly reflected and sent on its original direction without change except in one very important point, viz, the image of the object observed, which, without the intervention of the prism, would be upside down, is now erect, and will be magnified by the simple astronomical eyepiece just as the stars and planets are magnified in large telescopes.

The field of view of the Porro prism glass is considerably larger than that of the ordinary field glass. It decreases about  $12\frac{1}{2}$  per cent with each magnifying power, a number 6-power glass giving a linear view of 118 feet in a thousand, while in a number 10 glass the field is but 70 linear feet. This is explained as follows:

The rays of light emerging from the ocular of the ordinary field glass are divergent and cover an area much greater than the size of the pupil of the eye. As all rays falling outside the pupil of the eye are lost, but a small field of view can be seen, as in looking through an ordinary cone from the larger end. The prism glasses are constructed on the opposite principle. The rays of light gathered by the objective emerge from the eye piece in a convergent pencil of light small enough to enter the pupil of the eye, thus giving a larger field of view; theoretically, nine times the area given by the old style instrument of the same power. With these advantages, however,

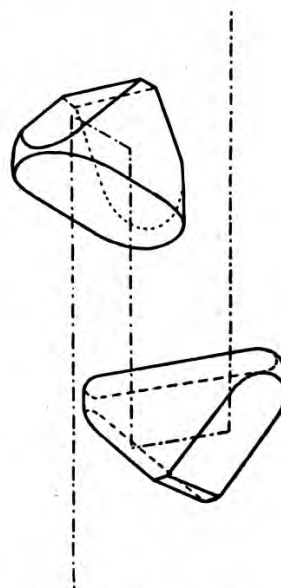

FIG. 45.—Porro prism.

the Porro prism glass has not been found in all respects satisfactory for field service. With a clear atmosphere and the object which is being viewed well illuminated, it is distinctly superior to the Galilean field-type glass in respect to light, power, and definition. The prisms having once been deranged, however slightly, satisfactory use of the glass can not be had until the prisms have been readjusted, and until very recently it was impracticable to have this done elsewhere than at the place of manufacture of the glass.

This defect, recognized by the expert manufacturers in the United States, has resulted in such mechanical improvements in the assembling of the prisms as to lessen the extreme care in handling which was previously necessary.

The function of the yellow disk which is sometimes placed between the eye of the observer and the ocular of the field glass or telescope is to absorb certain light rays which pass through the lenses. Absorption of these rays causes greater contrasts in adjacent objects, thus rendering them more distinct. Where, ordinarily, it would be difficult to read a white flag against a blue sky because of the lack of contrast, the disk can be used to advantage. The blue of the sky is absorbed and the white flag is very distinctly marked against the darkened ground of the sky.

## CHAPTER VII.

## CODES AND CIPHER.

## PRECONCERTED MESSAGE CODES.

Message codes are devised in order that preconcerted phrases may be expeditiously transmitted. Between stations where it may be necessary to send messages of great importance in the shortest time, codes are arranged in sentences, and opposite each sentence is placed one, two, or more letters of the alphabet to designate it. Such conventional signals serve a most useful purpose, especially in time of war, and signal officers should endeavor to anticipate urgent messages and replies thereto and indicate signals to represent them. Examples of such messages may be found in the International Code of Signals.

The following messages were prepared for the use of the Army during army and navy maneuvers, and are given merely as illustrations of how codes should be prepared.

## ABANDON:

Do not . . .  
 If you . . .  
 Will . . .  
 You may . . .  
 You must . . .

## ABANDONED:

Will be . . .  
 Will have to be . . .

## ABANDONMENT:

Do not give notice of . . .  
 Give notice of . . .  
 Notice of . . . has been given.  
 Shall we give notice of . . .

**ABLE:**

Are you . . . to  
 They are . . . to  
 We are . . . to

**ABSENCE:**

During the . . . of  
 You may have leave of . . . until.

**ACCIDENT:**

. . . , want surgeon immediately.  
 . . . , serious.  
 . . . , not serious.

**ACTION:**

Prepare for . . .  
 Commence . . . at once.

**ANNOUNCE:**

. . . arrival of  
 . . . departure of  
 Why did you not . . . arrival of  
 Why did you not . . . departure of

**ANSWER:**

Send an . . . to  
 Send an . . . telegram of  
 Must have a definite . . .  
 Can not get . . .  
 Can not give . . . yet.  
 Will communicate as soon as can obtain . . .  
 When you . . .  
 Did not . . . signals.  
 Wait for . . .  
 I am waiting for . . .

**ANSWERED:**

Have you . . .  
 They have . . .  
 They have not . . .  
 We have . . .

**ANXIOUS:**

Is . . . to know.

**APPEARED:**

Have not . . .

Have . . .

**ARRIVED:**

Has . . .

Has not . . .

**ARRIVAL:**

Report the . . . of

Await . . . of

**ASHORE:**

\_\_\_\_\_ . . . near \_\_\_\_\_.

**ATTENTION:**

. . . to signals.

Look out. Pay . . .

Pay strict . . . during the night.

Watch closely for signals from \_\_\_\_\_.

**AUTOMOBILE:**

. . . will proceed to

Where is . . .

**BACK:**

Has put . . .

**BALLOON:**

. . . reports enemy approaching from \_\_\_\_\_.

. . . will make immediate ascension and report.

. . . unserviceable.

**CABLE:**

The . . . between \_\_\_\_\_ and \_\_\_\_\_ has been cut.

The . . . between \_\_\_\_\_ and \_\_\_\_\_ is out of order.

The . . . between \_\_\_\_\_ and \_\_\_\_\_ is now in working order.

**CIPHER:**

Dispatch in . . . is not understood. Repeat it.

Send all important dispatches in . . .

**COLLISION:**

\_\_\_\_\_ . . . Apparently no great damage.

\_\_\_\_\_ . . . Former appears seriously damaged.

\_\_\_\_\_ . . . Latter appears seriously damaged.

\_\_\_\_\_ . . . Former sinking and abandoned.

\_\_\_\_\_ . . . Latter sinking and abandoned.



**COMMAND:**

Effective strength of . . . is  
 What is strength of . . .

**COMMUNICATE:**

I have something of importance to . . . to

**COMMUNICATION:**

I have no . . . with [place indicated].  
 Forward the following . . . to all stations.  
 . . . established between ——— and ———.

**DAYS:**

Monday.  
 Tuesday.  
 Wednesday.  
 Thursday.  
 Friday.  
 Saturday.  
 Sunday.

**DAMAGED:**

Is badly . . .  
 Is slightly . . .

**DELIVER:**

. . . immediately.

**DESPATCH:**

. . . immediately.

**DIRECTION:**

North.  
 Northeast.  
 East.  
 Southeast.  
 South.  
 Southwest.  
 West.  
 Northwest.

**DISTANT:**

1 mile.  
 1½ miles.  
 2 miles.  
 2½ miles.

**DISTANT—Continued.**

3 miles.  
 3½ miles.  
 4 miles.  
 4½ miles.  
 5 miles.  
 5½ miles.  
 6 miles.  
 6½ miles.  
 7 miles.  
 7½ miles.  
 8 miles.  
 8½ miles.  
 9 miles.  
 9½ miles.  
 10 miles.  
 10½ miles.  
 11 miles.  
 11½ miles.  
 12 miles.  
 12½ miles.  
 13 miles.  
 13½ miles.  
 14 miles.  
 14½ miles.  
 15 miles.  
 More than 15 miles.

**EFFORT:**

Every . . . must be made.  
 We are making every . . .

**ENEMY:**

Beware of . . .  
 Beware of . . . 's torpedo boats.  
 Beware of . . . 's cruisers.  
 If the . . . arrives before  
 If the . . . arrives at  
 If the . . . arrives after  
 The . . . is in sight.  
 The . . . is in sight — miles east.

## ENEMY—Continued.

- The . . . is in sight — miles west.  
 The . . . 's battleships.  
 The . . . 's cruisers.  
 The . . . 's cruisers have been sighted at ———.  
 The . . . 's fleet has been sighted at ———.  
 The . . . 's torpedo boats have been sighted at ———.  
 The . . . 's torpedo boats have passed ——— sailing west.  
 The . . . 's torpedo boats have passed ——— sailing east.  
 The . . . 's torpedo boats  
 The . . . 's fleet has passed ——— sailing west.  
 The . . . 's fleet has passed ——— sailing east.  
 The . . . 's fleet off to ———.  
 The . . . 's fleet consists of ———.  
 The . . . 's fleet bombarding ———.  
 The . . . 's fleet ceased bombarding ———; still stand-  
 ing by.  
 The . . . 's fleet ceased bombarding; sailing east.  
 The . . . 's fleet ceased bombarding; sailing west.  
 The . . . 's fleet silenced.  
 The . . . 's fleet captured ———.  
 The . . . 's fleet preparing to make landing at ———.  
 The . . . 's fleet succeeded in landing at ———.  
 The . . . 's fleet repulsed in attempted landing at ———.  
 The . . . 's fleet left here going east.  
 The . . . 's fleet left here going west.  
 The . . . 's fleet reported by wire as passing ———.  
 Nothing seen of the . . . 's fleet.  
 The . . . 's gunboats engaging shore batteries; one cruiser  
 passed west in advance.  
 The . . . 's gunboats engaging shore batteries; two cruis-  
 ers passed west in advance.

## FLEET:

- . . . vessels off ———.  
 . . . discovered off ———, ——— miles distant at ——— m.

## LANDED:

- Have . . .  
 . . . about ——— men.

**LAUNCH (OR TUG):**

Send . . . to —— at once.

. . . is unserviceable.

Send another.

Send . . . at once.

Will send . . . at once.

**LIGHT:**

. . . lamp.

. . . lanterns.

Put out . . . s.

Show a . . .

Do not show a . . .

**OPERATION:**

Have commenced . . .

Have ceased . . .

Now in full . . .

**ORDERS:**

Wait for . . .

You are . . . ed to proceed to ——.

**REPORT:**

. . . at once in person to the commanding general.

What is the last . . . from ——.

**SEA:**

Calm . . .

Considerable . . .

Heavy . . .

Very heavy . . .

Not much . . .

**SIGNALS:**

Annul whole . . .

Repeat whole . . .

**SIGHT:**

In . . .

Not in . . .

**STATION:**

Close signal . . . at ——.

Open signal . . . at ——.

**TIME:**

Allow sufficient . . .  
 Be sure to report the . . . carefully.  
 During part of the . . .  
 During the entire . . .  
 Have you . . .  
 Has ——— . . .  
 If ——— arrives in . . .  
 If ——— does not arrive in . . .  
 Midnight.  
 A quarter past ———.  
 Half past ———.  
 A quarter to ———.  
 One.  
 Two.  
 Three.  
 Four.  
 Five.  
 Six.  
 Seven.  
 Eight.  
 Nine.  
 Ten.  
 Eleven.  
 Twelve noon.  
 a. m.  
 p. m.

**TO-MORROW:**

. . . morning.  
 . . . noon.  
 . . . night.  
 . . . midnight.

**USE:**

For immediate . . .  
 For immediate . . . by ———.

**WEATHER:**

Bad . . .  
 Foggy . . .

## WEATHER—Continued.

Moderate . . .

Stormy . . .

Fair . . .

## WHERE IS:

Where will —— be this afternoon?

Where will —— be to-night?

Where will —— be to-morrow?

With two letters of the alphabet in each signal, and with no repetition of a letter in any display, 624 combinations are possible, each combination representing a prearranged message or sentence. These signals may be made during the day with the heliograph, the waving flag, flags on halyards, and at night by the flash lantern, rockets, bombs, or by any manner in which letters of the alphabet may be indicated and understood.

Six hundred phrases would cover, rather fully, any brief, urgent messages which it may be necessary to send. From a point of vantage, the signalist can inform the artillerist as to the direction of his shots. This was done by the Signal Corps during the civil war in the United States.

A few examples of these code messages follow:

Your shots are too high .....	BA
Your shots are too low .....	BC
Your shots are too far to your right .....	BD
Your shots are too far to your left .....	BE
Your shots are too high and too far to your right .....	BF
Your shots are too high and too far to your left .....	BG
Your shots are too low and too far to your right .....	BH
Your shots are too low and too far to your left .....	BI
Your shots are effective; your range is good .....	BJ

For instance, the above message would, under the subject head, be placed under the word "shots," as follows:

Shots, yours are too high..... BA  
 Shots, yours are too low..... BC  
 Shots, yours are too far to your right..... BD

By this means the message which it is wished to send may be most readily found. To facilitate finding the meanings of code message letters, the letters of the alphabet used should be arranged vertically in sequence, as (a new sheet being used with the commencement of each new letter, as, first sheet, "AB," "AC," "AD," etc.; second sheet, "BA," "BC," "BD," etc.):

BA ..... Your shots are too high  
 BC ..... Your shots are too low, etc.

Calls for cavalry or infantry, for reenforcements or ammunition, can by this method be quickly made. To permit such a code to be used with the greatest facility it should be arranged alphabetically, both as to subject-matter and as to the letters representative thereof.

#### CABLE CIPHER CODE.

There is now in use for cable and, when necessary, telegraphic communication, a cipher code, the use of which was enjoined by General Order No. 9, Headquarters of the Army, Adjutant-General's Office, Washington, January 16, 1899.

While, strictly speaking, the following does not apply specially to visual signaling, yet, in the belief that general instructions may be of value, the following

directions for the use of the War Department Telegraphic Code are inserted:

Messages may be part in plain language and part in cipher. In such cases, however, to prevent confusion, it is advisable that, as far as possible, the cipher words be consecutive. As a rule, either the whole or no part of a message should be enciphered; confusion in deciphering may result from a neglect of this rule.

Messages are enciphered by means of a key number or a series of key numbers. An additive number, say 55 additive, requires that the fifty-fifth word in advance of the proper code word shall be used. If 55 subtractive is used, the fifty-fifth word preceding the proper code word is used. By agreement a single key number can be used to be alternately additive and subtractive—first additive, second subtractive, third additive, etc. The key numbers are used over and over until the entire message is enciphered.

The key number can sometimes be expressed by a single word, as, for instance, “Grant,” each letter having *a value* in tens, according to its position in the alphabet; that is, g, the seventh letter, equals 70; r equals 180; a equals 10; n equals 140, and t equals 200. In other cases, instead of the letters of the word “grant” standing for tens, by preconcerted agreement they may represent *units* or *hundreds*.

Security from translation by parties not having the key number is greater when the key numbers used are *alternately additive and subtractive*. If a cipher key word is used, it should be one of an odd number of letters, as, for instance, “Grant,” the numbers corresponding to the position of the letters of the word in

10495—05—13



the alphabet. The first number should be additive, second subtractive, third additive, etc. By this means the first letter of the key word is additive the first time it is used, subtractive the second, additive the third, and so on, so the text letter may not be consecutively represented by the same code letter.

#### CIPHER KEY NUMBERS.

While the necessities of the service require that there shall be a general War Department cipher key—a key widely circulated—yet such cipher key should not be relied upon for communications of special value or vital importance, and must be supplemented by various keys of limited use and circulation.

*Private cipher keys* should be devised to meet military emergencies, and as far as possible should be communicated by word of mouth, and to the smallest possible number of subordinates. Each War Department Bureau should have its private cipher key for secret intercommunication between its officers. The names of individuals knowing the *private cipher key* should be noted; messages enciphered under it should be kept under lock, otherwise a comparison of the original messages and the code words would indicate clearly the *private cipher key* used. *Private cipher codes* should be changed at least once a year, and *oftener when circumstances demand*.

#### EXAMPLES OF ENCIPHERING.

In some instances the key number when added to or subtracted from the code number gives a resulting number exceeding the highest code number (100,000) or is less than unity (1). It should be remembered in

enciphering that the number 1 follows 100,000 in addition, and that the number 100,000 follows 1 in subtraction. In case of an excess then the numbered code word to be used will be found among the earlier serial numbers. For example: As the last number of this code is 100,000 if the code word to be enciphered is 99,190 and the key number is 100 additive the cipher word to be telegraphed would be the code word found opposite the number 90.

In view of the fact that there are a large number of vacant words at the end of the War Department Telegraphic Code it is suggested that the key numbers be usually additive.

When a cipher message is received it is translated by a reverse method to that used in enciphering by copying from the War Department Telegraphic Code not the phrase opposite the code word received, but by either the words preceding or succeeding equal to the key number selected, preceding words when the key number is additive, and succeeding words when it is subtractive.

The original message is written in this form:

OTIS, *Manila*:

Have received your telegram of the first defer action until further orders Base of operations will be established at San Fernando Luzon Have you sufficient force Make requisition by cable Report date of your arrival at San Fernando Luzon

CORBIN.

The same message in plain code, not enciphered, runs thus:

OTIS, *Manila*:

Kornhammer litharge mutualidad malfurada misleiders mirti-forme mutualidad.

CORBIN.

When enciphered by Grant (70, 180, 10, 140, 200), additive, it reads:

OTIS, *Manila*:

Kortbeenig lobgedicht matuatueros molonique mitiusculo miserandae nachdem.

CORBIN.

Its form when enciphered by Grant, subtractive, is:

OTIS, *Manila*:

Korbmass lintvormig muttines malaqueta mirabilite miragem muskatwein.

CORBIN.

When enciphered by Grant, additive and subtractive, it reads:

OTIS, *Manila*:

Kortbeenig lintvormig matuatueros malaqueta mitiusculo miragem nachdem.

CORBIN.

It is to be noted in this last example the words "San Fernando, Luzon," which appear twice, are enciphered in the same message by two different words.

#### CIPHERS.

Important messages which may fall into the enemy's hands, or signal messages which may be read by them, should be enciphered. As ciphers are undecipherable in proportion to the frequency of change of the key, secrecy is better secured by the use of key *words* instead of letters.

Messages written in plain text or cipher have been concealed in various ways, one of which is carrying the message in the cartridge of a loaded revolver or rifle. It may be disposed of in case of surprise or capture by discharging the weapon.

When a message is to be written enciphered, it is first written out in full. The letters of the key word or words are then written letter by letter over each word or each clause. The message is then enciphered by writing the letters of the key word over each letter of the message.

If the message is to be inverted, either as a whole or by clauses, it should be inverted before the cipher letters are written over it.

The terminations of words should be concealed. Perhaps the best method of concealing the beginning and terminations of words is to divide the words into groups of four or five letters, regardless of whether the word consists of four letters, or a lesser or greater number. This prevents knowledge of the beginning and ending of words, and should occasion no confusion to the receiver of the message. For instance, the words "sufficient time" would be divided "suff" "icie" "ntti" "me," and such repeated letters as may be agreed upon, filling the last two spaces of the group. With a single simple key word messages may be enciphered that will subserve the purpose for which intended, although it is recognized that, given time, the message may be deciphered, but the interpretation will ordinarily require so much time that the information gathered from it will be of little or no value.

Perhaps one of the most expeditious ways of communicating in cipher is that the correspondents shall each have a dictionary exactly alike. A prearranged number, which may be twice the number of the day of the month or any arbitrary number agreed upon, may be used for enciphering and deciphering messages. Thus, if we wish to transmit the two hundred and six-

tieth word in the dictionary, the number agreed upon should be added to it. Assuming it to be 58, therefore, instead of sending the two hundred and sixtieth word, the three hundred and eighteenth word in the dictionary would be sent. The correspondent who receives the message would decipher it by subtracting from 318 the arbitrary number agreed upon; thus, counting back, he would discover the word which his correspondent desires to send to him.

As an additional complication there may be left in the possession of each correspondent a dictionary or code in which the names of all prominent generals or places, and many of the prominent verbs—as to march, to sail, to encamp, to attack, to retreat, etc.—are represented by other words.

Cipher messages may be further complicated by sending the letters of each word backward, by sending the last word of the message first, and in various other ways that will occur to the sender.

#### THE CIPHER DISK.

The cipher disk is composed of two disks of cardboard, leather, or other material joined concentrically, the upper disk revolving upon the lower. The alphabet, reading from left to right, and such other signals, numerals, or combinations of letters, as may be desired, are printed around the circumference of the lower disk. On the upper disk are printed the alphabet and such other signals, numerals, or combinations of letters as are printed on the lower disk, *with this to be remembered difference*: On the lower disk they are printed from left to right, while on the upper disk they are

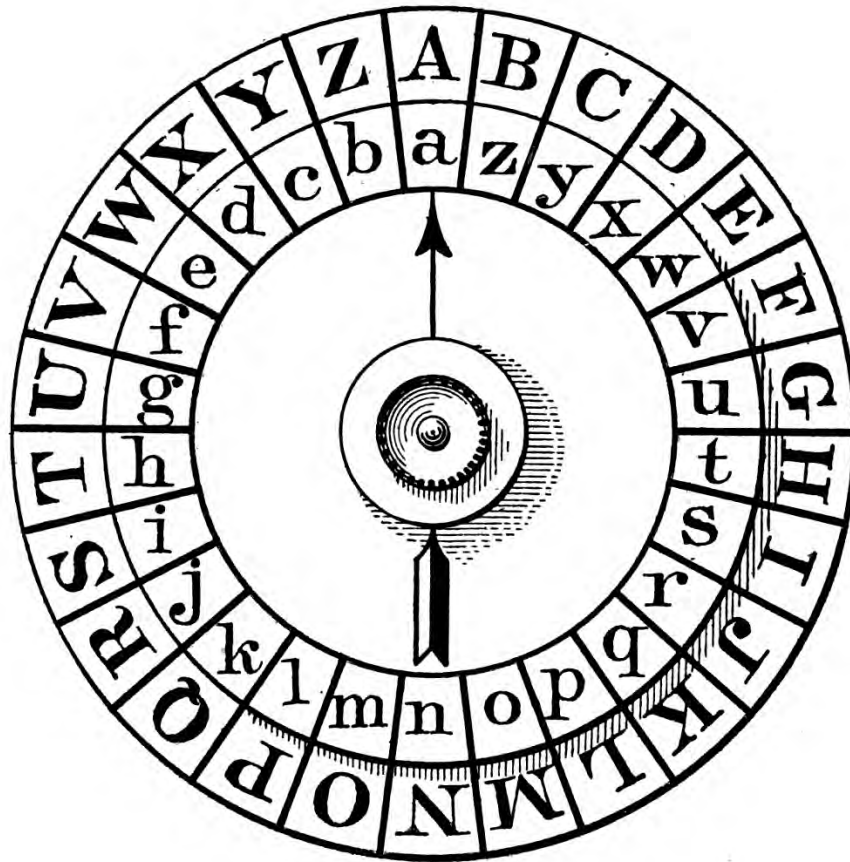

FIG. 46.—Cipher disk.

printed from right to left, or backward. If it is desired to encipher a message the key letter, or the first letter of the key word or words, is set opposite "A." Let us assume it to be "J." The cipher letters to be written are those opposite the text letter when the letter "a" on the upper disk is set opposite "J" on the lower disk. For example: "Send powder" would be written "rfwg uvugfs."

Having a cipher disk as above described, this mere transposition of letters would delay but a short time the deciphering of a message by one not knowing the key letter, as it would be necessary only to place, in turn, opposite "a," each of the letters of the alphabet beginning with "b," and noting the letters opposite the enciphered letters. But this simple disk can be used with a cipher word or, preferably, cipher words, known only to the correspondents, and it is entirely improbable that a message so enciphered could be deciphered in time to be of any value to the enemy. Using the key words "permanent body" to encipher the message "Reenforcements will reach you at daylight," we would proceed as follows: Write out the message to be enciphered and above it write the key word or key words, letter over letter, thus:

PERMANENTBODYPERMANENTBODYPERMANENTB  
 Reenforcements will reach you at daylight  
 y a n z v z n l p p k q f x i j b p w a n r u q p e p l o m e c w h m i

Now bring the a of the upper disk under the first letter of the key word on the lower disk, in this case P. The first letter of the message to be enciphered is R; we find y is the coincident letter and it is put down as the first cipher letter. The letter a is

then brought under E, which is the second letter of the key word and E is to be enciphered; a is the cipher letter. Then bring a to R and the cipher j will represent I, the third text letter of the message. Proceed in this manner until the last letter of the cipher words is used, and beginning again with the letter P, so continue until all letters of the message have been enciphered. Divided into groups of four letters, it will be as follows: "yajz vznl ppqq fxij ipwa nruq peak omcc ahma."

To decipher the message, reverse the proceedings above described; thus the letter "a" on the upper disk is brought under the first letter of the key word, "P." Following these instructions, we find the first cipher letter of the message. "a" is then brought to the next letter of the key word. In this case "E" is, of course, the next letter of the text. "R" is the next letter in the key and "a" is brought over it; the cipher letter "j" gives us the next text letter, which is "i;" and so on until the completion of the message. If the letters of the key word or phrase are exhausted, begin again with the first letter and so continue until the entire message is deciphered.

With a key word or, preferably, a key phrase of three or four words, the deciphering of a message is extremely difficult.

In a military cipher message it may be desired to transmit numerals, the spelling out of which would require considerable time. This can be done by an arrangement of the cipher disk so that the numerals of which will appear in the same order as and follow the letters of the alphabet. Disk 1 is placed under A; 2 under B; 3 under C; 4 under D; 5, 6, 7, 8, etc., the



zero (0) being under Z, and so on up, from left to right, to Y, under which is placed 25.

The numerals beginning with the numeral 1 opposite A on the upper disk should read from right to left, or backward, up to Y, in which space 25 should appear, while 0 should be under Z.

A period or other arbitrary sign may be used to indicate "numerals follow" and "numerals end." Supposing, then, we wish to send the following message: "Send 6,000 cavalry at once," and that the key word was "Washington." Following the instructions heretofore given for enciphering, we would place the words as follows:

W A S H I N G T O N W A S H I N G T O N W  
S e n d . 6 0 0 0 . c a v a l r y a t o n c e  
e w f d . d o h u . m u b a h q k u u f b l s

It will, of course, be understood that the arbitrary sign for "numerals follow" and "numerals end" must have for itself a place on the upper and lower disk.

Cipher disks should never be allowed to fall into the hands of the enemy or of anyone unauthorized to have and use them; to insure this, special instructions should be issued for their care and keeping.

Cipher disks have been used with several numbers or symbols on the lower disk, so that the same letter can be represented in different ways, but such refinement is unnecessary, especially in view of the fact that a message enciphered by a key sentence is, to all intents and purposes, undecipherable.

#### ENCIPHERING BY THE ALPHABETICAL SQUARE.

Not having a cipher disk, the alphabet may be arranged in a square of 26 columns and, with a key

phrase, used for enciphering messages with but little or no fear that they may be deciphered by anyone for whom not intended.

A B C D E F G H I J K L M N O P Q R S T U V W X Y Z  
 B C D E F G H I J K L M N O P Q R S T U V W X Y Z A  
 C D E F G H I J K L M N O P Q R S T U V W X Y Z A B  
 D E F G H I J K L M N O P Q R S T U V W X Y Z A B C  
 E F G H I J K L M N O P Q R S T U V W X Y Z A B C D  
 F G H I J K L M N O P Q R S T U V W X Y Z A B C D E  
 G H I J K L M N O P Q R S T U V W X Y Z A B C D E F  
 H I J K L M N O P Q R S T U V W X Y Z A B C D E F G  
 I J K L M N O P Q R S T U V W X Y Z A B C D E F G H  
 J K L M N O P Q R S T U V W X Y Z A B C D E F G H I  
 K L M N O P Q R S T U V W X Y Z A B C D E F G H I J  
 L M N O P Q R S T U V W X Y Z A B C D E F G H I J K  
 M N O P Q R S T U V W X Y Z A B C D E F G H I J K L  
 N O P Q R S T U V W X Y Z A B C D E F G H I J K L M  
 O P Q R S T U V W X Y Z A B C D E F G H I J K L M N  
 P Q R S T U V W X Y Z A B C D E F G H I J K L M N O  
 Q R S T U V W X Y Z A B C D E F G H I J K L M N O P  
 R S T U V W X Y Z A B C D E F G H I J K L M N O P Q  
 S T U V W X Y Z A B C D E F G H I J K L M N O P Q R  
 T U V W X Y Z A B C D E F G H I J K L M N O P Q R S  
 U V W X Y Z A B C D E F G H I J K L M N O P Q R S T  
 V W X Y Z A B C D E F G H I J K L M N O P Q R S T U  
 W X Y Z A B C D E F G H I J K L M N O P Q R S T U V  
 X Y Z A B C D E F G H I J K L M N O P Q R S T U V W  
 Y Z A B C D E F G H I J K L M N O P Q R S T U V W X  
 Z A B C D E F G H I J K L M N O P Q R S T U V W X Y

This method is best used with one or more cipher words, as follows:

Assume the key word to be "Discretion;" if it is desired to encipher the message "Send small force to watch lower ford," we would proceed as follows: Write out the message to be enciphered and write

above it the key word or phrase, letter over letter, thus:

DISCRETIONDISCRETIONDISCRETION  
S e n d s m a l l f o r c e t o w a t c h l o w e r f o r d  
v m f f j q t t z s r z u g k s p i h p k t g y v v y w f q

*The text letter of the message is always found in the first vertical column.*

Then, referring to the table, find in the first vertical column the first text letter of the message, which in this case is "S." Find the first letter of the key word in the first horizontal row, which in this case is "D." The letter at the intersection of the perpendicular and horizontal columns so found will be the cipher letter for "S," which in this case is "v." The second text letter is "e," the second key letter is "I"; at the intersection of "e" and "I" the letter "M" is given as the second cipher letter. "n" is the third text letter, and "S" the third cipher letter; "f" is found at the intersection of the horizontal and vertical columns. "d" is the fourth text letter, and "C" the fourth key letter, which gives "f" as the letter to be enciphered; the fifth cipher letter is "j," the sixth "q," the seventh "t," the eighth "t," the ninth "z," the tenth "s," the eleventh "r," the twelfth "z," the thirteenth "u," the fourteenth "g," the fifteenth "k," etc.

In groups of four letters the above message would be written as follows: "vmff jqtt zsrz ugks pihp ktgy vvyw fq."

It is generally advisable to fill out the last group by repeating one or more letters. This need cause no confusion to the receiver, who will understand that the last one, two, or three letters may be devoid of meaning.

## DECIPHERING MESSAGES.

To decipher this message, look for "D," the first key letter, in the top row, follow down the column of which it is the top until the first cipher letter "V" is found, now the letter at the left of this row (or in the first column) is the first text letter, "S." The next key letter is "I," following down the column of which it is the first letter we come to the second cipher letter "M," at the left of this row in which "M" is met we find "E," which is the second text letter. "S" is the third key letter, "f" the third cipher letter, and "n" the third text letter; "C" is the fourth key letter and "f" the fourth cipher letter which gives "d," as the fourth text letter; "R" is the fifth key letter, "J" the cipher letter, and "S" the text letter. "E" is the sixth key letter; "q" the cipher letter, which gives "m" as the sixth text letter; "T" is the seventh key letter, "t" the cipher letter, and "a" the seventh text letter. Proceed in like manner until the message is entirely deciphered.

Whenever the letter "A" is met in the text it will, following the above instructions, be represented by the cipher letter immediately following that cipher letter last used. When in deciphering the key letter and the cipher letter are the same, the text letter is "A."

"Send small force to watch lower ford."

It will be observed that the first time "S" is enciphered it is represented by the letter "V," the second time by "J." The text letter "E" is first represented by "M" and next by "G." And so it may be that in a message enciphered by this method any given

text letter, no matter how often used, may not be twice represented by the same cipher letter.

Cipher messages to be signaled should be reduced to cipher before being given to the signaler for transmission.

As an aid in deciphering messages where the same letter or symbol uniformly represents the same text letter the following data will be of assistance.

The order of precedence of the letters according to the frequency of their occurrence is about as follows:  
e a o i t d h n r s u y c f g l m w b k p v q j x z.

Their order according to the number of words of which they are the initial letters is about as follows:  
s c p a d i f b l b t.

The compounds most frequently met are the ng ee ll mm tt dd nn.

The proportion of occurrence of the letters is about as follows: For every two of the letter Q there are 4 of the letter X, 8 of K, 16 of B, 30 of C, 80 each of I, N, O, and S; 85 of A, 90 of T, and 120 of the letter E.

If messages are enciphered by a mere transposition of the letters of the alphabet, the cipher disk can be used to quickly decipher the message, as the following example will show: Assuming that F is used to represent A, G to represent B, H to represent C, I to represent D, J to represent E, etc., in regular sequence, and that the message to be enciphered is "We are short of rifle ammunition; send 30,000 rounds at once."

This would be enciphered if divided into groups of four letters as follows: jbfobnyromraoxubfulsxmrxsnbscmjbsmhm yrlnfscorlscnfmrsdb.

Place "a" of the upper cipher disk under B of the lower disk and notice whether the cipher letters jbf— the first group—are intelligible. They give "saw;" continue this for "saw," the first three letters, may be the text word. Now the next group is B N Y R and these give A O D K. We know that A does not represent B because the first eight cipher letters give the meaningless letters "sawnaodk." Turn "a" to C and we have for the first group T B X O, which is without meaning. Turning "a" to D we get U C Y P, a meaningless jumble. Turn "a" to E and we get V D Z Q, which is meaningless. Now turn "a" under F and we find that J B F O mean "Wear," which, so far at least, gives us a part of a word, or the word "We" and part of another word. We continue to the next group B N Y R, which gives us "esho." We now have these letters "Wearesho," which at a glance we read "We are sho;" continuing to the next group O M R A the cipher disk gives us "rtof," and we read "We are short of" and know we have found the key letter, and the information hidden in the cipher is ours. Continue deciphering with "a" under F until the end of the message. Sometimes the key letter is changed after two, three, or four letters.

It is a matter of minutes only to run through the alphabet and learn the meaning of a message so enciphered.

O

