

HOME OF MOUNTED WARFARE

FKSM 71-8
ARMOR/CAVALRY REFERENCE DATA
SUPPORT BRIGADES



May 2010

US ARMY ARMOR CENTER

DISTRIBUTION STATEMENT A. Approved for public release; distribution is unlimited.

TABLE OF CONTENTS

TABLE OF CONTENTS-----	i
PREFACE-----	ii
VEHICLE IDENTIFICATION-----	iii
EXPLANATION OF GRAPHICS-----	iv
BATTLEFIELD SURVEILLANCE BRIGADE-----	ANNEX BFSB
COMBAT AVIATION BRIGADE (HVY)-----	ANNEX CAB
FIRES BRIGADE-----	ANNEX FIRES
MANEUVER ENHANCEMENT BRIGADE-----	ANNEX MEB
SUSTAINMENT BRIGADE-----	ANNEX SUST

FORT KNOX SUPPLEMENTAL MANUAL (FKSM) 71-8
ARMOR/CAVALRY REFERENCE DATA
SUPPORT BRIGADES

PREPARED BY:

Directorate of Training, Doctrine, Combat Development, and Experimentation
ATTN: ATZK-TDO-D
204 1st Cavalry Regiment Road Ste 207
Fort Knox, KY 40121-5123
(502) 624-3914 -- DSN 464-3914
E-Mail: duane.klug@us.army.mil





















PREFACE

PURPOSE: THIS SUPPLEMENTAL MATERIAL PROVIDES AN OVERVIEW OF THE SUPPORT BRIGADES. THIS PUBLICATION IS INTENDED AS A GUIDE ONLY. COMMENTS AND RECOMMENDED CHANGES TO THIS PUBLICATION SHOULD BE FORWARDED TO COMMANDER, USAARMC, ATTN: ATZK-TDO-D, 204 1ST CAVALRY REGIMENT ROAD, STE 207, FORT KNOX, KY 40121-5123.

DISCLAIMER

THE INFORMATION DEPICTED HEREIN IS BASED ON CURRENT DATA AT THE TIME OF PUBLICATION. THIS UPDATE REFLECTS THE LATEST APPROVED FORCE DESIGN DECISIONS AND INCORPORATES HOLISTIC REVIEW AND TACTICAL WHEEL VEHICLE REDESIGN DECISIONS. THIS DATA WAS TAKEN DIRECTLY FROM THE "R" SERIES TABLES OF ORGANIZATION AND EQUIPMENT (TOE) AND MAY NOT REFLECT ACTUAL MODIFIED TABLE OF ORGANIZATION AND EQUIPMENT (MTOE) AUTHORIZATIONS UNDER WHICH UNITS ARE ORGANIZED.

VEHICLE IDENTIFICATION

	M1A2 ABRAMS MBT		M88A2 IRV (HERCULES)
	M3A3 CAVALRY FIGHTING VEHICLE M2A3 INFANTRY FIGHTING VEHICLE		TRACTOR FT HIGH SPEED ARMORED COMBAT M9 ACE
	M7 BRADLEY FIRE SUPPORT VEHICLE		TRACTOR FULL TRACKED HIGH SPEED: DEPLOYABLE LT ENGINEER (DEUCE)
	M109A6 PALADIN 155SP		M977/M985 HEMTT CGO
	M992A2 FA AMMO SPT VEH (FAASV)		M978 HEMTT POL TANKER
	M113A3 (CARRIER PERS (RISE))		M984A1 HEMTT WRECKER
	M113A3 AMBULANCE		M1120 HEMTT LHS
	M1064 120MM MORTAR CARRIER		M1074/M1075 TRUCK CARGO HEAVY PLS TRANSPORTER 15 - 16.5 TON
	M1068 CARRIER CP ARMD/ M577A3 CARRIER CP		FORWARD REPAIR SYSTEM MOUNTED ON HEAVY PLS TRANSPORTER
	M577A3 MEDICAL TREATMENT VEHICLE		FORWARD REPAIR SYSTEM MOUNTED ON HEMTT LHS
	M88A1 MED RCVY VEHICLE		

VEHICLE IDENTIFICATION (cont)



TRANSPORTER COMMON BRIDGE



M1076 TRAILER PLS 8X20



M1076 TRAILER PLS 8X20 W/MODULAR FUEL SYSTEM (MFS) TANKRACK MODULE



M1200 ARMORED KNIGHT



M1117 ARMORED SECURITY VEHICLE (ASV)



TRACTOR WHL DSL 4X4 W/FORKLIFT & CRANE (HMMH)



M1025/M1026 TRUCK UTIL ARMT: HMMWV



M1151A1 TRUCK EXP CAP: ARMAMENT CARRIER



M997 TRUCK AMBULANCE 4 LITTER: 4X4 HMMWV



M1165A1 TRUCK EXP CAP: ENHANCED



M1152A1 TRUCK EXP CAP: ENHANCED



M998/M1038 TRUCK UTIL CARGO/TROOP



M1152A1 TRUCK EXP CAP: ENHANCED W/S788 SHELTER



CMD SYSTEM: TACTICAL (CPP RWS) (MTD ON M1152A1 HMMWV)



M1152A1 TRUCK EXP CAP: W/RIGID WALL SHELTER



M1152A1 TRUCK EXP CAP: W/S250 SHELTER



M1152A1 TRUCK EXP CAP: W/SECM ORD/ENG APPL



M1078 TRUCK CARGO: LMTV



M1079 TRUCK VAN: LMTV



AN/ASM-146

ELECTRONICS SHOP SHELTER MOUNTED AVIONICS: AN/ASM-146/147 (SHOWN MTD ON M1078 LMTV)



M1083 TRUCK CARGO: MTV



M1083 TRUCK: MTV W/TPU



M1084 TRUCK CARGO: MTV W/MHE



M1084 TRUCK CARGO: MTV W/MHE W/XM 501 GUIDED MISSILE SYSTEM SURFACE ATTACK (NLOS)

VEHICLE IDENTIFICATION (cont)

- | | |
|--|--|
|  <p>M1089 TRUCK WRECKER: MTV</p>  <p>M1157 TRUCK DUMP 10 TON: MTV</p>  <p>M1087 TRUCK VAN EXPANSIBLE: MTV</p>  <p>M1085 TRUCK CARGO: MTV LWB</p>  <p>M1086 TRUCK CARGO: MTV LWB W/MHE</p>  <p>M1088 TRUCK TRACTOR: MTV</p>  <p>M1095 TRAILER CARGO: MTV W/DROPSIDES</p>  <p>M1095 MTV TRAILER W/FUEL POD</p>  <p>M1082 TRAILER CARGO: LMTV WITH DROPSIDES</p>  <p>CONTAINERIZED KITCHEN (CK)</p>  <p>STANDARD AUTOMOTIVE TOOL SETS (SATS) TRAILER</p> |  <p>M1101 LIGHT TACTICAL TRAILER 3/4 TON
M1102 TRAILER HIGH MOBILITY 1-1/4 TON</p>  <p>M1073 TRAILER FLAT BED 7.5T 4 WHL</p>  <p>TRAILER TANK WATER 800 GAL (CAMEL)</p>  <p>M149A2 TRAILER WATER 400 GAL</p>  <p>TOOL OUTFIT HYDRAULIC SYSTEM: (HYSTRU)</p>  <p>M989A1 TRAILER FLATBED 11 TON (HEMAT)</p>  <p>M129A3 SEMITRAILER VAN: SUPPLY 12 TON</p>  <p>M172A1 SEMITRAILER LOWBED: 25 TON</p>  <p>WELDING SHOP TRAILER MOUNTED</p>  <p>CRANE HYDRAULIC LIGHT 7 ½ TON</p>  <p>TRUCK LIFT FORK 4000LB CAP ROUGH TERRAIN</p>  <p>TRUCK LIFT FORK ALL TERRAIN LIFTER
ARTICULATED SYSTEM (ATLAS)</p>  <p>DOLLY LIFT SET 7 ½ TON</p>  <p>PU 797: GEN SET DED TM: 5KW 60HZ
PU 798: GEN SET DED TM: 10KW 60HZ</p>  <p>PU 801: GEN SET DSL ENG TM: 15KW 50/60HZ</p> |
|--|--|

VEHICLE IDENTIFICATION (cont)



PU 802: GEN SET DSL ENG TM: 15KW 50/60HZ
 PU 803: GEN SET DSL ENG TM: 30KW 50/60HZ
 PU 805: GEN SET DSL ENG TM: 60KW 50/60HZ
 PU 806: GEN SET DSL TM 60KW 400HZ
 PU-2101: GEN SET 15KW 50/60HZ M200A1



CY MULTIPURPOSE LOADER: LT SCOOP
 TYPE II DED 4X4



2.4M KU SATELLITE TERMINAL: SATCOM
 TRANSPORTABLE TRAILER W/ONBOARD 7KW
 GENERATOR



UAV GROUND CONTROL STATION



CHEMICAL-BIOLOGICAL PROTECTIVE SHELTER
 SYSTEM (CPBS)



TRUCK LIFT FORK: DSL DRVN
 10000LB CAP ROUGH TERRAIN



POWERPLANT: DSL TRLR MTD 10KW 60HZ AN/NJQ-37



TACTICAL UNMANNED AERIAL VEHICLE SYSTEM
 (SHADOW)



POWER PLANT UTILITY, LARGE
 35KW 12 TON ECU (HVY TMSS)



KITCHEN FIELD TRAILER MOUNTED (MKT)



POWERPLANT ELEC DED TM: 5KW 60HZ AC
 (2 MEP-802A GENERATORS) AN/MJQ-35



SMART-T



TROJAN SPIRIT

AN/TSQ-190(V)2/3
 (TROJAN SPIRIT)



TROJAN SPIRIT (AN/TSQ-190(V)2 OR (V)3)



POWER PLANT UTILITY, MEDIUM
 20KW 5 TON ECU (MED TMSS)



HIGH MOBILITY ENGINEER EXCAVATOR
 (HMEE)



M1126 STRYKER INFANTRY CARRIER



M1127 STRYKER RECONNAISSANCE VEHICLE



M1128 MOBILE GUN SYSTEM (MGS)



M1129 STRYKER MORTAR CARRIER



M1130 STRYKER COMMAND VEHICLE

VEHICLE IDENTIFICATION (cont)



M1131 STRYKER FIRE SUPPORT VEHICLE



MULTI-TEMP REFRIGERATED CONTAINER SYSTEM: MTRCS (ON M1120 HEMTT LHS)



M1132 ENGINEER SUPPORT VEHICLE



LOAD HANDLING SYSTEM 2000 GAL WATER (HIPPO) (ON M1120 HEMTT LHS)



M1133 STRYKER MEDICAL EVACUATION VEHICLE



TACTICAL WATER PURIFICATION SYSTEM (TWPS): (ON M1120 HEMTT LHS)



M1134 STRYKER ATGM



M871A2 SEMITRAILER FLAT BED: BRKBULK/CONTAINER 22-1/2 TON



M1135 STRYKER CBRN RECONNAISSANCE VEHICLE

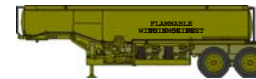

M969A1 SEMITRAILER TANK: 5000 GAL FUEL DISPENSING



UNMANNED AERIAL VEHICLE LAUNCHER: (TUAV-SHADOW)



AVIATION SHOP EQUIP CONTACT MAINT: (SECM) (MOUNTED ON M1152A1 HMMWV)



HOWITZER, LIGHT TOWED (105MM) M119



HOWITZER, MEDIUM TOWED (155MM) M777



LIGHT TYPE 1 ABN/ASLT: 1.6 - 2.1 CU YD LOADER

Explanation of Graphics

TOE Title

TOE Number and Unit Strength

Recon Troop, R&S Sqdn, BFSB

17227R000
OFF: 4/WO: 0/ENL: 41/TOTAL: 45

TOE Paragraph Title

SCOUT PLATOON PARA 02

C4I Equipment

AN/VRC-92F
AN/VRC-104(V)3
AN/PRC-148(V)4
FBCB2
2 DAGR
AN/PSC-5
LRAS3

AN/VRC-92F
AN/VRC-104(V)3
AN/PRC-148(V)4
FBCB2
2 DAGR
AN/PSC-5
LRAS3

AN/VRC-92F
AN/PRC-148(V)4
FBCB2
2 DAGR
LRAS3

AN/VRC-91F
FBCB2
DAGR
LRAS3

AN/VRC-92F
AN/PRC-148(V)4
FBCB2
2 DAGR
LRAS3

AN/VRC-91F
FBCB2
DAGR
LRAS3



LT 19C00 (PLT LDR) C
SP4 19D10 (SCOUT) C
PFC 19D10 (SCOUT DRIVER) C

SFC 19D40 (PLT SGT) C
SP4 19D10 (SCOUT) C
PFC 19D10 (SCOUT DRIVER) C

SSG 19D30 (SECTION LDR) C
SP4 19D10 (SCOUT) C
PFC 19D10 (SCOUT DRIVER) C

SGT 19D20 (TEAM LDR) C
SP4 19D10 (SCOUT) C
PFC 19D10 (SCOUT DRIVER) C

SSG 19D30 (SECTION LDR) C
SP4 19D10 (SCOUT) C
PFC 19D10 (SCOUT DRIVER) C

SGT 19D20 (TEAM LDR) C
SP4 19D10 (SCOUT) C
PFC 19D10 (SCOUT DRIVER) C

X2

Personal Weapon: P = M9 Pistol, R = M16 Rifle, C = M4 Carbine
P&C indicated soldier is armed with both Pistol and Carbine

Multiplier: This shows 2 Platoons, each with 6 HMMWVs.

If no personnel are shown under a vehicle icon, the vehicle is for Section/Squad use and has no dedicated TOE operator/user

BATTLEFIELD SURVEILLANCE BRIGADE

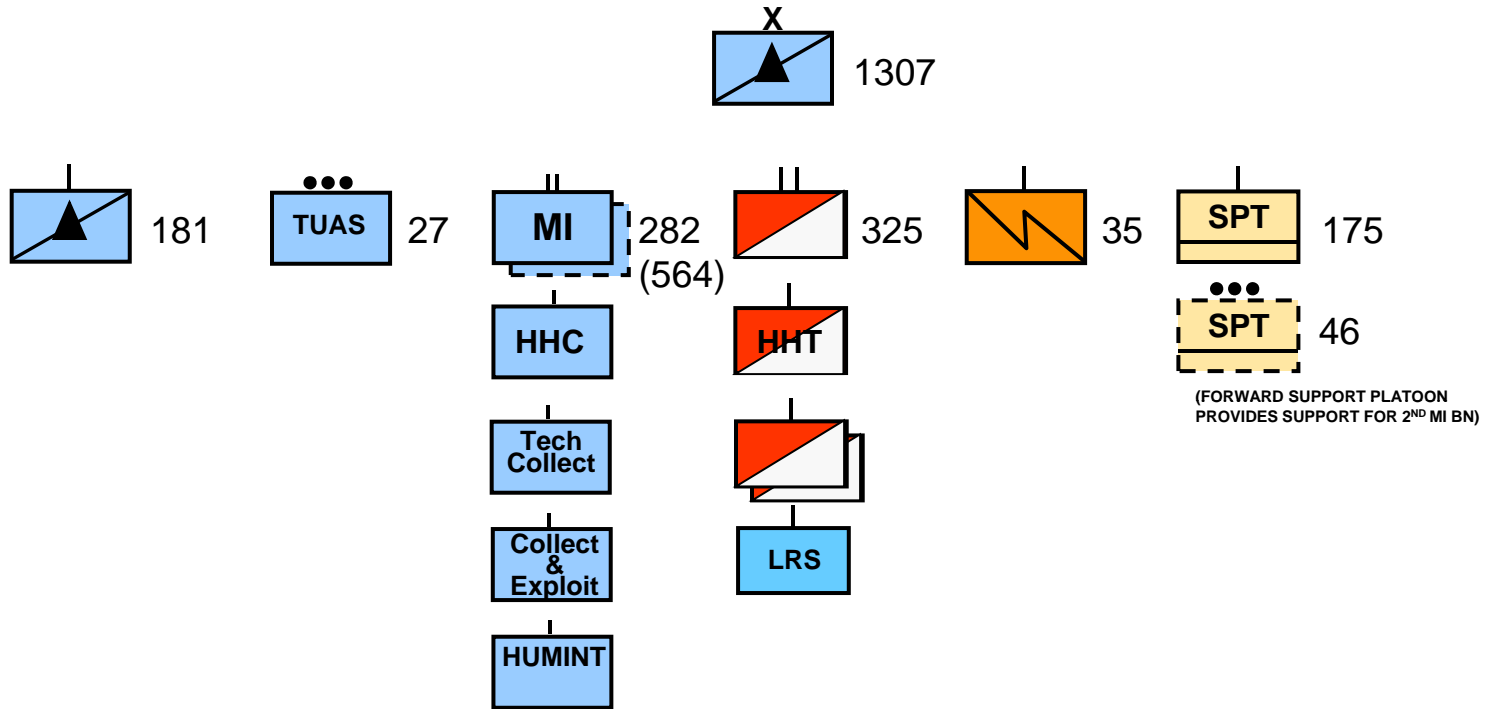

HHC, Battlefield Surveillance Brigade

49102R000
OFF: 39/WO: 15/ENL: 127/TOTAL: 181

COMMAND GROUP PARA 01

AN/VRC-92F
AN/VRC-104(V)3
FBCB2
AN/TYQ-137A:(V)2
DAGR
AN/PSC-5



COL 01B00 (COMMANDER) P
PFC 11B10 (VEH DRIVER) C

AN/VRC-92F
FBCB2
DAGR
AN/PSC-5



LTC 01B00 (EXEC OFF) P
PFC 11B10 (VEH DRIVER) C

AN/VRC-90F
FBCB2
DAGR



CSM 00Z50 (CSM) P
PFC 11B10 (VEH DRIVER) C

INTEL CELL/S2 PARA 02

AN/VRC-92F
AN/TYQ-93
FBCB2
DAGR



MAJ 35D00 (S2) P

AN/VRC-92F
AN/TYQ-137A:(V)2
DAGR



CPT 35D00 (ASST S2) C
CPT 35G00 (EW OFF) C
MSG 35X50 (CHIEF INTEL SGT) C

INTEL/ISR FUSION PARA 03

AN/VRC-92F



CW2 350F0 (ASI TECH) C

2 AN/VRC-92F
AN/VRC-104(V)3
3 AN/TYQ-93
2 AN/TYQ-93(V)2
FBCB2
FHMUX
DAGR
AN/PSC-5

AN/TYQ-103V (ACT-E)



SFC 35F40 (SR INTEL SGT) C
SSG 35F30 (ASAS MASTER ANALYST) C
SSG 35G30 (IMAGERY SGT) C
SSG 35N30 (SIGINT SGT) C
SGT 35F20 (INTEL ANALYST) C



X2

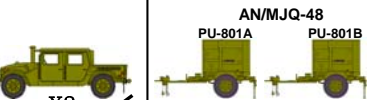

SGT 35N20 (SIGINT ANALYST) C
SP4 35F10 (INTEL ANALYST) C
SP4 35F10 (INTEL ANALYST) SAW
SP4 35G10 (IMAGERY ANALYST) C
2 PFC 35F10 (INTEL ANALYST) C
PFC 35N10 (SIGINT ANALYST) C

INTEL/CGS PARA 04

AN/VRC-90F
DAGR



SSG 35H30 (CGS SGT) C
SGT 35H20 (CGS OPR) C
2 SP4 35H10 (CGS OPR) SAW
PFC 35H10 (CGS OPR) C
PFC 35H10 (CGS OPR) SAW

AN/VRC-92F
AN/VRC-90F
AN/VRC-104(V)3
FBCB2
C-2299/VRC
DAGR
RT-1672/PSC-5
AN/PSC-5
KGV-8/TSEC

AN/TSQ-179(V)2



INTEL CELL/GI&S PARA 05

AN/VRC-90F
DAGR



SSG 12Y30 (SR GEOSPATIAL ENGR SGT) C
SGT 12Y20 (GEOSPATIAL ENGR SGT) C
SP4 12Y10 (GEOSPATIAL ENGR) C
PFC 12Y10 (GEOSPATIAL ENGR) C

AN/TSQ-67(V) DTSS-L



INTEL/SATCOM TEAM PARA 06

AN/VRC-90F
2 KG-175
DAGR



SGT 35F20 (INTEL ANALYST) C
SP4 35F10 (INTEL ANALYST) SAW
PFC 35F10 (INTEL ANALYST) C

AN/VRC-90F
DAGR

AN/TSQ-226(V)3
(TROJAN SPIRIT LITE (V)3)



INTEL CELL/HCS PARA 07

AN/VRC-90F
AN/PYQ-7
AN/PYQ-3 (CHATS)
2 DAGR
AN/PSC-5



CPT 35E00 (SECTION LDR) C
CW2 35110 (CI TECH) P
CW2 351M0 (HUMINT COLLECTION TECH) C
SGT 35L20 (CI AGENT) P
SP4 35M10 (HUMINT COLLECTOR) C

INTEL CELL/USAF CWT PARA 08

AN/VRC-89F
AN/GMQ-36 (IMETS-L)
DAGR



CPT 01A00 (AIR FORCE STAFF OFFICER) C
SSG 00D30 (AIR FORCE STAFF NCO) C
SGT 00D20 (AIR FORCE STAFF NCO) C

(USAF PERSONNEL - NOT ASSIGNED TO UNIT)

PLANS CELL/S5 PARA 09

AN/VRC-92F
FBCB2
DAGR



MAJ 35D00 (PLANS OFF) P
CPT 19A00 (ASST PLANS OFF) C
SP4 19D10 (OPNS SP) C

HQ, Battlefield Surveillance Brigade (cont)

MOVEMENT MANEUVER/CURRENT OPS/S3 PARA 10

AN/VR-90F
FBCB2
DAGR

2 AN/VR-92F
AN/VR-90F
AN/VR-104(V)3
AN/TYQ-93
FBCB2
AN/TYQ-129(V)2
AN/TYQ-137A:(V)2
FHMUX
DAGR
AN/TSR-8 (GRT)
AN/PSC-5

AN/VR-90F

AN/VR-90F
DAGR



MAJ 02B00 (ASST S3) P



CPT 02B00 (ASST S3) C
CPT 35D00 (ASST S3) C
CPT 74A00 (CBRN OFF) C
SGM 35Z50 (OPNS SGT) C
SFC 19D40 (ASST OPNS SGT) C
SFC 74D40 (CBRN STAFF NCO) C



POWER PLANT UTILITY

SSG 35F30 (INTEL SGT) C
SGT 11B20 (ASST OPNS SGT) C
SGT 35F20 (INTEL ANALYST) C
2 SP4 11B10 (OPNS ASST) C
SP4 35F10 (INTEL ANALYST) SAW



X2

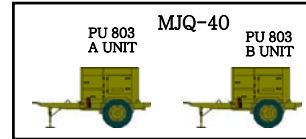

MOVEMENT MANEUVER/CURR OPS/ADAM/BAE PARA 11

AN/VR-92F
AN/VR-104(V)3
AN/VR-103(V)1
AN/GYK-88
DAGR
EPLRS-V1
AN/USQ-140(V)2(C)
AN/PRC-104A
3 AN/PSC-5
2 AN/PRC-117F

AN/TSQ-253



CPT 14A00 (AD FIRE COORD OFF) C
CW2 140A0 (C2 SYS INTEGR) C
SGT 14J20 (ASST OPNS SGT) C
SP4 14J10 (EWS OPR) C
SP4 14J10 (EWS OPR) SAW



MAJ 14A00 (AD COORD/MGMT OFF) P



MAJ 15B00 (OPNS OFF) P
CPT 15B00 (AIRSPACE MGMT OFF) C
CW3 153A1 (TAC OPS OFF) C
SFC 15P40 (AVIATION OPS SGT) C
SSG 15Q30 (ASST OPNS SGT) C
SP4 15P10 (AVIATION OPS SP) SAW

AN/VR-90F
FBCB2
AMPS
DAGR
AN/GRC-240
AN/VR-100(V)1
AN/PSC-5
AN/FSQ-211

FIRES/FIRES CELL PARA 12

AN/VR-92F
FBCB2
DAGR



CPT 13A00 (ASST FSO) C



CPT 29A00 (EW OFF) C
CW3 131A0 (TARGETING OFF) C
CW3 290A0 (EW TECH) C
CW2 290A0 (EW TECH) C
MSG 13Z50 (OPNS SGT) C
MSG 29E50 (EW SGT NCOIC) C
SP4 13D10 (FATDS SP) C
SP4 13F10 (FIRE SPT SP) SAW

2 AN/VR-92F
AN/VR-104(V)3
AN/GYK-57
AN/GYK-58
DAGR
AN/PSC-5
AN/GYK-56

MVMT MNVR/CURR OPS/LNO PARA 13

AN/VR-90F
FBCB2
DAGR
AN/PSC-5



CPT 19C00 (LIAISON OFF) C
SSG 11B30 (LIAISON SGT) C

FIRES/USAF TACP PARA 14

MAJ 01A00 (AIR FORCE STAFF OFF) P
SFC 00D40 (AIR FORCE STAFF NCO) C
SSG 00D30 (AIR FORCE STAFF NCO) C

(USAF PERSONNEL - NOT ASSIGNED TO UNIT)

SUSTAINMENT - S4 PARA 15

AN/VR-92F
FBCB2
AN/GYK-61 (BCS3)
DAGR
AN/PSC-5



MAJ 90A00 (S4) P

AN/VR-92F
AN/VR-104(V)3
AN/TYQ-129(V)1
AN/TYQ-129(V)2
AN/TYQ-109(V)1
AN/TYQ-109(V)2
OL-608/TYQ



MED PWR PLANT

CPT 90A00 (PLANS OFF) C
CPT 90A00 (OPNS OFF) C
CW2 882A0 (MOBILITY OFF) C
CW2 920A0 (PROP ACCT TECH) C
CW2 922A0 (FOOD ADVISOR) C
MSG 92G50 (SR FOOD OPNS SGT) C
MSG 92Y50 (SR SUPPLY SGT) C

BFSB-2

AN/VR-92F
AN/UYQ-90(V)3
AN/TYQ-95
DAGR
CAISI 2.0
OL-713(V)1/TYQ CSS VSAT
AN/TYQ-141



SFC 88N40 (STAFF MVMTS NCO) C
SFC 89B40 (AMMO LOG SGT) C
SFC 91X40 (MAINT MGMT NCO) C
SFC 92A40 (PLANS NCO) C
SSG 92A30 (MAT MGMT NCO) C

X2

AN/VR-90F
DAGR

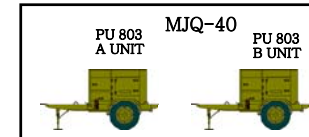

SSG 92M30 (MORTUARY AFFAIRS NCO) C
SGT 92Y20 (SUPPLY NCO) C
SGT 92Y20 (PROPERTY BOOK NCO) C
SP4 92A10 (MAT CON/ACCTG SP) SAW
SP4 92Y10 (SUPPLY SP) SAW

HQ, Battlefield Surveillance Brigade (cont)

SUSTAINMENT/CSSAMO PARA 16

AN/VRC-90F
AN/TYQ-107(V)2
AN/UHQ-90(V)2
FBCB2
AN/TYQ-129(V)2
AN/TYQ-105(V)1
AN/TYQ-108(V)2
AN/TYQ-108(V)3
AN/TYQ-109(V)2
OL-608/TYQ
OL-603/TYQ
AN/UHQ-90(V)3
AN/GYK-49(V)2
DAGR
CAISI 2.0
OL-713(V)1/TYQ CSS VSAT
AN/TYQ-141
AN/TYQ-139



CW2 251A0 (NETWORK SECURITY TECH) C
SFC 25B40 (INFO SYS SUPV) C
SSG 92A30 (MAT MGMT NCO) C
SP4 25B10 (INFO SYS SP) C



SUSTAINMENT - S1 PARA 17

AN/VRC-92F
FBCB2
DAGR
AN/TYQ-116(V)3



MAJ 42H00 (S1) P

AN/VRC-90F
AN/TYQ-137A:(V)2
DAGR
CAISI 2.0
8 AN/TYQ-116(V)3



LT 42B00 (STRENGTH MGR) C
CW2 420A0 (HR TECH) C
MSG 42A50 (SR HUMAN RES SGT) C
SSG 42A30 (HUMAN RES SGT) C
SGT 42A20 (HUMAN RES SGT) C
SGT 42F20 (HR INFO SYS SP) C
SP4 42A10 (HUMAN RES SP) C
SP4 42A10 (HUMAN RES SP) SAW
SP4 42F10 (HR INFO SYS SP) C
3 PFC 42A10 (HUMAN RES SP) C

SUSTAINMENT/UNIT MINISTRY TEAM PARA 18

AN/VRC-90F
FBCB2
DAGR



MAJ 56A00 (CHAPLAIN)
SSG 56M30 (CHAP ASST NCO) C

SUSTAINMENT/BRIGADE SURGEON PARA 19

AN/VRC-92F
AN/TYQ-107(V)1
AN/TYQ-106(V)1
FBCB2
2 AN/TYQ-105(V)1
AN/TYQ-108(V)3
DAGR



MAJ 62B00 (BRIGADE SURGEON) P
CPT 70H67 (MED OPNS OFF) C
SFC 68W40 (HEALTH CARE NCO) C

SUSTAINMENT/SJA PARA 20

AN/VRC-90F
FBCB2
DAGR



MAJ 27A00 (STAFF JUDGE ADVOCATE) P
CPT 27A00 (TRIAL COUNSEL) C
SFC 27D40 (SR PARALEGAL NCO) C
SGT 27D20 (PARALEGAL NCO) C
PFC 27D10 (PARALEGAL SP) SAW

C4 OPS/S6 PARA 21

AN/VRC-90F
FBCB2
DAGR
EPLRS-V1



MAJ 25A00 (S6) P

NETWORK MANAGEMENT

AN/VRC-90F
AN/VRC-104(V)3
AN/GYK-33D
AN/TYQ-137A:(V)2
DAGR
4 AN/TYQ-155 (V)1
2 AN/PYQ-16
AN/GYK-62B
AN/TSQ-243



PU-798



CPT 53A00 (INFO SYS MGMT OFF) C
CW2 250N0 (NETWORK MGMT TECH) C
MSG 25U50 (SGNL SPT SYS CHIEF) C
SFC 25B40 (INFO SYS SUPV) C
SSG 25E30 (ELECTRO SPECTRUM NCO) C
SSG 25Q30 (XMSN SYS OPS NCO) C
SSG 25S30 (SATCOM OPNS NCO) C
SSG 25U30 (SGNL INFO SVC NCO) C
SGT 25L20 (SR CABLE/ANT SYS SP) C
SP4 25L10 (CABLE/ANT SYS SP) C

IA/CND

AN/VRC-90F
DAGR

SSG 25B30 (CND INTEGR) C

COMSEC

AN/VRC-90F
AN/GYK-49(V)2
DAGR



SFC 25B40 (COMSEC CUSTODIAN) C
SSG 25B30 (ASST COMSEC CUSTODIAN) C

SYS INTEGR OVERSIGHT/IDM

AN/VRC-90F
AN/TYQ-137A:(V)2
DAGR
AN/TSR-8 (GRT)
AN/GYK-50A (ISYSCON) (V)4
AN/GYK-50B (ISYSCON) (V)4



MED PWR PLANT

CW2 254A0 (SNGL SYS TECH) C
SFC 25W40 (NETWORK OPNS CHIEF) C
SSG 25B30 (INFO TECH TEAM CHIEF) C
SSG 25N30 (NODAL OPS SYS NCO) C
SGT 25B20 (SR INFO TECH SP) C
SP4 25B10 (INFO TECH SP) C
SP4 25U10 (SGNL SPT SYS MAINT) C
SP4 25U10 (SGNL SPT SYS SP) C
2 PFC 25B10 (INFO TECH SP) C
PFC 25U10 (SGNL SPT SYS SP) C

BFSB-3

HQ, Battlefield Surveillance Brigade (cont)

TACTICAL CP PARA 22

AN/VR-92F
AN/VR-104(V)3
AN/PRC-119F
FBCB2
DAGR



LTC 01B00 (S3) P

AN/VR-92F
AN/TYQ-93
DAGR



CPT 35D00 (ASST INTEL OFF) C
SSG 35F30 (INTEL SGT) C
SGT 35F20 (INTEL ANALYST) C
SP4 35F10 (INTEL ANALYST) SAW
PFC 35F10 (INTEL ANALYST) SAW

AN/VR-92F
AN/TYQ-137A:(V)2
DAGR
AN/PSC-5



MED PWR PLANT



CPT 11A00 (OPNS OFF) C
CPT 19C00 (BATTLE CPT) C
SFC 19D40 (ASST OPNS SGT) C
SSG 11B30 (ASST OPNS SGT) C
2 SP4 11B10 (OPNS ASST) C

AN/VR-92F
AN/PRC-119F
DAGR



AN/VR-90F
DAGR



AN/VR-92F
2 AN/PRC-119F
AN/GYK-57
AN/GYK-48(V)1
DAGR
AN/PSC-5



MAJ 13A00 (FIRE SPT OFF) P
SFC 13F40 (FIRE SPT SGT) C
SGT 13F20 (FIRE SPT SGT) C

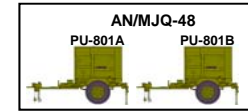

COMPANY HEADQUARTERS PARA 23

AN/VR-92F
FBCB2
DAGR



CPT 01A00 (COMMANDER) P

AN/VR-89F
FBCB2
DAGR



1SG 11Z5M (FIRST SERGEANT) C



AN/VR-90F
AN/TYQ-129(V)2
AN/TYQ-109(V)1
CAISI 2.0
DAGR



LT 01A00 (EXEC OFF) C
SSG 92Y30 (SUPPLY SGT) C
SGT 92Y20 (SUPPLY NCO) C
SP4 74D10 (CBRN SP) SAW
SP4 74D10 (CBRN DECON SP) SAW
SP4 92Y10 (SUPPLY SP) C

HHC/TREATMENT TEAM PARA 24

AN/VR-90F
AN/TYQ-106(V)1
FBCB2
2 AN/TYQ-105(V)1
DAGR



CPT 65D00 (PHYSICIAN ASSISTANT) P
SSG 68W30 (HEALTH CARE SGT) C
SP4 68W10 (HEALTH CARE SP) C
PFC 68W10 (HEALTH CARE SP) C

AN/VR-89F
AN/TYQ-106(V)1
FBCB2
2 AN/TYQ-105(V)1
DAGR



HHC/EVACUATION SQUAD PARA 25

AN/VR-90F
FBCB2
2 AN/TYQ-105(V)1
DAGR



SGT 68W20 (AMBUL AIDE/DRIVER) C
PFC 68W10 (AMB AIDE/DRIVER) C

X2

Summary of Equipment

WEAPONS

LAUNCHER GRENADE: M320A1-----	4
MACHINE GUN 5.56MM M249-----	17
MACHINE GUN LIGHT 5.56MM M249-----	4
MACHINE GUN GRENADE 40MM MK-19 MOD III-----	1
MACHINE GUN 7.62MM M240B-----	2
PISTOL 9MM AUTOMATIC M11-----	2
PISTOL 9MM AUTOMATIC M9-----	2
RIFLE 5.56MM M4 CARBINE-----	149
MACHINE GUN: CALIBER .50 (M2E2)-----	4

VEHICLES, TRAILERS, AND TRLR MTD SYSTEMS

COMMAND SYSTEM: TACTICAL (CPP RWS) (MTD ON HMMWV)---	3
GEN SET DED TM: 10KW 60HZ (PU-798)-----	3
POWER PLANT: ELECTRIC TRL/MTD 30KW 50/60HZ AN/MJQ 40---	2
POWER PLANT: UTILITY LARGE 35KW 12 TON ECU-----	1
POWER PLANT: UTILITY MEDIUM 20KW 5 TON ECU-----	4
POWER PLANT: ELECTRIC TLR MTD AN/MJQ-48-----	2
TRUCK UTILITY EXP CAPACITY: ARMT CARRIER M1151A1-----	5
TRUCK UTILITY EXP CAPACITY: ENH 4X4: M1152A1-----	19
TRUCK AMBULANCE: 4 LITTER HMMWV (M997)-----	3
TRUCK VAN EXPANSIBLE MTV (M1087A1)-----	1
TRUCK UTILITY EXP CAP ENHANCED 4X4: M1165A1-----	19
TRUCK CARGO: MTV (M1083)-----	6
TRUCK CARGO: 4X4 LMTV (M1078)-----	4
TRAILER CARGO: MTV W/ DROPSIDES (M1095)-----	1
TRAILER HIGH MOBILITY 1-1/4T (M1102)-----	6
LIGHT TACTICAL TRAILER: 3/4T (M1101)-----	11
TRAILER CARGO: LMTV W/DROPSIDES (M1082)-----	2
TRAILER TANK WATER (CAMEL) 800 GAL 5 TON-----	1

MISCELLANEOUS EQUIPMENT

DECON APPARATUS LT WT-----	2
GEN SET : DED SKID MTD 3KW 60HZ (MEP-831A)-----	8
SHELTER: NONEXPD LTWR MP RIGID WALL S788-----	1
TGT ACQ SUBSYS: COMMON GROUND STATION AN/TSQ-179(V)---	1
GEN SET DED 5KW 50/60HZ: SKID-MTD-----	2
GEN SET DED 10 KW 50/60HZ: SIDE-MTD-----	4

NIGHT VISION/OBSERVATION EQUIPMENT

DRIVERS VISION ENHANCER: AN/VAS-5-----	56
NIGHT VISION GOGGLES: AN/PVS-7B-----	120
MEDIUM THERMAL WEAPONS SIGHT: AN/PAS-13(V2)-----	6
HEAVY THERMAL WEAPONS SIGHT: AN/PAS-13(V3)-----	5

COMMUNICATION-ELECTRONICS EQUIPMENT

ALL SOURCE ANALYSIS SYSTEM: AN/TYQ-93 (ASAS-LT)-----	6
ALL SOURCE ANALYSIS SYSTEM: AN/TYQ-93(V)2 (ASAS-IFS)-----	2
ANTENNA GROUP: OE-254-----	30
COMPUTER SET: AN/GYK-57 (AFATDS - SINGLE)-----	2
COMPUTER SET: AN/GYK-58 (AFATDS - DUAL)-----	1
CENTER COMMUNICATIONS OPERATIONS: AN/TSQ-253 (COCS)---	1
COMPUTER SYSTEM DIGITAL: AN/TYQ-103 (ACT-E)-----	1
COMPUTER SYSTEM DIGITAL: AN/TYQ-107(V)2 (MC4-3B)-----	1
COMPUTER SET DIGITAL: AN/PYQ-7 (CI&I OPS WS)-----	1
COMPUTER SYSTEM DIGITAL: AN/TYQ-107(V)1 (MC4-3A)-----	1
COMPUTER SYSTEM DIGITAL: AN/UYQ-90(V)2 (MTS)-----	1
COMPUTER SET GENERAL: AN/GYK-33D-----	1
COMPUTER SYSTEM DIGITAL: AN/PYQ-3 (CHATS)-----	1
COMPUTER SYSTEM DIGITAL: AN/TYQ-106(V)1-----	3
COMPUTER SET DIGITAL: AN/UYK-128 (FBCB2)-----	25
COMPUTER SYSTEM DIGITAL: (AMPS)-----	1
BTL CMD SUSTAINMENT SPT SYSTEM: AN/GYK-61 (BCS3)-----	1
COMPUTER SYS DIGITAL: AN/TYQ-129(V1) (TC-AIMS II SERVER)---	1
COMPUTER SYS DIGITAL: AN/TYQ-129(V)2 (TC-AIMS II WS)-----	4
COMPUTER SYSTEM DIGITAL: AN/TYQ-105(V)1-----	11
COMPUTER SYSTEM DIGITAL: AN/TYQ-108(V)2-----	1
COMPUTER SYS DIGITAL: AN/TYQ-108(V)3-----	2
COMPUTER SET DIGITAL: AN/TYQ-109(V)1 (GCSS-A (V)1)-----	2
COMPUTER SET DIGITAL: AN/TYQ-109(V)2 (GCSS-A (V)2)-----	2
COMPUTER SET DIGITAL: OL-608/TYQ (SAAS-MOD DAO)-----	2
COMPUTER SYSTEM DIGITAL: ((CPOF WS) AN/TYQ-137A:(V)2)---	8
CENTRAL: COMMS AN/TSQ-226(V)3 (TROJAN SPIRIT LT (V)3)---	1
COMMAND CENTER SYSTEM: AN/TSQ-243-----	2
COMPUTER: TACTICAL AN/GYQ-88-----	1
COMPUTER SET DIGITAL: OL-603/TYQ (SARSS DSU SVR)-----	1
COMPUTER SYSTEM DIGITAL: AN/UYQ-90(V)3 (MTS-CS)-----	2
COMPUTER SET GENERAL: AN/GYK-49(V)2-----	1
DIGITAL TOPOGRAPHIC SYSTEM: AN/TYQ-67(V)-----	1
ENCRYPT/DECRYPT EQUIPMENT: TACLANE KG-175-----	2
CONTROL RADIO SET: C-2299/VRC-----	1
FREQUENCY HOPPING MULTIPLEXER: TF-1456VRC (FHMUX)-----	2
INTEGRATED METEOROLOGICAL SYSTEM LT: AN/GMQ-36-----	1
INTERROGATOR SET AN/TYQ-95 (TC-AIMS II INTERROGATOR)---	1
NAVIGATION SET: SATELLITE SIGNALS AN/PSN-13 (DAGR)-----	57
P/H SURFACE VEH RADIO SET: AN/VSQ-2(V)1 (EPLRS-V1)-----	2
PROCESSOR GROUP SIGNAL DATA: (CAISI 2.0)-----	4
RADIAC SET: AN/VDR-2-----	10
RECEIVER-TRANSMITER: RT-1672/PSC-5-----	1
RECEIVE SUITE: AN/TSR-8 (GRT)-----	2
RADIO SET: AN/GRC-240-----	1
RADIO SET: AN/USQ-140(V)2(C)-----	1
RADIO SET: AN/VRC-89F-----	3
RADIO SET: AN/VRC-90F-----	34
RADIO SET: AN/VRC-92F-----	25
AN/VRC-104(V)3 150 WATT IK: PRC-150 HF RADIO-----	8
RADIO SET: AN/PSC-5-----	10
RADIO SET: HIGH FREQ AN/VRC-100(V)1-----	1
RADIO SET: AN/PRC-119F-----	2
WORKSTATION: AIRSPACE OPERATION AN/FSQ-211 (TAIS AWS)---	1
COMPUTER SET FA GENERAL: AN/GYK-56 (EMT)-----	1
COMPUTER SYSTEM DIGITAL: AN/GYK-50A (ISYSCON) (V4)-----	1
COMPUTER SYSTEM DIGITAL: AN/GYK-50B (ISYSCON) (V4)-----	1
INTERFACE UNIT COMM EQ: OL-713(V)1/TYQ CSS VSAT-----	2
RADIO SET: AN/PRC-117F TACSAT RADIO MANPACK-----	2
COMPUTER SYSTEM: DIGITAL AN/TYQ-141-----	2
COMPUTER SYSTEM: DIGITAL AN/TYQ-139-----	1
COMPUTER SET: DIGITAL AN/GYK-62B (BFT TOC KIT)-----	1
COMMAND SYSTEM: TACTICAL AN/TYQ-155 (V)1 (TCB SERVER)---	4
COMPUTER SYSTEM DIGITAL: AN/PYQ-16-----	2
COMP SYS DIGITAL: (AHRIS) AN/TYQ-116(V)3-----	9

HQ, BATTLEFIELD SURVEILLANCE BRIGADE

Tactical Unmanned Aircraft System (TUAS) Platoon

01708RA00
OFF: 0/WO: 2/ENL: 25/TOTAL: 27

PLATOON HQ PARA 01

AN/VRC-92F
AN/TYQ-151(V)2

CW3 150UB (PLT LDR) C
CW2 150U0 (UAS OPNS TECH) C
SFC 15W40 (PLT SGT) C

MSN PLNG & CONT SECTION PARA 02

AN/VRC-92F
2 AN/VRC-89F
FBCB2
AMPS
FHMUX
DAGR
AN/TYQ-151(V)1 ULLS-A(E)
AN/TYQ-151(V)3
AN/TYQ-150(V)1 ULLS-A(E)
GDT

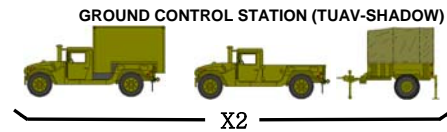

SSG 15W30 (UAV SGT) C
2 SGT 15W20 (UAV OPR) C
SP4 15J10 (SH-UAV SYS REP) SAW
3 SP4 15W10 (UAV OPR) C
2 PFC 15W10 (UAV OPR) C

LAUNCH & RECOVERY SECTION PARA 03

CAISI 2.0
5 AN/TYQ-151(V)1 ULLS-A(E)
AN/TYQ-151(V)2

AN/VRC-89F
AN/TYQ-151(V)1 ULLS-A(E)

AN/VRC-89F
CAISI 2.0
AN/TYQ-151(V)1 ULLS-A(E)
AN/TYQ-151(V)2

AN/VRC-89F
PGDT
AN/TYQ-151(V)1 ULLS-A(E)

(EQUIP VEH)



AVT



X4

MSMF



PGCS



SFC 15J40 (SR SH-UAV SYS REP) C
SSG 15J30 (UAS SYS TECH INSP) C
SSG 15W30 (UAV SGT) C
SGT 15J20 (SH-UAV SYS REP) C
SGT 15J20 (UAS SYS TECH INSP) C
2 SGT 15W20 (UAV OPR) C
2 SP4 15J10 (SH-UAV SYS REP) C
2 SP4 15W10 (UAV OPR) C
2 PFC 15J10 (SH-UAV SYS REP) C
2 PFC 15W10 (UAV OPR) SAW

Summary of Equipment

WEAPONS

MACHINE GUN 5.56MM M249 ----- 2
RIFLE 5.56MM M4 CARBINE ----- 25

VEHICLES, TRAILERS, AND TRLR MTD SYSTEMS

TRUCK UTILITY EXP CAPACITY ENH 4X4: M1152A1 ----- 7
TRUCK CARGO: 4X4 LMTV (M1078) ----- 1
TRAILER HIGH MOBILITY 1-1/4T (M1102) ----- 4

MISCELLANEOUS EQUIPMENT

GEN SET DIESEL: 60HZ AC MEP-531A ----- 8
GEN SET: DED SKID MTD 10KW 60HZ (MEP-803A) ----- 2
SAW CHAIN: GAS DRVN BAR FRAME ----- 2

TUAS SYSTEM EQUIPMENT

TACT UNMANNED AERIAL VEHICLE SYSTEM: (SHADOW) ----- 1
PORTABLE GROUND DATA TERMINAL (PGDT) ----- 1
MOBILE SECTION MULTI-FUNCTIONAL : (SHADOW) ----- 1
PORTABLE GROUND CONTROL STATION (PGCS) ----- 1
TRUCK AIR VEHICLE TRANSPORTER: (AVT) (TUAV-SHADOW) ----- 1
UNMANNED AERIAL VEHICLE (UAV): (TUAV-SHADOW) ----- 4
UNMANNED AERIAL VEHICLE LAUNCHER: (TUAV-SHADOW) ----- 2
GROUND CONTROL STATION (GCS): (TUAV-SHADOW) ----- 2
AUTOMATIC TAKEOFF AND LANDING SYSTEM: (TALS) ----- 2
GROUND DATA TERMINAL (GDT): (TUAV-SHADOW) ----- 2

BFSB-6

COMMUNICATION-ELECTRONICS EQUIPMENT

ANTENNA GROUP: OE-254 ----- 5
COMPUTER SET DIGITAL: AN/UYK-128 (FBCB2) ----- 2
COMPUTER SYSTEM DIGITAL: (AMPS) ----- 2
FREQUENCY HOPPING MULTIPLEXER: TF-1456VRC (FHMUX) ----- 2
NAVIGATION SET: SATELLITE SIGNALS AN/PSN-13 (DAGR) ----- 2
PROCESSOR GROUP SIGNAL DATA: (CAISI 2.0) ----- 2
RADIAC SET: AN/VDR-2 ----- 3
RADIO SET: AN/VRC-89F ----- 7
RADIO SET: AN/VRC-92F ----- 3
COMPUTER SET DIGITAL: AN/TYQ-151(V)1 ULLS-A(E) ----- 10
COMPUTER SET DIGITAL: AN/TYQ-151(V)2 ----- 1
COMPUTER SET DIGITAL: AN/TYQ-151(V)3 ----- 2
COMPUTER SET DIGITAL: AN/TYQ-150(V)1 ULLS-A(E) ----- 2

NIGHT VISION/OBSERVATION EQUIPMENT

DRIVERS VISION ENHANCER: AN/VAS-5 ----- 8
NIGHT VISION GOGGLES: AN/PVS-7B ----- 16

HHC, MI Bn (BFSB)

34106R100
OFF: 11/WO: 0/ENL: 44/TOTAL: 55

COMMAND SECTION PARA 01

AN/VRC-92F
AN/VRC-104(V)3
FBCB2
AN/TYQ-137A:(V)2
DAGR
AN/PSC-5
AN/GYK-62B



LTC 35D00 (COMMANDER) P

AN/VRC-90F
FBCB2
DAGR



MAJ 35D00 (EXEC OFF) P CSM 00Z50 (CSM) P

SUSTAINMENT - S1 PARA 02

AN/VRC-90F
FBCB2
DAGR
CAISI 2.0
5 AN/TYQ-116(V)3



LT 42B00 (S1) R
SFC 42A40 (SR HUMAN RES SGT) R
SSG 42A30 (HUMAN RES SGT) R
SGT 42A20 (HUMAN RES SGT) R
SP4 27D10 (PARALEGAL SP) R
SP4 42A10 (HUMAN RES SP) R
2 PFC 42A10 (HUMAN RES SP) R

CURR OPS - INTEL/S2 PARA 03

AN/VRC-92F
AN/TYQ-93
AN/TYQ-137A:(V)2
AN/PSC-5

LT 35D00 (S2) R
SFC 35F40 (SR INTEL SGT) R
SP4 35F10 (INTEL ANALYST) R (*DRIVES BN CDR*)
PFC 35F10 (INTEL ANALYST) R

CURR OPS - OPS/S3 PARA 04

AN/VRC-92F
FBCB2
DAGR



MAJ 35D00 (S3) P

AN/VRC-92F
AN/VRC-104(V)3
AN/TYQ-93
FBCB2
AN/TYQ-137A:(V)2
AN/TSQ-243
FHMUX
DAGR
AN/PSC-5



MED PWR PLANT

CPT 35D00 (ASST S3) R
LT 74A00 (CBRN OFF) R
SFC 35F40 (SR INTEL SGT) R
SFC 35N40 (SR SIGINT SGT) R
SSG 35F30 (INTEL SGT) R

AN/VRC-90F
AN/TYQ-129(V)1
AN/TYQ-129(V)2
DAGR



SSG 74D30 (CBRN NCO) R
SGT 35N20 (SIGINT ANALYST) R
SP4 35F10 (INTEL ANALYST) SAW
SP4 35M10 (HUMINT COLLECTOR) R
SP4 35N10 (SIGINT ANALYST) R
PFC 35N10 (SIGINT ANALYST) R



PU-798



PU-801

SUSTAINMENT - S4 PARA 05

AN/VRC-92F
FBCB2
AN/TYQ-129(V)2
AN/TYQ-109(V)1
AN/TYQ-109(V)2
AN/UYQ-90(V)3
AN/TYQ-95
DAGR
CAISI 2.0
OL-713(V)1/TYQ CSS VSAT



CPT 90A00 (S4) R
SFC 92Y40 (SR SUPPLY SGT) R
SGT 92Y20 (PROPERTY BOOK NCO) R
SP4 92Y10 (SUPPLY SP) R
PFC 92Y10 (SUPPLY SP) R



PU-798

SUSTAINMENT - C4 OPS/S6 PARA 06

AN/VRC-92F
AN/GYK-33D
FBCB2
DAGR



CPT 25A00 (S6) R

AN/VRC-90F
AN/PYQ-12
AN/TR-8 (GRT)



SFC 25U40 (SECTION CHIEF) R
SGT 25B20 (SR LAN MGR) R
SP4 25B10 (LAN MGR) R
SP4 25U10 (SIGNAL INFO SVC SP) R
SP4 25U10 (SGNL SPT SYS SP) R

AN/VRC-90F
AN/GYK-49(V)2
AN/GYK-50A (ISYSCON) (V)4
TSEC/KOK-22



BCP (SWITCHING GP): OM-87A/T

PU-798

SGT 25Q20 (SR XMSN SYS OPR-MAINT) R
SP4 25Q10 (XMSN SYS OPR-MAINT) R

AN/VRC-90F



IEW SYSTEMS INTEGRATION SECTION PARA 07

SSG 35T30 (MI SYS MNTR/INTGR SGT) R
2 SGT 35T20 (MI SYS MNTR/INTGR) R
2 SP4 35T10 (MI SYS MNTR/INTGR) R
SP4 35T10 (MI SYS MNTR/INTGR) R (*DRIVES BN XO*)
PFC 35T10 (MI SYS MNTR/INTGR) R (*DRIVES CSM*)

HHC, MI Bn (BFSSB) (cont)

SUSTAINMENT - UMT PARA 08

AN/VRC-90F
FBCB2
DAGR



CPT 56A00 (CHAPLAIN)
SP4 56M10 (CHAPLAIN ASST) R

HEADQUARTERS AND HEADQUARTERS COMPANY PARA 09

AN/VRC-92F
FBCB2
DAGR



CPT 35D00 (COMMANDER) P

AN/VRC-90F
FBCB2
DAGR



1SG 35X5M (FIRST SGT) R

AN/TYQ-109(V)1
CAISI 2.0



SGT 92Y20 (SUPPLY NCO) R
SP4 92Y20 (SUPPLY SP) R



2 SP4 74D10 (CBRN DECON SP) R

Summary of Equipment

WEAPONS

LAUNCHER GRENADE: M320-----	4
MACHINE GUN 5.56MM M249-----	4
MACHINE GUN LIGHT 5.56MM M249-----	4
MACHINE GUN GRENADE 40MM MK-19 MOD III-----	1
PISTOL 9MM AUTOMATIC M9-----	5
RIFLE 5.56MM M16A2-----	45
MACHINE GUN: CALIBER .50 (M2E2)-----	1

VEHICLES, TRAILERS, AND TRLR MTD SYSTEMS

GEN SET DED TM: 10KW 60HZ (PU-798)-----	3
GEN SET DIESEL ENGINE TM: 15KW 60HZ (PU-801)-----	1
POWER PLANT: UTILITY, MEDIUM 20KW 5 TON ECU-----	2
TRUCK UTILITY EXP CAPACITY ENH 4X4: M1152A1-----	5
TRUCK UTILITY EXP CAPACITY ENH 4X4: M1165A1-----	8
TRUCK CARGO: MTV (M1083)-----	1
TRUCK CARGO: 4X4 LMTV (M1078)-----	3
LIGHT TACTICAL TRAILER: 3/4T (M1101)-----	5
TRAILER CARGO: LMTV W/DROPSIDES (M1082)-----	2
TRAILER TANK WATER (CAMEL) 800 GAL 5 TON-----	1

MISCELLANEOUS EQUIPMENT

DECON APPARATUS LT WEIGHT-----	2
GEN SET: DED SKID MTD 5 KW 60HZ (MEP-802A)-----	1
GEN SET: DED SKID MTD 3KW 60HZ (MEP-831A)-----	2

COMMUNICATION-ELECTRONICS EQUIPMENT

ALL SOURCE ANALYSIS SYSTEM: AN/TYQ-93 (ASAS-LT)-----	2
ANTENNA GROUP: OE-254-----	14
COMPUTER SET GENERAL: AN/GYK-33D-----	1
COMPUTER SET DIGITAL: AN/UYK-128 (FBCB2)-----	11
COMPUTER SYSTEM DIGITAL: AN/PYQ-12-----	1
COMPUTER SYS DIGITAL: AN/TYQ-129(V1) (TC-AIMS II SERVER)-----	1
COMPUTER SYS DIGITAL: AN/TYQ-129(V2) (TC-AIMS II WS)-----	2
COMPUTER SET DIGITAL: AN/TYQ-109(V)1 (GCSS-A (V)1)-----	2
COMPUTER SET DIGITAL: AN/TYQ-109(V)2 (GCSS-A (V)2)-----	1
COMPUTER SYSTEM DIGITAL: ((CPOF WS) AN/TYQ-137A:(V)2)-----	3
COMMAND CENTER SYSTEM: AN/TSQ-243-----	1
COMPUTER SYSTEM DIGITAL: AN/UYQ-90(V)3 (MTS-CS)-----	1
COMPUTER SET GENERAL: AN/GYK-49(V)2-----	1
FREQUENCY HOPPING MULTIPLEXER: TF-1456VRC (FHMUX)-----	1
INTERROGATOR SET AN/TYQ-95 (TC-AIMS II INTERROGATOR)-----	1
NAVIGATION SET: SATELLITE SIGNALS AN/PSN-13 (DAGR)-----	12
PROCESSOR GROUP SIGNAL DATA: (CAISI 2.0)-----	3
RADIAC SET: AN/VDR-2-----	3
RECEIVE SUITE: AN/TSR-8 (GRT)-----	1
RADIO SET: AN/VRC-90F-----	8
RADIO SET: AN/VRC-92F-----	8
AN/VRC-104(V)3 150 WATT IK: PRC-150 HF RADIO-----	2
RADIO SET: AN/PSC-5-----	3
COMPUTER SYSTEM DIGITAL: AN/GYK-50A (ISYSCON) (V4)-----	1
INTERFACE UNIT COMM EQ: OL-713(V)1/TYQ CSS VSAT-----	1
BATTALION COMMAND POST (SWITCHING GROUP): OM-87A/T-----	1
COMPUTER SET: DIGITAL AN/GYK-62B (BFT TOC KIT)-----	1
KEY PROCESSOR: KP TSEC/KOK-22-----	1
COMPUTER SYSTEM DIGITAL: AN/TYQ-116(V)3 (AHR)-----	5

NIGHT VISION/OBSERVATION EQUIPMENT

NIGHT VISION GOGGLES: AN/PVS-7B-----	36
MEDIUM THERMAL WEAPONS SIGHT: AN/PAS-13(V2)-----	4
HEAVY THERMAL WEAPONS SIGHT: AN/PAS-13(V3)-----	2

Technical Collection Company (BFSB)

34107G100
OFF: 8/WO: 2/ENL: 91/TOTAL: 101

COMPANY HEADQUARTERS PARA 01

AN/VRC-92F
AN/VRC-104(V)3
FBCB2
DAGR
ANPSC-5



CPT 35G00 (COMMANDER) P
SP4 74D10 (CBRN SP) R

AN/VRC-90F
FBCB2
AN/TYQ-109(V)1
DAGR
CAISI 2.0



1SG 35Z5M (FIRST SGT) R
SSG 92Y30 (SUPPLY SGT) R
SP4 92Y10 (SUPPLY SP) R

SIGINT AUGMENTATION TEAM PARA 02

CW2 352P0 (VOICE INTERCEPT TECH) R
SGT 35N20 (SIGINT ANALYST) R
SGT 35P2L (CRYPTO LINGUIST) R
SP4 35N10 (SIGINT ANALYST) R
SP4 35P1L (CRYPTO LINGUIST) SAW
PFC 35N10 (SIGINT ANALYST) SAW

X2

SIGINT PLATOON HQ PARA 03

AN/VRC-92F
FBCB2
DAGR



LT 35D00 (PLT LDR) R
SFC 35P4L (PLT SGT) R

X2

SIGINT ANALYSIS AND CONTROL TEAM PARA 04

AN/VRC-90F
FBCB2
DAGR
AN/MSW-24

AN/MSW-24



SSG 35P3L (SR CRYPTO LINGUIST) R
SGT 35N20 (SIGINT ANALYST) R
SP4 35N10 (SIGINT ANALYST) R
PFC 35N10 (SIGINT ANALYST) R

X2

GRND BASED SIGINT COLL & EXPL TEAM PARA 05

AN/VRC-90F
AN/PRC-119F
FBCB2
DAGR

AN/MLQ-40 (V) 4



SGT 35P2L (CRYPTO LINGUIST) R
2 SP4 35P1L (CRYPTO LINGUIST) R

X4

MULTIFUNCTIONAL SECTION PARA 06

AN/VRC-91F
AN/PRC-119F
AN/PYQ-7
AN/PYQ-3
ANPYQ-8
2 DAGR

AN/VRC-91F
AN/PRC-119F
AN/PYQ-7
AN/PYQ-3
AN/PYQ-8
2 DAGR

AN/VRC-91F
AN/PRC-119F
AN/VRC-104(V)3
AN/PYQ-8
DAGR
AN/PSC-5



LT 35D00 (SECTION LDR) R
SFC 35M4L (SR HUMINT COLLECTION SGT) R
SSG 35L30 (CI SGT) P
SSG 35M3L (HUMINT COLLECTION SGT) R
SSG 35S30 (SGNL COLLECTOR/ANAL SGT) R
2 SGT 35M2L (HUMINT COLLECTOR) R
SGT 35P2L (CRYPTOLOGIC LINGUIST) R
2 SP4 34M10 (HUMINT COLLECTOR) R
2 PFC 35M10 (HUMINT COLLECTOR) R

X5

Summary of Equipment

WEAPONS

LAUNCHER GRENADE: M320-----	1
MACHINE GUN 5.56MM M249-----	4
MACHINE GUN LIGHT 5.56MM M249-----	9
MACHINE GUN GRENADE 40MM MK-19 MOD III-----	1
PISTOL 9MM AUTOMATIC M9-----	6
RIFLE 5.56MM M16A2-----	91
MACHINE GUN: CALIBER .50 (M2E2)-----	1

VEHICLES, TRAILERS, AND TRLR MTD SYSTEMS

TRUCK UTILITY EXP CAP: ARMAMENT CARRIER M1151A1-----	16
TRUCK UTILITY EXP CAPACITY ENH 4X4: M1165A1-----	10
TRUCK CARGO: MTV (M1083)-----	1
TRAILER HIGH MOBILITY 1-1/4T (M1102)-----	4
LIGHT TACTICAL TRAILER: 3/4T (M1101)-----	10
TRAILER TANK WATER (CAMEL) 800 GAL 5 TON-----	1

MISCELLANEOUS EQUIPMENT

GEN SET: DED SKID MTD 5 KW 60HZ (MEP-802A)-----	1
GEN SET : DED SKID MTD 3KW 60HZ (MEP-831A)-----	5

COMMUNICATION-ELECTRONICS EQUIPMENT

ANTENNA GROUP: OE-254-----	32
COMPUTER SET DIGITAL: AN/PYQ-7 (CI&I OPS WS)-----	10
COMPUTER SYSTEM DIGITAL: AN/PYQ-3 (CHATS)-----	10
COMPUTER SET DIGITAL: AN/UYK-128 (FBCB2)-----	10
COMPUTER SET DIGITAL: AN/TYQ-109(V)1 (GCSS-A (V)1)-----	1
COMPUTER: SYSTEM DIGITAL AN/PYQ-8 (TRT)-----	15
NAVIGATION SET: SATELLITE SIGNALS AN/PSN-13 (DAGR)-----	35
PROCESSOR GROUP SIGNAL DATA: (CAISI 2.0)-----	1
RADIAC SET: AN/VDR-2-----	12
RADIO SET: AN/VRC-90F-----	9
RADIO SET: AN/VRC-91F-----	15
RADIO SET: AN/VRC-92F-----	3
RADIO SET: AN/PRC-119F-----	19
RADIO SET: AN/VRC-104(V)3 150 WATT IK: PRC-150 HF RADIO-----	6
RADIO SET: AN/PSC-5-----	6
DETECTING SYSTEM COUNTERMEASURES: AN/MLQ-40(V)4-----	4
DATA ANALYSIS CENT: AN/MSW-24 (SPIRAL 1 PROPHET CONT)--	2

NIGHT VISION/OBSERVATION EQUIPMENT

DRIVERS VISION ENHANCER: AN/VAS-5-----	15
NIGHT VISION GOGGLES: AN/PVS-7B-----	54
MEDIUM THERMAL WEAPONS SIGHT: AN/PAS-13(V2)-----	9
HEAVY THERMAL WEAPONS SIGHT: AN/PAS-13(V3)-----	2

Collection & Exploitation Company (BFSB)

34109R100
OFF: 1/WO: 3/ENL: 49/TOTAL: 53

COMPANY HEADQUARTERS PARA 01

AN/VRC-89F
AN/VRC-104(V)3
FBCB2
KG-175
DAGR



CPT 35E00 (COMMANDER) P
SP4 74D10 (CBRN SP) SAW

AN/VRC-90F
AN/TYQ-109(V)1
DAGR
CAISI 2.0



1SG 35Y5M (FIRST SGT) R
SGT 92Y20 (SUPPLY NCO) R
SP4 92Y10 (SUPPLY SP) SAW

CI OPERATIONS MGMT TEAM PARA 02

AN/VRC-92F
AN/VRC-104(V)3
AN/PYQ-7
AN/PYQ-3
FBCB2
2 DAGR
AN/PSC-5



CW3 35L10 (CI TECH) P&R
SSG 35L30 (CI SGT) P&R
2 SGT 35L20 (CI AGENT) P&R

CI OPERATIONS TEAM PARA 03

AN/VRC-91F
AN/PRC-119F
AN/VRC-104(V)3
AN/PYQ-3
FBCB2
AN/PYQ-8
2 DAGR
AN/PSC-5

AN/VRC-91F
AN/PRC-119F
FBCB2
AN/PYQ-8
DAGR



SFC 35L40 (SR CI SGT) P&R
SSG 35L30 (CI SGT) P&R
2 SGT 35L20 (CI AGENT) P&R

X3

HUMINT OPERATIONAL MGMT TEAM PARA 04

AN/VRC-92F
AN/VRC-104(V)3
AN/PYQ-7
AN/PYQ-3
FBCB2
2 DAGR
AN/PSC-5



CW3 35M0 (HUMINT COLLECTION TECH) P&R
SSG 35M3L (HUMINT COLLECTION SGT) P&R
SP4 35M10 (HUMINT COLLECTOR) P&R
PFC 35M10 (HUMINT COLLECTOR) P&SAW

X2

HUMINT COLLECTION TEAM PARA 05

AN/VRC-91F
AN/PRC-119F
AN/VRC-104(V)3
AN/PYQ-3
FBCB2
AN/PYQ-8
2 DAGR
AN/PSC-5

AN/VRC-91F
AN/PRC-119F
FBCB2
DAGR



SSG 35M3L (HUMINT COLLECTION SGT) P&R
SGT 35M2L (HUMINT COLLECTOR) P&R
SP4 35M10 (HUMINT COLLECTOR) P&R
PFC 35M10 (HUMINT COLLECTOR) P&R

X6

Summary of Equipment

WEAPONS

LAUNCHER GRENADE: M320-----	4
MACHINE GUN 5.56MM M249-----	4
MACHINE GUN LIGHT 5.56MM M249-----	13
MACHINE GUN GRENADE 40MM MK-19 MOD III-----	1
PISTOL 9MM AUTOMATIC M9-----	33
PISTOL 9MM AUTOMATIC M11-----	16
RIFLE 5.56MM M16A2-----	48
MACHINE GUN: CALIBER .50 (M2E2)-----	1

VEHICLES, TRAILERS, AND TRLR MTD SYSTEMS

TRUCK UTILITY EXP CAP: ARMAMENT CARRIER M1151A1-----	18
TRUCK UTILITY EXP CAPACITY ENH 4X4: M1165A1-----	4
TRUCK CARGO: MTV (M1083)-----	1
LIGHT TACTICAL TRAILER: 3/4T (M1101)-----	13
TRAILER TANK WATER (CAMEL) 800 GAL 5 TON-----	1

MISCELLANEOUS EQUIPMENT

GEN SET: DED SKID MTD 5 KW 60HZ (MEP-802A)-----	1
GEN SET : DED SKID MTD 3KW 60HZ (MEP-831A)-----	12

COMMUNICATION-ELECTRONICS EQUIPMENT

ANTENNA GROUP: OE-254-----	26
COMPUTER SET DIGITAL: AN/PYQ-7 (CI&I OPS WS)-----	3
COMPUTER SYSTEM DIGITAL: AN/PYQ-3 (CHATS)-----	12
COMPUTER SET DIGITAL: AN/UYK-128 (FBCB2)-----	22
COMPUTER SET DIGITAL: AN/TYQ-109(V)1 (GCSS-A (V)1)-----	1
COMPUTER TACTICAL DIGITAL: AN/PYQ-8 (ITRT)-----	18
ENCRYPT/DECRYPT EQUIP: TAFLANE KG-175-----	1
NAVIGATION SET: SATELLITE SIGNALS AN/PSN-13 (DAGR)-----	35
PROCESSOR GROUP SIGNAL DATA: (CAISI 2.0)-----	1
RADIAC SET: AN/VDR-2-----	12
RADIO SET: AN/VRC-89F-----	1
RADIO SET: AN/VRC-90F-----	1
RADIO SET: AN/VRC-91F-----	18
RADIO SET: AN/VRC-92F-----	3
RADIO SET: AN/PRC-119F-----	18
RADIO SET: AN/PSC-5-----	12
RADIO SET: AN/VRC-104(V)3 150 WATT IK: PRC-150 HF RADIO---	7

NIGHT VISION/OBSERVATION EQUIPMENT

DRIVERS VISION ENHANCER: AN/VAS-5-----	19
NIGHT VISION GOGGLES: AN/PVS-7B-----	46
MEDIUM THERMAL WEAPONS SIGHT: AN/PAS-13(V2)-----	13
HEAVY THERMAL WEAPONS SIGHT: AN/PAS-13(V3)-----	2

HUMINT Company (BFSB)

34119R100
OFF: 3/WO: 4/ENL: 66/TOTAL: 73

COMPANY HEADQUARTERS PARA 01

AN/VRC-89F
FBCB2
DAGR



CPT 35E00 (COMMANDER) P
SP4 74D10 (CBRN SP) R

AN/VRC-90F
AN/TYQ-109(V)1
DAGR
CAISI 2.0



1SG 35Y5M (FIRST SGT) R
SGT 92Y20 (SUPPLY NCO) R
SP4 92Y10 (SUPPLY SP) R

HUMINT PLATOON HQ PARA 02

AN/VRC-92F
AN/VRC-104(V)3
FBCB2
DAGR
AN/PSC-5



LT 35D00 (PLT LDR) R
SFC 35M4L (PLT SGT) R
X2

OPERATIONAL MANAGEMENT TEAM PARA 03

AN/VRC-92F
AN/VRC-104(V)3
AN/PYQ-7
AN/PYQ-3
FBCB2
2 DAGR
AN/PSC-5



CW2 351M0 (HUMINT COLLECTION TECH) P&R
SSG 35M3L (HUMINT COLLECTION SGT) P&R
SP4 35M10 (HUMINT COLLECTOR) P&R
PFC 35M10 (HUMINT COLLECTOR) P&SAW
X4

HUMINT COLLECTION TEAM PARA 04

AN/VRC-91F
AN/PRC-119F
AN/VRC-104(V)3
AN/PYQ-3
FBCB2
AN/PYQ-8
2 DAGR
AN/PSC-5

AN/VRC-91F
AN/PRC-119F
FBCB2
AN/PYQ-8
DAGR



SSG 35M3L (HUMINT COLLECTION SGT) P&R
SGT 35M2L (HUMINT COLLECTOR) P&R
SP4 35M10 (HUMINT COLLECTOR) P&R
PFC 35M10 (HUMINT COLLECTOR) P&R
X12

Summary of Equipment

WEAPONS

LAUNCHER GRENADE: M320-----	4
MACHINE GUN 5.56MM M249-----	4
MACHINE GUN LIGHT 5.56MM M249-----	16
MACHINE GUN GRENADE 40MM MK-19 MOD III-----	1
PISTOL 9MM AUTOMATIC M9-----	65
RIFLE 5.56MM M16A2-----	68
MACHINE GUN: CALIBER .50 (M2E2)-----	1

VEHICLES, TRAILERS, AND TRLR MTD SYSTEMS

TRUCK UTILITY EXP CAP: ARMAMENT CARRIER M1151A1-----	24
TRUCK UTILITY EXP CAPACITY ENH 4X4: M1165A1-----	7
TRUCK CARGO: MTV (M1083)-----	1
LIGHT TACTICAL TRAILER: 3/4T (M1101)-----	18
TRAILER TANK WATER (CAMEL) 800 GAL 5 TON-----	1

MISCELLANEOUS EQUIPMENT

GEN SET: DED SKID MTD 10KW 60HZ (MEP-803A)-----	19
---	----

COMMUNICATION-ELECTRONICS EQUIPMENT

ANTENNA GROUP: OE-254-----	38
COMPUTER SET DIGITAL: AN/PYQ-7 (CI&I OPS WS)-----	4
COMPUTER SYSTEM DIGITAL: AN/PYQ-3 (CHATS)-----	16
COMPUTER SET DIGITAL: AN/UYK-128 (FBCB2)-----	31
COMPUTER SET DIGITAL: AN/TYQ-109(V)1 (GCSS-A (V)1)-----	1
COMPUTER TACTICAL DIGITAL: AN/PYQ-8 (ITRT)-----	24
NAVIGATION SET: SATELLITE SIGNALS AN/PSN-13 (DAGR)-----	48
PROCESSOR GROUP SIGNAL DATA: (CAISI 2.0)-----	1
RADIAC SET: AN/VDR-2-----	19
RADIO SET: AN/VRC-89F-----	1
RADIO SET: AN/VRC-90F-----	1
RADIO SET: AN/VRC-91F-----	24
RADIO SET: AN/VRC-92F-----	6
RADIO SET: AN/PRC-119F-----	24
RADIO SET: AN/PSC-5-----	18
RADIO SET: AN/VRC-104(V)3 150 WATT IK: PRC-150 HF RADIO---	6

NIGHT VISION/OBSERVATION EQUIPMENT

DRIVERS VISION ENHANCER: AN/VAS-5-----	27
NIGHT VISION GOGGLES: AN/PVS-7B-----	64
MEDIUM THERMAL WEAPONS SIGHT: AN/PAS-13(V2)-----	16
HEAVY THERMAL WEAPONS SIGHT: AN/PAS-13(V)3-----	2

HHT, Reconnaissance & Surveillance Squadron (BFSB)

17226R000
OFF: 19/WO: 0/ENL: 75/TOTAL: 94

COMMAND GROUP PARA 01

AN/VR-92F
AN/VR-104(V)3
AN/PRC-104A
FBCB2
AN/TYQ-137A:(V)2
DAGR
AN/PSC-5
AN/PRC-148(V) 4



LTC 02B00 (COMMANDER) P&C
PFC 19D10 (VEH DRIVER) C

MAJ 02B00 (EXEC OFF) C

AN/VR-90F
FBCB2
DAGR
AN/PSC-5



CSM 00Z5V (CSM) P&C
PFC 19D10 (VEH DRIVER) C

S1 SECTION PARA 02

AN/VR-92F
DAGR
CAISI 2.0
5 AN/TYQ-116(V)3



CPT 42B00 (S1) C
SFC 42A40 (SR HUMAN RES SGT) C
SSG 42A30 (HUMAN RES SGT) C
SGT 42A20 (HUMAN RES SGT) C
SP4 27D10 (PARALEGAL SP) C
SP4 42A10 (HUMAN RES SP) C
2 PFC 42A10 (HUMAN RES SP) C

S2 SECTION PARA 03

AN/VR-92F
AN/TYQ-93
FBCB2
DAGR



CPT 35D00 (S2) C
SP4 35F10 (INTEL ANALYST) C

AN/VR-92F
AN/VR-104(V)3
AN/TYQ-93
FBCB2
DAGR
AN/PSC-5



LT 35D00 (ASST S2) C
SFC 35F40 (SR INTEL SGT) C
SSG 35F30 (INTEL SGT) C
SGT 35F20 (INTEL ANALYST) C
SP4 35G10 (IMAGERY ANALYST) C
PFC 35F10 (INTEL ANALYST) C

S3 SECTION PARA 04

AN/VR-92F
FBCB2
DAGR
STE



MAJ 02B00 (S3) P&C
SP4 19D10 (OPNS SP) C

AN/VR-92F
AN/VR-104(V)3
FBCB2
AN/TYQ-137A:(V)2
AN/TSQ-243
FHMUX
DAGR
AN/PSC-5
AN/TSQ-259



CPT 19C00 (PLANS OFF) C
LT 74A00 (CHEM OFF) C
SGM 19Z50 (OPNS SGT) C
SFC 11B40 (ASST OPNS SGT) C
SSG 74D30 (CBRN NCO) C
SGT 19D20 (OPNS ASST) C
SP4 11B10 (OPNS ASST) C

AN/VR-90F
DAGR



X2

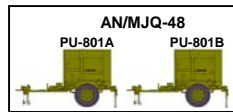

INSERT & EXTRACT SECTION PARA 05

AN/VR-90F
FBCB2
DAGR



CPT 11A00 (ASST S3) C
SP4 11B10 (VEH DRIVER) C

AN/VR-92F
AN/VR-104(V)3
FBCB2
DAGR
AN/PSC-5



SFC 11B4V (ASST OPNS SGT) C
SSG 11B3V (ASST OPNS SGT) C
SP4 11B10 (VEH DRIVER) C

FIRES CELL PARA 06

AN/VR-92F
AN/VR-119F
AN/VR-104(V)3
FBCB2
AN/GYK-48(V)1
2 DAGR



CPT 13A00 (FIRE SUPPORT OFF) C

2 AN/VR-92F
AN/VR-90F
AN/VR-104(V)3
AN/PSG-14(V)1 LFED
AN/GYK-57
FBCB2
FHMUX
DAGR
2 AN/PSC-5



SFC 13F40 (FIRE SUPPORT NCO) C
SSG 13F30 (FIRE SUPPORT SGT) C
SGT 13F20 (FIRE SUPPORT SGT) C
SP4 13F10 (FIRE SUPPORT SP) C

FIRE SUPPORT PLATOON PARA 07

2 AN/VR-92F
AN/PSG-14(V)1 LFED
FBCB2
2 DAGR
AN/PED-1 (LLDR)
AN/PSC-5
AN/PSG-10(V)



LT 13A00 (FIRE SPT OFF) C
SSG 13F30 (FIRE SPT SGT) C
SP4 13F10 (FIRE SPT SP) C

X2

DAGR
AN/PSG-10(V)

SSG 13F3V (FIRE SPT SGT) C
SGT 13F2V (FO) C

X3

S4 SECTION PARA 08

AN/VR-92F
FBCB2
DAGR



CPT 02B00 (S4) C
SFC 92Y40 (SR SUPPLY SGT) C
SGT 92Y20 (SUPPLY NCO) C
SP4 92Y10 (SUPPLY SP) C

AN/VR-92F
AN/VR-104(V)3
FBCB2
2 AN/TYQ-129(V)2
AN/TYQ-109(V)1
AN/TYQ-137A:(V)2
AN/TYQ-90(V)3
DAGR
CAISI 2.0
AN/PSC-5



HHT, R&S Sqdn, BFSB (cont)

TACAIR CONTROL PARTY PARA 09

AN/GYK-56

*CPT 01A00 (AF STAFF OFFICER)
SSG 00D30 (AF STAFF NCO)
(PERSONNEL PROVIDED BY USAF)*

UMT PARA 10

AN/VRC-90F
FBCB2
DAGR



CPT 56A00 (CHAPLAIN)
SGT 56M20 (CHAPLAIN ASST NCO) C

TROOP HEADQUARTERS PARA 11

AN/VRC-92F
FBCB2
DAGR
AN/PSC-5



CPT 02B00 (COMMANDER) P&C
PFC 19D10 (VEH DRIVER) C

AN/VRC-92F
FBCB2
DAGR



LT 02B00 (EXEC OFF) C

AN/VRC-90F
FBCB2
AN/TYQ-109(V)1
DAGR
CAISI 2.0



1SG 11Z5M (FIRST SERGEANT) C
SGT 92Y20 (SUPPLY NCO) C
SP4 92Y10 (SUPPLY SP) C

S6 SECTION PARA 12

AN/VRC-90F
FBCB2
DAGR



CPT 25A00 (S6) C

AN/VRC-90F
AN/PYQ-12
DAGR
AN/TSR-8 (GRT)
AN/GYK-50A (ISYSCON) (V)4
AN/GYK-62B



SFC 25U40 (SECTION CHIEF) C
SSG 25E30 (ELECTRO SPECTRUM NCO) C
SP4 25B10 (LAN MGR) C
SP4 25U10 (SIGNAL INFO SVC SP) C
SP4 25U10 (SGNL SPT SYS MAINT) C
SP4 25U10 (SGNL SPT SYS SP) C
PFC 25B10 (LAN MGR) C

AN/VRC-90F
DAGR



BCP (SWITCHING GP): OM-87A/T

PU-798

AN/VRC-90F
DAGR



SGT 25Q20 (SR XMSN SYS OPR-MAINT) C
SP4 25Q10 (XMSN SYS OPR-MAINT) C

MEDICAL TREATMENT PLATOON HQ PARA 13

AN/VRC-89F
AN/TYQ-107(V)1
AN/TYQ-106(V)1
FBCB2
AN/TYQ-105(V)1
DAGR
CAISI 2.0



LT 70B67 (FIELD MED ASST) C
SFC 68W40 (PLT SGT) C

MEDICAL TREATMENT TEAM PARA 14

AN/VRC-89F
AN/TYQ-106(V)1
FBCB2
4 AN/TYQ-105(V)1
DAGR
CAISI 2.0



CPT 65D00 (PHYSICIAN ASST) P
SSG 68W30 (HEALTH CARE SGT) C
SP4 68W10 (HEALTH CARE SP) C
PFC 68W10 (HEALTH CARE SP) C

AN/VRC-89F
FBCB2
DAGR

AMBULANCE SQUAD PARA 15

AN/VRC-90F
FBCB2
2 AN/TYQ-105(V)1
DAGR



SGT 68W20 (EMERGENCY CARE SGT) C
2 SP4 68W10 (AMB AIDE/DRIVER) C
PFC 68W10 (AMB AIDE/DRIVER) C

AN/VRC-90F
FBCB2
2 AN/TYQ-105(V)1
DAGR



COMBAT MEDIC SECTION PARA 16

AN/TYQ-106(V)1
10 AN/TYQ-105(V)1

SSG 68W3P (SECTION NCO) P
4 SP4 68W10 (COMBAT MEDIC) P
5 SP4 68W1P (COMBAT MEDIC) P

Summary of Equipment

WEAPONS

LAUNCHER GRENADE: M320A1-----	7
MACHINE GUN LIGHT 5.56MM M249-----	4
MACHINE GUN 7.62MM M240B-----	1
PISTOL 9MM AUTOMATIC M9-----	15
RIFLE 5.56MM M4 CARBINE-----	82
MACHINE GUN: CALIBER .50 (M2E2)-----	5

VEHICLES, TRAILERS, AND TRLR MTD SYSTEMS

GEN SET DED TM: 10KW 60HZ (PU-798)-----	1
ARMORED KNIGHT (M1200)-----	2
POWER PLANT: UTILITY, MEDIUM 20KW 5 TON ECU-----	2
POWER PLANT: ELECTRIC TLR MTD AN/MJQ-48-----	2
TRUCK UTILITY EXP CAPACITY: ARMAMENT CARRIER M1151-----	4
TRUCK UTILITY EXP CAPACITY ENH 4X4: M1152A1-----	13
TRUCK AMBULANCE: 4 LITTER HMMWV (M997)-----	2
TRUCK UTILITY EXP CAPACITY ENH 4X4: M1165A1-----	4
TRUCK CARGO: MTV (M1083)-----	2
TRUCK CARGO: 4X4 LMTV (M1078)-----	3
TRAILER HIGH MOBILITY 1-1/4T (M1101)-----	1
LIGHT TACTICAL TRAILER: 3/4T (M1102)-----	9
TRAILER CARGO: LMTV W/DROPSIDES (M1082)-----	1
TRAILER TANK WATER (CAMEL) 800 GAL 5 TON-----	1

MISCELLANEOUS EQUIPMENT

GEN SET : DED SKID MTD 3KW 60HZ (MEP-831A)-----	4
SHELTER: NONEXPANDABLE S250-----	3

NIGHT VISION/OBSERVATION EQUIPMENT

DRIVERS VISION ENHANCER AN/VAS-5-----	30
MINI EYESAFE LASER INFRARED OBSN DVC: (MELIOS) AN/PVS-6-----	5
MONOCULAR NIGHT VISION DEVICE (MNVD) AN/PVS-14-----	4
NIGHT VISION DEVICE: AN/PSQ-20 (ENVG)-----	6
NIGHT VISION GOGGLES: AN/PVS-7B-----	68
RANGE FINDER-TGT DESIGNATOR: LASER AN/PED-1 (LLDR)-----	2
MEDIUM THERMAL WEAPONS SIGHT: AN/PAS-13(V2)-----	6
HEAVY THERMAL WEAPONS SIGHT: AN/PAS-13(V3)-----	5

COMMUNICATION-ELECTRONICS EQUIPMENT

ALL SOURCE ANALYSIS SYSTEM: AN/TYQ-93 (ASAS-LT)-----	2
ANTENNA GROUP: OE-254-----	27
COMPUTER SYSTEM DIGITAL: AN/PSG-14(V)1 LFED-----	3
COMPUTER SET: AN/GYK-57 (AFATDS - SINGLE)-----	1
COMPUTER SYSTEM DIGITAL: AN/TYQ-107(V)1 (MC4-3A)-----	1
COMPUTER SYSTEM DIGITAL: AN/TYQ-106(V)1-----	3
COMPUTER SET DIGITAL: AN/UYSK-128 (FBCB2)-----	24
COMPUTER SET DIGITAL: AN/PYQ-12 (MCS GATEWAY SVR)-----	1
COMPUTER SYS DIGITAL: AN/TYQ-129(V)2 (TC-AIMS II WS)-----	2
COMPUTER SYSTEM DIGITAL: AN/TYQ-105(V)1 (MC4-1)-----	19
COMPUTER SET DIGITAL: AN/TYQ-109(V)1 (GCSS-A (V)1)-----	2
COMPUTER SYSTEM DIGITAL: ((CPOF WS) AN/TYQ-137A:(V)2)-----	3
COMMAND CENTER SYSTEM: AN/TSQ-243-----	1
COMPUTER SYSTEM DIGITAL: AN/UYSQ-90(V)3 (MTS-CS)-----	1
COMPUTER SET FA GENERAL: AN/GYK-48(V)1 (FSCoord)-----	1
FREQUENCY HOPPING MULTIPLEXER: TF-1456VRC (FHMUX)-----	2
NAVIGATION SET: SATELLITE SIGNALS AN/PSN-13 (DAGR)-----	36
PROCESSOR GROUP SIGNAL DATA: (CAISI 2.0)-----	5
RADIAC SET: AN/VDR-2-----	12
GROUND RECEIVER TERMINAL: AN/TRS-8 (GRT)-----	1
RADIO SET: AN/VRC-89F-----	3
RADIO SET: AN/VRC-90F-----	13
RADIO SET: AN/VRC-92F-----	18
RADIO SET: AN/VRC-104(V)3 150 WATT W/PRC-150 HF RADIO-----	7
RADIO SET: AN/PSC-5-----	11
RADIO SET: AN/PRC-104A-----	1
RADIO SET: AN/PRC-119F-----	1
COMPUTER SYSTEM DIGITAL: AN/PSG-10V (PFED)-----	5
COMPUTER SET FA GENERAL: AN/GYK-56 (EMT)-----	1
COMPUTER SYSTEM DIGITAL: AN/GYK-50A (ISYSCON) (V4)-----	1
BATTALION COMMAND POST (SWITCHING GROUP): OM-87A/T-----	1
COMMUNICATIONS SUBSYSTEM: AN/TSQ-259-----	1
COMPUTER SET: DIGITAL AN/GYK-62B (BFT TOC KIT)-----	1
RADIO SET, AN/PRC-148(V)4 URBAN JEM-----	1
COMPUTER SYSTEM DIGITAL: AN/TYQ-116(V)3 (AHRS)-----	5

HHT, Reconnaissance & Surveillance Squadron, BFSB

Recon Troop, R&S Sqdn, BFSB

17227R000
OFF: 4/WO: 0/ENL: 42/TOTAL: 46

TROOP HEADQUARTERS PARA 01

AN/VRC-92F
AN/VRC-104(V)3
AN/PRC-148(V)4
FBCB2
DAGR
AN/PSC-5
LRAS3



CPT 19C00 (COMMANDER) P&C
SP4 19D10 (SCOUT DRIVER) C

2 AN/VRC-92F
AN/VRC-104(V)3
FBCB2
DAGR
AN/PSC-5



LT 19C00 (EXEC OFF) C
SSG 19D30 (OPNS NCO) C
SGT 25U20 (FWD SGNL SPT NCO) C
SGT 74D20 (CBRN NCO) C

AN/VRC-92F
FBCB2
DAGR



1SG 19Z5M (FIRST SERGEANT) C
PFC 19D10 (VEH DRIVER) C

AN/VRC-90F
AN/TYQ-109(V)1
FBCB2
DAGR
CAISI 2.0



SGT 92Y20 (SUPPLY NCO) C
SP4 92Y10 (SUPPLY SP) C

SCOUT PLATOON PARA 02

AN/VRC-92F
AN/VRC-104(V)3
AN/PRC-148(V)4
FBCB2
2 DAGR
AN/PSC-5
LRAS3



LT 19C00 (PLT LDR) C
SP4 19D10 (SCOUT) C
PFC 19D10 (SCOUT DRIVER) C

AN/VRC-92F
AN/VRC-104(V)3
AN/PRC-148(V)4
FBCB2
2 DAGR
AN/PSC-5
LRAS3



SFC 19D40 (PLT SGT) C
SP4 19D10 (SCOUT) C
PFC 19D10 (SCOUT DRIVER) C

AN/VRC-92F
AN/PRC-148(V)4
FBCB2
2 DAGR
LRAS3



SSG 19D30 (SECTION LDR) C
SP4 19D10 (SCOUT) C
PFC 19D10 (SCOUT DRIVER) C

AN/VRC-91F
FBCB2
DAGR
LRAS3



SGT 19D20 (TEAM LDR) C
SP4 19D10 (SCOUT) C
PFC 19D10 (SCOUT DRIVER) C

AN/VRC-92F
AN/PRC-148(V)4
FBCB2
2 DAGR
LRAS3



SSG 19D30 (SECTION LDR) C
SP4 19D10 (SCOUT) C
PFC 19D10 (SCOUT DRIVER) C

AN/VRC-91F
FBCB2
DAGR
LRAS3



SGT 19D20 (TEAM LDR) C
SP4 19D10 (SCOUT) C
PFC 19D10 (SCOUT DRIVER) C

X2

Summary of Equipment

WEAPONS

COMMAND AND LAUNCH UNIT (JAVELIN)-----	6
LAUNCHER GRENADE: M320A1-----	16
MACHINE GUN GRENADE 40MM MK-19 MOD III-----	6
MACHINE GUN 7.62MM M240B-----	8
PISTOL 9MM AUTOMATIC M9-----	1
RIFLE 5.56MM M4 CARBINE-----	46
SHOTGUN: 12 GAUGE (MASS) XM26-----	12
MACHINE GUN: CALIBER .50 (M2E2)-----	8

VEHICLES, TRAILERS, AND TRLR MTD SYSTEMS

TRUCK UTILITY EXP CAPACITY: ARMAMENT CARRIER M1151---	13
TRUCK CARGO: MTV (M1083)-----	1
TRUCK UTILITY EXP CAPACITY ENH 4X4: M1152A1-----	2
LIGHT TACTICAL TRAILER: 3/4T (M1102)-----	1
TRAILER TANK WATER (CAMEL) 800 GAL 5 TON-----	1

MISCELLANEOUS EQUIPMENT

GEN SET: DED SKID MTD 5 KW 60HZ (MEP-802A)-----	1
SHELTER: NONEXPANDABLE S250-----	1
SAW CHAIN: GAS DRVN BAR FRAME-----	6

COMMUNICATION-ELECTRONICS EQUIPMENT

ANTENNA GROUP: OE-254-----	4
COMPUTER SET DIGITAL: AN/UYK-128 (FBCB2)-----	16
COMPUTER SET DIGITAL: AN/TYQ-109(V)1 (GCSS-A (V)1)-----	1
NAVIGATION SET: SATELLITE SIGNALS AN/PSN-13 (DAGR)-----	24
PROCESSOR GROUP SIGNAL DATA: (CAISI 2.0)-----	1
RADIAC SET: AN/VDR-2-----	13
RADIO SET: AN/VRC-90F-----	1
RADIO SET: AN/VRC-91F-----	4
RADIO SET: AN/VRC-92F-----	12
RADIO SET: AN/PSC-5-----	6
RADIO SET: AN/VRC-104(V)3 150 WATT W/PRC-150 HF RADIO---	6
RADIO SET, AN/PRC-148(V)4 URBAN JEM-----	9

NIGHT VISION/OBSERVATION EQUIPMENT

DRIVERS VISION ENHANCER: AN/VAS-5-----	16
MINI EYESAFE LASER IR OBS SET: AN/PVS-6 (MELIOS)-----	13
MONOCULAR NIGHT VISION DEVICE: AN/PVS-14-----	12
NIGHT VISION GOGGLES: AN/PVS-7B-----	8
NIGHT VISION DEVICE: AN/PSQ-20 (BNVG)-----	27
SURVEILLANCE SYS: SCOUT LONG RANGE AN/TAS-8 (LRAS3)-----	13
LIGHT THERMAL WEAPONS SIGHT: AN/PAS-13(B1)-----	4
MEDIUM THERMAL WEAPONS SIGHT: AN/PAS-13(V2)-----	26
HEAVY THERMAL WEAPONS SIGHT: AN/PAS-13(V3)-----	26

LRS Company, R&S Sqdn, BFSB

07228R000
OFF: 6/WO: 0/ENL: 133/TOTAL: 139

COMPANY HEADQUARTERS PARA 01

AN/VR-92F
AN/VR-104(V)3
FBCB2
DAGR
AN/PSC-5



CPT 11A00 (COMMANDER) P&C
SP4 11B1P (OPNS ASST) C

AN/VR-92F
FBCB2
DAGR



LT 11A00 (EXEC OFF) C
1SG 11Z5V (FIRST SERGEANT) C
SFC 11B4V (OPNS SGT) C
SGT 25U2V (FWD SGNL SPT NCO) C
SGT 74D2P (CBRN NCO) C

AN/VR-90F
FBCB2
AN/TYQ-109(V)1
DAGR
CAISI 2.0



SSG 92Y3P (SUPPLY SGT) C
SP4 92Y1P (SUPPLY SP) C

COMMO PLATOON HQ PARA 02

AN/VR-92F
FBCB2
DAGR



LT 25A00 (PLT LDR) C
SFC 25U4P (PLT SGT) C
SGT 25C2V (SR RADIO OPR-MAINT) C

AN/VR-90F
FBCB2
DAGR



AN/MJQ-35

BASE RADIO STATION PARA 03

AN/VR-90F
3 AN/VR-104(V)3
FBCB2
AN/TSC-128
DAGR
AN/PSC-5



SSG 25C3V (RADIO SECTION CHIEF) C
SGT 25C2V (SR RADIO OPR-MAINT) C
2 SP4 25C1P (RADIO OPR-MAINT) C
2 PFC 25C1P (RADIO OPR-MAINT) C

X4

TARGET INTERDICTION TEAM PARA 04

AN/PRC-148(V)4
DAGR
AN/PSC-5

SGT 11B2V (SR SNIPER) P
SP4 11B1P (SNIPER) C

X2

TRANSPORTATION SECTION PARA 05

AN/VR-90F
FBCB2
DAGR



X3

SSG 88M3P (SECTION SGT) C
2 SP4 88M1P (VEH DRIVER) C
3 PFC 88M1P (VEH DRIVER) C

LRS PLATOON HQ PARA 06 & 09

AN/VR-92F
AN/VR-104(V)3
FBCB2
DAGR
AN/PSC-5
AN/PRC-148(V)4



LT 11A00 (PLT LDR) P&C
SFC 11B4V (PLT SGT) P&C

X3

SURVEILLANCE TEAM PARA 07, 08, 10, 11, AND 12

FBCB2
DAGR
AN/PRQ-7
AN/PRC-104A
AN/PSC-5
2 AN/PRC-148(V)4



X15

12 SSG 11B3V (TEAM LEADER) P&C
15 SGT 11B2V (ASST TEAM LEADER) P&C
48 SP4 11B1P (SCOUT) C
15 PFC 11B1P (RATELO) C

Summary of Equipment

WEAPONS

LAUNCHER GRENADE: M320A1-----	26
MACHINE GUN LIGHT 5.56MM M249-----	21
MACHINE GUN 7.62MM M240B-----	20
PISTOL 9MM AUTOMATIC M9-----	36
RIFLE SNIPER .50CAL M107-----	2
RIFLE SNIPER 7.62MM: M110-----	2
RIFLE 5.56MM M4 CARBINE-----	137
MACHINE GUN: CALIBER .50 (M2E2)-----	7

VEHICLES, TRAILERS, AND TRLR MTD SYSTEMS

POWERPLANT ELEC DED TM: 5KW 60HZ AC AN/MJQ-35-----	9
TRUCK UTILITY EXP CAPACITY ENH 4X4: M1152A1-----	24
TRUCK CARGO: 4X4 LMTV LAPES/AD (M1081)-----	3
TRUCK CARGO: 5T 6X6 MTV LAPES/AD (M1093)-----	1
TRUCK UTILITY EXP CAPACITY ENH 4X4: M1165A1-----	6
LIGHT TACTICAL TRAILER: 3/4T (M1101)-----	2
TRAILER CARGO: LMTV W/DROPSIDES (M1082)-----	3
TRAILER TANK WATER (CAMEL) 800 GAL 5 TON-----	1

MISCELLANEOUS EQUIPMENT

BOAT LANDING CRAFT INFLATABLE: 7 PERSON-----	15
GEN SET: DED SKID MTD 5 KW 60HZ (MEP-802A)-----	1
MUNITION: NETWORK COMMAND (SPIDER)-----	1
SMALL UNMANNED AIRCRAFT SYSTEM: (SUAS) RAVEN B-----	4

COMMUNICATION-ELECTRONICS EQUIPMENT

ANTENNA GROUP: OE-254-----	13
COMPUTER SET DIGITAL: AN/UYK-128 (FBCB2)-----	34
COMPUTER SET DIGITAL: AN/TYQ-109(V)1 (GCSS-A (V)1)-----	1
CENTRAL COMMUNICATIONS (LRSUBRS): AN/TSC-128-----	8
NAVIGATION SET: SATELLITE SIGNALS AN/PSN-13 (DAGR)-----	36
PROCESSOR GROUP SIGNAL DATA: (CAISI 2.0)-----	1
RADIAC SET: AN/VDR-2-----	33
RADIO SET: AN/PRQ-7-----	15
RADIO SET: AN/VRC-90F-----	13
RADIO SET: AN/VRC-92F-----	6
RADIO SET: AN/PRC-104A-----	15
RADIO SET: AN/PSC-5-----	29
RADIO SET: AN/VRC-104(V)3 150 WATT W/PRC-150 HF RADIO-----	24
RADIO SET, AN/PRC-148(V)4 URBAN JEM-----	35

NIGHT VISION/OBSERVATION EQUIPMENT

DRIVERS VISION ENHANCER: AN/VAS-5-----	34
MINI EYESAFE LASER IR OBS SET: AN/PVS-6 (MELIOS)-----	17
MONOCULAR NIGHT VISION DEVICE: AN/PVS-14-----	5
NIGHT VISION GOGGLES: AN/PVS-7B-----	45
NIGHT VISION DEVICE: AN/PSQ-20 (ENVG)-----	97
SPOTTING INSTRUMENT: OPTICAL-----	2
SIGHT NIGHT VISION (SNS): AN/PVS-29-----	2
SIGHT THERMAL: AN/PAS-13B(V)1 LIGHT TWS-----	90
SIGHT THERMAL: AN/PAS-13B(V)2 MEDIUM TWS-----	41
SIGHT THERMAL: AN/PAS-13B(V)3 HEAVY TWS-----	24

LRS Company, R&S Sqdn, BFSB

Brigade Signal Company (FIB/BFSB)

11307R500
OFF: 4/WO: 0/ENL: 31/TOTAL: 35

COMPANY HEADQUARTERS PARA 01

AN/VRC-92F
AN/VRC-104(V)3
FBCB2
DAGR



CPT 25A00 (COMMANDER) P&C

AN/VRC-90F
FBCB2



LT 25A00 (EXEC OFF) C
1SG 25W5M (FIRST SGT) C
SGT 92Y2O (SUPPLY NCO) R
SP4 92Y1O (SUPPLY SP) R

RANGE EXTENSION PLATOON HQ PARA 02

AN/VRC-90F
AN/VRC-104(V)3
FBCB2
DAGR

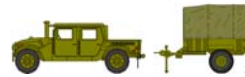

LT 25A00 (PLT LDR) C
SFC 25U4O (PLT SGT) C

SMALL COMMAND POST SUPPORT TEAM PARA 03

AN/VRC-89F
FBCB2
DAGR

AN/VRC-90F
DAGR

BCP (SWITCHING GP): OM-87A/T



SGT 25Q2O (SR XMSN SYS OPR-MAINT) R
SP4 25B1O (LAN MGR) R
SP4 25Q1O (XMSN SYS OPR-MAINT) R
PFC 25B1O (LAN MGR) R

RETRANSMISSION TEAM PARA 04

2 AN/VRC-92F
FBCB2
DAGR



SGT 25U2O (TEAM CHIEF) R
SP4 25U1O (RADIO RETRANS OPR) SAW
PFC 25U1O (RADIO RETRANS OPR) R

X3

NETWORK EXTENSION PLT HQ PARA 05

AN/VRC-90F
AN/VRC-104(V)3
FBCB2
DAGR



LT 25A00 (PLT LDR) C
SFC 25W4O (PLT SGT) C

JOINT NETWORK NODE/SMART-T TEAM PARA 06

AN/VRC-90F
AN/VRC-104(V)3
FBCB2
DAGR
AN/TYQ-122
TSEC/KG94A
OA-9511A/TYQ
AEHF COMMS PLAN ELEMENT
KSV-3

AN/VRC-90F
DAGR

AN/VRC-90F
DAGR

AN/VRC-90F
AN/VRC-104(V)3
DAGR

AN/TTC-59 (JNN)

AN/TSC-154



SGT 25N2O (SR NODAL NET SYS OPR-MAINT) R
SGT 25S2O (SR SAT COM SYS OPR-MAINT) R
SP4 25N1O (NODAL NET SYS OPR-MAINT) R



SP4 25S1O (SATCOM SYS OPR-MAINT) R
PFC 25N1O (NODAL NET SYS OPR-MAINT) R
PFC 25S1O (SATCOM SYS OPR-MAINT) R



SP4 25Q1O (RANGE EXT OPR) R

LOS V3 TEAM PARA 07

AN/VRC-90F
FBCB2
DAGR

AN/VRC-90F

AN/TRC-190C(V)3

AN/TRC-190C(V)1



SGT 25Q2O (SR XMSN SYS OPR-MAINT) R
SP4 25Q1O (XMSN SYS OPR-MAINT) R
PFC 25Q1O (XMSN SYS OPR-MAINT) R



X2

Brigade Signal Company (FIB/BFSB) (cont)

RETRANSMISSION TEAM PARA 08

2 AN/VRC-92F
FBCB2
DAGR



SGT 25U20 (TEAM CHIEF) R
SP4 25U10 (RADIO RETRANS OPR) SAW
PFC 25U10 (RADIO RETRANS OPR) R

Summary of Equipment

WEAPONS

LAUNCHER GRENADE: M320A1-----	8
MACHINE GUN 5.56MM M249-----	4
MACHINE GUN LIGHT 5.56MM M249-----	10
MACHINE GUN GRENADE 40MM MK-19 MOD III-----	2
PISTOL 9MM AUTOMATIC M9-----	1
RIFLE 5.56MM M16A2-----	24
RIFLE 5.56MM M4 CARBINE-----	7

VEHICLES, TRAILERS, AND TRLR MTD SYSTEMS

GEN SET DED TM: 10KW 60HZ (PU-798)-----	2
GEN SET DED TM: 5KW 60HZ (PU-797)-----	3
TRUCK UTILITY EXP CAPACITY ENH 4X4: M1152A1-----	9
TRUCK UTILITY EXP CAPACITY ENH 4X4: M1165A1-----	9
TRUCK CARGO: MTV (M1083)-----	1
TRAILER HIGH MOBILITY 1-1/4T (M1102)-----	1
LIGHT TACTICAL TRAILER: 3/4T (M1101)-----	7
TRAILER TANK WATER (CAMEL) 800 GAL 5 TON-----	1

MISCELLANEOUS EQUIPMENT

GEN SET : DED SKID MTD 3KW 60HZ (MEP-831A)-----	5
---	---

NIGHT VISION/OBSERVATION EQUIPMENT

NIGHT VISION GOGGLES: AN/PVS-7B-----	52
SIGHT THERMAL: AN/PAS-13B(V)2 MEDIUM TWS-----	10
SIGHT THERMAL: AN/PAS-13B(V)3 HEAVY TWS-----	2

COMMUNICATION-ELECTRONICS EQUIPMENT

ANTENNA GROUP: OE-254-----	15
COMPUTER SET DIGITAL: AN/UUK-128 (FBCB2)-----	11
NET CONTROL STATION: AN/TSQ-158-----	1
NAVIGATION SET: SATELLITE SIGNALS AN/PSN-13 (DAGR)-----	15
PROCESSOR GROUP SIGNAL DATA: (CAISI 2.0)-----	1
RADIAC SET: AN/VDR-2-----	9
RADIO SET: AN/VRC-89F-----	1
RADIO SET: AN/VRC-90F-----	11
RADIO SET: AN/VRC-92F-----	9
RADIO SET: AN/VRC-104(V)3 150 WATT IK: PRC-150 HF RADIO--	4
RADIO TERMINAL: LOS MULTI-CHANNEL AN/TRC-190C(V)1-----	2
RADIO TERMINAL: LOS MULTI-CHANNEL AN/TRC-190C(V)3-----	1
RADIO TERMINAL SET: AN/GRC-229-----	2
SWITCHING GROUP: DIGITAL DATA OA-9511/TYQ-----	1
TACTICAL ELECTRONIC KEY GENERATOR: TSEC/KG94A-----	1
TELECONFERENCE SYSTEM: AN/TYQ-122-----	1
TERMINAL: SATELLITE COMMUNICATIONS AN/TSC-154-----	1
JOINT NODE NETWORK (JNN) CEN OFC TEL AUTO: AN/TTC-----	1
BATTALION COMMAND POST (SWITCHING GROUP): OM-87A/T---	1
ABHF COMMUNICATIONS PLANNING ELEMENT:-----	1
TRANSEC MODULE: KSV-3-----	1

Support Company (BFSB)

TOE 63367R100
OFF: 5/WO: 3/ENL: 167/TOTAL: 175

COMPANY HQ PARA 01

AN/VRC-92F
AN/VRC-104(V)3
AN/UYQ-90(V)2
FBCB2
DAGR

AN/VRC-89F
FBCB2
DAGR

AN/VRC-90F
FBCB2
AN/GYK-61 (BCS3)
AN/TYQ-109(V)1
AN/UYQ-90(V)3
DAGR
CAISI 2.0



MAJ 90A00 (COMMANDER) P
SP4 74D10 (CBRN SP) SAW



LT 88A00 (EXEC OFF) R
PFC 92Y10 (SUPPLY SP) R



1SG 91Z5M (FIRST SGT) R
SSG 92Y30 (SUPPLY SGT) R
SP4 92Y10 (SUPPLY SP) R

FIELD FEEDING SECTION PARA 02

AN/VRC-90F
DAGR

AN/VRC-90F
FBCB2
DAGR

AN/VRC-90F



X4



X2



X2



AK



X2

SFC 92G40 (FOOD OPNS MGMT SGT) R
2 SSG 92G30 (FOOD OPNS MGR) R
5 SGT 92G20 (FOOD OPNS NCO) R

7 SP4 92G10 (FOOD OPNS SP) R
2 PFC 92G10 (FOOD OPNS SP) R
4 PFC 92G10 (FOOD OPNS SP) SAW

DISTRIBUTION PLATOON HQ PARA 03

AN/VRC-92F
AN/UYQ-90(V)2
FBCB2
AN/GYK-61 (BCS3)
AN/TYQ-129(V)2
AN/UYQ-90(V)3
DAGR



LT 92A00 (PLT LDR) R
SFC 88M40 (PLT SGT) R
SGT 88M20 (DISPATCHER) R
SP4 92A10 (MAT STORE/HDLG SP) R

DISTRIBUTION SECTION PARA 04

AN/VRC-90F
AN/UYQ-90(V)2
FBCB2
DAGR

AN/VRC-90F
AN/UYQ-90(V)2

AN/VRC-90F

AN/VRC-90F
AN/UYQ-90(V)2

AN/VRC-90F
AN/UYQ-90(V)2
DAGR



X2



X2



SSG 92F30 (SECTION CHIEF) R
PFC 92F10 (PETRL LT VEH OPR) R



X3



X2



X9

2 SGT 92F20 (PETRL HVY VEH OPR) R
5 SP4 92F10 (PETRL HVY VEH OPR) R
SP4 92F10 (PETRL HVY VEH OPR) SAW

SSG 92F30 (SECTION CHIEF) R
SGT 88M20 (HVY VEH DRIVER) R
3 SP4 88M10 (HVY VEH DRIVER) R
2 PFC 88M10 (HVY VEH DRIVER) R

WATER SECTION PARA 05

AN/VRC-90F
DAGR

AN/VRC-90F
DAGR

AN/VRC-90F

AN/VRC-90F
AN/UYQ-90(V)2



LWP



LWP



LWP

X2



X2

SSG 92W30 (WATER TRMT SUPV) R

4 SGT 92W20 (WATER TRMT NCO) R
4 SP4 92W10 (WATER TRMT SP) R
3 PFC 92W10 (WATER TRMT SP) R
PFC 92W10 (WATER TRMT SP) SAW

Support Company (BFSB) (cont)

MULTI-CLASS SSA PARA 06

AN/VRC-90F
AN/UYQ-90(V)2
FBCB2
5 OL-604/TYQ
OL-603/TYQ
AN/UYQ-90(V)3
DAGR
OL-713(V)1/TYQ CSS VSAT



CW2 920B0 (SUPPLY SYS TECH) R

AN/VRC-90F
AN/UYQ-90(V)2
FBCB2
DAGR



SSG 92A30 (MAT CON/ACCTG SUPV) R
SGT 88M20 (HVY VEH DRIVER) R
3 SGT 92A20 (MAT STORE/HDLG SGT) R
2 SP4 88M10 (HVY VEH DRIVER) R
2 SP4 92A10 (MAT STORE/HDLG SP) R
2 SP4 92A10 (MAT STORE/HDLG SP) SAW
PFC 88M10 (HVY VEH DRIVER) R
4 PFC 92A10 (MAT STORE/HDLG SP) R

AN/VRC-90F
AN/UYQ-90(V)2
FBCB2
DAGR



X2

AN/VRC-90F
AN/UYQ-90(V)2



AN/VRC-90F
AN/UYQ-90(V)2
FBCB2
DAGR



MAINTENANCE PLATOON HQ PARA 07

AN/VRC-92F
AN/UYQ-90(V)2
FBCB2
AN/UYQ-90(V)3
DAGR



LT 91A00 (PLT LDR) R
SFC 91X40 (PLT SGT) R

MAINTENANCE CONTROL SECTION PARA 08

AN/VRC-92F
FBCB2
DAGR



LT 91A00 (MAINT CONTROL OFF) R

AN/VRC-89F
DAGR
CAISI 2.0
3 AN/TYQ-139
AN/TYQ-140



SFC 91X40 (MAINT CONTROL SGT) R
SGT 92A20 (EQ RCD/PARTS SGT) R
SP4 92A10 (EQ RCD/PARTS SP) R
SP4 92A10 (EQ RCD/PARTS SP) SAW
2 PFC 92A10 (EQ RCD/PARTS SP) R

AN/VRC-90F
FBCB2
DAGR



AN/VRC-90F
DAGR



FIELD MAINTENANCE SECTION PARA 09

AN/VRC-90F
FBCB2
DAGR



CW2 915A0 (AUTO MAINT WO) R

AN/VRC-90F
FBCB2
DAGR



SFC 91X40 (MOTOR SGT) R
SSG 91B30 (SHOP FOREMAN) R
SSG 91B30 (SR MECHANIC) R
SSG 91D30 (SR PWR-GEN EQ REP) R
5 SGT 91B20 (WH VEH MECH) R
SGT 91C20 (UTIL EQ REP) R
SGT 91D20 (PWR-GEN EQ REP) R
SGT 91J20 (QM/CHEM EQ REP) R



AN/VRC-90F
DAGR



SGT 94E20 (SR COMSEC/RADIO REP) R
SGT 94F20 (COMP/DET SYS REP) R
6 SP4 91B10 (WH VEH MECH) R
2 SP4 91D10 (PWR-GEN EQ REP) R
SP4 91F10 (SM ARMS/ARTY REP) R

AN/VRC-90F
FBCB2
DAGR



SP4 94E10 (COMSEC/RADIO EQ REP) R
SP4 94F10 (COMP/DET SYS REP) R
4 PFC 91B10 (WH VEH MECH) R
3 PFC 91B10 (WH VEH MECH) SAW
PFC 91C10 (UTIL EQ REP) R
2 PFC 91D10 (PWR-GEN EQ REP) R
PFC 91J10 (QM/CHEM EQ REP) R

AN/VRC-90F
FBCB2
DAGR AN/ASM-146



PU 2101

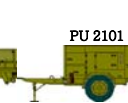

X2

AN/VRC-90F
DAGR



AN/VRC-90F
AN/UYQ-90(V)2
DAGR



AN/ASM-147

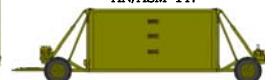

X2

Support Company (BFSB) (cont)

SERVICE/RECOVERY SECTION PARA 10

AN/VRC-90F
AN/UYQ-90(V)2
FBCB2
DAGR



SSG 91B30 (RCVY VEH SUPV) R
PFC 91B10 (RCVY VEH OPR) R

AN/VRC-90F
AN/UYQ-90(V)2
FBCB2
DAGR



X2
SGT 91B20 (RCVY VEH OPR) R
SP4 91B10 (RCVY VEH OPR) R

AN/VRC-90F



CW2 914A0 (ALLIED TRADES WO) R
SGT 91E20 (ADDIED TRADES SP) R
2 PFC 91E10 (ADDIED TRADES SP) R

AN/VRC-90F
FBCB2
DAGR



FIELD MAINTENANCE TEAM (MI) PARA 11

AN/VRC-90F
FBCB2
DAGR



SFC 91X40 (MOTOR SGT) R

AN/VRC-90F
FBCB2
DAGR



SSG 91B30 (SR MECHANIC) R
3 SGT 91B20 (WHL VEH MECH) R
SGT 91D20 (PWR-GEN EQ REP) R
SGT 92A20 (EQ RCD/PARTS SGT) R
SP4 91C10 (UTIL EQ REP) R
2 SP4 91B10 (WH VEH MECH) R

AN/VRC-90F
AN/UYQ-90(V)2
FBCB2
DAGR

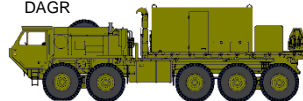

2 SP4 91B10 (WH VEH MECH) SAW
SP4 91D10 (PWR-GEN EQ REP) R
SP4 91F10 (SM ARMS/ARTY REP) R
SP4 92A10 (EQ RCD/PARTS SP) R
4 PFC 91B10 (WH VEH MECH) R
PFC 91D10 (PWR-GEN EQ REP) R

AN/VRC-90F
FBCB2
DAGR



AN/VRC-90F
FBCB2
DAGR
CAISI 2.0
6 AN/TYQ-139



AN/VRC-90F
AN/UYQ-90(V)2
FBCB2
DAGR



SGT 91B20 (RCVY VEH OPR) R

AN/VRC-90F
AN/UYQ-90(V)2
FBCB2
DAGR



SP4 91B10 (RCVY VEH OPR) R

AN/VRC-90F
FBCB2
DAGR



X2

FIELD MAINTENANCE TEAM (R&S) PARA 12

AN/VRC-90F
FBCB2
DAGR



SFC 91X40 (MOTOR SGT) R

AN/VRC-90F
AN/UYQ-90(V)2
FBCB2
DAGR



AN/VRC-90F
AN/UYQ-90(V)2
FBCB2
DAGR



SSG 91B30 (SR MECHANIC) R
3 SGT 91B20 (WHL VEH MECH) R
SGT 91D20 (PWR-GEN EQ REP) R
SGT 91F20 (SM ARMS/ARTY REP) R
SGT 92A20 (EQ RCD/PARTS SP) R
2 SP4 91B10 (WH VEH MECH) R
SP4 91B10 (WH VEH MECH) SAW

AN/VRC-90F
DAGR
CAISI 2.0
OL-713(V)1/TYQ CSS VSAT
6 AN/TYQ-139



SP4 91C10 (UTIL EQ REP) R
SP4 91L10 (CONST EQ REP) R
SP4 92A10 (EQ RCD/PARTS SP) R
4 PFC 91B10 (WH VEH MECH) R
PFC 91D10 (PWR-GEN EQ REP) R
PFC 91F10 (SM ARMS/ARTY REP) R

AN/VRC-90F
DAGR



AN/VRC-90F
DAGR



AN/VRC-90F



AN/VRC-90F
AN/UYQ-90(V)2
FBCB2
DAGR



SP4 91B10 (RCVY VEH OPR) R

Summary of Equipment

WEAPONS

LAUNCHER GRENADE: M320-----	4
MACHINE GUN 5.56MM M249-----	17
MACHINE GUN LIGHT 5.56MM M249-----	4
MACHINE GUN GRENADE 40MM MK-19 MOD III-----	2
MACHINE GUN 7.62MM M240B-----	10
PISTOL 9MM AUTOMATIC M9-----	1
RIFLE 5.56MM M16A2-----	157
MACHINE GUN: CALIBER .50 (M2E2)-----	12

VEHICLES, TRAILERS, AND TRLR MTD SYSTEMS

CONTAINERIZED KITCHEN (CK)-----	2
DOLLY SET LIFT TRANSPORTABLE SHEL: 7 1/2T (M1022A1)-----	1
FORWARD REPAIR SYSTEM: M7 (FRS)-----	3
GEN SET DED TM: 5KW 60HZ (PU-797)-----	1
TOOL SET STANDARD AUTOMOTIVE (TRAILER MTD)-----	3
SEMITRAILER LOW BED: 2ST 4 WHL (M172A1)-----	1
SEMITRAILER VAN: SUPPLY 12T 4 WHL (M129A2C)-----	3
TRUCK UTILITY EXP CAPACITY ENH 4X4: M1152A1-----	12
TRUCK CARGO: HVY PLS TRANSPORTER 10X10 (M1075)-----	3
TRUCK VAN LMTV (M1079)-----	2
TRUCK CARGO: MTV (M1083)-----	15
TRUCK VAN EXPANSIBLE MTV (M1087A1)-----	1
TRUCK UTILITY EXP CAPACITY ENH 4X4: M1165A1-----	5
TRUCK LIFT FORK: DSL DRVN 4000LB CAP ROUGH TERR-----	1
TRUCK TANK: FUEL SERVICING 2500 GAL 8X8 HEMTT (M978)-----	4
TRUCK CARGO: 4X4 LMTV (M1078)-----	6
TRUCK TRACTOR MTV (M1088)-----	4
TRUCK CARGO MTV LWB (M1085)-----	2
TRUCK WRECKER: TACTICAL 8X8 HEMTT (M984A1)-----	2
TRUCK LIFT: FORK VARIABLE REACH RT (ATLAS)-----	1
TRAILER: PLS 8X20 (M1076)-----	14
TRUCK WRECKER: MTV (M1089)-----	4
TRAILER CARGO: MTV W/ DROPSIDES (M1095)-----	2
TRAILER HIGH MOBILITY 1-1/4T (M1102)-----	5
LIGHT TACTICAL TRAILER: 3/4T (M1101)-----	1
TRUCK CARGO HEMTT LHS (M1120)-----	10
TRAILER CARGO: LMTV W/DROPSIDES (M1082)-----	2
SHOP EQUIPMENT: WELDING TRAILER MTD-----	1
TAC ELECT PWR (TEP) TM: PU-2101/ 15KW 50/60HZ/ M200A1-----	3
TRAILER TANK WATER (CAMEL) 800 GAL 5 TON-----	3

COMMUNICATION-ELECTRONICS EQUIPMENT

ANTENNA GROUP: OE-254-----	5
COMPUTER SYSTEM DIGITAL: AN/UYQ-90(V)2 (MTS)-----	31
COMPUTER SET DIGITAL: AN/UYK-128 (FBCB2)-----	38
BTL CMD SUSTAINMENT SPT SYSTEM: AN/GYK-61 (BCS3)-----	2
COMPUTER SET DIGITAL: OL-604/TYQ (SARSS DSU WS)-----	5
COMPUTER SYS DIGITAL: AN/TYQ-129(V)2 (TC-AIMS II WS)-----	1
COMPUTER SET DIGITAL: AN/TYQ-109(V)1 (GCSS-A (V)1)-----	1
COMPUTER SET DIGITAL: OL-603/TYQ (SARSS DSU SVR)-----	1
COMPUTER SYSTEM DIGITAL: AN/UYQ-90(V)3 (MTS-CS)-----	4
NAVIGATION SET: SATELLITE SIGNALS AN/PSN-13 (DAGR)-----	55
PROCESSOR GROUP SIGNAL DATA: (CAISI 2.0)-----	4
RADIAC SET: AN/VDR-2-----	3
RADIO SET: AN/VRC-89F-----	2
RADIO SET: AN/VRC-90F-----	64
RADIO SET: AN/VRC-92F-----	4
RADIO SET: AN/VRC-104(V)3 150 WATT IK: PRC-150 HF RADIO--	1
INTERFACE UNIT COMM EQ: OL-713(V)1/TYQ CSS VSAT-----	2
COMPUTER SYSTEM: DIGITAL AN/TYQ-139-----	15
COMPUTER SYSTEM DIGITAL: AN/TYQ-140-----	1

NIGHT VISION/OBSERVATION EQUIPMENT

NIGHT VISION GOGGLES: AN/PVS-7B-----	143
MEDIUM THERMAL WEAPONS SIGHT: AN/PAS-13(V2)-----	14
HEAVY THERMAL WEAPONS SIGHT: AN/PAS-13(V3)-----	14

MISCELLANEOUS EQUIPMENT

ASSAULT KITCHEN (AK)-----	1
BED CARGO: DEMOUNTABLE PLS 8X20-----	68
CONTAINER HANDLING: HVY EXP MOB TACK TRK (HEMTT)-----	2
GEN SET : DED SKID MTD 3KW 60HZ (MEP-831A)-----	9
ELECTRONICS SHOP SHEL MTD AVIONICS: AN/ASM-146-----	2
ELECTRONICS SHOP SHEL MTD AVIONICS: AN/ASM-147-----	3
SHOP EQUIP: CONTACT MAINT ORD/ENGR TRK MTD-----	3
LOAD HANDLING SYS: 2000GAL CAP WATER TANK (HIPPO)-----	4
TANK AND PUMP UNIT LIQ DISPENSING TRUCK MTD (TPU)-----	1
TANK UNIT LIQUID DISPENSING TRAILER MTG-----	1
WATER: PURIFIER LIGHT WEIGHT-----	4
MULTI-TEMP REFRIGERATED CONTAINER SYS: MTRCS-----	2
GENERATOR SET DED 10KW 50/60HZ: SKID MTD (TEP)-----	8
GENERATOR SET DED 15KW 50/60HZ: SKID MTD (TEP)-----	1

Support Company (BFSB)

Forward Support Platoon (MI), BSC (BFSB)

TOE 63567R100
OFF: 1/WO: 0/ENL: 45/TOTAL: 46

COMMAND SECTION PARA 01

AN/VRC-92F
AN/UYQ-90(V)2
FBCB2
AN/UYQ-90(V)3
DAGR



LT 91A00 (PLT LDR) R
SFC 92A40 (PLT SGT) R

FIELD FEEDING SECTION PARA 02

AN/VRC-90F
DAGR



X2
SSG 92G30 (FOOD OPNS MGR) R
SGT 92G20 (FOOD OPNS NCO) R

AN/VRC-90F



3 SP4 92G10 (FOOD OPNS SP) R
PFC 92G10 (FOOD OPNS SP) R
PFC 92G10 (FOOD OPNS SP) SAW

DISTRIBUTION SECTION PARA 03

AN/VRC-90F

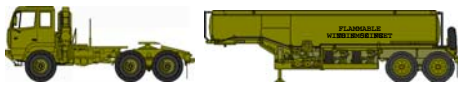

SGT 92F20 (PETRL HVY VEH OPR) R
SP4 92F10 (PETRL HVY VEH OPR) R

AN/VRC-90F
DAGR



SGT 88M20 (HVY VEH DRIVER) R
SP4 88M10 (HVY VEH DRIVER) R
PFC 88M10 (HVY VEH DRIVER) R

AN/VRC-90F



SGT 92W20 (WATER TRMT NCO) R
SP4 92W10 (WATER TRMT SP) R
PFC 92W10 (WATER TRMT SP) R

AN/VRC-90F
AN/UYQ-90(V)2



FIELD MAINTENANCE SECTION PARA 04

AN/VRC-90F
FBCB2
DAGR
CAISI 2.0
6 AN/TYQ-139



SFC 91X40 (MOTOR SGT) R

AN/VRC-90F
FBCB2
DAGR



SSG 91B30 (SR MECHANIC) R
4 SGT 91B20 (WH VEH MECH) R
SGT 91D20 (PWR-GEN EQ REP) R
SGT 92A20 (EQ RCD/PARTS SGT) R
3 SP4 91B10 (WH VEH MECH) R

AN/VRC-90F
AN/UYQ-90(V)2
FBCB2
DAGR



2 SP4 91B10 (WH VEH MECH) SAW
SP4 91C10 (UTIL EQ REP) R
SP4 91D10 (PWR-GEN EQ REP) R
SP4 91F10 (SM ARMS/ARTY REP) R
SP4 91J10 (QM/CHEM EQ REP) R

AN/VRC-90F
FBCB2
DAGR



SP4 94E10 (COMSEC/RADIO EQ REP) R
SP4 94F10 (COMP/DET SYS REP) R
SP4 92A10 (EQ RCD/PARTS SP) R
5 PFC 91B10 (WH VEH MECH) R
2 PFC 91D10 (PWR-GEN EQ REP) SAW

AN/VRC-90F
FBCB2
DAGR



AN/VRC-90F
AN/UYQ-90(V)2
FBCB2
DAGR



SP4 91B10 (RCVY VEH OPR) R

AN/VRC-90F
AN/UYQ-90(V)2
FBCB2
DAGR



SGT 91B20 (RCVY VEH OPR) R

AN/VRC-90F
FBCB2
DAGR

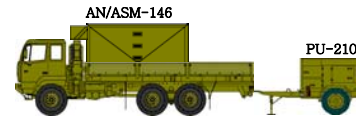

AN/VRC-90F
FBCB2
DAGR



AN/VRC-90F
FBCB2
DAGR



X2

Summary of Equipment

WEAPONS

MACHINE GUN 5.56MM M249-----	5
MACHINE GUN 7.62MM M240B-----	1
RIFLE 5.56MM M16A2-----	41
MACHINE GUN: CALIBER .50 (M2E2)-----	4

VEHICLES, TRAILERS, AND TRLR MTD SYSTEMS

CONTAINERIZED KITCHEN (CK)-----	1
FORWARD REPAIR SYSTEM: M7 (FRS)-----	1
GEN SET DIESEL ENGINE TM: 15KW 50/60HZ (PU-802)-----	1
TOOL SET STANDARD AUTOMOTIVE (TRAILER MTD)-----	1
SEMITRAILER TANK: 5000 GAL FUEL DISPENSING (M969A1)-----	1
TRUCK UTILITY EXP CAPACITY ENH 4X4: M1152A1-----	4
TRUCK CARGO: HVY PLS TRANSPORTER 10X10 (M1075)-----	1
TRUCK CARGO: MTV (M1083)-----	5
TRUCK UTILITY EXP CAPACITY ENH 4X4: M1165A1-----	1
TRUCK CARGO: 4X4 LMTV (M1078)-----	1
TRUCK CARGO MTV LWB (M1085)-----	1
TRUCK WRECKER: TACTICAL 8X8 HEMTT (M984A1)-----	1
TRAILER: PLS 8X20 (M1076)-----	3
TRUCK WRECKER: MTV (M1089)-----	1
TRAILER HIGH MOBILITY 1-1/4T (M1102)-----	1
TRUCK CARGO HEMTT LHS (M1120)-----	3
TAC ELECT PWR (TEP) TM: PU-2101/ 15KW 50/60HZ/ M200A1---	1
TRAILER TANK WATER (CAMEL) 800 GAL 5 TON-----	1

COMMUNICATION-ELECTRONICS EQUIPMENT

ANTENNA GROUP: OE-254-----	2
COMPUTER SYSTEM DIGITAL: AN/UYQ-90(V)2 (MTS)-----	5
COMPUTER SET DIGITAL: AN/UYK-128 (FBCB2)-----	11
COMPUTER SYSTEM DIGITAL: AN/UYQ-90(V)3 (MTS-CS)-----	1
NAVIGATION SET: SATELLITE SIGNALS AN/PSN-13 (DAGR)-----	14
PROCESSOR GROUP SIGNAL DATA: (CAISI 2.0)-----	1
RADIAC SET: AN/VDR-2-----	1
RADIO SET: AN/VRC-90F-----	17
RADIO SET: AN/VRC-92F-----	1
COMPUTER SYSTEM: DIGITAL AN/TYQ-139-----	6

NIGHT VISION/OBSERVATION EQUIPMENT

NIGHT VISION GOGGLES: AN/PVS-7B-----	38
MEDIUM THERMAL WEAPONS SIGHT: AN/PAS-13(V2)-----	1
HEAVY THERMAL WEAPONS SIGHT: AN/PAS-13(V3)-----	4

MISCELLANEOUS EQUIPMENT

BED CARGO: DEMOUNTABLE PLS 8X20-----	13
GEN SET : DED SKID MTD 3KW 60HZ (MEP-831A)-----	1
ELECTRONICS SHOP SHEL MTD AVIONICS: AN/ASM-146-----	1
ELECTRONICS SHOP SHEL MTD AVIONICS: AN/ASM-147-----	1
SHOP EQUIP: CONTACT MAINT ORD/ENGR TRK MTD-----	1
LOAD HANDLING SYS: 2000GAL CAP WATER TANK (HIPPO)-----	2
WATER: PURIFIER LIGHT WEIGHT-----	1
MULTI-TEMP REFRIGERATED CONTAINER SYS: MTRCS-----	1
GENERATOR SET DED 10KW 50/60HZ: SKID MTD (TEP)-----	4

Forward Support Platoon (MI), BSC (BFSB)

COMBAT AVIATION BDE (HEAVY)

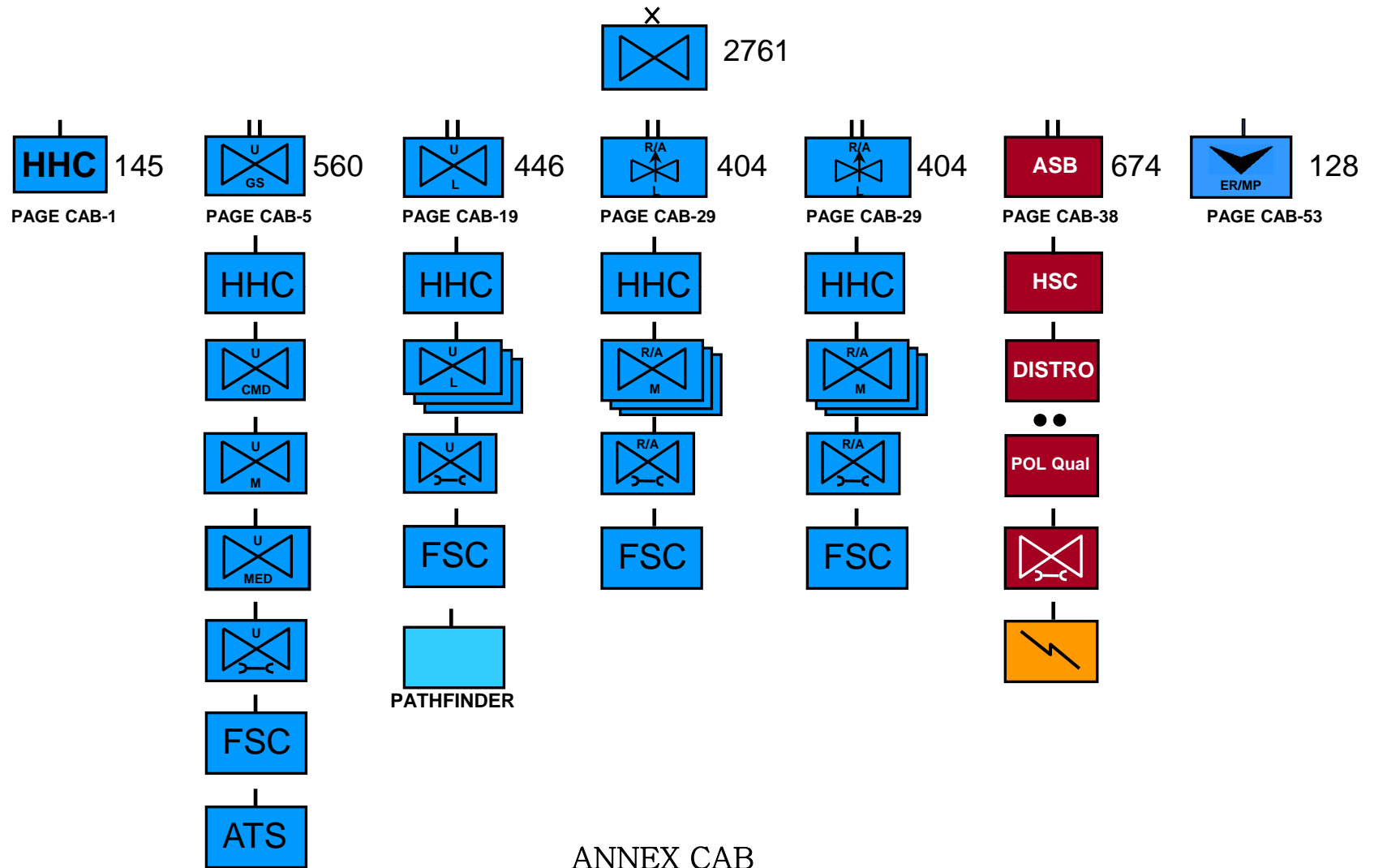

HHC, Combat Aviation Brigade (Hvy)

01302R000
OFF: 35/WO: 16/ENL: 95/TOTAL: 145

COMMAND SECTION PARA 01

AN/VRC-92F
FBCB2
DAGR
AN/PSC-5

AN/VRC-92F
FBCB2
DAGR

AN/VRC-90F
FBCB2
DAGR



COL 15B00 (COMMANDER) P
PFC 15P10 (VEH DRIVER) C



LTC 15B00 (EXEC OFF) P
PFC 15P10 (VEH DRIVER) C



CSM 00Z50 (CMD SGM) P

CW5 153AB (AVN SAFETY OFF) P
CW5 153AH (AVN STDZN OFF) P

S-1 SECTION PARA 02

AN/VRC-90F
FBCB2
DAGR
AN/TYQ-116(V)3

AN/VRC-90F
CAISI 2.0
OL-713(V)1/TYQ CSS VSAT
8 AN/TYQ-116(V)3



MAJ 42H00 (S1) P



LT 42B00 (STRENGTH MGR) C
CW2 420A0 (MIL PERS TECH) C
MSG 42A50 (SR HUMAN RES SGT) C
SSG 27D30 (PARALEGAL NCO) C
SSG 42A30 (HUMAN RES SGT) C

SGT 42A20 (HUMAN RES SGT) C
SGT 42F20 (HR INFO SYS MGMT SGT) C
2 SP4 42A10 (HUMAN RES SP) C
SP4 42F10 (HR INFO SYS MGMT SP) C
2 PFC 42A10 (HUMAN RES SP) C

S-2 SECTION PARA 03

AN/VRC-92F
FBCB2
DAGR

AN/VRC-90F
AN/TYQ-93
AN/TYQ-90(V)2
FBCB2
KG-175

AN/VRC-90F



MAJ 15C35 (S2) P



CPT 35D00 (ASST S2) C
CPT 35D00 (PLANS OFF) C
CW2 350F0 (ASI TECH) C
SFC 35F40 (SR INTEL SGT) C
SSG 35F30 (INTEL SGT) C
SGT 35F20 (INTEL ANALYST) C
SP4 35F10 (INTEL ANALYST) C
PFC 35F10 (INTEL ANALYST) C



X2

JSTARS CGS TEAM PARA 04

AN/VRC-92F
FBCB2
TSEC/KG-84
C-2299/VRC
DAGR

AN/VRC-90F



AN/TSQ-179(V)2

SFC 35H40 (SR CGS SGT) C
SGT 35H20 (CGS OPR) C
2 SP4 35H10 (CGS OPR) C
2 PFC 35H10 (CGS OPR) C



S-3 SECTION PARA 05

AN/VRC-92F
FBCB2
DAGR

AN/VRC-92F
AN/VRC-90F
FBCB2
AMPS
AN/PYQ-12
FHMUX
DAGR
AN/GRC-240
AN/PSC-5
AN/PSC-11
AN/VRC-100(V)1

AN/VRC-90F
DAGR



LTC 15B00 (S3) P



MED PWR PLANT
X3

MAJ 57A15 (ASST S3/SIMS OFF) P
MAJ 67J00 (MEDICAL OPS OFF) P
CPT 15B00 (S3 AIR) P
CPT 74B00 (CHEM OFF) C
CW5 153A0 (AVN MASTER GUNNER) P
CW5 153AI (TAC OPS OFF) P
SGM 15P50 (AVN OPS CHIEF) C



POWER PLANT UTILITY

SFC 68W40 (OPNS SGT) C
SFC 74D40 (CBRN STAFF NCO) C
SSG 15P30 (ASST AVN OPS SGT) C
SGT 15P20 (AVN OPS SGT) C
2 SP4 15P10 (AVN OPS SP) C
PFC 15P10 (AVN OPS SP) C

CP2 TOC PARA 06

AN/VRC-92F
AN/VRC-90F
AN/TYQ-93
FBCB2
AMPS
AN/TSQ-243
FHMUX
2 DAGR
AN/GRC-240
AN/PSC-5
AN/PSC-11
AN/GYK-56

AN/VRC-92F
FBCB2
DAGR



CPT 15B00 (ASST S3) P
CW4 153AI (TAC OPS OFF) P
SGT 15P20 (AVN OPS SGT) C
2 SP4 15P10 (AVN OPS SP) C
SP4 35F10 (INTEL ANALYST) C
PFC 15P10 (AVN OPS SP) C



MED PWR PLANT



MAJ 15B00 (LIAISON OFF) P
CPT 15B00 (LIAISON OFF) P

JOINT, INTERAGENCY AND
MULTINATIONAL AVN CMD
LIAISON ELEMENT PARA 07

CAB-1

HHC, Cbt Avn Bde (Hvy) (cont)

FECC PARA 08

AN/VRC-92F
FBCB2
DAGR



MAJ 13A00 (FIRE SPT OFF) P
MSG 13Z50 (OPNS SGT) C
SP4 13F10 (FIRE SPT SP) C

NON-LETHAL EFFECTS CELL PARA 09

AN/VRC-92F
AN/VRC-90F
FBCB2
DAGR
AN/GYK-56



CPT 30A00 (INFO OPS OFF) C
CPT 35G00 (EW OFF) C
SSG 35F30 (INTEL SGT) C

LETHAL FIRES PARA 10

AN/VRC-92F
AN/VRC-90F
AN/GYK-58
FBCB2
FHMUX
DAGR



CPT 13A00 (ASST FSO) C
CPT 13A00 (EFFECTS COORD) C
CW3 131A0 (TARGETING OFF) C
SFC 13F40 (FIRE SPT SGT) C
SFC 29E40 (EW SGT) C
SSG 13F30 (EFFECTS NCO) C
SSG 25E30 (ELECTRO SPECTRUM NCO) C
SSG 29E30 (EW SGT) C
SP4 13F10 (FIRE SPT SP) C

AN/VRC-92F
FBCB2
AN/GYK-48(V)1
FHMUX
DAGR
AN/PSC-5
AN/VRC-100(V)1



GEOSPATIAL INFO AND SERVICES (GI&S) TOPOGRAPHIC ENGINEER ELEMENT PARA 12

AIR SUPPORT PARA 11

AN/VRC-92F
FBCB2
DAGR
AN/GRC-240
AN/VRC-100(V)1



MAJ 01A00 (AIR FORCE STAFF OFF) P
CPT 01A00 (AIR FORCE STAFF OFF) C
SP4 00D40 (AIR FORCE STAFF NCO) C

(USAF PERSONNEL - NOT ASSIGNED TO UNIT)

AN/VRC-90F



SSG 12Y30 (SQUAD LEADER) C
SGT 12Y20 (GEOSPATIAL ENGR SGT) C
SP4 12Y10 (GEOSPATIAL ENGINEER) C
PFC 12Y10 (GEOSPATIAL ENGINEER) C

AN/VRC-90F
FBCB2
DAGR



S-4 SECTION PARA 13

AN/VRC-92F
FBCB2
2 AN/GYK-61 (BCS3)
4 AN/TYQ-129(V)2
AN/TYQ-109(V)1
KG-175
AN/TYQ-95
DAGR
CAISI 2.0
AN/VRC-100(V)1
AN/TYQ-150(V)2 ULLS-A(E)



MAJ 15D00 (S4) P
CPT 15B00 (ASST S4) P
CPT 92A00 (ASST S4) C
CW5 153AL (AVN MATERIEL OFF) P
CW2 882A0 (MOBILITY OFF) C
CW2 922A0 (FOOD ADVISOR) C
CW2 920A0 (PROP ACCT TECH) C

AN/VRC-92F
FBCB2
DAGR



MSG 91Z50 (SR MAINT SUPV) C
MSG 92G50 (SR FOOD OPNS SGT) C
MSG 92Y50 (SR SUPPLY SGT) C
SSG 88N30 (MOVEMENTS SUPV) C
SSG 92Y30 (SUPPLY SGT) C
SGT 92Y20 (PROP BOOK NCO) C

PUBLIC AFFAIRS PARA 14

AN/VRC-90F
FBCB2
DAGR
AN/PSC-5



CPT 46A00 (PAO) C
SGT 46Q20 (PA SGT) C

COMPANY HEADQUARTERS PARA 15

AN/VRC-90F
AN/PRC-119F
FBCB2
DAGR



CPT 15B00 (COMMANDER) P
PFC 15P10 (VEH DRIVER) C

AN/VRC-90F
CAISI 2.0
AN/TYQ-116(V)3



1SG 15Z5M (FIRST SGT) C
SP4 42A10 (HUMAN RES SP) C

SUPPLY SECTION (CO) PARA 16

AN/VRC-90F
AN/TYQ-109(V)1
DAGR
CAISI 2.0



SSG 92Y30 (SUPPLY SGT) C
SP4 92Y10 (SUPPLY SP) C

HHC, Cbt Avn Bde (Hvy) (cont)

S6 SECTION PARA 17

AN/VR-90F
FBCB2
DAGR

AN/VR-90F
AN/GYK-33D
FBCB2
DAGR
AEHF COMMS PLAN ELEM
AN/TYQ-140

NETWORK MANAGEMENT

AN/VR-90F
AN/GYK-33D
6 AN/TYQ-137A:(V)2
AN/TYQ-146(V)2
AN/PYQ-12
AN/TYQ-146(V)1
AN/TSQ-243
AN/GYK-49(V)2
2 AN/TSR-8 (GRT)
4 AN/TYQ-155 (V)1
2 AN/PYQ-16
TSEC/KOK-22
CPP RWS

IA/CND

COMSEC

AN/VR-89F
AN/GYK-33D
FBCB2
AN/GYK-49(V)2
NES
DAGR
TSEC/KOK-22

SYS INTEGR OVERSIGHT/IDM

AN/VR-90F
FBCB2
DAGR



MAJ 25A00 (S6) P



MSG 25U50 (SGNL SPT SYS CHIEF) C



SSG 25B30 (DATA SYS INTEGR) C
SSG 25E30 (ELECTRO SPECTRUM NCO) C
SSG 25S30 (SATCOM OPNS NCO) C
SSG 25U30 (SGNL INFO SVC NCO) C
SSG 25U30 (SGNL SPT SYS SUPV) C
SGT 25B20 (SR INFO SYS SP) C
2 SGT 25B20 (SR LAN MGR) C
SP4 25L20 (SR CABLE/ANT SYS SP) C
SP4 25B10 (LAN MGR) C
SP4 25L10 (CABLE SYS INSTL-MAINT) C
SP4 25U10 (SGNL SPT SYS SP) C
PFC 25B10 (LAN MGR) C

SSG 25B30 (IA STAFF ASST) C

AN/VR-90F
FBCB2
DAGR



SGT 25B20 (SR LAN MGR) C
PFC 25B10 (LAN MGR) C

AN/VR-90F



CW2 250N0 (NETWORK MGMT TECH) C
SP4 25U10 (SGNL SPT SYS SP) C



CPT 53A25 (AUTOMATION MGMT OFF) C
CW2 254A0 (SGNL SYS TECH) C
SFC 25W40 (NETWORK OPNS CHIEF) C
SSG 25N30 (NODAL OPS SYS NCO) C
SSG 25Q30 (XMSN SYS OPS NCO) C
SP4 25U10 (SGNL SPT SYS MAINT) C
PFC 25U10 (SGNL SPT SYS SP) C

BRIGADE SURGEON SECTION PARA 18

AN/VR-89F
FBCB2
AN/TYQ-105(V)1
AN/TYQ-108(V)3
DAGR
CAISI 2.0



MAJ 61N00 (FLIGHT SURGEON) P
CPT 70H67 (MEDICAL OPNS OFF) P
SFC 68W40 (OPNS SGT) C

MEDICAL TREATMENT TEAM PARA 19

AN/VR-90F
AN/TYQ-106(V)1
FBCB2
2 AN/TYQ-105(V)1
DAGR



CPT 65D00 (PHYSICIAN ASST) P
SSG 68W30 (HEALTH CARE SGT) C
SP4 68W10 (HEALTH CARE SP) C
PFC 68W10 (HEALTH CARE SP) C

AN/VR-90F
FBCB2
2 AN/TYQ-105(V)1
DAGR



UNIT MINISTRY TEAM PARA 20

AN/VR-90F
FBCB2
DAGR



MAJ 56A00 (CHAPLAIN)
SSG 56M30 (CHAP ASST NCO) C

USAF WEATHER TEAM (BDE) PARA 21

AN/VR-90F
FBCB2
DAGR



AN/VR-90F
DAGR



AN/VR-92F
DAGR
AN/GMQ-36



AIR DEFENSE AIRSPACE MANAGEMENT (ADAM) SECTION PARA 23

AN/VR-90F
AN/GYQ-88
DAGR
AN/FSQ-211



MAJ 15B00 (AIRSPACE MGMT OFF) P
CPT 14A00 (ASST AMD OPS OFF) C
CW2 140A0 (C2 SYS INTEGR) C
SFC 15Q40 (A2C2 SGT) C
SGT 14J20 (OPNS SGT) C
SGT 14J20 (SR EWS OPR) C
2 SP4 14J10 (EWS OPR) C

AN/MSQ-214(V)1



OP LAW PARA 24

AN/VR-90F
FBCB2
DAGR



MAJ 27A00 (LAW LAND WARFARE OFF) C
CPT 27A00 (INTL LAW OFF) C
SSG 27D30 (OPS LAW NCO) C

Summary of Equipment

WEAPONS

LAUNCHER GRENADE : M320A1-----	4
MACHINE GUN LIGHT 5.56MM M249-----	4
MACHINE GUN GRENADE 40MM MK-19 MOD III-----	2
PISTOL 9MM AUTOMATIC M9-----	28
RIFLE 5.56MM M4 CARBINE-----	119
MACHINE GUN: CALIBER .50 (M2E2)-----	1

VEHICLES, TRAILERS, AND TRLR MTD SYSTEMS

COMMAND SYSTEM: TACTICAL (CPP RWS) (MTD ON HMMWV)---	4
GEN SET DED TM: 10KW 60HZ (PU-798)-----	2
POWER PLANT: UTILITY, LARGE 35KW 12 TON ECU-----	1
POWER PLANT: UTILITY, MEDIUM 20KW 5 TON ECU-----	8
TRUCK UTILITY EXP CAPACITY ENH 4X4: M1152A1-----	32
TRUCK VAN EXPANSIBLE MTV (M1087A1)-----	1
TRUCK UTILITY EXP CAPACITY ENH 4X4: M1165A1-----	11
TRUCK CARGO: 4X4 LMTV (M1078)-----	4
TRAILER HIGH MOBILITY 1-1/4T (M1102)-----	4
LIGHT TACTICAL TRAILER: 3/4T (M1101)-----	12
TRAILER CARGO: LMTV W/DROPSIDES (M1082)-----	3
TRAILER TANK: WATER 400 GAL 1-1/2T 2 WHL (M149A2)-----	1

MISCELLANEOUS EQUIPMENT

GEN SET: DED SKID MTD 5 KW 60HZ (MEP-802A)-----	1
GEN SET : DED SKID MTD 3KW 60HZ (MEP-831A)-----	5
GEN SET: DED SKID MTD 10KW 60HZ (MEP-803A)-----	4

NIGHT VISION/OBSERVATION EQUIPMENT

NIGHT VISION GOGGLES: AN/PVS-7B-----	96
MEDIUM THERMAL WEAPONS SIGHT: AN/PAS-13(V2)-----	4
HEAVY THERMAL WEAPONS SIGHT: AN/PAS-13(V3)-----	4

COMMUNICATION-ELECTRONICS EQUIPMENT

ALL SOURCE ANALYSIS SYSTEM: AN/TYQ-93 (ASAS-LT)-----	2
ALL SOURCE ANALYSIS SYSTEM: AN/TYQ-93(V)2 (ASAS-IFS)-----	1
ANTENNA GROUP: OE-254-----	29
BCCS SHORT STACK CMD SYS TACTICAL: AN/TYQ-146(V)2-----	1
COMPUTER SET: AN/GYK-58 (AFATDS - DUAL)-----	1
COMPUTER SET GENERAL: AN/GYK-33D-----	2
COMPUTER SYSTEM DIGITAL: AN/TYQ-106(V)1-----	1
COMPUTER SET DIGITAL: AN/UYK-128 (FBCB2)-----	33
COMPUTER SYSTEM DIGITAL: (AMPS)-----	3
BITL CMD SUSTAINMENT SPT SYSTEM: AN/GYK-61 (BCS3)-----	2
COMPUTER SET DIGITAL: AN/PYQ-12 (MCS GATEWAY SVR)-----	2
COMPUTER SYS DIGITAL: AN/TYQ-129(V)2 (TC-AIMS II WS)-----	4
COMPUTER SYSTEM DIGITAL: AN/TYQ-105(V)1-----	5
COMPUTER SYS DIGITAL: AN/TYQ-108(V)3-----	1
COMPUTER SET DIGITAL: AN/TYQ-109(V)1 (GCSS-A (V)1)-----	2
COMPUTER SYSTEM DIGITAL: ((CPOF WS) AN/TYQ-137A:(V)2)-----	6
COMPUTER SET DIGITAL: OL-590/TYQ (SAMS-1)-----	1
COMMAND SYSTEM: TACTICAL AN/TYQ-146 (V) 1-----	1
COMMAND CENTER SYSTEM: AN/TSQ-243-----	2
COMPUTER: TACTICAL AN/GYQ-88-----	1
COMPUTER SET GENERAL: AN/GYK-49(V)2-----	2
COMPUTER SET FA GENERAL: AN/GYK-48(V)1 (FSCCOORD)-----	1
DIGITAL TOPOGRAPHIC SYSTEM: AN/TYQ-67(V)-----	1
ELECT EKY GEN DED LOOP ENCRYPTON DEVICE: TSEC/KG-84--	1
ENCRYPT/DECRYPT EQUIP: NES-----	1
ENCRYPT/DECRYPT EQUIPMENT: TACLANE KG-175-----	2
CONTROL RADIO SET: C-2299/VRC-----	1
FREQUENCY HOPPING MULTIPLEXER: TF-1456VRC (FHMUX)-----	3
INTEGRATED METEOROLOGICAL SYSTEM LIGHT: AN/GMQ-36---	1
INTERROGATOR SET AN/TYQ-95 (TC-AIMS II INTERROGATOR)---	2
METEOROLOGICAL STATION: AUTO AN/TMQ-40 (IMETS-B)-----	1
NAVIGATION SET: SATELLITE SIGNALS AN/PSN-13 (DAGR)-----	38
PROCESSOR GROUP SIGNAL DATA: (CAISI 2.0)-----	5
RADIAC SET: AN/VDR-2-----	6
RECEIVE SUITE: AN/TSR-8 (GRT)-----	2
RADIO SET: AN/GRC-240-----	3
RADIO SET: AN/VRC-89F-----	2
RADIO SET: AN/VRC-90F-----	33
RADIO SET: AN/VRC-92F-----	16
RADIO SET: AN/PSC-5-----	7
RADIO SET: AN/PSC-11-----	2
RADIO SET: HIGH FREQ AN/VRC-100(V)1-----	4
RADIO SET: AN/PRC-119F-----	1
TARGET ACQUISITION SUBSYSTEM: AN/TYQ-179(V)2-----	1
WORKSTATION: AIRSPACE OPERATION AN/FSQ-211 (TAIS AWS)---	1
COMPUTER SET FA GENERAL: AN/GYK-56 (EMT)-----	2
INTERFACE UNIT COMM EQ: OL-713(V)1/TYQ CSS VSAT-----	1
ABHF COMMUNICATIONS PLANNING ELEMENT:-----	1
COMPUTER SET DIGITAL: AN/TYQ-152 (V) 2 ULLS-A(E)-----	1
COMMAND SYSTEM TACTICAL: AN/TYQ-155 (V) 1-----	4
COMPUTER SYSTEM DIGITAL: AN/PYQ-16-----	2
AIR DEFENSE SYSTEM INTEGRATOR: AN/MSQ-214(V)1-----	1
KEY PROCESSOR KP TSEC/KOK-22-----	2
COMP SYS DIGITAL: (AHR) AN/TYQ-116(V)3-----	10

HHC, Combat Aviation Brigade (Hvy)

HHC, General Support Aviation Bn

01226R000
OFF: 17/WO: 5/ENL: 55/TOTAL: 77

COMMAND SECTION PARA 01

AN/VRC-92F
FBCB2
DAGR

AN/VRC-89F
FBCB2
DAGR



LTC 15B00 (COMMANDER) P
PFC 15P10 (VEH DRIVER) C

MAJ 15B00 (EXEC OFF) P
PFC 15P10 (VEH DRIVER) C

CSM 00Z50 (CMD SGM) P

CW4 153AB (AVN SAFETY OFF) P
CW4 153AH (AVN STDZN OFF) P

S1 SECTION PARA 02

AN/VRC-90F
DAGR
CAISI 2.0
9 AN/TYQ-116(V)3



CPT 42B00 (S1) C
SFC 42A40 (SR HUMAN RES SGT) C
SSG 42A30 (HUMAN RES SGT) C
SGT 42A20 (HUMAN RES SGT) C
SP4 27D10 (PARALEGAL SP) C
SP4 42A10 (HUMAN RES SP) C
2 PFC 42A10 (HUMAN RES SP) C

S2 SECTION PARA 03

AN/VRC-92F
AN/TYQ-93
FBCB2
DAGR



CPT 15C35 (S2) P
LT 35D00 (ASST S2) C
SSG 35F30 (INTEL SGT) C
SP4 35F10 (INTEL ANALYST) C
PFC 35F10 (INTEL ANALYST) C

S3 SECTION PARA 04

AN/VRC-92F
FBCB2
DAGR



MAJ 15B00 (S3) P

AN/VRC-92F
AN/VRC-90F
FBCB2
AMPS
AN/PYQ-12
AN/TYQ-129(V)2
AN/TSQ-243
FHMUX
DAGR



CPT 15B00 (ASST S3) P
CPT 67J00 (OPNS OFF) P
LT 74A00 (CBRN OFF) C
CW3 153AI (TAC OPS OFF) P
MSG 15P50 (SR AVN OPS SGT) C
SFC 68W40 (OPNS SGT) C
SSG 15P30 (ASST AVN OPS SGT) C
SSG 74D30 (CBRN NCO) C
2 SGT 15P20 (AVN OPS SGT) C
SGT 29E20 (EWS SGT) C
4 SP4 15P10 (AVN OPS SP) C
3 PFC 15P10 (AVN OPS SP) C

AN/VRC-90F
DAGR



TACTICAL CP PARA 05

AN/VRC-92F
FBCB2
AMPS
DAGR
AN/GRC-240
AN/PSC-5



CPT 15B00 (ASST S3) P
SGT 15P20 (AVN OPS SGT) C
2 SP4 15P10 (AVN OPS SP) C
PFC 15P10 (AVN OPS SP) C

AVIATION LIAISON ELEMENT PARA 06

AN/VRC-90F
FBCB2
AMPS
DAGR



LT 15A00 (LIAISON OFF) P
CW3 153MI (TAC OPS OFF) P
SP4 15P10 (AVN OPS SP) C

S4 SECTION PARA 07

AN/VRC-89F
FBCB2
DAGR



CPT 15B00 (S4) P

AN/VRC-92F
FBCB2
AN/TYQ-129(V)2
AN/TYQ-109(V)1
KG-175



CW3 153MG (AVN MATERIEL OFF) P
SFC 92Y40 (SR SUPPLY SGT) C
SGT 92Y20 (SUPPLY NCO) C
SP4 92Y10 (SUPPLY SP) C

DAGR
CAISI 2.0
AN/VRC-100(V)1

AN/VRC-90F



CO HQ PARA 08

AN/VRC-90F
AN/PRC-119F
FBCB2
DAGR
CAISI 2.0



CPT 15B00 (COMMANDER) P
PFC 15P10 (VEH DRIVER) C

AN/VRC-90F



1SG 15Z5M (FIRST SGT) C
SGT 74D20 (CBRN NCO) C

HHC, Gen Spt Avn Bn (cont)

SUPPLY SECTION (BN) PARA 09

AN/VRC-90F
AN/TYQ-109(V)1
DAGR
CAISI 2.0



SSG 92Y30 (SUPPLY SGT) C
2 SP4 92Y10 (SUPPLY SP) C
PFC 92Y10 (SUPPLY SP) C

S6 SECTION HQ PARA 10

AN/VRC-90F
FBCB2
3 AN/TYQ-137A:(V)2
DAGR
AN/TSR-8 (GRT)
AN/TSQ-259



CPT 25A00 (S6) C
SFC 25U40 (SECTION CHIEF) C
SP4 25B10 (LAN MGR) C
SP4 25U10 (SGNL SPT SYS MAINT) C
SP4 25U10 (SGNL INFO SVC SP) C
PFC 25B10 (LAN MGR) C
PFC 25U10 (SGNL SPT SYS SP) C

2 AN/VRC-92F
FBCB2
FHMUX
DAGR



SGT 25U20 (TEAM CHIEF) C
SP4 25U10 (RADIO RETRANS OPR) C
PFC 25U10 (RADIO RETRANS OPR) C

MEDICAL TREATMENT TEAM PARA 11

AN/VRC-90F
AN/TYQ-106(V)1
FBCB2
3 AN/TYQ-105(V)1
DAGR
CAISI 2.0



CPT 61N00 (FLIGHT SURGEON) P
CPT 65D00 (PHYSICIAN ASST) P
SSG 68W30 (HEALTH CARE SGT) C
SP4 68W10 (HEALTH CARE SP) C
PFC 68W10 (HEALTH CARE SP) C

AN/VRC-88F
2 AN/TYQ-105(V)1
DAGR

UNIT MINISTRY TEAM PARA 12

AN/VRC-90F
FBCB2
DAGR



CPT 56A00 (CHAPLAIN)
SP4 56M10 (CHAP ASST) C

Summary of Equipment

WEAPONS

LAUNCHER GRENADE (M320A1)-----	4
MACHINE GUN LIGHT 5.56MM M249-----	4
MACHINE GUN GRENADE 40MM MK-19 MOD III-----	2
PISTOL 9MM AUTOMATIC M9-----	15
RIFLE 5.56MM M4 CARBINE-----	43
MACHINE GUN: CALIBER .50 (M2E2)-----	1

VEHICLES, TRAILERS, AND TRLR MTD SYSTEMS

POWER PLANT: UTILITY, MEDIUM 20KW 5 TON ECU-----	2
TRUCK UTILITY EXP CAPACITY ENH 4X4: M1152A1-----	10
TRUCK UTILITY EXP CAPACITY ENH 4X4: M1165A1-----	7
TRUCK CARGO: 4X4 LMTV (M1078)-----	3
LIGHT TACTICAL TRAILER: 3/4T (M1101)-----	9
TRAILER CARGO: LMTV W/DROPSIDES (M1082)-----	2
TRAILER TANK: WATER 400 GAL 1-1/2T 2 WHL (M149A2)-----	1

MISCELLANEOUS EQUIPMENT

DECON APPARATUS LT WT-----	2
GEN SET: DED SKID MTD 5 KW 60HZ (MEP-802A)-----	1
GEN SET : DED SKID MTD 3KW 60HZ (MEP-831A)-----	3
GEN SET: DED SKID MTD 10KW 60HZ (MEP-803A)-----	2

NIGHT VISION/OBSERVATION EQUIPMENT

NIGHT VISION GOGGLES: AN/PVS-7B-----	40
MEDIUM THERMAL WEAPONS SIGHT: AN/PAS-13(V2)-----	4
HEAVY THERMAL WEAPONS SIGHT: AN/PAS-13(V3)-----	4

COMMUNICATION-ELECTRONICS EQUIPMENT

ALL SOURCE ANALYSIS SYSTEM: AN/TYQ-93 (ASAS-LT)-----	1
ANTENNA GROUP: OE-254-----	16
COMPUTER SYSTEM DIGITAL: AN/TYQ-106(V)1-----	1
COMPUTER SET DIGITAL: AN/UYK-128 (FBCB2)-----	14
COMPUTER SYSTEM DIGITAL: (AMPS)-----	3
COMPUTER SET DIGITAL: AN/PYQ-12 (MCS GATEWAY SVR)-----	1
COMPUTER SYS DIGITAL: AN/TYQ-129(V)2 (TC-AIMS II WS)-----	2
COMPUTER SYSTEM DIGITAL: AN/TYQ-105(V)1-----	5
COMPUTER SET DIGITAL: AN/TYQ-109(V)1 (GCSS-A (V)1)-----	5
COMPUTER SYSTEM DIGITAL: ((CPOF WS) AN/TYQ-137A:(V)2)-----	3
COMMAND CENTER SYSTEM: AN/TSQ-243-----	1
ENCRYPT/DECRYPT EQUIPMENT: TACLANE KG-175-----	1
FREQUENCY HOPPING MULTIPLEXER: TF-1456VRC (FHMUX)-----	2
NAVIGATION SET: SATELLITE SIGNALS AN/PSN-13 (DAGR)-----	18
PROCESSOR GROUP SIGNAL DATA: (CAISI 2.0)-----	5
RADIAC SET: AN/VDR-2-----	5
RECEIVE SUITE: AN/TSR-8 (GRT)-----	1
RADIO SET: AN/GRC-240-----	2
RADIO SET: AN/VRC-88F-----	1
RADIO SET: AN/VRC-89F-----	2
RADIO SET: AN/VRC-90F-----	11
RADIO SET: AN/VRC-92F-----	8
RADIO SET: AN/PRC-119F-----	1
RADIO SET: AN/PSC-5-----	2
RADIO SET: HIGH FREQ AN/VRC-100(V)1-----	2
COMMUNICATIONS SUBSYSTEM: AN/TSQ-259:-----	1
COMP SYS DIGITAL: (AHRs) AN/TYQ-116(V)3-----	9

Command Aviation Company (UH-60)

01218G000
OFF: 3/WO: 13/ENL: 23/TOTAL: 39

COMPANY HEADQUARTERS PARA 01

AN/VRC-92F
AN/PRC-119F
FBCB2
AMPS
DAGR
AN/TYQ-151(V)3



CPT 15B00 (COMMANDER) P
1SG 15Z5M (FIRST SGT) C

CW3 153MB (AVN SAFETY OFF) P
CW3 153MF (AVN STDZN OFF) P
CW3 153MI (TAC OPS OFF) C

C3 FLIGHT PLATOON PARA 02

FBCB2
AN/TYQ-XXX (V) 4 ULLS-A(E)



CPT 15B00 (COMMANDER) P
CW2 153MC (INST PILOT) P
SGT 15T2F (UH-60 CREWCHIEF) P
PFC 15T1F (AIR CREWMEMBER) P

FBCB2
AN/TYQ-XXX (V) 4 ULLS-A(E)



LT 15A00 (PLT LDR) P
CW2 153M0 (UH-60M PILOT) P
SP4 15T1F (UH-60 CREWCHIEF) P
SP4 15T1F (UH-60 AIR CREWMEMBER) P

FBCB2
AN/TYQ-XXX (V) 4 ULLS-A(E)



CW3 153MB (AVN SAFETY OFF) P
CW2 153M0 (MISSION PLANNER) P
SP4 15T1F (UH-60 CREWCHIEF) P
PFC 15T1F (UH-60 AIR CREWMEMBER) P

FBCB2
AN/TYQ-XXX (V) 4 ULLS-A(E)

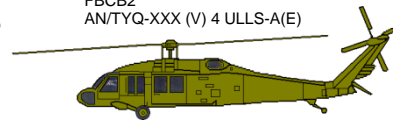

CW2 153MG (AVN MAINT OFF) P
CW2 153M0 (ALSE OFF) P
SP4 15T1F (UH-60 CREWCHIEF) P
PFC 15T1F (UH-60 AIR CREWMEMBER) P

AN/VRC-91F
FBCB2
AMPS
DAGR
CAISI 2.0

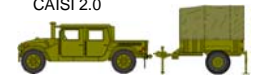

SFC 15T4F (PLT SGT) P

MISSION EQ PACKAGE: ABN C&C
SSG 25U3F (A2C2S CONSOLE NCO) C
X2

C3 FLIGHT PLATOON PARA 03

FBCB2
AN/TYQ-XXX (V) 4 ULLS-A(E)



LT 15A00 (PLT LDR) P
CW2 153MC (INST PILOT) P
SP4 15T1F (UH-60 CREWCHIEF) P
SP4 15T1F (UH-60 AIR CREWMEMBER) P

FBCB2
AN/TYQ-XXX (V) 4 ULLS-A(E)



CW3 153MI (TAC OPS OFF) P
CW2 153M0 (UH-60M PILOT) P
SGT 15T2F (UH-60 CREWCHIEF) P
PFC 15T1F (UH-60 AIR CREWMEMBER) P

FBCB2
AN/TYQ-XXX (V) 4 ULLS-A(E)

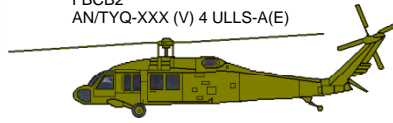

CW3 153MF (AVN STDZN OFF) P
CW2 153M0 (UH-60M PILOT) P
SP4 15T1F (UH-60 CREWCHIEF) P
PFC 15T1F (UH-60 AIR CREWMEMBER) P

FBCB2
AN/TYQ-XXX (V) 4 ULLS-A(E)



CW2 153MG (AVN MAINT OFF) P
CW2 153M0 (ALSE OFF) P
SP4 15T1F (UH-60 CREWCHIEF) P
PFC 15T1F (UH-60 AIR CREWMEMBER) P

AN/VRC-91F
FBCB2
AMPS
DAGR
CAISI 2.0

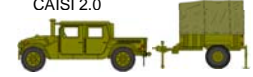

SFC 15T4F (PLT SGT) P

MISSION EQ PACKAGE: ABN C&C
SSG 25U3F (A2C2S CONSOLE NCO) C
X2

Summary of Equipment

WEAPONS

LAUNCHER GRENADE M320A1-----	2
MACHINE GUN LIGHT 5.56MM M249-----	2
MACHINE GUN 7.62MM: M240H-----	16
PISTOL 9MM AUTOMATIC M9-----	34
RIFLE 5.56MM M4 CARBINE-----	21

VEHICLES, TRAILERS, AND TRLR MTD SYSTEMS

HELICOPTER UTILITY: EUH-60L-----	5
HELICOPTER UTILITY: UH-60M-----	3
TRUCK UTILITY EXP CAPACITY ENH 4X4: M1165A1-----	3
LIGHT TACTICAL TRAILER: 3/4T (M1101)-----	3

MISCELLANEOUS EQUIPMENT

GEN SET: DED SKID MTD 5 KW 60HZ (MEP-802A)-----	1
ARMAMENT SUBSYSTEM HELICOPTER 7.62MM MG: LT-----	8

COMMUNICATION-ELECTRONICS EQUIPMENT

COMPUTER SET DIGITAL: AN/UYK-128 (FBCB2)-----	11
COMPUTER SYSTEM DIGITAL: (AMPS)-----	3
MISSION EQUIPMENT PACKAGE: ABN CMD & CNTRL-----	4
NAVIGATION SET: SATELLITE SIGNALS AN/PSN-13 (DAGR)-----	3
PROCESSOR GROUP SIGNAL DATA: (CAISI 2.0)-----	2
RADIAC SET: AN/VDR-2-----	3
RADIO SET: AN/PRC-119F-----	1
RADIO SET: AN/VRC-91F-----	2
RADIO SET: AN/VRC-92F-----	1
COMPUTER SET DIGITAL: AN/TYQ-151(V)3-----	1
COMPUTER SET DIGITAL: AN/TYQ-XXX(V)4 ULLS-A(E)-----	8

NIGHT VISION/OBSERVATION EQUIPMENT

AVIATORS NIGHT VISION IMAGING SYSTEM: AN/AVS-6 (V) 1-----	32
NIGHT VISION GOGGLES: AN/PVS-7B-----	6
MEDIUM WEAPON THERMAL SIGHT (MWTS): AN/PAS-13(V)2-----	2

CAB-7

Heavy Helicopter Company

01247G000
OFF: 4/WO: 20/ENL: 28/TOTAL: 52

COMPANY HEADQUARTERS PARA 01

AN/VRC-92F
AN/PRC-119F
FBCB2
DAGR
EPLRS-V1
AN/TYQ-151 (V) 3



CPT 15B00 (COMMANDER) P
1SG 15Z5M (FIRST SGT) C

CW3 154FB (AVN SAFETY OFF) P
CW3 154FF (AVN STDZN OFF) P
CW3 153MI (TAC OPS OFF) C

CH-47 FLIGHT PLATOON PARA 02

FBCB2
AN/TYQ-XXX (V) 4 ULLS-A(E)

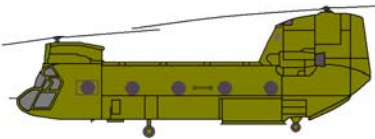

CW3 154FB (AVN SAFETY OFF) P
CW2 154F0 (CH-47F PILOT) P
SSG 15U3F (FLIGHT ENGINEER) P
SGT 15U2F (FLIGHT ENGINEER) P

FBCB2
AN/TYQ-XXX (V) 4 ULLS-A(E)

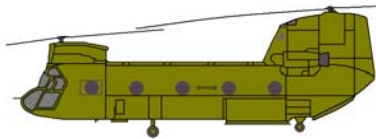

LT 15A00 (PLT LDR) P
CW3 154FF (SR IP/IFE) P
2 SGT 15U2F (FLIGHT ENGINEER) P

FBCB2
AN/TYQ-XXX (V) 4 ULLS-A(E)

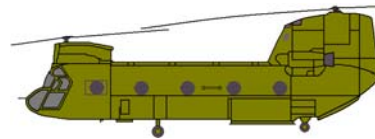

CW2 154FC (INSTR PILOT) P
CW2 154F0 (MISSION PLANNER) P
SSG 15U3F (FLIGHT ENGINEER) P
SGT 15U2F (FLIGHT ENGINEER) P

FBCB2
AN/TYQ-XXX (V) 4 ULLS-A(E)

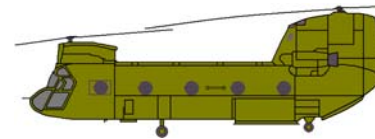

CW2 154FG (AVN MAINT OFF) P
CW2 154F0 (ALSE OFF) P
2 SGT 15U2F (FLIGHT ENGINEER) P

AN/VRC-91F
FBCB2
AMPS
DAGR
CAISI 2.0



SFC 15U4F (PLT SGT) P

CH-47 FLIGHT PLATOON PARA 03

FBCB2
AN/TYQ-XXX (V) 4 ULLS-A(E)

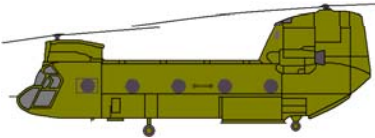

LT 15A00 (PLT LDR) P
CW3 154FF (SR IP/IFE) P
SSG 15U3F (FLIGHT ENGINEER) P
SGT 15U2F (FLIGHT ENGINEER) P

FBCB2
AN/TYQ-XXX (V) 4 ULLS-A(E)

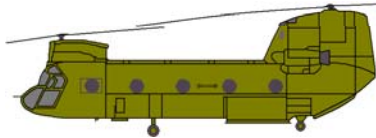

CW2 154FC (INSTR PILOT) P
CW2 154F0 (ALSE OFF) P
2 SGT 15U2F (FLIGHT ENGINEER) P

FBCB2
AN/TYQ-XXX (V) 4 ULLS-A(E)

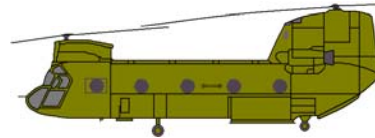

CW3 154FI (TAC OPS OFF) P
CW2 154F0 (CH-47F PILOT) P
SSG 15U3F (FLIGHT ENGINEER) P
SGT 15U2F (FLIGHT ENGINEER) P

FBCB2
AN/TYQ-XXX (V) 4 ULLS-A(E)

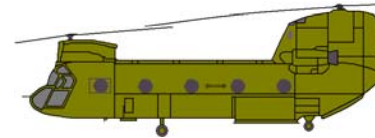

CW2 154FG (AVN MAINT OFF) P
CW2 154F0 (CH-47F PILOT) P
2 SGT 15U2F (FLIGHT ENGINEER) P

AN/VRC-91F
FBCB2
AMPS
DAGR
CAISI 2.0



SFC 15U4F (PLT SGT) P

CH-47 FLIGHT PLATOON PARA 04

FBCB2
AN/TYQ-XXX (V) 4 ULLS-A(E)

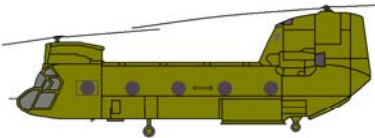

CPT 15B00 (COMMANDER) P
CW3 154FF (SR IP/IFE) P
SSG 15U3F (FLIGHT ENGINEER) P
SGT 15U2F (FLIGHT ENGINEER) P

FBCB2
AN/TYQ-XXX (V) 4 ULLS-A(E)

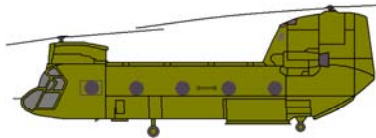

LT 15A00 (PLT LDR) P
CW2 154FC (INSTR PILOT) P
2 SGT 15U2F (FLIGHT ENGINEER) P

FBCB2
AN/TYQ-XXX (V) 4 ULLS-A(E)

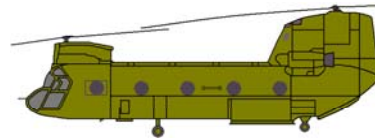

CW3 154FF (AVN STDZN OFF) P
CW2 154F0 (ALSE OFF) P
SSG 15U3F (FLIGHT ENGINEER) P
SGT 15U2F (FLIGHT ENGINEER) P

FBCB2
AN/TYQ-XXX (V) 4 ULLS-A(E)

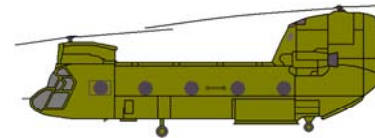

CW2 154FG (AVN MAINT OFF) P
CW2 154F0 (CH-47F PILOT) P
2 SGT 15U2F (FLIGHT ENGINEER) P

AN/VRC-91F
FBCB2
AMPS
DAGR
CAISI 2.0



SFC 15U4F (PLT SGT) P

CAB-8

Summary of Equipment

WEAPONS

LAUNCHER GRENADE 40MM M320A1 -----	2
MACHINE GUN LIGHT 5.56MM M249-----	2
MACHINE GUN 7.62MM: M240H-----	36
PISTOL 9MM AUTOMATIC M9-----	51
RIFLE 5.56MM M4 CARBINE-----	25

VEHICLES, TRAILERS, AND TRLR MTD SYSTEMS

CH-47F IMPROVED CARGO HELICOPTER-----	12
TRUCK UTILITY EXP CAPACITY ENH 4X4: M1165A1-----	4
LIGHT TACTICAL TRAILER: 3/4T (M1101)-----	4

MISCELLANEOUS EQUIPMENT

GEN SET: DED SKID MTD 5 KW 60HZ (MEP-802A)-----	2
ARMT SUBSYSTEM HELICOPTER 7.62MM MG: RMP MTD-----	12

COMMUNICATION-ELECTRONICS EQUIPMENT

COMPUTER SET DIGITAL: AN/UYK-128 (FBCB2)-----	16
COMPUTER SYSTEM DIGITAL: (AMPS)-----	3
NAVIGATION SET: SATELLITE SIGNALS AN/PSN-13 (DAGR)-----	4
PROCESSOR GROUP SIGNAL DATA: (CAISI 2.0)-----	3
RADIAC SET: AN/VDR-2-----	4
RADIO SET: AN/PRC-119F-----	1
RADIO SET: AN/VRC-91F-----	3
RADIO SET: AN/VRC-92F-----	1
COMPUTER SET DIGITAL: AN/TYQ-151 (V) 3-----	1
COMPUTER SET DIGITAL: AN/TYQ-XXX(V) 4 ULLS-A(E)-----	12

NIGHT VISION/OBSERVATION EQUIPMENT

AVIATORS NIGHT VISION IMAGING SYSTEM: AN/AVS-6 (V) 1-----	60
ANVIS/HEADS UP DISPLAY DEVICE: AN/AVS-7-----	12
NIGHT VISION GOGGLES: AN/PVS-7B-----	8
MEDIUM WEAPON THERMAL SIGHT (MWTS): AN/PAS-13(V)2-----	2

Heavy Helicopter Company

Medical Company, Air Ambulance (HH-60)

08443R000
OFF: 10/WO: 26/ENL: 49/TOTAL: 85

COMPANY HEADQUARTERS PARA 01

AN/VRC-92F
FBCB2
AMPS
DAGR

AN/VRC-90F
AN/PRC-119F
AMPS
AN/TYQ-151 (V) 3

AN/VRC-90F
AN/TYQ-107(V)1
AN/TYQ-108(V)3
AN/TYQ-109(V)1
CAISI 2.0
AN/TYQ-139



MAJ 67J00 (COMMANDER) P



CPT 67J00 (OPNS OFF) P
1SG 68W5M (FIRST SGT) C
SSG 15P30 (AVN OPS SGT) C
SGT 25U20 (FWD SPT SGNL NCO) C



SGT 92Y20 (SUPPLY NCO) C
SP4 92Y10 (SUPPLY SP) C

CW3 153MB (AVN SAFETY OFF) P
CW3 153MF (AVN STDZN OFF) P

FORWARD SUPPORT MEDEVAC TEAM PARA 02

FBCB2
AN/TYQ-105(V)1
AN/TYQ-XXX (V) 4 ULLS-A(E)

FBCB2
AN/TYQ-105(V)1
AN/TYQ-XXX (V) 4 ULLS-A(E)

FBCB2
AN/TYQ-105(V)1
AN/TYQ-XXX (V) 4 ULLS-A(E)

AN/VRC-90F
FBCB2
AN/TYQ-106(V)1
AMPS
DAGR
AN/PSC-5
AN/TYQ-151 (V) 3



CW3 153MI (TAC OPS OFF) P
CW2 153MD (AEROMED EVAC PILOT) P
SGT 15T2F (UH-60 CREWCHIEF) P
SGT 68W2F (FLIGHT MEDIC) P
SP4 15T1F (UH-60 AIR CREWMEMBER) P



CW2 153MC (INSTR PILOT) P
CW2 153MD (AEROMED EVAC PILOT) P
SSG 68W3F (AIR AMBULANCE NCO) P
SGT 15T2F (UH-60 CREWCHIEF) P
SP4 15T1F (UH-60 AIR CREWMEMBER) P



CW2 153MG (AVN MAINT OFF) P
CW2 153MD (AEROMED EVAC PILOT) P
SGT 15T2F (UH-60 CREWCHIEF) P
SGT 68W2F (FLIGHT MEDIC) P
SP4 15T1F (UH-60 AIR CREWMEMBER) P

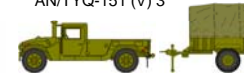

CPT 67J00 (AEROMED EVAC OFF) P
LT 67J00 (SECTION LDR) P
SGT 15P20 (AVN OPS SGT) C
SP4 25U10 (FWD SGNL SPT SP) C

X4

Summary of Equipment

WEAPONS

PISTOL 9MM AUTOMATIC M9----- 73
RIFLE 5.56MM M4 CARBINE----- 61

VEHICLES, TRAILERS, AND TRLR MTD SYSTEMS

MEDEVAC HELICOPTER: HH-60M----- 12
TRUCK CARGO: 4X4 LMTV (M1078)----- 1
TRUCK UTILITY EXP CAPACITY ENH 4X4: M1152A1----- 1
TRUCK UTILITY EXP CAPACITY ENH 4X4: M1165A1----- 5
LIGHT TACTICAL TRAILER: 3/4T (M1101)----- 5

MISCELLANEOUS EQUIPMENT

GEN SET: DED SKID MTD 5 KW 60HZ (MEP-802A)----- 6
TEST SET: ELECTRONIC SYSTEMS (SPORT)----- 12

NIGHT VISION/OBSERVATION EQUIPMENT

AVIATORS NIGHT VISION IMAGING SYSTEM: AN/AVS-6(V)1----- 48
NIGHT VISION GOGGLES: AN/PVS-7B----- 14

COMMUNICATION-ELECTRONICS EQUIPMENT

ANTENNA GROUP: OE-254----- 2
COMPUTER SYSTEM DIGITAL: AN/TYQ-107(V)1 (MC4-3A)----- 1
COMPUTER SYSTEM DIGITAL: AN/TYQ-106(V)1 (MC4-2)----- 4
COMPUTER SET DIGITAL: AN/UYK-128 (FBCB2)----- 17
COMPUTER SYSTEM DIGITAL: (AMPS)----- 6
COMPUTER SYSTEM DIGITAL: AN/TYQ-105(V)1 (MC4-1)----- 12
COMPUTER SYS DIGITAL: AN/TYQ-108(V)3----- 1
COMPUTER SET DIGITAL: AN/TYQ-109(V)1 (GCSS-A (V)1)----- 1
NAVIGATION SET: SATELLITE SIGNALS AN/PSN-13 (DAGR)----- 5
PROCESSOR GROUP SIGNAL DATA: (CAISI 2.0)----- 2
RADIAC SET: AN/VDR-2----- 13
RADIO SET: AN/PRC-119F----- 1
RADIO SET: AN/VRC-90F----- 6
RADIO SET: AN/VRC-92F----- 1
RADIO SET: AN/PSC-5----- 4
COMPUTER SET DIGITAL: AN/TYQ-151 (V) 3----- 5
COMPUTER SET DIGITAL: AN/TYQ-XXX (V) 4 ULLS-A(E)----- 12
COMPUTER SYSTEM: DIGITAL AN/TYQ-139 (SAMS-1E V1)----- 1

Aviation Maintenance Company (AVUM) (GSAB)

01229R100
OFF: 3/WO: 3/ENL: 139/TOTAL: 145

COMPANY HEADQUARTERS PARA 01

AN/VRC-92F
FBCB2
DAGR

AN/VRC-90F
AN/PRC-119F
AN/TYQ-109(V)1
DAGR
CAISI 2.0



CPT 15D00 (COMMANDER) P
PFC 15T10 (VEH DRIVER) C



1SG 15Z5M (FIRST SGT) C
SSG 92Y30 (SUPPLY SGT) C
SP4 74D10 (CBRN SP) C
SP4 92Y10 (SUPPLY SP) C

QUALITY CONTROL SECTION PARA 02

AN/VRC-90F
AN/TYQ-151(V)1 ULLS-A(E)
AN/TYQ-151(V)2



SFC 15T4F (ACFT QUAL CONT SUPV) P
3 SSG 15T3F (UH-60 HEL TI) P
2 SSG 15U3F (CH-47 HEL TI) P
3 SGT 15N2F (AVIONIC TI) P
2 SGT 15T2F (UH-60 HEL TI) P
2 SGT 15U2F (CH-47 HEL TI) P

PRODUCTION CONTROL SECTION PARA 03

AN/VRC-89F OL-713(V)1/TYQ CSS VSAT
AN/PRC-119F AN/TYQ-151 (V) 1 ULLS-A(E)
FBCB2 AN/TYQ-151 (V) 2
AMPS AN/TYQ-250 (V) 1 ULLS-A(E)
DAGR AN/TYQ-153 ULLS-A(E)
CAISI 2.0



CW3 154FG (PROD CONTROL OFF) C
SFC 15K40 (ACFT PROD CONTROL NCO) C
2 SGT 92A20 (EQ RCD/PARTS SGT) C
SP4 15T10 (UH-60 REP) C
SP4 15U10 (CH-47 REP) C
3 SP4 92A10 (EQ RCD/PARTS SP) C
2 PFC 92A10 (EQ RCD/PARTS SP) C

AIRFRAME REPAIR PLATOON HQ PARA 04

AN/PRC-119F

AN/VRC-90F
FBCB2
DAGR
AN/TYQ-151 (V) 1 ULLS-A(E)

AN/VRC-90F
AN/PRC-119F
DAGR

AN/VRC-90F
AN/PRC-119F
DAGR
AN/TYQ-151 (V) 2

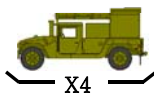

LT 15A00 (PLT LDR) P



CW3 153MG (AVN MAINT OFF) P
SFC 15U40 (PLT SGT) C



UH-60 REPAIR SECTION PARA 05

4 AN/TYQ-151 (V) 1 ULLS-A(E)
AN/TYQ-151 (V) 2

2 SSG 15T30 (SECTION CHIEF) C
4 SGT 15T20 (UH-60 REP/TM CHIEF) C
3 SP4 15T10 (UH-60 REP) C
11 PFC 15T10 (UH-60 REP) C

CH-47 REPAIR SECTION PARA 06

9 AN/TYQ-151(V) 1 ULLS-A(E)
3 AN/TYQ-151 (V) 2

SFC 15U40 (ACFT MAINT SUPV) C
3 SSG 15U30 (SECTION CHIEF) C
4 SGT 15U20 (CH-47 REP) C
23 SP4 15U10 (CH-47 REP) C
3 SP4 15U10 (SELF DEF WPNS SYS REP) C
18 PFC 15U10 (CH-47 REP) C

COMPONENT REPAIR PLATOON HQS PARA 07

AN/VRC-90F
3 AN/PRC-119F
DAGR

AN/VRC-90F

AN/VRC-90F
FBCB2
DAGR
AN/TYQ-151 (V) 1 ULLS-A(E)
AN/TYQ-151 (V) 2

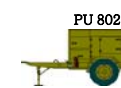

LT 15A00 (PLT LDR) P
CW2 151A0 (AVN MAINT TECH) C
SFC 15K40 (PLATOON SGT) C

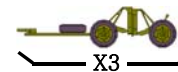

Aviation Support Company (AVUM) (GSAB) (cont)

POWERPLANT SECTION PARA 08

AN/TYQ-151 (V) 1 ULLS-A(E)

SSG 15B30 (ACFT PWRPLANT REP) C
 SGT 15B20 (ACFT PWRPLANT REP) C
 2 SP4 15B10 (ACFT PWRPLANT REP) C
 2 PFC 15B10 (ACFT PWRPLANT REP) C

POWER TRAIN SECTION PARA 09

AN/TYQ-151 (V) 1 ULLS-A(E)

SGT 15D20 (ACFT PWR TRAIN REP) C
 2 SP4 15D10 (ACFT PWR TRAIN REP) C
 2 PFC 15D10 (ACFT PWR TRAIN REP) C

STRUCTURAL SECTION PARA 10

AN/TYQ-151 (V) 1 ULLS-A(E)

SSG 15G30 (ACFT STRUCT REP) C
 SGT 15G20 (ACFT STRUCT REP) C
 3 SP4 15G10 (ACFT STRUCT REP) C
 3 PFC 15G10 (ACFT STRUCT REP) C

PNEUDRAULICS SECTION PARA 11

AN/TYQ-151 (V) 1 ULLS-A(E)

SGT 15H20 (ACFT PNEUDRAUL REP) C
 SP4 15H10 (ACFT PNEUDRAUL REP) C
 PFC 15H10 (ACFT PNEUDRAUL REP) C

AVIONICS/ELECTRICAL SECTION PARA 12

AN/VRC-90F
 2 AN/TYQ-151 (V) 1 ULLS-A(E)



SFC 15K40 (AVIONICS MAINT SUPV) C
 SSG 15F30 (ACFT ELECTRICIAN SUPV) C
 SSG 15N30 (AVIONIC LINE SUPV) C
 SGT 15F20 (ACFT ELECTRICIAN) C
 SGT 15N20 (AVIONIC MECH) C
 2 SP4 15F10 (ACFT ELECTRICIAN) C
 3 SP4 15N10 (AVIONIC MECH) C
 3 PFC 15F10 (ACFT ELECTRICIAN) C
 2 PFC 15N10 (AVIONIC MECH) C

Summary of Equipment

WEAPONS

LAUNCHER GRENADE M320A1-----	2
MACHINE GUN LIGHT 5.56MM M249-----	2
MACHINE GUN GRENADE 40MM: MK-19 MOD III-----	2
PISTOL 9MM AUTOMATIC M9-----	19
RIFLE 5.56MM M16A2-----	133
MACHINE GUN: CALIBER .50 (M2E2)-----	

VEHICLES, TRAILERS, AND TRLR MTD SYSTEMS

CRANE WHEEL MTD: HYDRAULIC LT 7-1/2 TON W/CAB-----	1
FLOODLIGHT SET TLR MTD 3 FLOODLIGHTS 1000 WATTS-----	2
DOLLY SET LIFT TRANSPORTABLE SHEL: 2 1/2T (M707A1)-----	3
GEN SET DIESEL ENGINE TM: 15KW 50/60HZ (PU-802)-----	1
TRUCK UTILITY EXP CAPACITY ENH 4X4: M1152A1-----	5
TRUCK UTILITY EXP CAPACITY ENH 4X4: M1165A1-----	1
TRUCK CARGO: 4X4 LMTV (M1078)-----	10
TRUCK VAN LMTV (M1079)-----	1
TRUCK LIFT FORK: (ATLAS)-----	1
LIGHT TACTICAL TRAILER: 3/4T (M1101)-----	1
TRAILER CARGO: LMTV W/DROPSIDES (M1082)-----	7
TRAILER TANK: WATER 400 GAL 1-1/2T 2 WHL (M107A1)-----	1

NIGHT VISION/OBSERVATION EQUIPMENT

NIGHT VISION GOGGLES: AN/PVS-7B-----	35
MEDIUM THERMAL WEAPONS SIGHT: AN/PAS-13 (V2)-----	2
HEAVY THERMAL WEAPONS SIGHT: AN/PAS-13 (V3)-----	8

COMMUNICATION-ELECTRONICS EQUIPMENT

ANTENNA GROUP: OE-254-----	3
COMPUTER SET DIGITAL: AN/UYK-128 (FBCB2)-----	7
COMPUTER SYSTEM DIGITAL: (AMPS)-----	1
COMPUTER SET DIGITAL: AN/TYQ-109(V)1 (GCSS-A (V)1)-----	1
NAVIGATION SET: SATELLITE SIGNALS AN/PSN-13 (DAGR)-----	10
PROCESSOR GROUP SIGNAL DATA: (CAISI 2.0)-----	2
RADIAC SET: AN/VDR-2-----	3
RADIO SET: AN/PRC-89F-----	1
RADIO SET: AN/VRC-90F-----	15
RADIO SET: AN/VRC-92F-----	1
RADIO SET: AN/PRC-119F-----	8
INTERFACE UNIT COMM EQ: OL-713(V)1/TYQ CSS VSAT-----	1
COMPUTER SET DIGITAL: AN/TYQ-151 (V) 1 ULLS-A(E)-----	24
COMPUTER SET DIGITAL: AN/TYQ-151 (V) 2-----	9
COMPUTER SET DIGITAL: AN/TYQ-150 (V) 1 ULLS-A(E)-----	1
COMPUTER SET DIGITAL: AN/TYQ-153 ULLS-A(E)-----	1

MISCELLANEOUS EQUIPMENT

CONTAINER ASSBLY: AIRMOBILE TYPE X-4 200 CU FT CAP-----	2
GENERATOR SET: DED SKID MTD 5KW 60 HZ (MEP 802A)-----	2
GEN SET : DED SKID MTD 3KW 60HZ (MEP-831A)-----	2
POWER UNIT AUXILIARY: (AGPU)-----	3
SHOP EQUIP CONTACT MAINT (SECM): AVIATION-----	5
UNIT MAINT AERIAL RECOVERY KIT: (UMARK)-----	2
STANDARD AIRCRAFT TOWING SYSTEM: (SATS)-----	3

Forward Support Company, (GSAB) w/ATS

TOE 63217R500
OFF: 4/WO: 1/ENL: 112/TOTAL: 117

COMPANY HEADQUARTERS PARA 01

AN/VRC-92F
AN/UYQ-90(V)2
AN/UYQ-90(V)3
DAGR

AN/VRC-90F
AN/GYK-61 (BCS3)
DAGR
CAISI 2.0

AN/TYQ-109(V)1



CPT 90A00 (COMMANDER) P 1SG 91Z5M (FIRST SGT) C
LT 88A00 (EXBC OFF) C
SSG 92Y30 (SUPPLY SGT) C
SP4 74D10 (CBRN SP) C
SP4 92Y10 (SUPPLY SP) C

FIELD FEEDING SECTION PARA 02

AN/VRC-90F
DAGR

AN/VRC-90F
DAGR

AN/VRC-90F
DAGR

AN/VRC-90F
DAGR

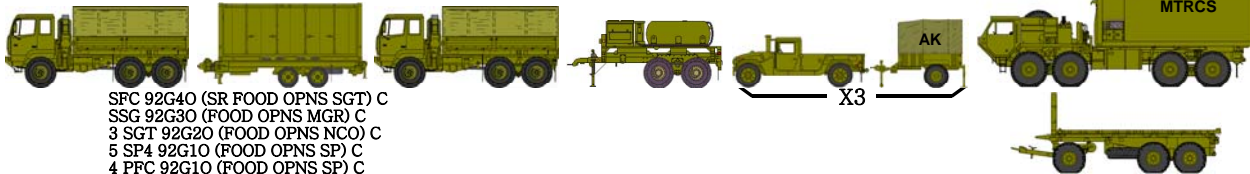

SFC 92G40 (SR FOOD OPNS SGT) C
SSG 92G30 (FOOD OPNS MGR) C
3 SGT 92G20 (FOOD OPNS NCO) C
5 SP4 92G10 (FOOD OPNS SP) C
4 PFC 92G10 (FOOD OPNS SP) C

X3

DISTRIBUTION PLATOON HQ PARA 03

AN/VRC-92F
AN/UYQ-90(V)2
FBCB2
AN/TYQ-129(V)2
AN/UYQ-90(V)3
DAGR

AN/VRC-90F
DAGR

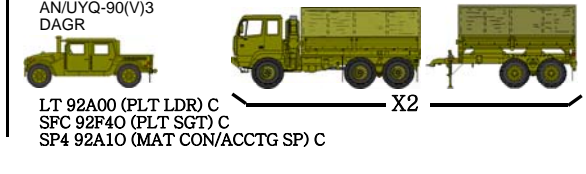

LT 92A00 (PLT LDR) C
SFC 92F40 (PLT SGT) C
SP4 92A10 (MAT CON/ACCTG SP) C

X2

CLASS III SECTION (HEAVY) PARA 04

AN/VRC-90F
AN/PRC-119F
AN/UYQ-90(V)2
DAGR

AN/VRC-90F
AN/UYQ-90(V)2
DAGR



SSG 92F30 (SECTION CHIEF) C
PFC 92F10 (ACFT FUEL HANDLER) C
X3

X9

X6

6 SGT 92F20 (ACFT FUEL HANDLER) C
9 SP4 92F10 (ACFT FUEL HANDLER) C

CLASS III SECTION (UTILITY) PARA 05

AN/PRC-119F
AN/UYQ-90(V)2
DAGR

AN/VRC-90F
AN/UYQ-90(V)2

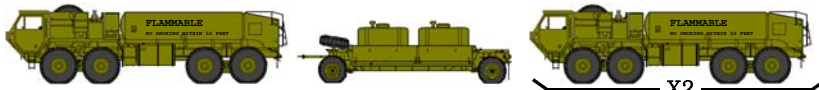

SSG 92F30 (SECTION CHIEF) C
PFC 92F10 (ACFT FUEL HANDLER) C

X2

2 SGT 92F20 (ACFT FUEL HANDLER) C
3 SP4 92F10 (ACFT FUEL HANDLER) C
PFC 92F10 (ACFT FUEL HANDLER) C

CLASS III SECTION (AIR AMBULANCE) PARA 06

AN/VRC-90F
AN/PRC-119F
DAGR

AN/VRC-90F
DAGR



SSG 92F30 (SECTION CHIEF) C
SP4 92F10 (ACFT FUEL HANDLER) C

X3

3 SGT 92F20 (ACFT FUEL HANDLER) C
3 SP4 92F10 (ACFT FUEL HANDLER) C
2 PFC 92F10 (ACFT FUEL HANDLER) C

Forward Support Company, (GSAB) w/ATS (cont)

DISTRIBUTION SECTION PARA 07

AN/VRC-90F
AN/UYQ-90(V)2
DAGR

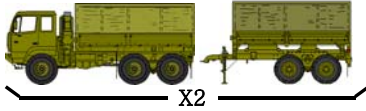

X2

SSG 88M30 (SECTION CHIEF) C
SP4 88M10 (VEH DRIVER) C
3 PFC 88M10 (VEH DRIVER) C

AN/VRC-90F
AN/UYQ-90(V)2
DAGR



X2

2 SP4 92F10 (PETRL HVY VEH OPR) C



X2

MAINTENANCE CONTROL & PLATOON HQ PARA 08

AN/VRC-92F
FBCB2
DAGR



LT 91A00 (PLT LDR) C
SFC 91X40 (PLT SGT) C

AN/VRC-90F
AN/UYQ-90(V)2
FBCB2
DAGR



AN/VRC-89F
FBCB2
AN/TYQ-90(V)3
DAGR
CAISI 2.0
OL-713(V)1/TYQ CSS VSAT
4 AN/TYQ-139
AN/TYQ-140



PU 2101

AN/VRC-90F
FBCB2
DAGR



CW2 915A0 (AUTO MAINT WO) C
SGT 92A20 (EQ RCD/PARTS SGT) C
SP4 92A10 (EQ RCD/PARTS SP) C
2 PFC 92A10 (EQ RCD/PARTS SP) C



MAINTENANCE SECTION PARA 09

AN/VRC-90F
FBCB2
DAGR



SFC 91X40 (MOTOR SGT) C

AN/VRC-90F
AN/UYQ-90(V)2
FBCB2
DAGR



X2

AN/VRC-90F
FBCB2
DAGR



X2

AN/VRC-90F
AN/UYQ-90(V)2
FBCB2
DAGR

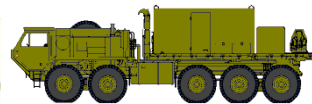

SSG 91B30 (SHOP FOREMAN) C
SSG 91B30 (SR MECHANIC) C
5 SGT 91B20 (WH VEH MECH) C
SGT 91C20 (UTIL EQ REP) C
SGT 91D20 (PWR-GEN EQ REP) C
SGT 91F20 (SM ARMS/ARTY REP) C
SGT 91J20 (QM/CHEM EQ REP) C
5 SP4 91B10 (WH VEH MECH) C
SP4 91D10 (PWR-GEN EQ REP) C
SP4 91F10 (SM ARMS/ARTY REP) C

AN/VRC-90F
FBCB2
DAGR



AN/VRC-90F
FBCB2
DAGR



SP4 91E10 (ALLIED TRADES SP) C

AN/VRC-90F
FBCB2
DAGR



AN/ASM-146

PU 2101

AN/VRC-90F
AN/UYQ-90(V)2
FBCB2
DAGR



SGT 91B20 (RCVY VEH OPR) C

AN/VRC-90F
AN/UYQ-90(V)2
FBCB2
DAGR



SP4 91B10 (RCVY VEH OPR) C

Summary of Equipment

WEAPONS

LAUNCHER GRENADE 40MM M320A1-----	4
MACHINE GUN 5.56MM M249-----	12
MACHINE GUN LIGHT 5.56MM M249-----	4
PISTOL 9MM AUTOMATIC M9-----	1
RIFLE 5.56MM M4 CARBINE-----	104
MACHINE GUN: CALIBER .50 (M2E2)-----	11

VEHICLES, TRAILERS, AND TRLR MTD SYSTEMS

CONTAINERIZED KITCHEN (CK)-----	1
FORWARD REPAIR SYSTEM: M7 (FRS)-----	1
GEN SET DIESEL ENGINE TM: 15KW 50/60HZ (PU-802)-----	2
SEMITRAILER VAN: SUPPLY 12T 4 WHL (M129A2C)-----	1
TRUCK UTILITY EXP CAPACITY ENH 4X4: M1152A1-----	7
TRUCK VAN EXPANSIBLE MTV (M1087A1)-----	1
TRAILER FLAT BED: 11 TON 4 WHL (M989A1) (HEMAT)-----	10
TRUCK UTILITY EXP CAPACITY ENH 4X4: M1165A1-----	3
TRUCK CARGO: 4X4 LMTV (M1078)-----	2
TRUCK CARGO: HVY PLS TRANSPORTER 10X10 (M1075)-----	1
TRUCK VAN LMTV (M1079)-----	1
TRUCK CARGO: MTV (M1083)-----	9
TRUCK CARGO MTV LWB (M1085)-----	1
TRUCK TANK: FUEL SERVICING 2500 GAL 8X8 HEMTT (M978)-----	21
TRUCK TRACTOR MTV (M1088)-----	1
TRUCK LIFT: FORK VARIABLE REACH RT (ATLAS)-----	2
TRAILER: PLS 8X20 (M1076)-----	1
TRUCK WRECKER: TACTICAL 8X8 HEMTT (M984A1)-----	1
TRUCK WRECKER: MTV (M1089)-----	1
LIGHT TACTICAL TRAILER: 3/4T (M1101)-----	4
TRUCK CARGO HEMTT LHS (M1120)-----	1
TRAILER CARGO: LMTV W/DROPSIDES (M1082)-----	2
SHOP EQUIPMENT: WELDING TRAILER MTD-----	1
TRAILER TANK WATER (CAMEL) 800 GAL 5 TON-----	2

NIGHT VISION/OBSERVATION EQUIPMENT

DRIVERS VISION ENHANCER: AN/VAS-5-----	28
NIGHT VISION GOGGLES: AN/PVS-7B-----	104
MEDIUM THERMAL WEAPONS SIGHT: AN/PAS-13(V2)-----	13
HEAVY THERMAL WEAPONS SIGHT: AN/PAS-13(V3)-----	11

COMMUNICATION-ELECTRONICS EQUIPMENT

ANTENNA GROUP: OE-254-----	3
COMPUTER SYSTEM DIGITAL: AN/UYQ-90(V)2 (MTS)-----	28
COMPUTER SET DIGITAL: AN/UYK-128 (FBCB2)-----	16
BTL CMD SUSTAINMENT SPT SYSTEM: AN/GYK-61 (BCS3)-----	1
COMPUTER SYS DIGITAL: AN/TYQ-129(V)2 (TC-AIMS II WS)-----	1
COMPUTER SET DIGITAL: AN/TYQ-109(V)1 (GCSS-A (V)1)-----	1
COMPUTER SYSTEM DIGITAL: AN/UYQ-90(V)3 (MTS-CS)-----	3
NAVIGATION SET: SATELLITE SIGNALS AN/PSN-13 (DAGR)-----	49
PROCESSOR GROUP SIGNAL DATA: (CAISI 2.0)-----	2
RADIAC SET: AN/VDR-2-----	8
RADIO SET: AN/VRC-89F-----	1
RADIO SET: AN/VRC-90F-----	45
RADIO SET: AN/VRC-92F-----	3
RADIO SET: AN/PRC-119F-----	5
INTERFACE UNIT COMM EQ: OL-713(V)1/TYQ CSS VSAT-----	1
COMPUTER SYSTEM: DIGITAL AN/TYQ-139 (SAMS-1E V1)-----	4
COMPUTER SYSTEM: DIGITAL AN/TYQ-140 (SAMS/SAMS-1E V2)-----	1

MISCELLANEOUS EQUIPMENT

ASSAULT KITCHEN (AK)-----	3
BED CARGO: DEMOUNTABLE PLS 8X20-----	1
FORWARD AREA REFUELING SYSTEM: ADV AVN (AAFARS)-----	2
GEN SET : DED SKID MTD 3KW 60HZ (MEP-831A)-----	2
ELECTRONICS SHOP SHEL MTD AVIONICS: AN/ASM-146-----	1
REFUELING SYTEM: AVIATION HEMTT TANKER-----	4
SHOP EQUIP: CONTACT MAINT ORD/ENGR TRK MTD-----	2
TANK UNIT LIQUID DISPENSING TRAILER MTG-----	19
TOWBAR MOTOR VEHICLE: WHEELED-----	5
MULTI-TEMP REFRIGERATED CONTAINER SYS: MTRCS-----	1
GENERATOR SET DED 5KW 50/60HZ: SKID MTD (TEP)-----	1
GEN SET DED 10KW 50/60HZ: SKID-MTD (TEP)-----	3

Forward Support Company, GSAB w/ATS

ATS Company (Med)

01227G000
OFF: 1/WO: 2/ENL: 42/TOTAL: 45

COMPANY HEADQUARTERS PARA 01

AN/VRC-89F
AMPS
DAGR



CPT 15B00 (COMMANDER) P
1SG 15P5M (FIRST SGT) C
SP4 74D10 (CBRN SP) C
PFC 15Q10 (VEH DRIVER) C

COMMUNICATION/NAVIGATIONAL (COMNAV) MAINTENANCE SECTION PARA 02

AN/VRC-90F
DAGR
CAISI 2.0
AN/VRC-100(V)1
AN/TYQ-151 (V) 1 ULLS-A(E)

AN/VRC-90F
DAGR
AN/TYQ-139
AN/TYQ-140



SSG 94D30 (ATC SYS MAINT SUPV) C
SGT 94D20 (ATC EQ REP) C
2 SP4 94D10 (ATC EQ REP) C
PFC 94D10 (ATC EQ REP) C

TERMINAL CONTROL PLATOON HQ PARA 03

AN/VRC-90F
DAGR



CW2 150AB (ATASM TECH) C
SFC 15Q40 (PLT SGT) C

CONTROL TOWER TEAM PARA 04

AN/VRC-92F
AN/ARC-220(V)1
DAGR

DAGR

MOBILE TOWER SYSTEM (MOTS)



SSG 15Q30 (FACILITY CHIEF) C
2 SGT 15Q20 (SHIFT LEADER) C
4 SP4 15Q10 (ATC TOWER OPR) C
2 PFC 15Q10 (ATC TOWER OPR) C

GCA TEAM PARA 05

AN/TPN-31 ATNAVICS



SSG 15Q30 (FACILITY CHIEF) C
2 SGT 15Q20 (SHIFT LEADER) C
2 SP4 15Q10 (ATC GCA OPR) C
2 PFC 15Q10 (ATC GCA OPR) C

AIRSPACE INFO RMATION SERVICES PLATOON HQ PARA 06

AN/VRC-90F
DAGR



CW2 150AB (ATASM TECH) C
SFC 15Q40 (PLT SGT) C

AIRSPACE INFORMATION CENTER TEAM PARA 07

AN/VRC-92F
DAGR
EPLRS-V1
AN/ARC-220(V)1
AN/PSC-5

AN/VRC-90F
DAGR

AN/TSQ-221



SSG 15Q30 (FACILITY CHIEF) C
2 SGT 15Q20 (SHIFT LEADER) C
3 SP4 15Q10 (ATC GCA OPR) C
2 PFC 15Q10 (ATC GCA OPR) C

TACTICAL TEAM PARA 08

AN/VRC-91F
DAGR

AN/TSQ-198 (TTCS)



SGT 15Q20 (TACTICAL TEAM LEADER) C
2 SP4 15Q10 (ATC TOWER OPR) C
PFC 15Q10 (ATC TOWER OPR) C

X2

Summary of Equipment

WEAPONS

LAUNCHER GRENADE M320A1-----	4
MACHINE GUN LIGHT 5.56MM M249-----	4
PISTOL 9MM AUTOMATIC M9-----	1
RIFLE 5.56MM M4 CARBINE-----	44

VEHICLES, TRAILERS, AND TRLR MTD SYSTEMS

DOLLY SET LIFT TRANSPORTABLE SHEL: 2 1/2T (M707A1)-----	1
GEN SET DIESEL ENGINE TM: 15KW 50/60HZ (PU-802)-----	2
GEN SET DIESEL ENGINE TM: 15KW 60HZ (PU-801)-----	1
TRUCK UTILITY EXP CAPACITY ENH 4X4: M1152A1-----	9
TRUCK UTILITY EXP CAPACITY ENH 4X4: M1165A1-----	3
TRUCK CARGO: 4X4 LMTV (M1078)-----	3
TRAILER HIGH MOBILITY 1-1/4T (M1102)-----	6
LIGHT TACTICAL TRAILER: 3/4T (M1101)-----	5

NIGHT VISION/OBSERVATION EQUIPMENT

DRIVERS VISION ENHANCER: AN/VAS-5-----	15
NIGHT VISION GOGGLES: AN/PVS-7B-----	32
MEDIUM THERMAL WEAPONS SIGHT: AN/PAS-13(V2)-----	4

COMMUNICATION-ELECTRONICS EQUIPMENT

ANTENNA GROUP: OE-254-----	6
COMPUTER SYSTEM DIGITAL: (AMPS)-----	1
COMMS SYS: TACT TERM CONT SYS (TTCS) AN/TSQ-198-----	2
COMMAND SYSTEM: TACTICAL AN/TSQ-221-----	1
NAVIGATION SET: SATELLITE SIGNALS AN/PSN-13 (DAGR)-----	12
PIH SURFACE VEH RADIO SET: AN/VSQ-2(V)1 (EPLRS-V1)-----	1
PROCESSOR GROUP SIGNAL DATA: (CAISI 2.0)-----	1
RADIAC SET: AN/VDR-2-----	5
RADIO SET: HIGH FREQUENCY AN/ARC-220(V)1-----	2
RADIO SET: AN/VRC-89F-----	1
RADIO SET: AN/VRC-90F-----	5
RADIO SET: AN/VRC-91F-----	2
RADIO SET: AN/VRC-92F-----	2
RADIO SET: HIGH FREQUENCY AN/VRC-100V)1-----	1
COMPUTER SYSTEM: DIGITAL AN/TYQ-139 (SAMS-1E V1)-----	1
COMPUTER SYSTEM: DIGITAL AN/TYQ-140 (SAMS/SAMS-1E V2)-----	1

MISCELLANEOUS EQUIPMENT

BEACON SET RADIO: AN/TRN-30(V)1-----	3
BEACON SET RADIO: AN/TRN-30(V)2-----	1
ELECTRONICS SHOP SHEL MTD AVIONICS: AN/ASM-146-----	2
ELECTRONICS SHOP SHEL MTD AVIONICS: AN/ASM-147-----	1
RADAR SET: AN/TPN-31-----	1
GENERATOR SET DED 5KW 50/60HZ: SKID MTD (TEP)-----	2
GEN SET DED 10KW 50/60HZ: SKID-MTD (TEP)-----	2
GENERATOR SET DED 15KW 50/60HZ: SKID MTD (TEP)-----	2
MOBILE TOWER SYSTEM: (MOTS)-----	1

ATS Company (Hvy)

HHC, Assault Bn

01206R000
OFF: 16/WO: 5/ENL: 55/TOTAL: 76

COMMAND SECTION PARA 01

AN/VRC-92F
FBCB2
DAGR



LTC 15B00 (COMMANDER) P
PFC 15P10 (VEH DRIVER) C

AN/VRC-89F
FBCB2
DAGR



MAJ 15B00 (EXEC OFF) P
PFC 15P10 (VEH DRIVER) C

CSM 00Z50 (CMD SGM) P

CW4 153MB (AVN SAFETY OFF) P
CW4 153MH (AVN STDZN OFF) P

S1 SECTION PARA 02

AN/VRC-90F
DAGR
CAISI 2.0
5 AN/TYQ-116(V)3



CPT 42B00 (S1) C
SPC 42A40 (SR HUMAN RES SGT) C
SSG 42A30 (HUMAN RES SGT) C
SGT 42A20 (HUMAN RES SGT) C
SP4 27D10 (PARALEGAL SP) C
SP4 42A10 (HUMAN RES SP) C
2 PFC 42A10 (HUMAN RES SP) C

S2 SECTION PARA 03

AN/VRC-92F
AN/TYQ-93
FBCB2
DAGR



CPT 15C35 (S2) P
LT 35D00 (ASST S2) C
SSG 35F30 (INTEL SGT) C
SP4 35F10 (INTEL ANALYST) C
PFC 35F10 (INTEL ANALYST) C

S3 SECTION PARA 04

AN/VRC-92F
FBCB2
DAGR



MAJ 15B00 (S3) P

AN/VRC-92F
AN/VRC-90F
FBCB2
AMPS
AN/PYQ-12
AN/TYQ-129(V)2
AN/TSQ-243



CPT 15B00 (ASST S3) P
LT 74B00 (CBRN OFF) C
CW3 153MI (TAC OPS OFF) P
MSG 15P50 (SR AVN OPS SGT) C
SSG 15P30 (ASST AVN OPS SGT) C
SSG 74D30 (CBRN NCO) C
2 SGT 15P20 (AVN OPS SGT) C
SGT 29E20 (EW SGT) C
3 SP4 15P10 (AVN OPS SP) C
3 PFC 15P10 (AVN OPS SP) C

MED PWR PLANT

AN/VRC-90F
DAGR



TACTICAL CP PARA 05

AN/VRC-92F
FBCB2
AMPS
DAGR
AN/GRC-240
AN/PSC-5



CPT 15B00 (ASST S3) P
SGT 15P20 (AVN OPS SGT) C
2 SP4 15P10 (AVN OPS SP) C
PFC 15P10 (AVN OPS SP) C

AVN LIAISON ELEMENT PARA 06 S4 SECTION PARA 07

AN/VRC-90F
FBCB2
AMPS
DAGR



LT 15A00 (LNO) P
CW3 153MI (TAC OPS OFF) P
SP4 15P10 (AVN OPS SP) C

AN/VRC-89F
FBCB2
DAGR



CPT 15B00 (S4) P

AN/VRC-92F
FBCB2
AN/TYQ-129(V)2
AN/TYQ-109(V)1
KG-175
AN/TYQ-95



CW3 153MG (AVN MATERIEL OFF) P
SFC 92Y40 (SR SUPPLY SGT) C
SP4 92Y10 (SUPPLY SP) C
PFC 92Y10 (SUPPLY SP) C

MED PWR PLANT

AN/VRC-90F
DAGR



COMPANY HEADQUARTERS PARA 08

AN/VRC-90F
AN/PRC-119F
FBCB2
DAGR
CAISI 2.0



CPT 15B00 (COMMANDER) P
PFC 15P10 (VEH DRIVER) C

AN/VRC-90F



1SG 15Z5M (FIRST SGT) C
SGT 74D20 (CBRN NCO) C

HHC, Assault Bn (cont)

SUPPLY SECTION (BN) PARA 09

AN/VRC-90F
AN/TYQ-109(V)1
DAGR
CAISI 2.0



SSG 92Y30 (SUPPLY SGT) C
2 SP4 92Y10 (SUPPLY SP) C
PFC 92Y10 (SUPPLY SP) C

S6 SECTION PARA 10

AN/VRC-90F
FBCB2
DAGR



CPT 25A00 (S6) C

AN/VRC-90F
FBCB2
AN/TYQ-137A:(V)2
DAGR
AN/TSR-8 (GRT)
AN/TSQ-259

BCP (SWITCHING GP): OM-87A/T

PU 798



SFC 25U40 (SECTION CHIEF) C
SGT 25Q20 (SR XMSN SYS OPR-MAINT) C
SP4 25B10 (LAN MGR) C
SP4 25Q10 (XMSN SYS OPR-MAINT) C
SP4 25U10 (SGNL SPT SYS MAINT) C
SP4 25U10 (SGNL INFO SVC SP) C
PFC 25B10 (LAN MGR) C
PFC 25U10 (SGNL SPT SYS SP) C

2 AN/VRC-92F
FBCB2
FHMUX
DAGR



SGT 25U20 (TEAM CHIEF) C
SP4 25U10 (RADIO RETRANS OPR) C
PFC 25U10 (RADIO RETRANS OPR) C

MEDICAL TREATMENT TEAM PARA 11

AN/VRC-90F
AN/TYQ-106(V)1
FBCB2
3 AN/TYQ-105(V)1
DAGR
CAISI 2.0

AN/VRC-88F
2 AN/TYQ-105(V)1
DAGR



CPT 61N00 (FLIGHT SURGEON) P
CPT 65D00 (PHYSICIAN ASST) P
SSG 68W30 (HEALTH CARE SGT) C
SP4 68W10 (HEALTH CARE SP) C
PFC 68W10 (HEALTH CARE SP) C

UNIT MINISTRY TEAM PARA 12

AN/VRC-90F
FBCB2
DAGR



CPT 56A00 (CHAPLAIN)
SP4 56M10 (CHAP ASST) C

Summary of Equipment

WEAPONS

LAUNCHER GRENADE M320A1-----	4
MACHINE GUN LIGHT 5.56MM M249-----	4
MACHINE GUN GRENADE 40MM MK-19 MOD III-----	2
PISTOL 9MM AUTOMATIC M9-----	20
RIFLE 5.56MM M16A2-----	58
MACHINE GUN: CALIBER .50 (M2E2)-----	1

VEHICLES, TRAILERS, AND TRLR MTD SYSTEMS

GEN SET DED TM: 10KW 60HZ (PU-798)-----	1
POWER PLANT: UTILITY, MEDIUM 20KW 5 TON ECU-----	2
TRUCK UTILITY EXP CAPACITY ENH 4X4: M1152A1-----	12
TRUCK UTILITY EXP CAPACITY ENH 4X4: M1165A1-----	7
TRUCK CARGO: 4X4 LMTV (M1078)-----	3
LIGHT TACTICAL TRAILER: 3/4T (M1101)-----	9
TRAILER CARGO: LMTV W/DROPSIDES (M1082)-----	2
TRAILER TANK: WATER 400 GAL 1-1/2T 2 WHL (M149A2)-----	1

MISCELLANEOUS EQUIPMENT

DECON APPARATUS LT WT-----	2
GEN SET: DED SKID MTD 5 KW 60HZ (MEP-802A)-----	1
GEN SET : DED SKID MTD 3KW 60HZ (MEP-831A)-----	3
GEN SET DED 10KW 50/60HZ: SKID MTD (TEP)-----	2

NIGHT VISION/OBSERVATION EQUIPMENT

NIGHT VISION GOGGLES: AN/PVS-7B-----	44
MEDIUM THERMAL WEAPONS SIGHT: AN/PAS-13(V2)-----	4
HEAVY THERMAL WEAPONS SIGHT: AN/PAS-13(V3)-----	4

COMMUNICATION-ELECTRONICS EQUIPMENT

ALL SOURCE ANALYSIS SYSTEM: AN/TYQ-93 (ASAS-LT)-----	1
ANTENNA GROUP: OE-254-----	16
COMPUTER SYSTEM DIGITAL: AN/TYQ-106(V)1-----	1
COMPUTER SET DIGITAL: AN/UYK-128 (FBCB2)-----	15
COMPUTER SYSTEM DIGITAL: (AMPS)-----	3
COMPUTER SET DIGITAL: AN/PYQ-12 (MCS GATEWAY SVR)-----	1
COMPUTER SYS DIGITAL: AN/TYQ-129(V)2 (TC-AIMS II WS)-----	2
COMPUTER SYSTEM DIGITAL: AN/TYQ-105(V)1-----	5
COMPUTER SET DIGITAL: AN/TYQ-109(V)1 (GCSS-A (V)1)-----	5
COMPUTER SYSTEM DIGITAL: ((CPOF WS) AN/TYQ-137A:(V)2)-----	1
COMMAND CENTER SYSTEM: AN/TSQ-243-----	1
ENCRYPT/DECRYPT EQUIPMENT: TACLANE KG-175-----	1
FREQUENCY HOPPING MULTIPLEXER: TF-1456VRC (FHMUX)-----	2
NAVIGATION SET: SATELLITE SIGNALS AN/PSN-13 (DAGR)-----	19
PROCESSOR GROUP SIGNAL DATA: (CAISI 2.0)-----	5
RADIAC SET: AN/VDR-2-----	5
RECEIVE SUITE: AN/TSR-8 (GRT)-----	1
RADIO SET: AN/GRC-240-----	2
RADIO SET: AN/VRC-88F-----	1
RADIO SET: AN/VRC-89F-----	2
RADIO SET: AN/VRC-90F-----	13
RADIO SET: AN/VRC-92F-----	8
RADIO SET: AN/PRC-119F-----	1
RADIO SET: AN/PSC-5-----	2
RADIO SET: HIGH FREQ AN/VRC-100(V)1-----	2
BATTALION COMMAND POST (SWITCHING GROUP): OM-87A/T-----	1
COMMUNICATIONS SUBSYSTEM: AN/TSQ-259:-----	1
COMP SYS DIGITAL: (AHR) AN/TYQ-116(V)3-----	5

HHC, Assault Bn

Assault Company (UH-60)

01207G200
OFF: 3/WO: 17/ENL: 23/TOTAL: 43

COMPANY HEADQUARTERS PARA 01

AN/VRC-92F
AN/PRC-119F
FBCB2
DAGR
EPLRS-V1
AN/TYQ-XXX(V)3 ULLS-A(E)



CPT 15B00 (COMMANDER) P
1SG 15Z5M (FIRST SGT) C

CW3 153MB (AVN SAFETY OFF) P
CW3 153MF (AVN STDZN OFF) P
CW3 153MI (TAC OPS OFF) C

ASSAULT PLATOON PARA 02

FBCB2
AN/TYQ-XXX (V) 4 ULLS-A(E)



CPT 15B00 (COMMANDER) P
CW2 153MC (INST PILOT) P
SGT 15T2F (UH-60 CREWCHIEF) P
PFC 15T1F (UH-60 AIR CREWMEMBER) P

FBCB2
AN/TYQ-XXX (V) 4 ULLS-A(E)



LT 15A00 (PLT LDR) P
CW2 153M0 (UH-60M PILOT) P
SP4 15T1F (UH-60 CREWCHIEF) P
SP4 15T1F (UH-60 AIR CREWMEMBER) P

FBCB2
AN/TYQ-XXX (V) 4 ULLS-A(E)



CW3 153MB (AVN SAFETY OFF) P
CW2 153M0 (UH-60M PILOT) P
SGT 15T2F (UH-60 CREWCHIEF) P
PFC 15T1F (UH-60 AIR CREWMEMBER) P

FBCB2
AN/TYQ-XXX (V) 4 ULLS-A(E)



CW2 153MG (AVN MAINT OFF) P
CW2 153M0 (UH-60M PILOT) P
SP4 15T1F (UH-60 CREWCHIEF) P
PFC 15T1F (UH-60 AIR CREWMEMBER) P

AN/VRC-91F
FBCB2
AMPS
DAGR



SFC 15T4F (PLT SGT) P

FBCB2
AN/TYQ-XXX (V) 4 ULLS-A(E)



CW2 153M0 (ALSE OFF) P
CW2 153M0 (MISSION PLANNER) P
SP4 15T1F (UH-60 CREWCHIEF) P
SP415T1F (UH-60 AIR CREWMEMBER) P

ASSAULT PLATOON PARA 03

FBCB2
AN/TYQ-XXX (V) 4 ULLS-A(E)



LT 15A00 (PLT LDR) P
CW2 153MC (INST PILOT) P
SP4 15T1F (UH-60 CREWCHIEF) P
SP4 15T1F (UH-60 AIR CREWMEMBER) P

FBCB2
AN/TYQ-XXX (V) 4 ULLS-A(E)



CW3 153MI (TAC OPS OFF) P
CW2 153M0 (UH-60M PILOT) P
SGT 15T2F (UH-60 CREWCHIEF) P
PFC 15T1F (UH-60 AIR CREWMEMBER) P

FBCB2
AN/TYQ-XXX (V) 4 ULLS-A(E)



CW3 153MF (AVN STDZN OFF) P
CW2 153M0 (UH-60M PILOT) P
SGT 15T2F (UH-60 CREWCHIEF) P
PFC 15T1F (UH-60 AIR CREWMEMBER) P

FBCB2
AN/TYQ-XXX (V) 4 ULLS-A(E)



CW2 153MG (AVN MAINT OFF) P
CW2 153M0 (UH-60M PILOT) P
SP4 15T1F (UH-60 CREWCHIEF) P
PFC 15T1F (UH-60 AIR CREWMEMBER) P

AN/VRC-91F
FBCB2
AMPS
DAGR



SFC 15T4F (PLT SGT) P

FBCB2
AN/TYQ-XXX (V) 4 ULLS-A(E)



CW2 153M0 (ALSE OFF) P
CW2 153M0 (UH-60M PILOT) P
SP4 15T1F (UH-60 CREWCHIEF) P
SP4 15T1F (UH-60 AIR CREWMEMBER) P

CAB-21

Summary of Equipment

WEAPONS

LAUNCHER GRENADE M320A1 -----	2
MACHINE GUN LIGHT 5.56MM M249-----	2
MACHINE GUN 7.62MM: M240H-----	20
PISTOL 9MM AUTOMATIC M9-----	43
RIFLE 5.56MM M4 CARBINE-----	21

VEHICLES, TRAILERS, AND TRLR MTD SYSTEMS

HELICOPTER UTILITY: UH-60M-----	10
TRUCK UTILITY EXP CAPACITY ENH 4X4: M1165A1-----	3
LIGHT TACTICAL TRAILER: 3/4T (M1101)-----	3

MISCELLANEOUS EQUIPMENT

GEN SET: DED SKID MTD 5 KW 60HZ (MEP-802A)-----	1
ARMAMENT SUBSYSTEM HELICOPTER 7.62MM MG: LT-----	10

COMMUNICATION-ELECTRONICS EQUIPMENT

COMPUTER SET DIGITAL: AN/UYK-128 (FBCB2)-----	13
COMPUTER SYSTEM DIGITAL: (AMPS)-----	3
MISSION EQUIPMENT PACKAGE: ABN CMD & CNTRL-----	4
NAVIGATION SET: SATELLITE SIGNALS AN/PSN-13 (DAGR)-----	3
PROCESSOR GROUP SIGNAL DATA: (CAIST 2.0)-----	2
RADIAC SET: AN/VDR-2-----	3
RADIO SET: AN/PRC-119F-----	1
RADIO SET: AN/VRC-91F-----	2
RADIO SET: AN/VRC-92F-----	1
COMPUTER SET DIGITAL: AN/TYQ-151(V)3-----	1
COMPUTER SET DIGITAL: AN/TYQ-XXX(V)4 ULLS-A(E)-----	10

NIGHT VISION/OBSERVATION EQUIPMENT

AVIATORS NIGHT VISION IMAGING SYSTEM: AN/AVS-6 (V) 1----	40
ANVIS/HEADS UP DISPLAY DEVICE: AN/AVS-7-----	10
NIGHT VISION GOGGLES: AN/PVS-7B-----	6
MEDIUM WEAPON THERMAL SIGHT (MWTS): AN/PAS-13(V)2-----	2

Assault Company (UH-60)

Aviation Maintenance Company (AVUM) (UH-60)

01209G100
OFF: 3/WO: 3/ENL: 86/TOTAL: 92

COMPANY HEADQUARTERS PARA 01

AN/VRC-92F
FBCB2
DAGR

AN/VRC-90F
AN/PRC-119F
AN/TYQ-109(V)1
DAGR
CAISI 2.0



CPT 15D00 (COMMANDER) P
PFC 15T10 (VEH DRIVER) C

1SG 15Z5M (FIRST SGT) C
SGT 92Y20 (SUPPLY NCO) C
SP4 74D20 (CBRN SP) C
SP4 92Y10 (SUPPLY SP) C

QUALITY CONTROL SECTION PARA 02

AN/VRC-90F
AN/TYQ-151(V)1 ULLS-A(E)
AN/TYQ-XXX(V)2 ULLS-A(E)



X2

SFC 15T4F (ACFT QUAL CONT SUPV) P
5 SSG 15T3F (UH-60 HEL TI) P
3 SGT 15N2F (AVIONIC TI) P
4 SGT 15T2F (UH-60 HEL TI) P

PRODUCTION CONTROL SECTION PARA 03

AN/VRC-89F
AN/PRC-119F
FBCB2
AMPS
DAGR
CAISI 2.0

OL-713(V)1/TYQ CSS VSAT
AN/TYQ-151 (V) 1 ULLS-A(E)
AN/TYQ-151 (V) 2
AN/TYQ-150 (V) 1 ULLS-A(E)
AN/TYQ-153 ULLS-A(E)



CW3 153MG (PROD CONTROL OFF) P
SFC 15K40 (ACFT PROD CONTROL NCO) C
SGT 92A20 (EQ RCD/PARTS SGT) C
SP4 15T10 (UH-60 REP) C
2 SP4 92A10 (EQ RCD/PARTS SP) C
PFC 15T10 (UH-60 REP) C
3 PFC 92A10 (EQ RCD/PARTS SP) C

AIRFRAME REPAIR PLATOON HQ PARA 04

AN/PRC-119F

AN/VRC-90F
FBCB2
DAGR

AN/VRC-90F
AN/PRC-119F
DAGR
AN/TYQ-151 (V) 1 ULLS-A(E)

AN/VRC-90F
AN/PRC-119F



X3



CW2 153MG (AVN MAINT OFF) P
SFC 15T40 (PLT SGT) C



LT 15A00 (PLT LDR) P

UH-60 REPAIR SECTION PARA 05

5 AN/TYQ-151 (V) 1 ULLS-A(E)
AN/TYQ-151 (V) 2

SFC 15T40 (ACFT MAINT SUPV) C
2 SSG 15T30 (SECTION CHIEF) C
4 SGT 15T20 (UH-60 REP/TM CHIEF) C
5 SP4 15T10 (UH-60 REP) C
15 PFC 15T10 (UH-60 REP) C

COMPONENT REPAIR PLATOON HQ PARA 06

AN/VRC-90F
3 AN/PRC-119F
DAGR
2 AN/TYQ-151 (V) 1 ULLS-A(E)
AN/TYQ-151 (V) 2

AN/VRC-90F

AN/VRC-90F
FBCB2
DAGR



X3



PU 802



X3



X3



X2

LT 15A00 (PLT LDR) P
CW2 151A0 (AVN MAINT TECH) C
SFC 15K40 (PLATOON SGT) C

Aviation Maintenance Company (AVUM) (UH-60) (cont)

POWERPLANT SECTION PARA 07

AN/TYQ-151 (V) 1 ULLS-A(E)

SGT 15B20 (ACFT PWRPLANT REP) C
SP4 15B10 (ACFT PWRPLANT REP) C
PFC 15B10 (ACFT PWRPLANT REP) C

POWER TRAIN SECTION PARA 08

AN/TYQ-151 (V) 1 ULLS-A(E)

SGT 15D20 (ACFT PWR TRAIN REP) C
SP4 15D10 (ACFT PWR TRAIN REP) C
PFC 15D10 (ACFT PWR TRAIN REP) C

STRUCTURAL SECTION PARA 09

AN/TYQ-151 (V) 1 ULLS-A(E)

SSG 15G30 (ACFT STRUCT REP) C
SGT 15G20 (ACFT STRUCT REP) C
2 SP4 15G10 (ACFT STRUCT REP) C
2 PFC 15G10 (ACFT STRUCT REP) C

PNEUDRAULICS SECTION PARA 10

AN/TYQ-151 (V) 1 ULLS-A(E)

SGT 15H20 (ACFT PNEUDRAUL REP) C
SP4 15H10 (ACFT PNEUDRAUL REP) C
PFC 15H10 (ACFT PNEUDRAUL REP) C

AVIONICS/ELECTRICAL SECTION PARA 11

AN/VRC-90F
2 AN/TYQ-151 (V) 1 ULLS-A(E)



SFC 15K40 (AVIONICS MAINT SUPV) C
SSG 15F30 (ACFT ELECTRICIAN SUPV) C
SSG 15N30 (AVIONIC LINE SUPV) C
SGT 15F20 (ACFT ELECTRICIAN) C
3 SGT 15N20 (AVIONIC MECH) C
SP4 15F10 (ACFT ELECTRICIAN) C
3 SP4 15N10 (AVIONIC MECH) C
PFC 15F10 (ACFT ELECTRICIAN) C
3 PFC 15N10 (AVIONIC MECH) C

Summary of Equipment

WEAPONS

LAUNCHER GRENADE M320A1-----	2
MACHINE GUN LIGHT 5.56MM M249-----	2
MACHINE GUN GRENADE 40MM: MK-19 MOD III-----	2
PISTOL 9MM AUTOMATIC M9-----	19
RIFLE 5.56MM M4 CARBINE-----	74
MACHINE GUN: CALIBER .50 (M2E2)-----	

VEHICLES, TRAILERS, AND TRLR MTD SYSTEMS

CRANE WHEEL MTD: HYDRAULIC LT 7-1/2 TON W/CAB-----	1
FLOODLIGHT SET TLR MTD 3 FLOODLIGHTS 1000 WATTS-----	2
DOLLY SET LIFT TRANSPORTABLE SHEL: 2 1/2T (M707A1)-----	3
GEN SET DIESEL ENGINE TM: 15KW 50/60HZ (PU-802)-----	1
TRUCK UTILITY EXP CAPACITY ENH 4X4: M1152A1-----	4
TRUCK UTILITY EXP CAPACITY ENH 4X4: M1165A1-----	1
TRUCK CARGO: 4X4 LMTV (M1078)-----	10
TRUCK VAN LMTV (M1079)-----	1
TRUCK LIFT FORK: (ATLAS)-----	1
LIGHT TACTICAL TRAILER: 3/4T (M1101)-----	1
TRAILER CARGO: LMTV W/DROPSIDES (M1082)-----	7
TRAILER TANK: WATER 400 GAL 1-1/2T 2 WHL (M107A1)-----	1

NIGHT VISION/OBSERVATION EQUIPMENT

NIGHT VISION GOGGLES: AN/PVS-7B-----	33
MEDIUM THERMAL WEAPONS SIGHT: AN/PAS-13 (V2)-----	2
HEAVY THERMAL WEAPONS SIGHT: AN/PAS-13 (V3)-----	8

COMMUNICATION-ELECTRONICS EQUIPMENT

ANTENNA GROUP: OE-254-----	4
COMPUTER SET DIGITAL: AN/UYSK-128 (FBCB2)-----	6
COMPUTER SYSTEM DIGITAL: (AMPS)-----	1
COMPUTER SET DIGITAL: AN/TYQ-109(V)1 (GCSS-A (V)1)-----	1
NAVIGATION SET: SATELLITE SIGNALS AN/PSN-13 (DAGR)-----	9
PROCESSOR GROUP SIGNAL DATA: (CAISI 2.0)-----	2
RADIAC SET: AN/VDR-2-----	3
RADIO SET: AN/PRC-89F-----	1
RADIO SET: AN/VRC-90F-----	14
RADIO SET: AN/VRC-92F-----	1
RADIO SET: AN/PRC-119F-----	8
INTERFACE UNIT COMM EQ: OL-713(V)1/TYQ CSS VSAT-----	1
COMPUTER SET DIGITAL: AN/TYQ-151 (V) 1 ULLS-A(E)-----	17
COMPUTER SET DIGITAL: AN/TYQ-151 (V) 2-----	5
COMPUTER SET DIGITAL: AN/TYQ-150 (V) 1 ULLS-A(E)-----	1
COMPUTER SET DIGITAL: AN/TYQ-153 ULLS-A(E)-----	1

MISCELLANEOUS EQUIPMENT

CONTAINER ASSBLY: AIRMOBILE TYPE X-4 200 CU FT CAP-----	3
GENERATOR SET: DED SKID MTD 5KW 60 HZ (MEP 802A)-----	2
POWER UNIT AUXILIARY: (AGPU)-----	3
SHOP EQUIP CONTACT MAINT (SECM): AVIATION-----	4
UNIT MAINT AERIAL RECOVERY KIT: (UMARK)-----	1
STANDARD AIRCRAFT TOWING SYSTEM: (SATS)-----	3

Forward Support Company, Assault Bn

TOE 63217R300
OFF: 4/WO: 1/ENL: 84/TOTAL: 89

COMPANY HQ PARA 01

AN/VRC-92F
AN/UYQ-90(V)2
FBCB2
DAGR



CPT 90A00 (CDR) P

AN/VRC-90F
AN/GYK-61 (BCS3)
AN/TYQ-109(V)1
AN/UYQ-90(V)3
DAGR
CAISI 2.0



LT 88A00 (EXEC OFF) C
1SG 91Z5M (FIRST SGT) C
SSG 92Y30 (SUPPLY SGT) C
SP4 74D10 (CBRN SP) C
SP4 92Y10 (SUPPLY SP) C

FIELD FEEDING SECTION PARA 02

AN/VRC-90F
DAGR



X2



SFC 92G40 (SR FOOD OPNS SGT) C
SSG 92G30 (FOOD OPNS MGR) C
2 SGT 92G20 (FOOD OPNS NCO) C
4 SP4 92G10 (FOOD OPNS SP) C
2 PFC 92G10 (FOOD OPNS SP) C
PFC 92G10 (FOOD OPNS SP) SAW

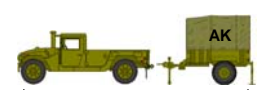

X3

DISTRIBUTION PLATOON HQ PARA 03

AN/VRC-92F
AN/UYQ-90(V)2
FBCB2
AN/UYQ-90(V)3
DAGR



LT 92A00 (PLT LDR) C
SFC 92F40 (PLT SGT) C
SP4 92A10 (MAT CON/ACCTG SP) C

AN/VRC-90F
AN/TYQ-129(V)2
DAGR
CAISI 2.0



AN/VRC-90F
DAGR



CLASS III SECTION PARA 04

AN/PRC-119F
AN/PRC-119F
AN/UYQ-90(V)2
DAGR

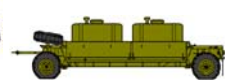

AN/VRC-90F
AN/UYQ-90(V)2
DAGR

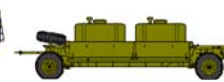

AN/VRC-90F
DAGR

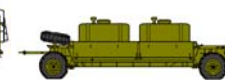

X3

3 SSG 92F30 (SECTION CHIEF) C
6 SGT 92F20 (ACFT FUEL HANDLER) C
11 SP4 92F10 (ACFT FUEL HANDLER) C
3 PFC 92F10 (ACFT FUEL HANDLER) C
3 PFC 92F10 (ACFT FUEL HANDLER) SAW

DISTRIBUTION SECTION PARA 05

AN/VRC-90F
AN/UYQ-90(V)2
DAGR



SSG 92F30 (SECTION CHIEF) C
SP4 92A10 (MAT STORE/HDLG SP) C

AN/VRC-90F
AN/UYQ-90(V)2
DAGR



SP4 88M10 (VEH DRIVER) C
PFC 88M10 (VEH DRIVER) C

AN/VRC-90F
AN/UYQ-90(V)2
DAGR



2 PFC 88M10 (VEH DRIVER) C



AN/VRC-90F
AN/UYQ-90(V)2
DAGR



SP4 92F10 (PETRL HVY VEH OPR) C

X2



X2

Forward Support Company, Assault Bn (cont)

MAINTENANCE CONTROL & PLATOON HQ PARA 06

AN/VRC-92F
FBCB2
DAGR



LT 91A00 (PLT LDR) C

AN/VRC-90F
AN/UYQ-90(V)2
DAGR



CW2 915A0 (AUTO MAINT WO) C
SFC 91X40 (PLT SGT) C

AN/VRC-89F
AN/VRC-90F
AN/UYQ-90(V)3
DAGR
CAISI 2.0
OL-713(V)1/TYQ CSS VSAT
AN/TYQ-139
AN/TYQ-140



SGT 92A20 (EQ RCD/PARTS SGT) C
SP4 92A10 (EQ RCD/PARTS SP) C
PFC 92A10 (EQ RCD/PARTS SP) C
PFC 92A10 (EQ RCD/PARTS SP) SAW

AN/VRC-90F
DAGR



MAINTENANCE SECTION PARA 07

AN/VRC-90F
DAGR



SFC 91X40 (MOTOR SGT) C

AN/VRC-90F
DAGR

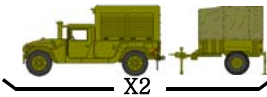

X2

AN/VRC-90F
DAGR

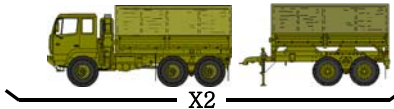

X2

AN/VRC-90F
AN/UYQ-90(V)2
DAGR



AN/VRC-90F
DAGR



AN/VRC-90F
DAGR



AN/VRC-90F
AN/UYQ-90(V)2
DAGR



SGT 91B20 (RCVY VEH OPR) C

AN/VRC-90F
AN/UYQ-90(V)2
DAGR



SP4 91B10 (RCVY VEH OPR) C

AN/VRC-90F



SP4 91E10 (ALLIED TRADES SP) C

SSG 91B30 (SHOP FOREMAN) C
SSG 91B30 (SR MECHANIC) C
3 SGT 91B20 (WH VEH MECH) C
SGT 91D20 (PWR-GEN EQ REP) C
SGT 91J20 (QM/CHEM EQ REP) C
4 SP4 91B10 (WH VEH MECH) C
SP4 91C10 (UTIL EQ REP) C
SP4 91F10 (SM ARMS/ARTY REP) C
SP4 91L10 (CONST EQ REP) C
SP4 94E1S (COMSEC/RADIO EQ REP) C
SP4 94F10 (COMP/DET SYS REP) C
5 PFC 91B10 (WH VEH MECH) C
PFC 91B10 (WH VEH MECH) SAW
PFC 91D10 (PWR-GEN EQ REP) C
PFC 91J10 (QM/CHEM EQ REP) C

Summary of Equipment

WEAPONS

LAUNCHER GRENADE M320A1-----	4
MACHINE GUN 5.56MM M249-----	9
MACHINE GUN LIGHT 5.56MM M249-----	4
MACHINE GUN GRENADE 40MM MK-19 MOD III-----	1
MACHINE GUN 7.62MM M240B-----	7
PISTOL 9MM AUTOMATIC M9-----	1
RIFLE 5.56MM M4 CARBINE-----	79
MACHINE GUN: CALIBER .50 (M2E2)-----	7

VEHICLES, TRAILERS, AND TRLR MTD SYSTEMS

CONTAINERIZED KITCHEN (CK)-----	1
FORWARD REPAIR SYSTEM: M7 (FRS)-----	1
SHOP EQUIPMENT: AUTOMOTIVE VEHICLE (TLR MTD) (SATS)-----	1
SEMITRAILER VAN: SUPPLY 12T 4 WHL (M129A2C)-----	1
TRUCK UTILITY EXP CAPACITY ENH 4X4: M1152A1-----	7
TRUCK VAN EXPANSIBLE MTV (M1087A1)-----	1
TRAILER FLAT BED: 11 TON 4 WHL (M989A1) (HEMAT)-----	9
TRUCK UTILITY EXP CAPACITY ENH 4X4: M1165A1-----	3
TRUCK CARGO: HVY PLS TRANSPORTER 10X10 (M1075)-----	1
TRUCK CARGO: TACTICAL 8X8 HEMTT W/LT CRANE (M977)-----	1
TRUCK CARGO: MTV (M1083)-----	11
TRUCK TANK: FUEL SERVICING 2500 GAL 8X8 HEMTT (M978)-----	8
TRUCK TRACTOR MTV (M1088)-----	1
TRUCK CARGO MTV LWB (M1085)-----	1
TRUCK LIFT: FORK VARIABLE REACH RT (ATLAS)-----	2
TRAILER: PLS 8X20 (M1076)-----	2
TRUCK WRECKER: TACTICAL 8X8 HEMTT (M984A1)-----	1
TRUCK WRECKER: MTV (M1089)-----	1
TRAILER CARGO: MTV W/ DROPSIDES (M1095)-----	5
LIGHT TACTICAL TRAILER: 3/4T (M1101)-----	5
TRUCK CARGO HEMTT LHS (M1120)-----	1
SHOP EQUIPMENT: WELDING TRAILER MTD-----	1
TRAILER TANK WATER (CAMEL) 800 GAL 5 TON-----	2

COMMUNICATION-ELECTRONICS EQUIPMENT

ANTENNA GROUP: OE-254-----	3
COMPUTER SYSTEM DIGITAL: AN/UYQ-90(V)2 (MTS)-----	17
COMPUTER SET DIGITAL: AN/UYK-128 (FBCB2)-----	3
BTL CMD SUSTAINMENT SPT SYSTEM: AN/GYK-61 (BCS3)-----	1
COMPUTER SYS DIGITAL: AN/TYQ-129(V)2 (TC-AIMS II WS)-----	1
COMPUTER SET DIGITAL: AN/TYQ-109(V)1 (GCSS-A (V)1)-----	1
COMPUTER SYSTEM DIGITAL: AN/UYQ-90(V)3 (MTS-CS)-----	3
NAVIGATION SET: SATELLITE SIGNALS AN/PSN-13 (DAGR)-----	39
PROCESSOR GROUP SIGNAL DATA: (CAISI 2.0)-----	3
RADIAC SET: AN/VDR-2-----	6
RADIO SET: AN/VRC-89F-----	1
RADIO SET: AN/VRC-90F-----	37
RADIO SET: AN/VRC-92F-----	3
RADIO SET: AN/PRC-119F-----	3
INTERFACE UNIT COMM EQ: OL-713(V)1/TYQ CSS VSAT-----	1
COMPUTER SYSTEM: DIGITAL AN/TYQ-139 (SAMS-1E V1)-----	1
COMPUTER SYSTEM: DIGITAL AN/TYQ-140 (SAMS/SAMS-1E V2)-----	1

MISCELLANEOUS EQUIPMENT

ASSAULT KITCHEN (AK)-----	3
BED CARGO: DEMOUNTABLE PLS 8X20-----	1
FORWARD AREA REFUELING SYSTEM: ADV AVN (AAFARS)-----	2
GEN SET : DED SKID MTD 3KW 60HZ (MEP-831A)-----	1
ELECTRONICS SHOP SHEL MTD AVIONICS: AN/ASM-146-----	1
REFUELING SYTEM: AVIATION HEMTT TANKER-----	4
SHOP EQUIP: CONTACT MAINT ORD/ENGR TRK MTD-----	2
TANK UNIT LIQUID DISPENSING TRAILER MTG-----	18
TOWBAR MOTOR VEHICLE: WHEELED-----	3
MULTI-TEMP REFRIGERATED CONTAINER SYS: MTRCS-----	1

NIGHT VISION/OBSERVATION EQUIPMENT

NIGHT VISION GOGGLES: AN/PVS-7B-----	84
MEDIUM THERMAL WEAPONS SIGHT: AN/PAS-13(V2)-----	1
HEAVY THERMAL WEAPONS SIGHT: AN/PAS-13(V3)-----	8

Forward Support Company, Assault Bn

Pathfinder Company

07783G000
OFF: 4/WO: 0/ENL: 56/TOTAL: 60

COMPANY HEADQUARTERS PARA 01

AN/VRC-88F
FBCB2
2 DAGR



CPT 11A00 (COMMANDER) P
PFC 11B1P (RATELO) C

AN/TYQ-109(V1)
CAISI 2.0



LT 11A00 (EXEC OFF) C
1SG 11Z5P (FIRST SGT) C
SFC 11B4P (OPNS SGT) C
SSG 11B3P (ASST OPNS SGT) C
SGT 74D2P (CBRN NCO) C
SGT 92Y2P (SUPPLY NCO) C
SP4 92Y1P (SUPPLY SP) C

GENERAL SUPPORT PLATOON HQ PARA 02

AN/VRC-91F
AN/PRC-119F
FBCB2
DAGR



LT 11A00 (PLT LDR) C
SFC 11B4P (PLT SGT) C
SP4 11B1P (PATHFINDER) C

GS PATHFINDER TEAM PARA 03

AN/VRC-91F
2 AN/PRC-119F
FBCB2
DAGR
7 AN/PRC-126



SSG 11B3P (TEAM LDR) C
2 SGT 11B2P (ASST TEAM LDR) C
2 SP4 11B1P (PATHFINDER) C
2 PFC 11B1P (PATHFINDER) C

GS PATHFINDER TEAM PARA 04

AN/VRC-91F
2 AN/PRC-119F
FBCB2
DAGR
7 AN/PRC-126



SSG 11B3P (TEAM LDR) C
2 SGT 11B2P (ASST TEAM LDR) C
2 SP4 11B1P (PATHFINDER) C
2 PFC 11B1P (PATHFINDER) C

DIRECT SUPPORT PLATOON HQ PARA 05

AN/VRC-88F
AN/PRC-119F
FBCB2
DAGR

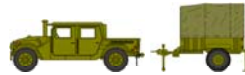

LT 11A00 (PLT LDR) C
SFC 11B4P (PLT SGT) C
SP4 11B1P (PATHFINDER) C

DS PATHFINDER TEAM PARA 06

AN/VRC-88F
6 AN/PRC-119F
DAGR



SSG 11B3P (TEAM LDR) C
3 SGT 11B2P (ASST TEAM LDR) C
3 SP4 11B1P (PATHFINDER) C
4 PFC 11B1P (PATHFINDER) C

DS PATHFINDER TEAM PARA 07

AN/VRC-88F
6 AN/PRC-119F
DAGR



SSG 11B3P (TEAM LDR) C
3 SGT 11B2P (ASST TEAM LDR) C
3 SP4 11B1P (PATHFINDER) C
4 PFC 11B1P (PATHFINDER) C

BASE RADIO STATION PARA 08

AN/VRC-90F
4 AN/VRC-104(V)3
FBCB2
4 OA-8990 ()/P
DAGR
EPLRS-V1
AN/PSC-5

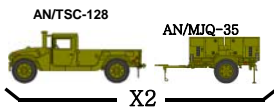

SGT 25C2P (SR RADIO OPR-MAINT) C
2 SP4 25C1P (RADIO OPR-MAINT) C
PFC 25C1P (RADIO OPR-MAINT) C

COMBAT MEDIC SECTION PARA 09

AN/TYQ-106(V1)
4 AN/TYQ-105(V)1

SSG 68W3P (SECTION NCO) P
4 SP4 68W1P (COMBAT MEDIC) P

Summary of Equipment

WEAPONS

LAUNCHER GRENADE M320A1----- 12
MACHINE GUN LIGHT 5.56MM M249----- 5
MACHINE GUN 7.62MM M240B----- 5
PISTOL 9MM AUTOMATIC M9----- 6
RIFLE 5.56MM M4 CARBINE----- 54

VEHICLES, TRAILERS, AND TRLR MTD SYSTEMS

POWERPLANT ELEC DED TM: 5KW 60HZ AC AN/MJQ-35----- 2
TRUCK UTILITY EXP CAPACITY ENH 4X4: M1152A1----- 6
TRUCK UTILITY EXP CAPACITY ENH 4X4: M1165A1----- 3
TRUCK CARGO: 2 1/2T 4X4 LMTV W/E LAPES/AD M1081----- 1
LIGHT TACTICAL TRAILER: 3/4T (M1101)----- 6
TRAILER TANK: WATER 400 GAL 1-1/2T 2 WHL (M149A2)----- 1

NIGHT VISION/OBSERVATION EQUIPMENT

DRIVERS VISION ENHANCER: AN/VAS-5----- 10
NIGHT VISION GOGGLES: AN/PVS-7B----- 51
NIGHT VISION DEVICE: AN/PSQ-20 (ENVG)----- 36
MEDIUM THERMAL WEAPONS SIGHT: AN/PAS-13(V2)----- 10
HEAVY THERMAL WEAPONS SIGHT: AN/PAS-13(V3)----- 1

COMMUNICATION-ELECTRONICS EQUIPMENT

ANTENNA GROUP: OE-254----- 7
COMPUTER SYSTEM DIGITAL: AN/TYQ-106(V1) (MC4-2)----- 1
COMPUTER SET DIGITAL: AN/UJK-128 (FBCB2)----- 5
COMPUTER SYSTEM DIGITAL: AN/TYQ-105(V1) (MC4-1)----- 4
COMPUTER SET DIGITAL: AN/TYQ-109(V1) (GCSS-A (V)1)----- 1
CENTRAL COMMUNICATIONS (LRSUBRS): AN/TSC-128----- 2
DIGITAL MESSAGE DEVICE GROUP: OA-8990 ()/P----- 8
NAVIGATION SET: SATELLITE SIGNALS AN/PSN-13 (DAGR)----- 11
PJH SURFACE VEH RADIO SET: AN/VSQ-2(V1) (EPLRS-V1)----- 2
PROCESSOR GROUP SIGNAL DATA: (CAISI 2.0)----- 1
RADIAC SET: AN/VDR-2----- 7
RADIO SET: AN/VRC-88F----- 4
RADIO SET: AN/VRC-90F----- 2
RADIO SET: AN/VRC-91F----- 3
RADIO SET: AN/PRC-119F----- 18
RADIO SET: AN/PSC-5----- 2
RADIO SET: AN/VRC-104(V)3 150 WATT IK: PRC-150 HF RADIO----- 8

MISCELLANEOUS EQUIPMENT

GEN SET : DED SKID MTD 3KW 60HZ (MEP-831A)----- 1
SMALL UNMANNED AIRCRAFT SYSTEM: (SUAS) RAVEN B----- 4

HHC, Attack/Recon Bn

01286R000
OFF: 17/WO: 6/ENL: 55/TOTAL: 78

COMMAND SECTION PARA 01

AN/VRC-92F
FBCB2
DAGR



LTC 15B00 (COMMANDER) P
PFC 15P10 (VEH DRIVER) C

AN/VRC-89F
FBCB2
DAGR



MAJ 15B00 (EXEC OFF) P
PFC 15P10 (VEH DRIVER) C

CSM 00Z50 (CMD SGM) P

CW4 152HB (AVN SAFETY OFF) P
CW4 152HH (AVN STDZN OFF) P

S1 SECTION PARA 02

AN/VRC-90F
DAGR
CAISI 2.0
5 AN/TYQ-116(V)3



CPT 42B00 (S1) P
SFC 42A40 (SR HUMAN RES SGT) C
SSG 42A30 (HUMAN RES SGT) C
SGT 42A20 (HUMAN RES SGT) C
SP4 27D10 (PARALEGAL SP) C
SP4 42A10 (HUMAN RES SP) C
2 PFC 42A10 (HUMAN RES SP) C

S2 SECTION PARA 03

AN/VRC-92F
AN/TYQ-93
FBCB2
DAGR



CPT 15C35 (S2) P
LT 35D00 (ASST S2) C
SSG 35F30 (INTEL SGT) C
SGT 35F20 (INTEL ANALYST) C
SP4 35F10 (INTEL ANALYST) C

S3 SECTION PARA 04

AN/VRC-92F
FBCB2
DAGR



MAJ 15B00 (S3) P

AN/VRC-90F
FBCB2
AMPS
AN/PYQ-12
AN/TYQ-129(V)2
AN/TSQ-243
FHMUX



CPT 15B00 (ASST S3) P
LT 74A00 (CBRN OFF) C
CW4 152H0 (AVN MASTER GUNNER) P
CW4 152HI (TAC OPS OFF) P
MSG 15P50 (SR AVN OPS SGT) C
SSG 15P30 (ASST AVN OPS SGT) C
SSG 74D30 (CBRN NCO) C
2 SGT 15P20 (AVN OPS SGT) C
3 SP4 15P10 (AVN OPS SP) C
2 PFC 15P10 (AVN OPS SP) C



AN/VRC-90F
DAGR



TACTICAL CP PARA 05

AN/VRC-92F
FBCB2
AMPS
DAGR
AN/GRC-240
AN/PSC-5



CPT 15B00 (ASST S3) P
SGT 15P20 (AVN OPS SGT) C
2 SP4 15P10 (AVN OPS SP) C
PFC 15P10 (AVN OPS SP) C

AVN LIAISON ELEMENT PARA 06

AN/VRC-90F
FBCB2
AMPS
DAGR



LT 15A00 (LNO) P
CW3 152HI (TAC OPS OFF) P
SP4 15P10 (AVN OPS SP) C

S4 SECTION PARA 07

AN/VRC-89F
FBCB2
DAGR



CPT 15B00 (S4) P

AN/VRC-92F
FBCB2
AN/TYQ-129(V)2
AN/TYQ-109(V)1
KG-175
DAGR
CAISI 2.0
AN/VRC-100(V)1



CW3 152HG (AVN MATERIEL OFF) P
SFC 92Y40 (SUPPLY SGT) C
SGT 92Y20 (SUPPLY NCO) C
SP4 92Y10 (SUPPLY SP) C

AN/VRC-90F



COMPANY HEADQUARTERS PARA 08

AN/VRC-90F
AN/PRC-119F
FBCB2
DAGR
CAISI 2.0



CPT 15B00 (CDR) P
PFC 15P10 (VEH DRIVER) C

AN/VRC-90F



1SG 15Z5M (FIRST SGT) C
SGT 74D20 (CBRN NCO) C

SUPPLY SECTION (BN) PARA 09

AN/VRC-90F
AN/TYQ-109(V)1
DAGR
CAISI 2.0



SSG 92Y30 (SUPPLY SGT) C
2 SP4 92Y10 (SUPPLY SP) C
PFC 92Y10 (SUPPLY SP) C

S6 SECTION HEADQUARTERS PARA 10

AN/VRC-90F
FBCB2
DAGR



CPT 25A00 (S6) C

AN/VRC-90F
FBCB2
AN/TYQ-137A:(V)2
DAGR
AN/TSR-8 (GRT)
AN/TSQ-259



BCP (SWITCHING GP): OM-87A/T
PU 798
SFC 25U40 (SECTION CHIEF) C
SGT 25Q20 (SR XMSN SYS OPR-MAINT) C
SP4 25B10 (LAN MGR) C
SP4 25Q10 (XMSN SYS OPR-MAINT) C

AN/VRC-90F



SP4 25U10 (SGNL SPT SYS MAINT) C
SP4 25U10 (SGNL INFO SVC SP) C
PFC 25B10 (LAN MGR) C
PFC 25U10 (SGNL SPT SYS SP) C

2 AN/VRC-92F
FBCB2
FHMUX
DAGR



SGT 25U20 (TEAM CHIEF) C
SP4 25U10 (RADIO RETRANS OPR) C
PFC 25U10 (RADIO RETRANS OPR) C

CAB-29

HHC, Attack/Recon Bn (cont)

MEDICAL TREATMENT TEAM PARA 11

AN/VRC-90F
AN/TYQ-106(V)1
FBCB2
3 AN/TYQ-105(V)1
DAGR

AN/VRC-88F
2 AN/TYQ-105(V)1
DAGR



CPT 61N00 (FLIGHT SURGEON) P
CPT 65D00 (PHYSICIAN ASST) P
SSG 91W30 (HEALTH CARE SGT) C
SP4 91W10 (HEALTH CARE SP) C
PFC 91W10 (HEALTH CARE SP) C

UNIT MINISTRY TEAM PARA 12

AN/VRC-90F
DAGR



CPT 56A00 (CHAPLAIN)
SP4 56M10 (CHAP ASST) C

FIRE SUPPORT ELEMENT PARA 13

2 AN/VRC-92F
AN/GYK-57
FBCB2
AN/GYK-48(V)1
DAGR
AN/PSC-5

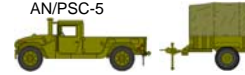

CPT 13A00 (FIRE SPT OFF) C
SFC 13F40 (FIRE SPT SGT) C
SGT 29E20 (EW SGT) C

Summary of Equipment

WEAPONS

LAUNCHER GRENADE M320A1-----	4
MACHINE GUN LIGHT 5.56MM M249-----	4
MACHINE GUN GRENADE 40MM MK-19 MOD III-----	2
PISTOL 9MM AUTOMATIC M9-----	18
RIFLE 5.56MM M4 CARBINE-----	59

VEHICLES, TRAILERS, AND TRLR MTD SYSTEMS

GEN SET DED TM: 10KW 60HZ (PU-798)-----	1
POWER PLANT: UTILITY, MEDIUM 20KW 5 TON ECU-----	2
TRUCK UTILITY EXP CAPACITY ENH 4X4: M1152A1-----	13
TRUCK UTILITY EXP CAPACITY ENH 4X4: M1165A1-----	7
TRUCK CARGO: 4X4 LMTV (M1078)-----	3
LIGHT TACTICAL TRAILER: 3/4T (M1101)-----	10
TRAILER CARGO: LMTV W/DROPSIDES (M1082)-----	2
TRAILER TANK: WATER 400 GAL 1-1/2T 2 WHL (M149A2)-----	1

MISCELLANEOUS EQUIPMENT

DECON APPARATUS LT WT-----	2
GEN SET: DED SKID MTD 5 KW 60HZ (MEP-802A)-----	2
GEN SET: DED SKID MTD 3KW 60HZ (MEP-831A)-----	3
GEN SET: DED SKID MTD 10KW 60HZ (MEP-803A)-----	2

NIGHT VISION/OBSERVATION EQUIPMENT

NIGHT VISION GOGGLES: AN/PVS-7B-----	46
MEDIUM THERMAL WEAPONS SIGHT: AN/PAS-13(V2)-----	4
HEAVY THERMAL WEAPONS SIGHT: AN/PAS-13(V3)-----	4

COMMUNICATION-ELECTRONICS EQUIPMENT

ALL SOURCE ANALYSIS SYSTEM: AN/TYQ-93 (ASAS-LT)-----	1
ANTENNA GROUP: OE-254-----	18
COMPUTER SET: AN/GYK-57 (AFATDS - SINGLE)-----	1
COMPUTER SYSTEM DIGITAL: AN/TYQ-106(V)1-----	1
COMPUTER SET DIGITAL: AN/UYK-128 (FBCB2)-----	15
COMPUTER SYSTEM DIGITAL: (AMPS)-----	3
COMPUTER SET DIGITAL: AN/PYQ-12 (MCS GATEWAY SVR)-----	1
COMPUTER SYS DIGITAL: AN/TYQ-129(V)2 (TC-AIMS II WS)-----	2
COMPUTER SYSTEM DIGITAL: AN/TYQ-105(V)1-----	5
COMPUTER SET DIGITAL: AN/TYQ-109(V)1 (GCSS-A (V)1)-----	5
COMMAND POST OF THE FUTURE (CPOF) WS: AN/TYQ-137A:(V)2-----	1
COMMAND SYSTEM: TACTICAL AN/TSQ-243-----	1
ENCRYPT/DECRYPT EQUIPMENT: TACLANE KG-175-----	1
FREQUENCY HOPPING MULTIPLEXER: TF-1456VRC (FHMUX)-----	2
NAVIGATION SET: SATELLITE SIGNALS AN/PSN-13 (DAGR)-----	20
PROCESSOR GROUP SIGNAL DATA: (CAISI 2.0)-----	4
RADIAC SET: AN/VDR-2-----	5
RECEIVE SUITE: AN/TSR-8 (GRT)-----	1
RADIO SET: AN/GRC-240-----	2
RADIO SET: AN/VRC-88F-----	1
RADIO SET: AN/VRC-89F-----	2
RADIO SET: AN/VRC-90F-----	13
RADIO SET: AN/VRC-92F-----	9
RADIO SET: AN/PRC-119F-----	1
RADIO SET: AN/PSC-5-----	3
RADIO SET: HIGH FREQ AN/VRC-100(V)1-----	2
BATTALION COMMAND POST (SWITCHING GROUP): OM-87A/T-----	1
COMMUNICATIONS SUBSYSTEM: AN/TSQ-259:-----	1
COMP SYS DIGITAL: (AHR) AN/TYQ-116(V)3-----	5

Attack/Recon Company (AH-64)

01387G000
OFF: 3/WO: 13/ENL: 19/TOTAL: 35

COMPANY HEADQUARTERS PARA 01

AN/VRC-92F
AN/PRC-119F
FBCB2
DAGR
AN/TYQ-151 (V) 3



CPT 15B00 (COMMANDER) P
1SG 15Z5M (FIRST SGT) C

CW3 15ZHB (AVN SAFETY OFF) P
CW3 15ZHF (AVN STDZN OFF) P
CW3 15ZHI (TAC OPS OFF) C

ATTACK/RECON PLATOON PARA 02

FBCB2
AN/TYQ-XXX (V) 4 ULLS-A(E)



CPT 15B00 (COMMANDER) P
CW2 15ZHO (ALSE OFF) P

FBCB2
AN/TYQ-XXX (V) 4 ULLS-A(E)



LT 15A00 (PLT LDR) P
CW2 15ZHO (MISSION PLANNER) C

FBCB2
AN/TYQ-XXX (V) 4 ULLS-A(E)



CW3 15ZHF (AVN STDZN OFF) P
CW2 15ZHE (ACFT ARMT MAINT OFF) P

FBCB2
AN/TYQ-XXX (V) 4 ULLS-A(E)



CW2 15ZHC (INSTR PILOT) P
CW2 15ZHG (AVN MAINT OFF) P

AN/VRC-91F
FBCB2
AMPS
DAGR
CAISI 2.0

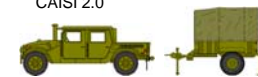

SFC 15R40 (PLT SGT) C
2 SGT 15R20 (CREW CHIEF) C
6 SP4 15R10 (CREW CHIEF) C

ATTACK/RECON PLATOON PARA 03

FBCB2
AN/TYQ-XXX (V) 4 ULLS-A(E)



LT 15A00 (PLT LDR) P
CW2 15ZHE (ACFT ARMT MAINT OFF) P

FBCB2
AN/TYQ-XXX (V) 4 ULLS-A(E)



CW2 15ZHC (INSTR PILOT) P
CW3 15ZHI (TAC OPS OFF) C

FBCB2
AN/TYQ-XXX (V) 4 ULLS-A(E)



CW3 15ZHB (AVN SAFETY OFF) P
CW2 15ZHO (ALSE OFF) P

FBCB2
AN/TYQ-XXX (V) 4 ULLS-A(E)



CW2 15ZHG (AVN MAINT OFF) P
CW2 15ZHO (AH-64D PILOT) P

AN/VRC-91F
FBCB2
AMPS
DAGR
CAISI 2.0



SFC 67R40 (PLT SGT) C
2 SGT 67R20 (CREW CHIEF) C
6 SP4 67R10 (CREW CHIEF) C

Summary of Equipment

WEAPONS

LAUNCHER: GRENADE M320A1 -----	2
LAUNCHER ROCKET ACFT: 2.75 IN 19 TUBE M261-----	16
LAUNCHER GUIDED MISSILE: LONGBOW HELLFIRE XM299-----	32
MACHINE GUN LIGHT 5.56MM M249-----	2
PISTOL 9MM AUTOMATIC M9-----	16
RIFLE 5.56MM M4 CARBINE-----	35

VEHICLES, TRAILERS, AND TRLR MTD SYSTEMS

HELICOPTER ATTACK: AH-64D-----	8
TRUCK UTILITY EXP CAPACITY ENH 4X4: M1165A1-----	2
TRUCK CARGO: 4X4 LMTV (M1078)-----	1
TRAILER HIGH MOBILITY 3/4T (M1101)-----	2
TRAILER CARGO: LMTV W/DROPSIDES (M1082)-----	1

MISCELLANEOUS EQUIPMENT

GEN SET: DED SKID MTD 5 KW 60HZ (MEP-802A)-----	1
---	---

COMMUNICATION-ELECTRONICS EQUIPMENT

COMPUTER SET DIGITAL: AN/UYK-128 (FBCB2)-----	11
COMPUTER SYSTEM DIGITAL: (AMPS)-----	3
NAVIGATION SET: SATELLITE SIGNALS AN/PSN-13 (DAGR)-----	3
PROCESSOR GROUP SIGNAL DATA: (CAISI 2.0)-----	2
RADIAC SET: AN/VDR-2-----	3
RADIO SET: AN/PRC-119F-----	1
RADIO SET: AN/VRC-91F-----	2
RADIO SET: AN/VRC-92F-----	1
COMPUTER SET DIGITAL: AN/TYQ-151(V)3-----	1
COMPUTER SET DIGITAL: AN/TYQ-XXX (V) 4 ULLS-A(E)-----	8

NIGHT VISION/OBSERVATION EQUIPMENT

AVIATORS NIGHT VISION IMAGING SYSTEM: AN/AVS-6-----	16
NIGHT VISION GOGGLES: AN/PVS-7B-----	6
MEDIUM WEAPON THERMAL SIGHT (MWTs): AN/PAS-13(V)2-----	2

Aviation Maintenance Company (AVUM) (AH-64)

01289G100
OFF: 3/WO: 4/ENL: 109/TOTAL: 116

COMPANY HEADQUARTERS PARA 01

AN/VRC-92F
FBCB2
DAGR

AN/VRC-90F
AN/PRC-119F
AN/TYQ-109(V)1
DAGR
CAISI 2.0



CPT 15D00 (COMMANDER) P
PFC 15R10 (VEH DRIVER) C

1SG 15Z5M (FIRST SGT) C
SSG 92Y30 (SUPPLY SGT) C
SP4 74D10 (CBRN SP) C
SP4 92Y10 (SUPPLY SP) C

QUALITY CONTROL SECTION PARA 02

AN/VRC-90F
2 AN/TYQ-151 (V) 1 ULLS-A(E)
AN/TYQ-151 (V) 2



SFC 15R4F (ACFT QUAL CONT SUPV) P
5 SSG 15R3F (AH-64 ATTACK HEL TI) P
2 SSG 15Y3F (AH-64D SYS TI) P
4 SGT 15R2F (AH-64D ATTACK HEL TI) P
2 SGT 15Y2F (AH-64D SYS TI) P

PRODUCTION CONTROL SECTION PARA 03

AN/VRC-89F
AN/PRC-119F
FBCB2
AMPS
DAGR
CAISI 2.0

OL-713(V)1/TYQ CSS VSAT
AN/TYQ-151 (V) 1 ULLS-A(E)
AN/TYQ-151(V)2
AN/TYQ-150 (V) 1 ULLS-A(E)
AN/TYQ-153 ULLS-A(E)



CW3 152HG (PROD CONTROL OFF) P
SFC 15K40 (ACFT PROD CONTROL NCO) C
SGT 92A20 (EQ RCD/PARTS SGT) C
2 SP4 92A10 (EQ RCD/PARTS SP) C
2 PFC 15R10 (AH-64 REP) C
2 PFC 92A10 (EQ RCD/PARTS SP) C

AIRFRAME REPAIR PLATOON HQ PARA 04

AN/PRC-119F

AN/VRC-90F
FBCB2
DAGR

AN/VRC-90F
AN/PRC-119F
DAGR
AN/TYQ-151 (V) 1 ULLS-A(E)

AN/VRC-90F
AN/PRC-119F
AN/TYQ-151 (V) 2



LT 15A00 (PLT LDR) P

X3

CW2 152HG (AVN MAINT OFF) P
SFC 15R40 (PLT SGT) C

X3

AH-64 REPAIR SECTION PARA 05

6 AN/TYQ-151 (V) 1 ULLS-A(E)
3 AN/TYQ-151 (V) 2

SFC 15R40 (ACFT MAINT SUPV) C
3 SSG 15R30 (AH-64 SUPV) C
6 SGT 15R20 (AH-64 REP/TM CHIEF) C
9 SP4 15R10 (AH-64 REP) C
18 PFC 15R10 (AH-64 REP) C

COMPONENT REPAIR PLATOON HQ PARA 06

AN/VRC-90F
3 AN/PRC-119F
DAGR
AN/TYQ-151 (V) 1 ULLS-A(E)
AN/TYQ-151 (V) 2

AN/VRC-90F
DAGR

AN/VRC-90F
FBCB2
DAGR



LT 15A00 (PLT LDR) P
SFC 15K40 (PLATOON SGT) C

X3

X3

X3

X2

SHOP SECTION HQ PARA 07

CW2 151A0 (AVN MAINT OFF) C
SFC 15K40 (ACFT COMP REP SUPV) C

POWER PLANT TEAM PARA 08

AN/TYQ-151 (V) 1 ULLS-A(E)

SGT 15B20 (ACFT POWER PLANT REP) C
SP4 15B10 (ACFT POWER PLANT REP) C
PFC 15B10 (ACFT POWER PLANT REP) C

POWERTRAIN TEAM PARA 09

AN/TYQ-151 (V) 1 ULLS-A(E)

SGT 15D20 (ACFT PWRTRAIN REP) C
SP4 15D10 (ACFT PWRTRAIN REP) C
PFC 15D10 (ACFT PWRTRAIN REP) C

STRUCTURAL TEAM PARA 10

AN/TYQ-151 (V) 1 ULLS-A(E)

SGT 15G20 (ACFT STRUCT REP) C
SP4 15G10 (ACFT STRUCT REP) C
PFC 15G10 (ACFT STRUCT REP) C

Aviation Maintenance Company (AVUM) (AH-64)(cont)

PNEUDRAULICS TEAM PARA 11

SYSTEM REPAIR SECTION PARA 12

AN/TYQ-151 (V) 1 ULLS-A(E)

AN/VRC-90F
4 AN/TYQ-151 (V) 1 ULLS-A(E)



SGT 15H20 (ACFT PNEUDRAUL REP) C
SP4 15H10 (ACFT PNEUDRAUL REP) C
PFC 15H10 (ACFT PNEUDRAUL REP) C

CW2 151AE (ACFT ARMT MAINT OFF) C
SFC 15Y40 (AH-64D (SR SYS SUPV) C
2 SSG 15Y30 (AH-64D SYS SUPV) C
8 15Y20 (AH-64D SYS REP) C
12 SP4 15Y10 (AH-64D SYS REP) C
7 PFC 15Y10 (AH-64D SYS REP) C

Summary of Equipment

WEAPONS

LAUNCHER: GRENADE M320A1-----	2
MACHINE GUN LIGHT 5.56MM M249-----	2
MACHINE GUN GRENADE 40MM: MK-19 MOD III-----	2
PISTOL 9MM AUTOMATIC M9-----	19
RIFLE 5.56MM M16A2-----	97
MACHINE GUN: CALIBER .50 (M2E2)-----	3

VEHICLES, TRAILERS, AND TRLR MTD SYSTEMS

CRANE WHEEL MTD: HYDRAULIC LT 7-1/2TON-----	1
FLOODLIGHT SET TLR MTD 3 FLOODLIGHTS 1000 WATTS-----	2
DOLLY SET LIFT TRANSPORTABLE SHEL: 2 1/2T (M707A1)-----	3
GEN SET DIESEL ENGINE TM: 15KW 50/60HZ (PU-802)-----	1
TRUCK UTILITY EXP CAPACITY ENH 4X4: M1152A1-----	4
TRUCK UTILITY EXP CAPACITY ENH 4X4: M1165A1-----	1
TRUCK CARGO: 4X4 LMTV (M1078)-----	10
TRUCK VAN LMTV (M1079)-----	1
TRUCK LIFT FORK: (ATLAS)-----	1
TRAILER HIGH MOBILITY 3/4T (M1101)-----	1
TRAILER CARGO: LMTV W/DROPSIDES (M1082)-----	7
TRAILER TANK: WATER 400 GAL 1-1/2T 2 WHL (M149A2)-----	1

NIGHT VISION/OBSERVATION EQUIPMENT

NIGHT VISION GOGGLES: AN/PVS-7B-----	33
MEDIUM THERMAL WEAPONS SIGHT: AN/PAS-13 (V2)-----	2
HEAVY THERMAL WEAPONS SIGHT: AN/PAS-13 (V3)-----	8

COMMUNICATION-ELECTRONICS EQUIPMENT

ANTENNA GROUP: OE-254-----	4
COMPUTER SET DIGITAL: AN/UYK-128 (FBCB2)-----	6
COMPUTER SYSTEM DIGITAL: (AMPS)-----	1
COMPUTER SET DIGITAL: AN/TYQ-109(V)1 (GCSS-A (V)1)-----	1
NAVIGATION SET: SATELLITE SIGNALS AN/PSN-13 (DAGR)-----	1
PROCESSOR GROUP SIGNAL DATA: (CAISI 2.0)-----	2
RADIAC SET: AN/VDR-2-----	3
RADIO SET: AN/PRC-89F-----	1
RADIO SET: AN/VRC-90F-----	14
RADIO SET: AN/VRC-92F-----	1
RADIO SET: AN/PRC-119F-----	8
INTERFACE UNIT COMM EQ: OL-713(V)1/TYQ CSS VSAT-----	1
COMPUTER SET DIGITAL: AN/TYQ-151 (V) 1 ULLS-A(E)-----	19
COMPUTER SET DIGITAL: AN/TYQ-152 (V) 2-----	7
COMPUTER SET DIGITAL: AN/TYQ-150 (V) 1 ULLS-A(E)-----	1
COMPUTER SET DIGITAL: AN/TYQ-153 ULLS-A(E)-----	1

MISCELLANEOUS EQUIPMENT

CONTAINER ASSEMBLY: AIRMOBILE TYPE X-4 200 CU FT CAP-----	2
GENERATOR SET: DED SKID MTD 5KW 60 HZ (MEP 802A)-----	2
GEN SET : DED SKID MTD 3KW 60HZ (MEP-831A)-----	2
POWER UNIT AUXILIARY: (AGPU)-----	3
SHOP EQUIP CONTACT MAINT (SECM): AVIATION-----	6
STANDARD AIRCRAFT TOWING SYSTEM: (SATS)-----	3

Forward Support Company, AH-64

TOE 63217R000
OFF: 4/WO: 1/ENL: 100/TOTAL: 105

COMPANY HQ PARA 01

AN/VRC-90F
AN/UYQ-90(V)2
FBCB2
DAGR



CPT 90A00 (CDR) P

AN/VRC-92F
AN/GYK-61 (BCS3)
AN/TYQ-109(V)1
AN/UYQ-90(V)3
DAGR
CAISI 2.0



LT 88A00 (EXEC OFF) C
1SG 91Z5M (FIRST SGT) C
SSG 92Y30 (SUPPLY SGT) C
SP4 74D10 (CBRN SP) C
SP4 92Y10 (SUPPLY SP) C

FIELD FEEDING SECTION PARA 02

AN/VRC-90F



X2

SFC 92G40 (SR FOOD OPNS SGT) C
SSG 92G30 (FOOD OPNS MGR) C
2 SGT 92G20 (FOOD OPNS NCO) C
4 SP4 92G10 (FOOD OPNS SP) C
3 PFC 92G10 (FOOD OPNS SP) C

AN/VRC-90F
DAGR



AN/VRC-90F
DAGR

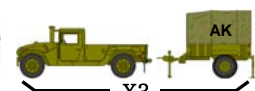

X3

DISTRIBUTION PLT HQ PARA 03

AN/VRC-92F
AN/UYQ-90(V)2
FBCB2
AN/TYQ-129(V)2
AN/UYQ-90(V)3
DAGR



LT 92A00 (PLT LDR) C
SFC 92F40 (PLT SGT) C
SGT 92A20 (MAT CON/ACCTG NCO) C

AN/VRC-90F
DAGR



AN/VRC-90F
DAGR



CLASS III SECTION PARA 04

AN/VRC-90F
AN/UYQ-90(V)2
DAGR



X3

3 SSG 92F30 (SECTION CHIEF) C
6 SGT 92F20 (ACFT FUEL HANDLER) C
7 SP4 92F10 (ACFT FUEL HANDLER) C
6 PFC 92F10 (ACFT FUEL HANDLER) C

AN/VRC-90F
AN/UYQ-90(V)2



AN/VRC-90F
AN/UYQ-90(V)2



2 SP4 88M10 (AMMO SP) C

CLASS V SECTION PARA 05

AN/VRC-90F
AN/UYQ-90(V)2
DAGR



SSG 88M30 (SECTION SGT) C
PFC 88M10 (AMMO SP) C

AN/VRC-90F
AN/UYQ-90(V)2



SGT 88M20 (AMMO SGT) C
PFC 88M10 (AMMO SP) C

X3

CAB-34

Forward Support Company, AH-64 (cont)

DISTRIBUTION SECTION PARA 06

AN/VRC-90F
AN/UYQ-90(V)2
DAGR



X2
SP4 88M10 (VEH DRIVER) C
PFC 88M10 (VEH DRIVER) C

AN/VRC-90F
AN/UYQ-90(V)2
DAGR



SP4 88M10 (VEH DRIVER) C

AN/VRC-90F
AN/UYQ-90(V)2
DAGR



X2
SSG 92F30 (SECTION CHIEF) C
SGT 92F20 (PETRL HVY VEH OPR) C
2 SP4 92F10 (PETRL HVY VEH OPR) C



X2

MAINTENANCE CONTROL SECTION/PLATOON HQ PARA 07

AN/VRC-92F
DAGR



LT 91A00 (PLT LDR) C

AN/VRC-90F
AN/UYQ-90(V)2
FBCB2
DAGR



CW2 915A0 (AUTO MAINT WO) C

AN/VRC-90F
DAGR
CAISI 2.0
OL-713(V)1/TYQ CSS VSAT
AN/TYQ-139
AN/TQ-140



SFC 91X40 (PLT SGT) C
SGT 92A20 (EQ RCD/PARTS SGT) C
SP4 92A10 (EQ RCD/PARTS SP) C
2 PFC 92A10 (EQ RCD/PARTS SP) C

PU 2101

AN/VRC-90F
DAGR



MAINTENANCE SECTION PARA 08

AN/VRC-90F
DAGR



SFC 91X40 (MOTOR SGT) C

AN/VRC-90F
AN/UYQ-90(V)2
DAGR



X2

AN/VRC-90F
DAGR



X2



AN/VRC-90F
AN/UYQ-90(V)2
DAGR



AN/VRC-90F
AN/UYQ-90(V)2
DAGR



AN/ASM-146

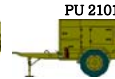

PU 2101

AN/UYQ-90(V)2



AN/VRC-90F
AN/UYQ-90(V)2
DAGR



SGT 91B20 (RCVY VEH OPR) C

AN/VRC-90F
AN/UYQ-90(V)2
DAGR



SP4 91B10 (RCVY VEH OPR) C

AN/UYQ-90(V)2
DAGR



SP4 91E10 (ALLIED TRADES SP) C

SSG 91B30 (SHOP FOREMAN) C
SSG 91B30 (SR MECHANIC) C
4 SGT 91B20 (WH VEH MECH) C
SGT 91D20 (PWR-GEN EQ REP) C
SGT 91F20 (SM ARMS/ARTY REP) C
SGT 91J20 (QM/CHEM EQ REP) C
4 SP4 91B10 (WH VEH MECH) C
SP4 91C10 (UTIL EQ REP) C
SP4 91D10 (PWR-GEN EQ REP) C
SP4 91J10 (QM/CHEM EQ REP) C
SP4 91L10 (CONST EQ REP) C
SP4 94F10 (COMP/DET SYS REP) C
6 PFC 91B10 (WH VEH MECH) C
PFC 91D10 (PWR-GEN EQ REP) C
PFC 91F10 (SM ARMS/ARTY REP) C
PFC 91J10 (QM/CHEM EQ REP) C

Summary of Equipment

WEAPONS

LAUNCHER: GRENADE M320A1-----	4
MACHINE GUN 5.56MM M249-----	4
MACHINE GUN GRENADE 40MM MK-19 MOD III-----	4
MACHINE GUN 7.62MM M240B-----	9
PISTOL 9MM AUTOMATIC M9-----	1
RIFLE 5.56MM M4 CARBINE-----	94
MACHINE GUN: CALIBER .50 (M2E2)-----	10

VEHICLES, TRAILERS, AND TRLR MTD SYSTEMS

CONTAINERIZED KITCHEN (CK)-----	1
FORWARD REPAIR SYSTEM: M7 (FRS)-----	1
SHOP EQUIPMENT: AUTOMOTIVE VEHICLE (TLR MTD) (SATS)-----	1
SEMITRAILER VAN: SUPPLY 12T 4 WHL (M129A2C)-----	1
TRUCK CARGO: TACTICAL 8X8 HEMTT W/LT CRANE (M977)-----	7
TRUCK UTILITY EXP CAPACITY ENH 4X4: M1152A1-----	7
TRUCK VAN EXPANSIBLE MTV (M1087A1)-----	1
TRAILER FLAT BED: 11 TON 4 WHL (M989A1) (HEMAT)-----	16
TRUCK UTILITY EXP CAPACITY ENH 4X4: M1165A1-----	3
TRUCK CARGO: HVY PLS TRANSPORTER 10X10 (M1075)-----	1
TRUCK CARGO: MTV (M1083)-----	10
TRUCK TANK: FUEL SERVICING 2500 GAL 8X8 HEMTT (M978)-----	8
TRUCK TRACTOR MTV (M1088)-----	1
TRUCK LIFT: FORK VARIABLE REACH RT (ATLAS)-----	2
TRAILER: PLS 8X20 (M1076)-----	1
TRUCK WRECKER: TACTICAL 8X8 HEMTT (M984A1)-----	1
TRUCK WRECKER: MTV (M1089)-----	1
TRAILER CARGO: MTV W/ DROPSIDES (M1095)-----	4
LIGHT TACTICAL TRAILER: 3/4T (M1101)-----	4
TRUCK CARGO HEMTT LHS (M1120)-----	4
SHOP EQUIPMENT: WELDING TRAILER MTD-----	3
TRAILER-MTD : PU-2101/ 15KW 50/60HZ/ M200A1-----	2
TRAILER TANK WATER (CAMEL) 800 GAL 5 TON-----	2

NIGHT VISION/OBSERVATION EQUIPMENT

DRIVERS VISION ENHANCER: AN/VAS-5-----	22
NIGHT VISION GOGGLES: AN/PVS-7B-----	100
MEDIUM THERMAL WEAPONS SIGHT: AN/PAS-13(V2)-----	13
HEAVY THERMAL WEAPONS SIGHT: AN/PAS-13(V3)-----	13

COMMUNICATION-ELECTRONICS EQUIPMENT

ANTENNA GROUP: OE-254-----	3
COMPUTER SYSTEM DIGITAL: AN/UYQ-90(V)2 (MTS)-----	35
COMPUTER SET DIGITAL: AN/UYK-128 (FBCB2)-----	3
BTL CMD SUSTAINMENT SPT SYSTEM: AN/GYK-61 (BCS3)-----	1
COMPUTER SYS DIGITAL: AN/TYQ-129(V)2 (TC-AIMS II WS)-----	1
COMPUTER SET DIGITAL: AN/TYQ-109(V)1 (GCSS-A (V)1)-----	1
COMPUTER SYSTEM DIGITAL: AN/UYQ-90(V)3 (MTS-CS)-----	2
NAVIGATION SET: SATELLITE SIGNALS AN/PSN-13 (DAGR)-----	31
PROCESSOR GROUP SIGNAL DATA: (CAISI 2.0)-----	2
RADIAC SET: AN/VDR-2-----	10
RADIO SET: AN/VRC-90F-----	41
RADIO SET: AN/VRC-92F-----	3
INTERFACE UNIT COMM EQ: OL-713(V)1/TYQ CSS VSAT-----	1
COMPUTER SYSTEM: DIGITAL AN/TYQ-139 (SAMS-1E V1)-----	1
COMPUTER SYSTEM: DIGITAL AN/TYQ-140 (SAMS/SAMS-1E V2)-----	1

MISCELLANEOUS EQUIPMENT

ASSAULT KITCHEN (AK)-----	3
BED CARGO: DEMOUNTABLE PLS 8X20-----	1
FORWARD AREA REFUELING SYSTEM: ADV AVN (AAFARS)-----	2
ELECTRONICS SHOP SHEL MTD AVIONICS: AN/ASM-146-----	1
REFUELING SYTEM: AVIATION HEMTT TANKER-----	6
SHOP EQUIP: CONTACT MAINT ORD/ENGR TRK MTD-----	2
TANK UNIT LIQUID DISPENSING TRAILER MTG-----	6
TOWBAR MOTOR VEHICLE: WHEELED-----	7
MULTI-TEMP REFRIGERATED CONTAINER SYS: MTRCS-----	1
GENERATOR SET DED 5KW 50/60HZ: SKID MTD (TEP)-----	1
GENERATOR SET DED 10KW 50/60HZ: SKID MTD (TEP)-----	3

Forward Support Company, AH-64

HQ & Support Company (ASB)

63316R200
OFF: 20/WO: 3/ENL: 167/TOTAL: 190

COMMAND SECTION PARA 01

AN/VRC-92F
AN/UYQ-90(V)2
FBCB2
AN/GYK-61 (BCS3)
DAGR

AN/VRC-92F
DAGR
EPLRS-V1



LTC 15D00 (COMMANDER) P
SP4 88M10 (VEH DRIVER) SAW



MAJ 90A00 (EXEC OFF) P

CSM 00Z50 (CMD SGM) P

CURR OPS -INTEL/S2 PARA 02

AN/VRC-92F
FBCB2
DAGR



CPT 35D00 (S2) P
SP4 35F10 (INTEL ANALYST) C
PFC 35F10 (INTEL ANALYST) C

CURR OPS -OPS/S3 PARA 03

AN/VRC-92F
FBCB2
AN/TYQ-137A:(V)2
AN/TSR-8 (GRT)
AN/VRC-100 (V) 1
AN/PSC-5

AN/VRC-90F
DAGR



CPT 15B00 (S3) P
CPT 15B00 (PLANS OFF) P
CPT 90A00 (OPNS OFF) C
MSG 92A50 (OPNS SGT) C
SSG 29E30 (EW SGT) C
SSG 74D30 (CBRN NCO) C
SGT 29E20 (EW SGT) C

MED PWR PLANT



PU 803

X2

SUSTAINMENT 1 - S1 PARA 04

AN/VRC-90F
FBCB2
DAGR
5 AN/TYQ-116(V)3



CPT 42B00 (S1) C
SPC 42A40 (SR HUMAN RES SGT) C
SSG 42A30 (HUMAN RES SGT) C
SGT 27D20 (PARALEGAL NCO) C
SGT 42A20 (HUMAN RES SGT) C
2 SP4 42A10 (HUMAN RES SP) C
3 PFC 42A10 (HUMAN RES SP) C

S4 SECTION PARA 05

AN/VRC-92F
AN/UYQ-90(V)2
FBCB2
DAGR



CPT 90A00 (S4) C

AN/VRC-90F
2 AN/GYK-61 (BCS3)
2 AN/TYQ-129(V)2
AN/TYQ-109(V)1
AN/UYQ-90(V)3
AN/TYQ-95
DAGR
CAISI 2.0



MED PWR PLANT

MSG 91Z50 (SR MAINT SUPV) C
SGT 92Y20 (SUPPLY NCO) C
SP4 92Y10 (SUPPLY SP) C

SUSTAINMENT 1 - C4 OPS/S6 PARA 06

AN/VRC-90F
FBCB2
DAGR



CPT 25A00 (S6) C

AN/VRC-92F
AN/TYQ-137A:(V)2
AN/UYQ-90(V)3
DAGR
AN/TSR-8 (GRT)
AN/GYK-50A (ISYSCON) (V) 4
AN/USQ-165



SPC 25U40 (SECTION CHIEF) C
SP4 25B10 (LAN MGR) C
SP4 25U10 (SGNL INFO SVC SP) SAW
PFC 25B10 (LAN MGR) C
PFC 25U10 (SGNL SPT SYS SP) C

AN/VRC-90F
KG-175
DAGR

BCP (SWITCHING GP): OM-87A/T



SGT 25Q20 (SR XMSN SYS OPR-MAINT) C
SP4 25Q10 (XMSN SYS OPR-MAINT) C

AN/VRC-90F
DAGR

SUSTAINMENT 1 - UMT PARA 07

AN/VRC-90F
DAGR



CPT 56A00 (CHAPLAIN)
SP4 56M10 (CHAP ASST) C

HQ & Support Company, ASB (cont)

SUSTAINMENT 2 – SUPPORT OPERATIONS PARA 08

AN/VRC-90F
AN/UYQ-90(V)2
FBCB2
KG-175
DAGR

AN/VRC-92F
AN/GYK-61 (BCS3)
AN/PYQ-12
OL-604/TYQ
2 AN/TYQ-129(V)2
AN/TYQ-109(V)2
OL-608/TYQ
AN/TYQ-137A:(V)2
AN/UYQ-90(V)3
DAGR
OL-713(V)1/TYQ CSS VSAT
AN/TYQ-141

AN/VRC-90F
DAGR

AN/VRC-90F
DAGR



MAJ 90A00 (SPT OPNS OFF) P



CPT 88A00 (TRANS OFF) C
CPT 90A00 (OPNS OFF) C
CPT 91A00 (AMMO OFF) C
CW5 153AL (AVN MATERIEL OFF) P



SGM 15Z50 (SR ACFT MAINT MGR) C
SFC 15T40 (ACFT MAINT SUPV) C
SFC 89B40 (AMMO LOG SGT) C
SFC 91X40 (MAINT MGT NCO) C
SFC 92A40 (OPNS SGT) C



SFC 92F40 (PETRL SUPPLY SGT) C
SSG 88N30 (MOVEMENTS SUPV) C
SSG 89B30 (AMMO INSPECTOR) C
SGT 92M20 (MORTUARY AFFAIRS SGT) C

SUSTAINMENT 1 – C4 OPS/CSSAMO PARA 09

AN/VRC-90F
AN/UYQ-90(V)2
DAGR

AN/VRC-90F
AN/TYQ-107(V)2
AN/TYQ-107(V)1
AN/TYQ-106(V)1
OL-604/TYQ
OL-591/TYQ
AN/TYQ-129(V)2
AN/TYQ-105(V)1
AN/TYQ-108(V)2
AN/TYQ-108(V)3
AN/TYQ-109(V)2

OL-608/TYQ
OL-603/TYQ
AN/UYQ-90(V)3
DAGR
AN/GYK-50A (ISYSCON) (V) 4
OL-713(V)1/TYQ-CSS VSAT
AN/TYQ-151 (V) 1 ULLS-A(E)
AN/TYQ-150 (V) 1 ULLS-A(E)
AN/TYQ-141
AN/TYQ-139
AN/TYQ-140

AN/VRC-90F
DAGR



CW2 251A0 (INFO SYS TECH) C
SFC 25B40 (INFO SYS SUPV) C

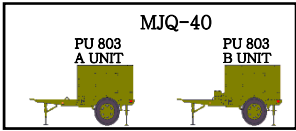

SSG 92A30 (MAT MGMT NCO) C
SSG 92Y30 (SUPPLY SGT) SAW
3 SGT 15T20 (UH-60 REP/TM CHIEF) C
SGT 25B20 (SR INFO SYS SP) C
SGT 68J20 (MEDICAL LOG SGT) C
SP4 25B10 (INFO SYS SP) SAW



COMPANY HEADQUARTERS PARA 10

AN/VRC-92F
AN/UYQ-90(V)2
DAGR

AN/VRC-90F
DAGR

AN/VRC-90F
AN/TYQ-109(V)1
DAGR
CAISI 2.0



CPT 90A00 (COMMANDER) P
1SG 92A5M (FIRST SGT) C



SP4 74D10 (CBRN DECON SP) SAW



SSG 92Y30 (SUPPLY SGT) C
SP4 92Y10 (SUPPLY SP) SAW

HQ & Support Company, ASB (cont)

FIELD FEEDING SECTION PARA 11

AN/VRC-90F
DAGR



X2

SFC 92G40 (SR FOOD OPNS SGT) C
2 SSG 92G30 (FOOD OPNS MGR) C
4 SGT 92G20 (FOOD OPNS NCO) C
8 SP4 92G10 (FOOD OPNS SP) C
4 PFC 92G10 (FOOD OPNS SP) C
2 PFC 92G10 (FOOD OPNS SP) SAW

AN/VRC-90F
DAGR



AN/VRC-90F
DAGR



X3

MAINTENANCE PLATOON HQ PARA 12

AN/VRC-92F
AN/UYQ-90(V)2
FBCB2
AN/UYQ-90(V)3
DAGR



LT 91A00 (PLT LDR) C
SFC 91X40 (PLT SGT) C

MAINTENANCE CONTROL SECTION PARA 13

AN/VRC-90F
AN/UYQ-90(V)2
DAGR



LT 91A00 (MAINT CONT OFF) C

AN/VRC-89F
DAGR
5 AN/TYQ-139
AN/TYQ-140



CW2 915A0 (AUTO MAINT WO) C
SFC 91X40 (MAINT CONT SGT) C
SGT 92A20 (EQ RCD/PARTS SGT) C
SP4 92A10 (EQ RCD/PARTS SP) SAW
2 PFC 92A10 (EQ RCD/PARTS SP) C

AN/VRC-90F
DAGR



MAINTENANCE SECTION PARA 14

AN/VRC-90F
DAGR



SFC 91X40 (MOTOR SGT) C

AN/VRC-90F
FBCB2
DAGR



X2

AN/VRC-90F
AN/UYQ-90(V)2
FBCB2
DAGR

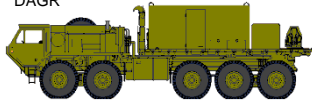

SGT 91B20 (RCVY VEH OPR) SAW



AN/VRC-90F
AN/UYQ-90(V)2
FBCB2
DAGR



SP4 91B10 (RCVY VEH OPR) C

AN/VRC-90F
DAGR



X6



X3



AN/VRC-90F
DAGR



AN/VRC-90F
DAGR



AN/VRC-90F
AN/UYQ-90(V)2
FBCB2
DAGR



SGT 91B20 (RCVY VEH OPR) SAW

AN/VRC-90F
AN/UYQ-90(V)2
FBCB2
DAGR



SP4 91B10 (RCVY VEH OPR) C

AN/VRC-90F
DAGR



X6



AN/VRC-90F
DAGR



X2

AN/VRC-90F
DAGR



SGT 91E20 (ALLIED TRADES SP) C
PFC 91E10 (ALLIED TRADES SP) C

AN/VRC-90F
DAGR

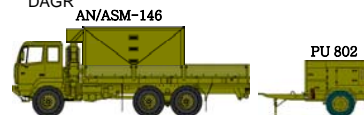

CAB-39

SSG 91B30 (SHOP FOREMAN) C
2 SSG 91B30 (SR MECHANIC) C
SSG 91C30 (SR UTIL EQ REP) C
SSG 91C30 (SR QM & CHEM EQ REP) C
SSG 91D30 (SR PWR-GEN EQ REP) C
12 SGT 91B20 (WH VEH MECH) C
3 SGT 91C20 (UTIL EQ REP) C
2 SGT 91D20 (PWR-GEN EQ REP) C
SGT 91F20 (SM ARMS/ARTY REP) C
2 SGT 91J20 (QM/CHEM EQ REP) C
7 SP4 91B10 (WH VEH MECH) C
6 SP4 91B10 (WH VEH MECH) SAW
3 SP4 91C10 (UTIL EQ REP) C
2 SP4 91D10 (PWR-GEN EQ REP) C
SP4 91F10 (SM ARMS/ARTY REP) C
2 SP4 91J10 (QM/CHEM EQ REP) C
SP4 91L10 (CONST EQ REP) C
SP4 94E10 (COMSEC/RADIO EQ REP) C
SP4 94F10 (COMP/DET SYS REP) SAW
15 PFC 91B10 (WH VEH MECH) C
3 PFC 91C10 (UTIL EQ REP) C
3 PFC 91D10 (PWR-GEN EQ REP) C
PFC 91F10 (SM ARMS/ARTY REP) SAW
2 PFC 91J10 (QM/CHEM EQ REP) C

HQ & Support Company, ASB (cont)

MEDICAL PLATOON HQ PARA 15

AN/VRC-92F
DAGR



LT 70B67 (FIELD MED ASST) C
SFC 68W40 (PLT SGT) C

TREATMENT SQUAD PARA 16

AN/VRC-90F
2 AN/TYQ-106(V)1
4 AN/TYQ-105(V)1
DAGR



X2

CPT 61N00 (FLIGHT SURGEON) P
CPT 65D00 (PHYSICIAN ASST) P
SSG 68W30 (HEALTH CARE SGT) C
2 SGT 68W20 (HEALTH CARE SGT) C
SP4 68W10 (HEALTH CARE SP) C
2 PFC 68W10 (HEALTH CARE SP) C

EVACUATION SECTION PARA 17

AN/VRC-90F
AN/UYQ-90(V)2
AN/TYQ-105(V)1
DAGR



SGT 68W20 (EMERGENCY CARE SGT) C
PFC 68W10 (AMBULANCE AIDE/DVR) C

AN/VRC-90F
AN/UYQ-90(V)2
AN/TYQ-105(V)1
DAGR



SGT 68W20 (EMERGENCY CARE SGT) C
PFC 68W10 (AMBULANCE AIDE/DVR) C

Summary of Equipment

WEAPONS

LAUNCHER: GRENADE M320A1-----	4
MACHINE GUN 5.56MM M249-----	18
MACHINE GUN LIGHT 5.56MM M249-----	4
MACHINE GUN GRENADE 40MM MK-19 MOD III-----	2
MACHINE GUN 7.62MM: M240L-----	1
MACHINE GUN 7.62MM M240B-----	4
PISTOL 9MM AUTOMATIC M9-----	10
RIFLE 5.56MM M16A2-----	161
MACHINE GUN: CALIBER .50 (M2E2)-----	7

VEHICLES, TRAILERS, AND TRLR MTD SYSTEMS

CONTAINERIZED KITCHEN (CK)-----	1
CHEM AND BIO PROTECTED SHELTER SYSTEM (CBPS)-----	2
FORWARD REPAIR SYSTEM: M7 (FRS)-----	1
GEN SET DIESEL ENGINE TM: 30KW 50/60 HZ (PU-803)-----	3
GEN SET DED TM: 10KW 60HZ (PU-798)-----	1
GEN SET DIESEL ENGINE TM: 15KW 50/60HZ (PU-802)-----	1
POWER PLANT ELEC TM: 30KW 50/60HZ (AN/MJQ-40)-----	1
POWER PLANT: UTILITY, MEDIUM 20KW 5 TON ECU-----	3
SHOP EQUIPMENT: AUTOMOTIVE VEHICLE (TLR MTD)-----	1
TOOL OUTFIT HYD SYS: TEST & REP 3/4T TLR MTD (HYSTRU)-----	1
TRUCK UTILITY EXP CAPACITY ENH 4X4: M1152A1-----	22
TRUCK AMBULANCE: 4 LITTER HMMWV (M997)-----	2
TRUCK VAN EXPANSIBLE MTV (M1087A1)-----	2
TRUCK UTILITY EXP CAPACITY ENH 4X4: M1165A1-----	9
TRUCK CARGO: 4X4 LMTV (M1078)-----	8
TRUCK CARGO: MTV (M1083)-----	14
TRUCK CARGO MTV LWB (M1085)-----	1
TRUCK VAN LMTV (M1079)-----	1
TRUCK CARGO: HVY PLS TRANSPORTER 10X10 (M1075)-----	1
TRAILER: PLS 8X20 (M1076)-----	2
TRUCK WRECKER: TACTICAL 8X8 HEMTT (M984A1)-----	1
TRUCK WRECKER: MTV (M1089)-----	1
TRAILER CARGO: MTV W/ DROPSIDES (M1095)-----	7
LIGHT TACTICAL TRAILER: 3/4T (M1101)-----	13
TRUCK CARGO HEMTT LHS (M1120)-----	1
TRAILER CARGO: LMTV W/DROPSIDES (M1082)-----	5
SHOP EQUIPMENT: WELDING TRAILER MTD-----	1
TRAILER TANK WATER (CAMEL) 800 GAL 5 TON-----	2
TRAILER-MTD : PU-2101/ 15KW 50/60HZ/ M200A1-----	1

MISCELLANEOUS EQUIPMENT

ASSAULT KITCHEN (AK)-----	3
BED CARGO: DEMOUNTABLE PLS 8X20-----	1
DECON APPARATUS LT WT-----	2
GEN SET : DED SKID MTD 3KW 60HZ (MEP-831A)-----	2
GEN SET: DED SKID MTD 10KW 60HZ (MEP-803A)-----	2
ELECTRONICS SHOP SHEL MTD AVIONICS: AN/ASM-146-----	1
ELECTRONICS SHOP SHEL MTD AVIONICS: AN/ASM-147-----	1
SHOP EQUIP: CONTACT MAINT ORD/ENGR TRK MTD-----	2
MULTI-TEMP REFRIGERATED CONTAINER SYS: MTRCS-----	1

COMMUNICATION-ELECTRONICS EQUIPMENT

ANTENNA GROUP: OE-254-----	8
COMPUTER SYSTEM DIGITAL: AN/TYQ-107(V1) (MC4-3A)-----	2
COMPUTER SYSTEM DIGITAL: AN/TYQ-107(V2) (MC4-3B)-----	1
COMPUTER SYSTEM DIGITAL: AN/UYQ-90(V2) (MTS)-----	11
COMPUTER SYSTEM DIGITAL: AN/TYQ-106(V1) (MC4-2)-----	3
COMPUTER SET DIGITAL: AN/UYK-128 (FBCB2)-----	13
BTL CMD SUSTAINMENT SPT SYSTEM: AN/GYK-61 (BCS3)-----	4
COMPUTER SET DIGITAL: AN/PYQ-12 (MCS GATEWAY SVR)-----	1
COMPUTER SET DIGITAL: OL-604/TYQ (SARSS DSU WS)-----	2
COMPUTER SYS DIGITAL: AN/TYQ-129(V2) (TC-AIMS II WS)-----	5
COMPUTER SYSTEM DIGITAL: AN/TYQ-105(V1) (MC4-1)-----	11
COMPUTER SYSTEM DIGITAL: AN/TYQ-108(V2) (MC4-4B)-----	1
COMPUTER SYSTEM DIGITAL: AN/TYQ-108(V3) (MC4-4C)-----	1
COMPUTER SET DIGITAL: AN/TYQ-109(V1) (GCSS-A (V1))-----	2
COMPUTER SET DIGITAL: AN/TYQ-109(V2) (GCSS-A (V2))-----	2
COMPUTER SET DIGITAL: OL-608/TYQ (SAAS-MOD DAO)-----	2
COMPUTER SYSTEM DIGITAL: ((CPOF WS) AN/TYQ-137A:(V2)-----	3
COMPUTER SET DIGITAL: OL-603/TYQ (SARSS DSU SVR)-----	1
COMPUTER SYSTEM DIGITAL: AN/UYQ-90(V3) (MTS-CS)-----	5
ENCRYPT/DECRYPT EQUIPMENT: TACLANE KG-175-----	2
INTERROGATOR SET AN/TYQ-95 (TC-AIMS II INTERROGATOR)-----	1
NAVIGATION SET: SATELLITE SIGNALS AN/PSN-13 (DAGR)-----	63
PROCESSOR GROUP SIGNAL DATA: (CAISI 2.0)-----	2
RADIAC SET: AN/VDR-2-----	7
RECEIVE SUITE: AN/TSR-8 (GRT)-----	2
RADIO SET: AN/VRC-89F-----	1
RADIO SET: AN/VRC-90F-----	52
RADIO SET: AN/VRC-92F-----	10
RADIO SET: AN/PSC-5-----	1
RADIO SET: HIGH FREQ AN/VRC-100 (V) 1-----	1
COMPUTER SYSTEM DIGITAL: AN/GYK-50A (ISYSCON) (V4)-----	2
INTERFACE UNIT COMM EQ: OL-713(V1)/TYQ CSS VSAT-----	2
BATTALION COMMAND POST (SWITCHING GROUP): OM-87A/T-----	1
COMPUTER SET DIGITAL: AN/TYQ-151 (V) 1 ULLS-A(E)-----	1
COMPUTER SET DIGITAL: AN/TYQ-150 (V) 1 ULLS-A(E)-----	1
COMPUTER SYSTEM DIGITAL: AN/TYQ-141 (SAMS-2E V2)-----	2
COMPUTER SYSTEM: DIGITAL AN/TYQ-139 (SAMS-1E V1)-----	6
COMPUTER SYSTEM: DIGITAL AN/TYQ-140 (SAMS/SAMS-1E V2)-----	2
COMP SYS DIGITAL: (AHR) AN/TYQ-116(V3)-----	5
COMMUNICATIONS SUBSYSTEM: AN/USQ-165-----	1

NIGHT VISION/OBSERVATION EQUIPMENT

AVIATORS NIGHT VISION INAGING SYSTEM: AN/AVS-6 (V) 1-----	1
DRIVERS VISION ENHANCER: AN/VAS-5-----	2
NIGHT VISION GOGGLES: AN/PVS-7B-----	130
MEDIUM THERMAL WEAPONS SIGHT: AN/PAS-13(V2)-----	6
HEAVY THERMAL WEAPONS SIGHT: AN/PAS-13(V3)-----	9

HQ and Support Company, ASB

Distribution Company (ASB)

TOE 63318R200
OFF: 4/WO: 2/ENL: 102/TOTAL: 108

COMPANY HQ PARA 01

AN/VRC-92F
FBCB2
DAGR



CPT 90A00 (COMMANDER) P

AN/VRC-90F
AN/UYQ-90(V)2
FBCB2
AN/TYQ-109(V)1
AN/UYQ-90(V)3
DAGR
CAISI 2.0



LT 92A00 (EXEC OFF) C
1SG 92A5M (FIRST SGT) C
SSG 92Y30 (SUPPLY SGT) C
SP4 74D10 (CBRN SP) C
SP4 92Y10 (SUPPLY SP) C

SUPPLY PLATOON HQ PARA 02

AN/VRC-92F
AN/UYQ-90(V)2
FBCB2
AN/UYQ-90(V)3
DAGR



LT 92A00 (PLT LDR) C

AN/VRC-90F
AN/UYQ-90(V)2
OL-603/TYQ
DAGR
CAISI 2.0



PU 798
CW2 920B0 (SUPPLY SYS TECH) C
SFC 92A40 (PLT SGT) C
SGT 92A20 (MAT CON/ACCTG NCO) C
2 SP4 92A10 (MAT CON/ACCTG SP) C
2 PFC 92A10 (MAT CON/ACCTG SP) C

TRUCK SQUAD PARA 03

AN/VRC-90F
AN/UYQ-90(V)2
FBCB2
DAGR



X5
SSG 88M30 (SQUAD LDR) C
SSG 88M30 (HVY VEH DRIVER) C
3 SGT 88M20 (HVY VEH DRIVER) C
3 SP4 88M10 (HVY VEH DRIVER) C
PFC 88M10 (HVY VEH DRIVER) C

GENERAL SUPPLY & CLASS IX SECTION PARA 04

AN/VRC-90F
AN/UYQ-90(V)2
FBCB2
OL-604/TYQ
DAGR



AN/VRC-90F
AN/UYQ-90(V)2
FBCB2
OL-604/TYQ
DAGR



AN/VRC-90F
AN/UYQ-90(V)2
FBCB2
OL-604/TYQ
DAGR



X3

AN/VRC-90F
AN/UYQ-90(V)2
FBCB2
DAGR



X7



X6



X2



X4

SFC 92A40 (STOCK CONTROL SUPV) C
2 SSG 92A30 (MAT MGMT SUPV) C
SGT 92A20 (MAT CONT/ACCTG NCO) C
5 SGT 92A20 (MAT STORE/HDLG SGT) C
4 SP4 92A10 (MAT CONT/ACCTG SP) C

5 SP4 92A10 (MAT STORE/HDLG SP) C
SP4 92A10 (SUBSISTANCE SUP SP) C
2 PFC 92A10 (MAT CONT/ACCTG SP) C
8 PFC 92A10 (MAT STORE/HDLG SP) C
PFC 92A10 (SUBSISTANCE SUP SP) C



AMMO TRANSFER HOLDING POINT SECTION PARA 05

AN/VRC-90F
AN/UYQ-90(V)2
FBCB2
DAGR



CW2 890A0 (AMMO WO) C

AN/VRC-90F
AN/UYQ-90(V)2
FBCB2
DAGR



SSG 89B30 (SECTION CHIEF) C

AN/VRC-90F
AN/UYQ-90(V)2
FBCB2
DAGR



X3

SGT 89A20 (AMMO STK CON/ACCTG SGT) C
SGT 89B20 (AMMO SGT) C
SP4 89A10 (AMMO STK/ACCTG SP) C
3 SP4 89B10 (AMMO SP) C
3 PFC 89B10 (AMMO SP) C



X2



AN/UYQ-90(V)3
CAISI 2.0
SAAS-MOD-ATHP

S-785G SHELTER

Distribution Company (ASB) (cont)

FUEL AND WATER PLATOON HQ PARA 06

CLASS III SECTION PARA 07

AN/VRC-92F
AN/UYQ-90(V)2
FBCB2
AN/UYQ-90(V)3
DAGR



LT 92F00 (PLT LDR) C
SFC 92F40 (PLT SGT) C

AN/VRC-90F
AN/UYQ-90(V)2
FBCB2
DAGR



AN/VRC-90F
AN/UYQ-90(V)2
FBCB2
DAGR



X6



AN/VRC-90F
AN/UYQ-90(V)2
FBCB2
DAGR



X2



2 SSG 92F30 (SECTION CHIEF) C
SGT 12N20 (HORIZ CONST ENGR) C
2 SGT 92F20 (PETRL HVY VEH OPR) C
SGT 92F20 (PETRL INV CONTROL SP) C
4 SP4 92F10 (PETRL HVY VEH OPR) C
4 SP4 92F10 (PETRL SUPPLY SP) C
6 PFC 92F10 (PETRL SUPPLY SP) C

AIRCRAFT REFUEL SECTION PARA 08

AN/VRC-90F
2 ANPRC-119F
FBCB2
DAGR



X2

AN/VRC-90F
AN/PRC-119F
FBCB2
DAGR



X4

SSG 92F30 (SECTION CHIEF) C
3 SGT 92F20 (ACFT FUEL HANDLER) C
5 SP4 92F10 (ACFT FUEL HANDLER) C
2 PFC 92F10 (ACFT FUEL HANDLER) C

WATER SECTION PARA 09

AN/VRC-90F
AN/UYQ-90(V)2
FBCB2
DAGR



X2

LWPS



SSG 92W30 (WATER TRMT SUPV) C
2 SGT 92W20 (WATER TRMT NCO) C
4 SP4 92W10 (WATER TRMT SP) C
3 PFC 92W10 (WATER TRMT SP) C

AN/VRC-90F
AN/UYQ-90(V)2
DAGR



X4



X3



X8

Summary of Equipment

WEAPONS

MACHINE GUN 5.56MM M249 -----	11
MACHINE GUN LIGHT 5.56MM M249-----	4
MACHINE GUN GRENADE 40MM MK-19 MOD III-----	6
MACHINE GUN 7.62MM M240B-----	12
PISTOL 9MM AUTOMATIC M9-----	1
RIFLE 5.56MM M4 CARBINE-----	96
MACHINE GUN: CALIBER .50 (M2E2)-----	8

VEHICLES, TRAILERS, AND TRLR MTD SYSTEMS

GEN SET DED TM: 10KW 60HZ (PU-798)-----	1
SEMITRLR FLAT BED: BRKBULK/CONT 22-1/2T (M871A2)-----	1
SEMITRAILER VAN: SUPPLY 12T 4 WHL (M129A2C)-----	6
SEMITRAILER TANK: 5000 GAL FUEL DISPENSING (M969A1)-----	4
TRUCK CARGO: MTV (M1083)-----	4
TRUCK UTILITY EXP CAPACITY ENH 4X4: M1152A1-----	6
TRUCK LIFT FORK: DSL DRVN 4000LB CAP ROUGH TERR-----	3
TRUCK UTILITY EXP CAPACITY ENH 4X4: M1165A1-----	4
TRUCK TANK: FUEL SERVICING 2500 GAL 8X8 HEMTT (M978)-----	6
TRUCK TRACTOR MTV (M1088)-----	11
TRUCK LIFT: FORK VARIABLE REACH RT (ATLAS)-----	6
TRAILER: PLS 8X20 (M1076)-----	22
TRAILER CARGO: MTV W/ DROPSIDES (M1095)-----	2
TRAILER HIGH MOBILITY 1-1/4T (M1102)-----	2
LIGHT TACTICAL TRAILER: 3/4T (M1101)-----	4
TRUCK CARGO HEMTT LHS (M1120)-----	17
TRAILER TANK WATER (CAMEL) 800 GAL 5 TON-----	1
LIGHT TYPE 1 ABN/ASLT: 1.6 - 2.1 CU YD LOADER-----	1

NIGHT VISION/OBSERVATION EQUIPMENT

NIGHT VISION GOGGLES: AN/PVS-7B-----	105
MEDIUM WEAPON THERMAL SIGHT (MWTS): AN/PAS-13(V)2-----	16
HEAVY WEAPON THERMAL SIGHT (HWTS): AN/PAS-13(V)3-----	14

COMMUNICATION-ELECTRONICS EQUIPMENT

ANTENNA GROUP: OE-254-----	2
COMPUTER SYSTEM DIGITAL: AN/UYQ-90(V)2 (MTS)-----	41
COMPUTER SET DIGITAL: AN/UYK-128 (FBCB2)-----	43
COMPUTER SET DIGITAL: OL-604/TYQ (SARSS DSU WS)-----	5
COMPUTER SET DIGITAL: AN/TYQ-109(V)1 (GCS-A (V)1)-----	1
COMPUTER SET DIGITAL: OL-603/TYQ (SARSS DSU SVR)-----	1
COMPUTER SYSTEM DIGITAL: AN/UYQ-90(V)3 (MTS-CS)-----	4
NAVIGATION SET: SATELLITE SIGNALS AN/PSN-13 (DAGR)-----	48
PROCESSOR GROUP SIGNAL DATA: (CAISI 2.0)-----	3
RADIAC SET: AN/VDR-2-----	3
RADIO SET: AN/VRC-90F-----	45
RADIO SET: AN/VRC-92F-----	3
RADIO SET: AN/PRC-119f-----	4
COMPUTER SYSTEM DIGITAL: SAAS-MOD-ATHP-----	1

MISCELLANEOUS EQUIPMENT

BED CARGO: DEMOUNTABLE PLS 8X20-----	66
CONTAINER HANDLING: HVY EXP MOBIL TACT TRK (HEMTT)-----	3
FUEL SYSTEM SUPPLY POINT: FSSP TYPE 3 120K-----	1
FORWARD AREA REFUELING SYSTEM: ADV AVN (AAFARS)-----	2
GEN SET: DED SKID MTD 60KW 50/60HZ (MEP 806A)-----	1
GEN SET : DED SKID MTD 3KW 60HZ (MEP-831A)-----	6
REFUELING SYSTEM: AVN HEMTT TANKER-----	2
SHELTER: TACTICAL EXPANDABLE TWOSIDE S785G-----	1
TACTICAL WATER PURIFICATION SYS (TWFS): 1500 GPH-----	1
LOAD HDLG SYS (LHS): 2000 GAL COMP WTR TK RACK (HIPPO)-----	15
WATER PURIFIER LIGHTWEIGHT-----	1
MODULAR FUEL SYSTEM - TANKRACK MODULE-----	16
GENERATOR SET DED 5KW 50/60HZ: SKID MTD (TEP)-----	3

Distribution Company (ASB)

QM Petroleum Quality Analysis Team

10560GA00
OFF: 0/WO: 0/ENL: 2/TOTAL: 2

PETROLEUM QUALITY ANALYSIS TEAM PARA 01

AN/VRC-90F
AN/UYQ-90(V)2
DAGR



SP4 92L10 (PETRL LAB SP) R
PFC 92L10 (PETRL LAB SP) R

Summary of Equipment

WEAPONS

RIFLE 5.56MM M16A2----- 2

VEHICLES, TRAILERS, AND TRLR MTD SYSTEMS

TRUCK CARGO: MTV (M1083)----- 1

PETROLEUM QUALITY ANALYSIS SYSTEM - ENHANCED (MTD ON
STANDARD CONTAINER TRAILER)----- 1

COMMUNICATION-ELECTRONICS EQUIPMENT

COMPUTER SYSTEM DIGITAL: AN/UYQ-90(V)2 (MTS)----- 1

NAVIGATION SET: SATELLITE SIGNALS AN/PSN-13 (DAGR)----- 1

RADIO SET: AN/VRC-90F----- 1

NIGHT VISION/OBSERVATION EQUIPMENT

DRIVERS VISION ENHANCER: AN/VAS-5----- 1

NIGHT VISION GOGGLES: AN/PVS-7B----- 2

Aviation Support Company (AVIM) (Hvy)

01918G000
OFF: 4/WO: 13/ENL: 313/TOTAL: 330

COMPANY HEADQUARTERS PARA 01

AN/VR-92F
FBCB2
DAGR



MAJ 15B00 (COMMANDER) P
SGT 74D20 (CBRN NCO) C

AN/VR-90F
AN/PRC-119F
AN/TYQ-109(V)1
AN/TYQ-109(V)2
CAISI 2.0



CW3 153AB (AVN SAFETY OFF) P
1SG 15Z5M (FIRST SGT) C
SSG 92Y3O (SUPPLY SGT) C
SP4 92Y1O (SUPPLY SP) C
PFC 92Y1O (SUPPLY SP) C

AN/VR-90F



PRODUCTION CONTROL SECTION PARA 02

AN/VR-89F
FBCB2
AMPS
DAGR
2 CAISI 2.0



OL-713(V)1/TYQ CSS VSAT
AN/TYQ-151 (V) 1 ULLS-A(E)
AN/TYQ-151 (V) 2
AN/TYQ-150 (V) 1 ULLS-A(E)
AN/TYQ-153 ULLS-A(E)
AN/TYQ-140

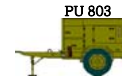

AN/VR-90F



CPT 15B00 (PRODUCTION CONTROL OFF) P
CW4 151A0 (PRODUCTION CONTROL OFF) C
MSG 15Z5O (ACFT PROD CONT NCO) C
SGT 15P2O (AVIATION OPS SGT) C
SP4 92A1O (EQ RCD/PARTS SP) C
PFC 92A1O (EQ RCD/PARTS SP) C

QUALITY CONTROL SECTION PARA 03

AN/TYQ-151 (V) 1 ULLS-A(E)
AN/TYQ-151 (V) 2

CW5 153AG (SECTION CHIEF) P
SFC 15R4F (ACFT QUAL CONT SUPV) P
3 SSG 15R3F (AH-64 ATK HEL TI) P
4 SSG 15T3F (UH-60 HEL TI) P
2 SSG 15U3F (CH-47 HEL TI) P
6 SSG 15Y3F (AH-64D SYS TI) P
2 SGT 15N2F (AVIONIC TI) P
3 SGT 15R2F (AH-64 ATK HEL TI) P
4 SGT 15T2F (UH-60 HEL TI) P
SGT 15U2F (CH-47 HEL TI) P
6 SGT 15Y2F (AH-64D SYS TI) P

MAINTENANCE TEST FLIGHT SECTION PARA 04

AN/TYQ-151 (V) 1 ULLS-A(E)
AN/TYQ-151 (V) 2

CW5 153AL (SECTION CHIEF) P
CW4 152HL (MAINT TEST FLT EVAL) P
CW4 153ML (MAINT TEST FLT EVAL) P
CW4 154FL (MAINT TEST FLT EVAL) P
CW3 152HG (AVN MAINT OFF) P
CW3 153MG (AVN MAINT OFF) P

AIRFRAME REPAIR PLATOON HQ PARA 05

AN/VR-91F
AN/PRC-119F
FBCB2
DAGR



CPT 15B00 (PLT LDR) P
SFC 15T4O (PLT SGT) C
SGT 92A2O (EQ RCD/PARTS SGT) C

AN/VR-90F
FBCB2
DAGR



AN/VR-90F



SATS
X4

AH-64 REPAIR SECTION PARA 06

AN/VR-90F
FBCB2
DAGR
4 AN/TYQ-151 (V) 1 ULLS-A(E)
AN/TYQ-151 (V) 2



SSG 15R3O (SECTION CHIEF) C
4 SGT 15R2O (AH-64 REP/TM CHIEF) C
6 SP4 15R1O (AH-64 REP) C
9 PFC 15R1O (AH-64 REP) C

UH-60 REPAIR SECTION (ASLT) PARA 07

AN/VR-90F
FBCB2
DAGR
2 AN/TYQ-151 (V) 1 ULLS-A(E)
AN/TYQ-151 (V) 2



SSG 15T3O (SECTION CHIEF) C
2 SGT 15T2F (UH-60 REP/TM CHIEF) C
2 SP4 15T1O (UH-60 REP) C
5 PFC 15T1O (UH-60 REP) C

UH-60 REPAIR SECTION (GSAB) PARA 08

AN/VR-90F
FBCB2
DAGR
EPLRS-V1
AN/TYQ-151(V)1 ULLS-A(E)
AN/TYQ-XXX(V)2 ULLS-A(E)



SSG 15T3O (SECTION CHIEF) C
SGT 15T2F (UH-60 REP/TM CHIEF) C
SP4 15T1O (UH-60 REP) C
5 PFC 15T1O (UH-60 REP) C

CH-47 REPAIR SECTION PARA 09

AN/VR-90F
FBCB2
DAGR
4 AN/TYQ-151 (V) 1 ULLS-A(E)
AN/TYQ-151 (V) 2



SSG 15U3O (SECTION CHIEF) C
2 SGT 15U2F (CH-47 REP/TM CHIEF) C
9 SP4 15U1O (CH-47 REP) C
7 PFC 15U1O (CH-47 REP) C

COMPONENT REPAIR PLATOON HQ PARA 10

AN/VR-91F
AN/PRC-119F
FBCB2
DAGR
AN/TYQ-151 (V) 1 ULLS-A(E)
AN/TYQ-151 (V) 2



CPT 15B00 (PLT LDR) P
CW3 151A0 (AVN MAINT TECH) C
SFC 15K4O (PLT SGT) C
SP4 92A1O (EQ RCD/PARTS SP) C
2 PFC 92A1O (EQ RCD/PARTS SP) C

AN/VR-90F
FBCB2
DAGR



CAB-46

Aviation Support Company (AVIM) (Hvy) (cont)

SHOP SECTION HQ PARA 11

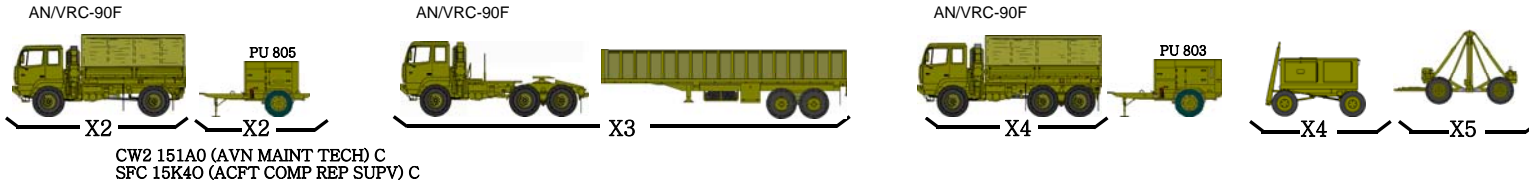

POWER PLANT SECTION PARA 12

3 AN/TYQ-151 (V) 1 ULLS-A(E)

2 SSG 15B30 (ACFT PWR PLANT SUPV) C
4 SSG 15B30 (ACFT PWR PLANT REP) C
5 SGT 15B20 (ACFT PWR PLANT REP) C
7 SP4 15B10 (ACFT PWR PLANT REP) C
8 PFC 15B10 (ACFT PWR PLANT REP) C

STRUCTURAL SECTION PARA 13

2 AN/TYQ-151 (V) 1 ULLS-A(E)

SSG 15G30 (ACFT STRUCT REP SUPV) C
2 SSG 15G30 (ACFT STRUCT REP) C
3 SGT 15G20 (ACFT STRUCT REP) C
SGT 91E20 (ALLIED TRADES SP) C
5 SP4 15G10 (ACFT STRUCT REP) C
SP4 91E10 (ALLIED TRADES SP) C
6 PFC 15G10 (ACFT STRUCT REP) C

POWER TRAIN SECTION PARA 14

3 AN/TYQ-151 (V) 1 ULLS-A(E)

2 SSG 15D30 (ACFT POWERTRAIN SUPV) C
2 SSG 15D30 (ACFT POWERTRAIN REP) C
4 SGT 15D20 (ACFT POWERTRAIN REP) C
6 SP4 15D10 (ACFT POWERTRAIN REP) C
8 PFC 15D10 (ACFT POWERTRAIN REP) C

PNEUDRAULICS SECTION PARA 15

3 AN/TYQ-151 (V) 1 ULLS-A(E)

2 SSG 15H30 (ACFT PNEUDRAULICS SUPV) C
4 SSG 15H30 (ACFT PNEUDRAULICS REP) C
4 SGT 15H20 (ACFT PNEUDRAULICS REP) C
5 SP4 15H10 (ACFT PNEUDRAULICS REP) C
8 PFC 15H10 (ACFT PNEUDRAULICS REP) C

ELECTRICAL REPAIR SECTION PARA 16

4 AN/TYQ-151 (V) 1 ULLS-A(E)

SFC 15K40 (AVIONICS MAINT SUPV) C
SSG 15F30 (ACFT ELECTRICIAN SUPV) C
SSG 15Y30 (AH-64D SYS SUPV) C
3 SGT 15F20 (ACFT ELECTRICIAN) C
4 SGT 15Y20 (AH-64D SYS REP) C
5 SP4 15F10 (ACFT ELECTRICIAN) C
SP4 15N10 (AVIONIC MECH) C
5 SP4 15Y10 (AH-64D SYS REP) C
4 PFC 15F10 (ACFT ELECTRICIAN) C
PFC 15N10 (AVIONIC MECH) C
3 PFC 15Y10 (AH-64D SYS REP) C

BATTERY SECTION PARA 17

AN/TYQ-151 (V) 1 ULLS-A(E)

SGT 15F20 (ACFT ELECTRICIAN) C
SP4 15F10 (ACFT ELECTRICIAN) C

ARMAMENT REPAIR SECTION HQ PARA 18

AN/VRC-91F
FBCB2
DAGR
AN/TYQ-151(V)1 ULLS-A(E)



AN/VRC-90F
DAGR



CW3 151AE (ACFT ARMT MAINT OFF) C
SPC 15Y40 (AH-64D SR SYS SUPV) C

AN/VRC-90F



AN/VRC-90F



WEAPONS SYSTEM REPAIR SHOP PARA 19

AN/TYQ-151 (V) 1 ULLS-A(E)

SSG 15Y30 (AH-64D SYS SUPV) C
2 SGT 15Y20 (AH-64D SYS REP) C
4 SP4 15Y10 (AH-64D SYS REP) C
3 PFC 15Y10 (AH-64D SYS REP) C

FIRE CONTROL REPAIR SECTION PARA 20

AN/TYQ-151 (V) 1 ULLS-A(E)

SSG 15Y30 (AH-64D SYS SUPV) C
2 SGT 15Y20 (AH-64D SYS REP) C
4 SP4 15Y10 (AH-64D SYS REP) C
3 PFC 15Y10 (AH-64D SYS REP) C

Aviation Support Company (AVIM) (Hvy) (cont)

AVIONIC REPAIR SECTION HQ PARA 21

AN/VRC-90F
FBCB2
DAGR
AN/TYQ-151 (V) 1 ULLS-A(E)



CW2 948B0 (EL SYS MAINT WO) C
SFC 15K40 (AVIONICS MAINT SUPV) C

AN/VRC-90F

X2

AN/VRC-90F

X4

COMMUNICATION EQUIPMENT REPAIR SECTION PARA 22

AN/VRC-100(V)1
2 AN/TYQ-151 (V) 1 ULLS-A(E)



X2

X2

SSG 94L30 (AVIONIC COMM EQ SUPV) C
3 SGT 94L20 (AVIONIC COMM EQ REP) C
7 SP4 94L10 (AVIONIC COMM EQ REP) C
4 PFC 94L10 (AVIONIC COMM EQ REP) C

NAVIGATION, FLIGHT CONTROL RADAR EQUIPMENT REPAIR SECTION PARA 23

4 AN/TYQ-151 (V) 1 ULLS-A(E)

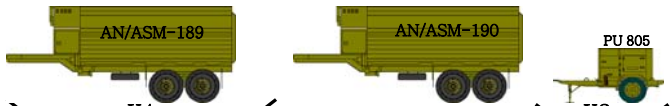

X4

X2

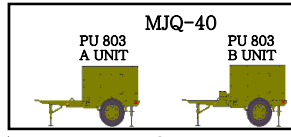

MJQ-40

X2

AN/VRC-90F

AN/VRC-90F



X2

2 SSG 94R30 (AVIONICS SYS REP SUPV) C
2 SSG 94Y30 (IFTE OPR/MAINT SUPV) C
8 SGT 94R20 (AVIONIC SYSTEMS REP) C
2 SGT 94Y20 (IFTE OPR/MAINT) C

11 SP4 94R10 (AVIONIC SYSTEMS REP) C
3 SP4 94Y10 (IFTE OPR/MAINT) C
8 PFC 94R10 (AVIONIC SYSTEMS REP) C
3 PFC 94Y10 (IFTE OPR/MAINT) C

FUEL SERVICE AND POL STORAGE SECTION PARA 24

AN/VRC-90F



X2

X2

SGT 92F20 (ACFT FUEL HANDLER) C
SP4 91C10 (UTIL EQ REP) C
SP4 91D10 (PWR-GEN EQ REP) C
SP4 92F10 (ACFT FUEL HANDLER) C

AN/VRC-90F
FBCB2
DAGR



SP4 91B10 (RCVY VEH OPR) C

AN/VRC-90F
AN/TYQ-151 (V) 1 ULLS-A(E)

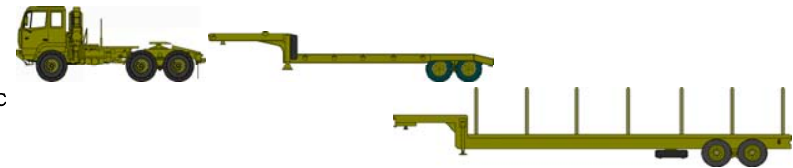

SHOP SUPPLY AND TOOL CRIB SECTION PARA 25

AN/VRC-90F



X3

SGT 92A20 (EQ RCD/PARTS SGT) C
2 SP4 92A10 (EQ RCD/PARTS SP) C
3 PFC 92A10 (EQ RCD/PARTS SP) C



AN/TYQ-151 (V) 1 ULLS-A(E)
AN/TYQ-151 (V) 2



X4

AN/VRC-90F



PU 803



Summary of Equipment

WEAPONS

LAUNCHER: GRENADE M320A1-----	4
MACHINE GUN 5.56MM M249-----	26
MACHINE GUN LIGHT 5.56MM M249-----	4
MACHINE GUN GRENADE 40MM: MK-19 MOD III-----	3
PISTOL 9MM AUTOMATIC M9-----	44
RIFLE 5.56MM M4 CARBINE-----	259
MACHINE GUN: CALIBER .50 (M2E2)-----	2

VEHICLES, TRAILERS, AND TRLR MTD SYSTEMS

CRANE WHEEL MTD: HYDRAULIC LT 7-1/2TON-----	2
DOLLY SET LIFT TRANSPORTABLE SHELTER: 7-1/2T-----	8
FLOODLIGHT SET TLR MTD 3 FLOODLIGHTS 1000 WATTS-----	1
GENERATOR SET DIESEL ENGINE TM: PU-803-----	4
GENERATOR SET: DSL TM 60KW 50/60HZ PU-805-----	6
ELECTRONICS SHOP SEMITLR MTD: AN/ASM-189-----	6
ELECTRONICS SHOP SEMITLR MTD: AN/ASM-190-----	2
POWER PLANT ELEC TM: 30KW 50/60HZ (AN/MJQ-40)-----	2
SEMITRLR FLAT BED: BRKBULK/CONT 22-1/2T (M871A2)-----	4
SEMITRAILER LB: WREAKER 12T 4 WHL 40FT LONG M270A1)-----	1
SEMITRAILER LOW BED: 25T 4 WHL (M172A1)-----	1
SEMITRAILER VAN: SUPPLY 12T 4 WHL (M129A2C)-----	4
TRUCK UTILITY EXP CAPACITY ENH 4X4: M1152A1-----	19
TRUCK UTILITY EXP CAPACITY ENH 4X4: M1165A1-----	3
TRUCK CARGO: MTV (M1083)-----	9
TRUCK CARGO: 4X4 LMTV (M1078)-----	7
TRUCK TRACTOR MTV (M1088)-----	11
TRUCK CARGO MTV LWB (M1085)-----	4
TRUCK LIFT: FORK VARIABLE REACH RT (ATLAS)-----	1
TRUCK TANK: FUEL SERVICING 2500 GAL 8X8 HEMTT (M978)-----	2
TRUCK WRECKER: MTV (M1089)-----	1
TRAILER CARGO: MTV W/ DROPSIDES (M1095)-----	1
TRAILER HIGH MOBILITY 1-1/4T (M1102)-----	12
TRAILER HIGH MOBILITY 3/4T (M1101)-----	9
TRAILER CARGO: LMTV W/DROPSIDES (M1082)-----	1
TRAILER TANK: WATER 400 GAL 1-1/2T 2 WHL (M149A2)-----	1

NIGHT VISION/OBSERVATION EQUIPMENT

NIGHT VISION GOGGLES: AN/PVS-7B-----	115
MEDIUM THERMAL WEAPONS SIGHT: AN/PAS-13 (V2)-----	4
HEAVY THERMAL WEAPONS SIGHT: AN/PAS-13 (V3)-----	7

COMMUNICATION-ELECTRONICS EQUIPMENT

ANTENNA GROUP: OE-254-----	1
COMPUTER SET DIGITAL: AN/UYK-128 (FBCB2)-----	23
COMPUTER SYSTEM DIGITAL: (AMPS)-----	1
COMPUTER SET DIGITAL: AN/TYQ-109(V1) (GCSS-A (V)1)-----	1
COMPUTER SET DIGITAL: AN/TYQ-109(V)2 (GCSS-A (V)2)-----	1
NAVIGATION SET: SATELLITE SIGNALS AN/PSN-13 (DAGR)-----	23
PROCESSOR GROUP SIGNAL DATA: (CAISI 2.0)-----	3
RADIAC SET: AN/VDR-2-----	8
RADIO SET: AN/PRC-89F-----	1
RADIO SET: AN/VRC-90F-----	51
RADIO SET: AN/VRC-91F-----	3
RADIO SET: AN/VRC-92F-----	1
RADIO SET: AN/PRC-119F-----	3
RADIO SET: HIGH FREQUENCY AN/VRC-100(V)1-----	1
INTERFACE UNIT COMM EQ: OL-713(V)1/TYQ CSS VSAT-----	1
COMPUTER SET DIGITAL: AN/TYQ-1511(V) 1 ULLS-A(E)-----	45
COMPUTER SET DIGITAL: AN/TYQ-151 (V) 2-----	10
COMPUTER SET DIGITAL: AN/TYQ-150 (V) 1 ULLS-A(E)-----	1
COMPUTER SET DIGITAL: AN/TYQ-153 ULLS-A(E)-----	1
COMPUTER SYSTEM: DIGITAL AN/TYQ-140-----	1

MISCELLANEOUS EQUIPMENT

GENERATOR SET: DED SKID MTD 5KW 60 HZ (MEP 802A)-----	1
GEN SET : DED SKID MTD 3KW 60HZ (MEP-831A)-----	1
POWER UNIT AUXILIARY: (AGPU)-----	4
SHELTER NON EXPANDABLE S280-----	4
SHOP EQUIP BATTERY SERVICING SHL MTD: AN/TSM-133 L/P-----	1
SHOP SET AVIM ARMT REPAIR SHL MTD: NON-DIV-----	1
SHOP SET FIRE CONTROL REPAIR SHL MTD: NON-DIV-----	1
SHOP SET ENGINE: AVIM-----	1
SHOP EQUIP CONTACT MAINT (SECM): AVIATION-----	12
SHOP SET ARMAMENT AND ELCTRICAL: AVIM-----	4
SHOP SET MACHINE/WELDING: AVIM-----	1
SHOP SET PNEUDRAULICS: AVIM-----	1
SHOP SET POWERTRAIN: AVIM-----	1
SHOP SET PRODUCTION/QUALITY CONTROL: AVIM-----	1
SHOP SET: NONDESTRUCTIVE INSPECTION (NDI) AVIM-----	1
SHOP SET SHEET METAL/COMP: AVIM-----	1
SHOP SET TOOL CRIB: AVIM-----	1
TEST FACILITY BASE SHOP: (BSTF S) AN/TSM-191 (V) 5-----	2
UNIT MAINT AERIAL RECOVERY KIT: (UMARK)-----	2
STANDARD AIRCRAFT TOWING SYSTEM: (SATS)-----	4

Aviation Support Company (AVIM) (Hvy)

Brigade Signal Company (MEB/CAB/SB)

11307R600
OFF: 4/WO: 0/ENL: 40/TOTAL: 44

COMPANY HEADQUARTERS PARA 01

AN/VRC-92F
AN/VRC-104(V)3
FBCB2
DAGR



CPT 25A00 (COMMANDER) P&C

AN/VRC-90F
AN/TYQ-109(V)1
FBCB2
DAGR
CAISI 2.0



LT 25A00 (EXEC OFF) C
1SG 25U5M (FIRST SGT) C
SGT 92Y20 (SUPPLY NCO) R
SP4 92Y10 (SUPPLY SP) R

RANGE EXTENSION PLATOON HQ PARA 02

AN/VRC-90F
AN/VRC-104(V)3
FBCB2
DAGR

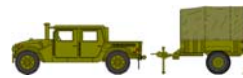

LT 25A00 (PLT LDR) C
SFC 25U40 (PLT SGT) C

SMALL COMMAND POST SUPPORT TEAM PARA 03

AN/VRC-89F
FBCB2
DAGR

AN/VRC-90F
DAGR



BCP (SWITCHING GP): OM-87A/T
PU 798

SGT 25Q20 (SR XMSN SYS OPR-MAINT) R
SP4 25B10 (LAN MGR) R
SP4 25Q10 (XMSN SYS OPR-MAINT) R
PFC 25B10 (LAN MGR) R

X2

RETRANSMISSION TEAM PARA 04

2 AN/VRC-92F
FBCB2
DAGR



SGT 25U20 (TEAM CHIEF) R
SP4 25U10 (RADIO RETRANS OPR) SAW
PFC 25U10 (RADIO RETRANS OPR) R

X3

NETWORK EXTENSION PLATOON HQ PARA 05

AN/VRC-90F
AN/VRC-104(V)3
FBCB2
DAGR



LT 25A00 (PLT LDR) C
SFC 25W40 (PLT SGT) C

JOINT NETWORK NODE/SMART-T TEAM PARA 06

AN/VRC-90F
DAGR
OA-9511/TYQ
AN/TYQ-122
KSV-3



SGT 25N20 (SR NODAL NET SYS OPR-MAINT) R
SP4 25N10 (NODAL NET SYS OPR-MAINT) R
PFC 25N10 (NODAL NET SYS OPR-MAINT) R

AN/VRC-90F
DAGR

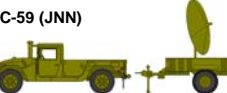

AN/TTC-59 (JNN)
PU-798

AN/VRC-90F
DAGR



SGT 25S20 (SR SATCOM SYS OPR-MAINT) R
SP4 25S10 (SATCOM SYS OPR-MAINT) R
PFC 25S10 (SATCOM SYS OPR-MAINT) R

AN/VRC-90F
AN/VRC-104(V)3
FBCB2
DAGR



SP4 25Q10 (RANGE EXT OPR) R

LOS V3 TEAM PARA 07

AN/VRC-90F

AN/TRC-190C(V)1



X2

SGT 25Q20 (SR XMSN SYS OPR-MAINT) R
SP4 25Q10 (XMSN SYS OPR-MAINT) R
PFC 25Q10 (XMSN SYS OPR-MAINT) R

AN/VRC-90F

AN/TRC-190C(V)3



PU-797

RETRANSMISSION TEAM PARA 08

2 AN/VRC-92F
FBCB2
DAGR



SGT 25U20 (TEAM CHIEF) R
SP4 25U10 (RADIO RETRANS OPR) SAW
PFC 25U10 (RADIO RETRANS OPR) R

EPLRS SECTION PARA 09

AN/VRC-90F
FBCB2
DAGR
EPLRS-V1
AN/GRC-229
KOK-13/TSEC



AN/TSQ-158 NCS

SSG 25C30 (EPLRS NCS SUPV) R
SP4 25C10 (EPLRS NCS OPR) R
PFC 25C10 (EPLRS NCS OPR) R

AN/VRC-92F
FBCB2
DAGR
EPLRS-V1



AN/VSQ-2(N)4

SGT 25C20 (SR EGRU OPR) R
SP4 25C10 (EGRU OPR) R

CAB-50

NOTE: SECTION APPLIES ONLY IF CAB IS ASSIGNED TO EPLRS-EQUIPPED DIVISION

Summary of Equipment

WEAPONS

LAUNCHER GRENADE: M320A1-----	4
MACHINE GUN 5.56MM M249-----	4
MACHINE GUN LIGHT 5.56MM M249-----	10
MACHINE GUN GRENADE 40MM MK-19 MOD III-----	2
PISTOL 9MM AUTOMATIC M9-----	1
RIFLE 5.56MM M16A2-----	33
RIFLE 5.56MM M4 CARBINE-----	7

VEHICLES, TRAILERS, AND TRLR MTD SYSTEMS

GEN SET DED TM: 10KW 60HZ (PU-798)-----	3
GEN SET DED TM: 5KW 60HZ (PU-797)-----	3
TRUCK CARGO: MTV (M1083)-----	1
TRUCK UTILITY EXP CAPACITY ENH 4X4: M1152A1-----	12
TRUCK UTILITY EXP CAPACITY ENH 4X4: M1165A1-----	8
TRAILER HIGH MOBILITY 1-1/4T (M1102)-----	1
LIGHT TACTICAL TRAILER: 3/4T (M1101)-----	8
TRAILER TANK WATER (CAMEL) 800 GAL 5 TON-----	1

MISCELLANEOUS EQUIPMENT

GEN SET : DED SKID MTD 3KW 60HZ (MEP-831A)-----	6
GEN SET DIESEL: 60HZ AC MEP-531A-----	1

NIGHT VISION/OBSERVATION EQUIPMENT

NIGHT VISION GOGGLES: AN/PVS-7B-----	54
MEDIUM WEAPON THERMAL SIGHT (MWTS): AN/PAS-13(V)2-----	10
HEAVY WEAPON THERMAL SIGHT (HWTS): AN/PAS-13(V)3-----	2

COMMUNICATION-ELECTRONICS EQUIPMENT

ANTENNA GROUP: OE-254-----	18
ANTENNA: AB-1404/TRC-----	1
COMPUTER SET DIGITAL: AN/UYK-128 (FBCB2)-----	14
COMPUTER SET DIGITAL: AN/TYQ-109(V)1 (GCSS-A (V)1)-----	1
NET CONTROL STATION: AN/TSQ-158-----	2
NAVIGATION SET: SATELLITE SIGNALS AN/PSN-13 (DAGR)-----	19
PJH SURFACE VEH RADIO SET: AN/VSQ-2(V)1 (BFLRS-V1)-----	2
PROCESSOR GROUP SIGNAL DATA: (CAIST 2.0)-----	1
RADIAC SET: AN/VDR-2-----	10
RADIO SET: AN/VRC-89F-----	2
RADIO SET: AN/VRC-90F-----	13
RADIO SET: AN/VRC-92F-----	10
RADIO SET GRID REFERENCE UNIT: AN/VSQ-2(N)4-----	1
RADIO TERMINAL: LOS MULTI-CHANNEL AN/TRC-190C(V)1-----	2
RADIO TERMINAL: LOS MULTI-CHANNEL AN/TRC-190C(V)3-----	1
RADIO TERMINAL SET: AN/GRC-229-----	1
SWITCHING GROUP DIGITAL DATA: OA-9511/TYQ-----	1
TELECONFERENCE SYSTEM: AN/TYQ-122-----	1
TERMINAL: SATELLITE COMMUNICATIONS AN/TSC-154-----	1
JOINT NODE NETWORK (JNN) CEN OFC TEL AUTO: AN/TTC-----	1
BATTALION COMMAND POST (SWITCHING GROUP): OM-87A/T-----	2
AEHF COMMUNICATIONS PLANNING ELEMENT-----	1
RADIO SET: AN/VRC-104(V)3 150 WATT IK: PRC-150 HF RADIO-----	4
REKEYING CONTROLLER: KOK-13/TSEC-----	1
TRANSEC MODULE: KSV-3-----	1

Brigade Signal Company (ME/CAB/SB)

Extended Range Multi-Purpose (ER/MP) UAS Company (Sep)

COMPANY HEADQUARTERS PARA 01

AN/VRC-92F
AN/PRC-119F
FBCB2
DAGR
CAISI 2.0
AN/TYQ-151 (V) 3
AN/TYQ-116(V)3



CPT 15B00 (COMMANDER) P
CW3 150UB (UAS SAFETY OFF) R
1SG 15Z5M (FIRST SGT) R
SGT 25U20 (FWD SGNL SPT NCO) R
SGT 42A20 (HUMAN RES SGT) R
SGT 74D20 (CBRN NCO) R
SP4 42A10 (HUMAN RES SP) SAW
SP4 68W10 (HEALTH CARE SP) R
PFC 15W10 (VEH DRIVER) R

FLIGHT OPERATIONS SECTION PARA 02

AN/VRC-92F
FBCB2
AMPS
DAGR
AN/GRC-240
AN/PSC-5
AN/VRC-100(V)1
AN/TYQ-151 (V) 2
AN/TYQ-150 (V) 1 ULLS-A(E)



CW3 150UI (UAS OPNS OFF) R
2 CW2 150UI (UAS OPNS TECH) R
SFC 15P40 (AVN OPS SGT) R
SGT 15P20 (AVN OPS SGT) R
SP4 15P10 (AVN OPS SP) R
PFC 15P10 (AVN OPS SP) SAW

COMPANY SUPPLY SECTION PARA 03

AN/VRC-90F
AN/TYQ-109(V)2
CAISI 2.0



SSG 92Y30 (SUPPLY SGT) R
SP4 92Y10 (SUPPLY SP) R

01707G400

OFF: 1/WO: 11/ENL: 116/TOTAL: 128

AUTOMOTIVE MAINTENANCE REPAIR SECTION PARA 04

AN/VRC-90F
DAGR



SFC 91X40 (MOTOR SGT) R

AN/VRC-90F
CAISI 2.0
AN/TYQ-139



SSG 91B30 (SR MECHANIC) R
SGT 91B20 (WH VEH MECH) R
SGT 91D20 (PWR-GEN EQ REP) R
SP4 91C10 (UTIL EQ REP) R
3 SP4 91B10 (WH VEH MECH) R
SP4 92A10 (EQ RCD/PARTS SP) R
PFC 91D10 (PWR-GEN EQ REP) R
3 PFC 91B10 (WH VEH MECH) SAW
PFC 92A10 (EQ RCD/PARTS SP) R

AN/VRC-90F
FBCB2
DAGR



SGT 91B20 (WH VEH MECH) R
SP4 91B10 (RCVY VEH OPR) R

AN/VRC-90F



PFC 92F10 (PETRL LT VEH OPR) R

AN/VRC-90F



FIELD FEEDING SECTION PARA 05

AN/VRC-90F



SSG 92G30 (FOOD OPNS MGR) R
SGT 92G20 (FOOD OPNS NCO) R
2 SP4 92G10 (FOOD OPNS SP) R
PFC 92G10 (FOOD OPNS SP) R

AN/VRC-90F
DAGR



Extended Range Multi-purpose (ER/MP) UAS Company (Sep) (cont)

CLASS III/V SECTION PARA 06

AN/VRC-90F
FBCB2
DAGR

AN/VRC-90F

AN/VRC-90F

AN/VRC-90F



SSG 92F30 (SECTION CHIEF) R
SGT 92F20 (ACFT FUEL HANDLER) R
SP4 92F10 (PETRL HVY VEH OPR) R
PFC 92F10 (ACFT FUEL HANDLER) R

SP4 89B10 (AMMO SP) R
PFC 89B10 (AMMO SP) R

X2

ER/MP UAS FLIGHT PLATOON HQ PARA 07

AN/VRC-90F
FBCB2
DAGR

AN/VRC-90F

GROUND DATA TERMINAL TRAILER MTD



CW3 150UB (PLT LDR) R
SFC 15W40 (PLT SGT) R

X2

ER/MP UAS GROUND CONTROL SECTION PARA 08

AN/VRC-90F
FBCB2
AMPS
2 MBITR
DAGR
3 AN/PRC-117F

AN/VRC-90F
AN/USQ-140(V)2(C)

AN/VRC-90F

GROUND DATA TERMINAL: ERMP UAS
GROUND CONTROL STATION TRUCK MTD: ERMP UAS

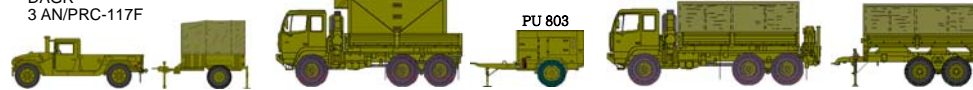

CW2 150UI (UAS OPNS TECH) R
SSG 15W30 (UAV SGT) R
2 SGT 15W20 (UAV OPR) R
3 SP4 15W10 (UAV OPR) R
3 PFC 15W10 (UAV OPR) R

X4

ER/MP UAS LAUNCH/RECOVERY SECTION PARA 09

AN/VRC-90F
FBCB2
AMPS
3 MBITR
DAGR
AN/USQ-140(V)2(C)

AN/VRC-90F
4 AN/PRC-117F
AN/TYQ-151 (V) 2

PORTABLE GROUND CONTROL STATION: ERMP UAS
GROUND DATA TERMINAL: ERMP UAS
PORTABLE GROUND CONTROL TERMINAL: ERMP UAS
GROUND CONTROL STATION TRUCK MTD: ERMP UAS



CW2 150UI (UAS OPNS TECH) R
SSG 15W30 (UAV SGT) R
2 SGT 15W20 (UAV OPR) R
3 SP4 15W10 (UAV OPR) R
2 PFC 15W10 (UAV OPR) SAW

MAINTENANCE PLATOON HQ PARA 10

AN/VRC-90F

AN/VRC-91F
FBCB2
DAGR
CAISI 2.0
AN/TYQ-151 (V) 2

AN/VRC-90F

MAINTENANCE SECTION GROUND SUPPORT (MSGS): ERMP



CW3 151AE (ACFT ARMT MAINT OFF) R
SFC 15J40 (PLT SGT) R
SSG 15J30 (UAS SYS TECH INSP) R
SGT 15J20 (OH-58D SYS TECH INSP/TM CHIEF) R
2 SP4 92A10 (EQ RCD/PARTS SP) R

CAB-53

Extended Range Multi-purpose (ER/MP) UAS Company (Sep) (cont)

ER/MP UAS MAINTENANCE SECTION PARA 11

ER/MP UAS AVIM AUGMENTATION SECTION PARA 12

AN/VRC-90F
CAISI 2.0
MBITR
12 RT-1478A/ARC-210AV
6 AN/TYQ-151 (V) 1 ULLS-A(E)

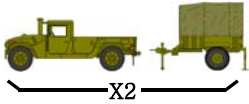

(1 AN/PRC-117F IN SECTION)

AN/VRC-90F

PORTABLE GROUND CONTROL STATION: ERMP UAS
PORTABLE GROUND DATA TERMINAL: ERMP UAS

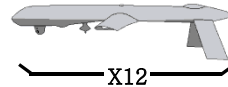
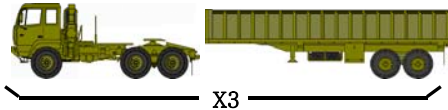

SSG 15J30 (SECTION CHIEF) R
2 SGT 15J20 (OH-58D SYS REP/TEAM CHIEF) R
SP4 15J10 (OH-58D SYS REP) R
3 SP4 15J10 (OH-58D SYS REP) SAW
3 PFC 15J10 (OH-58D SYS REP) R

SGT 15J20 (OH-58D SYS REP/TEAM CHIEF) R
SP4 15G10 (ACFT STRUCT REP) R
SP4 15J10 (OH-58D SYS REP) R
PFC 15G10 (ACFT STRUCT REP) R
PFC 15J10 (OH-58D SYS REP) R

Summary of Equipment

WEAPONS

LAUNCHER: GRENADE M230-----	4
MACHINE GUN 5.56MM M249-----	10
MACHINE GUN LIGHT 5.56MM M249-----	6
MACHINE GUN GRENADE 40MM MK-19 MOD III-----	3
PISTOL 9MM AUTOMATIC M9-----	1
RIFLE 5.56MM M16A2-----	116
MACHINE GUN: CALIBER .50 (M2E2)-----	4

VEHICLES, TRAILERS, AND TRLR MTD SYSTEMS

GEN SET DIESEL ENGINE TM: 30KW 50/60 HZ (PU-803)-----	6
KITCHEN FIELD TRAILER MOUNTED: MPK75 (MKT)-----	1
SHOP EQUIPMENT: AUTOMOTIVE VEHICLE (TLR MTD)-----	1
SEMITRLR FLAT BED: BRKBULK/CONT 22-1/2T (M871A2)-----	3
SEMITRAILER LOW BED: 25T 4 WHL (M172A1)-----	1
TRUCK UTILITY EXP CAPACITY ENH 4X4: M1152A1-----	7
TRUCK VAN EXPANSIBLE MTV (M1087A1)-----	1
TRAILER FLAT BED: 11 TON 4 WHL (M989A1) (HEMAT)-----	2
TRUCK CARGO: MTV (M1083)-----	10
TRUCK CARGO: MTV W/MHE (M1084)-----	6
TRUCK UTILITY EXP CAPACITY ENH 4X4: M1165A1-----	3
TRUCK CARGO: TACTICAL 8X8 HEMTT W/LT CRANE (M977)-----	2
TRUCK TANK: FUEL SERVICING 2500 GAL 8X8 HEMTT (M978)-----	2
TRUCK CARGO: 4X4 LMTV (M1078)-----	3
TRUCK TRACTOR MTV (M1088)-----	4
TRUCK WRECKER: TACTICAL 8X8 HEMTT (M984A1)-----	1
TRUCK LIFT: FORK VARIABLE REACH RT (ATLAS)-----	1
TRAILER: PLS 8X20 (M1076)-----	1
TRAILER CARGO: MTV W/ DROPSIDES (M1095)-----	7
TRAILER HIGH MOBILITY 1-1/4T (M1102)-----	2
LIGHT TACTICAL TRAILER: 3/4T (M1101)-----	5
TRUCK CARGO HEMTT LHS (M1120)-----	1
TRAILER CARGO: LMTV W/DROPSIDES (M1082)-----	1
TRAILER TANK: WATER 400 GAL 1-1/2T 2 WHL (M149A2)-----	1

ER/MP SYSTEM EQUIPMENT

PORTABLE GROUND CONTROL STATION: ERMP UAS-----	2
GROUND DATA TERMINAL: ERMP UAS-----	5
PORTABLE GROUND DATA TERMINAL: ERMP UAS-----	2
AUTOMATIC TAKE OFF AND LANDING SYSTEM: ERMP-----	4
GROUND CONTROL STATION TRUCK MTD: ERMP UAS-----	5
UNMANNED AERIAL VEHICLE: ERMP UAS-----	12
SATELLITE COMMS GRND DATA TERMINAL (SGDT) TRLR MTD---	1
MAINTENANCE SECTION GROUND SUPPORT (MSGS): ERMP-----	1

COMMUNICATION-ELECTRONICS EQUIPMENT

ANTENNA GROUP: OE-254-----	9
COMPUTER SET DIGITAL: AN/UYS-128 (FBCB2)-----	11
COMPUTER SYSTEM DIGITAL: (AMPS)-----	6
COMPUTER SET DIGITAL: AN/TYQ-109(V)1 (GCSS-A (V)1)-----	1
MBITR: URBAN VERSION-----	12
NAVIGATION SET: SATELLITE SIGNALS AN/PSN-13 (DAGR)-----	13
PROCESSOR GROUP SIGNAL DATA: (CAISI 2.0)-----	6
RADIAC SET: AN/VDR-2-----	3
RADIO SET: AN/GRC-240-----	1
RADIO SET: AN/USQ-140(V)2(C)-----	5
RADIO SET: AN/VRC-90F-----	38
RADIO SET: AN/VRC-91F-----	1
RADIO SET: AN/VRC-92F-----	2
RADIO SET: AN/PRC-119F-----	1
RECEIVER RADIO: RT-1478A/ARC-201AV-----	30
RADIO SET: HIGH FREQUENCY AN/VRC-100V1-----	1
RADIO SET: AN/PSC-5-----	1
RADIO SET: AN/PRC-117F TACSAT RADIO MANPACK-----	17
COMPUTER SET DIGITAL: AN/TYQ-151 (V) 1 ULLS-A(E)-----	12
COMPUTER SET DIGITAL: AN/TYQ-151 (V) 2-----	3
COMPUTER SET DIGITAL: AN/TYQ-151 (V) 3-----	1
COMPUTER SET DIGITAL: AN/TYQ-50 (V) 1 ULLS-A(E)-----	1
COMPUTER SYSTEM: DIGITAL AN/TYQ-139 (SAMS-1E V1)-----	1
COMP SYS DIGITAL: (AHRS) AN/TYQ-116(V)3-----	1

MISCELLANEOUS EQUIPMENT

BED CARGO: DEMOUNTABLE PLS 8X20-----	1
GEN SET: DED SKID MTD 5 KW 60HZ (MEP-802A)-----	4
GEN SET: DED SKID MTD 3KW 60HZ (MEP-831A)-----	9
GEN SET: DED SKID MTD 10KW 60HZ (MEP-803A)-----	3
TANK AND PUMP UNIT LIQ DISPENSING TRUCK MTD (TPU)-----	1
TANK UNIT LIQUID DISPENSING TRAILER MTG-----	1
MULTI-TEMP REFRIGERATED CONTAINER SYS: MTRCS-----	1

NIGHT VISION/OBSERVATION EQUIPMENT

DRIVERS VISION ENHANCER: AN/VAS-5-----	5
NIGHT VISION GOGGLES: AN/PVS-7B-----	81
MEDIUM THERMAL WEAPONS SIGHT: AN/PAS-13(V2)-----	6
HEAVY THERMAL WEAPONS SIGHT: AN/PAS-13 (V3)-----	11

Fires Brigade

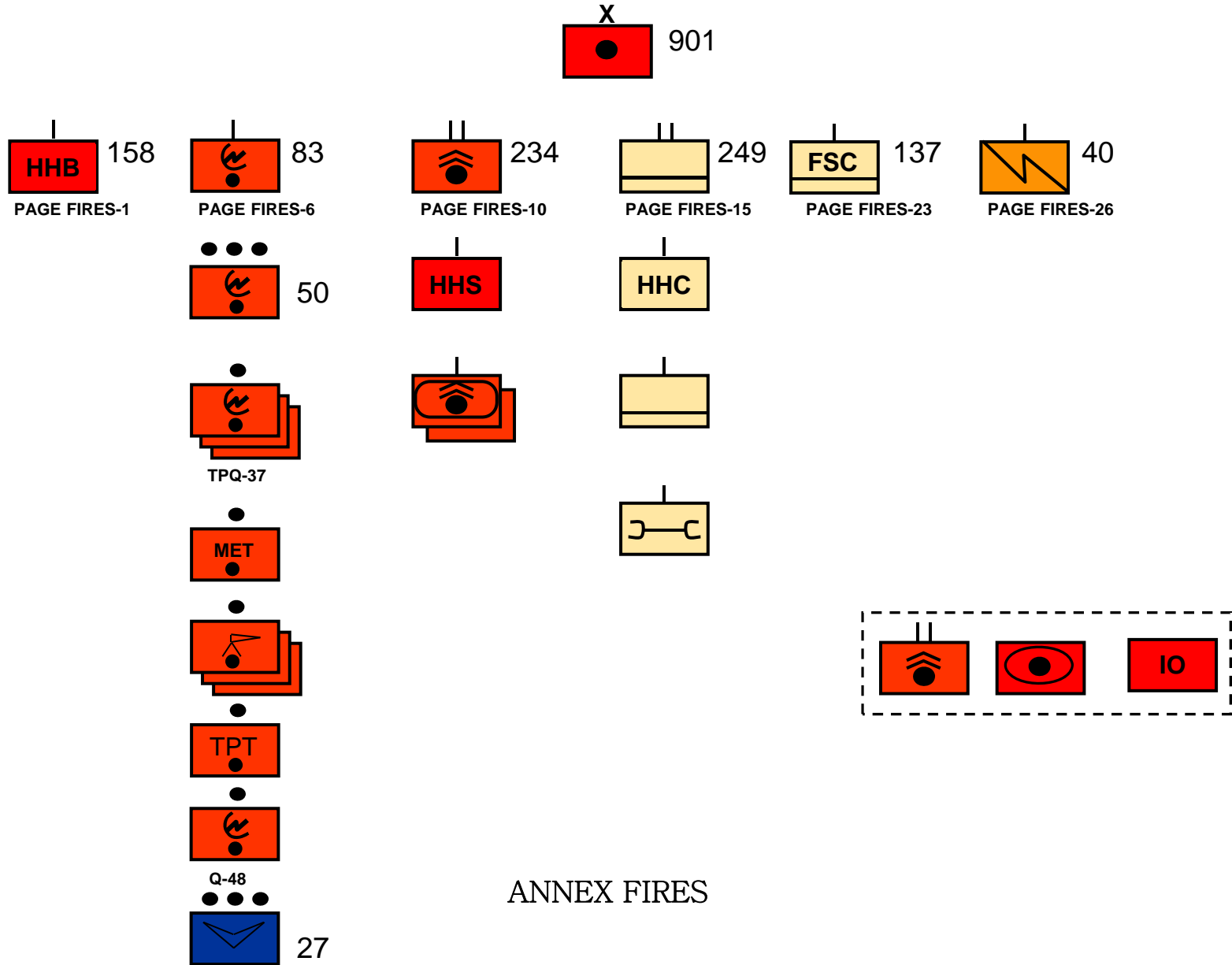

ANNEX FIRES

HHB, Fires Brigade

06402R000
OFF: 35/WO: 13/ENL: 110/TOTAL: 158

CP-CURRENT OPS – HQ PARA 01

2 AN/VRC-92F
AN/VRC-104(V)3
FBCB2
AN/TYQ-137A:(V)2
AN/GYK-48(V)1
DAGR
AN/PSC-5



COL 13A00 (COMMANDER) P&C
PFC 13D10 (VEH DRIVER) C

2 AN/VRC-92F
AN/VRC-104(V)3
FBCB2
AN/TYQ-137A:(V)2
AN/GYK-48(V)1
DAGR
AN/PSC-5



LTC 13A00 (DEPUTY CDR) P&C
PFC 13D10 (VEH DRIVER) C

AN/VRC-92F
FBCB2
DAGR



MAJ 13A00 (EXEC OFF) C
PFC 13D10 (VEH DRIVER) C

AN/VRC-90F

CSM 00Z50 (CSM) P&C

CP-CURRENT OPS – S1 PARA 02

AN/TYQ-116(V)3

MAJ 42H00 (S1) P&C

CP-CURRENT OPS – S2/TARGETING PARA 03

AN/TYQ-93

MAJ 35D00 (S2) P&C
CPT 35D00 (ASST S2) C
CW4 131A0 (TARGETING OFF) C
SFC 13F40 (TARGETING NCO) C

CP-CURRENT OPS – S3/OPS COUNTERFIRE PARA 04

AN/VRC-92F
FBCB2
DAGR



LTC 13A00 (S3) P&C

2 AN/VRC-92F
AN/VRC-104(V)3
AN/GYK-58
FBCB2
AN/TSQ-243
KG-175
DAGR
AN/PSC-5



MAJ 40A00 (SPACE OPNS OFF) P&C
MAJ 57A00 (ASST S3/SIMS OFF) P&C
CPT 13A00 (OPNS OFF) C
CW3 882A0 (MOBILITY OFF) C
SGM 19Z50 (OPNS SGM) C

AN/VRC-90F
FBCB2
DAGR



SFC 13D40 (SR FIRE CONTROL SGT) C
SFC 13T40 (CHIEF SURVEYOR) C
SSG 88N30 (MOBILITY NCO) C
2 SP4 13F10 (FATDS SP) C
2 PFC 13F10 (FATDS SP) C

AN/VRC-92F
FBCB2
KG-175
DAGR
AN/GYK-56



CW3 131A0 (COUNTERFIRE OFF) C
SFC 13M40 (OPS/COUNTERFIRE NCO) C

AN/VRC-90F
FBCB2
DAGR



CPT 74A00 (CBRN OFF) C
SFC 74D40 (CBRN STAFF NCO) C

CP-CURRENT OPS – AIR SUPPORT PARA 05

MAJ 01A00 (AIR FORCE STAFF OFF)
SFC 00D40 (AIR FORCE STAFF NCO)

(USAF AUGMENTATION)

CP-CURRENT OPS – FIRE & EFFECTS PARA 06

AN/VRC-92F
AN/VRC-104(V)3
FBCB2
AN/TYQ-137A:(V)2
DAGR
AN/GYK-48(V)1



MAJ 13A00 (BDE FIRE SPT COORD) P&C
MSG 13Z50 (OPNS SGT) C

CP-CURRENT OPS – LNO PARA 07

AN/VRC-90F
FBCB2
DAGR



MAJ 13A00 (LIAISON OFF) P&C

AN/VRC-92F
AN/VRC-90F
AN/VRC-104(V)3
FBCB2
AN/GYK-48(V)1
AN/GYK-59
DAGR



CPT 13A00 (LIAISON OFF) C
CW3 131A0 (TARGETING OFF) C
SFC 13F40 (FIRE SPT SGT) C
SSG 13F30 (FIRE SPT SGT) C
SP4 13F10 (FIRE SPT SP) C

CP-CURRENT OPS – PAO PARA 08

CPT 46A00 (PAO) C

CP-CURRENT OPS – SJA PARA 09

MAJ 27A00 (STAFF JUDGE ADVOCATE) P&C

HHB, Fires Brigade (cont)

CP-C4 OPS - S6 PARA 10

AN/VRC-92F
AN/VRC-90F
AN/VRC-104(V)3
FBCB2
AN/GYK-49(V)2
DAGR



MAJ 25A00 (S6) P&C

AN/VRC-90F
AN/VRC-104(V)3
AN/TYQ-137A:(V)2
DAGR
2 AN/TSR-8 (GRT)
2 AN/GYK-50A (ISYSCON) (V)4
4 AN/TYQ-155 (V) 1
2 AN/PYQ-16



CW2 254A0 (SGNL SYS TECH) C
MSG 25U50 (SGNL SPT SYS CHIEF) C
SFC 25D40 (CONSEC CUSTODIAN) C
SFC 25W40 (NETWORK OPNS CHIEF) C
SSG 25B30 (ASST COMSEC CUSTODIAN) C
SSG 25E30 (ELECTRO SPECTRUM NCO) C
SSG 25Q30 (XMSN SYS OPS NCO) C
SSG 25N30 (NODAL OPS SYS NCO) C
SSG 25S30 (SATCOM OPNS NCO) C
SP4 25U10 (SGNL SPT SYS SP) C
SP4 25U10 (SGNL SPT SYS MAINT) C

AN/VRC-90F
DAGR



SSG 25B30 (CND INTEGR) C

AN/VRC-90F
FBCB2
AN/GYK-49(V)2
DAGR
TSEC/KOK-22



CPT 53A00 (INFO MGMT OFF) C
CW2 250N0 (NETWORK MGMT TECH) C

AN/VRC-90F
FBCB2
DAGR



SGT 25L20 (SR CBL/ANT SYS SP) C
SP4 25L10 (CBL SYS INSTL-MAINT) C

AN/VRC-89F
FBCB2
DAGR



SFC 25B40 (INFO SYS SUPV) C
SSG 25B30 (INFO TECH TEAM CHIEF) C
SSG 25U30 (SGNL INFO SVC NCO) C
SGT 25B10 (SR INFO TECH SP) C
2 SP4 25B10 (INFO TECH SP) C
PRC 25B10 (INFO TECH SP) C

AN/VRC-90F
FBCB2
DAGR



PRC 25U10 (SGNL SPT SYS SP) C

CP-FIRE SPT/PROTECT - ADAM/BAE PARA 11

AN/VRC-92F
2 AN/PRC-117F
AN/GYQ-88
AN/USQ-140(V)2(C)
AN/VRC-106(V)1 (C)

AN/TSQ-253



CPT 14A00 (ADA OFF) C
CW2 140A0 (C2 SYS INTEGR) C
2 SGT 14J20 (EWS OPR) C
2 SP4 14J10 (EWS OPR) C

AN/VRC-90F
AN/VRC-104(V)3
FBCB2
DAGR



MAJ 15B00 (AIRSPACE MGMT OFF) P&C

AN/VRC-90F
AMPS
AN/GRC-240
AN/VRC-100(V)1
AN/FSQ-211 (TAIS-WS)



SFC 15Q40 (A2C2 SGT) C
SP4 15Q10 (TAIS OPR) C

CP-FIRE SPT/PROTECT - AIR SPT PARA 12

*CPT 01A00 (AIR FORCE STAFF OFF)
SSG 00D30 (AIR FORCE STAFF NCO)
(USAF AUGMENTATION)*

CP-FIRE SPT/PROTECT - FIRE CONTROL PARA 13

AN/VRC-92F
FBCB2
DAGR



CPT 13A00 (FIRE CONT OFF) C

AN/VRC-92F
AN/VRC-90F
AN/VRC-104(V)3
AN/GYK-58
FBCB2
KG-175
FHMUX
DAGR
AN/PSC-5



SFC 13D40 (SR FIRE CONTROL SGT) C
2 SSG 13D30 (FIRE CONTROL SGT) C
2 SGT 13D20 (FIRE CONTROL SGT) C
2 SP4 13F10 (FATDS SP) C
2 PRC 13F10 (FATDS SP) C

AN/VRC-90F
DAGR



AN/VRC-90F
DAGR

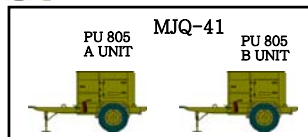

AN/VRC-90F
DAGR



CP-FIRE SPT/PROTECT - INFO OPS PARA 14

AN/VRC-92F
AN/VRC-90F
AN/VRC-104(V)3
FBCB2
AN/TYQ-137A:(V)2
DAGR
AN/GYK-56



MAJ 30A00 (IO COORD) P&C
MAJ 37A00 (PSYOP OFF) P&C
CPT 30A00 (INFO OPNS OFF) C
CPT 35G00 (EW SPT OFF) C

HHB, Fires Brigade (cont)

CP-FIRE SPT/PROTECT - LETHAL FIRES PARA 15

CP-SUSTAIN/PROTECT - PAO PARA 16

AN/VRC-92F
FBCB2
DAGR

2 AN/VRC-92F
AN/VRC-104(V)3
AN/GYK-57
FBCB2
AN/TYQ-137A:(V)2
KG-175
DAGR
AN/PSC-5
AN/GYK-56

AN/VRC-90F
DAGR

AN/VRC-90F
FBCB2
DAGR



MAJ 13A00 (EFFECTS/EW INTEGR OFF) P&C



MAJ 29A00 (EW OFF) C
CW3 131A0 (TARGET/EW INTEGR OFF) C
CW3 290A0 (EW TECH) C
CW2 290A0 (EW TECH) C
SFC 13F40 (EFFECTS NCO) C
SFC 29E40 (EW SGT) C
SSG 13F30 (EFFECTS NCO) C
SP4 13F10 (TARGET PROC SP) C
PFC 13F10 (FIRE SPT SP) C



MAJ 01A00 (MARINE STAFF OFF)
(USMC AUGMENTATION)



SGT 46Q20 (PUBLIC AFFAIRS SGT) C

CP-SUSTAIN/PROTECT - S1 PARA 17

CP-SUSTAIN/PROTECT - S4 PARA 18

CP-SUSTAIN/PROTECT - SJA PARA 19

AN/VRC-92F
FBCB2
AN/GYK-61 (BCS3)
2 KG-175
DAGR
8 AN/TYQ-116(V)3



LT 42B00 (STRENGTH MANAGER) C
CW2 420A0 (HUMAN RES TECH) C
MSG 42A50 (SR HUMAN RES SGT) C
SSG 42A30 (HUMAN RES SGT) C
SGT 42A20 (HUMAN RES SGT) C
SGT 42F20 (HR INFO SYS MGMT SGT) C
2 SP4 42A10 (HUMAN RES SP) C
SP4 42F10 (HR INFO SYS SP) C
3 PFC 42A10 (HUMAN RES SP) C

AN/VRC-92F
FBCB2
2 AN/GYK-61 (BCS3)
4 AN/TYQ-129(V)2
AN/TYQ-109(V)1
AN/TYQ-137A:(V)3

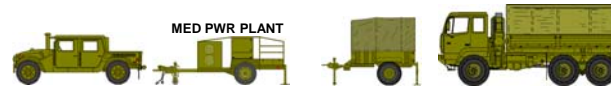

MAJ 13A00 (SUSTAINMENT OFF) P&R
CW2 920A0 (PROP ACCT TECH) C
CW2 922A0 (FOOD ADVISOR) C
MSG 92G50 (SR FOOD OPNS SGT) C
MSG 92Y50 (SR SUPPLY SGT) C
SGT 92Y20 (PROPERTY BOOK NCO) C
SGT 92Y20 (SUPPLY NCO) C
SP4 92Y10 (SUPPLY SP) C

AN/VRC-90F
DAGR

AN/VRC-90F
FBCB2
DAGR



CPT 27A00 (OPLAW JA) C
SSG 27D30 (PARALEGAL NCO) C

CP-SUSTAIN/PROTECT - SURGEON PARA 20

CP-SUSTAIN/PROTECT - TI&S PARA 21

CP-SUSTAIN/PROTECT - UMT PARA 22

AN/VRC-90F
AN/TYQ-106(V)1
FBCB2
AN/TYQ-108(V)3
DAGR
CAISI 2.0



MAJ 62B00 (FIELD SURGEON) P
CPT 70H67 (MEDICAL OPNS OFF) P
SFC 68W40 (OPNS SGT) C

AN/VRC-90F
FBCB2
AN/TYQ-71
DAGR

AN/VRC-90F
DAGR



SSG 12Y30 (SR GEOSPATIAL ENGR SGT) C
SGT 12Y20 (GEOSPATIAL ENGR SGT) C
SP4 12Y10 (GEOSPATIAL ENGR) C
PFC 12Y10 (GEOSPATIAL ENGR) C

AN/VRC-90F
FBCB2
DAGR



MAJ 56A00 (CHAPLAIN)
SSG 56M30 (CHAP ASST NCO) C

HHB, Fires Brigade (cont)

CP-INTELLIGENCE – S2/TARGETING PARA 23

CP-INTELLIGENCE – JSTARS CGS PARA 24

AN/VRC-90F
DAGR

AN/VRC-90F
DAGR

AN/VRC-92F
AN/VRC-90F
AN/VRC-104(V)3
AN/TYQ-93
AN/TYQ-93(V)2
FBCB2
KG-175
DAGR
AN/PSC-5
AN/GYK-56

AN/VRC-90F
DAGR

AN/VRC-92F
AN/TYQ-93
FBCB2
C-2299/VRC
DAGR
AN/PSC-5

AN/VRC-92F
DAGR



MSG 13Z50 (INTEL SGT) C
SFC 35F40 (SR INTEL SGT) C
SSG 13F30 (TARGETING NCO) C
SSG 35F30 (INTEL SGT) C
2 SGT 13F20 (TARGETING NCO) C
SP4 13F10 (TARGET PROC SP) C
SP4 35F10 (INTEL ANALYST) C
PFC 13F10 (TARGET PROC SP) C
PFC 35F10 (INTEL ANALYST) C

AN/TSQ-179(V)2
SSG 35G30 (GCS SGT) C
SGT 35H20 (CGS ANALYST) C
2 SP4 35H10 (CGS ANALYST) C
2 PFC 35H10 (CGS ANALYST) C

BATTERY HEADQUARTERS PARA 25

SUPPLY SECTION PARA 26

MEDICAL TREATMENT TEAM PARA 27

AN/VRC-92F
FBCB2
DAGR

AN/VRC-92F
FBCB2
DAGR

AN/VRC-90F
FBCB2
AN/TYQ-109(V)1
DAGR

AN/VRC-90F
FBCB2
DAGR

AN/VRC-90F
AN/TYQ-106(V)1
FBCB2
2 AN/TYQ-105(V)1
DAGR

AN/VRC-90F
FBCB2
2 AN/TYQ-105(V)1



CPT 13A00 (COMMANDER) P&C
PFC 13D10 (VEH DRIVER) C



1SG 13Z5M (FIRST SGT) C



SSG 92Y30 (SUPPLY SGT) C
SP4 92Y10 (SUPPLY SP) C



CPT 65D00 (PHYSICIAN ASST) P
SSG 68W30 (HEALTH CARE SGT) C
SP4 68W10 (HEALTH CARE SP) C
PFC 68W10 (HEALTH CARE SP) C

MEDICAL EVACUATION SECTION PARA 28

AN/VRC-90F
FBCB2
2 AN/TYQ-105(V)1
DAGR



SGT 68W20 (EMERG CARE SGT) C
PFC 68W10 (AMB AIDE/DRIVER) C

X2

Summary of Equipment

WEAPONS

LAUNCHER GRENADE 40MM M320A1-----	4
MACHINE GUN LIGHT 5.56MM M249-----	2
MACHINE GUN GRENADE 40MM MK-19 MOD III-----	4
MACHINE GUN 7.62MM M240B-----	11
PISTOL 9MM AUTOMATIC M9-----	22
RIFLE 5.56MM M4 CARBINE-----	153
MACHINE GUN: CALIBER .50 (M2E2)-----	8

VEHICLES, TRAILERS, AND TRLR MTD SYSTEMS

CMD SYSTEM: TACTICAL (CPP RWS) (MTD ON HMMWV)-----	2
GEN SET DED TM: 10KW 60HZ (PU-798)-----	2
POWER PLANT: ELEC TRL/MTD 60KW 50/60HZ (AN/MJQ 41)-----	1
POWER PLANT: UTILITY, LARGE 15WW 12 TON ECU-----	1
POWER PLANT: UTILITY, MEDIUM 20KW 5 TON ECU-----	4
TRUCK UTILITY EXP CAPACITY: ARMT CARRIER M1151A1-----	11
TRUCK UTILITY EXP CAPACITY ENH 4X4: M1152A1-----	20
TRUCK CARGO: MTV (M1083)-----	4
TRUCK AMBULANCE: 4 LITTER HMMWV (M997)-----	2
TRUCK UTILITY EXP CAPACITY ENH 4X4: M1165A1-----	11
TRUCK CARGO: 4X4 LMTV (M1078)-----	5
TRAILER CARGO: MTV W/ DROPSIDES (M1095)-----	1
TRAILER HIGH MOBILITY 1-1/4T (M1102)-----	25
TRAILER CARGO: LMTV W/DROPSIDES (M1082)-----	3
TRAILER TANK WATER (CAMEL) 800 GAL 5 TON-----	1

MISCELLANEOUS EQUIPMENT

GEN SET : DED SKID MTD 3KW 60HZ (MEP-831A)-----	4
GEN SET: DED SKID MTD 10KW 60HZ (MEP-803A)-----	2
SMALL UNMANNED AIRCRAFT SYSTEM: (SUAS) RAVEN B-----	1

NIGHT VISION/OBSERVATION EQUIPMENT

DRIVERS VISION ENHANCER: AN/VAS-5-----	6
NIGHT VISION GOGGLES: AN/PVS-7B-----	106
MEDIUM THERMAL WEAPONS SIGHT: AN/PAS-13(V2)-----	13
HEAVY THERMAL WEAPONS SIGHT: AN/PAS-13(V3)-----	20

COMMUNICATION-ELECTRONICS EQUIPMENT

ALL SOURCE ANALYSIS SYSTEM: AN/TYQ-93 (ASAS-LT)-----	2
ALL SOURCE ANALYSIS SYSTEM: AN/TYQ-93(V)2 (ASAS-IFS)-----	1
ANTENNA GROUP: OE-254-----	22
COMPUTER SET: AN/GYK-57 (AFATDS - SINGLE)-----	1
COMPUTER SET: AN/GYK-58 (AFATDS - DUAL)-----	2
CENTER COMMUNICATIONS OPERATIONS: AN/TSQ-253 (COCS)-----	1
COMPUTER SYSTEM DIGITAL: AN/TYQ-106(V)1-----	2
COMPUTER SET DIGITAL: AN/UYK-128 (FBCB2)-----	38
COMPUTER SYSTEM DIGITAL: (AMPS)-----	1
BTL CMD SUSTAINMENT SPT SYSTEM: AN/GYK-61 (BCS3)-----	2
COMPUTER SYS DIGITAL: AN/TYQ-129(V)2 (TC-AIMS II WS)-----	4
COMPUTER SYSTEM DIGITAL: AN/TYQ-105(V)1-----	8
COMPUTER SYS DIGITAL: AN/TYQ-108(V)3-----	1
COMPUTER SET DIGITAL: AN/TYQ-109(V)1 (GCSS-A (V)1)-----	2
COMPUTER SYSTEM DIGITAL: (CPOF WS) AN/TYQ-137A:(V)2-----	2
COMMAND SYSTEM: TACTICAL AN/TSQ-243-----	1
COMPUTER:: TACTICAL AN/GYQ-88-----	1
COMPUTER SET GENERAL: AN/GYK-49(V)2-----	2
COMPUTER SET FA GENERAL: AN/GYK-48(V)1 (FSCoord)-----	4
DIGITAL TOPOGRAPHIC SYSTEM: AN/TYQ-67(V)-----	1
DIGITAL TOPOGRAPHIC SUPPORT SYSTEM: AN/TYQ-71-----	1
ELECT EKY GEN DED LOOP ENCRYPTON DEVICE: TSEC/KG-84-----	1
ENCRYPT/DECRYPT EQUIPMENT: TACLANE KG-175-----	8
CONTROL RADIO SET: C-2299/VRC-----	1
COMPUTER SET FA GENERAL: AN/GYK-59-----	1
FREQUENCY HOPPING MULTIPLEXER: TF-1456VRC (FHMUX)-----	1
INTERROGATOR SET AN/TYQ-95 (TC-AIMS II INTERROGATOR)-----	2
NAVIGATION SET: SATELLITE SIGNALS AN/PSN-13 (DAGR)-----	50
RADIAC SET: AN/VDR-2-----	5
RECEIVE SUITE: AN/TSR-8 (GRT)-----	2
RADIO SET: AN/GRC-240-----	1
RADIO SET: AN/USQ-140 (V) 2 (C)-----	1
RADIO SET: AN/VRC-89F-----	1
RADIO SET: AN/VRC-90F-----	37
RADIO SET: AN/VRC-92F-----	25
RADIO SET: AN/PSC-5-----	7
RADIO SET: HIGH FRBQ AN/VRC-100(V)1-----	1
TARGET ACQUISITION SUBSYSTEM: AN/TYQ-179(V)2-----	1
WORKSTATION: AIRSPACE OPERATION AN/FSQ-211 (TAIS AWS)-----	1
COMPUTER SET FA GENERAL: AN/GYK-56 (EMT)-----	4
COMPUTER SYSTEM DIGITAL: AN/GYK-50A (ISYSCON) (V4)-----	2
INTERFACE UNIT COMM EQ: OL-713(V)1/TYQ CSS VSAT-----	1
RADIO SET: AN/PRC-117F TACSAT RADIO MANPACK-----	2
RADIO SET: AN/VRC-104(V)3 150 WATT W/PRC-150 HF RADIO-----	12
COMMAND SYSTEM TACTICAL: AN/TYQ-155 (V) 1-----	4
COMPUTER SYSTEM DIGITAL: AN/PYQ-16-----	2
KEY PROCESSOR KP TSEC/KOK-22-----	1
COMP SYS DIGITAL: (AHRs) AN/TYQ-116(V)3-----	9

HHB, Fires Brigade

Target Acquisition Battery (Fires Bde)

06410R000
OFF: 1/WO: 4/ENL: 79/TOTAL: 84

Target Acquisition Battery HQ (Fires Bde)

06413R000
OFF: 1/WO: 0/ENL: 5/TOTAL: 6

BATTERY HEADQUARTERS PARA 01

BATTERY SUPPLY SECTION PARA 02

AN/VRC-92F
AN/VRC-90F
FBCB2
DAGR
AN/PSG-14(V)1 LFED



CPT 13A00 (COMMANDER) P&C
1SG 13Z5M (FIRST SGT) C
PFC 13R10 (VEH DRIVER) C

AN/VRC-90F
FBCB2
AN/TYQ-109(V)1
DAGR
CAISI 2.0



SGT 74D20 (CBRN NCO) C
SGT 92Y20 (SUPPLY NCO) C
SP4 92Y10 (SUPPLY SP) C

Summary of Equipment

WEAPONS

LAUNCHER GRENADE: M320A1 ----- 4
PISTOL 9MM AUTOMATIC M9----- 1
RIFLE 5.56MM M4 CARBINE----- 6
MACHINE GUN: CALIBER .50 (M2E2)----- 1

VEHICLES AND VEHICLE EQUIPMENT

TRUCK UTILITY EXP CAPACITY ENH 4X4: M1165A1----- 1
TRUCK CARGO: MTV (M1083)----- 1
TRAILER TANK WATER (CAMEL) 800 GAL 5 TON----- 1

COMMUNICATION-ELECTRONICS EQUIPMENT

COMPUTER SET DIGITAL: AN/UYK-128 (FBCB2)----- 2
COMPUTER SET DIGITAL: AN/TYQ-109(V)1 (GCSS-A (V)1)----- 1
NAVIGATION SET: SATELLITE SIGNALS AN/PSN-13 (DAGR)----- 2
PROCESSOR GROUP SIGNAL DATA: (CAISI 2.0)----- 1
RADIAC SET: AN/VDR-2----- 2
RADIO SET: AN/VRC-90F----- 2
RADIO SET: AN/VRC-92F----- 1

NIGHT VISION/OBSERVATION EQUIPMENT

NIGHT VISION GOGGLES: AN/PVS-7B----- 4
HEAVY WEAPON THERMAL SIGHT (HWTS): AN/PAS-13(V)3----- 1

Target Acquisition Platoon HQ Team (Fires Bde)

06510RA00
OFF: 0/WO: 1/ENL: 1/TOTAL: 2

TARGET ACQUISITION PLATOON HQ PARA 01

AN/VRC-92F
AN/PSG-14(V)1 LFED
FBCB2
DAGR



CW2 131A0 (PLT LDR) C
SFC 13R40 (PLT SGT) C

Summary of Equipment

WEAPONS

LAUNCHER GRENADE: M320A1----- 1
MACHINE GUN 7.62MM M240B----- 1
RIFLE 5.56MM M4 CARBINE----- 1

VEHICLES, TRAILERS, AND TRLR MTD SYSTEMS

TRUCK UTILITY EXP CAPACITY ENH 4X4: M1165A1----- 1
TRAILER HIGH MOBILITY 1-1/4T (M1102)----- 1

COMMUNICATION-ELECTRONICS EQUIPMENT

ANTENNA GROUP: OE-254----- 1
COMPUTER SYSTEM DIGITAL: AN/PSG-14(V)1 LFED----- 1
COMPUTER SET DIGITAL: AN/UYK-128 (FBCB2)----- 1
NAVIGATION SET: SATELLITE SIGNALS AN/PSN-13 (DAGR)----- 1
RADIAC SET: AN/VDR-2----- 1
RADIO SET: AN/VRC-92F----- 1

NIGHT VISION/OBSERVATION EQUIPMENT

DRIVERS VISION ENHANCER AN/VAS-5----- 1
NIGHT VISION GOGGLES: AN/PVS-7B----- 2
MEDIUM WEAPON THERMAL SIGHT (MWTS): AN/PAS-13(V)2----- 1

(X3) 1 WLRS (TPQ-37) Team (Fires Bde)

06510RC00
OFF: 0/WO: 0/ENL: 10/TOTAL: 10

WEAPONS LOCATING RADAR SECTION (TPQ-37) PARA 01

AN/VRC-92F
AN/VRC-90F
FBCB2
DAGR

AN/VRC-90F

AN/VRC-90F
FBCB2
DAGR

AN/VRC-90F



SFC 13R40 (SR FA TARGETING NCO)
SSG 13R30 (SECTION CHIEF) C



PU-806



2 SGT 13R20 (SR FF RADAR OPR) C
3 SP4 13R10 (FF RADAR OPR) C
3 PFC 13R10 (FF RADAR OPR) C

Summary of Equipment

WEAPONS

LAUNCHER GRENADE: M320A1----- 1
MACHINE GUN 7.62MM M240B----- 1
RIFLE 5.56MM M4 CARBINE----- 10

VEHICLES, TRAILERS, AND TRLR MTD SYSTEMS

RADAR SET: AN/TPQ-37(V)1----- 1
GENERATOR SET: DIESEL TM: 60KW 400HZ PU-806----- 1
TRUCK UTILITY EXP CAPACITY ENH 4X4: M1152A1----- 2
TRUCK CARGO: MTV (M1083)----- 2

MISCELLANEOUS EQUIPMENT

GEN SET: DED SKID MTD 60KW 400HZ (MEP -813A)----- 1

COMMUNICATION-ELECTRONICS EQUIPMENT

ANTENNA GROUP: OE-254----- 2
COMPUTER SET DIGITAL: AN/UYK-128 (FBCB2)----- 2
NAVIGATION SET: SATELLITE SIGNALS AN/PSN-13 (DAGR)----- 4
RADIAC SET: AN/VDR-2----- 1
RADIO SET: AN/VRC-90F----- 4
RADIO SET: AN/VRC-92F----- 1

NIGHT VISION/OBSERVATION EQUIPMENT

DRIVERS VISION ENHANCER AN/VAS-5----- 3
NIGHT VISION GOGGLES: AN/PVS-7B----- 8
MEDIUM THERMAL WEAPONS SIGHT: AN/PAS-13 (V2)----- 1

Meteorological Team (Fires Bde)

06510RD00
OFF: 0/WO: 0/ENL: 2/TOTAL: 2

METEOROLOGICAL TEAM PARA 01

AN/VRC-92F
AN/VRC-90F
FBCB2
DAGR



AN/TMQ-52

SGT 13T20 (METRO EQ REP) C
SP4 13T10 (FA METRO CREWMEMBER) C

Summary of Equipment

WEAPONS

MACHINE GUN 7.62MM M240B----- 1
RIFLE 5.56MM M4 CARBINE----- 2

VEHICLES, TRAILERS, AND TRLR MTD SYSTEMS

TRUCK UTILITY EXP CAPACITY ENH 4X4: M1152A1----- 3
TRAILER HIGH MOBILITY 1-1/4T (M1102)----- 2

MISCELLANEOUS EQUIPMENT

METEOROLOGICAL MEASURING SET: PROFILER AN/TMQ-52----- 1

COMMUNICATION-ELECTRONICS EQUIPMENT

ANTENNA GROUP: OE-254----- 1
COMPUTER SET DIGITAL: AN/UYK-128 (FBCB2)----- 1
NAVIGATION SET: SATELLITE SIGNALS AN/PSN-13 (DAGR)----- 1
RADIAC SET: AN/VDR-2----- 1
RECEIVE SUITE: AN/TSR-8 (GRT)----- 1
RADIO SET: AN/VRC-90F----- 1
RADIO SET: AN/VRC-92F----- 1

NIGHT VISION/OBSERVATION EQUIPMENT

DRIVERS VISION ENHANCER AN/VAS-5----- 1
NIGHT VISION GOGGLES: AN/PVS-7B----- 2
MEDIUM WEAPON THERMAL SIGHT (MWTS): AN/PAS-13(V)2----- 1

(X3) Survey Team (Fires Bde)

06510RE00
OFF: 0/WO: 0/ENL: 2/TOTAL: 2

FA SURVEY TEAM PARA 01

AN/VRC-92F
AN/PSG-14(V)1 LFED
FBCB2
DAGR
IPADS

Summary of Equipment



SGT 13T20 (SURVEYOR COMPUTER/PADS TEAM CHIEF) C
PFC 13T10 (FA SURVEYOR/PADS VEH DRIVER) C

WEAPONS

LAUNCHER GRENADE: M320A1----- 1
MACHINE GUN LIGHT 5.56MM M249----- 1
RIFLE 5.56MM M4 CARBINE----- 1

VEHICLES, TRAILERS, AND TRLR MTD SYSTEMS

TRUCK UTILITY EXP CAPACITY ENH 4X4: M1152A1----- 1

MISCELLANEOUS EQUIPMENT

SURVEYING INSTRUMENT: AZIMUTH (IPADS)----- 1

COMMUNICATION-ELECTRONICS EQUIPMENT

COMPUTER SYSTEM DIGITAL: AN/PSG-14V)1 LFED----- 1
COMPUTER SET DIGITAL: AN/UYK-128 (FBCB2)----- 1
NAVIGATION SET: SATELLITE SIGNALS AN/PSN-13 (DAGR)----- 1
RADIAC SET: AN/VDR-2----- 1
RADIO SET: AN/VRC-92F----- 1

NIGHT VISION/OBSERVATION EQUIPMENT

DRIVERS VISION ENHANCER AN/VAS-5----- 1
MINI EYESAFE LASER INFRARED OBSN DEVICE: (MELIOS)----- 1
NIGHT VISION GOGGLES: AN/PVS-7B----- 2
MEDIUM THERMAL WEAPONS SIGHT: AN/PAS-13 (V2)----- 1

Target Processing Section (Fires Bde)

06510RF00
OFF: 0/WO: 1/ENL: 5/TOTAL: 6

TARGET PROCESSING SECTION PARA 01

AN/VRC-92F
AN/VRC-104(V)3
FBCB2
DAGR
AN/PSC-5
AN/GYK-56

Summary of Equipment



CW2 131A0 (ASST COUNTERFIRE OFF) C
SFC 13R40 (SR FA TARGETING NCO) C
SSG 13R30 (TARGETING NCO) C
SGT 13R20 (TARGETING NCO) C
SP4 13R10 (TARGET PROC SP) C
PFC 13R10 (TARGET PROC SP) C

WEAPONS

LAUNCHER GRENADE: M320A1----- 1
RIFLE 5.56MM M4 CARBINE----- 6

VEHICLES, TRAILERS, AND TRLR MTD SYSTEMS

TRUCK UTILITY EXP CAPACITY ENH 4X4: M1152A1----- 1
TRAILER HIGH MOBILITY 1-1/4T (M1102)----- 1

COMMUNICATION-ELECTRONICS EQUIPMENT

COMPUTER SET DIGITAL: AN/UYK-128 (FBCB2)----- 1
NAVIGATION SET: SATELLITE SIGNALS AN/PSN-13 (DAGR)----- 1
RADIO SET: AN/VRC-92F----- 1
RADIO SET: AN/PSC-5----- 1
COMPUTER SET FA GENERAL: AN/GYK-56 (EMT)----- 1
RADIO SET: AN/VRC-104(V)3 150 WATT IK: PRC-150 HF RADIO----- 1

NIGHT VISION/OBSERVATION EQUIPMENT

NIGHT VISION GOGGLES: AN/PVS-7B----- 2

Lightweight Counter Mortar Radar Section (Q-48) (Fires Bde)

06510RG00
OFF: 0/WO: 0/ENL: 4/TOTAL: 4

LCMR (V3) AN/TPQ-48 SECTION PARA 01

AN/VRC-89F
FBCB2
DAGR
AN/TPQ-48 (V) 3

Summary of Equipment



X2

SSG 13R30 (SECTION CHIEF) C
2 SP4 13R10 (FF RADAR OPR) C
PFC 13R10 (FF RADAR OPR) C

WEAPONS

LAUNCHER GRENADE: M320A1----- 2
RIFLE 5.56MM M4 CARBINE----- 4

VEHICLES, TRAILERS, AND TRLR MTD SYSTEMS

TRUCK UTILITY EXP CAPACITY ENH 4X4: M1152A1----- 2

MISCELLANEOUS EQUIPMENT

GEN SET DIESEL: 60HZ AC MEP-531A----- 2
LIGHTWEIGHT COUNTER MORTAR RADAR: AN/TPQ-48 (V) 3----- 2

COMMUNICATION-ELECTRONICS EQUIPMENT

COMPUTER SET DIGITAL: AN/UYK-128 (FBCB2)----- 2
NAVIGATION SET: SATELLITE SIGNALS AN/PSN-13 (DAGR)----- 2
RADIO SET: AN/VRC-89F----- 2

NIGHT VISION/OBSERVATION EQUIPMENT

NIGHT VISION GOGGLES: AN/PVS-7B----- 6

Tactical Unmanned Aircraft System (TUAS) Platoon

01708RA00
OFF: 0/WO: 2/ENL: 25/TOTAL: 27

TUAV PLATOON HQ PARA 01

AN/VRC-92F

CW3 150UB (PLT LDR) C
CW2 150U0 (UAV OPNS TECH) C
SFC 15W40 (PLT SGT) C

MSN PLNG & CONT SECTION PARA 02

AN/VRC-92F
2 AN/VRC-89F
FBCB2
AMPS
FHMUX (ONLY 1 IN PARAGRAPH)
DAGR
AN/TYQ-151 (V) 1 ULLS-A(E)
AN/TYQ-151 (V) 3
AN/TYQ-150 (V) 1 ULLS-A(E)
GDT (TUAV-SHADOW)

GROUND CONTROL STATION (TUAV-SHADOW)

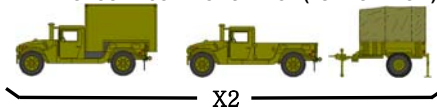

SSG 15W30 (UAV SGT) C
2 SGT 15W20 (UAV OPR) C
SP4 15J10 (SH-UAV SYS REP) C
3 SP4 15W10 (UAV OPR) C
2 PFC 15W10 (UAV OPR) C

LAUNCH & RECOVERY SECTION PARA 03

5 AN/TYQ-151 (V) 1 ULLS-A(E)
AN/TYQ-151 (V) 2
CAISI 2.0

AN/VRC-89F
AN/TYQ-151 (V) 1 ULLS-A(E)

AN/VRC-89F
CAISI 2.0
AN/TYQ-151 (V) 1 ULLS-A(E)
AN/TYQ-151 (V) 2

AN/VRC-89F
FHMUX
PGDT
AN/TYQ-151 (V) 1 ULLS-A(E)

(EQUIP VEH)



ATV

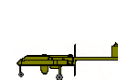

MSMF



PGCS



SFC 15J40 (SR SH-UAV SYS REP) C
SSG 15J30 (UAV SYS TECH INSP) C
SSG 15W30 (UAV SGT) C
SGT 15J20 (SH-UAV SYS REP) C
SGT 15J20 (UAV SYS TECH INSP) C
2 SGT 15W20 (UAV OPR) C
2 SP4 15J10 (SH-UAV SYS REP) C
2 SP4 15W10 (UAV OPR) C
2 PFC 15J10 (SH-UAV SYS REP) C
2 PFC 15W10 (UAV OPR) SAW

Summary of Equipment

WEAPONS

MACHINE GUN 5.56MM M249 ----- 2
RIFLE 5.56MM M4 CARBINE ----- 25

VEHICLES, TRAILERS, AND TRLR MTD SYSTEMS

TRUCK UTILITY EXP CAPACITY ENH 4X4: M1152A1 ----- 7
TRUCK CARGO: 4X4 LMTV (M1078) ----- 1
TRAILER HIGH MOBILITY 1-1/4T (M1102) ----- 4

MISCELLANEOUS EQUIPMENT

GEN SET DIESEL: 60HZ AC MEP-531A ----- 8
GEN SET: DED SKID MTD 10KW 60HZ (MEP-803A) ----- 2
SAW CHAIN: GAS DRVN BAR FRAME ----- 2

TUAS SYSTEM EQUIPMENT

TACT UNMANNED AERIAL VEHICLE SYSTEM: (SHADOW) ----- 1
PORTABLE GROUND DATA TERMINAL (PGDT) ----- 1
MAINTENANCE SECTION MULTI-FUNCTIONAL : (MSMF) ----- 1
PORTABLE GROUND CONTROL STATION (PGCS) ----- 1
TRUCK AIR VEHICLE TRANSPORTER: (AVT) (TUAV-SHADOW) ----- 1
UNMANNED AERIAL VEHICLE (UAV): (TUAV-SHADOW) ----- 4
UNMANNED AERIAL VEHICLE LAUNCHER: (TUAV-SHADOW) ----- 2
GROUND CONTROL STATION (GCS): (TUAV-SHADOW) ----- 2
TACTICAL AUTOMATIC LANDING SYSTEM: (TALS) ----- 2
GROUND DATA TERMINAL (GDT): (TUAV-SHADOW) ----- 2

COMMUNICATION-ELECTRONICS EQUIPMENT

ANTENNA GROUP: OE-254 ----- 5
COMPUTER SET DIGITAL: AN/UYSK-128 (FBCB2) ----- 2
COMPUTER SYSTEM DIGITAL: (AMPS) ----- 2
FREQUENCY HOPPING MULTIPLEXER: TF-1456VRC (FHMUX) ----- 2
NAVIGATION SET: SATELLITE SIGNALS AN/PSN-13 (DAGR) ----- 2
PROCESSOR GROUP SIGNAL DATA: (CAISI 2.0) ----- 2
RADIAC SET: AN/VDR-2 ----- 3
RADIO SET: AN/VRC-89F ----- 7
RADIO SET: AN/VRC-92F ----- 3
COMPUTER SET DIGITAL: AN/TYQ-151(V)1 ULLS-A(E) ----- 10
COMPUTER SET DIGITAL: AN/TYQ-151(V)2 ----- 1
COMPUTER SET DIGITAL: AN/TYQ-151(V)3 ----- 2
COMPUTER SET DIGITAL: AN/TYQ-150(V)1 ULLS-A(E) ----- 2

NIGHT VISION/OBSERVATION EQUIPMENT

DRIVERS VISION ENHANCER: AN/VAS-5 ----- 8
NIGHT VISION GOGGLES: AN/PVS-7B ----- 16

HHB, Fires Bn, MLRS (Fires Bde)

06466R000
OFF: 16/WO: 2/ENL: 74/TOTAL: 92

COMMAND SECTION PARA 01

2 AN/VRC-92F
AN/VRC-104(V)3
FBCB2
AN/TYQ-137A:(V)2
AN/GYK-48(V)1
DAGR



LTC 13A00 (COMMANDER) P&C
PFC 13P10 (VEH DRIVER) C

AN/VRC-92F
FBCB2
DAGR



MAJ 13A00 (EXEC OFF) P&C
PFC 13P10 (FIRE DIR SP) C

CSM 00Z50 (CSM) P&C

CURRENT OPS - INTEL/S2 PARA 02

2 AN/VRC-92F
AN/TYQ-93
FBCB2
DAGR
AN/GYK-56



CPT 13A00 (S2) C
CW2 131A0 (TARGETING OFF) C
MSG 13Z50 (INTEL SGT) C
SGT 35F20 (INTEL ANALYST) C
SP4 13P10 (FIRE DIR SP) C

CURRENT OPS - OPS/S3 PARA 03

2 AN/VRC-92F
FBCB2
AN/GYK-48(V)1
FHMUX
DAGR



MAJ 13A00 (S3) P&C
SP4 13P10 (FIRE DIR SP) C

2 AN/VRC-92F
AN/VRC-104(V)3
AN/GYK-57
FBCB2
AN/TYQ-129(V)2
AN/TYQ-137A:(V)2
FHMUX
DAGR
AN/PSC-5

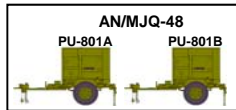

CPT 13A00 (OPNS OFF) C
LT 74B00 (CHEM OFF) C
CW2 740A0 (CBRN WARRANT OFF) C
SGM 13Z50 (OPNS SGM) C
SFC 13M40 (MASTER GNR/ASST OPS SGT) C
SSG 13T30 (CHIEF OF PARTY/CHIEF SURVEYOR) C
SSG 29E30 (EW SGT) C
SSG 74D30 (CBRN NCO) C
SGT 29E20 (EW SGT) C
SP4 13P10 (FIRE DIR SP) C
SP4 74D10 (CBRN DECON SP) C

CURRENT OPS - FIRE DIRECTION CENTER PARA 04

AN/VRC-90F
AN/VRC-104(V)3
FBCB2
DAGR



CPT 13A00 (FIRE DIRECTION OFF) C
SP4 13P10 (FIRE DIR SP) C

3 AN/VRC-92F
AN/GYK-58
FBCB2
FHMUX
DAGR
AN/PSC-5



SFC 13P40 (CHIEF FIRE DIR COMPUTER) C
2 SSG 13P30 (FIRE DIR COMPUTER) C
4 SGT 13P20 (BTRY DISPLAY OPR) C
SP4 13P10 (FIRE DIR SP) C

CURRENT OPS - LNO PARA 05

AN/VRC-92F
AN/VRC-104(V)3
FBCB2
AN/GYK-59
DAGR



LT 13A00 (LIAISON OFF) C
SSG 13P30 (LIAISON SGT) C
SP4 13P10 (LIAISON SP) C

X2

CURRENT OPS - SURVEY TEAM PARA 06

AN/VRC-92F
AN/PSG-14(V)1 LFED
FBCB2
DAGR
I-PADS



SGT 13T20 (SURVEYOR COMPUTER/PADS TEAM CHIEF) C
PFC 13T10 (FA SURVEYOR/PADS VEH DRIVER) C

SUSTAINMENT - S1 PARA 07

AN/VRC-92F
AN/VRC-90F
FBCB2
DAGR
CAISI 2.0
5 AN/TYQ-116(V)3



LT 42B00 (S1) C
SFC 42A40 (SR HUMAN RES SGT) R
SSG 42A30 (HUMAN RES SGT) C
SGT 42A10 (HUMAN RES SGT) C
SP4 27D10 (PARALEGAL SP) C
2 SP4 42A10 (HUMAN RES SP) C
2 PFC 42A10 (HUMAN RES SP) C

HHB, Fires Bn, MLRS (Fires Bde) (cont)

SUSTAINMENT - S4 PARA 08

AN/VRC-92F
FBCB2
AN/TYQ-129(V)2
AN/TYQ-109(V)1
AN/TYQ-137A:(V)2
AN/UYQ-90(V)3
AN/TYQ-95
DAGR
CAISI 2.0

AN/VRC-90F
DAGR



CPT 13A00 (S4) C
MSG 91Z50 (SR MAINT SUPV) C
SFC 92Y40 (SR SUPPLY SGT) C
SGT 92Y20 (SUPPLY NCO) C
2 SP4 92Y10 (SUPPLY SP) C
PFC 92Y10 (SUPPLY SP) C

SUSTAINMENT - AMMO MANAGEMENT PARA 09

AN/VRC-89F
FBCB2
AN/UYQ-90(V)3
DAGR



LT 13A00 (AMMO OFF) C
SFC 13M40 (AMMO NCO) C
PFC 13P10 (VEH DRIVER) C

SUSTAINMENT - UMT PARA 10

AN/VRC-90F
FBCB2
DAGR



CPT 56A00 (CHAPLAIN)
SP4 56M10 (CHAP ASST) C

SUSTAINMENT - C4 OPS/S6 PARA 11

AN/VRC-92F
FBCB2
DAGR



CPT 25A00 (S6) C
SPC 25U40 (SECTION CHIEF) C
SP4 25U10 (SGNL INFO SVC SP) C
PFC 25U10 (SGNL SPT SYS SP) C

AN/VRC-90F
FBCB2
DAGR



SSG 25U30 (FWD SGNL SPT NCO) C

X2

NETWORK MGMT TEAM PARA 12

AN/VRC-92F
FBCB2
AN/TSQ-243
DAGR



SP4 25B10 (LAN MGR) C
PFC 25B10 (LAN MGR) C

NETWORK OPERATIONS PARA 13

AN/VRC-92F
FBCB2
AN/PYQ-12
DAGR
AN/TSR-8 (GRT)

AN/VRC-90F
FBCB2
DAGR
AN/GYK-50A (ISYSCON) (V)4
AN/TSQ-259

BCP (SWITCHING GP): OM-87A/T



SGT 25Q20 (SR XMSN SYS OPR-MAINT) C
SP4 25Q10 (XMSN SYS OPR-MAINT) C

RETRANSMISSION TEAM PARA 14

2 AN/VRC-92F
FBCB2
DAGR



SGT 25U20 (TEAM CHIEF) C
SP4 25U10 (RADIO RETRANS OPR) C
PFC 25U10 (RADIO RETRANS OPR) C

HHB, Fires Bn, MLRS (Fires Bde) (cont)

BATTERY HQ PARA 15

AN/VR-89F
FBCB2
DAGR



CPT 13A00 (COMMANDER) P&C
1SG 13Z5M (FIRST SGT) C
PRC 13P1O (VEH DRIVER) C

SUPPLY SECTION PARA 16

AN/VR-90F
FBCB2
AN/TYQ-109(V)1
DAGR
CAISI 2.0



SGT 92Y2O (SUPPLY NCO) C
SP4 92Y1O (SUPPLY SP) C

AN/VR-90F
FBCB2
DAGR



AN/VR-90F
FBCB2
DAGR



MEDICAL PLATOON HQ PARA 17

AN/VR-89F
AN/TYQ-107(V)1
FBCB2
DAGR
CAISI 2.0



LT 70B67 (FIELD MEDICAL ASST) C
SSG 68W3O (SECTION NCO) C

MEDICAL TREATMENT TEAM PARA 18

AN/VR-90F
AN/TYQ-106(V)1
FBCB2
2 AN/TYQ-105(V)1
DAGR
CAISI 2.0



CPT 65D0O (PHYSICIAN ASST) P
SGT 68W2O (HEALTH CARE SGT) C
SP4 68W1O (HEALTH CARE SP) C
PRC 68W1O (HEALTH CARE SP) C

AN/VR-90F
FBCB2
2 AN/TYQ-105(V)1
DAGR

COMBAT MEDIC SECTION PARA 19

4 AN/TYQ-106(V)1
4 AN/TYQ-105(V)1

4 SP4 68W1O (COMBAT MEDIC) P

AMBULANCE TEAM PARA 20

AN/VR-92F
FBCB2
2 AN/TYQ-105(V)1
DAGR



SGT 68W2O (EMERG CARE SGT) C
PFC 68W1O (AMBUL AIDE/DRIVER) C

Summary of Equipment

WEAPONS

LAUNCHER GRENADE: M320A1-----	5
MACHINE GUN LIGHT 5.56MM M249-----	4
MACHINE GUN GRENADE 40MM MK-19 MOD III-----	2
MACHINE GUN 7.62MM M240B-----	7
PISTOL 9MM AUTOMATIC M9-----	10
RIFLE 5.56MM M4 CARBINE-----	86
MACHINE GUN: CALIBER .50 (M2E2)-----	7

VEHICLES, TRAILERS, AND TRLR MTD SYSTEMS

CARRIER ARMORED COMMAND POST: (M1068)-----	3
GEN SET DED TM: 10KW 60HZ (PU-798)-----	1
POWER PLANT: UTILITY, MEDIUM 20KW 5 TON ECU-----	2
POWER PLANT: ELECTRIC TLR MTD AN/MJQ-48-----	1
TRUCK UTILITY EXP CAPACITY ENH 4X4: M1152A1-----	11
TRUCK AMBULANCE: 4 LITTER HMMWV (M997)-----	1
TRUCK UTILITY EXP CAPACITY ENH 4X4: M1165A1-----	12
TRUCK CARGO: MTV (M1083)-----	1
TRUCK CARGO: 4X4 LMTV (M1078)-----	3
TRAILER HIGH MOBILITY 1-1/4T (M1102)-----	7
TRAILER CARGO: LMTV W/DROPSIDES (M1082)-----	3
TRAILER TANK WATER (CAMEL) 800 GAL 5 TON-----	1

MISCELLANEOUS EQUIPMENT

DECON APPARATUS LT WEIGHT-----	2
GEN SET: DED SKID MTD 5 KW 60HZ (MEP-802A)-----	1
GEN SET : DED SKID MTD 3KW 60HZ (MEP-831A)-----	7
SURVEYING INSTRUMENT: AZIMUTH (IPADS)-----	1

NIGHT VISION/OBSERVATION EQUIPMENT

DRIVERS VISION ENHANCER AN/VAS-5-----	5
MINI EYESAFE LASER INFRARED OBSN DEVICE: (MELIOS)-----	2
NIGHT VISION GOGGLES: AN/PVS-7B-----	70
MEDIUM THERMAL WEAPONS SIGHT: AN/PAS-13(V2)-----	11
HEAVY THERMAL WEAPONS SIGHT: AN/PAS-13(V3)-----	9

COMMUNICATION-ELECTRONICS EQUIPMENT

ALL SOURCE ANALYSIS SYSTEM: AN/TYQ-93 (ASAS-LT)-----	1
ANTENNA GROUP: OE-254-----	28
COMPUTER SET DIGITAL: AN/PSG-14(V)1 LFED-----	1
COMPUTER SET: AN/GYK-57 (AFATDS - SINGLE)-----	1
COMPUTER SET: AN/GYK-58 (AFATDS - DUAL)-----	1
COMPUTER SYSTEM DIGITAL: AN/TYQ-107(V)1-----	1
COMPUTER SET DIGITAL: AN/UYK-128 (FBCB2)-----	30
COMPUTER SET DIGITAL: AN/PYQ-12 (MCS GATEWAY SVR)-----	1
COMPUTER SYS DIGITAL: AN/TYQ-129(V)2 (TC-AIMS II WS)-----	2
COMPUTER SYSTEM DIGITAL: AN/TYQ-105(V)1-----	10
COMPUTER SET DIGITAL: AN/TYQ-109(V)1 (GCSS-A (V)1)-----	2
COMPUTER SYSTEM DIGITAL: ((CPOF WS) AN/TYQ-137A:(V)2)-----	5
COMMAND SYSTEM: DIGITAL AN/TSQ-243-----	1
COMPUTER SYSTEM DIGITAL: AN/UYQ-90(V)3 (MTS-CS)-----	2
COMPUTER SET FA GENERAL: AN/GYK-48(V)1 (FSCOORD)-----	2
COMPUTER SET FA GENERAL: AN/GYK-59-----	2
FREQUENCY HOPPING MULTIPLEXER: TF-1456VRC (FHMUX)-----	4
INTERROGATOR SET AN/TYQ-95 (TC-AIMS II INTERROGATOR)-----	1
NAVIGATION SET: SATELLITE SIGNALS AN/PSN-13 (DAGR)-----	32
PROCESSOR GROUP SIGNAL DATA: (CAISI 2.0)-----	5
RADIAC SET: AN/VDR-2-----	9
RECEIVE SUITE: AN/TSR-8 (GRT)-----	1
RADIO SET: AN/VRC-89F-----	3
RADIO SET: AN/VRC-90F-----	15
RADIO SET: AN/VRC-92F-----	22
RADIO SET: AN/PSC-5-----	2
COMPUTER SET FA GENERAL: AN/GYK-56 (EMT)-----	1
COMPUTER SYSTEM DIGITAL: AN/GYK-50A (ISYSCON) (V4)-----	1
BATTALION COMMAND POST (SWITCHING GROUP): OM-87A/T-----	1
RADIO SET: AN/VRC-104(V)3 150 WATT IK: PRC-150 HF RADIO-----	5
COMMUNICATIONS SUBSYSTEM: AN/TSQ-259:-----	1
COMP SYS DIGITAL: (AHR) AN/TYQ-116(V)3-----	5

HHB, Fires Bn, MLRS (Fires Bde)

Fires Battery, Fires Bn, MLRS (Fires Bde)

06467R000
OFF: 5/WO: 0/ENL: 66/TOTAL: 71

BATTERY HEADQUARTERS PARA 01

AN/VRC-92F
AN/VRC-90F
FBCB2
DAGR



CPT 13A00 (COMMANDER) P&C
1SG 13Z5M (FIRST SGT) C
PFC 13P10 (VEH DRIVER) C

BATTERY OPERATIONS CENTER PARA 02

AN/VRC-92F
FBCB2
DAGR



LT 13A00 (OPNS OFF) C
SFC 13P40 (BATTERY OPS SGT) C
SSG 13P30 (FDC SECTION CHIEF) C
2 SGT 13P20 (BATTERY DISPLAY OPR) C
4 SP4 13P10 (FIRE DIR SP) C

AN/VRC-92F
AN/VRC-90F
AN/VRC-104(V)3
AN/GYK-57
FBCB2
FHMUX
DAGR

FIRING PLATOON HQ PARA 03

AN/VRC-92F
AN/VRC-104(V)3
FBCB2
DAGR



LT 13A00 (PLT LDR) C
PFC 13P10 (VEH DRIVER) C

2 AN/VRC-92F
AN/GYK-57
FBCB2
FHMUX
DAGR



SFC 13M40 (PLT SGT) C
SGT 13P20 (BTRY DISPLAY OPR) C
SPC 13P10 (FIRE DIR SP) C
PFC 13P10 (FIRE DIR SP) C

AN/VRC-90F
DAGR



SGT 13M20 (RECON SGT) C

X2

FIRING SECTION (MLRS) PARA 04

AN/VRC-92F
AN/VRC-104(V)3
FBCB2
DAGR



SSG 13M30 (SECTION CHIEF) C
SGT 13M20 (GUNNER) C
SP4 13M10 (SPLL DRIVER) C

X8

SUPPORT PLATOON HQ PARA 05

AN/VRC-92F
FBCB2
AN/UYQ-90(V)3
DAGR



LT 13A00 (PLT LDR) C
SFC 13M40 (PLT SGT) C
PFC 13P10 (VEH DRIVER) C

SUPPLY SECTION PARA 06

AN/VRC-90F
FBCB2
AN/TYQ-109(V)1
DAGR
CAISI 2.0



SGT 92Y20 (SUPPLY NCO) C
SP4 92Y10 (SUPPLY SP) C

AMMUNITION SECTION PARA 07

AN/VRC-90F
AN/UYQ-90(V)2
DAGR



SSG 13M30 (SECTION CHIEF) C
SGT 13M20 (ASST SEC CHIEF) C
3 SP4 13B10 (AMMO SP) C
3 PFC 13B10 (AMMO SP) C

X2

Summary of Equipment

WEAPONS

LAUNCHER GRENADE: M320A1-----	14
MACHINE GUN LIGHT 5.56MM M249-----	1
MACHINE GUN GRENADE 40MM: MK-19-----	8
MACHINE GUN 7.62MM M240B-----	11
PISTOL 9MM AUTOMATIC M9-----	1
RIFLE 5.56MM M16A2-----	71
MACHINE GUN: CALIBER .50 (M2E2)-----	7

VEHICLES AND VEHICLE EQUIPMENT

CARRIER ARMORED COMMAND POST: (M1068)-----	3
MULTIPLE LAUNCH ROCKET SYS: (MLRS) M270A1 IMP LNCHR-----	8
TRUCK UTILITY EXP CAPACITY: ARMT CARRIER M1151A1-----	2
TRUCK UTILITY EXP CAPACITY ENH 4X4: M1165A1-----	5
TRUCK CARGO: TACTICAL 8X8 HEMTT W/MED CRANE (M985)-----	8
TRUCK CARGO: MTV (M1083)-----	1
TRAILER FLAT BED: 11 TON 4 WHL (M989A1) (HEMAT)-----	8
TRAILER HIGH MOBILITY 1-1/4T (M1102)-----	1
TRAILER TANK WATER (CAMEL) 800 GAL 5 TON-----	1

MISCELLANEOUS EQUIPMENT

GEN SET: DED SKID MTD 5 KW 60HZ (MEP-802A)-----	2
GEN SET : DED SKID MTD 3KW 60HZ (MEP-831A)-----	2
SMALL UNMANNED AIRCRAFT SYSTEM: (SUAS) RAVEN B-----	1

COMMUNICATION-ELECTRONICS EQUIPMENT

ANTENNA GROUP: OE-254-----	12
COMPUTER SET: AN/GYK-57 (AFATDS - SINGLE)-----	3
COMPUTER SYSTEM DIGITAL: AN/UYQ-90(V)2 (MTS)-----	8
COMPUTER SET DIGITAL: AN/UYK-128 (FBCB2)-----	18
COMPUTER SET DIGITAL: AN/TYQ-109(V)1 (GCSS-A (V)1)-----	1
COMPUTER SYSTEM DIGITAL: AN/UYQ-90(V)3 (MTS-CS)-----	1
FREQUENCY HOPPING MULTIPLEXER: TF-1456VRC (FHMUX)-----	3
NAVIGATION SET: SATELLITE SIGNALS AN/PSN-13 (DAGR)-----	28
PROCESSOR GROUP SIGNAL DATA: (CAISI 2.0)-----	1
RADIAC SET: AN/VDR-2-----	4
RADIO SET: AN/VRC-90F-----	14
RADIO SET: AN/VRC-92F-----	18
RADIO SET: AN/VRC-104(V)3 150 WATT IK: PRC-150 HF RADIO-----	11

NIGHT VISION/OBSERVATION EQUIPMENT

DRIVER'S VISION ENHANCER AN/VAS-5-----	22
NIGHT VISION GOGGLES: AN/PVS-7B-----	56
MEDIUM THERMAL WEAPONS SIGHT: AN/PAS-13(V2)-----	12
HEAVY THERMAL WEAPONS SIGHT: AN/PAS-13(V3)-----	22

HHC, Brigade Support Bn (Fires Bde)

63346R000

OFF: 15/WO: 2/ENL: 60/TOTAL: 77

COMMAND SECTION PARA 01

AN/VRC-92F
AN/UYQ-90(V)2
FBCB2
AN/TYQ-137A:(V)2
DAGR



LTC 90A00 (COMMANDER) P
SP4 88M10 (VEH DRIVER) R

AN/VRC-92F
FBCB2
DAGR



MAJ 90A00 (EXEC OFF) P

CSM 00Z50 (CSM) P

CURR OPS - INTEL/S2 PARA 02

AN/VRC-92F
DAGR



CPT 35D00 (S2) R
SGT 35F20 (INTEL ANALYST) SAW
SP4 35F10 (INTEL ANALYST) R

CURR OPS - OPS/S3 PARA 03

AN/VRC-92F
AN/VRC-104(V)3
FBCB2
DAGR



CPT 90A00 (S3) P

AN/VRC-90F
AN/GYK-61 (BCS3)
AN/TYQ-137A:(V)2
DAGR



CPT 90A00 (PLANS OFF) R
CPT 92A00 (OPNS OFF) R
MSG 92A50 (OPNS SGT) R
SSG 29E30 (EW SGT) R
SSG 74D30 (CBRN NCO) R
SSG 88N30 (MOEVMENTS SUPV) R
SGT 29E20 (EW SGT) R
SGT 74D20 (CBRN NCO) SAW

AN/VRC-90F
DAGR



X2

SUSTAINMENT 1 - S1 PARA 04

AN/VRC-90F
AN/GYK-61 (BCS3)
DAGR
CAISI 2.0
5 AN/TYQ-116(V)3



CPT 42B00 (S1) C
SFC 42A40 (SR HUMAN RES SGT) R
SSG 42A30 (HUMAN RES SGT) R
SGT 42A20 (HUMAN RES SGT) R
SP4 27D10 (PARALEGAL SP) R
SP4 42A10 (HUMAN RES SP) R
SP4 42A10 (HUMAN RES SP) SAW
2 PFC 42A10 (HUMAN RES SP) R

SUSTAINMENT 1 - S4 PARA 05

AN/VRC-92F
AN/UYQ-90(V)2
DAGR



CPT 90A00 (S4) R

AN/VRC-90F
AN/GYK-61 (BCS3)
2 AN/TYQ-129(V)2
AN/TYQ-109(V)1
AN/TYQ-137A:(V)2
AN/UYQ-90(V)3
AN/TYQ-95
CAISI 2.0



SFC 92Y40 (SR SUPPLY SGT) R
SGT 92Y20 (SUPPLY NCO) R
SP4 92Y10 (SUPPLY SP) R

SUSTAINMENT 1 - C4OPS/S6 PARA 06

AN/VRC-90F
DAGR



CPT 25A00 (S6) R

AN/VRC-90F
AN/PYQ-12
AN/TYQ-137A:(V)2
AN/TSQ-243
DAGR
AN/GYK-50A (ISYSCON) (V)4
AN/TSQ-259
AN/USQ-165



SFC 25U40 (SECTION CHIEF) R
SP4 25B10 (LAN MGR) R
SP4 25U10 (SGNL INFO SVC SP) R
SP4 25U10 (SGNL SPT SYS MAINT) R
PFC 25B10 (LAN MGR) R
PFC 25U10 (SGNL SPT SYS SP) SAW

AN/VRC-92F
KG-175
DAGR



BCP (SWITCHING GP): OM-87A/T

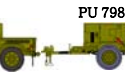

SGT 25Q20 (SR XMSN SYS OPR-MAINT) R
SP4 25Q10 (XMSN SYS OPR-MAINT) R

AN/VRC-90F
DAGR



UNIT MINISTRY TEAM PARA 07

AN/VRC-90F
AN/UYQ-90(V)2



CPT 56A00 (CHAPLAIN)
SP4 56M10 (CHAP ASST) R

SUSTAINMENT 2 - SUPPORT OPERATIONS PARA 08

AN/VRC-90F
FBCB2
AN/UYQ-90(V)3
DAGR



MAJ 90A00 (SPT OPNS OFF) P

AN/VRC-92F
AN/VRC-104(V)3
AN/GYK-61 (BCS3)
2 AN/TYQ-129(V)2
DAGR
CAISI 2.0
OL-713(V)1/TYQ CSS VSAT
AN/TYQ-141



CPT 92A00 (OPNS OFF) R
CW4 915E0 (SR ORD GROUND MAINT WO) R
MSG 92A50 (OPNS SGT) R
SFC 91X40 (MAINT MGMT NCO) R
SFC 92A40 (MAT MGMT NCO) R
SSG 92F30 (PETRL SUPPLY SGT) R
SGT 92M20 (MORTUARY AFFAIRS SGT) SAW

AN/VRC-90F
DAGR



CPT 88A00 (TRANS OFF) R
SFC 88N40 (CHIEF MVMT SUPV) R

AN/VRC-92F
AN/UYQ-90(V)2
FBCB2
OL-608/TYQ
DAGR



CPT 91A00 (AMMO OFF) R
SFC 89B40 (AMMO LOG SGT) R
SSG 89B30 (AMMO INSPECTOR) R

AN/VRC-90F
DAGR



X2

HHC, Brigade Support Bn (Fires Bde) (cont)

SUSTAINMENT 2 - CSSAMO PARA 09

AN/VRC-90F
DAGR

AN/VRC-90F
AN/TYQ-107(V)2
AN/TYQ-107(V)1
AN/UYQ-90(V)2
AN/TYQ-106(V)1
AN/TYQ-129(V)2
AN/TYQ-105(V)1
AN/TYQ-109(V)2

OL-608/TYQ
OL-603/TYQ
AN/UYQ-90(V)3
CAISI 2.0
OL-713(V)1/TYQ CSS VSAT
AN/TYQ-141
AN/TYQ-139



CW2 251A0 (INFO SYS TECH) R
PFC 25B10 (INFO SYS SP) SAW



SFC 25B40 (INFO SYS SUPV) R
SSG 92A30 (MAT MGMT NCO) R
SSG 92Y30 (SUPPLY SGT) R
SGT 25B20 (SR INFO SYS SP) R
SGT 92A20 (MAT MGMT NCO) R
SGT 92Y20 (SUPPLY NCO) R
SP4 25B10 (INFO SYS SP) R

COMPANY HQ PARA 10

AN/VRC-92F
AN/UYQ-90(V)2
FBCB2
DAGR

AN/VRC-90F
AN/TYQ-109(V)1
DAGR
CAISI 2.0



CPT 90A00 (COMMANDER) P



1SG 92A5M (FIRST SERGEANT) R
SGT 92Y20 (SUPPLY NCO) R
SP4 92Y10 (SUPPLY SP) R



SP4 74D10 (CBRN DECON SP) R

FIELD FEEDING SECTION PARA 11

AN/VRC-90F
DAGR

AN/VRC-90F
DAGR



SFC 92G40 (SR FOOD OPS SGT) R
SSG 92G30 (FOOD OPNS MGR) R
2 SGT 92G20 (FOOD OPNS NCO) R
3 SP4 92G10 (FOOD OPNS SP) R
2 PFC 92G10 (FOOD OPNS SP) R
PFC 92G10 (FOOD OPNS SP) SAW

Summary of Equipment

WEAPONS

LAUNCHER GRENADE: M320-----	4
MACHINE GUN 5.56MM M249-----	7
MACHINE GUN LIGHT 5.56MM M249-----	4
MACHINE GUN GRENADE 40MM MK-19 MOD III-----	1
MACHINE GUN 7.62MM M240B-----	3
PISTOL 9MM AUTOMATIC M9-----	6
RIFLE 5.56MM M16A2-----	63
MACHINE GUN: CALIBER .50 (M2E2)-----	3

VEHICLES, TRAILERS, AND TRLR MTD SYSTEMS

CONTAINERIZED KITCHEN (CK)-----	1
GEN SET DIESEL ENGINE TM: 30KW 50/60 HZ (PU-803)-----	1
GEN SET DED TM: 10KW 60HZ (PU-798)-----	1
GEN SET DED TM: 5KW 60HZ (PU-797)-----	1
POWER PLANT: UTILITY, MEDIUM 20KW 5 TON ECU-----	3
TRUCK UTILITY EXP CAPACITY ENH 4X4: M1152A1-----	11
TRUCK VAN EXPANSIBLE MTV (M1087A1)-----	1
TRUCK UTILITY EXP CAPACITY ENH 4X4: M1165A1-----	8
TRUCK CARGO: MTV (M1083)-----	5
TRUCK CARGO: 4X4 LMTV (M1078)-----	3
TRAILER HIGH MOBILITY 1-1/4T (M1102)-----	3
LIGHT TACTICAL TRAILER: 3/4T (M1101)-----	2
TRAILER CARGO: LMTV W/DROPSIDES (M1082)-----	3
TRAILER TANK WATER (CAMEL) 800 GAL 5 TON-----	2

MISCELLANEOUS EQUIPMENT

BED CARGO: DEMOUNTABLE PLS 8X20-----	1
DECON APPARATUS LT WEIGHT-----	2
GEN SET : DED SKID MTD 3KW 60HZ (MEP-831A)-----	2
GEN SET: DED SKID MTD 10KW 60HZ (MEP-803A)-----	1
SHELTER: NONEXPANDABLE S250-----	1
MULTI-TEMP REFRIGERATED CONTAINER SYS: MTRCS-----	1

NIGHT VISION/OBSERVATION EQUIPMENT

NIGHT VISION GOGGLES: AN/PVS-7B-----	56
MEDIUM THERMAL WEAPONS SIGHT: AN/PAS-13(V2)-----	7
HEAVY WEAPON THERMAL SIGHT (HWTS): AN/PAS-13(V3)-----	4

COMMUNICATION-ELECTRONICS EQUIPMENT

ANTENNA GROUP: OE-254-----	10
COMPUTER SYSTEM DIGITAL: AN/TYQ-107(V)2 (MC4-3B)-----	1
COMPUTER SYSTEM DIGITAL: AN/TYQ-107(V)1 (MC4-3A)-----	1
COMPUTER SYSTEM DIGITAL: AN/UYQ-90(V)2 (MTS)-----	6
COMPUTER SYSTEM DIGITAL: AN/TYQ-106(V)1 (MC4-2)-----	1
COMPUTER SET DIGITAL: AN/UYK-128 (FBCB2)-----	6
BTL CMD SUSTAINMENT SPT SYSTEM: AN/GYK-61 (BCS3)-----	4
COMPUTER SET DIGITAL: AN/PYQ-12 (MCS GATEWAY SVR)-----	1
COMPUTER SYS DIGITAL: AN/TYQ-129(V)2 (TC-AIMS II WS)-----	5
COMPUTER SYSTEM DIGITAL: AN/TYQ-105(V)1 (MC4-1)-----	1
COMPUTER SET DIGITAL: AN/TYQ-109(V)1 (GCSS-A (V)1)-----	2
COMPUTER SET DIGITAL: AN/TYQ-109(V)2 (GCSS-A (V)2)-----	1
COMPUTER SET DIGITAL: OL-608/TYQ (SAAS-MOD DAO)-----	2
COMPUTER SYSTEM DIGITAL: ((CPOF WS) AN/TYQ-137A:(V)2)-----	4
COMMAND SYSTEM: TACTICAL AN/TSQ-243-----	1
COMPUTER SET DIGITAL: OL-603/TYQ (SARSS DSU SVR)-----	1
COMPUTER SYSTEM DIGITAL: AN/UYQ-90(V)3 (MTS-CS)-----	3
ENCRYPT/DECRYPT EQUIPMENT: TACLANE KG-175-----	1
INTERROGATOR SET AN/TYQ-95 (TC-AIMS II INTERROGATOR)-----	1
NAVIGATION SET: SATELLITE SIGNALS AN/PSN-13 (DAGR)-----	24
PROCESSOR GROUP SIGNAL DATA: (CAISI 2.0)-----	5
RADIAC SET: AN/VDR-2-----	3
RADIO SET: AN/VRC-90F-----	19
RADIO SET: AN/VRC-92F-----	8
COMPUTER SYSTEM DIGITAL: AN/GYK-50A (ISYSCON) (V4)-----	1
INTERFACE UNIT COMM EQ: OL-713(V)1/TYQ CSS VSAT-----	2
BATTALION COMMAND POST (SWITCHING GROUP): OM-87A/T-----	1
COMMUNICATIONS SUBSYSTEM: AN/TSQ-259-----	1
COMPUTER SYSTEM DIGITAL: AN/TYQ-141 (SAMS-2E V2)-----	2
COMPUTER SYSTEM: DIGITAL AN/TYQ-139 (SAMS-1E V1)-----	1
COMP SYS DIGITAL: (AHRS) AN/TYQ-116(V)3-----	5
COMMUNICATIONS SUBSYSTEM: AN/USQ-165-----	1

HHC, Brigade Support Battalion (Fires Bde)

Distribution Company, BSB (Fires Bde)

63348R000
OFF: 4/WO: 2/ENL: 88/TOTAL: 94

COMPANY HEADQUARTERS PARA 01

AN/VRC-92F
AN/UYQ-90(V)2
FBCB2
DAGR



CPT 90A00 (COMMANDER) P

AN/VRC-90F
AN/TYQ-109(V)1
AN/UYQ-90(V)3
CAISI 2.0



LT 92A00 (OPNS OFF) R
1SG 92A5M (FIRST SGT) R
SSG 92Y30 (SUPPLY SGT) R
SGT 74D20 (CBRN NCO) SAW
SP4 92Y10 (SUPPLY SP) R

SUPPLY PLATOON HQ PARA 02

AN/VRC-90F
AN/UYQ-90(V)2
FBCB2
OL-603/TYQ
AN/UYQ-90(V)3
DAGR
CAISI 2.0



LT 92A00 (PLT LDR) R
CW2 920B0 (SUPPLY SYS TECH) R
SFC 92A40 (PLT SGT) R
SGT 92A20 (MAT CON/ACCTG NCO) R
2 SP4 92A10 (MAT CON/ACCTG SP) R
PFC 92A10 (MAT CON/ACCTG SP) R
PFC 92A10 (MAT CON/ACCTG SP) SAW

PU 798

S-785G SHELTER

TRUCK SQUAD PARA 03

AN/VRC-90F
AN/UYQ-90(V)2
DAGR



X2

AN/VRC-90F
AN/UYQ-90(V)2



X3

SSG 88M30 (SQUAD LDR) R
3 SGT 88M20 (HVY VEH DRIVER) R
4 SP4 88M10 (VEH DRIVER) SAW
2 PFC 88M10 (VEH DRIVER) R

GENERAL SUPPLY & CLASS IX SECTION PARA 04

AN/VRC-90F
FBCB2
OL-604/TYQ



SFC 92A40 (STOCK CONTROL SUPV) R
2 SSG 92A30 (MAT MGMT SUPV) R
SGT 92A20 (MAT CONT/ACCTG NCO) R

AN/VRC-90F
AN/UYQ-90(V)2
OL-604/TYQ



X3

AN/VRC-90F
AN/UYQ-90(V)2



X5

6 SGT 92A20 (MAT STORE/HDLG SGT) R
SP4 92A10 (MAT CONT/ACCTG SP) R
6 SP4 92A10 (MAT STORE/HDLG SP) R
SP4 92A10 (MAT STORE/HDLG SP) SAW
SP4 92A10 (SUBSISTANCE SUPPLY SP) R
9 PFC 92A10 (MAT STORE/HDLG SP) R



X5

AMMO TRANSFER HOLDING POINT SECTION PARA 05

AN/VRC-90F
AN/UYQ-90(V)2
FBCB2
AN/UYQ-90(V)3
2 DAGR
CAISI 2.0
SAAS-MOD-ATHP



CW2 890A0 (AMMO WO) R
SSG 89B30 (SECTION CHIEF) R

AN/VRC-90F
AN/UYQ-90(V)2



X3

AN/VRC-90F
AN/UYQ-90(V)2



X2

SGT 89A20 (AMMO STK CON/ACCTG SGT) R
SGT 89B20 (AMMO SGT) R
SP4 89A10 (AMMO STK CON/ACCTG SP) R
2 SP4 89B10 (AMMO SP) R
SP4 89B10 (AMMO SP) SAW
3 PFC 89B10 (AMMO SP) R



X2

S-785G SHELTER

FUEL & WATER PLATOON HQ PARA 06

AN/VRC-90F
AN/UYQ-90(V)2
FBCB2
AN/UYQ-90(V)3



LT 92A00 (PLT LDR) R
SFC 92W40 (PLT SGT) R
SGT 92L20 (PETRL LAB SGT) R

CLASS III STORAGE/ISSUE SECTION PARA 07

AN/VRC-90F
AN/UYQ-90(V)2

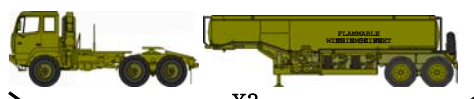

X3

SSG 92F30 (SECTION CHIEF) R
3 SGT 92F20 (PETRL HVY VEH OPR) R
6 SP4 92F10 (PETRL HVY VEH OPR) R

FIRES-18

CLASS III DISTRIBUTION SECTION PARA 08

AN/VRC-90F
DAGR



SSG 92F30 (SECTION CHIEF) R

AN/VRC-90F
AN/UYQ-90(V)2



X3

2 SGT 92F20 (PETRL HVY VEH OPR) R
3 SP4 92F10 (PETRL HVY VEH OPR) R
SP4 92F10 (PETRL HVY VEH OPR) SAW

Distribution Company, BSB, Fires Bde (cont)

WATER SECTION PARA 09

AN/VRC-90F
AN/UYQ-90(V)2

AN/VRC-90F
AN/UYQ-90(V)2

AN/VRC-90F
AN/UYQ-90(V)2

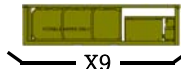
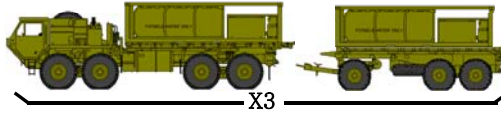

SSG 92W30 (WATER TRMT SUPV) R
3 SGT 92W20 (WATER TRMT NCO) R
4 SP4 92W10 (WATER TRMT SP) R
3 PFC 92W10 (WATER TRMT SP) R

Summary of Equipment

WEAPONS

LAUNCHER GRENADE 40MM M320	4
MACHINE GUN 5.56MM M249	9
MACHINE GUN LIGHT 5.56MM M249	4
MACHINE GUN GRENADE 40MM MK-19 MOD III	2
MACHINE GUN 7.62MM M240B	6
PISTOL 9MM AUTOMATIC M9	1
RIFLE 5.56MM M16A2	84
MACHINE GUN: CALIBER .50 (M2E2)	5

VEHICLES, TRAILERS, AND TRLR MTD SYSTEMS

GEN SET DED TM: 10KW 60HZ (PU-798)	1
GEN SET DED TM: 5KW 60HZ (PU-797)	1
SEMITRAILER LOW BED: 25T 4 WHL (M172A1)	7
SEMITRAILER TANK: 5000 GAL FUEL DISPENSING (M969A1)	3
TRUCK CARGO: MTV (M1083)	1
TRUCK UTILITY EXP CAPACITY ENH 4X4: M1152A1	3
TRUCK UTILITY EXP CAPACITY ENH 4X4: M1165A1	3
TRUCK TANK: FUEL SERVICING 2500 GAL 8X8 HEMTT (M978)	3
TRUCK CARGO: 4X4 LMTV (M1078)	5
TRUCK TRACTOR MTV (M1088)	10
TRUCK LIFT: FORK VARIABLE REACH RT (ATLAS)	7
TRAILER: PLS 8X20 (M1076)	13
TRAILER HIGH MOBILITY 1-1/4T (M1102)	1
LIGHT TACTICAL TRAILER: 3/4T (M1101)	4
TRUCK CARGO HEMTT LHS (M1120)	11
TRAILER CARGO: LMTV W/DROPSIDES (M1082)	5
TRAILER TANK WATER (CAMEL) 800 GAL 5 TON	1

NIGHT VISION/OBSERVATION EQUIPMENT

DRIVERS VISION ENHANCER: AN/VAS-5	28
NIGHT VISION GOGGLES: AN/PVS-7B	78
MEDIUM THERMAL WEAPONS SIGHT: AN/PAS-13(V2)	10
HEAVY WEAPON THERMAL SIGHT (HWTS): AN/PAS-13(V)3	7

COMMUNICATION-ELECTRONICS EQUIPMENT

ANTENNA GROUP: OE-254	1
COMPUTER SYSTEM DIGITAL: AN/UYQ-90(V)2 (MTS)	33
COMPUTER SET DIGITAL: AN/UYK-128 (FBCB2)	6
COMPUTER SET DIGITAL: OL-604/TYQ (SARSS DSU WS)	5
COMPUTER SYS DIGITAL: AN/TYQ-129(V)2 (TC-AIMS II WS)	2
COMPUTER SET DIGITAL: AN/TYQ-109(V)1 (GCSS-A (V)1)	1
COMPUTER SET DIGITAL: OL-603/TYQ (SARSS DSU SVR)	1
COMPUTER SYSTEM DIGITAL: AN/UYQ-90(V)3 (MTS-CS)	4
NAVIGATION SET: SATELLITE SIGNALS AN/PSN-13 (DAGR)	7
PROCESSOR GROUP SIGNAL DATA: (CAISI 2.0)	3
RADIAC SET: AN/VDR-2	6
RADIO SET: AN/VRC-90F	35
RADIO SET: AN/VRC-92F	1
COMPUTER SYSTEM DIGITAL: SAAS-MOD-ATHP	2

MISCELLANEOUS EQUIPMENT

BED CARGO: DEMOUNTABLE PLS 8X20	66
CONTAINER HANDLING: HVY EXP MOBIL TACT TRK (HEMTT)	2
GEN SET: DED SKID MTD 60KW 50/60HZ (MEP 806A)	1
GEN SET: DED SKID MTD 3KW 60HZ (MEP-831A)	5
FUEL SYSTEM SUPPLY POINT: FSSP TYPE 3 120K	1
SHELTER: TACTICAL EXPANDABLE TWOSIDE S785G	2
TACTICAL WATER PURIFICATION SYS (TWPS): 1500 GPH	1
LOAD HDLG SYS (LHS): 2000 GAL COMP WTR TK RACK (HIPPO)	15
WATER PURIFIER LIGHTWEIGHT	1
MODULAR FUEL SYSTEM - TANKRACK MODULE	3

Field Maintenance Company, BSB (Fires Bde)

43347R000
OFF: 4/WO: 6/ENL: 68/TOTAL: 78

COMPANY HQ PARA 01

AN/VRC-90F
FBCB2
DAGR



CPT 91B00 (COMMANDER) P
SP4 92Y10 (SUPPLY SP) R

AN/VRC-92F
FBCB2
AN/TYQ-109(V)1
DAGR



LT 91A00 (EXEC OFF) R
1SG 91Z5M (FIRST SERGEANT) R

AN/VRC-90F
FBCB2
DAGR



SGT 74D20 (CBRN NCO) R
SGT 92Y20 (SUPPLY NCO) R
SP4 74D10 (CBRN DECON SP) SAW

MAINT CONTROL SECTION/PLATOON HQ PARA 02

AN/VRC-89F
FBCB2
DAGR



LT 91B00 (MAINT CONT OFF) R

AN/VRC-90F
FBCB2
DAGR
CAISI 2.0
AN/TYQ-139
AN/TYQ-140



SFC 91X40 (MAINT CONT SGT) R

AN/VRC-90F
FBCB2
DAGR
2 AN/TYQ-139



SGT 92A20 (EQ RCD/PARTS SGT) R
SP4 92A10 (EQ RCD/PARTS SP) R
PFC 92A10 (EQ RCD/PARTS SP) R
PFC 92A10 (EQ RCD/PARTS SP) SAW

AN/VRC-90F
FBCB2
DAGR
2 AN/TYQ-139



SERVICE/RECOVERY SECTION PARA 03

AN/VRC-92F
FBCB2
DAGR



CW2 914A0 (ALLIED TRADES WO) R

AN/VRC-90F
FBCB2
DAGR



X2
SSG 91B30 (RCVY VEH SUPV) R
SP4 91B10 (RCVY VEH OPR) R
PFC 91B10 (RCVY VEH OPR) R

AN/VRC-90F
FBCB2
DAGR



SGT 91B20 (RCVY VEH OPR) R

AN/VRC-90F
FBCB2
DAGR



SGT 91E20 (ALLIED TRADES SP) R
SP4 91E10 (ALLIED TRADES SP) R
PFC 91E10 (ALLIED TRADES SP) R

WHEEL VEHICLE REPAIR SECTION PARA 04

AN/VRC-90F
FBCB2
DAGR



X2

AN/VRC-90F
FBCB2
DAGR



X2

CW2 915E0 (AUTO MAINT WO) R
SFC 91X40 (MOTOR SGT) R
SSG 91B30 (SHOP FOREMAN) R
SSG 91B30 (SR MECHANIC) R

AN/VRC-90F
FBCB2
DAGR



X2

6 SGT 91B20 (WH VEH MECH) R
SGT 91B20 (WH VEH MECH) SAW
5 SP4 91B10 (WH VEH MECH) R
2 SP4 91B10 (WH VEH MECH) SAW
6 PFC 91B10 (WH VEH MECH) R
PFC 91B10 (WH VEH MECH) SAW

AN/VRC-90F
FBCB2
DAGR



AN/VRC-90F
FBCB2
DAGR



Field Maintenance Company, BSB, Fires Bde (cont)

MAINTENANCE PLATOON HQ PARA 05 GROUND SUPPORT EQUIPMENT REPAIR SECTION PARA 06

AN/VRC-89F
FBCB2
DAGR



LT 91A00 (PLT LDR) R
SFC 91X40 (PLT SGT) R

AN/VRC-90F
FBCB2
DAGR



CW3 919A0 (ENGR EQUIP MAINT WO) R
SFC 91X40 (SP PURP EQ REP SUPV) R
SSG 91D30 (R PWR-GEN EQ REP) R
SGT 91C20 (UTIL EQ REP) R
SGT 91D20 (PWR-GEN EQ REP) R
SGT 91J20 (QM/CHEM EQ REP) R

AN/VRC-90F
FBCB2



SP4 91D10 (PWR-GEN EQ REP) SAW
SP4 91J10 (QM/CHEM EQ REP) R
PFC 91C10 (UTIL EQ REP) R
2 PFC 91D10 (PWR-GEN EQ REP) R
2 PFC 91J10 (QM/CHEM EQ REP) R

C&E SECTION PARA 07

AN/VRC-90F
FBCB2
DAGR



CW2 948B0 (EL SYS MAINT WO) R
CW2 948D0 (EL-MSL MAINT WO) R
SFC 94W41 (ELECT MAINT SUPV) R
SSG 94M30 (RADAR REP SUPV) R
SGT 91D20 (PWR-GEN EQ REP) R
SGT 91M20 (RADAR REP) SAW

AN/VRC-90F
FBCB2
DAGR



SP4 94E10 (COMSEC/RADIO EQ REP) R
SP4 94F10 (COMP/DET SYS REP) R
2 SP4 94M10 (RADAR REP) R
PFC 91D10 (PWR-GEN EQ REP) R
PFC 91M10 (RADAR REP) R

AN/VRC-90F
FBCB2
DAGR



ARMAMENT REPAIR SECTION PARA 08

AN/VRC-90F
FBCB2
DAGR



CW2 913A0 (ARMT SYS MAINT WO) R
SSG 45K30 (ARMT MAINT SUPV) R
SGT 91G20 (FIRE CONTROL REP) R
SP4 91F10 (SM ARMS/ARTY REP) R
PFC 91F10 (SM ARMS/ARTY REP) R

AN/VRC-90F
FBCB2
DAGR



AN/VRC-90F



Summary of Equipment

WEAPONS

LAUNCHER GRENADE: M320-----	4
MACHINE GUN 5.56MM M249-----	8
MACHINE GUN LIGHT 5.56MM M249-----	4
MACHINE GUN GRENADE 40MM MK-19 MOD III-----	1
MACHINE GUN 7.62MM M240B-----	4
PISTOL 9MM AUTOMATIC M9-----	1
RIFLE 5.56MM M16A2-----	69
MACHINE GUN: CALIBER .50 (M2E2)-----	6

VEHICLES, TRAILERS, AND TRLR MTD SYSTEMS

FORWARD REPAIR SYSTEM: (FRS)-----	2
GEN SET DED TM: 10KW 60HZ (PU-798)-----	1
GEN SET DIESEL ENGINE TM: 15KW 50/60HZ (PU-802)-----	1
TOOL SET STANDARD AUTOMOTIVE (TRAILER MTD)-----	3
SEMITRAILER VAN: SUPPLY 12T 4 WHL (M129A2C)-----	1
TRUCK UTILITY EXP CAPACITY ENH 4X4: M1152A1-----	9
TRUCK VAN EXPANSIBLE MTV (M1087A1)-----	1
TRUCK UTILITY EXP CAPACITY ENH 4X4: M1165A1-----	3
TRUCK VAN LMTV (M1079)-----	3
TRUCK CARGO: MTV (M1083)-----	7
TRUCK CARGO: 4X4 LMTV (M1078)-----	1
TRUCK TRACTOR MTV (M1088)-----	1
TRUCK WRECKER: TACTICAL 8X8 HEMTT (M984A1)-----	2
TRUCK WRECKER: MTV (M1089)-----	3
TRAILER CARGO: MTV W/ DROPSIDES (M1095)-----	1
LIGHT TACTICAL TRAILER: 3/4T (M1101)-----	8
SHOP EQUIPMENT: WELDING TRAILER MTD-----	1
TRAILER TANK WATER (CAMEL) 800 GAL 5 TON-----	1

COMMUNICATION-ELECTRONICS EQUIPMENT

ANTENNA GROUP: OE-254-----	3
COMPUTER SET DIGITAL: AN/UYK-128 (FBCB2)-----	32
COMPUTER SET DIGITAL: AN/TYQ-109(V)1 (GCSS-A (V)1)-----	1
NAVIGATION SET: SATELLITE SIGNALS AN/PSN-13 (DAGR)-----	32
PROCESSOR GROUP SIGNAL DATA: (CAISI 2.0)-----	1
RADIAC SET: AN/VDR-2-----	2
RADIO SET: AN/VRC-89F-----	2
RADIO SET: AN/VRC-90F-----	23
RADIO SET: AN/VRC-92F-----	2
COMPUTER SYSTEM: DIGITAL AN/TYQ-139 (SAMS-1E V1)-----	5
COMPUTER SYSTEM: DIGITAL AN/TYQ-140 (SAMS/SAMS-1E V2)-----	1

NIGHT VISION/OBSERVATION EQUIPMENT

NIGHT VISION GOGGLES: AN/PVS-7B-----	66
MEDIUM THERMAL WEAPONS SIGHT: AN/PAS-13(V)2-----	8
HEAVY WEAPON THERMAL SIGHT (HWTS): AN/PAS-13(V)3-----	13

MISCELLANEOUS EQUIPMENT

DECON APPARATUS LT WT-----	2
GEN SET : DED SKID MTD 3KW 60HZ (MEP-831A)-----	8
GEN SET: DED SKID MTD 10KW 60HZ (MEP-803A)-----	1
ELECTRONICS SHOP SHEL MTD AVIONICS: AN/ASM-146-----	3
ELECTRONICS SHOP SHEL MTD AVIONICS: AN/ASM-147-----	1
SHOP EQUIP: CONTACT MAINT ORD/ENGR TRK MTD-----	3

Forward Support Company, MLRS (2X8), (Fires Bde)

63347R000
OFF: 5/WO: 1/ENL: 131/TOTAL: 137

COMPANY HQ PARA 01

AN/VRC-92F
AN/UYQ-90(V)2
FBCB2
AN/GYK-61 (BCS3)
DAGR



CPT 90A00 (COMMANDER) P

AN/VRC-90F
FBCB2
AN/TYQ-109(V)1
AN/UYQ-90(V)3
DAGR
CAISI 2.0



LT 88A00 (EXEC OFF) R
1SG 91Z5M (FIRST SGT) R
SSG 92Y30 (SUPPLY SGT) R
SP4 74D10 (CBRN SP) R
SP4 92Y10 (SUPPLY SP) R

FIELD FEEDING SECTION PARA 02

AN/VRC-90F
DAGR



X2

SFC 92G40 (SR FOOD OPNS SGT) R
SSG 92G30 (FOOD OPNS MGR) R
2 SGT 92G20 (FOOD OPNS NCO) R

AN/VRC-90F
DAGR



X2

3 SP4 92G10 (FOOD OPNS SP) R
2 PFC 92G10 (FOOD OPNS SP) R
PFC 92G10 (FOOD OPNS SP) SAW



MTRCS

DISTRIBUTION PLATOON HQ PARA 03

AN/VRC-92F
AN/UYQ-90(V)2
FBCB2
AN/TYQ-129(V)2
AN/UYQ-90(V)3
DAGR



LT 92A00 (PLT LDR) R
SFC 88M40 (PLT SGT) R
SP4 92A10 (MAT CON/ACCTG SP) R

BATTALION SUPPORT SQUAD PARA 04

AN/VRC-90F
AN/UYQ-90(V)2



SSG 88M30 (SECTION SGT) R
SP4 92W10 (WATER TRMT SP) R

AN/VRC-90F
AN/UYQ-90(V)2



SGT 88M20 (HVY VEH DRIVER) R
SP4 88M10 (HVY VEH DRIVER) R

AN/VRC-90F
AN/UYQ-90(V)2



SGT 92F20 (PETRL HVY VEH OPR) R
SP4 92F10 (PETRL HVY VEH OPR) SAW

BATTERY SUPPORT SQUAD PARA 05

AN/VRC-90F
AN/UYQ-90(V)2



X8

SSG 88M30 (SQUAD LDR) R
2 SSG 88M30 (HVY VEH DRIVER) R
6 SGT 88M20 (HVY VEH DRIVER) R

AN/VRC-90F
AN/UYQ-90(V)2



X2

SGT 89B20 (AMMO SGT) SAW
8 SP4 88M10 (HVY VEH DRIVER) R
2 PFC 88M10 (HVY VEH DRIVER) R
2 PFC 88M10 (HVY VEH DRIVER) SAW

AN/VRC-90F
AN/UYQ-90(V)2



X2

SGT 92F20 (PETRL HVY VEH OPR) R
SP4 92F10 (PETRL HVY VEH OPR) R

X2

MAINT PLATOON HQ PARA 06

AN/VRC-92F
AN/UYQ-90(V)2
FBCB2
DAGR



LT 91A00 (PLT LDR) R
SFC 91X40 (PLT SGT) R

MAINTENANCE CONTROL SECTION PARA 07

AN/VRC-90F
DAGR



LT 91A00 (MAINT CONT OFF) R

AN/VRC-90F
DAGR



CW2 915E0 (AUTO MAINT WO) R
SFC 91X40 (MAINT CONT SGT) R

AN/VRC-90F
DAGR
OL-713(V)1/TYQ CSS VSAT
2 AN/TYQ-139
AN/THQ-140



PU 2101

AN/VRC-90F
DAGR
2 AN/TYQ-139



SGT 92A20 (EQ RCD/PARTS SGT) SAW
2 SP4 92A10 (EQ RCD/PARTS SP) R
2 PFC 92A10 (EQ RCD/PARTS SP) R

Forward Support Company, MLRS (2X8) (Fires Bde) (cont)

MAINTENANCE SECTION PARA 08

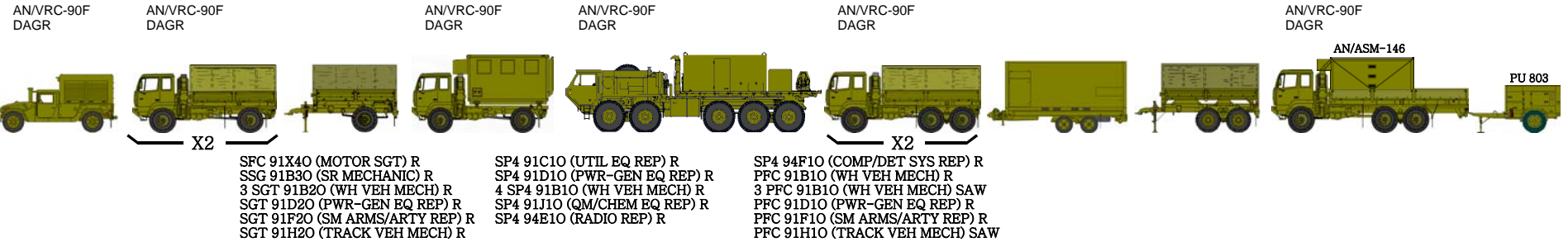

SERVICE/RECOVERY SECTION PARA 09



MAINTENANCE SUPPORT TEAM PARA 10

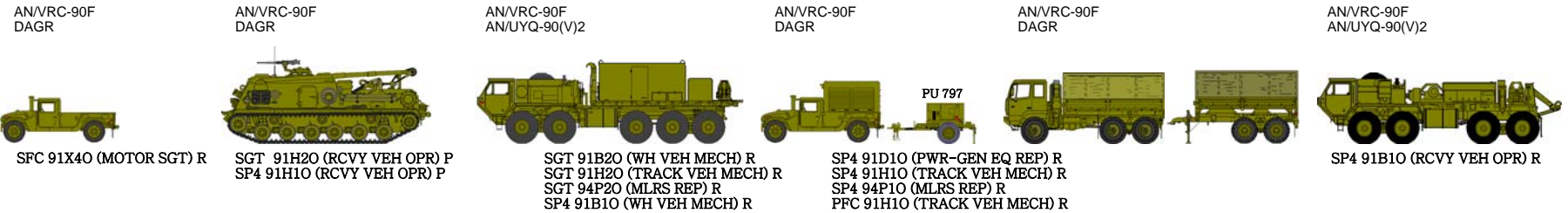

X2

Summary of Equipment

WEAPONS

LAUNCHER GRENADE: M320-----	4
MACHINE GUN 5.56MM M249-----	13
MACHINE GUN LIGHT 5.56MM M249-----	4
MACHINE GUN GRENADE 40MM MK-19 MOD III-----	3
MACHINE GUN 7.62MM M240B-----	10
PISTOL 9MM AUTOMATIC M9-----	7
RIFLE 5.56MM M16A2-----	117
RIFLE 5.56MM M4 CARBINE-----	6
MACHINE GUN: CALIBER .50 (M2E2)-----	17

VEHICLES, TRAILERS, AND TRLR MTD SYSTEMS

CONTAINERIZED KITCHEN (CK)-----	1
FORWARD REPAIR SYSTEM: (FRS)-----	4
GEN SET DIESEL ENGINE TM: 30KW 50/60 HZ (PU-803)-----	1
GEN SET DED TM: 5KW 60HZ (PU-797)-----	2
RECOVERY VEHICLE FT: MEDIUM (M88A1)-----	3
TOOL SET STANDARD AUTOMOTIVE (TRAILER MTD)-----	1
SEMITRAILER VAN: SUPPLY 12T 4 WHL (M129A2C)-----	1
TRUCK UTILITY EXP CAPACITY ENH 4X4: M1152A1-----	8
TRUCK CARGO: TACTICAL 8X8 HEMTT W/MED CRANE (M985)-----	16
TRUCK VAN EXPANSIBLE MTV (M1087A1)-----	1
TRUCK CARGO: Hvy PLS TRANSPORTER 10X10 (M1075)-----	3
TRAILER FLAT BED: 11 TON 4 WHL (M989A1) (HEMAT)-----	16
TRUCK UTILITY EXP CAPACITY ENH 4X4: M1165A1-----	4
TRUCK VAN LMTV (M1079)-----	1
TRUCK CARGO: MTV (M1083)-----	11
TRUCK TANK: FUEL SERVICING 2500 GAL 8X8 HEMTT (M978)-----	5
TRUCK CARGO: 4X4 LMTV (M1078)-----	3
TRUCK TRACTOR MTV (M1088)-----	1
TRUCK CARGO MTV LWB (M1085)-----	1
TRUCK WRECKER: TACTICAL 8X8 HEMTT (M984A1)-----	3
TRAILER: PLS 8X20 (M1076)-----	6
TRAILER CARGO: MTV W/ DROPSIDES (M1095)-----	7
LIGHT TACTICAL TRAILER: 3/4T (M1101)-----	3
TRUCK CARGO HEMTT LHS (M1120)-----	2
TRAILER CARGO: LMTV W/DROPSIDES (M1082)-----	1
SHOP EQUIPMENT: WELDING TRAILER MTD-----	1
TRAILER-MTD : PU-2101/ 15KW 50/60HZ/ M200A1-----	1
TRAILER TANK WATER (CAMEL) 800 GAL 5 TON-----	2

COMMUNICATION-ELECTRONICS EQUIPMENT

ANTENNA GROUP: OE-254-----	6
COMPUTER SYSTEM DIGITAL: AN/UYQ-90(V)2 (MTS)-----	36
COMPUTER SET DIGITAL: AN/UYK-128 (FBCB2)-----	4
BTL CMD SUSTAINMENT SPT SYSTEM: AN/GYK-61 (BCS3)-----	1
COMPUTER SYS DIGITAL: AN/TYQ-129(V)2 (TC-AIMS II WS)-----	1
COMPUTER SET DIGITAL: AN/TYQ-109(V)1 (GCSS-A (V)1)-----	1
COMPUTER SYSTEM DIGITAL: AN/UYQ-90(V)3 (MTS-CS)-----	3
NAVIGATION SET: SATELLITE SIGNALS AN/PSN-13 (DAGR)-----	29
PROCESSOR GROUP SIGNAL DATA: (CAISI 2.0)-----	2
RADIAC SET: AN/VDR-2-----	4
RADIO SET: AN/VRC-90F-----	59
RADIO SET: AN/VRC-92F-----	3
INTERFACE UNIT COMM EQ: OL-713(V)1/TYQ CSS VSAT-----	1
COMPUTER SYSTEM: DIGITAL AN/TYQ-139 (SAMS-1E V1)-----	4
COMPUTER SYSTEM: DIGITAL AN/TYQ-140 (SAMS/SAMS-1E V2)-----	1

NIGHT VISION/OBSERVATION EQUIPMENT

DRIVERS VISION ENHANCER: AN/VAS-5-----	60
NIGHT VISION GOGGLES: AN/PVS-7B-----	124
MEDIUM THERMAL WEAPONS SIGHT: AN/PAS-13(V2)-----	14
HEAVY THERMAL WEAPONS SIGHT: AN/PAS-13(V3)-----	20

MISCELLANEOUS EQUIPMENT

ASSAULT KITCHEN (AK)-----	2
BED CARGO: DEMOUNTABLE PLS 8X20-----	4
GEN SET : DED SKID MTD 3KW 60HZ (MEP-831A)-----	3
GEN SET: DED SKID MTD 10KW 60HZ (MEP-803A)-----	2
ELECTRONICS SHOP SHEL MTD AVIONICS: AN/ASM-146-----	1
SHOP EQUIP: CONTACT MAINT ORD/ENGR TRK MTD-----	3
LOAD HANDLING SYS: 2000GAL CAP WATER TANK (HIPPO)-----	2
MULTI-TEMP REFRIGERATED CONTAINER SYS: MTRCS-----	1
MODULAR FUEL SYSTEM - TANKRACK MODULE:-----	4

Forward Support Company, MLRS (2x8), (Fires Bde)

Brigade Signal Company (FIB/BFSB)

11307R500
OFF: 4/WO: 0/ENL: 31/TOTAL: 35

COMPANY HEADQUARTERS PARA 01

AN/VRC-92F
AN/VRC-104(V)3
FBCB2
DAGR



CPT 25A00 (COMMANDER) P&C

AN/VRC-90F
FBCB2



LT 25A00 (EXEC OFF) C
1SG 25W5M (FIRST SGT) C
SGT 92Y2O (SUPPLY NCO) R
SP4 92Y1O (SUPPLY SP) R

RANGE EXTENSION PLATOON HQ PARA 02

AN/VRC-90F
AN/VRC-104(V)3
FBCB2
DAGR

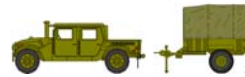

LT 25A00 (PLT LDR) C
SFC 25U4O (PLT SGT) C

SMALL COMMAND POST SUPPORT TEAM PARA 03

AN/VRC-89F
FBCB2
DAGR

AN/VRC-90F
DAGR

BCP (SWITCHING GP): OM-87A/T



SGT 25Q2O (SR XMSN SYS OPR-MAINT) R
SP4 25B1O (LAN MGR) R
SP4 25Q1O (XMSN SYS OPR-MAINT) R
PFC 25B1O (LAN MGR) R

RETRANSMISSION TEAM PARA 04

2 AN/VRC-92F
FBCB2
DAGR



SGT 25U2O (TEAM CHIEF) R
SP4 25U1O (RADIO RETRANS OPR) SAW
PFC 25U1O (RADIO RETRANS OPR) R

X3

NETWORK EXTENSION PLT HQ PARA 05

AN/VRC-90F
AN/VRC-104(V)3
FBCB2
DAGR



LT 25A00 (PLT LDR) C
SFC 25W4O (PLT SGT) C

JOINT NETWORK NODE/SMART-T TEAM PARA 06

AN/VRC-90F
AN/VRC-104(V)3
FBCB2
DAGR
AN/TYQ-122
TSEC/KG94A
OA-9511A/TYQ
AEHF COMMS PLAN ELEMENT
KSV-3

AN/VRC-90F
DAGR

AN/VRC-90F
DAGR

AN/VRC-90F
AN/VRC-104(V)3
DAGR

AN/TTC-59 (JNN)

AN/TSC-154



SGT 25N2O (SR NODAL NET SYS OPR-MAINT) R
SGT 25S2O (SR SAT COM SYS OPR-MAINT) R
SP4 25N1O (NODAL NET SYS OPR-MAINT) R

SP4 25S1O (SATCOM SYS OPR-MAINT) R
PFC 25N1O (NODAL NET SYS OPR-MAINT) R
PFC 25S1O (SATCOM SYS OPR-MAINT) R

SP4 25Q1O (RANGE EXT OPR) R

LOS V3 TEAM PARA 07

AN/VRC-90F
FBCB2
DAGR

AN/VRC-90F

AN/TRC-190C(V)3

AN/TRC-190C(V)1



SGT 25Q2O (SR XMSN SYS OPR-MAINT) R
SP4 25Q1O (XMSN SYS OPR-MAINT) R
PFC 25Q1O (XMSN SYS OPR-MAINT) R

X2

Brigade Signal Company (FIB/BFSB) (cont)

RETRANSMISSION TEAM PARA 08

2 AN/VRC-92F
FBCB2
DAGR



SGT 25U20 (TEAM CHIEF) C
SP4 25U10 (RADIO RETRANS OPR) SAW
PFC 25U10 (RADIO RETRANS OPR) C

EPLRS SECTION PARA 09

AN/VRC-90F
FBCB2
DAGR
EPLRS-V1
AN/GRC-229
KOK-13/TSEC

AN/TSQ-158 NCS

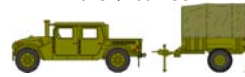

SSG 25C30 (EPLRS NCS SUPV) R
SP4 25C10 (EPLRS NCS OPR) R
PFC 25C10 (EPLRS NCS OPR) R

AN/VRC-92F
FBCB2
DAGR
EPLRS-V1

AN/VSQ-2(N)4



SGT 25C20 (SR EGRU OPR) R
SP4 25C10 (EGRU OPR) R

NOTE: SECTION APPLIES ONLY IF BDE IS ASSIGNED TO EPLRS-EQUIPPED DIVISION. SECTION EQUIPMENT IS NOT INCLUDED IN SUMMARY OF EQUIPMENT

Summary of Equipment

WEAPONS

LAUNCHER GRENADE: M320A1-----	8
MACHINE GUN 5.56MM M249-----	4
MACHINE GUN LIGHT 5.56MM M249-----	10
MACHINE GUN GRENADE 40MM MK-19 MOD III-----	2
PISTOL 9MM AUTOMATIC M9-----	1
RIFLE 5.56MM M16A2-----	24
RIFLE 5.56MM M4 CARBINE-----	7

VEHICLES, TRAILERS, AND TRLR MTD SYSTEMS

GEN SET DED TM: 10KW 60HZ (PU-798)-----	2
GEN SET DED TM: 5KW 60HZ (PU-797)-----	3
TRUCK UTILITY EXP CAPACITY ENH 4X4: M1152A1-----	9
TRUCK UTILITY EXP CAPACITY ENH 4X4: M1165A1-----	9
TRUCK CARGO: MTV (M1083)-----	1
TRAILER HIGH MOBILITY 1-1/4T (M1102)-----	1
LIGHT TACTICAL TRAILER: 3/4T (M1101)-----	7
TRAILER TANK WATER (CAMEL) 800 GAL 5 TON-----	1

MISCELLANEOUS EQUIPMENT

GEN SET : DED SKID MTD 3KW 60HZ (MEP-831A)-----	5
---	---

NIGHT VISION/OBSERVATION EQUIPMENT

NIGHT VISION GOGGLES: AN/PVS-7B-----	52
SIGHT THERMAL: AN/PAS-13B(V)2 MEDIUM TWS-----	10
SIGHT THERMAL: AN/PAS-13B(V)3 HEAVY TWS-----	2

COMMUNICATION-ELECTRONICS EQUIPMENT

ANTENNA GROUP: OE-254-----	15
COMPUTER SET DIGITAL: AN/UYK-128 (FBCB2)-----	11
NET CONTROL STATION: AN/TSQ-158-----	1
NAVIGATION SET: SATELLITE SIGNALS AN/PSN-13 (DAGR)-----	15
PROCESSOR GROUP SIGNAL DATA: (CAISI 2.0)-----	1
RADIAC SET: AN/VDR-2-----	9
RADIO SET: AN/VRC-89F-----	1
RADIO SET: AN/VRC-90F-----	11
RADIO SET: AN/VRC-92F-----	9
RADIO SET: AN/VRC-104(V)3 150 WATT IK: PRC-150 HF RADIO--	4
RADIO TERMINAL: LOS MULTI-CHANNEL AN/TRC-190C(V)1-----	2
RADIO TERMINAL: LOS MULTI-CHANNEL AN/TRC-190C(V)3-----	1
RADIO TERMINAL SET: AN/GRC-229-----	2
SWITCHING GROUP: DIGITAL DATA OA-9511/TYQ-----	1
TACTICAL ELECTRONIC KEY GENERATOR: TSEC/KG94A-----	1
TELECONFERENCE SYSTEM: AN/TYQ-122-----	1
TERMINAL: SATELLITE COMMUNICATIONS AN/TSC-154-----	1
JOINT NODE NETWORK (JNN) CEN OFC TEL AUTO: AN/TTC-----	1
BATTALION COMMAND POST (SWITCHING GROUP): OM-87A/T---	1
AEHF COMMUNICATIONS PLANNING ELEMENT-----	1
TRANSEC MODULE: KSV-3-----	1

Maneuver Enhancement Brigade

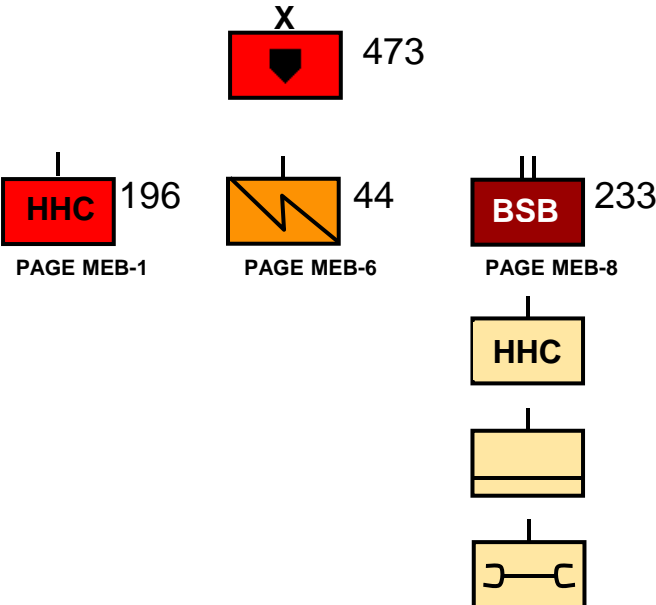

POTENTIAL FUNCTIONS THAT COULD AUGMENT/ASSIGNED OR ATTACHED TO THE BRIGADE

HHC, Maneuver Enhancement Brigade (MEB)

37342R000
OFF: 56/WO: 11/ENL: 129/TOTAL: 196

COMMAND GROUP PARA 01

AN/VRC-92F
AN/VRC-104(V)3
FBCB2
AN/TYQ-137A:(V)2
DAGR
AN/PSC-5



COL 01C00 (COMMANDER) P
SGT 88M20 (DRIVER) R

AN/VRC-92F
FBCB2
AN/TYQ-137A:(V)2
DAGR
AN/PSC-5



LTC 01C00 (DEP COMMANDER) P
PFC 31B10 (VEH DRIVER) P&R

AN/VRC-90F
FBCB2
DAGR



CSM 00Z50 (CSM) P
SP4 42A10 (EXEC ADMIN ASST) SAW

CURRENT OPERATIONS (TAC CP) PARA 02

AN/VRC-92F
AN/VRC-104(V)3
FBCB2
DAGR



LTC 01C00 (S3) P
MSG 11Z50 (OPNS SGT) R
PFC 31B10 (VEH DRIVER) P&SAW

POWER PLANT UTILITY

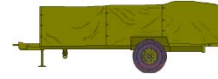

CURRENT OPS/INTEL (TAC CP) PARA 03

CPT 35E00 (INTEL OFF) P

CURRENT OPS/SUPPORT STAFF (TAC CP) PARA 04

AN/VRC-89F
DAGR



CPT 12B00 (ASST OPNS OFF) R
CPT 13A00 (ASST FIRE SPT OFF) R
CPT 31A00 (ASST OPNS OFF) P&R
CPT 53A00 (INFO SYS MGMT OFF) R
CPT 74A00 (ASST OPNS OFF) R
LT 42B00 (STRENGTH MGR) R
MSG 92Y50 (SR SUPPLY SGT) R
SFC 25W40 (NETWORK OPNS CHIEF) R
SSG 25B30 (ASST COMSEC CUSTODIAN) R
SSG 25B30 (DATA SYS INTEGRATOR) R
SGT 25B20 (SR INFO TECH SP) R

AN/VRC-90F
FBCB2
DAGR
AN/TYQ-116(V)3



CURRENT OPERATIONS (MAIN CP) PARA 05

AN/VRC-92F
AN/VRC-104(V)3
FBCB2
AN/TYQ-129(V)2
AN/TYQ-137A:(V)2
AN/TYQ-146(V)1
AN/UYQ-90(V)3



MAJ 01A00 (EXECUTIVE OFF) P
MAJ 57A00 (OPNS OFF) P
CPT 01A00 (OPNS OFF) P
SGM 11Z50 (CHIEF OPNS SGT) R
PFC 12B10 (VEH DRIVER) SAW

E/D EQ: NES
KG-175
DAGR
AN/TSR-8 (GRT)
AN/PSC-5
AN/TYQ-122

AN/VRC-92F
FBCB2



CURRENT OPS/INTEL (MAIN CP) PARA 06

AN/VRC-92F
AN/TYQ-137A:(V)2
DAGR



MAJ 35D00 (S2) P
SGT 35F20 (INTEL ANALYST) R

AIRSPACE MANAGEMENT SECTION PARA 07

AN/VRC-90F



MAJ 15B00 (AIRSPACE MGMT OFF) P

AN/VRC-92F
AN/VRC-90F
AN/VRC-104(V)3
AN/VRC-106(V)1 (C)
AN/GYQ-88
AN/USQ-140(V)2 (C)
DAGR
EPLRS-V1
2 AN/PRC-117F
AN/TSQ-253(V)1



CW3 140A0 (C2 SYS INTEGR) R
SPC 15Q40 (A2C2 SGT) R
SSG 14J30 (OPNS SGT) R
SP4 15Q10 (TAIS OPR) R
PFC 14J10 (EWS OPR) R

PU 798

AN/VRC-90F
FBCB2
AN/FSQ-211
DAGR



SP4 15Q10 (TAIS OPR) R

AN/TSQ-221

PU-801

AN/VRC-90F



CPT 14A00 (ASST OPNS OFF) R

AN/VRC-92F



HHC, Maneuver Enhancement Brigade (MEB) (cont)

CURRENT OPS - LNO PARA 08

AN/VR-92F
FBCB2
DAGR



X4

CPT 12B00 (LNO) R
CPT 31A00 (LNO) R
CPT 74A00 (LNO) R
SFC 21N40 (CONST INSP) R
SFC 31B40 (LIAISON NCO) P&R

AN/VR-90F
DAGR



MAJ 01A00 (TEAM CHIEF) P
SSG 74D30 (CBRN NCO) R

CURRENT OPS/SPT STAFF PARA 09

AN/VR-90F
FBCB2
DAGR



MAJ 12B00 (PLANS OFF) P

AN/VR-90F
FBCB2
DAGR
AN/PSC-5
AN/TYQ-116(V)3



LT 74A00 (ASST OPNS OFF) R
MSG 12Z50 (OPNS SGT) R
MSG 25U50 (SGNL SPT SYS CHIEF) R
MSG 74D50 (CBRN OPS SGT) R
SFC 12C40 (ASST OPNS SGT) R
2 SFC 31B40 (OPNS NCO) P&R
SFC 46Z40 (PUBLIC AFFAIRS OPS NCO) R
SSG 42A30 (HUMAN RES SGT) R
SSG 74D30 (CBRN NCO) R
SGT 25B20 (SR LAN MGR) R
SGT 42A20 (HUMAN RES SGT) R
SGT 46Q20 (PUBLIC AFFAIRS SGT) R
SGT 92Y20 (SUPPLY NCO) R

AN/VR-92F
FBCB2
DAGR



AN/VR-90F
FBCB2
DAGR



MAJ 38A00 (CIVIL AFFAIRS OFF) P
SFC 38B40 (CIVIL AFFAIRS SGT) R

AREA OPERATIONS SECTION PARA 10

AN/VR-92F
FBCB2
DAGR
AN/PSC-5



MAJ 02B00 (OPNS OFF) P
PFC 12B10 (VEH DRIVER) R

AN/VR-90F
2 FBCB2
E/D EQ: NES
KG-175
DAGR
AN/TYQ-122
AN/PSC-5

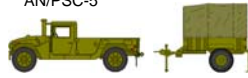

MAJ 12B00 (ENGR OPS OFF) P
MAJ 31A00 (AS/FP OFF) P
CPT 02A00 (OPNS OFF) R
CPT 12B00 (AREA DAMAGE OFF) R
CPT 12B00 (CIVIL ENGINEER) R
CPT 31A00 (AS/FP OFF) R
SGM 11Z50 (CHIEF OPNS SGT) R
MSG 11Z50 (OPNS SGT) R
MSG 12X50 (OPNS SGT) R
MSG 31B50 (OPNS NCO) P&R
PFC 31B10 (VEH DRIVER) R

AN/VR-92F
FBCB2
DAGR
AN/PSC-5

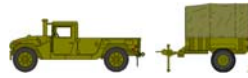

SFC 12T40 (SR TECH ENG NCO) R
SFC 12H40 (CONSTRUCTION INSP) R
SFC 12N40 (CONSTRUCTION INSP) R
SP4 12T10 (TECH ENGR SP) SAW

AN/VR-90F
FBCB2
DAGR



MAJ 74A00 (CHEM OFF) P
SFC 74D40 (CBRN STAFF NCO) R

INTEL CELL PARA 11

AN/VR-92F
2 AN/TYQ-93
AN/TYQ-92(V)2
FBCB2
DAGR
AN/PSC-5



CPT 31A00 (VULN ASST OFF) R
CW3 311A0 (CRIMINAL INTEL/OPS OFF) R
MSG 35X50 (CHIEF INTEL SGT) R
SFC 31B40 (VULN ASSESSMENT NCO) P&R
SSG 25F30 (INTEL SGT) R
SP4 35F10 (INTEL ANALYST) SAW
PFC 35F10 (INTEL ANALYST) R

C2 INFO SYS OPS/S6 PARA 12

AN/VR-90F
FBCB2
DAGR



MAJ 25A00 (S6) P
PFC 25B10 (INFO SYS SP) SAW

AN/VR-89F
AN/VR-90F
AN/VR-104(V)3
AN/VR-106(V)2 (C)
AN/GYK-33D
AN/PYQ-12
AN/TYQ-137A:(V)2
AN/TSQ-243
AN/GYK-49(V)2
KG-175



MAJ 25A00 (S6) P
CW2 250N0 (NETWORK MGMT TECH) R
CW2 254A0 (SGNL SYS TECH) R
SFC 25B40 (SR DATA SYS INTEGR) R
SFC 25B40 (COMSEC CUSTODIAN) R
SSG 25B30 (IA STAFF ASST) R
SSG 25E30 (ELECTRO SPECTRUM NCO) R
SSG 25N30 (NODAL OPS SYS NCO) R
SSG 25Q30 (XMSN SYS OPS NCO) R

AN/VR-90F



SSG 25S30 (SATCOM OPNS NCO) R
SSG 25U30 (SGNL SPT NCO) R
SSG 25U30 (SGNL INFO SVC NCO) R
SGT 25L20 (SR CBL/ANT SYS SP) R
SP4 25B10 (INFO TECH SP) R
SP4 25L10 (CABLE SYS INSTL-MAINT) R
SP4 25U10 (SGNL SPT SYS MAINT) SAW
PFC 25U10 (SGNL SPT SYS SP) R

AN/VR-90F



MEB-2

AN/VR-90F
DAGR



PLANS CELL PARA 13

AN/VR-90F
DAGR



MAJ 31A00 (PLANS OFF) P
MAJ 74A00 (PLANS OFF) P
CW4 120A5 (POWER SYS TECH) R
SFC 11B40 (OPNS SGT) R

HHC, Maneuver Enhancement Brigade (MEB) (cont)







PROTECTION/PMO CELL PARA 14

AN/VRC-92F AN/UYQ-90(V)3 FBCB2 DAGR 	AN/VRC-90F FBCB2 DAGR 	AN/VRC-90F FBCB2 DAGR 	AN/VRC-90F FBCB2 DAGR 
MAJ 31A00 (OPNS OFF) P	CPT 31A00 (ASST S3) P CW3 311A0 (PROT SERV OFF) P 2 MSG 31B50 (OPNS NCO) P&R 2 SFC 31B40 (OPNS NCO) P&R SFC 31E40 (I/R NCO) P&R SP4 31B10 (MILITARY POLICE) P&SAW	CPT 31A00 (MMS OPS OFF) P&R SSG 31B30 (OPNS SGT) P&R	CPT 31A00 (MMS OPS OFF) P&R SSG 31B30 (OPNS SGT) P&R



PROTECTION/CBRN CELL PARA 15

AN/VRC-89F FBCB2 DAGR 	AN/VRC-104(V)3 	AN/VRC-90F FBCB2 DAGR 
MAJ 74A00 (OPNS OFF) P PFC 74D10 (CBRN SP) R	CPT 89E00 (OPS OFF) R CPT 74A00 (INTEL OFF) R MSG 89D50 (OPNS SGT) R SFC 74D40 (CBRN STAFF NCO) R SSG 74D30 (CBRN NCO) R SP4 74D10 (CBRN SP) SAW	





PROTECTION/ENGR OPS CELL PARA 16

AN/VRC-90F 	AN/VRC-92F FBCB2 DAGR AN/TYQ-67(V) (DTSS-L) 	AN/VRC-90F DAGR 	AN/VRC-90F DAGR 	AN/VRC-90F FBCB2 DAGR 	AN/VRC-92F FBCB2 DAGR 
MAJ 12B00 (OPNS OFF) P	SSG 12Y30 (SR GEOSPATIAL ENGR SGT) R SGT 12Y20 (GEOSPATIAL ENGR SGT) R SP4 12Y10 (GEOSPATIAL ENGR) SAW PFC 12Y10 (GEOSPATIAL ENGR) R	PU 798 	CPT 12B00 (ENGR TAC ASST OIC) R	SSG 12B30 (RECON SGT) R <div style="text-align: center;">X2</div>	SFC 12B40 (ASST OPNS SGT) R

FIRES CELL PARA 17

AN/VRC-92F FBCB2 AN/GYK-48(V)1 DAGR 	AN/VRC-92F AN/VRC-104(V)3 AN/GYK-57 AN/GYK-58 AN/GYK-59 DAGR 
LTC 13A00 (FIRE SPT COORD) P SP4 13F10 (FIRE SPT SP) SAW	MAJ 13A00 (FIRE SPT OFF) P CW3 131A0 (TARGETING OFF) R MSG 13Z50 (OPNS SGT) R SFC 13F40 (EFFECTS NCO) R SFC 29E40 (EW SGT) R SSG 13F30 (TARGETING NCO) R SSG 29E30 (EW SGT) R

SUSTAINMENT/LOG CELL PARA 18

AN/VRC-92F FBCB2 DAGR 	AN/VRC-92F 2 AN/TYQ-129(V)2 AN/TYQ-109(V)1 AN/TYQ-109(V)2 AN/UYQ-90(V)3 KG-175 	AN/TYQ-95 DAGR CAISI 2.0 OL-713(V)1/TYQ CSS VSAT AN/TYQ-141 
MAJ 90A00 (S4) P SP4 92Y10 (SUPPLY SP) SAW	MED PWR PLANT 	
CPT 91A00 (MAINT OFF) R CW3 922A0 (SR FOOD ADVISOR) R CW2 882A0 (MOBILITY OFF) R CW2 920A0 (PROP ACCT TECH) R MSG 92G50 (SR FOOD OPNS SGT) R SFC 88N40 (SR MOVEMENTS NCO) R SSG 88N30 (MOVEMENTS SUPV) R SGT 92Y20 (PROP BOOK NCO) R		

SUSTAINMENT - S1 PARA 19

AN/VRC-90F FBCB2 AN/TYQ-137A:(V)2 DAGR CAISI 2.0 8 AN/TYQ-116(V)3 	SGT 42F20 (HR INFO SYS MGMT SP) R SP4 42A10 (HUMAN RES SP) SAW SP4 42F10 (HR INFO SYS MGMT SP) R 2 PFC 42A10 (HUMAN RES SP) R
MAJ 42H00 (S1) P CW2 420A0 (MIL PERS TECH) R MSG 42A50 (SR HUMAN RES SGT) R SSG 42A30 (HUMAN RES SGT) R SGT 42A20 (HUMAN RES SGT) R	

SUSTAINMENT - SJA PARA 20

AN/VRC-90F FBCB2 DAGR 	MAJ 27A00 (COMMAND JA) P CPT 27A00 (OPLAW JA) R SSG 27D30 (PARALEGAL NCO) R
--	---

SUSTAINMENT - BRIGADE SURGEON PARA 21

AN/VRC-89F AN/TYQ-107(V)1 AN/TYQ-106(V)1 FBCB2 AN/TYQ-105(V)1 AN/TYQ-108(V)3 DAGR 	MAJ 62B00 (BRIGADE SURGEON) P CPT 70H67 (MEDICAL OPNS OFF) R SFC 68W40 (HEALTH CARE NCO) R
--	--

HHC, Maneuver Enhancement Brigade (MEB) (cont)

SUSTAINMENT/MED PARA 22

AN/VRC-89F
AN/VRC-90F
AN/TYQ-106(V)1
FBCB2
4 AN/TYQ-105(V)1
DAGR



CPT 65D00 (PHYSICIAN ASST) P
SSG 68W30 (HEALTH CARE SGT) R
SP4 68W10 (HEALTH CARE SP) R
PFC 68W10 (HEALTH CARE SP/DRIVER) R

AN/VRC-89F
FBCB2
2 AN/TYQ-105(V)1
DAGR



SGT 68W2P (EMERGENCY CARE SGT) R
PFC 68W10 (AMBULANCE AIDE/DRIVER) R

AN/VRC-89F
FBCB2
2 AN/TYQ-105(V)1
DAGR



SGT 68W20P (EMERGENCY CARE SGT) R
PFC 68W10 (AMBULANCE AIDE/DRIVER) R

SUSTAINMENT - UMT PARA 23

AN/VRC-90F
FBCB2
DAGR



MAJ 56A00 (CHAPLAIN)
SSG 56M30 (CHAP ASST NCO) R

COMPANY HEADQUARTERS PARA 24

AN/VRC-92F
FBCB2
DAGR



CPT 01C00 (COMMANDER) P
PFC 92Y10 (SUPPLY SP) SAW

AN/VRC-90F
FBCB2
DAGR
AN/TYQ-122



1SG 31B5M (FIRST SERGEANT) P&R
SGT 42A20 (HUMAN RES SGT) R

AN/VRC-90F
FBCB2
AN/TYQ-109(V)1
DAGR
CAISI 2.0



SSG 92Y30 (SUPPLY SGT) R
SGT 92A20 (EQ RCD/PARTS SP) R
SP4 92A10 (EQ RCD/PARTS SP) R
SP4 92Y10 (SUPPLY SP) R

AN/VRC-90F



SFC 92G40 (FOOD OPNS MGMT NCO) R
SSG 92G30 (FOOD OPS MGR) R
SGT 92G20 (FOOD OPS NCO) R
2 SP4 92G10 (FOOD OPS SP) R
PFC 92G10 (FOOD OPS SP) R

SUMMARY OF EQUIPMENT

WEAPONS

LAUNCHER GRENADE M320-----	4
MACHINE GUN 5.56MM M249-----	15
MACHINE GUN LIGHT 5.56MM M249-----	4
PISTOL 9MM AUTOMATIC M9-----	57
RIFLE 5.56MM M16A2-----	144
MACHINE GUN: CALIBER .50 (M2E2)-----	2

VEHICLES, TRAILERS, AND TRLR MTD SYSTEMS

GEN SET DED TM: 10KW 60HZ (PU-798)-----	3
GEN SET DIESEL ENGINE TM: 15KW 60HZ (PU-801)-----	1
KITCHEN FIELD TRAILER MOUNTED: MPK75 (MKT)-----	1
POWER PLANT: UTILITY, LARGE 35KW 12 TON ECU-----	1
POWER PLANT: UTILITY, MEDIUM 20KW 5 TON ECU-----	4
TRUCK UTILITY EXP CAPACITY: ARMT CARRIER M1151A1-----	1
TRUCK UTILITY EXP CAPACITY ENH 4X4: M1152A1-----	46
TRUCK AMBULANCE: 4 LITTER HMMWV (M997)-----	2
TRUCK UTILITY EXP CAPACITY ENH 4X4: M1165A1-----	15
TRUCK CARGO: MTV (M1083)-----	2
TRUCK CARGO: 4X4 LMTV (M1078)-----	1
TRAILER: PLS 8X20 (M1076)-----	1
TRAILER HIGH MOBILITY 1-1/4T (M1102)-----	6
TRAILER HIGH MOBILITY 3/4T (M1101)-----	22
TRAILER CARGO: LMTV W/DROPSIDES (M1082)-----	2
TRAILER TANK WATER (CAMEL) 800 GAL 5 TON-----	2

MISCELLANEOUS EQUIPMENT

DECON APPARATUS LT WT-----	2
GEN SET TACT QUIET: 3KW 60 HZ (MEP-831A)-----	14
GEN SET DIESEL: 60HZ AC MEP-531A-----	1
GEN SET: DED SKID MTD 10KW 60HZ (MEP-803A)-----	1

NIGHT VISION/OBSERVATION EQUIPMENT

DRIVERS VISION ENHANCER: AN/VAS-5-----	2
NIGHT VISION GOGGLES: AN/PVS-7B-----	199
MEDIUM WEAPON THERMAL SIGHT (MWTS): AN/PAS-13(V)2-----	4
HEAVY WEAPON THERMAL SIGHT (HWTS): AN/PAS-13(V)3-----	5

COMMUNICATION-ELECTRONICS EQUIPMENT

ALL SOURCE ANALYSIS SYSTEM: AN/TYQ-93 (ASAS-LT)-----	2
ALL SOURCE ANALYSIS SYSTEM: AN/TYQ-93(V)2 (ASAS-IFS)-----	1
ANTENNA GROUP: OE-254-----	61
COMPUTER SET: AN/GYK-57 (AFATDS - SINGLE)-----	1
COMPUTER SET: AN/GYK-58 (AFATDS - DUAL)-----	1
COMPUTER SYSTEM DIGITAL: AN/TYQ-107(V)1 (MC4-3A)-----	1
COMPUTER SET GENERAL: AN/GYK-33D-----	1
COMPUTER SYSTEM DIGITAL: AN/TYQ-106(V)1-----	2
COMPUTER SET DIGITAL: AN/UJK-128 (FBCB2)-----	48
BTL CMD SUSTAINMENT SPT SYSTEM: AN/GYK-61 (BCS3)-----	2
COMPUTER SYS DIGITAL: AN/TYQ-129(V)2 (TC-AIMS II WS)-----	2
COMPUTER SYSTEM DIGITAL: AN/TYQ-105(V)1-----	9
COMPUTER SYSTEM DIGITAL: AN/TYQ-108(V)3 (MC4-4C)-----	1
COMPUTER SET DIGITAL: AN/TYQ-109(V)1 (GCSS-A (V)1)-----	2
COMPUTER SET DIGITAL: AN/TYQ-109(V)2 (GCSS-A (V)2)-----	1
COMMAND POST OF THE FUTURE (CPOF) WS: AN/TYQ-137A:(V)2-----	7
COMMAND SYS TACTICAL: AN/TYQ-146(V)1 (BCCS LONG STACK)-----	1
COMMAND SYSTEM TACTICAL: AN/TYQ-221-----	1
COMMAND CENTER SYSTEM: AN/TSQ-243-----	1
COMPUTER: TACTICAL AN/GYQ-88 (AMDWS)-----	1
COMPUTER SYSTEM DIGITAL: AN/UJQ-90(V)3 (MTS-CS)-----	3
COMPUTER SET GENERAL: AN/GYK-49(V)2-----	1
COMPUTER SET FA GENERAL: AN/GYK-48(V)1 (FSCOORD)-----	1
DIGITAL TOPOGRAPHIC SYSTEM: AN/TYQ-67(V)-----	1
ENCRYPT/DECRYPT EQUIP: NES-----	2
ENCRYPTION-DECRYPTION EQ: TACLANE KG-175-----	4
COMPUTER SET: AN/GYK-59(AFATDS FSCOORD TOOL)-----	1
INTERROGATOR SET AN/TYQ-95 (TC-AIMS II INTERROGATOR)-----	2
NAVIGATION SET: SATELLITE SIGNALS AN/PSN-13 (DAGR)-----	55
PIH SURFACE VEH RADIO SET: AN/VSQ-2(V)1 (EPLRS-V1)-----	1
PROCESSOR GROUP SIGNAL DATA: (CAISI 2.0) OL-701A/TYQ-----	4
RADIAC SET: AN/VDR-2-----	7
RECEIVE SUITE: AN/TSR-8 (GRT)-----	3
RADIO SET: AN/USQ-140(V)2 (C)-----	1
RADIO SET: AN/VRC-89F-----	7
RADIO SET: AN/VRC-90F-----	38
RADIO SET: AN/VRC-92F-----	24
RADIO SET: AN/VRC-106(V)2(C)-----	1
RADIO SET: AN/VRC-106(V)1(C)-----	1
RADIO SET: AN/VRC-104(V)3 150 WATT IK: PRC-150 HF RADIO-----	7
RADIO SET: AN/PRC-117F TACSAT RADIO MANPACK-----	2
RADIO SET: AN/PSC-5-----	8
TELECONFERENCE SYSTEM: AN/TYQ-122-----	3
WORKSTATION: AIRSPACE OPERATION AN/FSQ-211 (TAIS AWS)-----	1
COMPUTER SYSTEM DIGITAL: AN/GYK-50A (ISYSCON) (V4)-----	1
INTERFACE UNIT COMM EQ: OL-713(V)1/TYQ CSS VSAT-----	1
ABHF COMMS PLANNING ELEMENT: AN/FSQ-XX (TAC -MPSS)-----	1
COMPUTER SYSTEM DIGITAL: AN/TYQ-141 (SAMS-2E V2)-----	1
COMPUTER SYSTEM: DIGITAL AN/TYQ-139 (SAMS-1E V1)-----	1
COMMAND SYSTEM TACTICAL: AN/TYQ-155(V)1 (TCB SERVER)-----	3
KEY PROCESSOR: KP TSEC/KOK-22-----	1
COMP SYS DIGITAL: (AHRs) AN/TYQ-116(V)3-----	10

HHC, Maneuver Enhancement Brigade

Brigade Signal Company (MEB/CAB/SB)

11307R600
OFF: 4/WO: 0/ENL: 40/TOTAL: 44

COMPANY HEADQUARTERS PARA 01

AN/VRC-92F
AN/VRC-104(V)3
FBCB2
DAGR



CPT 25A00 (COMMANDER) P&C

AN/VRC-90F
AN/TYQ-109(V)1
FBCB2
DAGR
CAISI 2.0



LT 25A00 (EXEC OFF) C
1SG 25U5M (FIRST SGT) C
SGT 92Y20 (SUPPLY NCO) R
SP4 92Y10 (SUPPLY SP) R

RANGE EXTENSION PLATOON HQ PARA 02

AN/VRC-90F
AN/VRC-104(V)3
FBCB2
DAGR



LT 25A00 (PLT LDR) C
SFC 25U40 (PLT SGT) C

SMALL COMMAND POST SUPPORT TEAM PARA 03

AN/VRC-89F
FBCB2
DAGR

AN/VRC-90F
DAGR



SGT 25Q20 (SR XMSN SYS OPR-MAINT) R
SP4 25B10 (LAN MGR) R
SP4 25Q10 (XMSN SYS OPR-MAINT) R
PFC 25B10 (LAN MGR) R

X2

RETRANSMISSION TEAM PARA 04

2 AN/VRC-92F
FBCB2
DAGR



SGT 25U20 (TEAM CHIEF) R
SP4 25U10 (RADIO RETRANS OPR) SAW
PFC 25U10 (RADIO RETRANS OPR) R

X3

NETWORK EXTENSION PLATOON HQ PARA 05

AN/VRC-90F
AN/VRC-104(V)3
FBCB2
DAGR



LT 25A00 (PLT LDR) C
SFC 25W40 (PLT SGT) C

JOINT NETWORK NODE/SMART-T TEAM PARA 06

AN/VRC-90F
DAGR
OA-9511/TYQ
AN/TYQ-122
KSV-3



SGT 25N20 (SR NODAL NET SYS OPR-MAINT) R
SP4 25N10 (NODAL NET SYS OPR-MAINT) R
PFC 25N10 (NODAL NET SYS OPR-MAINT) R

AN/VRC-90F
DAGR

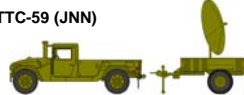

SGT 25S20 (SR SATCOM SYS OPR-MAINT) R
SP4 25S10 (SATCOM SYS OPR-MAINT) R
PFC 25S10 (SATCOM SYS OPR-MAINT) R

AN/VRC-90F
DAGR



AN/VRC-90F
AN/VRC-104(V)3
FBCB2
DAGR



SP4 25Q10 (RANGE EXT OPR) R

LOS V3 TEAM PARA 07

AN/VRC-90F

AN/TRC-190C(V)1



X2

SGT 25Q20 (SR XMSN SYS OPR-MAINT) R
SP4 25Q10 (XMSN SYS OPR-MAINT) R
PFC 25Q10 (XMSN SYS OPR-MAINT) R

AN/VRC-90F

AN/TRC-190C(V)3



RETRANSMISSION TEAM PARA 08

2 AN/VRC-92F
FBCB2
DAGR

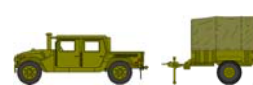

SGT 25U20 (TEAM CHIEF) R
SP4 25U10 (RADIO RETRANS OPR) SAW
PFC 25U10 (RADIO RETRANS OPR) R

EPLRS SECTION PARA 09

AN/VRC-90F
FBCB2
DAGR
EPLRS-V1
AN/GRC-229
KOK-13/TSEC



SSG 25C30 (EPLRS NCS SUPV) R
SP4 25C10 (EPLRS NCS OPR) R
PFC 25C10 (EPLRS NCS OPR) R

AN/VRC-92F
FBCB2
DAGR
EPLRS-V1



SGT 25C20 (SR EGRU OPR) R
SP4 25C10 (EGRU OPR) R

NOTE: SECTION APPLIES ONLY IF MEB IS ASSIGNED TO EPLRS-EQUIPPED DIVISION

Summary of Equipment

WEAPONS

LAUNCHER GRENADE: M320A1-----	4
MACHINE GUN 5.56MM M249-----	4
MACHINE GUN LIGHT 5.56MM M249-----	10
MACHINE GUN GRENADE 40MM MK-19 MOD III-----	2
PISTOL 9MM AUTOMATIC M9-----	1
RIFLE 5.56MM M16A2-----	33
RIFLE 5.56MM M4 CARBINE-----	7

VEHICLES, TRAILERS, AND TRLR MTD SYSTEMS

GEN SET DED TM: 10KW 60HZ (PU-798)-----	3
GEN SET DED TM: 5KW 60HZ (PU-797)-----	3
TRUCK CARGO: MTV (M1083)-----	1
TRUCK UTILITY EXP CAPACITY ENH 4X4: M1152A1-----	12
TRUCK UTILITY EXP CAPACITY ENH 4X4: M1165A1-----	8
TRAILER HIGH MOBILITY 1-1/4T (M1102)-----	1
LIGHT TACTICAL TRAILER: 3/4T (M1101)-----	8
TRAILER TANK WATER (CAMEL) 800 GAL 5 TON-----	1

MISCELLANEOUS EQUIPMENT

GEN SET : DED SKID MTD 3KW 60HZ (MEP-831A)-----	6
GEN SET DIESEL: 60HZ AC MEP-531A-----	1

NIGHT VISION/OBSERVATION EQUIPMENT

NIGHT VISION GOGGLES: AN/PVS-7B-----	54
MEDIUM WEAPON THERMAL SIGHT (MWTS): AN/PAS-13(V)2-----	10
HEAVY WEAPON THERMAL SIGHT (HWTS): AN/PAS-13(V)3-----	2

COMMUNICATION-ELECTRONICS EQUIPMENT

ANTENNA GROUP: OE-254-----	18
ANTENNA: AB-1404/TRC-----	1
COMPUTER SET DIGITAL: AN/UYK-128 (FBCB2)-----	14
COMPUTER SET DIGITAL: AN/TYQ-109(V)1 (GCSS-A (V)1)-----	1
NET CONTROL STATION: AN/TSQ-158-----	2
NAVIGATION SET: SATELLITE SIGNALS AN/PSN-13 (DAGR)-----	19
PJH SURFACE VEH RADIO SET: AN/VSQ-2(V)1 (BFLRS-V1)-----	2
PROCESSOR GROUP SIGNAL DATA: (CAIST 2.0)-----	1
RADIAC SET: AN/VDR-2-----	10
RADIO SET: AN/VRC-89F-----	2
RADIO SET: AN/VRC-90F-----	13
RADIO SET: AN/VRC-92F-----	10
RADIO SET GRID REFERENCE UNIT: AN/VSQ-2(N)4-----	1
RADIO TERMINAL: LOS MULTI-CHANNEL AN/TRC-190C(V)1-----	2
RADIO TERMINAL: LOS MULTI-CHANNEL AN/TRC-190C(V)3-----	1
RADIO TERMINAL SET: AN/GRC-229-----	1
SWITCHING GROUP DIGITAL DATA: OA-9511/TYQ-----	1
TELECONFERENCE SYSTEM: AN/TYQ-122-----	1
TERMINAL: SATELLITE COMMUNICATIONS AN/TSC-154-----	1
JOINT NODE NETWORK (JNN) CEN OFC TEL AUTO: AN/TTC-----	1
BATTALION COMMAND POST (SWITCHING GROUP): OM-87A/T-----	2
AEHF COMMUNICATIONS PLANNING ELEMENT-----	1
RADIO SET: AN/VRC-104(V)3 150 WATT IK: PRC-150 HF RADIO-----	4
REKEYING CONTROLLER: KOK-13/TSEC-----	1
TRANSEC MODULE: KSV-3-----	1

Brigade Signal Company (ME/CAB/SB)

HHC, Brigade Support Bn, Maneuver Enhancement Bde

63356R000
OFF: 15/WO: 2/ENL: 59/TOTAL: 76

COMMAND SECTION PARA 01

AN/VR-92F
AN/UYQ-90(V)2
FBCB2
DAGR



LTC 90A00 (COMMANDER) P
SP4 88M10 (VEH DRIVER) R

AN/VR-92F
AN/UYQ-90(V)2
FBCB2
DAGR



MAJ 90A00 (EXEC OFF) P CSM 00Z50 (CSM) P

CURRENT OPS - INTEL/S2PARA 02

AN/VR-92F
DAGR



CPT 35D00 (S2) R
SSG 35F30 (INTEL SGT) R
SP4 35F10 (INTEL ANALYST) R

CURRENT OPS - OPS/S3 PARA 03

AN/VR-90F
DAGR



CPT 90A00 (S3) R

AN/VR-90F
AN/GYK-61 (BCS3)
AN/TYQ-137A:(V)2
DAGR



CPT 90A00 (OPNS OFF) R
CPT 90A00 (PLANS OFF) R
MSG 92A50 (OPNS SGT) R
SSG 29E30 (EW SGT) R
SSG 74D30 (CBRN NCO) R
SGT 29E20 (EW SGT) SAW

SUSTAINMENT 1 - S1 PARA 04

AN/VR-90F
DAGR
CAISI 2.0
4 AN/TYQ-116(V)3



CPT 42B00 (S1) R
SFC 42A40 (SR HUMAN RES SGT) R
SGT 42A20 (HUMAN RES SGT) R
SP4 27D10 (PARALEGAL SP) R
SP4 42A10 (HUMAN RES SP) R
PRC 42A10 (HUMAN RES SP) R
PFC 42A10 (HUMAN RES SP) SAW

SUSTAINMENT 1 - S4 PARA 05

AN/VR-92F
AN/UYQ-90(V)2



CPT 90A00 (S4) R

AN/VR-90F
AN/GYK-61 (BCS3)
2 AN/TYQ-129(V)2
AN/TYQ-109(V)1
AN/TYQ-137A:(V)2
AN/UYQ-90(V)3
AN/TYQ-95
DAGR
CAISI 2.0



SFC 92Y40 (SR SUPPLY SGT) R
SGT 92Y20 (SUPPLY NCO) R
SP4 92Y10 (SUPPLY SP) R

SUSTAINMENT 1 - C4OPS/S6 PARA 06

AN/VR-92F
FBCB2
DAGR



CPT 25A00 (S6) R

AN/VR-90F
AN/TSQ-243
DAGR
AN/TSR-8 (GRT)
AN/TSQ-259



SFC 25U40 (SECTION CHIEF) R
SP4 25B10 (LAN MGR) R
SP4 25U10 (SGNL INFO SVC SP) R
PFC 25B10 (LAN MGR) R
PFC 25U10 (SGNL SPT SYS SP) SAW

AN/VR-87F
KG-175



BCP (SWITCHING GP): OM-87A/T

PU-798

SGT 25Q20 (SR XMSN SYS OPR-MAINT) R
SP4 25Q10 (XMSN SYS OPR-MAINT) R

AN/VR-87F



SUSTAINMENT 1 - UMT PARA 07

AN/VR-90F
DAGR



CPT 56A00 (CHAPLAIN)
SP4 56M10 (CHAP ASST) R

HHC, Brigade Support Bn, Maneuver Enhancement Bde (cont)

SUSTAINMENT 2 - SUPPORT OPERATIONS PARA 08

AN/VRC-92F
AN/UYQ-90(V)2
FBCB2
DAGR

AN/VRC-90F
AN/UYQ-90(V)2
AN/GYK-61 (BCS3)
2 AN/TYQ-129(V)2
OL-608/TYQ
AN/UYQ-90(V)3
CAISI 2.0
OL-713(V)1/TYQ CSS VSAT
AN/TYQ-141

AN/VRC-90F

AN/VRC-90F
DAGR

SUSTAINMENT 2 - C4OPS/CSSAMO PARA 09

AN/VRC-90F
AN/UYQ-90(V)2
DAGR

AN/VRC-90F
AN/TYQ-106(V)1
AN/TYQ-129(V)2
AN/TYQ-105(V)1
AN/TYQ-108(V)3
AN/TYQ-109(V)1

OL-608/TYQ
OL-603/TYQ
AN/UYQ-90(V)3
CAISI 2.0
OL-713(V)1/TYQ CSS VSAT
AN/TYQ-141



MAJ 90A00 (SPT OPNS OFF) P

CPT 88A00 (TRANS OFF) R
CPT 91A00 (AMMO OFF) R
CPT 92A00 (OPNS OFF) R
CW3 915A0 (AUTO MAINT WO) R
MSG 92A50 (OPNS SGT) R
SFC 89B40 (AMMO LOG SGT) R
SFC 91X40 (MAINT MGMT NCO) R



SFC 92F40 (PETRL RQMTS SGT) R
SSG 88N30 (MOVEMENTS SUPV) R
SSG 89B30 (AMMO INSPECTOR) R
SSG 92A30 (MAT MGMT NCO) R
SSG 92M30 (MORTUARY AFFAIRS SGT) R
SGT 88N20 (TRANS MGMT NCO) R
SP4 92A10 (MAT CON/ACCTG SP) SAW



CW2 251A0 (INFO SYS TECH) R
SFC 25B40 (INFO SYS SUPV) R
SSG 92A30 (MAT MGMT NCO) R
SSG 92Y30 (SUPPLY SGT) R
SGT 25B20 (SR INFO SYS SP) R

SGT 92A20 (MAT MGMT NCO) R
SGT 92Y20 (SUPPLY NCO) R
SP4 25B10 (INFO SYS SP) R
PFC 25B10 (INFO SYS SP) SAW

COMPANY HEADQUARTERS PARA 10

AN/VRC-92F
AN/UYQ-90(V)2
FBCB2
DAGR

AN/VRC-87F
DAGR

AN/VRC-90F
AN/TYQ-109(V)1
CAISI 2.0



CPT 90A00 (COMMANDER) P
1SG 92Y5M (FIRST SERGEANT) R



SP4 74D10 (CBRN DECON SP) R



SGT 92Y20 (SUPPLY NCO) R
SP4 92Y10 (SUPPLY SP) R

FIELD FEEDING SECTION PARA 11

AN/VRC-90F

AN/VRC-90F

AN/VRC-90F



SFC 92G40 (SR FOOD OPNS SGT) R
SSG 92G30 (FOOD OPNS MGR) R
2 SGT 92G20 (FOOD OPNS NCO) R
3 SP4 92G10 (FOOD OPNS SP) R
2 SP4 92G10 (FOOD OPNS SP) SAW
3 PFC 92G10 (FOOD OPSN SP) R



AN/VRC-90F



X2



Summary of Equipment

WEAPONS

LAUNCHER GRENADE (M203)-----	4
MACHINE GUN 5.56MM M249-----	7
MACHINE GUN LIGHT 5.56MM M249-----	6
MACHINE GUN GRENADE 40MM MK-19 MOD III-----	1
PISTOL 9MM AUTOMATIC M9-----	5
RIFLE 5.56MM M16A2-----	63
MACHINE GUN: CALIBER .50 (M2E2)-----	3

VEHICLES, TRAILERS, AND TRLR MTD SYSTEMS

CONTAINERIZED KITCHEN (CK)-----	1
GEN SET DED TM: 10KW 60HZ (PU-798)-----	1
POWER PLANT: UTILITY, MEDIUM 20KW 5 TON ECU-----	3
TRUCK UTILITY EXP CAPACITY ENH 4X4: M1152A1-----	12
TRUCK VAN EXPANSIBLE MTV (M1087A1)-----	1
TRUCK UTILITY EXP CAPACITY ENH 4X4: M1165A1-----	8
TRUCK CARGO: MTV (M1083)-----	4
TRUCK CARGO: 4X4 LMTV (M1078)-----	1
TRAILER: PLS 8X20 (M1076)-----	1
LIGHT TACTICAL TRAILER: 3/4T (M1101)-----	9
TRUCK CARGO HEMTT LHS (M1120)-----	1
TRAILER TANK WATER (CAMEL) 800 GAL 5 TON-----	2

MISCELLANEOUS EQUIPMENT

ASSAULT KITCHEN-----	2
BED CARGO: DEMOUNTABLE PLS 8X20-----	4
DECON APPARATUS LT WEIGHT-----	2
GEN SET : DED SKID MTD 3KW 60HZ (MEP-831A)-----	1
MULTI-TEMP REFRIGERATED CONTAINER SYS: MTRCS-----	1

NIGHT VISION/OBSERVATION EQUIPMENT

NIGHT VISION GOGGLES: AN/PVS-7B-----	54
MEDIUM WEAPON THERMAL SIGHT (MWTS): AN/PAS-13(V)2-----	7
HEAVY WEAPON THERMAL SIGHT (HWTS): AN/PAS-13(V)3-----	4

COMMUNICATION-ELECTRONICS EQUIPMENT



ANTENNA GROUP: OE-254-----	7
COMPUTER SYSTEM DIGITAL: AN/UYQ-90(V)2 (MTS)-----	7
COMPUTER SYSTEM DIGITAL: AN/TYQ-106(V)1 (MC4-2)-----	1
COMPUTER SET DIGITAL: AN/UYK-128 (FBCB2)-----	5
BTL CMD SUSTAINMENT SPT SYSTEM: AN/GYK-61 (BCS3)-----	4
COMPUTER SYS DIGITAL: AN/TYQ-129(V)2 (TC-AIMS II WS)-----	5
COMPUTER SYSTEM DIGITAL: AN/TYQ-105(V)1 (MC4-1)-----	1
COMPUTER SYSTEM DIGITAL: AN/TYQ-108(V)3 (MC4-4C)-----	1
COMPUTER SET DIGITAL: AN/TYQ-109(V)1 (GCSS-A (V)1)-----	3
COMPUTER SET DIGITAL: OL-608/TYQ (SAAS-MOD DAO)-----	2
COMPUTER SYSTEM DIGITAL: ((CPOF WS) AN/TYQ-137A:(V)2)-----	3
COMMAND CENTER SYSTEM: AN/TSQ-243-----	1
COMPUTER SET DIGITAL: OL-603/TYQ (SARSS DSU SVR)-----	1
COMPUTER SYSTEM DIGITAL: AN/UYQ-90(V)3 (MTS-CS)-----	3
ENCRYPT/DECRYPT EQUIPMENT: TACLANE KG-175-----	1
INTERROGATOR SET AN/TYQ-95 (TC-AIMS II INTERROGATOR)-----	1
NAVIGATION SET: SATELLITE SIGNALS AN/PSN-13 (DAGR)-----	13
PROCESSOR GROUP SIGNAL DATA: (CAISI 2.0)-----	5
RADIAC SET: AN/VDR-2-----	3
RECEIVE SUITE: AN/TSR-8 (GRT)-----	1
RADIO SET: AN/VRC-87F-----	3
RADIO SET: AN/VRC-90F-----	16
RADIO SET: AN/VRC-92F-----	8
INTERFACE UNIT COMM EQ: OL-713(V)1/TYQ CSS VSAT-----	2
BATTALION COMMAND POST (SWITCHING GROUP): OM-87A/T-----	1
COMMUNICATIONS SUBSYSTEM: AN/TSQ-259-----	1
COMPUTER SYSTEM DIGITAL: AN/TYQ-141 (SAMS-2E V2)-----	2
COMPUTER SET: DIGITAL AN/GYK-62B (BFT TOC KIT)-----	1
COMP SYS DIGITAL: (AHR) AN/TYQ-116(V)3-----	4

HHC, Brigade Support Bn, Maneuver Enhancement Bde

Distribution Company, BSB, (MEB)

63358R000
OFF: 5/WO: 1/ENL: 82/TOTAL: 88



COMPANY HQ PARA 01

<p>AN/VRC-92F AN/UYQ-90(V)2 FBCB2 KG-175 DAGR</p>  <p>CPT 90A00 (COMMANDER) P 1SG 92A5M (FIRST SGT) R</p>	<p>AN/VRC-90F FBCB2 AN/TYQ-109(V)1 AN/UYQ-90(V)3 DAGR CAISI 2.0</p>  <p>LT 92A00 (OPNS OFF) R SSG 92Y30 (SUPPLY SGT) R SGT 74D20 (CBRN NCO) R SP4 92Y10 (SUPPLY SP) SAW</p>
--	--







SUPPLY PLATOON HQ PARA 02

<p>AN/VRC-92F AN/UYQ-90(V)2 FBCB2 OL-604/TYQ OL-603/TYQ AN/UYQ-90(V)3 DAGR CAISI 2.0</p> 	<p>AN/VRC-90F AN/UYQ-90(V)2</p>  <p>LT 92A00 (PLT LDR) R CW2 920B0 (SUPPLY SYS TECH) R SFC 92A40 (PLT SGT) R SGT 92A20 (MAT CON/ACCTG NCO) R SP4 92A10 (MAT CON/ACCTG SP) R SP4 92A10 (MAT CON/ACCTG SP) SAW 2 PFC 92A10 (MAT CON/ACCTG SP) R</p>
---	--





TRUCK SQUAD PARA 03

<p>AN/VRC-90F AN/UYQ-90(V)2 FBCB2 DAGR</p> 	
<p>X5</p> <p>SSG 88M30 (SQUAD LDR) R 3 SGT 88M20 (HVY VEH DRIVER) R 3 SP4 88M10 (HVY VEH DRIVER) R 3 PFC 88M10 (HVY VEH DRIVER) R</p>	

GENERAL SUPPLY & CLASS IX SECTION PARA 04

<p>AN/VRC-90F AN/UYQ-90(V)2 FBCB2 DAGR</p>  <p>X4</p>	<p>2 OL-604/TYQ IN SECTION</p>  <p>X6</p>	<p>AN/VRC-90F AN/UYQ-90(V)2 FBCB2 DAGR</p>  <p>X3</p>	 <p>X3</p>	 <p>X3</p>	 <p>X3</p>
<p>SFC 92A40 (STOCK CONTROL SUPV) R 2 SSG 92A30 (MAT MGMT SUPV) R SGT 92A20 (MAT CON/ACCTG NCO) R 5 SGT 92A20 (MAT STORE/HDLG SGT) R SP4 92A10 (MAT CON/ACCTG SP) R 5 SP4 92A10 (MAT STORE/HDLG SP) R</p>		<p>SP4 92A10 (SUBSISTANCE SUP SP) R PFC 92A10 (MAT CON/ACCTG SP) R 4 PFC 92A10 (MAT STORE/HDLG SP) R 3 PFC 92A10 (MAT STORE/HDLG SP) SAW 2 PFC 92A10 (SUBSISTANCE SUP SP) R</p>			

AMMUNITION TRANSFER HOLDING POINT PARA 05

<p>AN/VRC-90F AN/UYQ-90(V)2 FBCB2 AN/UYQ-90(V)3 DAGR</p>  <p>CW2 890A0 (AMMO WO) R SSG 89B30 (SECTION CHIEF) R</p>	<p>AN/VRC-90F AN/UYQ-90(V)2 FBCB2 DAGR</p>  <p>X3</p>	<p>AN/VRC-90F AN/UYQ-90(V)2 FBCB2 DAGR</p>  <p>X2</p>	 <p>X2</p>	 <p>X2</p>	<p>CAISI 2.0 SAAS-MOD-ATHP</p> <div style="border: 1px solid black; padding: 5px; text-align: center;"> <p>S-785G SHELTER</p> </div>
<p>SGT 89A20 (AMMO STK CON/ACCTG SGT) R SGT 89B20 (AMMO SGT) R SP4 89A10 (AMMO STK CON/ACCTG SP) R 2 SP4 89B10 (AMMO SP) R SP4 89B10 (AMMO SP) SAW 3 PFC 89B10 (AMMO SP) R</p>					

Distribution Company, BSB, (MEB) (cont)

FUEL & WATER PLATOON HQ PARA 06

CLASS III STORAGE/ISSUE SECTION PARA 07

AN/VRC-90F
AN/UYQ-90(V)2
FBCB2
AN/UYQ-90(V)3
DAGR



LT 92A00 (PLT LDR) R
SFC 92W40 (PLT SGT) R
SGT 92L20 (PETRL LAB SGT) R

AN/VRC-90F
AN/UYQ-90(V)2
FBCB2
DAGR



X5

AN/VRC-90F
AN/UYQ-90(V)2
FBCB2
DAGR



X2

SSG 92F30 (SECTION CHIEF) R
3 SGT 92F20 (PETRL HVY VEH OPR) R
SP4 92F10 (PETRL LT VEH OPR) R
6 SP4 92F10 (PETRL HVY VEH OPR) R
3 PFC 92F10 (PETRL LT VEH OPR) R

WATER SECTION PARA 08

AN/VRC-90F
FBCB2
DAGR



AN/VRC-90F
AN/UYQ-90(V)2
FBCB2
DAGR



X4



X7

DAGR



SSG 92W30 (WATER TRMT SUPV) R
SGT 92W20 (WATER TRMT NCO) R
SGT 92W20 (WATER TRMT NCO) SAW
4 SP4 92W10 (WATER TRMT SP) R
3 PFC 92W10 (WATER TRMT SP) R

Summary of Equipment

WEAPONS

LAUNCHER GRENADE: M320-----	4
MACHINE GUN 5.56MM M249-----	7
MACHINE GUN LIGHT 5.56MM M249-----	4
MACHINE GUN GRENADE 40MM MK-19 MOD III-----	3
MACHINE GUN 7.62MM M240B-----	7
PISTOL 9MM AUTOMATIC M9-----	1
RIFLE 5.56MM M16A2-----	80
MACHINE GUN: CALIBER .50 (M2E2)-----	5

VEHICLES, TRAILERS, AND TRLR MTD SYSTEMS

GEN SET DED TM: 10KW 60HZ (PU-798)-----	1
SEMITRAILER LOW BED: 25T 4 WHL (M172A1)-----	5
SEMITRAILER VAN: SUPPLY 12T 4 WHL (M129A2C)-----	3
TRUCK UTILITY EXP CAPACITY ENH 4X4: M1152A1-----	3
TRUCK CARGO: HVY PLS TRANSPORTER 10X10 (M1075)-----	3
TRUCK UTILITY EXP CAPACITY ENH 4X4: M1165A1-----	3
TRUCK CARGO: MTV (M1083)-----	1
TRUCK TANK: FUEL SERVICING 2500 GAL 8X8 HEMTT (M978)-----	5
TRUCK TRACTOR MTV (M1088)-----	8
TRUCK LIFT: FORK VARIABLE REACH RT (ATLAS)-----	5
TRAILER: PLS 8X20 (M1076)-----	23
TRAILER HIGH MOBILITY 1-1/4T (M1102)-----	3
LIGHT TACTICAL TRAILER: 3/4T (M1101)-----	2
TRUCK CARGO HEMTT LHS (M1120)-----	15
TRAILER TANK WATER (CAMEL) 800 GAL 5 TON-----	1

MISCELLANEOUS EQUIPMENT

BED CARGO: DEMOUNTABLE PLS 8X20-----	48
CONTAINER HANDLING: HVY EXP MOBIL TACT TRK (HEMTT)-----	3
FUEL SYSTEM SUPPLY POINT: FSSP TYPE 3 120K-----	1
GEN SET: DED SKID MTD 60KW 50/60HZ (MEP 806A)-----	1
GEN SET : DED SKID MTD 3KW 60HZ (MEP-831A)-----	2
SHELTER: TACTICAL EXPANDABLE TWOSIDE S785G-----	1
TACTICAL WATER PURIFICATION SYS (TWPS): 1500 GPH-----	1
LOAD HANDLING SYS (LHS) 2000GAL COMP WATER: (HIPPO)-----	15
WATER PURIFIER LIGHTWEIGHT-----	1
MODULAR FUEL SYSTEM - TANKRACK MODULE-----	5

COMMUNICATION-ELECTRONICS EQUIPMENT

ANTENNA GROUP: OE-254-----	2
COMPUTER SYSTEM DIGITAL: AN/UYQ-90(V)2 (MTS)-----	35
COMPUTER SET DIGITAL: AN/UYK-128 (FBCB2)-----	37
COMPUTER SET DIGITAL: OL-604/TYQ (SARSS DSU WS)-----	4
COMPUTER SET DIGITAL: AN/TYQ-109(V)1 (GCSS-A (V)1)-----	1
COMPUTER SET DIGITAL: OL-603/TYQ (SARSS DSU SVR)-----	1
COMPUTER SYSTEM DIGITAL: AN/UYQ-90(V)3 (MTS-CS)-----	4
ENCRYPT/DECRYPT EQUIPMENT: TACLANE KG-175-----	1
NAVIGATION SET: SATELLITE SIGNALS AN/PSN-13 (DAGR)-----	37
PROCESSOR GROUP SIGNAL DATA: (CAISI 2.0)-----	4
RADIAC SET: AN/VDR-2-----	4
RADIO SET: AN/VRC-90F-----	36
RADIO SET: AN/VRC-92F-----	2
COMPUTER SYSTEM DIGITAL: SAS-MOD-ATHP-----	1

NIGHT VISION/OBSERVATION EQUIPMENT

DRIVERS VISION ENHANCER: AN/VAS-5-----	5
NIGHT VISION GOGGLES: AN/PVS-7B-----	81
MEDIUM WEAPON THERMAL SIGHT (MWTS): AN/PAS-13(V)2-----	11
HEAVY WEAPON THERMAL SIGHT (HWTS): AN/PAS-13(V)3-----	8

Distribution Company, BSB, Maneuver Enhancement Bde

Field Maintenance Company, BSB (MEB)

43357R000
OFF: 4/WO: 5/ENL: 60/TOTAL: 69

COMPANY HQ PARA 01

AN/VRC-89F
FBCB2
DAGR
CAISI 2.0



CPT 91A00 (COMMANDER) P



AN/VRC-90F
FBCB2
AN/TYQ-109(V)1
DAGR
CAISI 2.0



LT 91A00 (EXEC OFF) R
SFC 91X40 (DETACHMENT SERGEANT) R
SGT 74D20 (CBRN NCO) R
SGT 92Y20 (SUPPLY NCO) R
SP4 74D10 (CBRN DECON SP) R

MAINT CONTROL SECTION PARA 02

AN/VRC-92F
FBCB2
DAGR



LT 91A00 (LT LDR) R

AN/VRC-89F
FBCB2
DAGR
5 AN/TYQ-139
AN/TYQ-140



SFC 91X40 (MAINT CONT SGT) R

AN/VRC-90F
FBCB2
DAGR



SGT 92A20 (EQ RCD/PARTS SGT) R
SP4 92A10 (EQ RCD/PARTS SP) R
PFC 92A10 (EQ RCD/PARTS SP) R
PFC 92A10 (EQ RCD/PARTS SP) SAW

AN/VRC-90F



SERVICE/RECOVERY SECTION PARA 03

AN/VRC-90F
FBCB2
DAGR



X2
SGT 91B20 (RCVY VEH OPR) R
SP4 91B10 (RCVY VEH OPR) R

AN/VRC-90F
FBCB2
DAGR



SGT 91B20 (RCVY VEH OPR) R

AN/VRC-90F



CW2 914A0 (ALLIED TRADES WO) R
SSG 81B30 (RCVY VEH SUPV) R

AN/VRC-90F
FBCB2
DAGR



SGT 91E20 (ALLIED TRADES SP) R
SP4 91E10 (ALLIED TRADES SP) R
PFC 91E10 (ALLIED TRADES SP) R

FIELD MAINTENANCE SECTION PARA 04

AN/VRC-92F
FBCB2
DAGR



CW2 915A0 (AUTO MAINT WO) R
SFC 91X40 (MOTOR SGT) R

AN/VRC-92F
FBCB2
DAGR



X2

AN/VRC-92F
FBCB2
DAGR



X2

AN/VRC-90F



AN/VRC-90F



X3

SSG 91B30 (SHOP FIREMAN) R
SSG 91B30 (SR MECHANIC) R
7 SGT 91B20 (WH VEH MECH) R
2 SP4 91B10 (WH VEH MECH) R
5 SP4 91B10 (WH VEH MECH) SAW
8 PFC 91B10 (WH VEH MECH) R
PFC 91B10 (WH VEH MECH) SAW

Field Maintenance Company, BSB (MEB) (cont)

MAINTENANCE PLATOON HQ PARA 05

AN/VRC-92F
FBCB2
DAGR



LT 91A00 (LT LDR) R
SFC 91X40 (PLT SGT) R

GROUND SUPPORT EQUIPMENT REPAIR SECTION PARA 06

AN/VRC-90F
FBCB2
DAGR



CW2 919A0 (ENGR EQ MAINT WO) R
SFC 91X40 (SP PURP EQ REP SUPV) R

AN/VRC-90F
FBCB2
DAGR



SGT 91C20 (UTIL EQ REP) R
SGT 91D20 (PWR-GEN EQ REP) R
SGT 91J20 (QM/CHEM EQ REP) R
SP4 91D10 (PWR-GEN EQ REP) R

AN/VRC-90F



X3
2 SP4 91J10 (QM/CHEM EQ REP) R
PFC 91C10 (UTIL EQ REP) R
2 PFC 91D10 (PWR-GEN EQ REP) R
2 PFC 91J10 (QM/CHEM EQ REP) R

ELECTRONIC EQUIPMENT MAINTENANCE SECTION PARA 07

AN/VRC-90F



AN/ASM-146

AN/VRC-90F



AN/ASM-146



PU 2101

CW2 948B0 (EL SYS MAINT WO) R
SFC 94W40 (ELECT MAINT SUPV) R
SP4 94E10 (COMSEC/RADIO EQ REP) R
SP4 94F10 (COMP/DET SYS REP) R

ARMAMENT REPAIR SECTION PARA 08

AN/VRC-90F
FBCB2
DAGR

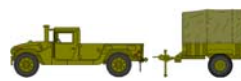

CW2 913A0 (ARMT SYS MAINT WO) R
SSG 91K30 (ARMT MAINT SUPV) R
SP4 91F10 (SM ARMS/ARTY REP) R

AN/VRC-90F



Summary of Equipment

WEAPONS

LAUNCHER GRENADE: M320-----	4
MACHINE GUN 5.56MM M249-----	7
MACHINE GUN LIGHT 5.56MM M249-----	4
MACHINE GUN 7.62MM M240B-----	3
PISTOL 9MM AUTOMATIC M9-----	1
RIFLE 5.56MM M16A2-----	61
MACHINE GUN: CALIBER .50 (M2E2)-----	7

VEHICLES, TRAILERS, AND TRLR MTD SYSTEMS

FORWARD REPAIR SYSTEM: M7 (FRS)-----	2
GEN SET DIESEL ENGINE TM: 30KW 50/60 HZ (PU-803)-----	2
SHOP EQUIPMENT: AUTOMOTIVE VEHICLE (TLR MTD) (SATS)---	1
SEMITRAILER VAN: SUPPLY 12T 4 WHL (M129A2C)-----	1
TOOL OUTFIT HYD SYS: TEST & REP 3/4T TLR MTD (HYSTRU)---	1
TRUCK UTILITY EXP CAPACITY ENH 4X4: M1152A1-----	7
TRUCK CARGO: HVY PLS TRANSPORTER 10X10 (M1075)-----	2
TRUCK VAN EXPANSIBLE MTV (M1087A1)-----	1
TRUCK UTILITY EXP CAPACITY ENH 4X4: M1165A1-----	3
TRUCK CARGO: MTV (M1083)-----	10
TRUCK CARGO: 4X4 LMTV (M1078)-----	1
TRUCK TRACTOR MTV (M1088)-----	1
TRUCK CARGO MTV LWB (M1085)-----	1
TRUCK WRECKER: TACTICAL 8X8 HEMTT (M984A1)-----	2
TRUCK VAN LMTV (M1079)-----	2
TRUCK WRECKER: MTV (M1089)-----	1
TRAILER CARGO: MTV W/ DROPSIDES (M1095)-----	5
TRAILER HIGH MOBILITY 1-1/4T (M1102)-----	4
LIGHT TACTICAL TRAILER: 3/4T (M1101)-----	1
TRAILER CARGO: LMTV W/DROPSIDES (M1082)-----	1
SHOP EQUIPMENT: WELDING TRAILER MTD-----	1
TRAILER-MTD : PU-2101/ 15KW 50/60HZ/ M200A1-----	2
TRAILER TANK WATER (CAMEL) 800 GAL 5 TON-----	1

COMMUNICATION-ELECTRONICS EQUIPMENT

ANTENNA GROUP: OE-254-----	2
COMPUTER SET DIGITAL: AN/UYK-128 (FBCB2)-----	18
COMPUTER SET DIGITAL: AN/TYQ-109(V)1 (GCSS-A (V)1)-----	1
NAVIGATION SET: SATELLITE SIGNALS AN/PSN-13 (DAGR)-----	18
PROCESSOR GROUP SIGNAL DATA: (CAISI 2.0)-----	3
RADIAC SET: AN/VDR-2-----	1
RADIO SET: AN/VRC-89F-----	2
RADIO SET: AN/VRC-90F-----	26
RADIO SET: AN/VRC-92F-----	2
COMPUTER SYSTEM: DIGITAL AN/TYQ-139 (SAMS-1E V1)-----	5
COMPUTER SYSTEM: DIGITAL AN/TYQ-140 (SAMS/SAMS-1E V2)---	1

NIGHT VISION/OBSERVATION EQUIPMENT

DRIVERS VISION ENHANCER: AN/VAS-5-----	19
NIGHT VISION GOGGLES: AN/PVS-7B-----	63
MEDIUM WEAPON THERMAL SIGHT (MWTS): AN/PAS-13(V)2-----	7
HEAVY WEAPON THERMAL SIGHT (HWTS): AN/PAS-13(V)3-----	7

MISCELLANEOUS EQUIPMENT

DECON APPARATUS LT WT-----	2
GEN SET : DED SKID MTD 3KW 60HZ (MEP-831A)-----	2
GEN SET: DED SKID MTD 10KW 60HZ (MEP-803A)-----	3
ELECTRONICS SHOP SHEL MTD AVIONICS: AN/ASM-146-----	1
ELECTRONICS SHOP SHEL MTD AVIONICS: AN/ASM-147-----	1
SHOP EQUIP: CONTACT MAINT ORD/ENGR TRK MTD-----	3

Sustainment Brigade

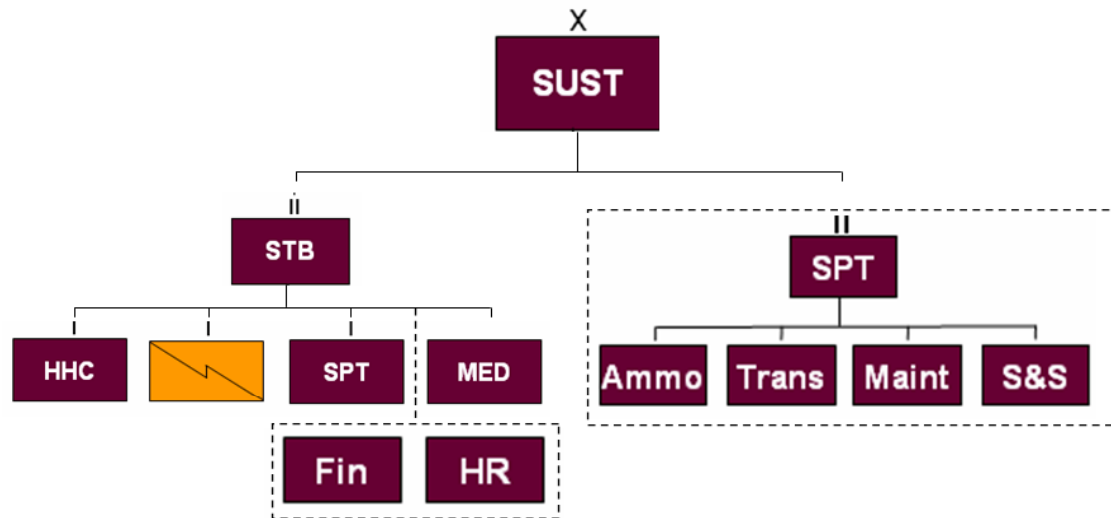

ANNEX SUST

HHC, Sustainment Brigade (Main)

63402G2A0

OFF: 47/WO: 12/ENL: 163/TOTAL: 222

COMMAND GROUP PARA 01

AN/VRC-92F
AN/UYQ-90(V)2
FBCB2
AN/TYQ-137A:(V)2
AN/PSC-5



COL 90A00 (COMMANDER) P
SGT 88M20 (VEH DRIVER) C

S1 SECTION PARA 02

AN/VRC-90F
AN/TYQ-137A:(V)2
CAISI 2.0



LT 42B00 (STRENGTH MGR) C
SSG 42A30 (HUMAN RES SGT) C
SGT 42A20 (HUMAN RES SGT) C
2 SP4 42A10 (HUMAN RES SP) C
SP4 42F10 (HR INFO SYS MGMT SP) C

S2 SECTION PARA 03

AN/VRC-90F
AN/TYQ-93



MAJ 35D00 (S2) P
SSG 35F30 (INTEL SGT) C
2 SP4 35F10 (INTEL ANALYST) C

S3 SECTION PARA 04

AN/VRC-92F
DAGR



LTC 90A00 (S3) P

AN/TSQ-243
AN/TSQ-259



MAJ 57A00 (ASST S3/SIMS OFF) P
7 CPT 90A00 (PLANS OFF) C
SFC 74D40 (CBRN STAFF NCO) C

AN/VRC-92F
AN/GYK-61 (BCS3)
AN/TYQ-137A:(V)2
DAGR



SFC 91X40 (OPNS SGT) C
2 SSG 92A30 (MAT MGMT NCO) C



S4 SECTION PARA 05

AN/VRC-90F
DAGR



MAJ 90A00 (S4) P

AN/GYK-61 (BCS3)
AN/TYQ-129(V)2
AN/TYQ-109(V)1



CW3 922A0 (SR FOOD ADVISOR) C
MSG 91Z50 (MECH MAINT OPS NCO) C
MSG 92Y50 (SR SUPPLY SGT) C
SFC 92Y40 (SR SUPPLY SGT) C



AN/TYQ-137A:(V)2
AN/UYQ-90(V)3
AN/TYQ-95
DAGR
CAISI 2.0
AN/TSQ-259



PU-798

CIVIL AFFAIRS SECTION PARA 06

AN/VRC-90F
DAGR



SFC 38B40 (CIVIL AFFAIRS NCO) C

S6 SECTION PARA 07

AN/VRC-90F



CW2 254A0 (SGNL SYS TECH) C
SGT 25B20 (SR LAN MGR) C
SP4 25U10 (SGNL INFO SVC SP) C
PFC 25U10 (SGNL SPT SYS SP) C

AN/VRC-92F
AN/GYK-33D
FBCB2
AN/GYK-61 (BCS3)
AN/TYQ-137A:(V)2
DAGR
2 AN/TSR-8 (GRT)
AN/GYK-50B (ISYSCON)(V)4



M1113

UNIT MINISTRY TEAM PARA 08

AN/VRC-90F
AN/UYQ-90(V)2
DAGR



MAJ 56A00 (CHAPLAIN)
SSG 56M30 (CHAP ASST NCO) C

STAFF JUDGE ADVOCATE (SJA) PARA 09



MAJ 27A00 (COMMAND JUDGE ADVOCATE) P
SSG 27D30 (PARALEGAL NCO) C

PAO SECTION PARA 10

DAGR



SFC 46Z40 (PUBLIC AFFAIRS NCO) C
SGT 46Q20 (PUBLIC AFFAIRS SGT) C

SURGEON SECTION PARA 11

DAGR
AN/PSC-5



LTC 60A00 (SURGEON) P

AN/TYQ-107(V)1
2 AN/TYQ-106(V)1
AN/TYQ-105(V)1
AN/TYQ-108(V)3
CAISI 2.0

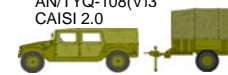

MAJ 70K67 (MED LOG OFF) P
CPT 70H67 (MED OPS OFF) C
MSG 68W50 (OPNS NCO) C

TREATMENT PLATOON HQ PARA 12

AN/VRC-89F
AN/TYQ-107(V)1
AN/UYQ-90(V)2
AN/TYQ-106(V)1
FBCB2
DAGR
CAISI 2.0
AN/PSC-5



SSG 68W30 (SECTION NCO) C

MEDICAL TREATMENT SQUAD PARA 13

AN/VRC-89F
2 AN/TYQ-106(V)1
4 AN/TYQ-105(V)1
DAGR
CAISI 2.0



CPT 62B00 (FIELD SURGEON) P
SSG 68W30 (HEALTH CARE SGT) C
SGT 68W20 (HEALTH CARE SGT) C
SP4 68W10 (HEALTH CARE SP) C

AN/VRC-89F
2 AN/TYQ-106(V)1
4 AN/TYQ-105(V)1
DAGR
CAISI 2.0



LT 65D00 (PHYSICIAN ASST) P
SGT 68W20 (HEALTH CARE SGT) C
SP4 68W10 (HEALTH CARE SP) C
PFC 68W10 (HEALTH CARE SP) C

AN/VRC-90F
AN/TYQ-106(V)1
FBCB2
DAGR
CAISI 2.0



MEDICAL EVACUATION SQUAD PARA 14

AN/VRC-90F
AN/UYQ-90(V)2
FBCB2
2 AN/TYQ-105(V)1
DAGR
CAISI 2.0



SGT 68W20 (EMERGENCY CARE SGT) C
SP4 68W10 (AMB AIDE/DRIVER) C
2 PFC 68W10 (AMB AIDE/DRIVER) C

AN/VRC-90F
AN/UYQ-90(V)2
FBCB2
2 AN/TYQ-105(V)1
DAGR
CAISI 2.0



HHC, Sustainment Brigade (Main) (cont)

SUPPORT OPERATIONS PARA 15

AN/VRC-92F
2 FBCB2
AN/GYK-61 (BCS3)
AN/TYQ-137A:(V)2
AN/UYQ-90(V)3



MAJ 90A00 (ASST SPT OPS OFF) P
SGM 92Z50 (SR LOG OPS NCO) C

PLANS BRANCH PARA 16

AN/VRC-90F



MAJ 12A00 (ENGINEER OFF) P
MAJ 90A00 (CHIEF) P
CPT 91A00 (PLANS OFF) C
CPT 92A00 (SUPPLY & SVC OFF) C

2 AN/VRC-90F
AN/GYK-61 (BCS3)



MSG 92A50 (OPNS SGT) C
SFC 91X40 (MAINT MGMT NCO) C

DISTRIBUTION OPERATIONS SECTION PARA 17

AN/VRC-90F
4 AN/GYK-61 (BCS3)
DAGR
2 CAISI 2.0



SGM 92Z50 (SR LOG OPNS NCO) C
SP4 92A10 (SUBSISTENCE SUPPLY SP) C

EFFECTS SECTION PARA 18



MAJ 90A00 (LOG OPNS OFF) P
MSG 91Z50 (OPNS SGT) C
SFC 91X40 (MAINT MGMT NCO) C
SSG 88N30 (MOVEMENTS NCO) C
SGT 89B20 (AMMO SGT) C
SGT 92Y20 (SUPPLY NCO) C
SP4 91B10 (WH VEH MECH) C

TRANS INTEGRATION DIVISION PARA 19

AN/VRC-90F
DAGR



CPT 31A00 (CIRCULATION CONTROL OFF) C
CPT 88A00 (AIR MOVEMENTS OFF) C
CPT 88D00 (MOTOR/RAIL TRANS OFF) C
MSG 88Z50 (OPNS SGT) C
SFC 31B40 (AS/FP SUPV) C
SFC 88N40 (TRANS LOG NCO) C

AN/VRC-90F
2 AN/TYQ-129(V)2
CAISI 2.0



CLASS V/MUNITIONS SECTION PARA 20

AN/VRC-90F
FBCB2
DAGR



CPT 91A00 (AMMO OFF) C

AN/VRC-90F
2 OL-605/TYQ
AN/GYK-61 (BCS3)
DAGR
2 CAISI 2.0



CW3 890A0 (AMMO WO) C
MSG 89B50 (CHIEF AMMO NCO) C
2 SSG 89B30 (AMMO SUPPLY SGT) C
SGT 89A20 (AMMO STK CON/ACCTG SGT) C
SGT 89B20 (AMMO SGT) C
SP4 89A10 (AMMO STK CON/ACCTG SP) C
PFC 89A10 (AMMO STK CON/ACCTG SP) C

GENERAL SUPPLY SECTION PARA 21



CW3 920B0 (SR SUPPLY SYS TECH) C
2 SFC 92A40 (MAT MGMT NCO) C
2 SSG 92A30 (SUBSISTENCE NCO) C
2 PFC 92A10 (MAT CONT/ACCTG SP) C

AN/VRC-90F
AN/GYK-61 (BCS3)
2 AN/TYQ-109(V)1
2 OL-589/TYQ
AN/PSC-5

PETROLEUM AND WATER SECTION PARA 22

AN/VRC-90F
AN/GYK-61 (BCS3)
DAGR



CW2 923A0 (PETROLEUM SYS TECH) C
SFC 92F40 (SR FUEL OPS SGT) C
SGT 92F20 (FUEL OPS SGT) C
SGT 92W20 (WATER TRMT NCO) C

AN/VRC-90F

PROPERTY BOOK OFFICE PARA 23

AN/VRC-90F
DAGR



CW4 920A0 (SR PROPERTY ACCT TECH) C
MSG 92Y50 (SR SUPPLY SGT) C
2 SFC 92Y40 (SR SUPPLY SGT) C
2 SGT 92Y20 (PROPERTY BOOK NCO) C
2 SP4 92Y10 (SUPPLY SP) C

AN/TYQ-109(V)2

MAINTENANCE BRANCH PARA 24

AN/VRC-90F
DAGR
AN/TYQ-141



MAJ 91A00 (MAINT MGMT OFF) P
CW4 948B0 (EL SYS MAINT WO) C
CW3 913A0 (AUTO MAINT WO) C
CW3 948D0 (EL-MSL SYS MAINT WO) C
SFC 91K40 (ARMT MAINT SGT) C
SFC 91X40 (ENGR EQ MAINT NCO) C



SFC 91X40 (SP PURP EQ MGT NCO) C
SFC 94W40 (ELECTR MAINT SUPV) C
SSG 25F30 (PLANS/OPS NCO) C
SSG 35T30 (MI SYS MNTR/INTEGR SGT) C
SSG 94E30 (COMSEC/RADIO SUPV) C
SGT 92A20 (MAT CONT/ACCTG NCO) C

HHC, Sustainment Brigade (Main) (cont)

SERVICES SECTION PARA 25

AN/VRC-90F
AN/GYK-61 (BCS3)
DAGR



MAJ 90A00 (SUPPLY MGMT OFF) P
SGM 92Z50 (SR LOG OPS NCO) C

FIELD SERVICES SECTION PARA 26

AN/VRC-90F
DAGR



CPT 92A00 (MORTUARY AFFAIRS OFF) C
CW3 921AP (SR AIRDROP SYS TECH) C
SFC 92S40 (SR SHW/LAU & CL RP NCO) C
SSG 92M30 (MORTUARY AFFAIRS NCO) C
SSG 92S30 (SR SHW/LAU & CL RP NCO) C

CSSAMO PARA 28

AN/VRC-90F
AN/UYQ-90(V)2
DAGR



CW3 920B0 (SR SUPPLY SYS TECH) C
SFC 92A40 (MAT CONT SUPV) C
SGT 92Y30 (SUPPLY SGT) C
SGT 25B20 (SR INFO SYS SP) C

AN/VRC-90F
AN/TYQ-107(V)2
AN/TYQ-107(V)1
AN/TYQ-106(V)1
OL-582/TYQ
OL-604/TYQ

AN/TYQ-105(V)1
AN/TYQ-108(V)3
AN/TYQ-109(V)2
OL-608/TYQ
OL-603/TYQ
AN/UYQ-90(V)3

CAISI 2.0
OL-713(V)1/TYQ CSS VSAT
AN/TYQ-141



SGT 68J20 (MED LOG SGT) C
SGT 89A20 (AMMO STK/ACCTG SGT) C
SGT 92A20 (MAT MGMT NCO) C
SGT 92Y20 (SUPPLY NCO) C
SP4 25B10 (INFO TECH SP) C
PFC 25B10 (INFO TECH SP) C

PU 805

HOST NATION SUPPORT BRANCH PARA 29

AN/VRC-90F
DAGR



MSG 92A50 (LOGISTIC NCO) C

HUMAN RESOURCE OPERATIONS PARA 30

AN/VRC-90F
DAGR
CAISI 2.0



MAJ 42H00 (ASST OPNS OFF) P



CPT 42B00 (PLANS OFF) C



CPT 42B00 (POSTAL OFF) C
SFC 42A40 (POSTAL SUPV) C
SGT 42A20 (POSTAL SGT) C

AN/GYK-61 (BCS3)
7 AN/TYQ-116(V)3



CW2 420A0 (CHIEF) C
MSG 42A50 (SR HUMAN RES SGT) C
SSG 42A30 (CASUALTY OPS NCO) C
SGT 42F20 (HR INFO SYS MGMT SP) C



FINANCIAL MANAGEMENT OPERATIONS PARA 31

AN/VRC-90F
DAGR
AN/TYQ-132(V)1



MAJ 36A00 (PLANS OFF) P

HEADQUARTERS/STB PARA 32

AN/VRC-92F
AN/UYQ-90(V)2
FBCB2
AN/TYQ-137A:(V)2
DAGR



LTC 90A00 (COMMANDER) P
SP4 25U10 (SGNL INFO SVC SP) C

AN/VRC-90F
FBCB2



CSM 00Z50 (CSM) P

S1 SECTION/STB PARA 33

AN/VRC-90F
DAGR



CPT 42B00 (S1) C

CAISI 2.0
3 AN/TYQ-116(V)3



M1113
SFC 42A40 (SR HUMAN RES SGT) C
SSG 27D30 (PARALEGAL NCO) C
SGT 42A20 (HUMAN RES SGT) C
SP4 42A10 (HUMAN RES SP) C

S2/S3 SECTION/STB PARA 34

AN/VRC-92F
FBCB2
DAGR



CPT 01A00 (ASST S3) C

AN/VRC-92F
FBCB2
2 AN/TYQ-137A:(V)2
CAISI 2.0



M1113

MSG 91Z50 (OPNS SGT) C
SSG 92A30 (MAT MGMT NCO) C
SGT 74D20 (CBRN NCO) C
SGT 88N20 (MOVEMENTS NCO) C
SP4 25U10 (SGNL INFO SVC SP) C

S4 SECTION/STB PARA 35

AN/VRC-90F
DAGR



MSG 91Z50 (SR MAINT SUPV) C
SGT 92Y20 (SUPPLY NCO) C
SP4 92Y10 (SUPPLY SP) C

AN/VRC-92F
AN/TYQ-129(V)2
AN/TYQ-109(V)1



M1113

RELIGIOUS SUPPORT TEAM/ STB PARA 36

AN/VRC-90F
AN/UYQ-90(V)2
DAGR



CPT 56A00 (CHAPLAIN)
SP4 56M10 (CHAPLAIN ASST) C

HHC, Sustainment Brigade (Main) (cont)

TRIAL DEFENSE TEAM/STB PARA 37



MAJ 27A00 (SR DEFENSE COUNSEL) P
 3 CPT 27A00 (DEFENSE COUNSEL) C
 SSG 27D30 (PARALEGAL NCO) C
 SP4 27D10 (PARALEGAL SP) C

HEADQUARTERS COMPANY PARA 38

AN/UYQ-90(V)2
 FBCB2
 DAGR



CPT 90A00 (COMMANDER) P

AN/TYQ-109(V)1
 CAISI 2.0



1SG 92A5M (FIRST SERGEANT) C
 SGT 74D20 (CBRN NCO) C
 SGT 92Y20 (SUPPLY NCO) C
 SP4 92Y10 (SUPPLY SP) C
 PFC 92Y10 (SUPPLY SP) C



AN/MJQ-41A



AN/MJQ-41B



PU 805

FIELD FEEDING SECTION PARA 39

AN/VRC-90F
 DAGR

DAGR

AN/UYQ-90(V)2



SFC 92G40 (SR FOOD OPNS SGT) C
 SSG 92G30 (FOOD OPNS MGR) C
 SGT 92G20 (FOOD OPNS NCO) C
 2 SP4 92G10 (FOOD OPNS SP) C
 2 PFC 92G10 (FOOD OPNS SP) C

X2

MAINTENANCE SECTION PARA 40

OL-582/TYQ
 CAISI 2.0

AN/VRC-90F
 AN/UYQ-90(V)2



SFC 91X40 (MOTOR SGT) C
 SSG 91B30 (SHOP FOREMAN) C
 SSG 91B30 (SR MECHANIC) C
 2 SSG 91D30 (SR PWR-GEN EQ REP) C
 4 SGT 91B20 (WHL VEH MECH) C
 SGT 91C20 (UTIL EQ REP) C
 SGT 91D20 (PWR-GEN EQ REP) C
 SGT 91J20 (QM/CHEM EQ REP) C
 SGT 92A20 (EQ RCD/PARTS SP) C
 SP4 25U10 (SGNL SPT SYS MAINT) C

SP4 74D10 (CBRN DECON SP) C
 4 SP4 91B10 (WHL VEH MECH) C
 2 SP4 91D10 (PWR-GEN EQ REP) C
 SP4 92A10 (EQ RCD/PARTS SP) C
 SP4 94F10 (COMP/DET SYS REP) C
 6 PFC 91B10 (WHL VEH MECH) C
 PFC 91C10 (UTILITIES EQ REP) C
 2 PFC 91D10 (PWR-GEN EQ REP) C
 PFC 91J10 (QM/CHEM EQ REP) C

SP4 91B10 (RCVY VEH OPR) C

Summary of Equipment

WEAPONS

LAUNCHER GRENADE 40MM M203A1-----	4
MACHINE GUN 5.56MM M249-----	19
MACHINE GUN LIGHT 5.56MM M249-----	4
MACHINE GUN GRENADE 40MM MK-19 MOD III-----	3
MACHINE GUN 7.62MM M240B-----	5
PISTOL 9MM AUTOMATIC M9-----	22
RIFLE 5.56MM M4 CARBINE-----	175
MACHINE GUN: CALIBER .50 (M2E2)-----	7

VEHICLES, TRAILERS, AND TRLR MTD SYSTEMS

CHEM AND BIO PROTECTED SHELTER SYSTEM (CBPS)-----	2
CONTAINERIZED KITCHEN (CK)-----	1
GEN SET DED TM: 10KW 60HZ (PU-798)-----	1
GEN SET DIESEL ENGINE TM: 60 KW 50/60HZ (PU-805)-----	2
POWER PLANT: ELEC TRL/MTD 60KW 50/60HZ (AN/MJQ 41)-----	1
POWER PLANT: UTILITY, LARGE 35KW 12 TON ECU-----	1
POWER PLANT: UTILITY, MEDIUM 20KW 5 TON ECU-----	4
SHOP EQUIPMENT: AUTOMOTIVE VEHICLE (TLR MTD)-----	1
TRUCK UTILITY EXP CAPACITY ENH 4X4: M1152A1-----	5
TRUCK AMBULANCE: 4 LITTER HMMWV (M997)-----	2
TRUCK CARGO: MTV (M1083)-----	7
TRUCK VAN EXPANSIBLE MTV (M1087A1)-----	6
TRUCK UTILITY EXP CAPACITY ENH 4X4: M1165A1-----	2
TRUCK CARGO: 4X4 LMTV (M1078)-----	2
TRUCK UTILITY: CGO/TRP CARRIER 1-1/4T HMMWV (M998)-----	48
TRUCK UTILITY: EXP CAP 4X4 HMMWV (M1113)-----	4
TRAILER: PLS 8X20 (M1076)-----	1
TRUCK WRECKER: MTV (M1089)-----	1
TRAILER CARGO: MTV W/ DROPSIDES (M1095)-----	2
TRAILER HIGH MOBILITY 1-1/4T (M1102)-----	2
LIGHT TACTICAL TRAILER: 3/4T (M1101)-----	39
TRUCK CARGO HEMTT LHS (M1120)-----	1
TRAILER CARGO: LMTV W/DROPSIDES (M1082)-----	1
TRAILER TANK WATER (CAMEL) 800 GAL 5 TON-----	4
TAC ELECT PWR (TEP) TM: PU-2101/ 15KW 50/60HZ/ M200A1-----	1

MISCELLANEOUS EQUIPMENT

BED CARGO: DEMOUNTABLE PLS 8X20-----	1
GEN SET : DED SKID MTD 3KW 60HZ (MEP-831A)-----	7
JOINT SERVICE: TRANSPORTABLE DECON SYSTEM (JSTDS)-----	2
RIGID WALL SHELTER: COMMAND POST-----	3
TANK AND PUMP UNIT LIQ DISPENSING TRUCK MTD (TPU)-----	1
TANK UNIT LIQUID DISPENSING TRAILER MTG-----	1
MULTI-TEMP REFRIGERATED CONTAINER SYS: MTRCS-----	1
GEN SET DED 5KW 50/60HZ: SKID-MTD-----	1
GENERATOR SET DED 10KW 50/60HZ: SKID MTD (TEP)-----	2
GENERATOR SET DED 15KW 50/60HZ: SKID MTD (TEP)-----	1

COMMUNICATION-ELECTRONICS EQUIPMENT

ALL SOURCE ANALYSIS SYSTEM: AN/TYQ-93 (ASAS-LT)-----	1
ANTENNA GROUP: OE-254-----	11
COMPUTER SYSTEM DIGITAL: AN/TYQ-107(V)1 (MC4-3A)-----	1
COMPUTER SYSTEM DIGITAL: AN/TYQ-107(V)2 (MC4-3B)-----	3
COMPUTER SYSTEM DIGITAL: AN/UYQ-90(V)2 (MTS)-----	11
COMPUTER SET GENERAL: AN/GYK-33D-----	1
COMPUTER SET DIGITAL: OL-605/TYQ (SAAS-MOD)-----	2
COMPUTER SYSTEM DIGITAL: AN/TYQ-106(V)1 (MC4-2)-----	9
COMPUTER SET DIGITAL: AN/UYK-128 (FBCB2)-----	14
COMPUTER SET DIGITAL: OL-582/TYQ (ULLS-G)-----	2
BTL CMD SUSTAINMENT SPT SYSTEM: AN/GYK-61 (BCS3)-----	16
COMPUTER SET DIGITAL: OL-604/TYQ (SARSS DSU WS)-----	1
COMPUTER SYS DIGITAL: AN/TYQ-129(V)2 (TC-AIMS II WS)-----	4
COMPUTER SYSTEM DIGITAL: AN/TYQ-105(V)1 (MC4-1)-----	14
COMPUTER SYSTEM DIGITAL: AN/TYQ-108(V)3 (MC4-4C)-----	2
COMPUTER SET DIGITAL: AN/TYQ-109(V)1 (GCSS-A (V)1)-----	5
COMPUTER SET DIGITAL: AN/TYQ-109(V)2 (GCSS-A (V)2)-----	2
COMPUTER SET DIGITAL: OL-608/TYQ (SAAS-MOD DAO)-----	1
COMPUTER SYSTEM DIGITAL: (CPWF WS) AN/TYQ-137A:(V)2-----	9
COMMAND CENTER SYSTEM: AN/TSQ-243-----	1
COM SET DIGITAL: OL-589/TYQ (CTSC-II FLYAWAY CONF)-----	2
COMPUTER SET DIGITAL: OL-603/TYQ (SARSS DSU SVR)-----	1
COMPUTER SYSTEM DIGITAL: AN/UYQ-90(V)3 (MTS-CS)-----	3
INTERROGATOR SET AN/TYQ-95 (TC-AIMS II INTERROGATOR)-----	2
NAVIGATION SET: SATELLITE SIGNALS AN/PSN-13 (DAGR)-----	33
PROCESSOR GROUP SIGNAL DATA: (CAISI 2.0)-----	21
RADIAC SET: AN/VDR-2-----	7
RECEIVE SUITE: AN/TSR-8 (GRT)-----	2
RADIO SET: AN/VRC-89F-----	3
RADIO SET: AN/VRC-90F-----	35
RADIO SET: AN/VRC-92F-----	9
RADIO SET: AN/PSC-5-----	4
SUPPORT SYSTEM TACTICAL: AN/TYQ-132(V)1-----	1
COMPUTER SYSTEM DIGITAL: AN/GYK-50B (ISYSCON) (V4)-----	1
INTERFACE UNIT COMM EQ: OL-713(V)1/TYQ CSS VSAT-----	1
COMMUNICATIONS SUBSYSTEM: AN/TSQ-259:-----	2
COMPUTER SYSTEM DIGITAL: AN/TYQ-141 (SAMS-2E V2)-----	2
COMMAND SYSTEM TACTICAL: AN/TYQ-155(V)1 (TCB SERVER)-----	1
COMP SYS DIGITAL: (AHR5) AN/TYQ-116(V)3-----	10

NIGHT VISION/OBSERVATION EQUIPMENT

DRIVERS VISION ENHANCER: AN/VAS-5-----	18
NIGHT VISION GOGGLES: AN/PVS-7B-----	162
MEDIUM WEAPON THERMAL SIGHT (MWTS): AN/PAS-13(V)2-----	9
HEAVY WEAPON THERMAL SIGHT (HWTS): AN/PAS-13(V)3-----	7

HHC, Sustainment Brigade (Main)

Early Entry Element, Sustainment Brigade

63402G2B0
OFF: 28/WO: 4/ENL: 70/TOTAL: 102

COMMAND GROUP PARA 01

AN/VRC-92F
AN/UYQ-90(V)2
DAGR



LTC 90A00 (DEPUTY CDR) P
SP4 88M10 (VEH DRIVER) C

AN/VRC-90F
FBCB2
DAGR



CSM 00Z50 (CSM) P

S1 SECTION PARA 02

AN/VRC-90F
DAGR
CAISI 2.0



MAJ 42H00 (S1) P
CW2 420A0 (MIL PERS TECH) C
MSG 42A50 (SR HUMAN RES SGT) C
SSG 42A30 (HUMAN RES SGT) C
SGT 42A20 (HUMAN RES SGT) C
SGT 42F20 (HR INFO SYS MGMT SP) C
SP4 42A10 (HUMAN RES SP) C

S2 SECTION PARA 03

AN/VRC-90F
DAGR



CPT 35D00 (ASST S2) C
SSG 35F30 (INTEL SGT) C

S3 SECTION PARA 04

AN/VRC-92F
AN/TSQ-243
DAGR
AN/TSQ-259



MED PWR PLANT

CPT 74A00 (CBRN OFF) C
SGM 92Z50 (SR LOG OPS NCO) C
SFC 91X40 (OPNS SGT) C

AN/TSQ-243
DAGR
CAISI 2.0



PU-2101



S4 SECTION PARA 05

AN/VRC-92F
DAGR



AN/GYK-61 (BCS3)
AN/TYQ-129(V)2
AN/TYQ-109(V)1
DAGR





PU-2101

MSG 92G50 (SR FOOD OPNS SGT) C
SFC 91X40 (SR MAINT ANALYST) C
SGT 92Y20 (SUPPLY NCO) C
SP4 92Y10 (SUPPLY SP) C

S6 SECTION PARA 06

AN/VRC-90F
DAGR



MAJ 25A00 (S6) P

AN/VRC-92F
AN/GYK-33D
DAGR
AN/TSR-8 (GRT)



M1113

MSG 25U50 (SGNL SPT SYS CHIEF) C
SSG 25B30 (DATA SYS INTEGR) C
SGT 25B20 (SR LAN MGR) C



STAFF JUDGE ADVOCATE PARA 07

CPT 27A00 (OPLAW JA) C

SURGEON SECTION PARA 08

DAGR

AN/VRC-89F
AN/TYQ-107(V)1
AN/TYQ-106(V)1
AN/TYQ-108(V)3
DAGR

MAJ 70H67 (MED OPNS OFF) P
CPT 70K67 (MED LOG OFF) C
MSG 68W50 (OPNS NCO) C

SUPPORT OPERATIONS PARA 09

AN/VRC-92F
AN/TYQ-129(V)2
AN/UYQ-90(V)3



MED PWR PLANT

LTC 90A00 (SPT OPNS OFF) P
SP4 92Y10 (SUPPLY SP) C

PLANS BRANCH PARA 10

CPT 88A00 (MOVEMENTS CONT OFF) C
SFC 12B40 (OPNS SGT) C

DISTRIBUTION OPNS SECTION PARA 11

AN/UYQ-90(V)3

MAJ 90A00 (LOG OPNS OFF) P

EFFECTS SECTION PARA 12

DAGR



CPT 90A00 (OPNS OFF) C
SFC 92A40 (MAT MGMT NCO) C

TRANS INTEGRATION DIVISION PARA 13

AN/VRC-90F
DAGR



AN/VRC-90F
AN/TYQ-129(V)2
CAISI 2.0



MED PWR PLANT

MAJ 88A00 (TRANS OFF) P
CPT 31A00 (CIRCULATION CONT OFF) C
CPT 88D00 (MOTOR/RAIL TRANS OFF) C
CPT 92D00 (AERIAL DELIVERY OFF) C
CW3 882A0 (MOBILITY OFF) C
SFC 31B40 (MMS NCO) C
SFC 88N40 (SR MOVEMENTS NCO) C

2 AN/TYQ-129(V)2
AN/UYQ-90(V)3



PU-2101



Early Entry Element, Sustainment Brigade (cont)

CLASS V/MUNITIONS SECTION PARA 14

AN/VRC-90F
DAGR



MAJ 91A00 (MUNITIONS MAT MGMT OFF) P

AN/VRC-90F
OL-605/TYQ
AN/UYQ-90(V)3
DAGR
CAISI 2.0



CW3 890A0 (AMMO WO) C
SFC 89B40 (AMMO LOG SGT) C
SGT 89A20 (AMMO STK CON/ACCTG SGT) C
SGT 89B20 (AMMO SGT) C
SP4 89A10 (AMMO STK CON/ACCTG SP) C
PFC 89A10 (AMMO STK CON/ACCTG SP) C

GENERAL SUPPLY BRANCH PARA 15

AN/VRC-90F
DAGR



MAJ 92A00 (LOG OFF) P
3 SGT 92A20 (MAT MGMT NCO) C
3 SP4 92A10 (MAT CONT/ACCTG SP) C

AN/TYQ-109(V)1
OL-589/TYQ
DAGR



PU-2101

PETROLEUM AND WATER SECTION PARA 16

AN/VRC-90F
DAGR



CPT 92F00 (FUEL OPNS OFF) C
SFC 92W40 (WATER TRMT NCO) C
SGT 92F20 (FUEL HANDLING SP) C

MAINTENANCE BRANCH PARA 17

DAGR
CAISI 2.0
AN/TYQ-141



MSG 91Z50 (MECH MAINT OPS NCO) C
SFC 91X40 (OPNS SGT) C
SFC 94X40 (SEC CHIEF) C

FIELD SERVICES SECTION PARA 18

AN/VRC-90F
DAGR



SFC 92M40 (MORTUARY AFFAIRS NCO) C

CSSAMO PARA 19

2 AN/VRC-90F
AN/UYQ-90(V)2
AN/TYQ-106(V)1
OL-582/TYQ
OL-604/TYQ
AN/TYQ-129(V)2
AN/TYQ-109(V)1

OL-603/TYQ
AN/UYQ-90(V)3
CAISI 2.0
OL-713(V)1/TYQ CSS VSAT
AN/TYQ-141



MAJ 53A00 (AUTOMATION MGMT OFF) P
CW2 251A0 (INFO SYS TECH) C
SFC 25B40 (INFO SYS SUPV) C
SSG 25B30 (INFO SYS SEC ANALYST) C
SSG 92A30 (MAT MGMT NCO) C

HOST NATION SPT BRANCH PARA 20

MAJ 39C00 (CIVIL AFFAIRS OFF) P
CPT 90A00 (SPT OPNS OFF) C

HUMAN RESOURCE OPERATIONS PARA 21

AN/VRC-90F
DAGR



CPT 42B00 (OPNS OFF) C
SFC 42A40 (CASUALTY OPS NCO) C

FINANCIAL MANAGEMENT PARA 22

AN/TYQ-132(V)1



MAJ 36A00 (FINANCIAL MGMT OFF) P
MSG 36B50 (FINANCIAL MGMT ADVISOR) C

HEADQUARTERS/BTB PARA 23

AN/VRC-92F
AN/UYQ-90(V)2
DAGR



MAJ 01A00 (EXEC OFF) P
SGT 25U20 (SGNL SPT NCO) C

S1 SECTION/STB PARA 24

AN/VRC-90F
DAGR
CAISI 2.0
2 AN/TYQ-116(V)3



SGT 42A20 (HUMAN RES SGT) C
2 PFC 42A10 (HUMAN RES SP) C

S2/S3 SECTION/STB PARA 25

AN/VRC-92F
DAGR
CAISI 2.0



CPT 01A00 (ASST S3) C
SSG 35F30 (INTEL SGT) C

S4 SECTION/STB PARA 26

AN/VRC-92F
AN/TYQ-129(V)2
AN/TYQ-109(V)1
AN/UYQ-90(V)3
DAGR



M1113

CPT 90A00 (S4) C
SFC 92Y40 (SR SUPPLY SGT) C
SP4 92Y10 (SUPPLY SP) C

HEADQUARTERS COMPANY PARA 27

AN/VRC-90F
AN/UYQ-90(V)2
AN/TYQ-109(V)1
CAISI 2.0



LT 92A00 (EXEC OFF) C
SSG 92Y30 (SUPPLY SGT) C

Early Entry Element, Sustainment Brigade (cont)

FIELD FEEDING SECTION PARA 28

AN/VRC-90F
DAGR

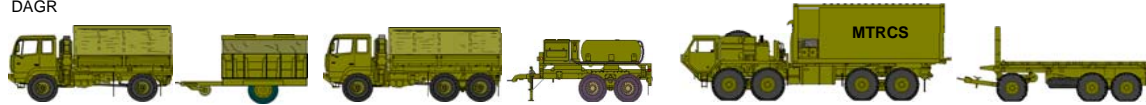

SSG 92G30 (FOOD OPNS MGR) C
SGT 92G20 (FOOD OPNS NCO) C
SP4 92G10 (FOOD OPNS SP) C
PFC 92G10 (FOOD OPNS SP) C

MAINTENANCE SECTION PARA 29

AN/VRC-90F
OL-582/TYQ
CAISI 2.0



SFC 91X40 (MOTOR SGT) C
SSG 91B30 (SR MECHANIC) C
SGT 91B20 (WHL VEH MECH) C
SGT 91D20 (PWR-GEN EQ REP) C
SGT 92A20 (EQ RCD/PARTS SP) C
SP4 25U10 (SGNL SPT SYS MAINT) C
SP4 91C10 (UTILITIES EQ REP) C

SP4 91J10 (QM/CHEM EQ REP) C
SP4 74D10 (CBRN DECON SP) C
2 PFC 91B10 (WHL VEH MECH) C
PFC 91D10 (PWR-GEN EQ REP) C

AN/VRC-90F
AN/UYQ-90(V)2

SP4 91B10 (RCVY VEH OPR) C

Summary of Equipment

WEAPONS

LAUNCHER GRENADE 40MM M320A1-----	4
MACHINE GUN 5.56MM M249-----	8
MACHINE GUN LIGHT 5.56MM M249-----	4
MACHINE GUN GRENADE 40MM MK-19 MOD III-----	1
MACHINE GUN 7.62MM M240B-----	4
PISTOL 9MM AUTOMATIC M9-----	13
RIFLE 5.56MM M4 CARBINE-----	82
MACHINE GUN: CALIBER .50 (M2E2)-----	6

VEHICLES, TRAILERS, AND TRLR MTD SYSTEMS

GEN SET DIESEL ENGINE TM: 30KW 50/60 HZ (PU-803)-----	1
GEN SET DIESEL ENGINE TM: 60 KW 50/60HZ (PU-805)-----	1
KITCHEN FIELD TRAILER MOUNTED: MFK75 (MKT)-----	1
POWER PLANT: UTILITY, MEDIUM 20KW 5 TON ECU-----	3
SHOP EQUIPMENT: AUTOMOTIVE VEHICLE (TLR MTD)-----	1
TRUCK UTILITY EXP CAPACITY ENH 4X4: M1152A1-----	4
TRUCK CARGO: MTV (M1083)-----	4
TRUCK VAN EXPANSIBLE MTV (M1087A1)-----	4
TRUCK CARGO: 4X4 LMTV (M1078)-----	4
TRUCK UTILITY: CGO/TRP CARRIER 1-1/4T HMMWV (M998)-----	22
TRUCK UTILITY: EXP CAP 4X4 HMMWV (M1113)-----	2
TRAILER: PLS 8X20 (M1076)-----	1
TRUCK WRECKER: MTV (M1089)-----	1
TRAILER CARGO: MTV W/ DROPSIDES (M1095)-----	1
TRAILER HIGH MOBILITY 1-1/4T (M1102)-----	1
LIGHT TACTICAL TRAILER: 3/4T (M1101)-----	16
TRAILER CARGO: LMTV W/DROPSIDES (M1082)-----	1
TRAILER TANK WATER (CAMEL) 800 GAL 5 TON-----	2
TAC ELECT PWR (TEP) TM: PU-2101/ 15KW 50/60HZ/ M200A1----	4

MISCELLANEOUS EQUIPMENT

BED CARGO: DEMOUNTABLE PLS 8X20 M1077-----	1
GEN SET : DED SKID MTD 3KW 60HZ (MEP-831A)-----	5
GEN SET DIESEL: 60HZ AC MEP-531A-----	1
GEN SET: DED SKID MTD 10KW 60HZ (MEP-803A)-----	1
RIGID WALL SHELTER: COMMAND POST-----	2
TANK AND PUMP UNIT LIQ DISPENSING TRUCK MTD (TPU)----	1
TANK UNIT LIQUID DISPENSING TRAILER MTG-----	1
MULTI-TEMP REFRIGERATED CONTAINER SYS: MTRCS-----	1
GEN SET DED 5KW 50/60HZ: SKID-MTD-----	1
GENERATOR SET DED 10KW 50/60HZ: SKID MTD (TEP)-----	2

COMMUNICATION-ELECTRONICS EQUIPMENT

ANTENNA GROUP: OE-254-----	7
COMPUTER SYSTEM DIGITAL: AN/TYQ-107(V)1 (MC4-3A)-----	1
COMPUTER SYSTEM DIGITAL: AN/UYQ-90(V)2 (MTS)-----	4
COMPUTER SET GENERAL: AN/GYK-33D-----	1
COMPUTER SET DIGITAL: OL-605/TYQ (SAAS-MOD)-----	1
COMPUTER SYSTEM DIGITAL: AN/TYQ-106(V)1 (MC4-2)-----	2
COMPUTER SET DIGITAL: AN/UYK-128 (FBCB2)-----	2
COMPUTER SET DIGITAL: OL-582/TYQ (ULLS-G)-----	2
COMPUTER SET DIGITAL: OL-604/TYQ (SARSS DSU WS)-----	1
COMPUTER SYS DIGITAL: AN/TYQ-129(V)2 (TC-AIMS II WS)-----	7
COMPUTER SYSTEM DIGITAL: AN/TYQ-108(V)3 (MCA-4C)-----	1
COMPUTER SET DIGITAL: AN/TYQ-109(V)1 (GCSS-A (V)1)-----	4
COMPUTER SET DIGITAL: AN/TYQ-109(V)2 (GCSS-A (V)2)-----	1
COMMAND CENTER SYSTEM: AN/TSQ-243-----	1
COM SET DIGITAL: OL-589/TYQ (CTSC-II FLYAWAY CONF)-----	1
COMPUTER SET DIGITAL: OL-603/TYQ (SARSS DSU SVR)-----	1
COMPUTER SYSTEM DIGITAL: AN/UYQ-90(V)3 (MTS-CS)-----	6
NAVIGATION SET: SATELLITE SIGNALS AN/PSN-13 (DAGR)-----	27
PROCESSOR GROUP SIGNAL DATA: (CAISI 2.0)-----	11
RADIAC SET: AN/VDR-2-----	2
RECEIVE SUITE: AN/TSR-8 (GRT)-----	1
RADIO SET: AN/WRC-89F-----	1
RADIO SET: AN/WRC-90F-----	19
RADIO SET: AN/WRC-92F-----	9
SUPPORT SYSTEM TACTICAL: AN/TYQ-132(V)1-----	1
INTERFACE UNIT COMM EQ: OL-713(V)1/TYQ CSS VSAT-----	1
COMMUNICATIONS SUBSYSTEM: AN/TSQ-259-----	1
COMPUTER SYSTEM DIGITAL: AN/TYQ-141 (SAMS-2E V2)-----	2
COMP SYS DIGITAL: (AHR) AN/TYQ-116(V)3-----	2

NIGHT VISION/OBSERVATION EQUIPMENT

NIGHT VISION GOGGLES: AN/PVS-7B-----	80
MEDIUM WEAPON THERMAL SIGHT (MWTS): AN/PAS-13(V)2-----	11
HEAVY WEAPON THERMAL SIGHT (HWTS): AN/PAS-13(V)3-----	4

Early Entry Element, Sustainment Brigade

Brigade Signal Company (MEB/CAB/SB)

11307R600
OFF: 4/WO: 0/ENL: 40/TOTAL: 44

COMPANY HEADQUARTERS PARA 01

AN/VRC-92F
AN/VRC-104(V)3
FBCB2
DAGR



CPT 25A00 (COMMANDER) P&C

AN/VRC-90F
AN/TYQ-109(V)1
FBCB2
DAGR
CAISI 2.0



LT 25A00 (EXEC OFF) C
1SG 25U5M (FIRST SGT) C
SGT 92Y20 (SUPPLY NCO) R
SP4 92Y10 (SUPPLY SP) R

RANGE EXTENSION PLATOON HQ PARA 02

AN/VRC-90F
AN/VRC-104(V)3
FBCB2
DAGR



LT 25A00 (PLT LDR) C
SFC 25U40 (PLT SGT) C

SMALL COMMAND POST SUPPORT TEAM PARA 03

AN/VRC-89F
FBCB2
DAGR

AN/VRC-90F
DAGR



BCP (SWITCHING GP): OM-87A/T
PU 798

SGT 25Q20 (SR XMSN SYS OPR-MAINT) R
SP4 25B10 (LAN MGR) R
SP4 25Q10 (XMSN SYS OPR-MAINT) R
PFC 25B10 (LAN MGR) R

X2

RETRANSMISSION TEAM PARA 04

2 AN/VRC-92F
FBCB2
DAGR



SGT 25U20 (TEAM CHIEF) R
SP4 25U10 (RADIO RETRANS OPR) SAW
PFC 25U10 (RADIO RETRANS OPR) R

X3

NETWORK EXTENSION PLATOON HQ PARA 05

AN/VRC-90F
AN/VRC-104(V)3
FBCB2
DAGR



LT 25A00 (PLT LDR) C
SFC 25W40 (PLT SGT) C

JOINT NETWORK NODE/SMART-T TEAM PARA 06

AN/VRC-90F
DAGR
OA-9511/TYQ
AN/TYQ-122
KSV-3



SGT 25N20 (SR NODAL NET SYS OPR-MAINT) R
SP4 25N10 (NODAL NET SYS OPR-MAINT) R
PFC 25N10 (NODAL NET SYS OPR-MAINT) R

AN/VRC-90F
DAGR

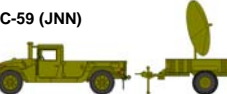

AN/TTC-59 (JNN)
PU-798

AN/VRC-90F
DAGR



SGT 25S20 (SR SATCOM SYS OPR-MAINT) R
SP4 25S10 (SATCOM SYS OPR-MAINT) R
PFC 25S10 (SATCOM SYS OPR-MAINT) R

AN/VRC-90F
AN/VRC-104(V)3
FBCB2
DAGR



SP4 25Q10 (RANGE EXT OPR) R

LOS V3 TEAM PARA 07

AN/VRC-90F

AN/TRC-190C(V)1

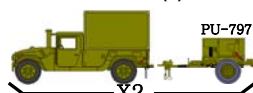

X2

SGT 25Q20 (SR XMSN SYS OPR-MAINT) R
SP4 25Q10 (XMSN SYS OPR-MAINT) R
PFC 25Q10 (XMSN SYS OPR-MAINT) R

AN/VRC-90F

AN/TRC-190C(V)3



PU-797

RETRANSMISSION TEAM PARA 08

2 AN/VRC-92F
FBCB2
DAGR

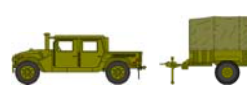

SGT 25U20 (TEAM CHIEF) R
SP4 25U10 (RADIO RETRANS OPR) SAW
PFC 25U10 (RADIO RETRANS OPR) R

EPLRS SECTION PARA 09

AN/VRC-90F
FBCB2
DAGR
EPLRS-V1
AN/GRC-229
KOK-13/TSEC



AN/TSQ-158 NCS

SSG 25C30 (EPLRS NCS SUPV) R
SP4 25C10 (EPLRS NCS OPR) R
PFC 25C10 (EPLRS NCS OPR) R

AN/VRC-92F
FBCB2
DAGR
EPLRS-V1



AN/VSQ-2(N)4

SGT 25C20 (SR EGRU OPR) R
SP4 25C10 (EGRU OPR) R

NOTE: SECTION APPLIES ONLY IF SB IS ASSIGNED TO EPLRS-EQUIPPED DIVISION

Summary of Equipment

WEAPONS

LAUNCHER GRENADE: M320A1-----	4
MACHINE GUN 5.56MM M249-----	4
MACHINE GUN LIGHT 5.56MM M249-----	10
MACHINE GUN GRENADE 40MM MK-19 MOD III-----	2
PISTOL 9MM AUTOMATIC M9-----	1
RIFLE 5.56MM M16A2-----	33
RIFLE 5.56MM M4 CARBINE-----	7

VEHICLES, TRAILERS, AND TRLR MTD SYSTEMS

GEN SET DED TM: 10KW 60HZ (PU-798)-----	3
GEN SET DED TM: 5KW 60HZ (PU-797)-----	3
TRUCK CARGO: MTV (M1083)-----	1
TRUCK UTILITY EXP CAPACITY ENH 4X4: M1152A1-----	12
TRUCK UTILITY EXP CAPACITY ENH 4X4: M1165A1-----	8
TRAILER HIGH MOBILITY 1-1/4T (M1102)-----	1
LIGHT TACTICAL TRAILER: 3/4T (M1101)-----	8
TRAILER TANK WATER (CAMEL) 800 GAL 5 TON-----	1

MISCELLANEOUS EQUIPMENT

GEN SET : DED SKID MTD 3KW 60HZ (MEP-831A)-----	6
GEN SET DIESEL: 60HZ AC MEP-531A-----	1

NIGHT VISION/OBSERVATION EQUIPMENT

NIGHT VISION GOGGLES: AN/PVS-7B-----	54
MEDIUM WEAPON THERMAL SIGHT (MWTS): AN/PAS-13(V)2-----	10
HEAVY WEAPON THERMAL SIGHT (HWTS): AN/PAS-13(V)3-----	2

COMMUNICATION-ELECTRONICS EQUIPMENT

ANTENNA GROUP: OE-254-----	18
ANTENNA: AB-1404/TRC-----	1
COMPUTER SET DIGITAL: AN/UYK-128 (FBCB2)-----	14
COMPUTER SET DIGITAL: AN/TYQ-109(V)1 (GCSS-A (V)1)-----	1
NET CONTROL STATION: AN/TSQ-158-----	2
NAVIGATION SET: SATELLITE SIGNALS AN/PSN-13 (DAGR)-----	19
PJH SURFACE VEH RADIO SET: AN/VSQ-2(V)1 (BFLRS-V1)-----	2
PROCESSOR GROUP SIGNAL DATA: (CAIST 2.0)-----	1
RADIAC SET: AN/VDR-2-----	10
RADIO SET: AN/VRC-89F-----	2
RADIO SET: AN/VRC-90F-----	13
RADIO SET: AN/VRC-92F-----	10
RADIO SET GRID REFERENCE UNIT: AN/VSQ-2(N)4-----	1
RADIO TERMINAL: LOS MULTI-CHANNEL AN/TRC-190C(V)1-----	2
RADIO TERMINAL: LOS MULTI-CHANNEL AN/TRC-190C(V)3-----	1
RADIO TERMINAL SET: AN/GRC-229-----	1
SWITCHING GROUP DIGITAL DATA: OA-9511/TYQ-----	1
TELECONFERENCE SYSTEM: AN/TYQ-122-----	1
TERMINAL: SATELLITE COMMUNICATIONS AN/TSC-154-----	1
JOINT NODE NETWORK (JNN) CEN OFC TEL AUTO: AN/TTC-----	1
BATTALION COMMAND POST (SWITCHING GROUP): OM-87A/T-----	2
AEHF COMMUNICATIONS PLANNING ELEMENT-----	1
RADIO SET: AN/VRC-104(V)3 150 WATT IK: PRC-150 HF RADIO-----	4
REKEYING CONTROLLER: KOK-13/TSEC-----	1
TRANSEC MODULE: KSV-3-----	1

Brigade Signal Company (ME/CAB/SB)