

TECHNICAL MANUAL

OPERATOR'S AND UNIT MAINTENANCE MANUAL

FOR

RADIO TEST SET

AN/GRM-114B

(NSN 6625-01-309-2824)

(EIC: KN2)

WARNING – This document contains technical data whose export is restricted by the Arms Export Control Act (Title 22, U. S. C., Sec 2751 et seq) or the Export Administration Act 1979, as amended, Title 50, U.S.C., App. 2401 et seq. Violations of these export laws are subject to severe criminal penalties. Disseminate in accordance with provisions of DOD Directive 5230.25.

DISTRIBUTION STATEMENT D – Distribution authorized to Department of Defense and DoD contractors only to protect critical technical data on systems or hardware. This determination was made Oct 1986. Other requests shall be referred to: Program Manager, TMDE, ATTN: SFAE-CS-FT-T-TEMOD, Redstone Arsenal, AL 35898-5000.

DESTRUCTION NOTICE – Destroy by any method that will prevent disclosure of contents or reconstruction of the document.



5 SAFETY STEPS TO FOLLOW IF SOMEONE IS THE VICTIM OF ELECTRICAL SHOCK:

- 1** DO NOT TRY TO PULL OR GRAB THE INDIVIDUAL.
- 2** IF POSSIBLE, TURN OFF THE ELECTRICAL POWER.
- 3** IF YOU CANNOT TURN OFF THE ELECTRICAL POWER, PULL, PUSH, OR LIFT THE PERSON TO SAFETY USING A DRY WOODEN POLE OR A DRY ROPE OR SOME OTHER INSULATING MATERIAL.
- 4** SEND FOR HELP AS SOON AS POSSIBLE.
- 5** AFTER THE INJURED PERSON IS FREE OF CONTACT WITH THE SOURCE OF ELECTRICAL SHOCK, MOVE THE PERSON A SHORT DISTANCE AWAY AND IMMEDIATELY START ARTIFICIAL RESPIRATION.

WARNING

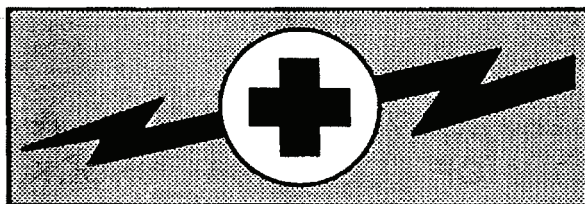

HIGH VOLTAGE

is used in the operation of this equipment

DEATH ON CONTACT

may result if personnel fail to observe safety precautions

Never work on electronic equipment unless there is another person nearby who is familiar with the operation and hazards of the equipment and who is competent in administering first aid. When technicians are aided by operators, they must warn them about dangerous areas.

Whenever possible, the power supply to the equipment must be shut off before beginning work on the equipment. Take particular care to ground every capacitor likely to hold a dangerous potential. When working inside the equipment, after the power has been turned off, always ground every part before touching it.

Be careful not to contact high-voltage connections of 115-volt ac input when installing or operating this equipment.

Whenever the nature of the operation permits, keep one hand away from the equipment to reduce the hazard of current flowing through vital organs of the body.

WARNING

Do not be misled by the term "LOW VOLTAGE". Potentials as low as 50 volts may cause death under adverse conditions.

For Artificial Respiration refer to FM 4-25.11.

CHANGE }
No. 2 }

Headquarters
Department of the Army
Washington, D.C., 23 March 2006

**OPERATOR'S AND UNIT MAINTENANCE MANUAL
FOR
RADIO TEST SET
AN/GRM-114B
(NSN 6625-01-309-2824) (EIC: KN2)**

HAZARDOUS MATERIAL INFORMATION – This document has been reviewed for the presence of solvents containing hazardous materials as defined by the EPCRA 302 and 313 lists by the AMCOM G-4 (Logistics) Environmental Division. As of the base document, dated 15 May 1993, all references to solvents containing hazardous materials have been removed from this document by substitution with non-hazardous or less hazardous materials where possible.

OZONE DEPLETING CHEMICAL INFORMATION – This document has been reviewed for the presence of Class I ozone depleting chemicals by AMCOM G-4 (Logistics) Environmental Division. As of the base document, dated 15 May 1993, all references to Class I ozone depleting chemicals have been removed from this document by substitution with chemicals that do not cause atmospheric ozone depletion.

DISTRIBUTION STATEMENT D – Distribution authorized to Department of Defense and DoD contractors only to protect critical technical data on systems or hardware. This determination was made Oct 1986. Other requests shall be referred to: Program Manager, TMDE, ATTN: SFAE-CS-FT-T-TEMOD, Redstone Arsenal, AL 35898-5000.

WARNING – This document contains technical data whose export is restricted by the Arms Export Control Act (Title 22, U. S. C., Sec 2751 et seq) or the Export Administration Act 1979, as amended, Title 50, U.S.C., App. 2401 et seq. Violations of these export laws are subject to severe criminal penalties. Disseminate in accordance with provisions of DOD Directive 5230.25.

DESTRUCTION NOTICE – Destroy by any method that will prevent disclosure of contents or reconstruction of the document.

TM 11-6625-3245-12/TM 09419A-12/1 dated 15 May 1993 is changed as follows:

1. Remove old pages and insert new pages as indicated below. New or changed material is indicated by a vertical bar in the outer margin of the page.

Remove Pages

A, B

i, ii
1-1, 1-2
3-1, 3-2
A-1/(A-2 blank)
D-1/(D-2 blank)
Cover

Insert Pages

A, B
C/(D Blank)
i, ii
1-1, 1-2
3-1, 3-2
A-1/(A-2 blank)
D-1/(D-2 blank)
Cover

2. File this change sheet in front of the publication for reference purposes.

By Order of the Secretary of the Army:

Official:



JOYCE E. MORROW

*Administrative Assistant to the
Secretary of the Army*

0604001

PETER J. SCHOOMAKER
*General, United States Army
Chief of Staff*

Distribution:

To be distributed in accordance with the initial distribution number (IDN) 363694,
requirements for TM 11-6625-3245-12.

Change

No 1

**OPERATOR'S AND UNIT MAINTENANCE MANUAL
FOR
RADIO TEST SET
AN/GRM-1 14B
(NSN 6625-01309-2824) (EIC: KN2)**

TM 11-6625-3245-121 TM 09419A-12/1, dated 15 May 1993, is changed as follows:

1. Remove old pages and insert new pages as indicated below. New or changed material is indicated by a vertical bar in the margin of the page. Added or revised illustrations are indicated by a vertical bar adjacent to the illustration identification number or by a miniature pointing hand.

Remove Pages

i and ii
1-1 through 1-20
2-7 and 2-8
2-17 through 2-20
2-95 and 2-96
2-219 through 2-222
2-225 through 2-228
2-241 and 2-242
B-3 through B-20
C-3 and C-4
F-27 through F-30
F-39 and F-40
F-53 through F-56
INDEX-1 through INDEX-7/(INDEX-8 blank)

Insert Pages

i and ii
1-1 through 1-20
2-7 and 2-8
2-17 through 2-20
2-95 and 2-96
2-219 through 2-222
2-225 through 2-228
2-241 and 2-242
B-3 through B-20
C-3 and C-4
F-27 through F-30
F-39 and F-40
F-53 through F-56
INDEX-1 through INDEX-7/(INDEX-8 blank)

2. File this change sheet in front of the publication for reference purposes.

Distribution authorized to US Government agencies and their contractors for official use or for administrative or operational purposes only This determination was made on 15 January 1996 Other requests for this document must be referred to Commander, US Army Communications-Electronics Command and Fort Monmouth, ATTN: AMSEL-LC-LEO-P-MM-T, Fort Monmouth, New Jersey 07703-5007.

DESTRUCTION NOTICE - Destroy by any method that will prevent disclosure of contents or reconstruction of the document.

By Order of the Secretary of the Army:

Official:



JOEL B. HUDSON
*Administrative Assistant to the
Secretary of the Army*
02443

DENNIS J. REIMER
*General, United States Army
Chief of Staff*

By Order of the Secretary of the Marine Corps:

H.E. REESE
*Deputy for Support
Marine Corps Research
Development and Acquisition
Command*

DISTRIBUTION:

To be distributed in accordance with the initial distribution number (IDN) 369438, requirements for TM 11-6625-3245-12.

INSERT LATEST CHANGED PAGES. DESTROY SUPERSEDED PAGES.

LIST OF EFFECTIVE PAGES

NOTE

ON CHANGED PAGES, THE PORTION OF THE TEXT AFFECTED BY THE LATEST CHANGE IS INDICATED BY A VERTICAL LINE OR OTHER CHANGE SYMBOL IN THE OUTER MARGIN OF THE PAGE.

Date of issue for original and changed pages are:

Original 0 15 May 1993
 Change 1 1 August 1996
 Change 2 23 March 2006

Total number of pages in this publication is 428 consisting of the following:

Page No.	*Change No.	Page No.	*Change No.
Cover	2	C-1 thru C-3	0
a	0	C-4	1
b	2	D-1 / (D-2 blank)	2
A/(B blank)	2	E-1 thru E-6	0
i	2	F-1 thru F-28	0
ii, iii	0	F-29, F-30	1
1-0	0	F-31 thru F-38	0
1-1, 1-2	2	F-39	1
1-3	0	B-40 thru F-52	0
1-4 thru 1-20	1	F-53 thru F-56	1
1-21, 1-22	0	G-1 / (G-2 blank)	0
2-1 thru 2-7	0	H-1 thru H-8	0
2-8	1	I-1 thru I-3 / (I-4 blank)	0
2-9 thru 2-17	0	GLOSSARY-1, 2	0
2-18	1	INDEX-1 thru 7/(8 blank)	1
2-19	0		
2-20	1		
2-21 thru 2-94	0		
2-95, 2-96	1		
2-97 thru 2-220	0		
2-221	1		
2-222 thru 2-225	0		
2-226, 2-227	1		
2-228 thru 2-241	0		
2-242	1		
2-243 thru 2-258	0		
3-1	0		
3-2	2		
3-3 thru 3-11 / (3-12 blank)	0		
A-1 / (A-2 blank)	2		
B-1 thru B-4	0		
B-5 thru B-12	1		
B-13	0		
B-14 thru B-20	1		

* Zero in this column indicates an original page.

Technical Manual
No. 11-6625-3245-12



Headquarters
Department of the Army
Washington, D.C., 15 May 1993

**OPERATOR'S AND UNIT MAINTENANCE MANUAL
FOR
RADIO TEST SET AN/GRM-114B
(NSN 6625-01-309-2824) (EIC: KN2)**

REPORTING ERRORS AND RECOMMENDING IMPROVEMENTS

You can help improve this manual. If you find any mistakes or if you know of a way to improve the procedures, please let us know. Mail your letter or DA Form 2028 (Recommended Changes to Publications and Blank Forms) directly to: Commander, U. S. Army Aviation and Missile Command, AMSAM-MMC-MA-NP, Redstone Arsenal, AL 35898-5000. A reply will be furnished to you. You may also provide DA Form 2028 information to AMCOM via email, fax or the World Wide Web. Our fax number is: DSN 788-6546 or Commercial 256-842-6546. Our email address is: 2028@redstone.army.mil. Instructions for sending an electronic 2028 may be found at the back of this manual immediately preceding the hardcopy 2028. For the World Wide Web use: <https://amcom2028.redstone.army.mil>.

HAZARDOUS MATERIAL INFORMATION

This document has been reviewed for the presence of solvents containing hazardous materials as defined by the EPCRA 302 and 313 lists by the AMCOM G-4 (Logistics) Environmental Division. As of the base document, dated 15 May 1993, all references to solvents containing hazardous materials have been removed from this document by substitution with non-hazardous or less hazardous materials where possible.

OZONE DEPLETING CHEMICAL INFORMATION

This document has been reviewed for the presence of Class I ozone depleting chemicals by AMCOM G-4 (Logistics) Environmental Division. As of the base document, 15 May 1993, all references to Class I ozone depleting chemicals have been removed from this document by substitution with chemicals that do not cause atmospheric ozone depletion.

WARNING – This document contains technical data whose export is restricted by the Arms Export Control Act (Title 22, U. S. C., Sec 2751 et seq) or the Export Administration Act 1979, as amended, Title 50, U.S.C., App. 2401 et seq. Violations of these export laws are subject to severe criminal penalties. Disseminate in accordance with provisions of DOD Directive 5230.25.

DISTRIBUTION STATEMENT D – Distribution authorized to Department of Defense and DoD contractors only to protect critical technical data on systems or hardware. This determination was made Oct 1986. Other requests shall be referred to: Program Manager, TMDE, ATTN: SFAE-CS-FT-T-TEMOD, Redstone Arsenal, AL 35898-5000.

DESTRUCTION NOTICE – Destroy by any method that will prevent disclosure of contents or reconstruction of the document.

TABLE OF CONTENTS

		Page
	HOW TO USE THIS MANUAL.....	iii
Chapter	1. INTRODUCTION.....	1-1
Section	I. General Information.....	1-1
	II. Equipment Description.....	1-3
	III. Technical Principals of Operation.....	1-14
Chapter	2. OPERATING INSTRUCTIONS.....	2-1
Section	I. Description and Use of Operators Controls, Indicators and Connectors.....	2-2
	II. Operator Preventive Maintenance Checks and Services (PMCS).....	2-158
	III. Operation Under Usual Conditions.....	2-158
Chapter	3. UNIT MAINTENANCE.....	3-1
Section	I. Repair Parts, Special Tools, TMDE, and Support Equipment.....	3-1
	II. Service Upon Receipt.....	3-2
	III. Troubleshooting.....	3-5
	IV. Maintenance Procedures.....	3-8
	V. Preparation for Storage or Shipment.....	3-11
APPENDIX	A. REFERENCE.....	A-1
	B. MAINTENANCE ALLOCATION CHART.....	B-1
	C. COMPONENTS OF END ITEM AND BASIC ISSUE ITEMS LIST.....	C-1
	D. EXPENDABLE SUPPLIES AND MATERIALS LIST.....	D-1
	E. AUXILIARY FUNCTIONS.....	E-1
	F. REMOTE OPERATION.....	F-1
	G. DBM TO MICROVOLT CONVERSION CHART.....	G-1
	H. TABLE OF USER I/O CONNECTORS AND PIN-OUT TABLES.....	H-1
	I. DRIVE-BY TEST.....	I-1
GLOSSARY.....		GLOSSARY-1
INDEX		INDEX-1

HOW TO USE THIS MANUAL

This manual tells about the Test Set AN/GRM-114B and contains instructions on how to use it while testing and maintaining other electronic equipment.

The Technical Manual for the other electronic equipment being maintained will tell where to make certain connections and where to use the various accessories which are part of the Test Set.

When the Test Set is first received, start at the front of the manual and go all the way through to the back. Become familiar with every part of the manual and the Test Set.

This manual has an edge index which will help find specific information in a hurry. Spread the pages on the right edge of the manual until the printed blocks can be seen. Open the manual where the block on the edge of the page lines up with the selected topic printed on the front cover index block.

**CHAPTER 1
INTRODUCTION**

	Para	Page
Administrative Storage	1-4	1-2
Consolidated Index of Army Publications and Blank Forms.....	1-2	1-1
Destruction of Army Electronics Materiel to Prevent Enemy Use	1-5	1-2
Equipment Characteristics, Capabilities and Features	1-9	1-3
Equipment Data	1-10	1-4
General Functional Description	1-11	1-14
Maintenance Forms, Records, and Reports	1-3	1-1
Nomenclature Cross-Reference List	1-8	1-2
Reporting Equipment Improvement Recommendations (EIR)	1-6	1-2
Scope	1-1	1-1
Warranty information	1-7	1-2

Section I. GENERAL INFORMATION

1-1. SCOPE.

- a. Type of Manual: Operator's and Unit Maintenance Manual.
- b. Equipment Name and Model Number: Radio Test Set FM/AM-1600/J-1601.
- c. Purpose of Equipment: The Radio Test Set FM/AM-1600/J-1601 is a general-purpose communications test set for testing radios and related equipment.

1-2. CONSOLIDATED INDEX OF ARMY PUBLICATIONS AND BLANK FORMS.

Refer to the latest issue of DA Pam 25-30 to determine whether there are new editions, changes, or additional publications pertaining to the equipment.

1-3. MAINTENANCE FORMS, RECORDS, AND REPORTS.

- a. Reports of Maintenance and Unsatisfactory Equipment. Department of the Army forms and procedures used for equipment maintenance will be those prescribed by DA Pam 750-8.
- b. Report of Item and Packaging Deficiencies. Fill out and forward SF 364 (Report of Discrepancy) (ROD) as prescribed in AR 735-11-2/DLAR 4140.55/NAVMATINST 4355.73A/AFR 400-54/MCO 4430.3J.
- c. Transportation Discrepancy Report (TDR)(SF 361). Fill out and forward Transportation Discrepancy Report (TDR)(SF 361) as prescribed in DA Pam 25-30/NAVSUPINST 4610.33C/AFR 75-18/MCO P4610.19D DLAR 4500.15.

1-4. ADMINISTRATIVE STORAGE.

Administrative storage of equipment issued to and used by Army activities will have Preventive Maintenance Checks and Services (PMCS) performed before storing. When removing the equipment from administrative storage, the PMCS should be performed to assure operational readiness.

1-5. DESTRUCTION OF ARMY MATERIEL TO PREVENT ENEMY USE.

Destruction of Army materiel to prevent enemy use is described in TM 750-244-2.

1-6. REPORTING EQUIPMENT IMPROVEMENT RECOMMENDATIONS (EIR).

a. If the Radio Test Set AN/GRM-114B needs improvement, let us know. Send us an EIR. You, the user, are the only one who can tell us what you don't like about your equipment. Let us know why you don't like the design or performance. Put it on an SF 368 (Product Quality Deficiency Report). Mail it to us at: Commander, U.S. Army Aviation and Missile Command, AMSAM-MMC-MA-NM, Redstone Arsenal, AL. 35898-5000. We'll send you a reply.

1-7. WARRANTY INFORMATION

The Radio Test Set AN/GRM-114B is warranted by IFR SYSTEMS, INC. for 24 months form date of government acceptance, found in Block 21 of DD Form 250. Report all defects in material or workmanship to your supervisor, who will take appropriate action.

1-8. NOMENCLATURE CROSS-REFERENCE LIST.

Common names will be used when the Radio Test Set AN/GRM-114B is mentioned in this manual.

NOTE

Official nomenclature must be used when filling our report forms or looking up technical manuals.

<i>Common Name</i>	<i>Official Nomenclature</i>
Test Set	Radio Test Set AN/GRM-114B
Test Adapter	Test Adapter J-4843/GRM-114B

Section II. EQUIPMENT DESCRIPTION

1-9. EQUIPMENT CHARACTERISTICS, CAPABILITIES AND FEATURES.

a. Characteristics.

- Provides the capability to maintain Army tactical radios in single channel mode.
- Used to verify radio performance characteristics and to diagnose failures.
- Operates as:
 - RF Signal Generator.
 - Radio Receiver, including:
 - RF Power Meter.
 - Radio Frequency and Frequency Error Meter.
 - Audio Frequency Meter.
 - FM Deviation Meter.
 - AM Modulation Meter.
 - PM Deviation Meter.
 - Distortion Meter.
 - SINAD Meter.
 - Duplex Transmitter/Receiver.
 - AF Signal Generator, including:
 - Digital Data Generator and Pattern Generator For Bit Error Rate (BER).
 - Bit Error Rate (BER) Meter.
 - Oscilloscope.
 - Spectrum Analyzer.
 - Digital Multimeter.
- Performs Pre-programmed SIN CGARS Family of Radio Tests.

b. Capabilities and Features.

- Color Monitor with 16-Color capability.
- Processor-controlled memory.
- Menu-driven display.
- 'Soft' (variable) Function Key operation.
- Test set-up Memory and Recall.
- 'Hold' display capability.
- Remote Operation (GPIB and RS-232).

Wave Forms: Sine, Square, Triangle, Ramp, Pulse

Total Harmonic Distortion: (Sine wave only) >6 kHz Deviation
 <0.7%, (700 Hz thru 1.1 kHz) (300 Hz to 3 kHz BW)
 <1.0%, (30 Hz thru 10.0 kHz)
 <2.0%, (>10.0 thru 20 kHz)
 <3 out of 106 BER for Digital

Internal Modulation - AM:

Range: 0.75 thru 999.999 MHz
 Modulation: 0, 1% thru 90%
 Accuracy: 5% of setting for 30% thru 90% modulation
 10% of setting for 30% thru 90% modulation (<1 MHz)
 Resolution: 1%
 Modulation Rate: 100 Hz to 10 kHz
 Wave Form: Sine, Square, Triangle, Ramp, Pulse
 Total Harmonic Distortion for 30% thru 70% modulation: (Sine wave only)
 <0.7%, (700 Hz thru 1.1 kHz) (300 Hz to 3 kHz Post Detection BW)
 <1.5%, (100 Hz thru 6 kHz)
 <2.5%, (>6.0 thru 10.0 kHz)
 <5.0%, (0.75 thru 1 MHz, RF)

Frequency Agility:

Settling Time (10 to 100 MHz only): 1.5 ms to settle within 1 kHz of desired frequency
 for channel spacing of 25 kHz. Measured from
 time Unit under Test (UUT) completes outputting
 the 16 Bit frequency word.-

Output Impedance:

T/R Connector: 50 Ω. (Return loss >16 dBrl)

AF SIGNAL GENERATOR

Frequency:

Range: 10 Hz to 40 kHz
 Resolution: 0.1 Hz <2.0 kHz
 1.0 Hz >2.0 kHz
 Accuracy: 0.1%

Level:

Range: 0.7 mV to 2.5 Vrms (150 L), up to 3 Vrms (600 Q)
 Resolution: 0.1 mV (0.7 to 200 mV); 3% (>200 mV)
 Accuracy: (150 L Load)
 ±0.1 mV or <3% (<10 kHz)
 <5% (>10 to 25 kHz)

TM 11-6625-3245-12

Spectral Purity:

Total Harmonic Distortion (Sine wave only): <1%
..... <0.7% (0.7 to 1.1 kHz)

AF COUNTER

Frequency:

Range: 10 Hz to 40 kHz
Accuracy: *0.5 PPM
Resolution: 0.1 Hz from 10 Hz thru <2 kHz
..... 1 Hz from >2 thru <20 kHz
..... 10 Hz from >20 to 40 kHz

External Input:

Level: 0.1 V to 10 Vrms
Impedance: 1 M C nominal

FREQUENCY ERROR METER OR FREQUENCY COUNTER

Frequency Counter:

Range:250000 to 999999990 Hz
Accuracy: *0.5 PPM
Resolution: 10 Hz (>20 MHz)
..... 1 Hz (<20 MHz)

Level:

Range: -10 to 50 dBm (250 kHz to <200 MHz)
..... -10 to 47 dBm (200 to 999.9999 MHz)

Frequency Error Counter/Meter:

Counter Range: 0 Hz thru i150.000 kHz
Meter Range: 0 Hz thru t100.0 kHz
Counter/Meter Accuracy: 0.5 PPM
Counter/Meter Resolution: 1 Hz from f1.0 Hz to ±10 kHz
..... 10 Hz from >±10 to i150.0 kHz
Counter/Meter Level: -10 thru +50 dBm at the T/R Connector

POWER METER

Level (Average RF Power of Steady Carriers):

Range: 0.2 mW to 200 W (up to 30 MHz)
..... 0.2 mW to 100 W (>30 to 200 MHz)
..... 0.2 mW to 50 W (>200 to 999.9999 MHz)
Accuracy: 10% (up to 400 MHz) +1 count
..... 20% (beyond 400 MHz) +1 count

SINAD METER

Range: 3.0 thru 30.0 dB
Resolution: 0.1 dB
Accuracy: 1.0 dB, i1 count
Frequency: 770 Hz and 1.0 kHz
Level: 0.1 thru 30.0 Vrms

MULTIMETER

Voltmeter:

Ranges: 0.1 mV to 2000 V*, in 5 ranges or less, full scale, (1 M Ω)
(¹1000.0 V max DC or 500.0 V max AC [true rms])
Resolution: 3.5 digit display,
Maximum resolution is 0.1 mV on 200 mV Scale
Accuracy: 5%, full scale (AC), * i1 count
 $\pm 1\%$, full scale (DC), i1 count
(*AC accuracy applies for AC Volts times kHz product <140)

NOTE

Incorrect probe connection (lead reversal) during AC voltage measurements voids accuracy specifications.

Frequency: DC, AC mode 50 Hz to 20 kHz
Input Impedance: Selectable $\pm 5\%$
150 Ω (speaker load)
600 Ω (line load)
1 M Ω (Nominal, Shunted by <150 pF)

Ohmmeter:

Range: 0.1 to 20 M Ω
Resolution: 3.5 digit display, Maximum resolution is 0.1 Ω on 200.0 L scale
Accuracy: 5% full scale, or 0.1 I, +1 count

Current Meter:

Range: 0.01mA to 10 ADC
Resolution: 3.5 digit display, Maximum resolution is 0.01 mA on 20.0 mA Scale
Accuracy: 5% full scale, or 0.1 mA, +1 count

OSCILLOSCOPE

Vertical Input:

Frequency Range:DC - 1.0 MHz (at 3 dB Bandwidth)
 Input Ranges: 2 mV, 5 mV, 10 mV, 20 mV, 50 mV, 100 mV, 200 mV, 500 mV, 1 V,
 2 V, 5 V, 10 V, 20 V, or 50 V per division with 8 divisions on screen
 Maximum Input Voltage: 200 V
 Accuracy: 5% of full scale (i10% with 10x probe)
 +10% of full scale in 2 mV range (i10% with 10x probe)
 Resolution:..... 1.25% of full scale (digital scope data range 0 to 255, in 8 divisions)
 Coupling: AC, DC, GND
 External Input Impedance: 1 MQ nominal, shunted by 27 pF

Horizontal Time Base:

Sweep Factors:..... 10 ls/Div, 100 lis/Div, 1 ms/Div, 10 ms/Div,
 with 10 divisions on screen
 Accuracy: ±3% of full scale
 Resolution:.....1%, (digital scope data sweep 400 points displayed per sweep)

SPECTRUM ANALYZER

Frequency:

Range:1 to 999.9999 MHz

Frequency Span:

Range: 1 kHz/Div to 1 MHz/Div
 Accuracy: ±5% of span width
 Time Base Accuracy: ±0.5 PPM

Level:

Vertical Range: 10 dB/Div
 Vertical Resolution:..... 1 dB (1/2 of a minor Division)
 Range (Dynamic): -85 to -30 dBm (at 0 dB attenuation)
 Accuracy: ±4 dB (to 400 MHz, normalized)
 ±5i dB (>400 to 999.9999 MHz, normalized)
 Attenuator: 0, 20 or 40 dB

Bandwidth Switching Error: < 2 dB (3, 30 and 300 kHz RBW Filters)
 <3 dB (0.3 kHz and 3 MHz RBW Filters)
 Display: 5 cm x 5 cm minimum, with a 10 dB/Div Log scale (vertical)

TM 11-6625-3245-12

IEEE-488 INTERFACE

IEEE-488.1-1987 Connector (24 pin IEEE Connector).

Interface Capabilities: SH1, AH1, T2, TEO, L2, LEO, SR1, RL2, PPO, DC1, DT1, CO

INPUT PROTECTION

Front Panel RF Input Connectors Protection: up to 65 W

DUPLEX OPERATION

Frequency:

Range: 500 kHz thru 999.9999 MHz

Resolution: 100 Hz

Accuracy: ±0.5 PPM

Level:

Range: -120 thru 0 dBm

Resolution: 1 dB

1-10 Change 1

Accuracy:..... ±2.0 dB, 0 to >-90 dBm, <400 MHz
 ±2.5 dB, <-90 to -120 dBm, S400 MHz
 ±3.5 dB, 0 to -120 dBm, >400 MHz
 Output Impedance:50 Q (Return Loss >16 dBrl)

Spectral Purity:

Residual FM: (Post detection BW: 50 Hz thru 15 kHz)
 <45 Hz rms from 1.0 to 100.0 MHz
 <140 Hz rms for <1.0 and >100.0 MHz

SSB Phase Noise: <-90 dBc/Hz at 20 kHz from output frequency >1.0 to <930 MHz
 <-85 dBc/Hz at 20 kHz from output frequency >930 MHz
 <-80 dBc/Hz at 20 kHz from output frequency 500 kHz to <1.0 MHz

Harmonics: <-26 dBc

Non Harmonics: <-50 dBc

Residual AM: (Post Detection BW: 50 Hz thru 15 kHz)
 <0.10% rms (>1.0 MHz to 999.9999 MHz)
 <0.20% rms (<1.0 MHz)

Modulation (Internal/External FM):

Deviation: Off, ±100 Hz thru ±25.0 kHz

Accuracy: 5%, 1.0 thru 20.0 kHz

Resolution: 100 Hz

Deviation Rate: Off, 30.0 Hz thru 20.0 kHz, up to 20 KBS Digital

Wave Forms: Sine, Square, Triangle, Ramp, Pulse

Total Harmonic Distortion: (Sine wave only), >6 kHz Deviation
 <0.7%, (700 Hz thru 1.1 kHz)
 (300 Hz to 3 kHz Post Detection BW)
 <1.0%, (30 Hz thru 10.0 kHz)
 <2.0%, (>10.0 thru 20.0 kHz)
 <3 out of 106 BER for Digital

Modulation (Internal AM):

RF Generator Range: 0.75 thru 999.9999 MHz

Modulation: 0, 1% thru 90%

Accuracy: 5% of setting, 30% thru 90% modulation
 10% of setting for 30% thru 90% modulation (<1.0 MHz)

Resolution: 1%

Modulation Rate: 100.0 Hz thru 10.0 kHz

Wave Forms: Sine, Square, Triangle, Ramp, Pulse

Total Harmonic Distortion: (Sine wave only), 30% thru 70% modulation
 <0.7%, (700 Hz thru 1.1 kHz) (300 Hz to 3 kHz BW)
 <1.5%, (100 Hz thru 6 kHz)
 <2.5%, (>6.0 thru 10 kHz)
 <5.0%, (0.75 thru 1 MHz RF)

SINGLE SIDE BAND (SSB)

Single Side Band demodulator, selectable for lower or upper sideband, with an offset of 300 Hz to 3 kHz from suppressed carrier for signal channel voice testing.

BIT ERROR RATE

Range: 1 x 10⁻¹ to 1 x 10⁵
 Data Rate: 75, 150, 300, 600, 1200, 2400, 4800 BPS and 16 kBPS
 Comparison Capacity: 100, 000 Bits
 Data Pattern Size: 100 to 100, 000 Bits
 Data Pattern Type: Random
 Accuracy: 1 x 10⁻⁶
 Range Indicators: Decimal Form. Measurements outside of Range are displayed
 as Overrange or Underrange.

PATTERN GENERATOR

Rates: 75, 150, 300, 600, 1200, 2400, 4800 BPS and 16 kBPS
 Size: 100 to 100, 000 Bits
 Type: Random
 Accuracy: 1 x 10⁻⁸

RF AMPLIFIER

Frequency Range: 30 to 88 MHz
 Output Level: 36 dBm (f1.5 dB) into load
 VSWR <2:1

SINAD (FREQUENCY HOPPING MODE)

Range: 3.0 thru 30.0 dB
 Resolution: 0.1 dB
 Accuracy: 1.0 dB, i1 count
 Frequency: 770 Hz and 1.0 kHz
 Level: 0.1 thru 30.0 Vrms

DISPLAY

Type: Color
 Size: 7.0" diagonal
 Resolution: 640 pixels by 350 pixels

WEIGHTS AND DIMENSIONS

TS-4317 (Without Bail Handle):	7.4" (18.8 cm) High, 17" (43.2 cm) Wide, 22" (63.5 cm) Deep (with front panel cover in place)
TS-4317 (With Bail Handle):	7.4" (18.8 cm) High, 18.8" (47.8 cm) Wide, 25" (63.5 cm) Deep (with front panel cover in place)
J-4843:	2.8" (18.8 cm) High, 17" (43.2 cm) Wide, 22" (63.5 cm) Deep (with front panel cover in place)
AN/GRM-114B (Without Bail Handle):	9.7" (18.8 cm) High, 17" (43.2 cm) Wide, 22" (55.9 cm) Deep (with front panel covers in place)
AN/GRM-114B (With Bail Handle):	9.7" (18.8 cm) High, 18.8" (47.8 cm) Wide, 25" (63.5 cm) Deep (with front panel covers in place)
Weight:	TS-4317, 48 lbs (21.8 kg) J-4843, 12 lbs (5.5 kg) AN/GRM-114B, 60 lbs (27.3 kg)

POWER REQUIREMENTS

Line:	103.5 to 130/207 to 260 VAC, 47.5 to 420 Hz at 220 Watts typical (AN/GRM-114B) and 180 Watts typical (TS-4317/GRM)
External DC:	22 to 30 VDC

ENVIRONMENTAL DATA

Operating Temperature:	320 to 1220 F (00 to 500 C)
Storage Temperature:	400 to +1600 F (-40° to +710 C)
Relative Humidity:	95% (±5%) >100 C 75% (±5%) >30° C 45% (±5%) >400 C Not Controlled <10° C
Operating Altitude:	10, 000 ft (3050 m)
Storage Altitude:	40, 000 ft (12, 192 m)

Section III. TECHNICAL PRINCIPLES OF OPERATION

1-11. FUNCTIONAL DESCRIPTION.

The Test Set includes two major parts: a Test Set and a J-4843/GRM-114B Test Adapter. These two components work together to perform all SINCGARS test functions. Most standard radio test functions (RF Receiver, RF and AF Signal Generator, Duplex, Oscilloscope, Spectrum Analyzer and all meter functions) are made by the Test Set. The Test Set includes three interactive systems:

- Digital Control System (fig. 1-3)
- Generate System (fig. 1-4)
- Receive System (fig. 1-5)

Each system is discussed in a separate subparagraph. A fourth subparagraph describes the Test Adapter (fig. 1-6). A block diagram of the Test Set is shown in Figure 1-2.

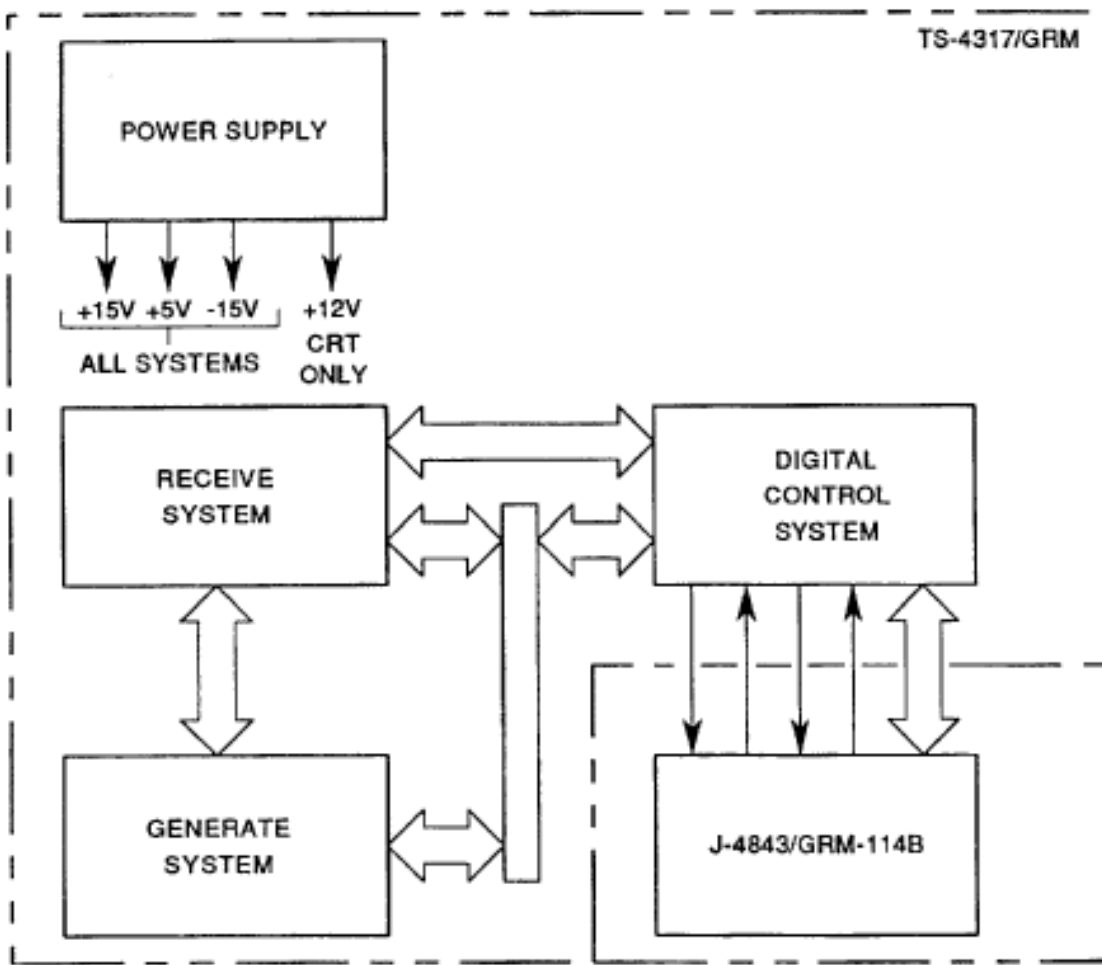

CE2FN677

Figure 1-2. AN/GRM-114B Simplified Block Diagram

a. Digital Control System (fig. 1-3). Microprocessor-based control center that controls all major input/output and interface functions of the Test Set.

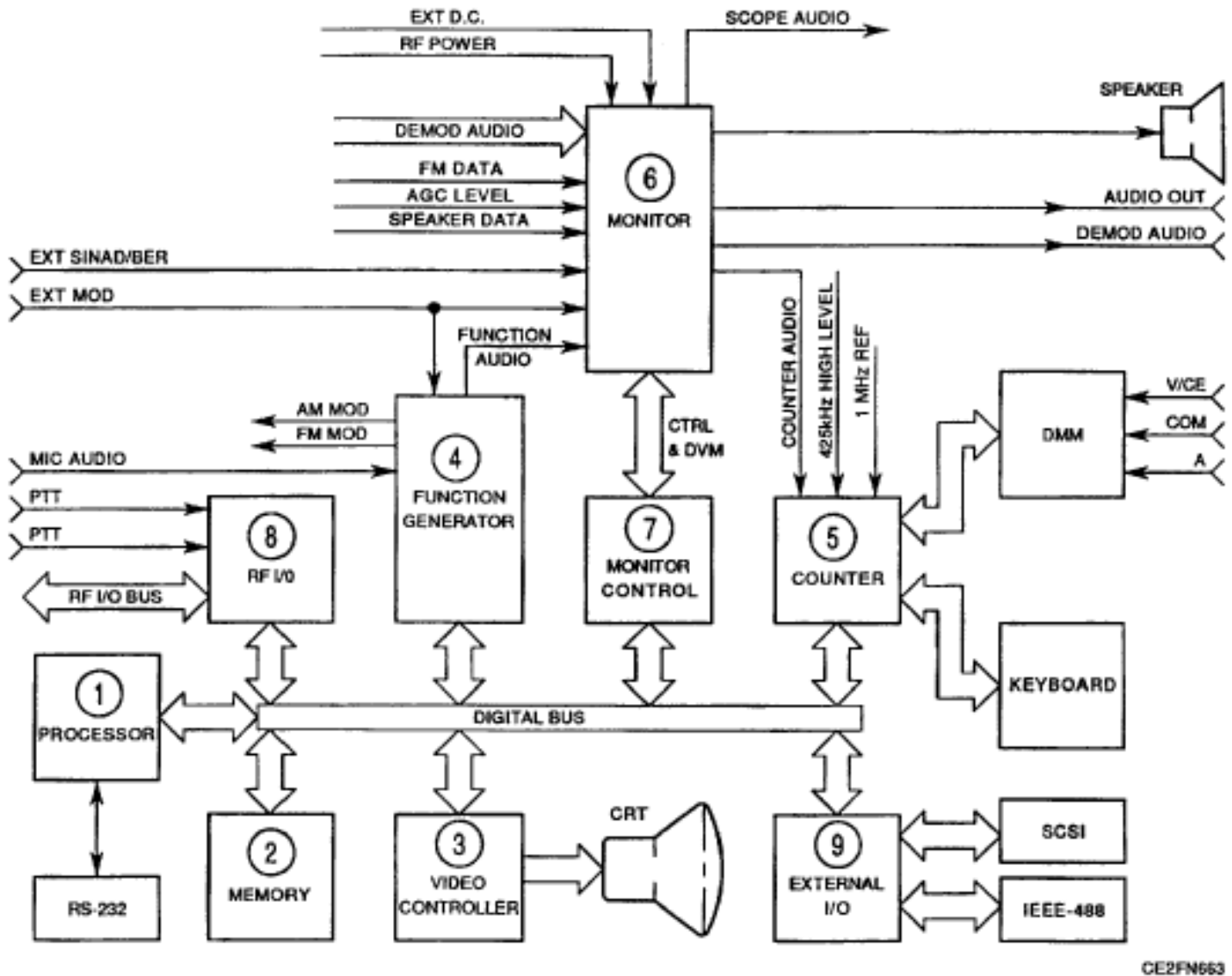

Figure 1-3. Digital Control System Block Diagram.

- 1 The **Processor** and Memory Board control all major information processing functions of the Test Set. These include input/output to the SCSI and IEEE-488 on the Test Set rear panel. The Processor and Memory also control the CRT display through the Video Controller. At power-on, the Processor/Memory does a self-test on all major Test Set digital components. A series of "Beeps" sound if the Processor and Memory Boards are functioning and communicating with other internal Test Set components. If communication is established, the Processor/Memory Group runs tests on all other major Test Set components. Any error messages caused by non-functioning modules are displayed on the CRT. During operations, the Processor/Memory Boards function as a group to control all other primary functions of the Test Set. All functional information is transferred for display on the CRT.

- ② The **Memory Board** and Processor provide most of the program routine which controls all major information processing functions of the Test Set. The Memory Board stores and recalls Test Set parameter settings.
- ③ The **Video Controller** receives information from the Processor/Memory Group. All information received is converted by this module for display on the CRT.
- ④ The **Function Generator** is controlled by the Processor/Memory Group. Acts as the primary audio source for generator system modulation and primary source for audio output frequencies to the Monitor.
- ⑤ The **Counter** counts audio and radio frequencies for the AF and RF meters displayed on the CRT. Receives a counter audio frequency input from the Monitor and a high level RF input from the Receiver. The counter is the primary interface between the Digital Multimeter input and the Processor/Memory Group and between the Keyboard and the Processor/Memory Group.
- ⑥ The **Monitor** is the controlling hub for distribution of analog audio signals. Receives demodulated AM, FM, PM and SSB signals plus FM Data and AGC level inputs from the Receiver. Receives RF Power input from the Power Termination block and Function Audio input from the Function Generator. Monitor output is routed to the Digitizer, Counter, Monitor Control, Speaker and front panel Audio Out and Demod Out connectors.
- ⑦ The **Monitor Control** is the interface between the Monitor and Processor/Memory Group. Provides control signals to the Monitor and metering video information to Processor/Memory Group.
- ⑧ The **RF I/O** block is the interface between the Processor/Memory Group and the Generate and Receive Systems.
- ⑨ The **External I/O** is the interface between the Processor/Memory Group and the SCSI and IEEE-488 Connectors on the Test Set rear panel.

b. Generate System (fig. 1-4). The Generate System outputs a frequency-selectable AM and/or FM RF signal that can be varied in amplitude.

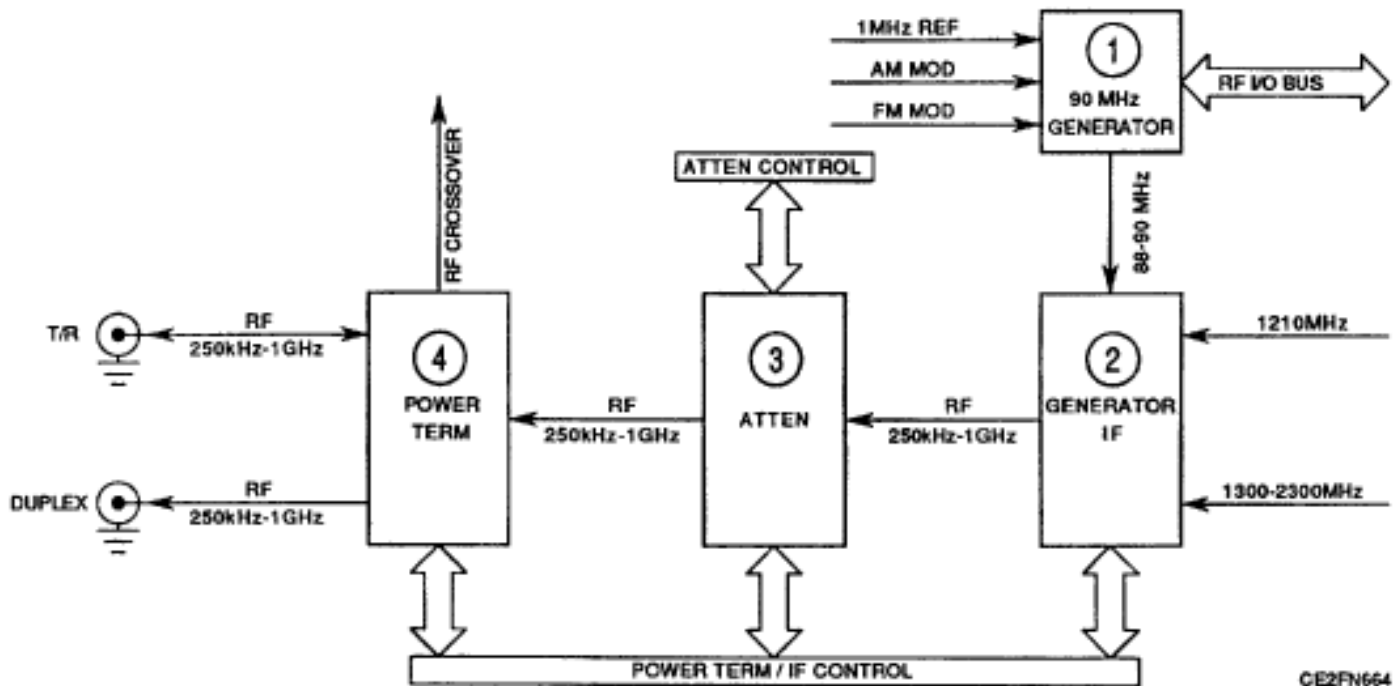
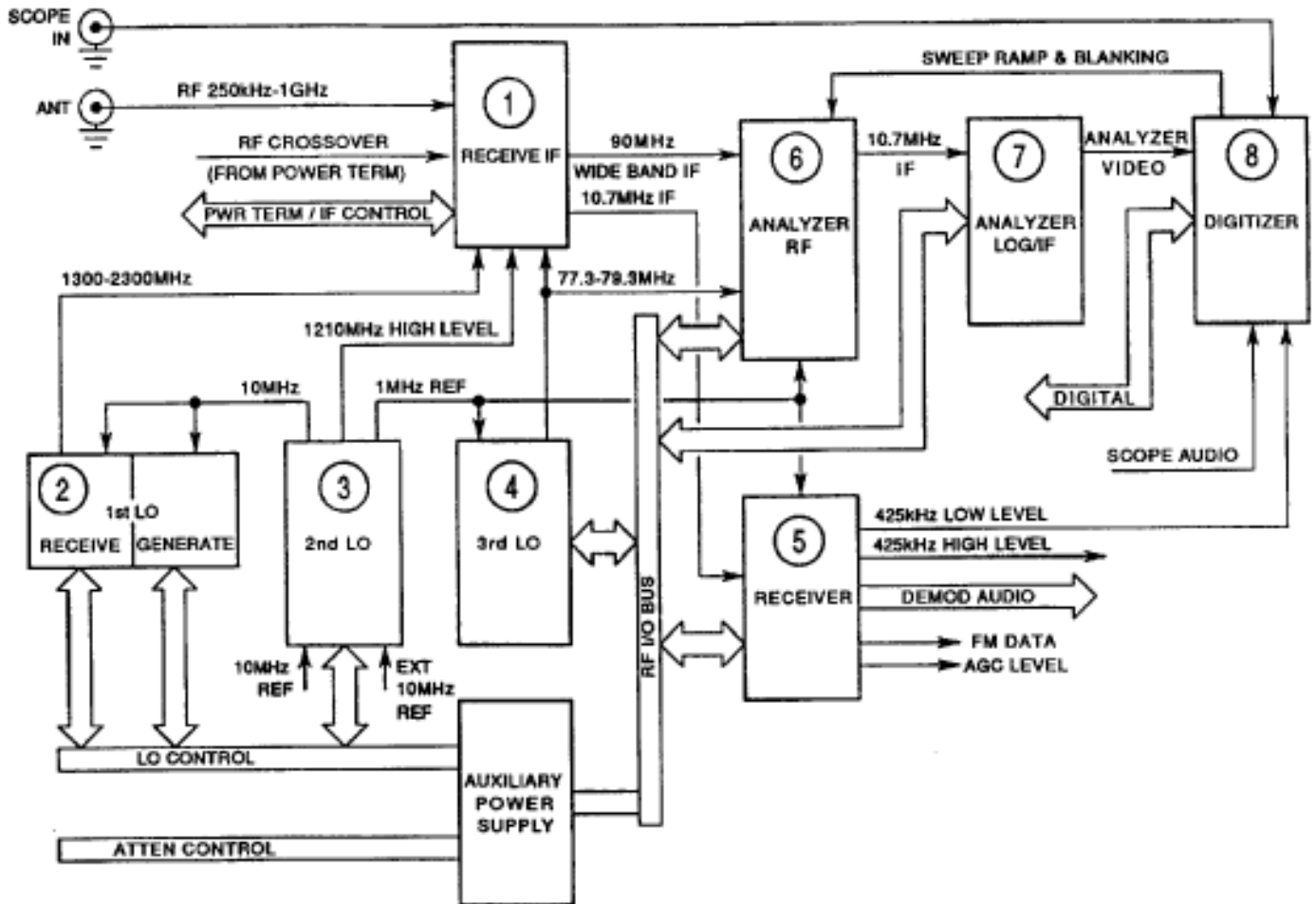

Figure 1-4. Generate System Block Diagram.

- ① The **90 MHz Generator** provides IF Source Frequency for the Generator IF and is the source for AM, FM and PM. Receives leveling information and, with the Generator IF, creates a constant output level.
- ② The **Generator IF** receives the IF source from the 90 MHz Generator and creates a fixed level at the desired output frequency. Outputs leveling feedback to the 90 MHz Generator to complete the feedback loop.
- ③ The **Attenuator** attenuates the fixed level output from the Generator IF and attenuates it to the desired output level.
- ④ The **Power Termination** block is a RF Signal routing hub. It controls Generator output destination through the Duplex or T/R Connectors. Acts as input to the Receive System for high-power inputs through the T/R connector and houses the Power Meter for the Test Set.

c. **Receive System** (fig. 1-5). Demodulates and analyzes input signals and presents a Spectrum Analyzer representation of an input signal. The Receive System includes:



CE2FN655

Figure 1-5. Receive System Block Diagram.

- ① The **Receive IF** block receives input RF Signals from the Antenna Connector or T/R Connector through the Power Termination block. These signals are attenuated 0, 20 or 40 dB, mixed with inputs from the 1st and 2nd Local Oscillator (LO) and output to the Analyzer RF or mixed with the inputs of the 1st and 3rd LOs and output to the Receiver.
- ② The **1st LO** signal preselects the desired input frequency for the Receive System. Operates between 1300 to 2298 MHz in 2 kHz steps.
- ③ The **2nd LO** receives a reference signal from the 10 MHz Frequency Standard. Provides input to the Receive IF. Supplies 1 MHz reference signal to the 3rd LO, Analyzer RF, Receiver, Counter and the 90 MHz Generator (fig. 1-4).

- ④ The **3rd LO** receives 1 MHz Reference signal from the 2nd LO. Outputs the final frequency tuning for the Receive IF and the Analyzer RF.
- ⑤ The **Receiver** receives input from the Receive IF block and creates an output to the Digitizer and the Counter. Demodulates AM, FM, PM and SSB signals for the Monitor. Provides the Monitor with FM DATA and AGC Level information.
- ⑥ The **Analyzer RF** sweeps a band of signals input from the Receive IF. Centered with the input from the 3rd LO, the Analyzer RF then supplies a fixed 10.7 MHz IF signal output to the Analyzer Log/IF.
- ⑦ The **Analyzer Log/IF** selects the resolution bandwidth for the Spectrum Analyzer. Creates a logarithmic analyzer video output to the Digitizer.
- ⑧ The **Digitizer** converts the Analyzer Log/IF video output for display by the Processor/Memory Group as a Spectrum Analyzer display on the CRT. Receives and converts the Oscilloscope input from the Scope connector or information from the monitor via the Scope Audio line and outputs the results to the Processor/Memory Group.

d. **Test Adapter** (fig. 1-6). Provides the interface link between the Test Set and the SINCGARS radio LRU or other system component being tested.

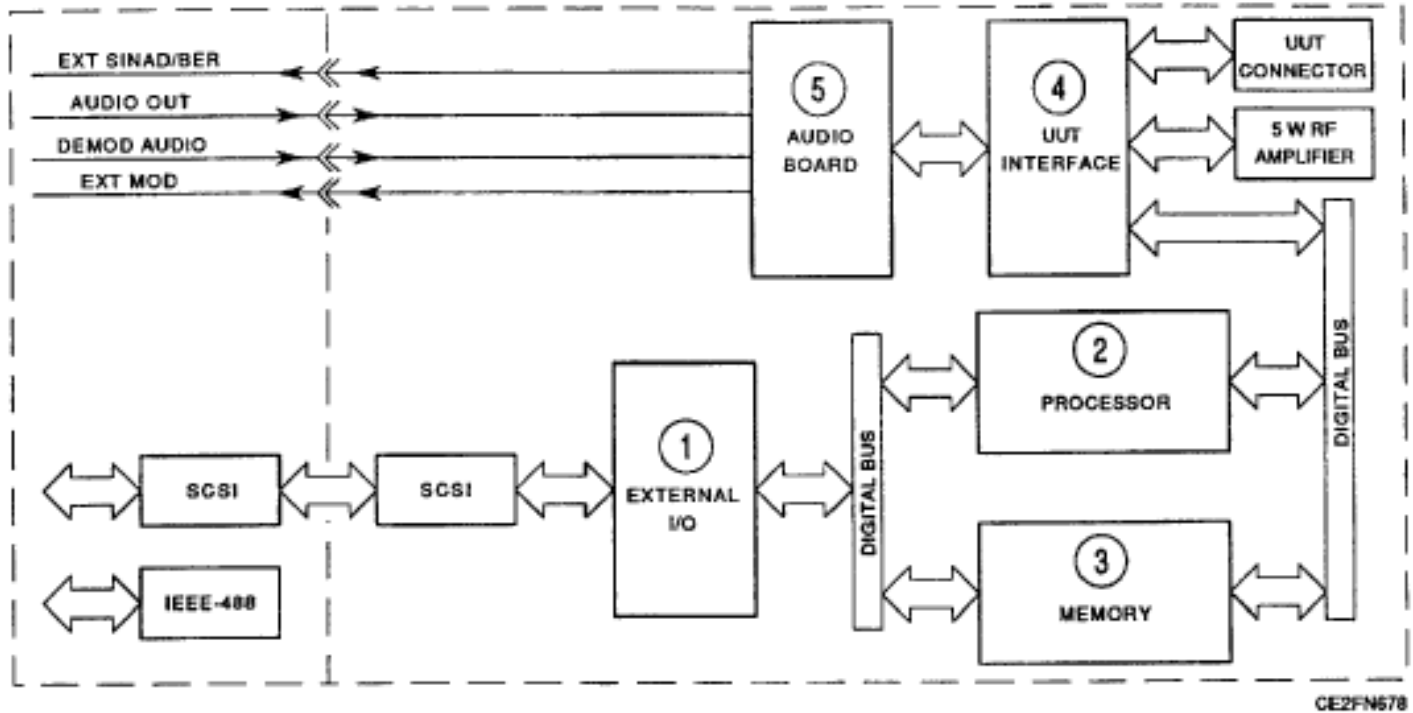

Figure 1-6. Test Adapter Block Diagram.

- ① The Test Adapter **External I/O** provides the interface between the Test Set External I/O interface and the Processor/Memory Group of the Test Adapter.
- ② The Test Adapter **Processor** couples with the Test Adapter Memory Board to control the Test Adapter.
- ③ The Test Adapter **Memory Board** couples with the Test Adapter Processor to control the Test Adapter.
- ④ The **UUT Interface Board** provides a link between the Processor/Memory Group and the UUT.
- ⑤ The **Audio Board** is a passive link between the UUT Interface Board and the Test Adapter front panel connectors.

The **3rd LO** receives 1 MHz Reference signal from the 2nd LO. Outputs the final frequency tuning for the Receive IF and the Analyzer RF.

- ④ The **Receiver** receives input from the Receive IF block and creates an output to the Digitizer and the Counter. Demodulates AM, FM, PM and SSB signals for the Monitor. Provides the Monitor with FM DATA and AGC Level information.

- ⑥ The **Analyzer RF** sweeps a band of signals input from the Receive IF. Centered with the input from the 3rd LO, the Analyzer RF then supplies a fixed 10.7 MHz IF signal output to the Analyzer Log/IF.

- ⑦ The **Analyzer Log/I F** selects the resolution bandwidth for the Spectrum Analyzer. Creates a logarithmic analyzer video output to the Digitizer.

- ⑧ The **Digitizer** converts the Analyzer Log/IF video output for display by the Processor/Memory Group as a Spectrum Analyzer display on the CRT. Receives and converts the Oscilloscope input from the Scope connector or information from the monitor via the Scope Audio line and outputs the results to the Processor/Memory Group.

d. **Test Adapter** (fig. 1-6). Provides the interface link between the Test Set and the SINGARS radio LRU or other system component being tested.

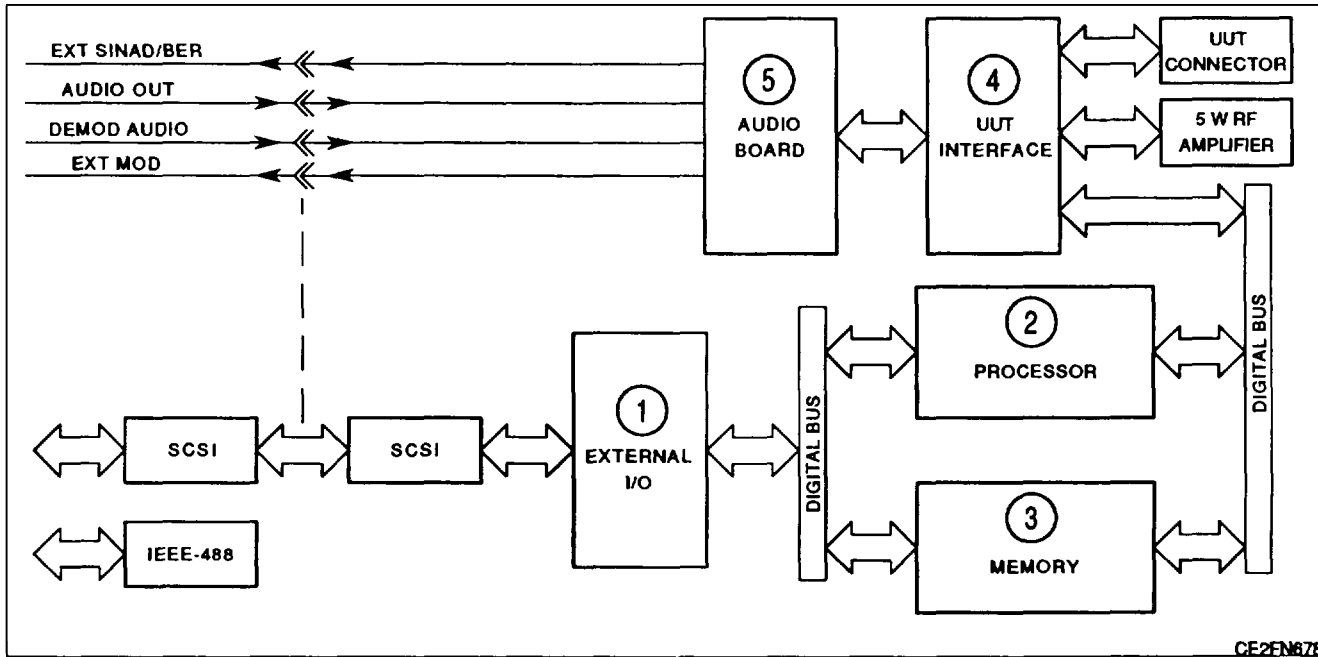

- ① The Test Adapter **External I/O** provides the interface between the Test Set External I/O interface and the Processor/Memory Group of the Test Adapter.
- ② The Test Adapter **Processor** couples with the Test Adapter Memory Board to control the Test Adapter.
- ③ The Test Adapter **Memory Board** couples with the Test Adapter Processor to control the Test Adapter.
- ④ The **UUT Interface Board** provides a link between the Processor/Memory Group and the UUT.
- ⑤ The **Audio Board** is a passive link between the UUT Interface Board and the Test Adapter front panel connectors.

CHAPTER 2

OPERATING INSTRUCTIONS

	Para	Page
AF Signal Generator2-14	2-199
AM Modulation Measurement2-21	2-226
Audio Frequency (AF) Measurement2-17	2-217
Bit Error Rate (BER) Measurement2-25	2-236
Digital Multimeter2-26	2-242
Distortion Measurement2-22	2-228
Duplex2-13	2-194
FM Deviation Measurement..2-20	2-224
FM RMS Deviation Measurement2-28	2-251
Frequency Error and Frequency Measurement	2-18	2-220
General.2-4	2-158
initial Adjustment and Daily Checks2-9	2-161
introduction (Section I)2-1	2-2
introduction (Section III)2-6	2-158
Operating Procedures2-10	2-165
Operation Screen and Menu Configurations	2-3	2-22
Operator's Controls, Indicators and Connectors	2-2	2-2
Oscilloscope2-15	2-207
PMCS Procedures2-5	2-158
PM Phase Measurement2-27	2-249
PM RMS Phase Measurement2-29	2-253
Preparation for Use2-7	2-158
Receiver2-12	2-183
Regenerator2-1 1	2-165
RF Power Measurement2-19	2-222
Signal Strength Measurement.2-24	2-234
SINAD Measurement2-23	2-231
SINCGARS Tests2-30	2-255
Spectrum Analyzer2-16	2-212
Turn-On Procedure2-8	2-160

Section i. DESCRIPTION AND USE OF OPERATOR'S CONTROLS, indicators AND CONNECTORS

2-1. INTRODUCTION.

This section describes the operator controls, indicators, connectors, operation screens and menus of the Test Set.

2-2. OPERATOR'S CONTROLS, INDICATORS AND CONNECTORS.

Due to the large number of controls and connectors on the front panel, it is necessary to separate the panel into seven different sections. Figure 2-1 shows each section of the front panel. The rear panel is shown in Figure 2-2.

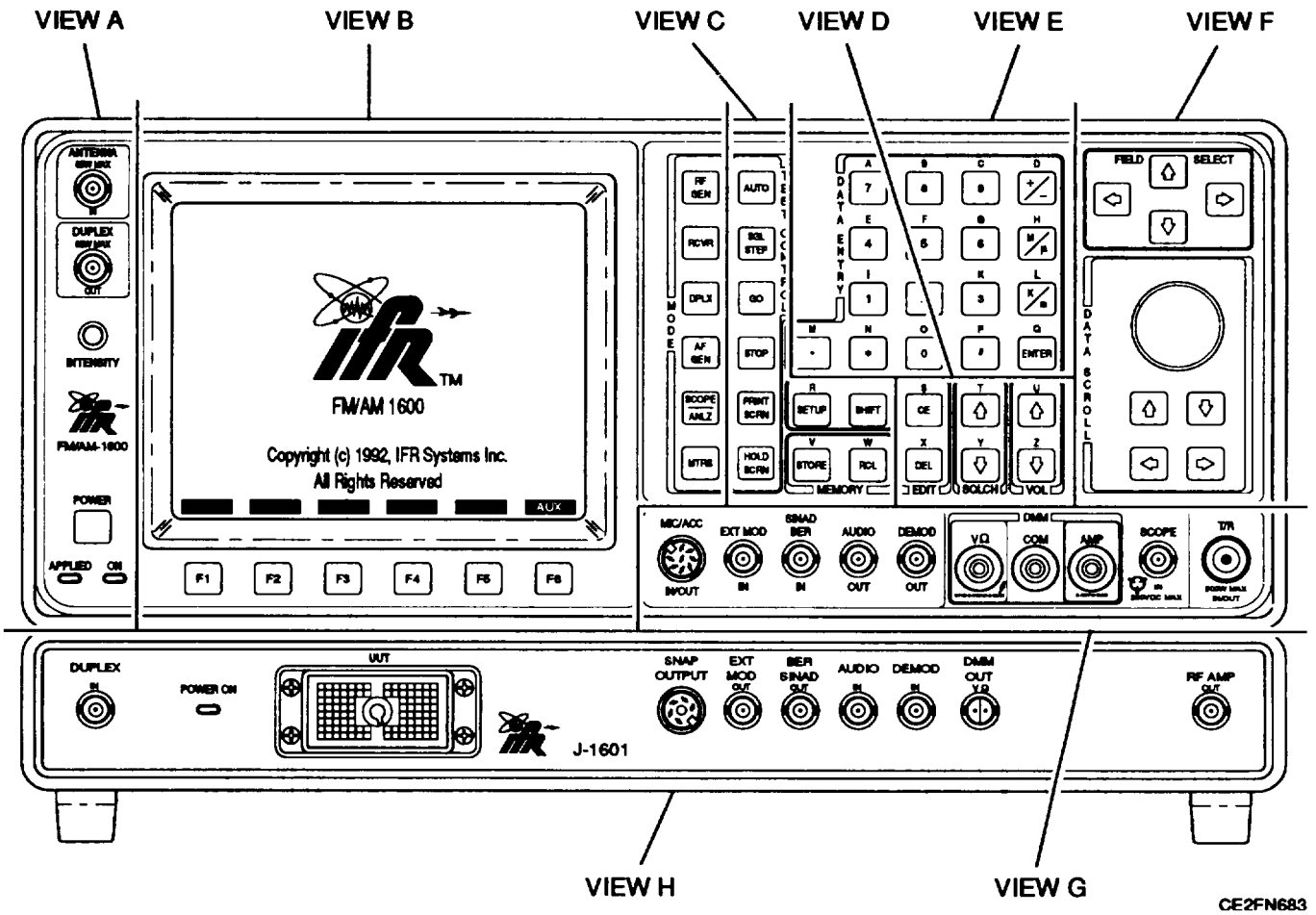
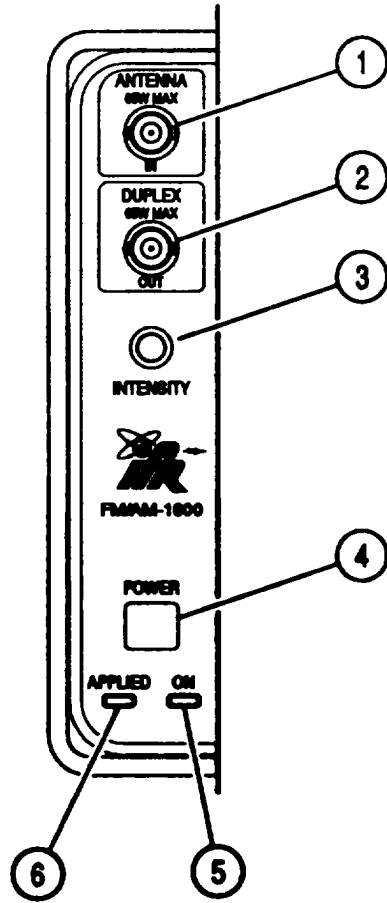

Figure 2-1. Operator's Controls, Indicators and Connectors, Front View.



CE2FN605

VIEW A

KEY	CONTROL, INDICATOR OR CONNECTOR	FUNCTION
1.	ANTENNA IN Connector	BNC Connector used to monitor low level "off-the-air" signals.
2.	DUPLEX OUT Connector	BNC connector supplies RF Generator output when Test Set is in Duplex Mode.
3.	INTENSITY/Contrast Adjustment	Adjusts Intensity and Contrast of CRT Display (7).
4.	POWER Switch	Turns Test Set AC or DC power on and off. In high internal temperature operating conditions, processor control may switch power off.
5.	ON Indicator	Illuminates when POWER Switch (4) is pressed to turn power on.
6.	APPLIED Indicator	Illuminates when AC or DC power is applied to Test Set.

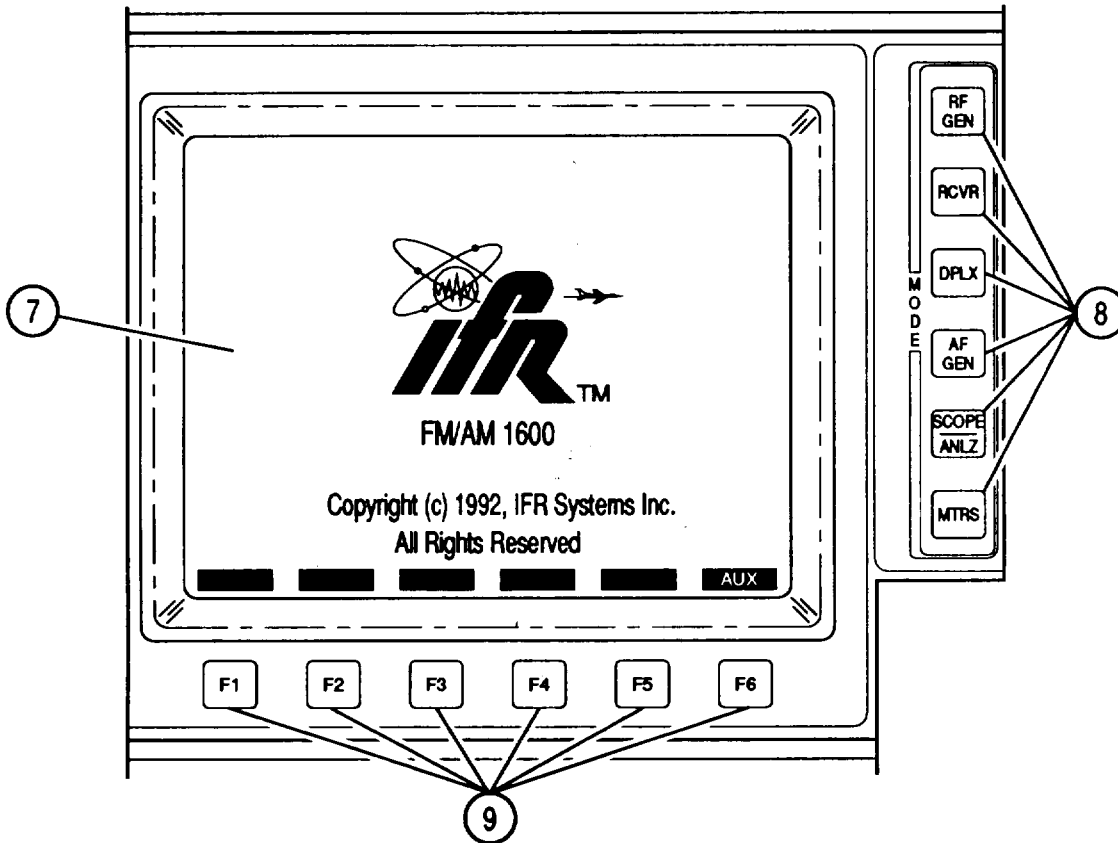

CE2FN506

VIEW B

KEY	CONTROL, INDICATOR OR CONNECTOR	FUNCTION
7.	CRT Display	Displays Test Set Operation Screens, Menus and Meters. See paragraph 2-3 for screen and menu configurations.
8.	MODE Keys:	Press indicated keys to display following screens on CRT Display (7).
	RF GEN	RF Generator Operation Screen.
	RCVR	Receive Operation Screen.
	DPLX	Duplex Operation Screen.
	AF GEN	AF Function Generator Operation Screen.
	SCOPE/ANLZ	Oscilloscope or Spectrum Analyzer Operation.
	MTRS	Meter Menu.

KEY	CONTROL, INDICATOR OR CONNECTOR	FUNCTION
9.	Soft Function Keys F1 thru F6	Definitions for use of Soft Function Keys are displayed on CRT Display (7) directly above each key. Press indicated Soft Function Key to access indicated data field or function. See paragraph 2-3 for information on configuration and use of Soft Function Keys.

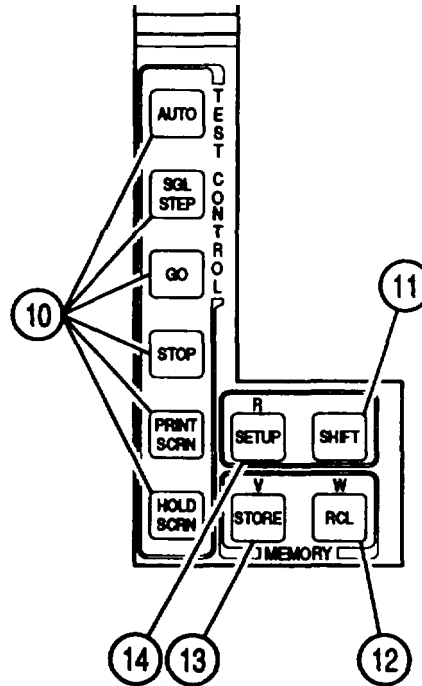

CE2FN607

VIEW C

KEY	CONTROL, INDICATOR OR CONNECTOR	FUNCTION
10.	TEST CONTROL Keys: AUTO SGL STEP GO STOP PRINT SCRIN	Press indicated TEST CONTROL Keys to enter following test execution mode or function: Enables Automatic Test Functions of Special Test Menu. Enables Single Step Test Functions of Special Test Menu. Starts Test Functions of Special Test Menu. Stops Test Functions of Special Test Menu. Prints copy of CRT Display (7).

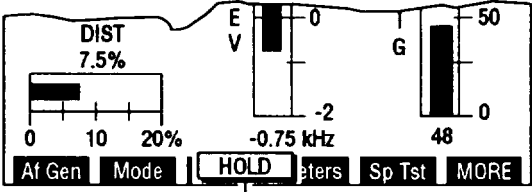
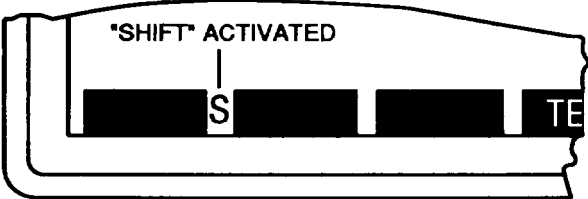
KEY	CONTROL, INDICATOR OR CONNECTOR	FUNCTION
10.	<p>TEST CONTROL Keys (Cont.):</p> <p>HOLD SCRN</p>	<p>Holds screen on CRT Display (7). When HOLD SCRN is pressed, HOLD indicator appears at bottom edge of CRT Display (7):</p>  <p style="text-align: center;">'HOLD SCRN' ACTIVATION INDICATOR</p> <p style="text-align: right;">CE2FN508</p> <p>When HOLD indicator is on CRT Display (7), all movement of Meters, Oscilloscope and Spectrum Analyzer stops. Press HOLD SCRN Key again to resume normal operation.</p>
11.	SHIFT Key	<p>Used for direct entry of hex digits and alphabet characters in data fields. When SHIFT Key is activated, "S" appears at bottom of CRT Display (7):</p>  <p style="text-align: right;">CE2FN509</p> <p>Press SHIFT Key, then appropriate front panel key to enter desired hex or alpha character into accessed, editable data field.</p> <p>Press SHIFT Key again to remove SHIFT indicator from CRT Display (7).</p>

KEY	CONTROL, INDICATOR OR CONNECTOR	FUNCTION
12.	RCL Key (SHIFT Character)	<p>Recalls set of previously stored Test Set parameters from memory. When RCL Key is pressed, 'Recall Parameters Menu' appears on CRT Display (7):</p> <div data-bbox="821 426 1347 831" data-label="Image"> <p>The image shows a rectangular menu box titled "Store Parameters Menu (REC)". Inside the box, there is a vertical list of numbers from 1 to 9. The number 1 is highlighted with a thick black bar to its left. At the bottom of the menu box, there is a row of keys, with the "Ret" key clearly visible. To the right of the menu box, the text "CE2FNS11" is printed.</p> </div> <p>Name in parentheses immediately after "Recall Parameters Menu" title ("REC' for Receive, in example shown) is type of parameters stored. Parameter type depends on operating mode of Test Set when RCL Key was pressed. To recall a set of Receive Operation Screen parameters, press RCVR MODE Key (8), RCL Key and number (1 thru 9) of stored parameter set on DATA ENTRY Keypad (18). Stored parameter set name appears within a submenu featuring a "Recall?" prompt followed by a "YES"/"NO' rollover data field. Use any key on DATA ENTRY Keypad (18) except ENTER to toggle between YES/NO. After selecting desired response, press ENTER. All Test Set parameters stored in parameter set are active.</p> <p>Recall parameter sets are available for each operation screen and Meter type. A SYSTEM parameter recall set is available for storing and recalling Test Set parameters for all operation screens.</p> <p>Places 'W' in a data field when SHIFT indicator is on CRT Display (7).</p>

(W)

KEY	CONTROL, INDICATOR OR CONNECTOR	FUNCTION
14.	<p>SETUP Key (SHIFT Character)</p> <p>(R)</p>	<p>Displays setup menu for operation screen on CRT Display (7). Each operation screen and meter has a menu linked to it. Most operation screen parameters are displayed on the menu for that screen. Some operation screens have parameters which can be set only from the menu. See paragraph 2-3 for information on screen and menu configurations.</p> <p>Places "R" in a data field when SHIFT indicator is on CRT Display (7).</p>

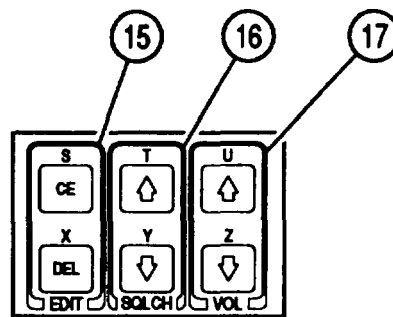

CE2FN512

VIEW D

KEY	CONTROL, INDICATOR OR CONNECTOR	FUNCTION
15.	<p>EDIT Keys (SHIFT Character)</p> <p>"CE"</p> <p>(S)</p> <p>"DEL"</p> <p>(X)</p>	<p>Press indicated keys to edit data within accessed data field.</p> <p>Clears all data from accessed data field.</p> <p>Places "S" in a data field when SHIFT indicator is on CRT Display (7).</p> <p>Deletes data character to left of cursor in accessed data field.</p> <p>Places "X" in a data field when SHIFT indicator is on CRT Display (7).</p>

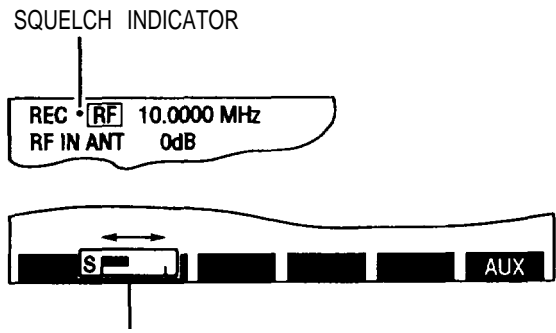
KEY	CONTROL, INDICATOR OR CONNECTOR	FUNCTION
16.	SQLCH Control Keys (SHIFT Character)	<p>Increases (↑ Key) or decreases (↓ Key) squelch level. When either SQLCH Control Key is pressed, a squelch level indicator appears at bottom of CRT Display (7):</p> <div style="text-align: center;">  </div> <p style="text-align: right;">CE2FNS13</p> <p>When ↑ SQLCH Control Key is pressed, squelch indicator expands to right and squelch level increases. When ↓ SQLCH Control Key is pressed, squelch level indicator contracts to left and squelch level decreases.</p> <p>Continue to press or hold in necessary SQLCH Control Key until squelch is broken, as indicated by green squelch indicator light appearing after REC on Receive Operation Screen or after TX on Duplex Transmitter Operation Screen. Press ENTER. Squelch level indicator disappears and squelch is adjusted to point indicated.</p> <p>(T) Pressing ↑ SQLCH Control Key places "T" in data field when SHIFT indicator is on CRT Display (7).</p> <p>(Y) Pressing ↓ SQLCH Control Key places "Y" in data field when SHIFT indicator is on CRT Display (7).</p>

KEY	CONTROL, INDICATOR OR CONNECTOR	FUNCTION
17.	VOL Control Keys (SHIFT Character) (u) (z)	Increases (↑ Key) or decreases (↓ Key) Test Set speaker volume. When either VOL Control Key is pressed, a volume level indicator appears at bottom of CRT Display (7):  VOLUME LEVEL INDICATOR CE2FN514 When ↑ VOL Control Key is pressed, indicator expands to right and speaker volume increases. When ↓ VOL Control Key is pressed, volume indicator contracts to left and speaker volume decreases. When desired speaker volume is reached, press ENTER. Volume level indicator disappears and volume is set. Pressing ↑ VOL Control Key places "U" in a data field when SHIFT indicator is on CRT Display (7). Pressing ↓ VOL Control Key places "Z" in a data field when SHIFT indicator is on CRT Display (7).

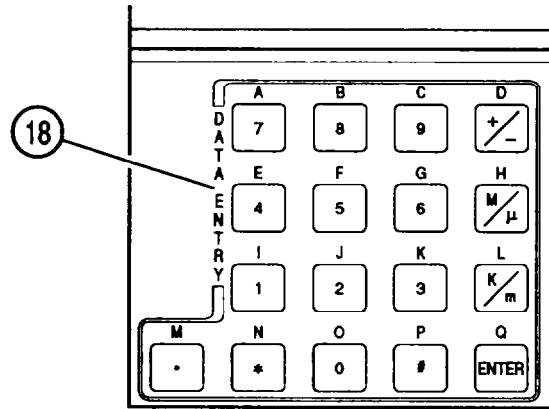

CE2FN515

VIEW E

KEY	CONTROL, INDICATOR OR CONNECTOR	FUNCTION
18.	DATA ENTRY Keypad (SHIFT Character)	<p>Press indicated key for direct entry of Test Set parameters into accessed data fields and entry of hex or alpha characters. Number keys repeat if held in for more than one second and repeat at two per second.</p> <p>7 Key (A) Places "7" in a data field or menu. Places "A" hex or alpha character in a data field when SHIFT indicator is on CRT Display (7).</p> <p>8 Key (B) Places "8" in a data field or menu. Places "B" hex or alpha character in a data field when SHIFT indicator is on CRT Display (7).</p> <p>9 Key (C) Places "9" in a data field or menu. Places "C" hex or alpha character in a data field when SHIFT indicator is on CRT Display (7).</p> <p>+/- Key (D) Press +/- key to change value of data from positive to negative or from negative to positive. Places "D" hex or alpha character in a data field when SHIFT indicator is on CRT Display (7).</p> <p>4 Key (E) Places "4" in a data field or menu. Places "E" hex or alpha character in a data field when SHIFT indicator is on CRT Display (7).</p>

KEY	CONTROL, INDICATOR OR CONNECTOR	FUNCTION
18.	<p>DATA ENTRY Keypad (Cont.) (SHIFT Character)</p> <p>5 Key (F)</p> <p>6 Key (G)</p> <p>M/μ Key (H)</p> <p>1 Key (1)</p> <p>2 Key (J)</p> <p>3 Key (K)</p> <p>K/m Key (L)</p> <p>• Key (M)</p> <p>* Key (N)</p>	<p>Places "5" in a data field or menu.</p> <p>Places "F" hex or alpha character in a data field when SHIFT indicator is on CRT Display (7).</p> <p>Places "6" in a data field or menu.</p> <p>Places "G" in a data field when SHIFT indicator is on CRT Display (7).</p> <p>Press M/μ Key to multiply data by 10⁶ or 10⁻⁶.</p> <p>Places "H" in a data field when SHIFT indicator is on CRT Display (7).</p> <p>Places "1" in a data field or menu.</p> <p>Places "1" in a data field when SHIFT indicator is on CRT Display (7).</p> <p>Places "2" in a data field or menu.</p> <p>Places "J" in a data field when SHIFT indicator is on CRT Display (7).</p> <p>Places "3" in a data field.</p> <p>Places "K" in a data field when SHIFT indicator is on CRT Display (7).</p> <p>Press K/m Key to multiply data by 10³ or 10⁻³.</p> <p>Places "L" in a data field when SHIFT indicator is on CRT Display (7).</p> <p>Places "•"(decimal point) in a data field.</p> <p>Places "M" in a data field when SHIFT indicator is on CRT Display (7).</p> <p>Places "*" in data field.</p> <p>Places "N" in a data field when SHIFT indicator is on CRT Display (7).</p>

KEY	CONTROL, INDICATOR OR CONNECTOR	FUNCTION
18.	<p>DATA ENTRY Keypad (Cont.) (SHIFT Character)</p> <p>O Key</p> <p>(o)</p> <p># Key</p> <p>(P)</p> <p>ENTER</p> <p>(Q)</p>	<p>Places "O" in a data field or menu.</p> <p>Places "O" in a data field when SHIFT indicator is on CRT Display (7).</p> <p>Places "#" in a data field.</p> <p>Places "P" in a data field when SHIFT indicator is on CRT Display (7).</p> <p>Accesses data field on operation screen or menu after cursor has been positioned. Activates highlighted parameter. Places entered data in present configuration into operation.</p> <p>Places "Q" in a data field when SHIFT indicator is on CRT Display (7).</p>

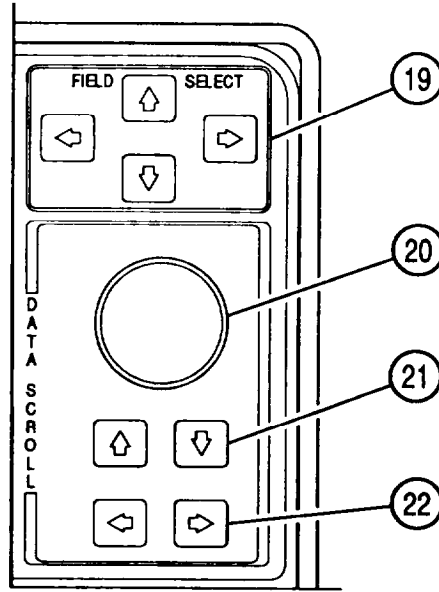

CE2FN516

VIEW F

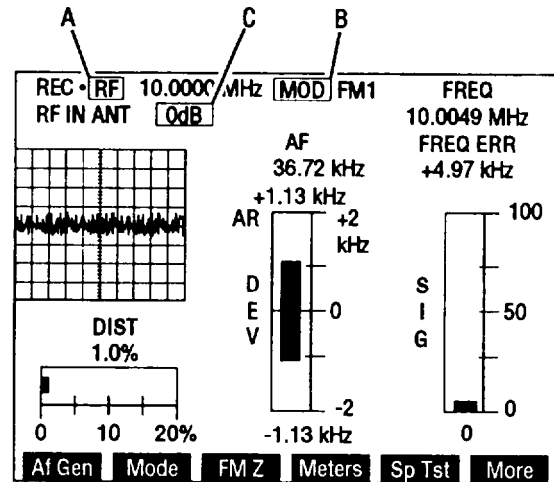

KEY	CONTROL, INDICATOR OR CONNECTOR	FUNCTION
-----	---------------------------------	----------

19.	FIELD SELECT Keys	Places cursor over a data field callout or menu item number.
-----	-------------------	--

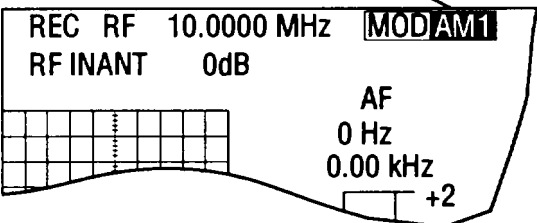
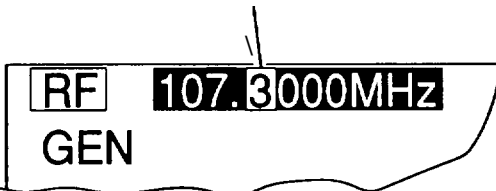

CE2FN517

Cursor moves as shown on key to next data field. On operation screen above, cursor is at position A. If →FIELD SELECT Key is pressed, cursor moves to position B. If no data field or menu item number is in direction indicated on key, cursor wraps around CRT Display (7) and goes to nearest field on opposite side of screen. If ↑FIELD SELECT Key is pressed while cursor is at position A, cursor goes to position C.

KEY	CONTROL, INDICATOR OR CONNECTOR	FUNCTION
20.	DATA SCROLL Spinner	<p>Selects parameters in active data field or scrolls digits in numeric data field.</p> <p>ROTATE SPINNER UNTIL DESIRED SELECTION APPEARS IN DATA FIELD</p>  <p style="text-align: right;">CE2FN518</p> <p>Rotate Spinner to choose entries from possible settings in data field.</p> <p>ROTATE SPINNER TO CHANGE DIGIT</p>  <p style="text-align: right;">CE2FN519</p> <p>In numeric data field, rotate Spinner to select desired number within a field.</p> <p>DIGIT LEFT OF CURSOR CHANGES AS CURSOR DIGIT PASSES "0"</p>  <p>Number displayed by cursor becomes significant digit. When this number is scrolled up or down, number to left increases or decreases as number within cursor passes 0.</p>

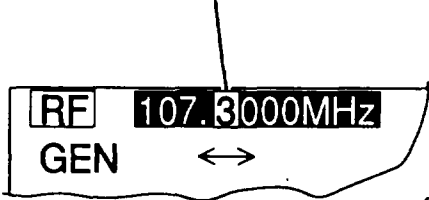
KEY	CONTROL, INDICATOR OR CONNECTOR	FUNCTION
21.	DATA SCROLL Up and Down Arrow Keys	Increases (↑) or decreases (↓) data within active data field. Numbers increase or decrease by 1 within a number data field or next higher or lower selection appears each time DATA SCROLL ↑ or ↓ Key is pressed.
22.	DATA SCROLL Left and Right Arrow Keys	<p>Moves cursor within numeric data field.</p> <p>LEFT AND RIGHT ARROWS MOVE DATA FIELD CURSOR LEFT OR RIGHT</p>  <p style="text-align: right; font-size: small;">CE2FN521</p> <p>Digit cursor moves left or right when DATA SCROLL ← or → Keys are pressed to cover any digit in data field.</p>

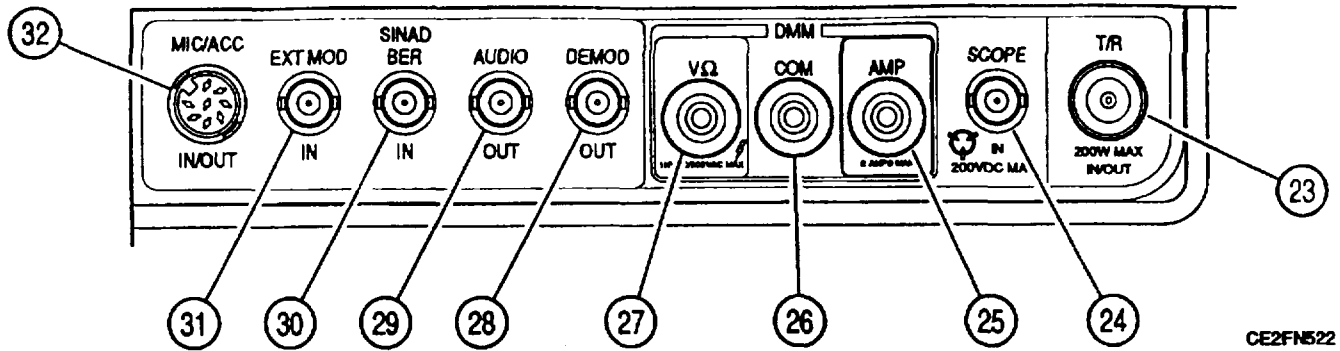

CE2FN522

VIEW G

KEY	CONNECTOR, INDICATOR OR CONNECTOR	FUNCTION
23	TIR Connector	Type N connector used for RF Generator output and high power input.
24	SCOPE IN Connector	BNC connector used for external Oscilloscope input.
25	DMM "AMPS Connector	Digital Multimeter External Input Connector (Banana Jack) for AC and DC current meter input. Remove Connector Plug to access connector.
26	DMM "COM' Connector	Digital Multimeter External Input Common Connector (Banana Jack) for DMM functions.
27	DMM V n Connector	Digital Multimeter External Input Connector (Banana Jack) for DMM AC or DC Voltmeter and Ohmmeter.
28	DEMOM OUT Connector	BNC connector that provides output source for demodulated audio or data from Receiver and AF Generator.
29	AUDIO OUT Connector	BNC Connector provides demodulated audio from Receiver, AF Generator, EXT MOD signal or SINAD/BER signals.
30	SINAD/BER IN Connector	BNC Connector routes input signals to SINAD or Bit Error Rate meter functions.
31	EXT MOD IN Connector	BNC Connector routes input signals applied for AM, FM or PM modulation sources.
32	MIC/ACC IN/OUT Connector	8-pin DIN Connector for Microphone or Accessory Audio Input/Output.

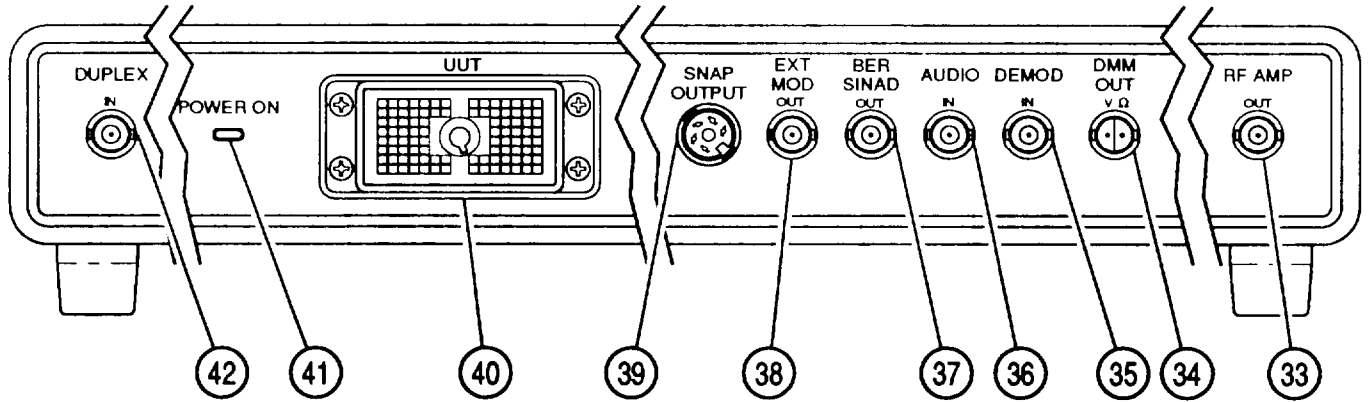

CE2FN684

VIEW H

KEY	CONTROL, INDICATOR OR CONNECTOR	FUNCTION
33.	Test Adapter RF Amplifier Connector	BNC connector routes RF Generator output to UUT.
34.	Test Adapter Volt Ω Digital Multimeter Output Connector	DMM connector receives Voltage Ohm output from UUT.
35.	Test Adapter DE MOD Audio Input Connector	BNC connector receives demodulated audio signal or data from Receiver or AF Generator.
36.	Test Adapter AUDIO Input Connector	BNC connector receives Audio Signal input, external modulation or SINAD/BER signals.
37.	Test Adapter SINAD/BER Output Connector	BNC connector routes UUT signals to Test Set.
38.	Test Adapter EXT MOD Output Connector	BNC connector routes UUT signals to Test Set.
39.	Test Adapter SNAP OUTPUT Connector	5-Pin DIN connector receives serial bus signals from UUT.
40.	Test Adapter UUT Connector	Provides bidirectional logic and signal data bus for connection to UUT.
41.	Test Adapter POWER ON Indicator	Illuminates when DC power is received from Test Set.
42.	Test Adapter Duplex Connector	BNC connector receives Duplex output from Test Set for selected SINGARS test procedures.

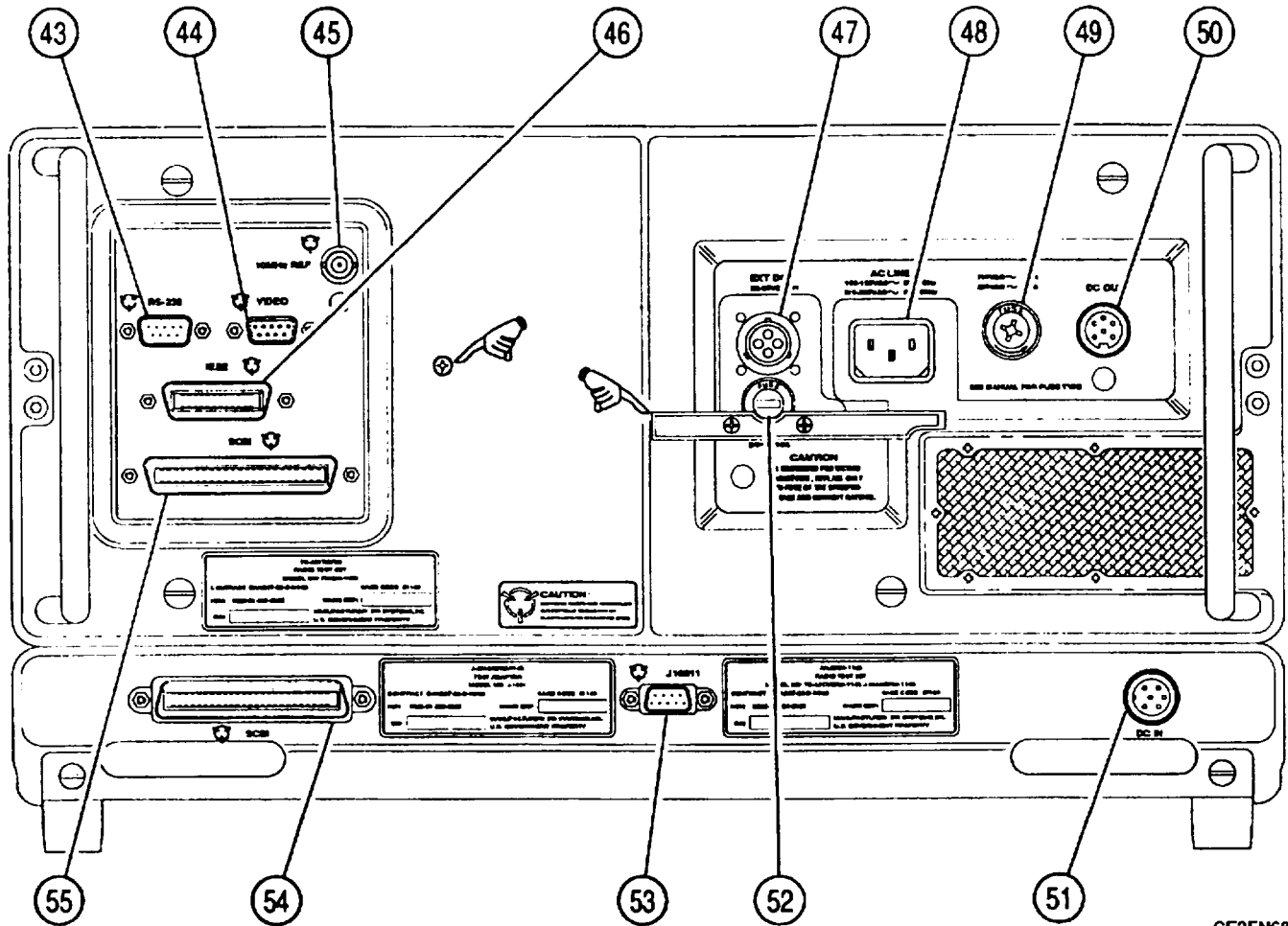

CE2FN685

Figure 2-2. Operator's Controls, Indicators and Connectors, Rear View.

KEY	CONNECTOR, INDICATOR OR CONNECTOR	FUNCTION
43	RS-232 Connector	9-pin sub-miniature D, male connector allows Test Set to communicate with other serial devices.
44	External Video Connector	9-pin EGA (RrGgBb) sub-miniature D, female connector allows attachment of external CRT to Test Set.
45	External Reference Connector	BNC connector allows attachment of 10 MHz reference to Test Set.
46.	IEEE-488 Connector	24-pin connector allows Test Set to control other test modules, transfer test results, drive a printer, plotter or be controlled by external test controller.

KEY	CONTROL, INDICATOR OR CONNECTOR	FUNCTION
47.	EXT DC Connector	22-30 Volt DC power source input.
48.	AC LINE IN Connector	AC power source input,
49.	AC Fuse Housing and Cover	Remove cover to remove, inspect and replace AC power fuse.
50.	DC OUT Connector	Provides power from Test Set to Test Adapter.
51.	Test Adapter DC Input Connector	Input power connector for Test Adapter connected directly to DC OUT Connector (50) on Test Set.
52.	DC Fuse Housing and Cover	Remove cover to remove, inspect and replace DC power fuse.
53.	Test Adapter RS-232 Connector	9-pin sub miniature D, male connector allows internal diagnostics of Test Adapter.
54.	Test Adapter SCSI (Small Computer System Interface) Connector	50-pin connector provides standard, high speed, digital bus for communication between Test Adapter and Test Set.
55.	Test Set SCSI (Small Computer System Interface) Connector	50-pin connector provides standard, high speed, digital bus for communication between Test Set and Test Adapter.

2-3. OPERATION SCREEN AND MENU CONFIGURATIONS.

Operation screens and setup menus of the Test Set contain a great deal of information. This information displays differently at different times according to:

- . Type of operation screen displayed.
 - Configuration of screen.
 - Signal Type.
 - Input source used.

	Para	Page
AF Generator Menu	2-3k	2-93
AF Generator Screen Configuration	2-3j	2-91
Duplex Receiver Menu.....	2-3i	2-80
Duplex Receiver Screen Configuration	2-3h	2-72
Duplex Screen Configuration.	2-3e	2-55
Duplex Transmitter Menu...	2-3g	2-69
Duplex Transmitter Screen Configuration	2-3f	2-60
Meter Screen Configurations and Menus	2-3p	2-113
Oscilloscope Screen Configuration	2-31	2-97
Receiver Menu	2-3d	2-51
Receive Screen Configuration.	2-3c	2-42
RF Generator Menu	2-3b	2-31
RF Generator Screen Configuration	2-3a	2-23
Scope/Analyzer (Oscilloscope) Menu	2-3m	2-101
Scope/Analyzer (Spectrum Analyzer) Menu	2-30	2-110
Spectrum Analyzer Screen Configuration	2-3n	2-104

a. **RF Generator Screen Configuration.** Press “RF GEN” MODE Key to access RF Generator Operation Screen. Most RF Generator parameters may be edited from this screen. Use list of screen features to identify items that may be edited, the value range available and function.

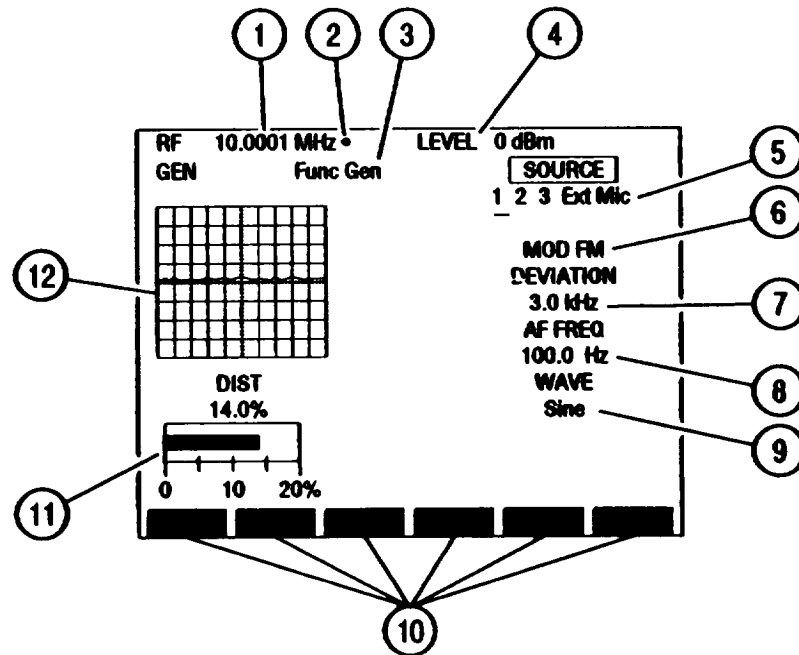

CE2FM400

KEY	SCREEN FEATURE	FUNCTION
1.	RF Generator Frequency	For Direct Mode (20), set from 0.2500 to 999.9999 MHz. For Channel Mode (20), set from 1 to 1023. Default 10.0000 MHz.
2.	10 MHz Indicator	Appears when 10 MHz signal is applied to External Reference Connector.
3.	Oscilloscope Input	Appears with Oscilloscope on. Select from: Rcvr IF Demod Audio RF Pwr Lvl SINAD/BER Func Gen Ext Mod AC DC GND Default Demod Audio.
4.	RF Generator Signal Level	Set from -137.0 to 0.0 dBm. Default -20.0 dBm.

KEY	SCREEN FEATURE	FUNCTION
5.	Modulation Source	<p>1 = Function Generator #1 2 = Function Generator #2 3 = Signaling Formats Ext = EXT MOD Connector Input Mic = MIC/ACC Connector Input Underline indicates active source. FM and PM cannot be selected for different sources at the same time. Select modulation type by color code: White = OFF Yellow = FM Red = AM Green = PM Default 1, OFF.</p>
6.	Modulation Type	<p>Not an editable feature. Readout echoes modulation type of active source (5). Indicates: FM AM PM OFF Default OFF.</p>
7.	Active Source FM Deviation or AM or PM Modulation	<p>Set deviation from 0.0 to 100.0 kHz. Set modulation for AM from 0.% to 90%. Set modulation for PM from 0.0 to 10.0 radians.</p>
8.	Active Source Audio Frequency	<p>Does not appear if OFF selected for active source or if Ext or Mic active. Set from 0.0 to 40000.0 Hz.</p>
9.	Active Source Wave Shape	<p>Does not appear if OFF selected for active source or if Ext or Mic active. Select from: Sine Square Ramp Triangle Pulse +1 Lvl 0 Lvl -1 Lvl</p>
10.	Soft Function Key Definitions	<p>Vary with operation screen configuration, type and output location of generated signals and configuration of RF Generator Screen when last accessed. Press Soft Function Key (F1 thru F6) directly under Soft Function Key Definition to access or activate feature named.</p>
11.	SINAD, Distortion, AF Level or DMM Meter	<p>Shows meter readings of selected meter input. Move cursor to meter and press ENTER to access Meter Operation Screen.</p>
12.	Oscilloscope or Spectrum Analyzer	<p>Oscilloscope displays selected Input (3) wave form, Spectrum Analyzer displays RF Generator output. Use F1 "Disp" (32) to display full-size or 1/4-size Oscilloscope or Spectrum Analyzer, or select None for no display. When full-size, Meters (1 1) display as digital readouts. Default None.</p>

When Modulation Source 3 (5) is active source and POCSAG or Tone Remote is not Signaling Code, RF Generator Operation Screen appears as follows:

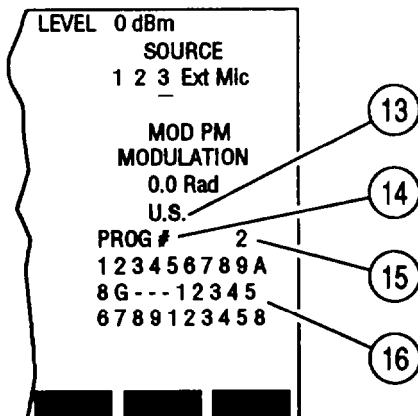

KEY	SCREEN FEATURE	FUNCTION
13.	Signaling Code Type	Selects Signaling Code Type. For Audio Signaling Format, select from: CCIR EEA US (EIA) ZVEI DDZVEI DVZEI NATEL EURO 5/6 Tone Seq CCIRH CCIRH4 User Defined For Digital Signaling Format, select from: DCS DCS INV POCSAG For RCC Signaling Format, select from: IMTS MTS 2805 Tone Rem
14.	Direct Entry/Programmed Sequence	Toggles to opposite function. DIRECT ENTRY allows entry of digits to encode from RF Generator Operation Screen. PROG # encodes selected sequence programmed from RF Generator Menu.
15.	Programmed Sequence Number	Appears with PROG # (14). Set from 1 to 15.
16.	Encoded Data	If PROG # (14), displays data encoded. If DIRECT ENTRY (14), allows entering of digits to encode.

When Modulation Source 3 (5) is active source and POCSAG or Tone Remote is Signaling Code, RF Generator Operation Screen appears as follows:

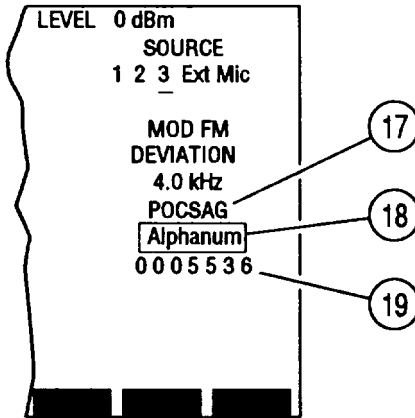

KEY	SCREEN FEATURE	FUNCTION																								
17.	Signaling Format	Displays Signaling Format selected in RF Generator Menu.																								
18.	Signaling Code Type	<p>Selects Signaling Code Type. If POCSAG is Signaling Code, select from:</p> <table border="0"> <tr> <td>Tone-1 beep</td> <td>Tone-2 beeps</td> <td>Tone-3-beeps</td> </tr> <tr> <td>Tone-4-beeps</td> <td>Numeric</td> <td>Numeric Seq</td> </tr> <tr> <td>Alpha lower</td> <td>Alpha upper</td> <td>Alphanumeric</td> </tr> <tr> <td>Alpha special</td> <td></td> <td></td> </tr> </table> <p>If Tone Remote is Signaling Code, select from:</p> <table border="0"> <tr> <td>2050</td> <td>1950</td> <td>1850</td> </tr> <tr> <td>1750</td> <td>1650</td> <td>1550</td> </tr> <tr> <td>1450</td> <td>1350</td> <td>1250</td> </tr> <tr> <td>1150</td> <td>1050</td> <td></td> </tr> </table>	Tone-1 beep	Tone-2 beeps	Tone-3-beeps	Tone-4-beeps	Numeric	Numeric Seq	Alpha lower	Alpha upper	Alphanumeric	Alpha special			2050	1950	1850	1750	1650	1550	1450	1350	1250	1150	1050	
Tone-1 beep	Tone-2 beeps	Tone-3-beeps																								
Tone-4-beeps	Numeric	Numeric Seq																								
Alpha lower	Alpha upper	Alphanumeric																								
Alpha special																										
2050	1950	1850																								
1750	1650	1550																								
1450	1350	1250																								
1150	1050																									
19.	Capcode	Does not appear with Tone Remote Signaling Code. Displays POCSAG capcodes generated.																								

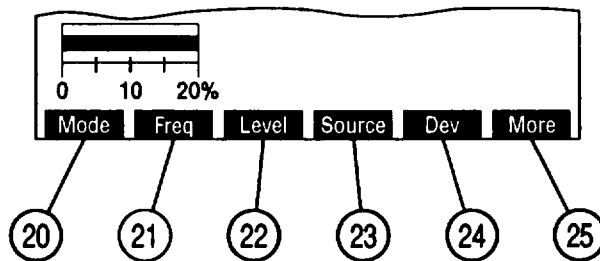

CE2FN391

KEY	SCREEN FEATURE	FUNCTION
20.	"Mode"	Press F1 to select Direct or Channel Mode. Channel Mode displays RF Generator Frequency (1) as a channel number. F or R is displayed indicating Forward or Reverse Channels. Cellular Channel Format is selected in RF Generator Menu.
21.	'Freq"	Press F2 to access RF Generator Frequency (1).
22.	'Level"	Press F3 to access RF Generator Signal Level (4).
23.	"Source"	Press F4 to access Modulation Source (5).
24.	"Dev"/"Mod"	Does not appear if OFF selected for active source or if Ext or Mic active. Press F5 to access FM Deviation, AM or PM Modulation (7).
25.	"More"/"ESC"	Press "More" F6 to access additional Soft Function Key Definitions. "ESC" appears while accessing parameters. Press "ESC" F6 to void edit procedure.

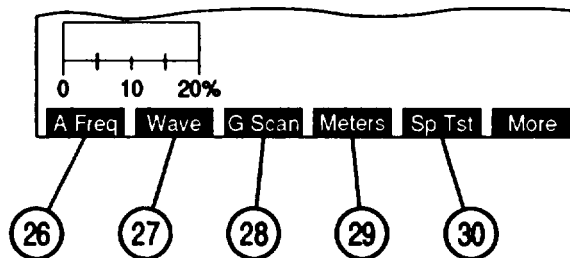

CE2FN392

KEY	SCREEN FEATURE	FUNCTION
26.	"A Freq"	Does not appear if OFF is active source or if Ext or Mic active. Press F1 to access Active Source Audio Frequency (8).
27.	"Wave"	Does not appear if OFF Modulation is active source or if Ext or Mic active. Press F2 to access Active Source Wave Shape (9).
28.	"G Scan"	Does not appear if Channel Mode (20). Press F3 to activate RF Generator Scan set in RF Generator Menu.
29.	'Meters'	Press F4 to select SINAD, Distortion, AF Level or DMM Meter (11). Default SINAD.

KEY	SCREEN FEATURE	FUNCTION
30.	"Sp Tst"/"AUX"	"Sp Tst" appears with Small Computer System Interface enabled. Press F5 to access Special Test Menu. "AUX" appears with Small Computer System Interface disabled. Press F5 to display Auxiliary Functions Menu.

When 1/4 Scope, Full Scope or None is selected using "Disp" Soft Function Key (32), RF Generator Soft Function Keys appear as follows:

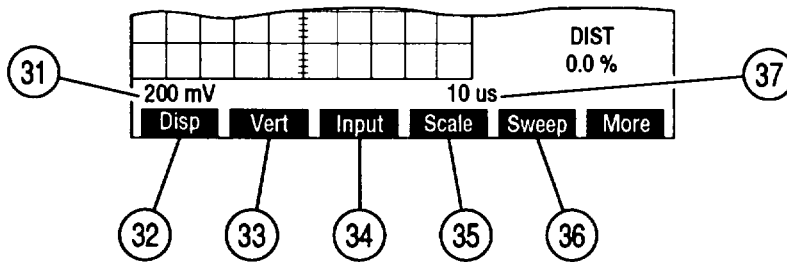

CE2FN393

KEY	SCREEN FEATURE	FUNCTION
31.	Oscilloscope Vertical Scale	Appears with full-size Oscilloscope (12). Does not appear if Input (3) is Rcvr IF. For AC, DC or GND Input (3), select from: 1 mV/div 2 mV/div 5 mV/div 10 mV/div 20 mV/div 50 mV/div 100 mV/div 200 mV/div 500 mV/div 1 V/div 2 V/div 5 V/div 10 V/div 20 V/div 50 V/div For Func Gen or Ext Mod Input, select from: 500 mV 1 V 2.5 V For Demod Audio Input with FM as active source, select from: 2 kHz 4 kHz 10 kHz 20 kHz Autorange (AR appears) For RF Pwr Lvl Input (3), Scale shows 2W or 200W, according to range setting of Power Meter. For SINAD/BER Input, Scale is 4 V.
32.	"Disp"	Selects Oscilloscope or Spectrum Analyzer display. Select from: 1/4 Anlz Full Anlz 1/4 Scope Full Scope None
33.	"Vert"	Appears with full-size Oscilloscope (12). Press F2 to enable vertical position adjustment of Oscilloscope trace. Adjust with DATA SCROLL Spinner, press ENTER.
34.	'Input"	Appears with 1/4 or full-size Oscilloscope. Press F3 to access Oscilloscope Input (3).

KEY	SCREEN FEATURE	FUNCTION
35.	"Scale"	Does not appear for Rcvr IF, RF Pwr Lvl or SINAD/BER Input (3) or when Oscilloscope (12) is 1/4 size. Press F4 to access Oscilloscope Vertical Scale (31).
36.	"Sweep"	Appears with full-size Oscilloscope (12). Does not appear for Rcvr IF Input (3). Press F5 to access Oscilloscope Horizontal Sweep Rate (37).
37.	Oscilloscope Horizontal Sweep Rate	Appears with full-size Oscilloscope (12). Does not appear for Rcvr IF Input (3). Select from: 1 μ s 2 μ s 5 μ s 10 μ s 20 μ s 50 μ s 100 μ s 200 μ s 500 μ s 1 ms 2 ms 5 ms 10 ms 20 ms 50 ms 100 ms

When 1/4 Anlz or Full Anlz is selected using "Disp" Soft Function Key (32), RF Generator Soft Function Keys appear as follows:

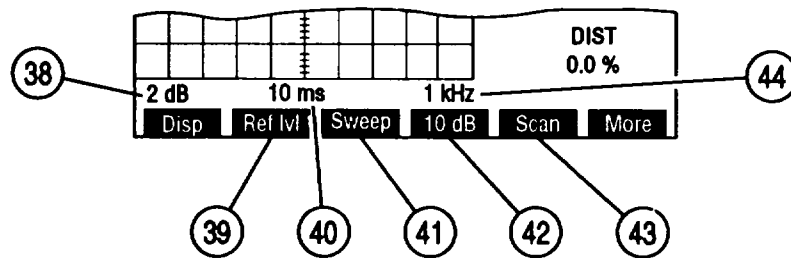

CE2FN394

KEY	SCREEN FEATURE	FUNCTION
38.	Spectrum Analyzer Units/Division Factor	Appears with full-size Spectrum Analyzer (12). Toggles between 10 and 2 dB.
39.	"Ref lvl"	Appears with full-size Spectrum Analyzer (12) and 2 dB Units/Division Factor (38). Press F2 to access 2 dB reference level. Adjust with DATA SCROLL Spinner, press ENTER Key.
40.	Spectrum Analyzer Zero Scan Sweep Rate	Appears with full-size Spectrum Analyzer (12) and 0 kHz Scan Width. Select: 1 μ s 2 μ s 5 μ s 10 μ s 20 μ s 50 μ s 100 μ s 200 μ s 500 μ s 1 ms 2 ms 5 ms 10 ms 20 ms 50 ms 100 ms

KEY	SCREEN FEATURE	FUNCTION
41.	"Sweep"	Appears with full-size Spectrum Analyzer (12) and 0 kHz Scan Width. Press F3 to access Spectrum Analyzer Zero Scan Sweep Rate.
42.	"10 dB"/"2 dB"	Press F4 to toggle Spectrum Analyzer Units/Division Factor between 10 and 2 dB.
43.	"Scan"	Appears with full-size Spectrum Analyzer (1 2). Press F4 to access Spectrum Analyzer Scan Width (44).
44.	Spectrum Analyzer Scan Width	Appears with full-size Spectrum Analyzer (12). Select from: 1 kHz 2 kHz 5 kHz 10 kHz 20 kHz 50 kHz 100 kHz 200 kHz 500 kHz 1 MHz 0 kHz (zero scan)

b. RF Generator Menu. When RF Generator Operation Screen is displayed on CRT, press SETUP Key to access RF Generator Menu. Many RF Generator Operation Screen parameters may be edited from Generator Menu or one of its submenus.

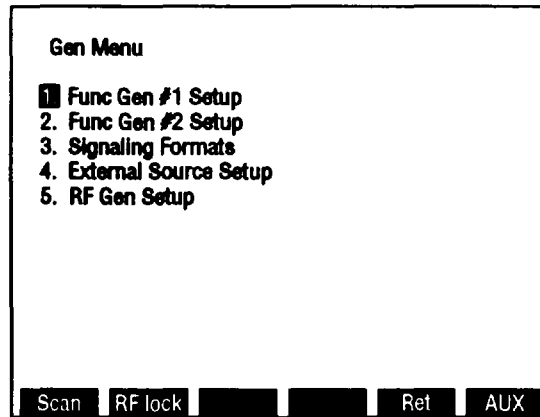

CE2FN395

KEY	MENU ITEM	FUNCTION
1.	Function Generator #1 Setup	Access displays Function Generator #1 Submenu.
2.	Function Generator #2 Setup	Access displays Function Generator #2 Submenu.
3.	Signaling Formats	Access displays Signaling Format Menu.
4.	External Source Setup	Access displays External Source Setup Menu.
5.	RF Generator Setup	Access displays RF Generator Setup Menu.

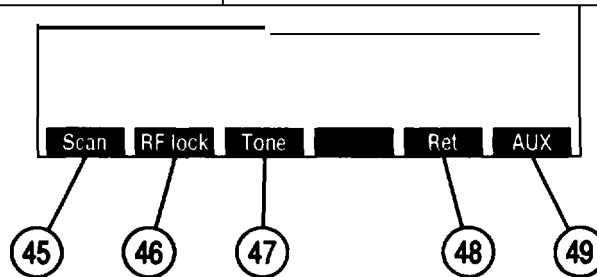

CE2FN380

KEY	SCREEN FEATURE	FUNCTION
45.	"Scan"	Access displays RF Frequency Scan Menu.
46.	"RF lock"/"Chan"	"RF lock" appears with Direct Mode (20). Press F2 to enable/disable RF Lock. RF Lock enabled locks RF Generator Frequency to same value as Receive Radio Frequency and Spectrum Analyzer Radio Frequency. "RF lock" appears red when enabled. "Chan" appears with Channel Mode (20). Press F2 to access Channel Format Menu allowing selection of Channel Format. Select from: AMPS Cellular (Fwd) AMPS Cellular (Rev) ETACS Cellular (Fwd) ETACS Cellular (Rev)

KEY	SCREEN FEATURE	FUNCTION
47.	"Tone"	Appears only while selecting 2805 sequences in 2805 Submenu. Access displays data field allowing entry of 2805 frequency. Range is 0.0 to 40000.0 Hz. Default is 2805 Hz.
48.	"Ret"	Press F5 to display RF Generator Operation Screen.
49.	"AUX"/"ESC"	Press "AUX" F6 to display Auxiliary Functions Menu. "ESC" appears while accessing parameters. Press "ESC" F6 to void edit procedure.

Pressing "Scan" Soft Function Key F1 displays RF Frequency Scan Menu. RF Frequency Scan parameters are edited from this menu:

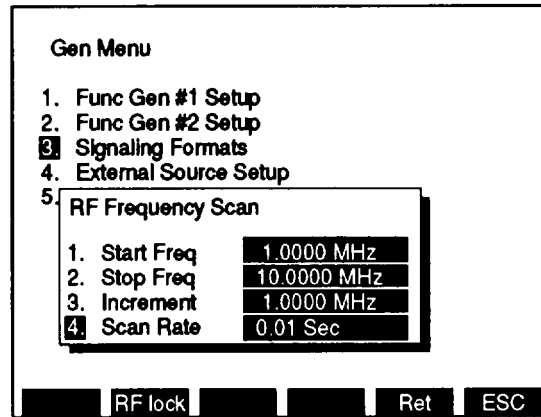

CE2FN379

KEY	MENU ITEM	FUNCTION
1.	RF Frequency Scan Starting Frequency	Set from 0.2500 to 999.9999 MHz. Default 10.0000 MHz.
2.	RF Frequency Scan Stopping Frequency	Set from 0.2500 to 999.9999 MHz. Default 100.0000 MHz.
3.	Increment between frequencies scanned	Set increment between frequencies to be scanned from 0.0000 to 999.9999 MHz. Default 1.0000 MHz.
4	Scan Rate, time period for each frequency to be generated	Set from 0.02 to 99.99 sec. Default 0.02 sec.

When Func Gen #1 Setup or Func Gen #2 Setup is accessed from Gen Menu, one of the following submenus appears on CRT. The setup Parameters for Function Generator #1 Submenu and Function-Generator #2 Submenu are identical.

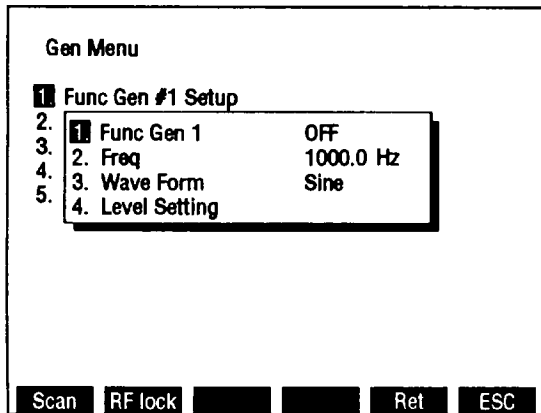

CE2FN396

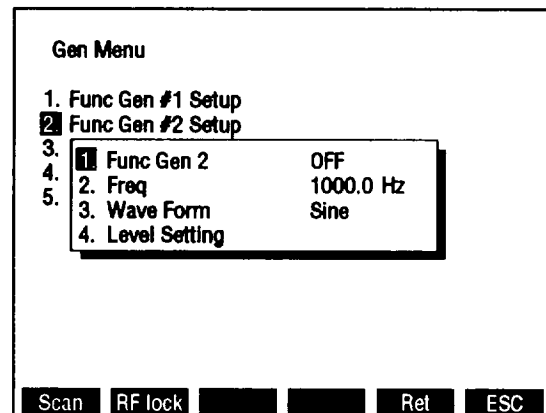

CE2FN397

KEY	MENU ITEM	FUNCTION
1.	Function Generator 1 and 2 Modulation Type	Select from: AM FM PM OFF Default OFF.
2.	Frequency Setting	Set from 0.0 to 40000.0 Hz. Default 1000.0 Hz.
3.	Wave Form	Access displays submenu. Select from: Sine Square Ramp Triangle Pulse +1 Lvl 0 Lvl -1 Lvl Default Sine.
4.	Level Setting:	Appears if OFF Modulation Type (l). Parameter field is blank.
	FM Dev	Appears if FM Modulation Type (l). Set from 0.0 to 100.0 kHz.
	AM Mod	Appears if AM Modulation Type (1). Set from 0% to 90%.
	PM Mod	Appears if PM Modulation Type (1). Set from 0.0 to 10.0 radians.

When 3. Signaling Formats is selected on Generator Menu, Signaling Format Menu appears:

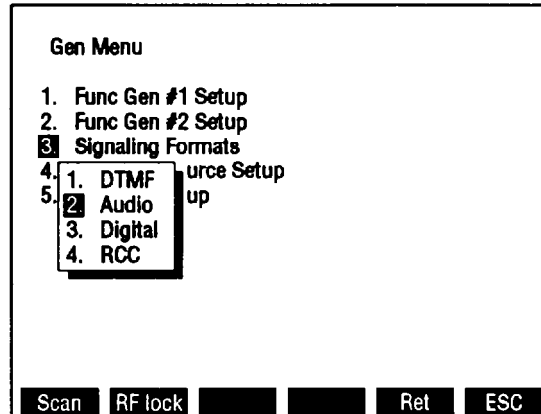

CE2FN368

KEY	MENU ITEM	FUNCTION
1	DTMF	Access selects DTMF as Signaling Format and displays DTMF Format Menu
2.	Audio	Access displays Audio Format Menu.
3.	Digital	Access displays Digital Format Menu.
4.	RCC	Access displays RCC Format Menu.

When 1. DTMF is selected on Signaling Format Menu, DTMF Format Menu appears. DTMF Format Menu allows assignment of identification numbers to sequences. Sequences are selected from RF Generator Operation Screen by entering identification number for Programmed Sequence Number (1 5).

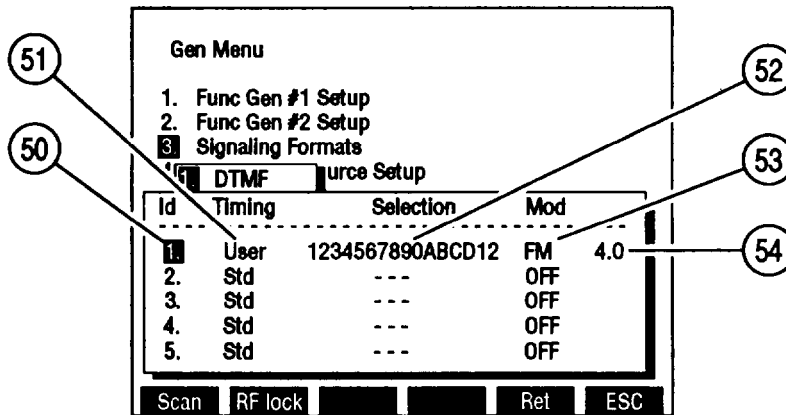

CE2FN369

KEY	SCREEN FEATURE	FUNCTION
50.	Identification number of sequence	Identification numbers range from 1 to 15.

KEY	SCREEN FEATURE	FUNCTION
51.	Mark and space timing	Select Std (Standard, 25 ms mark and space timing) or User. Selecting User displays data field allowing mark and space timing entry from 25 to 9999 ms. Default Std.
52.	Sequence of up to 16 digits to encode	Use 1 to 9, letters A to D, # and *. Default blank.
53.	Modulation Type	Select AM, FM, PM or OFF. Default OFF.
54.	Modulation Level	Set Modulation Level from 0.0 to 20.0 kHz for FM, 0.0% to 24.5% for AM, 0.0 to 3.0 radians for PM.

When 2. Audio is selected on Signaling Formats Menu, Audio Format Menu appears allowing selection of Audio Code:

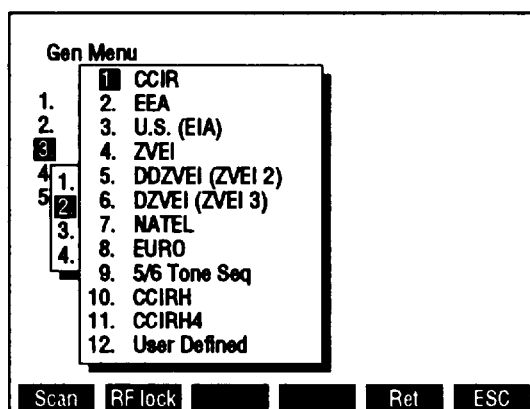

CE2FN370

Selecting an Audio Signaling Code except User Defined displays Audio Code Menu. Audio Code Menu allows assignment of identification numbers to sequences. Sequences are selected from RF Generator Operation Screen by entering identification number for Programmed Sequence Number (15).

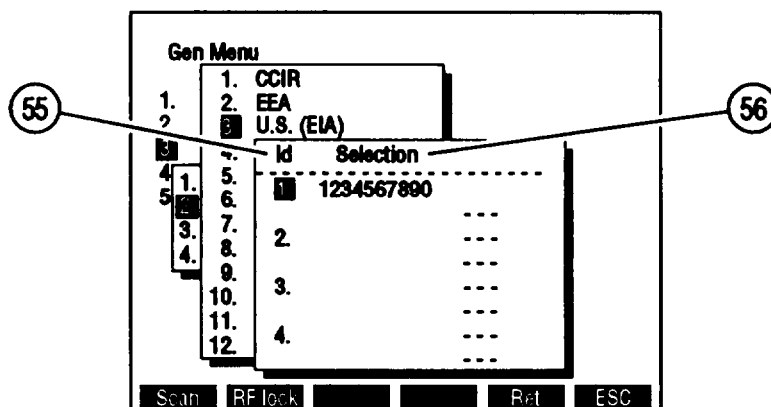

CE2FN371

KEY	MENU ITEM	FUNCTION
55.	Identification number of sequence	Identification number range from 1 to 16.
56.	Sequence of up to 30 digits to encode	Use O to 9, -, A, G and R.

When 12. User Defined is selected on Audio Code Menu, submenu appears:

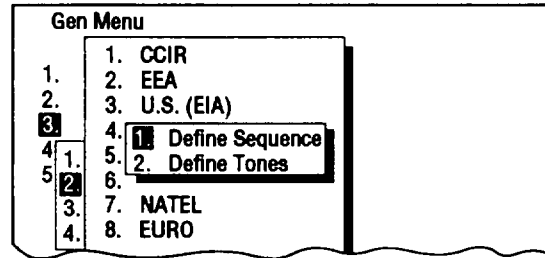

CE2FN372

When 1. Define Sequence is selected, Audio Code Menu appears. User Defined sequences are selected as other Audio Codes. User Defined Tones are defined in Defined Tones Menu.

When 2. Define Tones is selected, Defined Tones Menu appears allowing the defining of 30 different tones to be selected using Audio Code Menu.

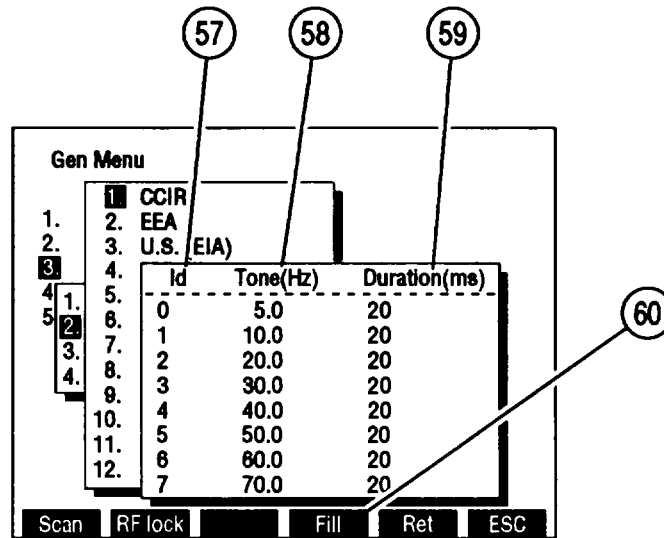

CE2FN373

KEY	SCREEN FEATURE	FUNCTION
57.	Identification number of tone	Identification numbers range from O to 9 and A to T.
58.	Tone frequency	Set from 0.0 to 9999.9 Hz.
59.	Tone duration	Set from 20 to 9999 ms.

KEY	SCREEN FEATURE	FUNCTION
60.	"Fill"	Press F4 to fill all entries below highlighted entry with highlighted entry value.

When 3. Digital is selected on Signaling Formats Menu, Digital Format Menu appears allowing Digital Code selection.

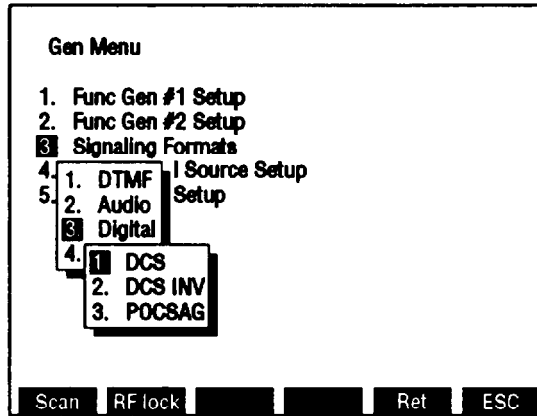

CE2FN374

KEY	MENU ITEM	FUNCTION
1.	DCS	Access selects DCS as Signaling Code and displays DCS Menu.
2.	DCS INV	Access selects DCS INV as Signaling Code and displays DCS Menu.
3.	POCSAG	Access selects POCSAG as Signaling Code and displays POCSAG Menu.

When 1. DCS or 2. DCS INV is selected on Digital Format Menu, DCS Menu appears. DCS Menu allows assignment of identification numbers to sequences. Sequences are selected from RF Generator Operation Screen by entering identification number for Programmed Sequence Number (15).

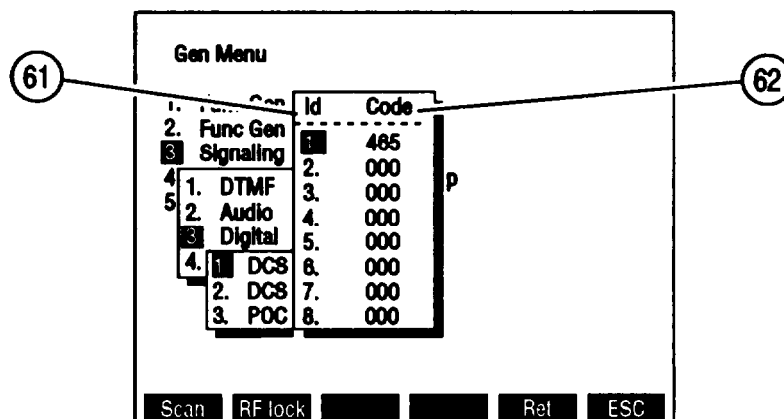

CE2FN375

KEY	SCREEN FEATURE	FUNCTION
61.	Identification number of sequence	Identification numbers range from 1 to 16.
62.	3 digit sequence to encode	Range of digits is 000 to 777. Default 000.

When 3. POCSAG is selected on Digital Format Menu, POCSAG Menu appears. POCSAG Menu allows setting of POCSAG Parameters. POCSAG codes are generated on RF Generator Operation Screen.

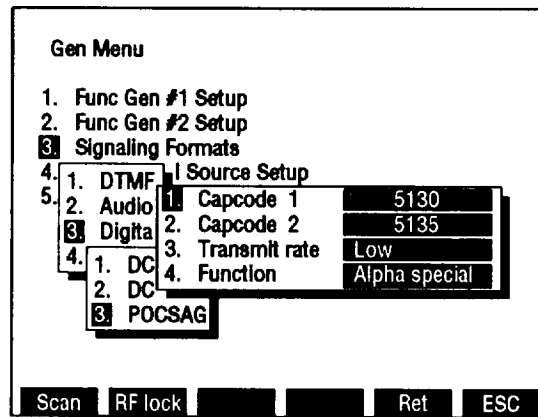

CE2FN376

KEY	MENU ITEM	FUNCTION
1	First capcode to generate	Capcodes between capcode 1 and capcode 2 are generated. Default 1.
2	Last capcode to generate	Capcodes between capcode 1 and capcode 2 are generated. Default 1.
3	Transmit rate	Toggles between Low and High. Default Low.
4.	POCSAG Function generated	Select from: Tone-1 beep Tone-2 beeps Tone-3 beeps Tone-4 beeps Numeric Numeric seq Alpha lower Alpha upper Alphanumeric Alpha special Default Tone-1 beep.

When 4. RCC is selected on Signaling Format Menu, RCC Format Menu appears allowing RCC Code selection:

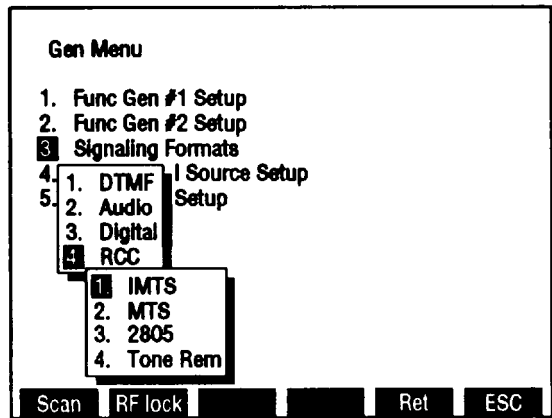

GE2FN37

KEY	MENU ITEM	FUNCTION
1.	IMTS	Access selects IMTS as Signaling Code and displays RCC Code Menu.
2.	MTS	Access selects MTS as Signaling Code and displays RCC Code Menu.
3.	2805	Access selects 2805 as Signaling Code and displays RCC Code Menu.
4.	Tone Rem	Access selects Tone Remote as Signaling Code and displays Tone Remote Menu allowing selection of tone Remote Function. Select from: 2050 1950 1850 1750 1650 1550 1450 1350 1250 1150 1050 Default 1950.

When 1. IMTS, 2. MTS or 3.2805 is selected on RCC Format Menu, RCC Code Menu appears. RCC Code Menu allows assignment of identification numbers to sequences. Sequences are selected from RF Generator Operation Screen by entering identification number for Programmed Sequence Number (1 5).

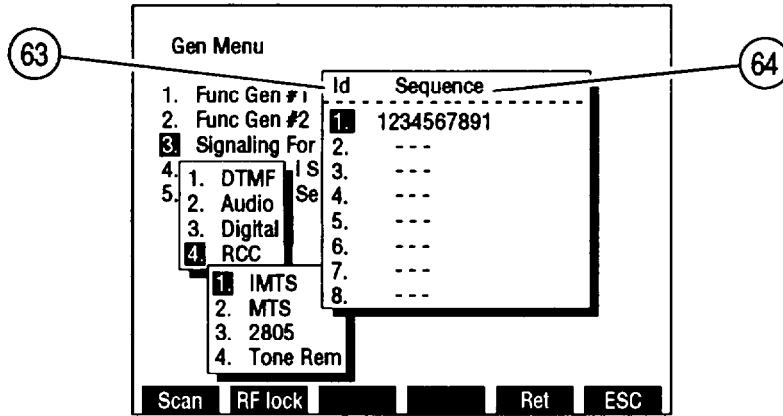

CE2FN378

KEY	SCREEN FEATURE	FUNCTION
63.	Identification number of sequence	Identification numbers range from 1 to 16.
64.	Sequence of up to 16 digits to encode	Use 0 to 9.

When 4. Tone Rem is selected on RCC Format Menu, Tone Remote Function Menu appears. Tone Remote Function Menu allows selection of Tone Remote Function. Tone Remote Codes are generated on RF Generator Operation Screen.

When 4. External Source Setup is selected on Gen Menu, submenu appears:

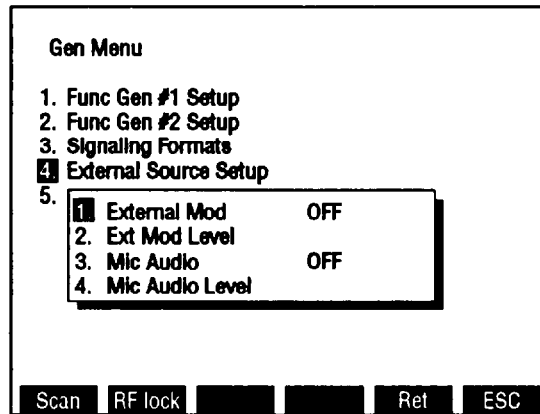

CE2FN398

KEY	MENU ITEM	FUNCTION
1.	External Modulation Type	Select from: FM AM PM OFF Default OFF.
2.	Set External Modulation Level	Set from 0.0 to 100.0 kHz if FM Modulation (I). Set from 0 to 90% if AM Modulation Type (I). Set from 0.0 to 10.0 if PM Modulation Type (I). No data field access if OFF Modulation Type (I).

KEY	MENU ITEM	FUNCTION
3.	Mic Audio Modulation Type	Select from: FM AM PM OFF Default OFF.
4.	Set Microphone Audio Level	Set from 0.0 to 100.0 kHz if FM Mic Audio (3). Set from 0 to 90% if AM Mic Audio (3). Set from 0.0 to 10.0 radians if PM Mic Audio (3). No data field access if OFF Mic Audio (3).

When 5. RF Gen Setup is selected on Gen Menu, submenu appears:

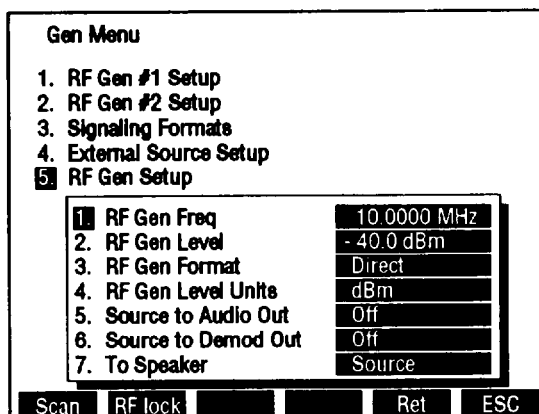

KEY	MENU ITEM	FUNCTION
1.	RF Generator Frequency	Set from 0.2500 to 999.9999 MHz. Default 10.0000 MHz.
2.	RF Generator Output Level	Set from -137.0 to 0.0 dBm or 0.031 μ V to 0.224 V. Default -20.0 dBm or 0.022 V.
3.	RF Generator Format	Toggles between Direct and Channel Mode. Channel Mode displays RF Generator Frequency as cellular channel number. Default Direct.
4.	RF Generator Level Units	Toggles between V and dBm. Default dBm.
5.	Source to Audio Out Connector	Access toggles between on and off. Default off.
6.	Source to Demod Out Connector	Access toggles between on and off. Default off.
7.	Source to Speaker	Selects signal routed to Speaker. Select from: None Source SINAD/BER Ext Mod/DTMF Default None.

c. Receive Screen Configuration. Press RCVR MODE Key to access Receive Operation Screen. Most Receive parameters may be edited from this screen. Use list of screen features to identify items that may be edited, the value range available and function.

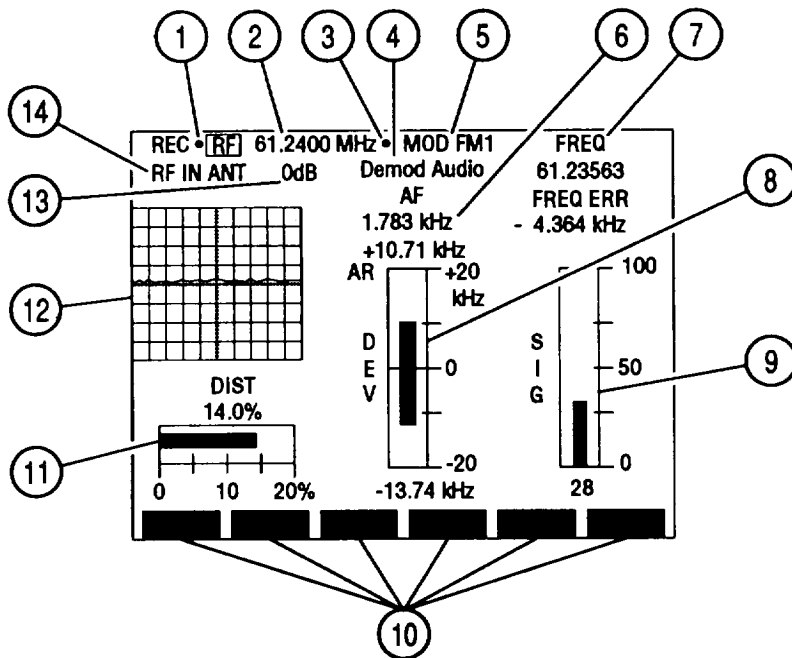

CE2FN401

KEY	SCREEN FEATURE	FUNCTION
1 .	Squelch indicator	Green dot appears when squelch is broken.
2 .	Receive Radio Frequency	Set from 0.2500 to 999.999 MHz. Default 10.0000 MHz.
3.	10 MHz Indicator	Appears when 10 MHz signal is applied to External Reference Connector.
4.	Oscilloscope Input	Appears with Oscilloscope on. Select from: Rcvr IF Demod Audio RF Pwr Lvl SINAD/BER Func Gen Ext Mod AC DC GND Default Demod Audio.
5.	Modulation Type	Select Receive IF and Audio Bandwidths from: FM1 FM2 FM3 FM4 AM1 AM2 USB LSB BFO User PM Default FM1.
6.	Audio Frequency Meter Digital Readout	Indicates Audio Frequency of received signal. Move cursor to meter, press ENTER to access Audio Frequency Meter operation screen.

KEY	SCREEN FEATURE	FUNCTION
7.	Frequency Meter and Frequency Error Meter Digital Readout	Frequency Meter indicates received frequency; Frequency Error Meter indicates difference between received frequency and Receive Radio Frequency (2). Move cursor to meter, press ENTER to access meter operation screen.
8.	Deviation Meter or Modulation Meter	Indicates Deviation frequency of received FM signal or Modulation Percentage of received AM signal. Does not appear if USB, LSB or BFO Modulation Type (5) is selected. Move cursor to meter, press ENTER to access meter operation screen. Default Deviation Meter.
9.	Signal Strength Meter or Power Meter	Indicates received relative Signal Strength if RF IN (14) is ANT or received signal Power if RF IN (14) is T/R. Move cursor to meter, press ENTER to access meter operation screen. Default Signal Strength Meter.
10.	Soft Function Key Definitions	Vary with operation screen configuration, type and input location of received signals and configuration of Receive Operation Screen when last accessed. Press Soft Function Key (F1 thru F6) directly under Soft Function Key Definition to access or activate feature named.
11.	Selected Meter or TUNE Adjust	Selected meter appears if Modulation Type (5) is not USB, LSB, BFO or User Defined USB or BFO. TUNE Adjust appears for USB, LSB, BFO or User Defined USB or BFO Modulation Type (5). Move cursor to meter or TUNE, press ENTER to access meter operation screen or to Tune USB, LSB or BFO input. Default Distortion Meter.
12.	Oscilloscope or Spectrum Analyzer	Oscilloscope displays selected Input (4) wave form, Spectrum Analyzer displays received signal. Use "Disp" F1 (28) to display full-size or 1/4-size Oscilloscope or Spectrum Analyzer, or to display Signaling Code. When full-size, Deviation/Modulation (8), Signal Strength/Power (9) and selected meter (11) displays as digital readouts. Default Signaling Decode.
13.	Receive RF Input Attenuation	Select from: 0 dB 20 dB 40 dB Default 0 dB.
14.	Receive RF Input Source	Select ANT or T/R. Default ANT.

When Decode is selected using "Disp" F1 (28), Receive Operation Screen appears as follows:

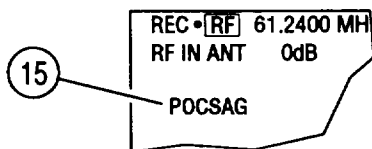

CE2FN381

KEY	SCREEN FEATURE	FUNCTION
15.	Signaling Code	Not selectable for DTMF Signaling Format. For Digital Signaling format, select DCS, DCS INV or POCSAG. Signaling Format selected in Receive Menu.

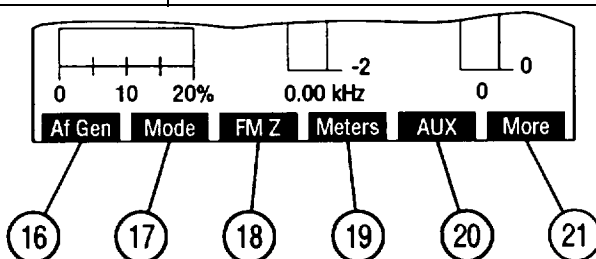

CE2FN385

KEY	SCREEN FEATURE	FUNCTION
16.	"At Gen"	Press F1 to display submenu accessing AF Generator frequencies and output level. Selecting F1 Freq displays data field allowing entry of AF Generator #1 Audio Frequency. Set from 0.0 to 40000.0 Hz. Selecting F2 Freq displays data field allowing entry of AF Generator #2 Audio Frequency. Set from 0.0 to 40000.0 Hz. Selecting Level displays data field allowing entry of AF Generator Output Level. Set from 0.0000 to 3.1000 v. Default 1000.0 Hz, 1000.0 Hz and 0.0000 V.
17.	"Mode"	Press F2 to select Direct (normal operation), Channel or Freq Scan (for Receive Scanning). Channel Mode displays Receive Radio Frequency (2) as a channel number. F or R is displayed indicating Forward or Reverse Channels. Cellular Channel Format is selected in Receive Menu.
18.	"FM Z"/"DMM"	"FM Z" appears for FM or User Defined FM Modulation Type (5). Press F3 to zero Deviation Meter reading. "DMM" appears for USB, LSB, BFO or User Defined SSB or BFO Modulation Type (5). Press F3 to display DMM on Receive Operation Screen.

KEY	SCREEN FEATURE	FUNCTION
19.	“Meters ”/” Dist”/”Modul’/”Tune”	“Meters” appears for FM or User Defined FM Modulation Type (5). Press F4 to display a meter on Receive Operation Screen. Select from Distortion, SINAD, Deviation (RMS) or DMM. “Meters” appears for PM or User Defined PM Modulation Type (5). Press F4 to display a meter on Receive Operation Screen. Select from Distortion, SINAD, Phase (RMS) or DMM. “Dist” or “Modul” appears for AM or User Defined AM Modulation Type (5). Press F4 to toggle active meter between Distortion and Modulation. Although both meters are displayed, one is active. “Tune” appears for USB, LSB, BFO or User Defined USB or BFO Modulation Type (5). Press F4 to tune receiver higher or lower in 125 Hz steps using DATA SCROLL Up and Down Arrow Keys.
20.	“AUX”/”Sp Tst”	‘AUX” appears with Small System Computer Interface disabled. Press F5 to display Auxiliary Functions Menu. “Sp Tst” appears with Small System Computer Interface enabled. Press F5 to access Special Test Menu.
21.	“More”/”ESC”	Press “More” F6 to access additional Soft Function Key Definitions. “ESC” appears while accessing parameters. Press “ESC” F6 to void edit procedure.

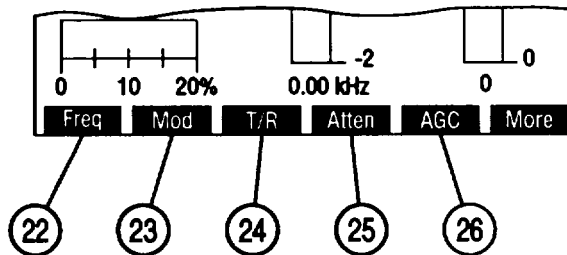

CE2FN402

KEY	SCREEN FEATURE	FUNCTION
22.	“Freq”	Press F1 to access Receive Radio Frequency (2).
23.	“Mod”	Press F2 to access Modulation Type (5).
24.	“T/R”/”ANT”	Press F3 to toggle Receive RF Input Source (14) between T/R and ANTENNA IN Connectors.
25.	“Atten”	Press F4 to access Input Attenuation (13).

KEY	SCREEN FEATURE	FUNCTION
26.	"AGC"	Appears for Manual AGC Type. Press F5 and use DATA SCROLL Spinner to edit AGC Manual setting. AGC Type is selected in Receive Menu.

When 1/4 Scope or Full Scope is selected using "Disp" F1 (28), Receive Soft Function Keys appear as follows:

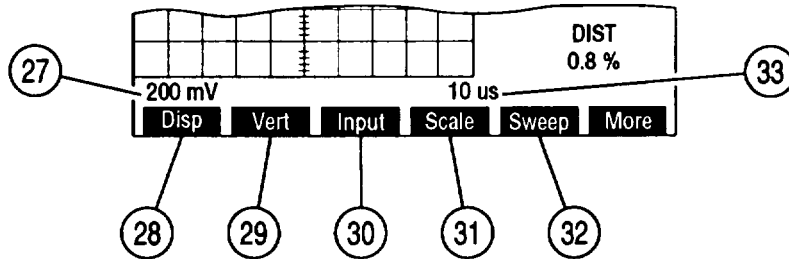

CE2FN407

KEY	SCREEN FEATURE	FUNCTION
27.	Oscilloscope Vertical Scale	Appears with full-size Oscilloscope (12). Does not appear if Input (4) is Rcvr IF. For AC, DC or GND Input (4), select from: 1 mV/div 2 mV/div 5 mV/div 10 mV/div 20 mV/div 50 mV/div 100 mV/div 200 mV/div 500 mV/div 1 V/div 2 V/div 5 V/div 10 V/div 20 V/div 50 V/div For Func Gen or Ext Mod Input, select from: 500 mV 1 V 2.5 V For Demod Audio Input with FM as Modulation Type (5), select from: 2 kHz 4 kHz 10 kHz 20 kHz Autorange (AR appears) For RF Pwr Lvl Input (4), Scale shows 2W or 200W, according to range setting of Power Meter. For SINAD/BER Input, Scale is 4 V.
28.	"Disp"	Selects Oscilloscope or Spectrum Analyzer display. Select from: 1/4 Anlz Full Anlz 1/4 Scope Full Scope Decode
29.	"Vert"	Appears with full-size Oscilloscope (12). Press F2 to enable vertical position adjustment of Oscilloscope trace. Adjust with DATA SCROLL Spinner, press ENTER.
30.	"Input"	Appears with 1/4 or full-size Oscilloscope. Press F3 to access Oscilloscope Input (4).
31.	"Scale"	Does not appear for Rcvr IF, RF Pwr Lvl or SINAD/BER Input (3) or when Oscilloscope (12) is 1/4 size. Press F4 to access Oscilloscope Vertical Scale (27).

KEY	SCREEN FEATURE	FUNCTION
32.	"Sweep"	Appears with full-size Oscilloscope (12). Does not appear for Rcvr IF Input (4). Press F5 to access Oscilloscope Horizontal Sweep Rate (33).
33.	Oscilloscope Horizontal Sweep Rate	Appears with full-size Oscilloscope (1 2). Does not appear for Rcvr IF Input (4). Select from: 1 μ s 2 μ s 5 μ s 10 μ s 20 μ s 50 μ s 100 μ s 200 μ s 500 μ s 1 ms 2 ms 5 ms 10 ms 20 ms 50 ms 100 ms

When 1/4 Anlz or Full Anlz is selected using "Disp" F1 (28), Receive Soft Function Keys appear as follows:

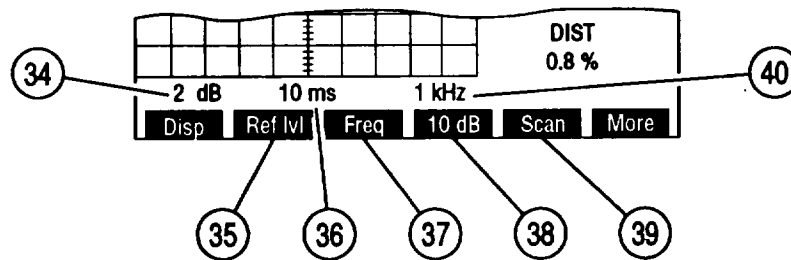

CE2FN403

KEY	SCREEN FEATURE	FUNCTION
34.	Spectrum Analyzer Units/Division Factor	Appears with full-size Spectrum Analyzer (12). Toggles between 10 and 2 dB.
35.	"Ref lvl"	Appears with full-size Spectrum Analyzer (12) and 2 dB Units/Division Factor (34). Press F2 to access 2 dB reference level. Adjust with DATA SCROLL Spinner, press ENTER.
36.	Spectrum Analyzer Zero Scan Sweep Rate	Appears with full-size Spectrum Analyzer (12) and 0 kHz Scan Width. Select: 1 μ s 2 μ s 5 μ s 10 μ s 20 μ s 50 μ s 100 μ s 200 μ s 500 μ s 1 ms 2 ms 5 ms 10 ms 20 ms 50 ms 100 ms
37.	"Freq"/"Sweep"	Press "Freq" F3 to access Receive Radio Frequency. "Sweep" appears with full-size Spectrum Analyzer (12) and 0 kHz Scan Width. Press "Sweep" F3 to access Spectrum Analyzer Zero Scan Sweep Rate.
38.	"10 dB"/"2 dB"	Press F4 to toggle Spectrum Analyzer Units/Division Factor between 10 and 2 dB.

KEY	SCREEN FEATURE	FUNCTION
39.	"Scan"	Appears with full-size Spectrum Analyzer (12). Press F4 to access Spectrum Analyzer Scan Width (40).
40.	Spectrum Analyzer Scan Width	Appears with full-size Spectrum Analyzer (12). Select from: 1 kHz 2 kHz 5 kHz 10 kHz 20 kHz 50 kHz 100 kHz 200 kHz 500 kHz 1 MHz 0 kHz (zero scan)

When Full Anlz is selected using "Disp" F1 (28) and "More" F6 (21) is pressed, Receive Soft Function Keys appear as follows:

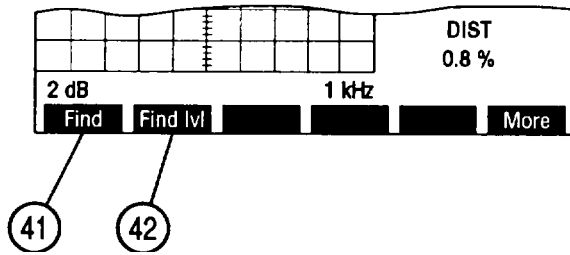

KEY	MENU ITEM	FUNCTION
41.	'Find"	Press F1 to change Receive Radio Frequency to lowest frequency with signal greater than Find Reference Level. Range of Find Function is from 4.0000 to 999.9999 MHz. Signal amplitude must be >-65 dBm.
42.	"Find lvl"	Press F2 to set Find Reference Level used with Find Function.

When Decode is selected using "Disp" F1 (28), Receive Soft Function Keys appear as follows:

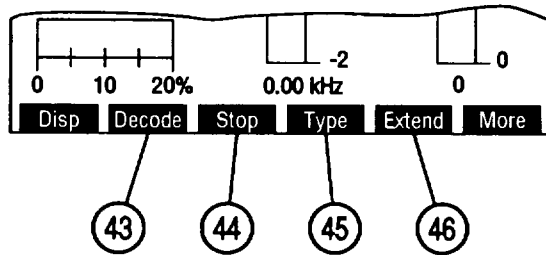

CE2FN382

KEY	MENU ITEM	FUNCTION
43.	"Decode"	Press F2 to start decoding of selected Signaling Code. "Decode" appears red while active.
44.	"stop"	Appears while Decode (43) is active. Press F3 to stop decoding.

KEY	MENU ITEM	FUNCTION
45.	'Type"	Appears with Digital Signaling Format. Press F4 to select a Digital Signaling Code. Select from: DCS DCS INV POCSAG
46.	"Extend"/" input"	"Extend" appears with POCSAG Signaling Code. Press F5 to display Extend Screen used to decode POCSAG signals. "Input" appears with DCS or DCS INV Signaling Code. Press F5 to select Decode Input. Select from: Demod Audio SIN/BER (Inv) Ext Mod (Norm)

When "Extend" F5 (45) is pressed, Extend Screen appears:

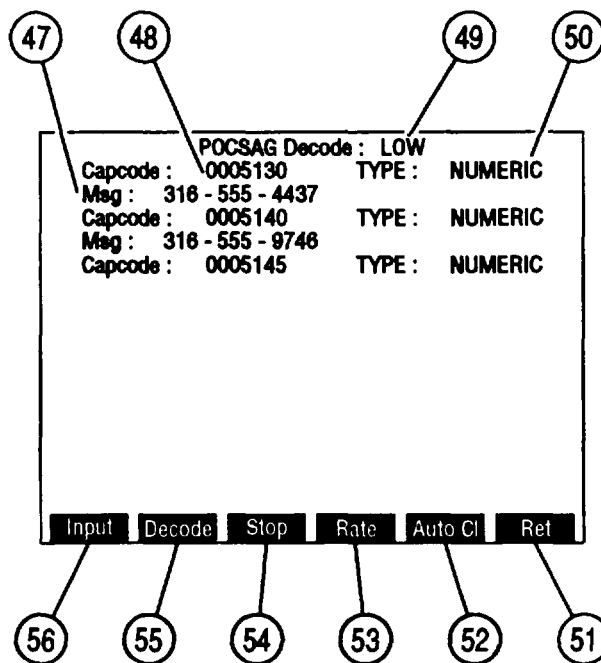

CE2FN383

KEY	SCREEN FEATURE	FUNCTION
47.	POCSAG message	Displays POCSAG message received.
48.	Capcode	Displays capcode received.
49.	POCSAG rate of received signals	Toggles between Low and High.
50.	POCSAG Function Type	Displays POCSAG Function Type received.
51.	"Ret"/"ESC"	Press "Ret" F6 to display Receive Operation Screen. "ESC" appears while accessing parameters. Press "ESC" F6 to void edit procedure.

KEY	SCREEN FEATURE	FUNCTION
52.	"Auto CI"	Press F5 to enable/disable automatic screen clear. When enabled, full Extend Screen is cleared upon receiving next POCSAG signal. When disabled, reception stops when Extend Screen full. 'Auto CI' appears red when enabled.
53.	"Rate"	Press F4 to toggle POCSAG rate (49).
54.	"stop"	Press F3 to stop POCSAG decoding.
55.	"Decode"	Press F2 to start POCSAG decoding.
56.	"Input"	Press F1 to select Decode Input. Select from: Demod Audio SIN/BER (Inv) Ext Mod (Norm)

d. Receiver Menu. When Receive Operation Screen is displayed on CRT, press SETUP Key to access Receiver Menu. Many Receive Operation Screen parameters may be edited from Receiver Menu or one of its submenus.

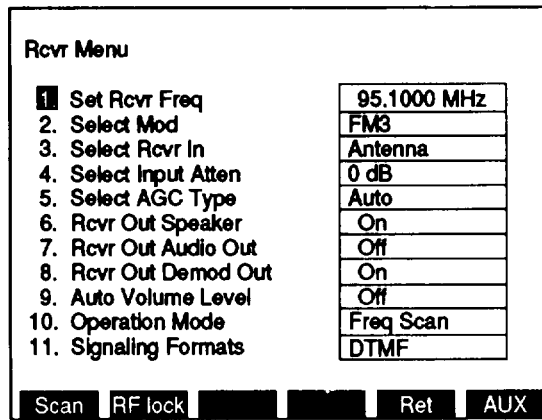

CE2FN404

KEY	MENU ITEM	FUNCTION
1.	Receive Radio Frequency	Set from 0.2500 to 999.9999 MHz. Default 10.0000 MHz.
2.	Modulation Type	Access displays submenu. Select from: FM1 FM2 FM3 FM4 AM1 AM2 USB LSB BFO PM User Defined Default FM1.
3.	Receive Input Source	Access toggles between Antenna and T/R. Default Antenna.
4.	Input Attenuation	Access displays submenu. Select from: 0 dB 20 dB 40 dB Default 0 dB.
5.	AGC Type	Access displays AGC Type Submenu.
6.	Receiver Output to Speaker	Access toggles between on and off. Default on.
7.	Receiver Output to Audio Out Connector	Access toggles between on and off. Default off.
8.	Receiver Output to Demod Out Connector	Access toggles between on and off. Default on.
9.	Automatic Volume Level	Access toggles between on and off. Default off.

KEY	MENU ITEM	FUNCTION
10.	Receive Operation Mode	Access displays submenu. Select from: Direct Channel Freq Scan Direct is for normal operation. Channel displays Receive Radio frequency as a channel number. F or R is displayed indicating Forward or Reverse Channels. Cellular Channel Format is selected using "Chan" F3. Default Direct.
11.	Signaling Format	Access displays submenu. Select DTMF or Digital. Selecting Digital displays submenu allowing selection of Digital Code. Select from: DCS DCS INV POCSAG Default DTMF.

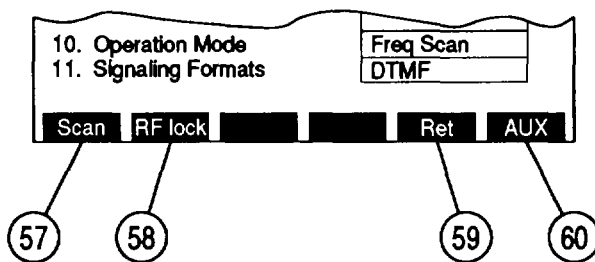

CE2FN386

KEY	SCREEN FEATURE	FUNCTION
57.	"Scan"	Press F1 to access Receive Scan Menu.
58.	'RF lock'/'Chan'	"RF lock" appears for Direct or Freq Scan Operation Modes. Press F2 to enable/disable RF Lock. Enabled RF Lock locks Receive Radio Frequency to RF Generator Frequency and Spectrum Analyzer Radio Frequency. "RF lock" appears red when enabled. "Chan" appears for Channel Operation Mode. Press F2 to access Channel Format Menu allowing selection of Channel Format. Select from: AMPS Cellular (Fwd) AMPS Cellular (Rev) ETACS Cellular (Fwd) ETACS Cellular (Rev)
59.	"Ret"	Press F5 to display Receive Operation Screen.
60.	"AUX"/'ESC"	Press "AUX" F6 to display Auxiliary Functions Menu. "ESC" appears while accessing parameters. Press "ESC" F6 to void edit procedure.

KEY	MENU ITEM	FUNCTION
2.	IF Filters	Access displays submenu. Select from: 3 kHz 30 kHz 300 kHz Default 3 kHz.
3.	Post Detection Filter	Access displays submenu. Select from: All Pass Low Pass High Pass Band Pass C Wt Pass Selecting Low Pass, High Pass or Bandpass displays data field allowing for entry of cutoff frequencies. Range of cutoff frequencies are: Low Pass 0.100 to 30.000 kHz High Pass 0.500 to 20.000 kHz Band Pass low 0.500 to 20.000 kHz Bandpass high 0.100 to 30.000 kHz Default All Pass.

When Select AGC Type is selected on Receiver Menu, submenu appears:

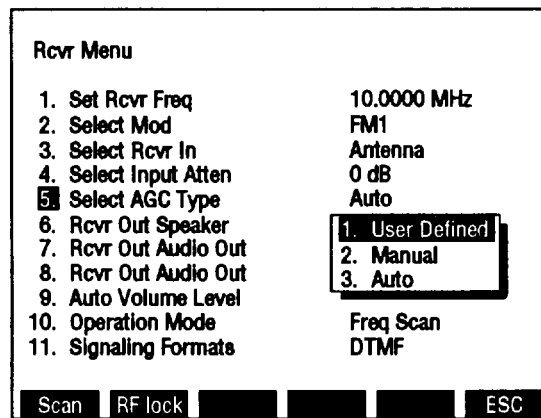

CE2FN406

KEY	MENU ITEM	FUNCTION
1.	User Defined	Access displays submenu. Select User Defined AGC Type from: Measurement Speech Data High Speed Type 1 Type 2 Type 3 Default Measurement.
2.	Manual	Set Receiver AGC Lvl from 1 to 255. Default 128.
3.	Auto	AGC Type is automatically set.

e. **Duplex Screen Configuration.** Press DPLX MODE Key to access Duplex Operation Screen. Many Duplex Transmitter and Duplex Receiver parameters may be edited from this screen. Use list of screen features to identify items that may be edited, the value range available and function.

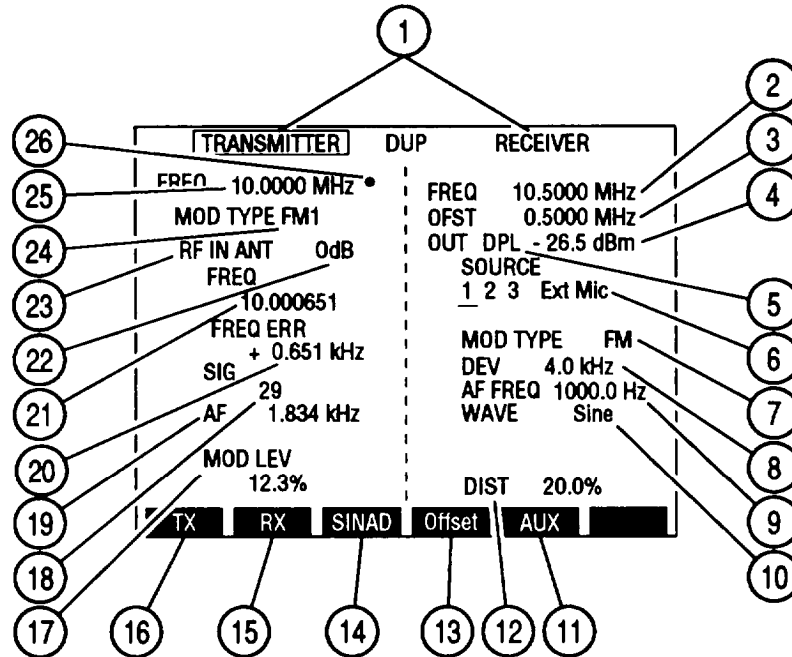

E2 N408

KEY	SCREEN FEATURE	FUNCTION
1.	DUPLEX Screen Label	With cursor over TRANSMITTER, press SETUP Key to access Duplex Transmitter Menu. With cursor over RECEIVER, press SETUP Key to access Duplex Receiver Menu.
2.	Duplex Receiver Frequency	Set from 0.2500 to 999.9999 MHz. Default 10.0000 MHz. Only Duplex Receiver Frequency (2) or Offset Frequency (3) is active and may be changed. The other is reactive between active feature and Duplex Transmitter Frequency (25). Active feature callout displays blue, reactive feature callout displays red. Default Duplex Receiver active.
3.	Offset Frequency	Set from -999.7499 to 999.7499 MHz. Default 0.0000 MHz.
4.	Duplex Output Level	If RF OUT (5) is DPL, set from -120.0 to 7.0 dBm. If RF OUT (5) is T/R, set from -137.0 to 0.0 dBm. Default -20.0 dBm.
5.	RF Output Connector	Select DPL (DUPLEX) or T/R Connector as Duplex Output Connector. Default DPL.

KEY	SCREEN FEATURE	FUNCTION
6.	Modulation Source	<p>1 = Function Generator #1 2 = Function Generator #2 3 = Signaling Formats Ext = EXT MOD Connector Input Mic = MIC/ACC Connector Input Underline indicates active source. FM and PM cannot be selected for different sources at the same time. Select modulation type by color code: White = OFF Yellow = FM Red . A M Green . PM Default 1, OFF.</p>
7.	Modulation Type	<p>Not an editable feature. Readout echoes modulation type of active source (6). Indicates: FM AM PM OFF Default OFF.</p>
8.	Active Source FM Deviation or AM or PM Modulation	<p>Set deviation from 0.0 to 100.0 kHz. Set modulation for AM from 0% to 90%. Set modulation for PM from 0.0 to 10.0 radians.</p>
9.	Active Source Audio Frequency	<p>Does not appear if OFF selected for active source or if Ext or Mic active. Set from 0.0 to 40000.0 Hz.</p>
10.	Active Source Wave Shape	<p>Does not appear if OFF selected for active source or if Ext or Mic active. Select from: Sine Square Ramp Triangle Pulse +1 Lvl 0 Lvl -1 Lvl</p>
11.	"Sp Tst"/"AUX"	<p>"Sp Tst" appears with Small System Computer Interface enabled. Press F5 to access Special Test Menu. "AUX" appears with Small System Computer Interface disabled. Press F5 to display Auxiliary Functions Menu.</p>
12.	Distortion or SINAD Meter Digital Readout	<p>Indicates Distortion or SINAD of SINAD/BER IN Connector Input. Move cursor to meter and press ENTER to access meter operation screen. Default Distortion Meter.</p>
13.	"Offset"/"R Freq"	<p>Press F4 to toggle between Offset Frequency (3) active with Duplex Receiver Frequency (2) reactive or Duplex Receiver Frequency (2) active with Offset Frequency (3) reactive.</p>

KEY	SCREEN FEATURE	FUNCTION
14.	“SINAD”/“Dist”/“Modul”/“Off”	Press F3 to rotate meter activated. Activate SINAD Meter (12), Distortion Meter (12) or AM Modulation Meter (17). Although 2 meters may be displayed, only selected meter is active. Off appears instead of AM Modulation Meter for FM Modulation (7).
15.	“RX”	Press F2 to display Duplex Receiver Operation Screen.
16.	“TX”	Press F1 to display Duplex Transmitter Operation Screen.
17.	FM Deviation Meter, AM Modulation Meter, Phase Meter or TUNE Adjust	If AM or FM Duplex Transmitter Modulation Type (24), Modulation or Deviation Meter displays. If PM Duplex Transmitter Modulation Type (24), Phase Meter displays. If USB, LSB or BFO Duplex Transmitter Modulation Type (24), TUNE Adjust displays. Move cursor to meter callout and press ENTER to access meter operation screen or to tune USB, LSB or BFO input.
18.	Signal Strength Meter or Power Meter Digital Display	Indicates received relative Signal Strength if RF IN (23) is ANT or received signal Power if RF IN (23) is T/R. Move cursor to meter, press ENTER to access meter operation screen.
19.	Audio Frequency Meter Digital Readout	Move cursor to meter, press ENTER to access AF Meter Operation Screen.
20.	Frequency Error Meter Digital Display	Displays received Frequency Error.
21.	RF Frequency Meter Digital Display	Move cursor to meter and press ENTER to access RF Frequency Meter Operation Screen.
22.	Duplex Transmitter Input Attenuation Level	Select from: 0 dB 20 dB 40 dB Default 0 dB.
23.	RF Input	Select ANT or T/R Connector.
24.	Duplex Transmitter Modulation Type	Select Receive IF and Audio Bandwidths from: FM1 FM2 FM3 FM4 AM1 AM2 USB LSB BFO User Default FM1.
25.	Duplex Transmitter Frequency	Set from 0.2500 to 999.999 MHz. Default 10.0000 MHz.
26.	10 MHz Indicator	Appears when 10 MHz signal is applied to External Reference Connector.

When Modulation Source 3 (6) is active source and POCSAG or Tone Remote is not Signaling Code, Duplex Operation Screen appears as follows:

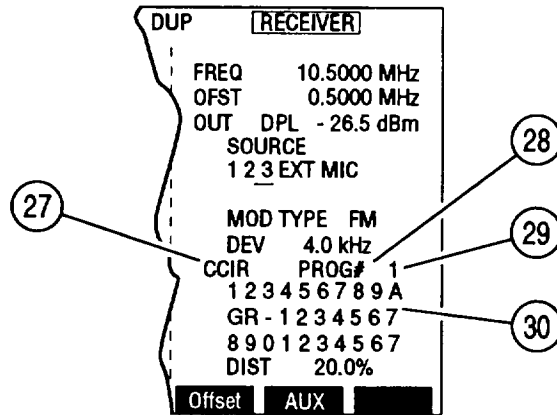

CE2FN409

KEY	SCREEN FEATURE	FUNCTION
27.	Signaling Code Type	Selects Signaling Code Type. For Audio Signaling Format, select from: CCIR EEA US (E IA) ZVEI DDZVEI DVZEI NATEL EURO 5/6 Tone Seq CCIRH CCIRH4 User Defined For Digital Signaling Format, select from: DCS DCS INV For RCC signaling Format, select from: IMTS MTS 2805
28.	Direct Entry/Programmed Sequence	Toggles to opposite function. DIRECT ENTRY allows entry of digits to encode from RF Generator Operation Screen. PROG # encodes selected sequence programmed from RF Generator Menu.
29.	Programmed Sequence Number	Appears with PROG # (28). Set from 1 to 16.
30.	Encoded Data	If PROG # (28), displays data encoded. If DIRECT ENTRY (28), allows entering of digits to encode.

When Modulation Source 3 (6) is active source and pOCSAG or Tone Remote is Si9nalin9 Code, Duplex Operation Screen appears as follows:

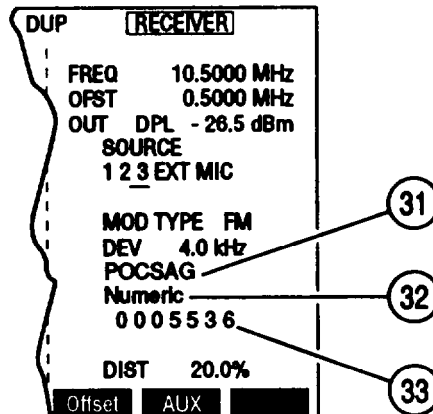

GE2FN410

KEY	SCREEN FEATURE	FUNCTION
31.	Signaling Format	Displays Signaling Format selected in RF Generator Menu.
32.	Signaling Code Type	<p>Selects Signaling Code Type. If POCSAG is Signaling Code, select from:</p> <p>Tone-1 beep Tone-2 beeps Tone-3-beeps Tone-4-beeps Numeric Numeric Seq Alpha lower Alpha upper Alphanumeric Alpha special</p> <p>If Tone Remote is Signaling Code, select from:</p> <p>2050 1950 1850 1750 1650 1550 1450 1350 1250 1150 1050</p>
33.	Capcode	Does not appear with Tone Remote Signaling Code. Displays POCSAG capcodes generated.

f. **Duplex Transmitter Screen Configuration.** When Duplex Operation Screen is displayed on CRT, press F1 Soft Function Key to access Duplex Transmitter Operation Screen. Use list of screen features to identify items that may be edited, the value range available and function.

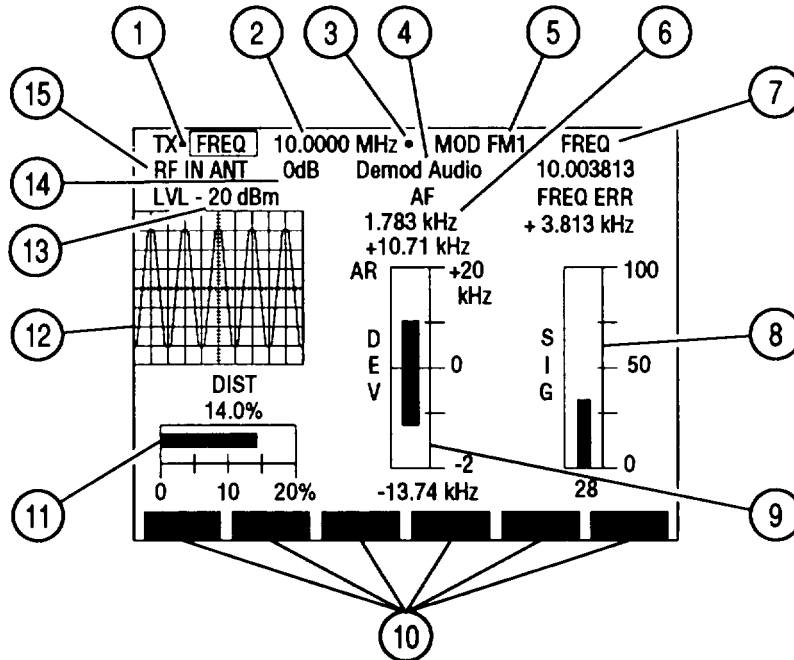

CE2FN411

KEY	SCREEN FEATURE	FUNCTION
1.	Squelch Indicator	Green dot appears when squelch is broken.
2.	Duplex Transmitter Frequency	Set from 0.2500 to 999.999 MHz. Default 10.0000 MHz.
3.	10 MHz Indicator	Appears when 10 MHz signal is applied to External Reference Connector.
4.	Oscilloscope Input	Appears with Oscilloscope on. Select from: Rcvr IF Demod Audio DC SINAD/BER Func Gen Ext Mod AC RF PWR LvL GND Default Demod Audio.
5.	Modulation Type	Select from: FM1 FM2 FM3 FM4 AM1 AM2 PM USB LSB BFO User Default FM1.
6.	Audio Frequency Meter Digital Readout	Indicates Duplex Transmitter received audio frequency. Move cursor to meter and press ENTER to access AF Meter Operation Screen.

KEY	SCREEN FEATURE	FUNCTION
7.	Frequency Meter and Frequency Error Meter Digital Readout	Frequency Meter indicates received frequency; Frequency Error Meter indicates difference between frequency received and Duplex Transmitter Frequency (2). Move cursor to meter and press ENTER to access Frequency Error Meter Operation Screen.
8.	Signal Strength Meter or Power Meter	Indicates received relative Signal Strength if Duplex Transmitter Input (15) is ANT or received signal Power if Duplex Transmitter Input (15) is T/R. Move cursor to meter, press ENTER to access meter operation screen. Default Signal Strength Meter.
9.	Deviation Meter or Modulation Meter or Phase Meter	Indicates Deviation frequency of received FM signal, Modulation Percentage of received AM or radians of received PM signal. Does not appear if USB, LSB or BFO Modulation Type (5). Move cursor to meter and press ENTER to access meter operation screen. Default Deviation Meter.
10.	Soft Function Key Definitions	Vary with operation screen configuration, type and output location of generated signals and configuration of Duplex Transmitter Screen when last accessed. Press Soft Function Key (F1 thru F6) directly under Soft Function Key Definition to access or activate feature named.
11.	Selected Meter or TUNE Adjust	Selected meter appears if Modulation Type (5) is not USB, LSB, BFO or User Defined USB or BFO. TUNE Adjust appears for USB, LSB, BFO or User Defined USB or BFO Modulation Type (5). Move cursor to meter or TUNE, press ENTER to access meter operation screen or to Tune USB, LSB or BFO input. Default Distortion Meter.
12.	Oscilloscope or Spectrum Analyzer	Oscilloscope displays selected Input (4) wave form, Spectrum Analyzer displays received signal. Use 'Disp" F1 (29) to display full-size or 1/4-size Oscilloscope or Spectrum Analyzer, or to display Signaling Code. When full-size, Deviation/Modulation (9), Signal Strength/Power (8) and selected meter (11) displays as digital readouts. Default Signaling Code.
13.	RF Output Level	If Duplex Receiver RF OUT is DPL, set from -120.0 to 7.0 dBm. If Duplex Receiver RF OUT is T/R, set from -137.0 to 0.0 dBm. Default -20.0 dBm.
14.	Duplex Transmitter Input Attenuation	Select from: 0 dB 20 dB 40 dB Default 0 dB.

KEY	SCREEN FEATURE	FUNCTION
15.	Duplex Transmitter Input	Select ANT or T/R Connector. Default ANT.

When Decode is selected using "Disp" F1 (29), Receive Operation Screen appears as follows:

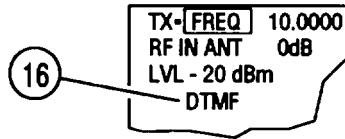

CE2FN446

KEY	SCREEN FEATURE	FUNCTION
16.	Signaling Code	Not selectable for DTMF Signaling Format. For Digital Signaling format, select DCS, DCS INV or POCSAG. Signaling Format selected in Receive Menu.

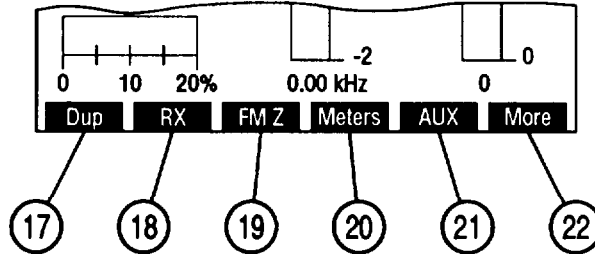

CE2FN412

KEY	SCREEN FEATURE	FUNCTION
17.	"Dup"/"AGC"	Press "Dup" F1 to displays Duplex Operation Screen. "AGC" appears when manual is selected for AGC. Press "AGC" F1 to edit manual AGC level.
18.	"RX"	Press F2 to displays Duplex Receiver Operation Screen.
19.	"FM Z"	Appears when FM is selected as Modulation Type (5). Press F3 to zero FM Deviation Meter.

KEY	SCREEN FEATURE	FUNCTION
20.	“Meters”/“Dist”/“Modul”/“Tune”	<p>“Meters” appears for FM or User Defined FM Modulation Type (5). Press F4 to display a meter on Duplex Transmitter Operation Screen. Select from Distortion, SINAD or Deviation (RMS).</p> <p>“Meters” appears for PM or User Defined PM Modulation Type (5). Press F4 to display a meter on Duplex Transmitter Operation Screen. Select from Distortion, SINAD or Phase (RMS).</p> <p>‘Dist’ or “Modul” appears for AM or User Defined AM Modulation Type (5). Press F4 to toggle active meter between Distortion and Modulation. Although both meters are displayed, one is active.</p> <p>“Tune” appears for USB, LSB, BFO or User Defined USB or BFO Modulation Type (5). Press F4 to tune receiver higher or lower in 125 Hz steps using DATA SCROLL Up and Down Arrow Keys.</p>
21.	“AUX”/“Sp Tst”	<p>“AUX” appears with Small System Computer Interface disabled. Press F5 to display Auxiliary Functions Menu.</p> <p>“Sp Tst” appears with Small System Computer Interface enabled. Press F5 to access Special Test Menu.</p>
22.	“More”/“ESC”	<p>Press “More” F6 to access additional Soft Function Key Definitions. “ESC” appears while accessing parameters. Press “ESC” F6 to void edit procedure.</p>

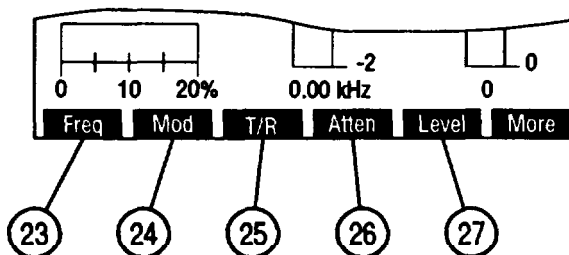

CE2FN413

KEY	SCREEN FEATURE	FUNCTION
23.	“Freq”	Press F1 to access Duplex Transmitter Frequency (2).
24.	“Mod”	Press F2 to access Modulation Type (5).
25.	“T/R”/“ANT”	Press F3 to toggle Duplex Transmitter Input (15) between T/R and ANT.
26.	“Atten”	Press F4 to access Input Attenuation (14).
27.	“Level”	Press F5 to access Output Level (13).

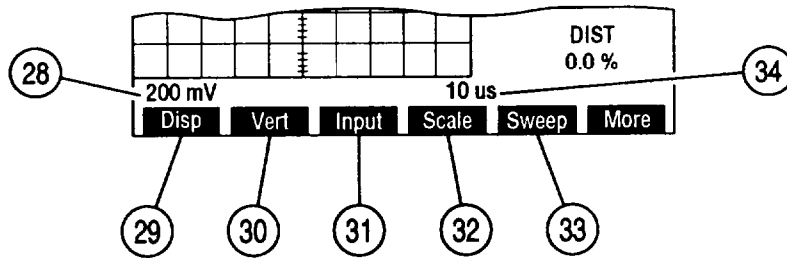

CE2FN414

KEY	SCREEN FEATURE	FUNCTION															
28.	Oscilloscope Vertical Scale	<p>Appears with full-size Oscilloscope (12). Does not appear if Input (4) is Rcvr IF. For AC, DC or GND Input (4), select from:</p> <table border="0"> <tr> <td>1 mV/div</td> <td>2 mV/div</td> <td>5 mV/div</td> </tr> <tr> <td>10 mV/div</td> <td>20 mV/div</td> <td>50 mV/div</td> </tr> <tr> <td>100 mV/div</td> <td>200 mV/div</td> <td>500 mV/div</td> </tr> <tr> <td>1 V/div</td> <td>2 V/div</td> <td>5 V/div</td> </tr> <tr> <td>10 V/div</td> <td>20 V/div</td> <td>50 V/div</td> </tr> </table> <p>For Func Gen or Ext Mod Input, select from: 500 mV 1 V 2.5 V</p> <p>For Demod Audio Input with FM as Modulation Type (5), select from: 2 kHz 4 kHz 10 kHz 20 kHz Autorange (AR appears)</p> <p>For RF Pwr Lvl Input (4), Scale shows 2W or 200W, according to range setting of Power Meter. For SINAD/BER Input, Scale is 4 V.</p>	1 mV/div	2 mV/div	5 mV/div	10 mV/div	20 mV/div	50 mV/div	100 mV/div	200 mV/div	500 mV/div	1 V/div	2 V/div	5 V/div	10 V/div	20 V/div	50 V/div
1 mV/div	2 mV/div	5 mV/div															
10 mV/div	20 mV/div	50 mV/div															
100 mV/div	200 mV/div	500 mV/div															
1 V/div	2 V/div	5 V/div															
10 V/div	20 V/div	50 V/div															
29.	"Disp"	<p>Selects Oscilloscope or Spectrum Analyzer display. Select from:</p> <table border="0"> <tr> <td>1/4 Anlz</td> <td>Full Anlz</td> <td>1/4 Scope</td> </tr> <tr> <td>Full Scope</td> <td>Decode</td> <td></td> </tr> </table>	1/4 Anlz	Full Anlz	1/4 Scope	Full Scope	Decode										
1/4 Anlz	Full Anlz	1/4 Scope															
Full Scope	Decode																
30.	"Vert"	<p>Appears with full-size Oscilloscope (12). Press F2 to enable vertical position adjustment of Oscilloscope trace. Adjust with DATA SCROLL Spinner, press ENTER.</p>															
31.	"Input"	<p>Appears with 1/4 or full-size Oscilloscope. Press F3 to access Oscilloscope Input (4).</p>															
32.	"Scale"	<p>Does not appear for Rcvr IF, RF Pwr Lvl or SINAD/BER Input (4) or when Oscilloscope (12) is 1/4 size. Press F4 to access Oscilloscope Vertical Scale (28).</p>															
33.	"Sweep"	<p>Appears with full-size Oscilloscope (1 2). Does not appear for Rcvr IF Input (4). Press F5 to access Oscilloscope Horizontal Sweep Rate (34).</p>															

KEY	SCREEN FEATURE	FUNCTION
34.	Oscilloscope Horizontal Sweep Rate	Appears with full-size Oscilloscope (12). Does not appear for Rcvr IF Input (4). Select from: 1 μ s 2 μ s 5 μ s 10 μ s 20 μ s 50 μ s 100 μ s 200 μ s 500 μ s 1 ms 2 ms 5 ms 10 ms 20 ms 50 ms 100 ms

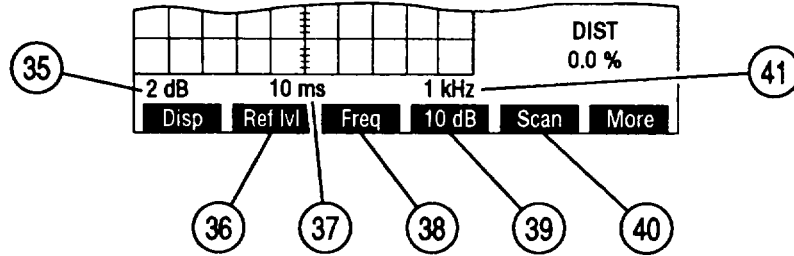

CE2FN415

KEY	SCREEN FEATURE	FUNCTION
35.	Spectrum Analyzer Units/Division Factor	Appears with full-size Spectrum Analyzer (12), Toggles between 10 and 2 dB.
36.	"Ref lvl"	Appears with full-size Spectrum Analyzer (12) and 2 dB Units/Division Factor (35). Press F2 to access 2 dB reference level. Adjust with DATA SCROLL Spinner, press ENTER.
37.	Spectrum Analyzer Zero Scan Sweep Rate	Appears with full-size Spectrum Analyzer (12) and 0 kHz Scan Width. Select: 1 μ s 2 μ s 5 μ s 10 μ s 20 μ s 50 μ s 100 μ s 200 μ s 500 μ s 1 ms 2 ms 5 ms 10 ms 20 ms 50 ms 100 ms
38.	"Freq"/"Sweep"	Press "Freq" F3 to access Receive Radio Frequency. "Sweep" appears with full-size Spectrum Analyzer (12) and 0 kHz Scan Rate. Press "Sweep" F3 to access Spectrum Analyzer Zero Scan Sweep Rate.
39.	"10 dB"/"2 dB"	Press F4 to toggle Spectrum Analyzer Units/Division Factor between 10 and 2 dB.
40.	"Scan"	Appears with full-size Spectrum Analyzer (12). Press F5 to access Spectrum Analyzer Scan Width (41).

KEY	SCREEN FEATURE	FUNCTION
41.	Spectrum Analyzer Scan Width	Appears with full-size Spectrum Analyzer (12). Select from: 1 kHz 2 kHz 5 kHz 10 kHz 20 kHz 50 kHz 100 kHz 200 kHz 500 kHz 1 MHz 0 kHz (zero scan)

When Full Anlz is selected using “Disp” F1 (29) and “More” F6 (22) is pressed, Receive Soft Function Keys appear as follows:

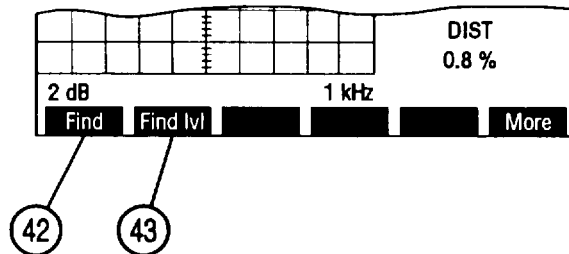

CE2FN416

KEY	MENU ITEM	FUNCTION
42.	“Find”	Press F1 to change Receive Radio Frequency to lowest frequency with signal greater than Find Reference Level. Range of Find Function is from 4.0000 to 999.9999 MHz. Signal amplitude must be >-65 dBm.
43.	“Find lvl”	Press F2 to set Find Reference Level used with Find Function.

When Decode is selected using “Disp” F (29), Duplex Transmitter Soft Function Keys appear as follows:

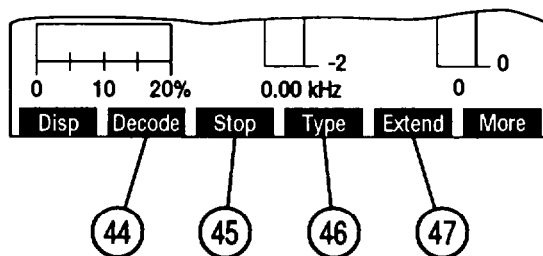

CE2FN417

KEY	MENU ITEM	FUNCTION
44.	“Decode”	Press F2 to start decoding of selected Signaling Code. “Decode” appears red while active.
45.	“stop”	Appears while Decode (44) is active. Press F3 to stop decoding.
46.	“Type”	Appears with Digital Signaling Format. Press F4 to select a Digital Signaling Code. Select from: DCS DCS INV POCSAG

KEY	MENU ITEM	FUNCTION
47.	“Extend”/“Input”	“Extend” appears with POCSAG Signaling Code. Press F5 to display Extend Screen used to decode POCSAG signals. “Input” appears with DCS or DCS INV Signaling Code. Press F5 to select Decode Input. Select from: Demod Audio SIN/BER (Inv) Ext Mod (Norm)

When “Extend” F5 (46) is pressed, Extend Screen appears:

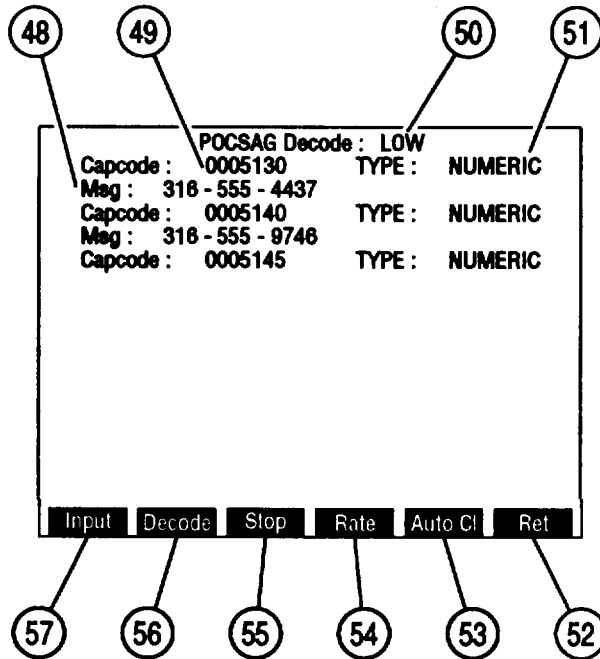

CE2FN418

KEY	SCREEN FEATURE	FUNCTION
48.	POCSAG message	Displays POCSAG message received.
49.	Capcode	Displays capcode received.
50.	POCSAG rate of received signals	Toggles between Low and High.
51.	POCSAG Function Type	Displays POCSAG Function Type received.
52.	“Ret”	Press “Ret” F6 to display Receive Operation Screen. “ESC” appears while accessing parameters. Press “ESC” F6 to void edit procedure.
53.	“Auto CI”	Press F5 to enable/disable automatic screen clear. When enabled, full Extend Screen is cleared upon receiving next POCSAG signal. When disabled, reception stops when Extend Screen full. “Auto CI” appears red when enabled.

KEY	SCREEN FEATURE	FUNCTION
54.	"Rate"	Press F4 to toggle POCSAG rate (50).
55.	"stop"	Press F3 to stop POCSAG decoding.
56.	"Decode"	Press F2 to start POCSAG decoding.
57.	"Input"	Press F1 to select Decode Input. Select from: Demod Audio SIN/BER (Inv) Ext Mod (Norm)

g. **Duplex Transmitter Menu.** When Duplex Transmitter Operation Screen is displayed on CRT, press SETUP Key to access Duplex Transmitter Menu.

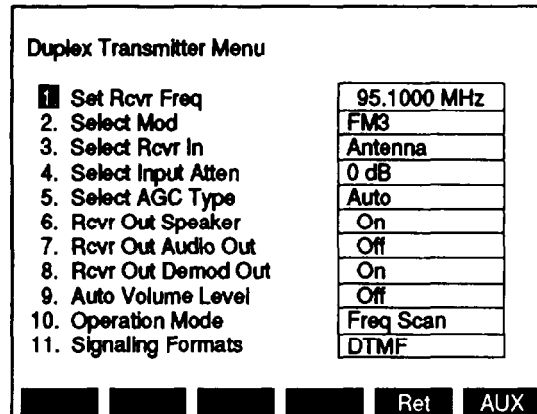

CE2FN419

KEY	MENU ITEM	FUNCTION
1.	Receive Radio Frequency	Set from 0.2500 to 999.9999 MHz. Default 10.0000 MHz.
2.	Modulation Type	Access displays submenu. Select from: FM1 FM2 FM3 FM4 AM1 AM2 USB LSB BFO PM User Defined Default FM1.
3.	Receive Input Source	Access toggles between Antenna and T/R. Default Antenna.
4.	Input Attenuation	Access displays submenu. Select from: 0 dB 20 dB 40 dB Default 0 dB.
5.	AGC Type	Access displays AGC Type Submenu.
6.	Receiver Output to Speaker	Access toggles between on and off. Default on.
7.	Receiver Output to AUDIO OUT Connector	Access toggles between on and off. Default off.
8.	Receiver Output to DEMOD OUT Connector	Access toggles between on and off. Default on.
9.	Automatic Volume Level	Access toggles between on and off. Default off.
10.	Receive Operation Mode	Access displays submenu. Select from: Direct Channel Direct is for normal operation. Channel displays Receive Radio Frequency as a channel. F or R appears indicating Forward or Reverse Channels. "Chan" F2 appears for Channel Mode and selects Cellular Channel Format. Default Direct.

KEY	MENU ITEM	FUNCTION
11.	Signaling Format	Access displays submenu. Select DTMF or Digital. Selecting Digital displays submenu allowing selection of Digital Code. Select from: DCS DCS INV POCSAG Default DTMF.

When User Defined is selected as Duplex Transmitter Modulation, submenu appears:

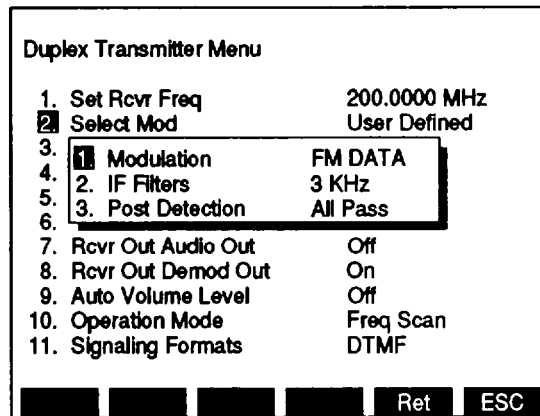

KEY	MENU ITEM	FUNCTION
1.	Modulation Type	Access displays submenu. Select from: FM AM SSB (Upper) SSB (Lower) BFO PM FM DATA Default FM.
2.	IF Filters	Access displays submenu. Select from: 3 kHz 30 kHz 300 kHz Default 3 kHz.
3.	Post Detection Filter	Access displays submenu. Select from: All Pass Low Pass High Pass Band Pass C Wt Pass Selecting Low Pass, High Pass or Bandpass displays data field allowing for entry of cutoff frequencies. Range of cutoff frequencies are: Low Pass 0.100 to 30.000 kHz High Pass 0.500 to 20.000 kHz Band Pass low 0.500 to 20.000 kHz Bandpass high 0.100 to 30.000 kHz Default All Pass.

When Select AGC Type is selected on Duplex Transmitter Menu, submenu appears:

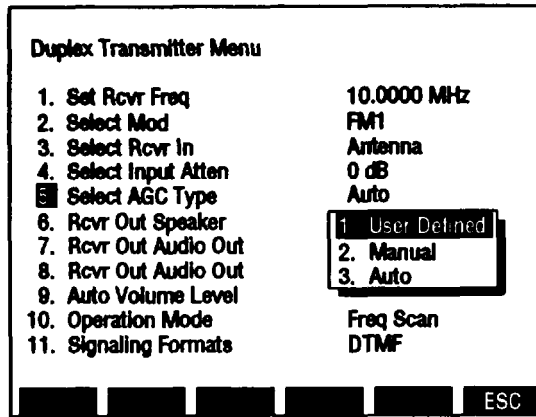

CE2FN421

KEY	MENU ITEM	FUNCTION
1.	User Defined	Access displays submenu. Select User Defined AGC Type from: Measurement Speech Data High Speed Type 1 Type 2 Type 3 Default Measurement.
2.	Manual	Set Receiver AGC Lvl from 1 to 255. Default 128.
3.	Auto	AGC Type is automatically set.

h. Duplex Receiver Screen Configuration. When Duplex Operation Screen is displayed on CRT, press F2 to access Duplex Receiver Operation Screen. Use list of screen features to identify items that may be edited, the value range available and function.

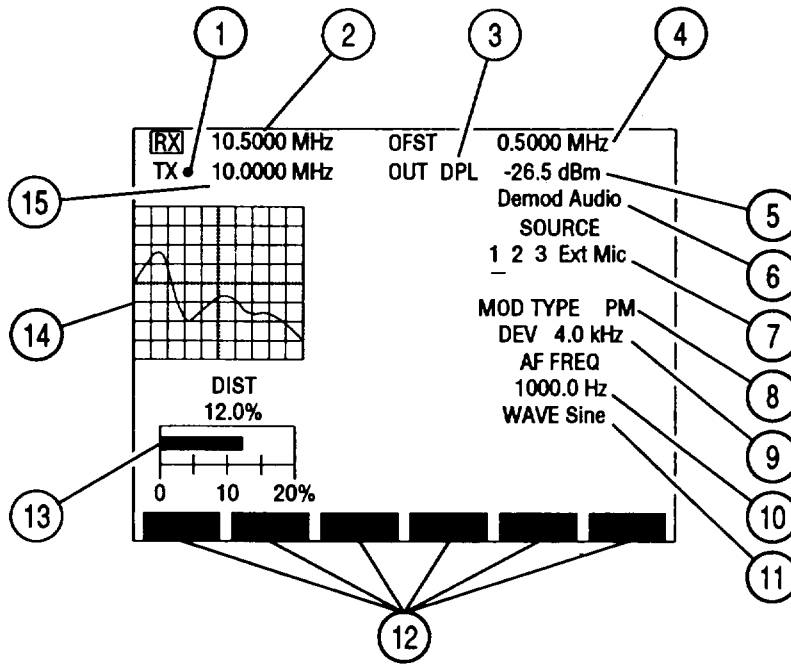

CE2FN422

KEY	SCREEN FEATURE	FUNCTION
1.	Squelch Indicator	Green dot appears when squelch is broken.
2.	Duplex Receiver Frequency	Set from 0.2500 to 999.9999 MHz when active. Default active, 10.0000 MHz. Only Duplex Receiver Frequency or Offset Frequency (4) is active and may be changed. The other is reactive between active feature and Duplex Transmitter Frequency (1 5). Active feature callout displays blue, reactive feature callout displays red.
3.	RF OUT	Access toggles between DPL or T/R. Default DPL.
4.	Offset Setting	Set from -999.7499 to 999.7499 MHz when active. Default reactive, 0.0000 MHz.
5.	Level	If RF OUT (3) is DPL, set from -120.0 to 7.0 dBm. If RF OUT (3) is T/R, set from -137.0 to 0.0 dBm. Default -20.0 dBm.
6.	Oscilloscope Input	Appears with Oscilloscope on. Select from: Rcvr IF Demod Audio RF Pwr Lvl SINAD/BER Func Gen Ext Mod AC DC GND Default Demod Audio.

KEY	SCREEN FEATURE	FUNCTION
7.	Modulation Source	<p>1 = Function Generator #1 2 = Function Generator #2 3 = Signaling Formats Ext = EXT MOD Connector Input Mic = MIC/ACC Connector Input Underline indicates active source. FM and PM cannot be selected for different sources at the same time. Select modulation type by color code: White = OFF Yellow = FM Red = AM Green = PM Default 1, OFF.</p>
8.	Modulation Type	<p>Not an editable feature. Readout echoes modulation type of active source (7). Indicates: FM AM PM OFF Default OFF.</p>
9.	Active Source FM Deviation or AM or PM Modulation	<p>Set deviation from 0.0 to 100.0 kHz. Set modulation for AM from 0%. to 90%. Set modulation for PM from 0.0 to 10.0 radians.</p>
10.	Active Source Audio Frequency	<p>Does not appear if OFF selected for active source or if Ext or Mic active. Set from 0.0 to 40000.0 Hz.</p>
11.	Active Source Wave Shape	<p>Does not appear if OFF selected for active source or if Ext or Mic active. Select from: Sine Square Ramp Triangle Pulse +1 Lvl 0 Lvl -1 Lvl</p>
12.	Soft Function Key Definitions	<p>Vary with operation screen configuration, type and output location of generated signals and configuration of RF Generator Screen when last accessed. Press Soft Function Key (F1 thru F6) directly under Soft Function Key Definition to access or activate feature named.</p>
13.	SINAD, Distortion, AF Level or DMM Meter	<p>Shows meter readings of selected meter input. Move cursor to meter and press ENTER to access Meter Operation Screen.</p>
14.	Oscilloscope or Spectrum Analyzer	<p>Oscilloscope displays selected Input (6) wave form, Spectrum Analyzer displays RF Generator output. Use F1 'Disp" (36) to display full-size or 1/4-size Oscilloscope or Spectrum Analyzer, or select None for no display. When full-size, Meters (13) display as digital readouts. Default None.</p>
15.	Duplex Transmitter Frequency	<p>Set from 0.2500 to 999.9999 MHz. Default 10.0000 MHz.</p>

When Modulation Source 3 (7) is active source and POCSAG or tone Remote is not Signaling Code, Duplex Operation Screen appears as follows:

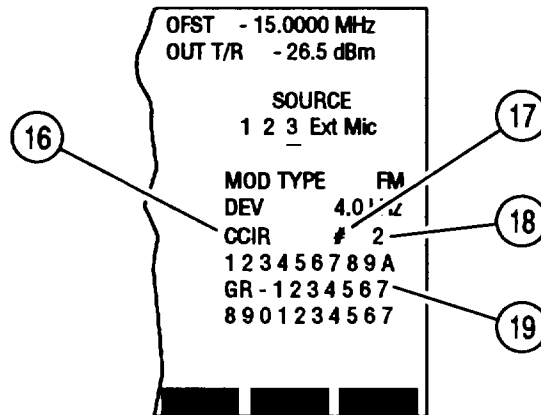

CE2FN423

KEY	SCREEN FEATURE	FUNCTION
16.	Signaling Code Type	Selects Signaling Code Type. For Audio Signaling Format, select from: CCIR EEA US (EIA) ZVEI DDZVEI DVZEI NATEL EURO 5/6 Tone Seq CCIRH CCIRH4 User Defined For Digital Signaling Format, select from: DCS DCS INV POCSAG For RCC signaling Format, select from: IMTS MTS 2805 Tone Rem
17.	Direct Entry/Programmed Sequence	Toggles to opposite function. DIRECT ENTRY allows entry of digits to encode from RF Generator Operation Screen. PROG # encodes selected sequence programmed from RF Generator Menu.
18.	Programmed Sequence Number	Appears with PROG # (17). Set from 1 to 16.
19.	Encoded Data	If PROG # (17), displays data encoded. If DIRECT ENTRY (17), allows entering of digits to encode.

When Modulation Source 3 (7) is active source and POCSAG or tone Remote is not Signaling Code, Duplex Operation Screen appears as follows:

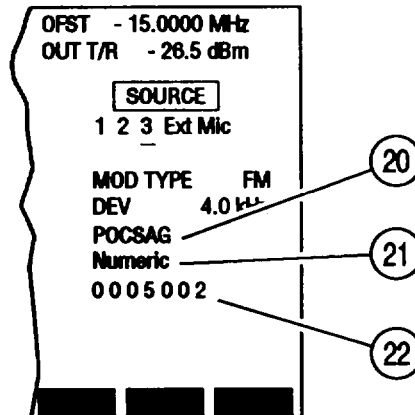

CE2FN424

KEY	SCREEN FEATURE	FUNCTION
20.	Signaling Format	Displays Signaling Format selected in RF Generator Menu.
21.	Signaling Code Type	Selects Signaling Code Type. If POCSAG is Signaling Code, select from: Tone-1 beep Tone-2 beeps Tone-3-beeps Tone-4-beeps Numeric Numeric seq Alpha lower Alpha upper Alphanum Alpha special If Tone Remote is Signaling Code, select from: 2050 1950 1850 1750 1650 1550 1450 1350 1250 1150 1050
22.	Capcode	Does not appear with Tone Remote Signaling Code. Displays POCSAG capcodes generated.

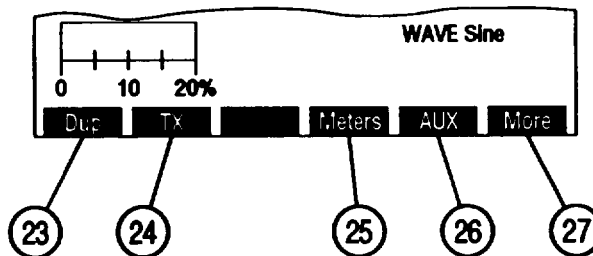

CE2FN425

KEY	SCREEN FEATURE	FUNCTION
23.	"Dup"	Press F1 to access Duplex Operation Screen.
24.	"TX"	Press F2 to access Duplex Transmitter Operation Screen.
25.	"Meters"	Press F4 to select SINAD, Distortion, AF Level or DMM Meter (1 3).

KEY	SCREEN FEATURE	FUNCTION
26.	"Sp Tst"/"AUX"	"Sp Tst" appears with Small System Computer Interface enabled. Press F5 to access Special Test Menu. "AUX" appears with Small System Computer Interface disabled. Press F5 to display Auxiliary Functions Menu. .
27.	'More'/' ESC"	Press "More" F6 to access additional Soft Function Key Definitions. "ESC" appears while accessing parameters. Press "ESC" F6 to void edit procedure.

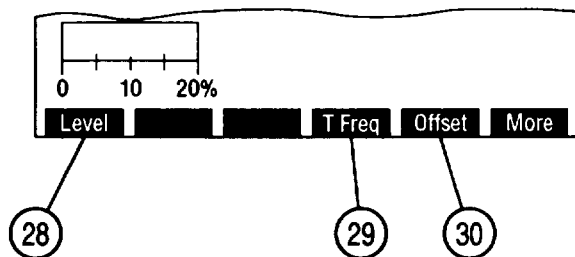

CE2FN426

KEY	SCREEN FEATURE	FUNCTION
28.	"Level"	Press F1 to access RF Out Level (5).
29.	"T Freq"	Press F4 to access Duplex Transmitter Frequency (15).
30.	"Offset"/" R Freq"	Press F5 to toggle between active Offset (4) with reactive RX (2), and active RX Frequency (2) with reactive Offset (4).

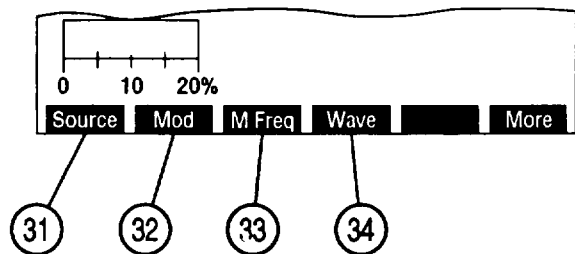

CE2FN427

KEY	SCREEN FEATURE	FUNCTION
31.	"Source"	Press F1 to access Source (7).
32.	"Mod"/" Dev"	Does not appear if OFF Modulation is active source or if Ext or Mic active. Press F2 to access FM Deviation, AM or PM Modulation (9).
33.	"M Freq"	Does not appear if OFF Modulation is active source or if Ext or Mic active. Press F3 to access Active Source Audio Frequency (10).

KEY	SCREEN FEATURE	FUNCTION
34.	"Wave"	Does not appear if OFF Modulation is active source or if Ext or Mic active. Press F4 to access Active Source Wave Shape (1 1).

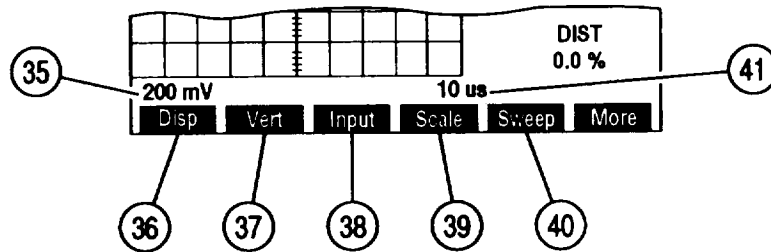

CE2FN428

KEY	SCREEN FEATURE	FUNCTION
35.	Oscilloscope Vertical Scale	Appears with full-size Oscilloscope (14). Does not appear if Input (6) is Rcvr IF. For AC, DC or GND Input (6), select from: 1 mV/div 2 mV/div 5 mV/div 10 mV/div 20 mV/div 50 mV/div 100 mV/div 200 mV/div 500 mV/div 1 V/div 2 V/div 5 V/div 10 V/div 20 V/div 50 V/div For Func Gen or Ext Mod Input, select from: 500 mV 1 V 2.5 V For Demod Audio Input with FM as Modulation Type (8), select from: 2 kHz 4 kHz 10 kHz 20 kHz Autorange (AR appears) For RF Pwr Lvl Input (6), Scale shows 2W or 200W, according to range setting of Power Meter. For SINAD/BER Input, Scale is 4 V.
36.	"Disp"	Selects Oscilloscope or Spectrum Analyzer display. Select from: 1/4 Anlz Full Anlz 1/4 Scope Full Scope None
37.	"Vert"	Appears with full-size Oscilloscope (14). Press F2 to enable vertical position adjustment of Oscilloscope trace. Adjust with DATA SCROLL Spinner, press ENTER.
38.	"Input"	Appears with 1/4 or full-size Oscilloscope. Press F3 to access Oscilloscope Input (6).
39.	"Scale"	Does not appear for Rcvr IF, RF Pwr Lvl or SINAD/BER Input (6) or when Oscilloscope (14) is 1/4 size. Press F4 to access Oscilloscope Vertical Scale (35).

KEY	SCREEN FEATURE	FUNCTION
40.	“Sweep”	Appears with full-size Oscilloscope (14). Does not appear for Rcvr IF input (6). Press F5 to access Oscilloscope Horizontal Sweep Rate (41).
41.	Oscilloscope Horizontal Sweep Rate	Appears with full-size Oscilloscope (1 4). Does not appear for Rcvr IF Input (6). Select from: 1 μ s 2 μ s 5 μ s 10 μ s 20 μ s 50 μ s 100 μ s 200 μ s 500 μ s 1 ms 2 ms 5 ms 10 ms 20 ms 50 ms 100 ms

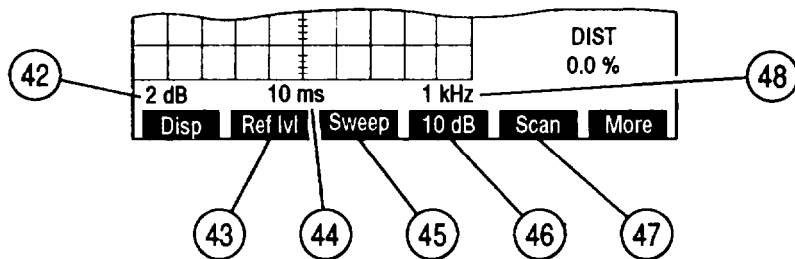

CE2FN429

KEY	SCREEN FEATURE	FUNCTION
42.	Spectrum Analyzer Units/Division Factor	Appears with full-size Spectrum Analyzer (14). Toggles between 10 and 2 dB.
43.	“Ref lvl”	Appears with full-size Spectrum Analyzer (14) and 2 dB Units/Division Factor (42). Press F2 to access 2 dB reference level. Adjust with DATA SCROLL Spinner, press ENTER.
44.	Spectrum Analyzer Zero Scan Sweep Rate	Appears with full-size Spectrum Analyzer (12) and 0 kHz Scan Width. Select: 1 μ s 2 μ s 5 μ s 10 μ s 20 μ s 50 μ s 100 μ s 200 μ s 500 μ s 1 ms 2 ms 5 ms 10 ms 20 ms 50 ms 100 ms
45.	“Sweep”	Appears with full-size Spectrum Analyzer (12) and 0 kHz Scan Width. Press F3 to access Spectrum Analyzer Zero Scan Sweep Rate.
46.	“10 dB”/“2 dB”	Press F4 to toggle Spectrum Analyzer Units/Division Factor between 10 and 2 dB.
47.	“Scan”	Appears with full-size Spectrum Analyzer (14). Press F5 to access Spectrum Analyzer Scan Width (48).

KEY	SCREEN FEATURE	FUNCTION
48.	Spectrum Analyzer Scan Width	Appears with full-size Spectrum Analyzer (14). Select from: 1 kHz 2 kHz 5 kHz 10 kHz 20 kHz 50 kHz 100 kHz 200 kHz 500 kHz 1 MHz 0 kHz (zero scan)

1. **Duplex Receiver Menu.** When Duplex Receiver Operation Screen is displayed on CRT, press SETUP Key to access Duplex Receiver Menu.

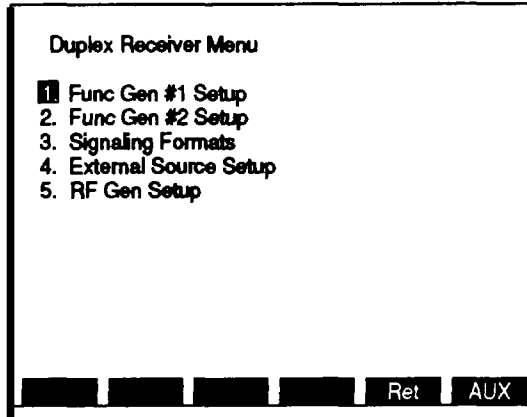

CE2FN430

KEY	MENU ITEM	FUNCTION
1.	Function Generator #1 Setup	Access displays Function Generator #1 Submenu.
2.	Function Generator #2 Setup	Access displays Function Generator #2 Submenu.
3.	Signaling Formats	Access displays Signaling Format Menu.
4.	External Source Setup	Access displays External Source Setup Menu.
5.	Duplex Receiver Setup	Access displays Duplex Receiver Setup Menu.

When Func Gen #1 Setup or Func Gen #2 Setup is accessed from Duplex Receiver Menu, one of the following submenus appears on CRT. The setup parameters for Function Generator #1 Submenu and Function Generator #2 Submenu are identical.

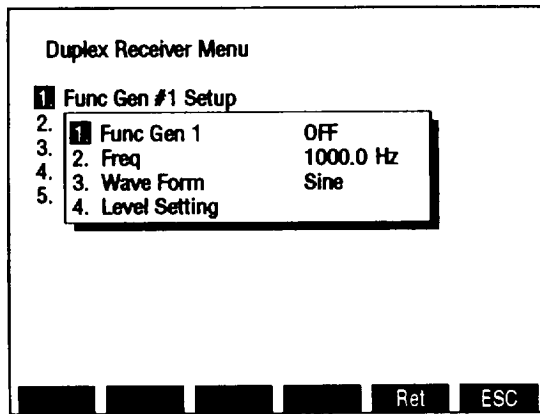

CE2FM431

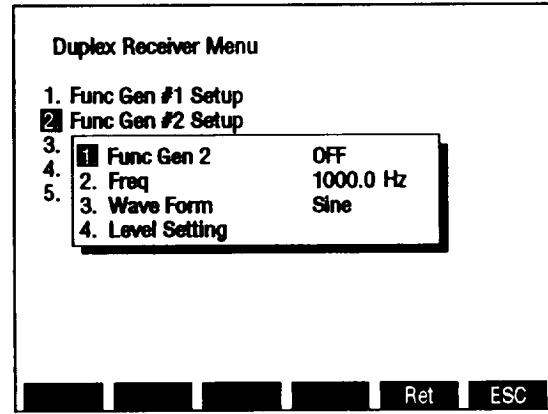

CE2FM432

KEY	MENU ITEM	FUNCTION
1.	Function Generator 1 and 2 Modulation Type	Select from: OFF AM FM PM Default OFF.
2.	Frequency Setting	Set from 0.0 to 40000.0 Hz. Default 1000.0 Hz.
3.	Wave Form	Access displays submenu. Select from: Sine Square Ramp Triangle Pulse +1 Lvl 0 Lvl -1 Lvl Default Sine.
4.	Level Setting:	Appears if OFF Modulation Type (1). Parameter field is blank.
	FM Dev	Appears if FM Modulation Type (1). Set from 0.0 to 100.0 kHz.
	AM Mod	Appears if AM Modulation Type (1). Set from 0% to 90%.
	PM Mod	Appears if PM Modulation Type (1). Set from 0.0 to 10.0 radians.

When 3. Signaling Formats is selected on Duplex Receiver Menu, Signaling Format Menu appears:

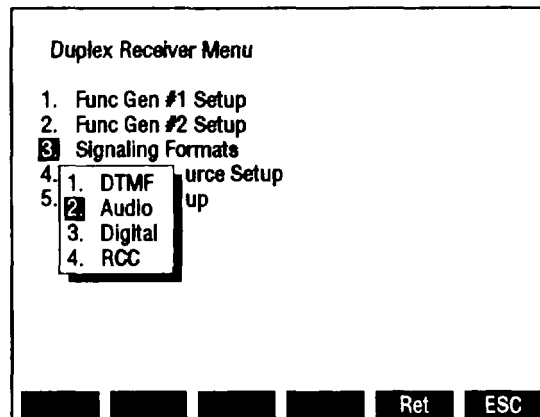

CE2FN433

KEY	MENU ITEM	FUNCTION
1.	DTMF	Access selects DTMF as Signaling Format and displays DTMF Format Menu.
2.	Audio	Access displays Audio Format Menu.
3.	Digital	Access displays Digital Format Menu.
4.	RCC	Access displays RCC Format Menu.

When 1. DTMF is selected on Signaling Format Menu, DTMF Format Menu appears. DTMF Format Menu allows assignment of identification numbers to sequences. Sequences are selected from Duplex Transmitter Operation Screen by entering identification number for Programmed Sequence Number (18).

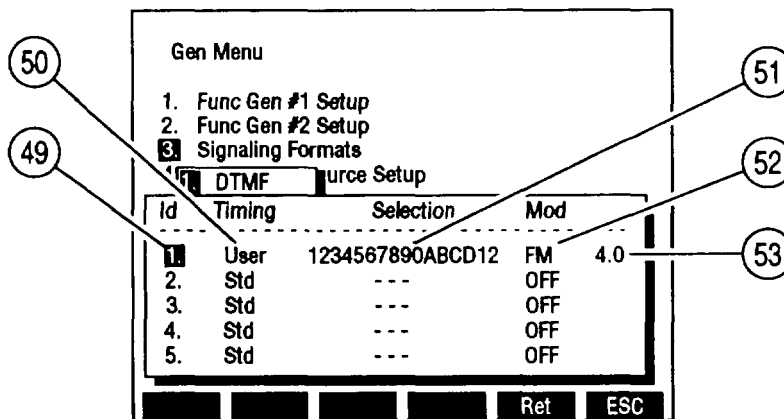

CE2FL408

KEY	SCREEN FEATURE	FUNCTION
49.	Identification number of sequence	Identification numbers range from 1 to 15.

KEY	SCREEN FEATURE	FUNCTION
50.	Mark and space timing	Select Std (Standard, 25 ms mark and space timing) or User. Selecting User displays data field allowing mark and space timing entry from 25 to 9999 ms. Default Std.
51.	Sequence of up to 16 digits to encode	Use 1 to 9, letters A to D, # and *.
52.	Modulation Type	Select AM, FM, PM or OFF. Default OFF.
53.	Modulation Level	Set Modulation Level from 0.0 to 20.0 kHz for FM, 0.0% to 24.5% for AM, 0.0 to 3.0 radians for PM.

When 2. Audio is selected on Signaling Formats Menu, Audio Format Menu appears allowing selection of Audio Code:

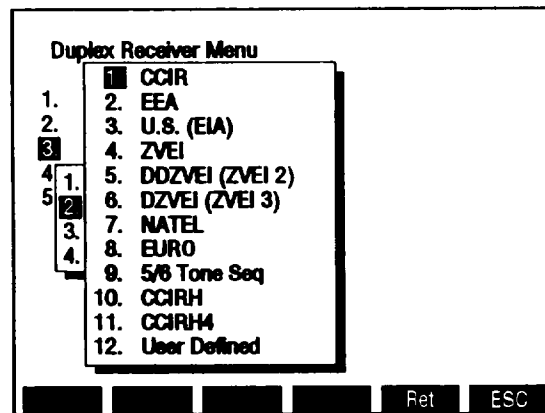

CE2FN435

Selecting an Audio Signaling Code except User Defined displays Audio Code Menu. Audio Code Menu allows assignment of identification numbers to sequences. Sequences are selected from Duplex Transmitter Operation Screen by entering identification number for Programmed Sequence Number (18).

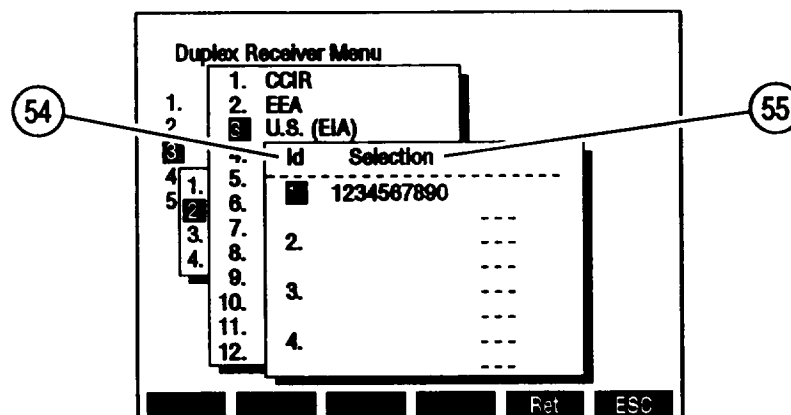

CE2FN436

KEY	MENU ITEM	FUNCTION
54.	Identification number of sequence	Identification number range from 1 to 16.
55.	Sequence of up to 30 digits to encode	Use O to 9, -, A, G and R.

When 12. User Defined is selected on Audio Code Menu, submenu appears:

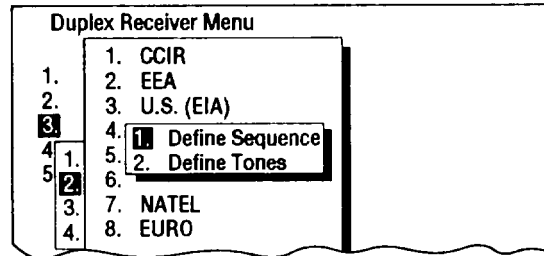

When 1. Define Sequence is selected, Audio Code Menu appears. User Defined sequences are selected as other Audio Codes. User Defined Tones are defined in Defined Tones Menu

When 2. Define Tones is selected, Defined Tones Menu appears allowing the defining of 30 different tones to be selected using Audio Code Menu.

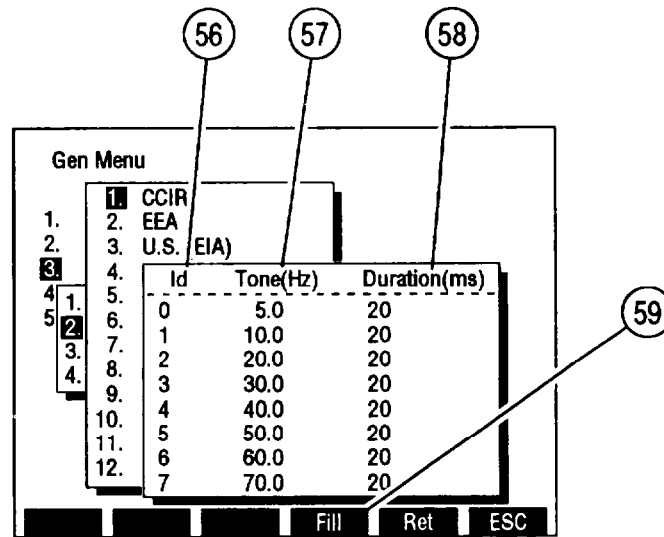

CE2FN438

KEY	SCREEN FEATURE	FUNCTION
56.	Identification number of tone	Identification numbers range from O to 9 and A to T.
57.	Tone frequency	Set from 0.0 to 9999.9 Hz.
58.	Tone duration	Set from 20 to 9999 ms.
59.	'Fill'	Press F4 to fill all entries below highlighted entry with highlighted entry value.

When 3. Digital is selected on Signaling Formats Menu, Digital Format Menu appears allowing Digital Code selection.

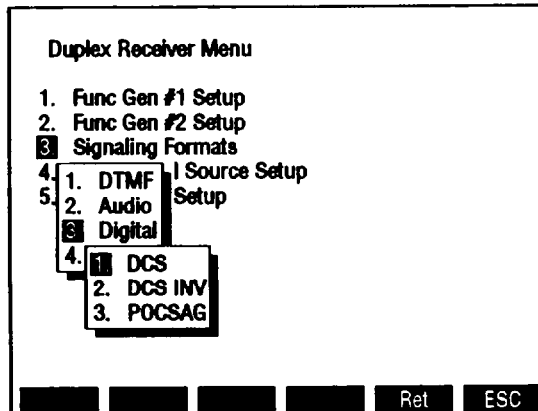

CE2FN439

KEY	MENU ITEM	FUNCTION
1.	DCS	Access selects DCS as Signaling Code and displays DCS Menu.
2.	DCS INV	Access selects DCS INV as Signaling Code and displays DCS Menu.
3.	POCSAG	Access selects POCSAG as Signaling Code and displays POCSAG Menu.

When 1. DCS or 2. DCS INV is selected on Digital Format Menu, DCS Menu appears. DCS Menu allows assignment of identification numbers to sequences. Sequences are selected from Duplex Transmitter Operation Screen by entering identification number for Programmed Sequence Number (18).

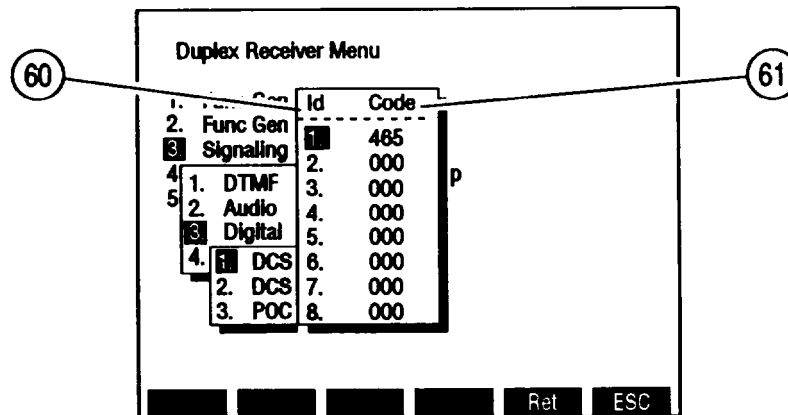

KEY	SCREEN FEATURE	FUNCTION
60.	Identification number of sequence	Identification numbers range from 1 to 16.
61.	3 digit sequence to encode	Range of digits is 000 to 777. Default 000.

When 3. POCSAG is selected on Digital Format Menu, POCSAG Menu appears. POCSAG Menu allows setting of POCSAG parameters. POCSAG codes are generated on Duplex Transmitter Operation Screen.

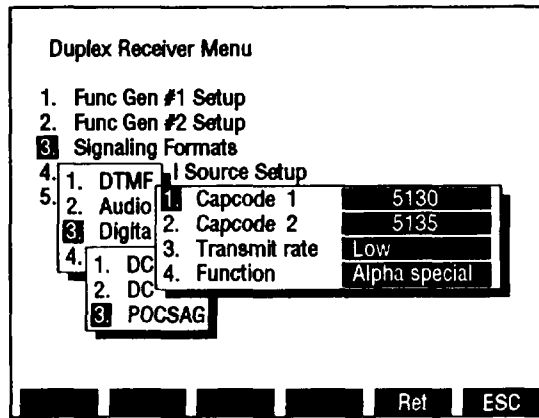

CE2FN441

KEY	MENU ITEM	FUNCTION
1.	First capcode to generate	Capcodes between capcode 1 and capcode 2 are generated. Default 1.
2.	Last capcode to generate	Capcodes between capcode 1 and capcode 2 are generated. Default 1.
3.	Transmit rate	Toggles between Low and High. Default Low.
4.	POCSAG Function generated	Select from: Tone-1 beep Tone-2 beeps Tone-3 beeps Tone-4 beeps Numeric Numeric seq Alpha lower Alpha upper Alphanumeric Alpha special Default Tone-1 beep.

When 4. RCC is selected on Signaling Format Menu, RCC Format Menu appears allowing RCC Code selection:

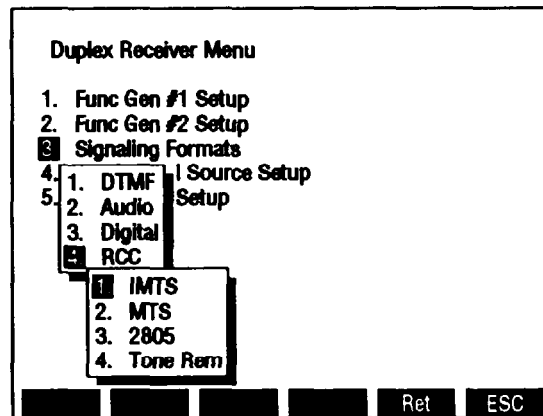

CE2FN442

KEY	MENU ITEM	FUNCTION
1.	IMTS	Access selects IMTS as Signaling Code and displays RCC Code Menu.
2.	MTS	Access selects MTS as Signaling Code and displays RCC Code Menu.
3.	2805	Access selects 2805 as Signaling Code and displays RCC Code Menu.
4.	Tone Rem	Access selects Tone Remote as Signaling Code and displays Tone Remote Menu allowing selection of tone Remote Function. Select from: 2050 1950 1850 1750 1650 1550 1450 1350 1250 1150 1050 Default 1950.

When 1. IMTS, 2. MTS or 3. 2805 is selected on RCC Format Menu, RCC Code Menu appears. RCC Code Menu allows assignment of identification numbers to sequences. Sequences are selected from Duplex Transmitter Operation Screen by entering identification number for Programmed Sequence Number (18).

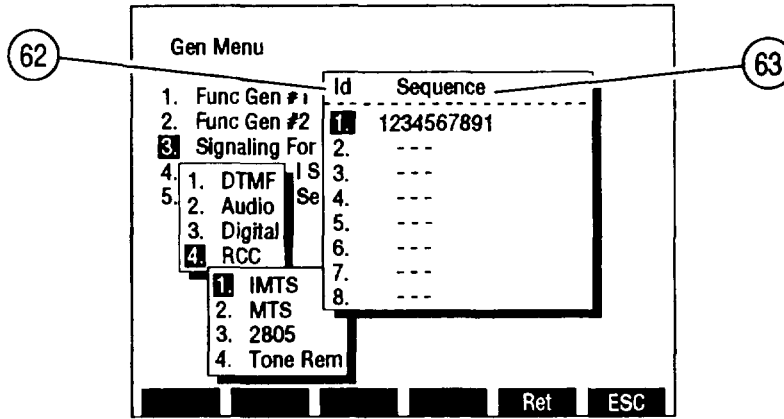

CE2FN443

KEY	SCREEN FEATURE	FUNCTION
62.	Identification number of sequence	Identification numbers range from 1 to 16.
63.	Sequence of up to 16 digits to encode	Use 0 to 9.

When 4. Tone Rem is selected on RCC Format Menu, Tone Remote Function Menu appears. Tone Remote Function Menu allows selection of Tone Remote Function. Tone Remote Codes are generated on RF Generator Operation Screen.

When 4. External Source Setup is selected on Duplex Receiver Menu, submenu appears:

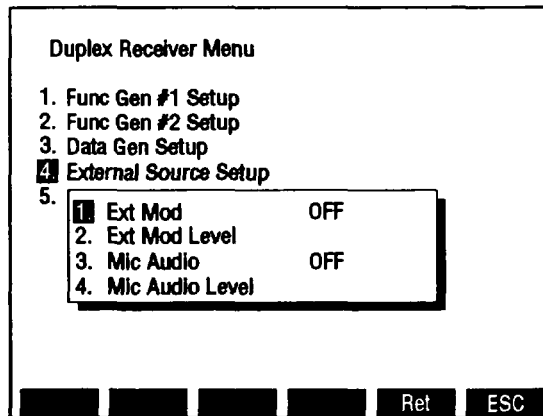

CE2FN444

KEY	MENU ITEM	FUNCTION
1.	External Modulation Type	Select from: FM AM PM OFF Default OFF.

KEY	MENU ITEM	FUNCTION
7.	Source to Speaker	Selects signal routed to Speaker. Select from: None Source SINAD/BER Ext Mod/DTMF Default None.

j. AF Generator Screen Configuration. Press AF GEN MODE Key to access AF Generator Operation Screen. Most AF Generator screen features may be edited from this screen. Use list of screen features to identify items that may be edited, the value range available and function.

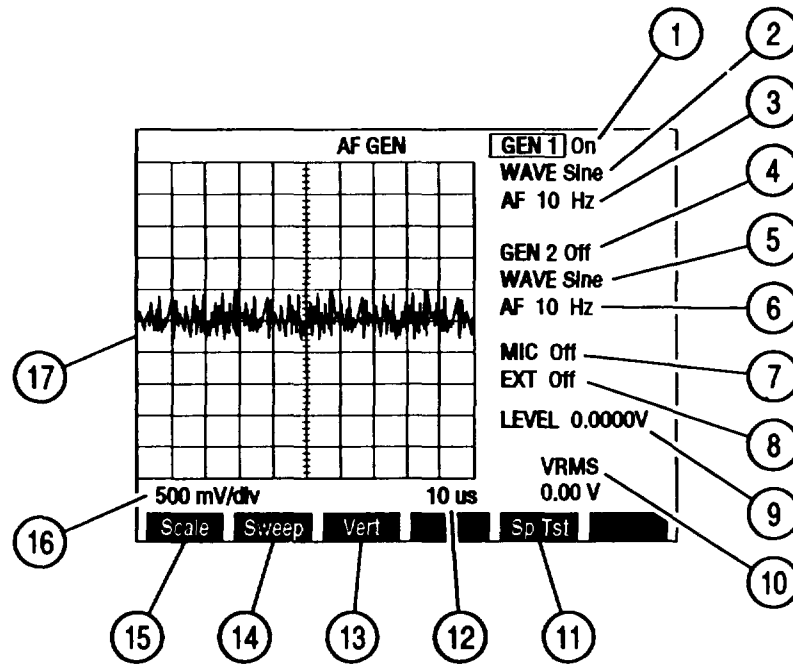

CE2FM447

KEY	SCREEN FEATURE	FUNCTION
1.	AF Generator #1 Status	Access toggles on or off. Default off. If Proportional Output is on (AF Output Setup Submenu), set from 0% to 100%. Default 0%.
2.	AF Generator #1 Output Wave Shape	Select from: Sine Square Ramp Triangle Pulse +1 Lvl 0 Lvl -1 Lvl Default Sine.
3.	AF Generator #1 Audio Frequency	Set from 0.0 to 40000.0 Hz. Default 1000.0 Hz.
4.	AF Generator #2 Status	Access toggles on or off. Default off. if Proportional Output is on (AF Output Setup Submenu), set from 0% to 100%. Default 0%.
5.	AF Generator #2 Output Wave Shape	Select from: Sine Square Ramp Triangle Pulse +1 Lvl 0 Lvl -1 Lvl Default Sine.
6.	AF Generator #2 Audio Frequency	Set from 0.0 to 40000.0 Hz. Default 1000.0 Hz.

KEY	SCREEN FEATURE	FUNCTION																		
7.	Function Generator input from MIC/ACC IN/OUT Connector	Access toggles on or off. Default off. If Proportional Output is on (AF Output Setup Submenu), set from 0% to 100%. Default 0%.																		
8.	Function Generator input from EXT MOD IN Connector	Access toggles on or off. Default off. If Proportional Output is on (AF Output Setup Submenu), set from 0% to 100%. Default 0%.																		
9.	Output Level	Set from 0.0000 to 3.1000 Vrms into 150 Ω load. Default 0.0000 V.																		
10.	Output Measurement	Not an editable parameter. Displays VRMS level of AF Generator Output.																		
11.	“Sp Tst”/“AUX”	“Sp Tst” appears with Small Computer System Interface enabled. Press F5 to access Special Test Menu. “AUX” appears with Small Computer System Interface disabled. Press F5 to display Auxiliary Functions Menu.																		
12.	Oscilloscope Sweep Rate	Select from: <table style="width: 100%; border: none;"> <tr> <td>1 μs</td> <td>2 μs</td> <td>5 μs</td> </tr> <tr> <td>10 μs</td> <td>20 μs</td> <td>50 μs</td> </tr> <tr> <td>100 μs</td> <td>200 μs</td> <td>500 μs</td> </tr> <tr> <td>1 ms</td> <td>2 ms</td> <td>5 ms</td> </tr> <tr> <td>10 ms</td> <td>20 ms</td> <td>50 ms</td> </tr> <tr> <td>100 ms</td> <td></td> <td></td> </tr> </table> Default 5 μs.	1 μs	2 μs	5 μs	10 μs	20 μs	50 μs	100 μs	200 μs	500 μs	1 ms	2 ms	5 ms	10 ms	20 ms	50 ms	100 ms		
1 μs	2 μs	5 μs																		
10 μs	20 μs	50 μs																		
100 μs	200 μs	500 μs																		
1 ms	2 ms	5 ms																		
10 ms	20 ms	50 ms																		
100 ms																				
13.	“Vert”	Press F3 to enable vertical position adjustment of Oscilloscope trace. Adjust with DATA SCROLL Spinner, press ENTER.																		
14.	“Sweep”	Press F2 to access Oscilloscope Sweep Rate (12).																		
15.	“Scale”	Press F1 to access Oscilloscope Scale (16).																		
16.	Oscilloscope Vertical Scale	Select from: <table style="width: 100%; border: none;"> <tr> <td>1 V/div</td> <td>2.5 V/div</td> <td>500 mV/div</td> </tr> </table> Default 1 V/div.	1 V/div	2.5 V/div	500 mV/div															
1 V/div	2.5 V/div	500 mV/div																		
17.	Oscilloscope	Allows view of Function Generator Wave Form output or external source input. Allows visual measurement of amplitude and time.																		

k. **AF Generator Menu.** When AF Generator Operation Screen is displayed on CRT, press SETUP Key to access AF Generator Menu. "

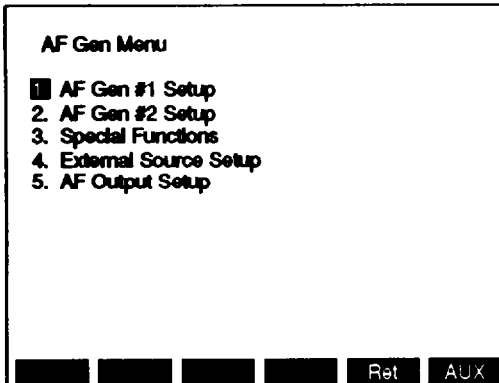

CE2FM448

KEY	MENU ITEM	FUNCTION
1.	Function Generator #1 Setup	Access displays Function Generator #1 Submenu.
2.	Function Generator #2 Setup	Access displays Function Generator #2 Submenu.
3.	Special Functions	Access displays Special Functions Submenu providing AF Generator Scan and Tone Remote generation.
4.	External Source Setup	Access displays External Source Setup Submenu.
5.	AF Generator Setup	Access displays RF Generator Setup Submenu.

When 1. AF Gen #1 Setup or 2. AF Gen #2 Setup is accessed from AF Generator Menu, one of the following submenus appears on CRT. The setup parameters for Function Generator #1 Submenu and Function Generator #2 Submenu are identical.

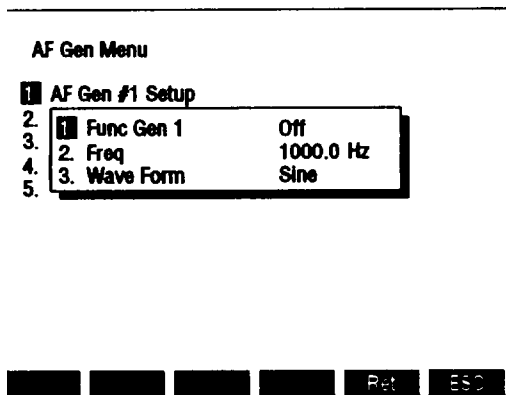

CE2FM449

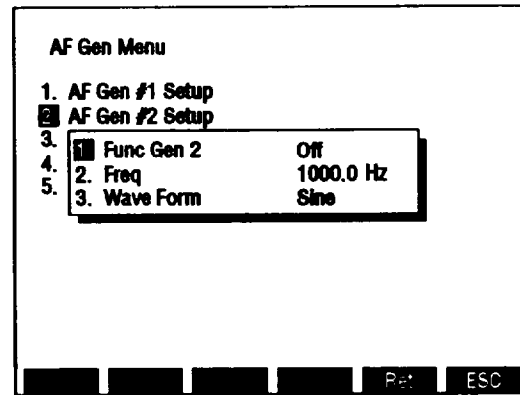

CE2FM450

KEY	MENU ITEM	FUNCTION
1.	Function Generator 1 and 2 Status	Access toggles off or on. Default off.
2.	Frequency	Set from 0.0 to 40000.0 Hz. Default 1000.0 Hz.

KEY	MENU ITEM	FUNCTION
3.	Wave Form	Access displays submenu. Select from: Sine Square Ramp Triangle Pulse +1 Lvl 0 Lvl -1 Lvl Default Sine.

When 3. Special Functions is selected on AF GEN Menu, Special Functions Submenu appears:

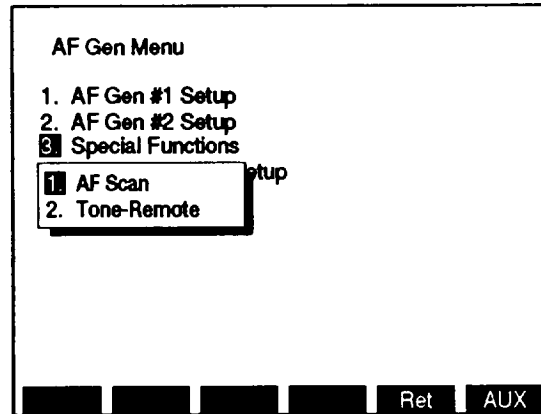

CE2FN503

KEY	MENU ITEM	FUNCTION
1.	AF Scan	Access displays AF Scan Submenu.
2.	Tone-Remote	Access displays Tone Remote Function Submenu

When 1. AF Scan is selected on Special Functions Submenu, AF Scan Submenu appears.

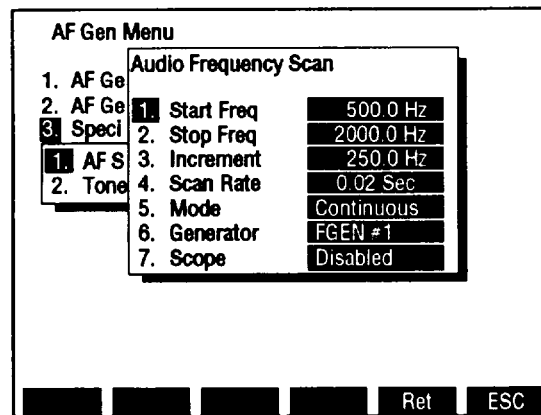

CE2FN451

KEY	MENU ITEM	FUNCTION
1.	AF Scan Starting Frequency	Set from 0.0 to 40000.0 Hz.
2.	AF Scan Stopping Frequency	Set from 0.0 to 40000.0 Hz.
3.	Increment between frequencies	Set from 0.0 to 40000.0 Hz.

KEY	CONNECTOR, INDICATOR OR CONNECTOR	FUNCTION
4	Scan Rate, time period to generate each frequency	Does not appear if Scope (7) enabled. Set from 0.02 to 99.99 sec.
5	Mode	Toggle between Continuous or One Shot.
6	AF Generator to perform scan	Toggle between FGEN#1 and FGEN #2.
7	Scope	Toggles Oscilloscope between Enabled and Disabled. With Oscilloscope enabled, Scan Rate (4) is not selectable.

When 2. Tone-Remote is selected on Special Functions Submenu, Tone Remote Function Submenu appears:

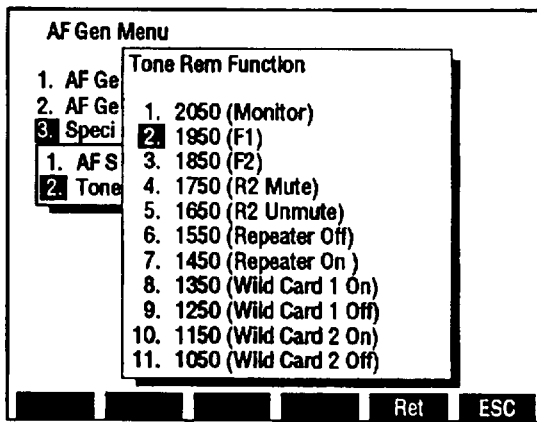

CE2FN452

Use FIELD SELECT Keys to position cursor on selected Tone Remote Function and press ENTER.

When 4. External Source Setup is selected on AF Gen Menu, submenu appears:

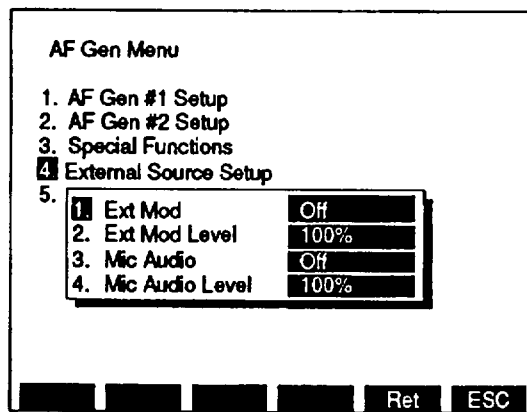

CE2FN453

KEY	CONNECTOR, INDICATOR OR CONNECTOR	FUNCTION
1.	External Modulation Status	Access toggles off or on. Default off.
2.	Set External Modulation Level	Set from 0% to 100%. Default 100%.

KEY	CONNECTOR, INDICATOR OR CONNECTOR	FUNCTION
3.	Mic Audio Status	Access toggles off or on. Default off.
4.	Set Mic Audio Level	Set from 0% to 100%. Default 100%.

When 5. AF Output Setup is selected on AF Gen Menu, submenu appears:

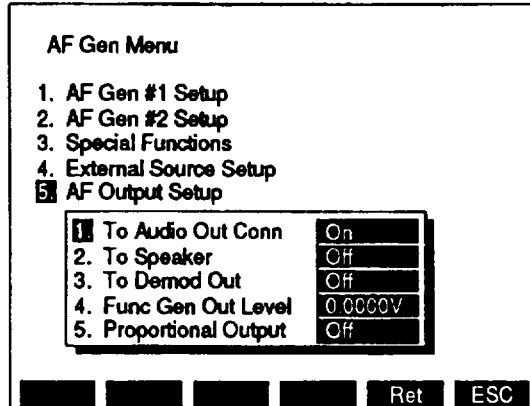

CE2FM54

KEY	CONNECTOR, INDICATOR OR CONNECTOR	FUNCTION
1.	To AUDIO OUT Connector	Access toggles off or on. Default on.
2.	To Speaker	Access toggles off or on. Default off.
3.	To DEMOD OUT Connector	Access toggles off or on. Default off.
4.	Function Generator Output Level	Set from 0.0000 to 3.1000 Vrms into 150 I load. Default 0.0000 V.
5.	Proportional Output	Access toggles off or on. Default off.

1. **Oscilloscope Screen Configuration.** Press SCOPE/ANLZ MODE Key to access Oscilloscope Operation Screen. Both Oscilloscope and Spectrum Analyzer are accessed with SCOPE/ANLZ MODE Key. It may be necessary to press key twice to access Oscilloscope Operation Screen. Use list of screen features to identify items that may be edited, the value range available and function.

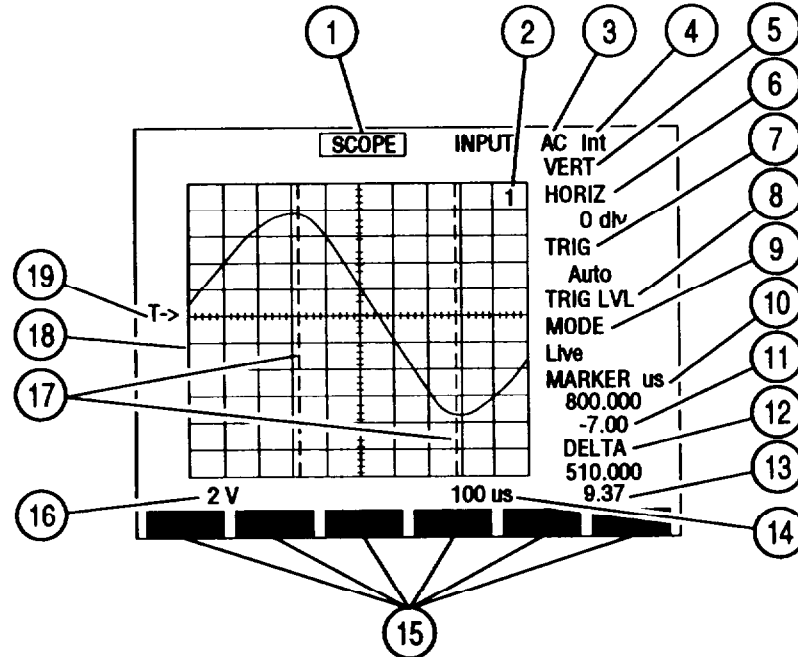

CE2FN455

KEY	SCREEN FEATURE	FUNCTION
1.	Oscilloscope Operation Screen Callout	Move cursor to SCOPE and press ENTER to display Spectrum Analyzer Operation Screen.
2.	Recall trace number	Appears if Mode (9) is Recall or Compare. Displays number of recalled trace. Possible recall trace numbers are 1 through 9.
3.	Input Source	When accessed, Input Submenu appears. Press number of desired Input on DATA ENTRY Keypad to activate. Select from: Rcvr IF Demod Audio RF Pwr Lvl SINAD/BER Func Gen Ext Mod AC DC GND Default Demod Audio.
4.	Trigger Source	Appears if Input Source (3) is AC or DC. Toggles between Int (Internal) and Ext (External). External Trigger received at EXT MOD IN Connector.
5.	Vertical Trace Adjustment	Access allows vertical position adjustment of trace on Oscilloscope grid with DATA SCROLL ↑ and ↓ Keys or Spinner.

KEY	SCREEN FEATURE	FUNCTION
6.	Horizontal Offset	Adjusts horizontal position of Oscilloscope Trace 0 to ± 12 div. Default 0 div.
7.	Trigger Setting	Select from: Normal Auto One Shot Default Auto.
8.	Trigger Level	Enables vertical position adjustment of Trigger Level Indicator (19). Adjust with DATA SCROLL \uparrow and \downarrow Keys or Spinner and press ENTER.
9.	Mode	Select from: Live Recall Compare Average Compare Mode compares recalled trace with live trace.
10.	Marker Setting	Marker setting indicates active marker position from Trigger Position in Sweep Rate (14) units. Marker setting is reactive to Horizontal Offset (6). Default is centerline value.
11.	Marker voltage reading	Appears if Marker active and Input Source (3) AC, DC or GND. Displays voltage of trace at point of marker.
12.	Delta reading	Appears if Marker active. Indicates position difference between Markers 1 and 2 in Sweep Rate (14) units.
13.	Delta voltage reading	Appears if Marker active and Input Source (3) AC, DC or GND. Displays voltage difference of trace between point of Marker 1 and Marker 2.
14.	Oscilloscope Sweep Rate (per div)	Select from: 1 μ s 2 μ s 5 μ s 10 μ s 20 μ s 50 μ s 100 μ s 200 μ s 500 μ s 1 ms 2 ms 5 ms 10 ms 20 ms 50 ms 100 ms Default 5 μ s.
15.	Soft Function Key Definitions	Vary with screen configuration, input type and configuration of Oscilloscope. Press Soft Function Key (F1 thru F6) directly under Soft Function Key Definition to access or activate feature named.

KEY	SCREEN FEATURE	FUNCTION
16.	Scale	Does not appear if Input Source (3) is Rcvr IF. For AC, DC or GND Input Source (3), select from: 1 mV/div 2 mV/div 5 mV/div 10 mV/div 20 mV/div 50 mV/div 100 mV/div 200 mV/div 500 mV/div 1 V/div 2 V/div 5 V/div 10 V/div 20 V/div 50 V/div For Func Gen or Ext Mod Input Source (3), select from: 500 mV 1 v 2.5 V For Demod Audio Input Source (3) select from: 2 kHz 4 kHz 10 kHz 20 kHz For RF Pwr Lvl Input (3), Scale shows 2W or 200W, according to range setting of Power Meter. For SINAD/BER Input, Scale is 4 V.
17.	Marker 1 and 2	May be turned on or off and adjusted to limits of Oscilloscope grid. Default off and positioned at centerline.
18.	Oscilloscope Grid	Used to view waveform of Input Source (3).
19.	Trigger Level Indicator	May be adjusted vertically on Oscilloscope to limits of grid. Adjust by accessing Trigger Level (8) and using DATA SCROLL ↑ and ↓ Keys or Spinner. Press ENTER.

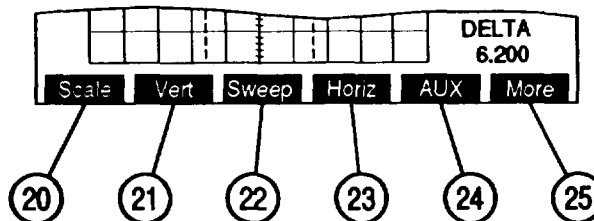

CE2FN456

KEY	SCREEN FEATURE	FUNCTION
20.	"Scale"	Appears when selectable. Press F1 to access Oscilloscope Scale (16).
21.	"Vert"	Press F2 to enable Vertical Trace Adjustment (5).
22.	"Sweep"	Press F3 to access Sweep Rate (14).
23.	"Horiz"	Press F4 to access Horizontal Offset (6).

KEY	SCREEN FEATURE	FUNCTION
24.	"AUX"/"Sp Tst"	"AUX" appears with Small Computer System Interface disabled. Press F5 to display Auxiliary Functions Menu. "Sp Tst" appears with Small Computer System Interface enabled. Press F5 to access Special Test Menu.
25.	"More"/"ESC"	Press "More" F6 to access additional Soft Function Key Definitions. "ESC" appears while accessing parameters. Press "ESC" F6 to void edit procedure.

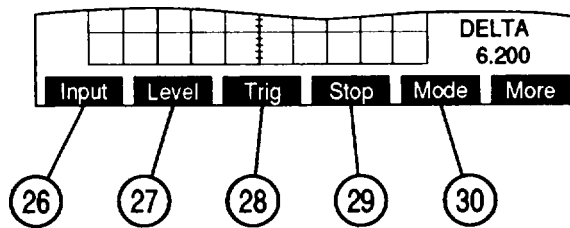

CE2FN457

KEY	SCREEN FEATURE	FUNCTION
26.	"Input"	Press F1 to access Input Source (3) Submenu.
27.	"Level"	Press F2 to enable Trigger Level Indicator (19) adjustment.
28.	"Trig"	Press F3 to access Oscilloscope Trigger Setting (7).
29.	"Stop"/"Start"	Press F4 to hold trace on Oscilloscope Screen. When trace is stopped, press F4 again to resume normal Oscilloscope function.
30.	"Mode"	Press F5 to access Mode (9).

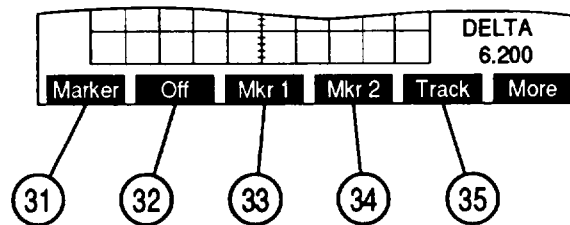

CE2FN458

KEY	SCREEN FEATURE	FUNCTION
31.	"Marker"	Press F1 to access Marker location (1 O).
32.	"Off"	Press F2 to turn Markers off. "Off" appears red when markers are off.

KEY	SCREEN FEATURE	FUNCTION
33.	"Mkr 1"	Press F3 to select Marker 1 as active marker and access Marker 1 position. "Mkr 1" appears red when active.
34.	"Mkr 2"	Press F4 to select Marker 2 as active marker and access Marker 2 position. "Mkr 2" appears red when active.
35.	"Track"	Press F5 to lock markers a constant distance apart. "Track" appears red when Track active.

m. Scope/Analyzer (Oscilloscope) Menu. When Oscilloscope Operation Screen is displayed on CRT, press SETUP Key to access Scope/Analyzer Menu. Both Oscilloscope and Spectrum Analyzer Operation Screens may be edited from Scope/Analyzer Menu or one of its submenus.

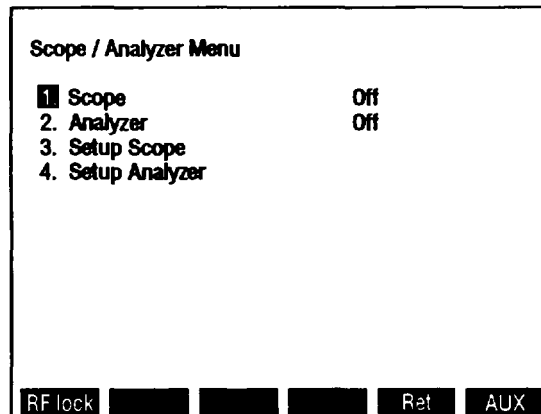

GE2FN459

KEY	MENU ITEM	FUNCTION
1.	Oscilloscope	Access toggles between off or on. Default off. Only Scope or Spectrum Analyzer may be on at one time, yet both may be off at the same time. Oscilloscope on or off affects Oscilloscope display on RF Generator, Receive, Duplex Transmitter and Duplex Receiver Operation Screens.
2.	Analyzer	Access toggles off or on. Default off.
3.	Setup Oscilloscope	Access displays Setup Scope Submenu.
4.	Setup Analyzer	Not applicable for Oscilloscope operation.

When 3. Setup Scope is selected on Scope/Analyzer Menu, submenu appears:

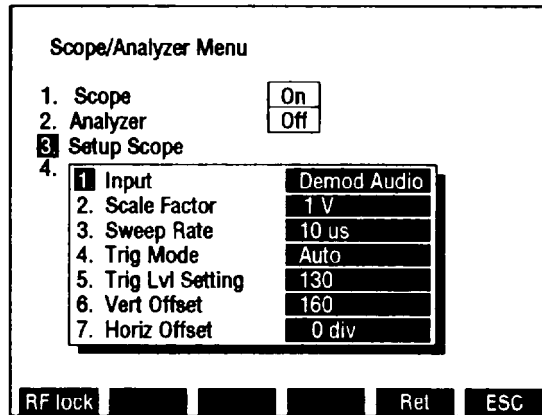

CE2FN460

KEY	MENU ITEM	FUNCTION
1.	Input	Access displays submenu. Select from: Rcvr IF Demod Audio RF Pwr Lvl SINAD/BER Func Gen Ext Mod AC DC GND Default Demod Audio.
2.	Scale Factor	Setting does not appear if Input Source (3) is Rcvr IF. For AC, DC or GND Input Source (3), select from: 1 mV/div 2 mV/div 5 mV/div 10 mV/div 20 mV/div 50 mV/div 100 mV/div 200 mV/div 500 mV/div 1 V/div 2 V/div 5 V/div 10 V/div 20 V/div 50 V/div For Func Gen or Ext Mod Input Source (3), select from: 500 mV 1 V 2.5 V For Demod Audio Input Source (3) select from: 2 kHz 4 kHz 10 kHz 20 kHz For RF Pwr Lvl Input (3), Scale shows 2W or 200W, according to range setting of Power Meter. For SINAD/BER Input, Scale is 4 V.
3.	Sweep Rate	Select from: 1 μs 2 μs 5 μs 10 μs 20 μs 50 μs 100 μs 200 μs 500 μs 1 ms 2 ms 5 ms 10 ms 20 ms 50 ms 100 ms Default 5 μs.
4.	Trigger Mode	Access displays submenu. Select from: One Shot Normal Auto Default Auto.

KEY	MENU ITEM	FUNCTION
5.	Trigger Level Setting	Set from 0 to 255. Default 130.
6.	Vertical Offset	Set from 0 to 255. Default 160.
7.	Horizontal Offset	Set from 0 to ± 12 div. Default 0 div.

n. **Spectrum Analyzer Screen Configuration.** Press SCOPE/ANLZ MODE Key to access Spectrum Analyzer Operation Screen. Both Oscilloscope and Spectrum Analyzer are accessed with SCOPE/ANLZ MODE Key. It may be necessary to press key twice to access Spectrum Analyzer Operation Screen. Use list of screen features to identify items that may be edited, the value range available and function.

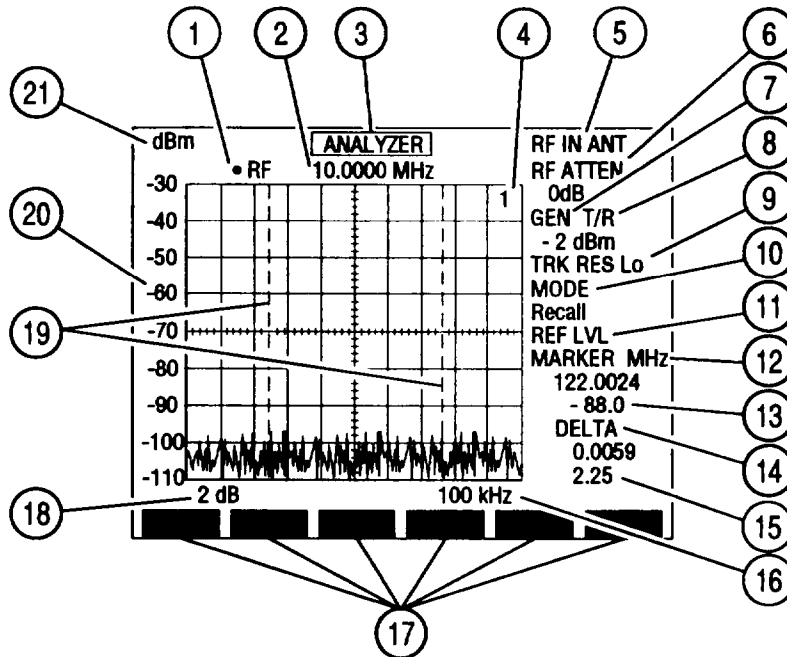

CE2FN461

KEY	SCREEN FEATURE	FUNCTION
1.	Squelch Indicator	Green dot appears when squelch is broken.
2.	Radio Frequency	Set from 0.2500 to 999.9999 MHz. Default 10.0000 MHz.
3.	Analyzer Operation Screen Callout	Move cursor to ANALYZER and press ENTER to access Oscilloscope Operation Screen.
4.	Recall trace number	Appears if Mode (1 O) is Recall or Compare. Displays number of recalled trace. Possible recall trace numbers are 1 through 9.
5.	RF Input	Access toggles between ANT (Antenna) and T/R Connector. Default ANT.
6.	RF Input Attenuation	Select from: 0 dB 20 dB 40 dB Default 0 dB.
7.	Tracking Generator Callout	Access to set Tracking Generator Output Level. If Tracking Generator Output Connector (8) is T/R, set from 0.0 to -137.0 dBm. If Tracking Generator Output Connector (8) is DPL, set from 7.0 to -120.0 dBm. Default -20.0 dBm.

KEY	SCREEN FEATURE	FUNCTION
8.	Tracking Generator Output Connector	Appears as Off when Tracking generator is off. Toggles between T/R and DPL (DUPLEX OUT) Connector. Default off.
9.	Tracking Generator Resolution	Select from: Lo (Low) Me (Medium) Hi (High) Default Lo.
10.	Mode	Select from: Live Recall Compare Average Peak Hold Default Live.
11.	2 dB Units/Division Factor Reference Level	Appears with 2 dB Units/Division Factor (18). Enables Reference Level adjustment. Adjust with DATA SCROLL ↑ and ↓ Keys or Spinner and press ENTER.
12.	Marker Frequency	If markers off, activates markers until setting entered. Displays active marker's frequency position in MHz.
13.	Marker amplitude reading	Appears with markers on. Displays trace amplitude at point of active marker. Amplitude reading is in units of Vertical Scale (20).
14.	Delta Frequency	Appears with markers on. Displays position difference between Markers 1 and 2 in MHz.
15.	Delta amplitude reading	Appears with markers on. Displays amplitude difference of trace between point of Marker 1 and 2.
16.	Scan Width (per div)	Select from: 1 kHz 2 kHz 5 kHz 10 kHz 20 kHz 50 kHz 100 kHz 200 kHz 500 kHz 1 MHz 2 MHz 5 MHz 10 MHz 20 MHz 50 MHz 100 MHz 0 kHz (zero scan) Default 1 kHz.
17.	Soft Function Key Definitions	Vary with screen configuration. Press Soft Function Key (F1 thru F6) directly under Soft Function Key Definition to access or activate feature named.
18.	Units/Division Factor	Toggles between 10 and 2 dB. Default 10 dB.
19.	Markers 1 and 2	May be turned on or off and adjusted to limits of Spectrum Analyzer grid. Default off and positioned at centerline.
20.	Vertical Scale	Displays in units of Scale Factor (21).

KEY	SCREEN FEATURE	FUNCTION
2 1	Scale Factor	If ANT is RF Input (5), select from: dBm dBmV dBu V dBV dBuW If T/R is RF Input (5), select from: dBW dBm Default dBm.

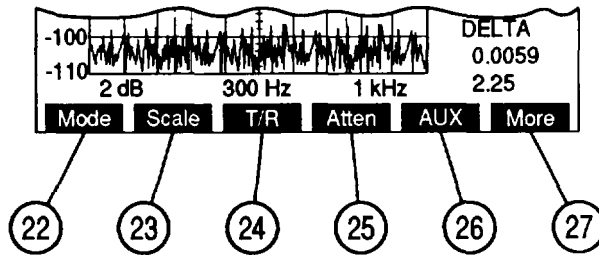

CE2FN462

KEY	SCREEN FEATURE	FUNCTION
22.	'Mode'	Press F1 to access Mode (10).
23.	"Scale"	Press F2 to access Scale Factor (21).
24.	"T/R"/"Ant"	Press F3 to toggle RF Input (5) between T/R and ANT.
25.	"Atten"	Press F4 to access RF Input Attenuation (6).
26.	"AUX"/"Sp Tst"	"AUX" appears with Small System Computer Interface disabled. Press F5 to display Auxiliary Functions Menu. "Sp Tst" appears with Small System Computer Interface enabled. Press F5 to access Special Test Menu.
27.	"More "/"ESC"	Press "More" F6 to access additional Soft Function Key Definitions. "ESC" appears while accessing parameters. Press "ESC" F6 to void edit procedure.

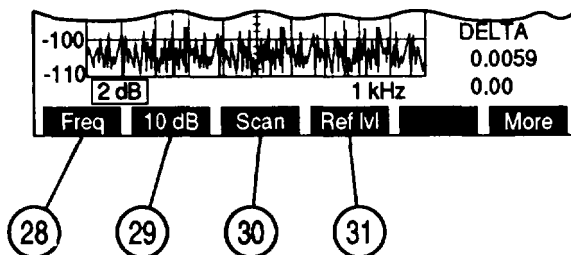

CE2FN463

KEY	SCREEN FEATURE	FUNCTION
28.	"Freq"	Press F1 to access Radio Frequency (2).

KEY	SCREEN FEATURE	FUNCTION
29.	"10 dB"/"2 dB"	Press F2 to toggle Units/Division Factor (18) between 2 and 10 dB.
30.	"Scan"	Press F3 to access Scan Width (16).
31.	"Ref lvl"	Appears with 2 dB Units/Division Factor. Press F4 to access 2 dB Units/Division Reference Level.

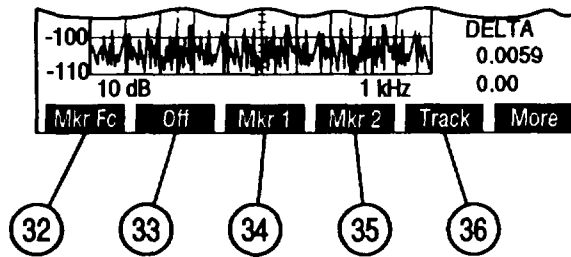

CEZFN464

KEY	SCREEN FEATURE	FUNCTION
32.	"Mkr Fc"	Appears when markers active and Scan Width not 0 kHz. Press F1 to set Radio Frequency (2) to active marker position.
33.	"off"	Press F2 to turn markers off. "Off" appears red when markers off.
34.	"Mkr 1"	Press F3 to select Marker 1 as active marker and access Marker 1 position. "Mkr 1" appears red when active.
35.	"Mkr 2"	Press F4 to select Marker 2 as active marker and access Marker 2 position. "Mkr 2" appears red when active.
36.	"Track"	Press F5 to lock markers a constant distance apart. "Track" appears red when Track active.

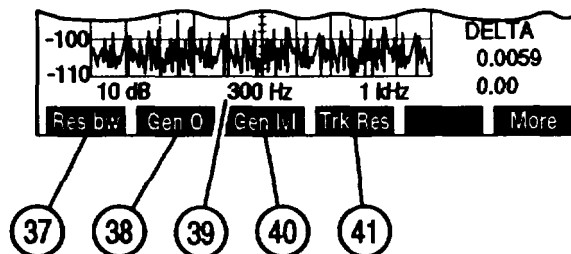

CE2FN465

KEY	SCREEN FEATURE	FUNCTION
37.	“Res bw”/” Norm”	“Res bw” appears when Tracking Generator on. Press F1 to access Resolution Bandwidth. “Norm” appears when Tracking Generator off. Press F1 to normalize Spectrum Analyzer to match RF Generator output.
38.	“Gen 0”/”Gen 1”	“Gen 0” appears when Tracking Generator on. Press F2 to activate Tracking Generator. “Gen 1” appears when Tracking Generator off. Press F2 to turn Tracking Generator off. Default off.
39.	Resolution Bandwidth	Select from: 300 Hz 3 kHz 30 kHz 300 kHz 3 MHz Default 3 kHz.
40.	“Gen lvl”	Press F3 to access Tracking Generator Output Level (7).
41.	“Trk Res”	Press F4 to access Tracking Generator Resolution (9).

When Tracking Generator is off, Spectrum Analyzer Soft Function Keys appear as follows:

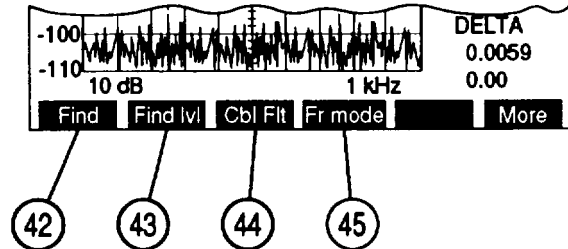

CE2FN466

KEY	SCREEN FEATURE	FUNCTION
42.	“Find”	Press F1 to change Radio Frequency to lowest frequency with signal greater than Find Reference Level. Range of Find Function is from 4.0000 to 999.9999 MHz. Signal amplitude must be >-65 dBm.
43.	“Find lvl”	Press F2 to set Find Reference Level used with Find Function.
44.	“Cbl Fit”	Press F3 to toggle Cable Fault testing between on and off. “Cbl Flt” appears red when on.

K E Y	SCREEN FEATURE	FUNCTION
45.	"Fr mode	Press F4 to toggle Radio Frequency between Direct and Channel Frequency Mode. Direct is for normal operation. Channel displays Receive Radio frequency as a channel number. F or R is displayed indicating Forward or Reverse Channels. Cellular Channel Format is selected using "Chan" F3 (46). Default Direct.

o. Scope/Analyzer (Spectrum Analyzer) Menu. When Spectrum Analyzer Operation Screen is displayed on CRT, press SETUP Key to access Scope/Analyzer Menu. Both Oscilloscope and Spectrum Analyzer Operation Screens may be edited from Scope/Analyzer Menu or one of its submenus.

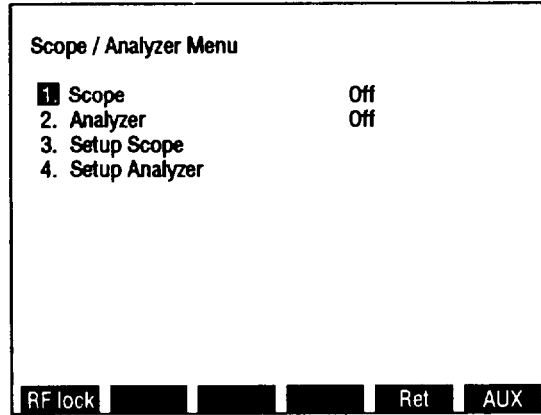

CE2FN467

KEY	MENU ITEM	FUNCTION
1.	Oscilloscope	Access toggles off or on. Default off. Only Scope or Analyzer may be on at one time, yet both may be off at the same time.
2.	Analyzer	Access toggles off or on. Default off.
3.	Setup Oscilloscope	Not applicable for Spectrum Analyzer operation.
4.	Setup Analyzer	Access displays Setup Analyzer Submenu.

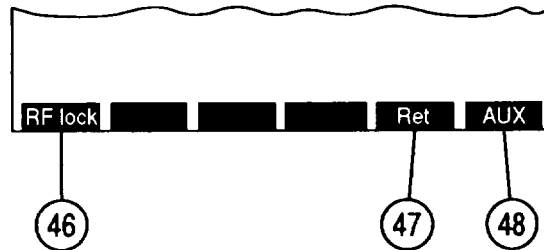

CE2FN468

KEY	SCREEN FEATURE	FUNCTION
46.	“RF lock”/“Chan”	<p>“RF lock” appears with Direct Mode (45). Press F1 to enable/disable RF Lock. RF Lock enabled locks Spectrum Analyzer Radio Frequency to same value as Receive Radio Frequency and RF Generator Frequency. “RF lock” appears red when enabled.</p> <p>“Chan” appears with Channel Mode (45). Press F1 to access Channel Format Menu allowing selection of Channel Format. Select from: AMPS Cellular (Fwd) AMPS Cellular (Rev) ETACS Cellular (Fwd) ETACS Cellular (Rev)</p>

KEY	SCREEN FEATURE	FUNCTION
47.	"Ret"	Press F5 to display Spectrum Analyzer Operation Screen.
48.	"AUX'/'ESC"	Press "AUX" F6 to display Auxiliary Functions Menu. "ESC" appears while editing parameters. Press "ESC" F6 to void edit procedure.

When 4. Setup Analyzer is selected on Scope/Analyzer Menu, submenu appears:

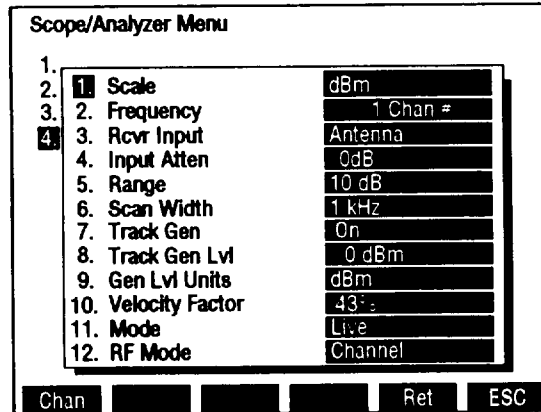

CE2FN469

KEY	MENU ITEM	FUNCTION
1.	Scale Factor	If ANT is RF Input (3), select from: dBm dBmV dBuV dBV dBuW If T/R is RF Input (3), select from: dBm dBW Default dBm.
2.	Radio Frequency	Set from 0.2500 to 999.9999 MHz. Default 10.0000 MHz.
3.	RF Input	Access toggles between ANT (Antenna) and T/R Connector. Default ANT
4.	RF Input Attenuation	Select from: 0 dB 20 dB 40 dB Default 0 dB.
5.	Units/Division Factor	Toggles between 10 and 2 dB. Default 10 dB.
6.	Scan Width	Select from: 1 kHz 2 kHz 5 kHz 10 kHz 20 kHz 50 kHz 100 kHz 200 kHz 500 kHz 1 MHz 2 MHz 5 MHz 10 MHz 20 MHz 50 MHz 100 MHz 0 kHz (zero scan) Default 1 kHz.

KEY	MENU ITEM	FUNCTION
7.	Tracking Generator Status	Toggles Tracking generator between on and off. Default off.
8.	Tracking Generator Output Level	If Tracking Generator Output Connector (8) is T/R, set from 0.0 to -137.0 dBm. If Tracking Generator Output Connector (8) is DPL, set from 7.0 to -120.0 dBm. Default -20.0 dBm.
9.	Tracking Generator Output Level Units	Toggles between dBm and Volts. Default dBm.
10.	Velocity Factor	Cable Velocity Factor used with Cable Fault testing. Set from 0.0% to 100.0%. Default 69.4%.
11.	Mode	Select from: Live Recall Compare Average Peak Hold Default Live.
12.	RF Mode	Toggles between Direct and Channel Frequency Mode. Direct is for normal operation. Channel displays Receive Radio frequency as a channel number. F or R is displayed indicating Forward or Reverse Channels. Cellular Channel Format is selected using "Chan" F1 (46). Default Direct.

p“ **Meter Screen Configurations and Menus.** Meters are displayed on operation screens as Digital Readouts or full meters. Each meter has an operation screen and menu. Meter Operation Screens are accessed from other operation screens by moving cursor to the meter callout and pressing ENTER. Pressing MTRS MODE Key displays the Meter Menu.

METER MENU

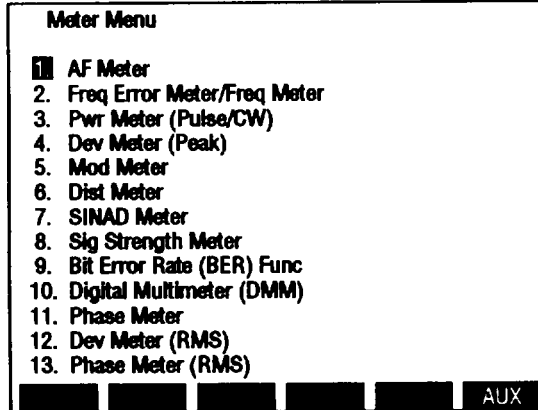

CE2FN470

	Page
1. AF Meter Screen Configuration	2-114
2. Frequency Error Meter Screen Configuration	2-117
3. Power Meter Screen Configuration	2-120
4. Deviation Meter Screen Configuration	2-123
5. Modulation Meter Screen Configuration	2-126
6. Distortion Meter Screen Configuration	2-129
7. SINAD Meter Screen Configuration	2-132
8. Signal Strength Meter Screen Configuration	2-135
9. Bit Error Rate (BER) Meter Screen Configuration	2-137
10. Digital Multimeter (D MM) Screen Configuration	2-144
11. Phase Meter Screen Configuration	2-149
12. Deviation Meter (RMS) Screen Configuration	2-152
13. Phase Meter (RMS) Screen Configuration	2-155

1. **AF Meter Screen Configuration.** When the Meter Menu is displayed on the CRT, press 1 on DATA ENTRY Keypad to access AF Meter Operation Screen.

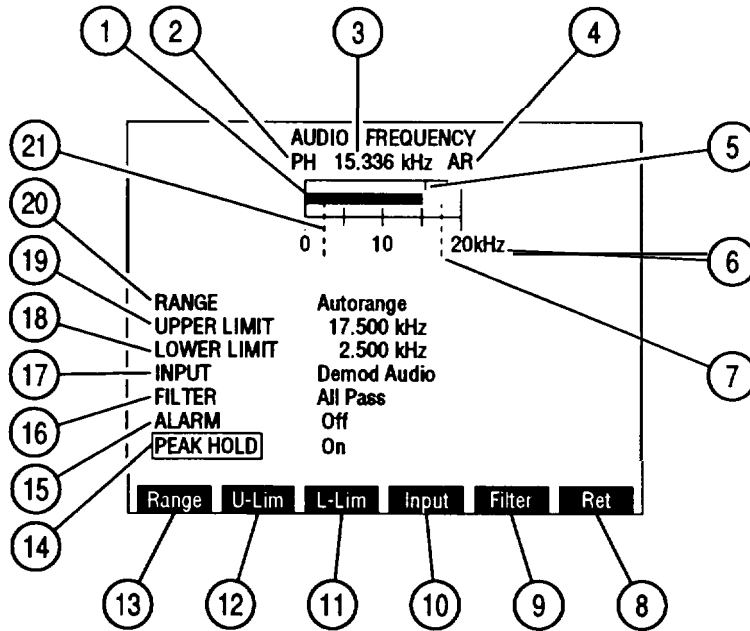

CE2FN471

KEY	METER FEATURE	FUNCTION
1.	Meter Indicator Bar	Shows meter indication according to Meter Range Scale (6). Turns red when exceeds upper limit or when less than lower limit. Turns green when reaches edge of meter window.
2.	PH Enabled	Appears above left corner of meter window when PEAK HOLD (14) is on.
3.	Digital Readout	Provides numeric meter indication. Shows highest meter indication reached when PEAK HOLD (14) is on.
4.	AR	Appears above upper right corner of meter window when RANGE (20) is set for Autorange. Meter Range Scale (6) automatically resets to next higher scale when Meter Indicator Bar (1) reaches edge of meter window. Meter resets to next lower scale when Meter Indicator Bar (1) falls to 1/2 of lowest scale division.
5.	Peak Hold Indicator	Appears when PEAK HOLD (14) is on. Green indicator shows highest point of meter deflection.
6.	Meter Range Scale	Scale of four divisions marked from 0 to limit of active range with center division labeled as midpoint of range.
7.	Upper Limit Indicator	When on, dotted line appears across meter window where limit is set.

KEY	METER FEATURE	FUNCTION
8.	"Ret"/"ESC"	Press "Ret" F6 to return to active operation screen. "ESC" appears while accessing a parameter. Press "ESC" F6 to void edit procedure.
9.	"Filter"	Press F5 to access FILTER data field (16).
10.	"Input"	Press F4 to access INPUT data field (17).
11.	"L-Lim"	Press F3 to activate LOWER LIMIT (18) and access data field.
12.	"U-Lim"	Press F2 to activate UPPER LIMIT (19) and access data field.
13.	"Range"	Press F1 to access RANGE data field (20).
14.	PEAK HOLD	Move cursor to PEAK HOLD, press ENTER to toggle on or off. Default off.
15.	ALARM	Move cursor to ALARM, press ENTER to toggle off or on. Default off. When on, tone sounds when Meter Indicator Bar (1) exceeds upper limit or lower limit.
16.	FILTER	Move cursor to FILTER, press ENTER to access data field. Use DATA SCROLL↑ and↓ Keys or Spinner to select filter type, press ENTER to activate. Select from: All Pass High Pass Low Pass Default All Pass.
17.	INPUT	Move cursor to INPUT, press ENTER to access data field. Use DATA SCROLL↑ and↓ Keys or Spinner to select, press ENTER to activate: Ext Mod In Demod Audio SINAD/BER Func Gen Out RF Power Default Demod Audio.
18.	LOWER LIMIT	Move cursor to LOWER LIMIT, press ENTER to activate Indicator (21) and access data field. Set from 0.000 to 200.0 kHz. Default off.
19.	UPPER LIMIT	Move cursor to UPPER LIMIT, press ENTER to activate Indicator (7) and access data field. Set from 0.000 to 200.0 kHz. Default off.
20.	RANGE	Move cursor to RANGE, press ENTER to access data field. Select from 200 Hz 2 kHz 20 kHz 200 kHz Autorange Default Autorange.
21.	Lower Limit Indicator	When on, dotted line appears across meter window where limit is set. Default off.

When AF Meter Operation Screen is displayed on CRT, press SETUP Key to access AF Meter Menu.

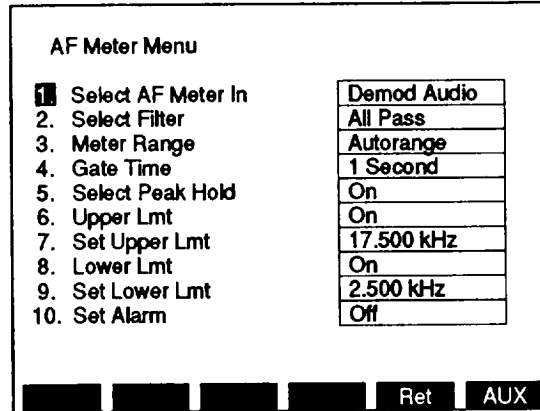

CE2FN472

KEY	METER FEATURE	FUNCTION
1.	Select AF Meter In	Access displays submenu. Select from: Ext Mod Demod Audio Func Gen Out SINAD/BER RF Power Default Demod Audio.
2.	Select Filter	Access displays submenu. Select from: All Pass Low Pass High Pass Selecting Low Pass or High Pass displays data field allowing entry of cutoff frequency. Range of Low Pass cutoff frequency is 0.1000 to 30.0000 kHz. Range of High Pass cutoff frequency is 0.500 to 20.000 kHz. Default All Pass.
3.	Meter Range	Access displays submenu. Select from: Autorange 200 Hz 2 kHz 20 kHz 200 kHz Default Autorange.
4.	Gate Time	Access toggles between 1 and 10 second. Default 1 second.
5.	Select Peak Hold	Access toggles off or on. Default off.
6.	Upper Lmt	Access toggles off or on.
7.	Set Upper Lmt	Set from 0.000 to 200.0 kHz. Default 0.000 Hz.
8.	Lower Lmt	Access toggles off or on. Default off.
9.	Set Lower Lmt	Set from 0.000 to 200.0 kHz. Default 0.000 Hz.
10.	Set Alarm	Access toggles off or on. Default off.

2. **Frequency Error Meter Screen Configuration.** When Meter Menu is displayed on CRT, press 2 on DATA ENTRY Keypad to access Frequency Error Meter Operation Screen.

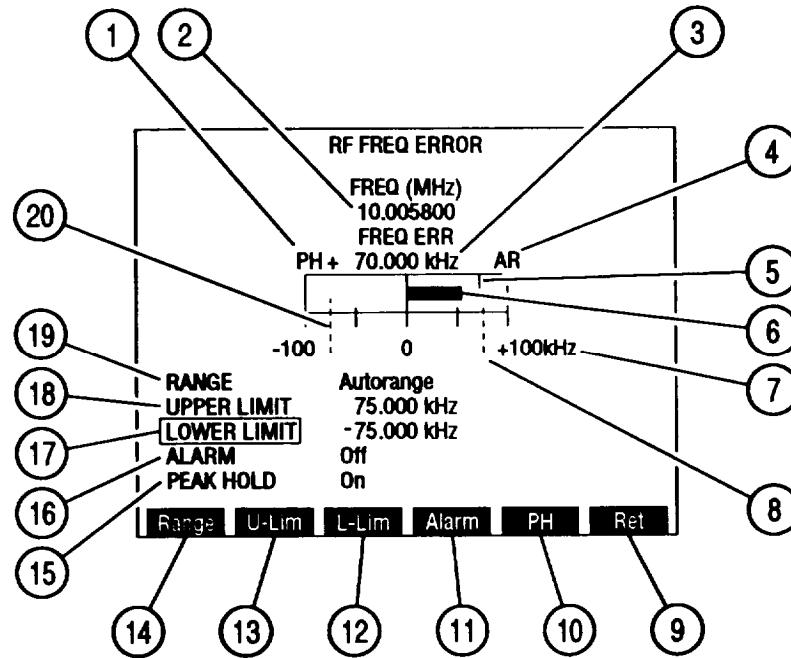

CE2FN473

KEY	METER FEATURE	FUNCTION
1.	PH Enabled	Appears above left corner of meter window when PEAK HOLD (15) is on.
2.	Frequency Digital Readout	Shows Received Frequency in MHz.
3.	Frequency Error Digital Readout	Shows difference, in kHz, between received frequency and receiver frequency setting. Displays highest meter indication reached when PEAK HOLD (15) is on.
4.	AR	Appears above right corner of meter window when RANGE (19) is set for Autorange. Meter Range Scale (7) automatically resets to next higher scale when Meter Indicator Bar (6) reaches edge of meter window. Meter resets to next lower scale when Meter Indicator Bar (6) falls to 1/2 of lowest scale division.
5.	Peak Hold Indicator	Appears when PEAK HOLD (15) is on. Green indicator shows highest point of positive meter deflection. A second green indicator shows lowest point of negative meter deflection.
6.	Meter Indicator Bar	Expands right from zero when Frequency Error is positive, expands left from zero when Frequency Error is negative. Turns red when exceeds upper or lower limit. Turns green when reaches edge of meter window.

KEY	METER FEATURE	FUNCTION
7.	Meter Range Scale	Marked from - scale limit on left to + scale limit on right. Center division is marked O.
8.	Upper Limit Indicator	When on, dotted line appears across meter window where limit is set. Indicator appears at right edge of window if limit set higher than meter range. Upper limit always positive and appears on right half of meter window. Default off.
9.	“Ret”/“ESC”	Press “Ret” F6 to return to active operation screen. “ESC” appears while accessing a parameter. Press “ESC” F6 to void edit procedure.
10.	“PH”	Press F5 to toggle PEAK HOLD (15) on or off.
11.	“Alarm”	Press F4 to toggle ALARM (16) on or off.
12.	“L-Lim”	Press F3 to activate LOWER LIMIT (17) and access data field.
13.	“U-Lim”	Press F2 to activate UPPER LIMIT (18) and access data field.
14.	‘Range”	Press F1 to access RANGE (19) data field.
15.	PEAK HOLD	Move cursor to PEAK HOLD, press ENTER to toggle on or off. Default off.
16.	ALARM	Move cursor to ALARM, press ENTER to toggle off and on. When on, tone sounds when Meter Indicator Bar (6) exceeds upper limit or lower limit. Default off.
17.	LOWER LIMIT	Move cursor to LOWER LIMIT, press ENTER to activate Indicator (20) and access data field. Set from 0.000 to 100.000 kHz. Default off.
18.	UPPER LIMIT	Move cursor to UPPER LIMIT, press ENTER to activate Indicator (8) and access data field. Set from 0.000 to 100.000 kHz. Default off.
19.	RANGE	Move cursor to RANGE, press ENTER to access data field. Select from: ± 100 Hz ± 1 kHz ± 10 kHz ± 100 kHz Autorange Default Autorange.
20.	Lower Limit Indicator	When on, dotted line appears across meter window where limit is set. Default off.

When Frequency Error **Meter Operation** Screen is displayed on CRT, press **SETUP** Key to access Frequency Error **Meter Menu**.

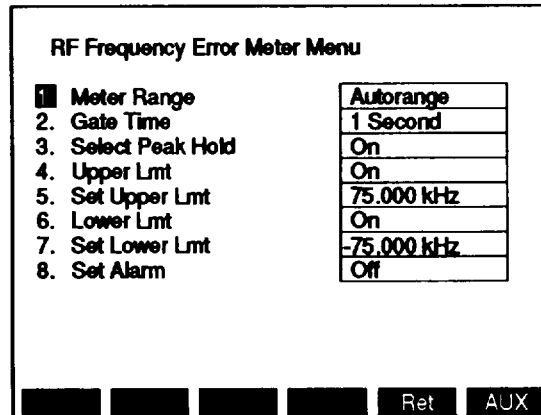

CE2FM474

KEY	METER FEATURE	FUNCTION
1.	Meter Range	Access displays submenu. Select from: Autorange ±100 Hz ±1 kHz ±10 kHz ±100 kHz Default Autorange.
2.	Gate Time	Access toggles between .1 and 1 second. Default 1 second.
3.	Select Peak Hold	Access toggles off or on. Default off.
4.	Upper Lmt	Access toggles off or on. Default off.
5.	Set Upper Lmt	Set from 0.000 to 100.0 kHz. Default 0.000 kHz.
6.	Lower Lmt	Access toggles off or on. Default off.
7.	Set Lower Lmt	Set from 0.000 to 100.0 kHz. Default 0.000 kHz.
8.	Set Alarm	Access toggles off or on. Default off.

3. Power Meter Screen Configuration. When Meter Menu is displayed on CRT, press 3 on DATA ENTRY Keypad to access Power Meter Operation Screen.

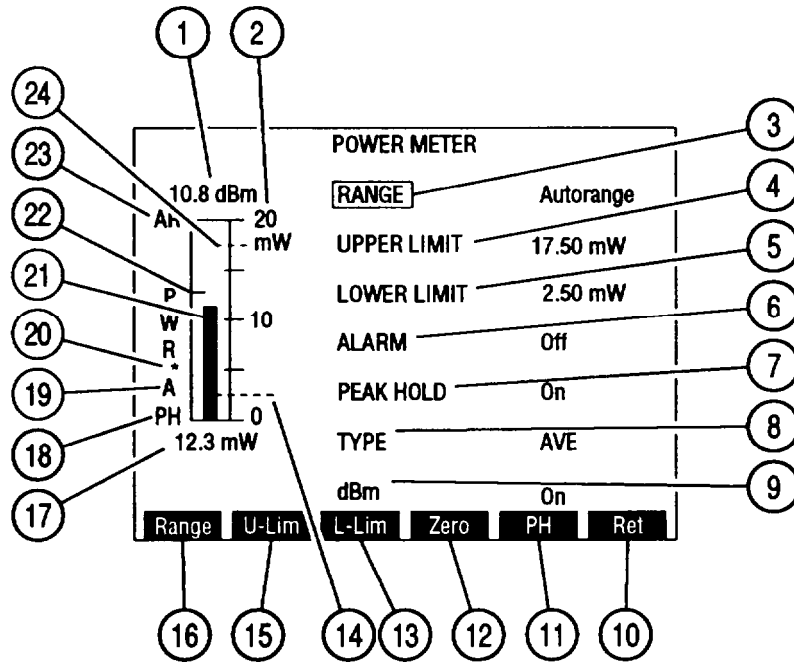

CE2FN475

KEY	METER FEATURE	FUNCTION
1.	dBm Readout	Appears only when dBm enable (9) is on. Provides dBm reading of meter indication.
2.	Meter Range Scale	Scale of four divisions marked from 0 to limit of active range with center division labeled as midpoint of range.
3.	RANGE	Move cursor to RANGE, press ENTER to access data field. Select from: 20 mW 50 mW 100 mW 200 mW 500 mW 1 W 2 W 5 W 10 W 20 w 50 w 100 W 200 w Autorange Default Autorange.
4.	UPPER LIMIT	Move cursor to UPPER LIMIT, press ENTER to activate indicator (24) and access data field. Set from 0.0 mW to 200.0 W. Default off.
5.	LOWER LIMIT	Move cursor to LOWER LIMIT, press ENTER to activate Indicator (14) and access data field. Set from 0.0 mW to 200.0 W. Default off.
6.	ALARM	Move cursor to ALARM, press ENTER to toggle off or on. When on, tone sounds when Meter Indicator Bar (21) exceeds upper limit or falls below lower limit. Default off.

KEY	METER FEATURE	FUNCTION
7.	PEAK HOLD	Move cursor to PEAK HOLD, press ENTER to toggle on or off. Default off.
8.	TYPE	Move cursor to TYPE, press ENTER to access data field. Select from: AVE Peak CW Default CW.
9.	dBm	Move cursor to dBm, press ENTER to enable dBm Readout (1) of meter indication above meter window. Default off.
10.	"Ret"/"ESC"	Press "Ret" F6 to return to active operation screen. "ESC" appears while accessing a parameter. Press "ESC" F6 to void edit procedure.
11.	'PH"	Press F5 to toggle PEAK HOLD (7) on or off.
12.	"Zero"	Press F4 to Zero Power Meter when RANGE (3) set to 20 mW or 20 W.
13.	"L-Lim"	Press F3 to activate LOWER LIMIT (5) and access data field.
14.	Lower Limit Indicator	When on, dotted line appears across meter window where limit is set.
15.	"U-Lim"	Press F2 to activate UPPER LIMIT (4) and access data field.
16.	"Range"	Press F1 to access RANGE (3) data field.
17.	Digital Readout	Displays power level of received frequency in W or mW.
18.	PH Enabled	Appears at lower left corner of meter window when PEAK HOLD (7) is on.
19.	Type Indicator	Displays letter indicating Power Meter Type (8). A for AVE, P for Peak and C for CW.
20.	External Offset Indicator	Displays asterisk when External Offset is on.
21.	Meter Indicator Bar	Shows meter indication according to Meter Range Scale (2). Turns red when exceeds upper limit or when less than lower limit. Turns green when reaches edge of meter window.
22.	Peak Hold Indicator	Appears only when PEAK HOLD (7) is on. Green indicator line shows highest point of meter bar deflection.

KEY	METER FEATURE	FUNCTION
23.	AR	Appears above left corner of meter window when RANGE (3) is set for Autorange. Meter Range Scale (2) automatically resets to next higher scale when Meter Indicator Bar (21) reaches edge of meter window. Meter resets to next lower scale when Meter Indicator Bar (21) falls to 1/2 of lowest scale division.
24.	Upper Limit Indicator	When on, dotted line appears across meter window where limit is set.

When Power Meter Operation Screen is displayed on CRT, press SETUP Key to access Power Meter Menu.

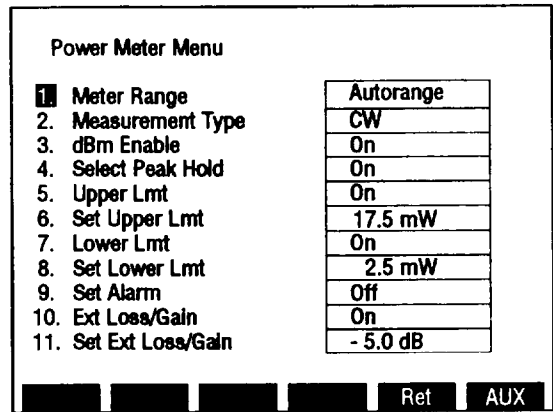

CE2FN476

KEY	METER FEATURE	FUNCTION
1.	Meter Range	Access displays submenu. Select from: Autorange 20 mW 50 mW 100 mW 200 mW 500 mW 1 W 2 W 5 W 10 w 20 w 50 w 100 W 200 w Default Autorange.
2.	Measurement Type	Select Peak, CW or AVE. Default CW.
3.	dBm Enable	Access toggles off or on. Default off.
4.	Select Peak Hold	Access toggles off or on. Default off.
5.	Upper Lmt	Access toggles off or on. Default off.
6.	Set Upper Lmt	Set from 0.0 mW to 200.0 W. Default 0.0 mW.
7.	Lower Lmt	Access toggles off or on. Default off.
8.	Set Lower Lmt	Set from 0.0 mW to 200.0 W. Default 0.0 mW.
9.	Set Alarm	Access toggles off or on. Default off.

KEY	METER FEATURE	FUNCTION
10.	External Loss/Gain	Access toggles off or on. Default off.
11.	Set External Loss/Gain Value	Set from -99.9 to 99.9 dB. Positive values lower Power Meter readings and compensate for external gains. Negative values raise Power Meter readings and compensate for external losses. Default 0.0 dB.

4. Deviation Meter Screen Configuration. When Meter Menu is displayed on CRT, press 4 on DATA ENTRY Keypad to access Deviation Meter Operation Screen.

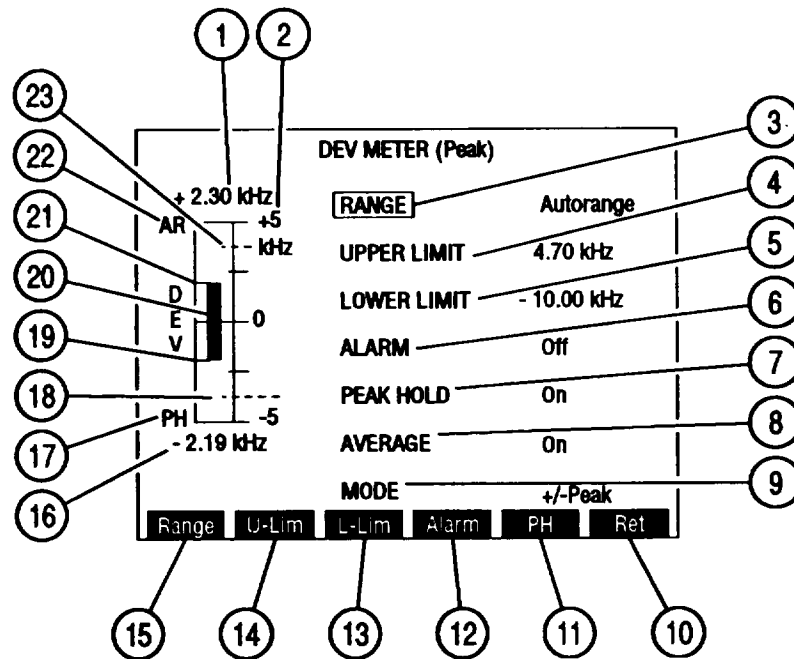

CE2FN477

KEY	METER FEATURE	FUNCTION
1.	Positive Digital Readout	Provides Digital Readout of deviation above 0 in +kHz.
2.	Meter Range Scale	Scale of four divisions marked from 0 to limit of active range with center division labeled as midpoint of range.
3.	RANGE	Move cursor to RANGE, press ENTER to access data field. Select from: 2 kHz 5 kHz 10 kHz 20 kHz 50 kHz 100 kHz Aurorange Default Aurorange.
4.	UPPER LIMIT	Move cursor to UPPER LIMIT, press ENTER to activate Upper Limit Indicator (23) and access data field. Set from 0.0 to 100.0 kHz. Default off.

KEY	METER FEATURE	FUNCTION
5.	LOWER LIMIT	Move cursor to LOWER LIMIT, press ENTER to activate Lower Limit Indicator (1 8) and access data field. Set from 0.0 to 100.0 kHz. Default off.
6.	ALARM	Move cursor to ALARM, press ENTER to toggle off or on. Default off. When on, tone sounds when Meter Indicator Bar (20) exceeds upper limit or lower limit.
7.	PEAK HOLD	Move cursor to PEAK HOLD, press ENTER to toggle on or off. Default off.
8.	AVERAGE	Move cursor to AVERAGE, press ENTER to toggle on or off. Default off.
9.	MODE	Move cursor to MODE, press ENTER to access data field. Select from: +Peak -Peak +/-Peak +/-Peak/2 +Peak displays positive deviation readings. -Peak displays negative deviation readings. +/-Peak displays positive and negative deviation readings. +/-Peak/2 displays absolute value of average of positive and negative deviation readings. Default +/-Peak.
10.	“Ret”/“ESC”	Press “Ret” F6 to return to active operation screen. “ESC” appears while accessing a parameter. Press “ESC” F6 to void edit procedure.
11.	“PH”	Press F5 to toggle PEAK HOLD (7) on or off.
12.	“Alarm”	Press F4 to toggle ALARM (6) on or off.
13.	“L-Lim”	Press F3 to activate LOWER LIMIT (5) and access data field.
14.	“U-Lim”	Press F2 to activate UPPER LIMIT (4) and access data field.
15.	“Range”	Press F1 to access RANGE data field (3).
16.	Negative Digital Readout	Provides Digital Readout of deviation below 0 in -kHz.
17.	PH Enabled	Appears at lower left corner of meter window when PEAK HOLD (7) is on.
18.	Lower Limit Indicator	When on, dotted line appears across meter window where limit is set.
19.	Lower Peak Hold Indicator	Appears when PEAK HOLD (7) is on. Green indicator shows lowest point of negative deviation.

KEY	METER FEATURE	FUNCTION
20.	Meter Indicator Bar	Shows meter indication according to Meter Range Scale (2). Turns red when exceeds upper limit or when less than lower limit. Turns green when reaches edge of meter window.
21.	Upper Peak Hold Indicator	Appears when PEAK HOLD (7) is on. Green indicator shows highest point of positive deviation.
22.	AR	Appears above left corner of meter window when RANGE (3) is set for Autorange. Meter Range Scale (2) automatically resets to next higher scale when Meter Indicator Bar (20) reaches edge of meter window. Meter resets to next lower scale when Meter Indicator Bar (20) falls to 1/2 of lowest scale division.
23.	Upper Limit Indicator	When on, dotted line appears across meter window where limit is set.

When Deviation Meter Operation Screen is displayed on CRT, press SETUP Key to access Deviation Meter Menu.

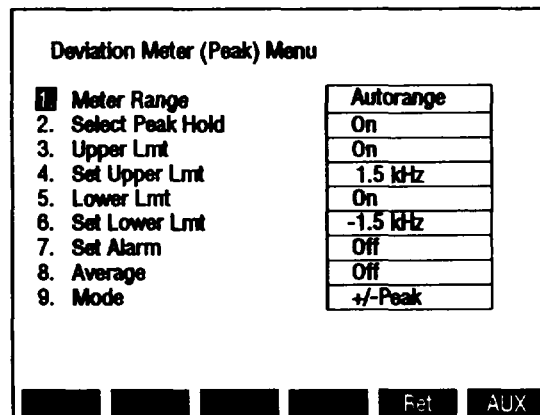

CE2FN478

KEY	METER FEATURE	FUNCTION
1.	Meter Range	Access displays submenu. Select from: Autorange 2 kHz 5 kHz 10 kHz 20 kHz 50 kHz 100 kHz Default Autorange.
2.	Select Peak Hold	Access toggles off or on. Default off.
3.	Upper Lmt	Access toggles off or on. Default off.
4.	Set Upper Lmt	Set from 0.0 to 100.0 kHz. Default 0.0 kHz.
5.	Lower Lmt	Access toggles off or on. Default off.

KEY	METER FEATURE	FUNCTION
6.	Set Lower Lmt	Set from 0.0 to 100.0 kHz. Default 0.0 kHz.
7.	Set Alarm	Access toggles off or on. Default off.
8.	Average	Access toggles off or on. Default off.
9.	Mode	Access displays submenu. Select from: +/-Peak +Peak -Peak +/-Peak/2 Default +/-Peak.

5. **Modulation Meter Screen Configuration.** When Meter Menu is displayed on CRT, press 5 on DATA ENTRY Keypad to access Modulation Meter Operation Screen.

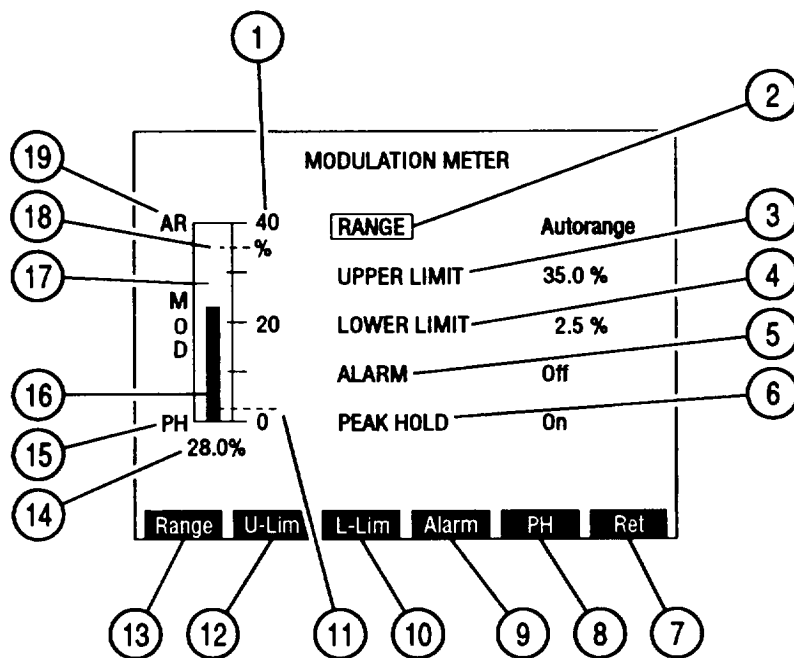

CE2FN479

KEY	METER FEATURE	FUNCTION
1.	Meter Range Scale	Scale of four divisions marked from 0 to limit of active scale with center division labeled as midpoint of range.
2.	RANGE	Move cursor to RANGE, press ENTER to access data field. Select from: Aurorange 40% 100% Default Aurorange.
3.	UPPER LIMIT	Move cursor to UPPER LIMIT, press ENTER to activate Indicator (18) and access data field. Set from 0% to 100%. Default off.

KEY	METER FEATURE	FUNCTION
4.	LOWER LIMIT	Move cursor to LOWER LIMIT, press ENTER to activate Indicator (1 1) and access data field. Set from 0% to 100%. Default off.
5.	ALARM	Move cursor to ALARM, press ENTER to toggle off or on. Default off. When on, tone sounds when meter indicator bar (16) exceeds upper limit or lower limit.
6.	PEAK HOLD	Move cursor to PEAK HOLD, press ENTER to toggle on or off. Default off.
7.	“Ret”/“ESC”	Press “Ret” F6 to return to active operation screen. “ESC” appears while accessing a parameter. Press “ESC” F6 to void edit procedure.
8.	“PH”	Press F5 to toggle PEAK HOLD (6) on or off.
9.	“Alarm”	Press F4 to toggle ALARM (5) on or off.
10.	“L-Lim”	Press F3 to activate LOWER LIMIT (4) and access data field.
11.	Lower Limit Indicator	When on, dotted line appears across meter window where limit is set.
12.	“U-Lim”	Press F2 to activate UPPER LIMIT (3) and access data field.
13.	“Range”	Press F1 to access RANGE (2) data field.
14.	Digital Readout	Shows Digital indication of Modulation percentage.
15.	PH Enabled	Appears at lower left corner of meter window when PEAK HOLD (6) is on.
16.	Meter Indicator Bar	Shows meter indication according to Meter Range Scale (I). Turns red when exceeds upper limit or when less than lower limit. Turns green when reaches edge of meter window.
17.	Peak Hold Indicator	Appears when PEAK HOLD (6) is on. Green indicator shows highest point of meter bar deflection.
18.	Upper Limit Indicator	When on, dotted line appears across meter window where limit is set.

KEY	METER FEATURE	FUNCTION
19.	AR	Appears above left corner of meter window when RANGE (2) is set for Autorange. Meter Range Scale (1) automatically resets to next higher scale when Meter Indicator Bar (16) reaches edge of meter window. Meter resets to next lower scale when Meter Indicator Bar (16) falls to 1/2 of lowest scale division.

When Modulation Meter Operation Screen is displayed on CRT, press SETUP Key to access Modulation Meter Menu.

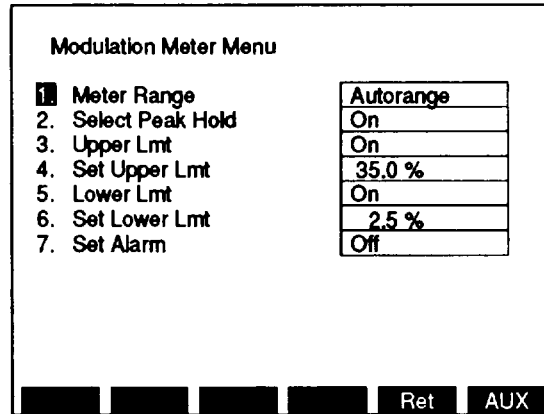

CE2FN480

KEY	METER FEATURE	FUNCTION
1.	Meter Range	Access displays submenu. Select from: Autorange 40% 100% Default Autorange.
2.	Select Peak Hold	Access toggles off or on. Default off.
3.	Upper Lmt	Access toggles off or on. Default off.
4.	Set Upper Lmt	Set from 0.0% to 100%. Default 0.0%.
5.	Lower Lmt	Access toggles off or on. Default off.
6.	Set Lower Lmt	Set from 0.0% to 100%. Default 0.0%.
7.	Set Alarm	Access toggles off or on. Default off.

6. Distortion Meter Screen Configuration. When Meter Menu is displayed on CRT, press 6 on DATA ENTRY Keypad to access Distortion Meter Operation Screen.

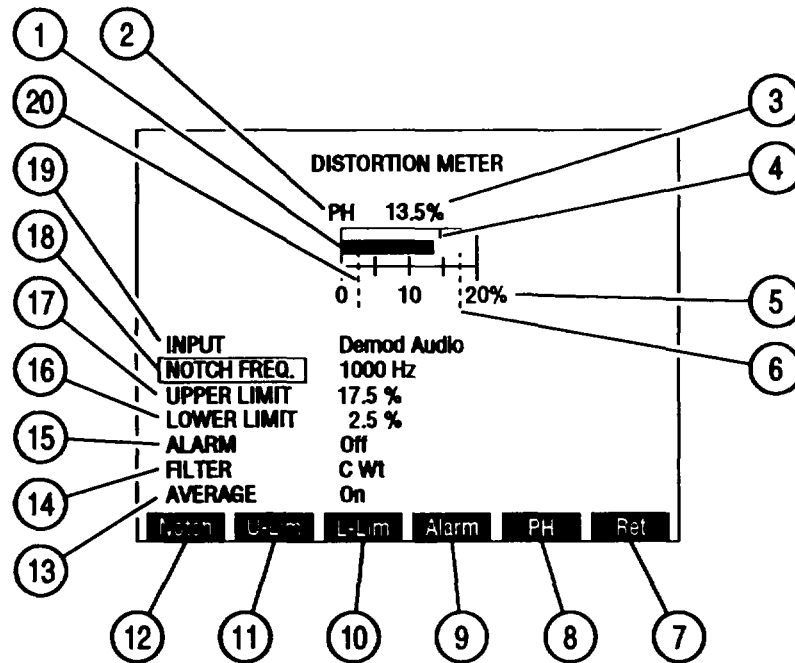

CE2FN481

KEY	METER FEATURE	FUNCTION
1.	Meter Indicator Bar	Shows meter indication according to Meter Range Scale (5). Turns red when exceeds upper limit or when less than lower limit. Turns green when reaches edge of meter window.
2.	PH Enabled	Appears above left corner of meter window when Peak Hold is on.
3.	Digital Readout	Provides exact reading of meter indication. Will show highest meter indication reached when Peak Hold is on.
4.	Peak Hold Indicator	Appears when Peak Hold is on. Green indicator shows highest point of meter bar deflection.
5.	Meter Range Scale	Scale of four divisions marked from 0 to limit of active scale with center division labeled as midpoint of range.
6.	Upper Limit Indicator	When on, dotted line appears across meter window where limit is set. Indicator appears at right edge of meter window when limit set higher than meter range.
7.	"Ret"/"ESC"	Press "Ret" F6 to return to active operation screen. "ESC" appears while accessing a parameter. Press "ESC" F6 to void edit procedure.

KEY	METER FEATURE	FUNCTION
8.	“PH”	Press F5 to toggle Peak Hold on or off.
9.	“Alarm”	Press F4 to toggle ALARM (15) on or off.
10.	“L-Lim”	Press F3 to activate LOWER LIMIT (16) and access data field.
11.	“U-Lim”	Press F2 to activate UPPER LIMIT (17) and access data field.
12.	“Notch”	Press F1 to access NOTCH FREQ (18) data field.
13.	AVERAGE	Move cursor to AVERAGE, press ENTER to toggle between on and off. Default off.
14.	FILTER	Move cursor to FILTER, press ENTER to toggle between C Wt and Low Pass. Selecting Low Pass displays cutoff frequency data field. Range of Low Pass cutoff frequency is from 0.100 to 30.000 kHz.
15.	ALARM	Move cursor to ALARM, press ENTER to toggle off or on. Default off. When on, tone sounds when Meter Indicator Bar (1) exceeds upper limit or lower limit.
16.	LOWER LIMIT	Move cursor to LOWER LIMIT, press ENTER to activate Indicator (20) and access data field. Set from 0.0% to 20.0%. Default off.
17.	UPPER LIMIT	Move cursor to UPPER LIMIT, press ENTER to activate Indicator (6) and access data field. Set from 0.0% to 20.0%. Default off.
18.	NOTCH FREQ	Move cursor to NOTCH FREQ, press ENTER to access data field. Set from 600 to 1400 Hz. Default 1000 Hz.
19.	INPUT	Move cursor to INPUT, press ENTER to access data field. Select from: Ext Mod Demod Audio Func Gen SINAD/BER Default Demod Audio.
20.	Lower Limit Indicator	When on, dotted line appears across meter window where limit is set.

When Distortion **Meter** Operation Screen is displayed on CRT, press SETUP Key to access Distortion **Meter Menu**.

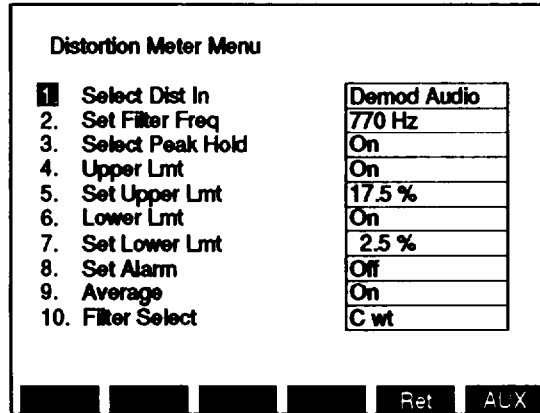

CE2FN462

KEY	METER FEATURE	FUNCTION
1.	Select Dist In	Access displays submenu. Select from: Demod Audio SINAD/BER Func Gen Ext Mod Default Demod Audio.
2.	Set Notch Filter Freq	Set from 600 to 1400 Hz. Default 1000 Hz.
3.	Select Peak Hold	Access toggles off or on. Default off.
4.	Upper Lmt	Access toggles off or on. Default off.
5.	Set Upper Lmt	Set from 0.0% to 20.0%. Default 0.0%.
6.	Lower Lmt	Access toggles off or on. Default off.
7.	Set Lower Lmt	Set from 0.0% to 20.0%. Default 0.0%.
8.	Set Alarm	Access toggles off or on. Default off.
9.	Average	Access toggles off or on. Default off.
10.	Filter Select	Access toggles between C Wt and Low Pass. Selecting Low Pass displays cutoff frequency data field. Range of Low Pass cutoff frequency is from 0.100 to 30.000 kHz.

7. SINAD Meter Screen Configuration. When Meter Menu is displayed on CRT, press 7 on DATA ENTRY Keypad to access SINAD Meter Operation Screen.

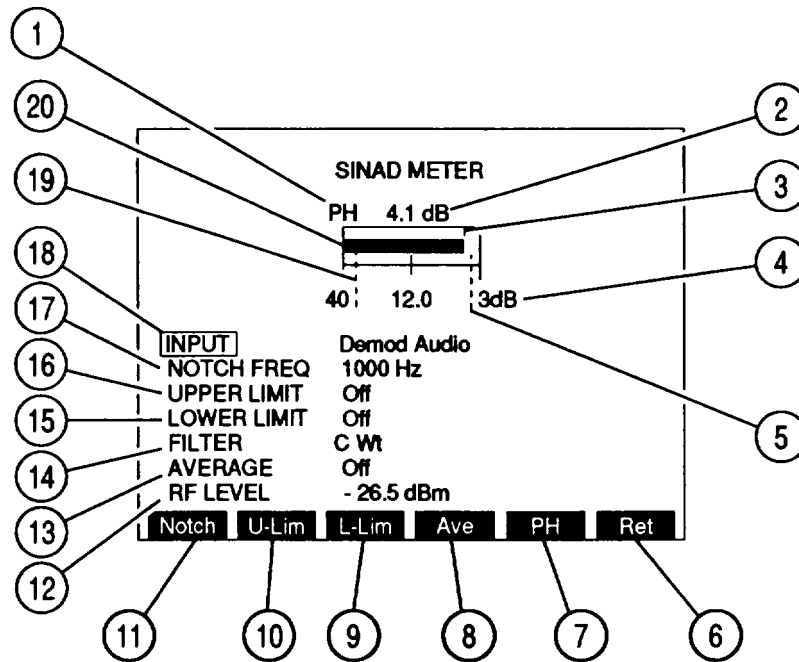

CE2FN483

KEY	METER FEATURE	FUNCTION
1.	PH Enabled	Appears above left corner of meter window when Peak Hold is on.
2.	Digital Readout	Provides exact reading of meter indication. Shows highest meter indication reached when Peak Hold is on.
3.	Peak Hold Indicator	Appears when Peak Hold is on. Green indicator shows highest point of meter bar deflection.
4.	Meter Range Scale	Scale of two divisions marked from 40 (dB) at left edge and 3 dB at right edge with center division labeled 12.0 (dB).
5.	Upper Limit Indicator	When on, dotted line appears across meter window where limit is set.
6.	"Ret"/"ESC"	Press "Ret" F6 to return to active operation screen. "ESC" appears while accessing a parameter. Press "ESC" F6 to void edit procedure.
7.	"PH"	Press F5 to toggle Peak Hold on or off. Default off.
8.	"Ave"	Press F4 to toggle AVERAGE (13) on or off.

KEY	METER FEATURE	FUNCTION
9.	"L-Lim"	Press F3 to activate LOWER LIMIT (15) and access data field.
10.	"U-Lim"	Press F2 to activate UPPER LIMIT (16) and access data field.
11.	"Notch"	Press F1 to access NOTCH FREQ (17) data field.
12.	RF LEVEL	Appears when RF Generator or Duplex Mode was last accessed. Move cursor to RF LEVEL, press ENTER to access data field. Set from: -120 to 7 dBm if Duplex RF Generator out DPL. -137 to 0 dBm if Duplex RF Generator out T/R. -137 to 0 dBm if RF Generator, Receiver or Duplex Transmitter. Default -20 dBm. +/- Key must be pressed to set any negative (-) dBm. Changing RF LEVEL changes output of active RF Generator or active Duplex Generator.
13.	AVERAGE	Move cursor to AVERAGE, press ENTER to toggle between on or off. Default off.
14.	FILTER	Move cursor to FILTER, press ENTER to toggle between C Wt and Low Pass. Selecting Low Pass displays cutoff frequency data field. Range of Low Pass cutoff frequency is from 0.100 to 30.000 kHz.
15.	LOWER LIMIT	Move cursor to LOWER LIMIT, press ENTER to activate Indicator (19) and access data field. Set from 40 to 3.0 dB. Default off.
16.	UPPER LIMIT	Move cursor to UPPER LIMIT, press ENTER to activate Indicator (5) and access data field. Set from 40 to 3.0 dB. Default off.
17.	NOTCH FREQ	Move cursor to NOTCH FREQ, press ENTER to access data field. Set from 600 to 1400 Hz. Default 1000 Hz.
18.	INPUT	Move cursor to INPUT, press ENTER to access data field. Select from: Demod Audio SINAD/BER Ext Mod Func Gen Default Demod Audio.
19.	Lower Limit Indicator	When on, dotted line appears across meter window where limit is set. Default off.
20.	Meter Indicator Bar	Shows meter indication according to Meter Range Scale (4). Turns red when exceeds upper limit or when less than lower limit. Turns green when reaches edge of meter window.

When SINAD Meter Operation Screen is displayed on CRT, press SETUP Key to access SINAD Meter Menu.

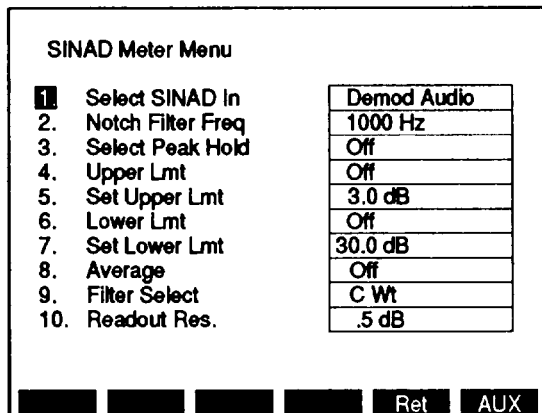

CE2FN484

KEY	METER FEATURE	FUNCTION
1.	Select SINAD In	Access displays submenu. Select from: Demod Audio SINAD/BER Func Gen Ext Mod Default Demod Audio.
2.	Set Filter Freq	Set from 600 to 1400 Hz. Default 1000 Hz.
3.	Select Peak Hold	Access toggles off or on. Default off.
4.	Upper Lmt	Access toggles off or on. Default off.
5.	Set Upper Lmt	Set from 40.0 to 3.0 dB. Default 3.0 dB.
6.	Lower Lmt	Access toggles off or on. Default off.
7.	Set Lower Lmt	Set from 40.0 to 3.0 dB. Default 30.0 dB.
8.	Average	Access toggles off or on. Default off.
9.	Filter Select	Access toggles between C Wt and Low Pass. Selecting Low Pass displays cutoff frequency data field. Range of Low Pass cutoff frequency is from 0.100 to 30.000 kHz.
10.	Readout Resolution	Access toggles between 0.1 and 0.5 dB. Default 0.1 dB.

8. Signal Strength Meter Screen Configuration. When Meter Menu is displayed on CRT, press 8 on DATA ENTRY Keypad to access Signal Strength Meter Operation Screen.

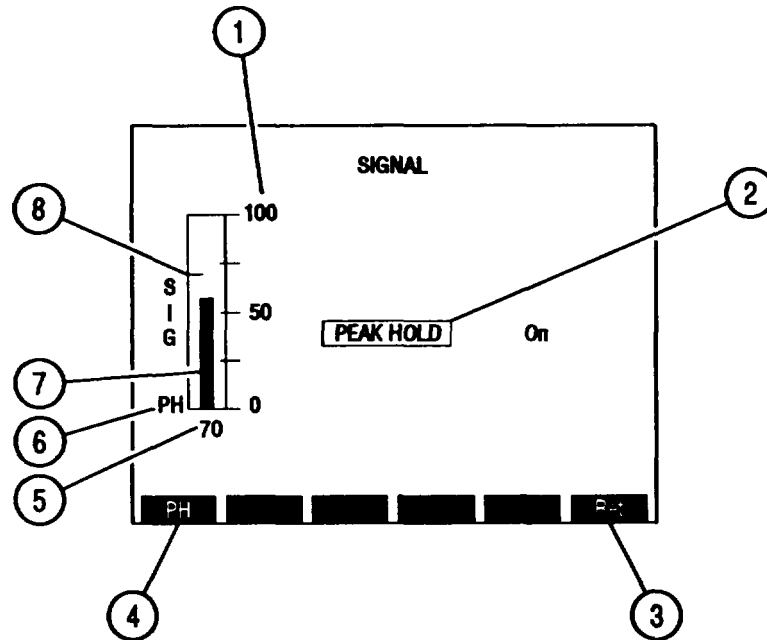

CE2FN485

KEY	METER FEATURE	FUNCTION
1.	Meter Range Scale	Scale of four divisions marked from 0 to 100. Shows received signal percentage at ANTENNA IN Connector relative to -30 dBm (e.g., 100 on meter indicates -30 dBm received signal).
2.	PEAK HOLD	Move cursor to PEAK HOLD, press ENTER to toggle on or off. Default off.
3.	"Ret"/"ESC"	Press "Ret" F6 to return to active operation screen. "ESC" appears while accessing a parameter. Press "ESC" F6 to void edit procedure.
4.	"PH"	Press F1 to toggle PEAK HOLD (2) on or off. Default off.
5.	Digital Readout	Provides indication of received signal strength relative to -30 dB. Shows highest meter indication when PEAK HOLD (2) is on.
6.	PH Enabled	Appears at lower left corner of meter window when PEAK HOLD (2) is on.
7.	Meter Indicator Bar	Shows meter indication according to Meter Range Scale (1). Turns green when reaches edge of meter window.

KEY	METER FEATURE	FUNCTION
8.	Peak Hold Indicator	Appears when PEAK HOLD (2) is on. Green indicator shows highest point of meter bar deflection.

When Signal Strength Meter Operation Screen is displayed on CRT, press SETUP Key to access Signal Strength Meter Menu.

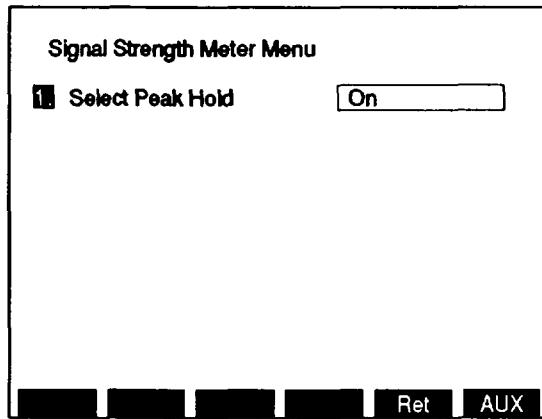

CE2FN486

KEY	METER FEATURE	FUNCTION
1.	Select Peak Hold	Access toggles off or on. Default off.

9. **Bit Error Rate (BER) Meter Screen Configuration.** When Meter Menu is displayed on CRT, press 9 on DATA ENTRY Keypad to access BER Meter Operation Screen. Bit Error Rate Function has no setup menu but does access several submenus.

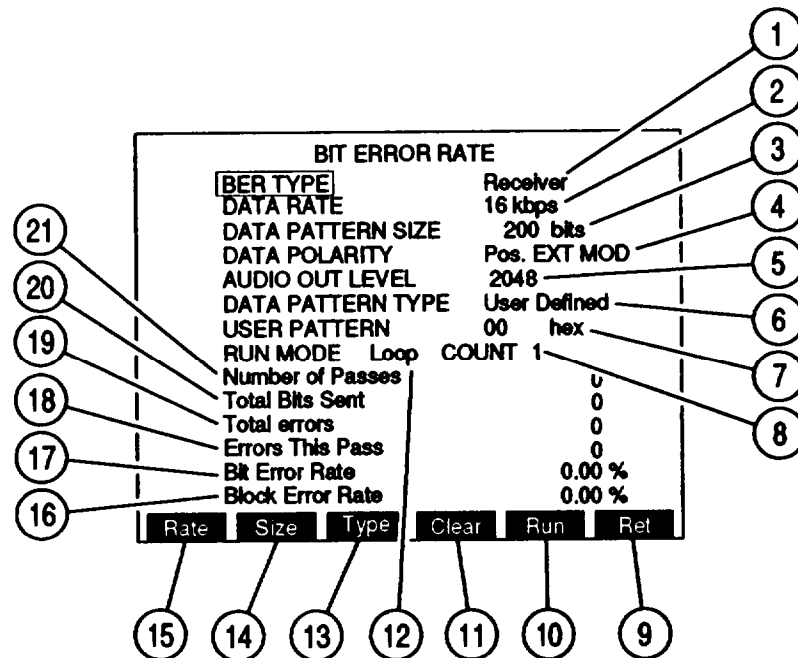

CE2FN487

KEY	METER FEATURE	FUNCTION
1.	BER TYPE	Access displays submenu. Select from: Receiver Generator Baseband Duplex Default Receiver.
2.	DATA RATE	Baud Rate of data. Access displays submenu: 75 bps 150 bps 300 bps 600 bps 200 bps 2400 bps 4800 bps 16 kbps Default 75 bps.
3.	DATA PATTERN SIZE	Set from 100 to 100000 bits. Default 100 bits.
4.	DATA POLARITY	Select from Pos. EXT MOD or Neg. SINAD/BER. Default Pos. EXT MOD.
5.	AUDIO OUT LEVEL/RF GEN LEVEL	AUDIO OUT LEVEL appears if BER TYPE (1) Receiver or Baseband. Set from 0 to 4095 with 4095 corresponding to 5 V. RF GEN LEVEL appears if BER TYPE (1) Generator or Duplex. Displayed in RF Generator Level Units. Set from -137.0 to 0.0 dBm or 0.031 μV to 0.224 V. Default 2048.

KEY	METER FEATURE	FUNCTION
6.	DATA PATTERN TYPE	Access displays submenu. Select from: Random Fixed User Defined Default Random.
7.	USER PATTERN	Appears if DATA PATTERN TYPE (6) is User Defined. Use DATA ENTRY Keypad and SHIFT Key to enter hexadecimal two-digit pattern type.
8.	LOOP COUNT	Appears if RUN MODE (8) is Looping. Set from 1 to 100000.
9.	“Ret”/“ESC”	Press “Ret” F6 to return to active operation screen. “ESC“ appears while accessing a parameter. Press “ESC” F6 to void edit procedure.
10.	“Run”/“Stop”	Press F5 to start or stop BER Test.
11.	“Clear”	Press F4 to clear all BER Test readout data.
12.	RUN MODE	Access displays submenu. Select from: Continuous One Shot Loop Default Continuous.
13.	“Type”	Press F3 to access DATA PATTERN TYPE (6).
14.	“Size”	Press F2 to access DATA PATTERN SIZE (3).
15.	“Rate”	Press F1 to access DATA RATE (2).
16.	Block Error Rate	Shows percentage of ratio of block errors versus number or blocks sent during BER Test.
17.	Bit Error Rate	Shows percentage of ratio of bit errors versus number or bits sent during BER Test.
18.	Errors This Pass	Shows of errors detected during current pass.
19.	Total Errors	Shows total number of errors occurring during BER Test.
20.	Total Bits Sent	Shows total number of bits sent during BER Test.
21.	Number of Passes	Shows passes made during BER Test.

When BER Meter Operation Screen is displayed on CRT, press SETUP Key to access BER Meter Menu. There are 4 different BER Meter Menus, one for each BER TYPE (1). If BER TYPE (1) is Receiver, Receiver BER Meter Menu appears:

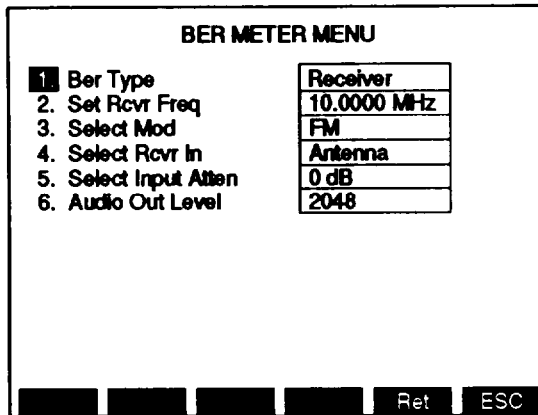

CE2FN488

KEY	MENU ITEM	FUNCTION
1.	BER Type	Select from: Receiver Generator Baseband Duplex Selection displays BER Meter Menu of BER Type selected.
2.	Set Receiver Frequency	Set from 0.2500 to 999.9999 MHz. Default 10.0000 MHz.
3.	Select Modulation	Access displays Modulation Submenu.
4.	Select Receiver Input	Access toggles between ANTENNA IN and T/R Connector. Default ANTENNA IN Connector.
5.	Select Input Attenuation	Select 0, 20 or 40 dB. Default 0 dB.
6.	Audio Out Level	Set from 0 to 4095. 0 corresponds to 0 V and 4095 corresponds to 5 V. Default 2048.

Pressing 3 on DATA ENTRY Keypad in Receiver BER Meter Menu displays Modulation Submenu.

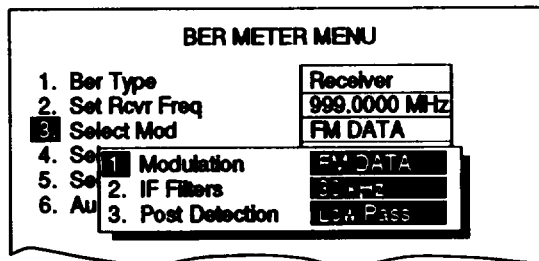

CE2FN489

KEY	MENU ITEM	FUNCTION
1.	Modulation Type	Select from: FM AM SSB (upper) SSB (lower) BFO PM FM DATA Default FM.
2.	IF Filter	Select from: 3 kHz 30 kHz 300 kHz Default 3 kHz.
3.	Post Detection Filter	Access displays submenu. Select from: All Pass Low Pass High Pass Band Pass Selecting Low Pass, High Pass or Bandpass displays data field allowing for entry of cutoff frequencies. Range of cutoff frequencies are: Low Pass 0.100 to 30.000 kHz High Pass 0.500 to 20.000 kHz Band Pass low 0.500 to 20.000 kHz Band Pass high 0.100 to 30.000 kHz. Default All Pass.

If BER TYPE (1) is Generator, press SETUP Key from BER Meter Operation Screen to display Generator BER Meter Menu:

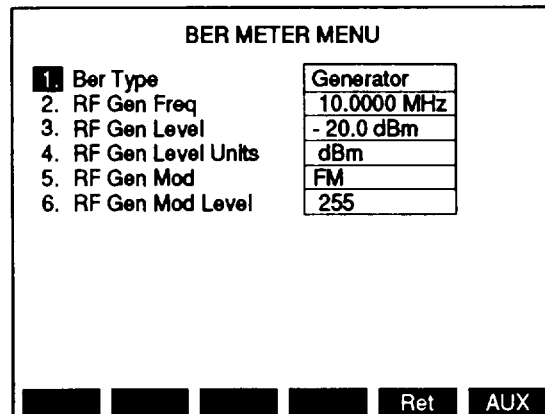

CE2FN490

KEY	MENU ITEM	FUNCTION
1.	BER Type	Select from: Receiver Generator Baseband Duplex Selection displays BER Meter Menu of BER Type selected.
2.	RF Generator Frequency	Set from 0.2500 to 999.9999 MHz. Default 10.0000 MHz.
3.	RF Generator Level	Set from 0.0 to -137.0 dBm or 0.031 μ V to 0.224 V. Default -20.0 dBm.

KEY	MENU ITEM	FUNCTION
4.	RF Generator Level Units	Access toggles between dBm and volts. Default dBm.
5.	RF Generator Modulation Type	Select from: OFF AM FM Default OFF.
6.	RF Generator Modulation Level	Does not appear if RF Generator Modulation Type (5) is OFF. Set from 0% to 90% for AM RF Generator Modulation Type (5). Set from 0.0 to 25.0 kHz for FM RF Generator Modulation Type (5).

If BER TYPE (1) is Baseband, press SETUP Key from BER Meter Operation Screen to display Baseband BER Meter Menu:

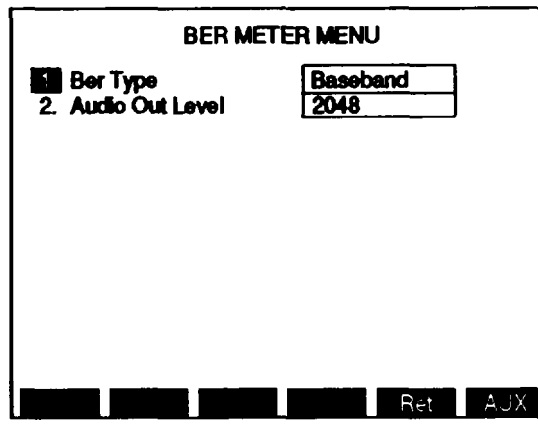

CE2FN491

KEY	MENU ITEM	FUNCTION
1.	BER Type	Select from: Receiver Generator Baseband Duplex Selection displays BER Meter Menu of BER Type selected.
2.	Audio Out Level	Set from 0 to 4095. 0 corresponds to 0 V and 4095 corresponds to 5 V. Default 2048.

If BER TYPE (1) is Duplex, press SETUP Key from BER Meter Operation Screen to display Duplex BER Meter Menu:

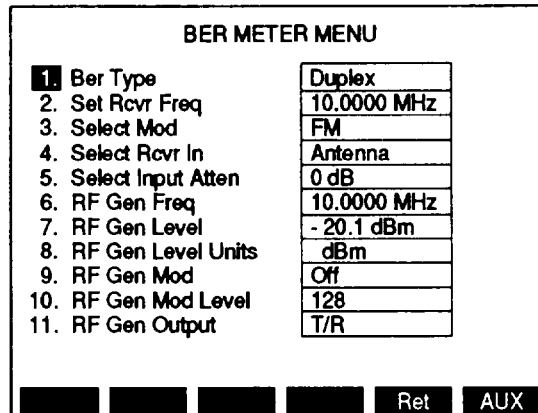

CE2FN492

KEY	MENU ITEM	FUNCTION
1.	BER Type	Select from: Receiver Generator Baseband Duplex Selection displays BER Meter Menu of BER Type selected.
2.	Set Receiver Frequency	Set from 0.2500 to 999.9999 MHz. Default 10.0000 MHz.
3.	Select Modulation	Access displays Modulation Submenu.
4.	Select Receiver Input	Access toggles between ANTENNA IN and T/R Connector. Default ANTENNA IN Connector.
5.	Select Input Attenuation	Select 0, 20 or 40 dB. Default 0 dB.
6.	RF Generator Frequency	Set from 0.2500 to 999.9999 MHz. Default 10.0000 MHz.
7.	RF Generator Level	Set from 0.0 to -137.0 dBm or 0.031 μ V to 0.224 V. Default -20.0 dBm.
8.	RF Generator Level Units	Access toggles between dBm and volts. Default dBm.
9.	RF Generator Modulation Type	Select from: OFF AM FM Default OFF.
10.	RF Generator Modulation Level	Does not appear if RF Generator Modulation Type (9) is OFF. Set from 0% to 90% for AM RF Generator Modulation Type (9). Set from 0.0 to 25.0 kHz for FM RF Generator Modulation Type (9).

KEY	MENU ITEM	FUNCTION
11.	RF Generator Output Connector	Access toggles between T/R and DUPLEX OUT Connector.

Pressing 3 on DATA ENTRY Keypad in Duplex BER Meter Menu displays Modulation Submenu.

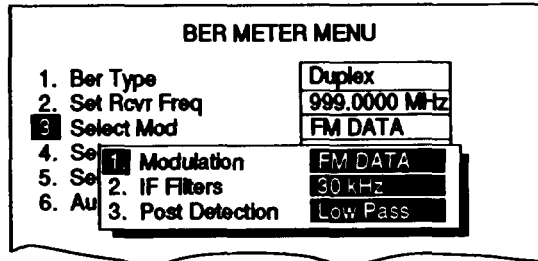

CE2FN493

KEY	MENU ITEM	FUNCTION
1.	Modulation Type	Select from: FM AM SSB (upper) SSB (lower) BFO PM FM DATA Default FM.
2.	IF Filter	Select from: 3 kHz 30 kHz 300 kHz Default 3 kHz.
3.	Post Detection Filter	Access displays submenu. Select from: All Pass Low Pass High Pass Band Pass Selecting Low Pass, High Pass or Bandpass displays data field allowing for entry of cutoff frequencies. Range of cutoff frequencies are: Low Pass 0.100 to 30.000 kHz High Pass 0.500 to 20.000 kHz Band Pass low 0.500 to 20.000 kHz Band Pass high 0.100 to 30.000 kHz. Default All Pass.

10. Digital Multimeter (DMM) Screen Configuration. When Meter Menu is displayed on CRT, use FIELD SELECT ↑ or ↓ Key move menu item number highlight to 10, press ENTER to access Digital Multimeter Operation Screen.

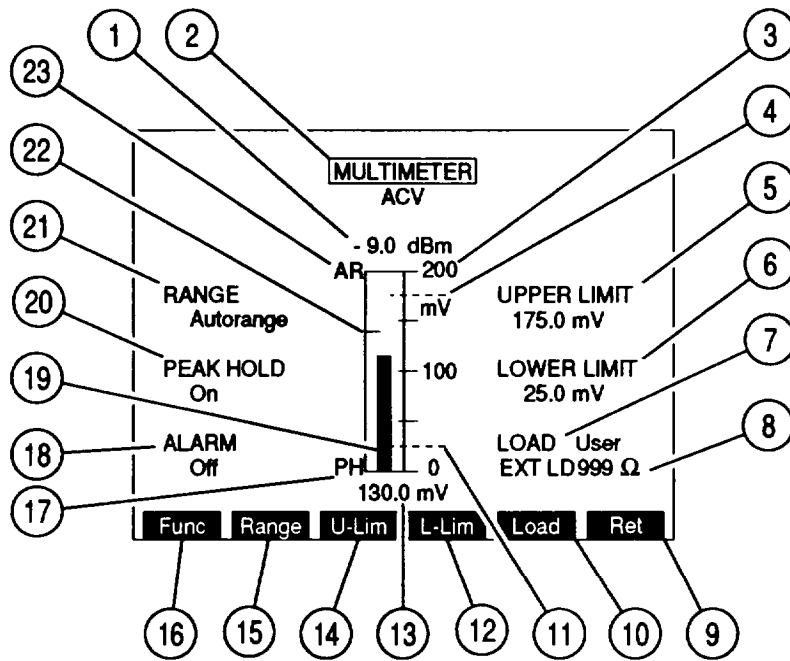

CE2FN494

KEY	METER FEATURE	FUNCTION
1.	dBm Readout	Appears with AC Voltmeter. Does not appear if RANGE (21) is set for 2000 V or 200 V or LOAD (7) is 1 MEG. Provides dBm readout of meter reading.
2.	MULTIMETER Function	Move cursor to MULTIMETER, press ENTER to access. Select from: ACV DCV ACC DCC Ohm Default ACV.
3.	Meter Range Scale	Scale of four divisions marked from O to limit of active range with center division labeled as midpoint of range.
4.	Upper Limit Indicator	When on, dotted line appears across meter window where limit is set.

KEY	METER FEATURE	FUNCTION
5.	UPPER LIMIT	Move cursor to UPPER LIMIT, press ENTER to activate Indicator (4) and access data field. Default off. When active: Set from 0.0 mV to 1000.00 V when ACV or DCV selected. Set from 0.0 mA to 19.99 A when ACC or DCC selected. Set from 0.000Ω to 19.990 MΩ when Ohm selected.
6.	LOWER LIMIT	Move cursor to LOWER LIMIT, press ENTER to activate Indicator (1 1) and access data field. Default off. When active: Set from 0.0 mV to 1000.00 V when ACV or DCV selected. Set from 0.0 mA to 19.99 A when ACC or DCC selected. Set from 0.000Ω to 19.990 MΩ when Ohm selected.
7.	LOAD	Appears only when ACV selected as MULTIMETER Function (2). Move cursor to LOAD, press ENTER to access data field. Select from: 1 MEG 600 Ω 150 Ω User Default 1 MEG.
8.	External Load	Appears when User selected as LOAD (7). Set from 1 to 999 Ω.
9.	“Ret”/“ESC”	Press ‘Ret’ F6 to return to active operation screen. “ESC” appears while accessing a parameter. Press “ESC” F6 to void edit procedure.
10.	‘Load’	Appears only when “ACV” selected as MULTIMETER Function (2). Press F5 to access LOAD data field (7).
11.	Lower Limit Indicator	When on, dotted line appears across meter window where limit is set.
12.	“L-Lim”	Press F4 to activate LOWER LIMIT (6) and access data field.
13.	Digital Readout	Provides numeric meter indication. Shows highest meter indication reached when PEAK HOLD (20) is on.
14.	“U-Lim”	Press F3 to activate UPPER LIMIT (5) and access data field.

KEY	METER FEATURE	FUNCTION																					
15.	"Range"	Press F2 to access RANGE data field (21).																					
16.	"Func"	Press F1 to access MULTIMETER Function data field (2).																					
17.	PH Enabled	Appears at lower left corner of meter window when PEAK HOLD (20) is on.																					
18.	ALARM	Move cursor to ALARM, press ENTER to toggle on or off. Default off.																					
19.	Meter Indicator Bar	Shows meter indication according to Meter Range Scale (3). Turns red when exceeds upper limit or when less than lower limit. Turns green when reaches edge of meter window.																					
20.	PEAK HOLD	Move cursor to PEAK HOLD, press ENTER to toggle on or off. Default off.																					
21.	RANGE	<p>Move cursor to RANGE, press ENTER to access RANGE data field.</p> <p>When ACV or DCV, select from:</p> <table style="width: 100%; border: none;"> <tr> <td>Autorange</td> <td>200 mV</td> <td>2.0 v</td> </tr> <tr> <td>20 v</td> <td>200 v</td> <td>2000 v</td> </tr> </table> <p>Default Autorange.</p> <p>When ACC or DCC, select from:</p> <table style="width: 100%; border: none;"> <tr> <td>Autorange</td> <td>20 mA</td> <td>200 mA</td> </tr> <tr> <td>2 A</td> <td>20 A</td> <td></td> </tr> </table> <p>Default Autorange.</p> <p>When Ohm, select from:</p> <table style="width: 100%; border: none;"> <tr> <td>Autorange</td> <td>200 Ω</td> <td>2 k Ω</td> </tr> <tr> <td>20 k Ω</td> <td>200 k Ω</td> <td>2 M Ω</td> </tr> <tr> <td>20 M Ω</td> <td></td> <td></td> </tr> </table> <p>Default Autorange.</p>	Autorange	200 mV	2.0 v	20 v	200 v	2000 v	Autorange	20 mA	200 mA	2 A	20 A		Autorange	200 Ω	2 k Ω	20 k Ω	200 k Ω	2 M Ω	20 M Ω		
Autorange	200 mV	2.0 v																					
20 v	200 v	2000 v																					
Autorange	20 mA	200 mA																					
2 A	20 A																						
Autorange	200 Ω	2 k Ω																					
20 k Ω	200 k Ω	2 M Ω																					
20 M Ω																							
22.	Peak Hold Indicator	Appears when PEAK HOLD (20) is on. Green indicator line shows highest point of meter bar deflection.																					
23.	AR	Appears above left corner of meter window when RANGE (21) is set for Autorange. Meter Range Scale (3) resets to next higher scale when Meter Indicator Bar (19) reaches edge of meter window. Meter resets to next lower scale when Meter Indicator Bar (19) falls to 1/2 of lowest scale division.																					

When Multimeter Meter Operation Screen is displayed on CRT, press SETUP Key to access Multimeter Meter Menu.

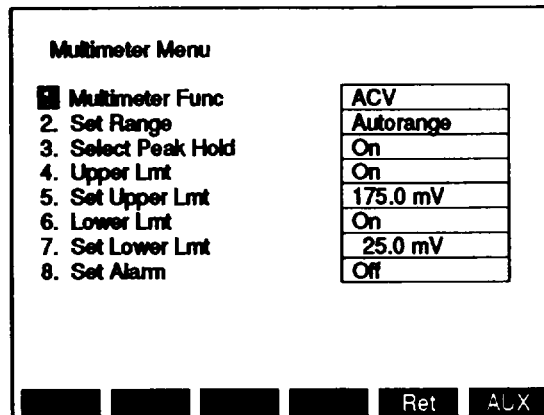

CE2FN495

KEY	METER FEATURE	FUNCTION
1.	Multimeter Func	Access displays submenu. Select from: ACV* DCV ACC DCC Ohm Default ACV. * Access displays Select Load Range Submenu. For ACV, select load range from: 1 MEG 600 Ω 150 Ω User Default 1 MEG. Selection of User displays data field allowing entry of User value. Set from 1 to 999 Ω
2.	Set Range	Access displays submenu. When ACV or DCV, select from: 200 mV 2.0 v 20 v 200 v 2000 v Autorange When ACC or DCC, select from: 20 mA 200 mA 2 A 20 A Autorange When Ohm, select from: 200 Ω 2 k Ω 20 k Ω 200 k Ω 2 M Ω 20 M Ω Autorange Default Autorange.
3.	Select Peak Hold	Access toggles off or on. Default off
4.	Upper Lmt	Access toggles off or on. Default off
5.	Set Upper Lmt	Set from 0.0 mV to 1000.00 V when ACV or DCV is selected. Default 0.0 mV. Set from 0.0 mA to 19.99 A when ACC or DCC is selected. Default 0.0 mA. Set from 0.000 Ω to 19.990 M Ω when Ohm is selected. Default 0.000 Ω.

KEY	METER FEATURE	FUNCTION
6.	Lower Lmt	Access toggles off or on. Default off.
7.	Set Lower Lmt	Set from 0.0 mV to 1000.00 V when ACV or DCV is selected. Default 0.0 mV. Set from 0.0 mA to 19.99 A when ACC or DCC is selected. Default 0.0 mA. Set from 0.000 Ω to 19.990 M Ω when Ohm is selected. Default 0.000 Ω .
8.	Set Alarm	Access toggles off or on. Default off.

11. Phase Meter Screen Configuration. When Meter Menu is displayed on CRT, use FIELD SELECT ↑ or ↓ Key to move menu item number highlight to 11, press ENTER to access Phase Meter Operation Screen.

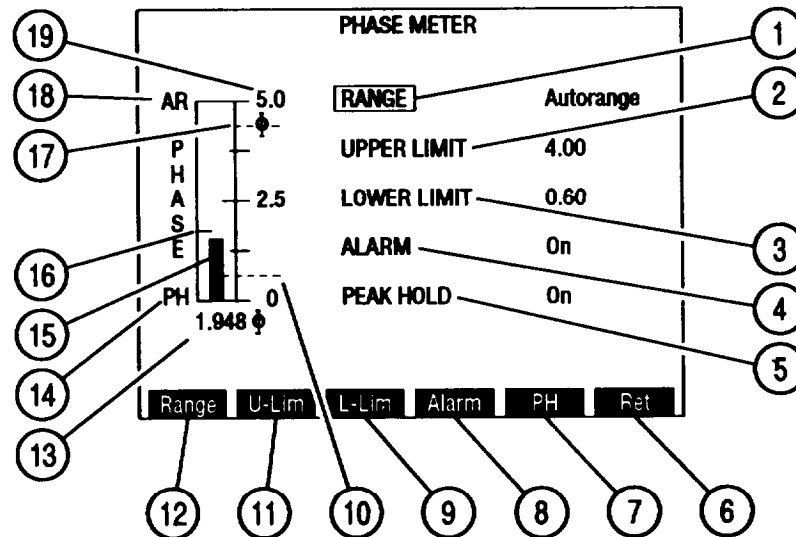

CE2FN496

KEY	METER FEATURE	FUNCTION
1.	RANGE	Move cursor to RANGE, press ENTER to access data field. Select from: 1 radian 5 radians 10 radians Autorange Default Autorange.
2.	UPPER LIMIT	Move cursor to UPPER LIMIT, press ENTER to activate Indicator (17) and access data field. Set from 0.00 to 10.00 radians. Default off.
3.	LOWER LIMIT	Move cursor to LOWER LIMIT, press ENTER to activate Indicator (10) and access data field. Set from 0.00 to 10.00 radians. Default off.
4.	ALARM	Move cursor to ALARM, press ENTER to toggle off or on. Default off. When on, tone sounds when Meter Indicator Bar (15) exceeds upper limit or lower limit.
5.	PEAK HOLD	Move cursor to PEAK HOLD, press ENTER to toggle on or off. Default off.
6.	"Ret"/ESC	Press "Ret" F6 to return to active operation screen. "ESC" appears while accessing a parameter. Press "ESC" F6 to void edit procedure.
7.	"PH"	Press F5 to toggle PEAK HOLD (5) on or off.
8.	"Alarm"	Press F4 to toggle ALARM (4) on or off.

KEY	METER FEATURE	FUNCTION
9.	"L-Lim"	Press F3 to activate LOWER LIMIT (3) and access data field.
10.	Lower Limit Indicator	When on, dotted line appears across meter window where limit is set.
11.	"U-Lim"	Press F2 to activate UPPER LIMIT (2) and access data field.
12.	"Range"	Press F1 to access RANGE (1) data field.
13.	Digital Readout	Shows Digital indication of Meter Indicator Bar (15).
14.	PH Enabled	Appears at lower left corner of meter window when PEAK HOLD (5) is on.
15.	Meter Indicator Bar	Shows meter indication according to Meter Range Scale (1). Turns red when exceeds upper limit or when less than lower limit. Turns green when reaches edge of meter window.
16.	Peak Hold Indicator	Appears when PEAK HOLD (5) is on. Green indicator shows highest point of meter bar deflection.
17.	Upper Limit Indicator	When on, dotted line appears across meter window where limit is set.
18.	AR	Appears above left corner of meter window when RANGE (1) is set for Autorange. Meter Range Scale (19) automatically resets to next higher scale when Meter Indicator Bar (15) reaches edge of meter window. Meter resets to next lower scale when Meter Indicator Bar (15) falls to 1/2 of lowest scale division.
19.	Meter Range Scale	Scale of four divisions marked from 0 to limit of active scale with center division labeled as midpoint of range.

When Phase Meter Operation Screen is displayed on CRT, press SETUP Key to access Phase Meter Menu

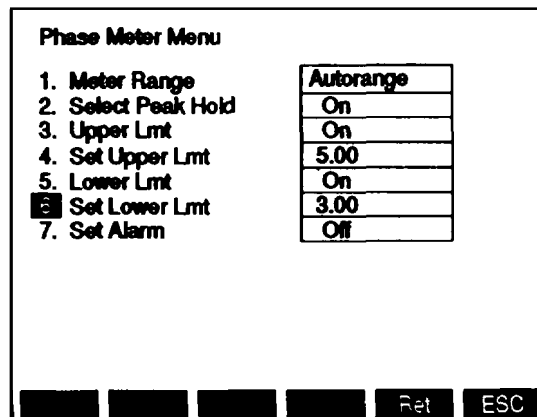

CE2FN497

KEY	METER FEATURE	FUNCTION
1.	Meter Range	Access displays submenu. Select from: 1 radian 5 radians 10 radians Autorange Default Autorange.
2.	Select Peak Hold	Access toggles off or on. Default off.
3.	Upper Limit	Access toggles off or on. Default off.
4.	Set Upper Lmt	Set from 0.00 to 10.00 radians. Default 0.00 radians.
5.	Lower Limit	Access toggles off or on. Default off.
6.	Set Lower Lmt	Set from 0.00 to 10.00 radians. Default 0.00 radians.
7.	Set Alarm	Access toggles off or on. Default off.

12. Deviation Meter (RMS) Screen Configuration. When Meter Menu is displayed on CRT, use FIELD SELECT ↑ or ↓ Key to move menu item number highlight to 12, press ENTER to access Deviation Meter (RMS) Operation Screen.

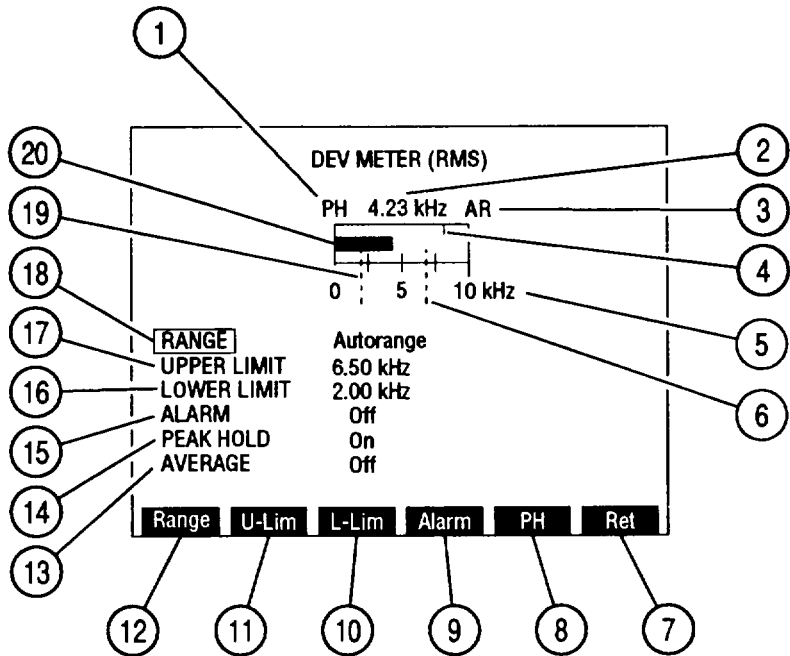

CE2FN498

KEY	METER FEATURE	FUNCTION
1.	PH Enabled	Appears above left corner of meter window when PEAK HOLD (14) is on.
2.	Digital Readout	Shows Digital indication of Meter Indicator Bar (20).
3.	AR	Appears above right corner of meter window when RANGE (18) is set for Autorange. Meter Range Scale (5) automatically resets to next higher scale when Meter Indicator Bar (20) reaches edge of meter window. Meter resets to next lower scale when Meter Indicator Bar (20) falls to 1/2 of lowest scale division.
4.	Peak Hold Indicator	Appears when PEAK HOLD (14) is on. Green indicator shows highest point of meter bar deflection.
5.	Meter Range Scale	Scale of four divisions marked from 0 to limit of active scale with center division labeled as midpoint of range.
6.	Upper Limit Indicator	When on, dotted line appears across meter window where limit is set.

KEY	METER FEATURE	FUNCTION
7.	“Ret”/“ESC”	Press “Ret” F6 to return to active operation screen. “ESC” appears while accessing a parameter. Press “ESC” F6 to void edit procedure.
8.	“PH”	Press F5 to toggle PEAK HOLD (14) on or off.
9.	“Alarm”	Press F4 to toggle ALARM (15) on or off.
10.	“L-Lim”	Press F3 to activate LOWER LIMIT (16) and access data field.
11.	“U-Lim”	Press F2 to activate UPPER LIMIT (17) and access data field.
12.	‘Range’	Press F1 to access RANGE (18) data field.
13.	AVERAGE	Move cursor to AVERAGE, press ENTER to toggle off and on. Default off.
14.	PEAK HOLD	Move cursor to PEAK HOLD, press ENTER to toggle on or off. Default off.
15.	ALARM	Move cursor to ALARM, press ENTER to toggle on or off. Default off.
16.	LOWER LIMIT	Move cursor to LOWER LIMIT, press ENTER to activate Indicator (19) and access data field. Set from 0.00 to 10.00 kHz. Default off.
17.	UPPER LIMIT	Move cursor to UPPER LIMIT, press ENTER to activate Indicator (6) and access data field. Set from 0.00 to 10.00 kHz. Default off.
18.	RANGE	Move cursor to RANGE, press ENTER to access data field. Select from: 2 kHz 5 kHz 10 kHz Autorange Default Autorange.
19.	Lower Limit Indicator	When on, dotted line appears across meter window where limit is set.
20.	Meter Indicator Bar	Shows meter indication according to Meter Range Scale (5). Turns red when exceeds upper limit or when less than lower limit. Turns green when reaches edge of meter window.

When Deviation Meter (RMS) Operation Screen is displayed on CRT, press SETUP Key to access Deviation Meter" (R MS) Menu.

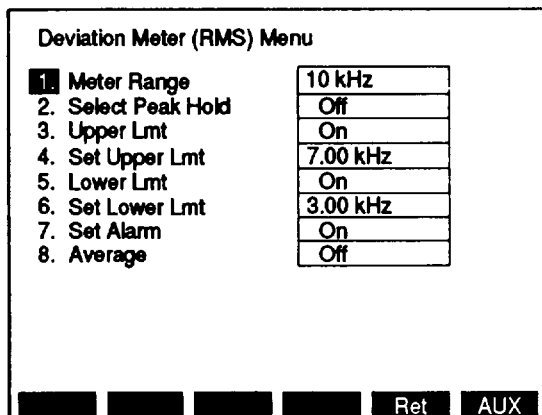

CE2FN499

KEY	METER FEATURE	FUNCTION
1.	Meter Range	Access displays submenu. Select from: 2 kHz 5 kHz 10 kHz Autorange Default Autorange.
2.	Select Peak Hold	Access toggles off or on. Default off.
3.	Upper Limit	Access toggles off or on. Default off.
4.	Set Upper Lmt	Set from 0.00 to 10.00 kHz. Default 0.00 kHz.
5.	Lower Limit	Access toggles off or on. Default off.
6.	Set Lower Lmt	Set from 0.00 to 10.00 kHz. Default 0.00 kHz.
7.	Set Alarm	Access toggles off or on. Default off.
8.	Average	Access toggles off or on. Default off.

13. Phase Meter (RMS) Screen Configuration. When Meter Menu is displayed on CRT, use FIELD SELECT ↑ or ↓ Key to move menu item number highlight to 13, press ENTER to access Phase Meter (RMS) Operation Screen.

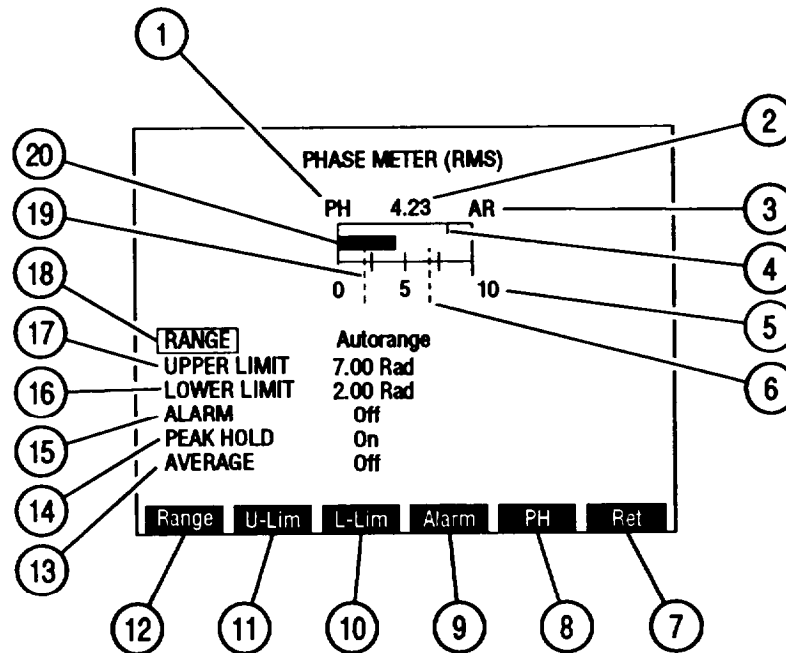

CE2FN500

KEY	METER FEATURE	FUNCTION
1.	PH Enabled	Appears above left corner of meter window when PEAK HOLD (14) is on.
2.	Digital Readout	Shows Digital indication of Meter Indicator Bar (20).
3.	AR	Appears above right corner of meter window when RANGE (18) is set for Autorange. Meter Range Scale (5) automatically resets to next higher scale when Meter Indicator Bar (20) reaches edge of meter window. Meter resets to next lower scale when Meter Indicator Bar (20) falls to 1/2 of lowest scale division.
4.	Peak Hold Indicator	Appears when PEAK HOLD (14) is on. Green indicator shows highest point of meter bar deflection.
5.	Meter Range Scale	Scale of four divisions marked from 0 to limit of active scale with center division labeled as midpoint of range.
6.	Upper Limit Indicator	When on, dotted line appears across meter window where limit is set.

KEY	METER FEATURE	FUNCTION
7.	"Ret"	Press "Ret" F6 to return to active operation screen. "ESC" appears while accessing a parameter. Press "ESC" F6 to void edit procedure.
8.	"PH"	Press F5 to toggle PEAK HOLD (14) on or off.
9.	"Alarm"	Press F4 to toggle ALARM (15) on or off.
10.	"L-Lim"	Press F3 to activate LOWER LIMIT (16) and access data field.
11.	"U-Lim"	Press F2 to activate UPPER LIMIT (17) and access data field.
12.	"Range"	Press F1 to access RANGE (18) data field.
13.	AVERAGE	Move cursor to AVERAGE, press ENTER to toggle off and on. Default off.
14.	PEAK HOLD	Move cursor to PEAK HOLD, press ENTER to toggle on or off. Default off.
15.	ALARM	Move cursor to ALARM, press ENTER to toggle on or off. Default off.
16.	LOWER LIMIT	Move cursor to LOWER LIMIT, press ENTER to activate Indicator (19) and access data field. Set from 0.00 to 10.00 radians. Default off.
17.	UPPER LIMIT	Move cursor to UPPER LIMIT, press ENTER to activate Indicator (6) and access data field. Set from 0.00 to 10.00 radians. Default off.
18.	RANGE	Move cursor to RANGE, press ENTER to access data field. Select from: 1 radian 5 radians 10 radians Autorange Default Autorange.
19.	Lower Limit Indicator	When on, dotted line appears across meter window where limit is set.
20.	Meter Indicator Bar	Shows meter indication according to Meter Range Scale (5). Turns red when exceeds upper limit or when less than lower limit. Turns green when reaches edge of meter window.

When Phase Meter (RMS) Operation Screen is displayed on CRT, press SETUP Key to access Phase Meter (RMS) Menu.

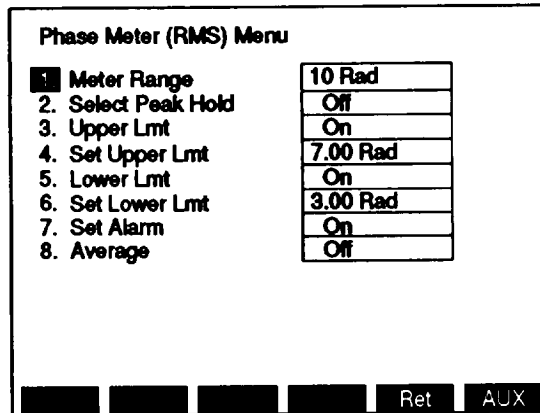

CE2FN501

KEY	METER FEATURE	FUNCTION
1.	Meter Range	Access displays submenu. Select from: 1 radians 5 radians 10 radians Autorange Default Autorange.
2.	Select Peak Hold	Access toggles off or on. Default off.
3.	Upper Limit	Access toggles off or on. Default off.
4.	Set Upper Lmt	Set from 0.00 to 10.00 radians. Default 0.00 radians.
5.	Lower Limit	Access toggles off or on. Default off.
6.	Set Lower Lmt	Set from 0.00 to 10.00 radians. Default 0.00 radians.
7.	Set Alarm	Access toggles off or on. Default off.
8.	Average	Access toggles off or on. Default off.

Section II. OPERATOR PREVENTIVE MAINTENANCE CHECKS AND SERVICES

2-4. GENERAL.

When doing any Preventive Maintenance or routine checks, keep in mind the WARNINGS and CAUTIONS about electrical shock and bodily harm.

2-5. PREVENTIVE MAINTENANCE PROCEDURES.

a. Tools, Materials and Equipment Required for Preventive Maintenance. No tools or equipment are required for operator preventive maintenance. Cleaning materials required are a lintless cloth and mild liquid detergent.

b. Preventive Maintenance for Test Set is limited to routine checks such as those shown below:

- Cleaning.
- Dusting.
- Wiping.
- Checking for frayed cables.
- Storing items not in use.
- Covering unused receptacles.
- Checking for loose nuts, bolts and screws.

c. Perform routine checks any time they must be done.

Section III. OPERATION UNDER USUAL CONDITIONS

2-6. INTRODUCTION.

This section provides information required to set up and operate Test Set. Operation is divided into 20 separate procedures. Information is provided on basic operation in setting up Test Set for each operation accessed through MODE Keys plus Meters and Digital Multi meter operation.

2-7. PREPARATION FOR USE.

Follow these instructions before connecting Test Set:

WARNING

Test Set is equipped with a 3-wire power cable. When connected to a grounded AC power receptacle, this cable grounds Radio Test Set chassis. Do not use extension cords or AC adapters without a ground connection.

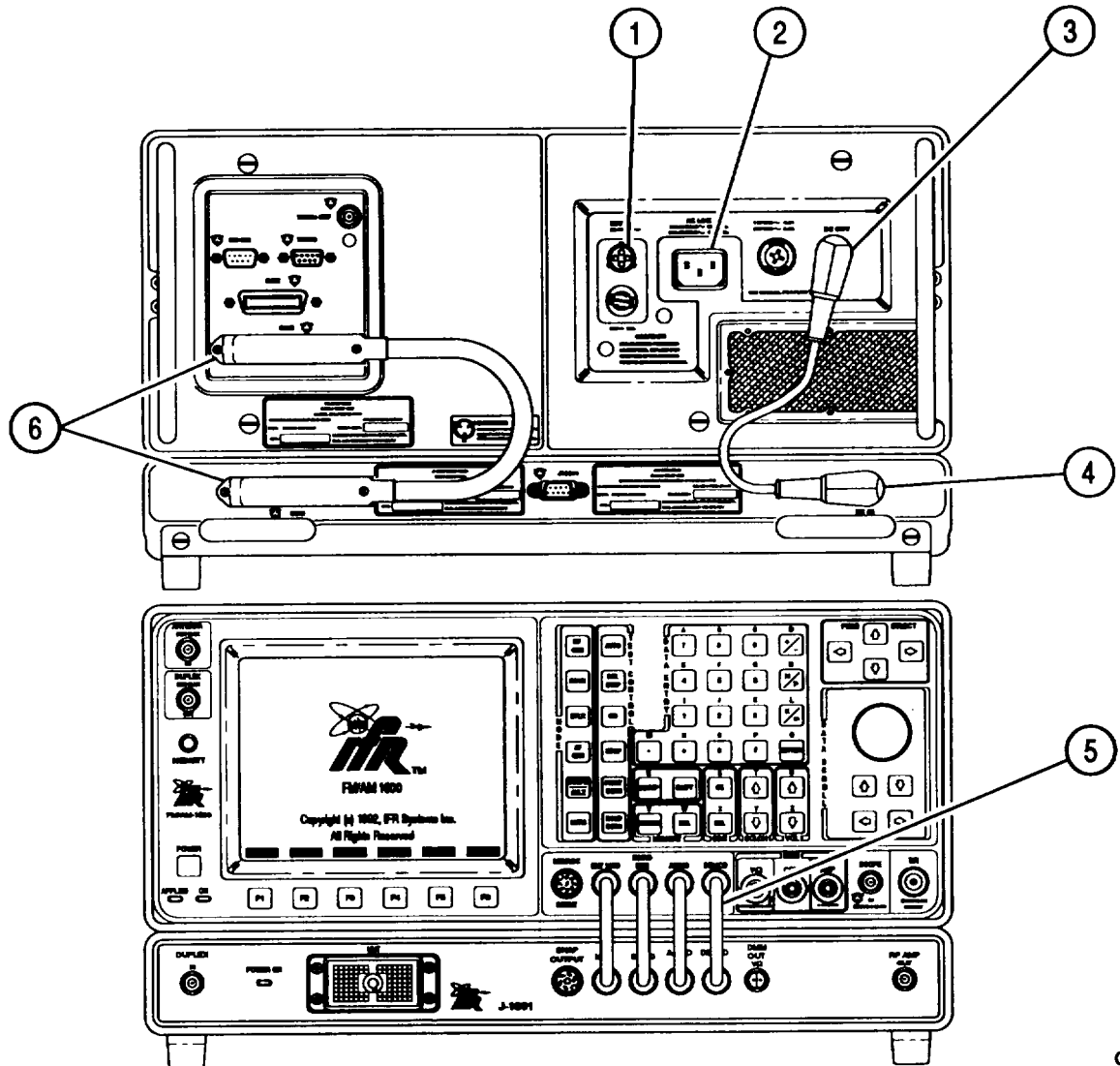

CE2FN686

1. Inspect:
 - DC power connectors from Test Set (3) to Test Adapter (4) for proper installation.
 - SCSI Connectors (6) on Test Set and Test Adapter for proper installation.
 - Four short BNC to BNC coax cables (5) are connected as shown.
2. Connect input AC power source matching the type of fuse installed to AC LINE IN Connector (2). For DC operation, connect input DC power source to EXT DC Power Source Connector (1).

2-8. TURN-ON PROCEDURE.

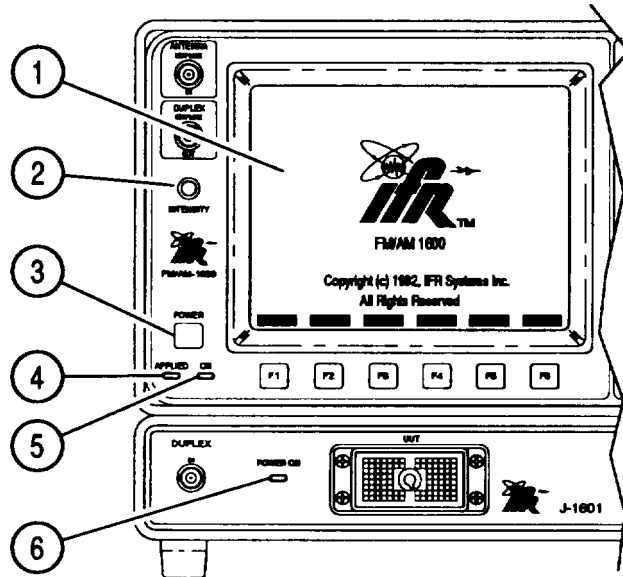

CE2FN687

1. Verify APPLIED Indicator (4) is illuminated.
2. Press POWER Switch (3).
3. Verify ON Indicator (5) illuminates without blinking within 10 seconds after pressing POWER Switch (3).
4. Verify fan operation. If fan does not operate, notify Unit Maintenance.
5. Verify processor operation (1 Beep), memory board operation (2 Beeps) and data bus operation (4 Beeps).
6. If sequence of beeps does not occur, allow 5 minute warm-up time with power ON, then press POWER Switch (3) to turn power off and repeat steps 1 thru 4. If sequence of beeps does not occur on second try, notify Unit Maintenance
7. Adjust INTENSITY/Contrast Adjustment (2) until CRT (1) display is clearly visible.
8. Verify following Software Restricted Rights Legend appears:

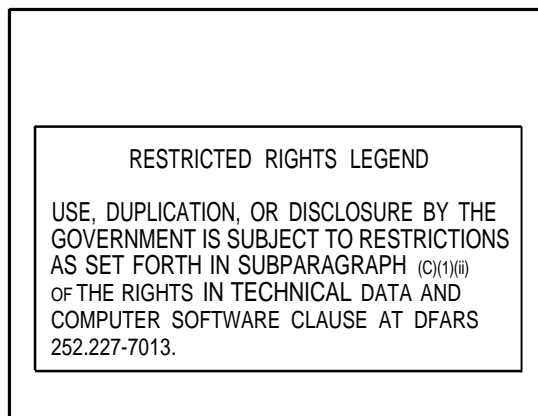

CE2FN721

9. Verify IFR SYSTEMS logo is displayed on CRT (1). Allow 5 minute warm-up time. If an error message is displayed on CRT, notify Unit Maintenance.

2-9. INITIAL ADJUSTMENT AND DAILY CHECKS.

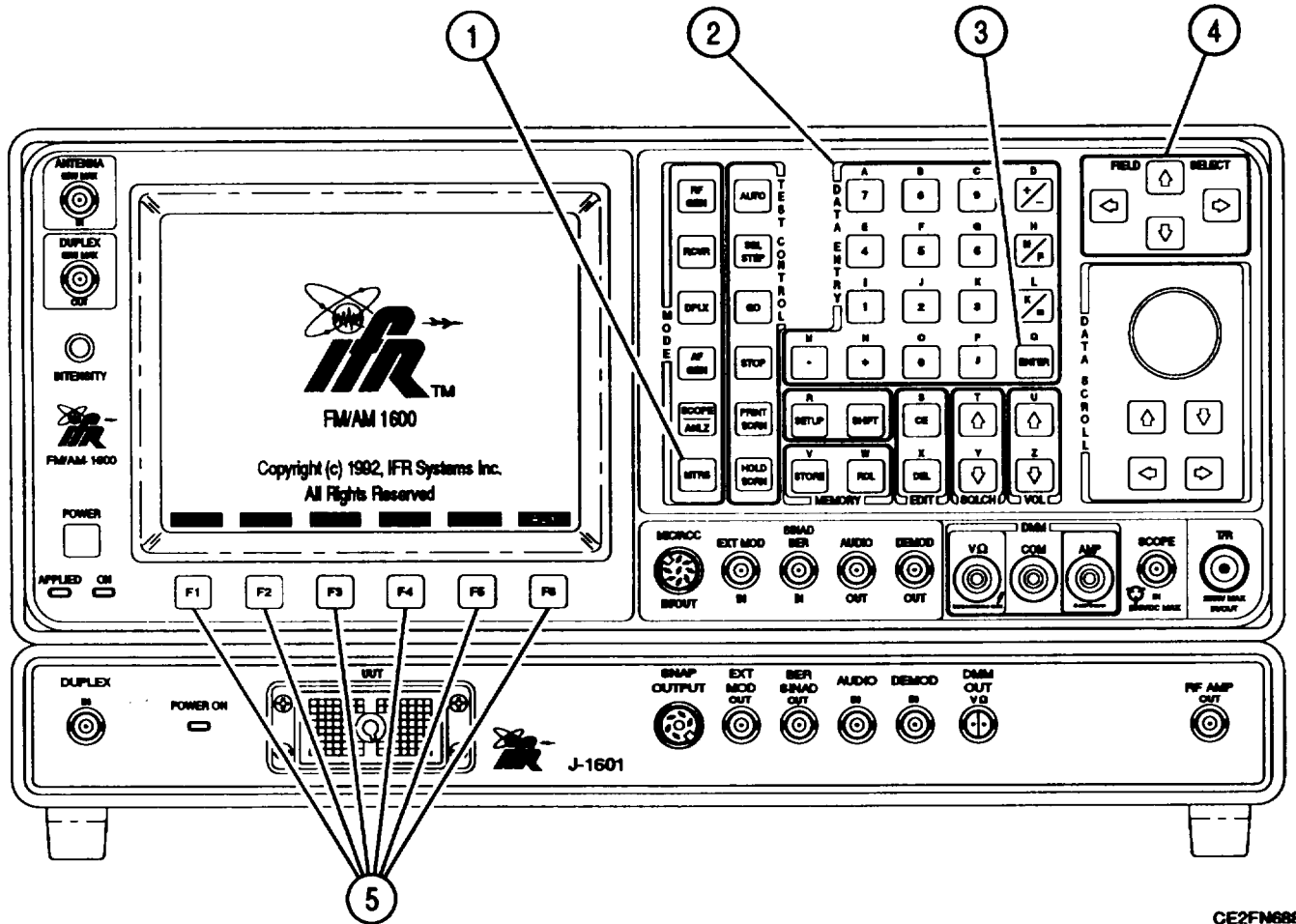

CE2FM688

a. Small Computer System Interface (SCSI) "On" Verification. Verify SCSI Connector is active as follows.

1. Press MTRS MODE Key (1) to display Meter Menu. Press "AUX" F6 to display Auxiliary Functions Menu.
2. Press 5 on DATA ENTRY Keypad (2) to display Configure submenu.

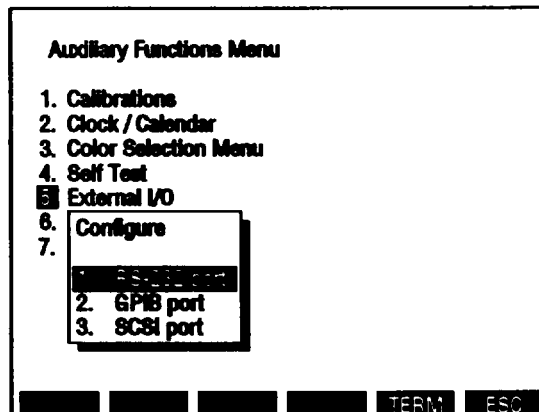

- Press 3 on DATA ENTRY Keypad (2) to display Configure SCSI Submenu.

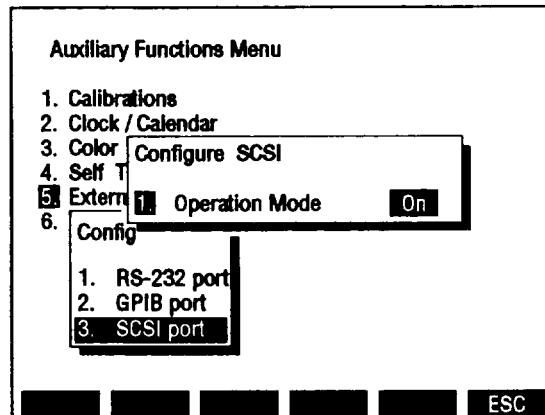

CE2FN717

- Verify SCSI Operation Mode is on. If off, press ENTER (3) to toggle on.
- Press "ESC" F6 (5) twice to return to Auxiliary Functions Menu.

b. **Self Test.** Perform Self Test as follows:

NOTE

All external input connections must be removed from Test Set prior to performing Self Test.

- When IFR SYSTEMS logo is displayed, press "AUX" F6 (5). Auxiliary Functions Menu appears.
- Press 4 on DATA ENTRY Keypad (3). Self Test Submenu appears.

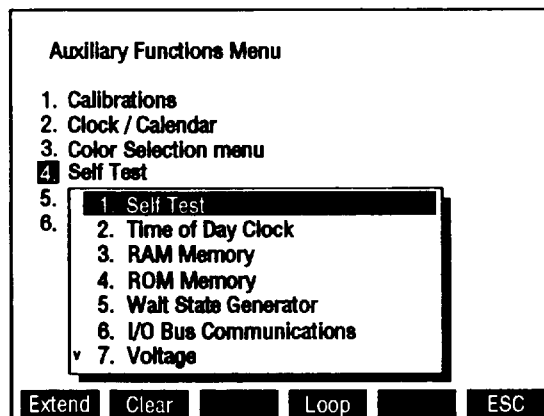

CE2FN524

- When submenu highlight is over 1. Self Test, press ENTER (4). A small Test Running Submenu (6) appears. A number (02 thru 24) following words Test Running indicates number of test running.

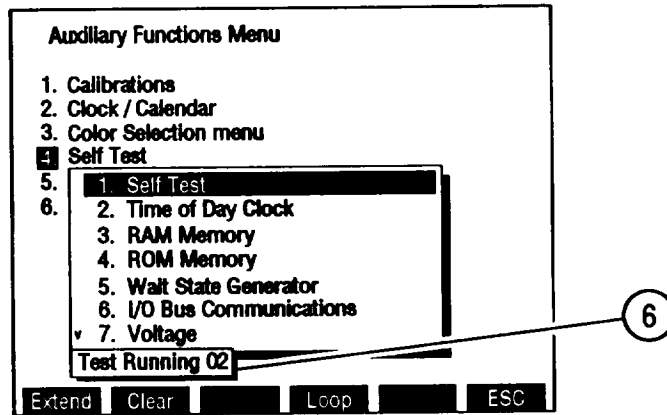

CE2FN525

4. After all tests have run, a P (Pass) (7) or F (Fail) (8) indicator appears after Self Test.

- If P appears, Test Set has passed Self Test. Press "ESC" F6 (5) to escape from Self Test Menu. Test Set is ready for use.
- If F appears, continue with step 5.

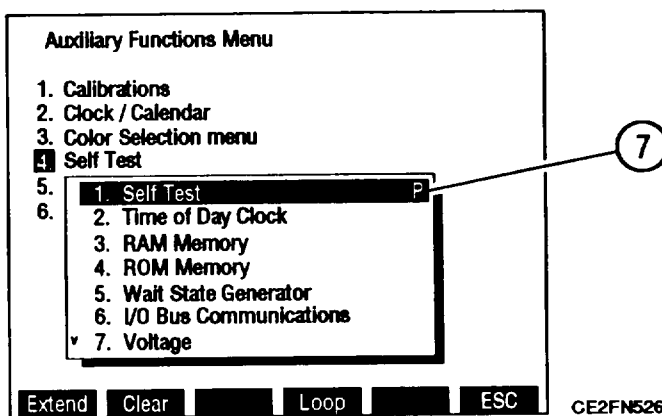

CE2FN526

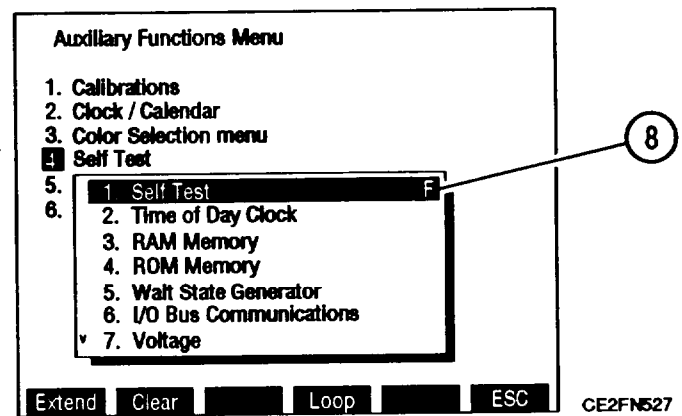

CE2FN527

5. Press FIELD SELECT ↑ or → Key (4) until failed test test is found.
6. When submenu highlight is over failed test, press "Extend" F1 (5). Highlighted test repeats and a small Extended Test submenu appears over test highlight.
- if extended submenu shows Fail (9), continue with step 7.
 - If extended submenu shows Fail (9) and a test value of function tested, record value shown, continue with step 7.
 - If extended test submenu contains a list of related items (10), perform tests on each submenu item by pressing list number on DATA ENTRY Keypad (3). Record test results of each submenu item, then continue with step 7.

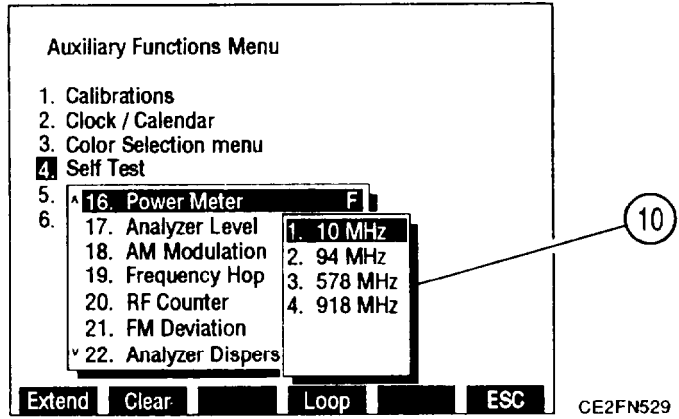
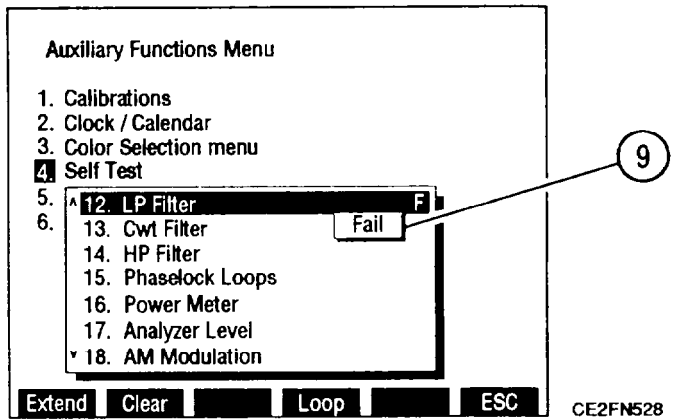

7. Press FIELD SELECT ↓ or → Key (5) to move through rest of Self Test Menu. Repeat step 5 for each item that failed and record results of each Extended test.
8. Notify unit maintenance and report results of all failed Self Test tests.

b. Reset Factory Defaults. Reset Test Set to factory default settings for all operation screens as follows:

NOTE

Resetting Factory Defaults returns frequencies for most operation screens to 10.000 MHz, resets most meter ranges to Autorange and turns upper and lower limits off. See paragraph 2-3 for a complete listing of Factory Defaults.

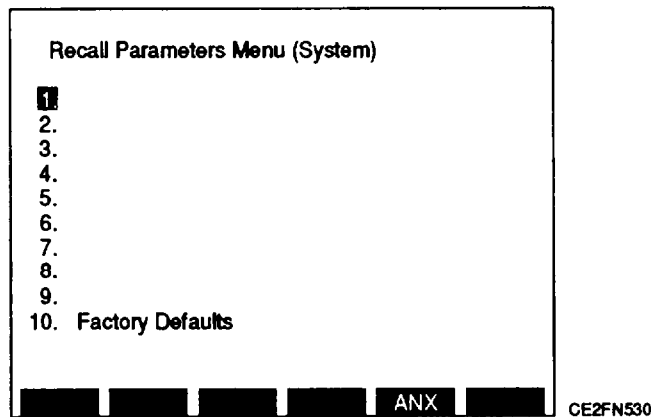

1. Press MTRS MODE Key (1) to display Meter Menu. Press "AUX" F6 (6) to display Auxiliary Functions Menu.
2. When Auxiliary Functions Menu is displayed on CRT (1), press RCL Key to display "Recall Parameters Menu (System)."
3. Press ↑ or ↓ FIELD SELECT Key (5) to move highlight to 10. Factory Defaults. Press ENTER. Recall Submenu appears.
4. Verify Yes/No selection is Yes. Press ENTER (4).
5. Resume normal operation.

2-10. OPERATING PROCEDURES.

Operation of Test Set is provided in paragraphs 2-11 thru 2-26. Refer to paragraph 2-2 for a further description of controls, indicators and connectors. Refer to paragraph 2-3 for a further description of operation screens and menus.

2-11. RF GENERATOR.

Operate RF Generator by following procedures:

- a. Generate Continuous Wave RF Signal.
- b. Generate Internally Modulated AM, FM or PM RF Signal.
- c. Generate Externally Modulated RF Signal.
- d. Generate DTMF Coded RF Signal.
- e. Generate Audio Coded RF Signal.
- f. Generate DCS or DCS Inverted Coded RF Signal.
- g. Generate POCSAG Coded RF Signal.
- h. Generate IMTS, MTS or 2805 Coded RF Signal.
- i. Generate Tone Remote Signal.
- j. Generate RF Frequency Scan.

NOTE

- Reset Factory Defaults before performing each operating procedure (para 2-9).
- Do not press any Soft Function Keys unless directed by procedures.
- To recall a set of stored screen parameters, use Test Set memory RCL (Recall) Key. For information on use of Store and Recall Keys, refer to operator's controls, indicators and connectors (para 2-2).
- All RF measurements are referenced to 50 Ohms.

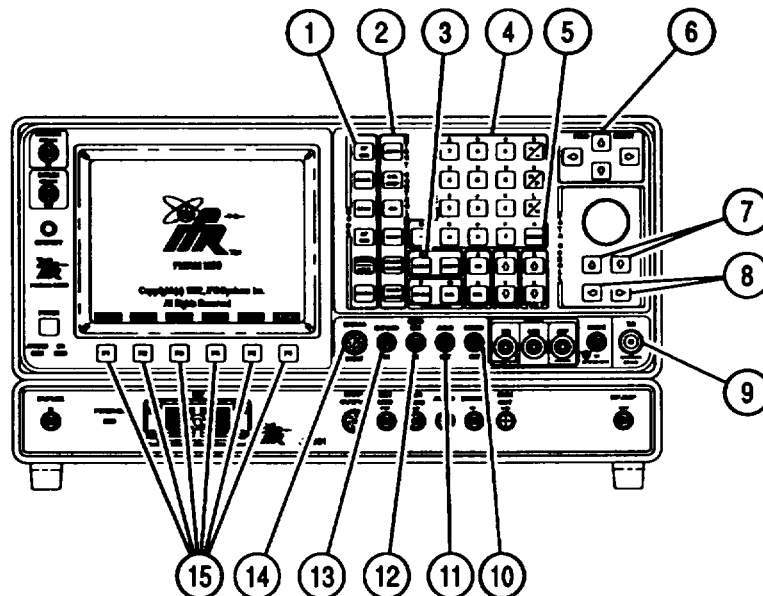

CE2FN000

a. Generate Continuous Wave RF Signal.

1. Press RF GEN MODE Key (1), then SETUP Key (3) to display RF Generator Menu.
2. Press 5 on DATA ENTRY Keypad (4). RF Gen Setup Submenu appears.

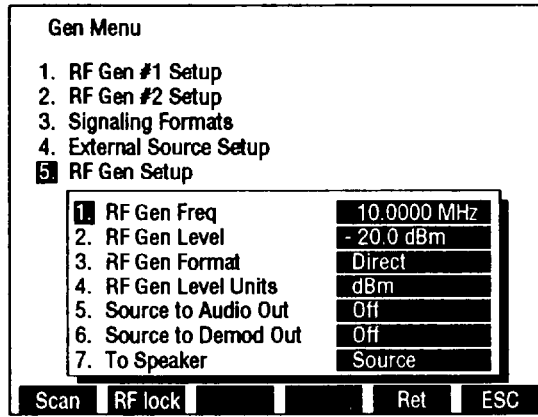

CE2FN533

3. Press 1 on DATA ENTRY Keypad (4) to access RF Freq data field.
4. Use DATA ENTRY Keypad (4) to enter frequency. Press ENTER (5) to activate.
5. Press 4 on DATA ENTRY Keypad (4) to toggle RF Gen Level Units to desired units.
6. Press 2 on DATA ENTRY Keypad (4) to access RF Gen Level data field.
7. Use DATA ENTRY Keypad (4) to enter output level. Press ENTER (5).
 - To set a level other than 0 dBm, press +/- on DATA ENTRY Keypad (4) during data entry.
8. If output from DE MOD OUT (10) or AUDIO OUT Connector (11) is desired:
 - Press 5 on DATA ENTRY Keypad (4) to toggle Source to Audio Out to On.
 - Press 6 on DATA ENTRY Keypad (4) to toggle Source to Demod Out to On.
9. If Speaker output is desired:
 - Press 7 on DATA ENTRY Keypad (4) to access To Speaker data field.
 - Use DATA SCROLL ↑ and ↓ Keys (7) until desired signal routed to Speaker is selected. Press ENTER (5).
10. Press "Ret" F5 (15) to return to RF Generator Operation Screen. Verify settings are as desired.
11. Connect BNC-N coax cable from T/R Connector (9) to UUT input.

b. Generate Internally Modulated AM, FM or PM RF Signal.

1. Press RF GEN MODE Key (I), then SETUP Key (3) to display RF Generator Menu.
2. Press 1 on DATA ENTRY Keypad (4) to access submenu.
 - Function Generator #1 and #2 are identical. Only Function Generator #1 is shown.

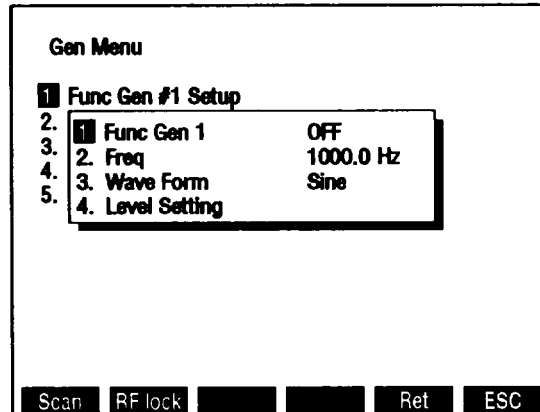

CE2FN534

3. Press 1 on DATA ENTRY Keypad (4). Func Gen 1 data field highlights.
4. Use DATA SCROLL ↑ and ↓ Keys (7) to select modulation type. Press ENTER (5).
5. Press 2 on DATA ENTRY Keypad (4). Freq data field highlights.
6. Use DATA ENTRY Keypad (4) to enter digits of Audio Frequency. Press ENTER (5).
7. Press 3 on DATA ENTRY Keypad (4). Wave Form Submenu appears.
8. Press number of desired wave form on DATA ENTRY Keypad (4).
9. Press 4 on DATA ENTRY Keypad (4). FM Dev, AM Mod or PM Mod data field highlights.
10. Use DATA ENTRY Keypad (4) to enter digits of FM Deviation Frequency, AM Modulation or PM Modulation. Press ENTER (5).
11. Press "ESC" F6 (15) to return to RF Generator Menu.
12. Press 5 on DATA ENTRY Keypad (4). RF Gen Setup Submenu appears.
13. Press 1 on DATA ENTRY Keypad (4) to access RF Freq data field.
14. Use DATA ENTRY Keypad (4) to enter frequency. Press ENTER (5) to activate.
15. Press 4 on DATA ENTRY Keypad (4) to toggle RF Gen Level Units to desired units.
16. Press 2 on DATA ENTRY Keypad (4) to access RF Gen Level data field.
17. Use DATA ENTRY Keypad (4) to enter output level. Press ENTER (5).
 - To set a level other than 0 dBm, press +/- on DATA ENTRY Keypad (4) during data entry.
 - RF Generator output is present at T/R Connector (9).
18. If output from DEMOD OUT Connector (10) or AUDIO OUT Connector (11) is desired:
 - Press 5 on DATA ENTRY Keypad (4) to toggle Source to Audio Out to On.

- Press 6 on DATA ENTRY Keypad (4) to toggle Source to Demod Out to On.
19. If Speaker output is desired:
 - Press 7 on DATA ENTRY Keypad (4) to access To Speaker data field.
 - Use DATA SCROLL ↑ and ↓ Keys (7) until desired signal routed to Speaker is selected. Press ENTER (5).
 20. Press “Ret” F5 (15) to return to RF Generator Operation Screen. Verify settings are as desired.
 21. Press “More” F6 (15) until “Meters” F4 (15) appears. Press “Meters” F4 (15). Submenu appears.
 22. Press number of desired meter on DATA ENTRY Keypad (4).
 23. Move cursor to any meter callout except for AF Level Meter. Press ENTER (5) to access meter operation screen. Press “Ret” F6 (15) to return to RF Generator Operation Screen.
 24. If Distortion measurement is required, see paragraph 2-22. If SINAD measurement is required, see paragraph 2-23: If DMM measurement is required, see paragraph 2-26.
 - Distortion or SINAD measurement on operation screens are made at SINAD/BER IN Connector (12).

c. Generate Externally Modulated RF Signal.

1. Press RF GEN MODE Key (2), then SETUP Key (3) to access RF Generator Menu.
2. Press 4 on DATA ENTRY Keypad (4) to display External Source Setup Submenu.

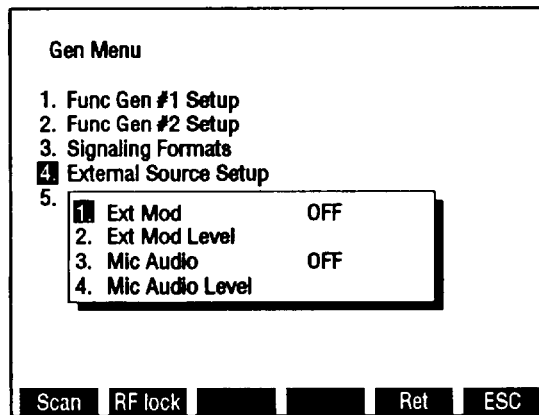

CE2FN543

3. To modulate EXT MOD IN Connector (13) input:
 - Press 1 on DATA ENTRY Keypad (4) to access External Mod data field.
 - Use DATA SCROLL ↑ and ↓ Keys (7) until desired modulation appears in data field. Press ENTER (5).
 - Press 2 on DATA ENTRY Keypad (4) to access External Mod Level data field.
 - Use DATA ENTRY Keypad (4) to enter digits of FM Deviation frequency, AM Modulation or PM Modulation. Press ENTER (5).
 - Apply 3.535 VRMS audio signal to EXT MOD IN Connector (13).

4. To modulate MIC/ACC IN/OUT Connector (14) input:
 - Press 3 on DATA ENTRY Keypad (4) to access Mic Audio data field.
 - Use DATA SCROLL ↑ and ↓ Keys (7) until desired modulation appears in data field. Press ENTER (5).
 - Press 4 on DATA ENTRY Keypad (4) to access Mic Audio Level data field.
 - Use DATA ENTRY Keypad (4) to enter digits of FM Deviation frequency, AM Modulation or PM Modulation. Press ENTER (5).
 - Press “ESC” F6 (15) to return to RF Generator Menu.
 - Connect Microphone (Appendix C, item 17) to MIC/ACC IN/OUT Connector (14).
5. Press 5 on DATA ENTRY Keypad (4). RF Gen Setup Submenu appears.
6. Press 1 on DATA ENTRY Keypad (4) to access RF Freq data field.
7. Use DATA ENTRY Keypad (4) to enter frequency. Press ENTER (5) to activate.
8. Press 4 on DATA ENTRY Keypad (4) to toggle RF Gen Level Units to desired units.
9. Press 2 on DATA ENTRY Keypad (4) to access RF Gen Level data field.
10. Use DATA ENTRY Keypad (4) to enter output level. Press ENTER (5).
 - To set a level other than 0 dBm, press +/- on DATA ENTRY Keypad (4) during data entry.
11. If output from DEMOD OUT Connector (10) or AUDIO OUT Connector (11) is desired:
 - Press 5 on DATA ENTRY Keypad (4) to toggle Source to Audio Out to On.
 - Press 6 on DATA ENTRY Keypad (4) to toggle Source to Demod Out to On.
12. If Speaker output is desired:
 - Press 7 on DATA ENTRY Keypad (4) to access To Speaker data field.
 - Use DATA SCROLL ↑ and ↓ Keys (7) until desired signal routed to Speaker is selected. Press ENTER (5).
13. Press “Ret” F5 (15) to return to RF Gen Operation Screen. Verify settings are as desired.
14. Press “More” F6 (15) until “Meters” F4 (15) appears. Press “Meters” F4 (15). Submenu appears.
15. Press number of desired meter on DATA ENTRY Keypad (4).
16. Move cursor to any meter callout except AF Level Meter. Press ENTER (5) to access meter operation screen. Press “Ret” F6 (15) to return to RF Generator Operation Screen.
17. If Distortion measurement is required, see paragraph 2-22. If SINAD measurement is required, see paragraph 2-23. If DMM measurement is required, see paragraph 2-26.
 - Distortion or SINAD measurement on operation screens are made at SINAD/BER IN Connector (12).
18. Apply input to microphone.

d. Generate DTMF Coded RF Signal.

1. Press RF GEN MODE Key (1), then SETUP Key (3) to access RF Generator Menu.
2. Press 3 on DATA ENTRY Keypad (4). Signaling Format Submenu appears.
3. Press 1 on DATA ENTRY Keypad (4). DTMF Format Menu appears.

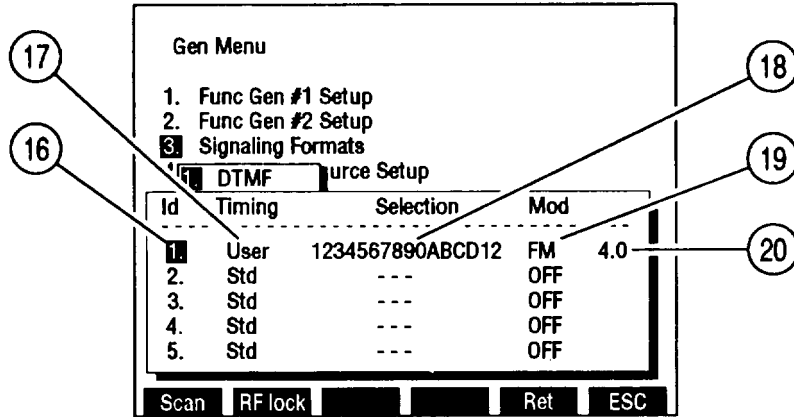

CE2FN531

4. Use FIELD SELECT ↑ and ↓ Keys (6) to move cursor to desired Id (Identification Number) (16).
5. Press FIELD SELECT → Key (6). Use DATA SCROLL ↑ and ↓ Keys (8) to select Std (Standard) or User Timing (17). Press ENTER (5).
6. If User is selected, Timing data fields appear:
 - Press 1 on DATA ENTRY Keypad (4). Use DATA ENTRY Keypad (4) to enter Mark Timing. Press ENTER (5).
 - Press 2 on DATA ENTRY Keypad (4). Use DATA ENTRY Keypad (4) to enter Space Timing. Press ENTER (5).
 - Press “ESC” F6 (15) to return to DTMF Format Menu.
7. Press FIELD SELECT → Key (6). Use DATA ENTRY Keypad (4) to enter Selection (18). Press ENTER (5).
8. Press FIELD SELECT → Key (6). Use DATA SCROLL ↑ and ↓ Keys (7) to select FM, AM or PM Modulation (19). Press ENTER (5).
9. Press FIELD SELECT → Key (6). Use DATA ENTRY Keypad (4) to enter Modulation Level (20). Press ENTER (5).
10. Define other sequences repeating steps 4 thru 9.
11. Press “ESC” F6 (15) twice to return to RF Generator Menu.
12. Press 5 on DATA ENTRY Keypad (4). RF Gen Setup Submenu appears.
13. Press 1 on DATA ENTRY Keypad (4) to access RF Freq data field.
14. Use DATA ENTRY Keypad (4) to enter frequency. Press ENTER (5) to activate.
15. Press 4 on DATA ENTRY Keypad (4) to toggle RF Gen Level Units to desired units.
16. Press 2 on DATA ENTRY Keypad (4) to access RF Gen Level data field.
17. Use DATA ENTRY Keypad (4) to enter output level. Press ENTER (5).

- To set a level other than 0 dBm, press +/- on DATA ENTRY Keypad (4) during data entry.
- 18. If output from DEMOD OUT Connector (10) or AUDIO OUT Connector (1 1) is desired:
 - Press 4 on DATA ENTRY Keypad (4) to toggle Source to Audio Out to On.
 - Press 5 on DATA ENTRY Keypad (4) to toggle Source to Demod Out to On.
- 19. If Speaker output is desired:
 - Press 7 on DATA ENTRY Keypad (4) to access To Speaker data field.
 - Use DATA SCROLL ↑ and ↓ Keys (7) until desired signal routed to Speaker is selected. Press ENTER (5).
- 20. Press "Ret" F5 (15) to return to RF Generator Operation Screen.

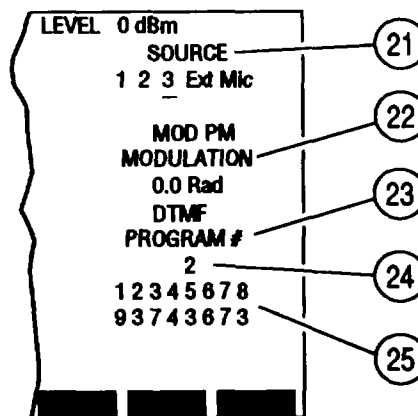

GE2FN532

- 21. Move cursor to SOURCE (21). Press ENTER (5).
- 22. Press DATA SCROLL → Key (8) twice. Use DATA SCROLL ↑ and ↓ Keys (7) to select desired modulation type. Press ENTER (5).
- 23. Move cursor to DEVIATION/MODULATION (22). Use DATA ENTRY Keypad (4) to enter deviation frequency, if Modulation Type FM or modulation level, if Modulation Type AM or PM. Press ENTER (5).
- 24. Move cursor to DIRECT ENTRY/PROGRAM # (23). Press ENTER (5) to select DIRECT ENTRY or PROGRAM #.
- 25. If DIRECT ENTRY is selected:
 - Move cursor to sequence (25).
 - Use DATA ENTRY Keypad (4) to enter sequence. Press ENTER (5).
- 26. If PROGRAM # is selected:
 - Move cursor to Program number (24).
 - Use DATA ENTRY Keypad (4) to enter Id (Identification Number) of sequence programmed on DTMF Format Menu. Press ENTER (5).
- 27. Verify settings are as desired.
- 28. Connect BNC-N coax cable from T/R Connector (9) to UUT input.
- 29. Press GO TEST CONTROL Key (2) to generate DTMF signal continually.

30. Press SGL STEP TEST CONTROL Key (2) to generate DTMF signal once.
31. Press STOP TEST CONTROL Key (2) to stop DTMF generation.

e. Generate Audio Coded RF Signal

1. Press RF GEN MODE Key (1), then SETUP Key (3) to access RF Generator Menu.
2. Press 3 on DATA ENTRY Keypad (4). Signaling Format Submenu appears.
3. Press 2 on DATA ENTRY Keypad (4). Audio Format Menu appears.

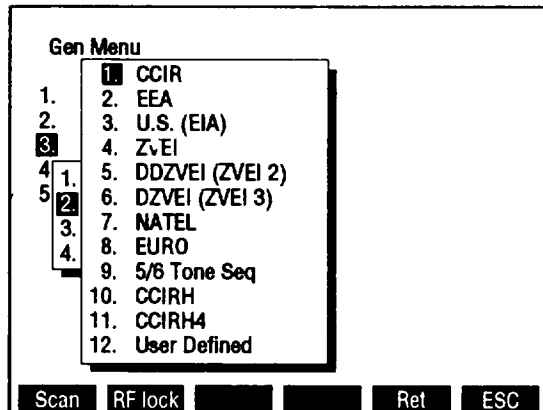

CE2FN535

4. Move cursor to desired Audio Signaling Code. Press ENTER (5).
5. If User Defined is not selected Audio Signaling Code, Audio Code Menu appears. Define sequences as follows:

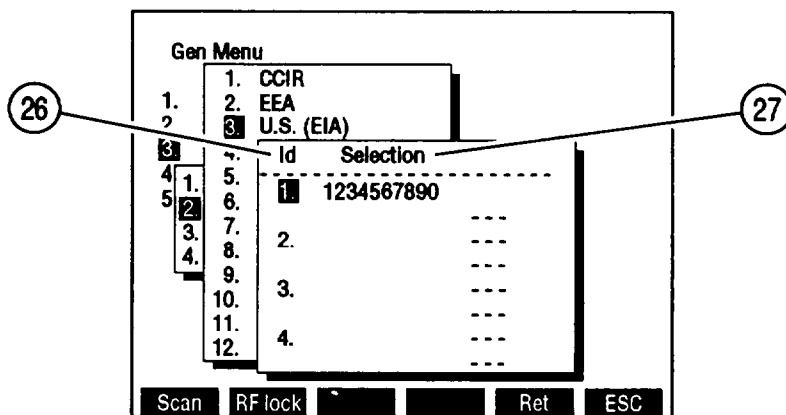

CE2FN536

- Use FIELD SELECT ↑ and ↓ Keys (6) to move cursor to desired Id (Identification Number) (26).
- Press ENTER Key (5). Use DATA ENTRY Keypad (4) to enter Selection (27). Press ENTER (5).
- Once selections are defined, press “ESC” F6 (15) 3 times to return to RF Generator Menu.

6. If User Defined is selected Audio Signaling Code, submenu appears:

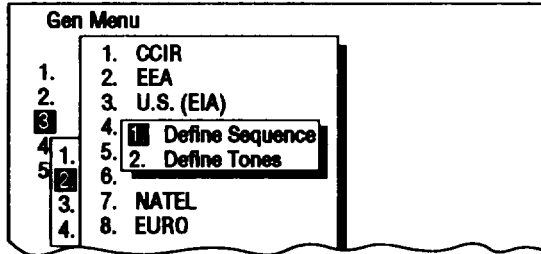

CE2FN538

● Press 2 on DATA ENTRY Keypad (4). Defined Tones Menu appears:

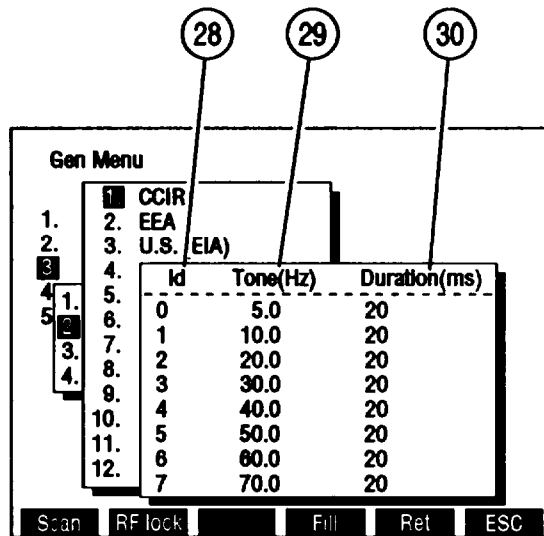

CE2FN537

- Define tones as follows:
 - Use FIELD SELECT ↑ and ↓ Keys (6) to move cursor to desired Id (Identification Number) (28).
 - To select tones, press FIELD SELECT → Key (6). Use DATA ENTRY Keypad (4) to enter tone frequency (29). Press ENTER (5).
 - To select duration, press FIELD SELECT → Key (6). Use DATA ENTRY Keypad (4) to enter tone duration (30). Press ENTER (5).
 - Once tones are defined, press "ESC" F6 (15).
 - Press 1 on DATA ENTRY Keypad (4). Audio Code Menu appears. Define sequences as follows:
 - Use FIELD SELECT ↑ and ↓ Keys (6) to move cursor to desired Id (Identification Number) (26). Press ENTER (5).
 - Use DATA ENTRY Keypad (4) to enter Selection (27). Press ENTER (5).
 - Once selections are defined, press "ESC" F6 (15) 4 times to return to RF Generator Menu.
7. Press 5 on DATA ENTRY Keypad (4). RF Gen Setup Submenu appears.
8. Press 1 on DATA ENTRY Keypad (4) to access RF Freq data field.

9. Use DATA ENTRY Keypad (4) to enter frequency. Press ENTER (5) to activate.
10. Press 4 on DATA ENTRY Keypad (4) to toggle RF Gen Level Units to desired units.
11. Press 2 on DATA ENTRY Keypad (4) to access RF Gen Level data field.
12. Use DATA ENTRY Keypad (4) to enter output level. Press ENTER (5).
 - To set a level other than 0 dBm, press +/- on DATA ENTRY Keypad (4) during data entry.
13. If output from DE MOD OUT Connector (10) or AUDIO OUT Connector (1 1) is desired:
 - Press 5 on DATA ENTRY Keypad (4) to toggle Source to Audio Out to On.
 - Press 6 on DATA ENTRY Keypad (4) to toggle Source to Demod Out to On.
14. If Speaker output is desired:
 - Press 7 on DATA ENTRY Keypad (4) to access To Speaker data field.
 - Use DATA SCROLL ↑ and ↓ Keys (7) until desired signal routed to Speaker is selected. Press ENTER (5).
15. Press "Ret" F5 (15) to return to RF Generator Operation Screen.

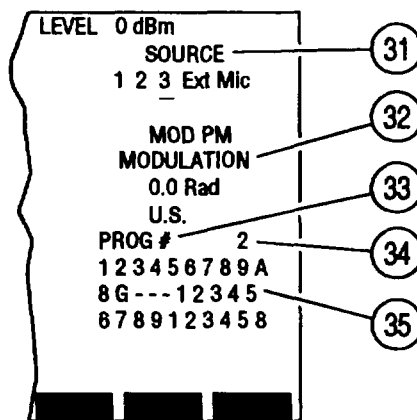

CE2FN539

16. Move cursor to SOURCE (31).
17. Press DATA SCROLL → Key (8) twice. Use DATA SCROLL ↑ and ↓ Keys (7) to select desired modulation type. Press ENTER (5).
18. Move cursor to DEVIATION/MODULATION (32). Use DATA ENTRY Keypad (4) to enter deviation frequency, if Modulation Type FM, or modulation level, if Modulation Type AM or PM. Press ENTER (5).
19. Move cursor to DIRECT ENTRY/PROG # (33). Press ENTER (5) to select DIRECT ENTRY or PROG #.
20. If DIRECT ENTRY is selected:
 - Move cursor to sequence (35).
 - Use DATA ENTRY Keypad (4) to enter sequence. Press ENTER (5).
21. If PROG # is selected:
 - Move cursor to Program number (34).
 - Use DATA ENTRY Keypad (4) to enter Id (Identification Number) of sequence programmed on Audio Format Menu. Press ENTER (5).

22. Verify settings are as desired.
 23. Connect BNC-N coax cable from T/R Connector (9) to UUT input.
 24. Press GO TEST CONTROL Key (2) to generate Audio Code continually.
 25. Press SGL STEP TEST CONTROL Key (2) to generate Audio "Code once.
 26. Press STOP TEST CONTROL Key (2) to stop Audio Code generation.
- f. Generate DCS or DCS Inverted Coded RF Signal.
1. Press RF GEN MODE Key (I), then SETUP Key (3) to access RF Generator Menu.
 2. Press 3 on DATA ENTRY Keypad (4). Signaling Format Submenu appears.
 3. Press 3 on DATA ENTRY Keypad (4). Digital Format Menu appears.
 4. Press 1 on DATA ENTRY Keypad (4) to select DCS Signaling Code. Press 2 on DATA ENTRY Keypad (4) to select DCS INV (Inverted) Signaling. Code. DCS Menu appears:

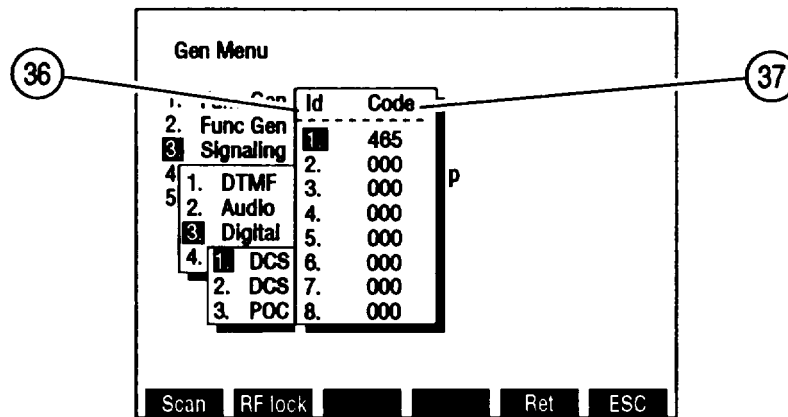

CE2FN540

5. Use FIELD SELECT ↑ and ↓ Keys (6) to move cursor to desired Id (Identification Number) (36). Press ENTER (5).
6. Use DATA ENTRY Keypad (4) to enter Code (37). Press ENTER (5).
7. Define other codes repeating steps 5 thru 6.
8. Press "ESC" F6 (15) 3 times to return to RF Generator Menu.
9. Press 5 on DATA ENTRY Keypad (4). RF Gen Setup Submenu appears.
10. Press 1 on DATA ENTRY Keypad (4) to access RF Freq data field.
11. Use DATA ENTRY Keypad (4) to enter frequency. Press ENTER (5) to activate.
12. Press 4 on DATA ENTRY Keypad (4) to toggle RF Gen Level Units to desired units.
13. Press 2 on DATA ENTRY Keypad (4) to access RF Gen Level data field.
14. Use DATA ENTRY Keypad (4) to enter output level. Press ENTER (5).
 - To set a level other than 0 dBm, press +/- on DATA ENTRY Keypad (4) during data entry.
15. If output from DEMOD OUT Connector (10) or AUDIO OUT Connector (11) is desired:
 - Press 5 on DATA ENTRY Keypad (4) to toggle Source to Audio Out to On.

- Press 6 on DATA ENTRY Keypad (4) to toggle Source to Demod Out to On.
16. If Speaker output is desired:
 - Press 7 on DATA ENTRY Keypad (4) to access To Speaker data field.
 - Use DATA SCROLL \uparrow and \downarrow Keys (8) until desired signal routed to Speaker is selected. Press ENTER (5).
 17. Press "Ret" F5 (15) to return to RF Generator Operation Screen.

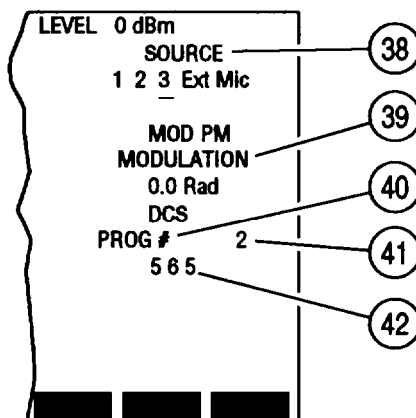

CE2FN544

18. Move cursor to SOURCE (38). Press ENTER (5).
19. Press DATA SCROLL \rightarrow Key (8) twice. Use DATA SCROLL \uparrow and \downarrow Keys (7) to select desired modulation type. Press ENTER (5).
20. Move cursor to DEVIATION/MODULATION (39). Use DATA ENTRY Keypad (4) to enter deviation frequency, if Modulation Type FM, or modulation level, if Modulation Type AM or PM. Press ENTER (5).
21. Move cursor to DIRECT ENTRY/PROG # (40). Press ENTER (5) to select DIRECT ENTRY or PROG #.
22. If DIRECT ENTRY is selected:
 - Move cursor to sequence (42).
 - Use DATA ENTRY Keypad (4) to enter sequence. Press ENTER (5).
23. If PROG # is selected:
 - Move cursor to Program number (41).
 - Use DATA ENTRY Keypad (4) to enter Id (Identification Number) of sequence programmed on Digital Format Menu. Press ENTER (5).
24. Verify settings are as desired.
25. Connect BNC-N coax cable from T/R Connector (9) to UUT input.
26. Press GO TEST CONTROL Key (2) to generate DCS Code continually.
27. Press STOP TEST CONTROL Key (2) to stop DCS Code generation.

g. Generate POCSAG Coded RF Signal.

1. Press RF GEN MODE Key (1), then SETUP Key (3) to access RF Generator Menu.
2. Press 3 on DATA ENTRY Keypad (4). Signaling Format Submenu appears.
3. Press 3 on DATA ENTRY Keypad (4). Digital Format Menu appears.
4. Press 3 on DATA ENTRY Keypad (4). POCSAG Menu appears:

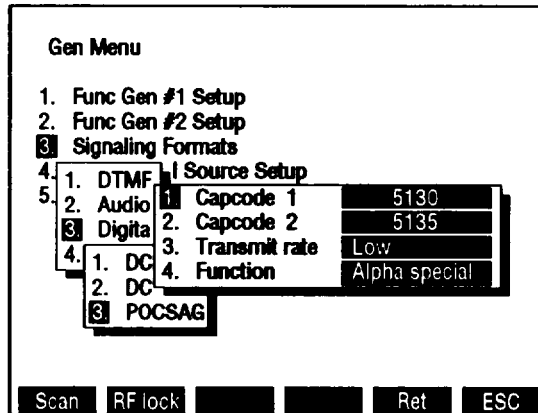

CE2FN541

5. Press 1 on DATA ENTRY Keypad (4). Use DATA ENTRY Keypad (4) to enter Capcode 1. Press ENTER (5).
6. Press 2 on DATA ENTRY Keypad (4). Use DATA ENTRY Keypad (4) to enter Capcode 2. Press ENTER (5).
7. Press 3 on DATA ENTRY Keypad (4) until POCSAG rate is set as desired.
8. Press 4 on DATA ENTRY Keypad (4). Submenu appears. Press DATA SCROLL ↑ and ↓ Keys (7) to select POCSAG function. Press ENTER (5).
9. Press "ESC" F6 (15) 3 times to return to RF Generator Menu.
10. Press 5 on DATA ENTRY Keypad (4). RF Gen Setup Submenu appears.
11. Press 1 on DATA ENTRY Keypad (4) to access RF Freq data field.
12. Use DATA ENTRY Keypad (4) to enter frequency. Press ENTER (5) to activate.
13. Press 4 on DATA ENTRY Keypad (4) to toggle RF Gen Level Units to desired units.
14. Press 2 on DATA ENTRY Keypad (4) to access RF Gen Level data field.
15. Use DATA ENTRY Keypad (4) to enter output level. Press ENTER (5).
 - To set a level other than 0 dBm, press +/- on DATA ENTRY Keypad during data entry.
 - RF Generator output is present at T/R Connector (9).
16. If output from DEMOD OUT Connector (10) or AUDIO OUT Connector (11) is desired:
 - Press 5 on DATA ENTRY Keypad (4) to toggle Source to Audio Out to On.
 - Press 6 on DATA ENTRY Keypad (4) to toggle Source to Demod Out to On.
17. If Speaker output is desired:
 - Press 7 on DATA ENTRY Keypad (4) to access To Speaker data field.

- Use DATA SCROLL ↑ and ↓ Keys (7) until desired signal routed to Speaker is selected. Press ENTER (5).

18. Press "Ret" F5 (15) to return to RF Generator Operation Screen.

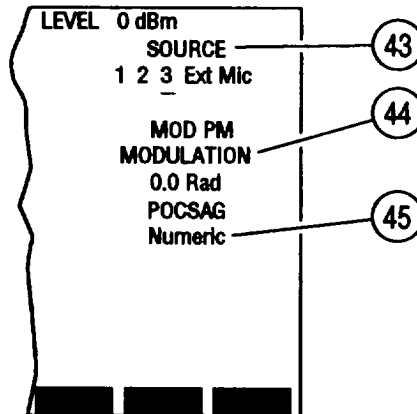

CE2FN545

19. Move cursor to SOURCE (43). Press ENTER (5).
20. Press DATA SCROLL → Key (8) twice. Use DATA SCROLL ↑ and ↓ Keys (7) to select desired modulation type. Press ENTER (5).
21. Move cursor to DEVIATION/MODULATION (44). Use DATA ENTRY Keypad (4) to enter deviation frequency, if Modulation Type FM, or modulation level, if Modulation Type AM or PM. Press ENTER (5).
22. Move cursor to POCSAG Type (45). Use DATA SCROLL ↑ and ↓ Keys (7) to select POCSAG Type. Press ENTER (5).
23. Verify settings are as desired.
24. Connect BNC-N coax cable from T/R Connector (9) to UUT input.
25. Press GO TEST CONTROL Key (2) to generate POCSAG Code from Capcode 1 thru Capcode 2.
26. Press SGL STEP TEST CONTROL Key (2) to generate POCSAG Code from Capcode 1 thru Capcode 2 once.
27. Press STOP TEST CONTROL Key (2) to stop POCSAG generation.

h. Generate IMTS, MTS or 2805 Coded RF Signal.

1. Press RF GEN MODE Key (1), then SETUP Key (3) to access RF Generator Menu.
2. Press 3 on DATA ENTRY Keypad (4). Signaling Format Submenu appears.
3. Press 4 on DATA ENTRY Keypad (4). RCC Format Menu appears. Press 1 on DATA ENTRY Keypad (4) to select IMTS Signaling Code. Press 2 on DATA ENTRY Keypad (4) to select MTS Signaling Code. Press 3 on DATA ENTRY Keypad (4) to select 2805 Signaling Code. RCC Code Menu appears:

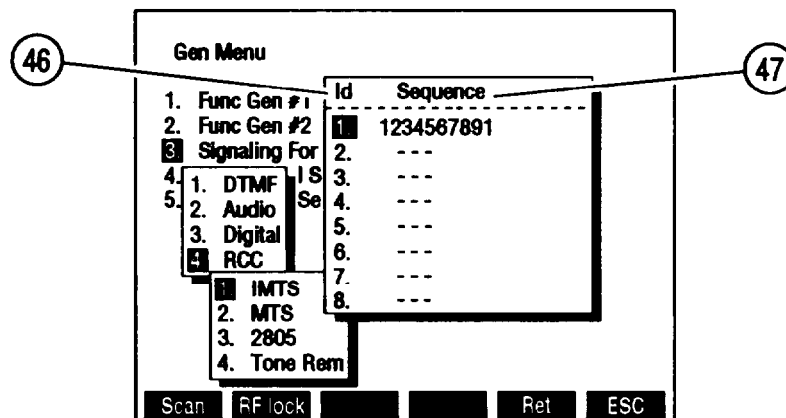

CE2FN542

4. Use FIELD SELECT ↑ and ↓ Keys (6) to move cursor to desired Id (Identification Number) (46). Press ENTER (5).
5. Use DATA ENTRY Keypad (4) to enter Sequence (47). Press ENTER (5).
6. Define other sequences repeating steps 4 thru 5.
7. Press "ESC"-F6 (15) 3 times to return to RF Generator Menu.
8. Press 5 on DATA ENTRY Keypad (4). RF Gen Setup Submenu appears.
9. Press 1 on DATA ENTRY Keypad (4) to access RF Freq data field.
10. Use DATA ENTRY Keypad (4) to enter frequency. Press ENTER (5) to activate.
11. Press 4 on DATA ENTRY Keypad (4) to toggle RF Gen Level Units to desired units.
12. Press 2 on DATA ENTRY Keypad (4) to access RF Gen Level data field.
13. Use DATA ENTRY Keypad (4) to enter output level. Press ENTER (5).
 - To set a level other than 0 dBm, press +/- on DATA ENTRY Keypad (4) during data entry.
 - RF Generator output is present at T/R Connector (9).
14. If output from DEMOD OUT Connector (10) or AUDIO OUT Connector (11) is desired:
 - Press 5 on DATA ENTRY Keypad (4) to toggle Source to Audio Out to On.
 - Press 6 on DATA ENTRY Keypad (4) to toggle Source to Demod Out to On.
15. If Speaker output is desired:
 - Press 7 on DATA ENTRY Keypad (4) to access To Speaker data field.
 - Use DATA SCROLL ↑ and ↓ Keys (7) until desired signal routed to Speaker is selected. Press ENTER (5).

16. Press "Ret" F5 (15) to return to RF Generator Operation Screen.

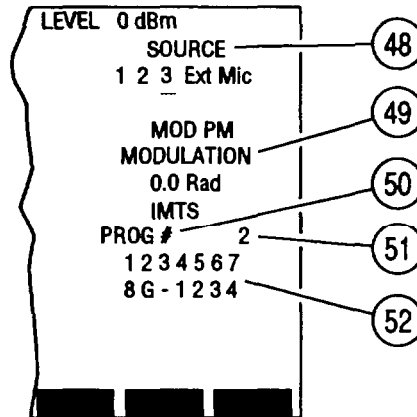

CE2FN546

17. Move cursor to SOURCE (48). Press ENTER
18. Press DATA SCROLL → Key (8) twice. Use DATA SCROLL ↑ and ↓ Keys (7) to select desired modulation type. Press ENTER (5).
19. Move cursor to DEVIATION/MODULATION (49). Use DATA ENTRY Keypad (4) to enter deviation frequency, if Modulation Type FM, or modulation level, if Modulation Type AM or PM. Press ENTER (5).
20. Move cursor to DIRECT ENTRY/PROG # (50). Press ENTER (5) to select DIRECT ENTRY or PROG #.
21. If DIRECT ENTRY is selected:
 - Move cursor to sequence (52).
 - Use DATA ENTRY Keypad (4) to enter sequence. Press ENTER (5).
22. If PROG # is selected:
 - Move cursor to Program number (51).
 - Use DATA ENTRY Keypad (4) to enter Id (Identification Number) of sequence programmed on DTMF Format Menu. Press ENTER (5).
23. Verify settings are as desired.
24. Connect BNC-N coax cable from T/R Connector (9) to UUT input.
25. Press GO TEST CONTROL Key (2) to generate selected RCC Code continually.
26. Press SGL STEP TEST CONTROL Key (2) to generate selected RCC Code once.
27. Press STOP TEST CONTROL Key (2) to stop RCC Code generation.

I. Generate Tone Remote Signal.

Refer to paragraph 2-14e for generating Tone Remote.

j. Generate RF Frequency Scan.

1. Press RF GEN MODE Key (1), then SETUP Key (3) to access RF Generator Menu.
2. Press "Scan" F1 (15). RF Frequency Scan Menu appears:

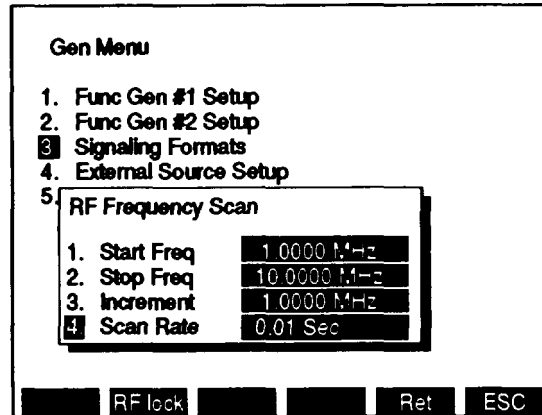

CE2FN547

3. Press 1 on DATA ENTRY Keypad (4). Start Freq data field highlights.
4. Use DATA ENTRY Keypad (4) to enter starting frequency. Press ENTER (5).
5. Press 2 on DATA ENTRY Keypad (4). Stop Freq data field highlights.
6. Use DATA ENTRY Keypad (4) to enter stopping frequency. Press ENTER (5).
7. Press 3 on DATA ENTRY Keypad (4). Increment data field highlights.
8. Use DATA ENTRY Keypad (4) to enter increment. Press ENTER (5).
9. Press 4 on DATA ENTRY Keypad (4). Scan Rate data field highlights.
10. Use DATA ENTRY Keypad (4) to enter scan rate. Press ENTER (5).
11. Press "ESC" F6 (15) to return to RF Generator Menu.
12. Press 1 on DATA ENTRY Keypad (4) to access submenu.
13. Press 1 on DATA ENTRY Keypad (4). Func Gen 1 data field highlights.
14. Use DATA SCROLL ↑ and ↓ Keys (7) to select modulation type. Press ENTER (5).
15. Press 2 on DATA ENTRY Keypad (4). Freq data field highlights.
16. Use DATA ENTRY Keypad (4) to enter digits of Audio Frequency. Press ENTER (5).
17. Press 3 on DATA ENTRY Keypad (4). Wave Form Submenu appears.
18. Press number of desired wave form on DATA ENTRY Keypad (4).
19. Press 4 on DATA ENTRY Keypad (4). FM Dev, AM Mod or PM Mod data field highlights.
20. Use DATA ENTRY Keypad (4) to enter digits of FM deviation frequency, AM modulation or PM modulation. Press ENTER (5).
21. Press "ESC" F6 (15) to return to RF Generator Menu.
22. Press 5 on DATA ENTRY Keypad (4). RF Gen Setup Submenu appears.
23. Press 4 on DATA ENTRY Keypad (4) to toggle RF Gen Level Units to desired units.
24. Press 2 on DATA ENTRY Keypad (4) to access RF Gen Level data field.

25. Use DATA ENTRY Keypad (4) to enter output level. Press ENTER (5).
 - To set a level other than 0 dBm, press +/- on DATA ENTRY Keypad (4) during data entry.
26. If output from DE MOD OUT Connector (10) or AUDIO OUT Connector (11) is desired:
 - Press 5 on DATA ENTRY Keypad (4) to toggle Source to Audio Out to On.
 - Press 6 on DATA ENTRY Keypad (4) to toggle Source to Demod Out to On.
27. Press "Ret" F5 (15) to return to RF Generator Operation Screen.
28. Verify settings are as desired.
29. Connect BNC-N coax cable from T/R Connector (9) to UUT input.
30. Press "More" F6 (15) until "G Scan" F3 (15) appears. Press "G Scan" F3 (15) to start RF Frequency Scan.
31. Press "G Scan" F3 (15) to stop RF Frequency Scan.

2-12. RECEIVER.

Operate Receiver by following procedures:

- a. Receiver Setup.
- b. Power Measurement.
- c. FM Deviation, AM Modulation or PM Phase Measurements.
- d. Distortion, SINAD, Phase (RMS), Deviation (RMS) or Digital Multimeter Measurements.
- e. Off-the-Air Receiver Measurements.
- f. DTMF, DCS or DCS INV (Inverted) Decode.
- g. POC SAG Decode.
- h. Receiver Scan.

NOTE

- Reset Factory Defaults before performing each operating procedure (para 2-9).
- Do not press any Soft Function Keys unless directed by procedures.
- To recall a set of stored screen parameters, use Test Set memory RCL (Recall) Key. For information on use of Store and Recall Keys, refer to operator's controls, indicators and connectors (para 2-2).
- Valid meter indications for Test Set Receiver do not display until Squelch is broken, as shown below.

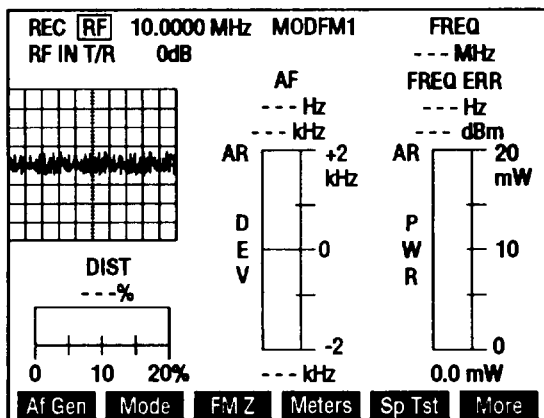

Receive Screen with Squelch Unbroken.

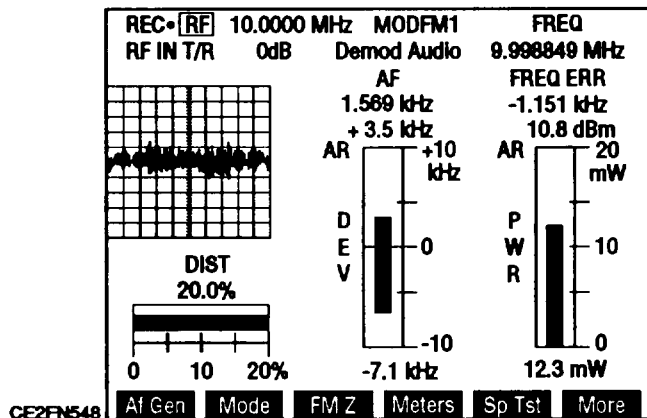

Receive Screen with Squelch Broken.

Table 2-2. Recommended Modulation Type Usage (Receiver).

MODE	RECEIVER IF BANDWIDTH	AUDIO BANDWIDTH	RECOMMENDED USE
FM1	30 kHz	3 kHz	Land mobile radios at low modulation rates.
FM2	30 kHz	10 kHz	Land mobile radios at moderate modulation rates.
FM3	300 kHz	20 kHz	Commercial FM transmitters or wide-deviation FM transmitters at medium modulation rates.
FM4	300 kHz	75 kHz	Commercial FM transmitters or wide-deviation FM transmitters at high modulation rates.
AM1	2.9 kHz	3.0 kHz	Off-the-air AM monitoring.
AM2	30 kHz	10 kHz	Direct-connection AM monitoring.
USB	2.9 kHz	3.0 kHz	Upper Sideband used to demodulate Single Sideband carrier.
LSB	2.9 kHz	3.0 kHz	Lower Sideband used to demodulate Single Sideband carrier.
BFO			Used to generate tone for testing Continuous Wave carriers.
User Defined	3 kHz 30 kHz 300 kHz	All Pass Low Pass (0.1 kHz-30 kHz) High Pass (0.5 kHz-20 kHz) Band Pass (0.5 kHz -30 kHz) C WT	General purpose usage as defined by user.

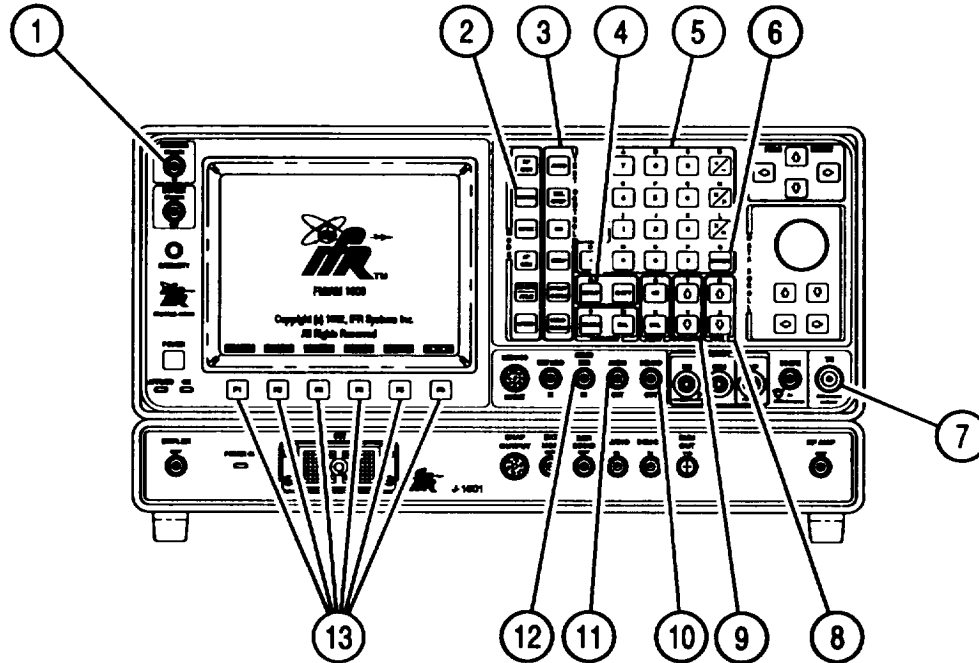

CE2FN690

CAUTION

- Maximum continuous input to ANTENNA IN Connector (1) is limited to 1/2 W with protection provided to a maximum input of 65 W.
- Maximum continuous input to T/R Connector (7) is limited to 50 W with protection provided to a maximum input of 200 W.

a. Receiver Setup.

1. Press RCVR MODE Key (2), then SETUP Key (4) to display Receiver Menu.

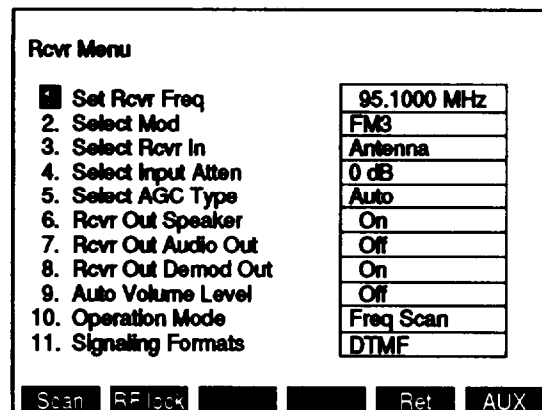

CE2FN650

2. Press 1 on DATA ENTRY Keypad (5) to highlight Set Rcvr Freq data field.
3. Use DATA ENTRY Keypad (5) to enter digits of receiver frequency. Press ENTER (6).

4. Press 2 on DATA ENTRY Keypad (5) to display Modulation Type Submenu.
5. Press number of desired modulation type on DATA ENTRY Keypad (5). See Table 2-2 for information on Modulation Type.
6. Press 3 on DATA ENTRY Keypad (5) to toggle Receiver Input to T/R.
7. Press 4 on DATA ENTRY Keypad (5) to display Receiver Attenuation Submenu.
8. Press number of desired input attenuation on DATA ENTRY Keypad (5).
9. Press 5 on DATA ENTRY Keypad (5) to display Automatic Gain Control Submenu.
10. Press number of Automatic Gain Control (AGC) Type on DATA ENTRY Keypad (5).
 - Unless specific Automatic Gain Control (AGC) settings are needed, select Auto AGC Type.
11. Make other adjustments to Rcvr Menu as desired.
 - If received signal output from Test Set Speaker is desired, press 6 on DATA ENTRY Keypad (5) to toggle Rcvr Out Speaker to On.
 - If received signal output to AUDIO OUT Connector (1 1) is desired, press 7 on DATA ENTRY Keypad (5) to toggle Rcvr Out Audio Out to On.
 - If received signal output to DE MOD OUT Connector (10) is desired, press 8 on DATA ENTRY Keypad (5) to toggle Rcvr Out Demod Out to On.
 - If Auto Volume Level of output from Test Set Speaker is desired, press 9 on DATA ENTRY Keypad (5) to toggle Auto Volume Level to On.
12. Press "Ret" F5 (13) to return to Receive Operation Screen. Verify settings of Receiver are as desired.
13. Press a SQLCH Control Key (9). Squelch Level Indicator appears. Press SQLCH Control Keys (9) until squelch is broken. Press ENTER (6).
14. Press a VOL Control Key (8). Volume Level Indicator appears. Press VOL Control Keys (8) until set as desired. Press ENTER (6).

b. Power Measurement.

NOTE

Power Measurement can only be performed on signals received at T/R Connector (7).

1. Press RCVR MODE Key (3). Perform Receiver Setup (para 2-12a).

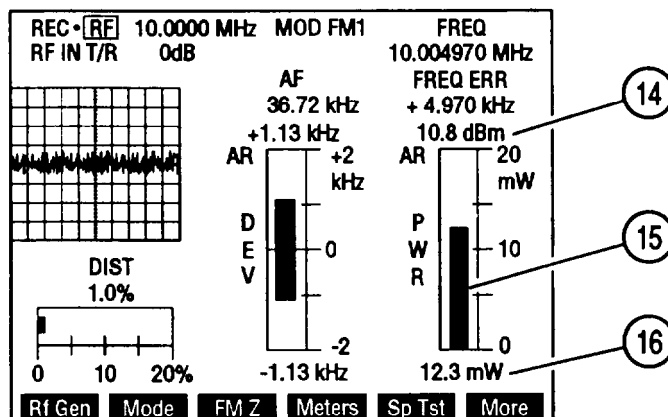

CE2FN551

2. Move cursor to Power Meter callout. Press ENTER (6) to display Power Meter Operation Screen.
 - Set meter to desired values as detailed in paragraph 2-19. Press "Ret" F6 (13) to return to Receive Operation Screen.
3. Attach BNC-N coax cable from UUT to T/R Connector (7).
 - Digital Readout (16) shows numeric value of Power Meter Indicator Bar (15) in W or mW. When enabled, dBm readout (14) shows numeric value of Power Meter Indicator Bar (15) in dBm.

c. FM Deviation, AM Modulation or PM Phase Measurements.

1. Press RCVR MODE Key (2). Perform Receiver Setup (para 2-12a).

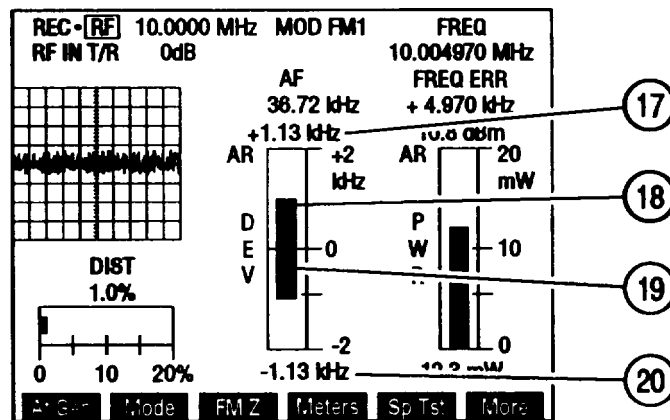

CE2FN552

2. Attach BNC-N coax cable from UUT to T/R Connector (7).
3. If FM Deviation measurement is required, move cursor to Deviation Meter callout. Press ENTER (6) to display Deviation Meter Operation Screen.
 - Set meter to desired values as detailed in paragraph 2-20. Press "Ret" F6 (13) to return to Receive Operation Screen.
 - Press "More" F6 (13) until "FM Z" F3 (13) appears. Press "FM Z" F3 (13) to zero Deviation Meter.
 - If Deviation Meter Mode is +Peak, -Peak or +/-Peak/2, Digital Readout (20) shows numeric value of Deviation Meter Indicator Bar (18). Digital Readout (17) does not appear.
 - If Deviation Meter Mode is +/-Peak, Positive Digital Readout (17) shows numeric value of Positive Deviation Meter Indicator Bar (18). Negative Digital Readout (20) shows numeric value of Negative Deviation Meter Indicator Bar (19).

- If AM Modulation measurement is required, move cursor to Modulation Meter callout. Press ENTER (6) to display Modulation Meter Operation Screen.

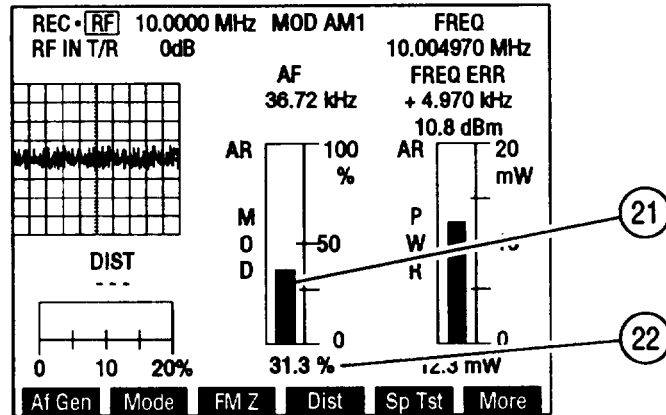

CE2FN553

- Set meter to desired values as detailed in paragraph 2-21. Press “Ret” F6 (13) to return to Receive Operation Screen.
 - Press “More” F6 (13) until “Af Gen” F1 (13) appears. Press F4 (13) until Modulation Meter is activated.
 - Digital Readout (22) shows numeric value of Meter Indicator Bar (21).
- If PM Phase measurement is required, move cursor to Phase Meter callout. Press ENTER (6) to display Phase Meter Operation Screen.

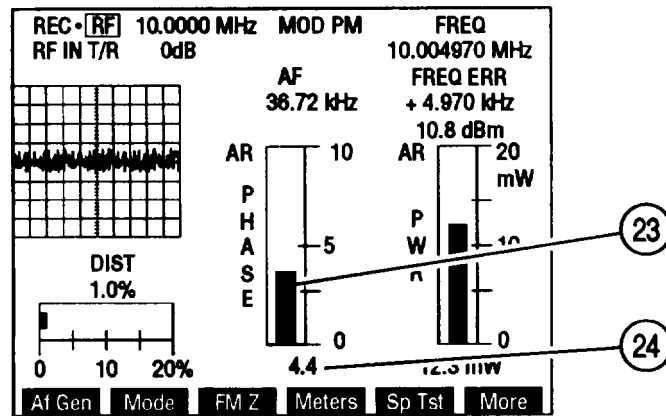

CE2FN554

- Set meter to desired values as detailed in paragraph 2-27. Press “Ret” F6 (13) to return to Receive Operation Screen.
- Digital Readout (24) shows numeric value of Meter Indicator Bar (23).

d. Distortion, SINAD, Phase (RMS), Deviation (RMS) or Digital Multimeter Measurement.

1. Press RCVR MODE Key (2). Perform Receiver Setup (para 2-12a).

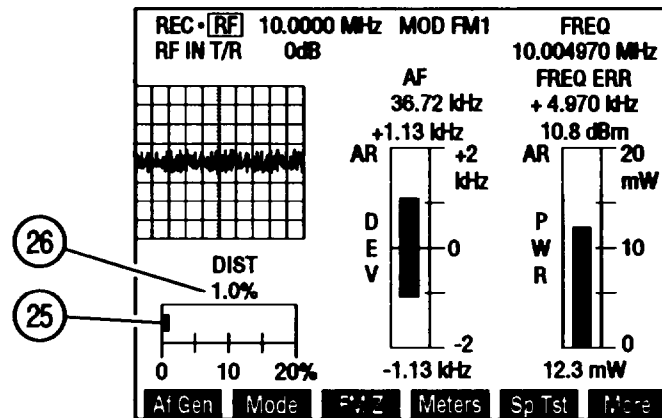

CE2FN555

2. Attach BNC-N coax cable from UUT to T/R Connector (7).
3. If Distortion measurement is required:
 - If Modulation Type is AM, press "More" F6 (13) until "Dist" or "Modul" F4 (13) appears. Press F4 (13) until Distortion Meter active.
 - If Modulation Type is FM or PM, press "More" F6 (13) until "Meters" F4 (13) appears. Press "Meters" F4 (13). Press 1 on DATA ENTRY Keypad (5).
 - Move cursor to Distortion Meter callout. Press ENTER (6) to display Distortion Meter Operation Screen.
 - Set meter to desired values as detailed in paragraph 2-22. Press "Ret" F6 (13) to return to Receive Operation Screen.
 - Digital Readout (26) shows numeric value of Meter Indicator Bar (25).
4. If SINAD measurement is required:
 - Press "More" F6 (13) until "Meters" F4 (13) appears. Press "Meters" F4 (13). Press 2 on DATA ENTRY Keypad (5).
 - Move cursor to SINAD Meter callout. Press ENTER (6) to display SINAD Meter Operation Screen.
 - Set meter to desired values as detailed in paragraph 2-23. Press "Ret" F6 (13) to return to Receive Operation Screen.
 - Digital Readout (26) shows numeric value of Meter Indicator Bar (25).
5. If Phase (RMS) measurement is required:
 - Press "More" F6 (13) until "Meters" F4 (13) appears. Press "Meters" F4 (13). Press 3 on DATA ENTRY Keypad (5).
 - Move cursor to Phase (RMS) Meter callout. Press ENTER (6) to display Phase (RMS) Meter Operation Screen.
 - Set meter to desired values as detailed in paragraph 2-29. Press "Ret" F6 (13) to return to Receive Operation Screen.
 - Digital Readout (26) shows numeric value of Meter Indicator Bar (25).

6. If Deviation (R MS) measurement is required:

- Press "More" F6 (13) until "Meters" F4 (13) appears. Press "Meters" F4 (13). Press 3 on DATA ENTRY Keypad (5).
 - Move cursor to Deviation (RMS) Meter callout. Press ENTER (6) to display Deviation (R MS) Meter Operation Screen.
 - Set meter to desired values as detailed in paragraph 2-28. Press "Ret" F6 (13) to return to Receive Operation Screen.
- Digital Readout (26) shows numeric value of Meter Indicator Bar (25).

NOTE

Deviation (Peak) Meter Range must be set on 2, 5 or 10 kHz for accurate Deviation (R MS) Meter reading.

7. If Digital Multimeter measurement is required:

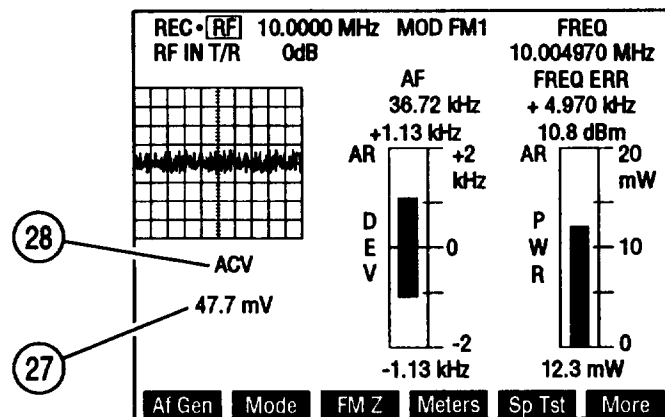

CE2FN556

- Press "More" F6 (13) until "Meters" F4 (13) appears. Press "Meters" F4 (13). Press 4 on DATA ENTRY Keypad (5).
- Move cursor to Digital Multi meter callout (28). Press ENTER (6) to display Digital Multimeter Operation Screen.
- Set meter to desired values as detailed in paragraph 2-26. Press "Ret" F6 (13) to return to Receive Operation Screen.
- Digital Multimeter callout (28) displays Multimeter Function active.
- Digital Readout (27) shows Digital Multimeter reading.

e. Off-the-Air Receiver Measurements.**NOTE**

Off-the-Air Measurements are relative measurements of signals received at ANTENNA IN Connector (1). Atmospheric conditions, distance between transmitting antenna and receiving antenna and interference from other radios may affect received signals.

1. Press RCVR MODE Key (2). Perform Receiver Setup (para 2-12a).
2. Move cursor to RF IN. Press ENTER (6) until ANT appears.
3. Verify settings of Receiver are as desired.
4. Move cursor to Signal Strength Meter callout. Press ENTER (6) to display Signal Strength Meter Operation Screen.
 - Set meter to desired values as detailed in paragraph 2-24. Press 'Ret' F6 (13) to return to Receive Operation Screen.
5. Attach Flexible Antenna (Appendix C, item 6) to ANTENNA IN Connector (1).
 - Digital Readout shows relative numeric value of Signal Strength Meter Indicator Bar as a percentage of 30 dB.

NOTE

For received signals that indicate 95% or greater, add attenuation to input signal or increase distance between transmitting and receiving antenna.

- For Off-the-Air radio tests, refer to Appendix I, Drive-By Test.

f. DTMF, DCS or DCS INV (Inverted) Decode.

1. Press RCVR MODE Key (2). Perform Receiver Setup (para 2-12a).
2. Press SETUP Key (4) to display Receiver Menu. Move cursor to 11. Press ENTER (6) to highlight data field. Use DATA ENTRY Keypad (5) to select signaling Format. If Digital is selected, use DATA ENTRY Keypad (5) to select DCS or DCS INV (inverted).
3. Press 'Ret' F5 (13) to return to Receive Operation Screen.
4. If DCS or DCS INV is selected, press "More" F6 (13) until "Input" F5 (13) appears. Press "Input" F5 (13). Use DATA ENTRY Keypad (5) to select Decode Input.
5. Press "Decode" F2 (13) to start decoding. Press "Stop" F3 (13) to stop decoding. Decoded data (29) appears as decoded.

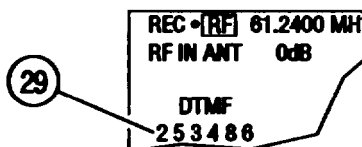

CE2FN557

g. **POCSAG Decode.**

1. Press RCVR MODE Key (2). Perform Receiver Setup (para 2-12a).
2. Press SETUP Key (4) to display Receiver Menu. Move cursor to 11, press ENTER (6) to highlight data field. Press 2 on DATA ENTRY Keypad (5). Press 3 on DATA ENTRY Keypad (5).
3. Press "Ret" F5 (13) to return to Receive Operation Screen.
4. Press "More" F6 (13) until "Extend" F5 (13) appears. Press "Extend" F5 (13) to display Extend Screen.
5. Press "Input" F1 (13). Use DATA ENTRY Keypad (5) to select Decode Input.
6. Press "Rate" F4 (13) to toggle POCSAG rate (32) Low or High.
7. Press "Decode" F2 (13) to start decoding. Press "Stop" F3 (13) to stop decoding. Decoded POCSAG message (30), capcode (31) and function type (33) appear decoded.

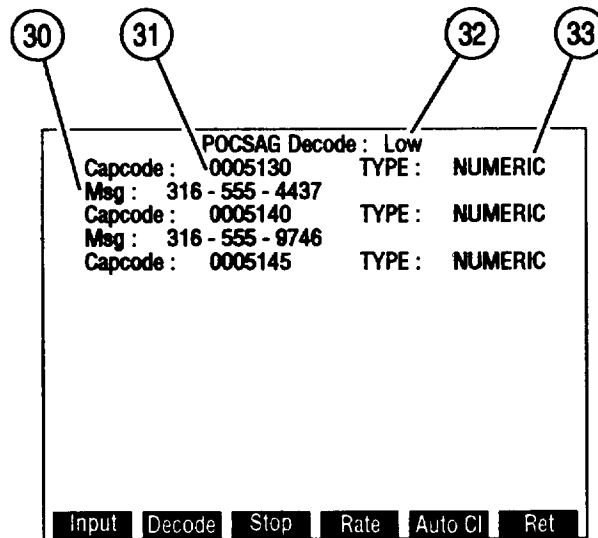

CE2FN558

8. Press "Ret" F6 (13) to return to Receive Operation Screen.

h. **Receiver Scan.**

1. Press RCVR MODE Key (2). Perform Receiver Setup (para 2-12a).
2. Press SETUP Key (4). Press "Scan" F1 (13) to display Receive Scan Menu.

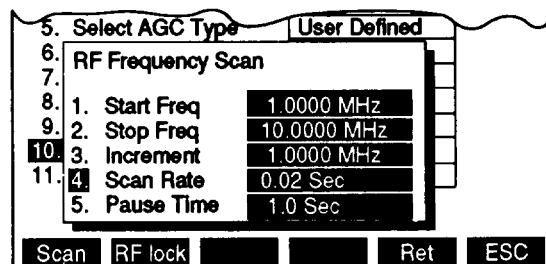

CE2FN579

3. Press 1 on DATA ENTRY Keypad (5). Start Freq data field highlights.

4. Use DATA ENTRY Keypad (5) to enter starting frequency. Press ENTER (6).
5. Press 2 on DATA ENTRY Keypad (5). Stop Freq data field highlights.
6. Use DATA ENTRY Keypad (5) to enter stopping frequency. Press ENTER (6).
7. Press 3 on DATA ENTRY Keypad (5). Increment data field highlights.
8. Use DATA ENTRY Keypad (5) to enter increment. Press ENTER (6).
9. Press 4 on DATA ENTRY Keypad (5). Scan Rate data field highlights.
10. Use DATA ENTRY Keypad (5) to enter scan rate. Press ENTER (6).
11. Press 5 on DATA ENTRY Keypad (5). Pause Time data field highlights.
12. Use DATA ENTRY Keypad (5) to enter pause time. Press ENTER (6).
13. Press "ESC" F6 (13) to return to Receiver Operation Screen.
14. Move cursor to 10. Press ENTER (6). Press 3 on DATA ENTRY Keypad (5).
15. Press "Ret" F5 (13) to return to Receive Operation Screen.
16. Press GO TEST CONTROL Key (3) to scan sequence repeatedly.
17. Press STOP TEST CONTROL Key (3) to stop scanning.
18. Press SGL STEP TEST CONTROL Key (3) to step through sequence one increment at a time.
19. Press AUTO TEST CONTROL Key (3) to step through sequence backwards one increment at a time.

2-13. DUPLEX.

Operate Duplex by following procedure:

- a. Duplex Transmitter Setup.
- b. Duplex Receiver Setup.
- c. Duplex Operation.

NOTE

- Duplex operations are labeled in reference to UUT, not Test Set. Duplex Transmitter is a Test Set Receive function. Duplex Receiver is a Test Set RF Generator function.
- Valid meter indications for any Test Set Receive Function, including Duplex Transmitter, does not display until Squelch is broken, as shown below.

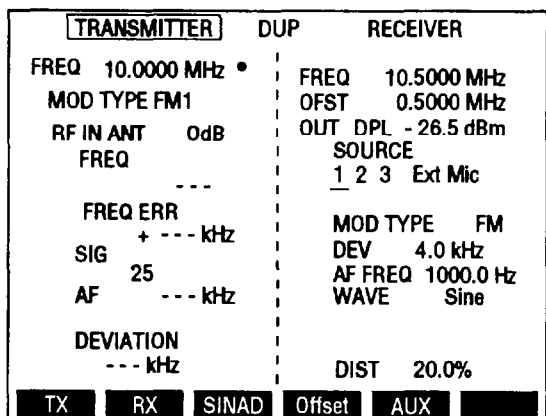

CE2FN559

Duplex Transmitter Screen with Squelch Unbroken.

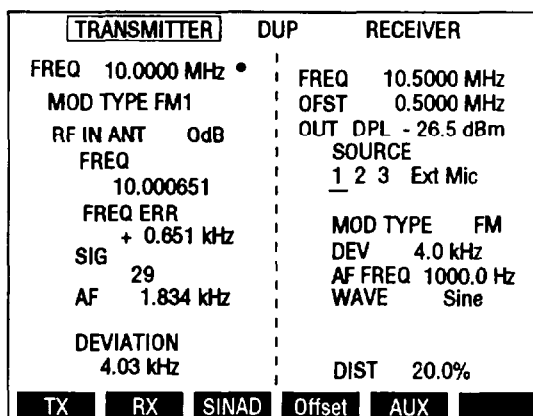

CE2FN560

Duplex Transmitter Screen with Squelch Broken.

- a. Duplex Transmitter Setup.

NOTE

- Reset Factory Defaults before performing each operating procedure (para 2-9).
- Do not press any Soft Function Keys unless directed by procedures.
- Operation Screens appear on CRT in last configuration used.
- To recall a set of stored screen parameters, use Test Set memory RCL (Recall) Key. For information on use of Store and Recall Keys, refer to operator's controls, indicators and connectors (para 2-2).

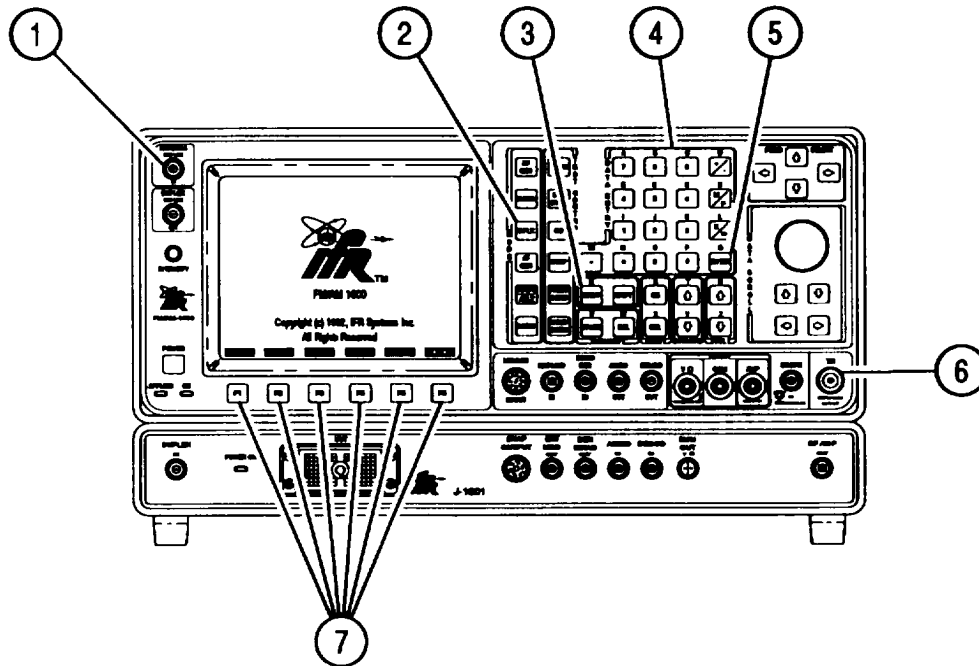

CE2FN691

CAUTION

- Maximum continuous input to ANTENNA IN Connector (1) is limited to 1/2 W with protection provided to a maximum input of 65 W.
- Maximum continuous input to T/R Connector (6) is limited to 50 W with protection provided to a maximum input of 200 W.

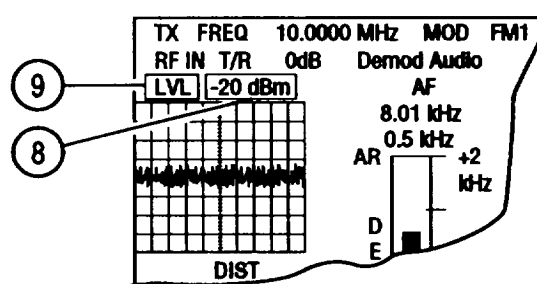

CE2FN661

1. Press DPLX MODE Key (2), then “TX” F1 (7) to access Duplex Transmitter Operation Screen.
2. Move cursor to LVL (9). Press ENTER (5). Output level data field (8) highlights.
3. Use DATA ENTRY Keypad (4) to enter digits of output level. Press ENTER (5).
 - To set any level other than 0 dBm, press +/- on DATA ENTRY Keypad (4) during data entry.
 - Changing output level from Duplex Transmitter Operation Screen changes output level of Duplex Receiver Operation Screen.

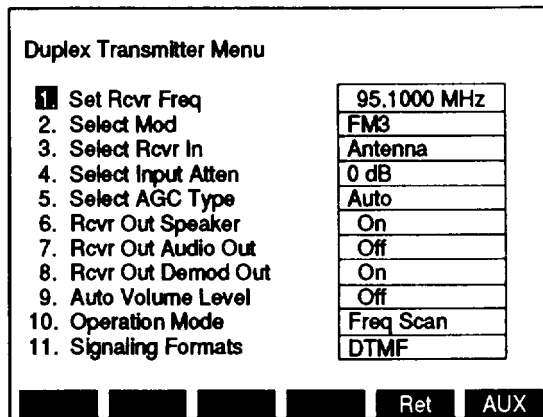

CE2FN562

4. Press SETUP Key (3) to access Duplex Transmitter Menu.
5. Perform Receiver Setup (para 2-12a).
6. Perform Receiver Operating procedures (para 2-12b, 2-12c, 2-12d, 2-12e, 2-12f and 2-12g, steps 2 and on) for Duplex Transmitter operation.

b. Duplex Receiver Setup. In Duplex Receiver operation, Duplex Transmitter (TX) Frequency is the controlling frequency. Duplex Receiver Frequency (RX) and Offset (OFST) Frequency (difference between TX and RX Frequency) react to changes in TX Frequency.

- If RX Frequency is active (blue RX), OFST displays red. Changing TX or RX Frequency changes OFST Frequency.
- If OFST Frequency is active (blue OFST), RX displays red. Changing TX or OFST Frequency changes RX Frequency.
- If RX is greater than TX, OFST is positive. If RX is less than TX, OFST is negative.

NOTE

- Reset Factory Defaults before performing each operating procedure (para 2-9).
- Do not press any Soft Function Keys unless directed by procedures.
- Operation screens appear on CRT in last configuration used.
- To recall a set of stored screen parameters, use Test Set memory RCL (Recall) Key. For information on use of Store and Recall Keys, refer to operator's controls, indicators and connectors (para 2-2).
- RF Output is referenced to 50 Ohms.

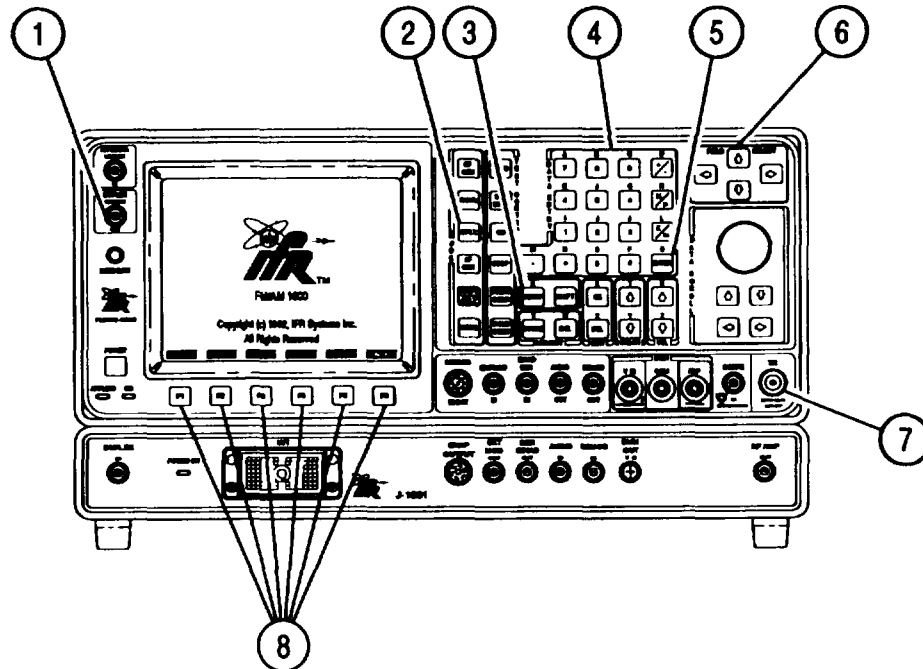

CE2FN692

1. Press DPLX MODE Key (2), then “RX” F2 (8) to access Duplex Receiver Operation Screen.

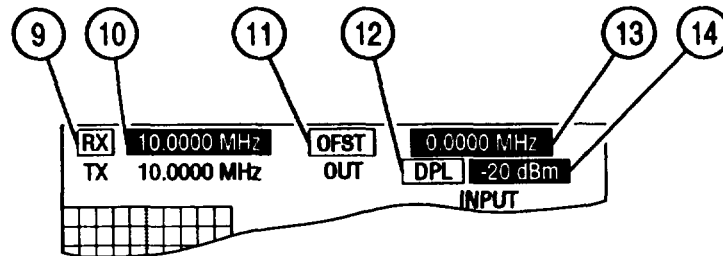

CE2FN563

2. Press “More” F6 (8) until ‘Offset’ or “R Freq” displays as definition for F5 (8).
3. Press F5 (8):
 - If Definition is “Offset,” OFST (11) activates and data field (13) highlights.
 - If Definition is “R Freq,” RX (9) activates and data field (10) highlights.
4. Use DATA ENTRY Keypad (4) to enter digits of RX or OFST Frequency. Press ENTER (5).
 - To enter negative Offset, press +/- on DATA ENTRY Keypad (4) during data entry.
5. Use FIELD SELECT Keys (6) to move cursor to OUT data field (12). Press ENTER (5) to toggle OUT between DPL (DUPLEX OUT Connector [1]) and T/R (T/R Connector [7]).
 - Output Level (14) may change by ± 7 dBm as OUT data field (12) toggles.

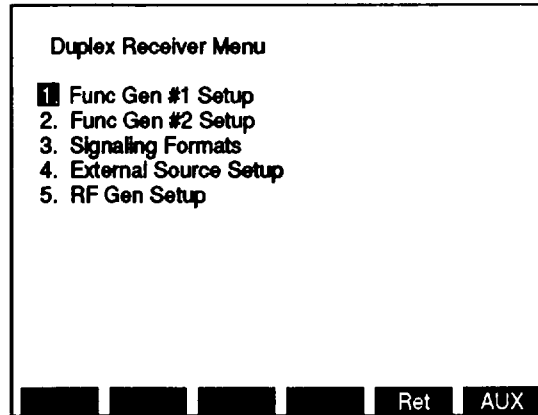

CE2FN564

6. Press SETUP Key (3) to access Duplex Receiver Menu.
7. Perform RF Generator Operating procedures (para 2-11a, 2-11b, 2-11c, 2-11d, 2-11e, 2-11f, 2-11g and 2-11h, steps 2 and on) for Duplex Receiver operation.

c. Duplex Operation.

1. Perform Duplex Transmitter Setup (para 2-13a).
2. Perform Duplex Receiver Setup (para 2-13b).
3. Press DPLX MODE Key (2) to return to Duplex Operation Screen. Verify settings for Duplex operation are as desired.

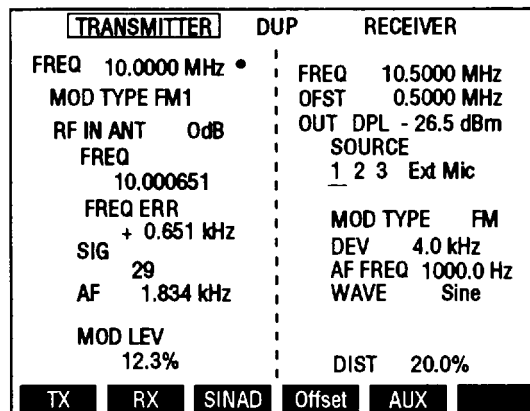

CE2FN565

4. Attach BNC-BNC coax cable from selected input and output connector to UUT. Take measurements.

2-14. AF SIGNAL GENERATOR.

Operate AF Signal Generator by following procedure:

- a. Generate AF Signal.
- b. Generate Proportional Output AF Signal.
- c. Generate Externally Modulated AF Signal.
- d. Generate AF Scanning.
- e. Generate Tone Remote Signal.

NOTE

Reset Factory Defaults before performing each operating procedure (para 2-9).

When generating signals < 2 mV, Receiver Squelch must be set to highest level if Receiver is not in use.

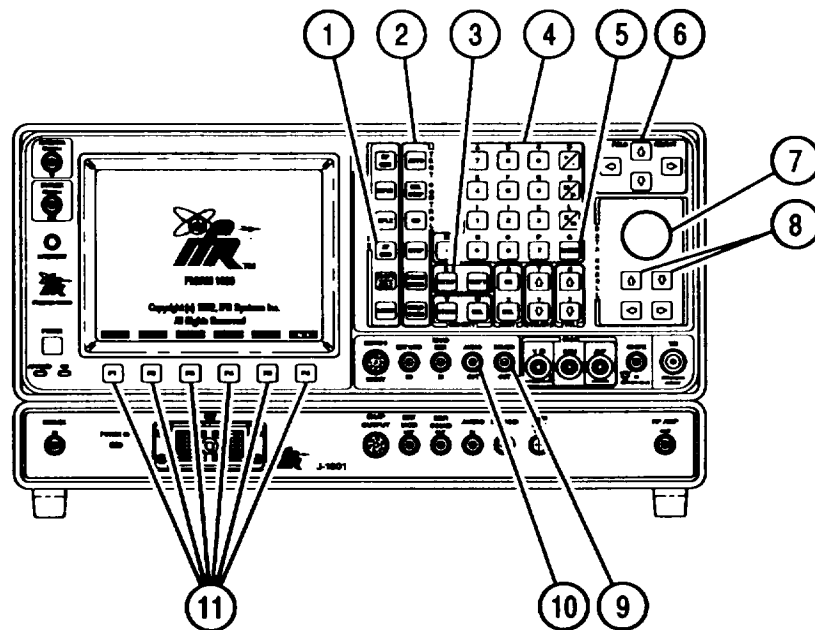

CE2FN693

a. Generate AF Signal.

1. Press AF GEN MODE Key (1), then SETUP Key (3) to display AF Gen Menu.

2. Press 1 on DATA ENTRY Keypad (4) to access submenu.

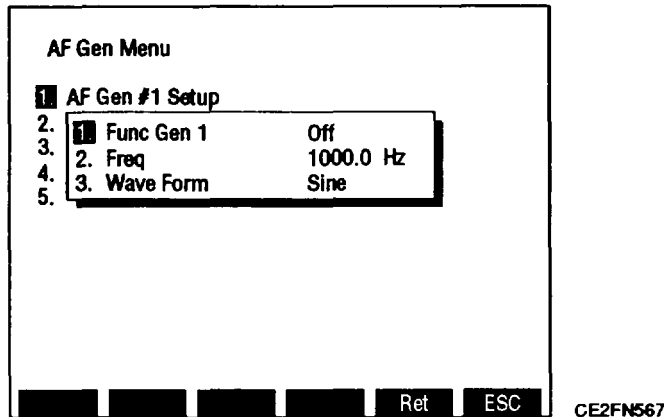

3. Press 1 on DATA ENTRY Keypad (4) to toggle Func Gen 1 On.
4. Press 2 on DATA ENTRY Keypad (4). Freq data field highlights.
5. Use DATA ENTRY Keypad (4) to enter Audio Frequency. Press ENTER (5).
6. Press 3 on DATA ENTRY Keypad (4) to access Wave Form Submenu.
7. Press number of desired wave form on DATA ENTRY Keypad (4).
8. Press "ESC" F6 (11) to return to AF Gen Menu.
9. Press 5 on DATA ENTRY Keypad (4). AF Output Setup Submenu appears.
 - AF Generator signal is output from AUDIO OUT Connector (10) or DE MOD OUT Connector (9) only and may be monitored on Test Set speaker.

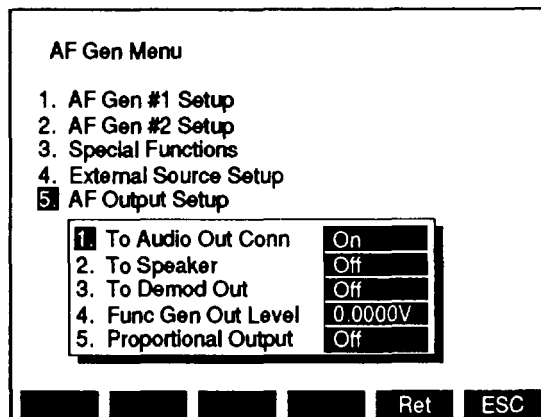

10. Select AF Generator output:
 - Press 1 on DATA ENTRY Keypad (4) to toggle To Audio Out Corm On or Off.
 - Press 2 on DATA ENTRY Keypad (4) to toggle To Speaker On or Off.
 - Press 3 on DATA ENTRY Keypad (4) to toggle To Demod Out On or Off.
11. Press 4 on DATA ENTRY Keypad (4) to access Func Gen Out Level data field.
12. Use DATA ENTRY Keypad (4) to enter output level. Press ENTER (5).

13. Press "Ret" F5 (11) to return to AF GEN Operation Screen. Verify settings are as desired.

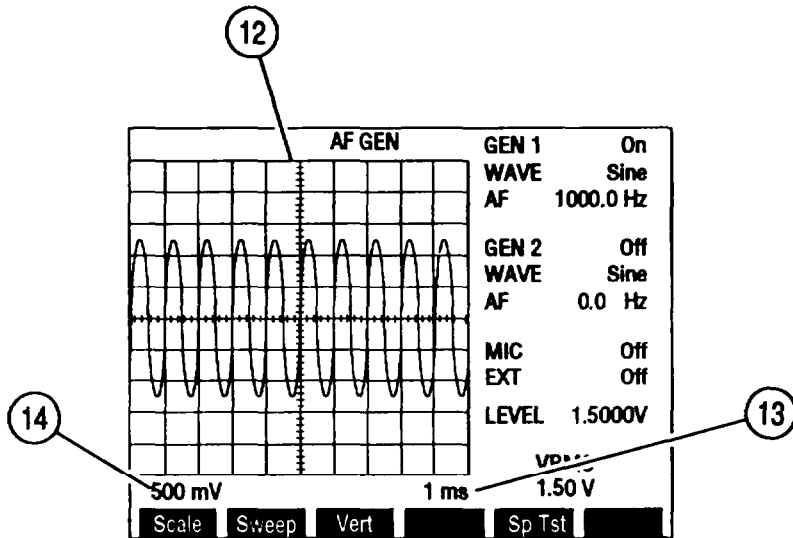

CE2FN569

14. View AF Generator waveform displayed on Oscilloscope (12). Adjust waveform:
 - Press "Vert" F3 (11) to activate Vertical Trace Adjustment. VERT callout (15) appears below Oscilloscope (12). Use DATA SCROLL ↑ and ↓ Keys (8) or DATA SCROLL Spinner (7) to adjust trace position. Press ENTER (5).



CE2FN570

- Press "Sweep" F2 (11) to access Oscilloscope Horizontal Sweep Rate (13). Use DATA SCROLL ↑ and ↓ Keys (8) or DATA SCROLL Spinner (7) to adjust sweep rate. Press ENTER (5).
 - Press "Scale" F1 (11) to access Oscilloscope Vertical Scale (14). Use DATA SCROLL ↑ and ↓ Keys (8) or DATA SCROLL Spinner (7) to adjust scale. Press ENTER (5).
15. Attach BNC-BNC coax cable from selected output connector to UUT input.

b. Generate Proportional Output AF Signal.

1. Press AF GEN MODE Key (1), then SETUP Key (3) to display AF Gen Menu.
2. Press 1 on DATA ENTRY Keypad (4) to access submenu.

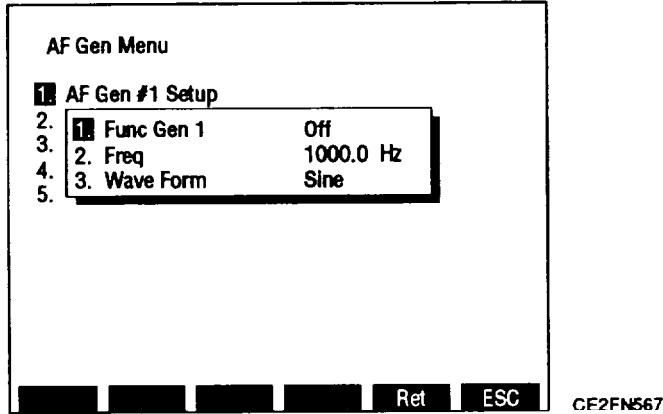

3. Press 1 on DATA ENTRY Keypad (4) to toggle Func Gen 1 On.
4. Press 2 on DATA ENTRY Keypad (4). Freq data field highlights.
5. Use DATA ENTRY Keypad (4) to enter Audio Frequency. Press ENTER (5).
6. Press 3 on DATA ENTRY Keypad (4) to access Wave Form Submenu.
7. Press number of desired wave form on DATA ENTRY Keypad (4).
8. Press "ESC" F6 (11) to return to AF Gen Menu.
9. Press 5 on DATA ENTRY Keypad (4). AF Output Setup Submenu appears.
 - AF Generator signal is output from AUDIO OUT Connector (10) or DE MOD OUT Connector (9) only and may be monitored on Test Set speaker.

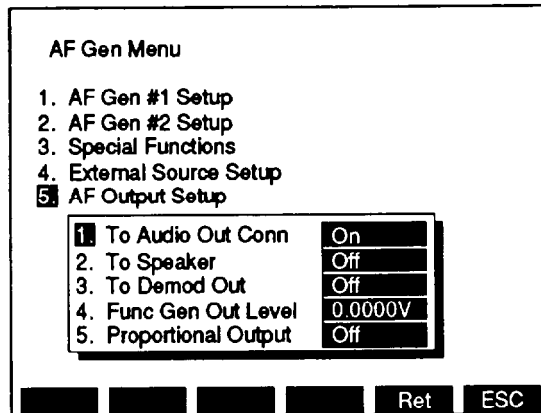

10. Select AF Generator output:
 - Press 1 on DATA ENTRY Keypad (4) to toggle To Audio Out Conn On or Off.
 - Press 2 on DATA ENTRY Keypad (4) to toggle To Speaker On or Off.
 - Press 3 on DATA ENTRY Keypad (4) to toggle To Demod Out On or Off.
11. Press 4 on DATA ENTRY Keypad (4) to access Func Gen Out Level data field.

12. Use DATA ENTRY Keypad (4) to enter output level. Press ENTER (5).
13. Press 5 on DATA ENTRY Keypad (4) to toggle Proportional Output data field to On.
14. Press "RetF5 (11) to return to AF GEN Operation Screen.

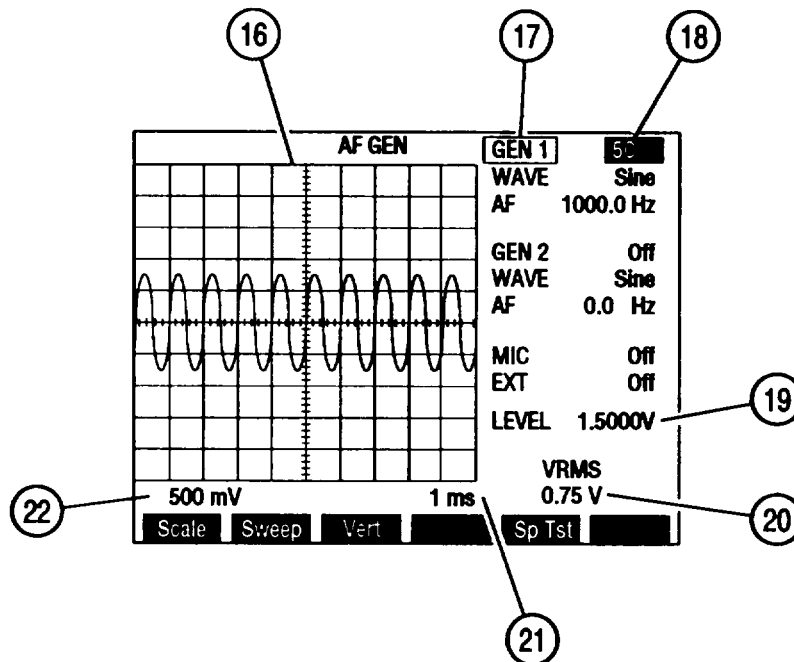

CE2FN323

15. Use FIELD SELECT Keys (6) to move cursor to GEN 1 (17). Press ENTER (5) to highlight Proportional Output #1 data field (18).
16. Use DATA ENTRY Keypad (4) to enter digits of proportional output percentage. Press ENTER (5).
 - VRMS Readout (20) shows entered Proportional Output percentage (18) of output level (entered in step 12) and displayed as LEVEL setting (19).
17. Verify all settings of AF GEN Operation Screen are as desired.
18. View AF Generator waveform displayed on Oscilloscope (16). Adjust waveform:
 - Press 'Vert' F3 (11) to activate Vertical Trace Adjustment. VERT callout (23), **appears below Oscilloscope (16). Use DATA SCROLL ↑ and ↓ Keys (8) or DATA SCROLL Spinner (7) to adjust trace position. Press ENTER (5).**



CE2FN573

- Press "Sweep" F2 (11) to access Oscilloscope Horizontal Sweep Rate (21). Use DATA SCROLL ↑ and ↓ Keys (8) or DATA SCROLL Spinner (7) to adjust sweep rate. Press ENTER (5).
 - Press "Scale" F1 (11) to access Oscilloscope Vertical Scale (22). Use DATA SCROLL ↑ and ↓ Keys (8) or DATA SCROLL Spinner (7) to adjust scale. Press ENTER (5).
19. Attach BNC-BNC coax cable from selected output connector to UUT input.

c. Generate Externally Modulated AF Signal.

1. Press AF GEN MODE Key (1), then SETUP Key (3) to access AF Gen Menu.
2. Press 4 on DATA ENTRY Keypad (4) to display External Source Setup Submenu.

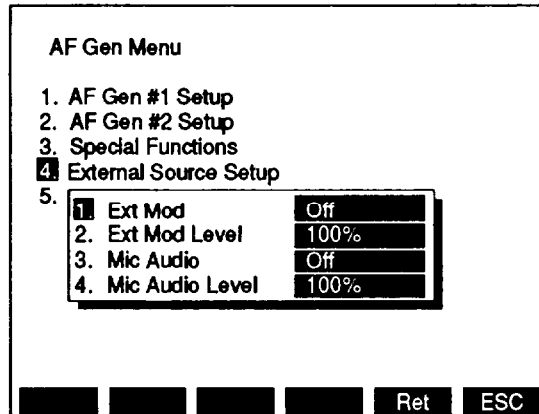

CE2FN571

3. Press 1 on DATA ENTRY Keypad (4) to toggle External Mod to On.
4. If Proportional Output is On, press 2 on DATA ENTRY Keypad (4) to access Set Ext Mod Level data field. Use DATA ENTRY Keypad (4) to enter External Modulation level. Press ENTER (5).
5. Press 3 on DATA ENTRY Keypad (4) to toggle Mic Audio to On.
6. If Proportional Output is On, press 4 on DATA ENTRY Keypad (4) to access Set Mic Audio Level data field. Use DATA ENTRY Keypad (4) to enter Mic Audio level. Press ENTER (5).
7. Press "Ret" F5 (11) to return to AF Gen Operation Screen. Verify settings are set as desired.
 - If Proportional Output is On, MIC callout (25) shows percentage entered in step 4. EXT callout (26) shows percentage entered in step 6.
8. Move cursor to LEVEL and use DATA ENTRY Keypad (4) to enter an output level. Press ENTER (5).

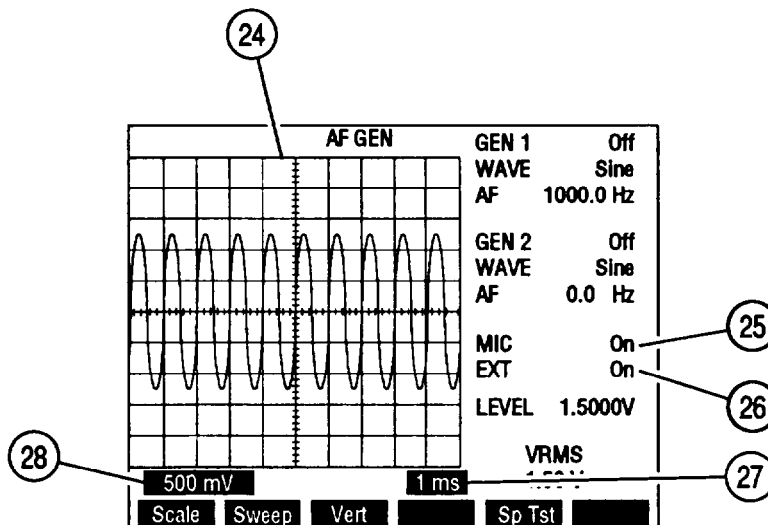

CE2FN574

9. If MIC is used, connect microphone (Appendix C, Item 17) to MIC/ACC Connector.
10. If EXT is used, connect coaxial cable from external source to EXT MOD IN Connector.
11. Connect coaxial cable from selected output connector to UUT input. Apply audio input to Test Set input connectors.
12. View AF Generator waveform displayed on Oscilloscope (24). Adjust waveform:
 - Press “Vert” F3 (11) to activate Vertical Trace Adjustment. VERT callout (29) appears below Oscilloscope (24). Use DATA SCROLL ↑ and ↓ Keys (8) or Spinner (7) to adjust trace position. Press ENTER (5).



CE2FN575

- Press ‘Sweep’ F2 (11) to access Oscilloscope Horizontal Sweep Rate (27). Use DATA SCROLL ↑ and ↓ Keys (8) or DATA SCROLL Spinner (7) to adjust sweep rate. Press ENTER (5).
- Press ‘Scale’ F1 (11) to access Oscilloscope Vertical Scale (28). Use DATA SCROLL ↑ and ↓ Keys (8) or DATA SCROLL Spinner (7) to adjust scale. Press ENTER (5).

d. Generate AF Scanning.

1. Press AF GEN MODE Key (1), then SETUP Key (3) to display AF Gen Menu.
2. Press 3 on DATA ENTRY Keypad (4) to access Special Functions Submenu.
3. Press 1 on DATA ENTRY Keypad (4) to display Audio Frequency Scan Submenu.

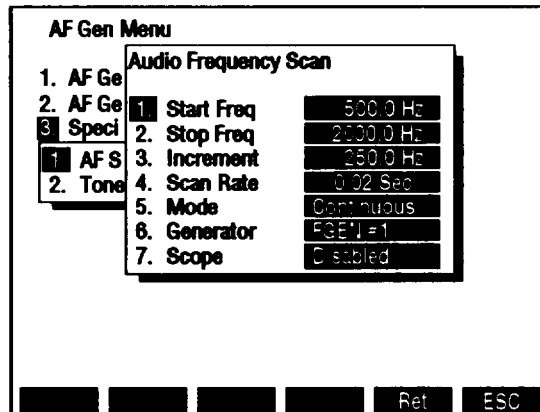

CE2FN577

4. Press 1 on DATA ENTRY Keypad (4). Start Freq data field highlights.
5. Use DATA ENTRY Keypad (4) to enter Start Frequency. Press ENTER (5).
6. Press 2 on DATA ENTRY Keypad (4). Stop Freq data field highlights.
7. Use DATA ENTRY Keypad (4) to enter Stop Frequency. Press ENTER (5).
8. Press 3 on DATA ENTRY Keypad (4). Increment data field highlights.
9. Use DATA ENTRY Keypad (4) to enter Increment. Press ENTER (5).
10. Press 4 on DATA ENTRY Keypad (4). Scan Rate data field highlights.

11. Use DATA ENTRY Keypad (4) to enter Scan Rate. Press ENTER (5).
12. Press 5 on DATA ENTRY Keypad (4) to toggle Mode to One Shot or Continuous.
13. Press 6 on DATA ENTRY Keypad (4) to toggle Generator to FGEN #1 or FGEN #2.
14. Press 7 on DATA ENTRY Keypad (4) to toggle Scope to Enabled or Disabled.
15. Press "ESC" F6 (11) twice to return to AF Gen Menu.
16. Press "Ret" F5 (11) to return to AF Generator Operation Screen.
17. Move cursor to LEVEL and use DATA ENTRY Keypad (4) to enter an output level. Press ENTER (5).
18. Attach BNC-BNC coax cable from selected output connector to UUT input.
19. If Mode Continuous, press GO TEST CONTROL Key (2) to generate sequence repeatedly. If Mode One Shot, press GO TEST CONTROL Key (2) to generate sequence once.
20. Press STOP TEST CONTROL Key (2) to stop generating sequence.
21. Press SGL STEP TEST CONTROL Key (2) to generate sequence one increment at a time.
22. Press AUTO TEST CONTROL Key (2) to generate sequence one decrement at a time.

e. Generate Tone Remote Signal.

1. Press AF GEN MODE Key (1), then SETUP Key (3) to display AF Gen Menu.
2. Press 3 on DATA ENTRY Keypad (4) to access Special Functions Submenu.

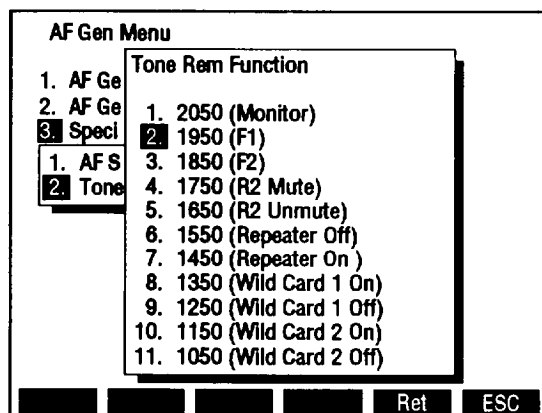

CE2FN578

3. Press 2 on DATA ENTRY Keypad (4) to display Tone Remote Function Menu.
4. Use DATA SCROLL ↑ and ↓ Keys (8) to select Tone Remote Function. Press ENTER (5).
5. Press "Ret" F5 (11) to return to AF Gen Operation Screen.
6. Press GO TEST CONTROL Key (2) to generate Tone Remote Signal.
7. Press STOP TEST CONTROL Key (2) to stop generating Tone Remote Signal.

2-15. OSCILLOSCOPE.

Operate Oscilloscope Screen by following procedures:

- a. Display Input Wave Form.
- b. Measure Amplitude and Period of Sine Wave.

NOTE

- Reset Factory Defaults before performing each operation procedure (para 2-9).
- Do not press any Soft Function Keys unless directed by procedures.
- To recall a set of saved screen parameters, use Test Set memory RCL (Recall) Key. For information on use of Store and Recall Keys, refer to operator's controls, indicators and connectors (para 2-2).

Table 2-3. Oscilloscope Input Signal Routing and Limits.

INPUT	SIGNAL	LIMITS
1. Rcvr IF	425 kHz IF of Test Set. Use for AM envelope measurements. Internal, Off-the-Air or T/R Connector input.	No Adjustments.
2. Demod Audio	AM or FM Demodulated Audio through Receiver Screen.	AM = 100% Full Scale. FM Vertical 2 kHz to 20 kHz/div. FM Horizontal 10 ms to 2 μs/div.
3. RF Pwr Lvl	AM or FM Signal Detected Power through T/R Connector.	2 W or 200 W Range. RF Pwr Lvl must be set through Power Meter Range (see para 2-19 for accurate power measurements).
4. SINAD/BER	Input at SINAD/BER IN Connector.	Vert = 4 V/div (Fixed). Horiz = 10 ms to 2 μs/div.
5. Func Gen	Output of Function Generator.	Vert = 500 mV/div, 1 and 2.5 V. Horiz = 10 ms to 2 μs/div.
6. Ext Mod	Input at EXT MOD IN Connector.	Vert = 500 mV/div, 1 and 2.5 V. Horiz = 10 ms to 2 μs/div.
7. AC	Input at SCOPE IN Connector.	Vert = 2 mV to 50 V/div. Horiz = 10 ms to 2 μs/div.
8. DC	Input at SCOPE IN Connector.	Vert = 2 mV to 50 V/div. Horiz = 10 ms to 2 μs/div.
9. GND	Input at SCOPE IN Connector.	Vert = 2 mV to 50 V/div. Horiz = 10 ms to 2 μs/div.

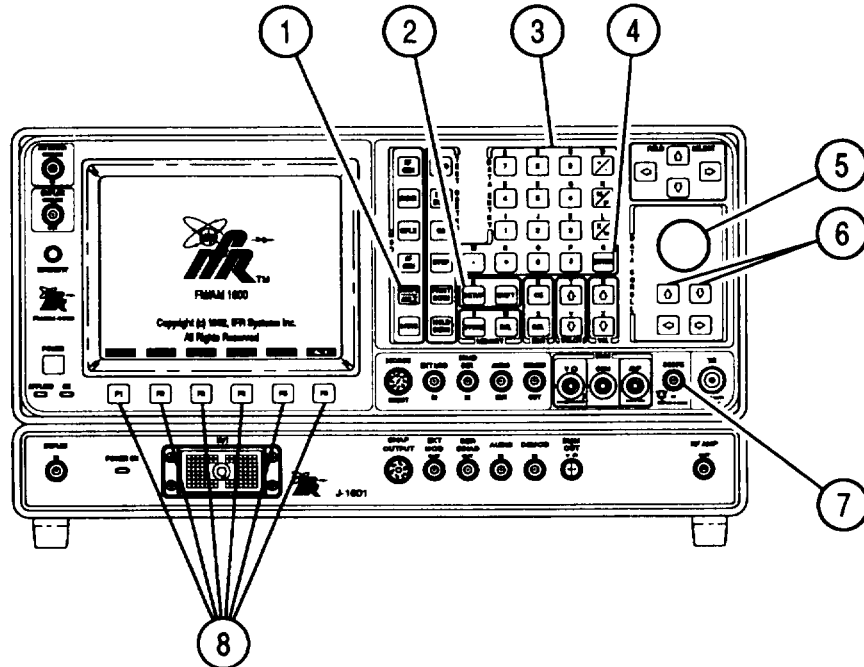

CE2FN694

a. Display Input Wave Form.

1. Press SCOPE/ANLZ MODE Key (1) until Oscilloscope Operation Screen appears. Press SETUP Key (2) to display Scope/Analyzer Menu.
 - Only Scope or Analyzer may be On at one time but both may be Off at same time.
 - Scope or Analyzer On only affects display of Oscilloscope or Spectrum Analyzer on RF Generator, Receiver, Duplex Transmitter and Duplex Receiver Operation Screens. Oscilloscope display on AF Generator or Oscilloscope Operation Screen is not affected.
2. Press 3 on DATA ENTRY Keypad (3) to display Setup Scope Submenu.

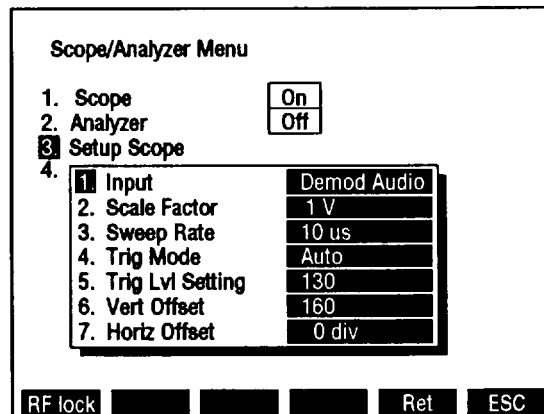

CE2FN581

- Press 1 on DATA ENTRY Keypad (3) to display Input Submenu.

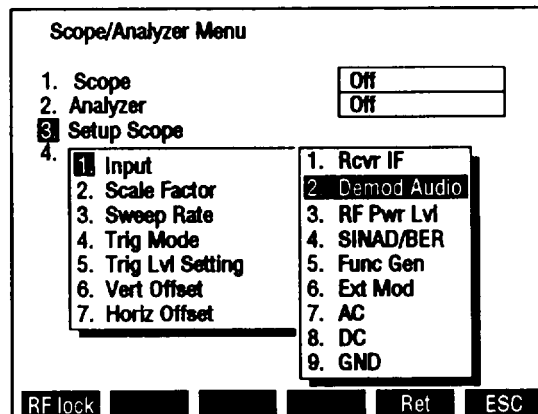

CE2FN582

- Press number on DATA ENTRY Keypad (3) of desired Input type according to Table 2-3.
- If AC or DC is selected as input type, submenu appears allowing entry of Trigger Source. Use DATA ENTRY Keypad (3) to select External or Internal.
- If input type is Demod Audio, Func Gen, Ext Mod, AC, DC or GND, press 2 on DATA ENTRY Keypad (3) to display Scale Factor Submenu.
- Use DATA SCROLL \uparrow and \downarrow Keys (6) or DATA SCROLL Spinner (5) to select Scale Factor. Press ENTER (4).
 - RF Pwr Lvl Input Vertical Scale Factor is determined by Power Meter Range setting (see para 2-19).
- Press 3 on DATA ENTRY Keypad (3) to display Sweep Rate Submenu.
- Use DATA SCROLL \uparrow and \downarrow Keys (6) or DATA SCROLL Spinner (5) to select Sweep Rate. Press ENTER (4).
- Press 4 on DATA ENTRY Keypad (3) to display Trig Mode Submenu.
- Press number on DATA ENTRY Keypad (3) of desired Trigger Mode.
- Press 5 on DATA ENTRY Keypad (3) to access Trig Lvl Setting data field.
- Use DATA ENTRY Keypad (3) to set Trigger Level (0 to 255). Press ENTER (4).
- Press 6 on DATA ENTRY Keypad (3) to access Vert Offset data field.
- Use DATA ENTRY Keypad (3) to set Vertical Offset (0 to 255). Press ENTER (4).
- Press 7 on DATA ENTRY Keypad (3) to access Horiz Offset data field.
- Use DATA ENTRY Keypad (3) to set Horizontal Offset of +12 to -12 divisions. Press ENTER (4).
 - Press +/- on DATA ENTRY Keypad (3) to place a - in data field when entering a negative horizontal offset.

- Press "Ret" F5 (8) to return to Scope Operation Screen. Verify settings are as desired.

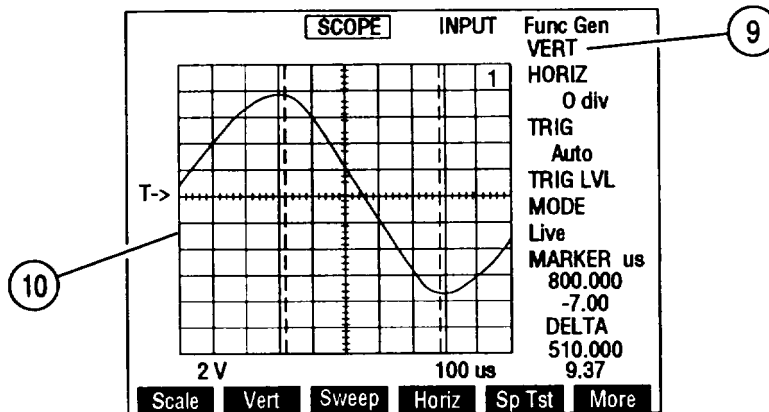

CE2FN583

- Attach BNC-BNC coax cable to selected input connector or connect Oscilloscope Probe (Appendix C, Item 15) to SCOPE IN Connector (7) and attach Oscilloscope Probe to desired test points of UUT.
- View wave form on Oscilloscope (10). Press "More" F6 (8) until "Vert" F2 (8) appears. Press "Vert" F2 (8) to activate Vertical Trace Adjustment. VERT callout (9) highlights red. Use DATA SCROLL \uparrow and \downarrow Keys (6) or DATA SCROLL Spinner (5) to adjust trace position. Press ENTER (4).

b. Measure Amplitude and Period of Sine Wave.

- Display sine wave on Oscilloscope using AC or DC Input through SCOPE IN Connector (8) (para 2-15a).

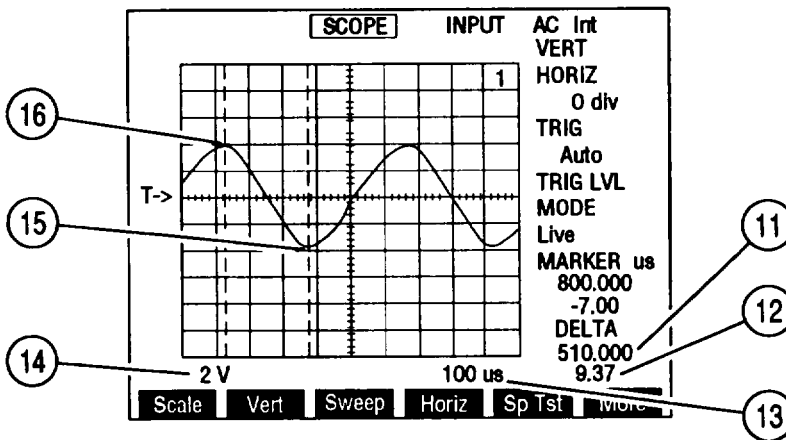

CE2FN584

- Press "More" F6 (8) until "Marker" F1 (8) appears. Press "Marker" F1 (8). Press "Mkr 1" F3 (8). Use DATA SCROLL \uparrow and \downarrow Keys (6) or DATA SCROLL Spinner (5) to place Marker 1 at first highest point of sine wave (16). Press ENTER (4).
- Press "Mkr 2" F4 (8). Use DATA SCROLL \uparrow and \downarrow Keys (6) or DATA SCROLL Spinner (5) to place Marker 2 at first lowest point of sine wave (15). Press ENTER (4).

4. Sine Wave period is twice Delta reading (11) in Sweep Rate (13) units. Sine Wave frequency is inverse of Sine Wave period.
5. Peak-to-peak amplitude is Delta Voltage reading (12) in Scale Factor (14) units.

2-16. SPECTRUM ANALYZER.

Operate Spectrum Analyzer by following procedures:

- a. Spectrum Analyzer Setup.
- b. Measure Frequency and Amplitude of Input Signal.
- c. Measure Second Harmonic Frequency and Amplitude.
- d. Cable Fault Testing.

NOTE

- Reset Factory Defaults before performing each operating procedure (para 2-9).
- Do not press any Soft Function Keys unless directed by procedures.
- Operation Screens appear on CRT in last configuration used.
- To recall a set of saved screen parameters, use Radio Test Set memory RCL (Recall) Key. For information on use of Store and Recall Keys, refer to operator's controls, indicators and connectors (para 2-2).

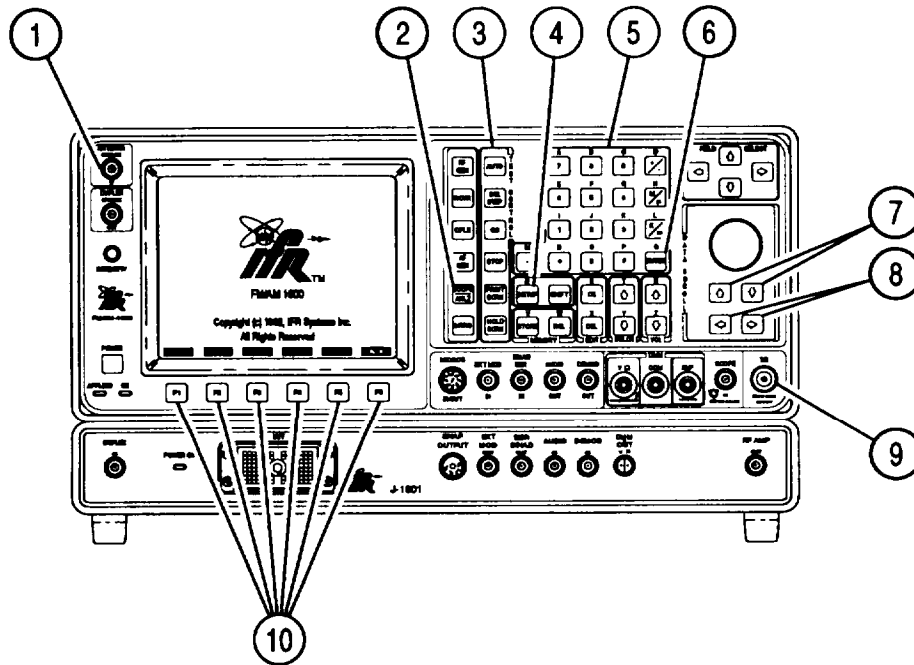

CE2FN695

a. Spectrum Analyzer Setup.

1. Press SCOPE/ANLZ MODE Key (2) until Spectrum Analyzer Operation Screen appears. Press SETUP Key (4) to display Scope/Analyzer Menu.
2. Press 4 on DATA ENTRY Keypad (5) to display Setup Analyzer Menu:

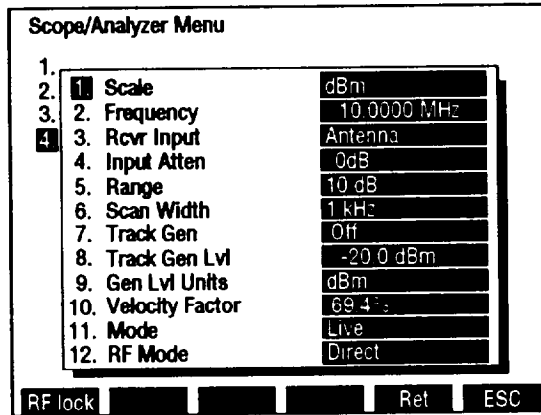

CE2FN628

3. Press 1 on DATA ENTRY Keypad (5) to display Scale Submenu.
4. Use DATA ENTRY Keypad (5) to select Scale Factor.
5. Press 2 on DATA ENTRY Keypad (5). frequency data field highlights.
6. Use DATA ENTRY Keypad (5) to enter Radio Frequency. Press ENTER (6).
7. Press 3 on DATA ENTRY Keypad (5) to toggle RF Input between Antenna (ANTENNA IN) (1) and T/R Connector (9).
8. Press 4 on DATA ENTRY Keypad (5) to display Input Atten Submenu.
9. Use DATA ENTRY Keypad (5) to select RF Input Attenuation.
10. Press 5 on DATA ENTRY Keypad (5) to toggle Units/Division Factor between 2 and 10 dB.
11. Press 6 on DATA ENTRY Keypad (5) to display Scan Width Submenu.
12. Use DATA SCROLL \uparrow and \downarrow Keys (8) to select Scan Width. Press ENTER (6).
13. Press "Ret" F5 (10) to return to Spectrum Analyzer Operation Screen.

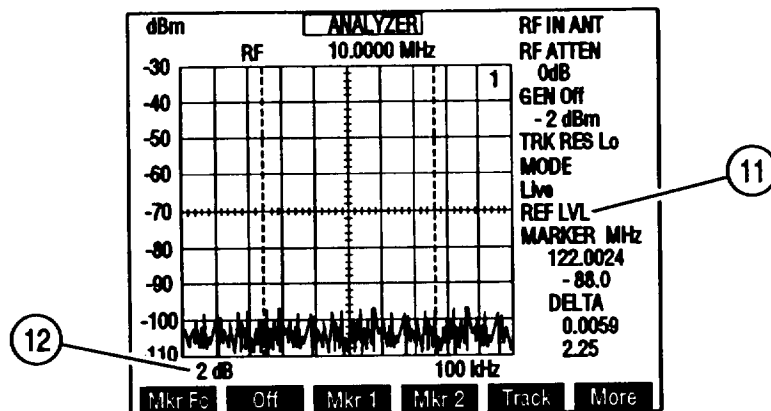

CE2FN666

14. If Units/Division Factor (12) is 2 dB, press "More" F6 (10) until "Ref lvl" F4 (10) appears. Press "Ref lvl" F4 (10). REF LVL (11) appears red. Use DATA SCROLL \uparrow and \downarrow Keys (8) or DATA SCROLL Spinner (8) to adjust Reference Level. Press ENTER (6).
15. Connect source of Spectrum Analyzer input signal:
 - If ANT selected, connect flex antenna (Appendix C, Item 6) to ANTENNA IN Connector (1).
 - If T/R selected, connect BNC-N coax cable from T/R Connector (9) to UUT.

b. Measure Frequency and Amplitude of Input Signal.

1. Perform Spectrum Analyzer Setup (para 2-16a).

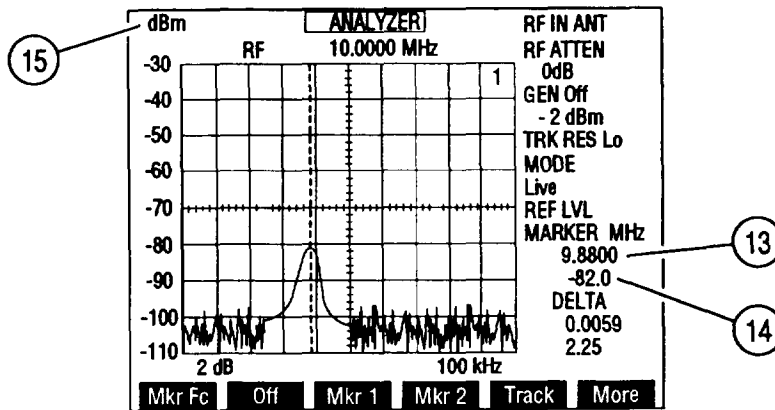

CE2FN586

2. Press "More" F6 (10) until "Mkr 1" F3 (10) appears. Press "Mkr 1" F3 (10) to activate Marker 1. Use DATA SCROLL \uparrow and \downarrow Keys (8) or DATA SCROLL Spinner (8) to place Marker 1 on signal to be measured. Press ENTER (6).
3. Marker setting (13) is frequency in MHz of measured signal. Marker amplitude reading (14) in Scale Factor units (15) is amplitude of measured signal.

c. Measure Second Harmonic Frequency and Amplitude.

1. Perform Spectrum Analyzer Setup (para 2-16a).

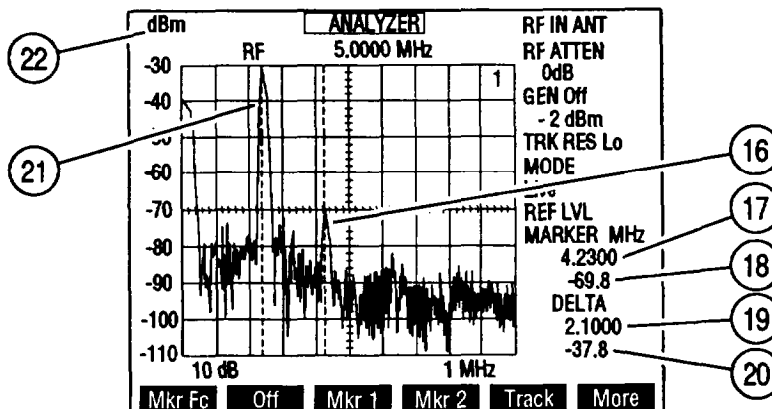

CE2FN587

2. View Trace of RF Input to determine location of peaks of fundamental frequency (21) and second harmonic (16).
3. Press "More" F6 (10) until "Mkr 1" F3 (10) appears. Press "Mkr 1" F3 (10) to activate Marker 1. Use DATA SCROLL ↑ and ↓ Keys (8) or DATA SCROLL Spinner (8) to place Marker 1 on fundamental frequency (21). Press ENTER (6).
4. Press "Mkr 2" F4 (10) to activate Marker 2. Use DATA SCROLL ↑ and ↓ Keys (8) or DATA SCROLL Spinner (8) to place Marker 2 on second harmonic (16). Press ENTER (6).
5. Marker frequency (17) is frequency in MHz of second harmonic (16). Marker amplitude reading (18) in Scale Factor units (22) is amplitude of second harmonic (16).
6. Delta frequency (19) is frequency difference between fundamental frequency (21) and second harmonic (16). Delta amplitude reading (20) is amplitude difference between fundamental frequency (21) and second harmonic (16).

d. Cable Fault Testing.

1. Press SCOPE/ANLZ MODE Key (2) until Spectrum Analyzer Operation Screen appears. Press SETUP Key (4) to display Scope/Analyzer Menu.
2. Press 4 on DATA ENTRY Keypad (5) to display Setup Analyzer Menu.

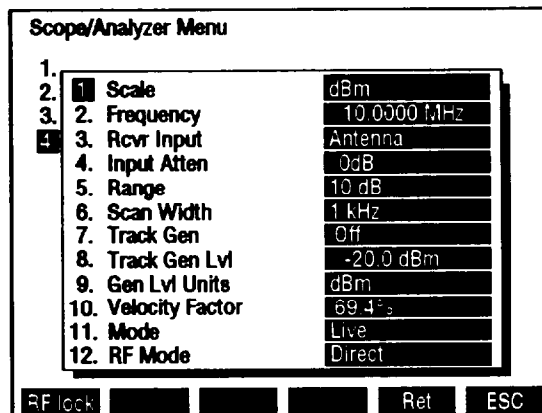

CE2FN628

3. Press 3 on DATA ENTRY Keypad (5) until RF Input is Antenna.
4. Press 5 on DATA ENTRY Keypad (5) until Units/Division Factor is 10 dB.
5. Press 6 on DATA ENTRY Keypad (5). Use DATA SCROLL ↑ and ↓ Keys (8) to select 100 MHz Scan Width. Press ENTER (6).
6. Press 8 on DATA ENTRY Keypad (5). Track Gen Lvl data field highlights.
7. Press +/-, 3 and 0 on DATA ENTRY Keypad (5). Press ENTER (6).
8. Move cursor to 10. Press ENTER (6). velocity Factor data field highlights.
9. Use DATA ENTRY Keypad (5) to enter velocity factor of cable under test. Press ENTER (6).
10. Press "Ret" F5 (10) to return to Spectrum Analyzer Operation Screen.
11. Connect coaxial tee to T/R Connector (9). Connect 50 Ω coaxial cable between coaxial tee and ANTENNA IN Connector (1). Connect cable under test to open side of coaxial tee.

12. Press "More" F6 (10) until "Cbl Fit" F3 (10) appears. Press "Cbl Fit" F3 (10).
13. Note approximate frequency of lowest trough displayed on Spectrum Analyzer.
14. Move cursor to Scan Width (24). Press DATA SCROLL ↓ Key (8) to select 50 MHz. Press ENTER (6).

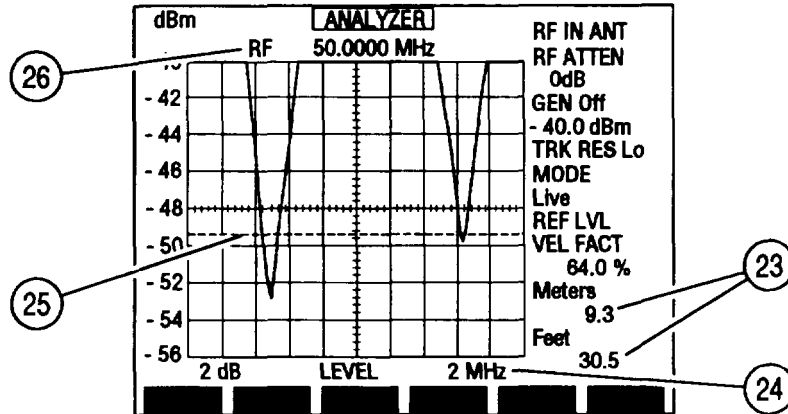

CE2FN627

15. Move cursor to RF (26) and use DATA ENTRY Keypad (5) to enter approximate frequency of lowest trough noted in step 13. Press ENTER (6)
16. Move cursor to Scan Width (24). Use DATA SCROLL ↑ and ↓ Keys (8) to set Scan Width (24) until only 2 troughs appear on Spectrum Analyzer. Press ENTER (6).
17. Press "More" F6 (10) until "2 dB" F2 (10) appears. Press "2 dB" F2 (10) to select 2 dB Units/Division Factor.
18. Press "Ref lvl" F4 (10) to access Reference Level. Use DATA SCROLL ↑ and ↓ Keys (8) or DATA SCROLL Spinner (8) to adjust Reference Level. Press ENTER (6).
19. Press "More" F6 (10) until "Find lvl" F2 (10) appears. Press "Find lvl" F2 (10).
20. Horizontal line (25) appears on Spectrum Analyzer. Use DATA SCROLL ↑ and ↓ Keys (8) or DATA SCROLL Spinner (8) to adjust horizontal line (25) to lowest level while still touching both troughs. Press "ESC" F6 (10).
21. Press GO TEST CONTROL Key (3). Cable Fault length reading (23) displays length to cable fault in feet and meters.

2-17. AUDIO FREQUENCY (AF) MEASUREMENT.

Use following procedure to make AF Measurement:

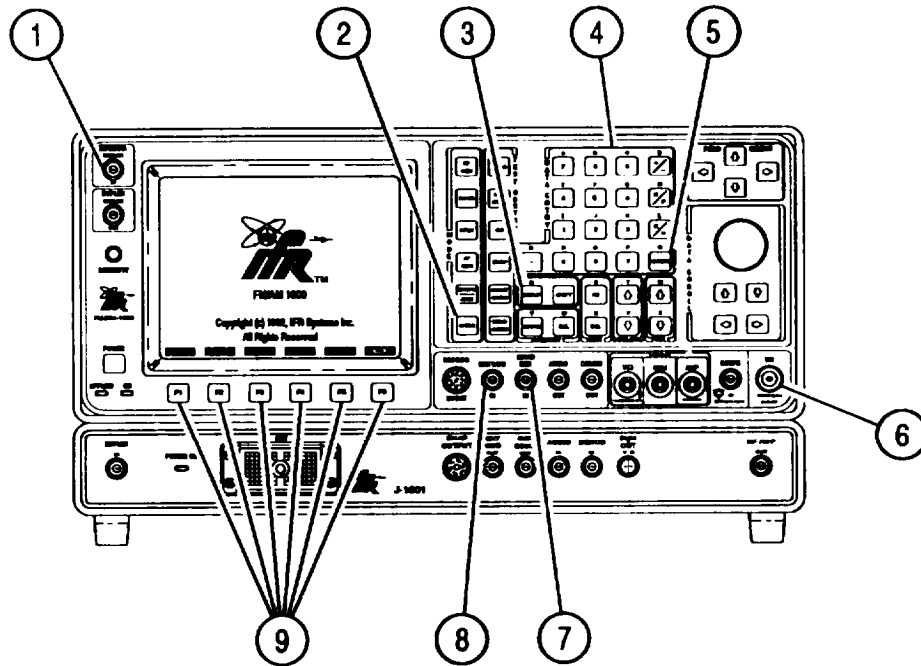

CE2FN696

NOTE

- Verify Receive Operation Screen settings are as desired prior to making measurements.
- To recall a set of saved screen parameters, use Test Set memory RCL (Recall) Key. For information on use of Store and Recall Keys, refer to operator's controls, indicators and connectors (para 2-2).
- When measuring signals <0.6 V through SINAD/BER Connector, Receiver Squelch must be set to highest level if Receiver is not in use.

1. Press MTRS MODE Key (2) to display Meter Menu.

2. Press 1 on DATA ENTRY Keypad (4), then SETUP Key (3) to display AF Meter Menu.

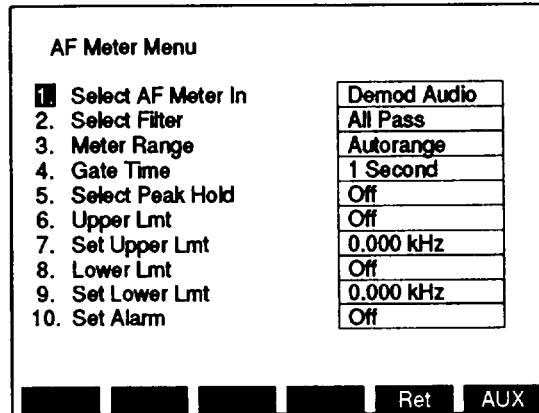

CE2FN589

3. Press 1 on DATA ENTRY Keypad (4) to display Select AF Meter In Submenu.
4. Use DATA ENTRY Keypad (4) to select desired AF Meter Input:
 - Ext Mod In measures AF input to EXT MOD IN Connector (8).
 - Demod Audio measures AF of signals received at T/R Connector (6) or ANTENNA IN Connector (1).
 - Func Gen Out internally measures AF of Function Generator output.
 - SINAD/BER measures AF input to SINAD/BER IN Connector (7).
 - RF Power measures AF of detected power through T/R Connector (6)
5. Press 2 on DATA ENTRY Keypad (4) to display Select Filter Submenu.
6. Use DATA ENTRY Keypad (4) to select desired Filter.
7. If Low Pass or High Pass is selected, cutoff data field appears. Use DATA ENTRY Keypad (4) to enter cutoff frequency. Press ENTER (5).
8. Press 3 on DATA ENTRY Keypad (4) to display Meter Range Submenu.
9. Use DATA ENTRY Keypad (4) to select desired meter range or Autorange.
10. Press 4 on DATA ENTRY Keypad (4) to toggle Gate Time between 1 sec and 10 sec.
11. Press 5 on DATA ENTRY Keypad (4) to toggle Select Peak Hold On or Off.
12. Press 6 on DATA ENTRY Keypad (4) to toggle Upper Lmt On or Off.
13. If Upper Limit is on, press 7 on DATA ENTRY Keypad (4) to access Set Upper Lmt data field.
14. Use DATA ENTRY Keypad (4) to enter digits of Upper Limit. Press ENTER (5).
15. Press 8 on DATA ENTRY Keypad (4) to toggle Lower Lmt On or Off.
16. If Lower Limit is on, press 9 on DATA ENTRY Keypad (4) to access Set Lower Lmt data field.
17. Use DATA ENTRY Keypad (4) to enter digits of Lower Limit. Press ENTER (5).
18. Move cursor to 10. Press ENTER (5) to toggle Set Alarm On or Off.

19. Press 'Ret' F5 (9) to return to AF Meter Operation Screen. Verify settings of AF Meter are as desired.

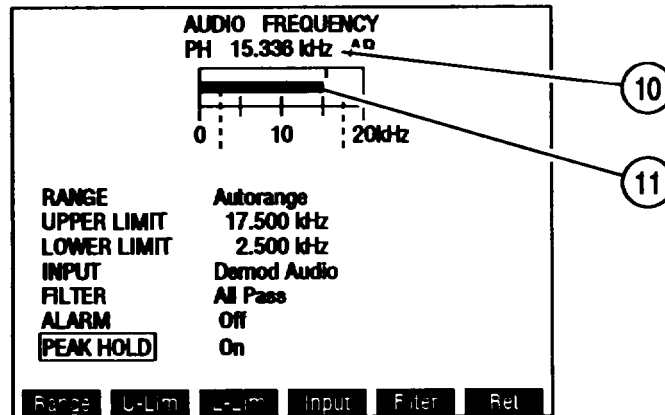

CE2FN500

20. Attach AF Meter input to selected connector:
- If Ext Mod In Input, connect BNC-BNC coax cable from UUT to EXT MOD IN Connector (8).
 - If Demod Audio Input, connect BNC-N coax cable to T/R Connector (6) and UUT or connect flex antenna (Appendix C, Item 6) to ANTENNA IN Connector (1).
 - If Func Gen Out Input, no input connection required.
 - If SINAD/BER Input, connect BNC-BNC coax cable from UUT to SINAD/BER IN Connector (7).
 - If RF Power In, connect BNC-N coax cable from T/R Connector (6) to UUT.
21. Measure Audio Frequency using Meter Indicator Bar (11) and Digital Readout (10).

2-18. FREQUENCY ERROR AND FREQUENCY MEASUREMENT.

Use following procedure to make Frequency Error and Frequency Measurement:

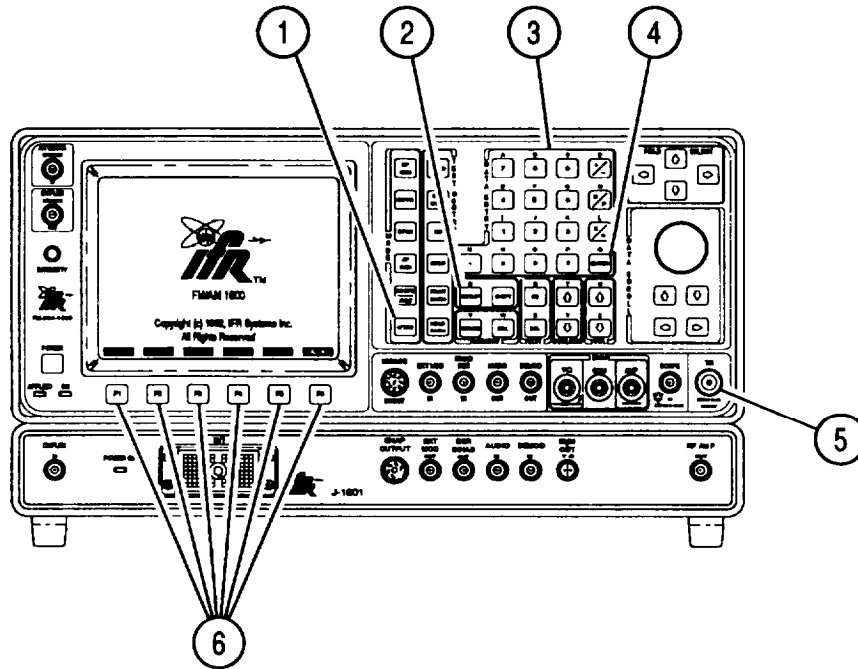

CE2FN697

NOTE

- Verify Receive Operation Screen settings are as desired prior to making measurements.
- To recall a set of saved screen parameters, use Test Set memory RCL (Recall) Key. For information on use of Store and Recall Keys, refer to operator's controls, indicators and connectors (para 2-2).

1. Press MTRS MODE Key (1) to display Meter Menu.
2. Press 2 on DATA ENTRY Keypad (3), then SETUP Key (2) to display RF Frequency Error Meter Menu.

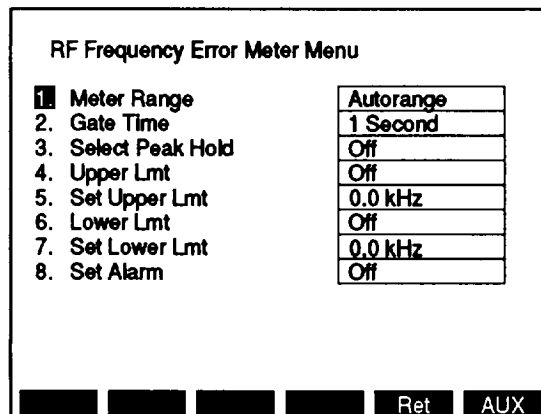

CE2FN592

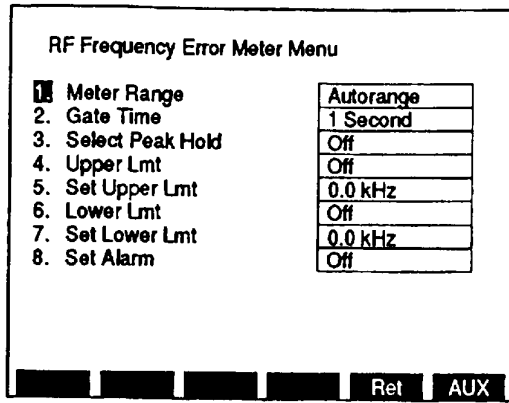

CE2FN592

3. Press 1 on DATA ENTRY Keypad (3) to display Meter Range Submenu.
4. Use DATA ENTRY Keypad (3) to select desired meter range or Aurorange.
5. Press 2 on DATA ENTRY Keypad (3) to toggle Gate Time between .1 Second and 1 Second.
6. Press 3 on DATA ENTRY Keypad (3) to toggle Select Peak Hold On or Off.
7. Press 4 on DATA ENTRY Keypad (3) to toggle Upper Lmt On or Off.
8. If Upper Limit is On, press 5 on DATA ENTRY Keypad (3) to access Set Upper Lmt data field.
9. Use DATA ENTRY Keypad (3) to enter digits of Upper Limit. Press ENTER (4).
10. Press 6 on DATA ENTRY Keypad (3) to toggle Lower Lmt On or Off.
11. If Lower Limit is On, press 7 on DATA ENTRY Keypad (4) to access Set Lower Lmt data field.
12. Use DATA ENTRY Keypad (3) to enter digits of Lower Limit. Press ENTER (4).
13. Press 8 on DATA ENTRY Keypad (3) to toggle Set Alarm On or Off.
14. Press "Ret" F5 (9) to return to Frequency Error Meter Operation Screen. Verify settings of Frequency Error Meter are as desired.

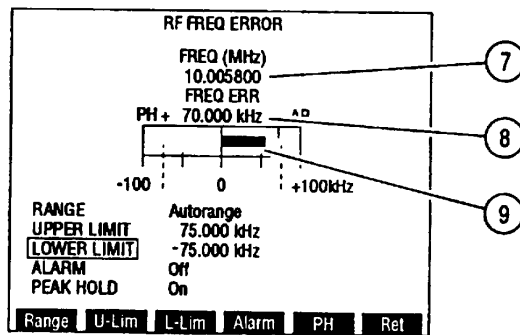

CE2FN593

15. Attach BNC-N coax cable from T/R Connector (8) to UUT.
16. Measure received frequency in MHz using Digital Readout (7) and RF Frequency Error in kHz using Meter Indicator Bar (9) and Digital Readout (8).

2-19. RF POWER MEASUREMENT.

Use following procedure to make RF Power Measurement:

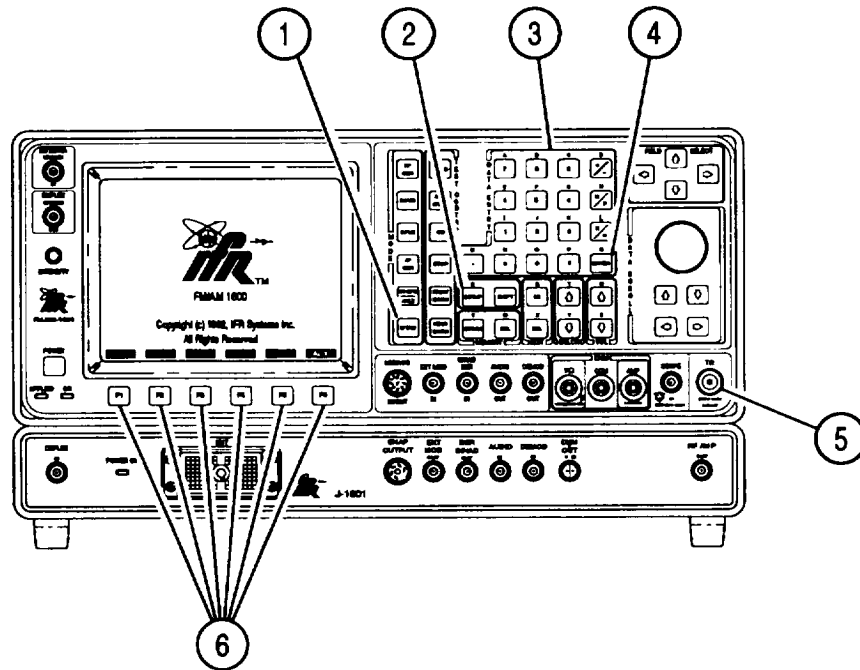

CE2FN698

NOTE

- Readings of meters reflect readings of current operation mode of Test Set.
- To recall a set of stored screen parameters, use Test Set memory RCL (Recall) Key. For information on use of Store and Recall Keys, refer to operator's controls, indicators and connectors (para 2-2).

1. Press MTRS MODE Key (1) to display Meter Menu.
2. Press 3 on DATA ENTRY Keypad (3), then SETUP Key (2) to display Power Meter Menu.

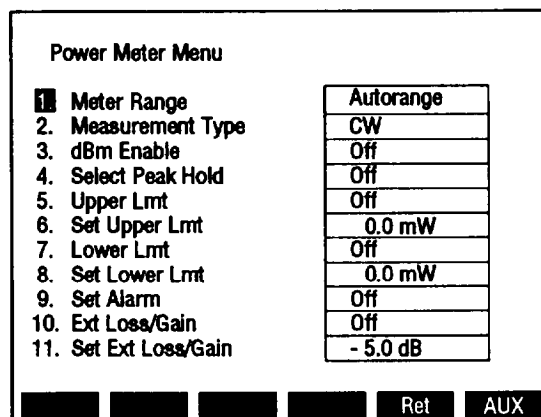

CE2FN595

3. Press 1 on DATA ENTRY Keypad (3) to display Meter Range Submenu.
4. Use DATA ENTRY Keypad (3) to select desired meter range or Autorange.
5. Press 2 on DATA ENTRY Keypad (3) to display Measurement Type Submenu.
6. Use DATA ENTRY Keypad (3) to select power measurement type.
7. Press 3 on DATA ENTRY Keypad (3) to toggle dBm Enable On or Off.
8. Press 4 on DATA ENTRY Keypad (3) to toggle Select Peak Hold On or Off.
9. Press 5 on DATA ENTRY Keypad (3) to toggle Upper Lmt On or Off.
10. If Upper Limit is On, press 6 on DATA ENTRY Keypad (3) to access Set Upper Lmt data field.
11. Use DATA ENTRY Keypad (3) to enter digits of Upper Limit. Press ENTER (4).
12. Press 7 on DATA ENTRY Keypad (3) to toggle Lower Lmt On or Off.
13. If Lower Limit is On, press 8 on DATA ENTRY Keypad (3) to access Set Lower Lmt data field.
14. Use DATA ENTRY Keypad (3) to enter digits of Lower Limit. Press ENTER (4).
15. Press 9 on DATA ENTRY Keypad (3) to toggle Set Alarm On or Off.
16. Press "Ret" F5 (6) to return to Power Meter Operation Screen. Verify settings of Power Meter are as desired.

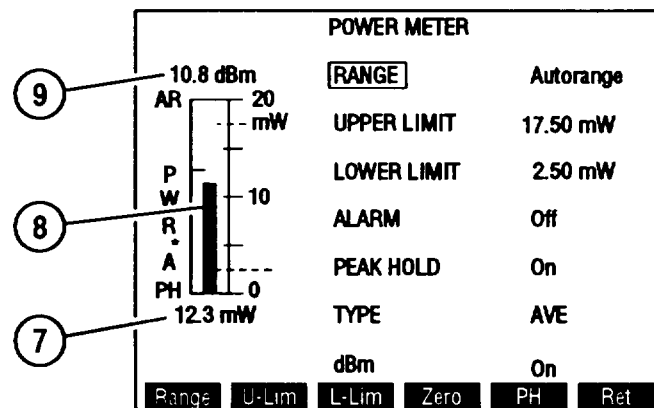

CE2FN596

17. Attach BNC-N coax cable from T/R Connector (5) to UUT.
18. Measure RF Power using Meter Indicator Bar (8) and Digital Readout in dBm (9) and Digital Readout in W or mW (7).

2-20. FM DEVIATION MEASUREMENT.

Use following procedure to make FM DEVIATION Measurements:

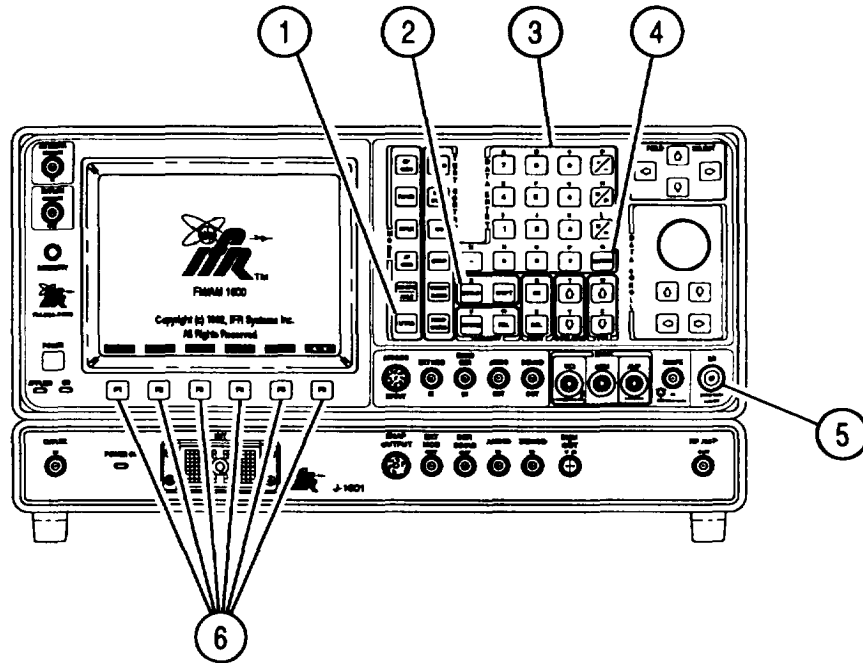

CE2FN699

NOTE

- Readings of meters reflect readings of current operation mode of Test Set.
 - To recall a set of stored screen parameters, use Test Set memory RCL (Recall) Key. For information on use of Store and Recall Keys, refer to operator's controls, indicators and connectors (para 2-2).
1. Press MTRS MODE Key (1) to display Meter Menu.
 2. Press 4 on DATA ENTRY Keypad (3), then SETUP Key (2) to display Deviation Meter Menu.

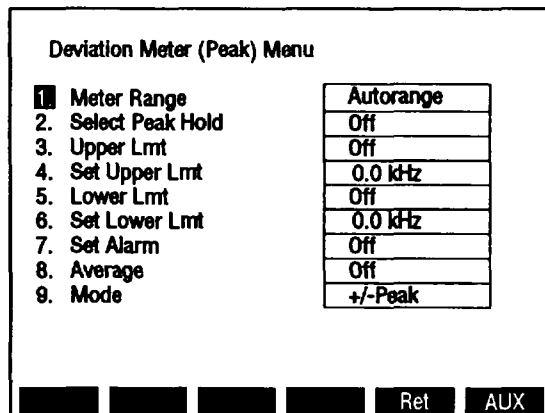

CE2FN598

3. Press 1 on DATA ENTRY Keypad (3) to display Meter Range Submenu.
4. Use DATA ENTRY Keypad (3) to select desired meter range or Autorange.
5. Press 2 on DATA ENTRY Keypad (3) to toggle Select Peak Hold On or Off.
6. Press 3 on DATA ENTRY Keypad (3) to toggle Upper Lmt On or Off.
7. If Upper Limit is on, press 4 on DATA ENTRY Keypad (3) to access Set Upper Lmt data field.
8. Use DATA ENTRY Keypad (3) to enter digits of Upper Limit. Press ENTER (4).
9. Press 5 on DATA ENTRY Keypad (3) to toggle Lower Lmt On or Off.
10. If Lower Limit is On, press 6 on DATA ENTRY Keypad (3) to access Set Lower Lmt data field.
11. Use DATA ENTRY Keypad (3) to enter digits of Lower Limit. Press ENTER (4).
12. Press 7 on DATA ENTRY Keypad (3) to toggle Set Alarm On or Off.
13. Press 8 on DATA ENTRY Keypad (3) to toggle Average On or Off.
14. Press 9 on DATA ENTRY Keypad (3) to access Mode data field.
15. Use DATA ENTRY Keypad (3) to select Mode.
16. Press "Ret" F5 (6) to return to Deviation Meter Operation Screen . Verify settings of Deviation Meter are as desired.

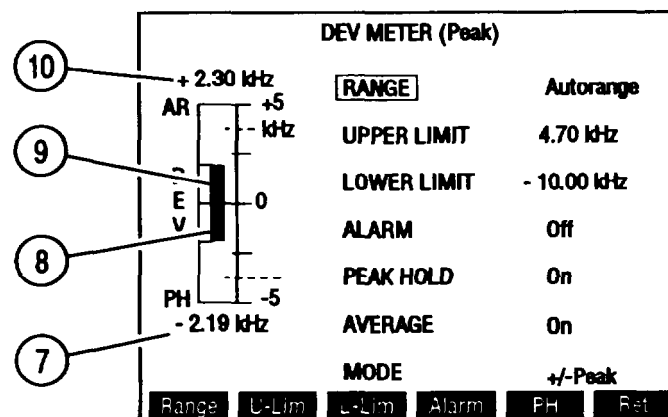

CE2FN590

17. Attach BNC-N coax cable from T/R Connector (5) to UUT.
18. if Mode +Peak, -Peak or +/-Peak/2, measure FM Deviation using Meter Indicator Bar (9) and Digital Readout (7).
19. If Mode +/-Peak, measure FM Deviation using Negative Meter Indicator Bar (8) and Digital Readout (7) for Negative Deviation and Positive Meter Indicator Bar (9) and Digital Readout (10) for Positive Deviation.

2-21. AM MODULATION MEASUREMENT.

Use following procedure to make AM Modulation Measurement:

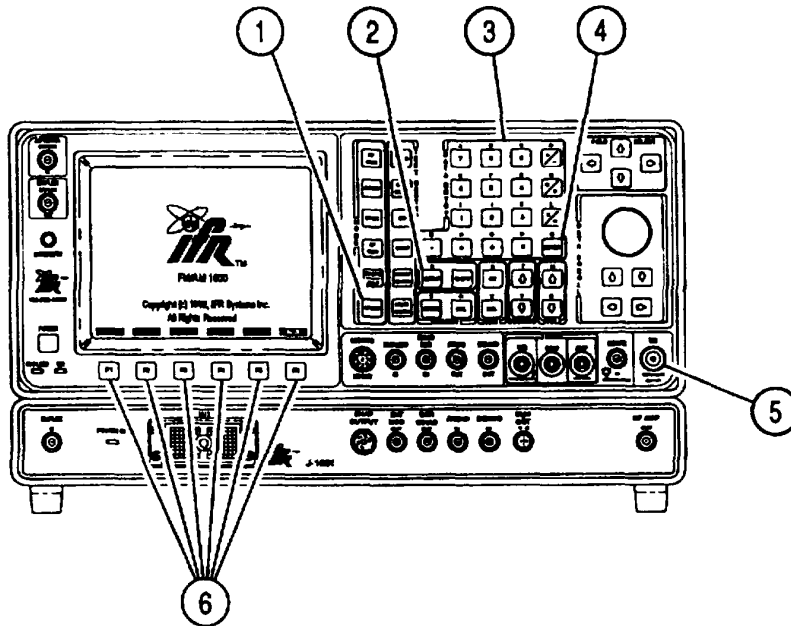

CE2FN700

RECOMMENDED INPUT CONNECTOR AND ATTENUATION SETTING

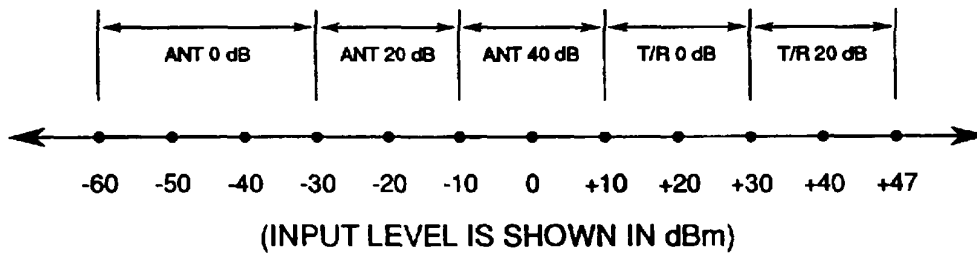

CE2FN750

NOTE

- Readings of meters reflect readings of current operation mode of Test Set.
- To recall a set 'of stored screen parameters, use Test Set memory RCL (Recall) Key. For information on use of Store and Recall Keys, refer to operator's controls, indicators and connectors (para 2-2).

1. Press MTRS MODE Key (1) to display Meter Menu.

- Press 5 on DATA ENTRY Keypad (3), then SETUP Key (2) to display Modulation Meter Menu.

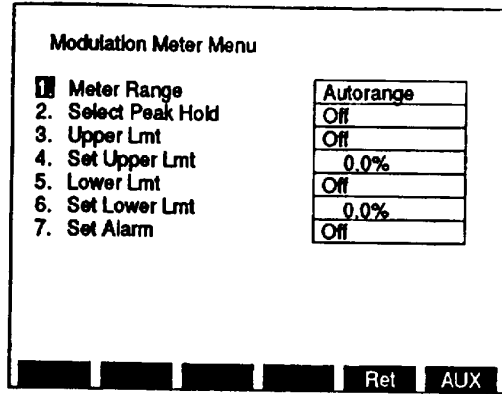

CE2FN601

- Press 1 on DATA ENTRY Keypad (3) to display Meter Range Submenu.
- Use DATA ENTRY Keypad (3) to select desired meter range or Autorange.
- Press 2 on DATA ENTRY Keypad (3) to toggle Select Peak Hold On or Off.
- Press 3 on DATA ENTRY Keypad (3) to toggle Upper Lmt On or Off.
- If Upper Limit Is On, press 4 on DATA ENTRY Keypad (3) to access Set Upper Lmt data field.
- Use DATA ENTRY Keypad (3) to enter digits of Upper Limit. Press ENTER (4).
- Press 5 on DATA ENTRY Keypad (3) to toggle Lower Lmt On or Off.
- If Lower Limit Is On, press 6 on DATA ENTRY Keypad (3) to access Set Lower Lmt data field.
- Use DATA ENTRY Keypad (3) to enter digits of Lower Limit. Press ENTER (4).
- Press 7 on DATA ENTRY Keypad (3) to toggle Set Alarm On or Off.
- Press "Ret" F5 (6) to return to Modulation Meter Operation Screen. Verify settings of Modulation Meter are as desired.

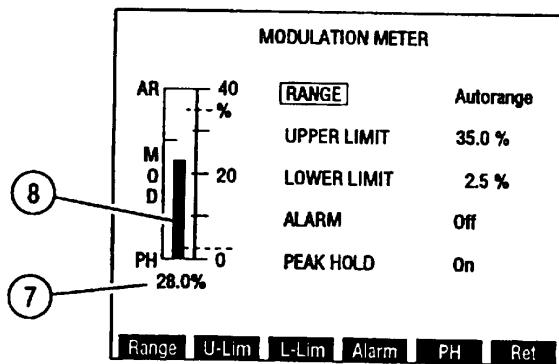

CE2FN602

- Attach BNC-N coax cable from T/R Connector (5) to UUT.
- Measure AM Modulation using Meter Indicator Bar (8) and Digital Readout (7).

2-22. DISTORTION MEASUREMENT.

Use following procedure to make Distortion Measurement:

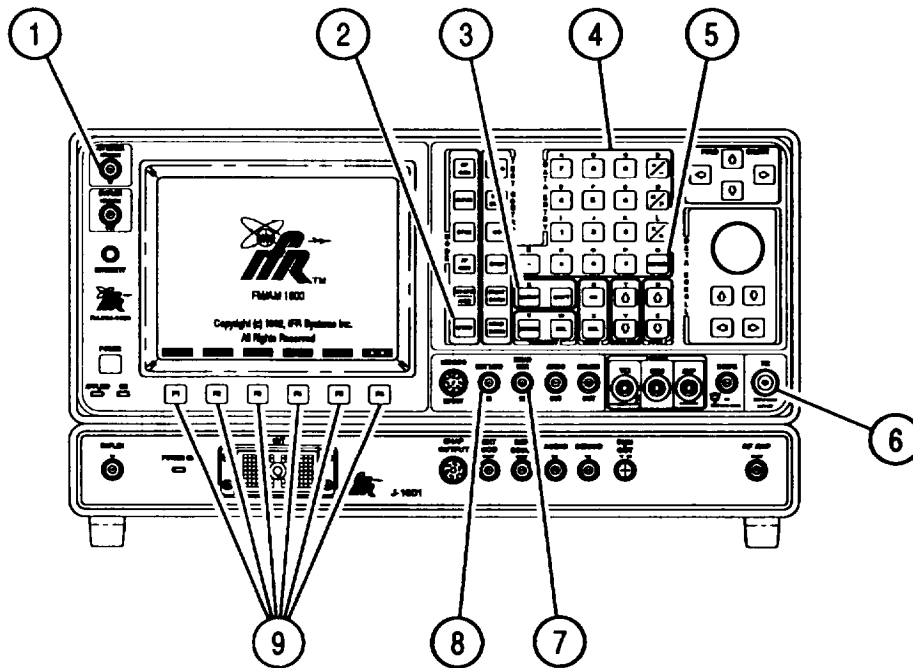

CE2FN701

NOTE

- Readings of meters reflect readings of current operation mode of Test Set.
- To recall a set of stored screen parameters, use Test Set memory RCL (Recall) Key. For information on use of Store and Recall Keys, refer to operator's controls, indicators and connectors (para 2-2).
- When measuring signals <0.6 V through SINAD/BER Connector, Receiver Squelch must be set to highest level if Receiver is not in use.

1. Press MTRS MODE Key (2) to display Meter Menu.

2. Press 6 on DATA ENTRY Keypad (4), then SETUP Key (3) to display Distortion Meter Menu.

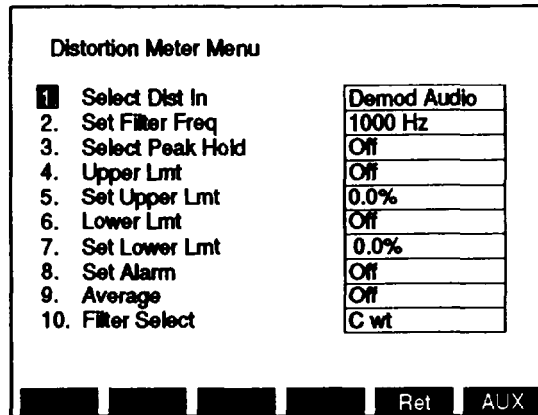

CE2FN604

3. Press 1 on DATA ENTRY Keypad (4) to display Select Dist In Submenu.

NOTE

Distortion measurements made on RF Generator Operation Screen, etc., use SINAD/BER Connector (7) input.

4. Use DATA ENTRY Keypad (4) to select Distortion Meter Input:
 - If Receive Operation Screen, press 1 on DATA ENTRY Keypad (4) to select Demod Audio input.
 - If RF GEN Operation Screen, press 2 on DATA ENTRY Keypad (4) to select SINAD/BER input.
 - Press 3 on DATA ENTRY Keypad (4) to select Func Gen input.
 - Press 4 on DATA ENTRY Keypad (4) to select Ext Mod input.
5. Press 2 on DATA ENTRY Keypad (4) to access Set Filter Freq data field.
6. Use DATA ENTRY Keypad (4) to enter Notch Filter frequency. Press ENTER (5).
7. Press 3 on DATA ENTRY Keypad (4) to toggle Select Peak Hold On or Off.
8. Press 4 on DATA ENTRY Keypad (4) to toggle Upper Lmt On or Off.
9. If Upper Limit is On, press 5 on DATA ENTRY Keypad (4) to access Set Upper Lmt data field.
10. Use DATA ENTRY Keypad (4) to enter Upper Limit. Press ENTER (5).
11. Press 6 on DATA ENTRY Keypad (4) to toggle Lower Lmt On or Off.
12. If Lower Limit is On, press 7 on DATA ENTRY Keypad (4) to access Set Lower Lmt data field.
13. Use DATA ENTRY Keypad (4) to enter digits of Lower Limit. Press ENTER (5).
14. Press 8 on DATA ENTRY Keypad (4) to toggle Set Alarm On or Off.
15. Press 9 on DATA ENTRY Keypad (4) to toggle Average On or Off.
16. Move cursor to 10. Press ENTER (5) to toggle filter between C Wt and Low Pass.

17. If Low Pass is selected for Filter, cutoff frequency data field appears. Use DATA ENTRY Keypad (4) to enter cutoff frequency. Press ENTER (5).
18. Press "Ret" F5 (9) to return to Distortion Meter Operation Screen. Verify settings of Distortion Meter are as desired.

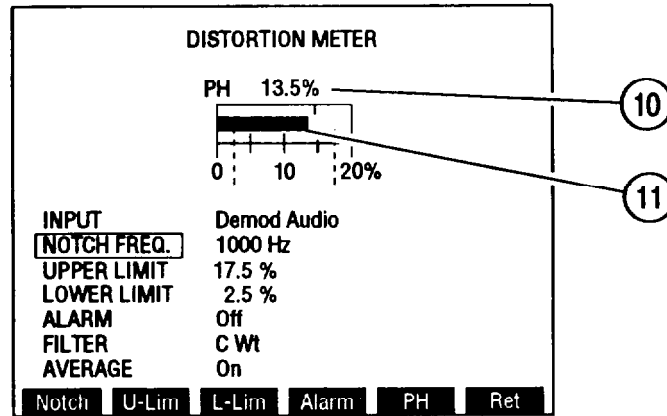

CE2FN605

19. Attach Distortion Meter input to selected connector:
 - If Demod Audio Input, connect BNC-N coax cable from T/R Connector (6) to UUT or connect flex antenna (Appendix C, Item 6) to ANTENNA IN Connector (1).
 - If SINAD/BER Input, connect BNC-BNC coax cable from SINAD/BER IN Connector (7) to UUT.
 - If Func Gen Out Input, no input connection required.
 - If Ext Mod In InDut, connect BNC-BNC coax cable from EXT MOD IN Connector (6) to UUT.
20. Attach BNC-N coax cable from T/R Connector (6) to UUT.
21. Measure Distortion using Meter Indicator Bar (11) and Digital Readout (10).

2-23. SINAD MEASUREMENTS.

Use following procedure to make SINAD Measurements:

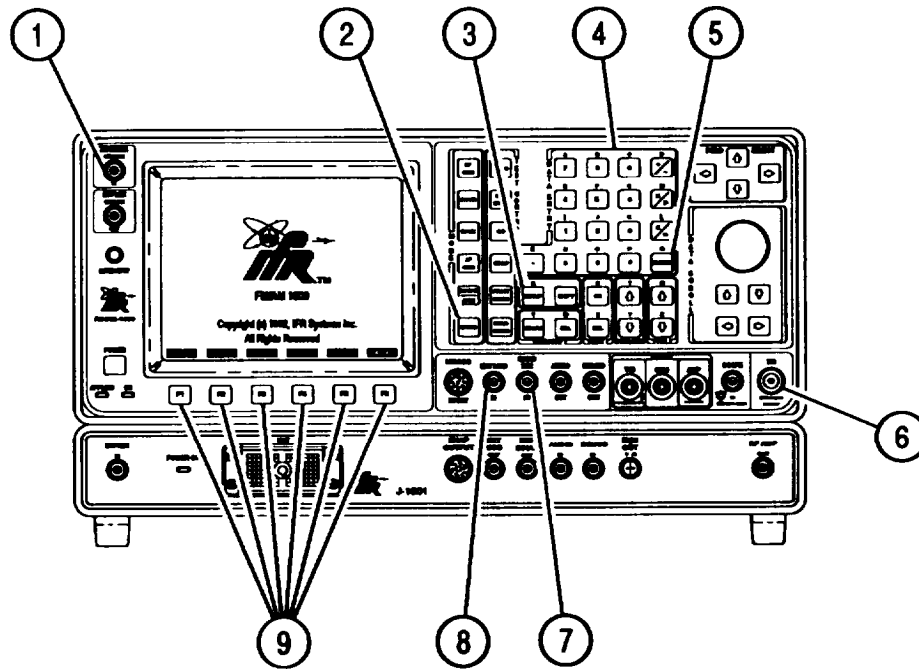

CE2FN702

NOTE

- Verify Receive or RF Generator Operation Screen settings are as desired prior to making measurements.
- To recall a set of stored screen parameters, use Test Set memory RCL (Recall) Key. For information on use of Store and Recall Keys, refer to operator's controls, indicators and connectors (para 2-2).
- When measuring signals <math><0.6\text{ V}</math> through SINAD/BER Connector, Receiver Squelch must be set to highest level if Receiver is not in use.

1. Press MTRS MODE Key (2) to display Meter Menu.

- Press 7 on DATA ENTRY Keypad (4), then SETUP Key (3) to display SINAD Meter Menu.

SINAD Meter Menu	
1. Select SINAD In	Demod Audio
2. Notch Filter Freq	1000 Hz
3. Select Peak Hold	Off
4. Upper Lmt	Off
5. Set Upper Lmt	3.0 dB
6. Lower Lmt	Off
7. Set Lower Lmt	30.0 dB
8. Average	Off
9. Filter Select	C Wt
10. Readout Res.	.5 dB

Ret AUX

CE2FN607

- Press 1 on DATA ENTRY Keypad (4) to display Select SINAD in Submenu.

NOTE

SINAD measurements made on RF Generator Operation Screen, etc., use SINAD/BER IN Connector (7) input.

- Use DATA ENTRY Keypad (4) to select SINAD Meter Input.
 - If Receive Operation Screen, press 1 on DATA ENTRY Keypad (4) to select Demod Audio input.
 - If RF GEN Operation Screen, press 2 on DATA ENTRY Keypad (4) to select SINAD/BER input.
 - Press 3 on DATA ENTRY Keypad (4) to select Ext Mod input.
- Press 2 on DATA ENTRY Keypad (4) to access Notch Filter Freq data field.
- Use DATA ENTRY Keypad (4) to enter Notch Filter frequency. Press ENTER (5).
- Press 3 on DATA ENTRY Keypad (4) to toggle Select Peak Hold On or Off.
- Press 4 on DATA ENTRY Keypad (4) to toggle Upper Lmt On or Off.
- If Upper Limit is On, press 5 on DATA ENTRY Keypad (4) to access Set Upper Lmt data field.
- Use DATA ENTRY Keypad (4) to enter digits of Upper Limit. Press ENTER (5).
- Press 6 on DATA ENTRY Keypad (4) to toggle Lower Lmt On or Off.
- If Lower Limit is On, press 7 on DATA ENTRY Keypad (4) to access Set Lower Lmt data field.
- Use DATA ENTRY Keypad (4) to enter digits of Lower Limit. Press ENTER (5).
- Press 8 on DATA ENTRY Keypad (4) to toggle Average On or Off.
- Press 9 on DATA ENTRY Keypad (4) to toggle Filter Select between C Wt and Low Pass.
- If Low Pass is selected for Filter, cutoff frequency data field appears. Use DATA ENTRY Keypad (4) to enter cutoff frequency. Press ENTER (5).

17. Move cursor to "10. Readout Res." Press ENTER Key (5) to toggle Readout Resolution between 0.1 and 0.5 dB.
18. Press "Ret" F5 (9) to return to SINAD Meter Operation Screen. Verify settings of SINAD Meter are as desired.

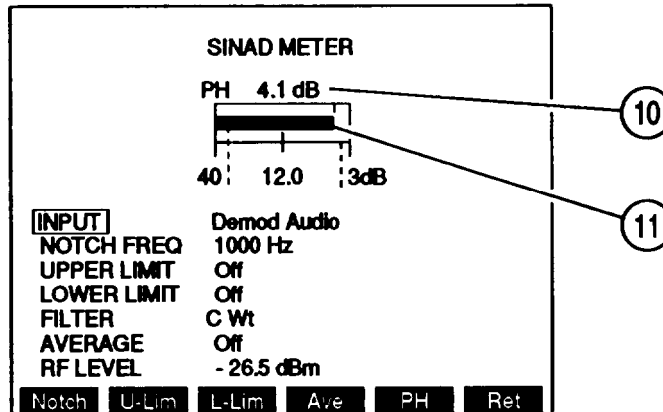

CE2FN608

19. Attach SINAD Meter input to selected connector:
 - If Demod Audio Input, connect BNC-N coax cable from T/R Connector (6) to UUT or connect flex antenna (Appendix C, Item 6) to ANTENNA IN Connector (1).
 - If SINAD/BER Input, connect BNC-BNC coax cable from SINAD/BER IN Connector (7) to UUT.
 - If Ext Mod In Input, connect BNC-BNC coax cable from EXT MOD IN Connector (8) to UUT.
20. Measure SINAD using Meter Indicator Bar (11) and Digital Readout (10).

2-24. SIGNAL STRENGTH MEASUREMENT.

Use following procedure to make Signal Strength Measurement:

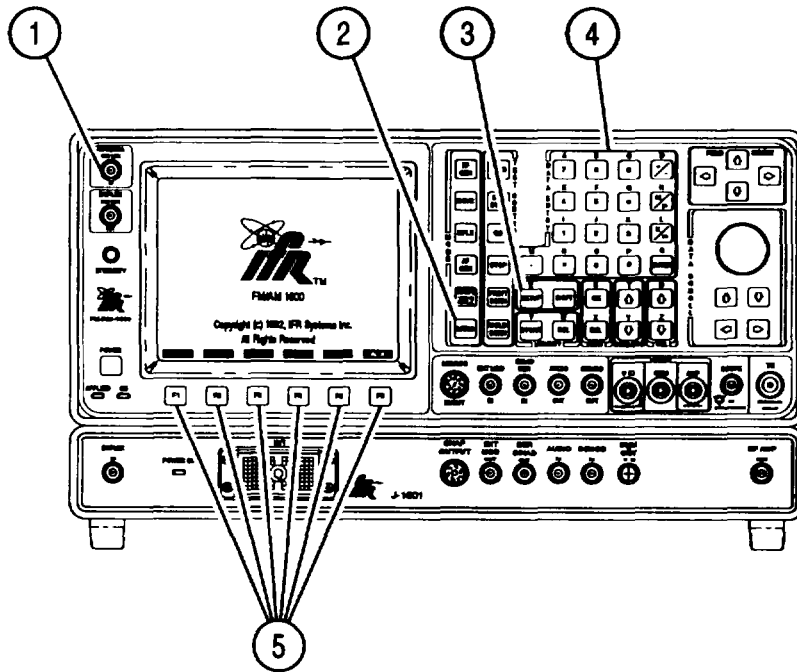

CE2FN703

NOTE

Signal Strength measurements are made only on signals received at ANTENNA IN Connector (1). Meter is calibrated for full scale with an input signal of -30 dBm at ANTENNA IN Connector (1).

1. Press MTRS MODE Key (2) to display Meter Menu.
2. Press 8 on DATA ENTRY Keypad (4), then SETUP Key (3) to display Signal Strength Meter Menu.

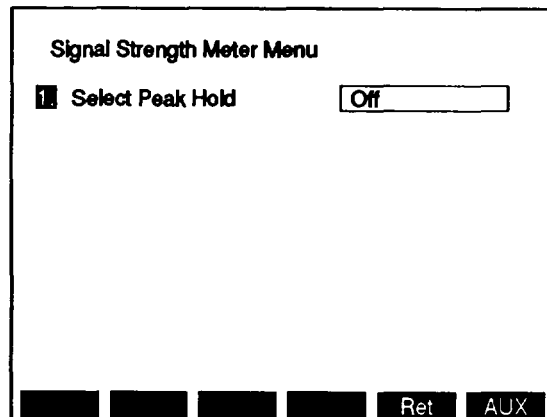

CE2FN610

3. Press 1 on DATA ENTRY Keypad (4) to toggle Select Peak Hold On or Off.

4. Press "Ret" F5 (5) to Signal Strength Meter Operation Screen. Verify setting is as desired.

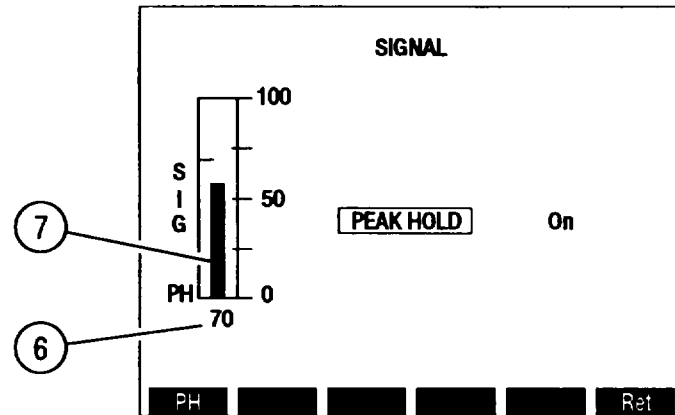

CE2FN611

5. Connect flex antenna (Appendix C, Item 6) to ANTENNA IN Connector (1).
6. Measure Signal Strength using Meter Indicator Bar (7) and Digital Readout (6).

2-25. BIT ERROR RATE (BER) MEASUREMENT.

Operate Bit Error Rate Meter by following procedure:

NOTE

- Do not press any Soft Function Keys unless directed by procedures.
- Operation Screens appear on CRT in last configuration used.
- To recall a set of saved screen parameters, use Test Set memory RCL (Recall) Key. For information on use of Store and Recall Keys, refer to operator's controls, indicators and connectors (para 2-2).

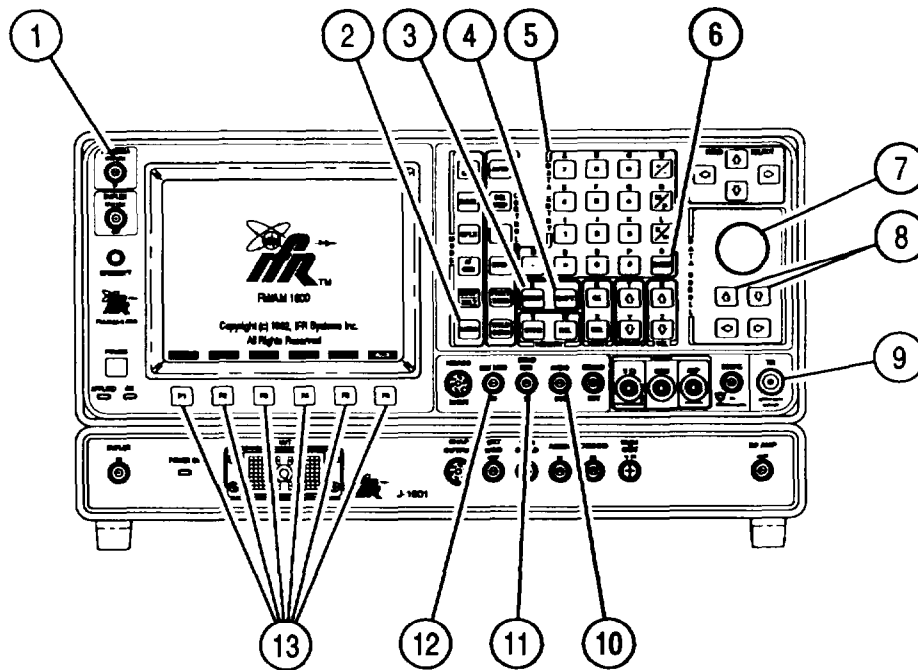

CE2FN704

1. Press MTRS Mode Key (2) to display Meter Menu.

- Press 9 on DATA ENTRY Keypad (5) to access BIT ERROR RATE Meter Operation Screen.

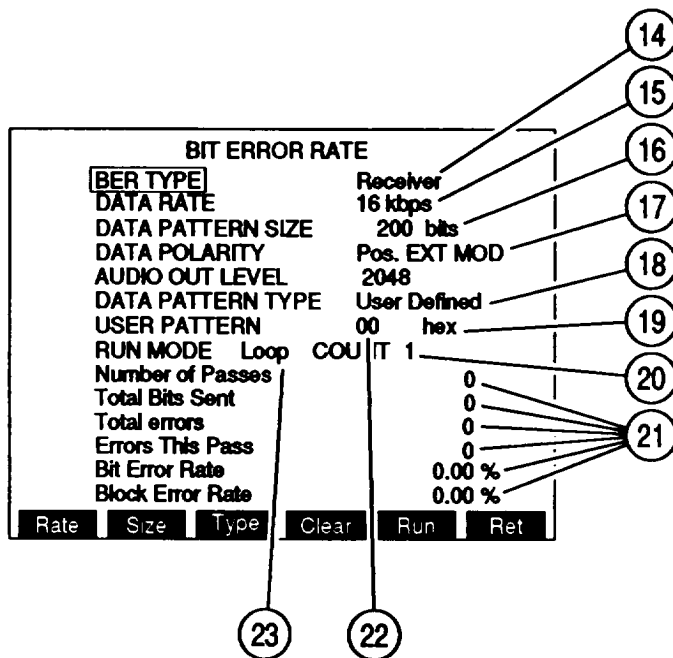

CE2FN618

- Move cursor to BER TYPE (14). Press ENTER (6). BER TYPE Submenu appears.
- Use DATA ENTRY Keypad (5) to select BER Type.
- Move cursor to DATA RATE (15). Press ENTER (6). DATA RATE Submenu appears.
- Use DATA ENTRY Keypad (5) to select Data Rate.
- Move cursor to DATA PATTERN SIZE (16). Press ENTER (6). DATA PATTERN SIZE data field highlights.
- Use DATA ENTRY Keypad (5) to enter Data Pattern Size. Press ENTER (6).
- Move cursor to DATA POLARITY (17). Press ENTER (6). DATA POLARITY data field highlights.
- Use DATA SCROLL \uparrow and \downarrow Keys (8) or DATA SCROLL Spinner (7) to toggle polarity to Pos. EXT MOD or Neg. SINAD/BER. Press ENTER (6).
- Move cursor to DATA PATTERN TYPE (18). Press ENTER (6). DATA PATTERN TYPE Submenu appears.
- Use DATA ENTRY Keypad (5) to select Data Pattern Type.
 - If User Defined is selected, USER PATTERN (19) appears. Move cursor to USER PATTERN (19). Press ENTER (6). USER PATTERN data field highlights.
 - Use DATA ENTRY Keypad (5) and SHIFT Key (4) to enter desired numbers and hex digits of data pattern. Press ENTER (6).
- Move cursor to RUN MODE (23). Press ENTER (6). RUN MODE Submenu appears.

14. Use DATA ENTRY Keypad (5) to select RUN MODE (23).
 - If LooD is selected, COUNT (20) appears. Move cursor to COUNT (20). Press ENTER (6), Loop COUNT data field highlights.
 - Use DATA ENTRY Keypad (5) to enter Loop Count. Press ENTER (6).
15. Press SETUP Key (3) to display BER Meter Menu.
16. If Receiver BER Type (14):
 - Press 2 on DATA ENTRY Keypad (5). Set Rcvr Freq data field highlights.
 - Use DATA ENTRY Keypad (5) to enter Receiver Frequency. Press ENTER (6).
 - Press 3 on DATA ENTRY Keypad (5). Select Mod Submenu appears.

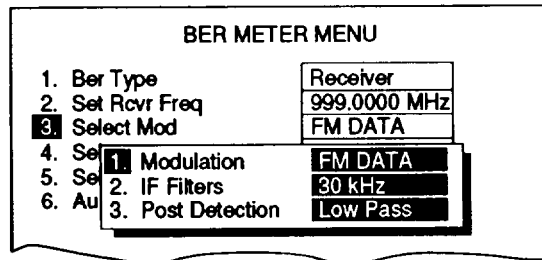

CE2FN616

- Press 1 on DATA ENTRY Keypad (5). Modulation Submenu appears.
 - Use DATA ENTRY Keypad (5) to select Modulation Type.
 - Press 2 on DATA ENTRY Keypad (5). IF Filters Submenu appears.
 - Use DATA ENTRY Keypad (5) to select IF Filter.
 - Press 3 on DATA ENTRY Keypad (5). Post Detection Submenu appears.
 - Use DATA ENTRY Keypad (5) to select proper Post Detection Filter. If Low Pass, High Pass or Bandpass is selected, cutoff frequency data field appears. Use DATA ENTRY Keypad (5) to enter cutoff frequency. Press ENTER (6).
 - Press "ESC" F6 (13).
 - Press 4 on DATA ENTRY Keypad (5) to toggle Select Rcvr In to Antenna or T/R.
 - Press 5 on DATA ENTRY Keypad (5). Input Atten Submenu appears.
 - Use DATA ENTRY Keypad (5) to select Input Attenuation.
 - Press 6 on DATA ENTRY Keypad (5). Audio Out Submenu appears.
 - Use DATA ENTRY Keypad (5) to enter Audio Out Level. Press ENTER (6).
 - Press "Ret" F5 (13) to return to BER Meter Operation Screen.
17. If Generator BER Type (14):
 - Press 2 on DATA ENTRY Keypad (5). RF Gen Freq data fields highlights.
 - Use DATA ENTRY Keypad (5) to enter RF Generator Frequency. Press ENTER (6).
 - Press 3 on DATA ENTRY Keypad (5). Use DATA ENTRY Keypad (5) to enter RF Generator Level. Press ENTER (6).

- Press 4 on DATA ENTRY Keypad (5) to toggle RF Generator Level Units to dBm or Volts.
 - Press 5 on DATA ENTRY Keypad (5). RF Gen Mod Submenu appears.
 - Use DATA ENTRY Keypad (5) to select RF Generator Modulation Type.
 - Press 6 on DATA ENTRY Keypad (5). RF Gen Mod Level Submenu appears.
 - Use DATA ENTRY Keypad (5) to enter RF Generator Modulation Level. Press ENTER (6).
 - Press "Ret" F5 (13) to return to BER Meter Operation Screen.
18. If Baseband BER Type (14):
- Press 2 on DATA ENTRY Keypad (5). Audio Out Level data field highlights.
 - Use DATA ENTRY Keypad (5) to enter Audio Out Level. Press ENTER (6).
 - Press "Ret" F5 (13) to return to BER Meter Operation Screen.
19. If Duplex BER Type (14):
- Press 2 on DATA ENTRY Keypad (5). Set Rcvr Freq data field highlights.
 - Use DATA ENTRY Keypad (5) to enter Receiver Frequency. Press ENTER (6).
 - Press 3 on DATA ENTRY Keypad (5). Select Mod Submenu appears.

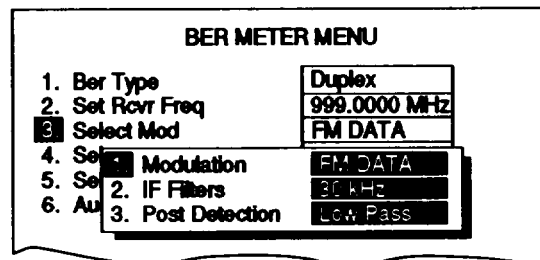

CE2FN617

- Press 1 on DATA ENTRY Keypad (5). Modulation Submenu appears.
- Use DATA ENTRY Keypad (5) to select Modulation Type.
- Press 2 on DATA ENTRY Keypad (5). IF Filters Submenu appears.
- Use DATA ENTRY Keypad (5) to select IF Filter.
- Press 3 on DATA ENTRY Keypad (5). Post Detection Submenu appears.
- Use DATA ENTRY Keypad (5) to select proper Post Detection Filter. If Low Pass, High Pass or Bandpass is selected, cutoff frequency data field appears. Use DATA ENTRY Keypad (5) to enter cutoff frequency. Press ENTER (6).
- Press "ESC" F6 (13).
- Press 4 on DATA ENTRY Keypad (5) to toggle select Rcvr In to Antenna or T/R.
- Press 5 on DATA ENTRY Keypad (5). Select Input Atten Submenu appears.
- Use DATA ENTRY Keypad (5) to select Input Attenuation.
- Press 6 on DATA ENTRY Keypad (5). RF Gen Freq data field highlights.

- Use DATA ENTRY Keypad (5) to enter RF Generator Frequency. Press ENTER (6).
- Press 7 on DATA ENTRY Keypad (5). RF Gen Level data field highlights.
- Use DATA ENTRY Keypad (5) to enter RF Generator Level. Press ENTER (6).
- Press 8 on DATA ENTRY Keypad (5) to toggle RF Generator Level Units to dBm or Volts.
- Press 9 on DATA ENTRY Keypad (5). RF Gen Mod Submenu appears.
- Use DATA ENTRY Keypad (5) to select RF Generator Modulation Type.
- Move cursor to 10. Press ENTER (6). Use DATA ENTRY Keypad (5) to enter RF Generator Modulation Level. Press ENTER (6).
- Move cursor to 11. Press ENTER (6) to toggle RF Generator Output to Duplex or T/R.
- Press “Ret” F5 (13) to return to BER Meter Operation Screen.

20. Connect UUT to Test Set for BER Test selected:

- If Receiver, connect BNC-N coax cable from UUT output to T/R Connector (9). Connect BNC-BNC coax cable from AUDIO OUT Connector (10) to UUT modulation input.
- If Generator, connect BNC-N coax cable from UUT input to T/R Connector (9). Connect BNC-BNC coax cable from SINAD/BER IN Connector (11) or EXT MOD IN Connector (12), depending upon which data polarity is selected, to UUT Demod.
- If Baseband, connect BNC-BNC coax cable from UUT input to AUDIO OUT Connector (10). Connect BNC-BNC coax cable from SINAD/BER IN Connector (11) or EXT MOD IN Connector (12), depending upon which data polarity is selected, to UUT output.
- If Duplex, connect BNC-N coax cable from UUT input to T/R Connector (9) or DUPLEX OUT Connector. Connect Flexible Antenna (Appendix C, Item 6) to ANTENNA IN Connector (1) or connect BNC-BNC coaxial cable from T/R Connector (9) to UUT output.

CAUTION

Maximum continuous input to ANTENNA IN Connector (1) is limited to 1/2 W with protection provided to a maximum input of 65 W.

21. Press “Run” F5 (13) to begin BER Test. Press “Stop” F5 (13) to stop BER Test.

- If Continuous Run Mode (23), BER Test continues making passes of number of bits shown for DATA PATTERN SIZE (16) until test is stopped.
- If One Shot Run Mode (23), BER Test makes one pass of number of bits shown for DATA PATTERN SIZE (16), then stops. Press “Run” F5 (13) again to repeat test.
- If Loop Run Mode (23), BER Test continues making passes of number of bits shown for DATA PATTERN SIZE (16) until number of passes shown for Loop Count is reached or test is stopped.

NOTE

- If communication between UUT and Test Set is lost, a LOST SYNC error message appears over BER Readouts. Press "Ret" F6 (13) to return to Operation Screen. Recheck Operation Screen and BER Meter setup and repeat BER Test.
 - If Receiver or Duplex BER TYPE, Squelch must be broken to perform BER Test.
22. For valid results, run each BER Test twice or make two passes, with results of first test or pass ignored.
- If Continuous or Loop RUN MODE (23), observe BER Meter readouts (21). Press 'Clear" F4 (13) to reset Meter readouts after first pass is completed. Test stops and BER Meter readouts (21) reset to 0 or 0.00%. Press "Run" F5 (13) again to begin test.
 - If One Shot RUN MODE (23), press 'Clear" F4 (13) to reset Meter readouts after first test. BER Meter readouts (21) reset to 0 or 0.00% Press "Run" F5 (13) to repeat test.
23. When BER Test is complete, read results on BER Meter readouts (21).

2-26. DIGITAL MULTIMETER.

Operate Digital Multimeter by following procedure:

- a. AC and DC Voltage Measurement.
- b. AC and DC Current Measurement.
- c. Ohm Measurement.

CAUTION

Remove DMM Banana Cable Assembly (Appendix C, Item 21) from the Test Set prior to performing DMM measurements utilizing the Test Set DMM Connectors.

NOTE

- Do not press any Soft Function Keys unless directed by procedures.
- Operation Screens appear on CRT in last configuration used.
- To recall a set of stored screen parameters, use Test Set memory RCL (Recall) Key. For information on use of Store and Recall Keys, refer to operator's controls, indicators and connectors (para 2-2).

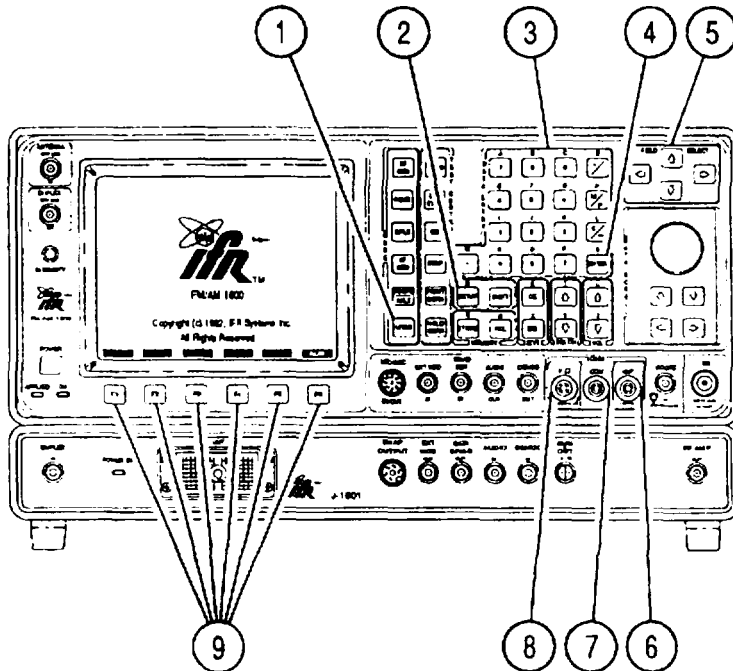

CE2FN705

a. AC and DC Voltage Measurement.

1. Press MTRS MODE Key (1) to access Meter Menu.
2. Use FIELD SELECT \uparrow and \downarrow Keys (5) to move highlight to 10, press ENTER (4), then SETUP Key (2) to display Multimeter Menu.

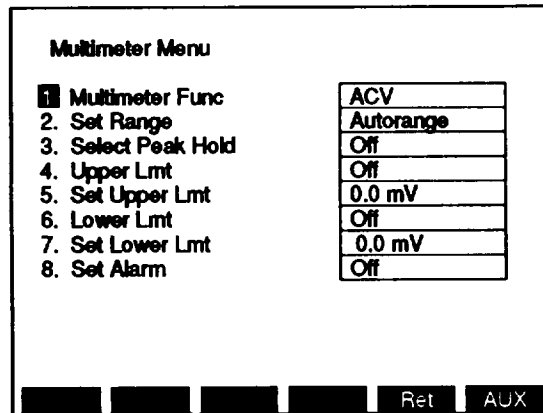

CE2FN619

3. Press 1 on DATA ENTRY Keypad (3). Multimeter Func Submenu appears.
4. Use DATA ENTRY Keypad (3) to select Multimeter Function.
 - If ACV is selected, Select Load Range Submenu appears. Press ENTER (4). Submenu with Load Ranges appears. Use DATA ENTRY Keypad (3) to select load. If User is selected, Load Value data field appears. Use DATA ENTRY Keypad (3) to enter load value. Press ENTER (4). Press "ESC" F6 (9) to return to Multi meter Menu.
5. Press 2 on DATA ENTRY Keypad (3). Set Range Submenu appears.
6. Use DATA ENTRY Keypad (3) to select Range.
7. Press 3 on DATA ENTRY Keypad (3) to toggle Select Peak Hold On or Off.
8. Press 4 on DATA ENTRY Keypad (3) to toggle Upper Lmt On or Off.
9. If Upper Limit is On, press 5 on DATA ENTRY Keypad (3) to access Set Upper Lmt data field.
10. Use DATA ENTRY Keypad (3) to enter Upper Limit. Press ENTER (4).
11. Press 6 on DATA ENTRY Keypad (3) to toggle Lower Lmt On or Off.
12. If Lower Limit is On, press 7 on DATA ENTRY Keypad (3) to access Set Lower Lmt data field.
13. Use DATA ENTRY Keypad (3) to enter Lower Limit. Press ENTER (4).
14. Press 8 on DATA ENTRY Keypad (3) to toggle Set Alarm On or Off.

- Press 'Ret' F5 (9) to return to Multimeter Operation Screen. Verify all settings are as desired.

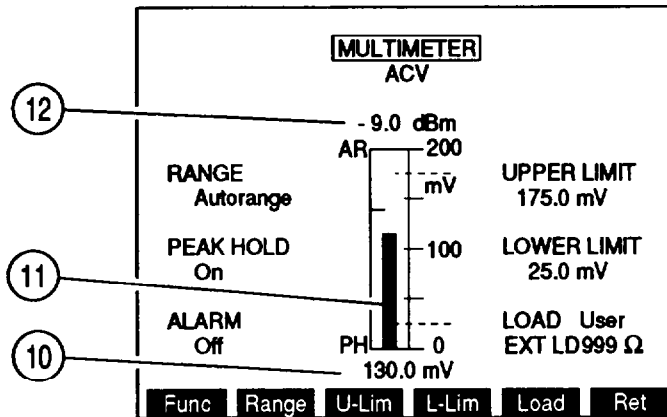

CE2FN620

- Connect Red probe of DMM probe set (Appendix C, Item 14) to DMM V W Connector (8). Connect "Black probe of DMM probe-set (Appendix C, Item 14) to DMM COM Connector (7).
- Touch probe tips to test points, read ACV or DCV on Digital Readout (10) and Meter indicator Bar (11). If ACV, <200 V Range, and 150 Ω or 600 Ω LOAD, read dBm readout (12).

b. AC and DC Current Measurement.

1. Press MTRS MODE Key (1) to access Meter Menu.
2. Use FIELD SELECT \uparrow and \downarrow Keys (5) to move highlight to 10, press ENTER (4), then SETUP Key (3) to display Multimeter Menu.

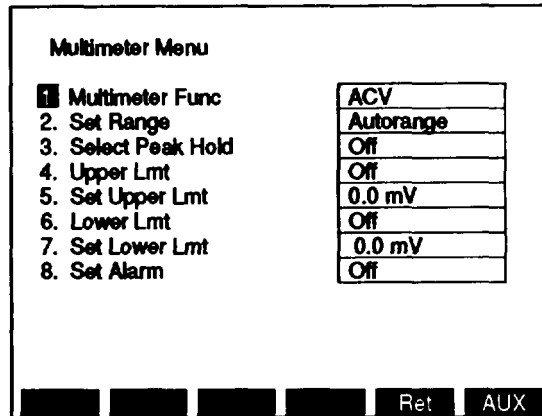

CE2FN619

3. Press 1 on DATA ENTRY Keypad (3). Multi meter Func Submenu appears.
4. Use DATA ENTRY keypad (3) to select Multimeter Function.
5. Press 2 on DATA ENTRY Keypad (3). Set Range Submenu appears.
6. Use DATA ENTRY Keypad (3) to select Range.
7. Press 3 on DATA ENTRY Keypad (3) to toggle Select Peak Hold On or Off.
8. Press 4 on DATA ENTRY Keypad (3) to toggle Upper Lmt On or Off.
9. If Upper Limit is On, press 5 on DATA ENTRY Keypad (3) to access Set Upper Lmt data field.
10. Use DATA ENTRY Keypad (3) to enter Upper Limit. Press ENTER (4).
11. Press 6 on DATA ENTRY Keypad (3) to toggle Lower Lmt On or Off.
12. If Lower Limit is On, press 7 on DATA ENTRY Keypad (3) to access Set Lower Lmt data field.
13. Use DATA ENTRY Keypad (3) to enter Lower Limit. Press ENTER (4).
14. Press 8 on DATA ENTRY Keypad (3) to toggle Set Alarm On or Off.

- Press "Ret" F5 (9) to return to Multimeter Operation Screen. Verify all settings are as desired.

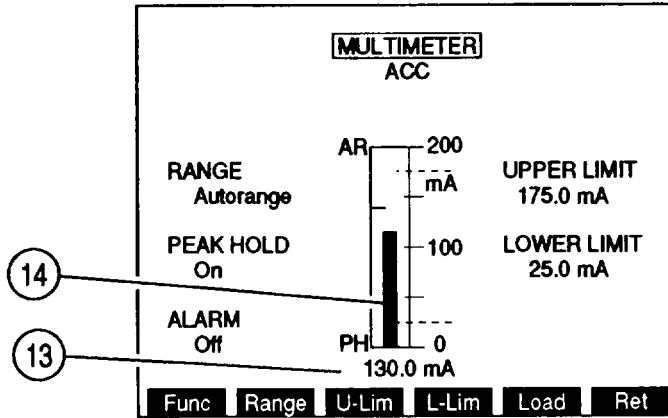

CE2FN629

- Connect Red probe of DMM probe set (Appendix C, Item 14) to DMM AMP Connector (6). Connect Black probe of DMM probe set (Appendix C, Item 14) to DMM COM Connector (7).
 - For high current measurements, install current shunt (15) (Appendix C, Item 15) to DMM V W Connector (8) and DMM COM Connector (7), then connect probes to current shunt (15).

NORMAL DMM AMP MEASUREMENTS

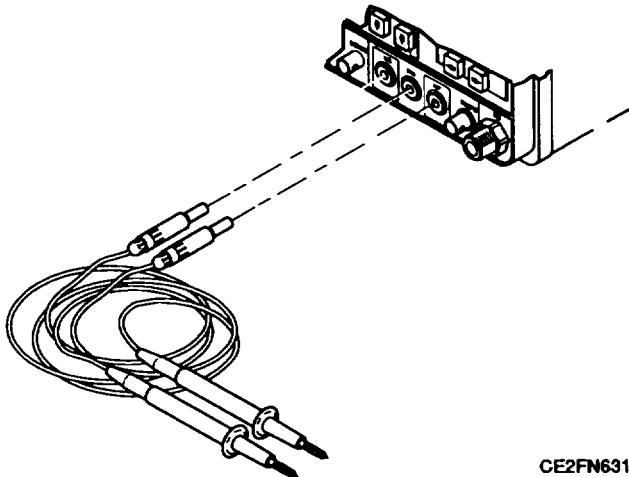

CE2FN631

HIGH CURRENT DMM AMP MEASUREMENTS

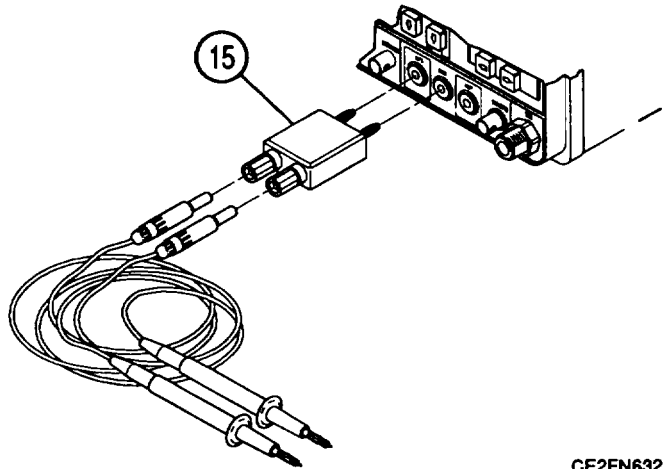

CE2FN632

- Touch probe tips to test points, read ACC or DCC on Digital Readout (13) and Meter Indicator Bar (14).

c. Ohm Measurement.

1. Press MTRS MODE Key (1) to access Meter Menu.
2. Use FIELD SELECT \uparrow and \downarrow Keys (5) to move highlight to 10, press ENTER (4), then SETUP Key (2) to display Multimeter Menu.

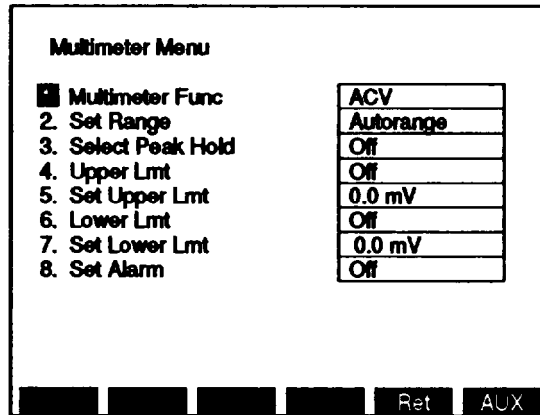

CE2FN619

3. Press 1 on DATA ENTRY Keypad (3). Multi meter Func Submenu appears.
4. Press 5 on DATA ENTRY Keypad (3).
5. Press 2 on DATA ENTRY Keypad (3). Set Range Submenu appears.
6. Use DATA ENTRY Keypad (3) to select Range.
7. Press 3 on DATA ENTRY Keypad (3) to toggle Peak Hold On or Off.
8. Press 4 on DATA ENTRY Keypad (3) to toggle Upper Lmt On or Off.
9. If Upper Limit is On, press 5 on DATA ENTRY Keypad (3) to access Set Upper Lmt data field.
10. Use DATA ENTRY Keypad (3) to enter Upper Limit. Press ENTER (4).
11. Press 6 on DATA ENTRY Keypad (3) to toggle Lower Lmt On or Off.
12. If Lower Limit is On, press 7 on DATA ENTRY Keypad (3) to access Set Lower Lmt data field.
13. Use DATA ENTRY Keypad (3) to enter Lower Limit. Press ENTER (4).
14. Press 8 on DATA ENTRY Keypad (3) to toggle Set Alarm On or Off.

- Press "Ret" F5 (9) to return to Multimeter Operation Screen. Verify all settings are as desired.

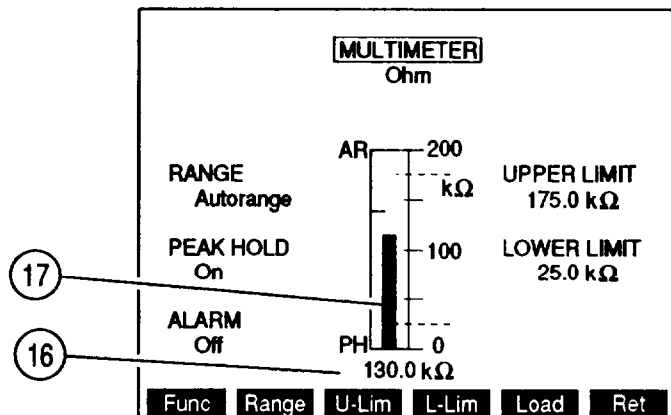

CE2FN630

- Connect Red probe of DMM probe set (Appendix C, Item 14) to DMM V Ω Connector (8). Connect Black probe of DMM probe set (Appendix C, Item 14) to DMM COM Connector (7).
- Touch probe tips to test points, read Ohms on Digital Readout (16) and Meter Indicator Bar (17).

2-27. PM PHASE MEASUREMENT.

Use following procedure to make PM Phase Measurement:

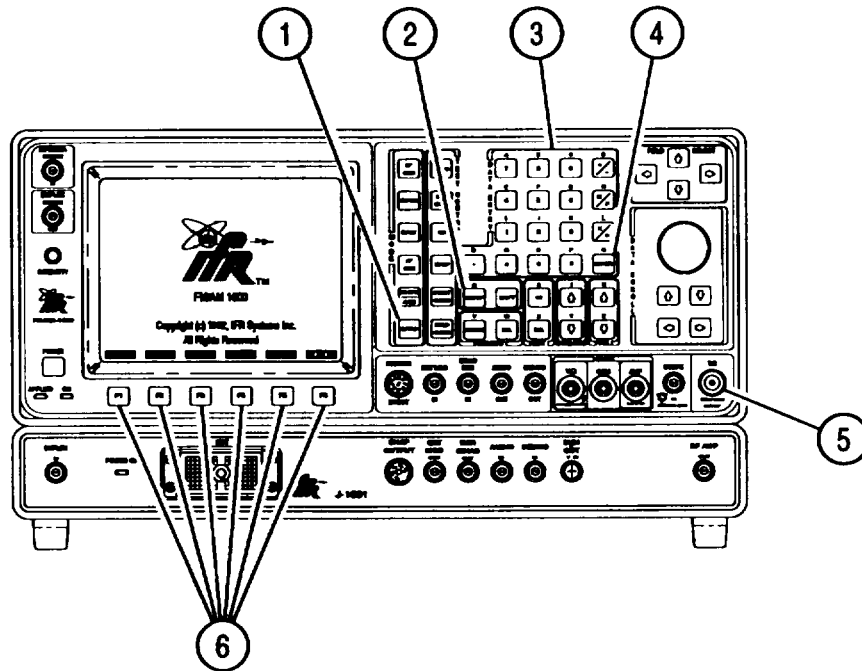

CE2FN706

NOTE

- Perform Receiver Setup (para 2-12a) prior to Phase Meter operation.
- To recall a set of stored screen parameters, use Test Set memory RCL (Recall) Key. For information on use of Store and Recall Keys, refer to operator's controls, indicators and connectors (para 2-2).

1. Press MTRS MODE Key (1) to display Meter Menu.
2. Move cursor to 11. Press ENTER (4). Press SETUP Key (2) to display Phase Meter Menu.

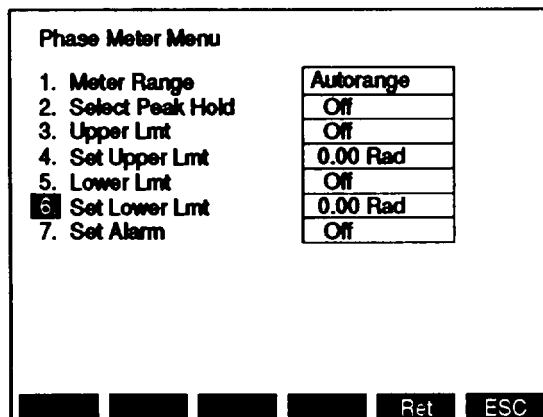

CE2FN621

3. Press 1 on DATA ENTRY Keypad (3) to display Meter Range Submenu.
4. Use DATA ENTRY Keypad (3) to select desired meter range or Autorange.
5. Press 2 on DATA ENTRY Keypad (3) to toggle Select Peak Hold On or Off.
6. Press 3 on DATA ENTRY Keypad (3) to toggle Upper Lmt On or Off.
7. If Upper Limit is On, press 4 on DATA ENTRY Keypad (3) to access Set Upper Lmt data field.
8. Use DATA ENTRY Keypad (3) to enter digits of Upper Limit. Press ENTER (4).
9. Press 5 on DATA ENTRY Keypad (3) to toggle Lower Lmt On or Off.
10. If Lower Limit is On, press 6 on DATA ENTRY Keypad (3) to access Set Lower Lmt data field.
11. Use DATA ENTRY Keypad (3) to enter digits of Lower Limit. Press ENTER (4).
12. Press 7 on DATA ENTRY Keypad (3) to toggle Set Alarm On or Off.
13. Press "Ret" F5 (6) to return to Modulation Meter Operation Screen. Verify settings of Modulation Meter are as desired.

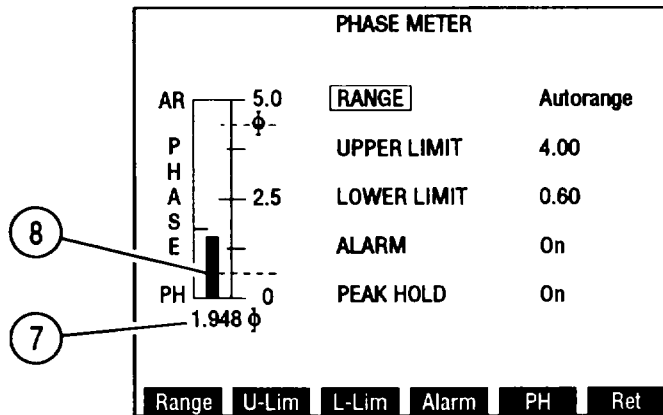

CE2FN622

14. Attach BNC-N coax cable from T/R Connector (5) to UUT.
15. Measure PM Phase using Meter Indicator Bar (8) and Digital Readout (7).

2-28. FM RMS DEVIATION MEASUREMENT.

Use following procedure to make FM RMS Deviation Measurement:

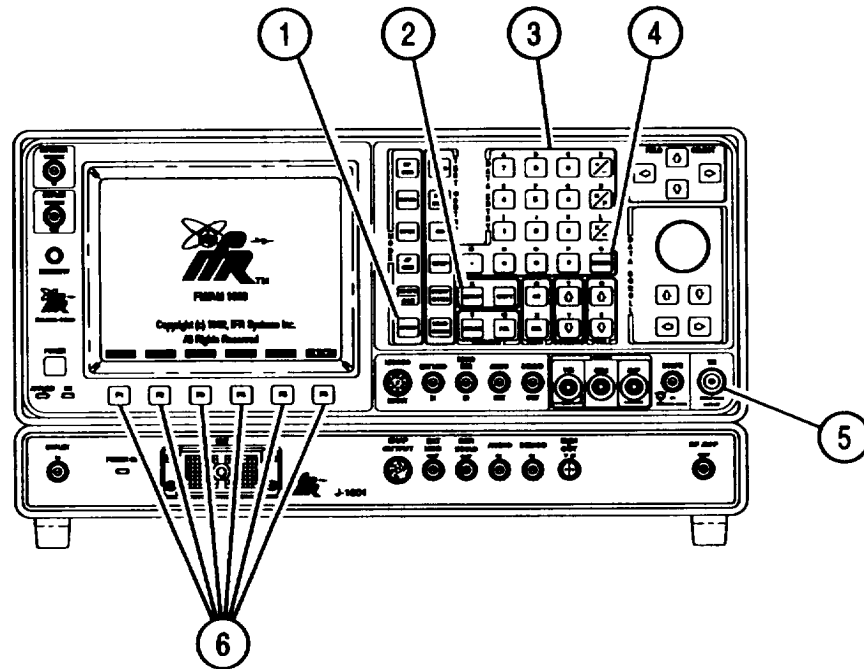

CE2FN707

NOTE

- Perform Receiver Setup (para 2-12a) prior to Deviation Meter (RMS) operation.
 - To recall a set of stored screen parameters, use Test Set memory RCL (Recall) Key. For information on use of Store and Recall Keys, refer to operator's controls, indicators and connectors (para 2-2).
 - FM Deviation (Peak) Meter Range must be set to 2, 5 or 10 kHz for accurate FM RMS Deviation measurements.
1. Press MTRS MODE Key (1) to display Meter Menu.
 2. Move cursor to 12. Press ENTER (4). Press SETUP Key (2) to display Deviation Meter (RMS) Menu.

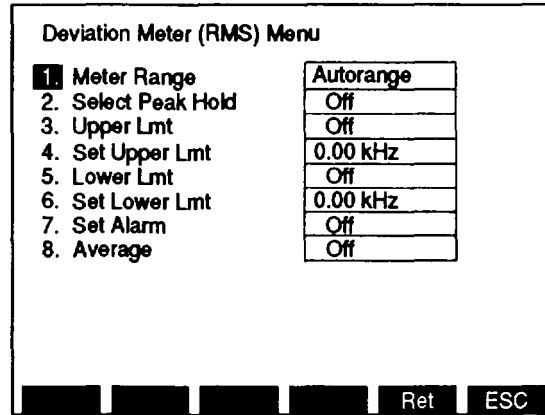

CE2FN623

3. Press 1 on DATA ENTRY Keypad (3) to display Meter Range Submenu.
4. Use DATA ENTRY Keypad (3) to select desired meter range or Aurorange.
5. Press 2 on DATA ENTRY Keypad (3) to Select toggle Peak Hold On or Off.
6. Press 3 on DATA ENTRY Keypad (3) to toggle Upper Lmt On or Off.
7. If Upper Limit is On, press 4 on DATA ENTRY Keypad (3) to access Set Upper Lmt data field.
8. Use DATA ENTRY Keypad (3) to enter digits of Upper Limit. Press ENTER (4).
9. Press 5 on DATA ENTRY Keypad (3) to toggle Lower Lmt On or Off.
10. If Lower Limit is On, press 6 on DATA ENTRY Keypad (3) to access Set Lower Lmt data field.
11. Use DATA ENTRY Keypad (3) to enter digits of Lower Limit. Press ENTER (4).
12. Press 7 on DATA ENTRY Keypad (3) to toggle Set Alarm On or Off.
13. Press 8 on DATA ENTRY Keypad (3) to toggle Average On or Off.
14. Press "Ret" F5 (6) to return to Deviation Meter Operation Screen. Verify settings of Deviation Meter are as desired.

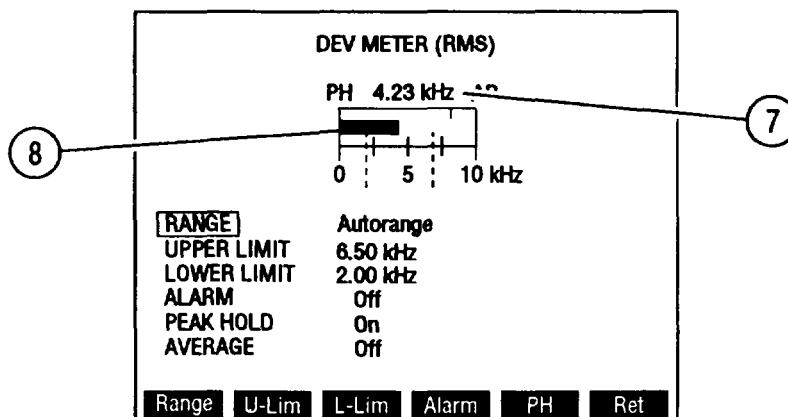

CE2FN624

15. Attach BNC-N coax cable from T/R Connector (5) to UUT.
16. Measure FM RMS Deviation using Meter Indicator Bar (8) and Digital Readout (7).

2-29. PM RMS PHASE MEASUREMENT.

Use following procedure to make PM RMS Phase Measurement:

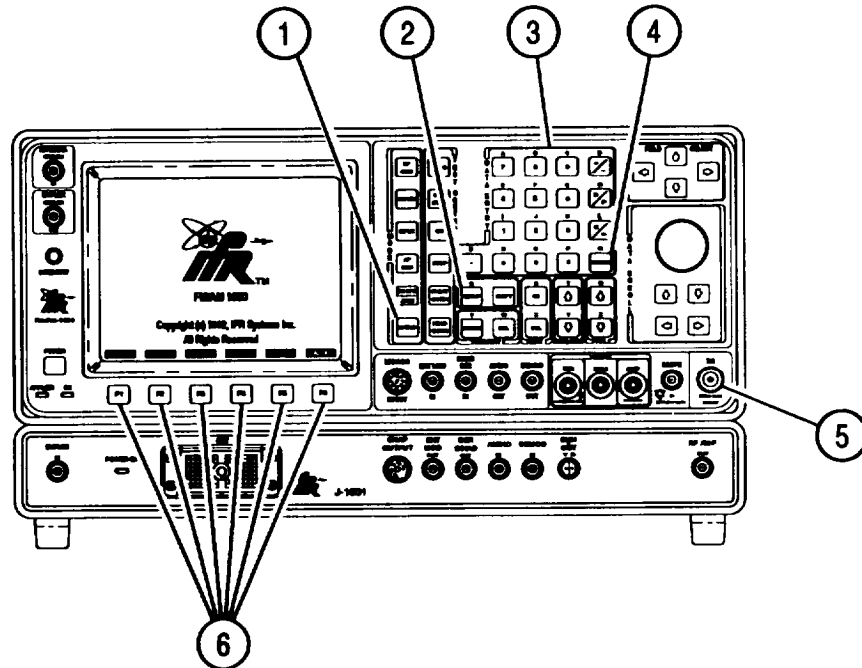

CE2FN708

NOTE

- Perform Receiver Setup (para 2-12a) prior to Phase Meter (RMS) operation.
- To recall a set of stored screen parameters, use Test Set memory RCL (Recall) Key. For information on use of Store and Recall Keys, refer to operator's controls, indicators and connectors (para 2-2).

1. Press MTRS MODE Key (1) to display Meter Menu.
2. Move cursor to 13. Press ENTER (4). Press SETUP Key (2) to display Phase Meter (RMS) Menu.

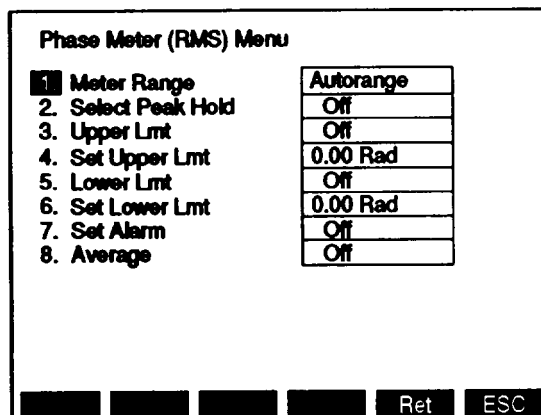

CE2FN625

3. Press 1 on DATA ENTRY Keypad (3) to display Meter Range Submenu.
4. Use DATA ENTRY Keypad (3) to select desired meter range or Autorange.
5. Press 2 on DATA ENTRY Keypad (3) to Select toggle Peak Hold On or Off.
6. Press 3 on DATA ENTRY Keypad (3) to toggle Upper Lmt On or Off.
7. If Upper Limit is On, press 4 on DATA ENTRY Keypad (3) to access Set Upper Lmt data field.
8. Use DATA ENTRY Keypad (3) to enter digits of Upper Limit. Press ENTER (4).
9. Press 5 on DATA ENTRY Keypad (3) to toggle Lower Lmt On or Off.
10. If Lower Limit is On, press 6 on DATA ENTRY Keypad (3) to access Set Lower Lmt data field.
11. Use DATA ENTRY Keypad (3) to enter digits of Lower Limit. Press ENTER (4).
12. Press 7 on DATA ENTRY Keypad (3) to toggle Set Alarm On or Off.
13. Press 8 on DATA ENTRY Keypad (3) to toggle Average On or Off.
14. Press "Ret" F5 (6) to return to Phase (RMS) Meter Operation Screen. Verify settings of Phase (RMS) Meter are as desired.

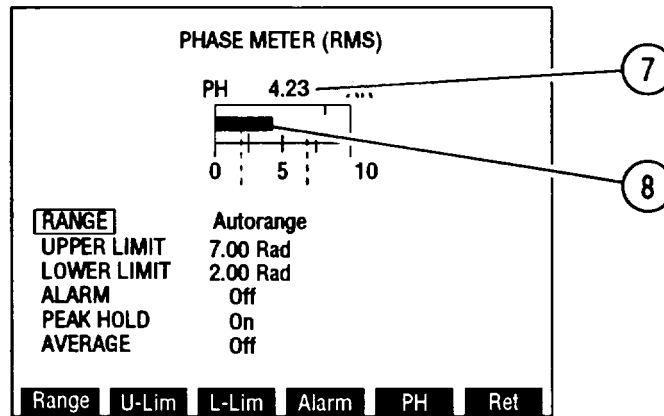

CE2FN626

15. Attach BNC-N coax cable from T/R Connector (5) to UUT.
16. Measure PM RMS Phase using Meter Indicator Bar (8) and Digital Readout (7).

2-30. SINGGARS TESTS.

Use following procedure for testing SINGGARS radios.

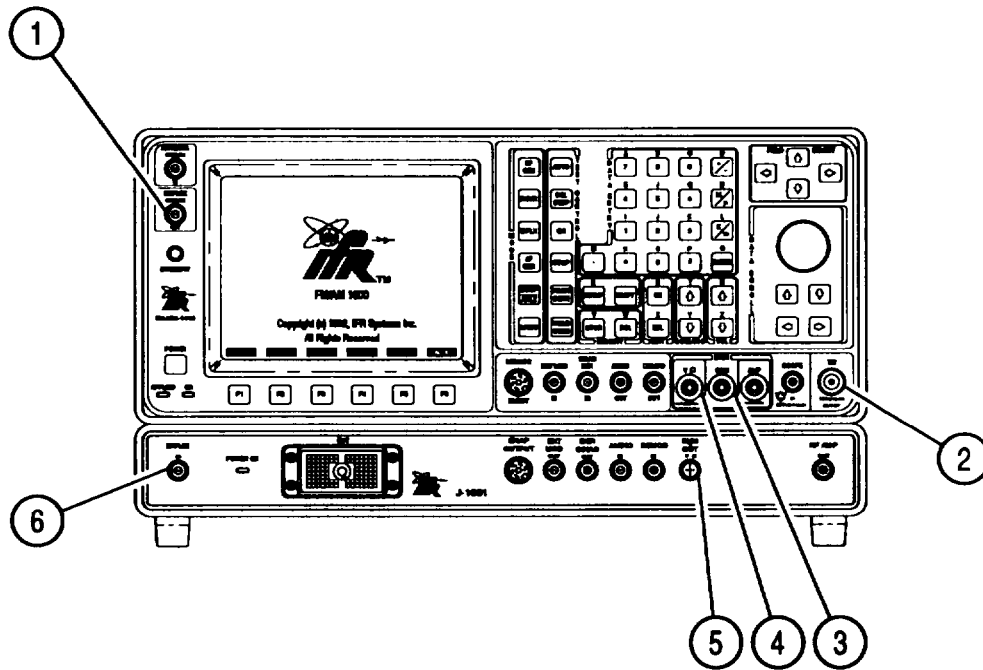

CE2FN720

1. When any screen displays "Sp Tst" as F5, press F5. SINGGARS Verification Tests Loading Menu appears followed, after a delay of about 1 minute, with SINGGARS Verification Tests Menu.

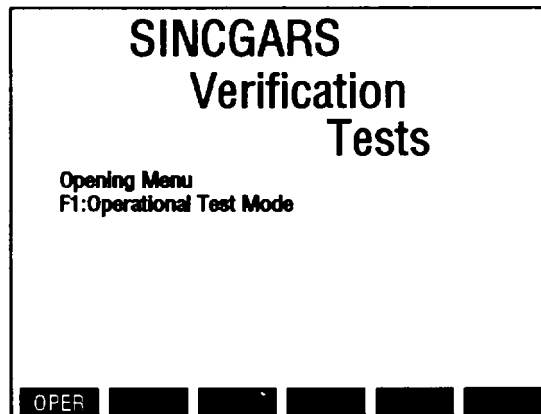

CE2FN668

2. Press "OPER" F1 to display Line Replaceable Unit (LRU) Selection Menu.

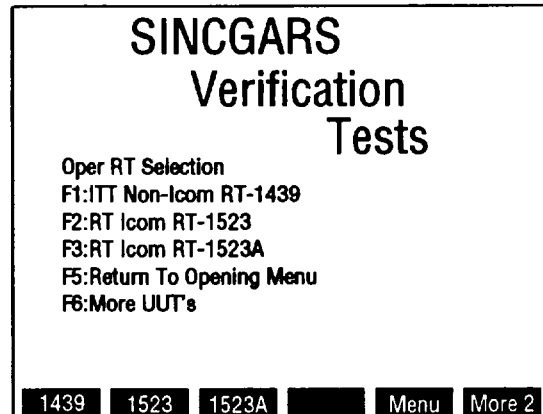

CE2FN669

3. Use Soft Function Keys to select LRU to test. Press F6 to display more LRU selections.
4. Connect BNC-BNC coax cable (7) (Appendix C, Item 22) from Test Set DUPLEX OUT Connector (1) to Test Adapter DUPLEX Connector (6).
5. Connect DMM banana cable assembly (9) (Appendix C, Item 21) from Test Adapter Volt Ω Digital Multi meter Output Connector (5) to Test Set V Ω Connector (4) and DMM "COM" Connector (3).
6. Connect four BNC-BNC coax cables (8) (Appendix C, Item 22) between Test Set and Test Adapter as shown (fig. 2-3 and fig. 2-4).
7. Connect RT-1439 as shown (fig. 2-3).
 - RT-1439/RT-1523 cable assembly (10).
 - T/R Connector (2) to UUT BNC-N coax cable (11).
8. Connect RT-1523 as shown (fig. 2-4).
 - RT-1439/RT-1523 cable assembly (10).
 - T/R Connector (2) to UUT BNC-N coax cable (11).
9. Perform SINGGARS radio tests (refer to TM 11-5820-890-30-5).

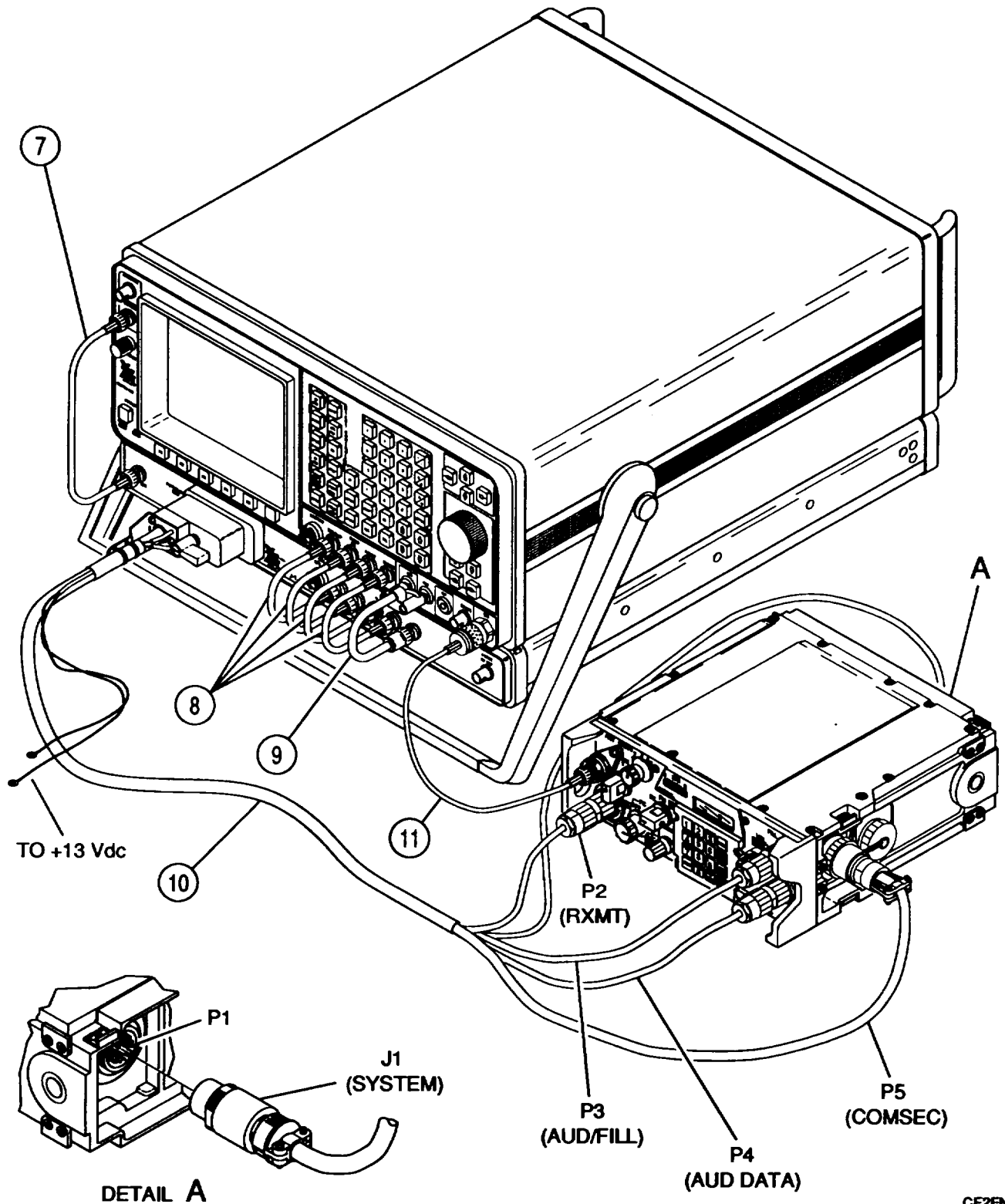
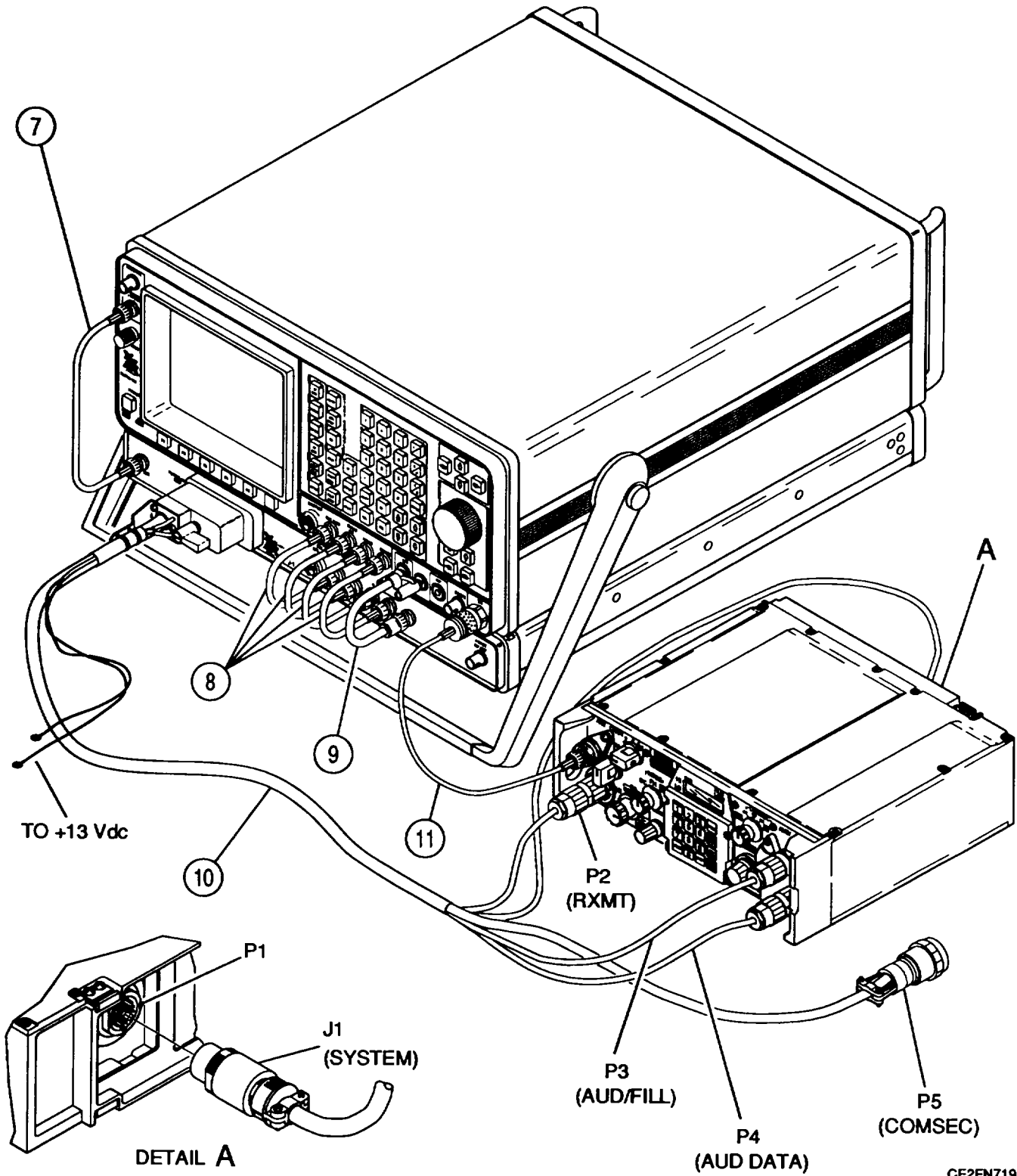

Figure 2-3. RT-1439 Test Connection.

CE2FN718



CE2FN719

Figure 2-4. RT-1523, RT-1523A Test Connection.

CHAPTER 3 UNIT MAINTENANCE

	Para	Page
Common Tools and Equipment	3-1	3-1
Environment	3-12	3-11
Packaging	3-10	3-11
Preliminary Servicing and Adjustment of Equipment	3-5	3-3
Repair Parts	3-3	3-1
Replace AC and DC Fuses	3-7	3-8
Replace Carrying Handle.	3-9	3-10
Replace Control Knobs	3-8	3-9
Service Upon Receipt of Materiel	3-4	3-2
Special Tools, TMDE and Support Equipment	3-2	3-1
Troubleshooting Table	3-6	3-5
Types of Storage	3-4	3-11

Section I. REPAIR PARTS, SPECIAL TOOLS, TMDE AND SUPPORT EQUIPMENT

3-1. COMMON TOOLS AND EQUIPMENT.

Common tools and equipment required for unit maintenance of Test Set FM/AM-1600/J-1601 are listed in the Maintenance Allocation Chart (MAC) (Appendix B).

3-2. SPECIAL TOOLS, TMDE AND SUPPORT EQUIPMENT.

There are no special tools, TMDE or support equipment required.

3-3. REPAIR PARTS.

Repair parts are listed and illustrated in the Repair Parts and Special Tools Lists, TM 11-6625-3244-24P and TM 11-6625-3246-24P.

Section II. SERVICE UPON RECEIPT

3-4. SERVICE UPON RECEIPT OF MATERIEL.

a. Unpacking. Special-design packing material inside this shipping carton provides maximum protection for Test Set. Avoid damaging carton and packing material during equipment unpacking. Use following steps for unpacking Test Set.

- Cut and remove sealing tape on carton top and open carton.
- Grasp Test Set firmly while restraining shipping carton and lift equipment and packing vertically.

CAUTION

Two people are required to lift and/or carry Test Set.

- Place Test Set and end cap packing on a suitable flat, clean and dry surface.
- Remove protective plastic bag from Test Set. Place desiccant bags back inside protective plastic bag.
- Remove rubber band from handle.
- Place protective plastic bag and end cap packing material inside shipping carton.
- Return shipping carton to supply system.

b. Checking Unpacked Equipment.

- Inspect the equipment for damage incurred during shipment. If equipment has been damaged, report damage on SF 364, Report of Discrepancy (ROD).
- Check equipment against packing slip to see if shipment is complete. Report all discrepancies in accordance with instructions of DA PAM 750-8.
- Check to see whether equipment has been modified.

3-5. PRELIMINARY SERVICING AND ADJUSTMENT OF EQUIPMENT.

- a. Verify DC-DC Interconnect Cable (Appendix C, item 20) and SCSI-SCSI Interconnect Cable (Appendix C, item 24) are connected as shown.
- b. Remove AC fuse or DC fuse from rear panel of Test Set. Check that fuses are correct for line voltage available in your area. Verify fuse is operable.

Input Voltage	Rear Panel Fuse
105 to 130 VAC	4.0 amp fast-blo
210 to 260 VAC	2.0 amp slow-blo
22 to 30 VDC	15 amp slow-blo

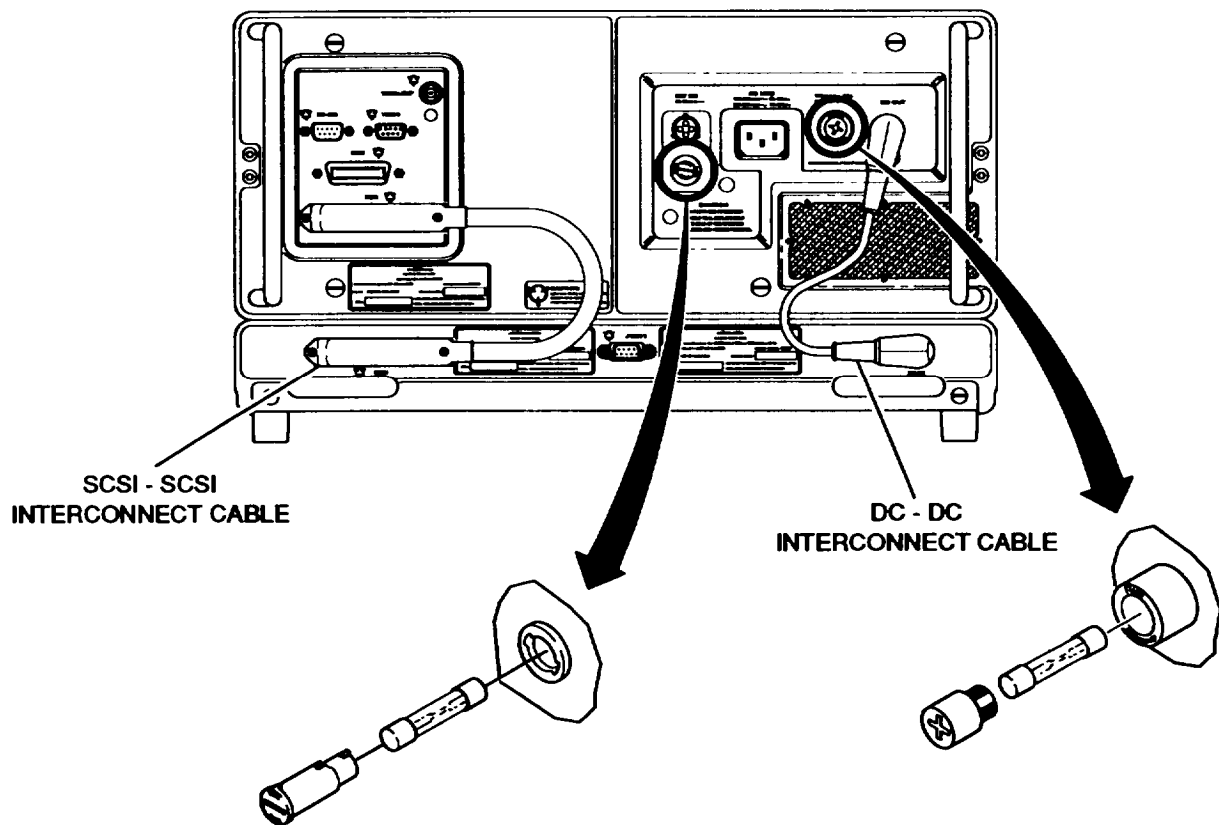

CE2FN679

- c. Connect four cables, Short BNC-BNC Coaxial Cable (Appendix C, item 21) as shown.

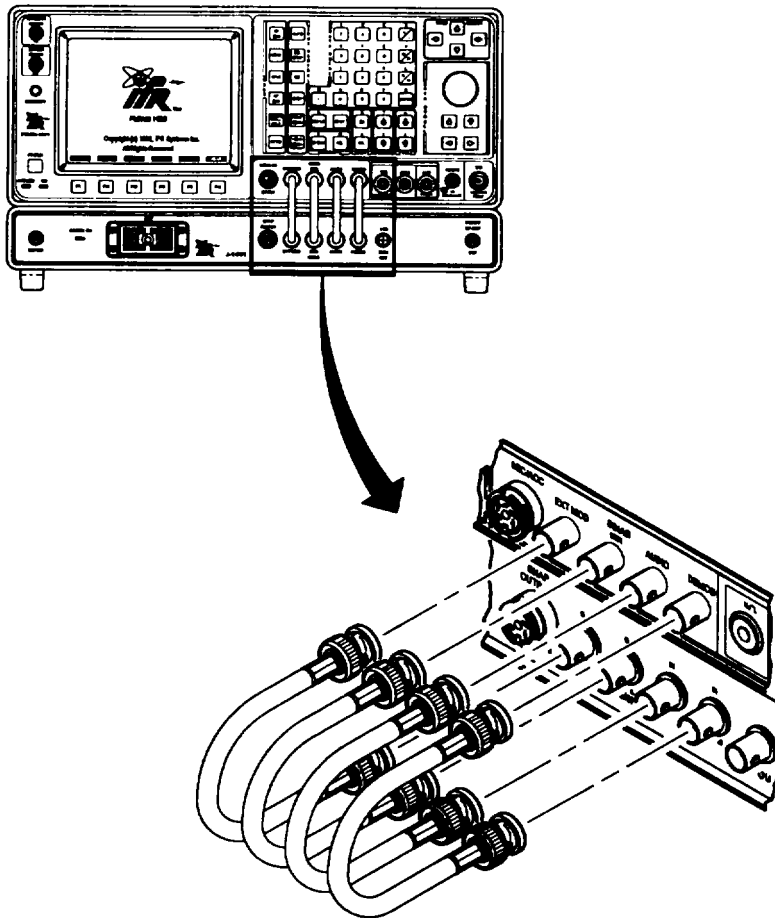

CE2FN680

- d. Apply input AC or DC power to Test Set,
- e. Perform Turn-On Procedure (para 2-8), SCSI ON Verification (para 2-9a) and Self Test (para 2-9b).

Section III. TROUBLESHOOTING

SYMPTOM INDEX

Symptom	Page
1. Test Set APPLIED Indicator does not illuminate3-5
2. Test Set ON Indicator does not illuminate3-5
3. Test Adapter POWER ON Indicator does not illuminate.3-6
4. CRT does not illuminate or illuminates dimly3-6
5. CRT displays error messages during Turn-On Procedure3-6
6. Test Set fails Self Test.....3-7

3-6. TROUBLESHOOTING TABLE.

Table 3-1 lists common malfunctions which may occur during operation or maintenance of Test Set. Perform tests/inspections and corrective actions in order listed.

NOTE

This manual cannot list all malfunctions that may occur, nor all tests or inspections and corrective actions. If a malfunction is not listed or is not corrected by listed corrective actions, notify next higher level of maintenance.

Table 3-1. Troubleshooting.

MALFUNCTION	TEST OR INSPECTION	CORRECTIVE ACTION
1. Test Set APPLIED Indicator does not illuminate.	Step 1. Check for blown AC or DC fuse.	<ul style="list-style-type: none"> ● Replace fuse (para 3-7).
	Step 2. Check for shorted, open or damaged AC or DC Power Cable.	<ul style="list-style-type: none"> ● Replace AC or DC Power Cable. ● Notify next higher level of maintenance.
2. Test Set ON Indicator does not illuminate.	Verify POWER Switch is in ON position.	<ul style="list-style-type: none"> ● Press POWER Switch. ● Notify next higher level of maintenance.

Table 3-1. Troubleshooting - Continued.

MALFUNCTION	TEST OR INSPECTION	CORRECTIVE ACTION
3. Test Adapter POWER ON Indicator does not illuminate.	Check for shorted, open or damaged DC-DC Interconnect Cable between Test Adapter and Test Set.	<ul style="list-style-type: none"> ● Replace DC-DC Interconnect Cable. ● Notify next higher level of maintenance.
4. CRT does not illuminate or illuminates dimly.	Check CRT Intensity/Contrast Adjustment.	<ul style="list-style-type: none"> ● Adjust Intensity/Contrast Adjustment. ● Notify next higher level of maintenance.
5. CRT displays error messages during Turn-On Procedure.	Evaluate displayed error message.	
	Inactive Funct Gen Board	
	Press POWER Switch Off and On.	<ul style="list-style-type: none"> ● If error message reappears, notify next higher level of maintenance.
	Inactive Monitor Control Board	
	Press POWER Switch Off and On.	<ul style="list-style-type: none"> ● If error message reappears, notify next higher level of maintenance.
	Inactive Counter Board	
	Press POWER Switch Off and On.	<ul style="list-style-type: none"> ● If error message reappears, notify next higher level of maintenance.
	Inactive RF I/O Board	
	Press POWER Switch Off and On.	<ul style="list-style-type: none"> ● If error message reappears, notify next higher level of maintenance. ● If fail message reappears, notify next higher level of maintenance.

Table 3-1. Troubleshooting - Continued.

MALFUNCTION	TEST OR INSPECTION	CORRECTIVE ACTION
5. CRT displays error messages during Turn-On Procedure - Continued.	Evaluate displayed error message - Continued.	Inactive SCSI Interface Press POWER Switch Off and On. <ul style="list-style-type: none"> ● Verify SCSI Connector is connected to Test Adapter (para 3-5a). ● Verify SCSI Connector is activated (para 2-9a). ● If error message reappears, notify next higher level of maintenance.
6. Test Set fails Self Test.	Press POWER Switch Off and On. Perform Self Test (para 2-9a).	<ul style="list-style-type: none"> ● If fail message reappears, notify next higher level of maintenance.

Section IV. MAINTENANCE PROCEDURES.

3-7. REPLACE AC AND DC FUSES.

DESCRIPTION

This procedure covers: Remove. Install.

REMOVE

1. Remove power from Test Set.
2. Remove fuse cap (1) if installed.
3. Remove fuseholder (2).
4. Remove fuse (3) from fuseholder (2).

INSTALL

1. Install fuse (3) in fuseholder (2).
2. Install fuseholder (2).
3. Install fuse cap (1) if applicable.

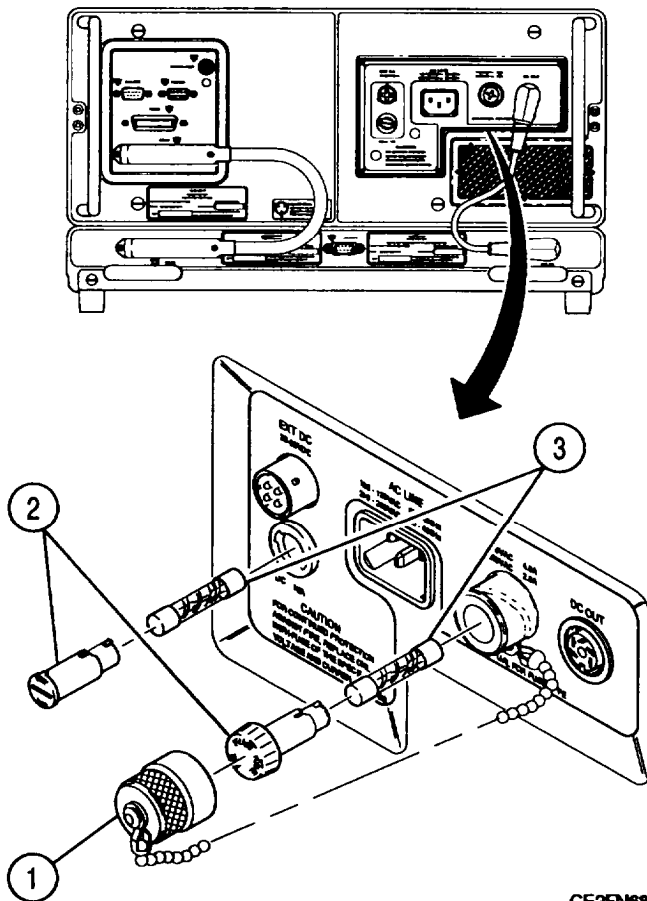

CE2FN681

END OF TASK

3-8. REPLACE CONTROL KNOBS.**DESCRIPTION**

This procedure covers: Remove. Install.

NOTE

Remove/Install procedure is identical for both front panel control knobs. Only INTENSITY knob is shown.

REMOVE

1. Loosen two hex head screws (1) in control knob (2).
2. Remove control knob (2) from front panel control (3).

INSTALL

1. With two hex head screws (1) loose, position replacement control knob (2) on front panel control (3).

NOTE

Alignment is not necessary.

2. Tighten two hex head screws (1) in control knob (2).

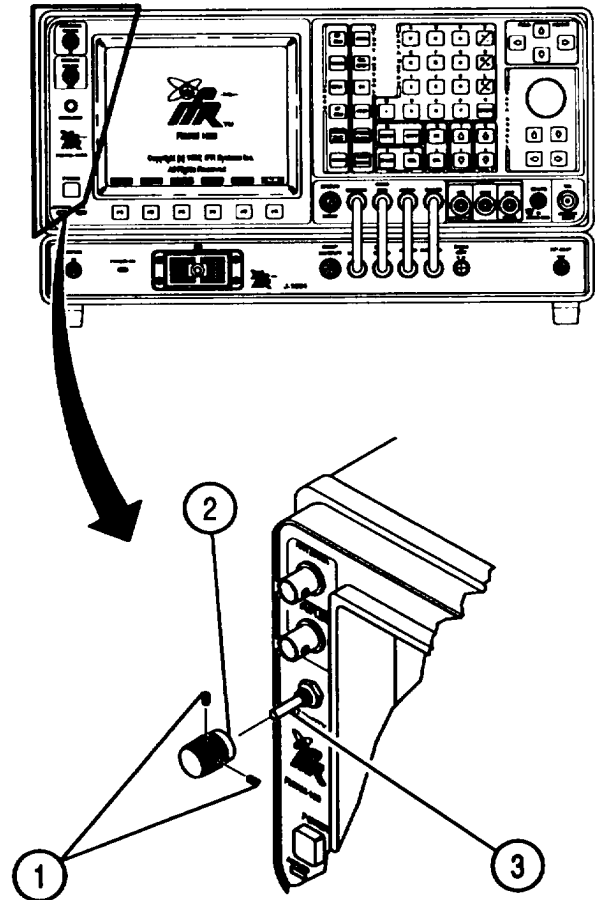

CE2FN682

END OF TASK

3-9. REPLACE CARRYING HANDLE.

DESCRIPTION

This procedure covers: Remove. Install.

REMOVE

1. Remove button (1) and spring (2).
2. Remove screw (3) and washer (4).
3. Repeat steps 1 and 2 for other side.
4. Remove carrying handle (5).
5. Remove ratchet (6).
6. Remove ratchet housing (7).
7. Repeat steps 5 and 6 for other side.

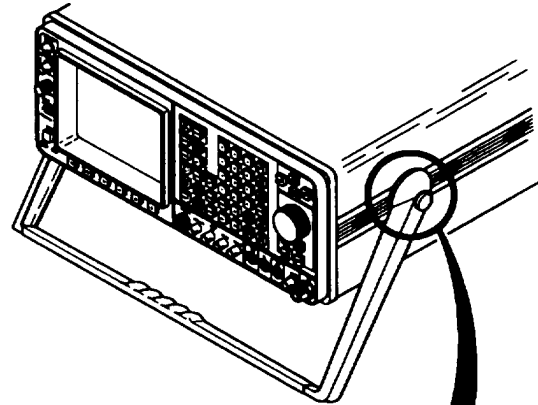

INSTALL

1. Install ratchet housing (7).
2. Install ratchet (6).
3. Repeat steps 1 and 2 for other side.
4. Install carrying handle (5).
5. Install screw (3) and washer (4).
6. Install spring (2) and button (1).
7. Repeat steps 5 and 6 for other side.

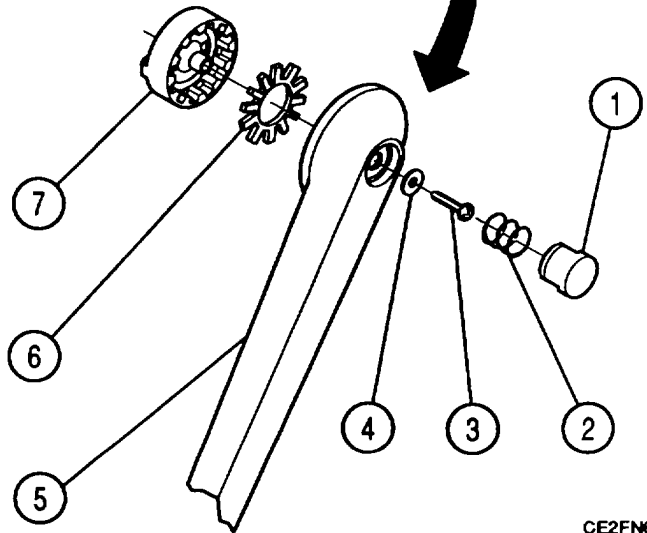

CE2FN635

END OF TASK

Section V. PREPARATION FOR STORAGE OR SHIPMENT

3-10. PACKAGING.

Package Test Set in original shipping container. When using packing materials other than original, use following guidelines:

- Wrap Test Set in plastic packing material.
- Use double-wall cardboard shipping container.
- Protect all sides with shock-absorbing material to prevent Test Set movement within container.
- Seal shipping container with approved sealing tape.
- Mark "FRAGILE" on all sides, top and bottom of shipping container.

3-11. TYPES OF STORAGE.

- Short-Term (administrative) = 1 to 45 days.
- Intermediate = 46 to 180 days.
- Long-term = over 180 days. After long-term storage, perform Turn-On Procedure (para 2-8) and Self Test (para 2-9a). If these tests fail, notify next higher level of maintenance.

3-12. ENVIRONMENT.

The Test Set should be stored in a clean, dry environment. In high humidity environments, protect Test Set from temperature variations that could cause internal condensation. The following environmental conditions apply to both shipping and storage:

Temperature	-40°F to +158°F (-40°C to +70°C)
Relative Humidity	0%-95%
Altitude	0 to 40,000 ft (0 to 12,192 m)
Vibration	<2.0 g
Shock<40 g

APPENDIX A REFERENCES

A-1. SCOPE.

This appendix lists all forms, field manuals, technical manuals, and miscellaneous publications referenced in this manual.

A-2. FORMS.

Equipment Inspection and Maintenance Worksheet	DA Form 2404
Product Quality Deficiency Report	Form SF 368
Recommended Changes to Publications and Blank Forms	DA Form 2028
Report of Discrepancy (ROD)	Form SF 364
Transportation Discrepancy Report (TDR)	Form SF 361

A-3. TECHNICAL MANUALS.

Procedures for Destruction of Electronics Materiel to Prevent Enemy Use (Electronics Command)	TM 750-244-2
Unit, Direct Support and General Support Repair Parts and Special Tools List for Radio Test Set TS-4317/GRM, including Depot Maintenance Repair Parts	TM 11-6625-3244-24P
Unit, Direct Support and General Support Repair Parts and Special Tools List for Radio Test Set Adapter J-4843/GRM-114B, including Depot Maintenance Repair Parts	TM 11-6625-3246-24P

A-4. MISCELLANEOUS.

Abbreviations for Use on Drawings, Specifications, Standards and in Technical Documents	MIL-STD-12
Common Table of Allowances	CTA 50-970
Consolidated Index of Army Publications and Blank Forms	DA Pam 25-30
First Aid for Soldiers	FM 4-25.11
The Army Maintenance Management System (TAMMS) Users Manual	DA Pam 750-8

APPENDIX B

MAINTENANCE ALLOCATION CHART

Section I. INTRODUCTION

B-1. GENERAL.

This appendix contains the Maintenance Allocation Chart (MAC) for the TS-4317/GRM and the MAC for the J-4843/GRM-114B. Sections II, III and IV of the TS-4317/GRM MAC follow the introduction. Sections II, III and IV of the J-4843/GRM-114B MAC follow Section IV of the TS-4317/GRM MAC. Both MACS together make up the MAC for the AN/GRM-114B.

- a. This section provides a general explanation of all maintenance and repair functions authorized at various maintenance categories.
- b. The Maintenance Allocation Chart (MAC) in section II designates overall authority and responsibility for the performance of maintenance functions on the identified end item or component. The application of the maintenance functions to the end item or component will be consistent with the capacities and capabilities of the designated maintenance categories.
- c. Section III lists the tools and test equipment (both special tools and common tool sets) required for each maintenance function as referenced from section II.
- d. Section IV contains supplemental instructions and explanatory notes for a particular maintenance function.

B-2. MAINTENANCE FUNCTIONS.

Maintenance functions will be limited to and defined as follows:

- a. **Inspect.** To determine the serviceability of an item by comparing its physical, mechanical, and/or electrical characteristics with established standards through examination (e. g., by sight, sound or feel).
- b. **Test.** To verify serviceability by measuring the mechanical, pneumatic, hydraulic, or electrical characteristics of an item and comparing those characteristics with prescribed standards.
- c. **Service.** Operations required periodically to keep an item in proper operating condition, i.e., to clean, (includes decontaminate, when required), to preserve, to drain, to paint, or to replenish fuel, lubricants, chemical fluids, or gases.
- d. **Adjust.** Maintain or regulate within prescribed limits, by bringing into proper or exact position, or by setting the operating characteristics to specified parameters.
- e. **Align.** To adjust specified variable elements of an item to bring about optimum or desired performance.

f. Calibrate. To determine and cause corrections to be made or to be adjusted on instruments or test, measuring, and diagnostic equipment used in precision measurement. Consists of the comparisons of two instruments, one which is a certified standard of known accuracy, to detect and adjust any discrepancy in the accuracy of the instrument being compared.

g. Remove/Install. To remove and install the same item when required to perform service or other maintenance functions. Install may be the act of emplacing, seating, or fixing into position a spare, repair part, or module (component or assembly) in a manner to allow the proper functioning of an equipment or system.

h. Replace. To remove an unserviceable item and install a serviceable counterpart in its place. "Replace" is authorized by the MAC and is shown as the 3d position code of the SMR code.

i. Repair. The application of maintenance services, including fault location/troubleshooting, removal/installation, and disassembly/assembly procedures, and maintenance actions to identify troubles and restore serviceability to an item by correcting specific damage, fault, malfunction, or failure in a part, subassembly, module (component or assembly), end item, or system.

j. Overhaul. That maintenance effort (service/action) prescribed to restore an item to a completely serviceable/operational condition as required by maintenance standards in appropriate technical publications (i.e., DMWR). Overhaul is normally the highest degree of maintenance performed by the Army. Overhaul does not normally return an item to like new condition.

k. Rebuild. Consists of those services/actions necessary for the restoration of unserviceable equipment to a like-new condition in accordance with original manufacturing standards. Rebuild is the highest degree of materiel maintenance applied to Army equipment. The rebuild operation includes the act of returning to zero those age measurements (hours/miles, etc.) considered in classifying Army equipment/components.

B-3. EXPLANATION OF COLUMNS IN THE MAC, SECTION II.

a. Column 1, Group Number. Column 1 lists functional group code numbers, the purpose of which is to identify maintenance significant components, assemblies, subassemblies, and modules with the next higher assembly. End item group number shall be "00".

b. Column 2, Component/Assembly. Column 2 contains the names of components, assemblies, subassemblies, and modules on which maintenance is authorized.

c. Column 3, Maintenance Function. Column 3 lists the functions to be performed on the item listed in Column 2. (For detailed explanation of these functions, see paragraph 2.)

d. Column 4, Maintenance Category. Column 4 specifies, by the listing of a work time figure in the appropriate subcolumn(s), the category of maintenance authorized to perform the function listed in Column 3. This figure represents the active time required to perform that maintenance function at the indicated category of maintenance. If the number or complexity of the tasks within the listed maintenance function vary at different maintenance categories, appropriate work time figures will be shown for each category. The work time figure represents the average time required to restore an item (assembly, subassembly, component, module, end item, or system) to a serviceable condition under typical field operating conditions. This time includes preparation time (including any necessary disassembly/assembly time), troubleshooting/fault isolation time, and quality assurance/quality control time in addition to the time required to perform the specific tasks identified for the maintenance functions authorized in the maintenance allocation chart. The symbol designations for the various maintenance categories are as follows:

- C Operator or Crew
- O Unit Maintenance
- F Direct Support Maintenance
- H General Support Maintenance
- D Depot Maintenance

e. Column 5, Tools and Equipment. Column 5 specifies, by code, those common tool sets (not individual tools) and special tools, TM DE, and support equipment required to perform the designated function.

f. Column 6, Remarks. This column shall, when applicable, contain a letter code, in alphabetic order, which shall be keyed to the remarks contained in Section IV.

B-4. EXPLANATION OF COLUMNS IN TOOL AND TEST EQUIPMENT REQUIREMENTS, SECTION III.

a. Column 1, Reference Code. The tool and test equipment reference code correlates with a code used in the MAC, Section II, Column 5.

b. Column 2, Maintenance Category. The lowest category of maintenance authorized to use the tool or test equipment.

c. Column 3, Nomenclature. Name or identification of the tool or test equipment.

d. Column 4, National Stock Number. The National stock number of the tool or test equipment.

e. Column 5, Tool Number. Manufacturer's part number.

B-5. EXPLANATION OF COLUMNS IN REMARKS, SECTION IV.

a. Column 1, Reference Code. The code recorded in column 6, Section II.

b. Column 2, Remarks. This column lists information pertinent to the maintenance function being performed as indicated in the MAC, Section II.

**Section II. MAINTENANCE ALLOCATION CHART
FOR
TS-4317/GRM**

(1) GROUP NUMBER	(2) COMPONENT / ASSEMBLY	(3) MAINTENANCE FUNCTION	(4) MAINTENANCE CATEGORY					(5) TOOLS AND EQUIPMENT	(6) REMARKS
			C	O	F	H	D		
00	TS-4317/GRM	Inspect		0.2					A
		Inspect				0.2			D
		Calibrate				8.0			S
		Test		0.2					B
		Replace		0.1					
		Repair		0.2				1,2	C
		Repair				0.8			F,T
01	Front Cover Assembly	Inspect		0.1					A
		Replace		0.1					
		Repair		0.2					G
02	TS-4317/GRM Composite Assembly 10000	Inspect				0.2			D
		Test				0.5		4,11,14,18,19,20, 21,22,23,24,25,26, 30,34,44,47	B,W
		Replace				0.1			
		Repair				2.5		5,6,7,8,9,10,12,13, 16,18,20,21,22,23, 24,26,27,29,31,32, 33,34,35,36,37,44, 45,46	H,Y
0201	Chassis Assembly	Inspect				0.2		18	D
		Test				1.0		18,21	
		Replace				2.0		18	
		Repair				2.0		18,21	I
0202	Monitor Assembly 12000	Replace				0.1		18	
		Repair				0.1		18	AA
020201	Monitor PC Board Assembly 13000	Replace				0.1		18	
		Test					1.6	4,15,18,21,23,25, 28,30,34,39,41,43	
		Repair					4.0	4,15,21,23,25,28, 30,34,39,41,43	

**Section II. MAINTENANCE ALLOCATION CHART
FOR
TS-4317/GRM**

(1) GROUP NUMBER	(2) COMPONENT ASSEMBLY	(3) MAINTENANCE FUNCTION	(4) MAINTENANCE CATEGORY					(5) TOOLS AND EQUIPMENT	(6) REMARKS	
			C	O	F	H	D			
020201	Monitor PC Board Assembly 78A1A3A1	Replace				0.1		18		
		Test				1.6		4,15,18,21,23,25, 30,34,39,41,43		
		Repair				4.0		4,15,21,23,25,28, 30,34,39,41,43		
0203	Analyzer Log/IF Assembly 7SA1A4	Replace				0.1		18	AA	
020301	Analyzer Log/IF PC Board Assembly 78A1A4A1	Repair				0.1		18		
		Replace				0.1		18		
0204	Analyzer RF Assembly 78A1A5	Test					0.6	13,15,18,20,21,22, 31,32,34,35,38,41, 43		
		Repair					1.0	13,15,18,20,21,22, 23,31,32,34,35,38, 41,43		
		Replace				0.1		18	AA	
020401	Analyzer RF PC Board Assembly 78A1A5A1	Repair				0.1		18		
		Replace				0.1		18		
		Test					0.6	13,15,18,20,21,22, 31,32,34,35,39,41, 43		
0205	Receiver Assembly 78A1A6	Repair					1.0	13,15,18,20,21,22, 23,31,32,34,35,39, 41,43		
		Test				0.1		0.7	13,15,18,20,21,22, 23,31,32,34,35,39, 41,43	
020501	Ampi PC Board Assembly 78A1AGA1	Replace						0.1	18	
		Repair						0.1	18	
		Repair					4.0		13,15,20,21,22,23, 31,32,34,35,39,41, 43	
020502	Demod PC Board Assembly 7SA1A6A2	Replace						0.1	18	
		Repair					4.0		4,13,15,20,21,22, 23,31,32,34,35,39, 41,43	

Section II. MAINTENANCE ALLOCATION CHART

FOR

TS-4317/GRM

(1) GROUP NUMBER	(2) COMPONENT ASSEMBLY	(3) MAINTENANCE FUNCTION	(4) MAINTENANCE CATEGORY					(5) TOOLS AND EQUIPMENT	(6) REMARKS
			C	O	F	H	D		
0206	3rd LO Assembly 78A1 A7	Replace				0.1		18	
		Repair				0.1		18	AA
020601	3rd LO PC Board Assembly 78A1 A7A1	Replace						18	
		Test					0.3	13,18,19,20,21,22, 23,31,32,34,35,38, 41,43	
		Repair					2.0	13,15,18,19,20,21, 22,23,31,32,34,35, 38,41,43	J
0207	DMM Assembly 78A1AB	Test				1.0		26	
		Replace				02		18	
		Repair				2.5		18,21,23,25	L,R
0208	90 MHz Generator Assembly 78A1 A9	Replace				0.1		18	
020801	90 MHz Generator PC Board Assembly 78A1 A9A1	Repair				0.1		18	AA
		Replace				0.1		18	
		Test					0.6	4,13,15,18,20,21, 22,23,31,32,34,35, 38,39,41,43	
		Repair					3.0	4,13,15,18,20,21, 22,23,31,32,34,35, 38,39,41,43	Z
0209	1 st LO Assembly 7SA1A10	Replace				0.3		18	
		Repair				1.0		18	E
		Test					1.0	13,21,22,23,31,32, 34,35,36,39,41,42	
020901	1st LO Control PC Board Assembly 78A1A10A1	Repair					1.0	18	X
		Replace					0.7	18,21	
		Repair					1.5	18,21,22,23,38,39, 41,42	AB
020902	1 st LO VCO/Buffer PC Board Assembly 78A1A10A2	Replace					0.6	18,21	
		Repair					1.0	18,21,23,38,39,41, 42	AB

**Section II. MAINTENANCE ALLOCATION CHART
FOR
TS-4317/GRM**

(1) GROUP NUMBER	(2) COMPONENT ASSEMBLY	(3) MAINTENANCE FUNCTION	(4) MAINTENANCE CATEGORY					(5) TOOLS AND EQUIPMENT	(6) REMARKS
			C	O	F	H	D		
020903	1 st LO Control PC Board Assembly 78A1A10A3	Same as 020901							
020904	1st LO VCO/Buffer PC Board Assembly 78A1A10A4	Same as 020902							
0210	Receive IF Assembly 78A1A12	Replace Repair Test				0.3 1.0	0.6	18 18,21 13,20,21,22,27,31,32,34,35,36,39,41,42	U
		Repair					1.0	10,13,18,20,21,22,23,27,31,32,33,34,35,36,39,41,42	N
0211	Generator IF Assembly 78A1A13	Replace Repair Test				0.3 1.0	0.7	18 18,21 13,20,21,22,27,31,32,33,34,35,36,39,41,42	V
		Repair					1.0	13,18,20,21,22,23,27,31,32,34,35,39,41,42	O
0212	Power Termination Assembly 78A1A14	Replace Repair Test				0.4	1.0 0.7	18 18,21 13,20,21,22,27,36,39,42	M
		Repair					1.0	18,21	X
021201	Power Termination PC Board Assembly 78A1A14A1	Replace					0.7	18,21	
		Repair					3.0	10,13,18,20,21,22,23,27,36,39,42	
0213	CRT Assembly 7A1A15	Test Replace Repair Align				0.5 0.1 2.0 2.0		18 3,17,18,21,23 17,18	Q, AD

**Section II. MAINTENANCE ALLOCATION CHART
FOR
TS-4317/GRM**

(1) GROUP NUMBER	(2) COMPONENT ASSEMBLY	(3) MAINTENANCE FUNCTION	(4) MAINTENANCE CATEGORY					(5) TOOLS AND EQUIPMENT	(6) REMARKS
			C	O	F	H	D		
021301	CRT HN PC Board Assembly 78A1A15A1	Replace				0.1		18	RAC
		Repair				2.0		3,17,18,21,22	
021302	CRT Color PC Board Assembly 78A1A15A2	Replace				0.1		18	AC
		Repair				2.0		18,21,22	
0214	Power Supply Assembly 78A1A16	Replace				0.4		18	P
		Test					0.7	21,26,42	
		Repair					1.5	18,21,23,26,42	
0215	Front Panel Assembly 78A1A17	Test					0.7		K
		Replace					0.6	18	
		Repair					2.0	18,21,23,48	
0216	Processor PC Board Assembly 781A19	Replace				0.1		18	
		Test					0.5	15,39,40,43	
		Repair					8.0	15,21,39,40,43	
0217	Memory PC Board Assembly 78A1A20	Replace				0.1		18	
		Test					0.5	15,41,43	
		Repair					8.0	15,21,23,41,43	
0218	Video Controller PC Board Assembly 78A1A21	Replace				0.1		18	
		Test					0.5	41,42	
		Repair					3.0	18,21,23,29,37,41, 42	
0219	Function Generator PC Board Assembly 78A1A24	Replace				0.1		18	
		Test					1.5	4,15,19,21,23,30, 34,41,43	
		Repair					8.0	4,15,19,21,23,34, 35,37,41,43	

**Section II. MAINTENANCE ALLOCATION CHART
FOR
TS-4317/GRM**

(1) GROUP NUMBER	(2) COMPONENT ASSEMBLY	(3) MAINTENANCE FUNCTION	(4) MAINTENANCE CATEGORY					(5) TOOLS AND EQUIPMENT	(6) REMARKS
			C	O	F	H	D		
0220	Digitizer PC Board Assembly 78A1A25	Replace				0.1		18	
		Test					1.7	13,15,20,21,31,34, 35,41,43	
		Repair					12.0	13,15,20,21,23,31, 34,35,37,41,43	
0221	Attenuator PC Board Assembly 78A1A28	Test				0.7		20,24,44	
		Replace				0.5		18	
		Repair				1.0		18,21,23	

**SECTION III. TOOL AND TEST EQUIPMENT REQUIREMENTS
FOR
TS-4317/GRM**

(1) TOOL OR TEST EQUIPMENT REF CODE	(2) MAINTENANCE LEVEL	(3) NOMENCLATURE	(4) NATIONAL/NATO STOCK NUMBER	(5) TOOL NUMBER
1	0	Multimeter, Digital	662501-2654000	AN/PSM45A
2	0	Tool Kit, Electronic Equipment	5180-00610-8177	TK-105/G
3	H	Probe, High Voltage	6625-0179-4627	P6015
4	H	Analyzer, Distortion	6625-01-217-0054	TS4084/G
5	H	Extender, PC Board Assembly	701 0-7830-400	
6	H	Extender, PC Board Assembly	7010-7839-800	
7	H	Extender, PC Board Assembly	7010-7830-000	
8	H	Extender, PC Board Assembly	7010-7839-700	
9	H	Extender, PC Board Assembly	7010-7839-600	
10	H	Coupler, 10 dB SMA	4202B-10	
11	H	Power Splitter	6695-01-108-9833	1870A
12	H	Coax Assembly, 24" SMA(F) - BNC(M)		6050-0093-600
13	H	Coax Assembly, 24" SMB(F) - BNC(M) (2)		6050-0032-400
14	H	Test Set, Radio Frequency Power	6625-01-075-0261	TS-3793/U
15	D	Software, Module Test- Automatic		0021-78V0-400
16	H	Cable Assembly, Serial Interface 9-pin D Sub F/F		TANDY 26-152
17	H	Coil, Degausing		9317
18	H	Tool Kit, Electronic Equipment	6625-01-070-8900	JTK-17AL
19	H,D	Counter, Frequency	662501-271-3012	AN/USM-459A
20	H,D	Generator, Signal VHF	6625-01-2338615	SG-1207/G

B-10 Change 1

**SECTION III. TOOL AND TEST EQUIPMENT REQUIREMENTS
FOR
TS-4317/GRM**

(1) TOOL OR TEST EQUIPMENT REF CODE	(2) MAINTENANCE LEVEL	(3) NOMENCLATURE	(4) NATIONAL/NATO STOCK NUMBER	(5) TOOL NUMBER
21	H,D	Multimeter, Digital with 5 1/2 digit resolution	6625-01-221-9367	AN/GSM-64D
22	H,D	Analyzer, Spectrum with Tracking Generator w/ Soope Probe	6625-01-259-1060	AN/USM-489A
23	H,D	Oscilloscope	6625-01-25&0022	OS-291/U
24	H,D	Receiver, Measuring	662501-169-7744	HP-8902A
25	H,D	Calibrator	6625-01-099-2414	Fluke 5100B
26	H,D	Source, Power 0-40V, 0-30A	6130-00-408-9969	LK351FM
27	H,D	Meter, Power	6625-01-191-7679	AN/USM491
28	H,D	Extender, Cable Assembly		6045-7883-600
29	H,D	Extender, PC Board Assembly		7010-7839-900
30	H,D	Generator, Function	6625-01-276-9421	SG- 1288/U
31	H,D	Adapter, Plug SMB(MySMB (M) (2)		AEP 5222-1501-000
32	H,D	Adapter, Tee SMB (M F M)		HP1250-1391
33	H,D	Adapter, Jack SMA(F)/SMA(F)	5935-00-931-3004	HP1250-1158
34	H,D	Coax Assembly, BNC/BNC (4)	4931-00-842-9273	RG58AU
35	H,D	Coax Assembly, 24" SMB(F)/SMB(F) (2)		6050-0042-200
36	H,D	Coax Assembly, 24" BNC(M)/SMA(M)		6050-0092400
37	H,D	Analyzer, Logic	6625-01-321-9286	HP-1650B
38	D	Analyzer, Modulation	669501-110-8952	HP-8901A
39	D	Source, Power (Triple Output)		B & K 1660
40	D	Emulator		Fluke 9100 (FT/A)

**SECTION III. TOOL AND TEST EQUIPMENT REQUIREMENTS
FOR
TS-4317/GRM**

(1) TOOL OR TEST EQUIPMENT REF CODE	(2) MAINTENANCE LEVEL	(3) NOMENCLATURE	(4) NATIONAL/NATO STOCK NUMBER	(5) TOOL NUMBER
41	D	Computer, AT-386 with 1/0 PC Board, (2 Serial, 1 Parallel port) GPIB PC Board, Math Co- processor & 2 Meg RAM		386AT
42	D	Kit, Test Fixture Module Test - Manual		0021-78VO-100
43	D	Kit, Test Fixture Module Test - Automatic		0021-78VO-200
44	H,D	Sensor Module	6625-01-169-7669	HP-11722A
45	H	Controller, Core	4931-01-305-8132	MIS-3893812
46	H	Kit, Software		7112-7841-900
47	H	Power Sensor	6625-01-094-8263	HP-8482B
48	H	150 OHM Load, BNC(M)-BNC(F) MDC1 079-B-150		MIDISCO
49	H	10 MHz Standard		QUARTZ 28480
50	H	BNC T-Connector		AMPHENOL 31-2208
51	H	Modulation Domain Analyzer		HP-5331 0A
52	H	Decade, Resistor	6625-00-585-4915	Winslow 240C
53	H	Coupler, 20 dB, Type N		Narda 3020A
54	H	Attenuator, 10 dB, 10 W, Type N		Winshel Model 1
55	H	Amplifier, RF	4931-00-128-1444	Triplett Model 815
56	H	Cable, Test, MIC/ACC		0021-AAJ1-100
B-12 Change 1				

Section IV. REMARKS

TS-4317/GRM

REFERENCE CODE	REMARKS
A	External visual inspection and check for completeness.
B	Turn on Procedure and Initiate Self Test.
C	Repair is limited to replacement of the following non-repairables: Current Shunt, 10 A/100 mV Attenuator, 10 dB Attenuator, 20 dB Fuse, 2 A, 250 V Fuse, 4 A, 250 V Fuse, 15 A, 32 V Cable Assembly, AC Power Cable Assembly, DC Power Probes, DMM Probe, Scope Antenna, Flex BNC, Right Angle Knobs Carrying Handle Microphone.
D	Internal and external inspection for signs of damage, loose parts, broken connectors or cables or any missing items.
E	Repair is limited to replacement of the following non-repairable assembly: 1st LO Wire Harness Assembly.
F	If the TS-4317/GRM cannot be repaired by TSG, forward complete unit including all COEI items to Depot.
G	Repair is limited to replacement of the following non-repairable items: Front Cover Pouch Front Cover.
H	Repair is limited to repair/replacement of the authorized repairable assembly and the following non-repairable assemblies: 10 MHz Frequency Standard Rear Panel Assembly RF I/O PC Board Assembly Cable Assemblies External I/O PC Board Assembly Auxiliary Power Supply PC Board Assembly 2nd LO Assembly Counter PC Board Assembly Monitor Control PC Board Assembly Rear Panel Connector PC Board Assembly.
I	Repair is limited to replacement of the following non-repairable item/assembly: Motherboard PC Board Assembly External Reference Connector.
J	Repair is limited to replacement of the following non-repairable item/assembly: VCO PC Board Assembly Failed piece parts on 3rd LO PC Board assembly.
K	Repair is limited to replacement of the following non-repairable items/assemblies: Connector PC Board Assembly Keyboard PC Board Assembly Failed piece part on Front Panel Assembly.

**Section IV. REMARKS
FOR
TS-4317/GRM**

Reference Code	Remarks
L	Repair is limited to replacement of the following non-repairable items/assemblies: DMM I/Relay PC Board Assembly DMM/Digital PC Board Assembly Defective Fuses.
M	Repair is limited to replacement of the following non-repairable assembly: Power Termination Wire Harness Assembly.
N	Repair is limited to replacement of the following non-repairable assemblies: 1st Mixer PC Board Assembly 2nd Mixer PC Board Assembly 3rd Mixer PC Board Assembly Null PC Board Assembly 1300 MHz Band Pass Filter.
O	Repair is limited to replacement of the following non-repairable assemblies: Generator IF Mixer PC Board Assembly Generator IF Output PC Board Assembly 1299 MHz Band Pass Filter.
P	Repair is limited to replacement of the following non-repairable assemblies: DC Distribution/Filter PC Board Assembly Control PC Board Assembly Power Supply Wire Harnesses Converter PC Board Assembly 150 W Power Supply PC Board Assembly Schedule replacement of Fan every 3000 hours.
Q	For part number 7005-7840-600, repair is by replacement of failed CRTIY Yoke Assembly and Mechanical hardware.
R	Conformal coating is required after repair.
S	Calibrate in accordance with TB43-180.
T	Repair is limited to replacement of the following non-repairable assemblies: Top Case Assembly Bottom Case Assembly.
U	Repair is limited to replacement of the following non-repairable assembly: Receive IF Wire Harness Assembly.
V	Repair is limited to replacement of the following non-repairable assembly: Generator IF Wire Harness Assembly.
W	Additional testing required using external test instruments.
X	Repair by replacement of Housing Feedthru Terminals and defective PC Board Assembly.
Y	Requires Software Download Procedure when Memory PC Board Assembly (78A1A20) is removed and replaced.
Z	Repair is limited to replacement of the following non-repairable item/assembly: VCO PC Board Assembly Failed piece part on 90 MHz Generator PC Board Assembly.
AA	Repair is limited to replacement of defective Assembly.
AB	Must be aligned with 020901 or 020902 for corresponding Gen or Rec side.
AC	Used only on CRT Assembly P/N 7005-7840-600.
B-14 Change 1	

**Section IV. REMARKS
FOR
TS-4317/GRM**

Reference Code	Remarks
AD	<p>For Part Number 7005-8644-300, repair is limited to replacement of the following non-repairable assemblies:</p> <ul style="list-style-type: none"> CRT/Yoke Assembly Video PC Board Assembly Deflection Assembly Wire Harness Assembly Fuse.

**Section II. MAINTENANCE ALLOCATION CHART
FOR
J-4843/GRM-114B**

(1) GROUP NUMBER	(2) COMPONENT ASSEMBLY	(3) MAINTENANCE FUNCTION	(4) MAINTENANCE LEVEL					(5) TOOLS AND TEST EQUIPMENT	(6) REMARKS
			C	O	F	H	D		
00	J4843/GRM-11 4B 83	Inspect		0.2					A E J C D A F E
		Inspect				0.2		4	
		Install				0.4		4	
		Test		0.2					
		Replace				0.2			
01	Front Cover Assembly 83A3	Repair		0.2				1,2	D A
		Repair				0.8		4,14	
		Replace		0.1					
02	4843/GRM-114B Composite Assembly 83A1	Repair		0.1					F E
		Inspect			0.2			4	
		Test				1.0		10,14,23	
0201	Cardcage Assembly 83A1 A2	Replace					0.1		C I E
		Repair				2.0		4,9,10,12,14,15,16, 24,25	
		Inspect				0.2			
0202	RF Amplifier Assembly 83A1A3	Test					1.0		G
		Replace				2.0		4,14	
		Repair				0.7		4	
020201	Preamp PC Board Assembly 83AIA3A1	Align					0.5		4,6,11,13,14,15,27 4,6,11,13,14,15,27 4 4,5,6,14
		Replace				2.0		4	
		Repair				4.0		4,6,11,13,14,15,27	

**Section II. MAINTENANCE ALLOCATION CHART
FOR
J-4843/GRM-114B**

(1) GROUP NUMBER	(2) COMPONENT ASSEMBLY	(3) MAINTENANCE FUNCTION	(4) MAINTENANCE LEVEL					(5) TOOLS AND TEST EQUIPMENT	(6) REMARKS
			C	O	F	H	D		
020202	Amplifier PC Board Assembly 83AIA3A2	Replace				0.5		4	
		Repair				4.0		3,4,5,6,7,8,11,14, 15,27	
0203	Front Panel Assembly 83A1 A4	Test				0.7		4,14	
		Replace				0.5		5	
		Repair				1.0		4,14	B
0204	Rear Panel Assembly 83A1 A5	Test				0.7		4,14	
		Replace				0.5		4	
		Repair				1.0		4,14	H
0205	UUT Interface PC Board Assembly 83A1 A7	Replace				02		4	
		Test					0.7	4,14,15,17,21,22	
		Repair					12.0	14,15,16,17,19, 20,21,22	
0206	Processor PC Board Assembly 83A1A8	Replace				0.1		4	
		Test					0.5	4,14,18,21,22	
0207	Memory PC Board Assembly 83A1 A6	Repair					8.0	14,15,18,21,22	
		Replace				0.1		4	K
		Test					0.5	4,14,15,17,21,22, 26	
		Repair					3.0	4,14,15,17,21,22, 26	

**SECTION III. TOOL AND TEST EQUIPMENT REQUIREMENTS
FOR
J-4843/GRM-114B**

(1) TOOL OR TEST EQUIPMENT REFERENCE CODE	(2) MAINTENANCE CATEGORY	(3) NOMENCLATURE	(4) NATIONAL/NATO STOCK NUMBER	(5) TOOL NUMBER
1	0	Multimeter, Digital	6625-01-2656000	AN/PSM-45A
2	0	Tool Kit, Electronic Equipment	5180-00-610-8177	TK-105/G
3	H	Power Splitter	6625-01-017-2713	HP-11667A
4	H	Tool Kit, Electronic Equipment	6625-01-070-8900	JTK-17AL
5	H	Generator, Signal VHF	6625-01-233-8615	SG-1207/G
6	H	Analyzer, Spectrum with Tracking Generator and Scope Probe	6625-01-259-1060	ANIUSM489A
7	H	30 dB, 10 Wan Attenuator (2)	598501-055-1829	WEINSCHEL 23-3034
8	H	Meter, Power	6625-01-191-7679	AN/USM491
9	H	Adapter, BNC/N	5935-00-761-5765	
10	H	Cable Assembly, Serial Interface F/F (1)		6041-7885-200
11	H	RF Probe (w/DC Block)		Auburn Tech P-20A
12	H	Coax Assembly 24' SMB (F) BNC (M) (2)		85680-60093
13	H	Cable Assembly, RF Amp		0021-83JO-100
14	H,D	Multimeter, Digital 5 1/2 Digit Resolution	6625-01-221-9367	AN/GSM-64D
15	H,D	Oscilloscope	6625-01-250-0022	OS-291/U
16	H,D	Analyzer, Logic	6625-01-321-9286	HP-1650B
17	D	Source, Power (Triple Output)		B&K 1660
18	D	Emulator, Fluke		Fluke 9100 (FT/A:
19	D	Counter, Frequency	6625-01-271-3012	AN/USM-459A
20	D	Generator, Function	6625-01-276-9421	SG-1288/U

**SECTION III. TOOL AND TEST EQUIPMENT REQUIREMENTS
FOR
J-4843/GRM-114B**

(1) TOOL OR TEST EQUIPMENT REFERENCE CODE	(2) MAINTENANCE CATEGORY	(3) NOMENCLATURE	(4) NATIONAL/NATO STOCK NUMBER	(5) TOOL NUMBER
21	D	Kit, Test Fixture Module Test - Automatic	0021-78V0-200	0021-78V0-400
22	D	Software, Module Test - Automatic		0021-BMEO-100
23	H	Plug, Test (TF-119)		0021-BMEO-100
24	H	Controller, Core	4931-3058132	MIS-39938/2
25	H	Kit, Software		7112-8341-900
26	D	Computer, AT-386 with VO PC Board,		386 AT
		(2 Serial, 1 Parallel) GPIB PC Board,		
		Math Co-processor and 2 Meg RAM		
27	H	BNC T-Connector		AMPHENOL 31-2208

**Section IV. REMARKS
FOR
TS-4317/GRM**

Reference Code	Remarks
A	External visual inspection and check for completeness.
B	Repair is limited to replacement of: Front Panel UUT Connector PC Board Assembly (Non-repairable Assembly) Front Panel Audio Connector PC Board Assembly (Non-repairable Assembly) Failed piece parts on Front Panel Assembly.
C	Turn on Procedure, Initiate Self Test with the TS-4317/GRM.
D	Repair is limited to replacement of the following non-repairable items: External Cables Test Adapter.
E	Internal and external inspection for signs of damage, loose parts, broken connectors or cables and any missing items.
F	Repair is limited to replacement of the following non-repairable items: Front Cover Front Cover Pouch.
G	Repair is limited to replacement of the following non-repairable assembly: Motherboard PC Board Assembly.
H	Repair is limited to replacement of the following non-repairable assemblies: Rear Panel PC Board Assembly RS-232 Cable Assembly DC IN Wire Harness Assembly. Repair is limited to repair/replacement of authorized repairable assemblies and/or the following non-repairable assemblies: Cable Assemblies External I/O PC Board Assembly Bottom Case Assembly.
J	Attachment to a TS-4317/GRM
K	Requires Software Upload Procedure when Memory PC Board (83A1 A6) is removed and replaced.

APPENDIX C

COMPONENTS OF END ITEM AND BASIC ISSUE ITEMS LISTS

Section I. INTRODUCTION

C-1. SCOPE.

This appendix lists components of end item and basic issue items for the AN/GRM-114B to help you inventory items required for safe and efficient operation.

C-2. GENERAL.

The Components of the End Item and Basic Issue Items Lists are divided into the following sections:

a. Section II. Components of End Item. This listing is for informational purposes only and is not authority to requisition replacements. These items are part of the end item, but are removed and separately packaged for transportation or shipment. A part of the end item, these items must be with the end item whenever it is issued or transferred between property accounts. The list is divided into sublistings for each Radio Test Set. Illustrations are furnished to assist you in identifying the items.

b. Section III. Basic Issue Items. These are the minimum essential items required to place the AN/GRM-114B in operation, to operate it and to perform emergency repairs. Although shipped separately packaged, BII must be with the AN/GRM-114B during operation and whenever it is transferred between property accounts. The illustrations will assist with hard-to-identify items. This manual is your authority to request/requisition replacement BII, based on TOE/MTOE authorization of the end item.

C-3. EXPLANATION OF COLUMNS.

The following explains the columns in the tabular listings:

a. Column (1), Illustration Number (Illus No.). This column indicates the number of the illustration showing the item.

b. Column (2), National Stock Number. This column indicates the national stock number assigned to the item and will be used for requisitioning purposes.

c. Column (3), Description. This column indicates the federal item name and if required, a minimum description to identify and locate the item. The last line for each item indicates the CAGEC (in parentheses), followed by the part number.

d. Column (4), Unit of Measure (U/M). This column indicates the measure used in performing the actual operational maintenance function. This measure is expressed by a two-character alphabetical abbreviation (e.g., ea, in, pr).

e. Column (5), Quantity Required (Qty Req'd). This column indicates the quantity of the item authorized to be used with/on the equipment.

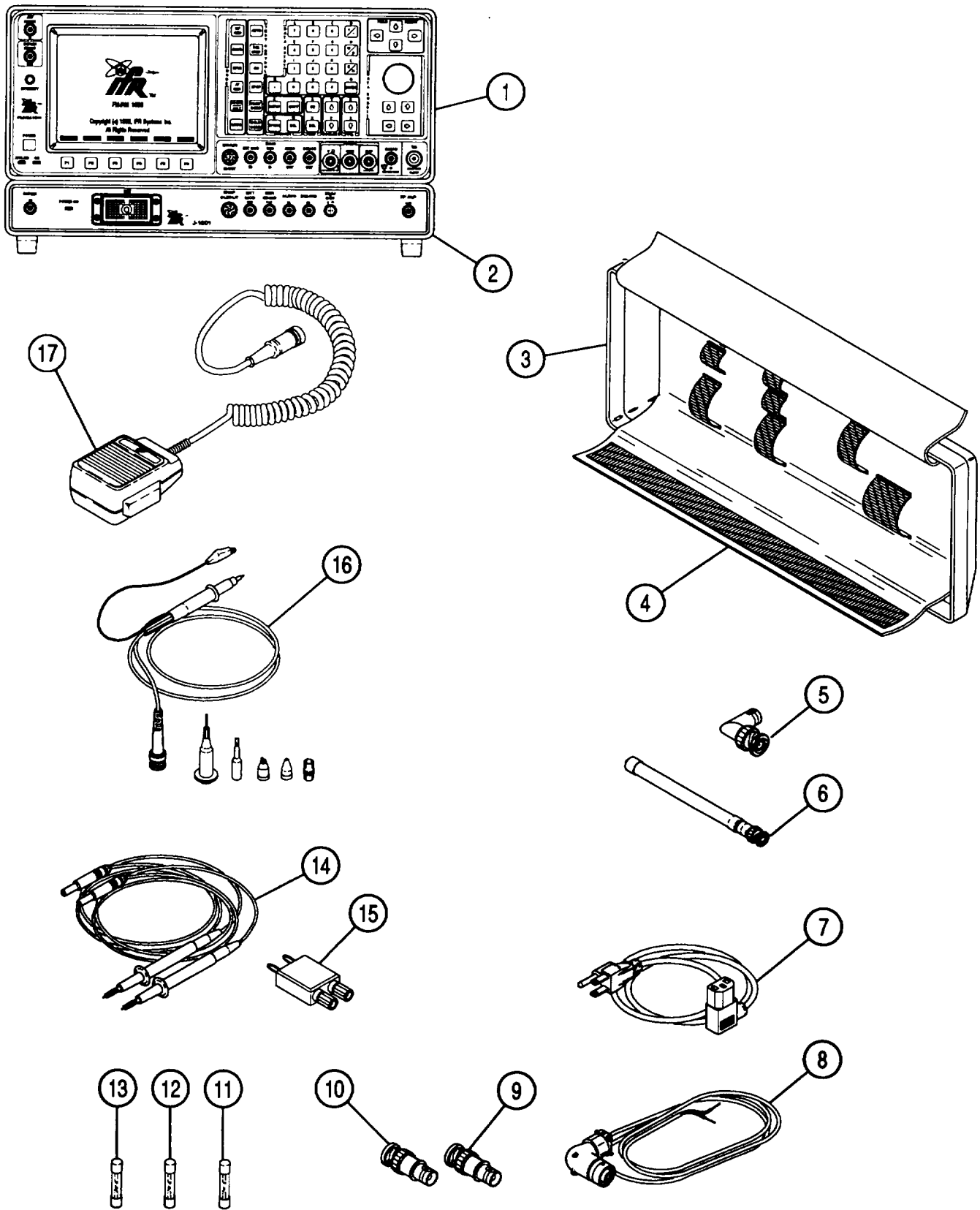

CE2FN709

(1) ILLUS NO.	(2) NATIONAL STOCK NUMBER	(3) DESCRIPTION (CAGEC) AND PART NUMBER	(4) U/M	(5) QTY REQ'D
1	6625-01-309-2825	TEST SET, TS-4317/GRM (51190) 7003-7845-000	ea	1
2	6625-01-309-2827	TEST ADAPTER J-4843/GRM-114B (51190) 7003-8340-000	ea	1
3		LID, FRONT COVER FOR TS-4317/GRM (51190) 2503-7862-200	ea	1
4		CARRYING POUCH (51190) 1412-7883-700	ea	1
5		CONNECTOR, ADAPTER, M-F BNC, RIGHT ANGLE (51190) 2113-0000-013	ea	1
6		ANTENNA, FLEX (51190) 1201-7616-500	ea	1
7		CABLE ASSEMBLY, AC POWER (51190) 6041-0001-001	ea	1
8		CABLE ASSEMBLY, DC POWER (51190) 6041-7884-500	ea	1
9		ATTENUATOR, 10 dB, 1 W, BNC, 2.0 GHz (51190) 2901-0401-010	ea	1
10		ATTENUATOR, 20 dB (51190) 2901-0401-020	ea	1
11		FUSE, 1.25, GL, SLOW, 250 V, 2.0 A (51190) 5106-4602-000	ea	1
12		FUSE, 1.25, GL, FAST, 250 V, 4.0 A (51190) 5106-0000-023	ea	1
13		FUSE, 1.25, GL, SLOW, 32 V, 15 A (51190) 5106-0000-029	ea	1
14		PROBE SET, DMM (1 BLACK PROBE, 1 RED PROBE) (51190) 2128-7801-100	ea	1
15		CURRENT SHUNT 10 AMP/100 mV (51190) 7113-7801-100	ea	1
16		KIT, PROBE, OSCILLOSCOPE, X1/REF/X10 (51190) 7112-0100-101	ea	1
17		MICROPHONE (51190) 7001-8645-900	ea	1

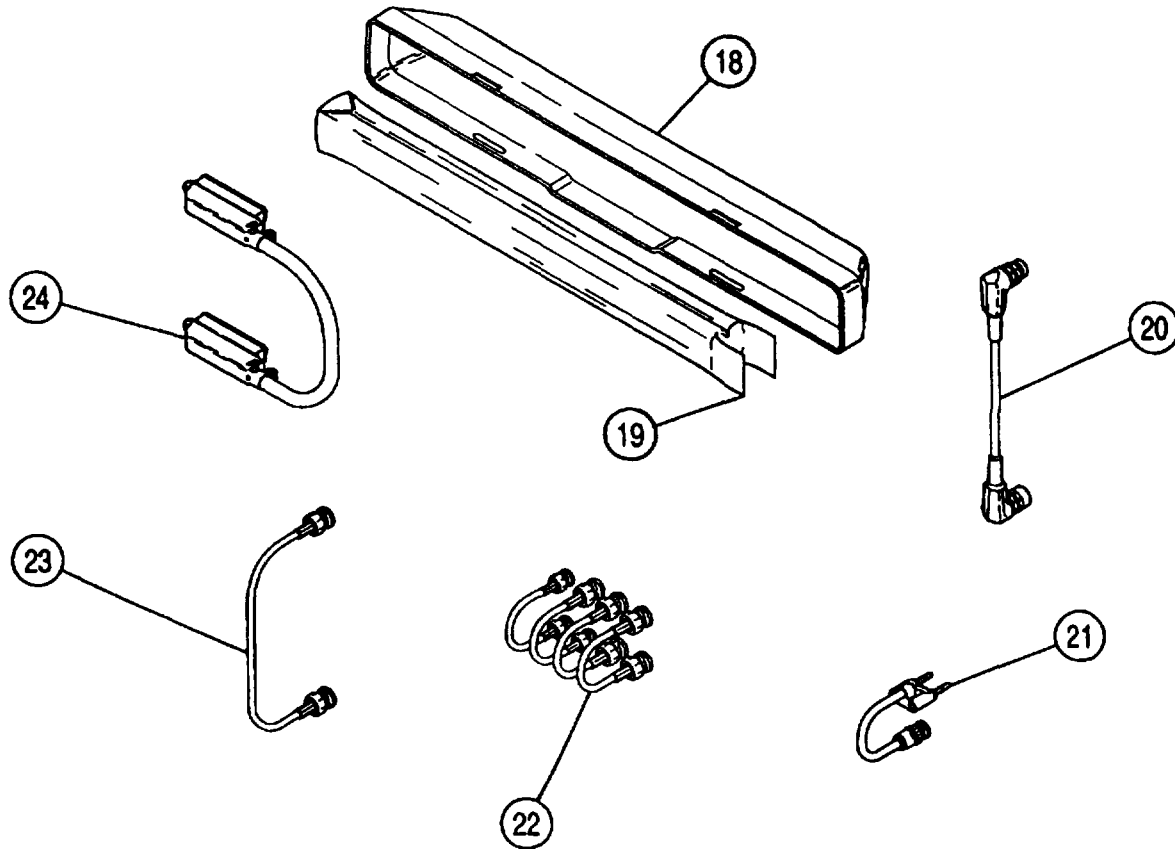

CE2FN710

(1) ILLUS NUMBER	(2) NATIONAL STOCK NUMBER	(3) DESCRIPTION, CAGEC and Part Number	(4) U/M	(5) QTY Reqd
18		LID, FRONT COVER FOR J-4823/GRM- 114B	ea	1
19		CARRYING POUCH (51190) 2503-8353-600	ea	1
20		CABLE INTERCONNECT, DC-DC (51190) 6041-8380-700	ea	1
21		CABLE ASSEMBLY, DMM BANANA (51190) 6041-8380-400	ea	1
22		COAXIAL CABLE, SHORT BNC-BNC (51190) 6052-0700-580	ea	4
23		COAXIAL CABLE, LONG BNC-BNC (51190) 6052-0700-060	ea	1
24		CABLE INTERCONNECT, SCSI-SCSI (51190) 6041-8380-600	ea	1

APPENDIX D

EXPENDABLE SUPPLIES AND MATERIALS LIST

Section I. INTRODUCTION

D- 1. SCOPE.

This appendix lists expendable supplies you will need for maintenance on the Radio Test Set AN/GRM-114B. These items are authorized to you by CTA 50-970, Expendable items (Except Medical, Class V, Repair Parts, and Heraldic Items).

D- 2. EXPLANATION OF COLUMNS.

- a. Column (1)—Item Number. This number is assigned to the entry in the listing and is referenced in the narrative instructions to identify the material (e.g., "Use cleaning compound, item 5, App. D").
- b. Column (2)—Level. This column identifies the lowest level of maintenance that requires the listed item.
 - C - Operator/Crew.
 - O - Unit Maintenance.
- c. Column (3)—National Stock Number. This column indicates the national stock number assigned to the item and will be used for requisitioning purposes.
- d. Column (4)—Description. This column indicates the federal item name and if required, a minimum description to identify the item. The last line for each item indicates the Commercial And Government Entity (CAGE) Code (in parentheses) followed by the part number.
- e. Column (5)—Unit of Measure (U/M). This column indicates the measure used in performing the actual maintenance function. This measure is expressed by a two-character alphabetical abbreviation (e.g., EA, IN, PR). If the unit of measure differs from the unit of issue, requisition the lowest unit of issue that will satisfy your requirements.

Section II. EXPENDABLE SUPPLIES AND MATERIALS LIST

(1) ITEM NUMBER	(2) LEVEL	(3) NATIONAL STOCK NUMBER	(4) DESCRIPTION	(5) UN
1	O	6810-00-753-4993	Alcohol, Isopropyl, 8OZ. Can, TT-I-735, Grade A (81349)	CN
2	O	8305-00-267-3015	Cloth, Cheesecloth, Cotton, Lintless, CCC-C-440, Type II, Class 2 (81349)	YD
3	O	7930-00-066-1669	Detergent, Mild, Liquid	OZ
4	O		Swab, Cotton	BX

APPENDIX E

AUXILIARY FUNCTIONS

NOTE

Test Set Clock/Calendar is initially set to USA Central Daylight Time or Central Standard Time. Clock/Calendar runs from a 10-year battery when Test Set is off. When on, Clock/Calendar operates from internal current supplied by Test Set power supply. During normal use, Clock/Calendar may never need resetting unless unit is transported to a different time zone or after Daylight Saving Time adjustments. Reset Clock/Calendar when necessary.

a. Setting Clock and Calendar.

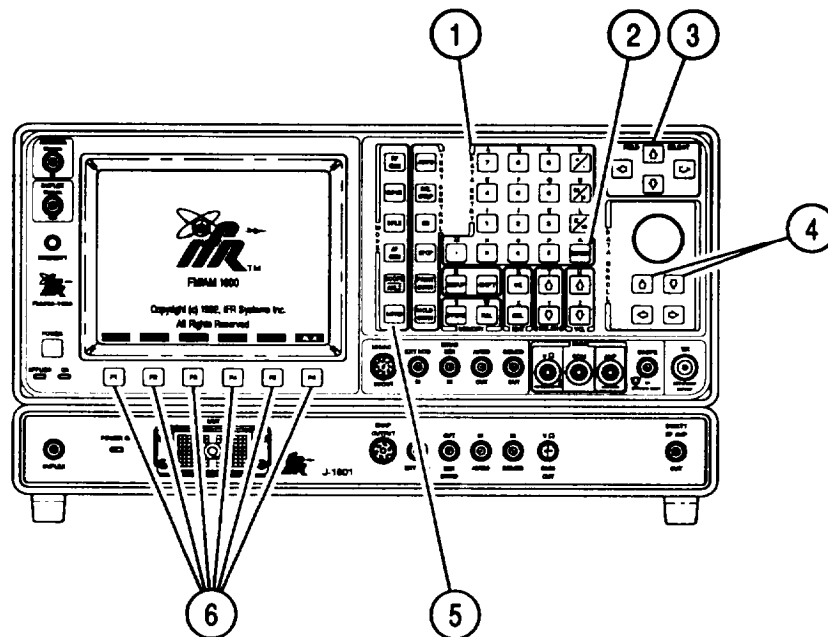

CE2FN711

1. Press MTRS MODE Key (5). Press "AUX" F6 (6) to display Auxiliary Functions Menu.

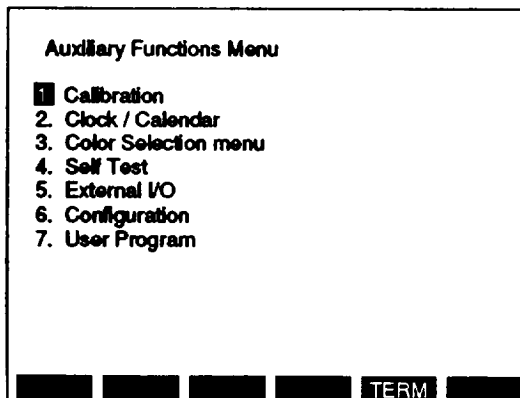

CE2FN636

2. Press 2 on DATA ENTRY Keypad (1). Clock/Calendar Setup Submenu appears. Verify time and date. If correct, press "ESC" F6 (6) to escape Clock/Calendar Submenu and continue with normal operation.
 - If incorrect, continue with step 3.

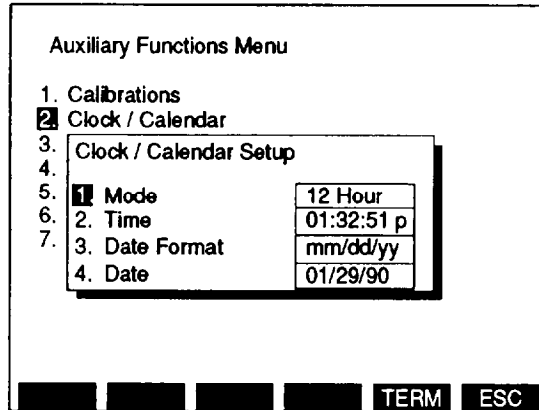

CE2FN637

3. Press 1 on DATA ENTRY Keypad (1) to toggle clock mode between 12 Hour and 24 Hour.
4. Press 2 on DATA ENTRY Keypad (1). Time Submenu appears.

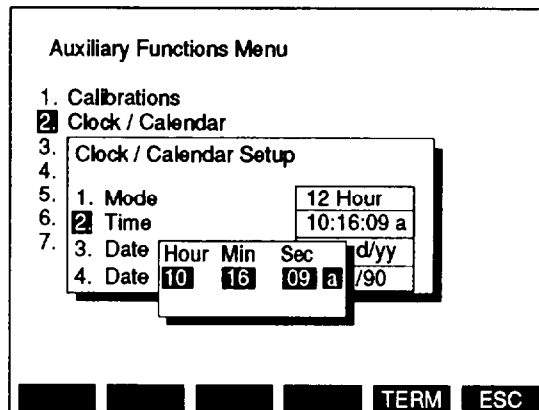

CE2FN638

5. Use DATA ENTRY Keypad (1) to enter digits of each data field:
 - Enter digits of Hour, press ENTER (2);
 - Enter digits of Min, press ENTER (2);
 - Enter digits of Sec, press ENTER (2).
 - If 12-Hour Clock Mode is active, a (for A.M.) or p (for P.M.) callout may need changing. Complete step 6.
 - If 24-Hour Clock Mode is active, Time Submenu disappears after Seconds activated. Continue with step 7.
6. After Hour, Min and Sec are set, highlight covers a (for A.M.) or p (for P.M.) callout. Use DATA SCROLL ↑ or ↓ Keys (4) to toggle setting, press ENTER (2).
7. Press 3 on DATA ENTRY Keypad (1) to toggle Date Format between "mm/dd/yy" and "dd/mm/yy."

8. Press 4 on DATA ENTRY Keypad (1) to access Date Submenu.

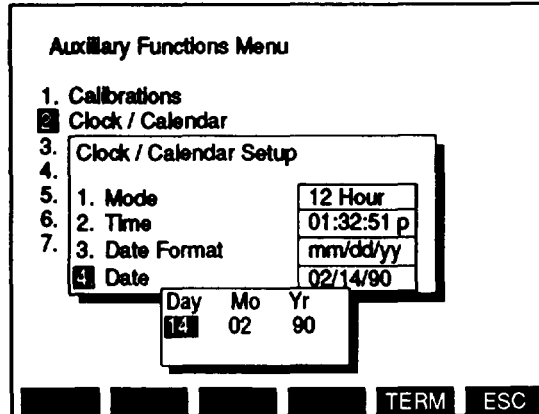

CE2FN639

9. Use DATA ENTRY Keypad (1) to enter digits of each data field:
 - Enter digits of Day (or Mo), press ENTER (2);
 - Enter digits of Mo (or Day), press ENTER (2);
 - Enter digits of Yr, press ENTER (2).
10. Press "ESC" F6 (6) to return to Auxiliary Functions Menu.

b. Changing Color Selections.

1. Press MTRS MODE Key (5). Press "AUX" F6 (6) to display Auxiliary Functions Menu.

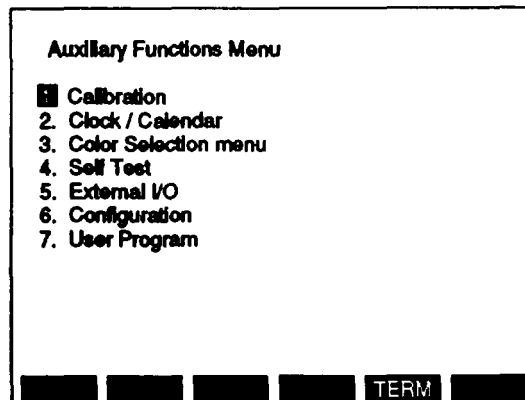

CE2FN636

2. Press 3 on DATA ENTRY Keypad (1). Color Selection Menu appears.
 - Only one Color Selection Set may be on at one time.

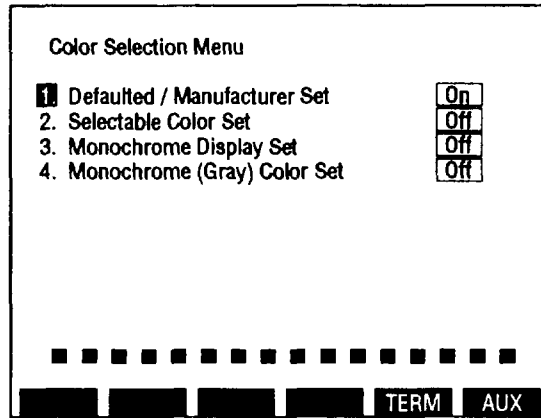

CE2FN640

3. Press number of desired color set on DATA ENTRY Keypad (1). For explanation of each color set, see Table E-1 .
 - If Default/Manufacturer's Set, Monochrome Display Set or Monochrome Gray Color Set is selected, Color Selection Menu disappears and Colors are set.
 - If Selectable Color Set is selected, Selectable Color Set Submenu appears. Continue with step 4.

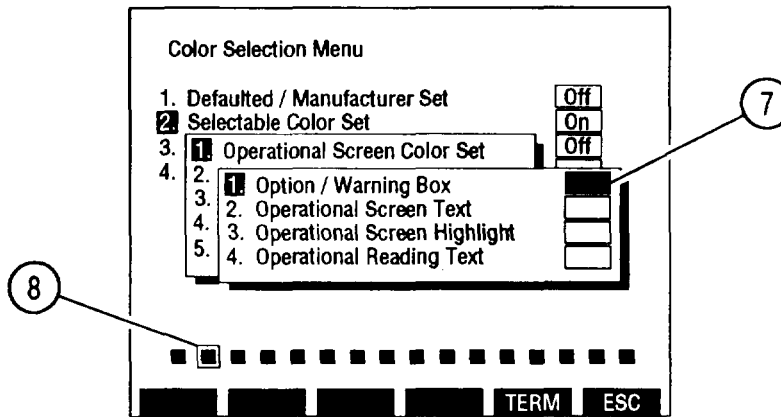

CE2FN642

4. Press number of Selectable Color Set to be adjusted on DATA ENTRY Keypad (1). See Table E-2 for information or, items in each color set. A submenu of screen features appears. At right edge of submenu a box (7) shows present color of listed screen feature.
5. Press number of feature to be changed on DATA ENTRY Keypad (1). A color selection cursor (8) appears on list of colors at bottom of Color Selection Menu. Color selection cursor (8) position echoes color selection of feature.
6. Select new color by using FIELD SELECT ← and → Keys (3) to move color selection cursor (8) to desired color. Press ENTER (2). Color selection box (7) shows new color of screen feature. See Table E-3 for list of colors.
7. Repeat steps 4 thru 6 for each Selectable Color Set Submenu listing as desired.

Table E-1. Color Selection Menu Color Sets.

KEY	COLOR SET	FUNCTION
1.	Defaulted/Manufacturer Set	These colors are programmed for AN/GRM-114B at time of manufacture. Contrasting colors and data field backgrounds are used for overlaying menus to allow easy viewing of parameter settings or menu choices.
2.	Selectable Color Set	Use this Color Set to program color choices for Operating Screens, On-Screen Text, Menus, Soft Function Keys and Cursor selections. See "Selectable Color Set" Submenus, Table E-2.
3.	Monochrome Display Set	Use this Color Set for a Black-and-White Display. Screen Backgrounds display black with white letters, numbers, meters and Oscilloscope/Spectrum Analyzer grids. Data Entry selections boxes display white with black letters and numbers within them.
4.	Monochrome Gray Color Set	Use this Color Set for a Black and Gray Display. Screen Backgrounds display black with gray letters, numbers and meters. Oscilloscope and Spectrum Analyzer traces and markers display white and Oscilloscope and Spectrum Analyzer grids display Blue.

Table E-2. Selectable Color Set Screen Features.

KEY	SELECTABLE COLOR SET	SCREEN FEATURES IN SET
1.	Operational Screen Color Set	<ol style="list-style-type: none"> 1. Option/Warning Box 2. Operational Screen Text 3. Operational Screen Highlight 4. Operational Reading Text
2.	Scope/Analyzer Color Set	<ol style="list-style-type: none"> 1. Scope/Analyzer Background 2. Scope/Analyzer Grid 3. Scope/Analyzer Trace 4. Scope/Analyzer Marker
3.	Menu Screen Color Set	<ol style="list-style-type: none"> 1. Background 2. Lettering/Script 3. First Level Entry Box 4. Second Level Entry Box
4.	Softkey Color Set	<ol style="list-style-type: none"> 1. Softkey Background 2. Softkey Selection Box 3. Softkey Selection Highlight 4. Softkey Lettering
5.	Cursor Color Set	<ol style="list-style-type: none"> 1. Cursor 2. Cursor Lettering

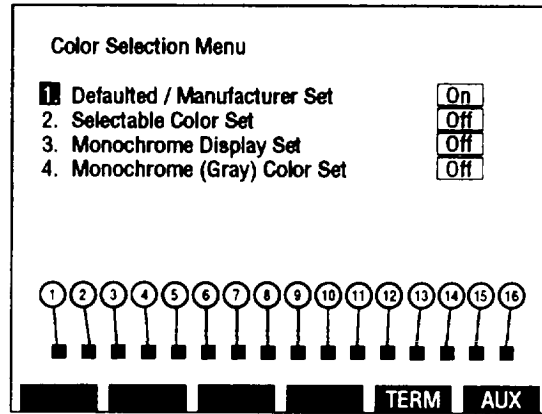

CE2FN643

Table E-3. Color Selections.

KEY	COLOR	KEY	COLOR
1.	Black	9.	Grey
2.	Blue	10.	Light Blue
3.	Green	11.	Light Green
4.	Cyan	12.	Light Cyan
5.	Red	13.	Light Red
6.	Magenta	14.	Light Magenta
7.	Brown	15.	Yellow
8.	White	16.	Intense White

APPENDIX F

REMOTE OPERATION

F-1. SCOPE.

This appendix describes the Test Set remote operation (RS-232/GPIB) procedures using an external controller. GPIB Digital Interface conforms to IEEE-488.2 1987.

F-2. GENERAL.

Remote operation of the Test Set is very similar to local operation, except the commands are entered and received using an external controller, and not by pressing keys and observing the display and indicators on the front panel. The GPIB connector permits remote control of all functions except POWER switch and ADDRESS selection. Refer as necessary to Chapter 2 for descriptions of controls, indicators and connectors (para 2-2), and individual operating procedures (para 2-10 through 2-28). Restrictions listed under controls, indicators and connectors are different for remote command operation. Under local operation, the command is disregarded and not executed. Under remote operation, the command may be allowed and executed. An SRQ message may be generated on error or special condition under GPIB control. Rear panel RS-232 and GPIB connector input/output information is supplied as follows:

RS-232 CONNECTOR INFORMATION

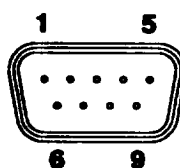

CB2FM044

PIN	ASSIGNMENT
1	4.7 KΩ to +15 VDC
2	TX DATA
3	RX DATA
4	N/C
5	GND
6	4.7 KΩ to +15 VDC
7	CTS
8	RTS
9	N/C

GPIB CONNECTOR INFORMATION

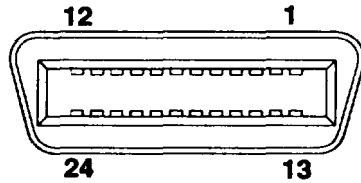

PIN	ASSIGNMENT	NOMENCLATURE	DESCRIPTION
1	DIO 1	Data In/Out Bit 1 (LSB)	Data Line*
2	DIO 2	Data In/Out Bit 2	Data Line*
3	DIO 3	Data In/Out Bit 3	Data Line*
4	DIO 4	Data In/Out Bit 4	Data Line*
5	EOI	End or Identify	Interface Line***
6	DAV	Data Valid	Handshake Line**
7	NRFD	Not Ready for Data	Handshake Line**
8	NDAC	Not Data Accepted	Handshake Line**
9	IFC	Interface Clear	Interface Line***
10	SRQ	Service Request	Interface Line***
11	ATN	Attention	Interface Line***
12	GND		Ground
13	DIO 5	Data In/Out Bit 5	Data Line*
14	DIO 6	Data In/Out Bit 6	Data Line*
15	DIO 7	Data In/Out Bit 7	Data Line*
16	DIO 8	Data In/Out Bit 8	Data Line*
17	REN	Remote Enable	Interface Line***
18	GND		Ground
19	GND		Ground
20	GND		Ground
21	GND		Ground
22	GND		Ground
23	GND		Ground
24	GND		Ground

* Data lines are used to transfer data from one instrument to another.

** Handshake lines operate in a proper time sequence for complete communication between instruments.

*** Interface lines are used to provide an orderly flow of information between units.

F-3. OPERATING PROCEDURES.

Perform following steps for remote operation of Test Set.

1. Connect equipment as follows:

NOTE

Keep GP1B interconnect cable length below 6.6 ft (2 m).

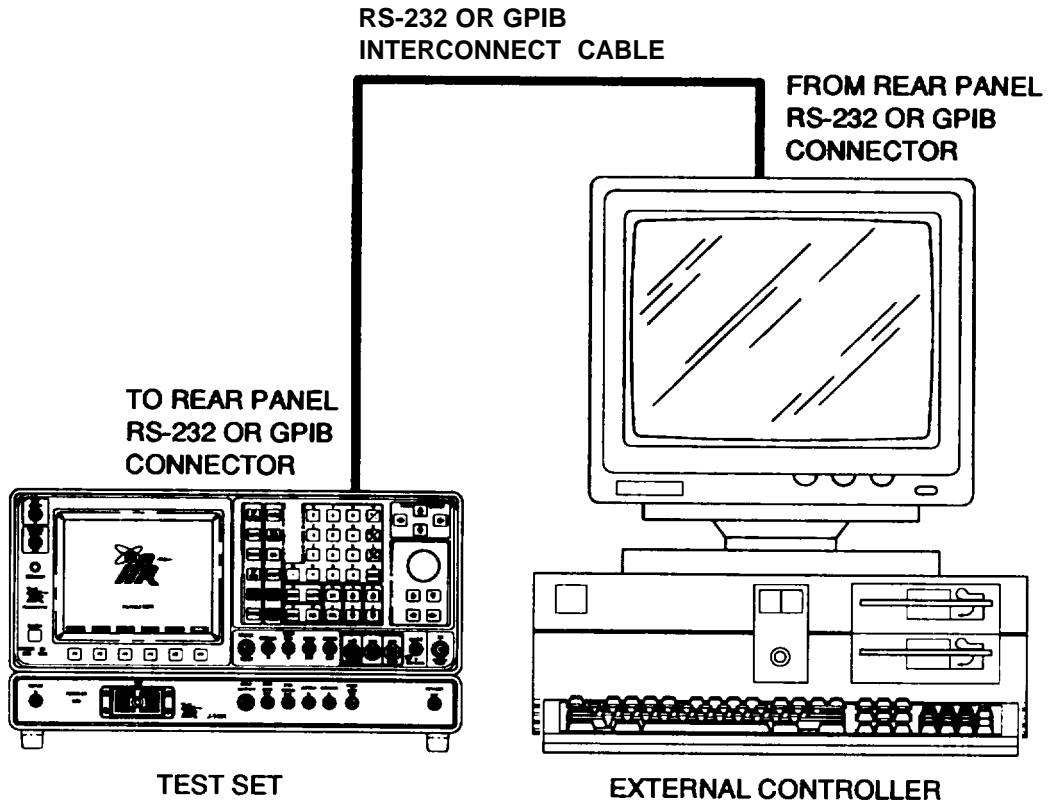

2. Perform Turn-On Procedure (para 2-8).

CE2FN712

3. Press MTRS MODE Key. Press "AUX" F6 to display Auxiliary Functions Menu.

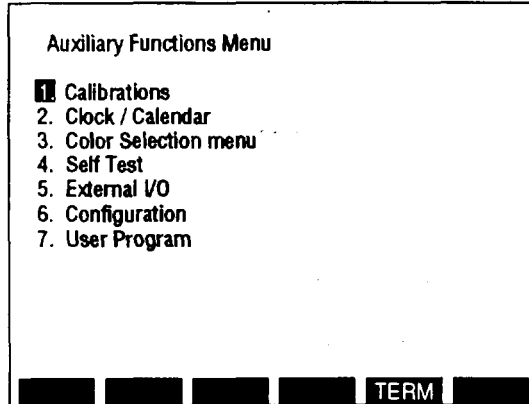

CE2FN646

4. Press 5 on DATA ENTRY Keypad. External I/O submenu appears.

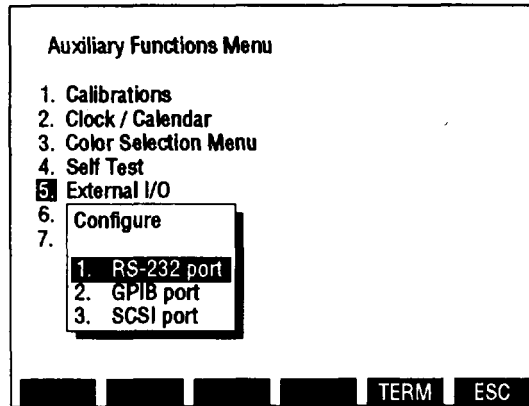

CE2FN647

5. Press number on DATA ENTRY Keypad of connector to be configured.

6. Use RS-232 and GPIB index of menu items to configure connectors as desired.

- Press 1 on DATA ENTRY Keypad to access Configure RS-232 submenu. Use index to identify parameters of connector output that are edited. Access and edit parameters by pressing number on DATA ENTRY Keypad of parameter to be edited.

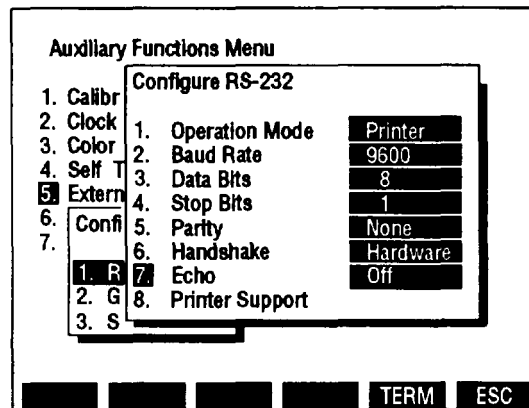

CE2FN648

KEY	MENU ITEM	FUNCTION
1.	Operation Mode	Access displays submenu. Select from: off Host Printer/Plotter
2.	Baud Rate	Access displays submenu. Select from: 300 600 1200 2400 4800 9600 19200
3.	Data Bits	Select 7 or 8.
4.	Stop Bits	Select 1 or 2.
5.	Parity	Access displays submenu. Select from: None Odd Even Mark Space
6.	Handshake	Access displays submenu. Select from: None Hardware Xon/Xoff
7.	Echo	Select Off or On.
8.	Printer Support	Displays Printer Support submenu.

When 8. Printer Support is selected on Configure RS-232 submenu, Printer support Submenu appears.

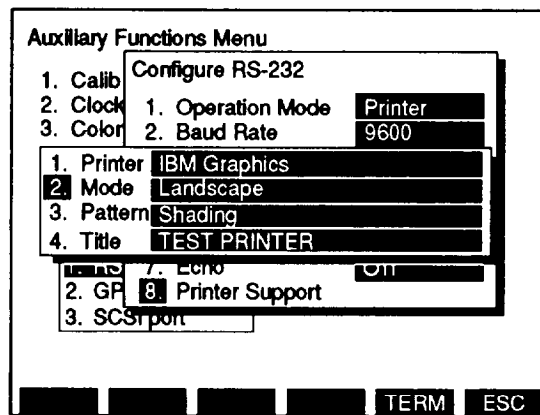

CE2FN649

KEY	MENU ITEM	FUNCTION
1.	Printer	Select from: Epson EX/FX/RX HP LaserJet II IBM Graphics
2.	Mode	Select Portrait or Landscape.
3.	Pattern	Select Black and White or Shading.
4.	Title	Enter title (up to 14 characters) using DATA ENTRY Keypad. Press ENTER.

- Press 2 on DATA ENTRY Keypad to access Configure GPIB submenu. Use index to identify parameters of connector output that may be edited. Access and edit parameters by pressing number on DATA ENTRY Keypad of parameter to be edited.

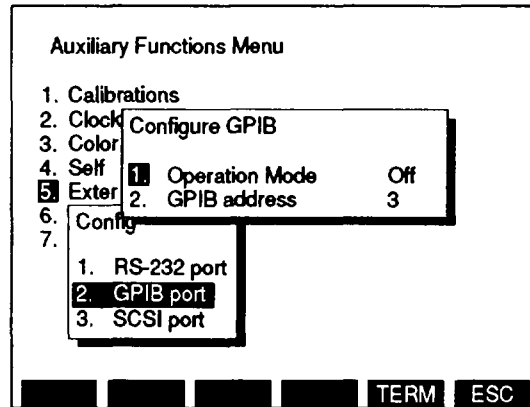

CE2FN650

KEY	MENU ITEM	FUNCTION
1.	Operation Mode	Access displays submenu. Select from: Off Talk Only Talk/Listen Controller
2.	GPIB Address	Set from 0 to 31.

F-4. COMMAND SYNTAX.

Test Set commands are structured hierarchically through the use of the colon (:) delimiter. This concept allows the command paths to be formulated using common key sequences (e. g., To set either of the generator frequencies, :GEN:FREQ 1000 or :RX:FREQ 1000 are employed).

In order to allow access to command paths, Test Set interpreter keeps track of current path or command level where it expects to find the next command. Current path is determined by using a set of rules.

On power-up or after an *RST command, the Test Set sets the current path to the root command node. This is the highest level of the command tree structure. Also, the end of a message or command line will reset the current path to the root node.

When a colon is used as delimiter between commands, current path is moved down one level in the command structure (e.g., The colon in GEN:FREQ specifies that FREQ is one level down from GE N). When a colon is used as first character of a command, it specifies that the next command is to be found at the root node. A semicolon is used to separate multiple commands in the same message line. A semicolon does not change current path.

For example, :FGEN:DATA:STAT ON;BILVL;DEV 5600;ATT 0;RATE 16000;FLT:OUT;

is equivalent to:

```
:FGEN:DATA:STAT ON
:FGEN:DATA:BILVL
:FGEN:DATA:DEV 5600
:FGEN:DATA:ATT 0
:FGEN:DATA:RATE 16000
:FGEN:DATA:FLT:OUT
```

At least one space is needed between commands and parameters, other spaces or lack of them do not affect command execution. Commas are used between parameters when more than one is listed.

A back slash (\) allows a command to be continued on the next line. The back slash must be inserted between command words.

Many commands can be entered using a short form or a long form. The short form is shown in upper case, while the remainder of the long form is shown in lower case. Upper and lower case letters are used in this manual only to differentiate between the long and short form of commands. Test Set commands can be entered either upper or lower case.

F-5. GPIB OPERATION.

When the GPIB connector is used for remote operation, Test Set commands are received and transmitted as strings using the command SYSTEM:PTHRough:GPIB address, "string" "address" is the peripheral address and "string" is the Test Set command to be executed.

F-6. INSTRUMENT RESET.

Reset or "RST" command resets Test Set to initialized condition.

F-7 COMMAND LIST

Test Set commands are entered using an external controller and an RS-232 or GPIB cable connecting the external controller to the Test Set.

The Test Set commands are listed by operation type such as Deviation Meter or Oscilloscope commands. These commands are complete commands except where user must determine a parameter. User defined parameters are shown as x. All possible values or value ranges are listed for commands requiring parameters.

COMMAND	RANGE/VALUE	DESCRIPTION
AUDIO FREQUENCY METER COMMANDS		
:M_AF:RANGe:UPPer x	.2, 2, 20 or 200	Sets Frequency Range of Audio Frequency Meter in kHz.
:M_AF:RANGe:AUTO		Enables Autorange of Audio Frequency Meter.
:M_AF:UL:STATe x	0=off, 1=on	Toggles Upper Limit of Audio Frequency Meter on or off.
:M_AF:UL:LEVel x	0.0000 to 200.0000	Sets Upper Limit Level of Audio Frequency Meter in kHz.
:M_AF:LL:STATe x	0=off, 1=on	Toggles Lower Limit of Audio Frequency Meter on or off.
:M_AF:LL:LEVel x	0.0000 to 200.0000	Sets Lower Limit Level of Audio Frequency Meter in kHz.
:M_AF:ALARM x	0=off, 1=on	Enables/Disables Over/Under Limit Alarm of Audio Frequency Meter.
:M_AF:PH x	0=off, 1=on	Enables/Disables Peak Hold of Audio Frequency Meter.
:M_AF:RESolution x	1 or 0.1 Hz	Sets Audio Frequency Meter resolution.
:M_AF:STORe x	1 to 9	Stores parameters of Audio Frequency Meter at indicated Store Parameters Menu location.
:M_AF:RCL x	1 to 9	Recalls parameters of Audio Frequency Meter from indicated Recall Parameters Menu location.
:M_AF:INPut:XAUDio		Selects External Audio Input for Audio Frequency Meter.

COMMAND	RANGE/VALUE	DESCRIPTION
:M_AF:INPut:DEMOD		Selects Demod Audio Input for Audio Frequency Meter.
:M_AF:INPut:FGEN		Selects Function Generator Input for Audio Frequency Meter.
:M_AF:INPut:SINAD		Selects SINAD Input for Audio Frequency Meter.
:M_AF:INPut:BER		Selects BER Input for Audio Frequency Meter.
:M_AF:INPut:POWer		Selects RF Power Input for Audio Frequency Meter.
:M_AF:FILTer:LPASs: STATE x		Enables/Disables low-pass filter.
:M_AF:FILTer:LPASs: STATE?		Queries low-pass filter state.
:M_AF:FILTer:LPASs: FREQuency x	0.1 to 30.0 kHz	Sets low-pass filter frequency.
:M_AF:FILTer:LPASs: FREQuency?		Queries low-pass filter frequency.
:M_AF:FILTer:HPASs: STATE x		Enables/Disables high-pass filter.
:M_AF:FILTer:HPASs: STATE?		Queries high-pass filter state.
:M_AF:FILTer:HPASs: FREQuency x	0.5 to 20.0 kHz	Sets high-pass filter frequency.
:M_AF:FILTer:HPASs: FREQuency?		Queries high-pass filter frequency.
:M_AF?		Returns Audio Frequency Meter reading in Hz.
:M_AF:PEAK?		Returns Audio Frequency Meter Peak reading in Hz.

COMMAND	RANGE/VALUE	DESCRIPTION
RADIO FREQUENCY ERROR METER COMMANDS		
:M_RF:RANGe:UPPer x	0.1, 1, 10 or 100	Sets Frequency Range of Radio Frequency Error Meter in kHz.
:M_RF:RANGe:AUTO		Enables Autorange of Radio Frequency Error Meter.
:M_RF:UL:STATe x	0 = off, 1 = on	Toggles Upper Limit of Radio Frequency Error Meter on or off.
:M_RF:UL:LEVel x	0.0000 to 100.0000	Sets Upper Limit Level of Radio Frequency Error Meter in kHz.
:M_RF:LL:STATe x	0=off, 1=on	Toggles Lower Limit of Radio Frequency Error Meter on or off.
:M_RF:LL:LEVel x	0.0000 to 100.0000	Sets Lower Limit Level of Radio Frequency Error Meter in kHz.
:M_RF:ALARM x	0=off, 1=on	Enables/Disables Over/Under Limit Alarm of Radio Frequency Error Meter.
:M_RF:PH X	0=off, 1=on	Enables/Disables Peak Hold of Radio Frequency Error Meter.
:M_RF:RESolution x	1 or 10	Sets Radio Frequency Error Meter resolution in Hz.
:M_RF:STORe x	1 to 9	Stores parameters of Radio Frequency Error Meter at indicated Store Parameters Menu location.
:M_RF:RCL X	1 to 9	Recalls parameters of Radio Frequency Meter from indicated Recall Parameters Menu location.
:M_RF?		Requests return of Radio Frequency Error Meter reading in Hz.

COMMAND	RANGE/VALUE	DESCRIPTION
:M_RF:PEAK?		Requests return of Radio Frequency Error Meter Peak reading in Hz.
POWER METER COMMANDS		
:M_PWR:RANGe:UPPer x	.02, .05, .10, .2, .5, 1, 2, 5, 10, 20, 50, 100 or 200	Sets Range Value of Power Meter in Watts.
:M_PWR:RANGe:AUTO		Enables Autorange of Power Meter.
:M_PWR:UL:STATe x	0=off, 1=on	Toggles Upper Limit of Power Meter on or off.
:M_PWR:UL:LEVel x	0.0000 to 200.0000	Sets Upper Limit Level of Power Meter in Watts.
:M_PWR:LL:STATe x	0=off, 1=on	Toggles Lower Limit of Power Meter on or off.
:M_PWR:LL:LEVel x	0.0000 to 200.0000	Sets Lower Limit Level of Power Meter in Watts.
:M_PWR:ALARM x	0=-off, 1=on	Enables/Disables Over/Under Limit Alarm of Power Error Meter.
:M_PWR:PH x	0=off 1=on	Enables/Disables Peak Hold of Power Meter.
:M_PWR:STORe x	1 to 9	Stores parameters of Power Meter at indicated Store Parameters Menu location.
:M_PWR:RCL X	1 to 9	Recalls parameters of Power Meter from indicated Recall Parameters Menu location.
:M_PWR:TYPE:CW		Selects Continuous Wave measurement type.
:M_PWR:TYPE:PEAK		Selects Peak measurement type.
:M_PWR:TYPE:RMS		Selects Average measurement type.
:M_PWR:EXT:STATe x	0=off, 1=on	Enables/Disables External Loss/Gain Offset.

COMMAND	RANGE/VALUE	DESCRIPTION
:M_PWR:EXT:STATe?		Returns External Loss/Gain Offset status.
:M_PWR:EXT:OFFSet x	-99.9 to 99.9	Selects External Loss/Gain Offset value.
:M_PWR:EXT:OFFSet?		Returns External Loss/Gain Offset value.
:M_PWR?		Requests return of Power Meter reading in mW.
x= M_PWR?		Queries power meter for value.
:M_PWR:PEAK?		Requests return of Power Meter Peak reading in mW.

DEVIATION METER COMMANDS

:M_DEV:RANGe:UPPer x	2, 5, 10, 20, 50 or 100	Sets Range Value of Deviation Meter in kHz.
:M_DEV:RANGe:AUTO		Enables Autorange of Deviation Meter.
:M_DEV:UL:STATe x	0 = off, 1 = on	Toggles Upper Limit of Deviation Meter on or off.
:M_DEV:UL:LEVel x	0.00 to 100.00	Sets Upper Limit Level of Deviation Meter in kHz with .05 kHz resolution.
:M_DEV:LL:STATe x	0 = off, 1 = on	Toggles Lower Limit of Deviation Meter on or off.
:M_DEV:LL:LEVel x	0.00 to 100.00	Sets Lower Limit Level of Deviation Meter in kHz with .05 kHz resolution.
:M_DEV:ALARM x	0 = off, 1 = on	Enables/Disables Over/Under Limit Alarm of Deviation Meter.
:M_DEV:AVErage x	0 = of f, 1 = on	Enables/Disables Averaging of Deviation-RMS Meter.
:M_DEV:PH x	0 = off, 1 = on	Enables/Disables Peak Hold of Deviation Meter.

COMMAND	RANGE/VALUE	DESCRIPTION
:M_DEV:STORe x	1 to 9	Stores parameters of Deviation Meter at indicated Store Parameters Menu location.
:M_DEV:RCL X	1 to 9	Recalls parameters of Deviation Meter from indicated Recall Parameters Menu location.
:M_DEV:POS?		Returns positive Deviation Meter reading in kHz.
:M_DEV:NEG?		Returns negative Deviation Meter reading in kHz.
:M_DEV:PEAK:POS?		Returns Positive Deviation Peak reading in kHz.
:M_DEV:PEAK:NEG?		Returns Negative Deviation Peak reading in kHz.
:M_DEV:MODE:BOTH		Reads positive and negative deviation.
:M_DEV:MODE:POSitive		Reads positive deviation only.
:M_DEV:MODE:NEGative		Reads negative deviation only.
:M_DEV:MODE:NORMalize		Reads (pos+neg)/2 deviation.

MODULATION METER COMMANDS

:M_MOD:RANGe:UPPer x	40 or 100	Sets Range Value of Modulation Meter in %.
:M_MOD:RANGe:AUTO		Enables Autorange of Modulation Meter.
:M_MOD:UL:STATe x	0=off, 1=on ,	Toggles Upper Limit of Modulation Meter on or off.
:M_MOD:UL:LEVel X	0.0 to 100.0	Sets Upper Limit Level of Modulation Meter in %.
:M_MOD:LL:STATe X	0=off, 1-on	Toggles Lower Limit of Modulation Meter on or off.

COMMAND	RANGE/VALUE	DESCRIPTION
:M_MOD:LL:LEVel x	0.0 to 100.0	Sets Lower Limit Level of Modulation Meter in %.
:M_MOD:ALARM x	0 = off, 1 = on	Enables/Disables Over/Under Limit Alarm of Modulation Meter.
:M_MOD:PH x	0 = off, 1 = on	Enables/Disables Peak Hold of Modulation Meter.
:M_MOD:STORe x	1 to 9	Stores parameters of Modulation Meter at indicated Store Parameters Menu location.
:M_MOD:RCL x	1 to 9	Recalls parameters of Modulation Meter from indicated Recall Parameters Menu location.
:M_MOD?		Requests return of Modulation Meter reading in %.
:M_MOD:PEAK?		Requests return of Modulation Meter Peak reading in %.

DISTORTION METER COMMANDS

:M_DISTortion:SElect:LPASs x	100 to 30000	Selects low-pass filter with cutoff frequency of x Hz.
:M_DISTortion:SElect:CWeight		Selects C-Weight filter.
:M_DISTortion:FILTer x	600 to 1400	Sets Notch Filter Frequency of Distortion Meter in Hz.
:M_DISTortion:UL: STATE x	0 = off, 1 = on	Toggles Upper Limit of Distortion Meter on or off.
:M_DISTortion:UL: LEVel x	0.0 to 20.0	Sets Upper Limit Level of Distortion Meter in %.
:M_DISTortion:LL: STATE x	0 = off, 1 = on	Toggles Lower Limit of Distortion Meter on or off.
:M_DISTortion:LL: LEVel x	0.0 to 20.0	Sets Lower Limit Level of Distortion Meter in %.

COMMAND	RANGE/VALUE	DESCRIPTION
:M_DISTortion:ALARM x	0=off, 1=on	Enables/Disables Over/Under Limit Alarm of Distortion Meter.
:M_DISTortion:AVErage		Enables Distortion averaging.
:M_DISTortion:PH x	0=off, 1=on	Enables/Disables Peak Hold of Distortion Meter.
:M_DISTortion:STORe x	1 to 9	Stores parameters of Distortion Meter at indicated Store Parameters Menu location.
:M_DISTortion:RCL x	1 to 9	Recalls parameters of Distortion Meter from indicated Recall Parameters Menu location.
:M_DISTortion:INPut:DEMOD		Selects Demod Audio Input for Distortion Meter.
:M_DISTortion:INPut:SINAD		Selects SINAD Input for Distortion Meter.
:M_DISTortion:INPut:BER		Selects BER Input for Distortion Meter.
:M_DISTortion:INPut:XAUDio		Selects External Audio Input for Distortion Meter.
:M_DISTortion:INPut:FGEN		Selects AF Generator Input for Distortion Meter.
:M_DISTortion?		Returns Distortion Meter reading in Y..
x= M_ Distortion?		Queries for value.
:M_DISTortion:PEAK?		Returns Distortion Meter Peak reading in %.

SINAD METER COMMANDS

:M_SINAD:SELEct:LPASs x	100 to 30000	Selects low-pass filter with cutoff frequency of x Hz.
:M_SINAD:SELEct:CWeight		Selects C-Weight filter.

COMMAND	RANGE/VALUE	DESCRIPTION
:M_SINAD:FILTer x	770 or 1000	Sets Notch Filter Frequency of SINAD Meter in Hz.
:M_SINAD:UL:STATe x	0=off, 1=on	Toggles Upper Limit of SINAD Meter on or off.
:M_SINAD:UL:LEVel x	3.0 to 30.0	Sets Upper Limit Level of SINAD Meter in dB.
:M_SINAD:LL:STATe x	0=off, 1=on	Toggles Lower Limit of SINAD Meter on or off.
:M_SINAD:LL:LEVel x	3.0 to 30.0	Sets Lower Limit Level of SINAD Meter in dB.
:M_SINAD:PH X	0=off, 1=on	Enables/Disables Peak Hold of SINAD Meter.
:M_SINAD:STORe x	1 to 9	Stores parameters of SINAD Meter at indicated Store Parameters Menu location.
:M_SINAD:RCL X	1 to 9	Recalls parameters of SINAD Meter from indicated Recall Parameters Menu location.
:M_SINAD:INPut:DEMOD		Selects Demod Audio Input for SINAD Meter.
:M_SINAD:INPut:SINAD		Selects SINAD Input for SINAD Meter.
:M_SINAD:INPut:BER		Selects BER Input for SINAD Meter.
:M_SINAD:INPut:XAUDio		Selects External Audio Input for SINAD Meter.
:M_SINAD:RESolution x	.1 or .5	Selects meter resolution.
:M_SINAD:RESolution?		Returns meter resolution.
:M_SINAD?		Returns SINAD Meter reading in dB.
x= M_ SINAD?		Queries for value.
:M_SINAD:PEAK?		Returns SINAD Meter Peak reading in dB.

COMMAND	RANGE/VALUE	DESCRIPTION
SIGNAL STRENGTH METER COMMANDS		
:M_SIG:PH x	0 = off, 1 = on	Enables/Disables Peak Hold of Signal Strength Meter.
:M_SIG:STORE x	1 to 9	Stores parameters of Signal Strength Meter at indicated Store Parameters Menu location.
:M_SIG:RCL X	1 to 9	Recalls parameters of Signal Strength Meter from indicated Recall Parameters Menu location.
:M_SIG?		Returns Signal Strength Meter reading.
:M_SIG:PEAK?		Returns Signal Strength Meter Peak reading.
x-M_SIG?		Queries for value.
AF LEVEL METER		
:M_VRMS?		Returns voltage RMS reading.
BIT ERROR RATE (BER) METER COMMANDS		
:M_BER:TYPE:GENerator		Sets Bit Error Rate Meter Type to Generator.
:M_BER:TYPE:RECeive		Sets Bit Error Rate Meter Type to Receiver.
:M_BER:TYPE:DUPlax		Sets Bit Error Rate Meter Type to Duplex.
:M_BER:TYPE:BASEband		Sets Bit Error Rate Meter Type to Baseband.
:M_BER:SIZE X	100 to 100000	Sets Bit Error Rate Meter Block Size in bits.
:M_BER:SIZE?	100 to 100000	Returns Bit Error Rate Meter Block Size setting in bits.

COMMAND	RANGE/VALUE	DESCRIPTION
:M_BER:PATtern:RANDom		Sets Bit Error Rate Meter Data Pattern to "Random."
:M_BER:PATtern:FIXED		Sets Bit Error Rate Meter Data Pattern to "Fixed."
:M_BER:PATtern:USER xx	B Bit Pattern	Sets Bit Error Rate Meter Data Pattern to "User Defined" (8-bit pattern).
:M_BER:RATE x	75, 150, 300, 600, 1200, 2400, 4800 or 16000	Sets Bit Error Rate Meter bit rate in bps.
:M_BER:RATE?	75, 150, 300, 600, 1200, 2400, 4800 or 16000	Returns Bit Error Rate Meter rate setting in bps.
:M_BER:POLarity:POSitive		Sets Bit Error Rate Meter data polarity to "Pos. EXT AUDIO" setting.
:M_BER:POLarity:NEGative		Sets Bit Error Rate Meter data polarity to "Neg. SINAD/BER" setting.
:M_BER:STORE x	1 to 9	Stores parameters of Bit Error Rate Meter at indicated Store Parameters Menu location.
:M_BER:RCL x	1 to 9	Recalls parameters of Bit Error Rate Meter from indicated Recall Parameters Menu location.
:M_BER?		Returns Bit Error for 1 pass.
x=M_BER?		Queries for value.

DIGITAL MULTIMETER COMMANDS

:M_DMM:FUNcTION:VOLTage:DC		Sets Digital Multimeter Function for DC Voltage measurement.
:M_DMM:FUNcTION:VOLTage:AC		Sets Digital Multimeter Function for AC Voltage measurement.
:M_DMM:FUNcTION:CURREnt:DC		Sets Digital Multimeter Function for DC Current measurement.

COMMAND	RANGE/VALUE	DESCRIPTION
:M_DMM:FUNcTion:CURRent:AC		Sets Digital Multi meter Function for AC Current measurement.
:M_DMM:FUNcTion:Resistance		Sets Digital Multimeter Function for Resistance (ohm) measurement.
:M_DMM:FUNcTion?		Returns Digital Multimeter Function setting.
:M_DMM:RANGe:UPPer x	If ACV or DCV function: .2, 2, 20, 200 or 2000 If ACC or DCC function: .02, .2, 2 or 20 If Resistance Function: .2, 2, 20, 200, 2000 or 20000	Sets Range Value of Digital Multi meter for selected function.
:M_DMM:RANGe:AUTO		Sets Digital Multi meter for selected function to Autorange.
:M_DMM:UL:STATe x	0=off, 1=on	Toggles Upper Limit of Digital Multimeter on or off.
:M_DMM:UL:LEVel x	If ACV or DCV function: 0.0000 to 1000.0 (v) If ACC or DCC function: 0.0000 to 19.99 (A) If Resistance Function: 0.000 to 19999 (Ohm)	Sets Upper Limit Level of Digital Multimeter.
:M_DMM:LL:STATe x	0=off, 1=on	Toggles Lower Limit of Digital Multimeter on or off,
:M_DMM:LL:LEVel x	If ACV or DCV function: 0.0000 to 1000.0 (v) If ACC or DCC function: 0.0000 to 19.99 (A) If Resistance Function: 0.000 to 1999999 (Ohm)	Sets Lower Limit Level of Digital Multimeter.
:M_DMM:ALARM x	0=off, 1=on	Enables/Disables Over/Under Limit Alarm of Digital Multimeter.
:M_DMM:PH x	0=off, 1=on	Enables/Disables Peak Hold of Digital Multimeter.

COMMAND	RANGE/VALUE	DESCRIPTION
:M_DMM:INPut:IMPedance x	150, 600 or 1e6	Sets input impedance in ohms for Digital Multi meter ACV or DCV measurement functions.
:M_DMM:STORe x	1 to 9	Stores parameters of Digital Multimeter at indicated Store Parameters Menu location.
:M_DMM:RCL x	1 to 9	Recalls parameters of Digital Multimeter from indicated Recall Parameters Menu location.
:M_DMM?		Returns DMM reading depending on current range and function settings.
x=M_DMM?		Queries for DMM reading depending on current DMM range and function.

PHASE METER COMMANDS

:M_PM:RANGe:UPPer x	2,5 or 10	Sets Range Value of Phase Meter in radians.
:M_PM:RANGe:AUTO		Enables Autorange of Phase Meter.
:M_PM:UL:STATe x	0=off, 1=on	Toggles Upper Limit of Phase Meter on or off.
:M_PM:UL:LEVel x	0.00 to 10.00	Sets Upper Limit Level of Phase Meter in radians.
:M_PM:LL:STATe x	0=off, 1=on	Toggles Lower Limit of Phase Meter on or off.
:M_PM:LL:LEVel x	0.00 to 10.00	Sets Lower Limit Level of Phase Meter in radians.
:M_PM:ALARM x	0=off, 1=on	Enables/Disables Over/Under Limit Alarm of Phase Meter.
:M_PM:PH x	0=off, 1=on	Enables/Disables Peak Hold of Phase Meter.

COMMAND	RANGE/VALUE	DESCRIPTION
:M_PM:STORe x	1 to 9	Stores parameters of Phase Meter at indicated Store Parameters Menu location.
:M_PM:RCL x	1 to 9	Recalls parameters of Phase Meter from indicated Recall Parameters Menu location.
:M_PM?		Requests return of Phase Meter reading in .01 radians.

DEVIATION METER (RMS) COMMANDS

:M_DRMS:RANGe:UPPer x	2,5 or 10	Sets Range Value of Deviation (RMS) Meter in kHz.
:M_DRMS:RANGe:AUTO		Enables Autorange of Deviation-RMS Meter.
:M_DRMS:UL:STATe x	0=off, 1=on	Toggles Upper Limit of Deviation-RMS Meter on or off.
:M_DRMS:UL:LEVel x	0.00 to 10.00	Sets Upper Limit Level of Deviation-RMS Meter in kHz.
:M_DRMS:LL:STATe x	0=off, 1=on	Toggles Lower Limit of Deviation-RMS Meter on or off.
:M_DRMS:LL:LEVel x	0.00 to 10.00	Sets Lower Limit Level of Deviation-RMS Meter in kHz.
:M_DRMS:ALARM X	0=off, 1=on	Enables/Disables Over/Under Limit Alarm of Deviation-RMS Meter.
:M_DRMS:AVErAge x	0=off, 1=on	Enables/Disables Averaging of Deviation-RMS Meter.
:M_DRMS:PH X	0=off, 1=on	Enables/Disables Peak Hold of Deviation-RMS Meter.

COMMAND	RANGE/VALUE	DESCRIPTION
:M_DRMS:STORe x	1 to 9	Stores parameters of Deviation-RMS Meter at indicated Store Parameters Menu location.
:M_DRMS:RCL x	1 to 9	Recalls parameters of Deviation-RMS Meter from indicated Recall Parameters Menu location.
:M_DRMS?		Requests return of Deviation-RMS Meter reading in kHz.

PHASE (RMS) METER COMMANDS

:M_PMRMS:RANGe:UPPer x	1, 5 or 10	Sets Range Value of Phase (RMS) Meter in radians.
:M_PMRMS:RANGe:AUTO		Enables Autorange of Phase (RMS) Meter.
:M_PMRMS:UL:STATe x	0=off, 1=on	Toggles Upper Limit of Phase (RMS) Meter on or off.
:M_PMRMS:UL:LEVel x	0.00 to 10.00	Sets Upper Limit Level of Phase (RMS) Meter in radians.
:M_PMRMS:LL:STATe x	0=off, 1=on	Toggles Lower Limit of Phase (RMS) Meter on or off.
:M_PMRMS:LL:LEVel x	0.00 to 10.00	Sets Lower Limit Level of Phase (RMS) Meter in radians.
:M_PMRMS:ALARM x	0=off, 1=on	Enables/Disables Over/Under Limit Alarm of Phase (RMS) Meter.
:M_PMRMS:AVERage x	0=off, 1=on	Enables/Disables Averaging of Phase (RMS) Meter.
:M_PMRMS:PH X	0=off, 1=on	Enables/Disables Peak Hold of Phase (RMS) Meter.

COMMAND	RANGE/VALUE	DESCRIPTION
:M_PMRMS:STORe x	1 to 9	Stores parameters of Phase (RMS) Meter at indicated Store Parameters Menu location.
:M_PMRMS:RCL X	1 to 9	Recalls parameters of Phase (RMS) Meter from indicated Recall Parameters Menu location.
:M_PMRMS?		Requests return of Phase (RMS) Meter reading in radians.

OSCILLOSCOPE OPERATION SCREEN COMMANDS

:SCOPE:STATe x	0=off, 1=on	Enables/Disables Oscilloscope Operation Screen.
:SCOPE:SCALE x	For Demod Audio Input and FM Modulation: 2, 4, 10 or 20 (kHz) For AC, DC or GND input: 1, 2, 5, 10, 20, 50, 100, 200, 500, 1000, 2000, 5000, 10000, 20000 or 50000 (mV) For Func Gen or Ext Mod Input: 500, 1000 or 2500	Sets Oscilloscope vertical scale.
:SCOPE:SCALE?	For Demod Audio Input and FM Modulation: 1, 2, 4, 10 or 20 (kHz) For AC, DC or GND input: 2, 5, 10, 20, 50, 100, 200, 500, 1000, 2000, 5000, 10000, 20000 or 50000 (mV) For Func Gen or Ext Mod Input: 500, 1000 or 2500	Returns Oscilloscope scale setting.
:SCOPE:SWEEP x	1, 2, 5, 10, 20, 50, 100, 200, 500, 1000, 2000, 5000, 10000, 20000, 50000 or 100000	Sets Oscilloscope horizontal sweep rate in μ s.
:SCOPE:SWEEP?	1, 2, 5, 10, 20, 50, 100, 200, 500, 1000, 2000, 5000, 10000, 20000, 50000, 100000	Requests return of Oscilloscope sweep rate setting in μ s.

COMMAND	RANGE/VALUE	DESCRIPTION
:SCOPE:SOURce x	EXT or INTernal	Selects External Scope Input or Internal routing Scope input.
:SCOPE:INTernal x	IF, DEMOD, POWer, SINAD, FUNCtion or XAUDio	Sets Oscilloscope Input to: Receiver IF Demodulated Audio RF Power Level SINAD/BER Function Generators External Audio
:SCOPE:INPut:FILTer:LPASs:STATe x	0 = off, 1 = on	Enables Oscilloscope Input from Low-Pass Filter.
:SCOPE:INPut:FILT:LPAS:FREquency x	0.2 to 50	Sets Low-Pass Filter Frequency in kHz.
:SCOPE:INPut:FILTer:HPASs:STATe x	0=off, 1=on	Enables Oscilloscope Input from High-Pass Filter.
:SCOPE:INPut:FILT:HPAS:FREQuency x	0.2 to 100	Sets High-Pass Filter Frequency in kHz.
:SCOPE:INPut:FILT:CWEIght:STATe x	0=off, 1=on	Enables Oscilloscope Input from C-Weight Filter.
:SCOPE:INPut:FILTer:NOTch:STATe x	0 = off, 1 = on	Enables Oscilloscope Input from internal Notch Filter.
:SCOPE:INPut:FILT:NOT:FREQuency x	0.5 to 1.5	Sets Notch Filter width in kHz.
:SCOPE:COUPling x	AC, DC or GROund	Sets Oscilloscope internal coupling.
:SCOPE:TRIGger:x	IMMeadiate, ONE, NORM or AUTO	Sets Oscilloscope Trigger Mode.
:SCOPE:ARM		Arms Oscilloscope (Ignored if not in "One-Shot" mode).
:SCOPE:LEVel x	0 to 255	Sets Trigger Level.
:SCOPE:VERTical x	0 to 255	Sets Vertical Offset of Oscilloscope Trace

COMMAND	RANGE/VALUE	DESCRIPTION
:SCOPE:HORIZontal x	-12to12	Sets Horizontal Offset of Oscilloscope center line in number of grid divisions.
:SCOPE:FULL		Sets Oscilloscope for "full size" display on RF Generator, Receive, Duplex Transmitter and Duplex Receiver Operation Screens.
:SCOPE:QTR		Sets Oscilloscope for "1/4 size" display on RF Generator, Receive, Duplex Transmitter and Duplex Receiver Operation Screens.
:SCOPE:STORe x	1 to 9	Stores parameters of Oscilloscope Operation Screen at indicated Store Parameters Menu location.
:SCOPE:RCL x	1 to 9	Recalls parameters of Oscilloscope Operation Screen from indicated Recall Parameters Menu location.
:SCOPE:LIVe		Activates Live Scope Mode.
:SCOPE:AVERage x	1 to 100	Activates Average Scope Mode with number of average samples specified.
:SCOPE:C0OMPare x	1 to 9	Activates Compare Scope Mode. Compares against given stored trace number.
:SCOPE:MARKer1:STATe x	0=off, 1=on	Enables/Disables Oscilloscope Marker 1.
:SCOPE:MARKer1:STATe?	0=off, 1=on	Returns state of Oscilloscope Marker 1.
:SCOPE:MARKer1:POINt x	0 to 100	Sets Oscilloscope Marker 1 graticule position in .25 graticule resolution (100 graticules in grid or 10 per grid division).

COMMAND	RANGE/VALUE	DESCRIPTION
:SCOPE:MARKer1:POINT?	0 to 100	Returns Oscilloscope Marker 1 horizontal position in graticules.
:SCOPE:MARKer1:TIME?		Returns Oscilloscope Marker 1 horizontal position in ms.
:SCOPE:MARKer1:AMPLitude?		Returns vertical value of trace at Marker 1 in V with AC, DC or GND Input and in Live Mode.
:SCOPE:MARKer2:STATe x	0 = off, 1 = on	Enables/Disables Oscilloscope Marker 2.
:SCOPE:MARKer2:STATe?	0 = off, 1 = on	Returns state of Oscilloscope Marker 2.
:SCOPE:MARKer2:POINT x	0 to 100	Sets Oscilloscope Marker 2 graticule position in .25 graticule resolution (100 graticules in grid or 10 per grid division).
:SCOPE:MARKer2:POINT?	0 to 100	Returns Oscilloscope Marker 2 horizontal position in graticules.
:SCOPE:MARKer2:TIME?		Returns Oscilloscope Marker 2 horizontal position in ms.
:SCOPE:MARKer2:AMPLitude?		Returns vertical value of trace at Marker 2 in V with AC, DC or GND Input and in Live Mode.
:SCOPE:MARKer:STATe x	0 = OFF, 1 = ON	Enables/Disables Oscilloscope Marker 1.
:SCOPE:MARKer:STATe?	0 = OFF, 1 = ON	Returns state of Oscilloscope Marker 1.
:SCOPE:MARKer:POINT x	0 to 100	Sets Oscilloscope Marker 1 graticule position in .25 graticule resolution (100 graticules in grid or 10 per grid division).
:SCOPE:MARKer:POINT?	0 to 100	Returns Oscilloscope Marker 1 horizontal position in graticules.

COMMAND	RANGE/VALUE	DESCRIPTION
:SCOPE:MARKer:TIME?		Returns Oscilloscope Marker 1 horizontal position in ms.
:SCOPE:MARKer:AMPLitude?		Returns vertical value of trace at Marker 1 in V.
:SCOPE:MARKer:AOff		Turns off all markers.
:SCOPE:TRACK x	0 = off, 1 = on	Enables/Disables Oscilloscope tracking,
:SCOPE:DELTA:AMPLitude?		Returns amplitude difference between Marker 1 and Marker 2.
:SCOPE:DELTA:POINT?		Returns horizontal difference between markers in graticules.
:SCOPE:DELTA:TIME?		Returns horizontal difference between markers in ms.
:SCOPE:TRACE:DATAx,y,z	x is storage location number 1 to 9. y is horizontal offset 0 to 399. z is data location where point is placed 0 to 255.	Creates abstract trace, pixel by pixel, at specified memory location.
:SCOPE:TRACE:DATA?x,y,z	x is storage location number 0 to 9. y is horizontal offset 0 to 399 (optional; default = 0). z is number of points to be returned (optional; default = 400).	Returns trace data points from desired stored trace or live trace (0). All data points are returned unless otherwise specified by optional parameters.
:SCOPE:TRACE:MAX?x,y,z	x is storage location number 0 to 9. y is horizontal offset 0 to 399 (optional; default = 0). z is number of points to be returned (optional; default = 400).	Returns x, y position of maximum vertical point in trace. Entire trace is considered unless otherwise specified by optional parameters.

COMMAND	RANGE/VALUE	DESCRIPTION
:SCOPE:TRACE:MIN?x,y,z	x is storage location number 1 to 9. y is horizontal offset 0 to 399 (optional; default = 0). z is number of points to be returned (optional; default - 400).	Returns x,y position of minimum vertical point in trace. Entire trace is considered unless otherwise specified by optional parameters.
:SCOPE:TRACE:GET?x,y	x is storage location number 1 to 9. y is horizontal offset 0 to 399.	Returns point at location specified. Point returned is vertical pixel value 0 to 255.

SPECTRUM ANALYZER COMMANDS

:ANLZ:SCAN x	0, 1, 2, 5, 10, 20, 50, 100, 200, 500, 1000, 2000, 5000, 10000, 20000, 50000, 100000	Sets Spectrum Analyzer Scan Width in kHz.
:ANLZ:SCAN?	D, 1, 2, 5, 10, 20, 50, 100, 200, 500, 1000, 2000, 5000, 10000, 20000, 50000, 100000	Returns Spectrum Analyzer Scan Width in kHz.
:ANLZ:FREQuency x	250 to 999999.9	Sets Spectrum Analyzer Frequency in kHz.
:ANLZ:FREQuency?	250 to 999999.9	Returns Spectrum Analyzer Frequency in kHz.
:ANLZ:STATe x	0 = OFF, 1=ON	Enables/Disables Spectrum Analyzer.
:ANLZ:FULL		Sets Spectrum Analyzer for "full size" display on RF Generator, Receive, Duplex Transmitter and Duplex Receiver Operation Screens.
:ANLZ:QTR		Sets Spectrum Analyzer for "1/4 size" display on RF Generator, Receive, Duplex Transmitter and Duplex Receiver Operation Screens.

COMMAND	RANGE/VALUE	DESCRIPTION
:ANLZ:QTR		Sets Spectrum Analyzer for "1/4 size" display on RF Generator, Receive, Duplex Transmitter and Duplex Receiver Operation Screens.
:ANLZ:STORe x	1 to 9	Stores parameters of Spectrum Analyzer Operation Screen at indicated Store Parameters Menu location.
:ANLZ:RCL x	1 to 9	Recalls parameters of Spectrum Analyzer Operation Screen from indicated Recall Parameters Menu location.
:ANLZ:LIVe		Activates Live Analyzer Mode.
:ANLZ:AVERage x	1 to 100	Activates Average Analyzer Mode. Sample number may be specified. Default is 100.
:ANLZ:PEAK		Activates Peak Hold Analyzer Mode.
:ANLZ:COMPare x	1 to 9	Put Analyzer into Compare Mode. Compares against given stored trace number.
:ANLZ:SCALE x	2 or 10	Sets Analyzer Scale to 2 or 10 dB.
:ANLZ:SCALE?	2 or 10	Returns scale setting.
:ANLZ:SCALE:UNIT:DBM		Sets reference scale to dBm.
:ANLZ:SCALE:UNIT:DBMV		Sets reference scale to dBmV.
:ANLZ:SCALE:UNIT:DBUV		Sets reference scale to dBIV.
:ANLZ:SCALE:UNIT:DBV		Sets reference scale to dBV.
:ANLZ:SCALE:UNIT:DBUW		Sets reference scale to dBW.

COMMAND	RANGE/VALUE	DESCRIPTION
:ANLZ:SCALE:UNIT:DBW		Sets reference scale to W (TIR Connector only).
:ANLZ:SCALE:UNIT:UNIT?		Queries reference setting. T/R Connector returns dBm and dBW only. ANT does not return dBW.
:ANLZ:MARKer1 :STATE x	0=off, 1=on	Enables/Disables Spectrum Analyzer Marker 1.
:ANLZ:MARKer1:POINT x	0.5 to 100.0	Sets Spectrum Analyzer Marker 1 graticule position in .25 graticule resolution (100 graticules in grid or 10 per grid division).
:ANLZ:MARKer1 :POINT?		Returns Spectrum Analyzer Marker 1 position in graticules.
:ANLZ:MARKer1 :FREQUENCY?		Returns Spectrum Analyzer Marker 1 position in kHz.
:ANLZ:MARKer1 :AMPLitude?		Returns Spectrum Analyzer Trace value at point where it crosses Marker 1. This value is in units of Spectrum Analyzer reference setting.
:ANLZ:MARKer2:STATE x	0= off, 1= on	Enables/Disables Spectrum Analyzer Marker 2.
:ANLZ:MARKer2:POINT? x	0.5 to 100.0	Sets Spectrum Analyzer Marker 2 graticule position in .25 graticule resolution (100 graticules in grid or 10 per grid division).
:ANLZ:MARKer2:POINT?		Returns Spectrum Analyzer Marker 2 position in graticules.
:ANLZ:MARKer2:FREQUENCY?		Request return of Spectrum Analyzer Marker 2 position in kHz.

COMMAND	RANGE/VALUE	DESCRIPTION
:ANLZ:MARKer2:AMPLitude?		Returns Spectrum Analyzer Trace value at point where it crosses Marker 2. This value is in units of Spectrum Analyzer reference setting.
:ANLZ:MARKer:STATe x	0 = off, 1 = on	Enables/Disables Spectrum Analyzer Marker 1.
:ANLZ:MARKer:POINT? x	0.5 to 100.0	Sets Spectrum Analyzer Marker 1 graticule position in .25 graticule resolution (100 graticules in grid or 10 per grid division).
:ANLZ:MARKer:POINT?		Returns Spectrum Analyzer Marker 1 position in graticules.
:ANLZ:MARKer:FREQuency?		Returns Spectrum Analyzer Marker 1 position in kHz.
:ANLZ:MARKer:AMPLitude?		Returns Spectrum Analyzer Trace value at point where it crosses Marker 1. This value is in units of Spectrum Analyzer reference setting.
:ANLZ:MARKer:AOff		Deactivates all markers.
:ANLZ:MARKer:TRACk x	0 = off, 1 = on	Enables/Disables Marker tracking function.
:ANLZ:MARKer:DELTA:AMPLitude?		Returns vertical difference between two markers in current vertical scale units.
:ANLZ:MARKer:DELTA:POINT?		Returns horizontal difference in frequency between two markers in graticules.
:ANLZ:MARKer:DELTA:FREQuency?		Returns horizontal difference in frequency between two markers in MHz.

COMMAND	RANGE/VALUE	DESCRIPTION
:ANLZ:TRACE:DATA x,y,z	x is storage location number 1 to 9. y is horizontal offset 0 to 399. z is data location where point is placed 0 to 255.	Creates abstract trace, pixel by pixel, at specified memory location.
:ANLZ:TRACE:DATA? x,y,z	x is storage location number 0 to 9. y is horizontal offset 0 to 399 (optional; default = 0). z is number of points to be returned (optional; default = 400).	Returns trace data points from desired stored trace or live trace (0). All data points are returned unless otherwise specified by optional parameters.
:ANLZ:TRACE:MAX? x,y,z	x is storage location number 0 to 9. y is horizontal offset 0 to 399 (optional; default = 0). z is number of points to be returned (optional; default = 400).	Returns x,y position of maximum vertical point in trace. Entire trace is considered unless otherwise specified by optional parameters.
:ANLZ:TRACE:MIN? x,y,z	x is storage location number 1 to 9. y is horizontal offset 0 to 399 (optional; default = 0). z is number of points to be returned (optional; default = 400).	Returns x,y position of minimum vertical point in trace. Entire trace is considered unless otherwise specified by optional parameters.
:ANLZ:TRACE:GET? x,y	x is storage location number 1 to 9. y is horizontal offset 0 to 399.	Returns point at location specified. Point returned is vertical pixel value 0 to 255.
:ANLZ:TRACK:STATE x	0 = off, 1 = on	Enables/Disables Spectrum Analyzer Tracking Generator.
:ANLZ:TRACK:STATE?		Returns status of Tracking Generator.
:ANLZ:TRACK:RESolution: HIGH		Sets Tracking Generator to high resolution trace.
:ANLZ:TRACK:RESolution: MED		Sets Tracking Generator to medium resolution trace.
:ANLZ:TRACK:RESolution: LOW		Sets Tracking Generator to low resolution trace.

COMMAND	RANGE/VALUE	DESCRIPTION
:ANLZ:TRACK:RESolution?		Returns Tracking Generator resolution setting.
:ANLZ:TRACK:LEVel x	-127 to 0	Sets Tracking Generator output level in dBm.
:ANLZ:TRACK:LEVel?		Returns Tracking Generator output level.
:ANLZ:TRACK:BWIDth x	.3, 3, 30, 300 or 3000	Sets Tracking Generator Bandwidth in kHz.
:ANLZ:TRACK:BWIDth?		Returns value of current Tracking Generator bandwidth.
:ANLZ:TRACK:OUTput:TR		Selects T/R Connector for Tracking Generator output.
:ANLZ:TRACK:OUTput:DUplex		Selects DUPLEX OUT Connector for Tracking Generator output.
:ANLZ:TRACK:OUTput?		Returns Tracking Generator output selection.
:ANLZ:INPut:ANTenna		Sets Analyzer input to ANT. Analyzer screen should already be displayed.
:ANLZ:INPut:TR		Sets Analyzer input to T/R. Analyzer screen should already be displayed.
:ANLZ:INPut:Attenuation?		Sets analyzer attenuation value.
:ANLZ:INPut:Attenuation x	0, 20, 40	Queries analyzer attenuation value.
:ANLZ:INPut?		Queries analyzer input setting.
:ANLZ:TOP?		Queries top of screen scale value.
:ANLZ:RLEVel?	0 to 64	Queries scalar offset used in 2 dB/div scale.

COMMAND	RANGE/VALUE	DESCRIPTION
:ANLZ:FIND:FREQuency?		Searches for frequency with largest amplitude in Receiver spectrum.
:ANLZ:FIND:Reference x		Sets Find frequency amplitude search level in dB.
:ANLZ:FIND:REFeRence?		Queries reference setting.
:ANLZ:MODE: x	DIRect or CHANnel	Selects Analyzer Mode.
:ANLZ:CHANnel:FORM:AMPS:FORward		Selects AMPS Forward for Analyzer Channel Format.
:ANLZ:CHANnel:FORM:AMPS:REVerse		Selects AMPS Reverse for Analyzer Channel Format.
:ANLZ:CHANnel:FORM:ETACS:FORward		Selects ETACS Forward for Analyzer Channel Format.
:ANLZ:CHANnel:FORM:ETACS:Reverse		Selects ETACS Reverse for Analyzer Channel Format.
:ANLZ:NORMAlize		Normalizes Analyzer.

RECEIVER COMMANDS

:RECeive:SQUelch x	0.0 to 1.0	Turn squelch up or down.
:RECeive:SQUelch? x	0.0 to 1.0	Returns squelch setting.
:RECeive:VOLume x	0.0 to 1.0	Turns volume up or down.
:RECeive:VOLume?		Returns volume setting.
:RECeive:VOLume:AUTO b	0 = off, 1 = on	Enables/Disables Automatic volume control.
:RECeive:VOLume:AUTO?		Returns automatic volume control setting.
:RECeive:FREQuency x	250.0 to 999999.9	Sets Receiver RF Frequency from 250 kHz to 999.9999 MHz in 1 kHz steps.
:RECeive:FREQuency?	250.0 to 999999.9	Returns RF Frequency.

COMMAND	RANGE/VALUE	DESCRIPTION
:RECeive:MODulation:x	FM1, FM2, FM3, FM4, AM 1 , AM2, USB, LSB, BFO or PM	Sets Receiver Modulation Type.
:RECeive:MOD:USER:MODulation:x	FM, AM, USB, LSB, BFO, PM or DATA	Sets Receiver Modulation Type - User Selected Modulation.
:RECeive:MOD:USER:FILTer x	3, 30 or 300	Sets User selected IF Filter in kHz.
:RECeive:MOD:USER:POST:APASs		Sets User selected Post Detection - All Pass.
:RECeive:MOD:USER:POST:HPASs x	0.5 to 20.0	Sets User selected Post Detection High-Pass Filter cutoff in kHz.
:RECeive:MOD:USER:POST:LPASs x	0.1 to 30.0	Sets User selected Post Detection Low-Pass Filter cutoff in kHz.
:RECeive:MOD:USER:POST:BPASs x,y	Range for lower cutoff is 0.5 to 20, for upper cutoff 0.1 to 30.	Sets User selected Post Detection Bandpass Filter cutoff in kHz.
:RECeive:MODulation:USER:POST:CWT		Sets User selected Post Detection C-Weighted filter.
:RECeive:MODulation?		Returns Modulation Type.
:RECeive:INPut:ANTenna		Selects Antenna Receiver input.
:RECeive:INPut:TR		Selects T/R Connector Receiver input.
:RECeive:INPut:ATTenuation x	0, 20 or 40	Sets IF Block Attenuator in dB.
:RECeive:OUTput:SPEAKer x	0 = off, 1 = on	Turns Speaker output to on or off.
:RECeive:OUTput:DEMOD x	0 = off, 1 = on	Turns Demod output to on or off.
:RECeive:OUTput:AUDio x	0 = off, 1 = on	Turns Audio output to on or off.
:RECeive:AGC:MANual x	0 to 255	Sets AGC Manual mode level.

COMMAND	RANGE/VALUE	DESCRIPTION
:RECeive:AGC:AUTO		Selects AGC Auto mode.
:RECeive:AGC:USER x	MEASure, SPeech, DATA, HIGH, TYPE1, TYPE2 or TYPE3	Selects AGC User Type.
:RECeive:OFF:USB x	0.200 to 30000	Sets Receiver Offset Frequency - USB in kHz.
:RECeive:OFF:LSB x	0.200 to 30000	Sets Receiver Offset Frequency - LSB in kHz.
:RECeive:DISToRTion		When followed by SCREEN:RECeiver command, insures Distortion Meter is shown.
:RECeive:SINAD		When followed by SCREEN:RECeiver command, insures SINAD Meter is shown.
:RECeive:MODMeTeR		When followed by SCREEN:RECeiver command, insures Modulation Meter is shown.
:RECeive:PMRms		When followed by SCREEN:RECeiver command, insures Phase (RMS) Meter is shown.
:RECeive:DMM		When followed by SCREEN:RECeiver command, insures DMM is shown.
:RECeive:DTMF:STATe x	0 = off, 1 = on	Enables/Disables DTMF decoding.
:RECeive:DTMF?		Returns decoded digits or -1 if nothing decoded.
:RECeive:POCSAG:STATe x	0= off, 1 = on	Enables/Disables POCSAG decoding.
:RECeive:POCSAG:RATE x	0 = LOW, 1 = HIGH	Sets POCSAG rate to decode.
:RECeive:POCSAG:RATE?		Returns POCSAG Rate. 1 for high, 0 for low.

COMMAND	RANGE/VALUE	DESCRIPTION
:RECeive:POCSAG:CAPcode?		Returns received capcode or -1 if not available.
:RECeive:POCSAG:TYPE?		Returns POCSAG Function Type or -1 if not available.
:RECeive:POCSAG:MESSAge?		Returns POCSAG message string or -1 if not available.
:RECeive:DCS:STATe x	0 = off, 1 = on	Enables/Disables DCS decoding.
:RECeive:DCS:NORMAl?		Returns received DCS digits or -1 if normal DCS not received.
:RECeive:DCS:INVert?		Returns received DCS digits or -1 if inverted DCS not received.
:RECeive:TONE:STATe	0 = off, 1 = on	Enables/Disables Audio Tone decoding.
:RECeive:TONE:TYPE x	CCIR, EEA, EIA, ZVEI, DDZVEI, DZVEI, NATEL, EURO, TONE56, CCIRH, CCIRH4 or USER	Sets Audio Tone Type decoded.
:RECeive:TONE?		Returns received Audio Tone sequence or -1 if not available.
:RECeive:FIND:FREQuency?		Returns first frequency with amplitude greater than Find Reference.
:RECeive:FIND:REFerence x		Sets Find Reference Level in dB.
:RECeive:FIND:REFerence?		Returns Find Reference Level in dB.
:RECeive:SCAN:START x	250.0 to 999999.9	Receivers Scan starting frequency in kHz.
:RECeive:SCAN:STOP	250.0 to 999999.9	Receivers Scan stopping frequency in kHz.
:RECeive:SCAN:INCrement x	250.0 to 999999.9	Sets Receiver Scan increment in kHz.

COMMAND	RANGE/VALUE	DESCRIPTION
:RECeive:SCAN:RATE x	0.00 to 99.99	Sets time, in see, frequency is received if squelch not broken.
:RECeive:SCAN:PAUSE x	0.00 to 99.99	Sets time, in sec. frequency is received if squelch is broken.
:RECeive:SCAN:CONTInue		Starts or continues Receiver Scan.
:RECeive:SCAN:PAUSE?		Returns 1 if paused, 0 if not.
:RECeive:SCAN:ABORT		Aborts Receiver Scan.
:RECeive:SCAN:FREQUency?		Returns frequency currently being scanned.
:RECeive:CHANnel x	1 to 1023	Selects Channel to receive.
:RECeive:CHAN:FORM:AMPS:FORward		Selects AMPS Forward for Analyzer Channel Format.
:RECeive:CHAN:FORM:AMPS:REVerse		Selects AMPS Reverse for Analyzer Channel Format.
:RECeive:CHAN:FORM:ETACS:FORward		Selects ETACS Forward for Analyzer Channel Format.
:RECeive:CHAN:FORM:ETACS:REVerse		Selects ETACS Reverse for Analyzer Channel Format.
:RECeive:CHANnel:FORMAT?		Returns Channel Format.
:RECeive:STORe	1 to 9	Stores parameters.
:RECeive:RCL	1 to 9	Recalls parameters.

RF GENERATOR COMMANDS

:GENerator:FREQUency x	250.0 to 999999.9	Sets Generator RF Frequency 250 kHz to 999.9999 MHz in 1 kHz steps.
:GENerator:FREQUency?	250.0 to 999999.9	Requests RF Frequency.
:GENerator:LEVel:DBm x	-137.0 to 0.0	Sets Output level in dBm, 1 dB steps.

COMMAND	RANGE/VALUE	DESCRIPTION
:GENerator:LEVel:DBm?	-137.0 to 0.0	Returns output level.
:GENerator:LEVel:UNIT		Toggles between V and dBm.
:GENerator:STORe x	1 to 9	Stores parameters.
:GENerator:RCL x	1 to 9	Recalls parameters.
:GENerator:DISToRTion		When followed by SCREEN :GENerator command, insures Distortion Meter is shown.
:GENerator:SINAD		When followed by SCREEN:GENerator command, insures SINAD Meter is shown.
:GENerator:AF		When followed by SCREEN :GENerator command, insures AF Meter is shown.
:GENerator:DMM		When followed by screen :generator command, insures DMM Meter is shown.
:GENerator:DTMF x,y,z	Range of y and z is 25 to 9999	x is string to be encoded. y is mark time in ms. z is space time in ms.
:GENerator:POCSAG:BEEP x,y	Range of x is 1 to 4 Range of y is 0 to 9999999	Generates Beep Tone specified by x for capcode y.
:GENerator:POCSAG:RATE x	0 = low, 1 - high	Sets generated POCSAG rate.
:GENerator:POCSAG:RATE?		Returns current POCSAG rate 1 for high, 0 for low.
:GENerator:POCSAG:NUMeric x	0 to 9999999	Generates a numeric message for capcode x.
:GENerator:POCSAG:ALPHA:LOWer x	0 to 9999999	Generates a lower case message for capcode x.
:GENerator:POCSAG:ALPHA:UPPer x	0 to 9999999	Generates an upper case message for capcode x.
:GENerator:POCSAG:ALPHA:NUMeric x	0 to 9999999	Generates an alphanumeric message for capcode x.

COMMAND	RANGE/VALUE	DESCRIPTION
:GENerator:POCSAG:ALPHA:SPECial x	0 to 9999999	Generates a special character message for capcode x.
:GENerator:DCS:NORMal x	000 to 777	Generates DCS octal code in normal mode.
:GENerator:DCS:INVert x	000 to 777	Generates DCS octal code in inverted mode.
:GENerator:DCS:STOP		Stops DCS transmit.
:GENerator:IMTS x	0 to 9	Generates IMTS sequence up to 16 characters.
:GENerator:MTS	0 to 9	Generates MTS sequence up to 16 characters.
:GENerator:DIAL x	0 to 9	Generates 2805 pulse sequence up to 16 characters.
:GENerator:DIAL:Frequency x	0.0 to 40000.0	Sets pulse tone frequency to x Hz.
:GENerator:DIAL:Frequency?		Returns current 2805 pulse frequency.
:GENerator:TREMOte x	2050, 1950, 1850, 1750, 1650, 1550, 1450, 1350, 1250, 1150 or 1050	Generates sequence for given frequency in Hz.
:GENerator:TREMOte:STOP		Stops Tone Remote guard tone.
:GENerator:TONE:TYPE x	CCIR, EEA, EIA, ZVEI, DDZVEI, DZVEI, NATEL, EURO, TONE56, CCIRH, CCIRH4, USER	Sets Audio Type to generate.
:GENerator:TONE:USER:DEFine x,y,z	Range of y is 0.0 to 9999.9. Range of z is 20 to 9999.	Defines first character of string x with frequency y in Hz and duration z in ms.
:GENerator:TONE x	0 to 9, A, G, R or -	Generates sequence x using Audio tone previously defined.
:GENerator:OUTput:DEMODO x	0 = off, 1 = on	Turns Demod output to on or off.
:GENerator:OUTput:AUDIO x	0 = off, 1 = on	Turns Audio output to on or off.

COMMAND	RANGE/VALUE	DESCRIPTION
GENerator:MODE x	DIRect or CHANnel	Selects Generator Mode.
GENerator:CHANnel x	1 to 1023	Selects channel.
GENerator:CHAN:FORM:AMPS:FORward		Selects AMPS Forward as Generator Channel Format.
GENerator:CHAN:FORM:AMPS:REVerse		Selects AMPS Reverse as Generator Channel Format.
GENerator:CHAN:FORM:ETACS:FOR		Selects ETACS Forward as Generator Channel Format.
GENerator:CHAN:FORM:ETACS:REV		Selects ETACS Reverse as Generator Channel Format.

DUPLEX COMMANDS

:DUPlEx:INPut:FREQuency x		Sets Duplex Transmitter Frequency.
:DUPlEx:INPut:FREQuency?		Sets Duplex Transmitter Frequency.
:DUPlEx:INPut:MODulation:x	FM1, FM2, FM3, FM4, AM1, AM2, USB, LSB, BFO or PM	Sets Duplex Transmitter Modulation Type.
:DUPlEx:INPut:MOD:USER:MODulation:x	FM, AM, USB, LSB, BFO, PM or DATA	Sets Duplex Transmitter Modulation Type - User Selected Modulation.
:DUPlEx:INPut:MOD:USER:FILTer x	3, 30 or 300	Sets User selected IF Filter in kHz.
:DUPlEx:INPut:MOD:USER:POST:APASs		Sets User selected Post Detection - All Pass.
:DUPlEx:INPut:MOD:USER:POST:HPAS x	0.5 to 20.0	Sets User selected Post Detection High-Pass Filter cutoff in kHz.
:DUPlEx:INPut:MOD:USER:POST:LPASs x	0.1 to 30.0	Sets User selected Post Detection Low-Pass Filter cutoff in kHz.
:DUP:INP:MOD:USER:POST:BPASS x,y	Range for lower cutoff is 0.5 to 20.0. Range for upper cutoff is 0.1 to 30.0.	Sets User selected Post Detection Bandpass Filter with cutoffs in kHz.

COMMAND	RANGE/VALUE	DESCRIPTION
:DUplex:INPut:MOD:USER:POST:CWT		Sets User selected Post Detection - C-Weighted filter.
:DUplex:INPut:MODulation?		Returns Modulation type.
:DUplex:INPut:AGC:MANual x	0 to 255	Sets volume control to manual level specified.
:DUplex:INPut:AGC:AUTO		Sets volume control to automatic.
:DUplex:INPut:AGC:USER:x	MEASure, SPeech, DATA, HIGH, TYPE1, TYPE2 or TYPE3	Sets volume control to user type specified.
:DUplex:INPut:TO:SPEAKer b	0 = off, 1 = on	Enables/Disables routing to speaker.
:DUplex:INPut:TO:DEMOD b	0 = off, 1 = on	Enables/Disables routing to DEMOD OUT Connector.
:DUplex:INPut:TO:AUDio b	0 = off, 1 = on	Enables/Disables routing to AUDIO OUT Connector.
:DUplex:INPut:ANTenna		Selects Antenna Receiver input.
:DUplex:INPut:TR		Selects T/R Connector Receiver input.
:DUplex:INPut:ATTenuation x	0, 20, 40	Sets IF Block Attenuators in dB.
:DUplex:INPut:FIND:FREQuency?		Searches for frequency. with largest amplitude in Receiver spectrum.
:DUplex:INPut:FIND:REFerence x		Sets Find frequency. amplitude search level in dB.
:DUplex:INPut:FIND:REFerence?		Queries reference setting.
:DUplex:INPut:METER:MODMeter		When followed by SCREEN:DUplex command, insures Modulation Meter is shown.
:DUplex:INPut:METER:DISTortion		When followed by SCREEN:DUplex command, insures Distortion Meter is shown.

COMMAND	RANGE/VALUE	DESCRIPTION
:DUplex:INPut:METER:SINAD		When followed by SCREEN:DUplex command, insures SINAD Meter is shown.
:DUplex:INPut:METER:PMRms		When followed by SCREEN:DUplex command, insures Phase (RMS) Meter is shown.
:DUplex:INPut:MODE x	DIRect or CHANnel	Selects Duplex Transmitter Mode.
:DUplex:INPut:CHANnel x	1 to 1023	Selects Duplex Transmitter channel.
:DUplex:INPut:CHAN:FORM:AMPS:FOR		Selects AMPS Forward as Duplex Transmitter Channel Format.
:DUplex:INPut:CHAN:FORM:AMPS:REV		Selects AMPS Reverse as Duplex Transmitter Channel Format.
:DUplex:INPut:CHAN:FORM:ETACS:FOR		Selects ETACS Forward as Duplex Transmitter Channel Format.
:DUplex:INPut:CHAN:FORM:ETACS:REV		Selects ETACS Reverse as Duplex Transmitter Channel Format.
:DUplex:OUTput:FREQuency x		Sets RF Generator Frequency.
:DUplex:OUTput:FREQuency?		Returns Duplex Generator Frequency.
:DUplex:OUTput:OFFSet x	-999.7499 to 999.7499	Sets RF Generator relative to Duplex Receiver Frequency.
:DUplex:OUTput:OFFSet?		Returns Offset in kHz.
:DUplex:OUTput:LEVel:DBm x	-137.0 to 7.0	Sets Duplex output level.
:DUplex:OUTput:LEVel:DBm?	-137.0 to 7.0	Returns Duplex output level.
:DUplex:OUTput:DUplex		Changes output to Duplex Connector.

COMMAND	RANGE/VALUE	DESCRIPTION
:DUPlEx:OUTput:TR		Changes output to T/R Connector.
:DUPlEx:OUTput:DEMOD x	0 = off, 1 = on	Turns Demod output to on or off.
:DUPlEx:OUTput:AUDio x	0 = off, 1 = on	Turns Audio output to on or off.
:DUPlEx:OUTput:SPEAKer:SOURce x	OFF, FGEN, SINAD or EXTMOD	Selects Speaker source.
:DUPlEx:OUTput:METER:DISToRTion		When followed by SCREEN:DUPlEx command, insures Distortion Meter is shown.
:DUPlEx:OUTput:METER:SINAD		When followed by SCREEN:DUPlEx command, insures SINAD Meter is shown.
:DUPlEx:OUTput:METER:AF		When followed by SCREEN:DUPlEx command, insures AF Meter is shown.
:DUPlEx:OUTput:METER:DMM		When followed by SCREEN:DUPlEx command, insures DMM Meter is shown.
:DUPlEx:OUTput:MODE x	DIRect or CHANnel	Selects Duplex Receiver Mode.
:DUPlEx:OUTput:ChanNel x	1 to 1023	Selects channel.
:DUPlEx:OUTput:CHAN:FORM:AMPS:FOR		Selects AMPS Forward as Duplex Receiver Channel Format.
:DUPlEx:OUTput:CHAN:FORM:AMPS:REV		Selects AMPS Reverse as Duplex Receiver Channel Format.
:DUPlEx:OUT:CHAN:FORM:ETACS:FOR		Selects ETACS Forward as Duplex Receiver Channel Format.
:DUPlEx:OUT:CHAN:FORM:ETACS:REV		Selects ETACS Reverse as Duplex Receiver Channel Format.

COMMAND	RANGE/VALUE	DESCRIPTION
:DUPlEx:StORe	1 t o 9	Stores parameters.
:DUPlEx:RCL	1 to 9	Recalls parameters.
AF MODULATION COMMANDS		
:FGEN:GEN1:StATe x	0 = off, 1 = on	Turns AF GENERator 1 to on or off.
:FGEN:GEN1:FREQUency x	0.0 to 40000.0	Sets AF GENERator 1 Frequency in Hz.
:FGEN:GEN1:FREQUency?	0.0 to 40000.0	Returns AF GENERator 1 Frequency in Hz.
:FGEN:GEN1:MODulation: x	AM, FM, PM or OFF	Sets Modulation type.
:FGEN:GEN1:MODulation?	AM, FM, PM or OFF	Returns Modulation type.
:FGEN:GEN1:MODL x	0 to 90 for AM 0.0 to 100.0 for FM 0.0 to 10.0 for PM	Sets Modulation level. AM in %, FM in kHz, PM in radians.
:FGEN:GEN1:MODL?	0 to 90 for AM 0.0 to 100.0 for FM 0.0 to 10.0 for PM	Returns Modulation level. AM in %, FM in kHz, PM in radians.
:FGEN:GEN1:SHAPE: X	SIN, SQU, RAMP or TRI	Selects Wave Shape
:FGEN:GEN1:SHAPE:PULse:DCYCLe 50		Selects Pulse Shape with 50% Duty Cycle.
:FGEN:GEN1:SHAPE:DC X	1,0 or -1	Sets DC Level to -1, 0 or 1.
:FGEN:GEN1:LEVel x	0 to 255	Sets Generator Attenuator setting in DAC steps.
:FGEN:GEN1:LEVel?	0 to 255	Returns Attenuator level.
:FGEN:GEN2:StATe x	0 = off, 1 = on	Turns AF GENERator 2 to on or off.
:FGEN:GEN2:FREQUency x	0.0 to 40000.0	Sets AF GENERator 2 Frequency in Hz.
:FGEN:GEN2:FREQUency?	0.0 to 40000.0	Returns AF GENERator 1 Frequency in Hz.
:FGEN:GEN2:MODulation x	AM, FM, PM or OFF	Sets Modulation type.
:FGEN:GEN2:MODulation?	AM, FM, PM or OFF	Returns Modulation type.

COMMAND	RANGE/VALUE	DESCRIPTION
:FGEN:GEN2:MODL x	0 to 90 for AM 0.0 to 100.0 for FM 0.0 to 10.0 for PM	Sets Modulation level. AM in %, FM in kHz, PM in radians.
:FGEN:GEN2:MODL?	0 to 90 for AM 0.0 to 100.0 for FM 0.0 to 10.0 for PM	Returns Modulation level. AM in %, FM in kHz, PM in radians.
:FGEN:GEN2:SHAPE:X	SIN, SQU, RAMP or TRI	Selects Wave Shape.
:FGEN:GEN2:SHAPE:PULSe:DCYCLe 50		Selects Pulse Shape with 50% Duty Cycle.
:FGEN:GEN2:SHAPE:DC x	1, 0, -1	Sets DC Level to -1,0 or 1.
:FGEN:GEN2:LEVel x	0 to 255	Sets Generator Attenuator setting in DAC steps.
:FGEN:GEN2:LEVel?	0 to 255	Returns Attenuator level.
:FGEN:GEN3:MODulation: x	AM, FM, PM or OFF	Sets Modulation type.
:FGEN:GEN3:MODulation?	AM, FM, PM or OFF	Returns Modulation type.
:FGEN:GEN3:MODL x	0 to 100 for AM 0.0 to 100.0 for FM 0.0 to 10.0 for PM	Sets Modulation level. AM in %, FM in kHz, PM in radians.
:FGEN:GEN3:MODL?	0 to 100 for AM 0.0 to 100.0 for FM 0.0 to 10.0 for PM	Returns Modulation level. AM in %, FM in kHz, PM in radians.
:FGEN:GEN3:ENCode x	DTMF, TONE, DIGital, RCC	Selects Function Generator 3 for encoding of format specified. Must be followed with SETUP: or SCREEN: command.
:FGEN:DATA:STATe x	0 = off, 1 = on	Sets Digital Data Generator to on or off.
:FGEN:DATA:MODulation x	AM, FM or OFF	Selects Modulation type.
:FGEN:DATA:MODulation?	AM, FM or OFF	Returns Modulation type.
:FGEN:DATA:MODL X	0 to 90 for AM 0.0 to 100.0 for FM 0.0 to 10.0 for PM	Sets Modulation level. AM in%, FM in kHz, PM in radians.
:FGEN:DATA:MODL?	0 to 90 for AM 0.0 to 100.0 for FM 0.0 to 10.0 for PM	Returns Modulation level. AM in %, FM in kHz, PM in radians.

COMMAND	RANGE/VALUE	DESCRIPTION
:FGEN:DATA:PA ^T tern:FIX		Selects Data Type - Fixed Pattern,
:FGEN:DATA:PA ^T tern:RND x		Selects Data Type - Pseudo-Random Pattern.
:FGEN:DATA:PA ^T tern:USR x		Selects Data Type - User Enter Pattern.
:FGEN:DATA:SIZE X	100 to 100,000	Selects Data block size in bits.
:FGEN:DATA:SIZE?	100 to 100,000	Returns Block size setting.
:FGEN:DATA:RA ^T e x	75, 150, 300, 600, 1200, 1600, 2400, 4800 or 16000	Sets Rate in bps.
:FGEN:EXT:STA ^T e x	0 = off, 1 = on	Turns External Mod to on or off.
:FGEN:EXT:MO ^D ulation: x	AM, FM, PM or OFF	Sets Modulation type.
:FGEN:EXT:MO ^D ulation?	AM, FM, PM or OFF	Returns Modulation type.
:FGEN:EXT:MO ^D L X		Sets External Attenuation.
:FGEN:EXT:MO ^D L?		Returns External Attenuation.
:FGEN:EXT:LE ^V el x	0 to 100%	Sets Generate Attenuator setting in DAC steps.
:FGEN:EXT:LE ^V el?	0 to 100%	Returns Attenuator setting.
:FGEN:MIC:STA ^T e x	0 = off, 1 = on	Turns MIC/ACC to on or off.
:FGEN:MIC:MO ^D ulation: x	AM, FM, PM or OFF	Sets Modulation type.
:FGEN:MIC:MO ^D ulation?	AM, FM, PM or OFF	Returns Modulation type.
:FGEN:MIC:MO ^D L X		Sets MIC Attenuator.
:FGEN:MIC:MO ^D L?		Returns MIC Attenuator.
:FGEN:MIC:LE ^V el x	0 to 100%	Sets Generate Attenuator setting in DAC steps.
:FGEN:MIC:LE ^V el?	0 to 100%	Returns Attenuator setting.
:FGEN:OUT ^{put} :LE ^V el x	0 to 3.276	Sets Audio output level in volts.

COMMAND	RANGE/VALUE	DESCRIPTION
:FGEN:OUTput:LEVel?	0 to 3.276	Returns Audio output level.
:FGEN:OUTput:SPEAKer x	0 = off, 1 = on	Sets Speaker output to on or off.
:FGEN:OUTput:SPEAKer?	0 = off, 1 = on	Returns whether Speaker is enabled.
:FGEN:OUTput:DEMod X	0 = off, 1 = on	Sets Demod output to on or off.
:FGEN:OUTput:DEMod?	0 = off, 1 = on	Returns value of Demod output enable.
:FGEN:OUTput:AUDio x	0 = off, 1 = on	Sets Audio output to on or off.
:FGEN:OUTput:AUDio?	0 = off, 1 = on	Returns value of Audio output enable.
:FGEN:PROPOrtional x	0 = off, 1 = on	Sets Proportional output enable.
:FGEN:PROPOrtional?	0 = off, 1 = on	Returns value of proportional state.
:FGEN:STORE x	1 to 9	Stores screen parameters.
:FGEN:RCL X	1 to 9	Recalls screen parameters.
:FGEN:FSK X	0 =off, 1 = on	Selects GEN1 and GEN2 as two tones for a FSK implementation. GEN1 is designated true tone and GEN2 is designated false tone. Frequency and level of each must be independently set.

GENERIC MEASUREMENT COMMANDS

MEASure:VOLTage:DC?		Returns DMM DC voltage reading.
MEASure:VOLTage:AC?		Returns DMM AC voltage reading.
MEASure:VOLTage:SUPply? x	-15, 5 or 15	Returns Supply voltage specified.
MEASure:CURRent:DC?		Returns DMM DC current reading.

COMMAND	RANGE/VALUE	DESCRIPTION
MEASure:CURRent:AC?		Return DMM AC current reading.
MEASure:RESistance?		Returns DMM resistance reading.
MEASure:POWer?		Returns Power Meter reading.
MEASure:AUDio?		Returns AF Meter demodulated audio frequency. reading.
MEASure:FREQuency?		Returns RF Meter reading.
MEASure:PHASe?		Returns Phase Meter reading in radians.
MEASure:TEMPerature:AMBient?		Returns ambient temperature in °C.
MEASure:TEMPerature:POWer?		Returns Power Term temperature in °C.
MEASure:SQUelch?		Returns 1 if squelch broken, 0 otherwise.
MEASure:MIC?		Returns 1 if receiving MIC/ACC Input, 0 otherwise.

MISCELLANEOUS COMMANDS

:DELAY x		Delays strobe in seconds.
:PAD x	0, 20 or 40	Sets Attenuator pads.
:PWR_PAD:STATe x	0 = off, 1 = on	Sets power Pad on or off.
:PTT:STATe x	0 = off, 1 = on	Sets Push to talk pin on MIC/ACC Connector.
:SCREEN:RECeive		Renews Receiver Screen.
:SCREEN:GENerator		Renews Gen Screen.
:SCREEN:DUPlax		Renews Duplex Screen.
SCREEN:DUPRX		Renews Duplex Receiver Screen.

COMMAND	RANGE/VALUE	DESCRIPTION
SCREEN:DUPTX		Renews Duplex Transmitter Screen.
:SCREEN:SCOPE		Renews Scope Screen.
:SCREEN:ANLZ		Renews Analyzer Screen.
:SCREEN:AF		Renews AF Counter Screen.
:SCREEN:FREQUENCY		Renews Frequency Meter Screen.
:SCREEN:POWER		Renews Power Meter Screen.
:SCREEN:DEV		Renews Deviation Screen.
:SCREEN:MODULATION		Renews Mod Meter Screen.
:SCREEN:DISTORTION		Renews Distortion Screen.
:SCREEN:SINAD		Renews SINAD Meter Screen.
:SCREEN:SIG		Renews Signal Strength Screen.
:SCREEN:DMM		Renews DMM Screen.
:SCREEN:FUNC		Renews Function Generator Screen.
:SCREEN:BER		Renews BER Meter Screen.
:SCREEN:USER		Renews Blank Screen for user.
:SCREEN:PM		Renews Phase Meter Screen
:SCREEN:DRMS		Renews Deviation RMS Screen.
:SCREEN:PMRMS		Renews Phase RMS Meter Screen
:SETUP:RECEIVE		Configures hardware for Receiver routing.
:SETUP:GENERATOR		Configures hardware for Generator routing.

COMMAND	RANGE/VALUE	DESCRIPTION
:SETUP:DUPl _e x		Configures hardware for Duplex routing.
:SETUP:SCOPE		Configures hardware for Scope routing.
:SETUP:ANLZ		Configures hardware for Analyzer screen routing.
:SETUP:FUNC		Configures hardware for AF GENERator screen routing.
:SETUP:DUPTX		Configures hardware for Duplex - TX routing.
:SETUP:DUPRX		Configures hardware for Duplex - RX routing.
:SETUP:AF		Configures hardware for AF Meter Screen routing.
:SETUP:DIS _T ortion		Configures hardware for Distortion Meter routing.
:SETUP:SINAD		Configures hardware for SINAD Meter routing.
:FLUSH		Flushes query data to remote.

F-8. UNIVERSAL AND ADDRESSED COMMANDS.

Universal and addressed (U/A) commands make most RS-232/GPIB instruments perform generally accepted standard functions. Usually, universal commands control all of the instruments on the bus, while addressed commands control individual instruments at specific addresses on the bus. The Test Set accepts the ● CLS, ● ESE, ● ESR, ● IDN, ● OPC, ● RST, *SRE, ● STB, ● TST, ● WAI, ● DMC, ● EMC, ● LMC, ● RCL and ● SAV commands (these are common command headers; consult with the IEEE-488.2 Standard).

F-9. SERVICE REQUESTS (SRQ).

The user can set bits in the Service Request Enable Register (SRE). These bits correspond to bits in the Status Byte (STB). When a bit is set in the SRE, it enables that bit in the Status Byte to request service.

F-10 MASS MEMORY OPERATION

Operate Mass Memory by following procedure:

1. Press MTRS MODE Key. Press "AUX" F6 to display Auxiliary Functions Menu. Press 7 DATA ENTRY Key to display Memory Manager Screen.

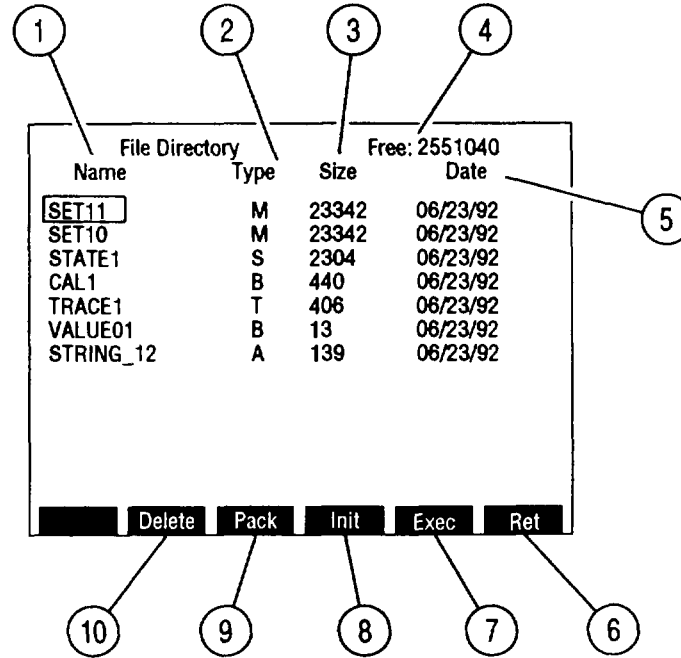

CE2FN667

2. Use index to identify features and parameters that may be edited.

KEY	SCREEN FEATURE	FUNCTION
1.	File Name	Name given to file stored in Mass Memory. 512 file names are allowed. Names cannot be reused unless Mass Memory is initialized. File names start with a letter but rest of characters can be numbers and underscore. File names are limited to 8 characters.
2.	File Type	Type of file stored in Mass Memory. Following are the 5 types: ASCII Variable storage. Binary Calibration Data storage. State Test Set State storage. Trace Oscilloscope or Spectrum Analyzer trace storage. Macro Macro storage.
3.	File Size	File size in bytes.
4.	Free Memory Size	Available bytes in Mass Memory.
5.	File Date	Date file stored in Mass Memory.

KEY	SCREEN FEATURE	FUNCTION
6	"Ret"	Press F6 to return to Auxiliary Functions Menu.
7	"Exec"/"Load"	"Exec" appears when cursor is on Macro Type file. Press F5 to load file into Test Set memory and execute designated macro. "Load" appears when cursor is on State or Binary Type file Press F5 to load Test Set State or Calibration Data into Test Set memory.
8	"Init"	Press F4 to initialize Mass Memory. Initializing erases all files stored in Mass Memory.
9	"Pack"	Press F3 to Pack Mass Memory Pack releases memory space taken by deleted files. Do not power off Test Set during Pack operation as files may be lost.
10	"Delete"	Press F2 to delete file cursor is on. Mass Memory space is not released until Pack operation is done.

Mass Memory is operated remotely using commands listed in following table.

COMMAND	RANGE/VALUE	DESCRIPTION
MMEemory:CATalog?		Returns Mass Memory status. First number returned is memory space used in bytes. Second number returned is memory space available in bytes. Remainder data returned in sets of 3 consisting of file name, file type and file size of each file stored in Mass Memory.
MMEemory:CATalog:FREE?		Returns number of free bytes.
MMEemory:CATalog:USED?		Returns number of used bytes.
MMEemory:CATalog:ENTRY? x	x=0 to 512	Returns string of catalog entry.

COMMAND	RANGE/VALUE	DESCRIPTION
MMEMory:DELeTe "f"	f is file name	Deletes file but does not release memory space until Pack operation is done.
MMEMory:INITialize		Erases all files stored in Mass Memory.
MMEMory:INITialize?	0=no, 1=yes	Returns Flash Memory initialization condition.
MMEMory:LOAD:MACRo 'm','f'	m is name of designated macro f is file name	Loads macros and variables stored as the file name from Mass Memory into Test Set memory. If m is ', designated macro is executed. If m is macro name, that macro is executed. If m is omitted ("), no macro is executed.
MMEMory:LOAD:STATe n,'f'	n is number of stored state of Test Set. Set n from 0 to 9. f is file name	Loads Test Set State stored as f from Mass Memory into Auxiliary Functions 'Store Parameters Menu' as entry n.
MMEMory:LOAD:TRACe:SCOPE n,'f'	n is number of stored trace. Set n from 0 to 9 f is file name	Loads Oscilloscope trace stored as f into Oscilloscope 'Store Parameters menu' as entry n.
MMEMory:LOAD:TRACe:ANLZ n,'f'	n is number of stored trace. Set n from 0 to 9 f is file name.	Loads Spectrum Analyzer trace stored as f into Spectrum Analyzer "Store Parameters menu' as entry n.
MMEMory:LOAD:DATA "v",'f'	v is name of variable. f is file name.	Loads variable stored as f into Test Set memory with name v.
MMEMory:LOAD:CALibration 'f'	f is file name	Loads Calibration Data from Mass Memory into Test Set memory.

COMMAND	RANGE/VALUE	DESCRIPTION
MMEMory:PACK		Packs Mass Memory and frees memory space from deleted files. Files may be lost if Test Set is powered off during Pack operation.
MMEMory:STORE:MACRo 'm','f'	m is name of designated macro. f is file name	Stores all Test Set macros and variables (except free variables) into Mass Memory as f with macro specified as designated macro.
MMEMory:STORE:STATe n,"f'	n is number of stored state of Test Set. Set n from 0 to 9	Stores entry n of Auxiliary Functions 'Store Parameters Menu" as f in Mass Memory.
MMEMory:STORE:TRACe:SCOPE n,"f'	n is number of stored trace. Set n from 0 to 9 f is file name.	Stores entry n (stored trace) of Oscilloscope "Store Parameters Menu" as f in Mass Memory.
MMEMory:STORE:TRACe:ANLZ n,"f'	n is number of stored trace. Set n from 0 to 9 f is file name	Stores entry n (stored trace) of Spectrum Analyzer "Store Parameters Menu" as f in Mass Memory.
MMEMory:STORE:DATA 'v',"f'	v is name of variable. f is file name	Stores variable v into Mass Memory as f.
MMEMory:STORE:CALibration 'f'	f is file name	Stores Test Set Calibration Data into Mass Memory.
MMEMory:TYPE 'f'	f is file name	Returns file name. Returns null string if file does not exist.

Error messages are returned to Host when an error occurs. Error messages are detailed in following table.

ERROR NUMBER	ERROR DEFINITION	DESCRIPTION
220	Parameter Error	Incorrect number of parameters were entered with command.
224	Illegal Parameter Value	A parameter entered was not appropriate for command.

ERROR NUMBER	ERROR DEFINITION	DESCRIPTION
225	Out of Memory	Insufficient memory space to perform command.
250	Mass Storage Error	Indicates Mass Memory could not be erased or data could not be stored in Mass Memory.
253	Corrupt Media	Indicates Mass Memory not properly initialized. Initialize Mass Memory.
254	Media Full	Indicates insufficient Mass Memory space to perform command.
255	Directory Full	Indicates command not performed because 512 file names have been used.
256	File Name Not Found	Specified file not stored in Mass Memory.
257	File Name Error	Indicates command attempted to create file name already stored or file name syntax incorrect.

APPENDIX G

dBm TO MICROVOLT CONVERSION CHART

dBm	μV	dBm	μV	dBm	μV
7	500,578	-45	1,257	-97	3.16
6	446,141	-46	1,121	-98	2.82
5	397,623	-47	1,000	-99	2.51
4	354,382	-48	890	-100	2.24
3	315,843	-49	793	-101	1.99
2	281,495	-50	707	-102	1.78
1	250,883	-51	630	-103	1.58
0	223,607	-52	562	-104	1.41
-1	199,290	-53	501	-105	1.26
-2	177,617	-54	446	-106	1.12
-3	158,302	-55	398	-107	1.00
-4	141,086	-56	354	-108	0.890
-5	125,743	-57	316	-109	0.793
-6	112,069	-58	282	-110	0.707
-7	99,882	-59	251	-111	0.630
-8	89,020	-60	224	-112	0.562
-9	79,339	-61	199	-113	0.501
-10	70,711	-62	178	-114	0.446
-11	63,021	-63	158	-115	0.398
-12	56,168	-64	141	-116	0.354
-13	50,059	-65	126	-117	0.316
-14	44,615	-66	112	-118	0.282
-15	39,764	-67	100	-119	0.251
-16	35,439	-68	89.0	-120	0.224
-17	31,585	-69	79.3	-121	0.199
-18	28,150	-70	70.7	-122	0.178
-19	25,089	-71	63.0	-123	0.158
-20	22,361	-72	56.2	-124	0.141
-21	19,929	-73	50.1	-125	0.126
-22	17,762	-74	44.6	-126	0.112
-23	15,830	-75	39.8	-127	0.100
-24	14,109	-76	35.4	-128	0.0890
-25	12,574	-77	31.6	-129	0.0794
-26	11,207	-78	28.2	-130	0.0707
-27	9,988	-79	25.1	-131	0.0630
-28	8,902	-80	22.4	-132	0.0562
-29	7,934	-81	19.9	-133	0.0501
-30	7,071	-82	17.8	-134	0.0446
-31	6,302	-83	15.8	-135	0.0398
-32	5,617	-84	14.1	-136	0.0354
-33	5,006	-85	12.6	-137	0.0316
-34	4,462	-86	11.2	-138	0.0282
-35	3,976	-87	10.0	-139	0.0251
-36	3,544	-88	8.90	-140	0.0224
-37	3,159	-89	7.93	-141	0.0199
-38	2,815	-90	7.07	-142	0.0178
-39	2,509	-91	6.30	-143	0.0158
-40	2,236	-92	5.62	-144	0.0141
-41	1,993	-93	5.01	-145	0.0126
-42	1,776	-94	4.46	-146	0.0112
-43	1,583	-95	3.98	-147	0.00999
-44	1,411	-96	3.54		

APPENDIX H

TABLE OF USER I/O CONNECTORS AND PIN-OUT TABLES

H-1. TABLE OF I/O CONNECTORS, TS-4317/GRM.

CONNECTOR NAME	CONNECTOR TYPE	SIGNAL IN/OUT	SIGNAL TYPE
T/R	"N" TYPE	IN/OUT	RF, 200 W MAX
SCOPE IN	BNC	IN	Analog, 200 VDC MAX
DMM AMP	Banana Jack	IN	AC/DC, 2 A MAX
DMM COM	Banana Jack	IN	GND
DMM V Ω	Banana Jack	IN	AC/DC, 1 kVDC or 500 VAC MAX
DEMODO OUT	BNC	OUT	Audio
AUDIO OUT	BNC	OUT	Audio
SINAD/BER IN	BNC	IN	Analog - SINAD Digital - BER
EXT MOD IN	BNC	IN	Audio
MIC/ACC IN/OUT	8-Pin DIN	IN/OUT	See Pin-out (para H-3)
DUPLEX OUT	BNC	OUT	RF, 65 W MAX
ANT IN	BNC	IN	RF, 65 W MAX
AC LINE IN	AC Power In	IN	90-260 VAC 115/230 V
EXT DC	4-Pin	IN	See Pin-out (para H-12)
DC OUT	6-Pin Lumberg	OUT	See Pin-out (para H-4)
SCSI	50-Pin Champ	IN/OUT	See Pin-out (para H-5)
IEEE-488	24-Pin Champ	IN/OUT	See Pin-out (para H-7)
RS-232	9-Pin, D	IN/OUT	See Pin-out (para H-10)
External Video	9-Pin, D	OUT	See Pin-out (para H-11)
External Reference	BNC	IN	10 MHz (0 dBm)

H-2. I/O CONNECTORS, J-4843/GRM-114B.

CONNECTOR NAME	CONNECTOR TYPE	SIGNAL IN/OUT	SIGNAL TYPE
DUPLEX	BNC	IN	RF, 65 W MAX
UUT	F RECT, CAM ACTUATED	IN/OUT	See Pin-out (para H-9)
SNAP OUTPUT	5-Pin	OUT	See Pin-out (para H-6)
EXT MOD	BNC	OUT	Audio
BER/SINAD OUT	BNC	OUT	Analog - SINAD Digital - BER
AUDIO IN	BNC	IN	Audio
DEMOD IN	BNC	IN	Audio
V Ω DMM OUT	Twin BNC	OUT	AC/DC, 1 kVDC or 500 VAC MAX
5 WATT RF AMP	BNC	OUT	RF, 30-88 MHz
DC IN	6-Pin Lumberg	IN	See Pin-out (para H-8)
SCSI	50-Pin Champ	IN/OUT	See Pin-out (para H-5)
RS-232	9-Pin, D	IN/OUT	See Pin-out (para H-10)

H-3. PIN-OUTS FOR MIC/ACC IN/OUT CONNECTOR, TS-4317/GRM.

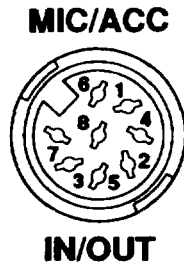

CE2FN652

PIN NUMBER	SIGNAL NAME	SIGNAL TYPE	I/O
1	PTT-Out	TTL	Programmable Out
2	Mic Audio	Audio	In
3	Demod Audio	Audio	out
4	ACC-2	TTL	Programmable In
5	+15 VDC	10-15 VDC, 1mA	out
6	ACC-1	TTL	Programmable In
7	Mic Switch	TTL	Programmable In
8	GND		

H-4. PIN-OUTS FOR DC OUT CONNECTOR, TS-4317/GRM.



CE2FN653

PIN NUMBER	SIGNAL TYPE
1	+5 VDC, 3 A MAX
2,4,6	GND
3	+15 VDC, 1.5 A MAX
5	-15 VDC, 100 mA MAX

H-5. PIN-OUTS FOR SCSI CONNECTOR, TS-4317/GRM AND J-4843/GRM.

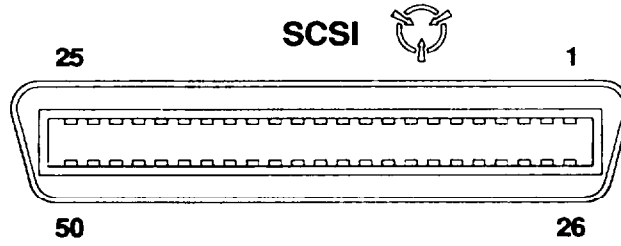

CE2FN654

PIN NUMBER	ASSIGNMENT	PIN NUMBER	ASSIGNMENT
1-25,35-37,39,40,42	Digital GND	38	TERM PWR
26	SD0	41	ATN
27	SD1	43	BSY
28	SD2	44	ACK
29	SD3	45	RST
30	SD4	46	MSG
31	SD5	47	SEL
32	SD6	48	C/D
33	SD7	49	REQ
34	SD8	50	I/O

H-6. PIN-OUTS FOR SNAP OUTPUT CONNECTOR, J-4843/GRM-114B.

**SNAP
OUTPUT**



CE2FN713

PIN NUMBER	SIGNAL NAME	SIGNAL TYPE
1	+15V	+15 VDC
2	GND	GND
3	Tune Word (TW) Clock	TTL-Out
4	Tune Word (TW) Gate	TTL-Out
5	Tune Word (TW) Data	TTL-Out

H-7. PIN-OUTS FOR IEEE-448 CONNECTOR, TS-4317/GRM.

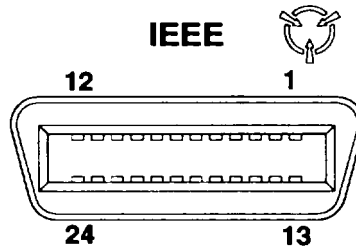

CE2FN655

PIN NUMBER	ASSIGNMENT	PIN NUMBER	ASSIGNMENT
1	DIO 1	10	SRO
2	DIO 2	11	ATN
3	DIO 3	13	DIO 5
4	DIO 4	14	DIO 6
5	EOI	15	DIO 7
6	DAV	16	DIO 8
7	NFRD	17	REN
8	NDAC	12,18-24	Digital GND
9	IFC		

H-8. PIN-OUTS FOR DC IN CONNECTOR, J-4843/GRM-114B.

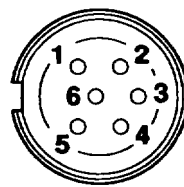

DC IN

CE2FN715

PIN NUMBER	SIGNAL TYPE
1	+5 VDC, 3 A MAX
2,4,6	GND
3	+15 VDC, 1.5 A MAX
5	-15 VDC, 100 mA MAX

H-9. PIN-OUTS FOR UUT CONNECTOR, J-4843/GRM-114B.

Pin assignments for UUT Connector vary with type of radio or radio component tested. For information on pin-outs, see General Support Maintenance Manual, TM 11-6625-3245-40.

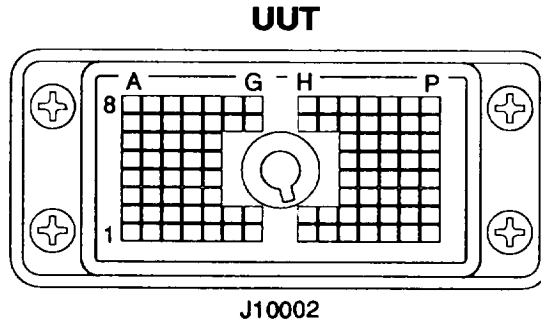

CE2FN714

H-10. PIN-OUT FOR RS-232 CONNECTOR, TS-4317/GRM AND J-4843/GRM-114B.

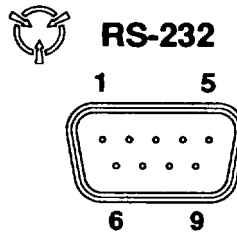

CE2FN656

PIN NUMBER	ASSIGNMENT
1	4.7 K Ω to +15 VDC
2	TX DATA
3	RX DATA
4	N/C
5	GND
6	4.7 K Ω to +15 VDC
7	CTS
8	RTS
9	N/C

H-11. PIN-OUT FOR EXTERNAL VIDEO CONNECTOR, TS-4317/GRM.

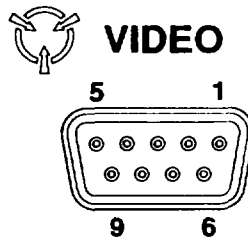

CE2FL650

PIN NUMBER	SIGNAL TYPE
1	Digital GND
2	Secondary Red
3	Primary Red
4	Primary Green
5	Primary Blue
6	Secondary Green
7	Secondary Blue
8	Horizontal Sync
9	Vertical Sync

H-12. PIN-OUT FOR EXTERNAL DC CONNECTOR, TS-4317/GRM.

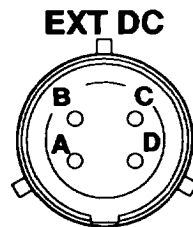

CE2FN674

PIN NUMBER	SIGNAL TYPE
A	GND
B	GND
c	22 TO 30 VDC
D	22 TO 30 VDC

APPENDIX I

DRIVE-BY TEST

APPLICABLE TO RADIO SETS: AN\PRC-119A, AN\VRC-87A, AN\VRC-87C, AN\VRC-88A, AN\VRC-88C, AN\VRC-89A, AN\VRC-90A, AN\VRC-90C, AN\VRC-91A, AN\VRC-92A

I-1. INTRODUCTION.

This test is designed to give a quick GO\NO GO check of mission capability of Radio systems. Test is only a comparison test and does not determine if an individual component has failed. Test Set is programmed by operator to test specific frequencies and power levels. Test may be performed one of two ways:

Stationary test platform. Test setup places AN\GRM-114B in a stationary vehicle (one parked next to motor pool gate, for example). Each system (vehicle) is driven past test point. Test operator gives a signal to vehicle's radio telephone operator (RTO). RTO responds by keying transmitter of his vehicle's radio. Test operator watches Test Set's CRT for pass/fail indication and notifies RTO of result. If a second or third radio is installed in vehicle, procedure is repeated for each radio until test is completed.

b. Mobile test platform. Test setup places AN\GRM-114B in a vehicle driven past systems under test (a convoy parked along the side of a road, for example). Test operator gives a signal to vehicle's radio telephone operator (RTO). RTO responds by keying transmitter of vehicle's radio. Test operator watches Radio Test Set's CRT for pass/fail indications and notifies RTO of result. If a second or third radio is installed in vehicle, procedure is repeated until test is completed.

I-2. DRIVE-BY TEST.

CAUTION

FOR HIGH POWER TESTS, MONITOR SIGNAL STRENGTH METER TO PREVENT DAMAGE TO TEST SET. WHEN SIGNAL STRENGTH METER INDICATES GREATER THAN 99, INCREASE DISTANCE BETWEEN ANTENNAS OR INCREASE SELECT INPUT ATTENUATION (para 2-12a, Steps 7 and 8).

NOTE

Test evaluates transmit/receive capability of radio systems at 3 frequencies, one in each radio band, of 30.0 to 43.0 MHz, 43.0 to 61.5 MHz and 61.5 to 88.0 MHz. At least one frequency from each band must be tested to assure radio system is fully tested.

To test each LO power radio frequency:

- a. Configure Radio Test Set as shown in Figure I-1.
- b. Complete Radio Test Set Setup Procedure (refer to 1-3) and test first system for each testing frequency. Record results. First system (unless proven faulty) is baseline system.
- c. Repeat test for remainder of systems under test.

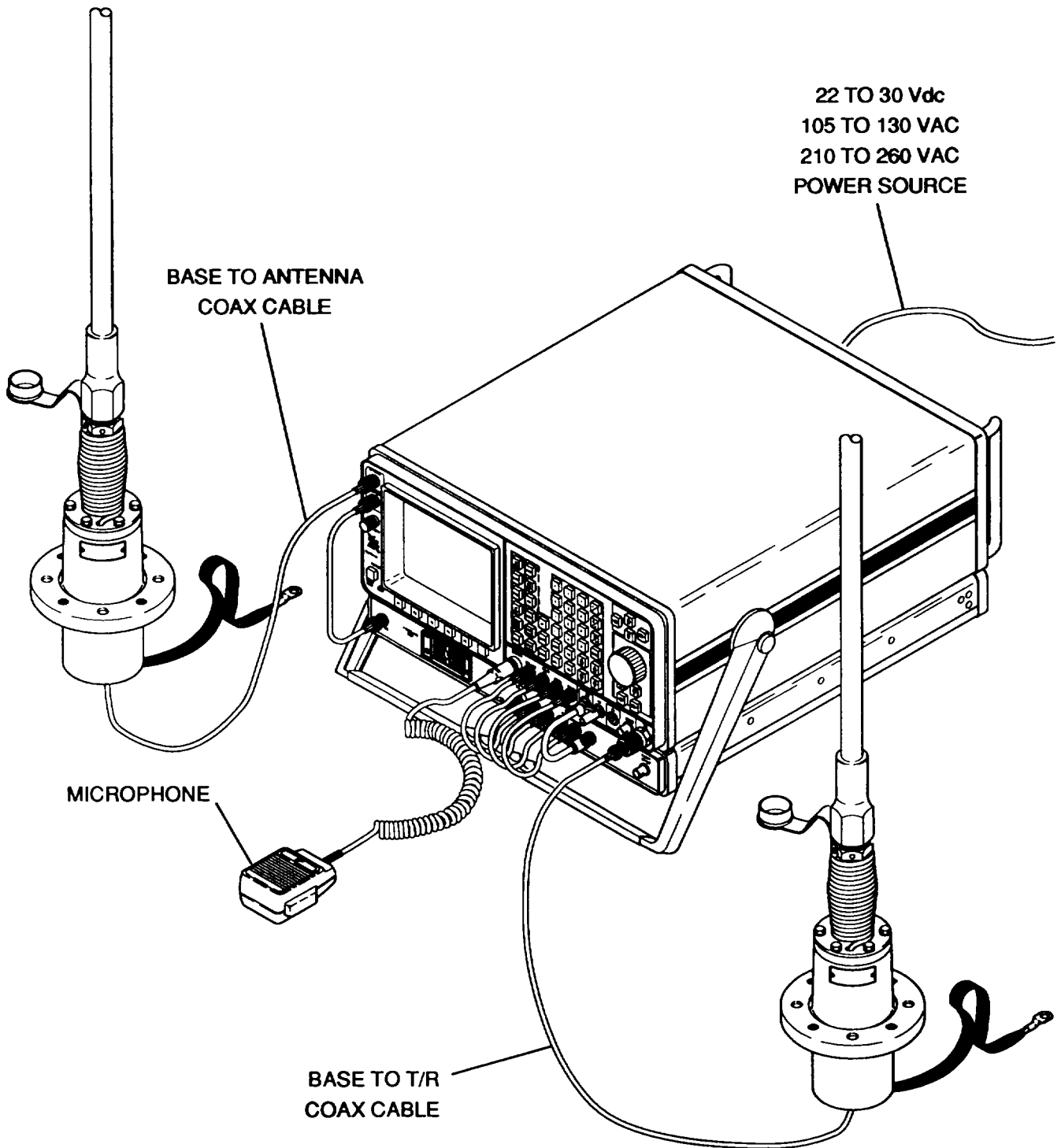

CE2FN666

Figure I-1. Drive-By Test Setup.

I-3 RADIO TEST SET SETUP PROCEDURE.

Follow procedure to setup for Drive-by test:

1. Restore Factory Defaults (para 2-9).
2. Press RCVR MODE Key. Press SETUP Key.
 - Press 1 DATA ENTRY Key. Set frequency to 30.0000 MHz (43.0000 MHz, 61.5000 MHz for HI power 3-frequency tests). Press ENTER.
 - Press 2 on DATA ENTRY Keypad. Press 2 on DATA ENTRY Keypad to select FM2.
 - Press RF lock F2.
3. Press SCOPE/ANLZ MODE Key. Press SETUP Key.
 - Press 2 on DATA ENTRY Keypad.
 - Press 4 on DATA ENTRY Keypad. Press 6 on DATA ENTRY Keypad. Use FIELD SELECT Keys to select 10 kHz for Scan Width. Press ENTER Key.
4. Press RF GEN MODE Key. Press SETUP Key.
 - Press 1 on DATA ENTRY Keypad. Press 1 on DATA ENTRY Keypad to access data field. Press 3 on DATA ENTRY Keypad to select FM.
 - Press 2 on DATA ENTRY Keypad. Use DATA ENTRY Keypad to set frequency to 150.0 Hz. Press ENTER.
 - Press 4 on DATA ENTRY Keypad. Use DATA ENTRY Keypad to set FM Dev to 3.0 kHz. Press ENTER. Press ESC F6.
 - Press 4 on DATA ENTRY Keypad. Press 3 on DATA ENTRY Keypad to access Mic Audio data field. Use DATA SCROLL ↑ and ↓ Keys to set to FM. Press ENTER.
 - Press 4 on DATA ENTRY Keypad. Use DATA ENTRY Keypad to set to 100.0 kHz. Press ENTER. Press ESC F6.
 - Press 5 on DATA ENTRY Keypad. Press 2 on DATA ENTRY Keypad. Use DATA ENTRY Keypad to set to 0 dBm. Press ENTER.
5. Press RCVR MODE Key.

I-4. Evaluating responses for GO/NO GO Indications.

The GO/NO GO test provides relative values for indications received. To determine if a system has passed or failed, record Receiver Screen parameters prior to conducting first test. A system fails when either occurs:

- There is no change in any parameters on Test Set Receiver Operation Screen parameters.
- If Receiver Frequency Error or Signal Strength readings are out of line with other, similar systems being tested.

INDEX

Subject	Page
A	
Administrative Storage	1-2
Adjustment and Daily Checks, Initial	2-161
AF (Signal) Generator	
Menu	2-93
Operation	2-199
Performance Data	1-5
Screen Configuration	2-91
Audio Frequency (AF) Meter	
Menu	2-116
Operation	2-217
Screen Configuration	2-114
AM Modulation Meter	
Menu	2-128
Operation	2-226
Performance Data	1-7
Screen Configuration	2-126
Army Publications and Blank Forms, Consolidated Index of	1-1
Auxiliary Functions	E-1
B	
Basic Issue Items Lists, Components of End Item and	C-1
Bit Error Rate (BER) Meter	
Menu	2-139
Operation	2-236
Screen Configuration	2-137
Blank Forms, Consolidated Index of Army Publications and	1-1
C	
Carrying Handle, Replace	3-10
Changing Color Selections	E-3
Color Selection	
Changing Procedure	E-3
Color Selections (Table E-3)	E-6
Menu Color Sets (Table E-1)	E-5
Selectable Color Set Screen Features (Table E-2)	E-5
Command List, Remote Operation	F-7
Common Tools and Equipment	3-1
Components of End Item and Basic Issue Items Lists	C-1

Subject	Page
C (Continued)	
Configure I/O Connectors	
GPIB Submenu	F-6
RS-232 Submenu	F-4
Consolidated Index of Army Publications and Blank Forms.....	1-1
Control Knobs, Replace.....	3-9
Controls, Indicators and Connectors	
Front View, AN/GRM-114B (Figure 2-1).....	2-2
Rear View, AN/GRM-114B (Figure 2-2).....	2-20
Cross-Reference List, Nomenclature	1-2
D	
dBm to Microvolt Conversion Chart.....	G-1
Description and Use of Operator's Controls, Indicators and Connectors.....	2-2
Destruction of Army Materiel to Prevent Enemy Use	1-2
Deviation Meter, FM	
Menu	2-125
Operation	2-224
Performance Data.....	1-7
Screen Configuration	2-123
Deviation (RMS) Meter, FM	
Menu	2-154
Operation	2-251
Performance Data.....	1-7
Screen Configuration	2-152
Digital Control System Functional Description	1-15
Digital Multimeter (DMM)	
Menu	2-147
Operation	2-242
Performance Data.....	1-8
Screen Configuration	2-144
Display Performance Data	1-12
Distortion Meter	
Menu	2-131
Operation	2-228
Performance Data.....	1-7
Screen Configuration	2-129
Drive-By Test.....	1-1
Duplex	
Operation	2-194
Performance Data.....	1-10
Receiver (Duplex)	
Menu.....	2-80
Operation Screen Setup.....	2-196
Screen Configuration.....	2-72

Subject	Page
D (Continued)	
Screen Configuration.....	2-55
Transmitter (Duplex)	
Menu	2-69
Operation Screen Setup	2-194
Screen Configuration	2-60
E	
EIR, Reporting Equipment Improvement Recommendations	1-2
Environmental Data	1-13
Environment (Shipping and Storing).....	3-11
Equipment Characteristics, Capabilities and Features.....	1-3
Equipment Data.....	1-4
Expendable Supplies And Materials List	D-1
F	
Factory Defaults, Reset.....	2-164
FM Deviation Meter	
Menu	2-125
Operation	2-224
Performance Data.....	1-7
Screen Configuration	2-123
FM (RMS) Deviation Meter	
Menu	2-154
Operation	2-251
Performance Data.....	1-7
Screen Configuration	2-152
Forms, Records and Reports, Maintenance	1-1
Frequency Agility Performance Data.....	1-5
Frequency Error Meter, Radio Frequency (RF) Meter and	
Menu	2-119
Operation	2-220
Performance Data.....	1-6
Screen Configuration	2-117
Functional Description	
Test Set.....	1-14
Digital Control System	1-15
Generate System.....	1-17
Receive System	1-18
Test Adapter	1-20
Fuses, Replace AC and DC	3-8

Subject	Page
G	
General Information.....	1-1
Generate System Functional Description.....	1-17
GPIB Submenu, Configure.....	F-6
I	
I/O Connectors and Pin-Out Tables, Table of User	H-1
Initial Adjustment and Daily Checks	2-161
Input Protection Data.....	1-10
Interface Connector Performance Data	1-10
K	
Knobs, Replace Control.....	3-9
M	
Maintenance Allocation Chart (MAC)	B-1
Maintenance Forms, Records and Reports	1-1
Materials List, Expendable Supplies and.....	D-1
Meter Screen Configurations and Menus.....	2-113
Modulation Meter (AM)	
Menu	2-128
Operation	2-226
Performance Data.....	1-7
Screen Configuration	2-126
Multimeter, Digital (DMM)	
Menu	2-147
Operation	2-242
Performance Data.....	1-8
Screen Configuration	2-144
N	
Nomenclature Cross-Reference List	1-2
Operating Instructions	2-1
Operating Procedures	2-165
Operation Screen and Menu Configurations	2-22
Operator's Controls, Indicators and Connectors, Front View (Figure 2-1)	2-2
Operator's Controls, Indicators and Connectors, Rear View (Figure 2-2).....	2-20
Operator Preventive Maintenance Checks and Services (PMCS).....	2-158

Subject	O (Continued)	Page
Oscilloscope		
Input Signal Routing and Limits (Table 2-3)		2-207
Menu (Scope/Analyzer).....		2-101
Operation		2-207
Performance Data.....		1-9
Screen Configuration		2-97
Output Impedance Performance Data		1-5
	P	
Packaging.....		3-11
Pattern Generator Performance Data		1-12
Performance.....		1-4
Pin-Out Tables, Table of User I/O Connectors and		H-1
PM Phase Meter		
Menu		2-151
Operation		2-249
Screen Configuration		2-149
PM Phase (RMS) Meter		
Menu		2-157
Operation		2-253
Screen Configuration		2-155
PMCS Procedures.....		2-158
Power Meter (RF)		
Menu		2-122
Operation		2-222
Performance Data.....		1-6
Screen Configuration		2-120
Power Requirements.....		1-13
Preliminary Servicing and Adjustment of Equipment		3-3
Preparation for Storage or Shipment.....		3-11
Preparation for Use		2-158
Preventive Maintenance Checks and Services (PMCS), Operator		2-158
Principles of Operation, Technical.....		1-14
	R	
Radio Frequency Meter and Frequency Error Meter		
Menu		2-119
Operation		2-220
Performance Data.....		1-6
Screen Configuration		2-117

Subject	Page
R (Continued)	
Receive	
Modulation Type Usage, Receiver (Table 2-2)	2-184
Menu	2-51
Operation	2-183
Screen Configuration	2-42
Receive System Functional Description	1-18
References	A-1
Remote Operation	F-1
Command List	F-7
Command Syntax	F-6
Instrument Reset	F-7
Mass Memory	F-52
Operating Procedures	F-3
Service Requests (SRO)	F-51
Universal and Addressed Commands	F-51
Repair Parts, Special Tools, TMDE and Support Equipment	3-1
Replace AC and DC Fuses	3-8
Replace Carrying Handle	3-10
Replace Control Knobs	3-9
Reporting Equipment Improvement Recommendations (EIR)	1-2
Reset Factory Defaults	2-164
RF Amplifier Performance Data	1-12
RF Generator	
Menu	2-31
Operation	2-165
Performance Data	1-4
Screen Configuration	2-23
RF Power Meter	
Menu	2-122
Operation	2-222
Performance Data	1-6
Screen Configuration	2-120
RS-232 Submenu, Configure	F-4
S	
Scope/Analyzer Menu	
Oscilloscope	2-101
Spectrum Analyzer	2-110
Selectable Color Set Screen Features (Table E-2)	E-5
Service Upon Receipt of Materiel	3-2
Setting Clock and Calendar	E-1

Subject	S (Continued)	Page
Signal Generator, AF		
Menu		2-93
Operation		2-199
Performance Data		1-5
Screen Configuration		2-91
Signal Strength Meter		
Menu		2-136
Operation		2-234
Screen Configuration		2-135
SINAD Meter		
Menu		2-134
Operation		2-231
Performance Data		1-8
Performance Data (Frequency Hopping Mode)		1-12
Screen Configuration		2-132
SINCGARS Tests		2-255
Single Side Band (SSB) Performance Data		1-12
Special Tools, TMDE and Support Equipment		3-1
Self Test Procedure		2-162
Spectrum Analyzer		
Menu (Scope/Analyzer)		2-110
Operation		2-212
Performance Data		1-9
Screen Configuration		2-104
Storage or Shipment, Preparation for		3-11
Storage, Administrative		1-2
T		
Table of User I/O Connectors and Pin-Out Tables		H-1
Technical Principles of Operation		1-14
Test Adapter Functional Description		1-20
Troubleshooting Table		3-5
Turn-On Procedure		2-160
Types of Storage		3-11
W		
Warranty Information		1-2
Weights and Dimensions		1-13

GLOSSARY

I. LIST OF ABBREVIATIONS.

A Freq	Audio Frequency Setting
AF Gen	Audio Frequency Generator
AF M	Audio Frequency Meter
Anlz	Spectrum Analyzer
Ant	Antenna
AUK	Auxiliary
BAR	Bit Error Rate
bps	Bits per second
dB	Decibel
dBc	Decibels below Carrier
dBrI	Decibels of Return Loss
DCS	Digital Coded Squelch
Dev	Deviation
Deem	Deviation Meter
Dist	Distortion
Dist M	Distortion Meter
DTMF	Dual Tone Multi-Frequency
Dup	Duplex Operation Screen
Esc	Escape
FE M	Frequency Error Meter
FE Z	Frequency Modulation Zero
kbps	Kilobits per Second
L-Lim	Lower Limit
LO	Local Oscillator
M Freq	Modulation Frequency
Mar	Marker
Mod, Modul	Modulation
Norm	Normalize
OFST	Offset
P H	Peak Hold
Rad	Radians
RCL	Recall
Rcvr	Receiver
Ret	Return
R Freq	Duplex Receiver Frequency
RF Lev	Radio Frequency Level
R X	Duplex Receiver
SOC	System Operation Check
SCRN	Screen
SCSI	Small Computer System Interface
SQLCH	Squelch
T Freq	Duplex Transmitter Frequency
Trig	Trigger
T X	Duplex Transmitter
U-Lim	Upper Limit

II. DEFINITION OF UNUSUAL TERMS.

Duplex. Ability of a test set or UUT to both transmit and receive. Duplex is always expressed from UUT, not test set. "Duplex Transmit" is UUT transmit function; Duplex Receive is UUT receive function.

Duplex Offset. Difference between a UUT's receive frequency and UUT's transmit frequency. If receive frequency is higher than transmit frequency, offset is positive. If receive frequency is lower than transmit frequency, offset is negative.

Frequency Error. Difference between a received frequency and frequency setting of receiver. If received frequency is higher than frequency setting, frequency error is positive. If received frequency is lower than frequency setting, frequency error is negative.

SINAD. Ratio of signal plus noise plus distortion to noise plus distortion. Expressed in decibels.

By Order of the Secretary of the Army:

GORDON R. SULLIVAN
General, United States Army
Chief of Staff

Official:

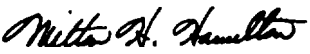
MILTON H. HAMILTON
Administrative Assistant to the
Secretary of the Army
03801

By Order of the Marine Corps:

H. E. REESE
Deputy for Support
Marine Corps Research
Development and Acquisition
Command

DISTRIBUTION:

To be distributed in accordance with DA Form 12-36-E, block 9438, requirements for TM 11-6625-3245-12.

These are the instructions for sending an electronic 2028

The following format must be used if submitting an electronic 2028. The subject line must be exactly the same and all fields must be included; however only the following fields are mandatory: 1, 3, 4, 5, 6, 7, 8, 9, 10, 13, 15, 16, 17, and 27.

From: "Whomever" <whomever@wherever.army.mil>

To: 2028@redstone.army.mil

Subject: DA Form 2028

1. **From:** Joe Smith
2. **Unit:** home
3. **Address:** 4300 Park
4. **City:** Hometown
5. **St:** MO
6. **Zip:** 77777
7. **Date Sent:** 19-OCT-93
8. **Pub no:** 55-2840-229-23
9. **Pub Title:** TM
10. **Publication Date:** 04-JUL-85
11. **Change Number:** 7
12. **Submitter Rank:** MSG
13. **Submitter FName:** Joe
14. **Submitter MName:** T
15. **Submitter LName:** Smith
16. **Submitter Phone:** 123-123-1234
17. **Problem:** 1
18. **Page:** 2
19. **Paragraph:** 3
20. **Line:** 4
21. **NSN:** 5
22. **Reference:** 6
23. **Figure:** 7
24. **Table:** 8
25. **Item:** 9
26. **Total:** 123
27. **Text:**

This is the text for the problem below line 27.

RECOMMENDED CHANGES TO PUBLICATIONS AND BLANK FORMS <small>For use of this form, see AR 25-30; the proponent agency is ODISC4.</small>						Use Part II (<i>reverse</i>) for Repair Parts and Special Tool Lists (RPSTL) and Supply Catalogs/Supply Manuals (SC/SM)	DATE 8/30/02
TO: (<i>Forward to proponent of publication or form</i>)(<i>Include ZIP Code</i>) Commander, U.S. Army Aviation and Missile Command ATTN: AMSAM-MMC-MA-NP Redstone Arsenal, 35898						FROM: (<i>Activity and location</i>)(<i>Include ZIP Code</i>) MSG, Jane Q. Doe 1234 Any Street Nowhere Town, AL 34565	
PART 1 - ALL PUBLICATIONS (EXCEPT RPSTL AND SC/SM) AND BLANK FORMS							
PUBLICATION/FORM NUMBER TM 9-1005-433-24						DATE 16 Sep 2002	TITLE Organizational, Direct Support, And General Support Maintenance Manual for Machine Gun, .50 Caliber M3P and M3P Machine Gun Electrical Test Set Used On Avenger Air Defense Weapon System
ITEM NO.	PAGE NO.	PARA-GRAPH	LINE NO. *	FIGURE NO.	TABLE NO.	RECOMMENDED CHANGES AND REASON	
1	WP0005 PG 3		2			Test or Corrective Action column should identify a different WP number.	
EXAMPLE							
<small>* Reference to line numbers within the paragraph or subparagraph.</small>							
TYPED NAME, GRADE OR TITLE MSG, Jane Q. Doe, SFC						TELEPHONE EXCHANGE/ AUTOVON, PLUS EXTENSION 788-1234	SIGNATURE

TO: (Forward direct to addressee listed in publication) Commander, U.S. Army Aviation and Missile Command ATTN: AMSAM-MMC-MA-NP Redstone Arsenal, 35898	FROM: (Activity and location) (Include ZIP Code) MSG, Jane Q. Doe 1234 Any Street Nowhere Town, AL 34565	DATE 8/30/02
---	--	------------------------

PART II - REPAIR PARTS AND SPECIAL TOOL LISTS AND SUPPLY CATALOGS/SUPPLY MANUALS

PUBLICATION NUMBER			DATE	TITLE				
PAGE NO.	COLM NO.	LINE NO.	NATIONAL STOCK NUMBER	REFERENCE NO.	FIGURE NO.	ITEM NO.	TOTAL NO. OF MAJOR ITEMS SUPPORTED	RECOMMENDED ACTION

PART III - REMARKS (Any general remarks, corrections, or suggestions for improvement of publications and blank forms. Additional blank sheets may be used if more space is needed.)

EXAMPLE

TYPED NAME, GRADE OR TITLE MSG, Jane Q. Doe, SFC	TELEPHONE EXCHANGE/AUTOVON, PLUS EXTENSION 788-1234	SIGNATURE
---	---	-----------

RECOMMENDED CHANGES TO PUBLICATIONS AND BLANK FORMS <small>For use of this form, see AR 25-30; the proponent agency is ODISC4.</small>						Use Part II (reverse) for Repair Parts and Special Tool Lists (RPSTL) and Supply Catalogs/Supply Manuals (SC/SM)	DATE
TO: (Forward to proponent of publication or form)(Include ZIP Code) Commander, U.S. Army Aviation and Missile Command ATTN: AMSAM-MMC-MA-NP Redstone Arsenal, AL 35898						FROM: (Activity and location)(Include ZIP Code)	
PART 1 - ALL PUBLICATIONS (EXCEPT RPSTL AND SC/SM) AND BLANK FORMS							
PUBLICATION/FORM NUMBER						DATE	TITLE
ITEM NO.	PAGE NO.	PARA-GRAPH	LINE NO. *	FIGURE NO.	TABLE NO.	RECOMMENDED CHANGES AND REASON	
<i>* Reference to line numbers within the paragraph or subparagraph.</i>							
TYPED NAME, GRADE OR TITLE						TELEPHONE EXCHANGE/ AUTOVON, PLUS EXTENSION	SIGNATURE

TO: (Forward direct to addressee listed in publication) Commander, U.S. Army Aviation and Missile Command ATTN: AMSAM-MMC-MA-NP Redstone Arsenal, AL 35898	FROM: (Activity and location) (Include ZIP Code)	DATE
--	---	-------------

PART II - REPAIR PARTS AND SPECIAL TOOL LISTS AND SUPPLY CATALOGS/SUPPLY MANUALS

PUBLICATION NUMBER			DATE	TITLE				
PAGE NO.	COLM NO.	LINE NO.	NATIONAL STOCK NUMBER	REFERENCE NO.	FIGURE NO.	ITEM NO.	TOTAL NO. OF MAJOR ITEMS SUPPORTED	RECOMMENDED ACTION

PART III - REMARKS (Any general remarks or recommendations, or suggestions for improvement of publications and blank forms. Additional blank sheets may be used if more space is needed.)

--

TYPED NAME, GRADE OR TITLE	TELEPHONE EXCHANGE/AUTOVON, PLUS EXTENSION	SIGNATURE

