

MHI  
Copy 3

COPY

# FM 11-21

DEPARTMENT OF THE ARMY FIELD MANUAL

---

LOGISTICS LIBRARY BR. 12210

## TACTICAL SIGNAL COMMUNICATION SYSTEMS, ARMY, CORPS, AND DIVISION



HEADQUARTERS, DEPARTMENT OF THE ARMY

NOVEMBER 1961

AGO 2522B

FIELD MANUAL }  
 No. 11-21 }

HEADQUARTERS,  
 DEPARTMENT OF THE ARMY  
 WASHINGTON 25, D. C., 21 November 1961

**TACTICAL SIGNAL COMMUNICATION SYSTEMS,  
 ARMY, CORPS, AND DIVISION**

	Paragraph	Page
<b>CHAPTER 1. INTRODUCTION</b>		
Purpose.....	1	3
Scope.....	2	3
References.....	3	3
<b>2. SIGNAL COMMUNICATION SYSTEMS</b>		
Section I. General		
Basic considerations.....	4	4
Signal communication requirements.....	5	4
Signal centers.....	6	5
Signal communication.....	7	5
Transmission media.....	8	7
II. Field army area communication system		
General.....	9	8
Field army area signal communication troop units..	10	9
Radio nets.....	11	9
Messenger service.....	12	10
III. Corps signal communication system		
General.....	13	10
Trunking systems.....	14	11
Signal centers.....	15	11
Utilization of field army area communication system	16	11
Radio nets.....	17	13
Messenger service.....	18	13
IV. Division area communication system		
General.....	19	13
Signal centers.....	20	13
Lateral communication.....	21	14
Infantry division.....	22	14
Armored and mechanized division.....	23	16
Airborne division.....	24	20
<b>CHAPTER 3. SIGNAL COMMUNICATION PLANNING</b>		
General.....	25	22
Basic considerations.....	26	22
Planning procedures.....	27	23
Planning guidance.....	28	23
Analysis of communication requirements.....	29	26
General plan.....	30	28
Assignments of tasks.....	31	28
Detailed system design.....	32	31
Orders and records.....	33	33

	Paragraph	Page
CHAPTER 4. APPLIED SYSTEMS ENGINEERING		
General.....	34	34
Systems and circuit engineering.....	35	34
Telephone traffic engineering.....	36	36
Teletypewriter traffic engineering.....	37	37
Manually switched teletypewriter system.....	38	37
Tape relay system.....	39	38
Sole-user teletypewriter service.....	40	40
Reserve facilities.....	41	40
5. SIGNAL COMMUNICATION CONTROL		
General.....	42	41
Field army organization for signal communication control.....	43	41
Applications of control.....	44	43
Signal center and unit communication designators..	45	44
System designation.....	46	47
Circuit numbering system.....	47	48
Signal locator and routing service.....	48	49
Records and reports.....	49	52
Electronic accounting machine applications.....	50	59
Telephone directory service.....	51	59
6. SIGNAL CENTER DISPLACEMENT		
Displacement of field army signal centers.....	52	63
Displacement of corps signal centers.....	53	64
Displacement of division signal centers.....	54	64
APPENDIX I. REFERENCES.....	--	68
II. GUIDE FOR PLANNING TACTICAL SIGNAL COMMUNICATION SYSTEMS.....	--	70

# CHAPTER 1

## INTRODUCTION

---

### 1. Purpose

This manual is prepared as a guide for personnel who must plan, engineer, control, and supervise the installation, operation, and maintenance of field army, corps, or division signal communication systems.

### 2. Scope

*a.* This manual contains information on signal communication systems, requirement planning, applied system engineering, signal communication control, and signal center displacement for field army, corps, and division.

*b.* The material contained herein is applicable without modification to both nuclear and nonnuclear warfare.

*c.* The diagrams included in this manual are sample illustrations only.

*d.* Users of this manual are encouraged to submit recommended changes or comments to improve the manual. Comments should be keyed to the specific page, paragraph, and line of the text in which change is recommended. Reasons should be provided for each comment to insure understanding and complete evaluation. Comments should be forwarded direct to Commandant, USA Signal School, Fort Monmouth, N.J.

### 3. References

The publications listed in appendix I provide additional information on subjects related to the material contained in this manual. Their use will assist the reader to better understand and employ the material presented herein.

## CHAPTER 2

# SIGNAL COMMUNICATION SYSTEMS

---

### Section I. GENERAL

#### 4. Basic Considerations

*a.* Tactical commanders continually stress dispersion, mobility, and flexibility in the employment of tactical units. However, dispersion, mobility, and flexibility can be realized only if signal communication systems are designed to support these operational concepts and provide the commander with the necessary capability for control. The signal communication system must be able to absorb damage from nuclear attack without complete disruption of signal communications. It must be flexible and capable of quick reaction to changes in operational plans and task organization. It must be able to support all command requirements, as well as certain sole-user circuit requirements of higher headquarters. It must provide, as an integral feature, communication security to the maximum extent possible, consistent with operational considerations.

*b.* The communication system, of a field army, is composed of the field army area communication system, the communication system organic to subordinate corps, the area communication system of the divisions, and other communication facilities of units integral to the field army.

#### 5. Signal Communication Requirements

The tactical communication system is designed to:

*a.* Provide continuous communication service to widely dispersed units and installations utilizing security equipment where required.

*b.* Meet changes in task organization and, at the same time, facilitate relocation of units, command posts (CP's) and installations.

*c.* Provide patching facilities to permit the electrical rerouting and physical relocation of circuits with a minimum of system changes.

*d.* Be able to operate at extended distances; have a high capacity potential to meet demands placed upon it, and be composed of building-block type units so that changing requirements can be met by adding or removing unit elements.

*e.* Provide continuity of communication service during non-nuclear or nuclear warfare.

f. Provide a common-user system over which sole-user circuits can be provided on the basis of precedence or volume of traffic as approved by the commander.

g. Be sufficiently mobile to support the elements of a rapidly moving tactical force.

## 6. Signal Centers

A signal center is a grouping of signal communication facilities that are installed, operated, and maintained by U.S. Army Signal Corps units. Each signal center normally provides a communications center and messenger service, telephone and teletypewriter switching, circuit testing and rerouting facility, radio/wire integration stations, radio, radio relay and carrier transmission and receipt media. Additional facilities, such as facsimile and automatic data processing, may be provided when authorized. The two types of signal centers are command signal centers and area signal centers.

a. *Command Signal Centers.* Command signal centers provide signal facilities for specific command headquarters and to designated units located in their immediate vicinity.

b. *Area Signal Centers.* Area signal centers provide signal facilities within designated geographical areas, and serve all units within the area requiring such support. Area signal centers remain under the operational control of the signal officer of the command providing the area center. Internal communication of supported units remains the responsibility of those units.

## 7. Signal Communication

a. *Telephone.* The telephone system for tactical units is designed primarily as a common-user system. Telephone requirements are largely dictated by the density of military population and missions of the units or activities. A great number of calls originating in the division area will go directly to activities and units outside of the division area. Calls from division to army units are likely to cover great distances and, to avoid delays and transmission losses, they must be routed through the minimum number of switching points.

b. *Teletypewriter.* Teletypewriter is the principal electrical facility used to transmit message traffic between signal centers. In addition, many units and activities have organic teletypewriter sets operated by their own personnel. Examples of teletypewriter use are—

- (1) Normally, teletypewriter sets are connected to teletypewriter switchboards, in a teletypewriter system similar to the telephone system. Some teletypewriter circuits

may be patched around the switching centers to provide direct communication.

- (2) Signal centers utilize multichannel teletypewriter carrier systems and teletypewriter switchboards to provide the circuit needs for teletypewriter service.
- (3) Teletypewriter is also used with single-channel mobile radio sets. This type of facility retains the advantages of teletypewriter and provides the additional advantages of mobility and flexibility of service. Radio teletypewriter (RATT) equipment is used in command and administrative radio nets, emergency communication nets, special purpose nets such as those used for the coordination of air-ground operations, weather information, flight plans, and aircraft identification.

*c. Communications Center.* Communications centers, provided at all signal centers, are established by the signal unit that installs and operates the signal center. Each communications center normally includes a message center section, a cryptographic section, and transmitting and receiving section.

*d. Facsimile.* Facsimile is a very effective method for the transmission of graphic data, such as charts, maps, diagrams, and photographs. The signal officer provides facsimile service between installations as required. For example, facsimile service may be required between the echelons of army headquarters, between army headquarters and corps headquarters, and between aviation installations. Circuits for facsimile service should be provided on a sole-user basis when the volume or precedence of traffic justifies such action.

*e. Data Processing.* Automatic data processing (ADP) (command control information systems) may be used for many functions; for example, fire control, target analysis, intelligence, personnel, supply, and similar operations. ADP facilities and equipment are to be managed to the maximum extent practical as an integral part of the signal communication system. Use of ADP in the field army requires signal communication channels for the transmission of data. Data may be transferred by data transceivers operating at teletypewriter speed, or data may be transferred directly between computers at high speeds over wide band communication circuits. In the former case, teletypewriter quality circuits are sufficient. In the case of data transfer between computers, high quality wide band circuits equivalent to many voice circuits are required. Data cards or tape may be transmitted by messenger.

*f. Cryptographic.* Cryptographic equipment is used to provide a degree of communication security. The ultimate objective is the

transmission of all message traffic, whether classified or unclassified, over circuits protected by on line encryption equipment.

- (1) Crypto-equipment and associated material is used to provide security of communications. Information pertaining to communications security is contained in FM 32-5.
- (2) Cryptographic equipment can be used either off or on line depending upon the particular needs of the user and the type of equipment provided.
  - (a) Off line equipment is normally not associated with communication equipment.
  - (b) On line equipment is associated with specific communications means and provides encryption/decryption simultaneously with transmission/reception. On line equipment should be used to the maximum extent possible to insure speed of service consistent with security requirements.
- (3) Cryptologic support in any given theater of operations is provided by Command Issuing Offices, Field Army Issuing Offices, and Distribution Authorities. Within CONUS, cryptologic support is provided by COMSEC Regional Issuing Offices and Distribution Authorities.

## **8. Transmission Media**

Signal communication facilities are interconnected by a transmission medium to form a communication system. The transmission medium is provided by one or a combination of the following:

*a. Wire.* Wire is a major medium of communications because of its reliability and relative security and freedom from interference as compared with radio. Its employment is limited in rapidly moving tactical situations because of the installation time required. Field cable used with carrier equipment is the principal type of wire system used in the field army.

*b. Radio.* Radio is a major medium of communications.

- (1) High frequency (HF) and very high frequency (VHF) radio sets can be installed in vehicles to provide mobility.
- (2) High-power radio sets are used for long range communication, emergency communication, communication in air-ground operations, and to establish command and administrative radio nets.
- (3) Low-power short range radio sets are used at the lower command levels.
- (4) Radio/wire integration stations, provided at designated signal centers, give considerable flexibility to the use of radio in the field army area.



*c. Radio Relay.* Radio relay is a major medium of transmission because of its great mobility, flexibility, and relative ease of installation. Although radio relay uses frequencies in the very high frequency (VHF), ultra high frequency (UHF) or super high frequency (SHF) range with transmission characteristics which may limit the range to line-of sight, intermediate repeaters can extend the range to several hundred miles. Radio repeaters may be eliminated in certain applicable cases through use of tropospheric scatter equipment. Radio relay is always used in conjunction with carrier or multiplexing equipment providing many channels of communication and achieving more efficient use of the radio frequency spectrum available.

*d. Messenger Service.* A properly organized messenger service is one of the most effective means of communications for transmitting bulk materials, such as orders, requisitions, packages, data cards, and maps. Signal messenger service can be used to deliver documents classified up to and including secret.

## **Section II. FIELD ARMY AREA COMMUNICATION SYSTEM**

### **9. General**

*a.* The field army area communication system is composed of signal centers interconnected by trunk circuits under centralized control. Each signal center provides all signal facilities required to support the units and activities within its assigned area of responsibility. Each signal center of the field army area communication system is interconnected with at least two others to provide divided and alternate routing and permit distribution of the traffic load. Command signal centers may be directly interconnected when availability of facilities, distance, and other factors permit.

*b.* The field army area communication system varies in configuration, size, and composition according to the following factors:

- (1) Mission, composition, and organization of the field army.
- (2) Location and disposition of the supported forces, units, and installations.
- (3) Characteristics of the area of operation.
- (4) Enemy capabilities.
- (5) Availability of indigenous facilities.
- (6) Number of signal centers comprising the system.
- (7) Communication-electronics requirements of the supported forces, units, and installations.

*c.* The field army area communication system is interconnected through its area and command signal centers with the headquarters of corps, the area communication system of the divisions,

and other major subordinate commands comprising the field army. Army area signal centers may be physically located within the division area. In the rear of the field army area, signal facilities operated by the Signal Long Lines Command are located to interconnect with field army signal centers and to provide the field army access to the theater army communication system. Figure 1 illustrates the interconnection of various signal centers by multi-channel communication systems.

d. The field army area communication system is designed primarily as a common-user system. When communication requirements cannot be satisfied by the use of common-user facilities because of the need for immediate reaction, or when the volume of justifiable traffic from one given point to another is great, sole-user circuits may be provided. The requirement for sole-user facilities must be properly justified in terms of urgency or volume of traffic and carry the approval of the field army commander. This approval should be indicated in the signal portion of the field army SOP for recurring and established requirements. Authority to approve sole-user circuits should be delegated to the Army Signal Officer for temporary or unforeseen requirements.

## **10. Field Army Area Signal Communication Troop Units**

The field army area communication system is installed, operated, and maintained by the combat area signal group (with its signal combat area battalions and a signal cable construction battalion), an army signal battalion, a signal communications center operations company, and such other units as required. The number and types of battalions may be tailored to meet the tactical communications requirements of the field army. The signal combat area battalions install, operate, and maintain the army signal centers and the interconnecting trunks (FM 11-86). The signal cable construction battalion installs field cable for trunk circuits and field cable for extension purposes as required (FM 11-15). The army signal battalion provides the command signal centers which serve the echelons of field army headquarters. It also provides the personnel and equipment to install and maintain a main and alternate field army tactical operations center (FATOC) (FM 11-95). The signal communications center operations company provides internal communications for operational headquarters within the field army as required.

## **11. Radio Nets**

Frequency modulation (FM) and amplitude modulation (AM) radio nets form an integral part of the field area communication system. Details on the composition of field army radio nets and their use are covered in FM 11-95.

## 12. Messenger Service

a. Regular and special air and motor messengers link the field army headquarters and its echelons with army area signal centers and major subordinate units of the field army. Details on the employment of signal units providing messenger service in the field army area communication system may be found in FM 11-95 and in FM 11-86.

b. The field army area communication system employs scheduled air and motor messengers between the field army headquarters, its echelons, major subordinate units, and pouch distribution centers. It also employs scheduled messengers between each army area signal center and a designated pouch distribution center. Pouch distribution centers are army area signal centers that have been designated to handle pouched message traffic in order to reduce the long-haul messenger runs and provide more effective messenger service in the field army area communication system.

c. The messenger schedules of the corps and divisions are coordinated with the field army area communication system messenger schedule to assure timely messenger connections.

*Figure 1. Type field army multichannel communication system.  
(Located in back of manual)*

## Section III. CORPS SIGNAL COMMUNICATION SYSTEM

### 13. General

a. The corps signal communication system provides communication facilities from corps headquarters to corps troops and divisions. The corps communications system is provided in addition to the army area communication system. By providing a direct link between corps CP and CP's of the major attached units, the corps communication system reduces the reaction time of the corps. The corps signal communication system is connected into the field army communication system (fig. 2). At least two echelons of corps headquarters are connected to two army area signal centers through trunk circuits which are the responsibility of army signal troops. The corps signal communication system incorporates all the means of signal communication.

b. A corps signal battalion installs, operates, and maintains the corps signal communication system. This system provides internal communications for echelons of the corps headquarters (fig. 3), trunk circuits from corps headquarters to major subordinate units, to include a radio relay system from corps artillery to its major subordinate units, and corps messenger service. The

corps signal officer is normally delegated operational control of the corps signal battalion by the corps commander.

c. The corps signal battalion consists of a headquarters and headquarters company, a command operations company, and a field operations company. For details on the organization and employment of the corps signal battalion, refer to FM 11-92.

## 14. Trunking Systems

a. Multichannel communication trunks of the corps signal communication system extend between echelons of corps headquarters, and from corps headquarters direct to major subordinate headquarters, attached divisions, and other combat and special units (fig. 3). When corps rear is established, the corps communication trunks are extended to that echelon. However, this may be accomplished through the field army area communication system. Priority is placed upon use of radio relay for corps trunks; however, field cable is installed when practicable.

b. Multichannel communication facilities of the corps signal battalion are provided to establish trunks between corps artillery headquarters and attached field artillery groups. Trunks also are established between corps artillery and each division artillery (fig. 3).

*Figure 2. Corps communication system integrated with the field army communication system, schematic diagram.*

(Located in back of manual)

## 15. Signal Centers

Signal communication is provided for corps headquarters through signal centers established at each echelon of the command. The principal command signal centers in the corps communication system are at corps main, corps advance, and corps rear. Trunks connecting with the field army area communication system are the responsibility of army signal troops.

## 16. Utilization of Field Army Area Communication System

Corps headquarters and field army headquarters are connected by circuits routed through multichannel systems interconnecting army area signal centers and by point-to-point facilities. The latter may be high-frequency radio circuits, radio relay systems, and/or field cable. Divisions use the field army system for communication direct to field army units and installations on administrative and logistical matters in which corps headquarters is not involved. The corps signal communication system, integrated with the field army area communication system, provides the degree of

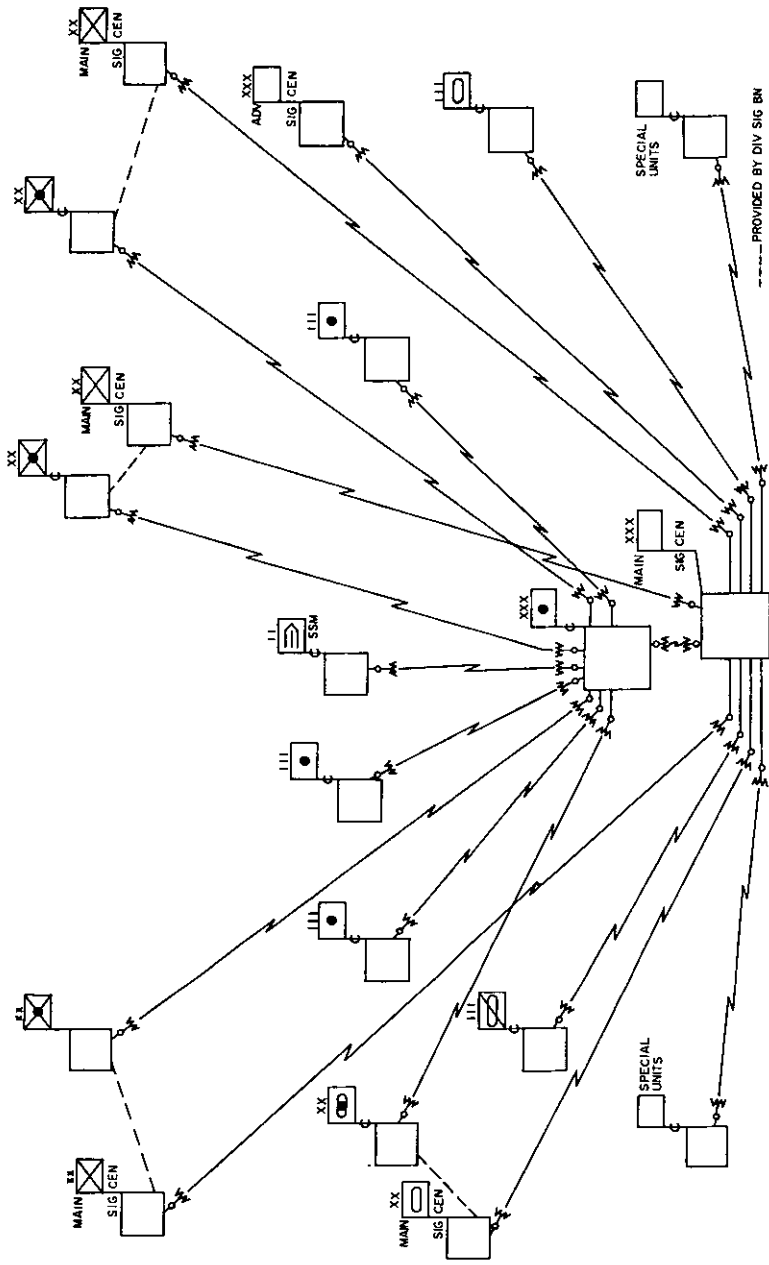

FM 11-21-3

--- PROVIDED BY DIV SIG BN

Figure 3. Type corps multichannel communication network.

flexibility required of signal communication on the nuclear battlefield.

## **17. Radio Nets**

Corps radio communication facilities are provided at each echelon of corps headquarters, and at subordinate corps unit headquarters as required. Stations are operated in both the field army and corps nets. In general, corps organizations provide their own radio station for operation in corps and army nets. Corps provides radio teletypewriter stations for entry by corps artillery and special units into certain corps nets. The nets established and those in which corps stations operate are discussed in detail in FM 11-92. The radio nets of the corps form an integral part of the corps communication system.

## **18. Messenger Service**

Corps operates a signal messenger service providing scheduled and special air and motor messenger runs. Scheduled messenger runs are established to provide the most frequent and economical service practicable. Corps signal messenger service also prepares and handles pouched message distribution through the field army area messenger system.

# **Section IV. DIVISION AREA COMMUNICATION SYSTEM**

## **19. General**

*a.* The division area communication system is installed, operated, maintained, and controlled by personnel of the division signal battalion. The system is composed of forward area signal centers and command signal centers interconnected through multi- and single-channel circuits, radio/wire integration stations, and signal messenger service.

*b.* The division signal officer (DSO), assisted by his staff, plans and directs the installation and operation of the division area communication system. The battalion S3, under the direction of the DSO, establishes and operates a division systems control and signal information center which supervises circuit routing, circuit assignment, emergency rerouting, and designation of control terminals for the system.

## **20. Signal Centers**

*a. General.* Signal centers are interconnected by multichannel radio relay and, when the situation permits, by field cable. Command signal centers are located at each echelon of division headquarters and at the division support command CP. The system is

extended to other users by field cable, field wire, or by FM radio/wire integration links.

*b. Trunks.* Trunks of the division area communication system provide a means of communication from the echelons of division headquarters to immediate subordinate elements, and between subordinate elements. They provide circuits for other division elements as required, to supplement the organic communications of these elements.

*c. Circuits.* The division area communication system is comprised mainly of common-user circuits. To meet special requirements, sole-user circuits may be allocated to an organization for full-time use to provide point-to-point communication.

*d. Signal Center Interconnections.*

- (1) Command and forward area signal centers are interconnected by trunk circuits. Each center is linked to at least two other centers; this provides alternate routing between centers to cope with emergencies, to facilitate traffic handling, to distribute the traffic load, and to reduce telephone switching.
- (2) The division area communication system is integrated with the corps and the field army communication systems. Corps signal troops provide an interconnecting link between the corps and the division area communication systems, usually terminating at the division main signal center. The field army provides an interconnecting link between the field army and division area communication systems, usually terminating at the division support command signal center.

## **21. Lateral Communication**

Normally, lateral communications are provided between divisions. It is the responsibility of the division on the left to provide communication to the division on the right unless directed otherwise by a common commander. Lateral circuits between divisions may be provided through the field army area communication system to augment or supplement facilities provided by the divisions.

## **22. Infantry Division**

*a. General.* A type division area communication system is illustrated in figure 4. Type multichannel networks are shown in figures 5, 6, and 7. Radio nets form an integral part of the division area communication system.

- (1) FM and AM radio normally are used as an initial means of communications, particularly when other means, such as wire or radio relay, are unavailable or unsuit-

able. As other means become available, the use of radio may be curtailed and, when practicable, radio stations are placed on standby or listening silence as dictated by the situation.

- (2) Although radio nets are designated functionally (command, intelligence, warning), traffic and other considerations will frequently dictate that the nets be combined and used for more than one type of traffic.

*b. Signal Centers.* The infantry division signal battalion has the capability to install, operate, and maintain the following signal centers:

- (1) Division main.
- (2) Division alternate.
- (3) Division support command.
- (4) Division rear.
- (5) Three forward signal centers.

*c. Additional Installations.* If required, additional installations will be established, such as—

- (1) Switching facilities.
- (2) Own terminals on radio relay systems to adjacent divisions.
- (3) Facilities for a division fire support coordination center (FSCC).

*d. Messenger Service.*

- (1) Scheduled and special air messenger runs are the normal method of the messenger support provided the division. Air messengers are supplemented by ground motor messengers. The aviation battalion is responsible for providing aircraft and aviators for both scheduled and special air messenger service. Messenger service is normally provided from higher unit headquarters to lower headquarters. However, special messengers may be dispatched from lower to higher unit headquarters when the situation warrants.
- (2) Messengers operating in the division messenger service make deliveries directly to the signal centers and to headquarters message centers of the brigades and to other major divisional elements. The forward area signal centers serve only as messenger pickup and delivery points for the divisional unit elements in their respective areas. The division area ground messenger service is normally provided by messengers operating in pairs for optimum security. If increased messenger service is required, messengers may have to operate



separately. In this case, an additional person should be assigned to each messenger as a security guard.

### 23. Armored and Mechanical Divisions

The armored and mechanized divisions employ an area communication system similar to that employed by the infantry di-

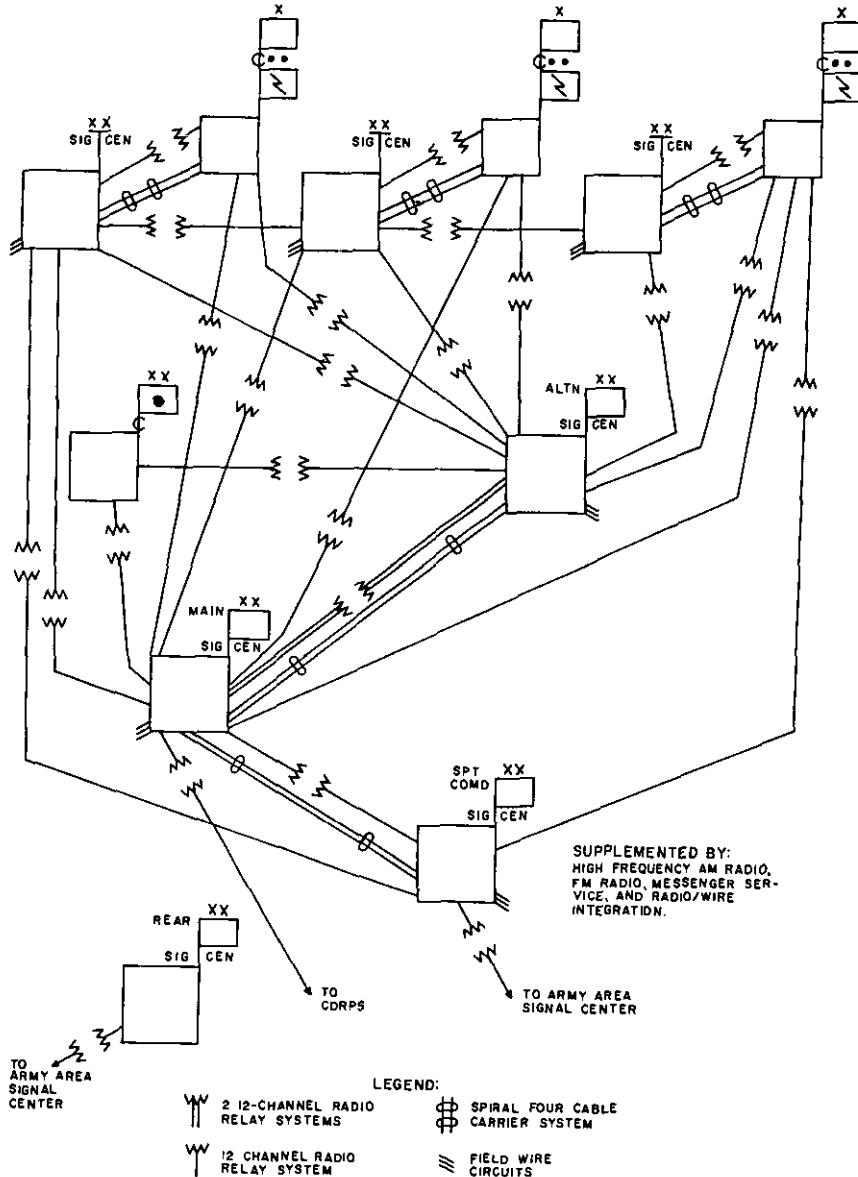

FM 11-50-5

Figure 4. Type division area communication system.

vision. The armored and mechanized divisions depend to a greater degree on internal radio communication than does the infantry division.

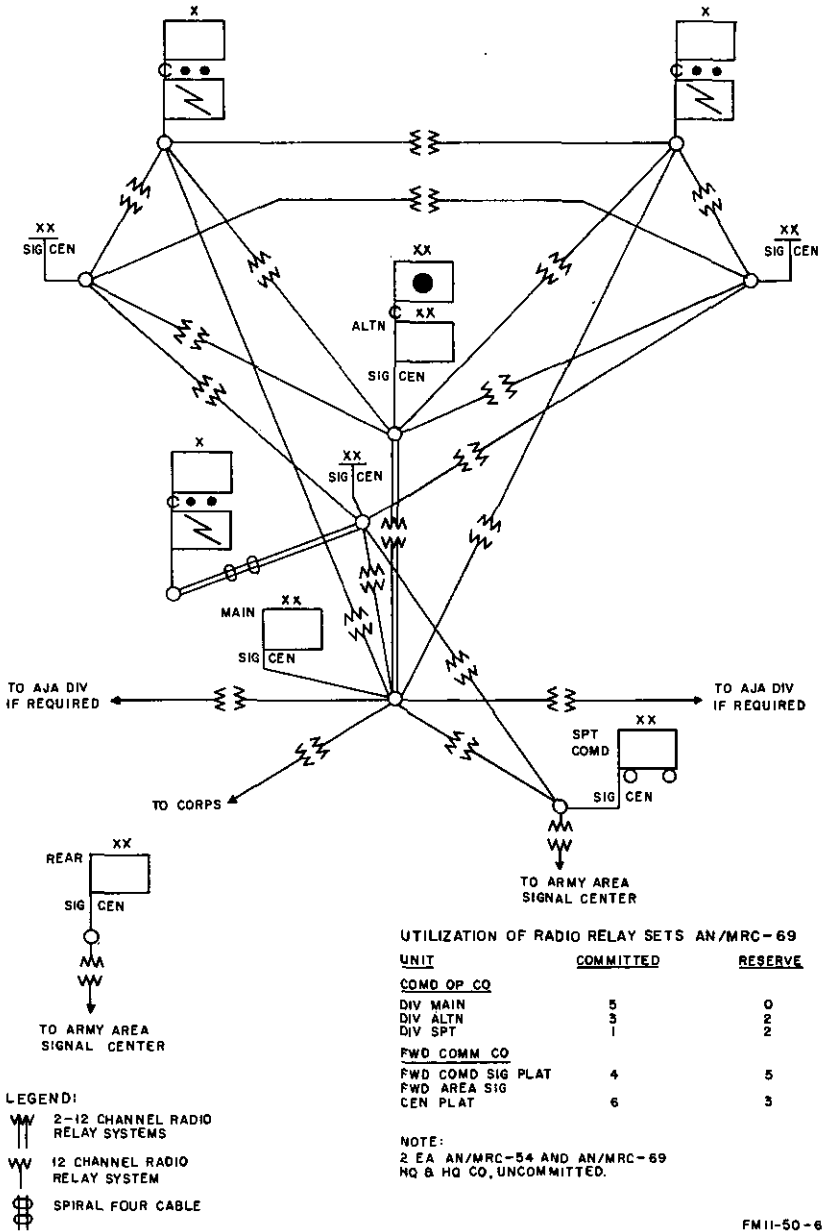

Figure 5. Type multichannel communication network for the offense.





## 24. Airborne Division

*a. General.* The airborne division employs a division area communication system. Tactical radio nets established in the airborne division augment the communication facilities of the division multichannel communication system. The nets provide flexible communication for the initial assault phase of an airborne operation, for rapid displacement of major command posts, and for periods during which personal voice communication between commanders is desired. Radio sets within division headquarters and division units are primarily for internal organizational communication and for communication between major division units. Radio equipment is also provided for communication between division and higher headquarters. A type airborne division multichannel communication system is illustrated in figure 8.

*b. Signal Centers.* The airborne signal battalion has the capability to install, operate, and maintain the following signal centers:

- (1) Division headquarters.
- (2) Three area signal centers.
- (3) Division alternate signal center.
- (4) Division support command signal center.

*c. Additional Installations.* If required, additional installations will be established, such as—facilities for an FSOC.

*d. Radio Nets.* Detailed information concerning the internal and external radio nets in which the airborne division operates is contained in FM 11-57. The radio nets of the airborne division, as do those of the infantry and armored divisions, form an integral part of the airborne division area communication system.

*e. Messenger Service Division Headquarters.* Messenger service in the signal battalion is limited to two 2-man messenger teams with vehicles. The division aviation battalion is responsible for providing aircraft and aviators for both scheduled and special air messenger service.

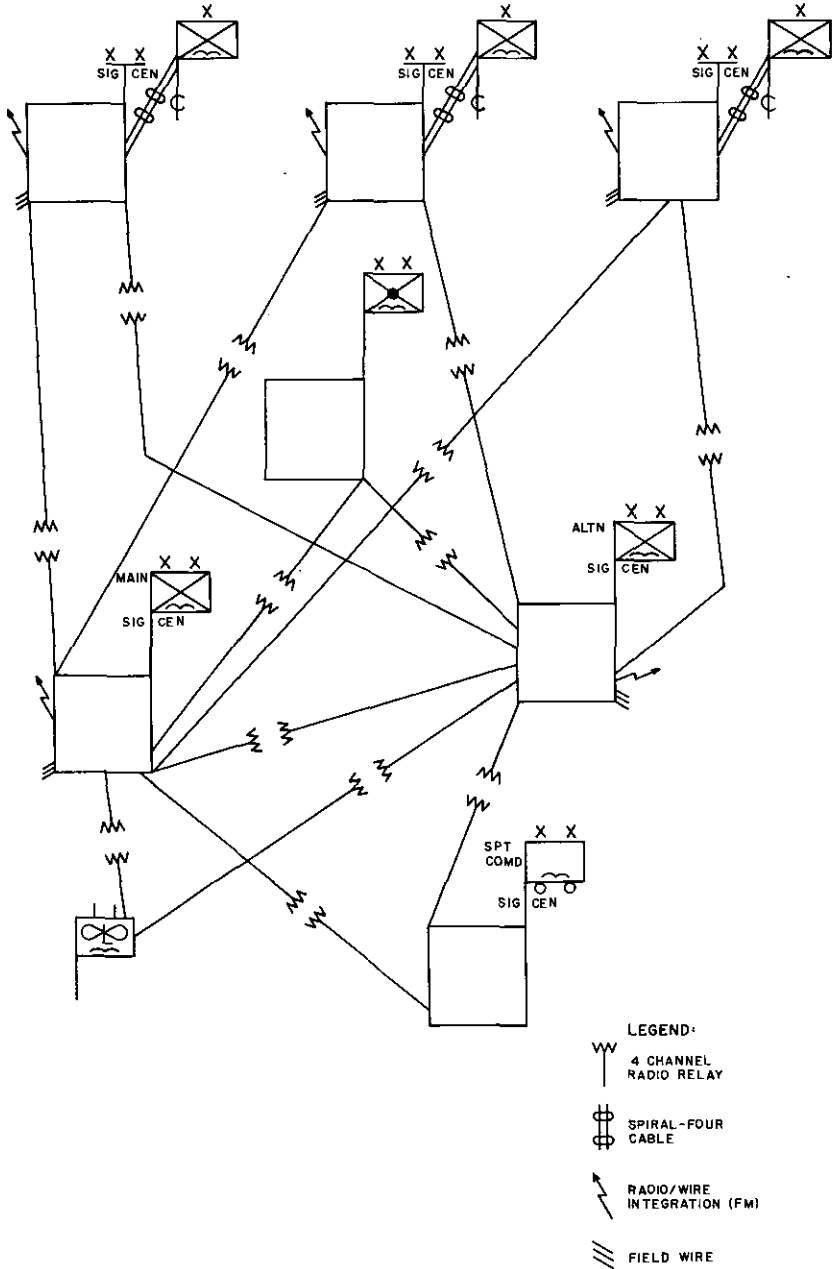

FM11-57-2

Figure 8. Type Airborne Division Multichannel Communication Network.

## CHAPTER 3

# SIGNAL COMMUNICATION PLANNING

---

### 25. General

Signal communication plans are developed for each tactical plan. The planning cycle for the signal planner follows the same tested sequence used by the tactical planner. This chapter provides broad guidance for the signal planner at army, corps, and division level. It applies, regardless of the nature of the situation. In general, two types of situations are considered; first, situations involving the installation of complete initial systems; and second, situations requiring the modification or expansion of existing systems.

### 26. Basic Considerations

The process of communication planning consists primarily of determining how capabilities can best be utilized to meet requirements. Selection of a course of action is based on analysis and comparison of possible solutions in the light of certain basic considerations. These considerations are mission, time, troops, enemy capabilities, logistics, and characteristics of the area of operations.

*a. Mission.* The signal mission can be determined only through an analysis of the mission of the command. Fulfillment of the signal mission thus determined then becomes the overriding consideration.

*b. Time.* Under time, the communication planner considers how long he has for planning, the length of time available for installation, and the probable duration of the operation.

*c. Troops.* All aspects of the troop structure of the command must be considered. The number, type, mission, dispositions, and organic communication capability of all units must be known if requirements are to be accurately determined. Knowledge of the status of signal troops is essential to the understanding of capabilities.

*d. Enemy Capabilities.* The signal communication planner considers primarily the ability of the enemy to interfere with or disrupt communications and the vulnerability of his radio communications to intercept and subsequent intelligence exploitation. In this respect, the planner must consider the requirement for communications security.

*e. Logistics.* The elements of logistics which most affect communication planning are supply, maintenance, and transportation.

*f. Characteristics of the Area of Operation.* These characteristics include weather, terrain, size, and shape of the area and existing signal communication facilities.

## **27. Planning Procedures**

Successful signal communication planning depends upon the accomplishment of a series of specific procedures. These include the issuance of planning guidance, analysis of communication requirements, design of general plan to meet requirements, assignment of tasks, detailed system design, publication of orders, and maintenance of records.

*a. Planning Guidance.* This includes criteria for circuit allocations, priorities, transmission, and traffic engineering data; provision for reserve facilities for expansion or replacement purposes; and limitations on use of organic means or indigenous facilities. Much of the detail of this guidance is placed in the standing operating procedure (SOP) of the command and thus requires only review and updating for application to a specific operation.

*b. Analysis of Communication Requirements.* The degree to which requirements are analyzed will depend on the time available for planning and the information known to the planner. Requirements must be converted to allocations during the planning process.

*c. Design of General Plan.* After the analysis of requirements, as many courses of action are developed as time and the situation permit. All courses of action must be capable of meeting the requirements, if adopted. Selection of the best of the proposed courses of action results in a general plan to meet the signal communication requirements. This must then be translated into detailed system design and task assignments.

*d. Detailed System Design.* Once the planner has determined which elements will be interconnected, what means will be utilized, and how circuits will be routed, he makes his detailed system design.

*e. Assignment of Tasks.* Signal units are assigned tasks in terms of units to be supported or areas of responsibility. Whenever possible, mission type orders are utilized.

*f. Orders and Records.* The culmination of the planning cycle is the issuance of orders. The signal communication planner is interested in records primarily for their effect on future plans.

## **28. Planning Guidance**

*a. Allocations.* The command SOP should contain a tabulation of common-user and sole-user circuit allocations. These should



further specify the type service, such as telephone, teletypewriter, data, or facsimile. This tabulation is particularly important at field army level. An example is given in table I. Only those sole-user circuits considered necessary for all operations should be contained in the SOP. Criteria for establishment of additional sole-user circuits should be stated in terms of traffic volume or precedence of traffic.

Table I. Example of Common and Sole-User Circuit Allocations, Field Army

Circuits	Telephone circuits	Teletypewriter circuits
1. Common-user tributary trunk circuit.		
a. From nearest army area signal center to all division support commands.....	7	4
b. From each corps main and each corps advance CP to the two nearest army area signal centers.....	7	4
c. From army main to the two nearest army area signal centers.....	11	6
d. From army alternate to the two nearest army area signal centers.....	11	6
e. From the nearest army area signal center to—		
(1) Each brigade or similar sized unit.....	6	2
(2) Each group or similar sized unit.....	4	1
(3) Each separate battalion or similar sized unit.....	3	1
(4) Each mobile army surgical or evacuation hospital.....	4	1
(5) Each surface-to-air missile (SAM) battalion.....	2	1
(6) Each surface-to-air missile (SSM) unit (medium and heavy).....	4	1
(7) Each supply point.....	3	1
(8) Each general depot headquarters.....	7	2
(9) Each technical service depot.....	4	1
2. Common user direct trunks.		
From army main to—		
Each corps main.....	4	
Army rear.....	4	
Theater army or army group.....	6	
Army alternate.....	6	
3. Local loop.		
a. From nearest army area signal center to each separate company, separate platoon, or similar-sized unit.....	1	
b. In addition to the above, add a requirement of 25 local lines for each signal center to provide service for activities, such as the counterintelligence corps (CIC), criminal investigation detachment (CID), rail transportation office (RTO), traffic control points (TCP), shower points, and the Red Cross, etc., that are normally on troop lists.....	25	
4. Sole-user.		
a. Air Defense Artillery (DA).		
(1) From army air defense command post (AADCP) at brigade to—		
(a) Army main.....	2	

Table I. Example of Common and Sole-User Circuit Allocations, Field Army—  
Continued

Circuits	Telephone circuits	Teletype-writer circuits
(b) Air defense element (ADE), FATOC, 1 full-duplex (FDX) secure teletypewriter (TT) circuit.....	1	1
(c) Each ADA group.....	2	
(d) Army alternate.....	2	
(e) Army air defense command post (AADCP) at each corps.....	2	
(2) Each ADA group attached to corps to the CTOC.....	2	
(3) From each of the army ADA groups to—		
(a) Army flight operations center (FOC).....	2	
(b) Tactical air force control reporting center (AFCRC).....	2	
(c) Subordinate firing battalions excluding automatic weapons selfpropelled battalions.....	2	
<i>b. Field Artillery.</i>		
(1) From army fire support element (FSE), FATOC, to—		
(a) Army artillery fire direction center (FDC).....	1	1
(b) Each corps fire support element (FSE) at corps tactical operations center (CTOC).....	1	1
(2) From army artillery FDC to each missile unit retained under army artillery control.....	1	1
(3) From fire support element (FSE) at CTOC to fire support coordination center (FSCC) at division.....	1	1
<i>c. Army Aviation.</i> From army aviation element (AAE) at tactical operations center to FOC 1-half-duplex (HDX) TT weather circuit, and 1-full-duplex (FDX) TT circuit.....	1	2
<i>d. Field Army Tactical Operation Center (FATOC).</i>		
(1) From G2-G3 operations, FATOC, at army main to to each subordinate corps G2-G3 operations 1 FDX secure TT circuit.....	1	1
(2) From G2-G3 operations, FATOC, to the army main switchboard 3 (HDX) secure TT circuits.....		3
(3) From tactical air support element (TASE), for the air request nets-1 HDX secure RATT circuit for each net. These are to operate by remote control from the TASE van at FATOC.....		3
(4) From tactical air support element (TASE), FATOC for information and ground liaison nets, three FDX secure teletypewriter RATT circuits. These are to operate by remote control from the TASE van at FATOC.....		3
<i>e. Army Alternate and Alternate FATOC.</i> Duplicate facilities must be established for army alternate and the alternate FATOC.		

*b. Priorities.* Priorities are used primarily to determine the order of installation or reconstitution of facilities. They may be published as a separate SOP item or in conjunction with the allocation lists. Publication as a separate item is preferred, since detailed listing of priorities is not in consonance with the use of mission type orders. Thus, a separate item would give classes of priorities as opposed to specific circuit priorities and would leave certain latitude to those who install, operate, and control the system. An example of classes of priorities is given in table II. A table published in this form would require a brief narrative statement giving guidelines for its application.

Table II. Sample of Classes of Circuit Priorities

Priority	Class
I	Command control of combat elements.
II	Intelligence and nuclear control.
III	Fire control, command control for combat support elements.
IV	Direct support logistics.
V	All others.

*c. Transmission and Traffic Engineering Data.* A more detailed discussion of this subject is discussed in chapter 4 of this manual.

*d. Reserve Facilities.* The requirements for reserve facilities should be stated in broad terms. The SOP should specify a 20 percent reserve on systems in operation, one spare system for each three in operation, and one reserve signal center for each five area centers in operation. A further statement should be included specifying the conditions under which reserve facilities might be committed.

*e. Limitations.* The variety of limitations which might be imposed because of peculiarities of a situation are too numerous to discuss in detail. They may be dictated by any of the basic considerations given in paragraph 26. For example, enemy capabilities may require limitations on the use of radio relay; the logistical situation might demand restrictions on wire; or time may dictate installation of an austere area system with heavy reliance on messengers and HF radio nets.

## 29. Analysis of Communication Requirements

The analysis of communication requirements involves collecting certain factual data and placing it in proper form for use in further planning.

*a. Source of Data.* In analyzing requirements, the signal communication planner may use any or all of the following sources:

- (1) *Troop and station list.* These are particularly important at field army level when installation of a complete initial system is indicated. Possible use of the electrical accounting machine (EAM) cards prepared by The Adjutant General (AG) greatly enhances the value of these lists in detailed planning.
- (2) *Administrative and operations overlays.* For broad planning where time is of the essence, these become the primary source of information on distribution of requirements.
- (3) *Circuit allocation list.* Refer to paragraph 28a and table I.
- (4) *Equipment lists.* These show the major items of signal communication equipment authorized to assigned and attached units (table III).
- (5) *Traffic studies.* The primary use of traffic studies is the refinement of detailed design of the system.
- (6) *Past experience.* Each signal communication planner draws on his own past experience as well as previous results recorded in permanent records of the command.

b. *Form.* Where time is of the essence, the above data may be considered in broad planning without conversion to other forms.

- (1) *Division and corps.* The nature of the system, the relative stability of the troop list, and the time normally available for planning dictate the use of requirements data without conversion at these levels. Broad plans can usually be developed from a study of operation and administrative overlays in conjunction with SOP circuit allocations.
- (2) *Field army.* Where planning time is limited or when planning objectives involve only the expansion or modification of existing systems, it is normally possible for the planner at field army level to follow the same procedures used at division and corps. If installation of a complete system is anticipated and sufficient time and information are available, it is desirable to place the data in more useable form.
  - (a) *Circuit requirement listings.* These listings may be prepared manually as shown in table IV, using the troop and station lists in conjunction with SOP circuit allocations. A faster method would be to obtain EAM cards from the AG and use them to print out units and locations as desired. If further use of the data is anticipated in future planning, control, routing, or

information service, a duplicate set of cards should be made with additional information as required. To gain accurate totals in the preparation of the above listing, it will be noted that certain tentative decisions as to provision of circuits must be made at this time. For example, according to the SOP circuit allocations, a NIKE battalion is authorized two common-user trunks from an area center to its unit switchboard, and an ordnance company is authorized one loop from an area center. However, in preparing circuit requirement listings, the planner must tentatively decide whether an ordnance company supporting a NIKE battalion warrants a separate circuit or should gain area access through the NIKE battalion. His decision would be based primarily on the relative location of the two units.

- (b) *Requirements density overlay.* This overlay has application in the planning of a complete initial installation. It is particularly effective in preparation for field exercises and maneuvers or occupation of planned positions. It is prepared simply by transferring the total circuit requirements for each 10,000 meter grid square onto a gridded overlay. This gives the planner a complete graphic picture of the requirements densities. It assists in the selection of general locations of signal centers and the division of the army area into areas of responsibility for signal units. Figure 9 shows a type employment of field army signal units based on plans such as above.

### **30. General Plan**

The preparation of the general plan involves the developing of courses of action, analysis and comparison of these, and reaching of a decision. This decision is expanded into a concept to include the following:

- a. Number and type of signal installations that will comprise the system.
- b. General plan for division of responsibilities.
- c. Provisions for reserve.
- d. Broad plan for interconnections.

### **31. Assignment of Tasks**

Using the general plan as a guide, tasks are assigned to all signal units to insure the meeting of known or anticipated requirements.

Table III. Sample Communication Equipment List Format

Unit	TOE	Date	Equipment														
			SR-22/PT	SR-86/P	AN/TCC-7	TA-312/PT	AN/PCC-1	AN/GCC-3	AN/TCC-14	Radio Sets, FM	Radio Sets, AM	Miscellaneous					
Hq Co, Army-----	Headquarters, Army	Jul 56															
MP Co-----	51-2C	Oct 57	1			8								17	1		
Loudspeaker and Leaflet Co	19-37D	Apr 55	1			22								22	5		
(Army). Transportation Car Co. *	33-77R													12	2		
	55-19C	Jan 56				6											
	*	*	*	*	*	*	*	*	*	*	*	*	*	*	*	*	*

Table IV. Sample Circuit Requirements List Format

MAP 1:250,000 Southern France  
 100,000 Meter Grid Square: LM  
 10,000 Meter Grid Square: 2040

Unit	Coordinates	Circuit requirements				Remarks
		Common-user		Sole-user		
		Tel	TT	Tel	TT	
14 ADA Gp	2247	6 trunks	2 locals	8	2	
514 Eng Bn	2342	2 trunks	0	0	0	
872 QM Co	2241	2 locals	0	0	0	
*	*	*	*	*	*	*

Note: The data contained in this list can be converted to punch card form for use with electrical accounting machines. The card may also contain other data useful for unit location, routing service, and similar information. These data may also be fed into automatic data processing systems (ADPS).

a. *Division and Corps.* Tasks for signal elements at division and corps level are assigned on a basis of units or installations to be supported. Missions may include direct support missions with secondary missions of general support to other units in the area.

b. *Field Army.* Signal units of the field army are assigned tasks either in terms of units to be supported or areas of responsibility.

(1) *Army signal group.* Communications elements of the army signal group normally are given missions to provide direct support to command posts, operations centers, or logistical centers. These direct support missions may or may not include provision of access systems to area centers.

(2) *Combat area signal group.* Units of the combat area signal group are given mission-type orders for the support of all units in a given area of responsibility. Whenever possible, the planning of extension facilities is left to the unit concerned. The area-type mission includes the provision of access systems to major units. For example, an area signal center may be assigned a specific geographical area and, in addition, be required to provide one 12-channel system to an echelon of corps which is located in another signal center area. This is necessary in all cases where a unit or activity is allocated access to more than one signal center. Selection of areas of responsibility is based primarily on geographical considerations and anticipated requirements.

(a) *Complete system.* The first step in assignment of tasks for installation of a complete system is selection of

general locations for signal centers. These general locations must be selected based on a study of the area of operations, planned dispositions of major combat elements, and anticipated deployment of other elements. Exact areas of responsibility can be assigned after receipt of the troop and station list. Publication of these lists makes available more accurate data on the distribution of communication requirements. Final task assignments can thus be based on consideration both of a unit's capability to cover an area and its capacity for handling a communication load. Once areas are assigned, units select exact locations conforming as closely as possible to general locations previously selected.

- (b) *Expansion of existing system.* This normally involves either extending the area of responsibility of a unit or commitment of reserve signal units. Circumstances normally dictate extension of an area of responsibility first, since all planning for expansion is based on anticipated needs. This area will normally show only lateral and rear boundaries, with forward boundaries being designated later based on actual developments. When commitment of a reserve unit is necessary, the time and general location are given and the unit is required to report specific locations through channels. As reserve elements are committed, every effort is made to reconstitute this reserve by releasing units serving sparsely populated areas and adjusting boundaries accordingly.
- c. *Construction Elements.* The assignment of missions to construction units at all levels may be done on an area basis, a unit-to-be-supported basis, or a combination thereof.

## **32. Detailed System Design**

Once the general plan has been developed and tasks have been assigned, the planner must go back to the original planning guidance and proceed with detailed planning. During this phase, plans are prepared to meet each specific requirement and tasks are refined to insure meeting these requirements.

a. *Extension Facilities.* The plan for local distribution at each installation is developed by the unit providing communications support. Approval of these plans is required only in cases involving frequency utilization or the use of critical equipment. Completed plans are forwarded to higher headquarters for inclu-



sion in the overall plan, use in future planning, and provision of information service.

*b. Interconnections.* The detailed mechanics of planning interconnections are covered in other field manuals and in chapters 4 and 5 and appendix II of this manual. This paragraph outlines an orderly procedure for the accomplishment of this planning.

(1) *Planning a complete system.* Essentially, the planning of a complete system is accomplished through the preparation of a series of charts and diagrams based on the general plan, tasks assigned to units, and planning guidance. A logical sequence for this planning is as follows:

- (a) *Traffic diagrams.* These are prepared for sole-user and common-user circuits and include telephone, teletypewriter, facsimile, data, and tape-relay circuits. They show only the terminals and do not reflect the routing of circuits. The actual number of circuits are based on SOP circuit allocations (table I) and traffic and transmission engineering data (ch. 4 and app. II).
- (b) *Fundamental trunking plan.* This plan is a worksheet showing only which center will have direct systems. It does not show the number of systems or the means to be employed.
- (c) *Routing worksheets.* Using the traffic diagrams and the fundamental trunking plan, worksheets are prepared showing the routing of each circuit. Systems, channels, or means are of no concern at this point. The primary purpose of these worksheets is to determine the number of systems required and the adequacy of the fundamental trunking plan. In the process of preparing the worksheets, the fundamental trunking plan may be modified as required.
- (d) *Systems diagram.* The preparation of a systems diagram involves totalling the circuits of all types between centers, adding a reserve factor, and determining the number of systems required. The inclusion of media to be utilized is optional on this diagram.
- (e) *Selection of media.* If not included in the above diagram, selection of media is the next logical step. These must be based on planning guidance. Basic considerations influencing the selection of media are time, characteristics of the area, enemy capabilities, logistics, and capabilities of troops providing support. At this time, the use of existing facilities must be considered.

- (f) *Issuance of orders.* At this point, plans are formalized and orders issued. Each subordinate element in turn issues implementing orders in greater detail.
- (2) *Modification of an existing system.* Minor modifications of an existing system are brought about by movement of units or changes in traffic flow. These normally do not involve command decisions and may be accomplished as a function of systems control as outlined in chapter 5.
- (3) *Extension of an existing system.* The extension of an existing system normally involves changes in unit missions and/or commitment of additional signal communication troops. These require command decisions and must be directed through command channels. Extension of a system must be planned based on anticipated requirements generated by changes in the tactical situation. Sufficient latitude must be given in plans for extension to provide for adjustments without further command action. Procedures for planning the extension of a system are generally the same as shown in (1) above.

### **33. Orders and Records**

Detailed guidance as to form and content of signal orders and records is contained in FM 11-16. In addition, examples of orders and records which might be used by systems control are contained in chapter 5 of this manual.

*Figure 9. Type signal unit employed, field army communication system.  
(Located in back of manual)*

## CHAPTER 4

### APPLIED SYSTEMS ENGINEERING

---

#### 34. General

Signal communication engineering in the field army is generally limited to consideration of single or multichannel systems. The equipment comes in preengineered packages that are to be integrated in building block fashion. A need always exists for an orderly and logical method of organizing the signal communication system.

#### 35. Systems and Circuit Engineering

*a.* Signal communication equipment for the army communication system is listed in the tables of organization and equipment (TOE's) of the army signal units. This equipment is authorized in standardized component groupings. Each equipment is described in its respective technical manual that covers the installation, operation, and maintenance of the equipment.

*b.* Overall detailed guidance for systems engineering is provided in the TM 11-486-series of manuals. TM 11-486-3 and TM 11-486-6 are particularly applicable to the army signal system. These manuals emphasize the standard methods of using U.S. Army Signal Corps equipment. Applicable guidelines and standards are to be adhered to as much as possible.

*c.* Communication control circuits are required to effectively engineer, maintain, and operate the signal communication systems of field army, corps, and the divisions. Normally, one voice circuit will be required from the field army, corps, or division systems control center to each subordinate signal center. Where possible these circuits should be on a conference network. In the case of the field army, one teletypewriter circuit in addition to the voice circuit will be required. Communication control circuits are sometimes referred to as system(s) control circuits, engineering circuits, or facilities control circuits. For the purpose of this manual, communication control circuits are those circuits established and utilized exclusively by the field army, corps, or division signal officer in the engineering, installation, operation, and maintenance of the signal communication system for which he has staff responsibility.

*d.* Some of the major problems encountered in communication systems engineering for the field army are the selection, allocation, utilization, and administration of radio frequencies. These problems are the responsibility of the frequency allocation branch,

communication division, army signal section. The field army is the lowest command level that has personnel specifically authorized to handle this function. The fact that frequencies are assigned to the field army, as an item of the signal operation instructions (SOI) of a higher headquarters, does not give the field army exclusive rights to those frequencies. Successful communication systems engineering requires coordination and liaison with other frequency users (such as civil authorities, higher headquarters, other services, and adjacent armies). Coordination and liaison must be thorough and continuing to prevent interference with other essential services, such as navigational aids, traffic control systems, operational channels for tactical aircraft, forward air-controllers, missile guidance systems, civilian facilities, and other existing communication systems. Further limitations may be imposed due to political, atmospheric, and terrain problems where the operation is taking place.

*e.* To achieve maximum flexibility and to meet unforeseen difficulties, as well as to provide adequate information for engineering purposes, a complete up-to-date record of all frequency assignments for the field army systems and systems of other frequency users operating in the field army area must be maintained. The frequency allocation branch must establish procedures whereby subordinate units may quickly receive frequency assignments for new systems being established and be prepared to provide immediate frequency changes when required. As a general practice, alternate frequencies cannot be provided in reserve for a unit, because of the shortage of frequencies and the basic requirement for spot engineering of each frequency used. Frequency assignment plans, as outlined in applicable technical manuals, are excellent when the field army is assigned an exclusive block of frequencies, for its own use, by higher headquarters. In actual practice, the field army is not the only user, and frequency assignment procedures have to be based on close coordination, available frequencies, frequency sharing, terrain, and experience gained.

*f.* A standard transmission plan has been adopted by the army to assure a system of communication with technical characteristics that will meet the army's need for rapid, reliable, secure, and high-quality service. It is based primarily on the amount of transmission loss which can be tolerated in a circuit between two terminal instruments. When the distances between units in the army area becomes excessive, exceptions to the army standard transmission plan may be justified. This may be accomplished by reducing the loss in the long-distance trunk circuit (i.e., terminal grade to via grade trunks) and allowing more loss to occur in the local network.

*g.* Military systems are engineered so as not to exceed a maximum loss of 36 decibels (db) between terminal instruments. When the loss reaches 36 db, speech may become unintelligible.

*h.* To meet special problems encountered under tactical conditions, it may be necessary to modify the standard transmission plan. The goal is to modify the plan only as necessary to solve these problems and without destroying its universal application throughout the theater.

### **36. Telephone Traffic Engineering**

*a.* The objectives of traffic engineering, as compiled in TM 11-486-2, must be amended so that they can be adapted to a tactical communication system. These objectives are—

- (1) To determine the expected traffic load of the communication system, and to provide this information in time to permit delivery of personnel and equipment at the proper time and place.
- (2) To determine whether the trunking system meets the traffic requirements of all switching centers.
- (3) To assure that policies and practices of operating personnel properly meet the needs of the commands.
- (4) To coordinate with signal officers, their staffs, and operating personnel of subordinate, adjacent, and higher commands, to assure that efficient use is made of all signal equipment and personnel throughout the communication system.

*b.* Detailed traffic engineering, in accordance with TM 11-486-2 and TM 11-486-3, is performed at field army level for the installation of the field army communication system. It is a function of the traffic branch, communication division, army signal section. The field army is the lowest command level that has personnel designated by TOE to perform traffic engineering; however, traffic studies should be made at all echelons as part of communications system planning.

*c.* The design and layout of a communication system is primarily dictated by the signal mission. Due to the requirement for personal contact between commanders and staff officers and for the processing of large volumes of record traffic, specific engineering of the communication system will be based on telephone and teletypewriter requirements. In correlating these data, considerations should also be given to facsimile and data transmission requirements.

*d.* After the field army communication system has been established, valuable traffic engineering data, such as the party called, the calling party, and the frequency and length of the calls, are

available. This information is collected and analyzed; then, through-trunks, direct circuits, and specially engineered local circuits may be installed to improve the system. A general guide for planning tactical signal systems, when no actual experience data is available, is provided in appendix II.

e. Operators of local switchboards, and subscribers connected directly to the switchboard at signal centers, depend on the signal centers for routing information. Routing information is furnished the signal centers in form of route bulletins, prepared by the field army systems control center.

### **37. Teletypewriter Traffic Engineering**

Teletypewriter service falls into three general categories—manually switched, tape relay, and sole user. Machines used for teletypewriter service are of two general types—page printing and tape. Tape-handling machines are not limited to use on a tape-relay system. Such machines may be used on any teletypewriter system to provide increased speed of service through the use of automatic transmission; however, a page printer must be associated with each tape machine used in terminal service. This is necessary in order to produce page copy for delivery, as tape copy should not be delivered to staff personnel. In the initial planning phases, when actual operating data does not exist, teletypewriter circuits are based entirely upon the number of teletypewriters available, and their capabilities. It is assumed that the existence of teletypewriters on the TOE's of the various units, including the signal combat area companies, has been adequately justified. When determining circuit requirements, where data does not exist, procedures such as those outlined in appendix II may be used. When operating experience data are available, standard engineering procedures are used to determine the circuit requirements.

### **38. Manually Switched Teletypewriter System**

The manually switched teletypewriter system includes teletypewriters used by signal centers, communications centers, and other subscribers, such as staff sections, units, and activities. Essentially, this system provides a teletypewriter switchboard to which all subscribers are connected. The teletypewriter switchboard is then connected by suitable trunk circuits to other teletypewriter switchboards. These interconnections form a network that provides service to all subscribers in the system. The number of circuits for such a system is initially determined by the number of machines in a given area and the probable traffic to be handled by each machine.

## 39. Tape Relay System

*a. General.* The tape relay system in the field army is a network of point-to-point teletypewriter facilities established for the transmission of message traffic by the torn tape method. Tape relay stations of the field army usually operate as part of the theater tape-relay system to integrate efficiently the transmission of traffic throughout the theater (fig. 10). To achieve a measure of reliability within the tape relay system in the field army, tape relay stations (major and minor relays) have been dispersed throughout the field army area. These tape relay stations are established at designated signal centers. While all installed army signal centers will qualify as major tape relay stations in the tape relay system as defined by ACP 121 ( ), only specifically designated army area signal centers (AASC's) will be assigned responsibilities as major relay stations. In the same light, the tape-relay stations of major headquarters also qualify as major tape-relay stations due to the alternate routes provided. However, the tape-relay stations of major command headquarters should be considered as a minor relay station with terminal facilities and alternate routes provided for the receipt and transmission of tape relay traffic at the prerogative of the commander. This is necessary to avoid channelizing great amounts of relay traffic at the signal centers of major headquarters. A tape relay system incorporating these concepts is shown in Figure 11. In this system, all tributaries (subscribers) would be assigned a fixed three letter suffix which would remain the same wherever they were located throughout the field army. Specially designated army area signal centers would be selected and assigned routing designators of 5 letters, (i.e., UUTFM UUTFL UUTFX and UUTFG). In figure 10, UUTFM is further designated as the control and information relay center for the field army. The remaining major tape relay stations act as control and information relay centers in their respective zones.

*b. Routing Indicator Plan.* The routing indicator plan outlined in ACP 121 ( ) is adaptable to the tape-relay operation of the field army. The system is based on a principle that permits quick routing without detailed reference to a routing directory. When a unit moves from one tape-relay area to another, changes in the routing indicator and the routing directory are required.

*c. Field Army Tape-Relay System.* The number of tape-relay stations established for a field army is determined by the number and location of the users and the volume of their traffic. As a general rule, tape-relay stations are established in the corps zone to provide tape-relay service for the corps and divisions. Two or

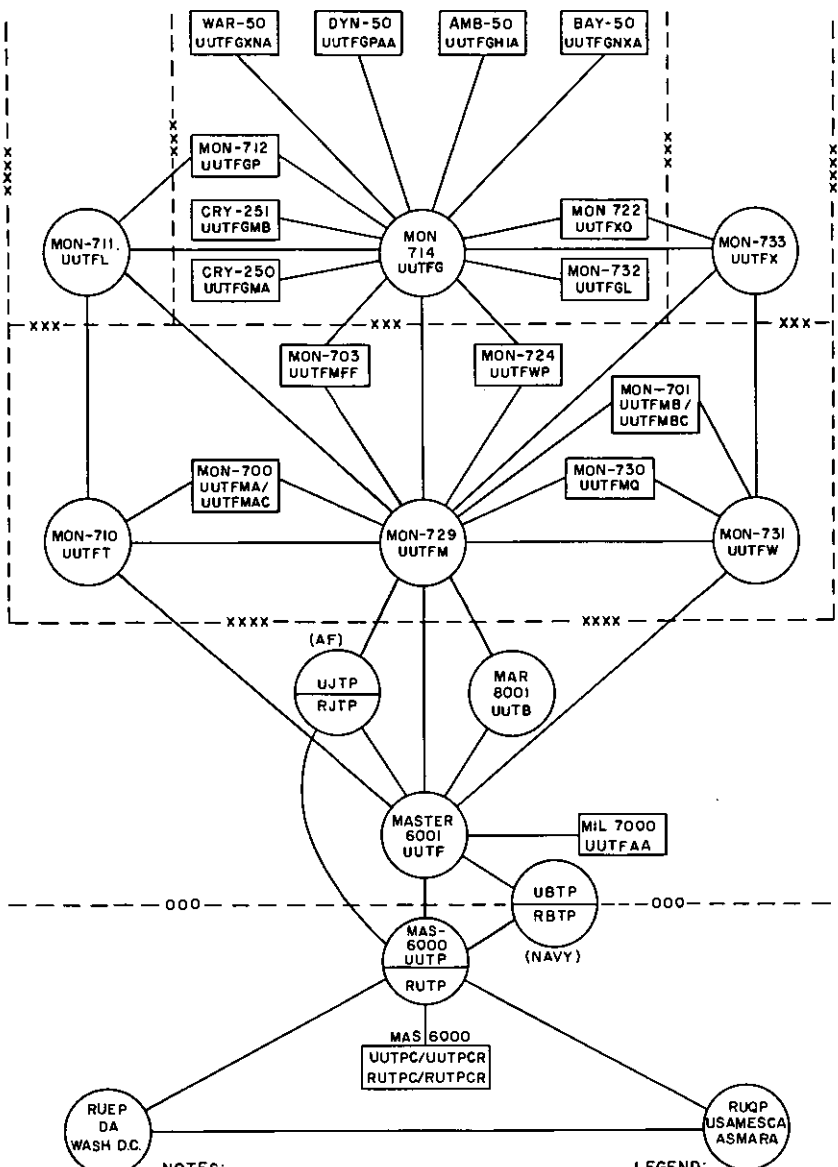

**NOTES:**

1. COMMUNICATION DESIGNATOR INDICATES THE SIGNAL CENTER WHERE THE RELAY, TRIBUTARY OR TERMINAL STATION IS LOCATED.
2. ALL DESIGNATORS SHOWN IN FIELD ARMY AREA ARE PRECEDED BY "UUTF" FOR INTER-THEATER TRAFFIC.

**LEGEND:**

- - TAPE RELAY STATION
- - TRIBUTARY OR TERMINAL

FMII-21-100

Figure 10. Type tactical tape-relay system.



more tape-relay stations are required in the army service area to provide normal tape-relay functions for echelons of field army headquarters and other units and activities.

#### **40. Sole-User Teletypewriter Service**

Sole-user teletypewriter service is provided on point-to-point circuits by the field army area communication system, the corps communication system, and the division area communication systems. Sole-user circuits may be authorized when the volume or precedence of traffic between two specific points is sufficiently high to warrant them.

#### **41. Reserve Facilities**

*a.* A reserve signal communication capacity should be maintained at each signal center to provide communications during critical situations. During such periods, when traffic requirements may temporarily exceed system capacity, service to low priority subscribers is curtailed. The order of precedence is recommended by the command signal officer in accordance with the tactical situation, coordinated with the general staff, and approved by the commanding general.

*b.* A communication system must provide for operating spares to replace equipment that becomes inoperative. Upon the repair of inoperative equipments they become operating spares. The operating spares provide a method of minimizing delays due to equipment failure. Operating spares should not be considered as a reserve facility for use in establishing additional facilities.

*c.* Flexibility of the field army area communication system can be maintained by holding signal combat area companies in reserve. The reserve companies will provide the troops and equipment to establish signal centers as required.

## CHAPTER 5

### SIGNAL COMMUNICATION CONTROL

---

#### 42. General

The field army is a mobile and extremely flexible organization, tailored for specific combat missions. The field army area communication system meets the army requirements for flexibility and reliability by circuit routing through multichannel communication systems. In order to achieve the necessary degree of flexibility and reliability, the communication system must be engineered to the known and prospective needs arising from the army's mission, and control of multichannel systems and individual circuits must be carefully exercised. Effective control is achieved by centralized planning and decentralized execution. This philosophy requires that systems and circuit control be effected at the lowest possible level. The three types of control are—

*a. Communications Control.* This is the process by which communications resources are matched with communication requirements generated by the overall mission of the command. Communication control is a responsibility of the signal officer, it involves planning and operations and is normally executed through his signal staff.

*b. Systems Control.* This is the detailed engineering and operation of multichannel systems at each applicable level of signal command. Systems control sections operate within the limits of policies, plans, resources, and SOP's furnished by the next higher echelon. Systems control at local facilities may be referred to as facilities control.

*c. Circuit Control.* This is the engineering of individual circuits between one or more signal centers or subscribers to meet the requirements of the army signal plan.

#### 43. Field Army Organization for Signal Communication Control

*a.* At the field army level, communication control is provided by the communications division, army signal staff. This section prepares broad plans for the communication network to meet both current and future communications requirements. The army signal staff prepares the signal plan and makes recommendations for circuit allocations, priority of installation and rerouting, and frequency allocation within the field army. Upon approval of the plan, mission-type orders are prepared and issued to army signal troops. To achieve close and continuous coordination of the com-

munication system with the operations of the command, all or any part of these functions may be performed by a signal element located at the tactical operations center.

b. Systems control at field army level is accomplished by establishing a systems control center. Because the center must have immediate access to both the army signal section and the area signal centers in order to exercise its technical control over the network, it is normally located near the army main command post. An alternate center is always established. The systems control center is manned by the systems control and information section of the combat area signal group. The center normally operates under the control of the combat area signal group. Relations with units of the field army signal battalion are governed by policies and SOP's provided by the army signal officer. The systems control center may be placed under the operational control of the field army signal officer. The field army systems control center—

- (1) Prepares and issues detailed systems and circuit orders to implement the orders and directives of the field army signal officer.
- (2) Coordinates the operation of the network to facilitate integration of the field army area system with systems installed by subordinate (corps and division) and coequal commands (air force and navy).
- (3) Analyzes traffic to determine the current efficiency of the network, and compiles experience data for future references.
- (4) Prepares and issues rerouting directives and plans based upon circuit priorities furnished by the army signal officer.
- (5) Establishes and operates a signal information service which collects, records, and disseminates signal directory service and communication-routing information to all components of the field army communication system.
- (6) Coordinates the field army area messenger service.
- (7) Advises commanders of signal units on the location and displacement of individual army area signal centers.
- (8) Maintains detailed records reflecting the current communications situation.
- (9) Establishes standard control procedures for all subordinate control centers and exercises control of the field army area communication system through these subordinate control centers.

c. Each signal combat area battalion establishes a systems control center at or adjacent to one of the signal centers operating in its area of responsibility. Battalion control centers are under

the technical control of the field army systems control center, and perform in essentially the same manner as the field army control center within their geographical area. An alternate control center is always established.

*d.* Each signal combat area company establishes a facilities control center at its signal center to plan and supervise internal operation of the center and provide extension facilities to subscribers in its area. The facilities control center issues circuit and systems orders to provide for local distribution within its area of responsibility. The facilities control center at each company operates under the technical control of the battalion control center.

*e.* The army signal battalion establishes a systems control center at the army main signal center and facilities control centers at each of the other command signal centers. The systems control center of the army signal battalion is under the technical control of the field army systems control center.

*f.* The corps establishes its own internal command communication system, but depends on the field army area communications network for area communication. The corps signal battalion establishes a central systems control center under the supervision of the battalion S3. Facilities control centers are established at other signal centers serving echelons of the corps command. Facilities control centers within the corps are under the technical control of the corps systems control center. Circuits that enter both the army and the corps communication systems are controlled by the higher headquarters. In all other respects, the corps systems control center performs functions for the corps communication system similar to those listed for the field army systems control center.

*g.* The division establishes and controls its own area communication system. A systems control and information center is established at or adjacent to the main signal center. Facilities control centers are established at each signal center. Where circuits use the division area system and the systems of higher headquarters, circuit control is under the direction of the higher headquarters. The division system control center fulfills functions similar to those listed for the field army systems control center. An alternate systems control center is designated.

#### **44. Applications of Control**

*a.* The following are some examples of how control might be applied to typical field army problems. In all cases a sole-user circuit is selected to simplify the explanation.

- (1) A request is received at army signal center MON 711 from an engineer battalion for installation of a sole-user circuit previously allocated to it. Both terminals of this

circuit are now being served by MON 711. The facilities control center at MON 711 prepares plans and issues circuit orders for the installation. When the circuit order is completed, facilities control at MON 711 informs the systems control center of its parent battalion, which in turn informs the field army systems control center.

- (2) A request is received at army signal center MON 712 from a quartermaster group for a previously allocated sole-user circuit to one of its battalions now being served by MON 714 (a unit served by the same area signal battalion). The request is forwarded from MON 712 to the battalion systems control center, with all available information. Since both subscribers are located within the area signal battalion's area of responsibility, the battalion systems control center prepares plans and issues the circuit installation order. Upon completion of the installation, the field army systems control center is notified.
- (3) A request is received at army signal center MON 730 from an ordnance battalion for a previously allocated sole-user circuit to the army ordnance officer. Since this circuit must be routed out of the signal battalion area, the request will be forwarded to the field army systems control center, where the circuit will be engineered and the circuit installation order issued.

b. In the three cases illustrated above, the lowest unit capable of controlling the entire circuit prepared the plans and issued the circuit installation order. It should be noted that all circuits cited were preallocated by action of the army signal staff. This preallocation is a portion of signal staff planning. Requests for communications not previously allocated must be referred to the army signal staff for action.

#### **45. Signal Center and Unit Communication Designators**

a. Basically, the signal center and unit communication designator consists of two parts, the unit telephone directory name and an exchange number. For signal communication purposes, the communication designator identifies command signal centers, area signal centers, and the organizational elements and activities of the field army.

b. Telephone directory names are assigned to each unit equipped with a switchboard. These names are assigned by theater headquarters and subordinate headquarters and are published as a part of an item in the SOI or standing signal instructions (SSI).

c. The telephone directory name should be a simple two-syllable word that is easily understood when spoken over the telephone.

d. Field army, corps, and divisions are assigned blocks of exchange numbers for their use. Separate companies, battalions, and other subordinate units that have switchboards are assigned separate telephone directory names and exchange numbers. An example of this is the assignment of telephone directory names and exchange numbers to engineer units. Engineer companies often operate away from their parent battalions; thus, they should be assigned a separate exchange number for each company. A recommended exchange number assignment follows:

(1) Exchange numbers for divisions—

<i>Element or signal center</i>	<i>Exchange No.</i>
Command signal centers -----	50-59
Area signal centers -----	60-69
Subordinate elements -----	70-249

(2) Exchange numbers for corps:

<i>Element or signal center</i>	<i>Exchange No.</i>
Command signal centers -----	250-259
Subordinate elements -----	260-699

(3) Exchange numbers for field army:

<i>Element or signal center</i>	<i>Exchange No.</i>
Command signal centers -----	700-709
Area signal centers -----	710-745
Subordinate elements -----	746-2500

e. An explanation of the assignment of telephone directory names and exchange numbers is shown below—

- (1) Assume that the 10th U.S. Army is composed of the 1st Corps, 2d Corps, and 3d Corps, and that the following telephone directory names have been assigned in the theater army SOI:

10th Army -----	MONARCH
1st Corps -----	CRYSTAL
2d Corps -----	DANGER
3d Corps -----	AMBER

- (2) Using the telephone directory names and exchange numbers as explained above, a sample of directory listings would appear as follows:

<i>Element or signal center</i>	<i>Communication designator</i>
10th Army main -----	MONARCH 700
Army area signal center -----	MONARCH 710
42d Missile Battalion (AJAX) Artillery -----	MOHAWK 752
<i>Element or signal center</i>	<i>Communication designator</i>
1st Corps Main -----	CRYSTAL 250
2d Corps Main -----	DANGER 250
3d Corps Main -----	AMBER 250
1st Corps Artillery -----	CRYSTAL 368

- (3) Local extensions of each large exchange are numbered consecutively from 200 up to the maximum number permitted by the size of the exchange. The two-digit numbers 00 to 99 are not used, except for small tactical manual switchboards such as the SB-22 and SB-86, and the numbers from 100 to 199 are reserved for special purposes. The uniform series of tactical telephone numbers described in FM 24-20, which is directly applicable to small switchboards using two-digit numbering, must be modified for application to larger switchboards. For example, in an infantry brigade using an SB-86 switchboard, the use of a two-digit number series will permit the assignment of number 3 to the S-3 in accordance with FM 24-20. In a corps headquarters, using an AN/TTC-7 switchboard with 200 line capacity numbered 200-399, the numbers 203 and 303 can be assigned to the G-3 section. If additional lines are required by that section, numbers ending in digits other than 03 must be assigned. In this event, a possible solution would be to assign 253 and 353 to the G-3 section. On the other hand, in the Army headquarters where a 600 line capacity switchboard is used, the G-3 may be assigned all 03 numbers from 203 to 703 if desired.
- (4) During the displacement of any headquarters or activity, the designator used at the new location is the same as that used at the old, except that the suffix JUMP is added. After the old location is closed out, the suffix is dropped.
- (5) In certain situations, the signal combat area companies may be required to operate one or more satellite switchboards from the area center switchboard. To maintain the integrity of the area center designation, the satellite switchboards use the same designation as that of the area center, followed by word suffixes as required. Word suffixes, such as RED, WHITE, or BLUE, are suggested for this purpose. For example, a satellite switchboard of MONARCH 710 would be MONARCH 710 RED.
- (6) Telephone directory names and exchange numbers should not be regarded as a code. They have no security value, but are intended only as a convenience in system operation. However, telephone directories often include complete troop listings which might afford valuable order-of-battle information to an enemy. Therefore, it may be necessary to apply a security classification to the directory, or to add the identification marking FOR OFFICIAL USE ONLY, as determined by command policy.

## 46. System Designation

a. To identify the telephone or teletypewriter multichannel communication system between any two signal centers, it is necessary to use the communication designator of the two connected signal centers (figure 11). The same numbering method is used for both telephone and teletypewriter systems; however, the suffix TG is added to a teletypewriter designator. The absence of this suffix indicates that it is a telephone system. When one or more systems are required between two signal centers, the letters A, B, C, etc., are used immediately after the exchange number of the signal center having responsibility for the system. Examples of systems designation are shown below.

- (1) One voice system between 10th Army (MONARCH) signal centers 710 and 711 would be designated *MON 710A-711*.
- (2) One voice system between 10th Army signal center 710 and 1st Corps main signal center (CRYSTAL 250) would be designated *MON 710A-CRY 250*.
- (3) Three voice systems between 10th Army signal center 710 and 1st Corps main signal center (CRYSTAL 250) would be designated as follows:

*MON 710A-CRY 250*

*MON 710B-CRY 250*

*MON 710C-CRY 250*

- (4) Two teletypewriter systems between 10th Army Signal centers 723 and 717 would be designated as follows:

*MON 723A-717 TG.*

*MON 723B-717 TG*

- (5) One teletypewriter system between 10th Army signal center (MONARCH 723) and 2d Corps main signal center (DANGER 250) would be designated *MON 723A-DAN 250 TG.*

b. A system may be further identified by adding suffixes to the designator to identify the medium of transmission, number of telephone channels, and number of telegraph channels. For example, by adding the suffix V or S the transmission medium can be shown. V would indicate VHF radio relay, and S would indicate spiral-four cable. By adding further numerical suffixes, the number of telephone and teletypewriter channels, respectively, can be indicated. Thus, system designators showing all of this information would appear as follows:

*MON 710A-711/V/11/4*

*MON 710B-711/S/11/8*

*MON 722A-DAN 250/V/11/8*



c. The extent and manner of using these suffixes are determined by the command signal officer.

Figure 11. Type army (two-corps) systems diagram.  
(Located in back of manual)

## 47. Circuit Numbering System

a. Circuits are designated by numbers that identify the echelon of command that initiates and establishes them. Blocks of circuit numbers are assigned to various major command echelons throughout the theater for assignment to their circuits. These blocks of circuit numbers are as follows :

<i>Circuits for</i>	<i>Circuit number block</i>
Division -----	1000-1999
Corps -----	2000-2999
Field army -----	3000-7999
Army group -----	8000-11999
ADLOG -----	12000-15999
BALOG -----	16000-21999
TALOG -----	22000-24000
Theater Army -----	24000-any limit

b. The command echelon that initiates the requirement for a circuit provides the circuit number for control and identification. This circuit number remains unchanged, even though the circuit passes through the facilities of the systems belonging to one or more subordinate or adjacent commands. Within the block allocation of circuit numbers for various command levels, priorities for the installation and rerouting of circuits may be indicated by use of especially designated sub-blocks. For example at field army (circuit numbers 3000-7999) a sub-block 3000-3500 may indicate all priority I circuits.

c. The first three letters of the unit telephone directory name and the circuit number are used to identify a given circuit. For example, *MON 3001* indicates that this is circuit 3001 of the 10th Army communication system. A circuit number with the suffix TG indicates a teletypewriter circuit; a circuit number without a suffix indicates a voice circuit.

d. To keep an accurate record of a circuit, it is necessary to maintain the circuit order and record card. On the reverse side of this card a trouble record may be kept. The sample circuit order and record card format shown in table V indicates the point of origin and termination of the circuit, the systems through which the circuit passes, and the channel of the system used.

Table V. Sample Circuit Order and Record Card Format

3000		Circuit Order and Record Card (make entries in pencil)	
(Circuit Number)		Circuit Order Number 258	
From MONARCH 700		Date 28 January 1960	
To CRYSTAL 250			
Circuit Control—MON 700			
From	To	Channel	System
MONARCH 700	MONARCH 720	1	MON 700B-720
MONARCH 720	MONARCH 718	2	MON 720C-718
MONARCH 718	MONARCH 714	4	MON 714A-718
MONARCH 714	MONARCH 716	11	MON 714B-716
MONARCH 716	CRYSTAL 250	5	MON 716A-CRY 250

Table V. Sample Circuit Order and Record Card Format—Continued

(Reverse Side of Circuit Order and Record Card Format)							
TROUBLE RECORD							
Reported				Trouble found			
Date	Time	By	Trouble		Date	Time	By
5/3/61/	0400Z	RW	Power Failure	Power Failure at MON 720.	5/3/61	0350Z	RRW

#### 48. Signal Locator and Routing Service

*a. General.* In any signal system an efficient and practical locator and routing service is essential. Locator service provides information on the location and directory designation of units served by the communication system. Routing service provides information to assist the switchboard operators in routing traffic between signal centers. The information necessary to provide this service is compiled and disseminated by the field army systems control center and by subordinate control centers. A distinction is made between locator and routing service for a signal system and for unit telephone directories.

*b. Responsibility.*

- (1) In the field army area communication system, locator and routing information is compiled and disseminated by the field army systems control center. Personnel and facilities for this control center are provided by the sys-

tems control and signal information section of the headquarters and headquarters detachment, combat area signal group. Personnel and facilities for subordinate control centers are provided by the battalion operation and intelligence section, headquarters and headquarters company, signal combat area battalions. Personnel and facilities for facilities control are provided by the platoon headquarters, signal center platoon, signal combat area companies.

- (2) Locator and routing service for the corps signal system is the responsibility of the telephone operation section, wire operations platoon, command signal operations company, corps signal battalion. The corps systems control center establishes collection and dissemination procedures.
- (3) Locator and routing service for the division area communication system is provided by the division systems control center, established by the division signal battalion S3. The S3 establishes collection and dissemination procedures.
- (4) Locator and routing records maintained at each level of control must be easily adaptable to a changing situation. Changes to the locator records are made from information transmitted between levels of control. This data is transmitted over circuits of the signal communication facilities provided for control purposes. The first control center receiving information that a unit is leaving or entering the system is responsible for initiating the changes on the locator and routing records.

*c. Unit Locator Service.*

- (1) Unit locator service provides geographical location of users and the points of entry of their communication facilities into the field army area communication system.
- (2) The unit locator service is used by signal communication personnel in traffic routing, messenger service, and systems engineering. Unit locator service provides, to chief operators and other individuals responsible for determining routing, the destination in the communication system of calls to specific units. This information, used in conjunction with routing information to that destination, allows the calls to progress in accordance with an established traffic pattern.
- (3) The field army systems control center prepares a unit locator register that shows all organic and attached units, their location, their unit directory designations,

and the signal center serving them. Units not part of, but served by, the signal system are also shown. The locator register is issued, initially, to all signal centers. Once issued, the register is maintained by the signal center. This is done by posting information received through control channels. A type format for a locator register is shown in table VI.

*d. Routing Service.*

- (1) Routing information is furnished the signal centers to assist the switchboard operators in routing traffic through the communication system. This information is furnished to the switchboard operators in the form of traffic diagrams and route bulletins.
- (2) Routing information, used principally at signal centers, is compiled and disseminated by the control centers of the communication system. Local switchboard operators depend on signal centers for routing information.
- (3) Each switchboard operator requires routing information to be able to contact all units served by the communication system and to gain entrance into higher, lower, and adjacent communication systems. The telephone route bulletin and the telephone traffic diagram serve as the major routing guides. Additional assistance can be obtained from the information and directory operator. Telephone routing service is compiled and used as follows:
  - (a) The field army systems control center prepares a master telephone traffic diagram which is issued to subordinate signal centers. This diagram shows common-user trunks of the communication system. Each signal center indicates on its copy of the traffic diagram all trunks to local exchanges within its area of responsibility.
  - (b) The field army systems control center maintains a traffic diagram of the field army area communication system to show trunks to the theater communication system and to adjacent communication systems.
  - (c) Telephone route bulletins are maintained at all signal centers. A route bulletin is a list of all units served by the communication system showing the signal center through which each may be reached. Additions or deletions are transmitted immediately, by the signal center initiating the change, over a communication control circuit to all other signal centers in the battalion area and, in the case of the field army area com-

munication system, to the battalion systems control center. The battalion systems control center transmits the change to the field army systems control center where it is simultaneously transmitted to all other battalion systems control centers.

- (4) At least once a day, or as often as necessary, the field army systems control center sends a complete new route bulletin to each area and command signal center over control circuits.
- (5) The field army systems control center has at least one information and directory operator to provide routing information to the signal center chief operators for trunking to higher, lower, and adjacent communication systems, or to assist in routing calls within the communication system. A type format for a route bulletin is shown in table VII.
- (6) Routing service is provided by the first signal center switchboard operator. The local operator extends the call to the first signal center switchboard operator. The first signal center switchboard operator then routes the call to its destination and remains on the connection until the final operator has received and understood the final connection order.

#### **49. Records and Reports**

At field army, corps, and division level, the systems control centers keep the signal sections informed as to the current operational status of the signal communication system and the availability of personnel and equipment to meet additional operational demands. To accomplish this and to assure effective, accurate control and operation of the signal system at each level, the applicable control centers must maintain and have available certain essential records. These may include, but will not be limited to, the following:

*a. Line Route Map.* A line route map is a map overlay that indicates the exact route and number of wire lines. Guidance as to format is contained in FM 24-20.

*b. Radio Relay Systems Map.* A radio relay systems map (fig. 12) is a map overlay that indicates locations of radio relay terminals and intermediate relay stations, operating radio frequencies, magnetic azimuth of antenna orientation, and location of signal centers being served by the radio relay terminal sites. At division and corps level it is prepared and disseminated as an appendix to the signal battalion operations order; at field army it is prepared and issued by the field army systems control center.

Table VI. Sample Locator Register Format

Communication designator	Served by	Unit	Location (coordinates)	Teletypewriter routing indicator or call sign
MONARCH 752 MONARCH 785 *	MONARCH 710 MONARCH 713 *	42d Missile Battalion (HERCULES) 89th Engineer Battalion *	437831 495672 *	KY3 DR6 *

Table VII. Sample 10th Army Telephone Route Bulletin Format

Effective: 010500 Dec 1960

Unit communication designator	Communication designator of signal center providing service
CRYSTAL 250	MONARCH 715/716
JOKER 50	MONARCH 718
MONARCH 700	MONARCH 720/726/701/710
MONARCH 701	MONARCH 723/729/700
MONARCH 927	MONARCH 715
*	*

*c. Radio Net Diagram.* A radio net diagram is a graphic display of the employment of AM and FM radio sets within a designated area. It shows number and type of sets, arrangements and participants of the various radio nets, assigned frequencies and call signs, and other related data as required. At division level it is prepared and disseminated by the systems control center of the signal section; at army, it is prepared and disseminated by the field army signal section.

*d. Communication Systems Diagram.* A communications systems diagram is a working document which shows the multi-channel systems available for use. It is used in systems control centers as an aid to circuit routing. Each control center prepares a communication systems diagram showing its own area of responsibility (fig. 11).

*e. Telephone Traffic Diagram.* A telephone traffic diagram is a graphic display of the common-user telephone trunk circuits between signal centers.

(1) At division level, the diagram (fig. 13) is prepared and disseminated by the division systems control center or the signal section and shows the number of common-user telephone trunk circuits in the division area communication systems. It also shows the number of common-user trunk circuits between the division system and higher adjacent commands.

(2) At army level, the diagram (fig. 14) is prepared and disseminated by the army signal section. It shows access points to the telephone switching centers of higher, lower, and adjacent commands and is used by the telephone operators for routing calls.

*f. Teletypewriter Traffic Diagram.* A teletypewriter traffic diagram shows the number of common-user teletypewriter trunk circuits between signal centers.

(1) At division level, it shows the number of common-user

teletypewriter trunk circuits within the division area communication systems. It also shows the number of common-user teletypewriter circuits between the division system and higher and adjacent commands (fig. 15).

- (2) At army level, it shows access points to teletypewriter switching centers of higher, lower, and adjacent commands (fig. 16). It is used by the teletypewriter switchboard operator for routing teletypewriter calls.

*g. Division Sole-User Traffic Diagram.* A division sole-user traffic diagram contains the origin, number, destination, and routing of all sole-user telephone and teletypewriter circuits in the division area communication system. In addition, it shows sole user circuits established by higher or adjacent commands that occupy channels of any of the division multichannel systems. The diagram is prepared by the division systems control center.

*h. Army Sole-User Traffic Diagram.* An army sole-user traffic diagram (fig. 17) shows the origin, number, and designation of all sole-user telephone and teletypewriter circuits approved for installation within the field army. It is prepared by the army signal section and is included in the signal portion of the Army SOP. It is used by subscribers as a record of their allocation of sole-user service, and by systems control centers in the preparation of detailed circuit orders.

*i. Unit Locator Register.* A unit locator register gives the exact geographical location of units, unit designations, and their points of access to the particular communication system. This information is used by signal communication personnel in routing of telephone calls, teletypewriter messages, and messengers. Units not part of but served by the communication system are also listed. The unit register, which is issued to all signal centers upon initiation of operations, is maintained by the individual signal centers. This is done by posting the changes as they occur. A recommended format is shown in table VI.

- (1) At division level, the register is prepared by the division systems control center.
- (2) At army level, the register is prepared by the field army systems control center.

*j. Telephone Route Bulletin.* The telephone route bulletin is an alphabetical listing of all units by telephone directory name or communication designator. It lists the signal centers through which each of these units can be reached. It is used by the signal center telephone switchboard operator routing trunk calls. The bulletin is prepared and maintained by all command and area signal centers. A consolidated route bulletin is distributed peri-



odically by the field army systems control center. Table VII shows a type telephone route bulletin.

*k. Circuit Register.* A circuit register format (table VIII) is a numerical listing of the block of circuit numbers assigned to the particular unit. Columns in the register indicate the circuit number, the type of circuit, the point of origin, and the destination. The register is used by control centers to identify circuits that originate within the particular communication system. As each circuit is assigned a number, the register is posted and a circuit order and record card is prepared. As each circuit is cancelled, the information is posted on the register and the circuit record card is retired.

Table VIII. Sample Circuit Register Format

Circuit number	Type circuit	Origin	Destination
3000	Tel	MON-700	CRYSTAL--250
3001	Tel	MON-700	CRYSTAL--250
3002	Tel	MON-700	MON-702
3003	Tel	MON-700	MON-702
3004	Tel	MON-700	MON-702
3005	Tel	MON-700	MON-702
3006	Tel	MON-700	MON-702
3007	Tel	MON-700	MON-729
3008	Tel	MON-700	MON-729
3010	Tel	MON-700	MON-729
*	*	*	*

*l. Circuit Order and Record Card.* A circuit order and record card contains information pertaining to the facilities used on each circuit (channel number, system number, or facility used). It also indicates the circuit order number and the effective date. The contents of this card are transmitted in abbreviated format and constitute a circuit installation order to the signal center involved. The circuit order and record card is prepared and maintained at control centers. A type circuit order and record card format is shown in table V.

*m. Carrier System Record Card.* A carrier system record card indicates the facility used, the channels available for use, the spare channels, the origin and destination of each channel in use, and the circuit number for each circuit occupying a channel in the system. The card is prepared and maintained at control centers. A card is prepared and maintained for each carrier system operated. The reverse side of the card is used to indicate trouble on the system or trouble on individual channels. One method of use is to remove the card from the operational file and place it in an

outage file during periods that the system is out because of trouble. A record of the time in and time out maintained on the reverse of the card will be the basis of a history of the system that can be used for many purposes. A type format is shown in table IX.

Table IX. Sample Carrier System Record Card Format

MON 700A-270

Carrier System Record Card

(System Number)

Facility used: Radio relay Terminal Equipment AN/TCC-7

Channel	From	To	Circuit No.
1	MON 700	MON 701	3701
2	G3 MON 700	G3 CRY 250	3704
3	MON 700	CRY 250	3769
4	MON 700	CRY 250	3770
5	MON 700	MON 701	3790
6	MON 710	MON 711	3810
7	MON 710	MON 711	3811
8	Spare		
9	MON 710	MON 711	SIO 43* MON 710-711 TG
10	Spare		
11	Spare		
12	Spare		

see reverse side

\*.system installation order

Table IX. Sample Carrier System Record Card Format—Continued  
(reverse side)

Carrier System Record Card Format

Time date out	Time date in	Remarks
140012Z	140112Z	System out. Generator trouble, relay No. 1
190012Z	191504Z	Channel 12 out. Bad ringer, terminal "B".

n. Carrier System Record Chart. A carrier system record chart illustrates the individual systems that terminate at a particular signal center and shows the use made of each channel. The chart is prepared by and maintained at the individual signal centers. In some cases, it may be necessary to prepare two charts to separate the telephone carrier systems and the teletypewriter carrier systems. If this chart is covered with clean acetate, system changes may be made with a grease pencil. A type format is shown in table X.

Table X. Sample Carrier System Record Chart Format

MONARCH 710

Terminating system No.	Channel numbers												Remarks
	1	2	3	4	5	6	7	8	9	10	11	12	
MON 710B-711	3100	3210	3160	3480	3316	3215	spare	spare	spare	spare	spare	System control.	
MON 710A-726	3400	3519	3362	3219	3334	3245	3214	spare	spare	spare	TG (1)	System control.	(1) Mon 710A 727TG
*	*	*	*	*	*	*	*	*	*	*	*	*	*

## 50. Electronic Accounting Machine Applications

By using the systems, units, and circuit designators as discussed above, the problem of systems control and circuit control becomes semi-mechanical in nature, and hence is amenable to EAM and ADP applications. Figure 18 represents a possible machine card layout format, applied to the problem of unit designation, location, communication requirements, signal center providing service, etc. Such a card, by either machine sorting or ADP application, could be used to provide telephone directories, unit locator files, signal center communications loads, etc. Similarly, a circuit order and installation card may be punched (fig. 19) showing the maximum center and system routing (seven signal centers), and could be used as both a circuit order and a circuit record. Such a card, by machine sorting, could be used to indicate circuit routing, circuit and system utilization at each signal center, systems record cards, etc. Through ADP application, the same input card could indicate system and channel availability, system and channel usage, etc.

## 51. Telephone Directory Service

At division level, a telephone directory is prepared by the division signal section and distributed as an SOI item. At army level, it is prepared by the field army signal section. The directory lists all assigned and attached units and their associated directory communication designator names. It also lists those units that are not a part of, but which are served by, the particular signal system. The control center notifies all signal centers of changes to the telephone directory. Signal centers and units prepare telephone directories in accordance with local requirements.

a. Subordinate control centers notify the higher control center as soon as possible when circuits to units, located within their area of responsibility, have been installed. The information to be provided to the higher control center normally includes, but is not limited to—

- (1) Unit designation.
- (2) Communication designator name of unit, if not listed in directory.
- (3) Coordinates of unit.
- (4) Type of circuit provided.

b. When units served by a signal center move, they notify the signal center concerned before disrupting their communication.

*Figure 12. Type field army (two-corps) radio-relay system map.  
(Located in back of manual)*

*Figure 13. Type infantry division telephone traffic diagram.*  
**(Located in back of manual)**

*Figure 14. Type field army telephone traffic diagram.*  
**(Located in back of manual)**

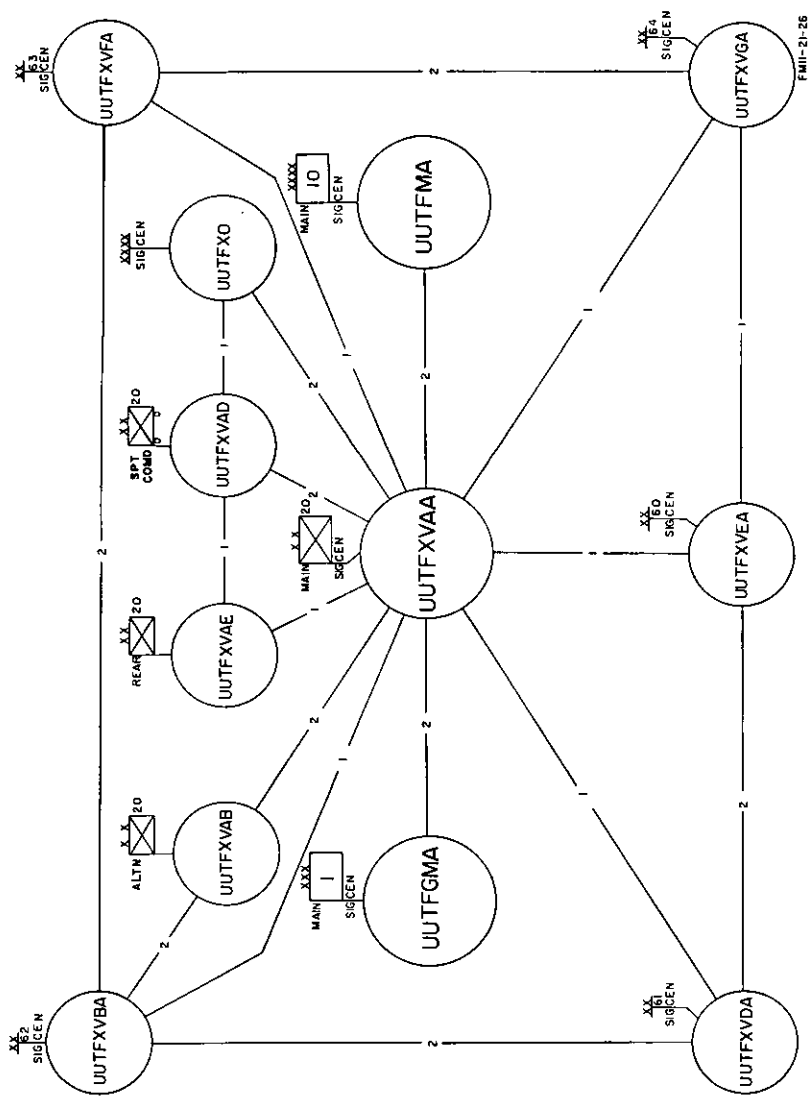

Figure 15. Type infantry division teletypewriter traffic diagram.

*Figure 16. Type field army teletypewriter traffic diagram.*  
**(Located in back of manual)**

*Figure 17. Type army sole-user telephone and teletypewriter traffic diagram.*  
**(Located in back of manual)**

*Figure 18. Format for type machine card layout for unit designator card.*  
**(Located in back of manual)**

*Figure 19. Format for type machine card layout for circuit order and record card.*  
**(Located in back of manual)**

## CHAPTER 6

### SIGNAL CENTER DISPLACEMENT

---

#### 52. Displacement of Field Army Signal Centers

a. There are several methods of displacing the field army main and the field army alternate signal centers. Based on existing circumstances, the field army signal officer decides the method to be used. Two methods are discussed below :

- (1) Signal facilities that are not absolutely necessary at the old command post are moved and established at the new command post. This permits the headquarters to begin operations at the new command post. Signal facilities are moved to the new location as quickly as the situation permits. The old command post is finally closed out.
- (2) Operations are closed out completely at the old command post, and the headquarters and signal facilities are moved to the new command post. With this method, army alternate headquarters must exercise control until the new CP is ready to resume control. Army alternate is then closed and moved to its new location.

b. The nature and size of the system requires displacement of the field army area signal centers by establishing new centers in the forward areas and closing out those in the rear areas.

- (1) As corps and divisions move forward, the field army area signal centers in reserve are committed to forward areas to continue area support.
- (2) Field army area signal centers in the army service area are phased out to provide reserve or immediate displacement units. Two methods used to close out area signal centers are :
  - (a) The signal center is phased out by rerouting its trunk circuits and by connecting the units left within the area to another area signal center.
  - (b) Signal combat area companies are relieved by the signal operations platoon of the headquarters and headquarters company, signal combat area battalion. This platoon may be used under the following conditions :
    1. When the units requiring support in an area served by an area signal center are reduced in number to the extent that a full signal combat area company is no longer required.



2. In an area where switching and trunking facilities are required, but where no units are located.

c. When the army rear boundary is to be moved forward, the signal section of field army headquarters coordinates with the signal section of the theater army to assure that signal communication is provided to units that remain in the area.

d. Signal combat area companies held in reserve remain under the control of their parent battalions, unless operational considerations make this impossible. These reserve companies are kept in a ready status and should be located to facilitate future employment.

### **53. Displacement of Corps Signal Centers**

Frequent movement of echelons of corps headquarters causes signal communication displacement operations to be carried on continuously. Proposed future locations of command posts are selected and surveyed, plans are developed for physical rearrangement and electrical rerouting of communication circuits, and all effected elements are advised of the action to be taken to effect the displacement. Physical movement of personnel and equipment is then initiated. This movement is conducted in phases that permit establishment of signal communications prior to the time operations are scheduled to begin at the new command post. The phases also must permit communication to continue at the old command post until communication is established at the new command post. As a result, personnel and equipment must be available for displacement operations.

### **54. Displacement of Division Signal Centers**

a. *General.* Signal centers of the division area communication system must be able to displace without interrupting the continuity of service to users of the system. The task of providing uninterrupted communication is made easier by intelligent, detailed advanced planning on the part of the division signal officer and his close coordination with the division staff, particularly G3. Certain basic principles to be considered in any displacement plan are to :

- (1) Provide continuous communication service.
- (2) Establish a complete and comprehensive procedure for any contingency. This procedure must be followed by personnel who install and operate the system, particularly radio relay and circuit control personnel.
- (3) Establish and follow a standardized method of circuit control.

- (4) Maintain displacement equipment in a ready state and locate the equipment where it may be rapidly committed.
- (5) Make maximum use of the alternate routing capabilities provided by the division area communication system.
- (6) Make provision for continuous service to subscribers subsequent to displacement of a signal center.

*b. Division Main Signal Center.* Methods of displacing command signal centers vary with tactical requirements. Accordingly, it is impractical to explain every imaginable situation. The displacement procedures listed below are based on division main's displacement to the division advance signal center; however, the identical basic principles apply for displacement of all command signal centers.

- (1) *Radio relay facilities.* Radio relay equipment from the reserve pool is moved to and installed at the new location. Existing division main radio relay circuits are then monitored and taken over by the advance group when the command post moves forward. Old division main closes down and its radio relay equipment reverts to the reserve pool at the new location.
- (2) *Patching and Switching Facilities.* Since patching and switching facilities are already established at division advance, the division main circuits need only be patched into or through them. After the old division main signal center is closed out, the patching and switching equipment can either be displaced to the next location of division advance or reverted to the reserve pool.
- (3) *Radio facilities.* It may be necessary to combine certain radio nets to make a displacement. When this is required, the division signal officer determines which nets are to be combined. The radio/wire integration service operated at division advance provides integration facilities for elements of division main as they move into their new location. Full radio facilities are reestablished as rapidly as personnel and equipment arrive at the new location.
- (4) *Communications center facilities.* These facilities are already provided at division advance. When division main closes out the old signal center, the communications center equipment is moved to the new location of division main or to a new division advance location.

*c. Division Advance Signal Center.* The division advance signal center affords close control of the forward elements of the division, provides alternate routing, and may serve as a location for

the displacement of the division main. The division advance signal center generally displaces more frequently than division main.

- (1) *Radio relay facilities.* Radio relay facilities are displaced by moving the reserve equipment to the new division advance location, monitoring the present radio relay system, and taking over at a predetermined time. After the radio relay system has been taken over at the new location, the released radio relay terminals at the old division advance represent a reserve pool of equipment for use during future displacements.
- (2) *Patching and switching facilities.* The telephone section of the command signal center platoon, command operations company, is not authorized patching and switching facilities for displacement purposes. However, there are sufficient switching facilities available in the other telephone sections of the signal battalion that may be used to support a displacement of division advance.
- (3) *Radio facilities.* It may be necessary to combine certain AM radio nets to facilitate a displacement. Upon completion of the displacement, these facilities are restored at the new location to their full capabilities as rapidly as possible. The FM facilities can be displaced without any appreciable reduction of service.
- (4) *Communications center facilities.* No displacement facilities are provided. To displace communications center facilities at division advance, facilities are closed down, moved to the new location, and then reestablished.

*d. Forward Signal Centers.*

- (1) *General.* Forward signal centers normally can displace by employing only their authorized personnel and equipment. However, the division signal officer may augment any signal center with personnel and equipment available elsewhere in the signal battalion.
- (2) *Radio relay facilities.* Radio relay facilities at a forward signal center may consist of three radio terminals (two in operation and one in reserve). Figure 20 indicates that one terminal is used as a single terminal in system TAN 51A-61 and another terminal is used as a double terminal in a systems TAN 60A-61 and TAN 61A-62. Methods of displacing radio relay facilities at a particular forward signal center (in this case, center 61) are described in (a) through (d) below.
  - (a) The reserve terminal moves forward to establish a new area signal center (TAN 61 JUMP).

- (b) System TAN 51A-61 JUMP is established by using one-half the reserve terminal that displaced to 61 JUMP.
  - (c) System TAN 51A-61 is closed out, and that terminal is displaced to 61 JUMP, where it establishes systems TAN 60A-61 JUMP and TAN 61A-62 JUMP.
  - (d) Systems TAN 60A-61 and TAN 61A-62 are closed out when the command closes, and this equipment is displaced to forward signal center TAN 61, (formerly 61 JUMP) and is held in reserve for the next displacement.
- (3) *Patching and switching facilities.* Each forward signal center is authorized two patching panels (one in operation and one in reserve). When an area signal center displaces, the reserve patch panel moves forward to the new location, where it is installed to handle the switching and patching operations at the new signal center.
  - (4) *Radio facilities.* Radio facilities provided by a forward signal center are a radio/wire integration station and an FM radio set operated in the signal battalion command.
  - (5) *Communications center facilities.* No displacement facilities are provided. In order to displace the communications center facilities at an area signal center, the facilities must be closed down, moved to the next location, and then reestablished.

*Figure 20. Type diagram for displacement of forward signal center radio relay facilities (worksheet).*

(Located in back of manual)

# APPENDIX I

## REFERENCES

---

### 1. Army Regulations

- AR 105-15      Army Field Commands  
AR 320-5      Dictionary of United States Army Terms  
AR 320-50      Military Abbreviation and Symbols  
                  (Authorized Abbreviations and Brevity  
                  Codes).  
AR 380-40      Safeguarding Cryptomatter  
AR 380-41      Control of Cryptomaterial

### 2. Field Manuals

- FM 11-8      Field Radio Relay Techniques  
FM 11-14      Army Signal Supply and Maintenance Bat-  
                  talion.  
FM 11-15      Signal Cable Construction Battalion  
FM 11-16      Signal Orders, Records, and Reports  
FM 11-57      Signal Battalion, Airborne Division  
FM 11-86      Combat Area Signal Battalion, Army  
FM 11-92      Corps Signal Battalion  
FM 11-95      Army Signal Battalion  
FM 21-5      Military Training  
FM 21-6      Techniques of Military Instruction  
FM 21-30      Military Symbols  
FM 24-17      Tactical Communications Center Operation  
FM 24-18      Field Radio Techniques  
FM 24-20      Field Wire and Field Cable Techniques  
FM 32-5      Communications Security (U)  
FM 100-5      Field Service Regulations; Operations  
FM 100-10     Field Service Regulations; Administration  
FM 100-11     Signal Communications Doctrine  
FM 101-5      Staff Officers' Field Manual; Staff Organi-  
                  zation and Procedure.  
FM 101-10     Staff Officers' Field Manual: Organization,  
                  Technical and Logistical Data.

### 3. Department of the Army Pamphlets

- DA Pam 108-1    Index of Army Motion Pictures, Film Strips,  
                  Slides, and Phono-Recordings.  
DA Pam 310-1    Military Publications: Index of Administra-  
                  tive Publications (Army Regulations, Spe-  
                  cial Regulations, Circulars, Pamphlets,

- Commercial Traffic Bulletins, Military Traffic Management Bulletins, (Joint Chiefs of Staff Publications, General Orders, and Bulletins).
- DA Pam 310-2 Military Publications: Index of Blank Forms
- DA Pam 310-3 Military Publications: Index of Training Publications (Field Manuals, Reserve Officers Training Corps Manuals, Training Circulars, Army Training Tests, War Department and Department of the Army Posters, and Firing Tables and Trajectory Charts).
- DA Pam 310-4 Military Publications: Index of Technical Manuals, Technical Bulletins, Supply Bulletins, Lubrication Orders, and Modification Work Orders.
- DA Pam 310-7 Military Publications: Index of Tables of Organization and Equipment, Type Tables of Distribution, and Tables of Allowances.

#### **4. Technical Manuals**

- TM 11-486-1 Electrical Communications Systems Engineering: Military Communications Systems.
- TM 11-486-2 Electrical Communication Systems Engineering: Traffic.
- TM 11-486-3 Electrical Communications Systems Engineering: Transmission and Circuit Layout.
- TM 11-486-6 Electrical Communication Systems Engineering: Radio.
- TM 11-486-7 Electrical Communications Systems Engineering: Power.
- TM 11-486-10 Electrical Communications Systems Engineering: Handbook.
- TM 11-486-11 Electrical Communications Systems Engineering: Definitions and Abbreviations.

#### **5. Allied Communication Publications**

- ACP 121 Communication Instructions—General (U)
- ACP 194A BAFCOM-US Army Communication Frequency Plan (U).

#### **6. Training Circular**

- DA Training Circular 101-2 Tactical Operations Center

## APPENDIX II

# GUIDE FOR PLANNING TACTICAL SIGNAL COMMUNICATION SYSTEMS

---

### 1. General

To assure the greatest possible reliability, traffic engineering factors should be developed from actual operating experience. Where such factors do not exist, standard factors must be used. This appendix gives some general guidance in planning tactical communication systems.

a. Communication equipment necessary for operating communication systems at various levels is authorized in the form of standardized component groupings. Each of the components used is described in a technical manual which covers the installation, operation, and maintenance of the equipment.

b. Engineering of field army communications is relatively simple, because of the inherent capability of the type of equipment authorized. A major problem is the selection, allocation, and utilization of radio frequencies. Various frequency assignment plans are described in applicable equipment and engineering manuals and in ACP 194A. Another problem is the selection, allocation, and distribution of cryptosystems to insure compatible cryptonetting.

c. Overall guidance for systems engineering is provided in the TM 11-486-series of manuals. These guidelines and standards should be adhered to as far as practicable.

### 2. Telephone

To determine the number of long-distance trunks required for an army area signal center, it is necessary to first determine how many local trunks and loops will be connected to the switchboard of the area signal center. The following steps may be used to estimate the number of long-distance trunks required to support the subscribers of a given area signal center.

a. Total the local trunks and loops terminated at the signal center. This total may be obtained by totaling the number of telephone trunks and loops on the requirements density overlay pertaining to the area of responsibility of this signal center. See table IV.

b. Add to the number of loops calculated a general planning factor of 25 loops for use within the immediate vicinity of the area signal center.

c. Apply the following formula to determine long-distance trunks required for this center.

$$\frac{\text{Loops served} \times \text{CR} + \text{local trunks} \times \text{CR}^*}{\text{Average calls per hour}}$$

- (1) CR represents the long distance calling rate for subscribers connected to the area center, by means of telephone loops. CR may be assumed to be 0.5 call per hour for each loop.
- (2) CR\* represents the long-distance calling rate for each *local* trunk connected to the area center switchboard. CR\* may be assumed to be 1.5 calls per hour for each local trunk.
- (3) The average calls per hour represents the average number of calls that may be handled at the area center switchboard on one long distance trunk. This constant may be assumed to be 7.5 calls per hour for each long distance trunk.

*Example:*

An area center anticipated that it will provide 80 local trunks to subscribers in its area. It anticipates installing a total of 60 loops in its area of responsibility. Applying the formula above to these anticipated requirements we have:

$$\frac{\text{loops served} \times \text{CR} + \text{local trunks} \times 1.5}{7.5} = \frac{60 \times 0.5 + 80 \times 1.5}{7.5}$$

$$\frac{30 + 120}{7.5} = 20 \text{ long distance trunks required to satisfy the anticipated subscriber load.}$$

d. After the area signal center is installed, it is imperative that actual traffic data be obtained and analyzed to accurately modify the common user telephone system to meet requirements in a realistic manner.

### 3. Teletypewriter

When actual operating data are not available, use maximum machine capacity to determine teletypewriter circuit requirements. Use TOE's to determine the number of teletypewriter machines available; use the procedures below to determine the number of circuits required for their operation.

a. *Tape Equipment.* To determine the maximum busy-hour group count, multiply the number of tape machines in the signal



center by 20,000. (Tactical tape machines are capable of handling approximately 20,000 groups per day). Use this group count figure and refer to the tables in the TM 11-486-series to arrive at the approximate number of trunks required.

*b. Manual Switched Service.* Switched service, in this instance, means the use of keyboard-operated machines connected to a switchboard. To determine the maximum busy-hour group count, multiply the total number of keyboard operated machines by 10,000. Use this figure and refer to the appropriate tables in TM 11-486-series of manuals to determine the number of trunks required.

#### **4. Sole-User Circuits**

Message precedence and traffic volume are the two considerations in justifying allocation of circuits on a sole-user basis. Requirements must be verified by coordination with appropriate staff sections and with the units that generate traffic requirements based on operational needs.

BY ORDER OF THE SECRETARY OF THE ARMY:

G. H. DECKER,  
*General, United States Army,*  
*Chief of Staff.*

Official:

J. C. LAMBERT,  
*Major General, United States Army,*  
*The Adjutant General.*

Distribution:

*Active Army:*

CNGB (50)  
Tech Stf, DA (2) except  
CSigO (15)  
Tech Stf Bd (1)  
USCONARC (5)  
OS Maj Comd (10)  
MDW (1)  
Armies (10) except  
Seventh USA (30)  
EUSA (25)  
Corps (5)  
Div (10)  
Bde (2)  
Bg (1)  
Bn (1) except  
TOE 11-5 (25)  
TOE 11-15 (25)  
TOE 11-25 (25)  
TOE 11-45 (25)  
TOE 11-55 (25)  
TOE 11-85 (25)  
TOE 11-95 (25)  
TOE 11-155 (10)  
TOE 11-555 (25)

Svc Colleges (2) except  
USACGSC (150)  
Br Svc Sch (5) except  
USASCS (1500)  
PMGS (100)  
US ARADSCH (10)  
USAAVNS (30)  
AMSS (25)  
USAIS (20)  
USASESCS (100)  
USMA (5)  
PMS Sr Div Units (4)  
PMS Jr Div Units (4)  
PMS Mil Sch Div Units (4)  
ACS (5)  
USASRDL (5)  
USAEPG (10)  
MAAG (2)  
Mil Msn (2)  
Units organized under fol-  
lowing TOE:  
11-22 (10)  
11-32 (10)  
11-66 (5)  
11-137 (10)

*NG:* State AG (3); Units—same as Active Army except allowance is one copy to each unit.

*USAR:* Same as Active Army except allowance is one copy to each unit.

For explanation of abbreviations used, see AR 320-50.

☆U.S. GOVERNMENT PRINTING OFFICE: 1961-610517

- NOTES:
1. WHEN SPIRAL-FOUR CABLE IS INSTALLED TO PROVIDE THESE SYSTEMS, THE CABLE IS INSTALLED BY THE CABLE CONSTRUCTION BATTALION.
  2. THE EXTENSION SYSTEMS TO THE DIVISIONS NORMALLY TERMINATE AT DIVISION SUPPORT COMMAND

LEGEND:

- MULTICHANNEL SYSTEMS PROVIDED BY COMBAT AREA SIGNAL COMPANIES.
- - - MULTICHANNEL SYSTEMS PROVIDED BY FIELD OPERATIONS COMPANY, ARMY SIGNAL BATTALION.
- - - MULTICHANNEL EXTENSION SYSTEMS PROVIDED BY COMBAT AREA SIGNAL COMPANIES.

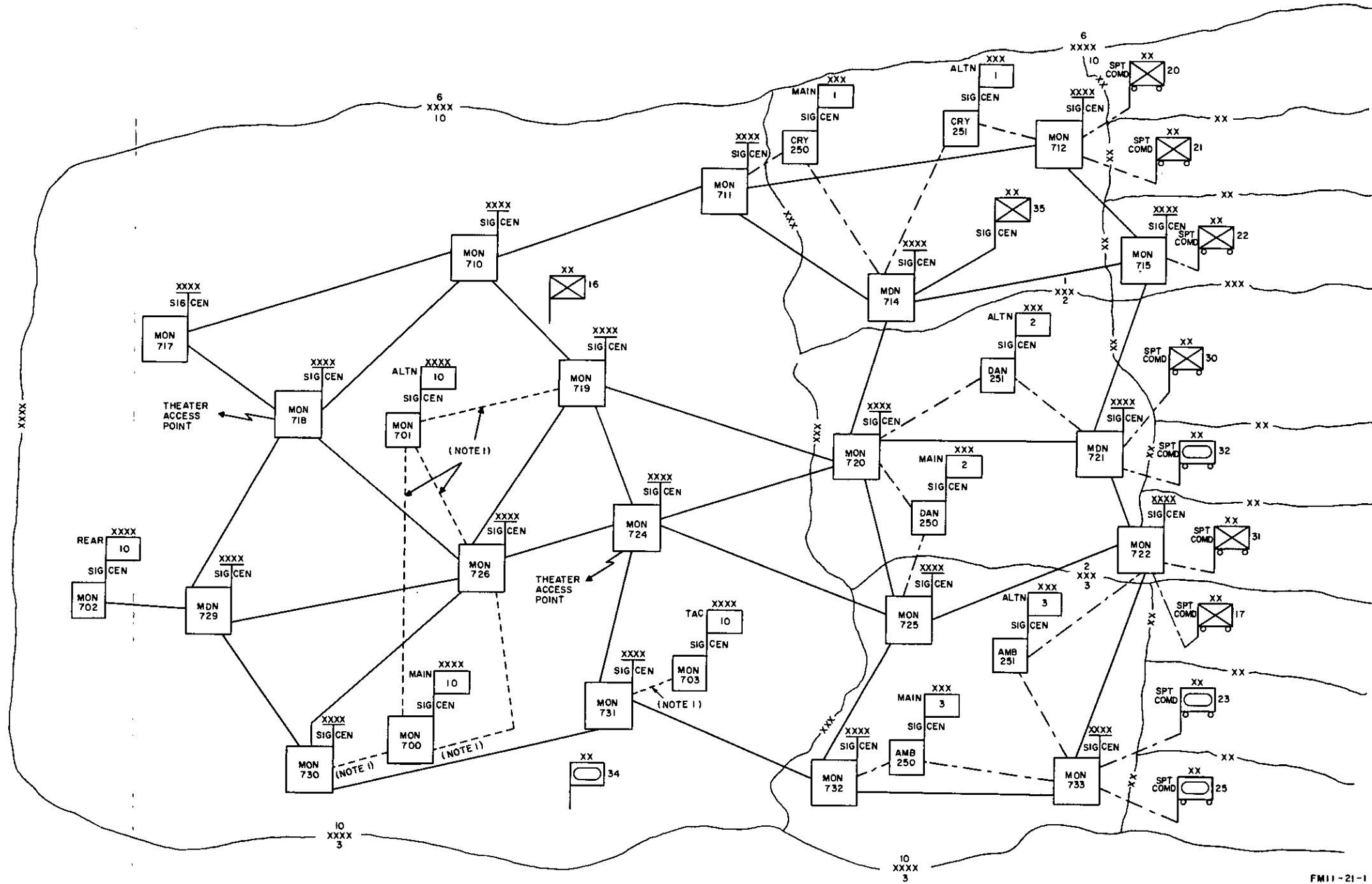
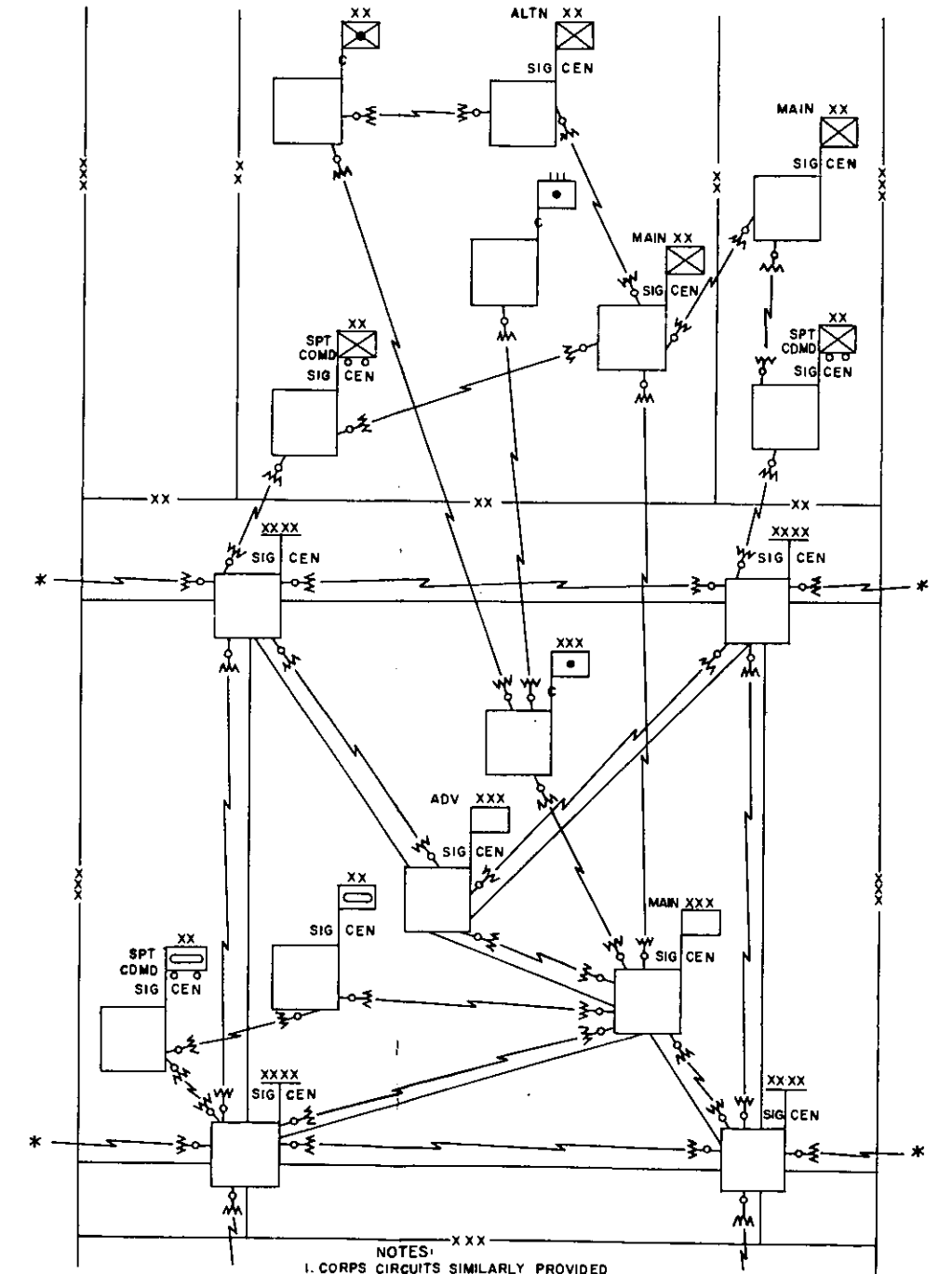

Figure 1. Type field army multichannel communication system.

FM 11-21-1

Figure 1



- NOTES:
1. CORPS CIRCUITS SIMILARLY PROVIDED TO ALL ATTACHED INF DIV.
  2. RATT CIRCUITS NOT SHOWN.
- \* TO ADJACENT ARMY AREA SIGNAL CENTERS

FM 11-21-30

Figure 2. Corps communication system integrated with the field army communication system, schematic diagram.

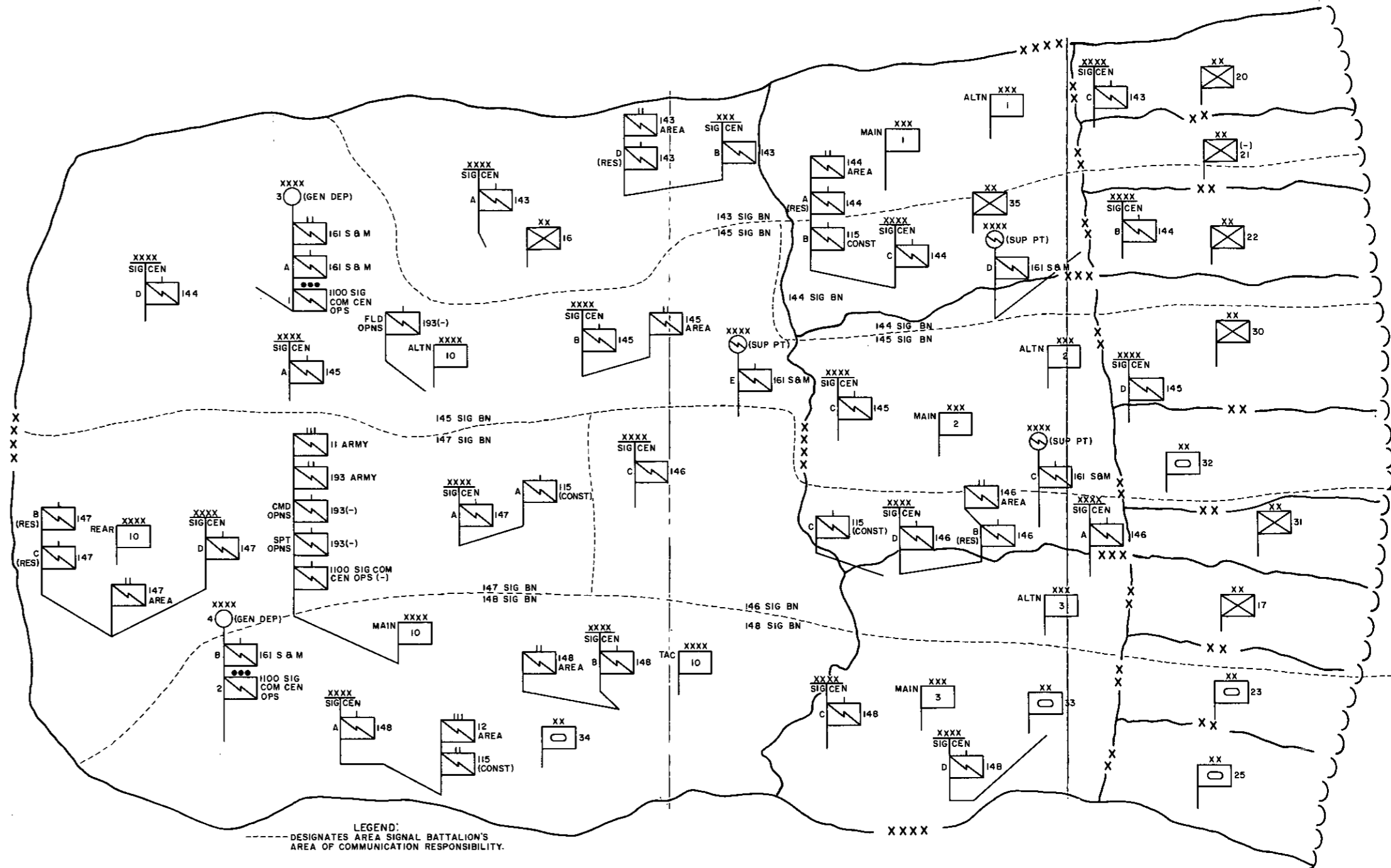

Figure 9. Type signal unit employment, field army communication system.

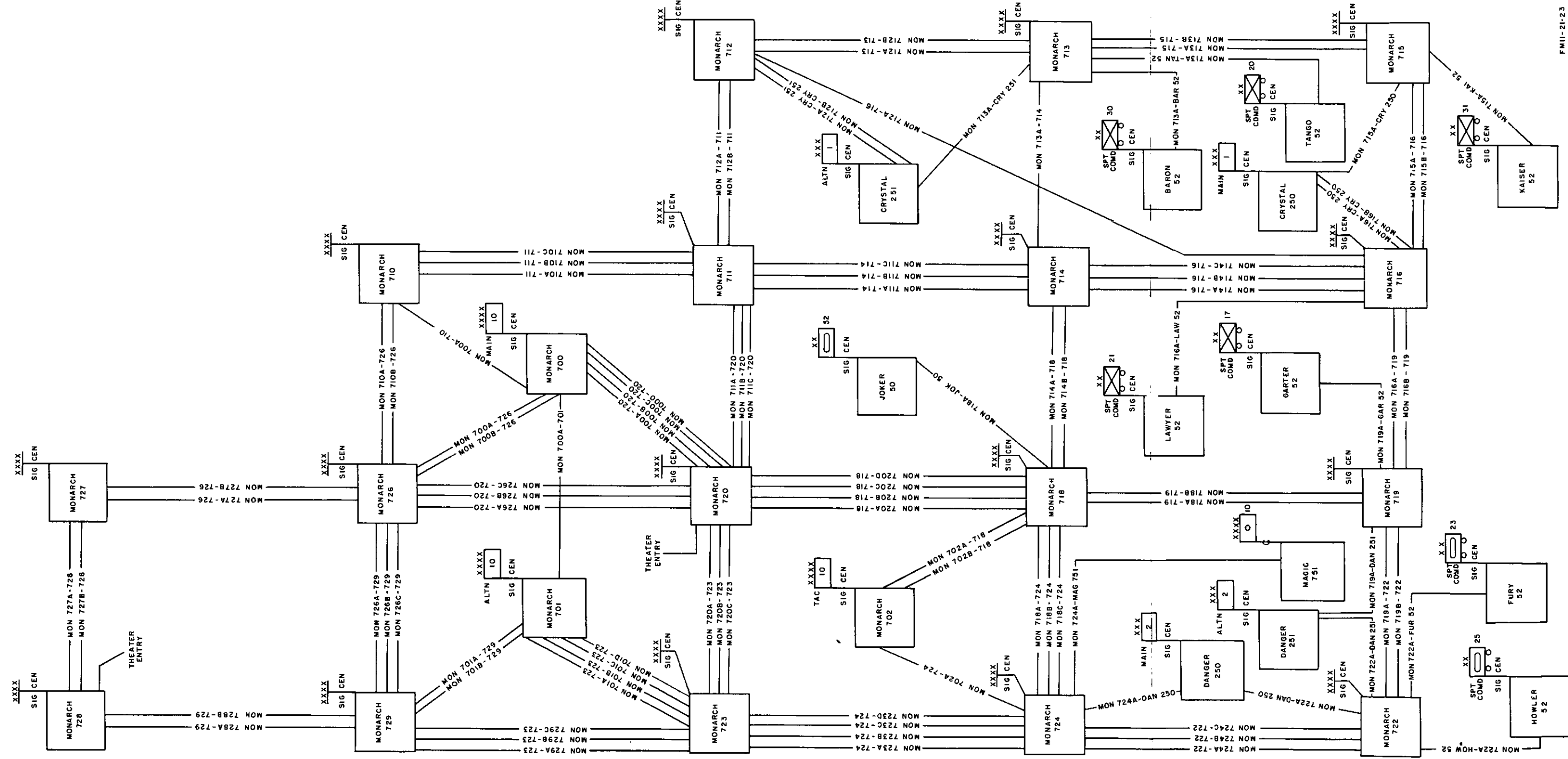
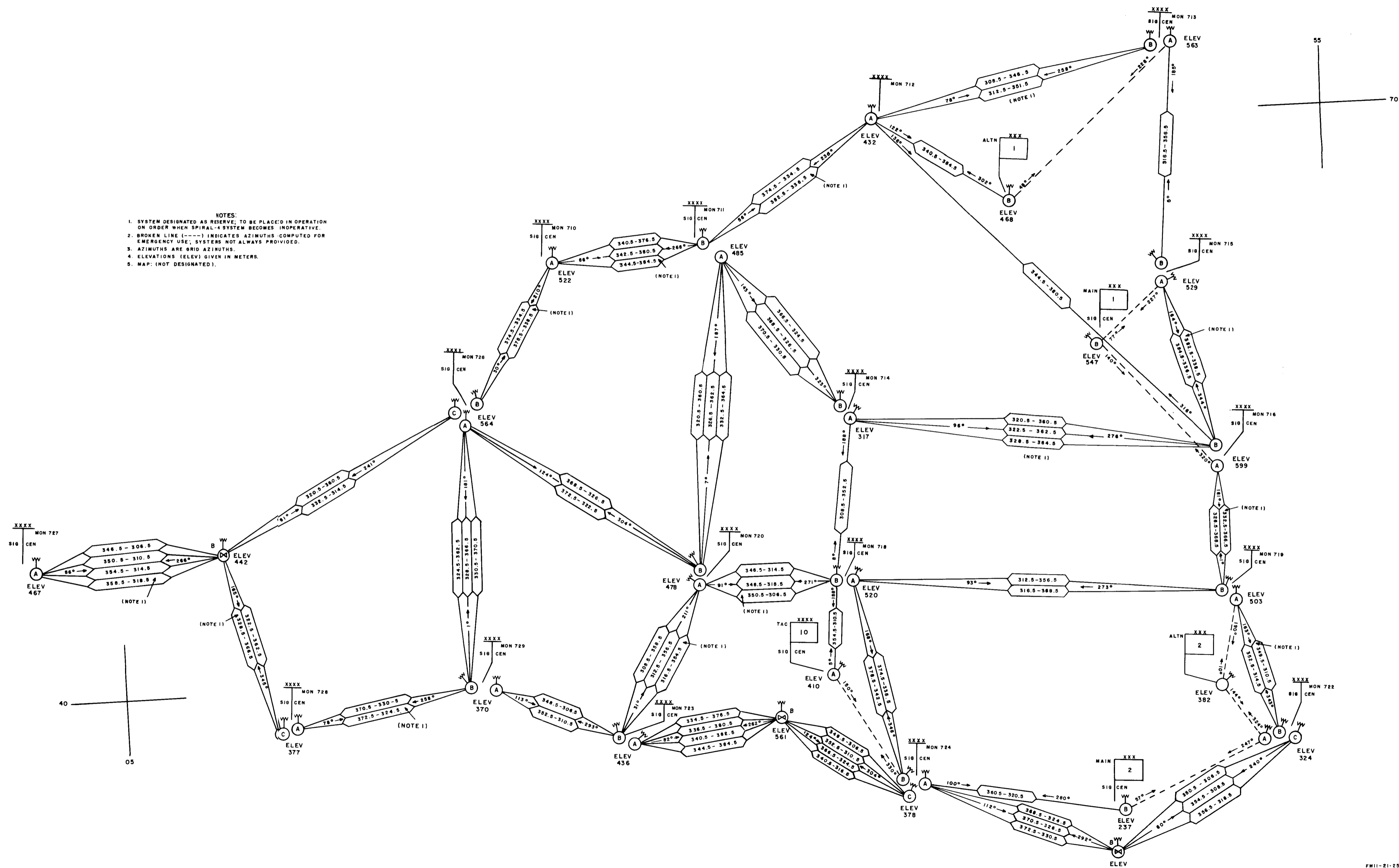

Figure 11. Type army (two-corps) systems diagram.

Figure 11



- NOTES:
1. SYSTEM DESIGNATED AS RESERVE, TO BE PLACED IN OPERATION ON ORDER WHEN SPIRAL-4 SYSTEM BECOMES INOPERATIVE.
  2. BROKEN LINE (---) INDICATES AZIMUTHS COMPUTED FOR EMERGENCY USE; SYSTEMS NOT ALWAYS PROVIDED.
  3. AZIMUTHS ARE GRID AZIMUTHS.
  4. ELEVATIONS (ELEV) GIVEN IN METERS.
  5. MAP: (NOT DESIGNATED).

Figure 12. Type field army (two-corps) radio-relay system map.

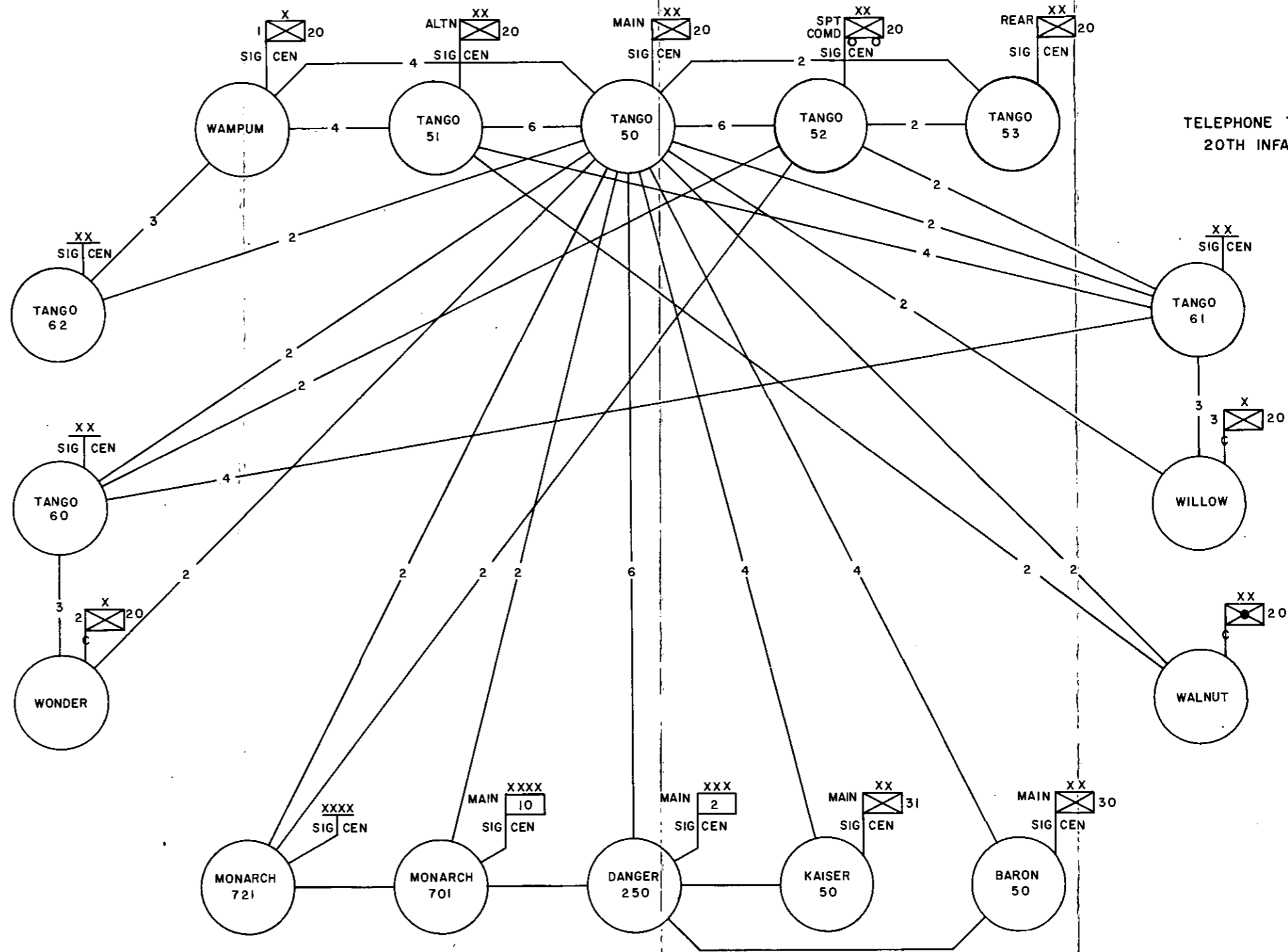

TELEPHONE TRAFFIC DIAGRAM  
20TH INFANTRY DIVISION

Figure 13. Type infantry division telephone traffic diagram.

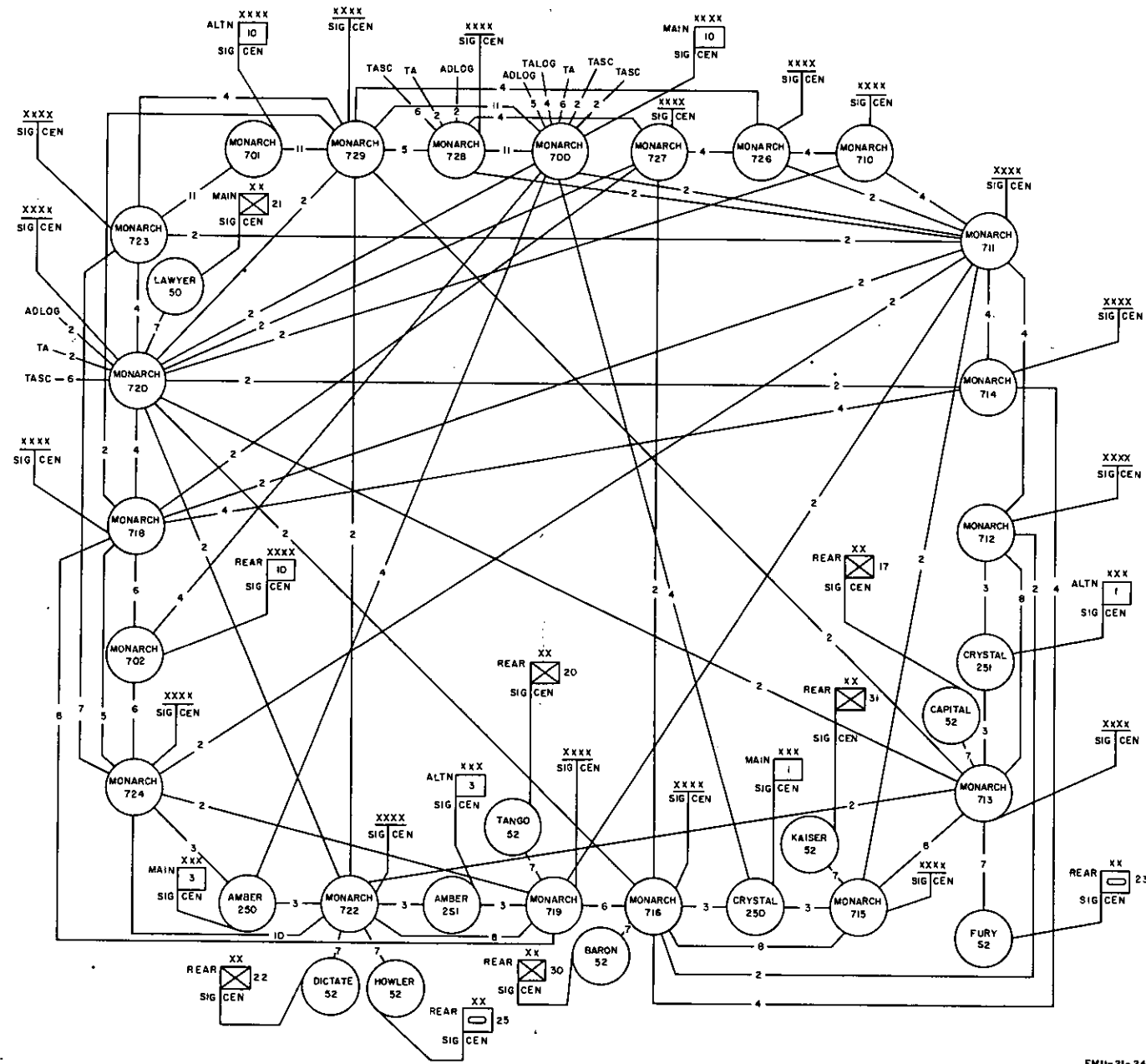

FMII-21-24

Figure 14. Type field army telephone traffic diagram.

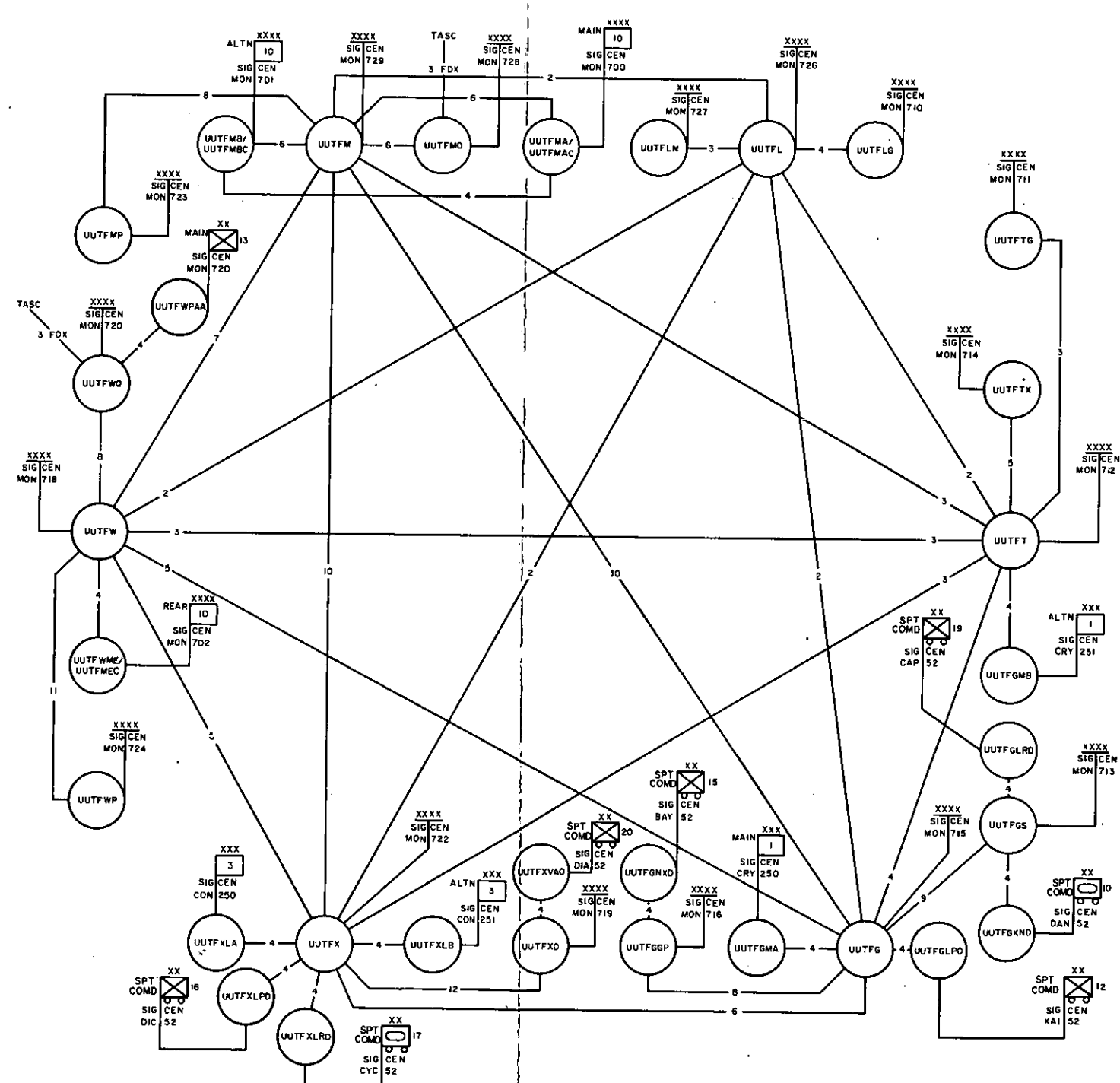

FMII-21-27

Figure 16. Type field army teletypewriter traffic diagram.

Figure 16



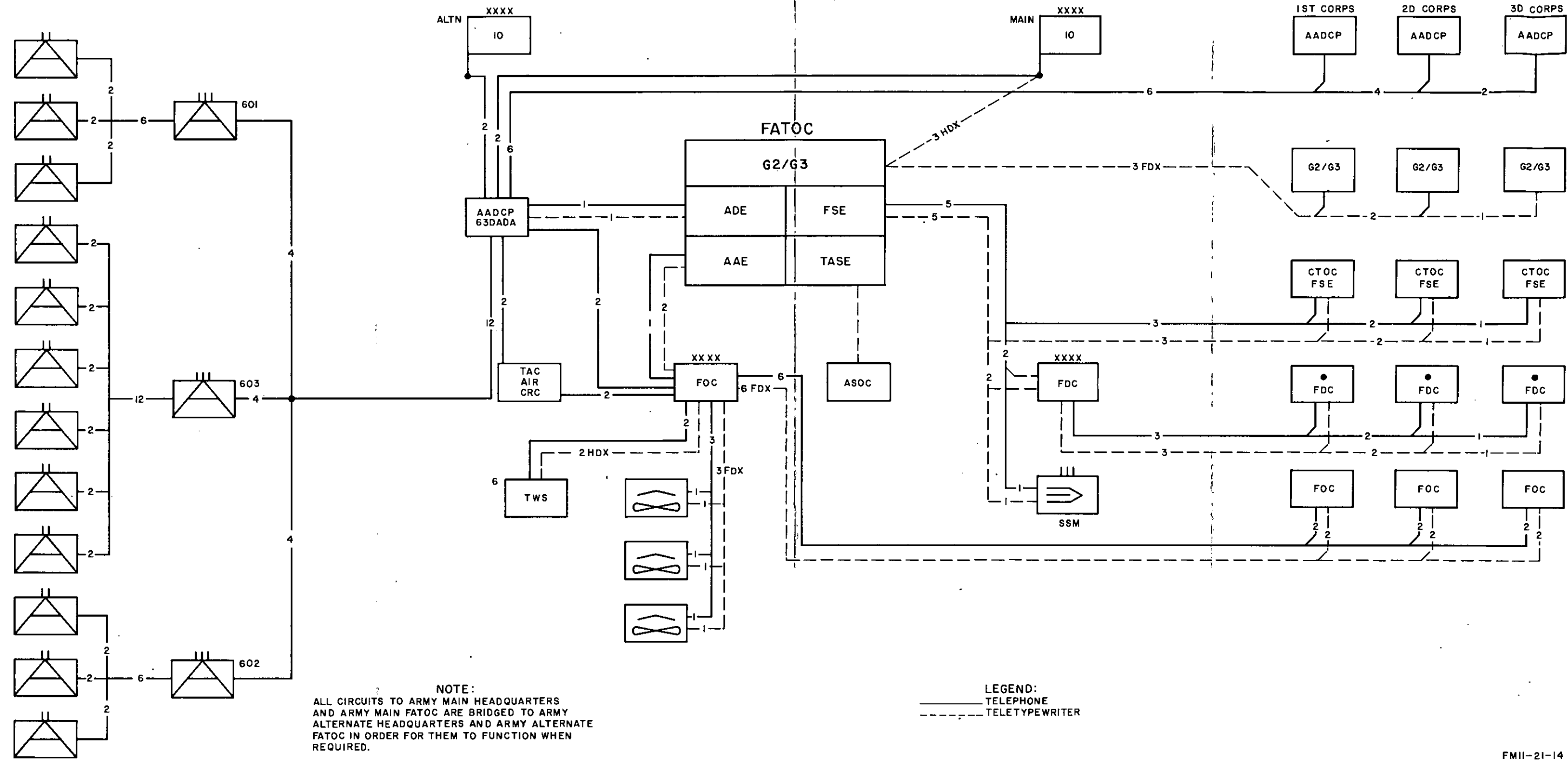

NOTE:  
 ALL CIRCUITS TO ARMY MAIN HEADQUARTERS  
 AND ARMY MAIN FATOC ARE BRIDGED TO ARMY  
 ALTERNATE HEADQUARTERS AND ARMY ALTERNATE  
 FATOC IN ORDER FOR THEM TO FUNCTION WHEN  
 REQUIRED.

LEGEND:  
 — TELEPHONE  
 - - - TELETYPEWRITER

Figure 17. Type army sole-user telephone and teletypewriter traffic diagram.

