

**ARMY  
NAVY  
AIR FORCE**

**TM 11-5895-1303-24P  
EE162-NG-PLD-010/W110-RT1512G  
TO 31R2-4-562-4**

---

**TECHNICAL MANUAL**

**ORGANIZATIONAL, DIRECT SUPPORT, AND GENERAL SUPPORT  
MAINTENANCE REPAIR PARTS AND SPECIAL TOOLS LIST  
(INCLUDING DEPOT MAINTENANCE REPAIR PARTS AND SPECIAL TOOLS)**

**FOR**

**RECEIVER-TRANSMITTER  
RT-1512/G  
(NSN 5895-01-205-6148)**

Distribution authorized to the Department of Defense and DOD contractors only for official use or for administration or operational purposes. This determination was made on 7 July 1989. Other requests for this document will be referred to Commander, US Army Communications-Electronics Command and Fort Monmouth, ATTN: AMSEL-ME-LC-P, Fort Monmouth, NJ 07703-5000.

DESTRUCTION NOTICE—Destroy by any method that will prevent disclosure of contents or reconstruction of the document.

---

**DEPARTMENTS OF THE ARMY, THE NAVY AND THE AIR FORCE**

**15 JULY 1989**

Technical Manual  
No. 11-5895-1303-24P  
NAVY EE162-NG-PLD-010/W110-RT1512G  
Technical Order  
No. 31R2-4-562-4

DEPARTMENTS OF THE ARMY,  
THE NAVY, AND THE AIR FORCE

Washington, DC, 15 July 1989

ORGANIZATIONAL, DIRECT SUPPORT AND GENERAL SUPPORT  
MAINTENANCE REPAIR PARTS AND SPECIAL TOOLS LIST  
(INCLUDING DEPOT MAINTENANCE REPAIR PARTS AND SPECIAL TOOLS)  
FOR  
RECEIVER-TRANSMITTER RT-1512/G  
(NSN 5895-01-205-6148)

REPORTING ERRORS AND RECOMMENDING IMPROVEMENTS

You can help improve this manual. If you find any mistakes or if you know of a way to improve the procedures, please let us know. Mail your letter, DA Form 2028 (Recommended Changes to Publications and Blank Forms), or DA Form 2028-2 located in back of this manual direct to: Commander, US Army Communications-Electronics Command and Fort Monmouth, ATTN: AMSEL-LC-ME-PS, Fort Monmouth, New Jersey 07703-5000.

For Air Force, submit AFTO Form 22 (Technical Order System Publication Improvement Report and Reply) in accordance with paragraph 6-5, Section VI, TO 00-5-1. Forward direct to prime ALC/MST.

For Navy, mail comments to the Commander, Space and Naval Warfare Systems Command, ATTN: SPAWAR 8122, Washington, DC 20363-5100.

In either case, a reply will be furnished direct to you.

TABLE OF CONTENTS

		Page	Illus Figure
Section	I. Introduction .....		1
	II. Repair Parts List .....		
Group	00 Receiver, Transmitter RT-1512/G (A3023756) .....	1-1	1
	01 Chassis Assembly A1 (A3024604) .....	2-1	2
	0101 Module Interconnect CCA A1A1 (A3024659) .....	3-1	3
	0102 Printed Cable Assembly, Flexible Interconnect A1W3 (A3024609) .....	4-1	4
	02 Controller, RT C-11670/G A2 (A3023813) (See TM 11-5895-1315-24P for Repair Parts)		
	03 Synthesizer A3 (A3024340) .....	5-1	5

TABLE OF CONTENTS

Group		Page	Illus. Figure
	0301 Loop 1/Sum Loop 1 Assy A3A1 (A3024344) .....	6-1	6
	030101 Loop 1 CCA A3A1A1 (A3024346) .....	7-1	7
	030102 Sum Loop 1 CCA A3A1A2 (A3024350) .....	8-1	8
	0302 Loop 2/Sum Loop 2 Assy A3A2 (A3024354) .....	9-1	9
	030201 Loop 2 CCA A3A2A1 (A3024356) .....	10-1	10
	030202 Sum Loop 2 CCA A3A2A2 (A3024360) .....	11-1	11
	0303 Loop 3/Ref Assembly A3A3 (A3024364).	12-1	12
	030301 Loop 3 CCA A3A3A1 (A3024366) .....	13-1	13
	030302 Reference CCA A3A3A2 (A3024370) .....	14-1	14
	0304 Chassis/Regulator Assy A3A4 (A3024374) .....	15-1	15
04	Reference Oscillator Assembly A4 (A3024618) .....	16-1	16
	0401 Reference Oscillator CCA A4A1 (A3024621) .....	17-1	17
	0402 Status CCA A4A2 (A3024625) .....	18-1	18
05	Audio Sideband Exciter Assembly A5 (A3024629) .....	19-1	19
	0501 Audio Sideband Exciter CCA A5A1 (A3024630) .....	20-1	20
06	RF Amp Exciter Assembly A6 (A3024634) ...	21-1	21
	0601 RF Amp Exciter CCA A6A1 (A3024635) ..	22-1	22
07	RF Switch Assembly A7 (A3024649) .....	23-1	23
	0701 RF Switch CCA A7A1 (A3024650) .....	24-1	24
08	RF Receiver Assembly A8 (A3024644) .....	25-1	25
	0801 RF Receiver CCA A8A1 (A3024645) ....	26-1	26
09	IF Receiver Assembly A9 (A3024639) .....	27-1	27
	0901 IF Receiver CCA A9A1 (A3024640) ....	28-1	28
10	Audio Receiver Assembly A10 (A3024654) ..	29-1	29
	1001 Audio Receiver CCA A10A1 (A3024655) .....	30-1	30
11	Power Supply Assembly PS1 (A3024060) .....	31-1	31
	1101 AC to DC Inverter CCA PS1A2 (A3024841) .....	32-1	32
	1102 Regulator Output CCA PS1A3 (A3028133) .....	33-1	33
Section III.	Special Tools List.....		
Group 20	Special Tools.....	34-1	34
Section IV.	Cross-Reference Indexes		
	National Stock Number Index.....	I-1	
	Part Number Index.....	I-15	
	Figure and Item Number Index.....	I-50	

# SECTION I INTRODUCTION

## 1. Scope

This manual lists and authorizes spares and repair parts; special tools; special test, measurement, and diagnostic equipment (TMDE), and other special support equipment required for performance of organizational, direct support, and general maintenance of Receiver-Transmitter RT-1512/G. It authorizes the requisitioning, issue, and disposition of spares, repair parts and special tools as indicated by the source maintenance and recoverability (SMR) codes.

## 2. General

This Repair Parts and Special Tools List is divided into the following sections:

a. *Section II. Repair Parts List.* A list of spares and repair parts authorized by this RPSTL for use in the performance of maintenance. The list also includes parts which must be removed for replacement of the authorized parts. Parts lists are composed of functional groups in ascending numeric sequence, with the parts in each group listed in ascending item number sequence. Figure numbers are listed directly beneath the group header. Bulk materials are listed in item name sequence.

b. *Section III. Special Tools List.* A list of special tools, special TMDE, and other special support equipment authorized by this RPSTL (as indicated by Basis of Issue (BOI) information in (column (5)) for the performance of maintenance.

c. *Section IV. Cross-Reference Indexes.* A list in National item identification number (NIIN) sequence, of all National stock numbered items appearing in the listing, followed by a list in alphameric sequence of all part numbers appearing in the listings. National stock numbers and part numbers are cross-referenced to each illustration figure and item number appearance. The figure number and item number index lists figure and item numbers in numeric sequence and cross-references National stock number, Federal supply code for manufacturer and part numbers.

## 3. Explanation of Columns (Section II and III)

a. *Item No. (Column (1)).* Indicates the number used to identify items called out in the illustration.

b. *SMR Code (Column (2)).* The source, maintenance, and recoverability (SMR) code is a five-position code containing supply/requisitioning information, maintenance category authorization criteria, and disposition instruction, as shown in the following breakout:

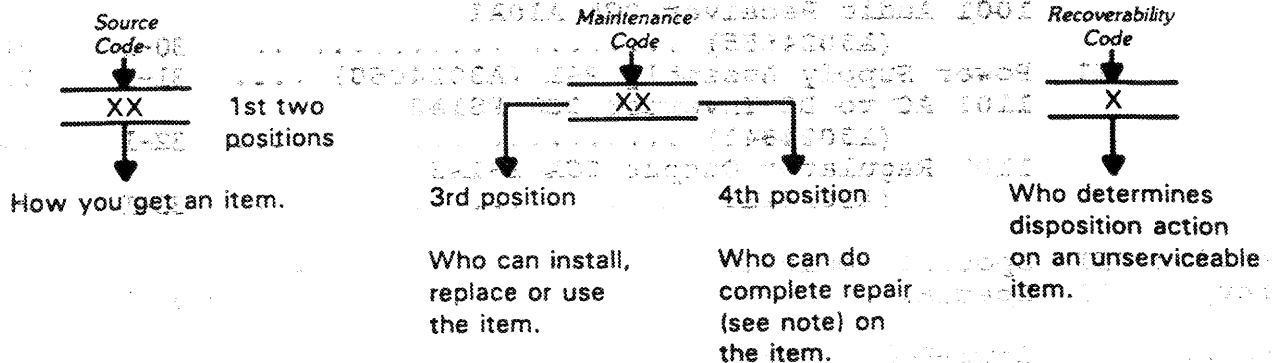



**NOTE**

Complete repair: Maintenance capacity, capability, and authority to perform all corrective maintenance tasks of the "Repair" function in a use/user environment in order to restore serviceability to a failed item.

(1) *Source Code.* The source code tells you how to get an item needed for maintenance, repair, or overhaul of an end item/equipment. Explanations of source codes follows:

<i>Code</i>	<i>Explanation</i>
PA PB PC PD PE PF PG	Stocked items; use the applicable NSN to request/requisition items with these source codes. They are authorized to the category indicated by the code entered in the third position of the SMR code.

**NOTE**

Items coded PC are subject to deterioration.

KD KF KB	Items with these codes are not to be requested/requisitioned individually. They are part of a kit which is authorized to the maintenance category indicated in the third position of the SMR code. The complete kit must be requisitioned and applied.
----------------	--

MO — Made at org/ AVUM category MF — Made at DS/ AVIM category MH — Made at GS category ML — Made at Spec- ialized Repair Activity (SRA) MD — Made at Depot	Items with these codes are not to be requested/requisitioned individually. They must be made from bulk material which is identified by the part number in the description and usable on code (UOC) column and listed in the Bulk Material group of the repair parts list. If the item is authorized to you by the third position code of the SMR code, but the source code indicates it is made at a higher category, order the item from the higher category of maintenance.
--	---

AO — Assembled by org/ AVUM category AF — Assembled by DS/ AVIM category AH — Assembled by GS category AL — Assembled by SRA AD — Assembled by Depot	Items with these codes are not to be requested/requisitioned individually. The parts that make up the assembled item must be requisitioned or fabricated and assembled at the category of maintenance indicated by the source code. If the disposition code of the SMR code authorizes you to replace the item, but the source code indicates the item is assembled at a higher category, order the item from the higher category of maintenance.
---	---

- XA — Do not requisition an "XA" coded item. Order its next higher assembly.
- XB — If an "XB" item is not available from salvage, order it using the FSCM and part number given.
- XC — Installation drawing, diagram, instruction sheet, field service drawing, that is identified by manufacturers part number.
- XD — Item is not stocked. Order an "XD" coded item through normal supply channels using the FSCM and part number given, if no NSN is available.

**NOTE**

Cannibalization or controlled exchange, when authorized, may be used as a source of supply for items with the above source codes, except for those source coded "XA" or those aircraft support items restricted by requirements of AR 750-1.

(2) *Maintenance Code.* Maintenance codes tell you the category of maintenance authorized to USE and REPAIR support items. The maintenance codes are entered in the third and fourth positions of the SMR code as follows:

(a) The maintenance code entered in the third position tells you the lowest maintenance category authorized to remove, replace, and use an item. The maintenance code entered in the third position will indicate authorization to one of the following categories of maintenance.

Code Application/Explanation

- C — Crew or operator maintenance done within organizational or aviation maintenance.
- Q — Organizational or aviation unit category can remove, replace, and use the item.
- F — Direct support or aviation intermediate category can remove, replace, and use the item.
- H — General support category can remove, replace, and use the item.
- L — Specialized repair activity can remove, replace, and use the item.
- D — Depot category can remove, replace, and use the item.

(b) The maintenance code entered in the fourth position tells whether or not the item is to be repaired and identifies the lowest maintenance category with the capability to do complete repair (i.e., perform all authorized repair functions). This position will contain one of the following maintenance codes:

**NOTE**

Some limited repair may be done on the item at a lower category of maintenance, if authorized by the Maintenance Allocation Chart (MAC) and SMR codes.

Code Application/Explanation

- O — Organizational or aviation unit is the lowest category that can do complete repair of the item.
- F — Direct support or aviation intermediate is the lowest category that can do complete repair of the item.
- H — General support is the lowest category that can do complete repair of the item.
- L — Specialized repair activity (designate the specialized repair activity) is the lowest category that can do complete repair of the item.
- D — Depot is the lowest category that can do complete repair of the item.
- Z — Nonreparable. No repair is authorized.
- B — No repair is authorized. (No parts or special tools are authorized for the maintenance of a "B" coded item.) However, the item may be reconditioned by adjusting, lubricating, etc., at the user category.

(3) *Recoverability Code.* Recoverability codes are assigned to items to indicate the disposition action on unserviceable items. The recoverability code is entered in the fifth position of the SMR Code as follows:

**Recoverability  
codes****Application/Explanation:**

- Z** — Nonreparable item. When unserviceable, condemn and dispose of the item at the category of maintenance shown in the third position of SMR-Code.
- O** — Reparable item. When uneconomically repairable, condemn and dispose of the item at organizational or aviation unit category.
- F** — Reparable item. When uneconomically repairable, condemn and dispose of the item at the direct support or aviation intermediate category.
- H** — Reparable item. When uneconomically repairable, condemn and dispose of the item at general support category.
- D** — Reparable item. When beyond lower level repair capability, return to depot. Condemnation and disposal of item not authorized below depot category.
- L** — Reparable item. Condemnation and disposal not authorized below specialized repair activity (SRA).
- A** — Item requires special handling or condemnation procedures because of specific reasons (e.g., precious metal content, high dollar value, critical material, or hazardous material). Refer to appropriate manuals/directives for specific instructions.

*c. FSCM (Column (3)).* The Federal Supply Code for Manufacturer (FSCM) is a 5-digit numeric code which is used to identify the manufacturer, distributor, or Government agency, etc., that supplies the item.

*d. Part Number (Column (4)).* Indicates the primary number used by the manufacturer (individual, company, firm, corporation, or Government activity), which controls the design and characteristics of the item by means of its engineering drawings, specifications, standards, and inspection requirements to identify an item or range of items.

**NOTE**

When you use a NSN to requisition an item, the item you receive may have a different part number from the part ordered.

*e. Description and Usable on Code (UOC) (Column (5)).* This column includes the following information.

- (1) The Federal item name and, when required, a minimum description to identify the item.
- (2) In the Special Tools section, the basis of issue (BOI) appears as the last line in the entry for each special tool, special TMDE, and other special support equipment. When density of equipments supported exceeds density spread indicated in the basis of issue, the total authorization is increased proportionately.
- (3) The statement "END OF FIGURE" appears just below the last item description in Column (5) for a given figure in both section II and section III.

*f. Qty (Column (6)).* Indicates the quantity of the item used in the breakout shown on the illustration figure, which is prepared for a functional group, subfunctional group, or an assembly. A "V" appearing in this column in lieu of a quantity indicates that the quantity is variable and the quantity may vary from application to application.

**4. Explanation of Columns (Section IV)***a. National Stock Number (NSN) Index.*

(1) *Stock number column.* This column lists the NSN by National item identification number (NIIN) sequence. The NIIN consists of the last nine digits of the NSN. When using this column to locate an item, ignore the first four digits of the NSN. When requisitioning items use the complete NSN (13 digits).

(2) *Fig. column.* This column lists the number of the figure where the item is identified/located. The illustrations are in numerical sequence in sections II and III.

(3) *Item column.* The item number identifies the item associated with the figure listed in the adjacent *Fig. column*. This item is also identified by the NSN listed on the same line.

*b. Part Number Index.* Part numbers in this index are listed by part number in ascending alphanumeric sequence.

(1) *FSCM column.* This column lists the Federal supply code for manufacturer (FSCM).

(2) *Part number column.* This column indicates the part number assigned to the item.

(3) *Stock number column.* This column lists the National stock number for the associated part number and manufacturer identified in the part number and FSCM columns to the left.

(4) *Fig. column.* This column lists the number of the figure where the item is identified/located in sections II and III.

(5) *Item column.* The item number is that number assigned to the item as it appears in the figure referenced in the adjacent figure number column.

*c. Figure and Item Number Index.*

(1) *Fig. column.* This column lists the number of the figure where the item is identified/located in sections II and III.

(2) *Item column.* The item number is that number assigned to the item as it appears in the figure referenced in the adjacent figure number column.

(3) *Stock number column.* This column lists the National stock number for the item.

(4) *FSCM column.* The Federal supply code for manufacturer (FSCM) is a 5-digit numeric code used to identify the manufacturer, distributor, or Government agency, etc., that supplies the item.

(5) *Part number column.* Indicates the primary number used by the manufacturer (individual, firm, corporation, or Government activity), which controls the design and characteristics of the item by means of its engineering drawings, specifications, standards, and inspection requirements to identify an item or range of items.

## 5. Special Information

*a. Associated Publications.* The publication listed below pertains to Controller, Receiver-Transmitter, C-11670/G and its components:

TM 11-5895-1315-24P, Controller, Receiver-Transmitter, C-11670/G

*b. National Stock Numbers.* National stock numbers (NSN's) that are missing from P source coded items have been applied for and will be added to this TM by future change/revision when they are entered in the Army Master Data File (AMDF). Until the NSN's are established and published, submit exception requisitions to: Commander, US Army Communications-Electronics Command and Fort Monmouth, ATTN: AMSEL-LC-MM, Fort Monmouth, NJ 07703-5000 for the part required to support your equipment.

### NOTE

An item SMR coded "H" in the third, fourth, and fifth position is interpreted as Intermediate for Air Force Repair.

## 6. How to Locate Repair Parts

a. *When National stock number or part number is not known.*

(1) *First.* Using the table of contents, determine the assembly group or subassembly group to which the item belongs. This is necessary since figures are prepared for assembly groups and subassembly groups, and listings are divided into the same groups.

(2) *Second.* Find the figure covering the assembly group or subassembly group to which the item belongs.

(3) *Third.* Identify the item on the figure and note the item number.

(4) *Fourth.* Refer to the Repair Parts List for the figure to find the part number for the item number noted on the figure.

(5) *Fifth.* Refer to the Part Number Index to find the NSN, if assigned.

b. *When National stock number or part number is known.*

(1) *First.* Using the Index of National stock numbers and part numbers, find the pertinent National stock number or part number. The NSN index is in National item identification number (NIIN) sequence (para 4a(1)). The part numbers in the part number index are listed in ascending alphameric sequence (para 4b). Both indexes cross-reference you to the illustration figure and item number of the item you are looking for.

(2) *Second.* After finding the figure and item number, verify that the item is the one you're looking for, then locate the item number in the repair parts list for the figure.

## 7. Abbreviations

Not applicable.

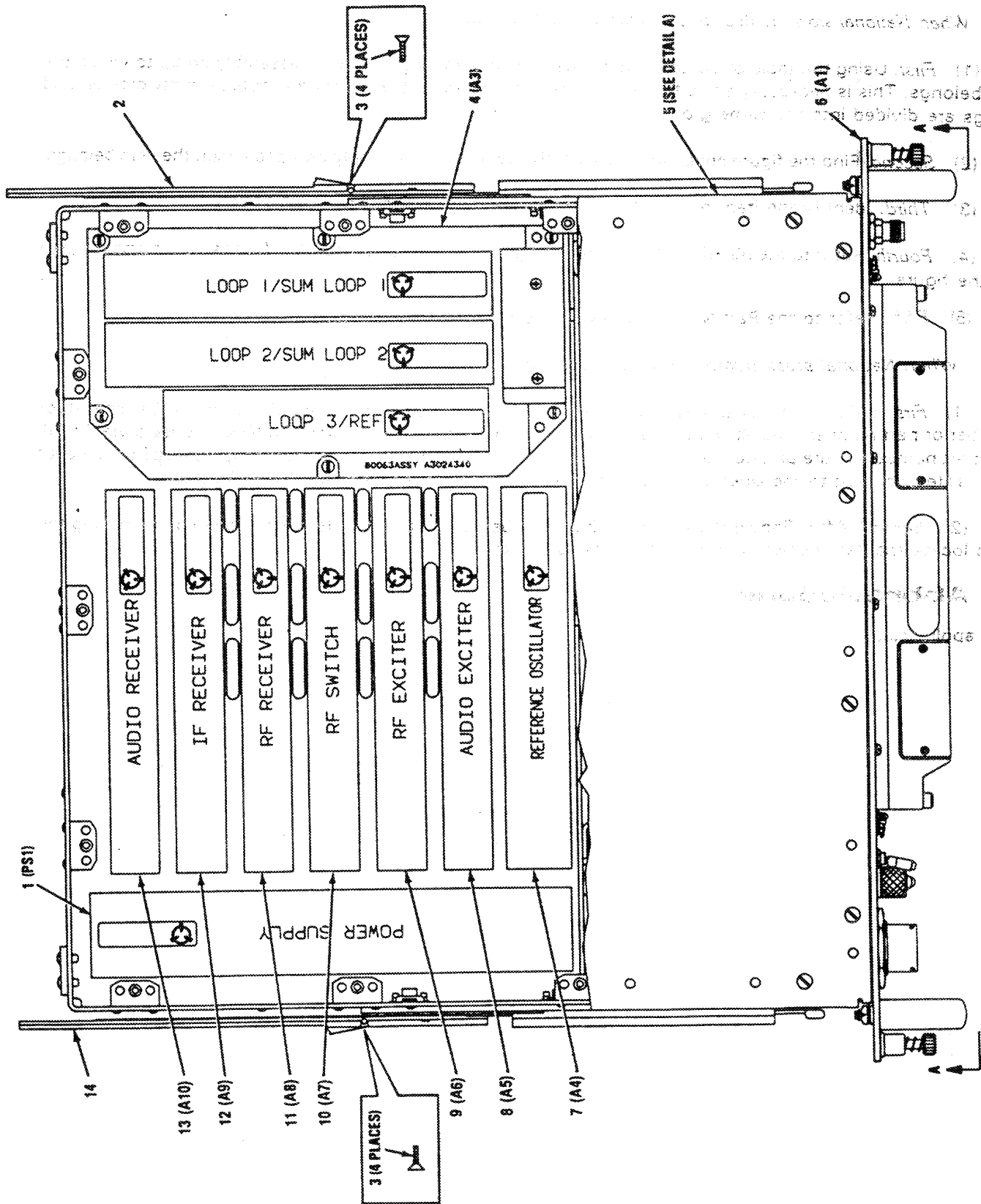

NOTE: PREFIX ALL REFERENCE DESIGNATIONS WITH 1A1, 1A2, 1A3, 3A5

TOP VIEW

Figure 1. Receiver-Transmitter RT1512/G (A3023756) (Sheet 1 of 4)

CEOMY 001

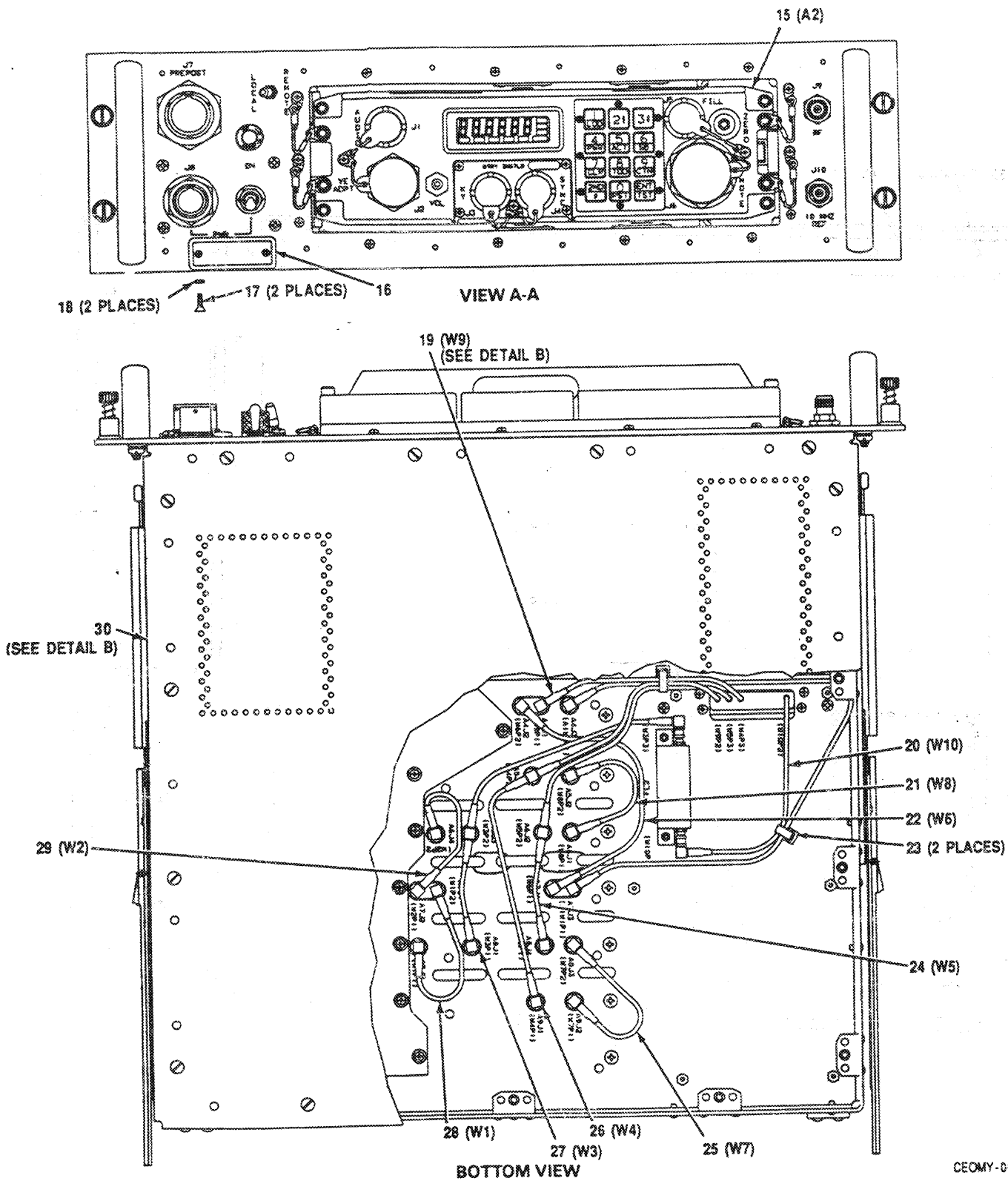

CEOMY-002

Figure 1. Receiver-Transmitter RT-1512/G (A3023756) (Sheet 2 of 4)

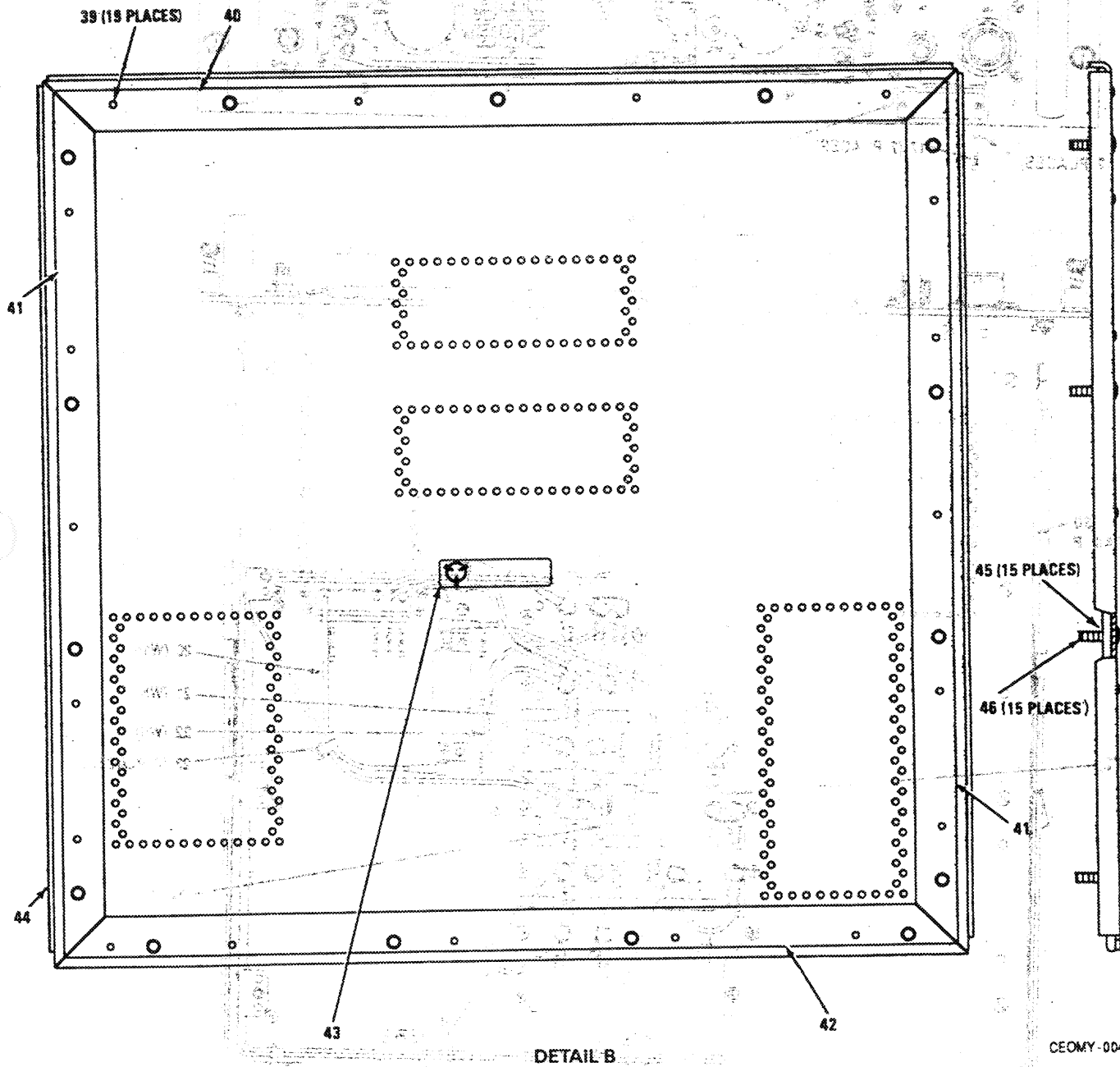

Figure 1. Receiver-Transmitter RT-1512/G (A3023756) (Sheet 4 of 4)



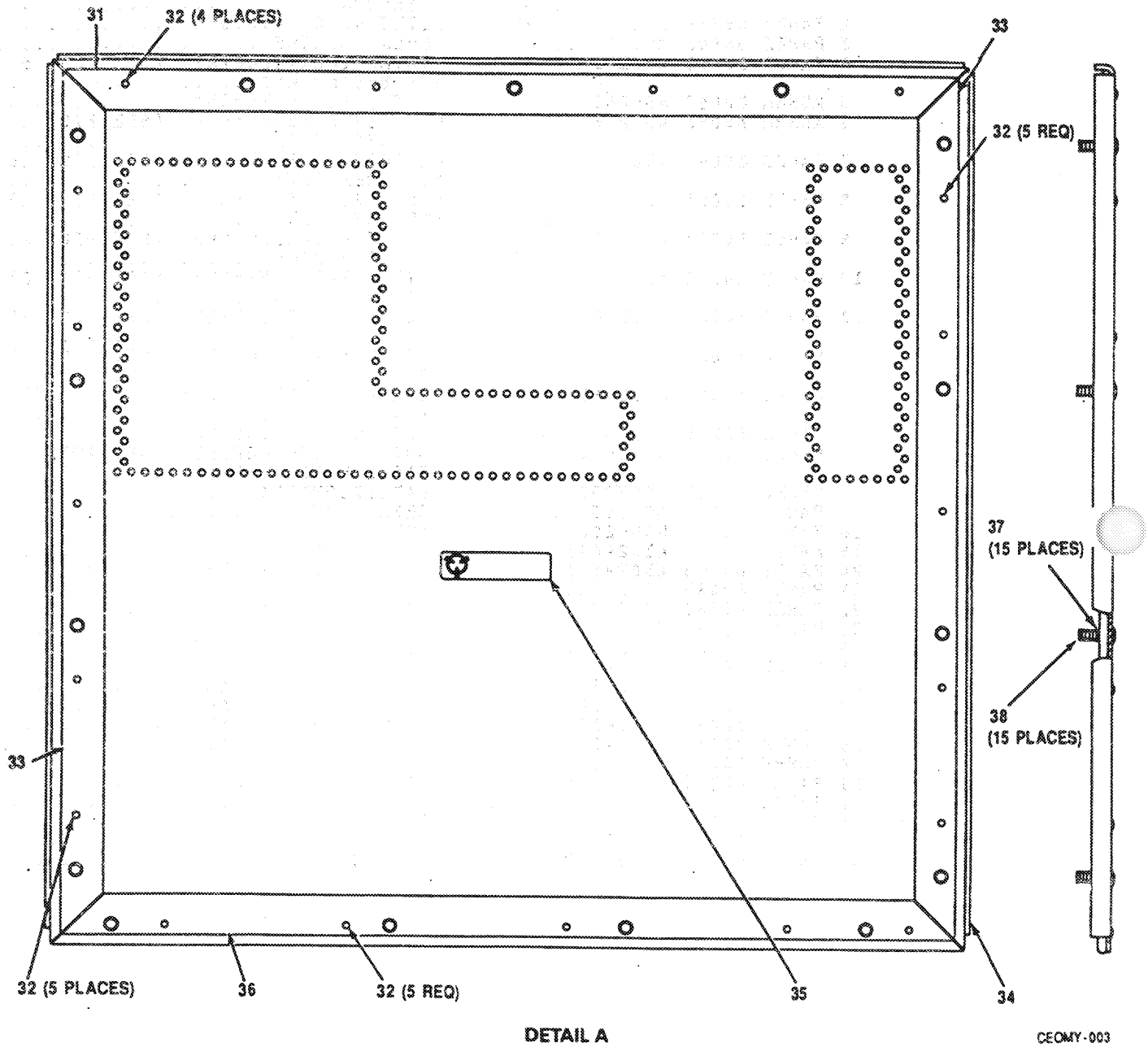

Figure 1. Receiver-Transmitter RT-1512/G (A3023756) (Sheet 3 of 4)

SECTION II  
 (1) (2) (3)  
 ITEM SMR  
 NO CODE FSCM

TM11-5895-1303-24P  
 (4)  
 PART  
 NUMBER

1001-8888-11 MT  
 (5) (6)

DESCRIPTION AND USABLE ON CODES(UOC) QTY  
 GROUP 00 RECEIVER, TRANSMITTER  
 RT-1512/G (A3023756)

FIG. 1

1	PAHHD	80063	A3024060	POWER SUPPLY (SEE FIG. 31 FOR BREAKDOWN)	1
2	PAHZZ	05236	05236-1201964B-R	SLIDE, QUICK DISCONN	1
3	PAHZZ	96906	MS24693C53	SCREW, MACHINE	8
4	PAHLD	80063	A3024340	SYNTHESIZER, ELECTRI (SEE FIG. 5 FOR BREAKDOWN)	1
5	XBHHH	80063	A3028035	COVER, ASSEMBLY--CHA	1
6	XBHHH	80063	A3024604	CHASSIS ASSEMBLY--R (SEE FIG. 2 FOR BREAKDOWN)	1
7	PAHDD	80063	A3024618	REFERENCE OSCILLATO (SEE FIG. 16 FOR BREAKDOWN)	1
8	PAHLD	80063	A3024629	AUDIO SIDEBAND EXCI (SEE FIG. 19 FOR BREAKDOWN)	1
9	PAHLD	80063	A3024634	AMPLIFIER, RADIO FRE (SEE FIG. 21 FOR BREAKDOWN)	1
10	PAHLD	80063	A3024649	SWITCH, RADIO FREQUE (SEE FIG. 23 FOR BREAKDOWN)	1
11	PAHLD	80063	A3024644	RECEIVER, RADIO FREQ (SEE FIG. 25 FOR BREAKDOWN)	1
12	PAHLD	80063	A3024639	RECEIVER, INTERMEDIA (SEE FIG. 27 FOR BREAKDOWN)	1
13	PAHLD	80063	A3024654	RECEIVER, RADIO (SEE FIG. 29 FOR BREAKDOWN)	1
14	PAHZZ	05236	05236-1201964B-L	SLIDE, QUICK DISCONN	1
15	PAOLD	80058	C-11670/G	CONTROL ECCM MODULE (SEE TM11-5895-1315-24P FOR PARTS BREAKDOWN)	1
16	XBHZZ	80063	A3032505	PLATE, IDENTIFICATIO	1
17	PAHZZ	96906	MS51957-12	SCREW, MACHINE	2
18	PAHZZ	80205	NAS620C4	WASHER, FLAT	2
19	PAHZZ	80063	A3024615-1	CABLE ASSEMBLY, RADI	1
20	PAHZZ	80063	A3024615-2	CABLE ASSEMBLY--RF	1
21	PAHZZ	80063	A3024380-7	CABLE ASSEMBLY, RADI	1
22	PAHZZ	80063	A3024380-5	CABLE ASSEMBLY, RADI	1
23	PAHZZ	96906	MS3367-1-9	STRAP, TIEDOWN, ELECT	2
24	PAHZZ	80063	A3024616-3	CABLE ASSEMBLY, RADI	1
25	PAHZZ	80063	A3024380-6	CABLE ASSEMBLY, RADI	1
26	PAHZZ	80063	A3024616-2	CABLE ASSEMBLY, RADI	1
27	PAHZZ	80063	A3024381-2	CABLE ASSEMBLY, RADI	1
28	PAHZZ	80063	A3024380-3	CABLE ASSEMBLY, RADI	1
29	PAHZZ	80063	A3024380-4	CABLE ASSEMBLY, RADI	1
30	XBHHH	80063	A3028579	COVER ASSEMBLY--CHA	1
31	PAHZZ	80063	A3028559	WIRE MESH, KNITTED	1
32	PAHZZ	96906	MS20470AD3-5-5	RIVET, SOLID	19
33	PAHZZ	80063	A3028557	WIRE MESH, KNITTED	2
34	XBHZZ	80063	A3028036	COVER, CHASSIS--TOP	1
35	XBHZZ	80063	A3034572	LABEL, SENSITIVE	1

1-1

SECTION II			TM11-5895-1303-24P			
(1)	(2)	(3)	(4)	(5)	(6)	
ITEM NO	SMR CODE	FSCM	PART NUMBER	DESCRIPTION AND USABLE ON CODES(UOC)	QTY	
36	PAHZZ	80063	A3028558	WIRE MESH,KNITTED.....	1	
37	PAHZZ	72794	UA3 T25	STUD,TURNLOCK FASTE.....	15	
38	PAHZZ	72794	Y166	RING,RETAINING.....	15	
39	PAHZZ	96906	MS20470AD3-5-5	RIVET,SOLID.....	19	
40	PAHZZ	80063	A3028559	WIRE MESH,KNITTED.....	1	
41	PAHZZ	80063	A3028557	WIRE MESH,KNITTED.....	2	
42	PAHZZ	80063	A3028558	WIRE MESH,KNITTED.....	1	
43	XBHZZ	80063	A3034572	LABEL, SENSITIVE.....	1	
44	XBHZZ	80063	A3028580	COVER, CHASSIS--BOTT.....	1	
45	PAHZZ	72794	UA3 T25	STUD,TURNLOCK FASTE.....	15	
46	PAHZZ	72794	Y166	RING,RETAINING.....	15	

END OF FIGURE

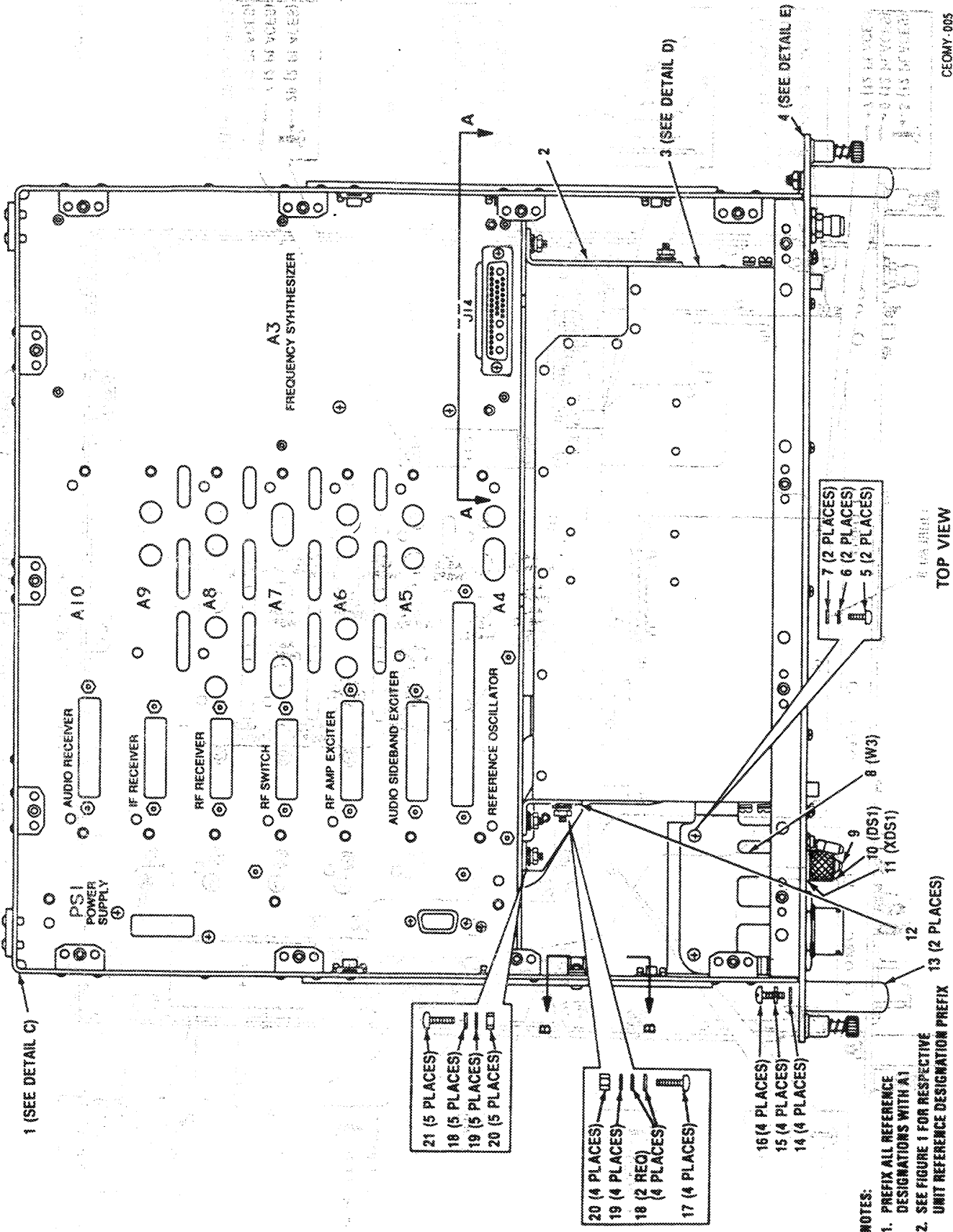

Figure 2. Chassis Assembly A1 (A3024604) (Sheet 1 of 9)

- NOTES:
1. PREFIX ALL REFERENCE DESIGNATIONS WITH A1
  2. SEE FIGURE 1 FOR RESPECTIVE UNIT REFERENCE DESIGNATION PREFIX

GEOMY-006

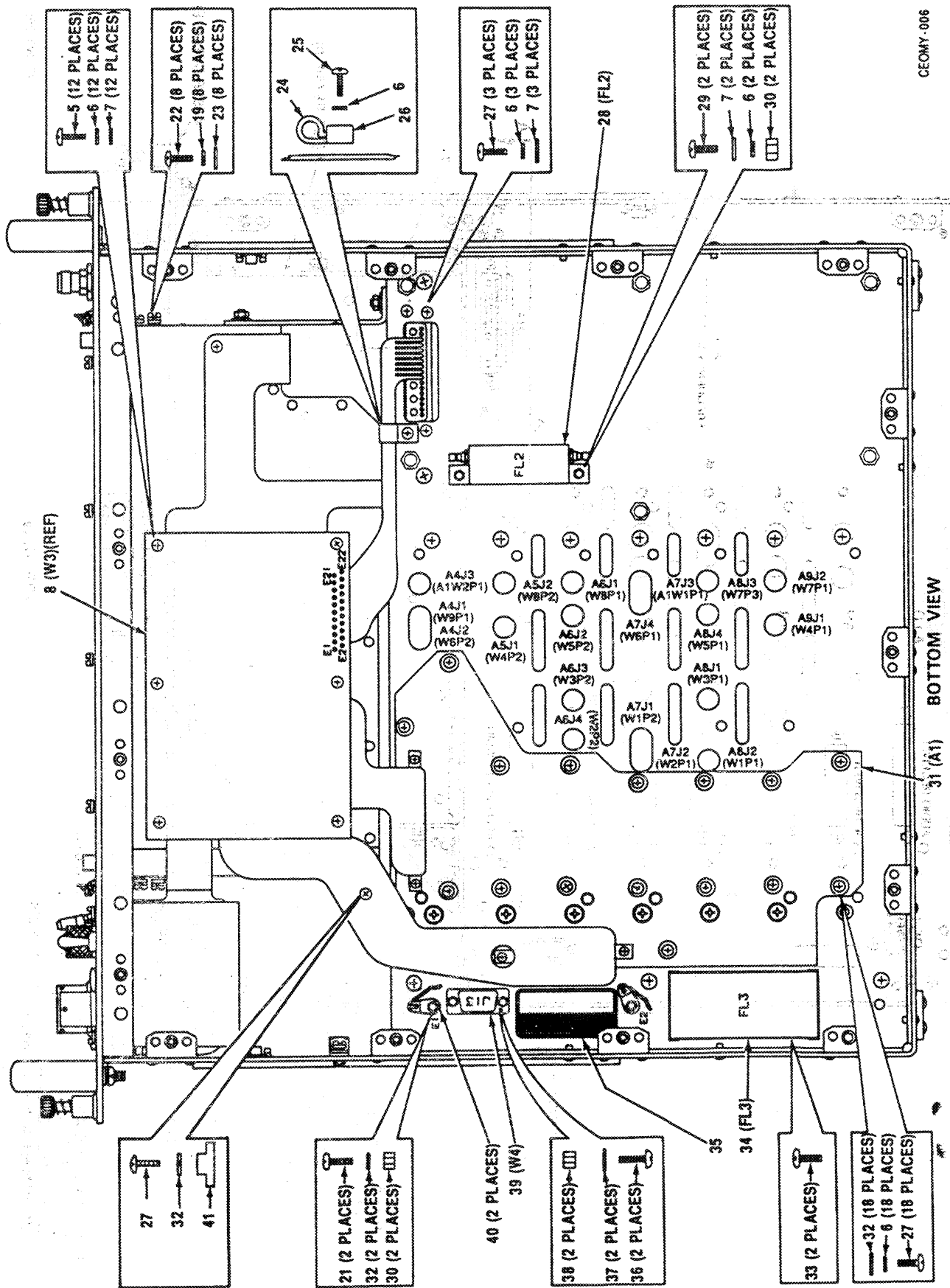

Figure 2. Chassis Assembly A1 (A3024604) (Sheet 2 of 9)

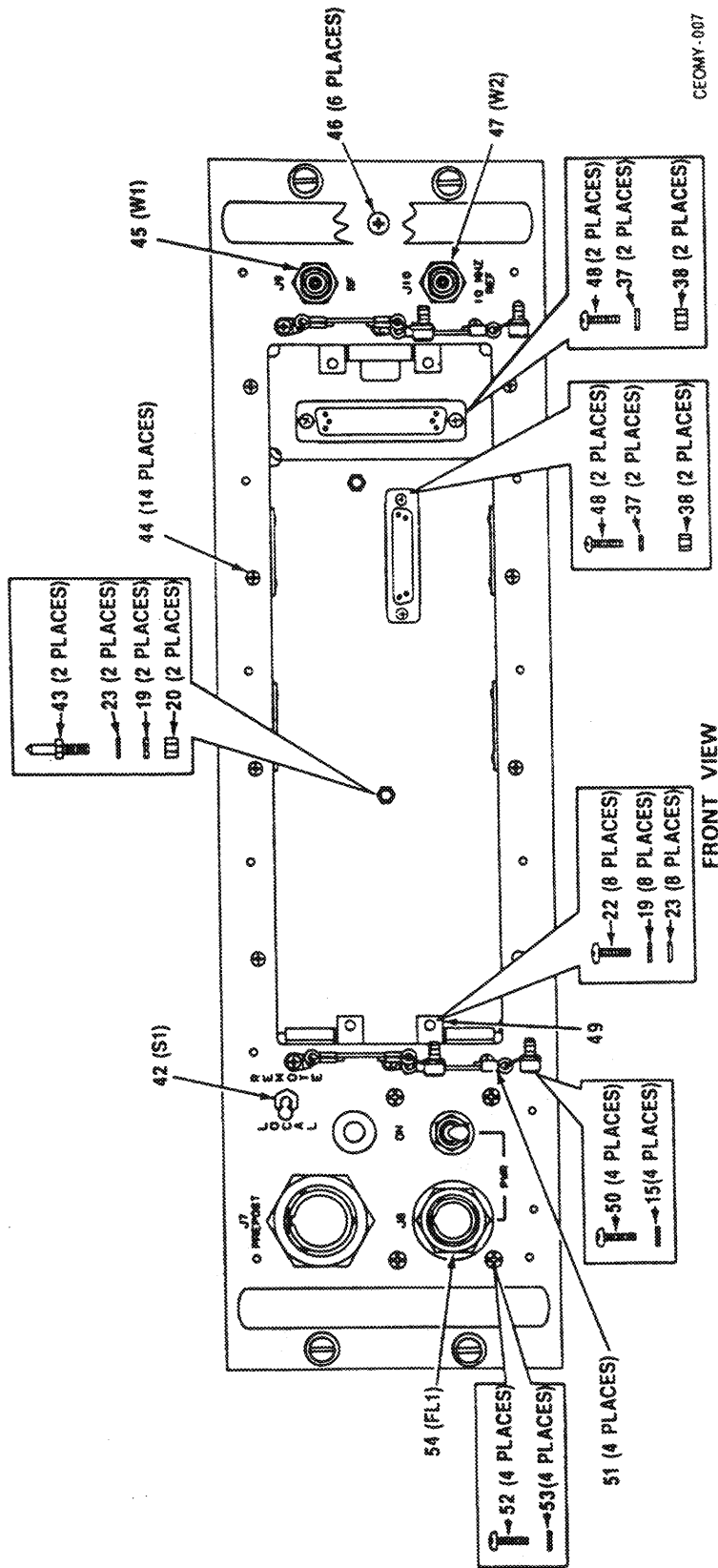
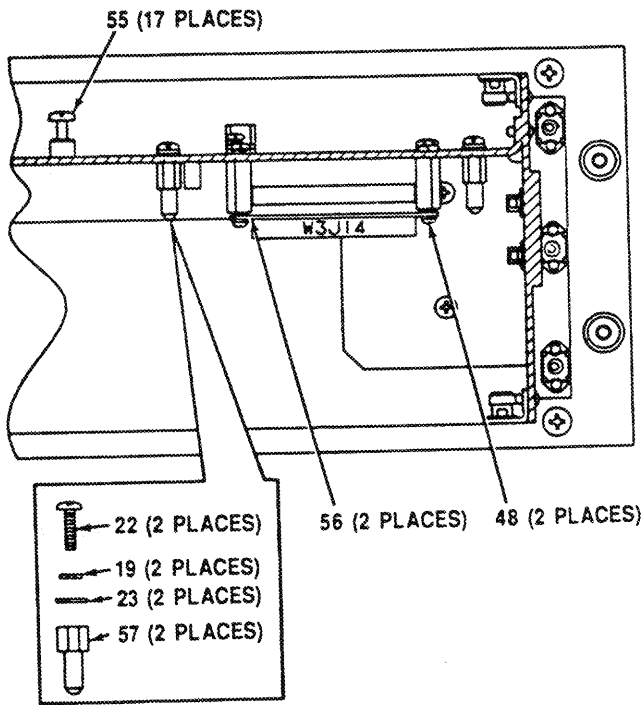
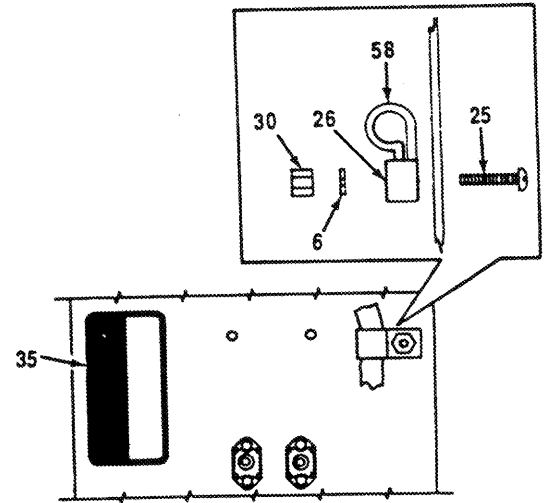

Figure 2. Chassis Assembly Al (A3024604) (Sheet 3 of 9)



SECTION A-A



SECTION B-B

CEOMY-008

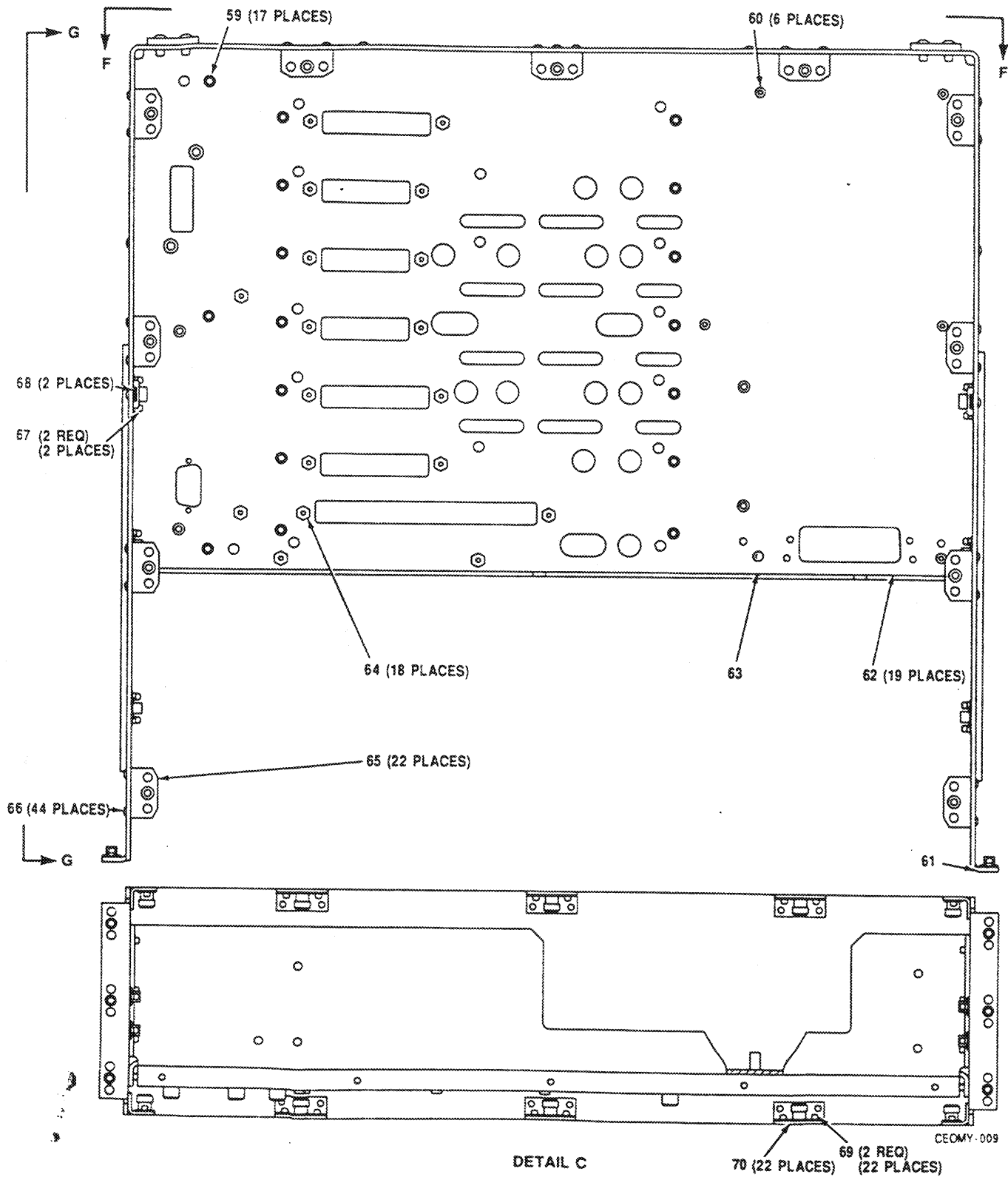
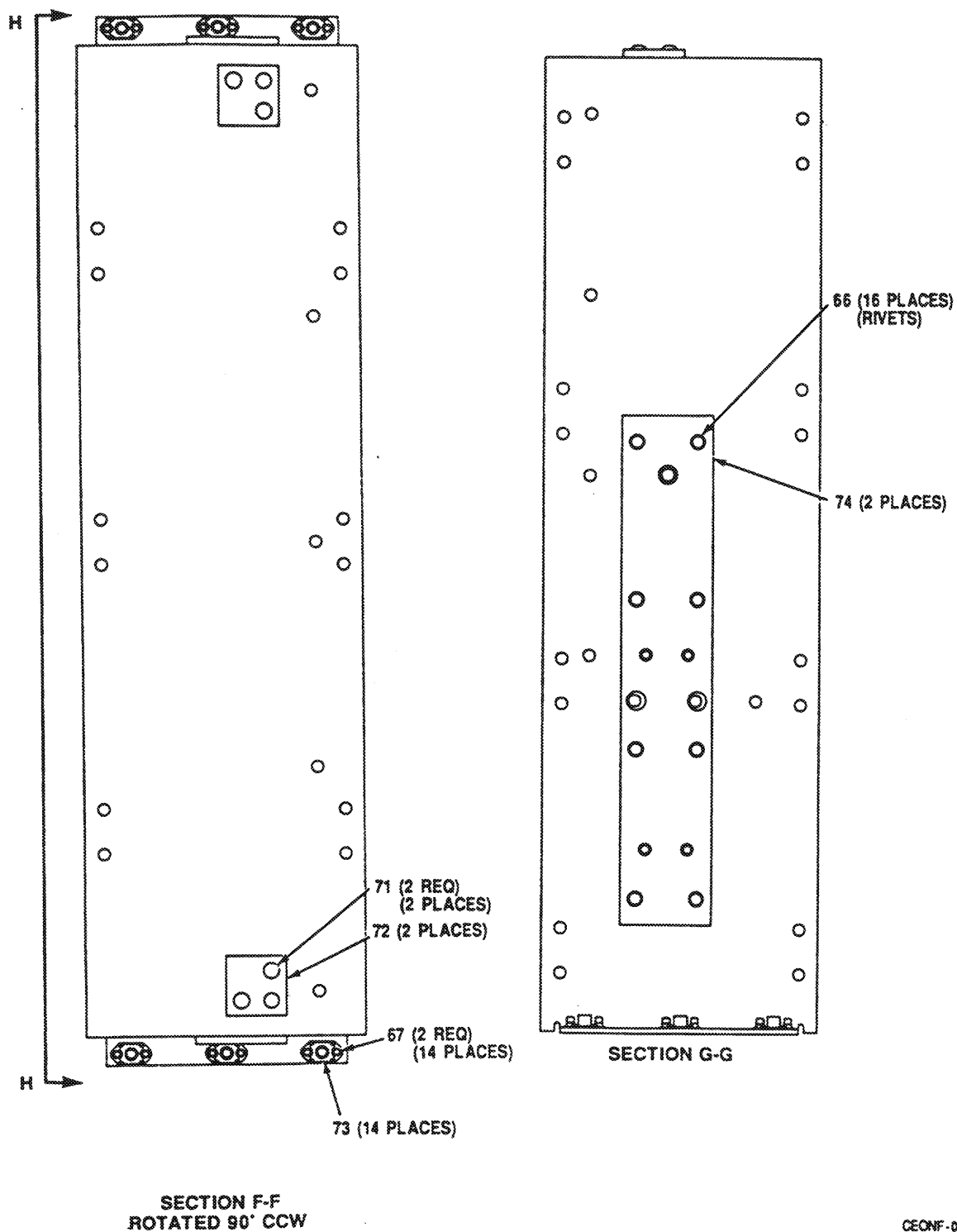

Figure 2. Chassis Assembly A1 (A3024604) (Sheet 5 of 9)







CEONF-010

Figure 2. Chassis Assembly A1 (A3023757) (Sheet 6 of 9)

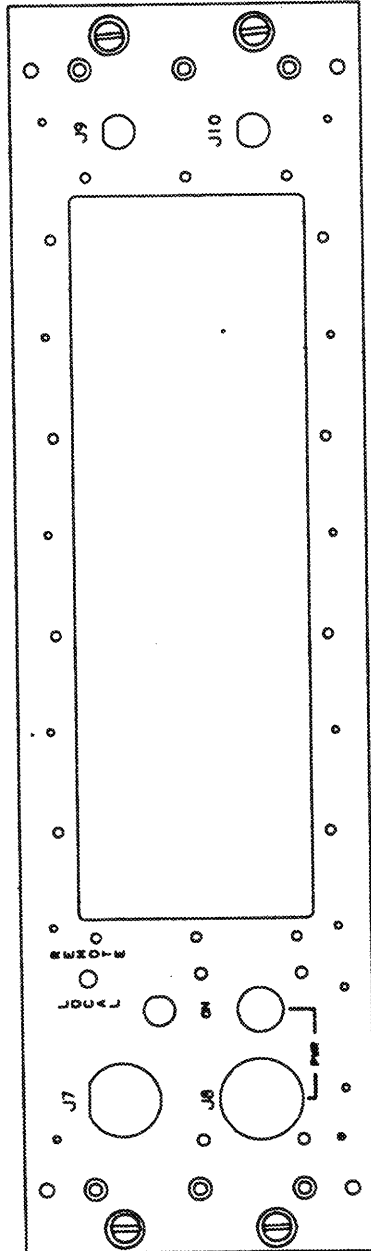
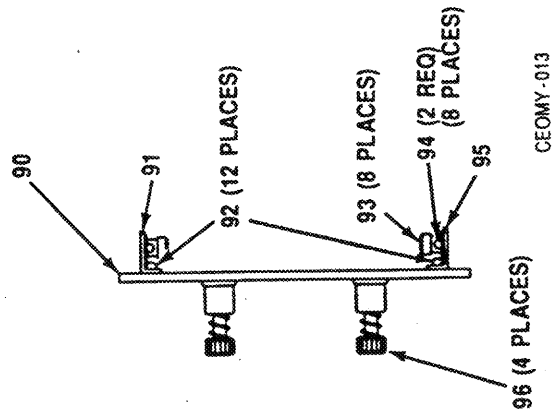

FRONT SURFACE  
DETAIL E

Figure 2. Chassis Assembly A1 (A3024604) (Sheet 9 of 9)

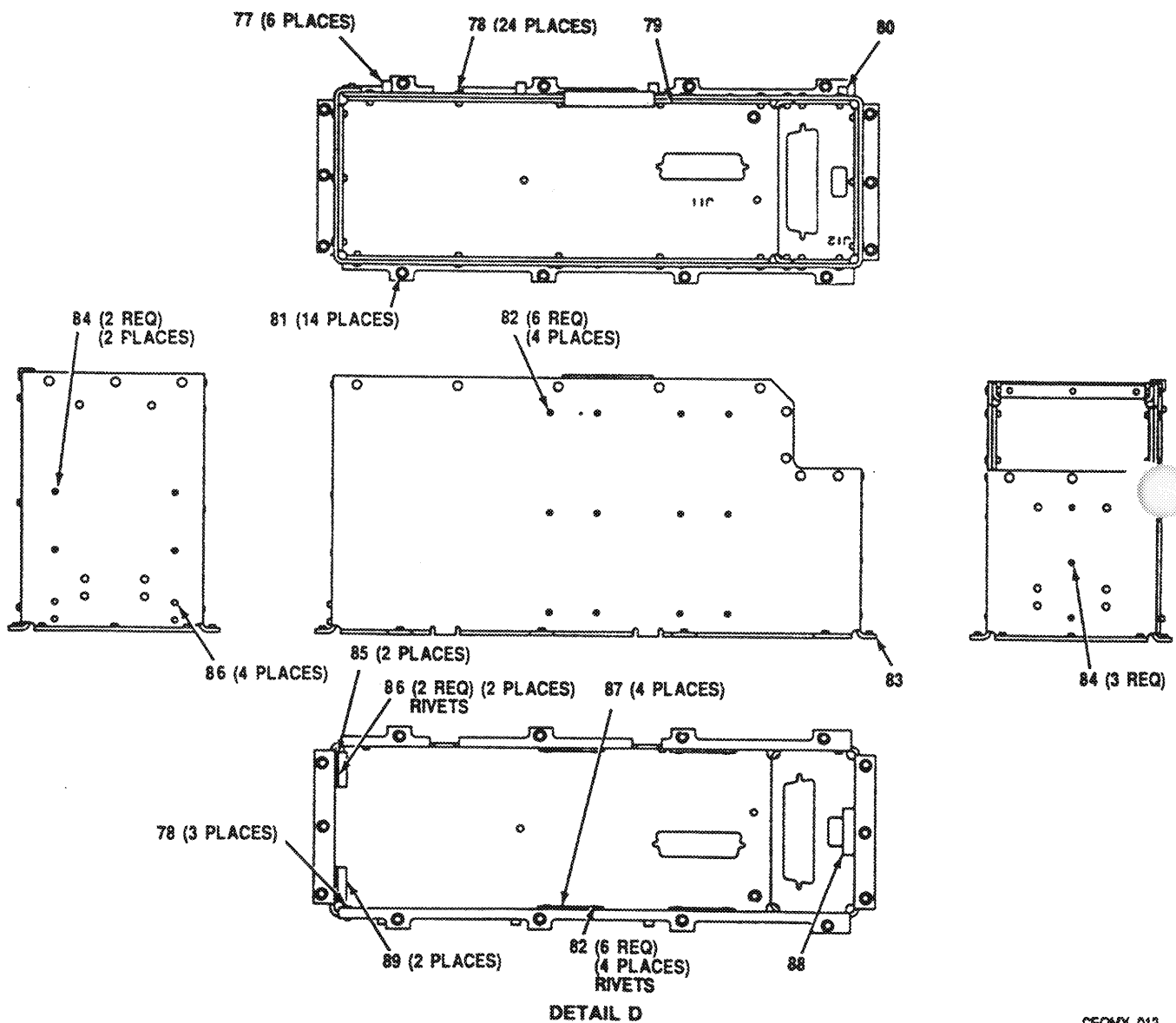

Figure 2. Chassis Assembly A1 (A3024604) (Sheet 8 of 9)

SECTION II			TM11-5895-1303-24P		(5)	(6)
(1)	(2)	(3)	(4)			
ITEM	SMR	FSCM	PART	DESCRIPTION AND USABLE ON CODES(UOC)		QTY
7	CODE		NUMBER			
45	PAHZZ	80063	A3024607	CABLE ASSEMBLY,RADI.....		1
46	PAHZZ	80063	A3028723-3	SCREW,MACHINE--SPEC.....		6
47	PAHZZ	80063	A3024608	CABLE ASSEMBLY,RADI.....		1
48	PAHZZ	96906	MS51957-5	SCREW,MACHINE.....		6
49	XBHZZ	80063	A3028044	BLOCK,MOUNTING-ECCM.....		4
50	PAHZZ	80063	A3028686	SCREW, SOCKET HEAD.....		4
51	PAZZZ	80063	A3028687	LANYARD ASSEMBLY--E.....		4
52	PAHZZ	80063	A3028723-2	SCREW,MACHINE--SPEC.....		4
53	PAHZZ	96906	MS35333-71	WASHER, LOCK.....		4
54	PAHZZ	37695	325431-1	FILTER,RADIO FREQUE.....		1
55	PAHZZ	80063	A3028192-1	SCREW,PAN HEAD--EXT.....		17
56	XBHZZ	80063	A3028560	MOUNTING BLOCK ASSE.....		2
57	XBHZZ	80063	A3028552	PIN,GUIDE-SYNTHESIZ.....		2
58	PAHZZ	80205	NAS1397R2B	CLAMP, LOOP.....		1
59	XBHZZ	51506	400009-S-8	RETAINER, CAPTIVE, SC.....		17
60	PAHZZ	80063	A3024716-6	INSERT, SCREW THREAD.....		6
61	XBHZZ	80063	A3028032	CHASSIS, DRAWER--WRA.....		1
62	PAHZZ	96906	MS20470AD3-5	RIVET, SOLID.....		19
63	XBHZZ	80063	A3028033	FLOOR, MODULE--CHASS.....		1
64	PAHZZ	07886	NCN4-3-2-3	INSERT, SCREW THREAD.....		18
65	XBHZZ	80063	A3028034	BRACKET, MOUNTING--R.....		22
66	PAHZZ	96906	MS20470AD3-4	RIVET, SOLID.....		60
67	PAHZZ	06848	175496	RIVET, SOLID.....		32
68	PAHZZ	96906	MS21075L4	NUT, SELF-LOCKING, PL.....		2
69	PAHZZ	96906	MS20426AD3-3	RIVET, SOLID.....		44
70	PAHZZ	72794	URA-3	RECEPTACLE, TURNLOCK.....		22
71	PAHZZ	96906	MS20470AD4-6	RIVET, SOLID.....		4
72	XBHZZ	80063	A3028556	PLATE, GUIDE PIN.....		2
73	PAHZZ	96906	MS21075L08	NUT, SELF-LOCKING, PL.....		14
74	XBHZZ	80063	A3028554	SPACER, SLIDE.....		2
75	PAHZZ	80063	A3028802-1	INSULATION CLOTH, EL.....		2
76	PAHZZ	80063	A3034778	INSULATION CLOTH, EL.....		1
77	PAHZZ	80063	A3024716-5	INSERT, SCREW THREAD.....		6
78	PAHZZ	96906	MS20470AD3-5	RIVET, SOLID.....		27
79	XBHZZ	80063	A3028039	END, ENCLOSURE--CONN.....		1
80	PAHZZ	80063	A3024716-4	INSERT, SCREW THREAD.....		1
81	PAHZZ	81349	M45938/7-2	NUT, SELF-LOCKING, CL.....		14
82	PAHZZ	96906	MS16535-67	RIVET, TUBULAR.....		24
83	XBHZZ	80063	A3028038	ENCLOSURE, MOUNTING.....		1
84	PAHZZ	96906	MS16535-70	RIVET, TUBULAR.....		7
85	XBHZZ	80063	A3028041	GUIDE, ECCM--LEFT FR.....		2
86	PAHZZ	06848	175496	RIVET, SOLID.....		4
87	XBHZZ	80063	A3028040	GUIDE, ECCM--TOP/BOT.....		4
88	XBHZZ	80063	A3028043	GUIDE, ECCM RIGHT.....		1
89	XBHZZ	80063	A3028042	GUIDE, ECCM--LEFT RE.....		2
90	XBHZZ	80063	A3028028	PANEL, FRONT.....		1
91	XBHZZ	80063	A3028029	BRACKET, ANGLE--MOUN.....		1
92	PAHZZ	96906	MS20426AD2-4-5	RIVET, SOLID.....		12
93	PAHZZ	72794	URA-3	RECEPTACLE, TURNLOCK.....		8
94	PAHZZ	96906	MS20426AD3-3	RIVET, SOLID.....		16
95	XBHZZ	80063	A3028030	BRACKET, ANGLE--MOUN.....		1
96	PAZZZ	94222	53-16-711-24	SCREW, ASSEMBLY PANE.....		4

END OF FIGURE

SECTION II TM11-5895-1303-24P (5) (6)  
 (1) (2) (3) (4)  
 ITEM SMR FSC PART  
 NO CODE FSC NUMBER DESCRIPTION AND USABLE ON CODES(UDC) QTY  
 GROUP 01 CHASSIS ASSEMBLY A1  
 (A3024604)

FIG. 2

1	XBHHH	80063	A3028031	CHASSIS ASSEMBLY--R.....	1
2	XBHZZ	80063	A3028553	BRACKET, MOUNTING-EN.....	1
3	XBHHH	80063	A3028037	MOUNTING ENCLOSURE.....	1
4	XBHHH	80063	A3028027	FRONT PANEL ASSEMBL.....	1
5	PAHZZ	96906	MS51957-13	SCREW, MACHINE.....	13
6	PAHZZ	96906	MS35338-135	WASHER, LOCK.....	38
7	PAHZZ	80205	NAS620C4	WASHER, FLAT.....	18
8	PAHHD	80063	A3024609	CABLE ASSEMBLY, PRIN (SEE FIG. 4 FOR BREAKDOWN).....	1
9	PAOZZ	81349	LC36GD2	LENS, LIGHT.....	1
10	PAOZZ	96906	MS25237-387	LAMP, INCANDESCENT.....	1
11	PAHZZ	81349	LH89/1	LIGHT, INDICATOR.....	1
12	XBHZZ	80063	A3028976	MOUNTING BRACKET AS.....	1
13	XBHZZ	96906	MS39087-204AN	HANDLE, BOW.....	2
14	PAHZZ	80205	NAS620C10	WASHER, FLAT.....	4
15	PAHZZ	96906	MS35338-138	WASHER, LOCK.....	8
16	PAHZZ	96906	MS51958-64	SCREW, MACHINE.....	4
17	PAHZZ	96906	MS51957-29	SCREW, MACHINE.....	4
18	PAHZZ	88044	AN960C6	WASHER, FLAT.....	13
19	PAHZZ	96906	MS35338-136	WASHER, LOCK.....	21
20	PAHZZ	80205	NAS671C6	NUT, PLAIN, HEXAGON.....	11
21	PAHZZ	96906	MS24693C27	SCREW, MACHINE.....	5
22	PAHZZ	96906	MS51957-28	SCREW, MACHINE.....	10
23	PAHZZ	80205	NAS620C6	WASHER, FLAT.....	12
24	PAHZZ	80205	NAS1397P4N	CLAMP, LOOP.....	1
25	PAHZZ	96906	MS51957-15	SCREW, MACHINE.....	2
26	PAHZZ	85480	D4-128	WASHER, SADDLE.....	2
27	PAHZZ	96906	MS51957-14	SCREW, MACHINE.....	2
28	PAHZZ	62744	STF-471-1	FILTER, BAND PASS-BA.....	1
29	PAHZZ	96906	MS24693C3	SCREW, MACHINE.....	1
30	PAHZZ	80205	NAS671C4	NUT, PLAIN, HEXAGON.....	4
31	PAHLD	80063	A3024659	CIRCUIT CARD ASSEMB (SEE FIG. 3 FOR BREAKDOWN).....	1
32	PAHZZ	88044	AN960C4	WASHER, FLAT.....	21
33	PAHZZ	96906	MS24693C24	SCREW, MACHINE.....	2
34	PAHZZ	23939	A-5122	FILTER, RADIO FREQUE.....	1
35	XBHZZ	80063	A3028948	LABEL, WARNING--HIGH.....	2
36	PAHZZ	96906	MS51957-6	SCREW, MACHINE.....	2
37	PAHZZ	88044	AN960C3	WASHER, FLAT.....	6
38	PAHZZ	96096	MS21042-02	NUT, SELF-LOCKING.....	6
39	PAHZZ	80063	A3028047	CABLE ASSEMBLY, POWE.....	1
40	PAHZZ	96906	MS77068-1	TERMINAL, LUG.....	3
41	PAHZZ	81349	M45595/1-05	SPACER, SLEEVE.....	1
42	PAHZZ	81349	M83731/11-732	SWITCH, TOGGLE.....	1
43	XBHZZ	80063	A3028551	PIN, GUIDE--ECCM.....	2
44	PAHZZ	80063	A3028723-1	SCREW, MACHINE--SPEC.....	14

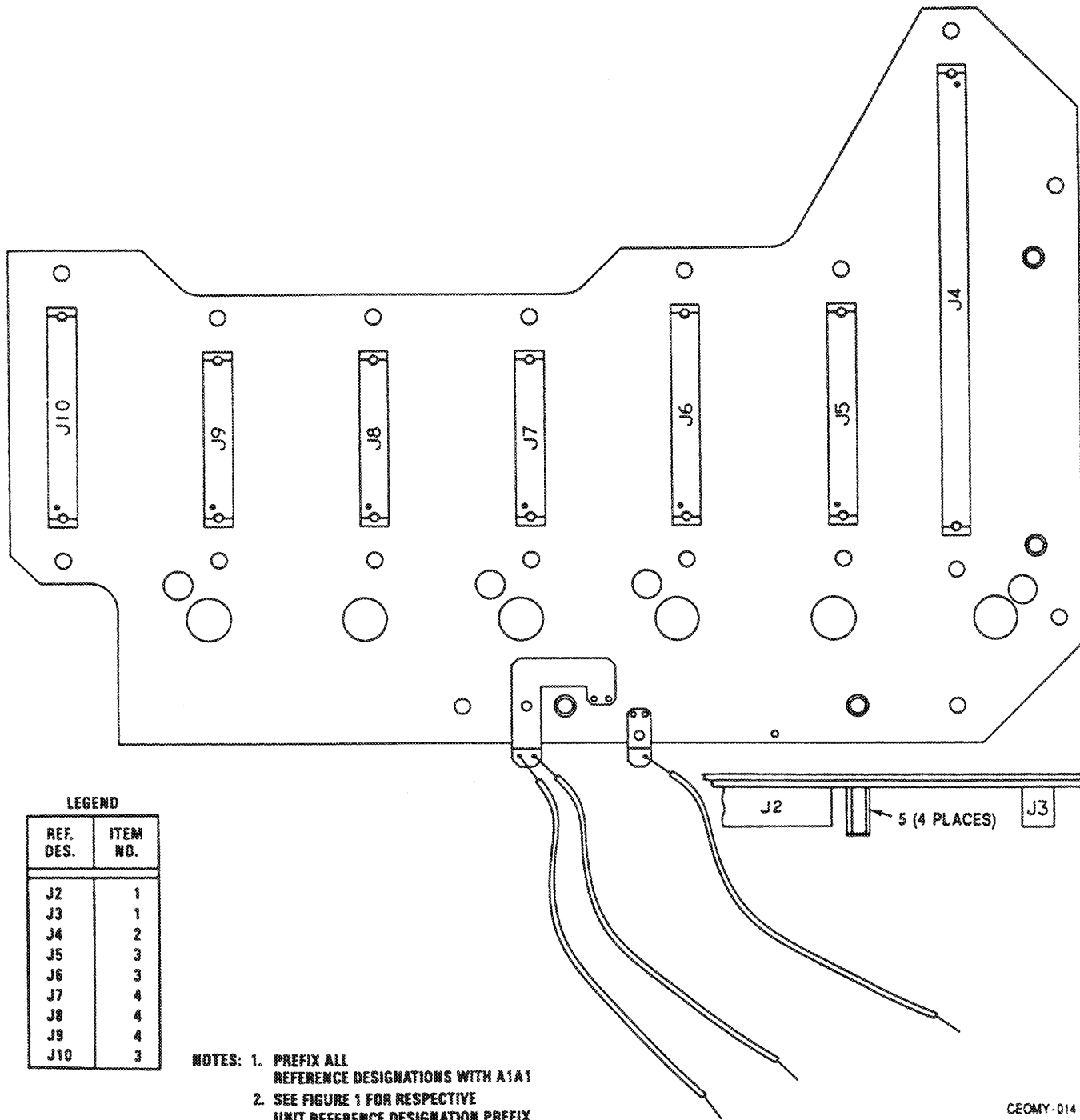

LEGEND

REF. DES.	ITEM NO.
J2	1
J3	1
J4	2
J5	3
J6	3
J7	4
J8	4
J9	4
J10	3

- NOTES: 1. PREFIX ALL REFERENCE DESIGNATIONS WITH A1A1  
 2. SEE FIGURE 1 FOR RESPECTIVE UNIT REFERENCE DESIGNATION PREFIX

CEOMY-014

Figure 3. Module Interconnect CCA A1A1 (A3024659)

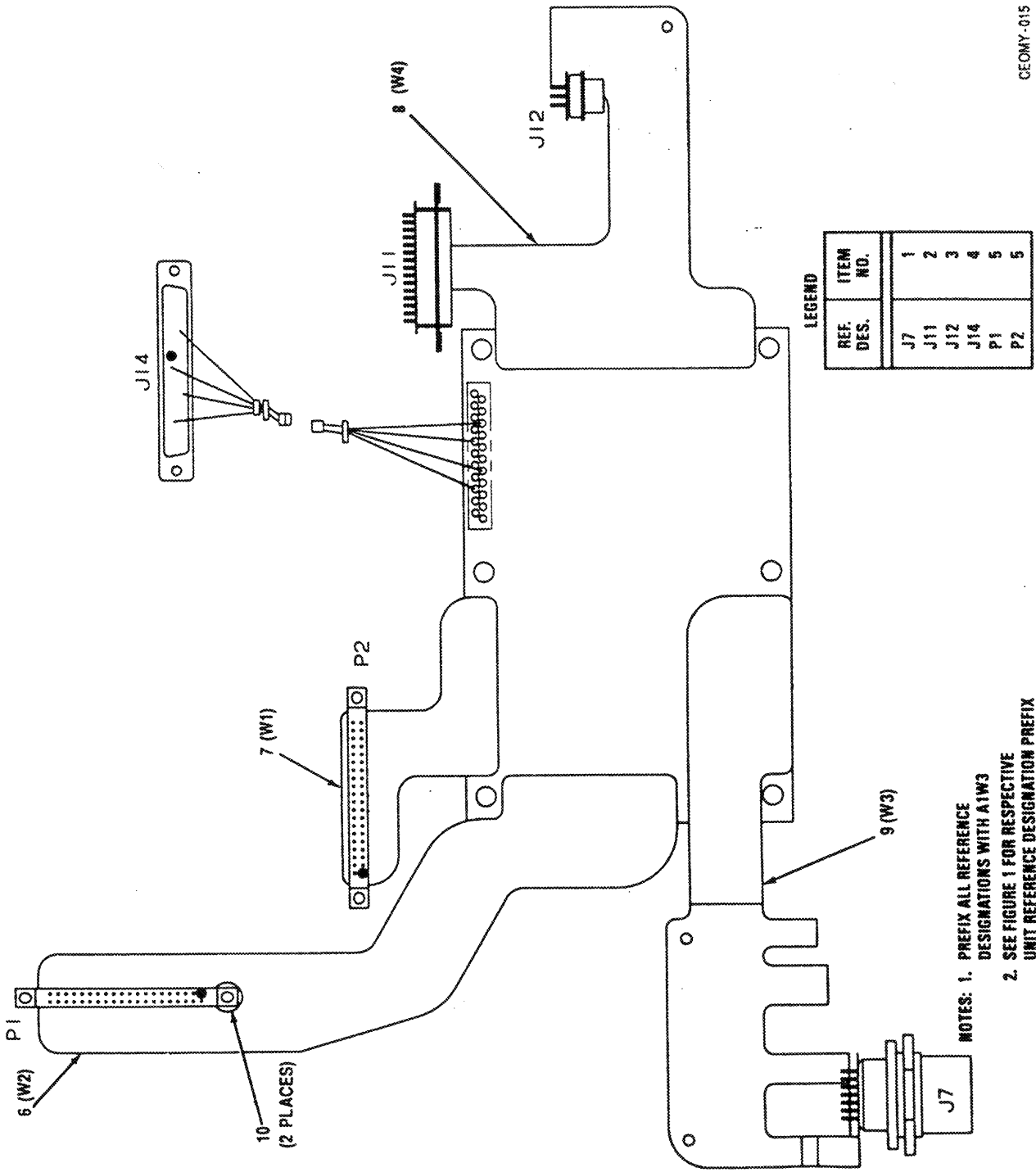

Figure 4. Printed Cable Assembly, Flexible Interconnect AIW3 (A3024609)



SECTION II			TM11-5895-1303-24P			
(1)	(2)	(3)	(4)	(5)	(6)	
ITEM	SMR	FSCM	PART			
NO	CODE		NUMBER		DESCRIPTION AND USABLE ON CODES(UOC)	QTY
					GROUP 0101 MODULE INTERCONNECT	
					CCA A1A1 (A3024659)	

FIG. 3

1	PAHZA	71468	UBS4C040C4DL	CONNECTOR, RECEPTACL.....	2
2	PAHZA	81349	M55302/6-06	CONNECTOR, RECEPTACL.....	1
3	PAHZZ	81349	M55302/6-04	CONNECTOR, RECEPTACL.....	3
4	PAHZZ	81349	M55302/6-03	CONNECTOR, RECEPTACL.....	3
5	PAHZZ	80063	A3028868	POST, ELECTRICAL-MEC.....	4

END OF FIGURE

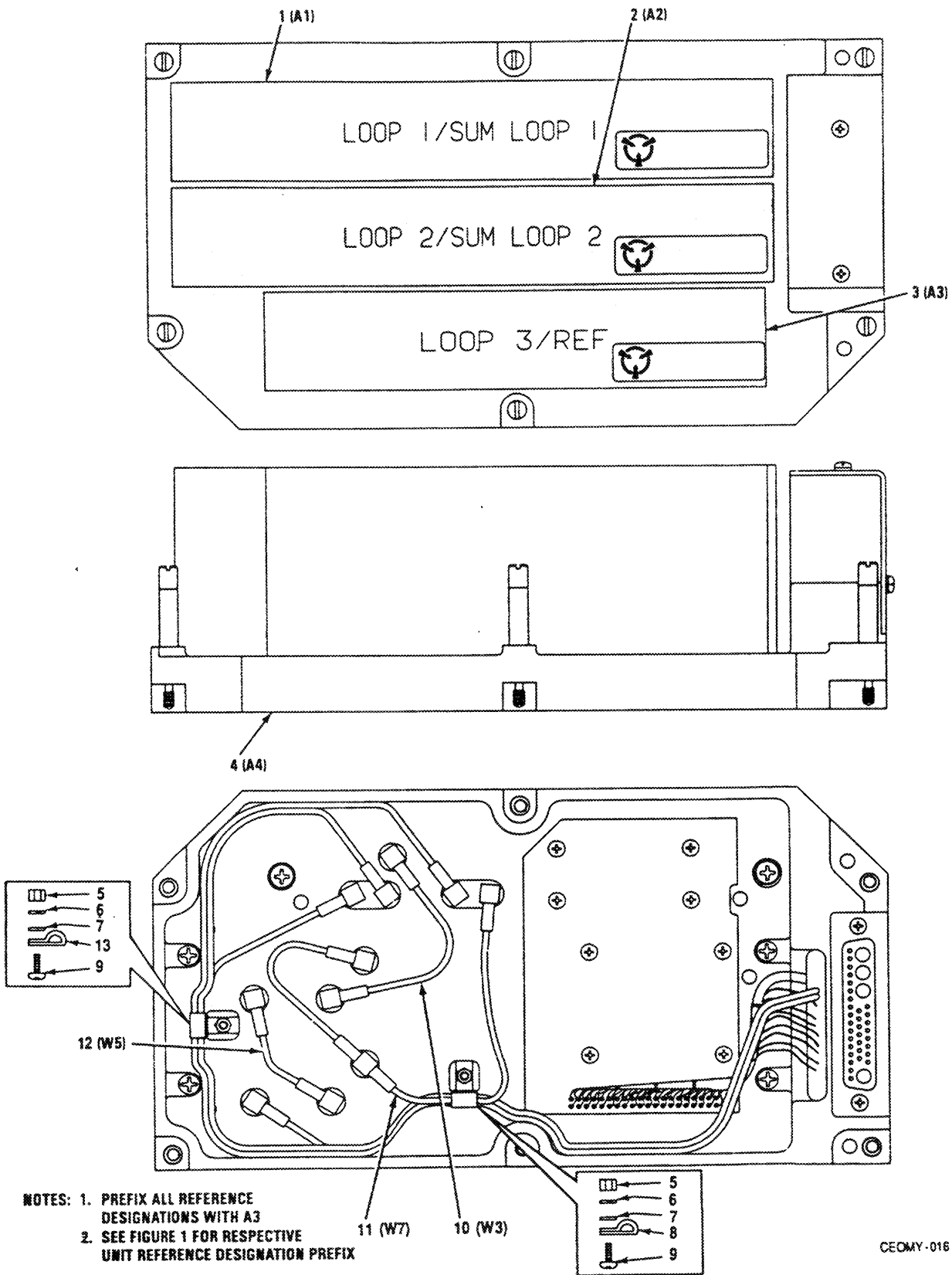

Figure 5. Synthesizer A3 (A3024340)

SECTION II  
 (1) (2) (3)  
 ITEM SMR FSCM  
 NO CODE FSCM

TM11-5895-1303-24P  
 (4)  
 PART  
 NUMBER

(5)

(6)

DESCRIPTION AND USABLE ON CODES(UOC) QTY  
 GROUP 0102 PRINTED CABLE ASSEMBLY  
 FLEXIBLE INTERCONNECT  
 AIW3 (A3024609)

FIG. 4

1	PAHZZ	08718	4055-14047-2	CONNECTOR,RFI FILTE.....	1
2	PAHZZ	71468	DBMMR255E	CONNECTOR,RECEPTACL.....	1
3	PAHZA	71468	DDMMR505E	CONNECTOR,RECEPTACL.....	1
4	PAHZZ	71468	DDMMR36W4S	CONNECTOR,RACK AND.....	1
5	PAHZA	80063	A3028888-1	CONNECTOR,RECEPTACL.....	2
6	PAHZZ	80063	A3029123	CABLE ASSEMBLY,PRIN.....	1
7	PAHZZ	80063	A3029122	CABLE ASSEMBLY,PRIN.....	1
8	PAHZZ	80063	A3029121	CABLE ASSEMBLY,PRIN.....	1
9	PAHZZ	80063	A3029124	CABLE ASSEMBLY,PRIN.....	1
10	PAHZZ	80063	A3086592	SPACER,PLATE.....	2

END OF FIGURE

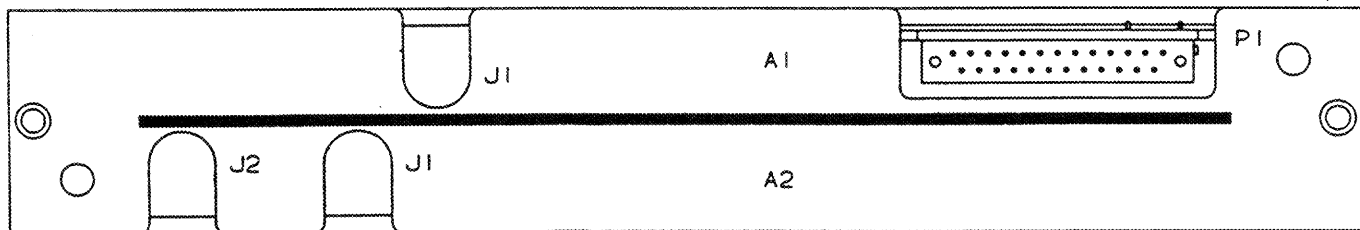
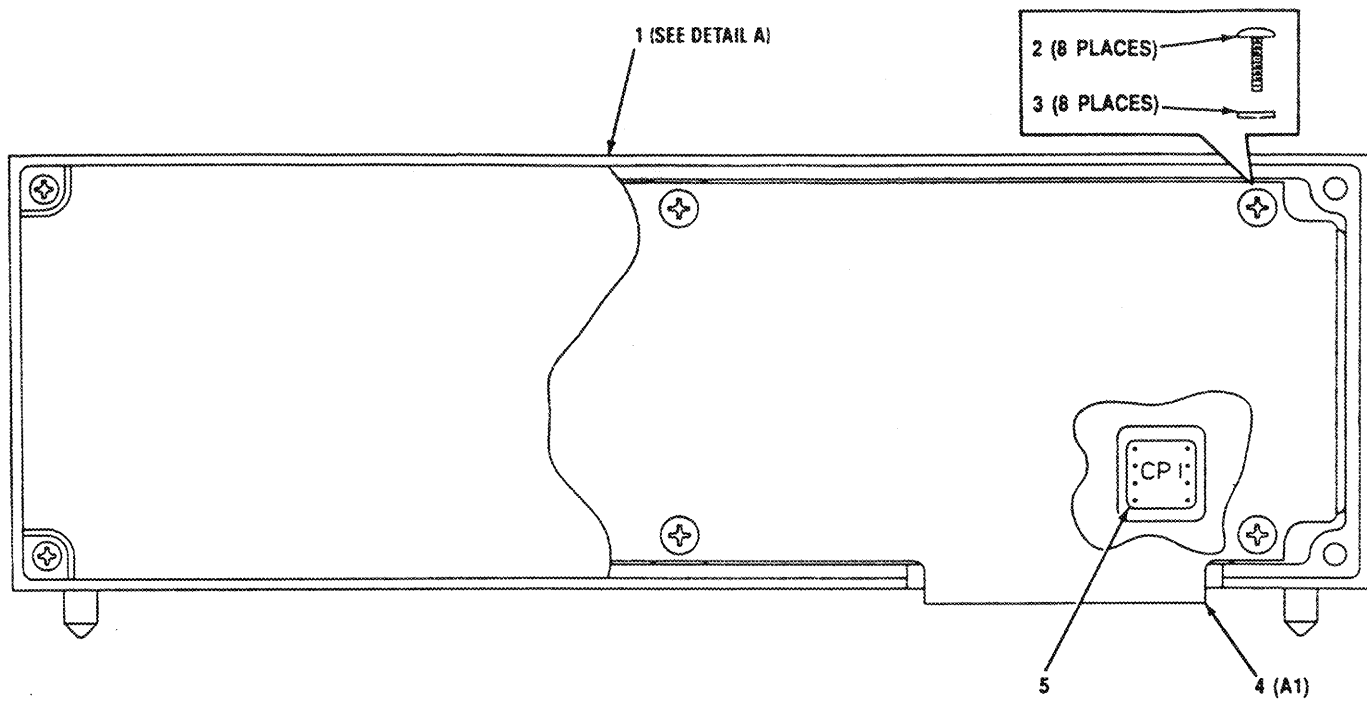

- NOTES: 1. PREFIX ALL REFERENCE DESIGNATIONS WITH A3A1  
2. SEE FIGURE 1 FOR RESPECTIVE UNIT REFERENCE DESIGNATION PREFIX

CEOMY-017

Figure 6. Loop 1/Sum Loop 1 Assy A3A1 (A3024344) (Sheet 1 of 3)

SECTION II			TM11-5895-1303-24P			
(1)	(2)	(3)	(4)	(5)	(6)	
ITEM	SMR		PART			
NO	CODE	FSCM	NUMBER	DESCRIPTION AND USABLE ON CODES(UOC)	QT	
				GROUP 03 SYNTHESIZER A3		
				(A3024340)		

FIG. 5

1	XBDLD	80063	A3024344	LOOP ASSEMBLY (SEE FIG. 6 FOR BREAKDOWN).....	1
2	XBDLD	80063	A3024354	LOOP ASSEMBLY (SEE FIG. 9 FOR BREAKDOWN).....	1
3	XBDLD	80063	A3024364	LOOP ASSEMBLY (SEE FIG. 12 FOR BREAKDOWN).....	1
4	XBDDD	80063	A3024374	CHASSIS ASSEMBLY, EL (SEE FIG. 15 FOR BREAKDOWN).....	1
5	PADZZ	80205	NAS671C4	NUT, PLAIN, HEXAGON.....	2
6	PADZZ	96906	MS35338-135	WASHER, LOCK.....	2
7	PADZZ	85480	D4-128	WASHER, SADDLE.....	2
8	PADZZ	80205	NAS1397R5	CLAMP, LOOP.....	1
9	PADZZ	96906	MS24693C4	SCREW, MACHINE.....	2
10	PADZZ	80063	A3024380-1	CABLE ASSEMBLY, RADI.....	1
11	PADZZ	80063	A3024381-1	CABLE ASSEMBLY, RADI.....	1
12	PADZZ	80063	A3024380-2	CABLE ASSEMBLY, RADI.....	1
13	PADZZ	80205	NAS1397R3B	CLAMP, LOOP.....	1

END OF FIGURE

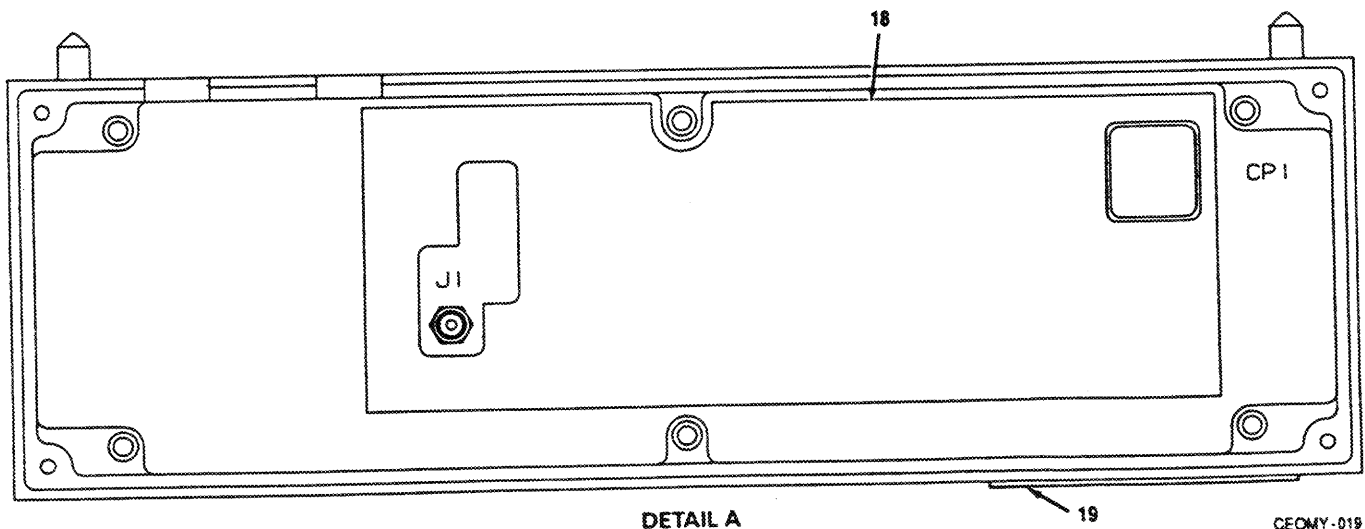
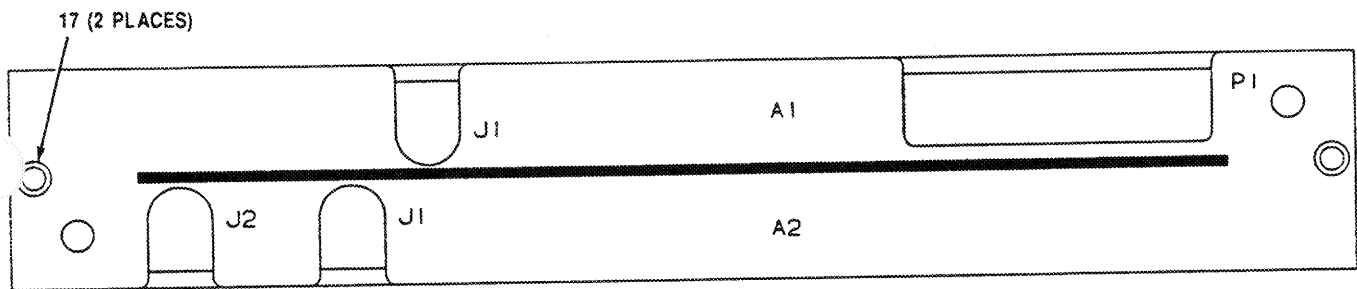
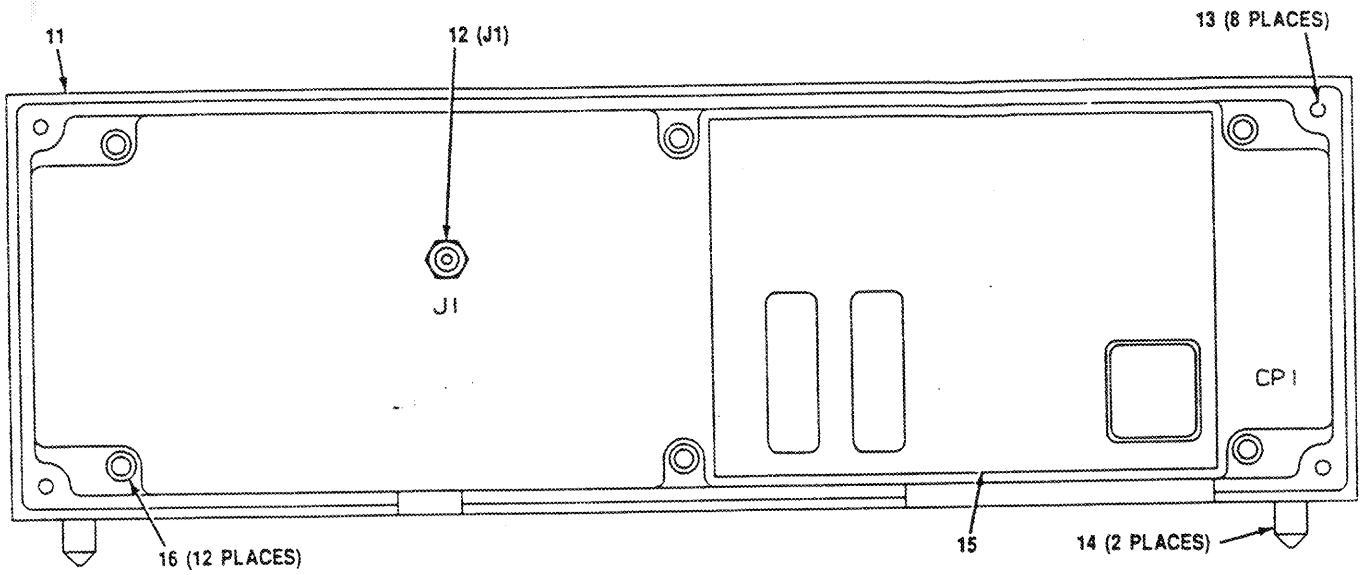

CEOMY-019

Figure 6. Loop1/Sum Loop 1 Assy A3A1 (A3024344) (Sheet 3 of 3)

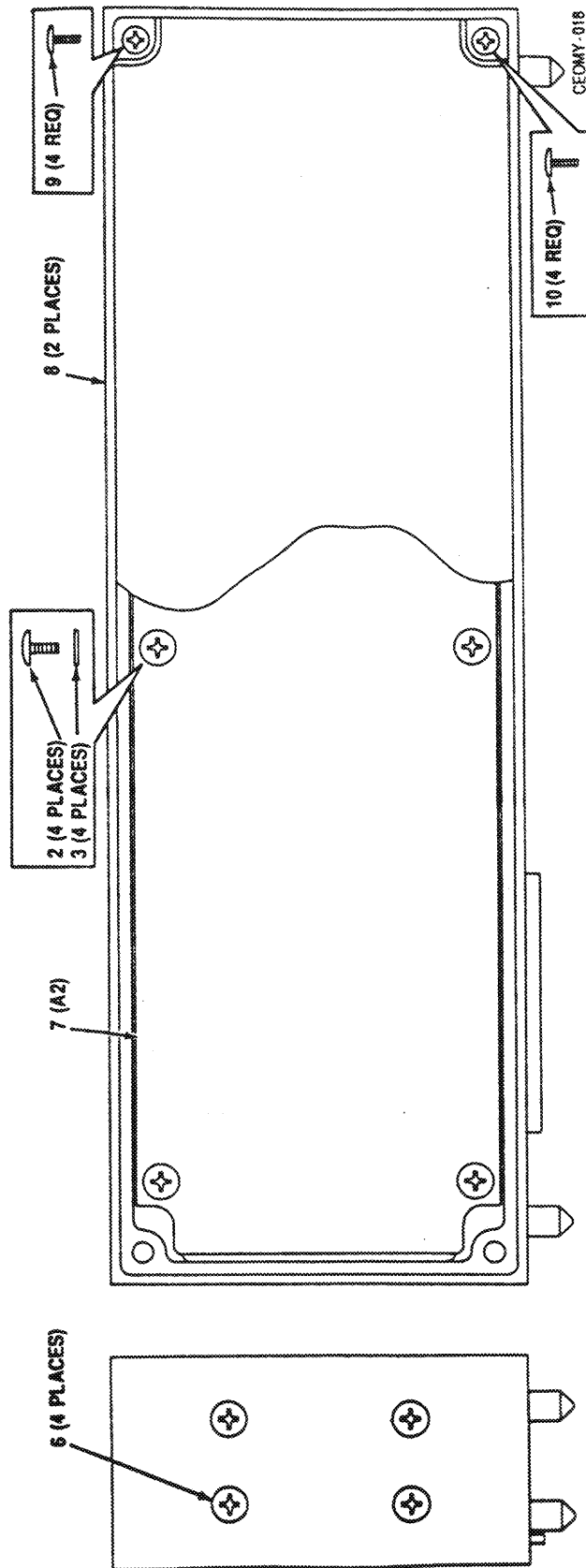

Figure 6. Loop 1/Sum Loop 1 As 3A1 (A3024344) (Sheet 2 of 3)

SECTION II			TM11-5895-1303-24P	(5)	(6)
(1)	(2)	(3)	(4)		
ITEM	SMR		PART		
NO	CODE	FSCM	NUMBER	DESCRIPTION AND USABLE ON CODES(UOC)	QTY

GROUP 0301 LOOP 1/SUM LOOP 1  
 ASSY A3A1  
 (A3024344)

FIG. 6

1	XBDDD	80063	A3024345	FRAME ASSEMBLY, LOOP.....	1
2	PADZZ	96906	MS51957-14	SCREW, MACHINE.....	8
3	PADZZ	80205	NAS620C4L	WASHER, FLAT.....	8
4	PADDD	80063	A3024346	CIRCUIT CARD ASSEMB (SEE FIG. 7 FOR BREAKDOWN).....	1
5	PADZZ	56207	400119	CONNECTOR, RECEPTACL.....	1
6	PADZZ	96906	MS24693C2	SCREW, MACHINE.....	4
7	PADDD	80063	A3024350	CIRCUIT CARD ASSEMB (SEE FIG. 8 FOR BREAKDOWN).....	1
8	XBDZZ	80063	A3086607	COVER, MODULE ACCESS.....	2
9	PADZZ	96906	MS51957-2	SCREW, MACHINE.....	8
10	PADZZ	96906	MS24693C5	SCREW, MACHINE.....	4
11	XBDZZ	80063	A3024671	FRAME--LOOP 1/SUM L.....	1
12	PADZA	58167	1111-1180-01C	CONNECTOR, RECEPTACL.....	1
13	PADZZ	26344	3585-02CNW0129	INSERT, SCREW THREAD.....	8
14	XBDZZ	80063	A3028102	PIN, GUIDE--MODULE.....	2
15	PADZZ	80063	A3029325	INSULATOR, CIRCUIT C.....	1
16	PADZZ	96906	MS21209C0415L	INSERT, SCREW THREAD.....	12
17	PADZZ	96906	MS21209C0815L	INSERT, SCREW THREAD.....	2
18	PADZZ	80063	A3029326	INSULATOR, CIRCUIT C.....	1
19	XBDZZ	80063	A3034572	LABEL, SENSITIVE.....	1

END OF FIGURE



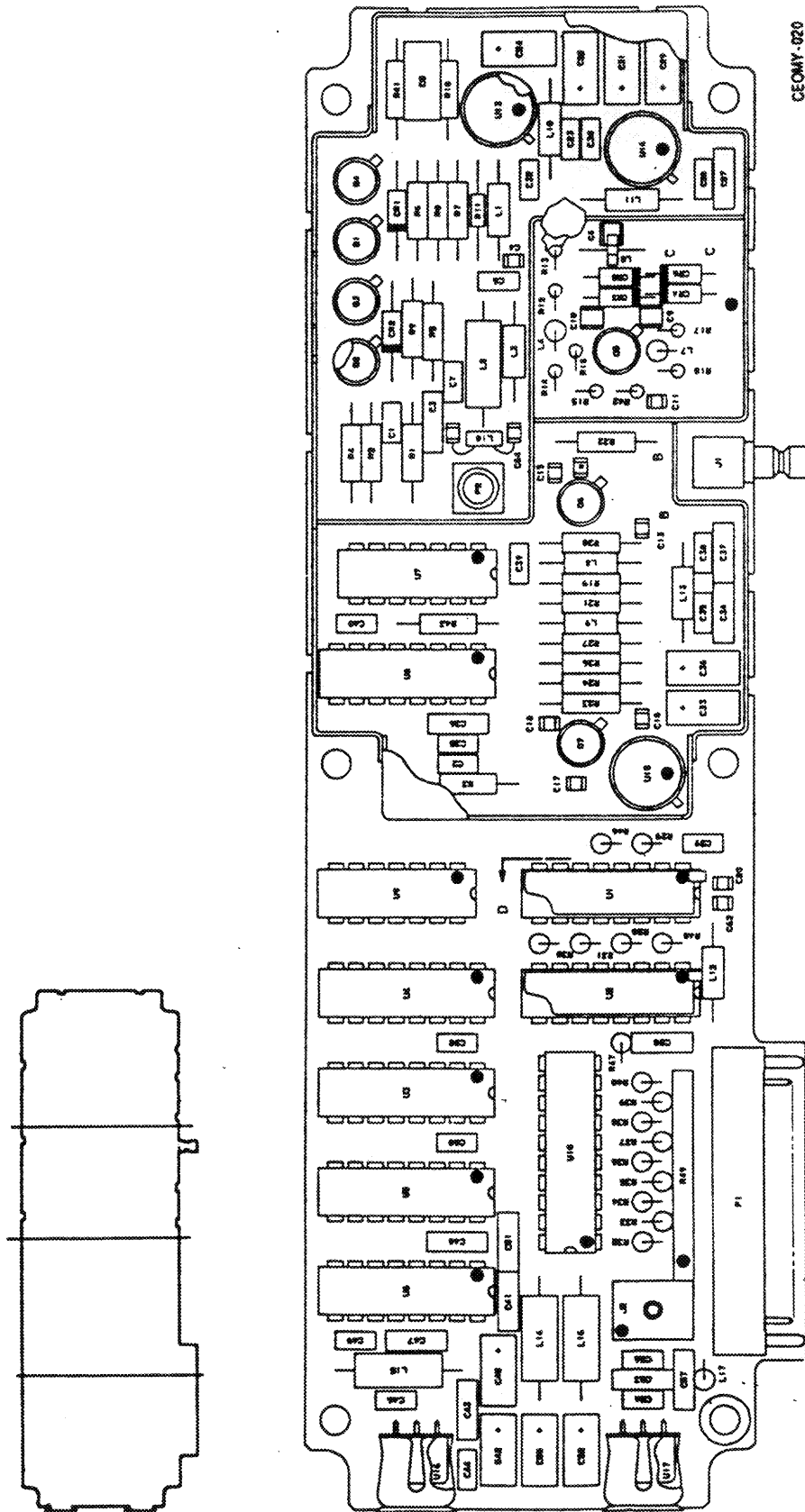
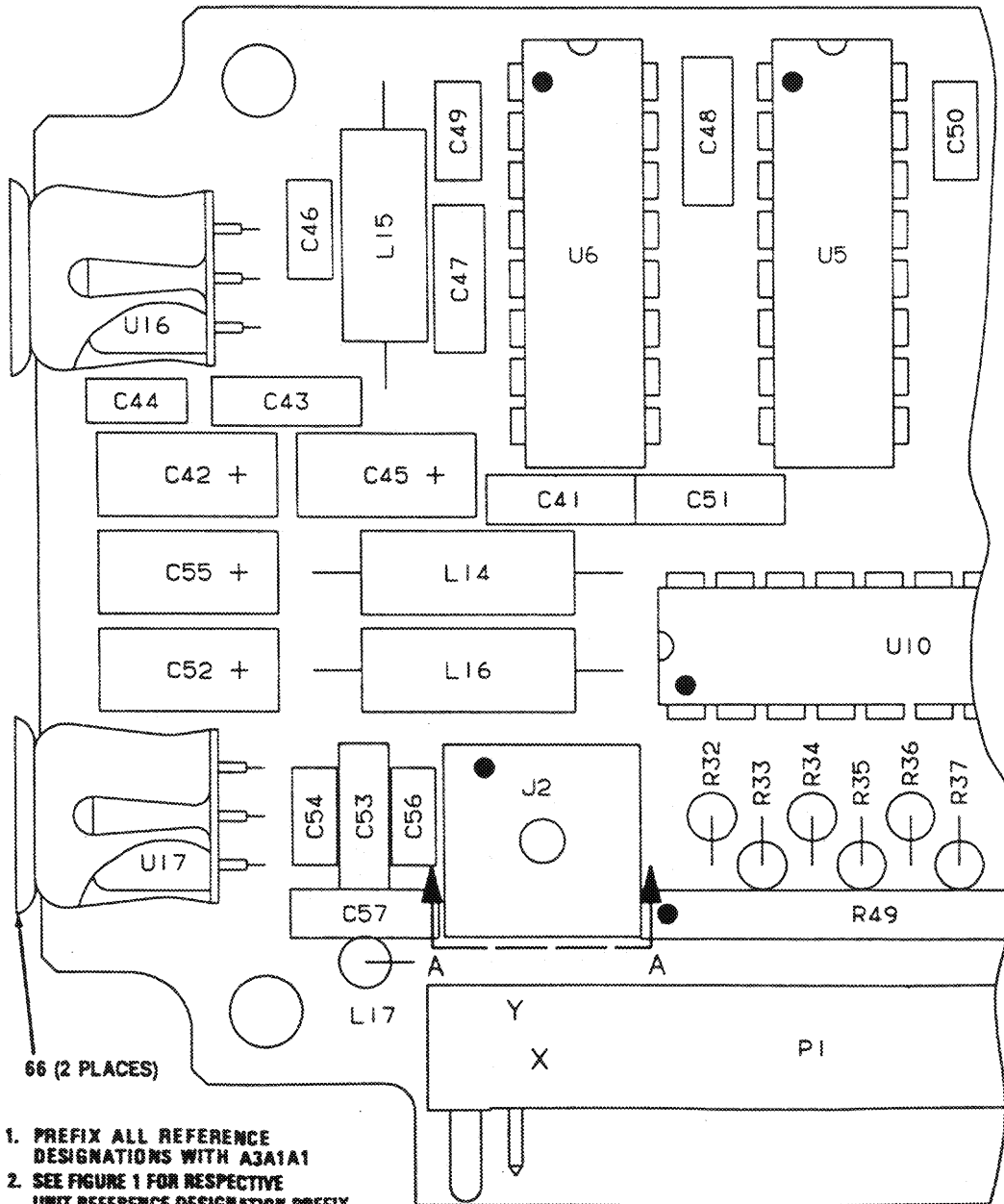
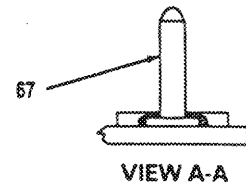

Figure 7. Loop 1 CCA A3A1A1 (A3024346) (Sheet 1 of 6)



- NOTES: 1. PREFIX ALL REFERENCE DESIGNATIONS WITH A3A1A1
- 2. SEE FIGURE 1 FOR RESPECTIVE UNIT REFERENCE DESIGNATION PREFIX

CEOMY-021

Figure 7. Loop 1 CCA A3A1A1 (A3024346) (Sheet 2 of 6)

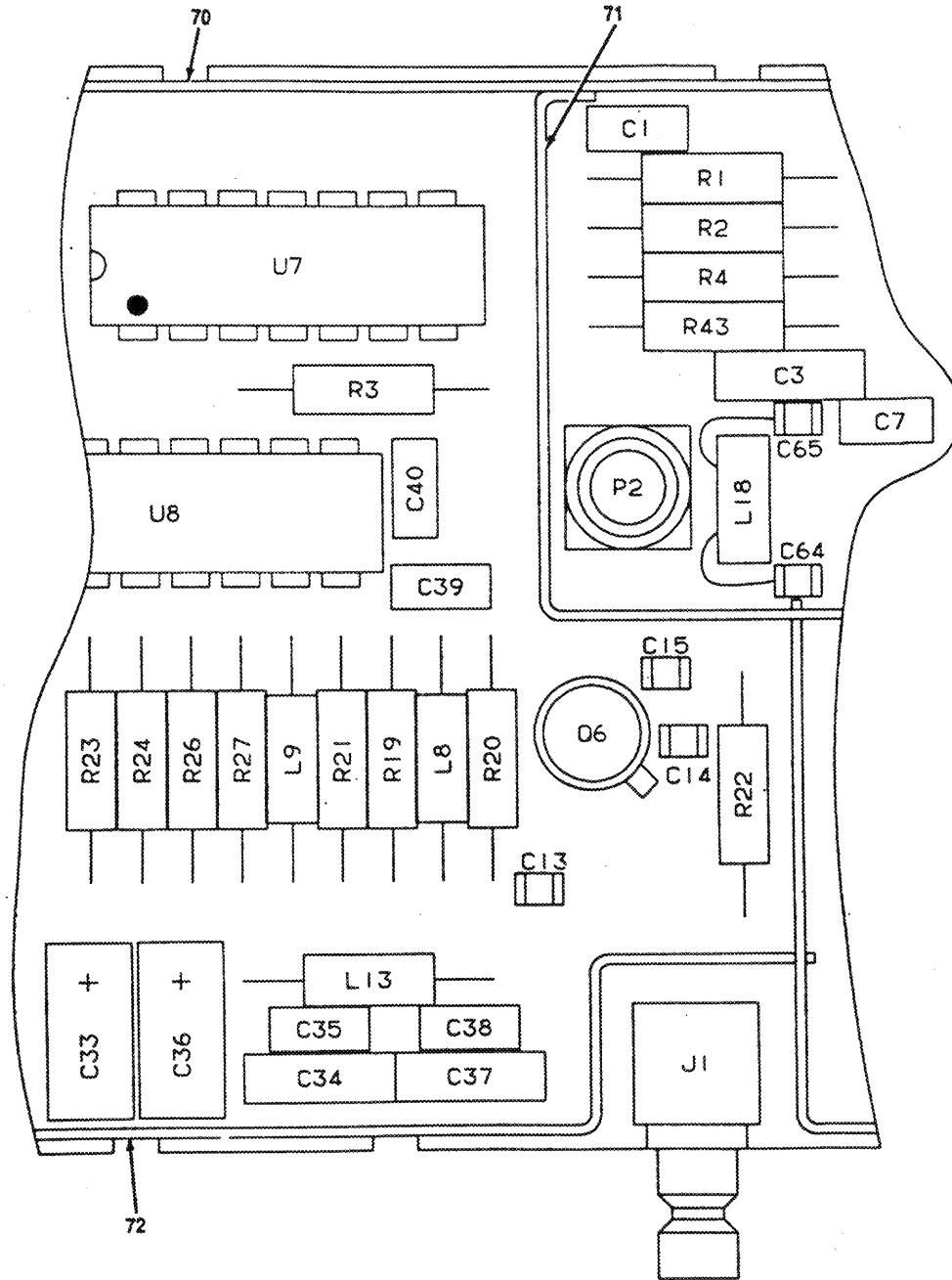

CEOMY-023

Figure 7. Loop 1 CCA A3A1A1 (A3024346) (Sheet 4 of 6)

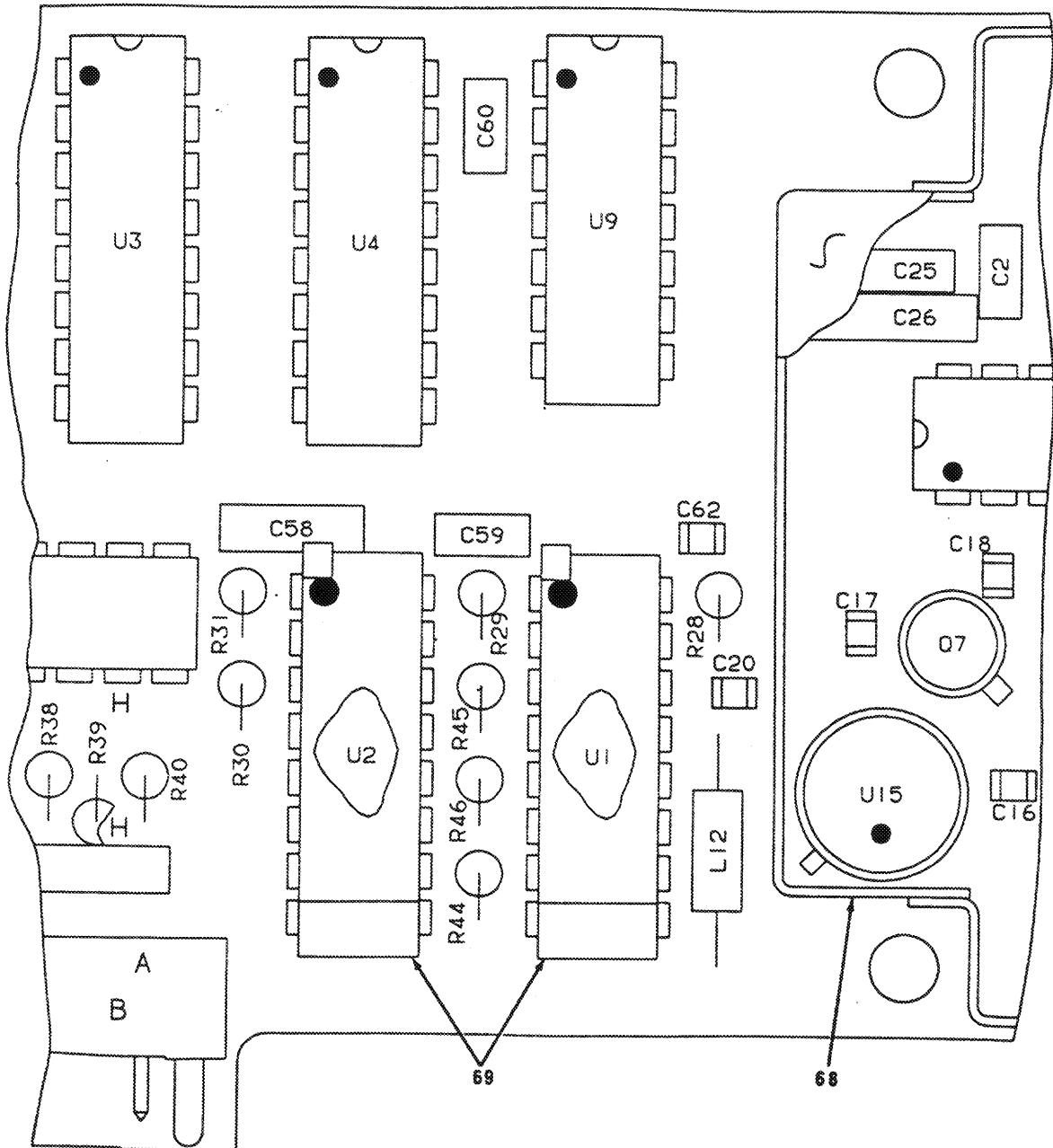
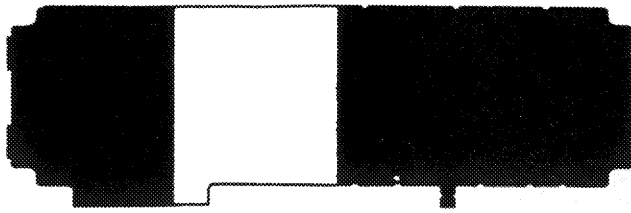

CEOMY-0

Figure 7. Loop 1 CCA A3A1A1 (A3024346) (Sheet 3 of 6)

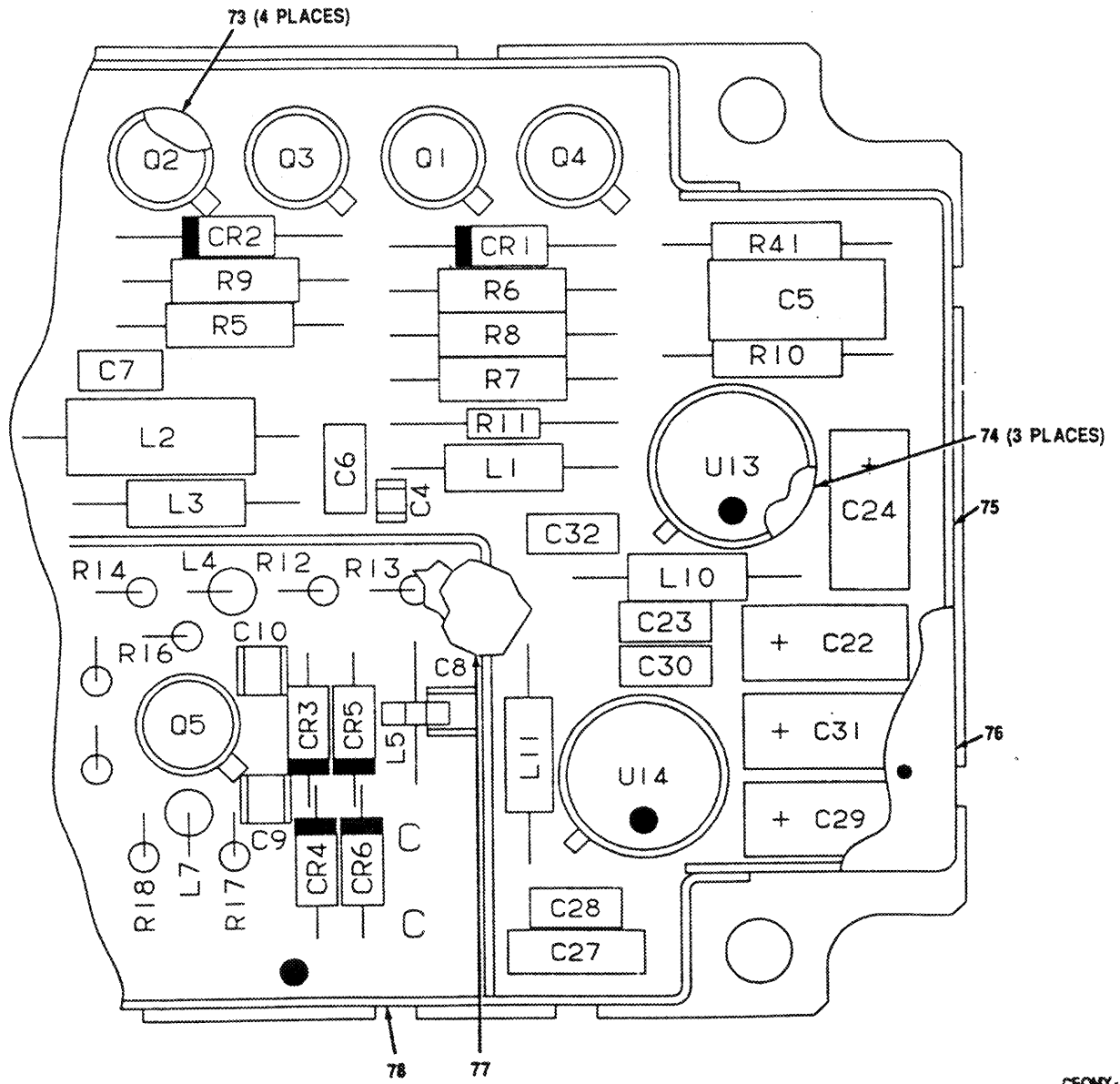

CEOMY-024

Figure 7. Loop 1 CCA A3A1A1 (A3024346) (Sheet 5 of 6)

LEGEND

REF. DES.	ITEM NO.	REF. DES.	ITEM NO.	REF. DES.	ITEM NO.	REF. DES.	ITEM NO.	REF. DES.	ITEM NO.	REF. DES.	ITEM NO.
CR1	1	C25	8	C51	5	L12	24	R11	41	R38	50
CR2	1	C26	5	C52	11	L13	24	R12	42	R39	50
CR3	2	C27	5	C53	5	L14	25	R13	42	R40	50
CR4	2	C28	8	C54	8	L15	26	R14	43	R41	52
C1	3	C29	13	C55	11	L16	25	R15	44	R42	53
C2	4	C30	12	C56	8	L17	23	R16	45	R43	54
C3	5	C31	13	C57	5	L18	27	R17	46	R44	51
C4	6	C32	8	C58	5	P1	28	R18	47	R45	51
C5	7	C33	11	C59	12	P2	29	R19	34	R46	51
C6	8	C34	5	C60	12	Q1	30	R20	48	R49	55
C7	8	C35	8	C61	15	Q2	30	R21	40	U1	56
C9	9	C36	11	C62	6	Q3	30	R22	49	U2	57
C10	10	C37	5	C64	15	Q4	31	R23	48	U3	58
C11	6	C38	8	C65	15	Q5	32	R24	34	U4	59
C12	6	C39	12	J1	16	Q6	32	R26	40	U5	58
C13	6	C40	14	J2	17	Q7	32	R27	49	U6	59
C14	6	C41	5	L1	18	R1	33	R28	50	U7	60
C15	6	C42	11	L2	19	R2	34	R29	51	U8	61
C16	6	C43	5	L3	20	R3	35	R30	51	U9	62
C17	6	C44	8	L4	20	R4	33	R31	51	U10	63
C18	6	C45	11	L5	21	R5	36	R32	50	U13	64
C19	6	C46	8	L7	22	R6	37	R33	50	U14	65
C20	6	C47	5	L8	23	R7	38	R34	50	U15	64
C22	11	C48	5	L9	23	R8	36	R35	50	U16	64
C23	12	C49	12	L10	24	R9	39	R36	50	U17	64
C24	11	C50	12	L11	18	R10	40	R37	50		

CEOMY-025

Figure 7. Loop 1 CCA A3A1A1 (A3024346) (Sheet 6 of 6)

SECTION II  
 (1) (2) (3) (4) (5) (6)  
 ITEM SMR FSCM PART NUMBER DESCRIPTION AND USABLE ON CODES(UOC) QTY  
 NO CODE FSCM NUMBER

GROUP 030101 LOOP 1 CCA A3A1A1  
 (A3024346)

FIG. 7

1	PADZZ	81349	JANTX1N4454-1	SEMICONDUCTOR DEVIC.....	2
2	PADZZ	50101	V20-4629	SEMICONDUCTOR DEVIC.....	2
3	PADZZ	81349	M39014/01-1338	CAPACITOR, FIXED, CER.....	1
4	PADZZ	81349	M39014/01-1578	CAPACITOR, FIXED, CER.....	1
5	PADZZ	81349	M39014/02-1350	CAPACITOR, FIXED, CER.....	13
6	PADZZ	81349	CDR01BX102BKUP	CAPACITOR, CHIP.....	12
7	PADZZ	81349	CFR06RRA183JP	CAPACITOR, FIXED, MET.....	1
8	PADZZ	81349	M39014/01-1357	CAPACITOR, FIXED, CER.....	11
9	PADZZ	81349	CDR14BG101EKUPX	CAPACITOR, FIXED, ELE.....	1
10	PADZZ	81349	CDR14BG620EKUPX	CAPACITOR, FIXED, ELE.....	1
11	PADZZ	56996	B4003327-3126	CAPACITOR, FIXED, ELE.....	8
12	PADZZ	81349	M39014/01-1575	CAPACITOR, FIXED, CER.....	7
13	PADZZ	56996	B4003327-3123	CAPACITOR, FIXED, ELE.....	2
14	PADZZ	81349	M39014-01-1563	CAPACITOR, FIXED, CER.....	1
15	PADZZ	81349	CDR12BG150AJUPX	CAPACITOR, CHIP.....	3
16	PADZZ	19505	2010-6511-002	CONNECTOR, RECEPTACL.....	1
17	PADZZ	37695	189698	SOCKET, PLUG-IN ELEC.....	1
18	PADZZ	96906	MS75085-7	COIL, RADIO FREQUENC.....	2
19	PADZZ	96906	MS75089-27	COIL, RADIO FREQUENC.....	1
20	PADZZ	96906	MS75083-13	COIL, RADIO FREQUENC.....	2
21	PADZZ	80063	A3024684-10	COIL, RADIO FREQUENC.....	1
22	PADZZ	96906	MS75083-7	COIL, RADIO FREQUENC.....	1
23	PADZZ	96906	MS75084-6	COIL, RADIO FREQUENC.....	3
24	PADZZ	96906	MS75084-7	COIL, RADIO FREQUENC.....	3
25	PADZZ	96906	MS75089-1	COIL, RADIO FREQUENC.....	2
26	PADZZ	96906	MS75088-7	COIL, RADIO FREQUENC.....	1
27	PADZZ	80063	A3024684-12	COIL, RADIO FREQUENC.....	1
28	PADZZ	81349	M55302/4-03	CONNECTOR, RECEPTACL.....	1
29	PADZZ	58167	11-0450-01C	CONNECTOR, RECEPTACL.....	1
30	PADZZ	81349	JANTX2N2369A	TRANSISTOR.....	3
31	PADZZ	81349	JANTXV2N2907A	TRANSISTOR.....	1
32	PADZZ	56996	B4002964	TRANSISTOR.....	3
33	PADZZ	81349	RCR07G112JS	RESISTOR, FIXED, COMP.....	2
34	PADZZ	81349	RCR07G222JS	RESISTOR, FIXED, COMP.....	3
35	PADZZ	81349	RCR07G513JS	RESISTOR, FIXED, COMP.....	1
36	PADZZ	81349	RCR07G123JS	RESISTOR, FIXED, COMP.....	2
37	PADZZ	81349	RCR07G911JS	RESISTOR, FIXED, COMP.....	1
38	PADZZ	81349	RCR07G331JS	RESISTOR, FIXED, COMP.....	1
39	PADZZ	81349	RCR07G131JS	RESISTOR, FIXED, COMP.....	1
40	PADZZ	81349	RCR07G242JS	RESISTOR, FIXED, COMP.....	3
41	PADZZ	81349	RCR05G511JS	RESISTOR, FIXED, COMP.....	1
42	PADZZ	81349	RCR05G512JS	RESISTOR, FIXED, COMP.....	2
43	PADZZ	81349	RCR05G101JS	RESISTOR, FIXED, COMP.....	1
44	PADZZ	81349	RCR05G113JS	RESISTOR, FIXED, COMP.....	1
45	PADZZ	81349	RCR05G432JS	RESISTOR, FIXED, COMP.....	1
46	PADZZ	81349	RCR05G271JS	RESISTOR, FIXED, COMP.....	1

SECTION II		TM11-5895-1303-24P				
(1)	(2)	(3)	(4)	(5)	(6)	
ITEM NO	SMR CODE	FSCM	PART NUMBER	DESCRIPTION AND USABLE ON CODES(UOC)	QTY	
47	PADZZ	81349	RCR05G361JS	RESISTOR, FIXED, COMP.....	1	
48	PADZZ	81349	RCR07G510JS	RESISTOR, FIXED, COMP.....	2	
49	PADZZ	81349	RCR07G101JS	RESISTOR, FIXED, COMP.....	2	
50	PADZZ	81349	RCR07G102JS	RESISTOR, FIXED, COMP.....	10	
51	PADZZ	81349	RCR07G511JS	RESISTOR, FIXED, COMP.....	6	
52	PADZZ	81349	RCR07G305JS	RESISTOR, FIXED, COMP.....	1	
53	PADZZ	81349	RCR05G510JS	RESISTOR, FIXED, COMP.....	1	
54	PADZZ	81349	RCR07G103JS	RESISTOR, FIXED, COMP.....	1	
55	PADZZ	81349	M8340109M5103JC	RESISTOR NETWORK, FI.....	1	
56	PADZZ	04713	12513/BEBJC	MICROCIRCUIT, DIGITA.....	1	
57	PADZZ	81349	JM38510/06101BEX	MICROCIRCUIT, DIGITA.....	1	
58	PADZZ	81349	M38510/31504BEB	MICROCIRCUIT, DIGITA.....	2	
59	PADZZ	07263	54F161ADMQB	MICROCIRCUIT, DIGITA.....	2	
60	PADZZ	56996	B4003379-901	MICROCIRCUIT, LINEAR.....	1	
61	PADZZ	81349	M38510-31401BEB	MICROCIRCUIT, DIGITA.....	1	
62	PADZZ	81349	M38510-30301BCB	MICROCIRCUIT, DIGITA.....	1	
63	PADZA	27014	MM54HC374J/883B	MICROCIRCUIT, DIGITA.....	1	
64	PADZZ	81349	M38510/10702-BXC	MICROCIRCUIT, LINEAR.....	4	
65	PADZZ	81349	M38510/10703-BXC	MICROCIRCUIT, LINEAR.....	1	
66	PADZZ	81349	M871111/2-2B05	HEAT SINK.....	2	
67	XBDZZ	80063	A3034661	PIN, GUIDE.....	1	
68	PADZZ	80063	A3028564	PARTITION, SHIELD--L.....	1	
69	PADZZ	07556	2467 TALL	HEAT SINK, ELECTRICA.....	2	
70	PADZZ	80063	A3028561	PARTITION, SHIELD--L.....	1	
71	PADZZ	80063	A3028566	PARTITION, SHIELD--L.....	1	
72	PADZZ	80063	A3028565	PARTITION, SHIELD--L.....	1	
73	PADZZ	81349	M38527/03-002N	MOUNTING PAD, ELECTR.....	4	
74	PADZZ	81349	M38527/02-018N	MOUNTING PAD, ELECTR.....	3	
75	PADZZ	80063	A3028563	PARTITION, SHIELD--L.....	1	
76	PADZZ	80063	A3028572	COVER, SHIELD-- LOOP.....	1	
77	PADZZ	80063	A3079136	INSULATION CLOTH, EL.....	1	
78	PADZZ	80063	A3028562	SHIELD, ELECTRICAL C.....	1	

END OF FIGURE



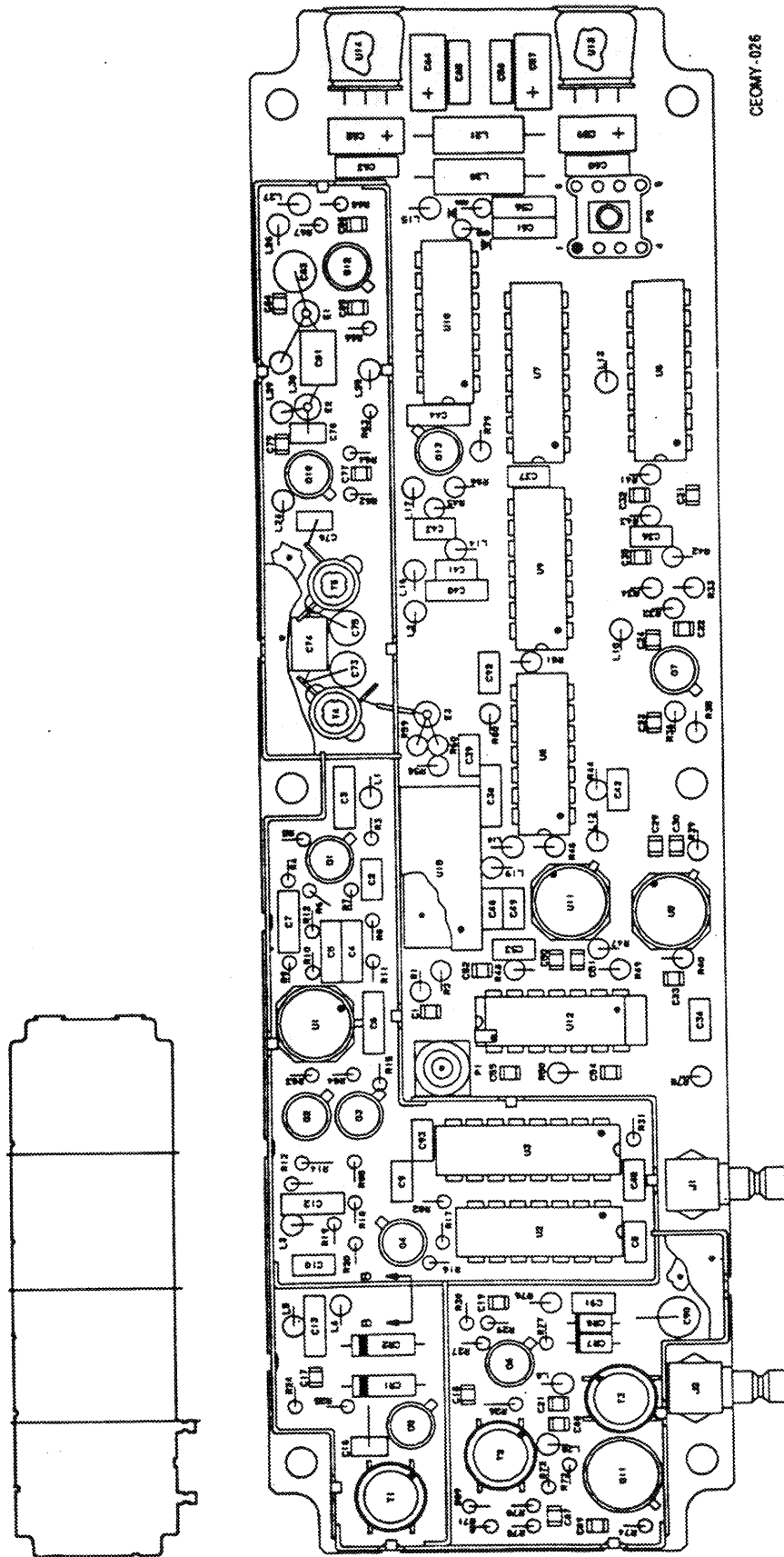

CEOMY-026

Figure 8. Sum Loop 1 CCA A3A1A2 (A3024350) (Sheet 1 of 6)

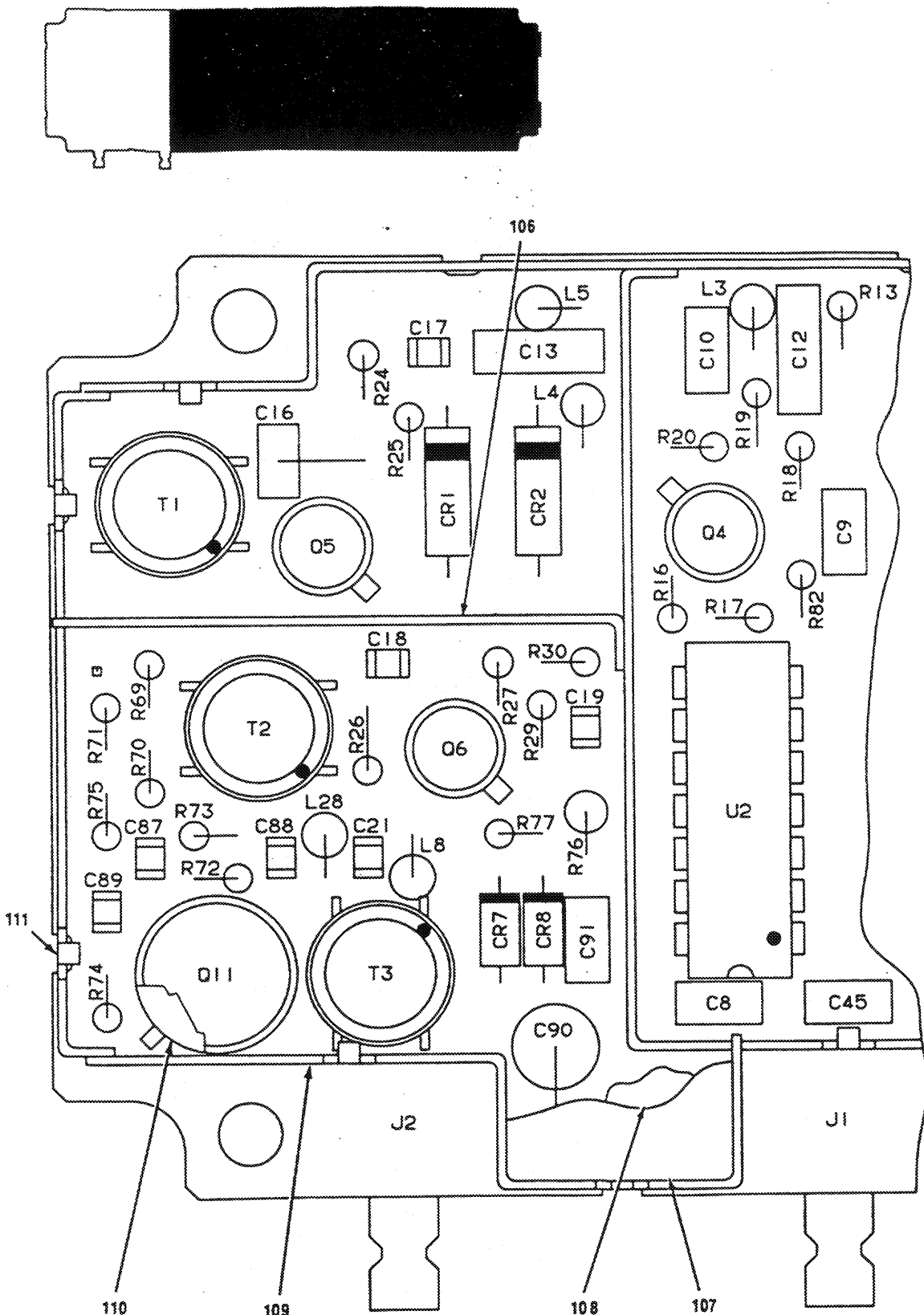

NOTES: 1. PREFIX ALL REFERENCE DESIGNATIONS WITH A3A1A2

2. SEE FIGURE 1 FOR RESPECTIVE UNIT REFERENCE DESIGNATION PREFIX

CEOMY-027

Figure 8. Sum Loop 1 CCA A3A1A2 (A3024350) (Sheet 2 of 6)

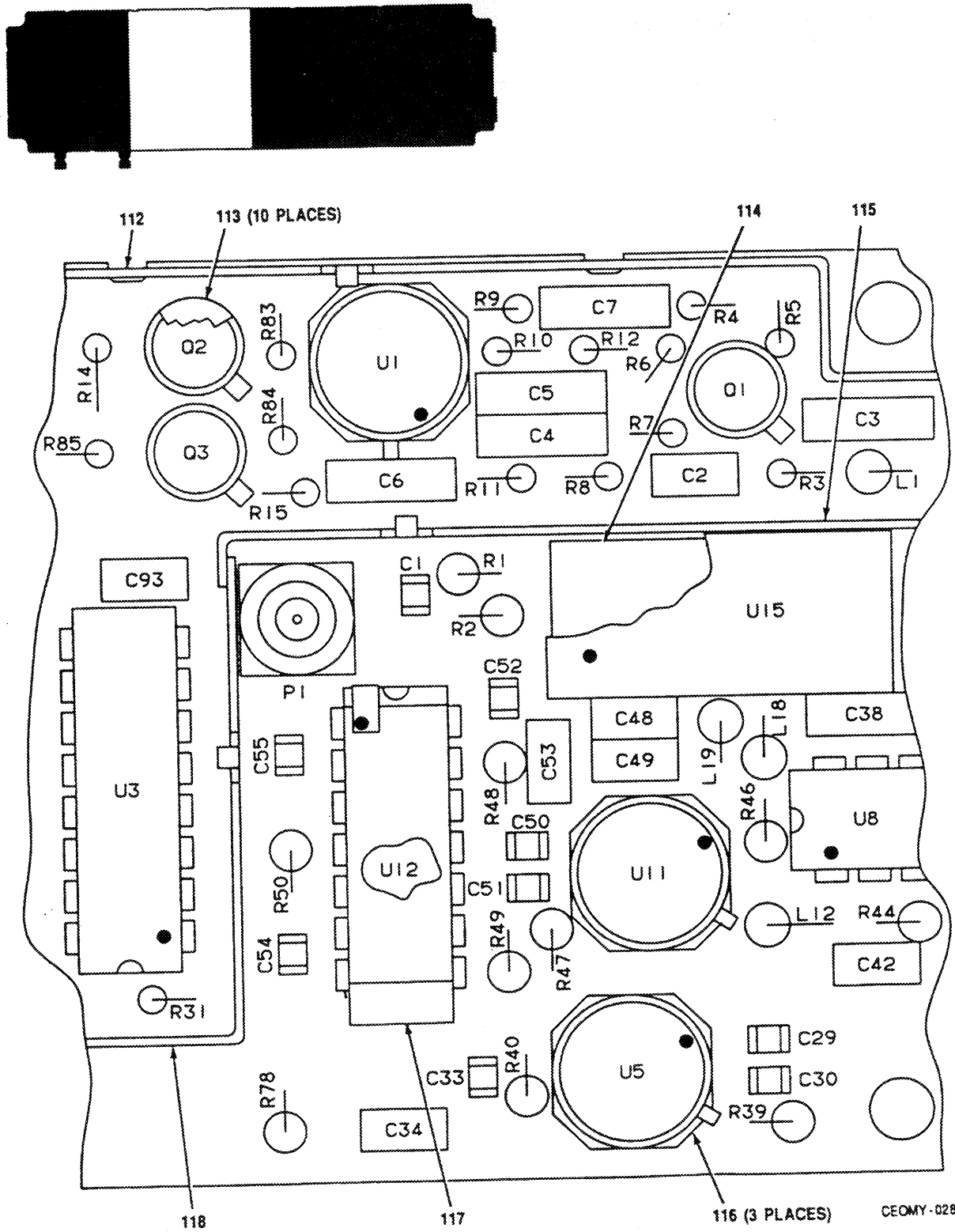

Figure 8. Sum Loop 1 CCA A3A1A2 (A3024350) (Sheet 3 of 6)

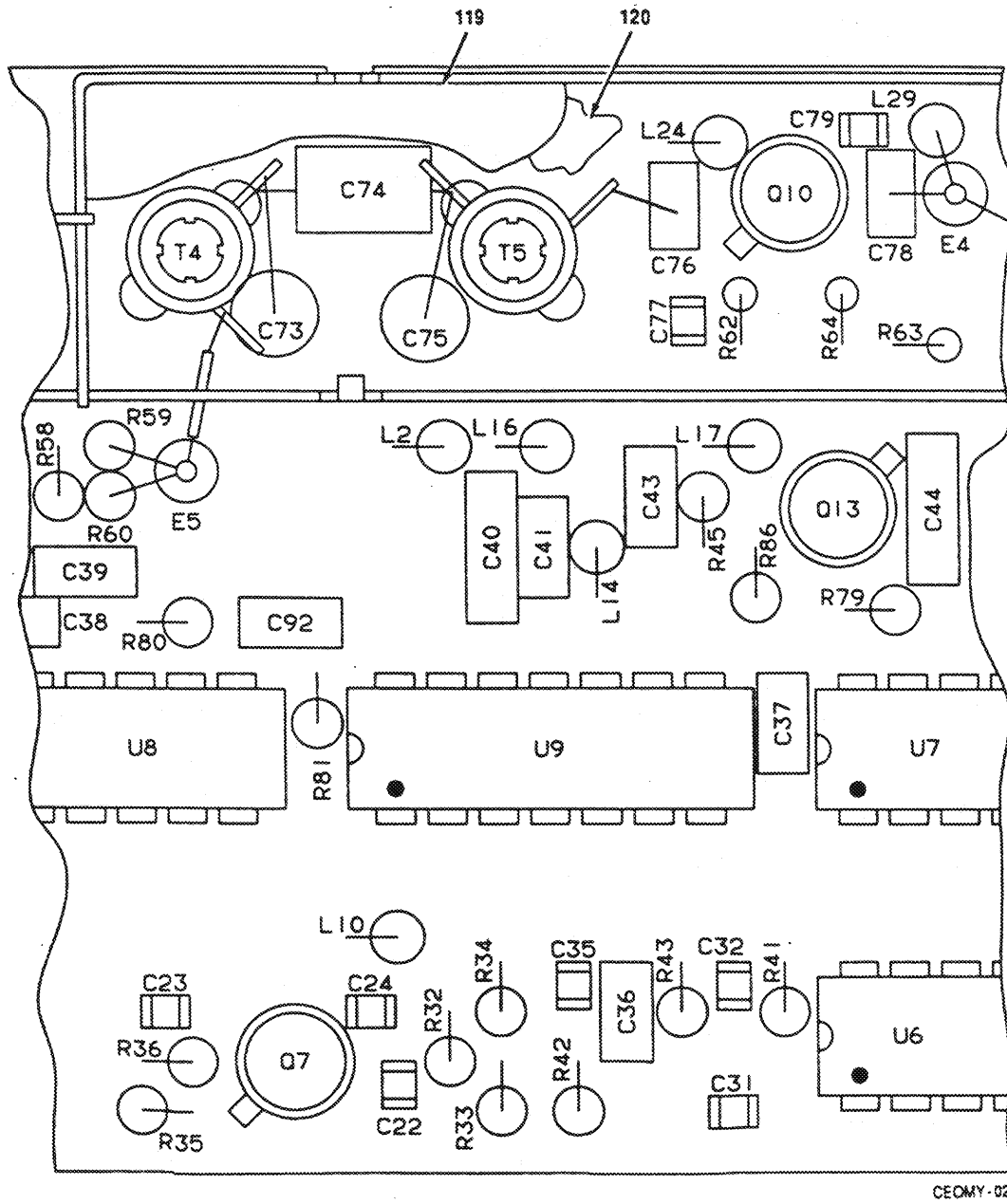
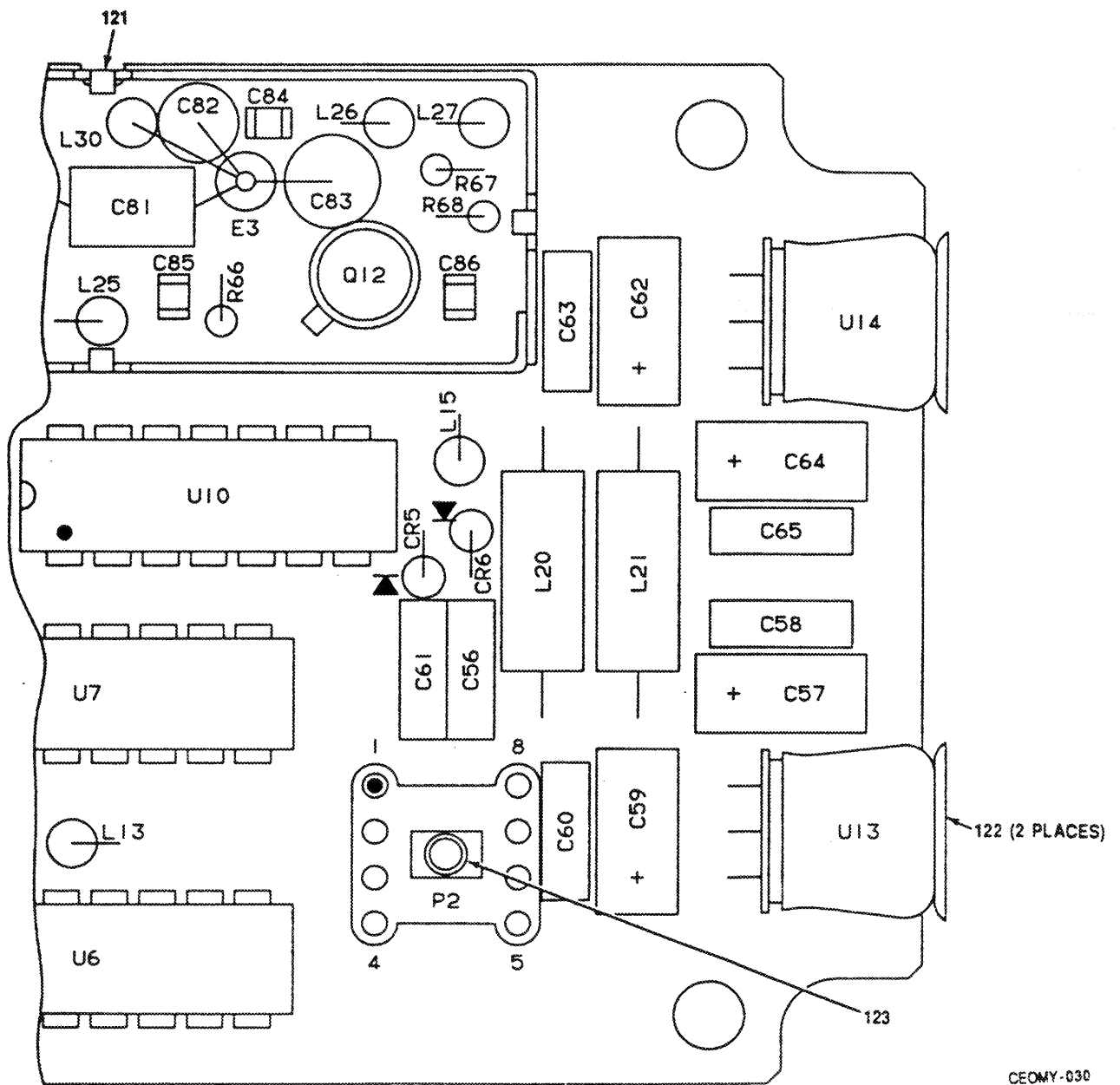
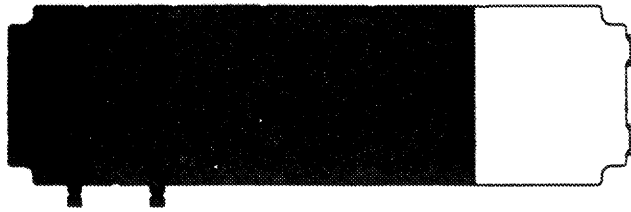

Figure 8. Sum Loop 1 CCA A3A1A2 (A3024350) (Sheet 4 of 6)



CEOMY-030

Figure 8. Sum Loop 1 CCA A3A1A2 (A3024350) (Sheet 5 of 6)

LEGEND

REF. DES.	ITEM NO.	REF. DES.	ITEM NO.	REF. DES.	ITEM NO.	REF. DES.	ITEM NO.	REF. DES.	ITEM NO.	REF. DES.	ITEM NO.
CR1	1	C41	11	C89	4	Q2	36	R32	58	R74*	80
CR2	1	C42	12	C90	20	Q3	37	R33	59	R75	81
CR5	2	C43	12	C91	20	Q4	38	R34	44	R76	46
CR6	2	C44	5	C92	11	Q5	39	R35	60	R77	82
CR7	3	C45	13	C93	21	Q6	35	R36	61	R78	83
CR8	3	C48	11	E1	22	Q7	35	R39	62	R79	84
C1	4	C49	6	E2	22	Q10	40	R40	63	R80	85
C3	5	C50	4	E3	22	Q11	41	R41	64	R81	63
C4	5	C51	4	J1	23	Q12	35	R42	65	R82	86
C5	5	C52	4	J2	23	Q13	42	R43	66	R83	87
C6	5	C53	6	L1	24	R1	43	R44	67	R85	87
C7	5	C54	4	L2	25	R2	44	R45	67	R86	88
C8	6	C55	4	L3	26	R3	45	R46	63	R87	89
C9	7	C56	9	L4	27	R4	46	R47	62	R88	90
C10	8	C57	14	L5	25	R5	46	R48	66	T1	91
C12	5	C58	9	L8	25	R6	46	R49	66	T2	92
C13	9	C59	14	L10	25	R7	47	R50	65	T3	93
C16	10	C60	9	L12	28	R8	48	R58	68	T4	94
C17	4	C61	9	L13	28	R9	46	R59	69	T5	94
C18	4	C62	14	L14	28	R10	49	R60	68	U1	95
C19	4	C63	9	L15	29	R11	49	R62	70	U2	96
C21	4	C64	14	L16	29	R12	46	R63	71	U3	97
C22	4	C65	9	L17	29	R13	50	R64	72	U5	98
C23	4	C73	15	L18	28	R14	50	R66	70	U6	99
C24	4	C74	16	L19	25	R15	51	R67	71	U7	100
C29	4	C75	17	L20	30	R16	46	R68	72	U8	96
C30	4	C76	10	L21	30	R17	52	R69	73	U9	96
C31	4	C77	4	L24	31	R18	46	R70	74	U10	101
C32	4	C78	10	L25	25	R19	53	R71	73	U11	98
C33	4	C79	4	L26	31	R20	54	R72	75	U12	102
C34	6	C81	18	L27	26	R24	52	R73	48	U13	103
C35	4	C83	19	L28	25	R25	55	R74*	45	U14	104
C36	6	C84	4	L29	32	R26	56	R74*	74	U15	105
C37	6	C85	4	L30	32	R27	57	R74*	76		
C38	5	C86	4	P1	33	R29	45	R74*	77		
C39	11	C87	4	P2	34	R30	53	R74*	78		
C40	5	C88	4	Q1	35	R31	46	R74*	79		

\* Select At Test

CEOMY-031

Figure 8. Sum Loop 1 CCA A3A1A2 (A3024350) (Sheet 6 of 6)

SECTION II			TM11-5895-1303-24P		(5)	(6)
(1)	(2)	(3)	(4)			
ITEM	SMR		PART		DESCRIPTION AND USABLE ON CODES(UOC)	QTY
NO	CODE	FSCM	NUMBER			
92	PADZZ	80063	A3024684-2		TRANSFORMER, RADIO F.....	1
93	PADZZ	80063	A3024684-3		TRANSFORMER, RADIO F.....	1
94	PADZZ	56996	B4003346-1		TRANSFORMER, RADIO F.....	2
95	PADZZ	96214	531932-2		MICROCIRCUIT, LINEAR.....	1
96	PADZZ	56996	B4003379-901		MICROCIRCUIT, LINEAR.....	3
97	PADZZ	81349	M38510-31401BEB		MICROCIRCUIT, DIGITA.....	1
98	PADZA	64863	SP8655AB		MICROCIRCUIT, DIGITA.....	2
99	PADZA	52648	SP8690AB		MICROCIRCUIT, DIGITA.....	1
100	PADZZ	81349	M38510/30110BEB		MICROCIRCUIT, DIGITA.....	1
101	PADZZ	81349	M38510/30003BCB		MICROCIRCUIT, DIGITA.....	1
102	PADZA	52648	SP8610AB		MIRCOCIRCUIT DIGITA.....	1
103	PADZZ	81349	M38510/10703-BXC		MICROCIRCUIT, LINEAR.....	1
104	PADZZ	81349	M38510/10702-BXC		MICROCIRCUIT, LINEAR.....	1
105	PADZZ	81349	M28837/1-02N		MIXER STAGES, RADIO.....	1
106	PADZZ	80063	A3028636		PARTITION, SHIELD SU.....	1
107	PADZZ	80063	A3028816		COVER, SHIELD--SUM L.....	1
108	PADZZ	80063	A3079148		INSULATION CLOTH, EL.....	1
109	PADZZ	80063	A3028639		PARTITION, SHIELD SU.....	1
110	PADZZ	81349	M38527/02-018N		MOUNTING PAD, ELECTR.....	1
111	PADZZ	80063	A3028633		PARTITION, SHIELD SU.....	1
112	PADZZ	80063	A3028632		PARTITION, SHIELD SU.....	1
113	PADZZ	81349	M38527/01-040N		MOUNTING, PADS, INSUL.....	10
114	PADZZ	80063	A3034171		INSULATOR, MIXER.....	1
115	PADZZ	80063	A3028641		PARTITION, SHIELD--S.....	1
116	PADZZ	81349	M38527/05-001D		MOUNTING PAD, ELECTR.....	3
117	PADZZ	07556	2467 TALL		HEAT SINK, ELECTRICA.....	1
118	PADZZ	80063	A3028640		PARTITION, SHIELD SU.....	1
119	PADZZ	80063	A3028645		COVER, SHIELD SUM LO.....	1
120	PADZZ	80063	A3079145		INSULATION CLOTH, EL.....	1
121	PADZZ	80063	A3028642		PARTITION, SHIELD--S.....	1
122	PADZZ	81349	M871111/2-2B05		HEAT SINK.....	2
123	XBDZZ	80063	A3034661		PIN, GUIDE.....	1

END OF FIGURE

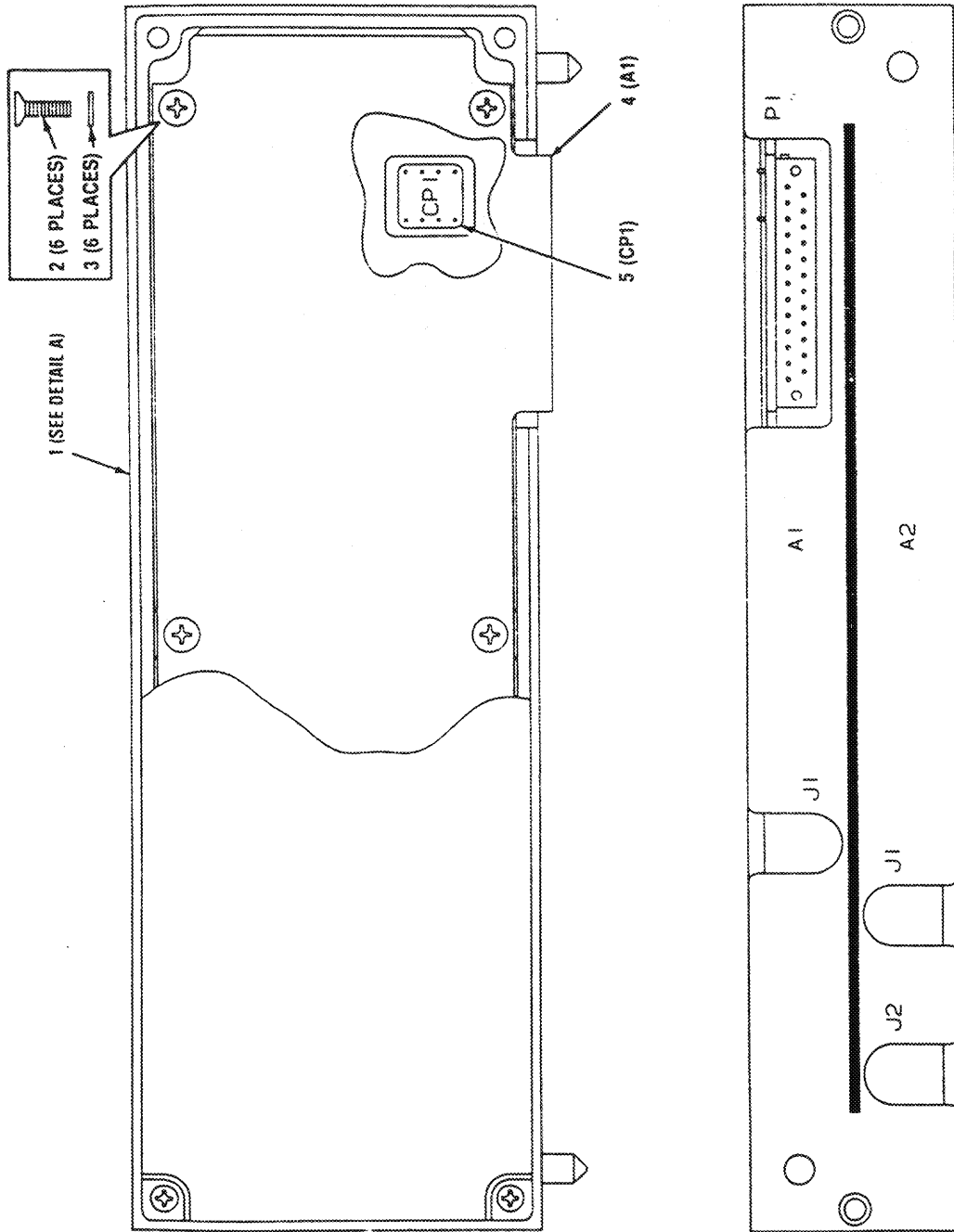

CEOMY-032

NOTES: 1. PREFIX ALL REFERENCE DESIGNATIONS WITH A3A2  
2. SEE FIGURE 1 FOR RESPECTIVE UNIT REFERENCE DESIGNATION PREFIX

Figure 9. Loop 2/Sum Loop 2 Assy A3A2 (A3024354) (Sheet 1 of 3)



SECTION II			TM11-5895-1303-24P		(5)	(6)
(1)	(2)	(3)	(4)			
ITEM NO	SMR CODE	FSCM	PART NUMBER	DESCRIPTION AND USABLE ON CODES(UOC)	QTY	
46	PADZZ	81349	RCR05G102JS	RESISTOR, FIXED, COMP	9	
47	PADZZ	81349	RCR05G750JS	RESISTOR, FIXED, COMP	1	
48	PADZZ	81349	RCR05G122JS	RESISTOR, FIXED, COMP	2	
49	PADZZ	81349	RCR05G222JS	RESISTOR, FIXED, COMP	2	
50	PADZZ	81349	RCR05G561JS	RESISTOR, FIXED, COMP	2	
51	PADZZ	81349	RCR05G152JS	RESISTOR, FIXED, COMP	1	
52	PADZZ	81349	RCR05G101JS	RESISTOR, FIXED, COMP	2	
53	PADZZ	81349	RCR05G471JS	RESISTOR, FIXED, COMP	2	
54	PADZZ	81349	RCR05G103JS	RESISTOR, FIXED, COMP	1	
55	PADZZ	81349	RCR05G751JS	RESISTOR, FIXED, COMP	1	
56	PADZZ	81349	RCR05G822JS	RESISTOR, FIXED, COMP	1	
57	PADZZ	81349	RCR05G362JS	RESISTOR, FIXED, COMP	1	
58	PADZZ	81349	RCR07G822JS	RESISTOR, FIXED, COMP	1	
59	PADZZ	81349	RCR07G362JS	RESISTOR, FIXED, COMP	1	
60	PADZZ	81349	RCR07G200JS	RESISTOR, FIXED, COMP	1	
61	PADZZ	81349	RCR07G471JS	RESISTOR, FIXED, COMP	1	
62	PADZZ	81349	RCR07G393JS	RESISTOR, FIXED, COMP	2	
63	PADZZ	81349	RCR07G332JS	RESISTOR, FIXED, COMP	3	
64	PADZZ	81349	RCR07G683JS	RESISTOR, FIXED, COMP	1	
65	PADZZ	81349	RCR07G103JS	RESISTOR, FIXED, COMP	2	
66	PADZZ	81349	RCR07G561JS	RESISTOR, FIXED, COMP	3	
67	PADZZ	81349	RCR07G361JS	RESISTOR, FIXED, COMP	2	
68	PADZZ	81349	RCR07G431JS	RESISTOR, FIXED, COMP	2	
69	PADZZ	81349	RCR07G110JS	RESISTOR, FIXED, COMP	1	
70	PADZZ	81349	RCR05G331JS	RESISTOR, FIXED, COMP	2	
71	PADZZ	81349	RCR05G562JS	RESISTOR, FIXED, COMP	2	
72	PADZZ	81349	RCR05G272JS	RESISTOR, FIXED, COMP	2	
73	PADZZ	81349	RCR05G151JS	RESISTOR, FIXED, COMP	2	
74	PADZZ	81349	RCR05G180JS	RESISTOR, FIXED, COMP (SELECT AT TEST R74)	2	
75	PADZZ	81349	RCR05G332JS	RESISTOR, FIXED, COMP	1	
76	PADZZ	81349	RCR05G120JS	RESISTOR, FIXED, COMP (SELECT AT TEST)	1	
77	PADZZ	81349	RCR05G150JS	RESISTOR, FIXED, COMP (SELECT AT TEST)	1	
78	PADZZ	81349	RCR05G200JS	RESISTOR, FIXED, COMP (SELECT AT TEST)	1	
79	PADZZ	81349	RCR05G220JS	RESISTOR, FIXED, COMP (SELECT AT TEST)	1	
80	PADZZ	81349	RCR05G240JS	RESISTOR, FIXED, COMP (SELECT AT TEST)	1	
81	PADZZ	81349	RCR05G680JS	RESISTOR, FIXED, COMP	1	
82	PADZZ	81349	RCR05G203JS	RESISTOR, FIXED, COMP	1	
83	PADZZ	81349	RCR07G333JS	RESISTOR, FIXED, COMP	1	
84	PADZZ	81349	RCR07G751JS	RESISTOR, FIXED, COMP	1	
85	PADZZ	81349	RCR07G102JS	RESISTOR, FIXED, COMP	1	
86	PADZZ	81349	RCR05G154JS	RESISTOR, FIXED, COMP	1	
87	PADZZ	81349	RCR05G511JS	RESISTOR, FIXED, COMP	2	
88	PADZZ	81349	RCR07G562JS	RESISTOR, FIXED, COMP	1	
89	PADZZ	81349	M55342M03B2K00P	RESISTOR, FIXED, FILM	1	
90	PADZZ	81349	RCR05G431JS	RESISTOR, FIXED, COMP	1	
91	PADZZ	80063	A3024684-1	TRANSFORMER, RADIO F	1	

SECTION II TM11-5895-1303-24P (5) (6)  
 (1) (2) (3) (4)  
 ITEM SMR PART  
 NO CODE FSCM NUMBER DESCRIPTION AND USABLE ON CODES(UOC) QTY  
 GROUP 030102 SUM LOOP 1 CCA A3A1A2  
 (A3024350)

FIG. 8

1	PADZZ	52673	KV2201	SEMICONDUCTOR DEVIC.....	2
2	PADZZ	81349	JANTX1N4454-1	SEMICONDUCTOR DEVIC.....	2
3	PADZZ	81349	JANTX1N5712	SEMICONDUCTOR DEVIC.....	2
4	PADZZ	81349	CDR01BX102BKUP	CAPACITOR,CHIP.....	27
5	PADZZ	81349	M39014/02-1419	CAPACITOR, FIXED, CER.....	9
6	PADZZ	81349	M39014-01-1575	CAPACITOR, FIXED, CER.....	6
7	PADZZ	81349	M39014/01-1589	CAPACITOR, FIXED, CER.....	1
8	PADZZ	81349	M39014/01-1348	CAPACITOR, FIXED, CER.....	1
9	PADZZ	81349	M39014/02-1350	CAPACITOR, FIXED, CER.....	7
10	PADZZ	56996	B4003318-78	CAPACITOR, FIXED, CER.....	3
11	PADZZ	81349	M39014/01-1357	CAPACITOR, FIXED, CER.....	4
12	PADZZ	81349	M39014/01-1336	CAPACITOR, FIXED, CER.....	2
13	PADZZ	81349	M39014/01-1345	CAPACITOR, FIXED, CER.....	1
14	PADZZ	56996	B4003327-3126	CAPACITOR, FIXED, ELE.....	4
15	PADZZ	56996	B4003317-24	CAPACITOR, FIXED, CER.....	1
16	PADZZ	56996	B4003317-18	CAPACITOR, FIXED, CER.....	1
17	PADZZ	56996	B4003317-23	CAPACITOR, FIXED, CER.....	1
18	PADZZ	56996	B4003317-21	CAPACITOR, FIXED, PLA.....	1
19	PADZZ	56996	B4003317-32	CAPACITOR, FIXED, PLA.....	1
20	PADZZ	81349	M39014/01-1569	CAPACITOR, FIXED, CER.....	2
21	PADZZ	81349	M39014-01-1575	CAPACITOR, FIXED, CER.....	1
22	PADZZ	56996	B4003308-901	TERMINAL, FEEDTHRU I.....	3
23	PADZZ	19505	2010-6511-002	CONNECTOR, RECEPTACL.....	2
24	PADZZ	96906	MS75084-8	COIL, RADIO FREQUENC.....	1
25	PADZZ	96906	MS75084-4	COIL, RADIO FREQUENC.....	7
26	PADZZ	96906	MS75085-7	COIL, RADIO FREQUENC.....	2
27	PADZZ	96906	MS75084-3	COIL, RADIO FREQUENC.....	1
28	PADZZ	96906	MS75084-10	COIL, RADIO FREQUENC.....	4
29	PADZZ	96906	MS75084-15	COIL, RADIO FREQUENC.....	3
30	PADZZ	96906	MS75089-3	COIL, RADIO FREQUENC.....	2
31	PADZZ	96906	MS75083-13	COIL, RADIO FREQUENC.....	2
32	PADZZ	96906	MS75083-1	COIL, RADIO FREQUENC.....	2
33	PADZZ	58167	11-0450-01C	CONNECTOR, RECEPTACL.....	1
34	PADZZ	37695	189698	SOCKET, PLUG-IN ELEC.....	1
35	PADZZ	81349	JANTX2N918	TRANSISTOR.....	4
36	PADZZ	81349	JANTX2N3251A	TRANSISTOR.....	1
37	PADZZ	81349	JANTX2N2369A	TRANSISTOR.....	1
38	PADZZ	56996	B4002963	TRANSISTOR.....	1
39	PADZZ	04713	U310	TRANSISTOR.....	1
40	PADZZ	56996	B4002964	TRANSISTOR.....	1
41	PADZZ	81349	JANTX2N5109	TRANSISTOR.....	1
42	PADZZ	81349	JANTXV2N2907A	TRANSISTOR.....	1
43	PADZZ	81349	RCR07G151JS	RESISTOR, FIXED, COMP.....	1
44	PADZZ	81349	RCR07G510JS	RESISTOR, FIXED, COMP.....	2
45	PADZZ	81349	RCR05G100JS	RESISTOR, FIXED, COMP (SELECT AT TEST R74).....	3

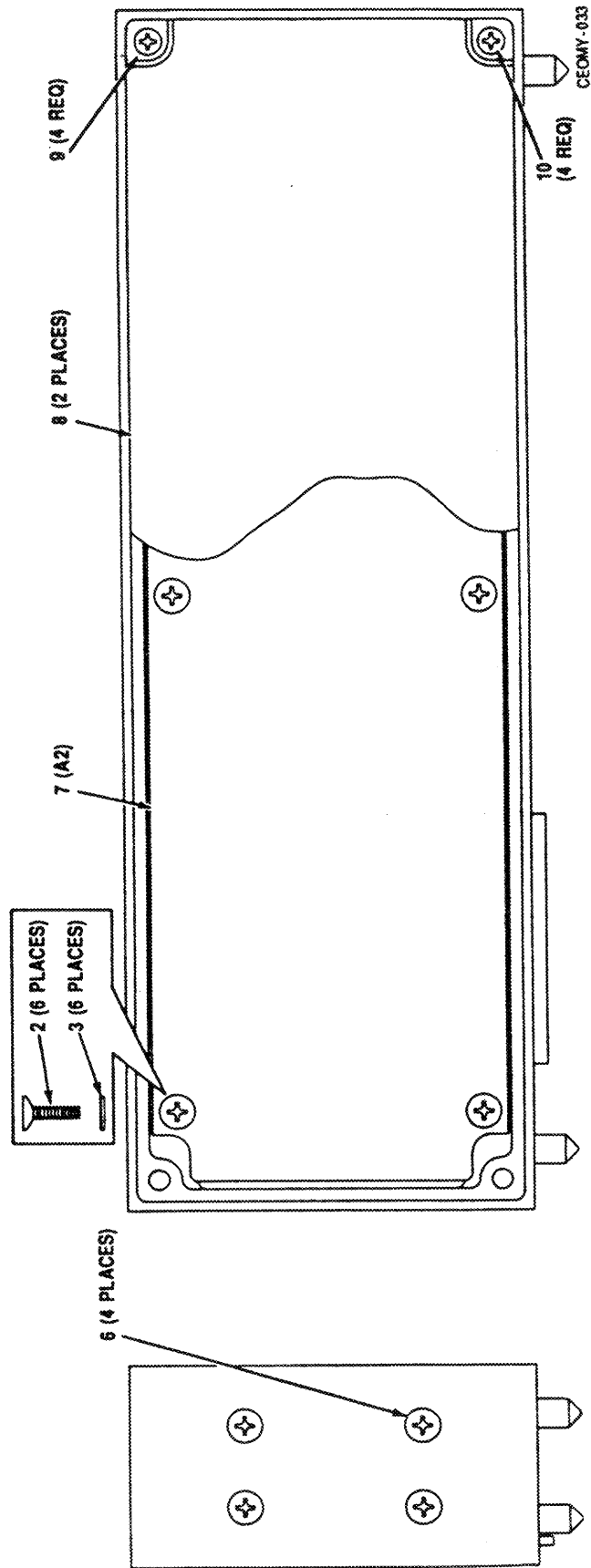
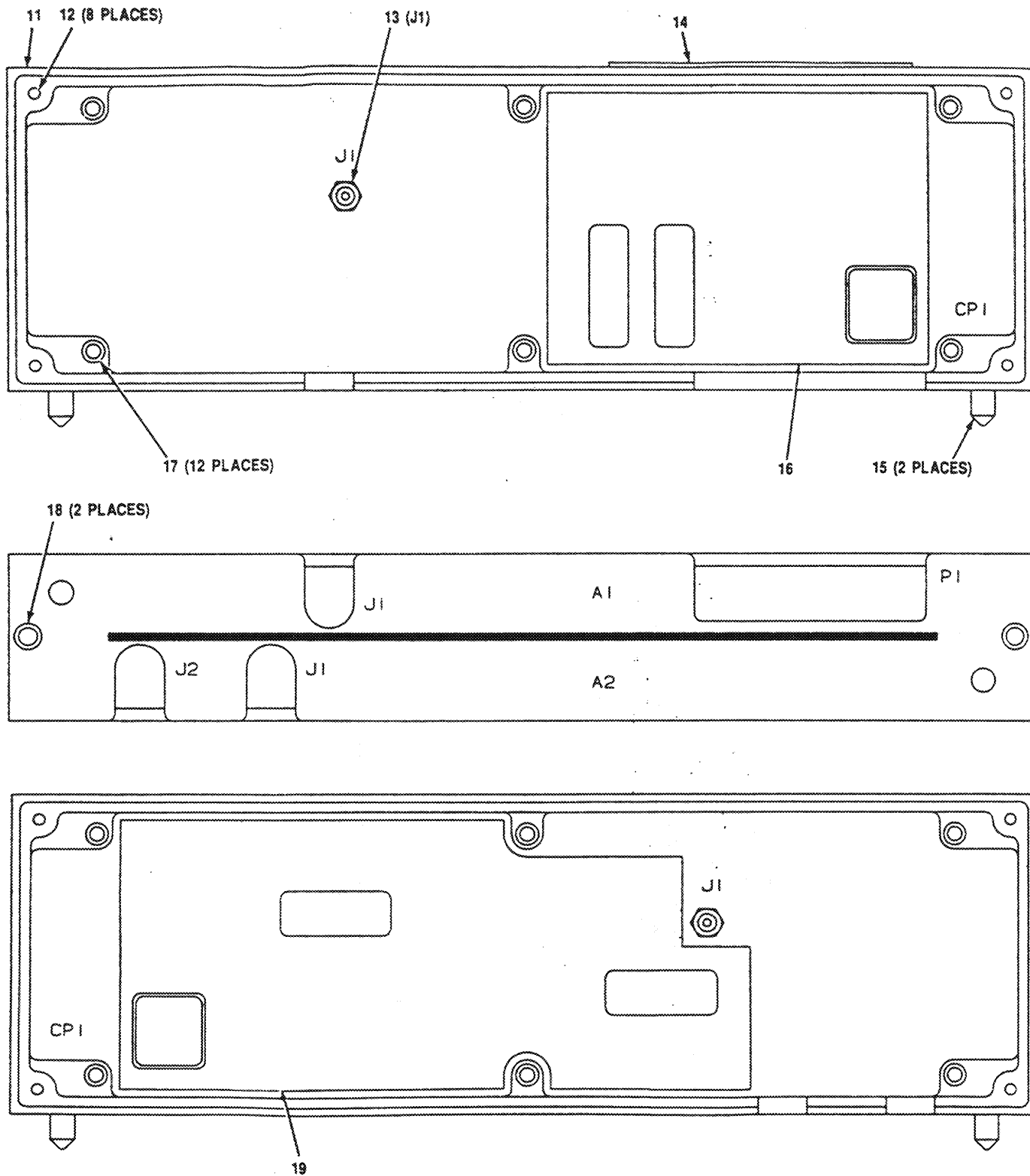

Figure 9. Loop 2/Sum Loop 2 Assy A3A2 (A3024354) (Sheet 2 of 3)



DETAIL A

CEOMY-034

Figure 9. Loop 2/Sum Loop 2 Assy A3A2 (A3024354) (Sheet 3 of 3)

SECTION II			TM11-5895-1303-24P			
(1)	(2)	(3)	(4)	(5)	(6)	
ITEM NO	SMR CODE	FSCM	PART NUMBER	DESCRIPTION AND USABLE ON CODES(UOC)	QTY	

GROUP 0302 LOOP 2/SUM LOOP 2  
ASSY A3A2 (A3024354)

FIG. 9

1	XBDDD	80063	A3024355	FRAME ASSEMBLY, LOOP.....	1
2	PADZZ	96906	MS51957-14	SCREW, MACHINE.....	8
3	PADZZ	80205	NAS620C4L	WASHER, FLAT.....	8
4	PADDD	80063	A3024356	CIRCUIT CARD ASSEMB (SEE FIG. 10 FOR BREAKDOWN).....	1
5	PADZZ	56207	400119	CONNECTOR, RECEPTAC.....	1
6	PADZZ	96906	MS24693C2	SCREW, MACHINE.....	4
7	PADDD	80063	A3024360	CIRCUIT CARD ASSEMB (SEE FIG. 11 FOR BREAKDOWN).....	1
8	XBDZZ	80063	A3086607	COVER, MODULE ACCESS.....	2
9	PADZZ	96906	MS51957-2	SCREW, MACHINE.....	8
10	PADZZ	96906	MS24693C5	SCREW, MACHINE.....	4
11	XBDZZ	80063	A3028013	FRAME--LOOP 2/SUM L.....	1
12	PADZZ	26344	3585-02CNW0129	INSERT, SCREW THREAD.....	8
13	PADZA	58167	1111-1180-01C	CONNECTOR, RECEPTAC.....	1
14	XBDZZ	80063	A3034572	LABEL, SENSITIVE.....	1
15	XBDZZ	80063	A3028102	PIN, GUIDE--MODULE.....	2
16	PADZZ	80063	A3029325	INSULATOR, CIRCUIT C.....	1
17	PADZZ	96906	MS21209C0415L	INSERT, SCREW THREAD.....	12
18	PADZZ	96906	MS21209C0815L	INSERT, SCREW THREAD.....	2
19	PADZZ	80063	A3032177	INSULATOR, CIRCUIT C.....	1

END OF FIGURE

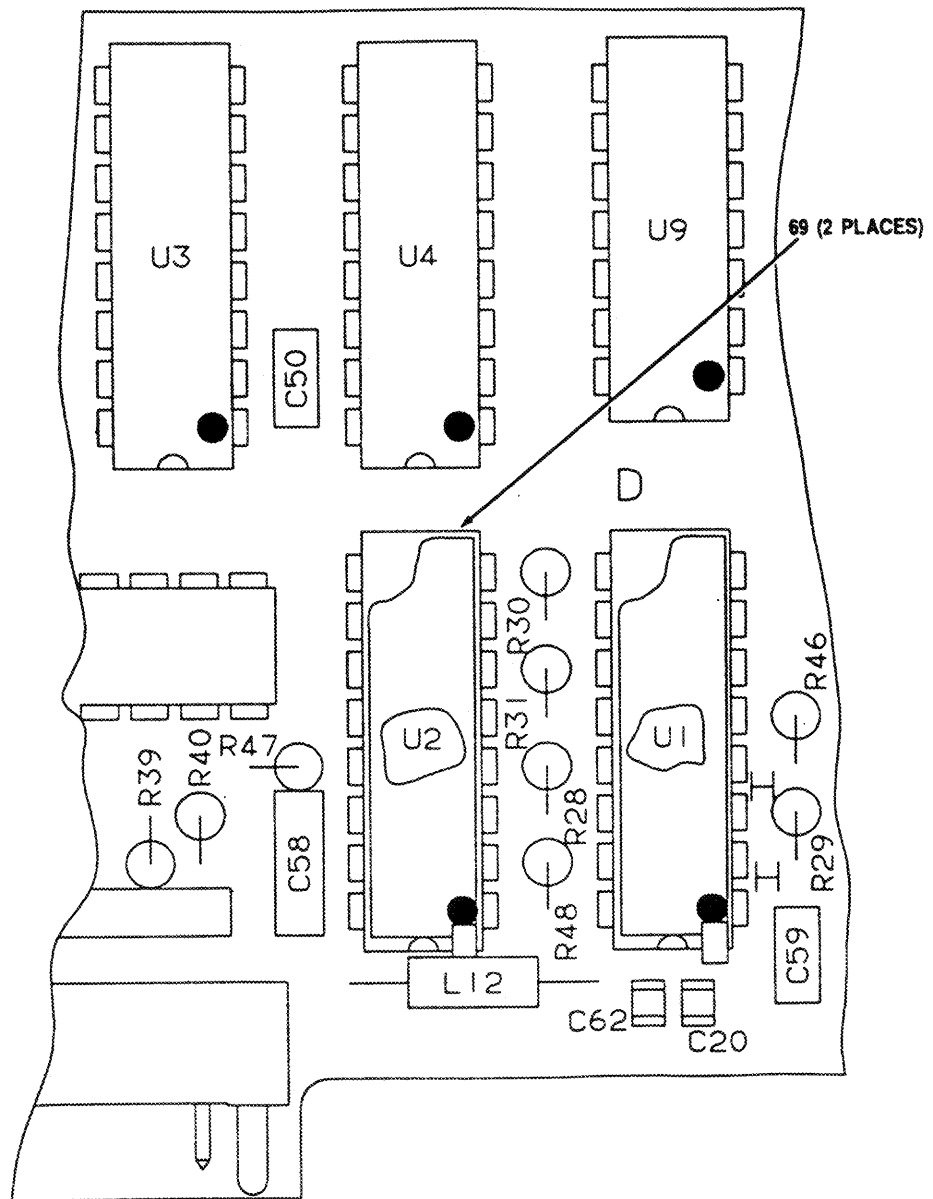
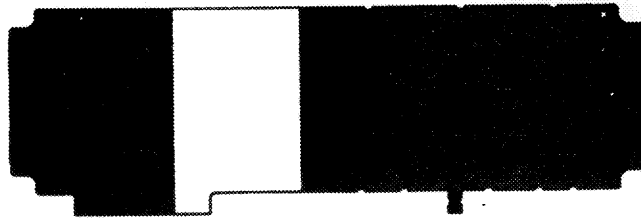

CEOMY-037

Figure 10. Loop 2 CCA A3A2A1 (A3024356) (Sheet 3 of 6)

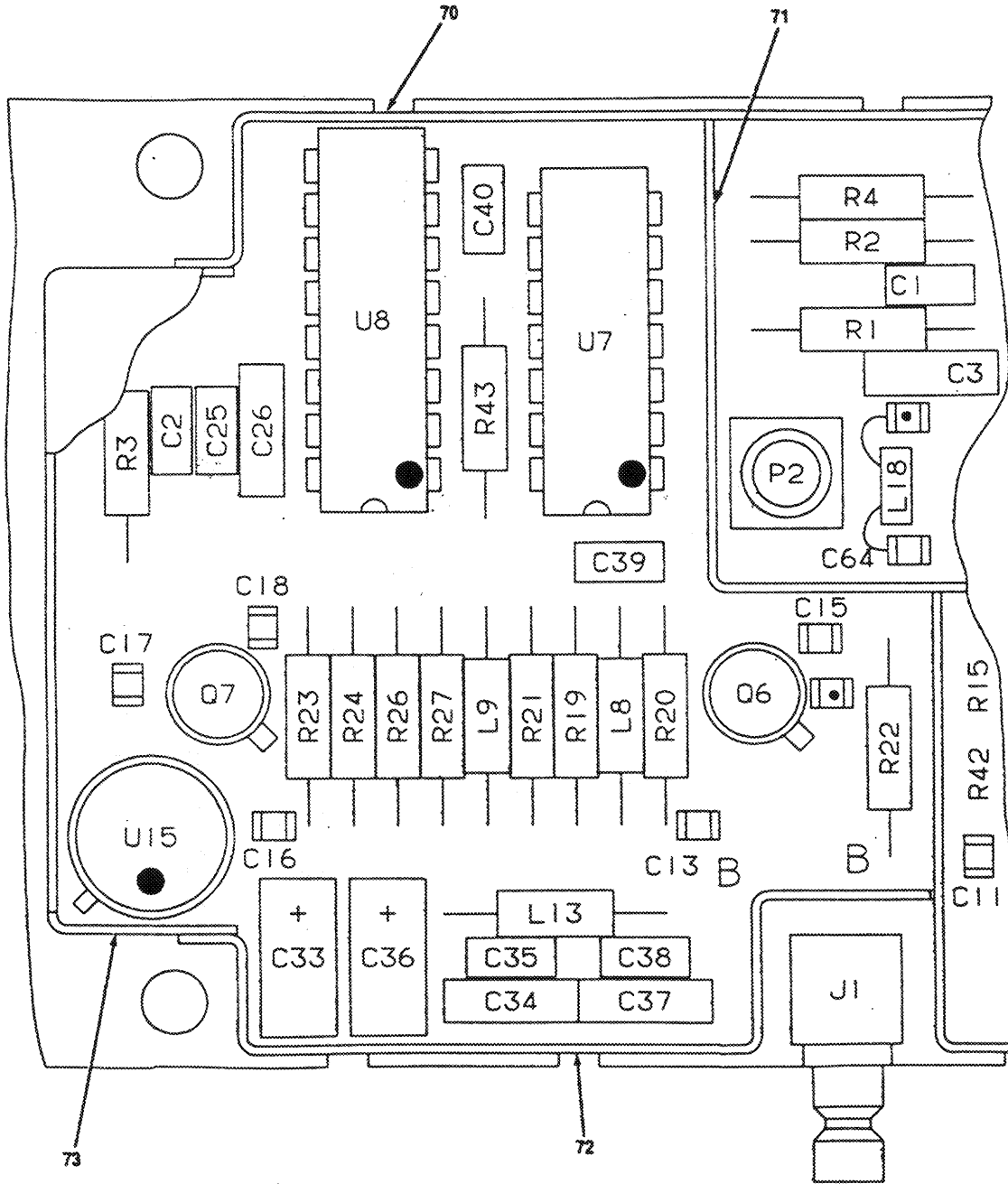
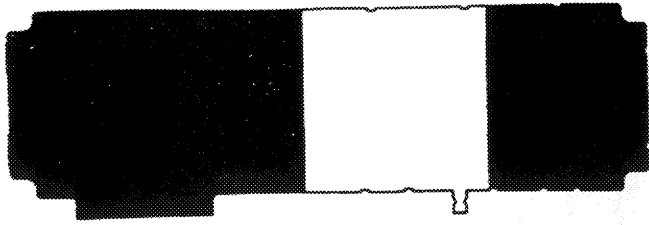

CEOMY-038

Figure 10. Loop 2 CCA A3A2A1 (A3024356) (Sheet 4 of 6)

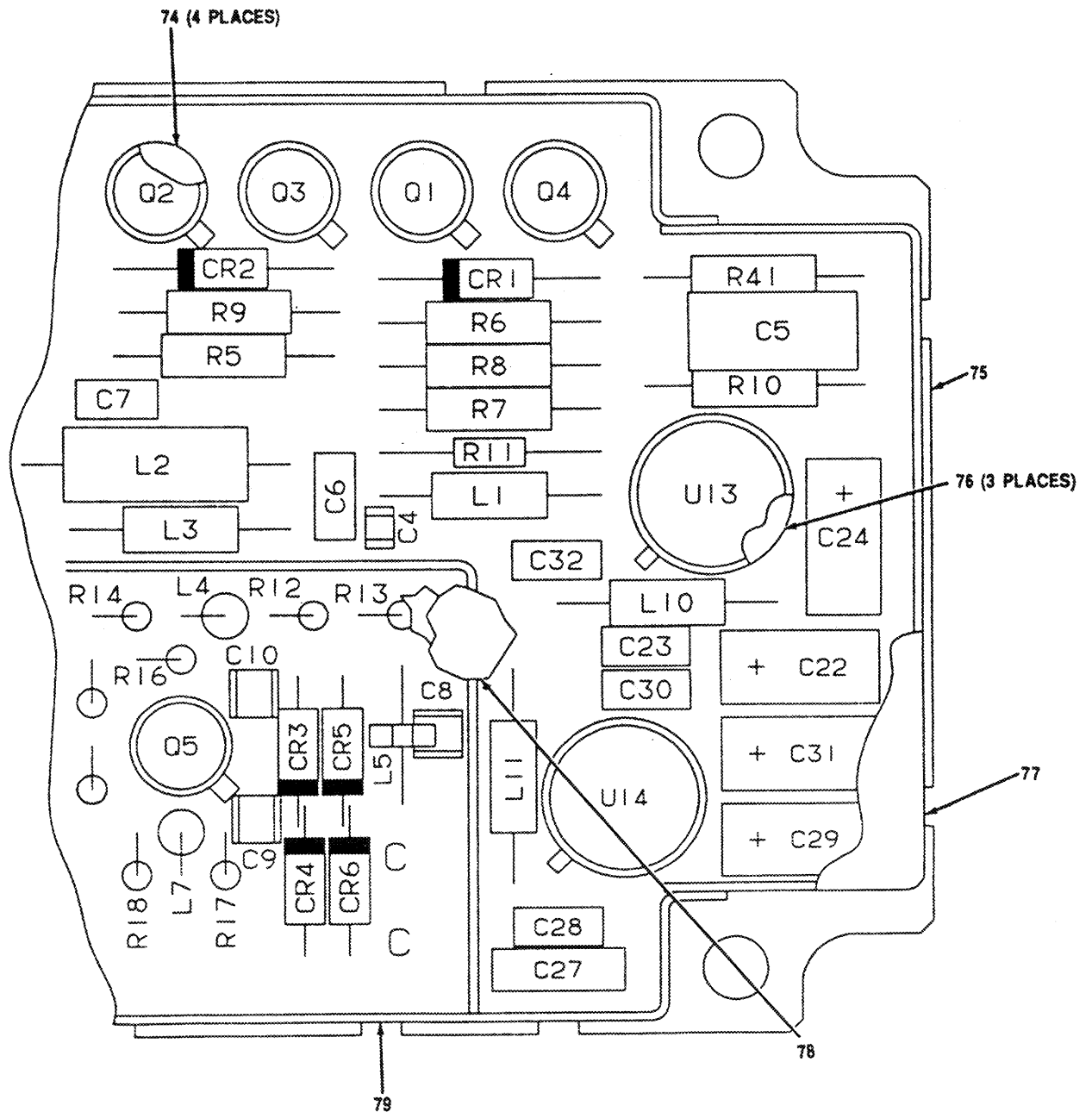

CEOMY-039

Figure 10. Loop 2 CCA A3A2A1 (A3024356) (Sheet 5 of 6)



LEGEND

REF. DES.	ITEM NO.	REF. DES.	ITEM NO.	REF. DES.	ITEM NO.	REF. DES.	ITEM NO.	REF. DES.	ITEM NO.	REF. DES.	ITEM NO.
CR1	1	C23	13	C50	13	L13	25	R13	43	R41	53
CR2	1	C24	12	C51	5	L14	26	R14	44	R42	54
CR3	2	C25	8	C52	12	L15	27	R15	45	R43	55
CR4	2	C26	5	C53	5	L16	26	R16	46	R46	52
CR5	2	C27	5	C54	8	L17	24	R17	47	R47	52
CR6	2	C28	8	C55	12	L18	28	R18	48	R48	52
C1	3	C29	14	C56	8	P1	29	R19	35	R49	56
C2	4	C30	13	C57	5	P2	30	R20	49	U1	57
C3	5	C31	14	C58	5	Q1	31	R21	41	U2	58
C4	6	C32	8	C59	13	Q2	31	R22	50	U3	59
C5	7	C33	12	C60	13	Q3	31	R23	49	U4	60
C6	8	C34	5	C62	6	Q4	32	R24	35	U5	59
C7	8	C35	8	C64	16	Q5	33	R26	41	U6	60
C8	9	C36	12	C65	16	Q6	33	R27	50	U7	61
C9	10	C37	5	J1	17	Q7	33	R28	51	U8	62
C10	11	C38	8	J2	18	R1	34	R29	52	U9	63
C11	6	C39	13	L1	19	R2	35	R30	52	U10	64
C12	6	C40	15	L2	20	R3	36	R31	52	U13	65
C13	6	C41	5	L3	21	R4	34	R32	51	U14	66
C14	6	C42	12	L4	21	R5	37	R33	51	U15	65
C15	6	C43	5	L5	22	R6	38	R34	51	U16	65
C16	6	C44	8	L7	23	R7	39	R35	51	U17	65
C17	6	C45	12	L8	24	R8	37	R36	51		
C18	6	C46	8	L9	24	R9	40	R37	51		
C19	6	C47	5	L10	25	R10	41	R38	51		
C20	6	C48	5	L11	19	R11	42	R39	51		
C22	12	C49	13	L12	25	R12	43	R40	51		

CEOMY-040

Figure 10. Loop 2 CCA A3A2A1 (A3024356) (Sheet 6 of 6)

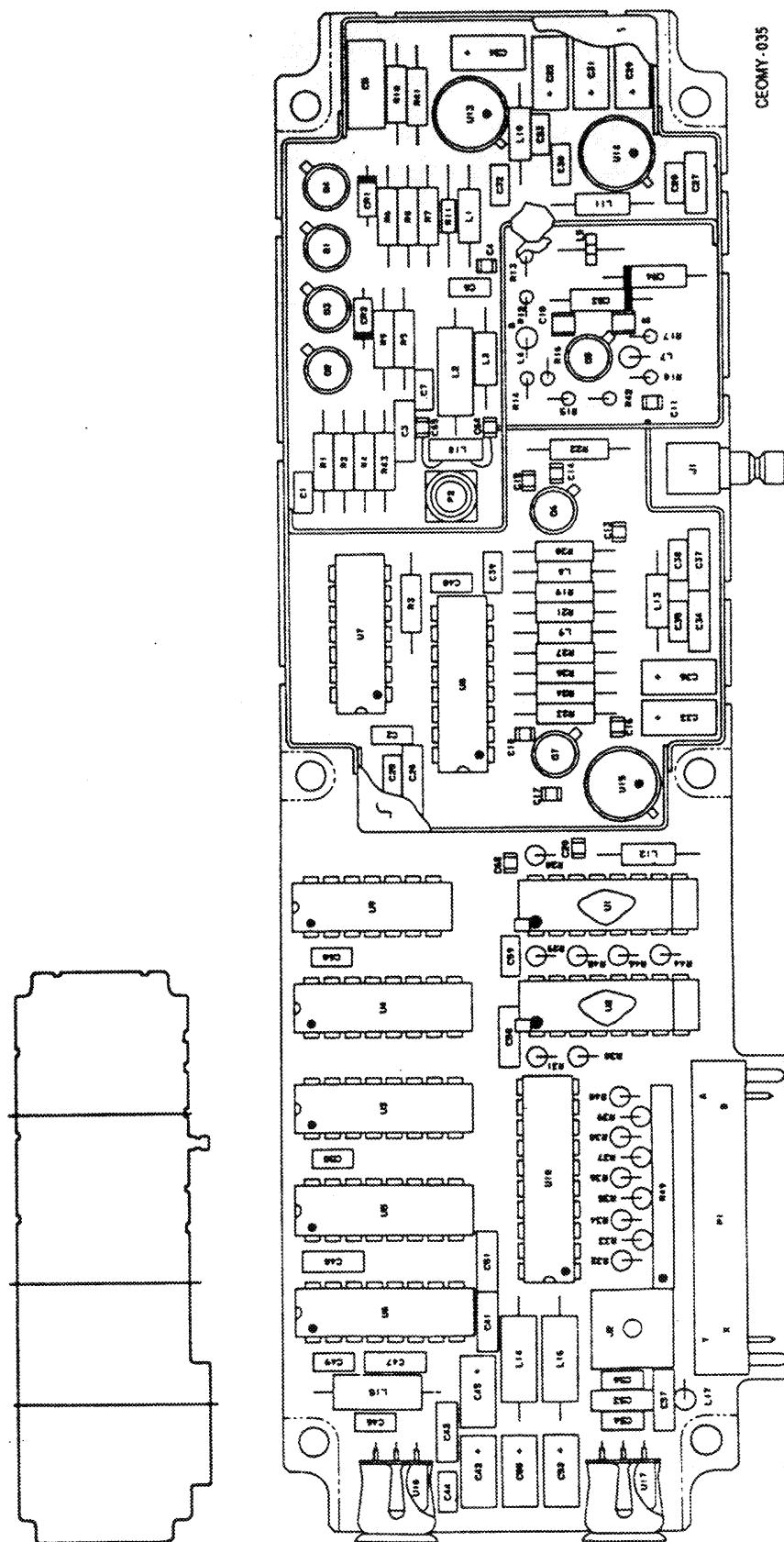
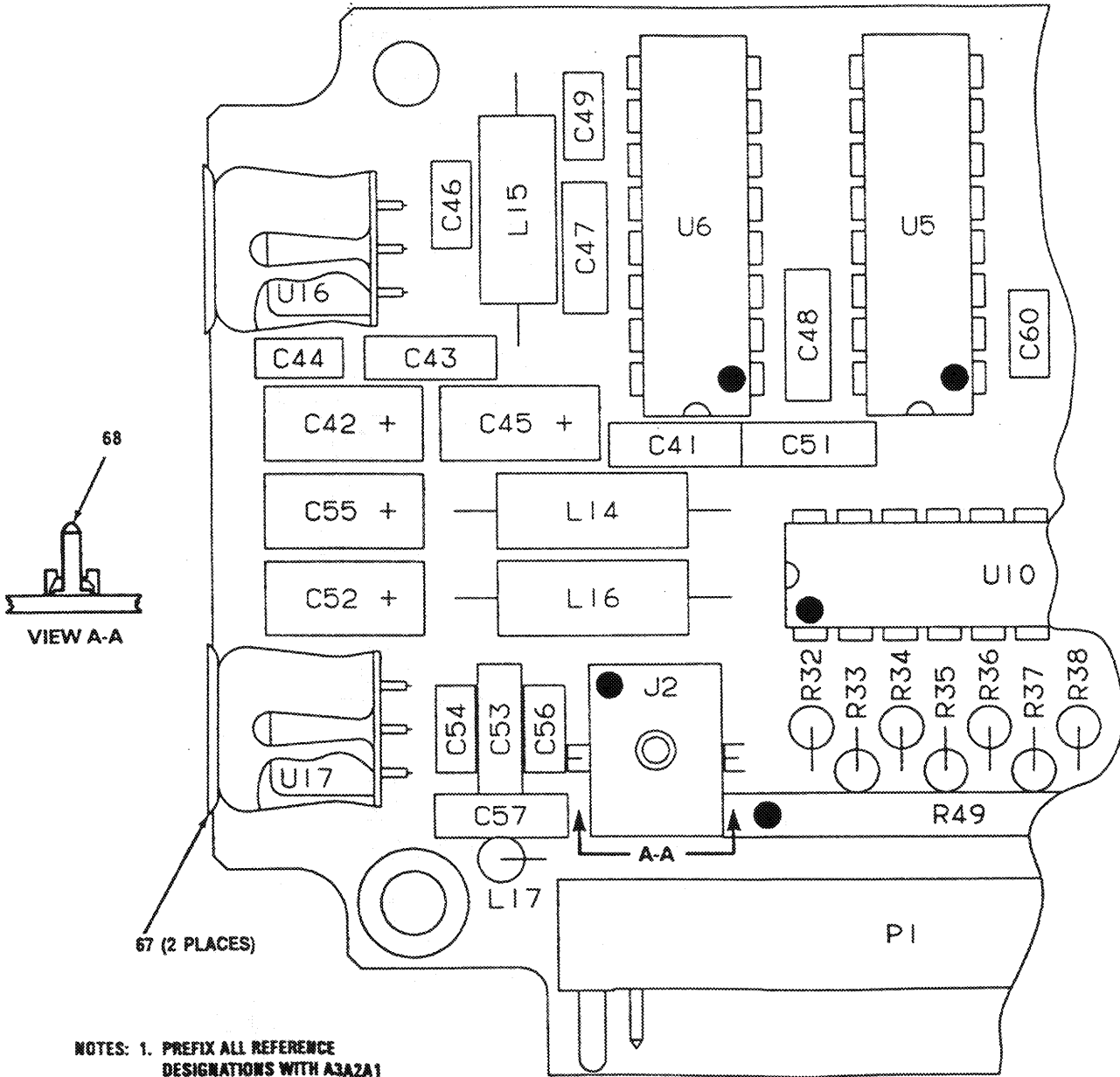
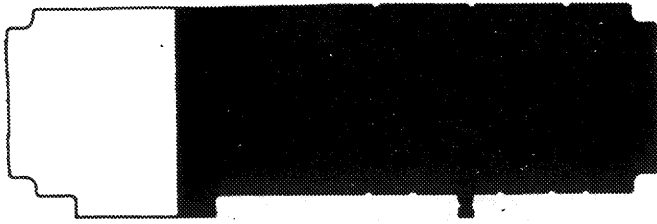

Figure 10. Loop 2 CCA A3A2A1 (A3024356) (Sheet 1 of 6)



- NOTES: 1. PREFIX ALL REFERENCE DESIGNATIONS WITH A3A2A1  
2. SEE FIGURE 1 FOR RESPECTIVE UNIT REFERENCE DESIGNATION PREFIX

CEOMY-036

Figure 10. Loop 2 CCA A3A2A1 (A3024356) (Sheet 2 of 6)

SECTION II  
 (1) (2) (3) (4) (5) (6)  
 ITEM SMR FSCM PART DESCRIPTION AND USABLE ON CODES(UDC) QTY  
 NO CODE FSCM NUMBER

GROUP 030201 LOOP 2 CCA, A3A2A1  
 (A3024356)

FIG. 10

1	PADZZ	81349	JANTX1N4454-1	SEMICONDUCTOR DEVIC.....	2
2	PADZZ	80063	A3028098	SEMICONDUCTOR DEVIC.....	4
3	PADZZ	81349	M39014/01-1338	CAPACITOR, FIXED, CER.....	1
4	PADZZ	81349	M39014/01-1578	CAPACITOR, FIXED, CER.....	1
5	PADZZ	81349	M39014/02-1350	CAPACITOR, FIXED, CER.....	13
6	PADZZ	81349	CDR01BX102BKUP	CAPACITOR, CHIP.....	12
7	PADZZ	81349	CFR06RRA183JP	CAPACITOR, FIXED, MET.....	1
8	PADZZ	81349	M39014/01-1357	CAPACITOR, FIXED, CER.....	11
9	PADZZ	81349	CDR14BG2R0ECUPX	CAPACITOR, FIXED, ELE.....	1
10	PADZZ	81349	CDR14BG101EKUPX	CAPACITOR, FIXED, ELE.....	1
11	PADZZ	81349	CDR14BG620EKUPX	CAPACITOR, FIXED, ELE.....	1
12	PADZZ	56996	B4003327-3126	CAPACITOR, FIXED, ELE.....	8
13	PADZZ	81349	M39014/01-1575	CAPACITOR, FIXED, CER.....	7
14	PADZZ	56996	B4003327-3123	CAPACITOR, FIXED, ELE.....	2
15	PADZZ	81349	M39014-01-1563	CAPACITOR, FIXED, CER.....	1
16	PADZZ	81349	CDR12BG150AJUPX	CAPACITOR, CHIP.....	2
17	PADZZ	19505	2010-6511-002	CONNECTOR, RECEPTACL.....	1
18	PADZZ	37695	189698	SOCKET, PLUG-IN ELEC.....	1
19	PADZZ	96906	MS75085-7	COIL, RADIO FREQUENC.....	2
20	PADZZ	96906	MS75089-27	COIL, RADIO FREQUENC.....	1
21	PADZZ	96906	MS75083-13	COIL, RADIO FREQUENC.....	2
22	PADZZ	80063	A3024684-10	COIL, RADIO FREQUENC.....	1
23	PADZZ	96906	MS75083-7	COIL, RADIO FREQUENC.....	1
24	PADZZ	96906	MS75084-6	COIL, RADIO FREQUENC.....	3
25	PADZZ	96906	MS75084-7	COIL, RADIO FREQUENC.....	3
26	PADZZ	96906	MS75089-1	COIL, RADIO FREQUENC.....	2
27	PADZZ	96906	MS75088-7	COIL, RADIO FREQUENC.....	1
28	PADZZ	80063	A3024684-12	COIL, RADIO FREQUENC.....	1
29	PADZZ	81349	M55302/4-03	CONNECTOR, RECEPTACL.....	1
30	PADZZ	58167	11-0450-01C	CONNECTOR, RECEPTACL.....	1
31	PADZZ	81349	JANTX2N2369A	TRANSISTOR.....	3
32	PADZZ	81349	JANTXV2N2907A	TRANSISTOR.....	1
33	PADZZ	56996	B4002964	TRANSISTOR.....	3
34	PADZZ	81349	RCR07G112JS	RESISTOR, FIXED, COMP.....	2
35	PADZZ	81349	RCR07G222JS	RESISTOR, FIXED, COMP.....	3
36	PADZZ	81349	RCR07G513JS	RESISTOR, FIXED, COMP.....	1
37	PADZZ	81349	RCR07G123JS	RESISTOR, FIXED, COMP.....	2
38	PADZZ	81349	RCR07G911JS	RESISTOR, FIXED, COMP.....	1
39	PADZZ	81349	RCR07G331JS	RESISTOR, FIXED, COMP.....	1
40	PADZZ	81349	RCR07G131JS	RESISTOR, FIXED, COMP.....	1
41	PADZZ	81349	RCR07G242JS	RESISTOR, FIXED, COMP.....	3
42	PADZZ	81349	RCR05G511JS	RESISTOR, FIXED, COMP.....	1
43	PADZZ	81349	RCR05G512JS	RESISTOR, FIXED, COMP.....	2
44	PADZZ	81349	RCR05G101JS	RESISTOR, FIXED, COMP.....	1
45	PADZZ	81349	RCR05G113JS	RESISTOR, FIXED, COMP.....	1
46	PADZZ	81349	RCR05G432JS	RESISTOR, FIXED, COMP.....	1

SECTION II		TM11-5895-1303-24P				
(1)	(2)	(3)	(4)	(5)	(6)	
ITEM NO	SMR CODE	FSCM	PART NUMBER	DESCRIPTION AND USABLE DN CODES(UDC)	QTY	
47	PADZZ	81349	RCR05G271JS	RESISTOR, FIXED, COMP.	1	
48	PADZZ	81349	RCR05G361JS	RESISTOR, FIXED, COMP.	1	
49	PADZZ	81349	RCR07G510JS	RESISTOR, FIXED, COMP.	2	
50	PADZZ	81349	RCR07G101JS	RESISTOR, FIXED, COMP.	2	
51	PADZZ	81349	RCR07G102JS	RESISTOR, FIXED, COMP.	10	
52	PADZZ	81349	RCR07G511JS	RESISTOR, FIXED, COMP.	6	
53	PADZZ	81349	RCR07G305JS	RESISTOR, FIXED, COMP.	1	
54	PADZZ	81349	RCR05G510JS	RESISTOR, FIXED, COMP.	1	
55	PADZZ	81349	RCR07G103JS	RESISTOR, FIXED, COMP.	1	
56	PADZZ	81349	M8340109M5103JC	RESISTOR NETWORK, FI.	1	
57	PADZZ	04713	12513/BEBJC	MICROCIRCUIT, DIGITA.	1	
58	PADZZ	81349	JM38510/06101BEX	MICROCIRCUIT, DIGITA.	1	
59	PADZZ	81349	M38510/31504BEB	MICROCIRCUIT, DIGITA.	2	
60	PADZZ	07263	54F161ADMQB	MICROCIRCUIT, DIGITA.	2	
61	PADZZ	56996	B4003379-901	MICROCIRCUIT, LINEAR.	1	
62	PADZZ	81349	M38510-31401BEB	MICROCIRCUIT, DIGITA.	1	
63	PADZZ	81349	M38510-30301BCB	MICROCIRCUIT, DIGITA.	1	
64	PADZA	27014	MM54HC374J/883B	MICROCIRCUIT, DIGITA.	1	
65	PADZZ	81349	M38510/10702-BXC	MICROCIRCUIT, LINEAR.	4	
66	PADZZ	81349	M38510/10703-BXC	MICROCIRCUIT, LINEAR.	1	
67	PADZZ	81349	M871111/2-2805	HEAT SINK.	2	
68	XBDZZ	80063	A3034661	PIN, GUIDE.	1	
69	PADZZ	07556	2467 TALL	HEAT SINK, ELECTRICA.	2	
70	PADZZ	80063	A3028561	PARTITION, SHIELD--L.	1	
71	PADZZ	80063	A3028566	PARTITION, SHIELD--L.	1	
72	PADZZ	80063	A3028565	PARTITION, SHIELD--L.	1	
73	PADZZ	80063	A3028564	PARTITION, SHIELD--L.	1	
74	PADZZ	81349	M38527/03-002N	MOUNTING PAD, ELECTR.	4	
75	PADZZ	80063	A3028563	PARTITION, SHIELD--L.	1	
76	PADZZ	81349	M38527/02-018N	MOUNTING PAD, ELECTR.	3	
77	PADZZ	80063	A3028572	COVER, SHIELD-- LOOP.	1	
78	PADZZ	80063	A3079136	INSULATION CLOTH, EL.	1	
79	PADZZ	80063	A3028562	SHIELD, ELECTRICAL C.	1	

END OF FIGURE

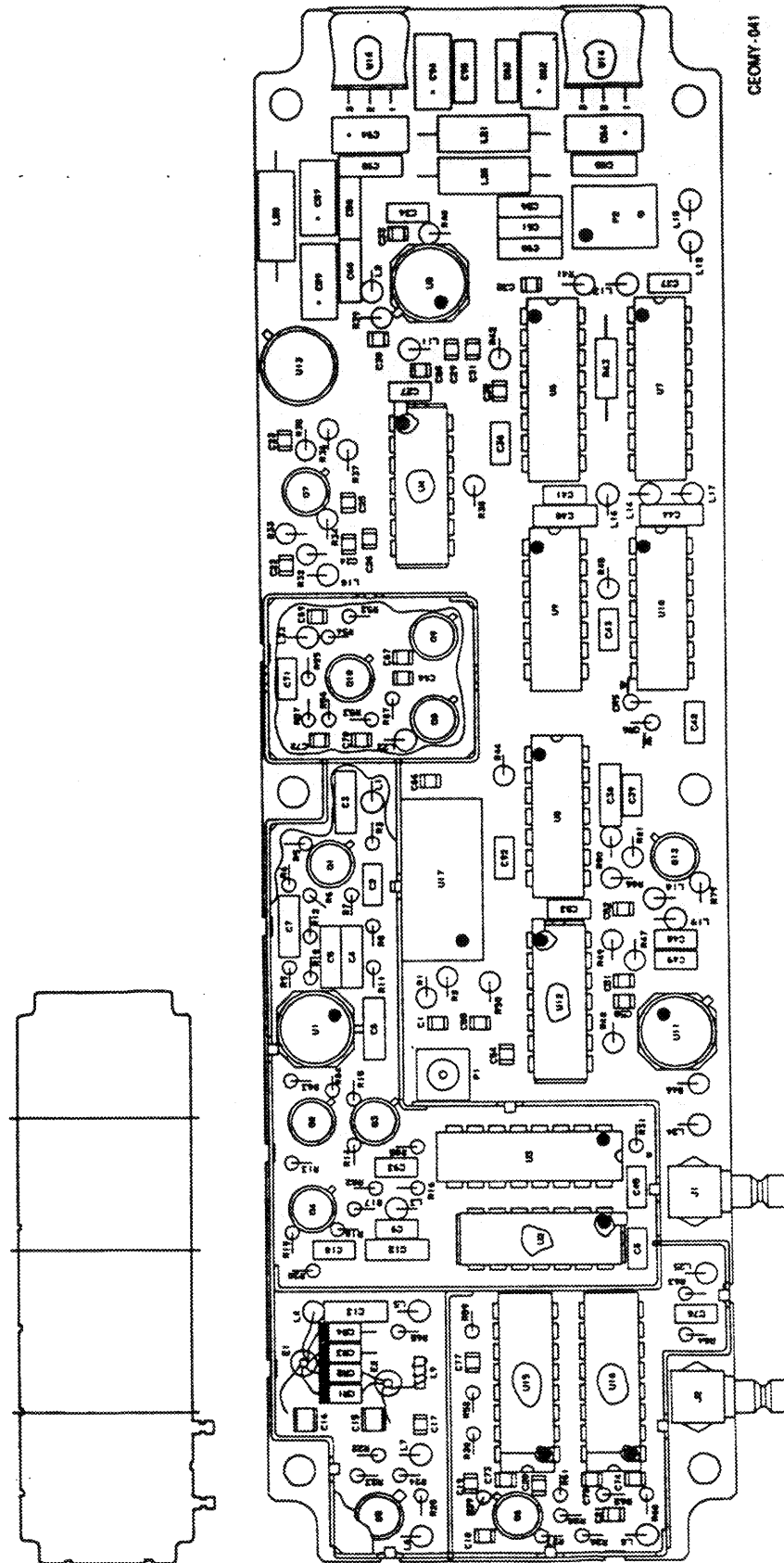

GEOMY-041

Figure 11. Sum Loop 2 CCA A3A2A2 (A3024360) (Sheet 1 of 6)

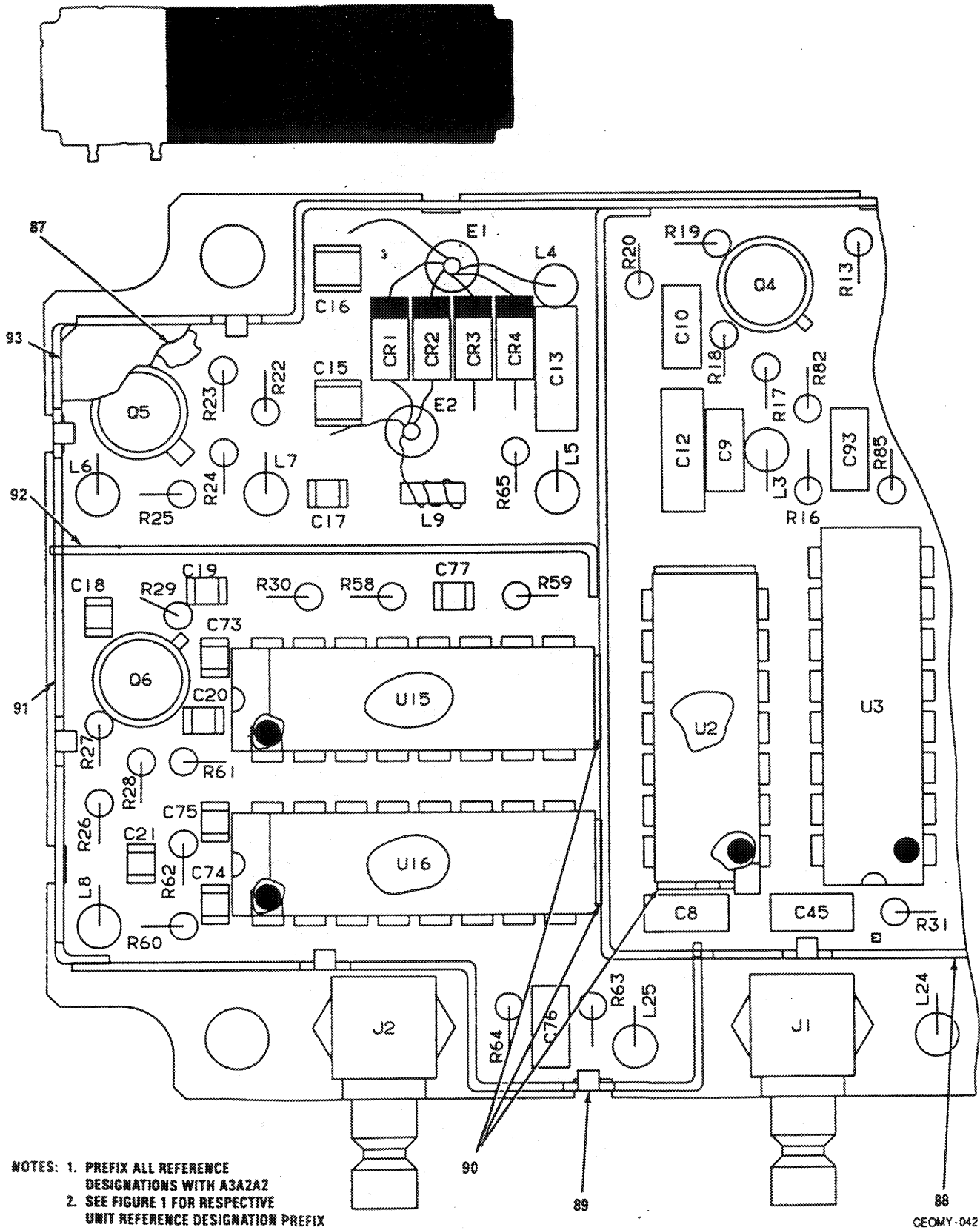

NOTES: 1. PREFIX ALL REFERENCE DESIGNATIONS WITH A3A2A2  
 2. SEE FIGURE 1 FOR RESPECTIVE UNIT REFERENCE DESIGNATION PREFIX

CEOMY-042

Figure 11. Sum Loop 2 CCA A3A2A2 (A3024360) (Sheet 2 of 6)

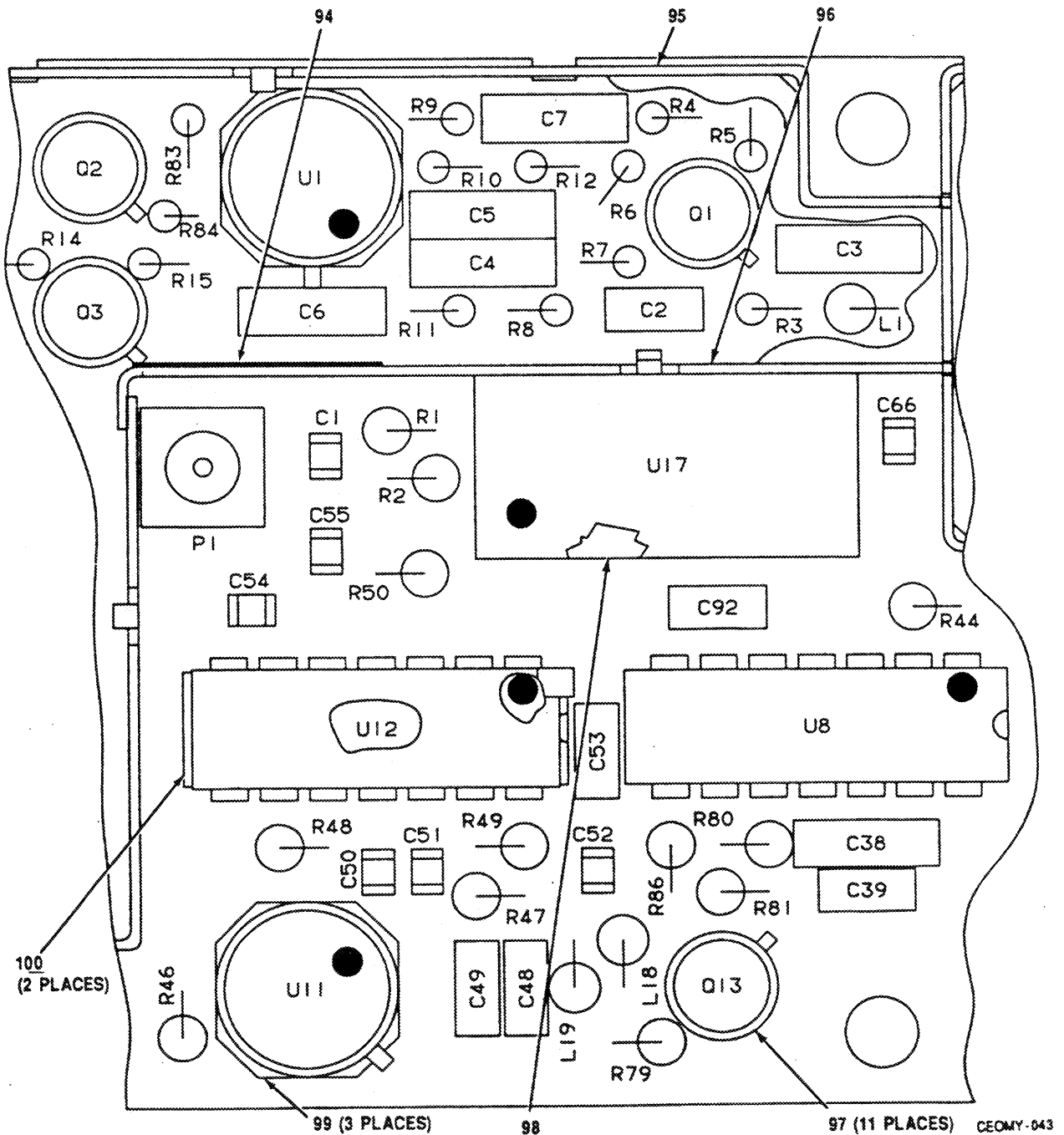
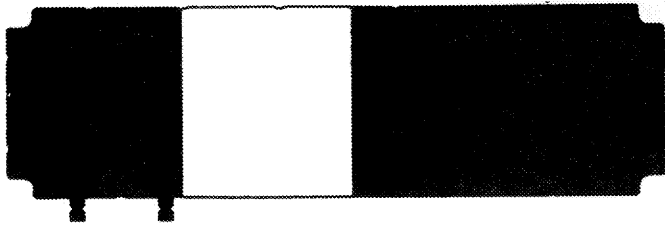

Figure 11. Sum Loop 2 CCA A3A2A2 (A3024360) (Sheet 3 of 6)



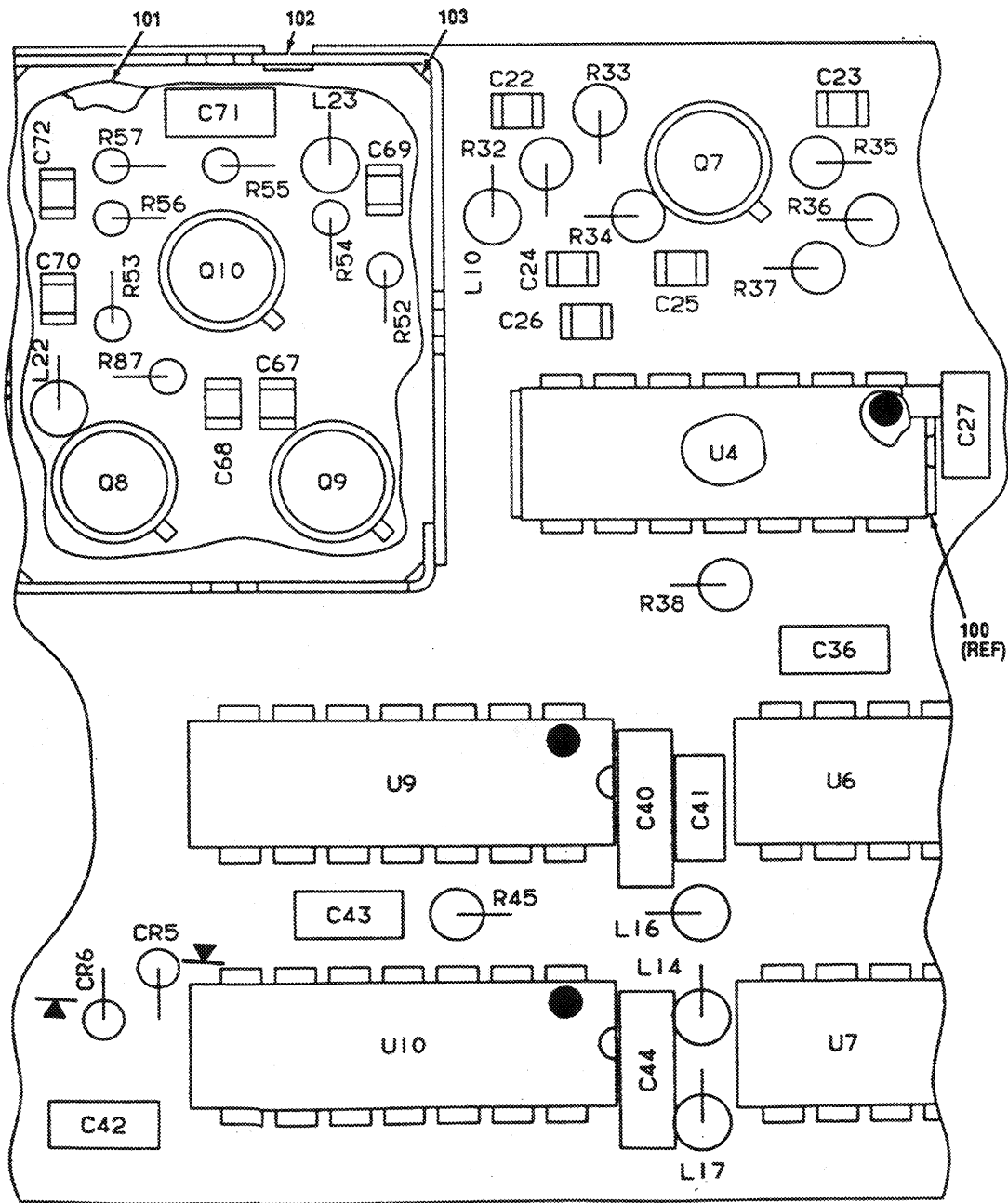
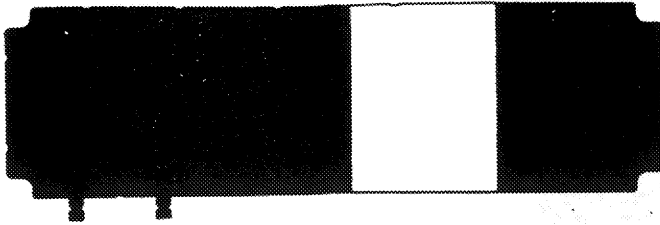

Figure 11. Sum Loop 2 CCA A3A2A2 (A3024360) (Sheet 4 of 6)

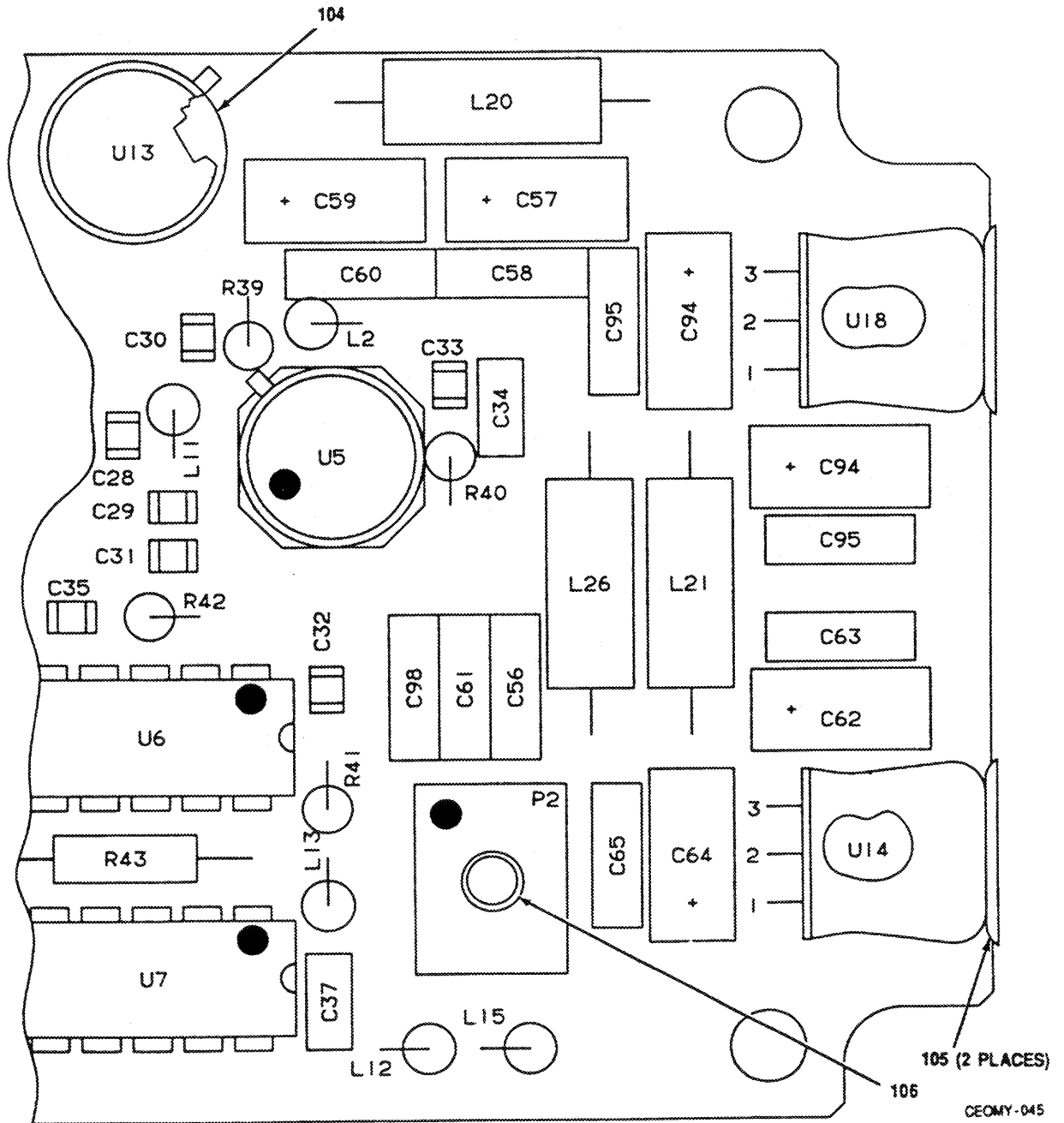

Figure 11. Sum Loop 2 CCA A3A2A2 (A3024360) (Sheet 5 of 6)

CEOMY-045

LEGEND

REF. DES.	ITEM NO.	REF. DES.	ITEM NO.	REF. DES.	ITEM NO.	REF. DES.	ITEM NO.	REF. DES.	ITEM NO.	REF. DES.	ITEM NO.
CR1	1	C34	6	C73	3	L22	23	R20	47	R59	40
CR2	1	C35	3	C74	3	L23	21	R22	48	R60	44
CR3	1	C36	6	C75	3	L24	20	R23	49	R61	44
CR4	1	C37	6	C76	6	L25	21	R24	50	R62	68
CR5	2	C38	5	C77	3	L26	27	R25	51	R63	45
CR6	2	C39	12	C92	12	P1	28	R26	52	R64	44
C1	3	C40	5	C93	16	P2	29	R27	53	R65	38
C2	4	C41	12	C94	15	Q1	30	R28	50	R79	69
C3	5	C42	13	C95	9	Q2	31	R29	54	R80	70
C4	5	C43	13	C96	15	Q3	32	R30	46	R81	62
C5	5	C44	5	C97	9	Q4	33	R31	40	R82	71
C6	5	C45	14	C98	9	Q5	34	R32	55	R83	72
C7	5	C48	12	E1	17	Q6	34	R33	56	R85	72
C8	6	C49	6	E2	17	Q7	34	R34	37	R86	73
C9	7	C50	3	J1	18	Q8	34	R35	57	R87	54
C10	8	C51	3	J2	18	Q9	34	R36	58	R88	74
C12	5	C52	3	L1	19	Q10	34	R37	59	U1	75
C13	9	C53	6	L2	20	Q13	35	R38	60	U2	76
C15	10	C54	3	L3	21	R1	36	R39	61	U3	77
C16	11	C55	3	L4	22	R2	37	R40	62	U4	78
C17	3	C56	9	L5	23	R3	38	R41	61	U5	79
C18	3	C57	15	L6	23	R4	39	R42	59	U6	80
C19	3	C58	9	L7	23	R5	39	R43	60	U7	81
C20	3	C59	15	L8	20	R6	40	R44	63	U8	76
C21	3	C60	9	L9	24	R7	41	R45	63	U9	76
C22	3	C61	9	L10	20	R8	42	R46	62	U10	82
C23	3	C62	15	L11	20	R9	40	R47	64	U11	79
C24	3	C63	9	L12	25	R10	43	R48	60	U12	78
C25	3	C64	15	L13	25	R11	43	R49	60	U13	83
C26	3	C65	9	L14	25	R12	40	R50	59	U14	84
C27	6	C66	3	L15	26	R13	44	R52	65	U15	85
C28	3	C67	3	L16	26	R14	44	R53	66	U16	80
C29	3	C68	3	L17	26	R15	45	R54	42	U17	86
C30	3	C69	3	L18	25	R16	40	R55	67	U18	84
C31	3	C70	3	L19	20	R17	38	R56	67		
C32	3	C71	6	L20	27	R18	40	R57	50		
C33	3	C72	3	L21	27	R19	46	R58	40		

CEOMY-046

Figure 11. Sum Loop 2 CCA A3A2A2 (A3024360) (Sheet 6 of 6)

SECTION II  
 (1) (2) (3) (4) (5) (6)  
 ITEM SMR FSCM PART DESCRIPTION AND USABLE ON CODES(UOC) QTY  
 NO CODE FSCM NUMBER

TM11-5895-1303-24P

GROUP 030202 SUM LOOP 2 CCA  
 A3A2A2 (A3024360)

FIG. 11

1	PADZZ	80063	A3028098	SEMICONDUCTOR DEVIC.....	4
2	PADZZ	81349	JANTX1N4454-1	SEMICONDUCTOR DEVIC.....	2
3	PADZZ	81349	CDR01BX102BKUP	CAPACITOR,CHIP.....	33
4	PADZZ	81349	M39014/01-1353	CAPACITOR, FIXED, CER.....	1
5	PADZZ	81349	M39014/02-1419	CAPACITOR, FIXED, CER.....	9
6	PADZZ	81349	M39014-01-1575	CAPACITOR, FIXED, CER.....	9
7	PADZZ	81349	M39014/01-1589	CAPACITOR, FIXED, CER.....	1
8	PADZZ	81349	M39014/01-1348	CAPACITOR, FIXED, CER.....	1
9	PADZZ	81349	M39014/02-1350	CAPACITOR, FIXED, CER.....	10
10	PADZZ	81349	CDR14BG620EKUPX	CAPACITOR, FIXED, ELE.....	1
11	PADZZ	81349	CDR14BG101EKUPX	CAPACITOR, FIXED, ELE.....	1
12	PADZZ	81349	M39014/01-1357	CAPACITOR, FIXED, CER.....	4
13	PADZZ	81349	M39014/01-1336	CAPACITOR, FIXED, CER.....	2
14	PADZZ	81349	M39014/01-1345	CAPACITOR, FIXED, CER.....	1
15	PADZZ	56996	B4003327-3126	CAPACITOR, FIXED, ELE.....	6
16	PADZZ	81349	M39014-01-1575	CAPACITOR, FIXED, CER.....	1
17	PADZZ	56996	B4003308-901	TERMINAL, FEEDTHRU I.....	2
18	PADZZ	19505	2010-6511-002	CONNECTOR, RECEPTACL.....	2
19	PADZZ	96906	MS75084-8	COIL, RADIO FREQUENC.....	1
20	PADZZ	96906	MS75084-6	COIL, RADIO FREQUENC.....	6
21	PADZZ	96906	MS75085-7	COIL, RADIO FREQUENC.....	3
22	PADZZ	96906	MS75084-3	COIL, RADIO FREQUENC.....	1
23	PADZZ	96906	MS75083-13	COIL, RADIO FREQUENC.....	4
24	PADZZ	80063	A3024684-10	COIL, RADIO FREQUENC.....	1
25	PADZZ	96906	MS75084-10	COIL, RADIO FREQUENC.....	4
26	PADZZ	96906	MS75084-15	COIL, RADIO FREQUENC.....	3
27	PADZZ	96906	MS75089-3	COIL, RADIO FREQUENC.....	3
28	PADZZ	58167	11-0450-01C	CONNECTOR, RECEPTACL.....	1
29	PADZZ	37695	189698	SOCKET, PLUG-IN ELEC.....	1
30	PADZZ	81349	JANTX2N918	TRANSISTOR.....	1
31	PADZZ	81349	JANTX2N3251A	TRANSISTOR.....	1
32	PADZZ	81349	JANTX2N2369A	TRANSISTOR.....	1
33	PADZZ	56996	B4002963	TRANSISTOR.....	1
34	PADZZ	56996	B4002964	TRANSISTOR.....	6
35	PADZZ	81349	JANTXV2N2907A	TRANSISTOR.....	1
36	PADZZ	81349	RCR07G151JS	RESISTOR, FIXED, COMP.....	1
37	PADZZ	81349	RCR07G510JS	RESISTOR, FIXED, COMP.....	2
38	PADZZ	81349	RCR05G101JS	RESISTOR, FIXED, COMP.....	3
39	PADZZ	81349	RCR05G332JS	RESISTOR, FIXED, COMP.....	2
40	PADZZ	81349	RCR05G102JS	RESISTOR, FIXED, COMP.....	8
41	PADZZ	81349	RCR05G330JS	RESISTOR, FIXED, COMP.....	1
42	PADZZ	81349	RCR05G122JS	RESISTOR, FIXED, COMP.....	2
43	PADZZ	81349	RCR05G222JS	RESISTOR, FIXED, COMP.....	2
44	PADZZ	81349	RCR05G561JS	RESISTOR, FIXED, COMP.....	5
45	PADZZ	81349	RCR05G152JS	RESISTOR, FIXED, COMP.....	2
46	PADZZ	81349	RCR05G471JS	RESISTOR, FIXED, COMP.....	2

SECTION II			TM11-5895-1303-24P			
(1)	(2)	(3)	(4)	(5)	(6)	
ITEM NO	SMR CODE	FSCM	PART NUMBER	DESCRIPTION AND USABLE ON CODES(UOC)	QTY	
47	PADZZ	81349	RCR05G103JS	RESISTOR, FIXED, COMP.	1	
48	PADZZ	81349	RCR05G113JS	RESISTOR, FIXED, COMP.	1	
49	PADZZ	81349	RCR05G432JS	RESISTOR, FIXED, COMP.	1	
50	PADZZ	81349	RCR05G510JS	RESISTOR, FIXED, COMP.	3	
51	PADZZ	81349	RCR05G361JS	RESISTOR, FIXED, COMP.	1	
52	PADZZ	81349	RCR05G822JS	RESISTOR, FIXED, COMP.	1	
53	PADZZ	81349	RCR05G362JS	RESISTOR, FIXED, COMP.	1	
54	PADZZ	81349	RCR05G200JS	RESISTOR, FIXED, COMP.	2	
55	PADZZ	81349	RCR07G822JS	RESISTOR, FIXED, COMP.	1	
56	PADZZ	81349	RCR07G362JS	RESISTOR, FIXED, COMP.	1	
57	PADZZ	81349	RCR07G200JS	RESISTOR, FIXED, COMP.	1	
58	PADZZ	81349	RCR07G471JS	RESISTOR, FIXED, COMP.	1	
59	PADZZ	81349	RCR07G103JS	RESISTOR, FIXED, COMP.	3	
60	PADZZ	81349	RCR07G561JS	RESISTOR, FIXED, COMP.	4	
61	PADZZ	81349	RCR07G683JS	RESISTOR, FIXED, COMP.	2	
62	PADZZ	81349	RCR07G332JS	RESISTOR, FIXED, COMP.	3	
63	PADZZ	81349	RCR07G361JS	RESISTOR, FIXED, COMP.	2	
64	PADZZ	81349	RCR07G393JS	RESISTOR, FIXED, COMP.	1	
65	PADZZ	81349	RCR05G271JS	RESISTOR, FIXED, COMP.	1	
66	PADZZ	81349	RCR05G681JS	RESISTOR, FIXED, COMP.	1	
67	PADZZ	81349	RCR05G622JS	RESISTOR, FIXED, COMP.	2	
68	PADZZ	81349	RCR05G683JS	RESISTOR, FIXED, COMP.	1	
69	PADZZ	81349	RCR07G751JS	RESISTOR, FIXED, COMP.	1	
70	PADZZ	81349	RCR07G102JS	RESISTOR, FIXED, COMP.	1	
71	PADZZ	81349	RCR05G154JS	RESISTOR, FIXED, COMP.	1	
72	PADZZ	81349	RCR05G511JS	RESISTOR, FIXED, COMP.	2	
73	PADZZ	81349	RCR07G562JS	RESISTOR, FIXED, COMP.	1	
74	PADZZ	81349	M55342M03B2K00P	RESISTOR, FIXED, FILM.	1	
75	PADZZ	96214	531932-2	MICROCIRCUIT, LINEAR.	1	
76	PADZZ	56996	B4003379-901	MICROCIRCUIT, LINEAR.	3	
77	PADZZ	81349	M38510-31401BEB	MICROCIRCUIT, DIGITA.	1	
78	PADZA	52648	SP8610AB	MIRCOCIRCUIT DIGITA.	2	
79	PADZA	64863	SP8655AB	MICROCIRCUIT, DIGITA.	2	
80	PADZA	52648	SP8690AB	MICROCIRCUIT, DIGITA.	2	
81	PADZZ	81349	M38510/30110BEB	MICROCIRCUIT, DIGITA.	1	
82	PADZZ	81349	M38510/30003BCB	MICROCIRCUIT, DIGITA.	1	
83	PADZZ	81349	M38510/10703-BXC	MICROCIRCUIT, LINEAR.	1	
84	PADZZ	81349	M38510/10702-BXC	MICROCIRCUIT, LINEAR.	2	
85	PADZZ	04713	12513/BEBJC	MICROCIRCUIT, DIGITA.	1	
86	PADZZ	81349	M28837/1-02N	MIXER STAGES, RADIO.	1	
87	PADZZ	80063	A3079148	INSULATION CLOTH, EL.	1	
88	PADZZ	80063	A3028640	PARTITION, SHIELD SU.	1	
89	PADZZ	80063	A3028639	PARTITION, SHIELD SU.	1	
90	PADZZ	07556	2467 SHORT	HEAT SINK, ELECTRICA.	3	
91	PADZZ	80063	A3028633	PARTITION, SHIELD SU.	1	
92	PADZZ	80063	A3028636	PARTITION, SHIELD SU.	1	
93	PADZZ	80063	A3028816	COVER, SHIELD--SUM L.	1	
94	PADZZ	80063	A3078673	INSULATION CLOTH, EL.	1	
95	PADZZ	80063	A3028632	PARTITION, SHIELD SU.	1	
96	PADZZ	80063	A3029118	PARTITION, SHIELD--S.	1	
97	PADZZ	81349	M38527/1-040N	MOUNTING PADS, INSUL.	11	
98	PADZZ	80063	A3034171	INSULATOR, MIXER.	1	

SECTION II			TM11-5895-1303-24P		(5)	(6)
(1)	(2)	(3)	(4)			
ITEM	SMR		PART		DESCRIPTION AND USABLE ON CODES(UDC)	QTY
NO	CODE	FSCM	NUMBER			
99	PADZZ	81349	M38527/05-001D		MOUNTING PAD,ELECTR.....	3
100	PADZZ	07556	2467 TALL		HEAT SINK,ELECTRICA.....	2
101	PADZZ	80063	A3079144		INSULATION CLOTH,EL.....	1
102	PADZZ	80063	A3029119		PARTITION,SHIELD--S.....	1
103	PADZZ	80063	A3029120		COVER,SHIELD--SUM L.....	1
104	PADZZ	81349	M38527/2-018N		MOUNTING,PADS,INSUL.....	1
105	PADZZ	81349	M87111/2-2B05		HEAT SINK.....	2
106	XBDZZ	80063	A3034661		PIN,GUIDE.....	1

END OF FIGURE

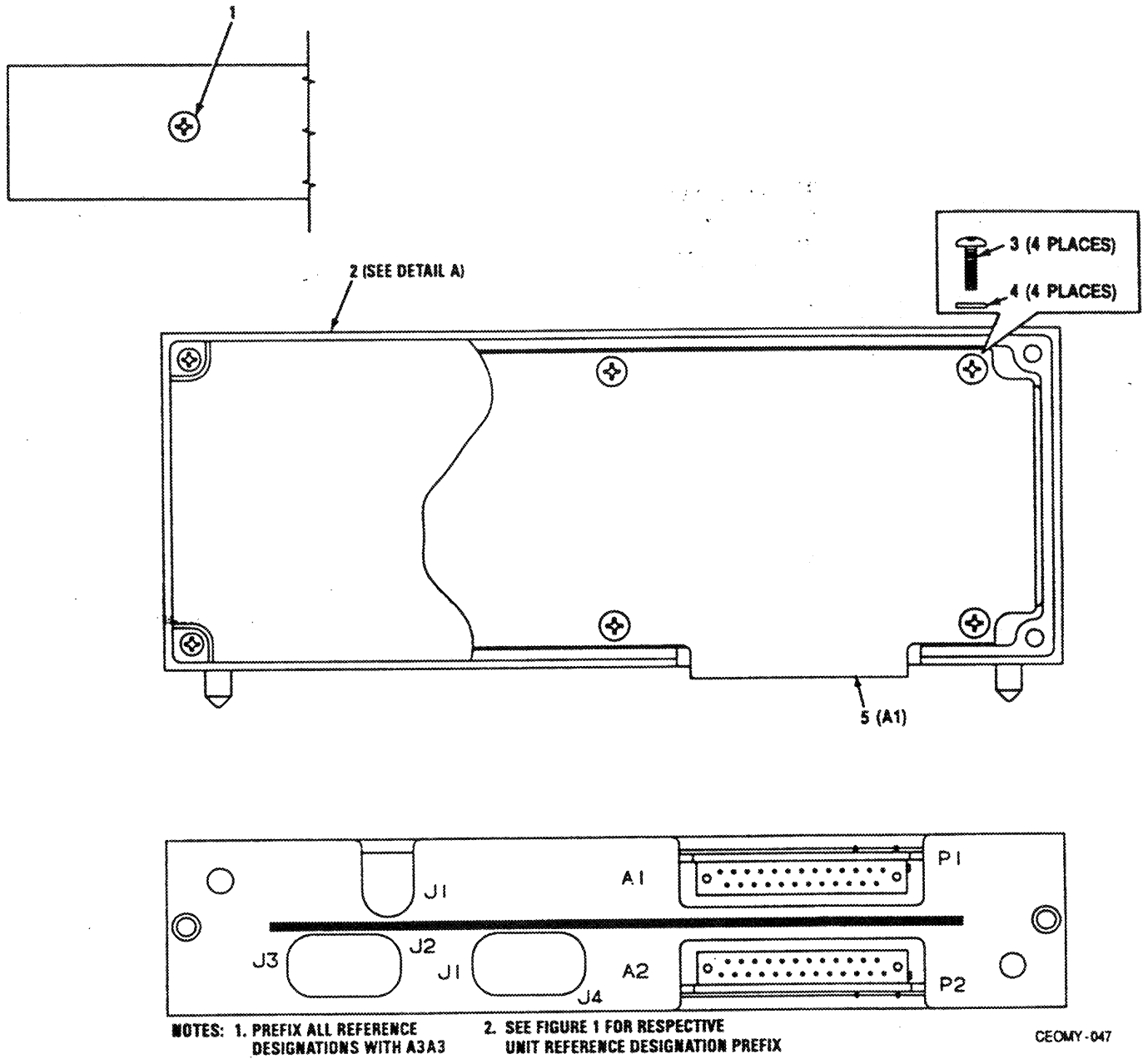

Figure 12. Loop 3/Ref. Assembly A3A3 (A3024364) (Sheet 1 of 4)

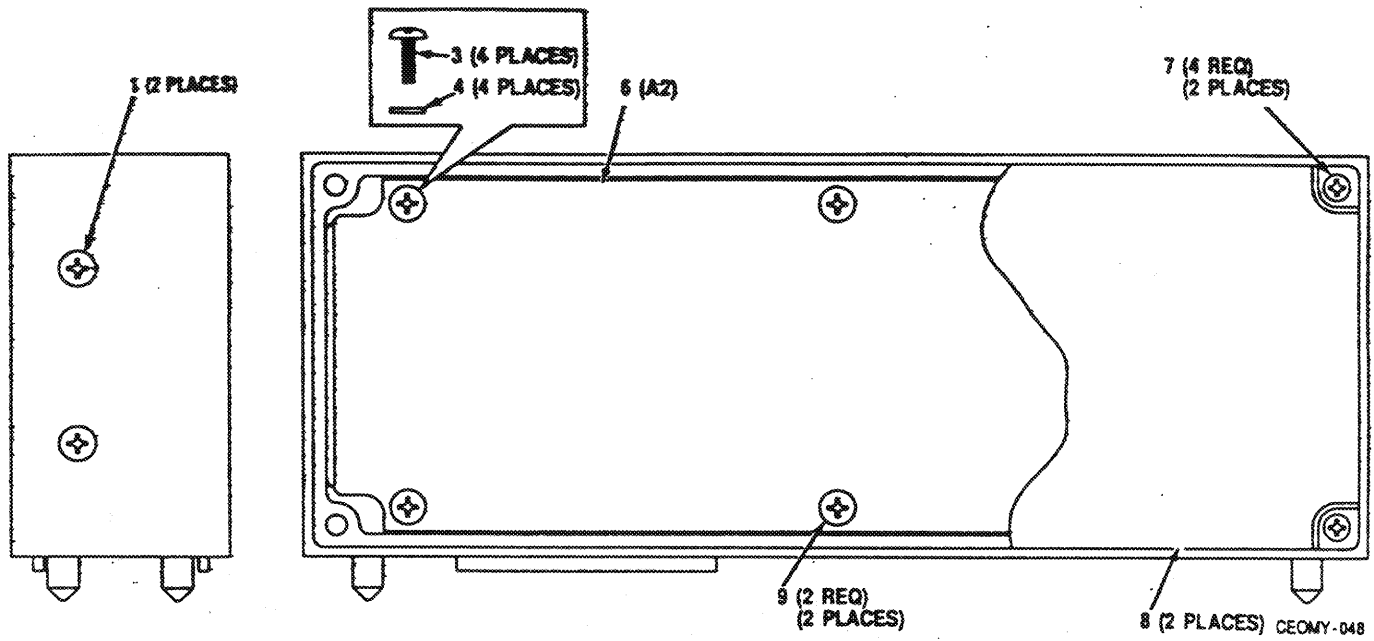
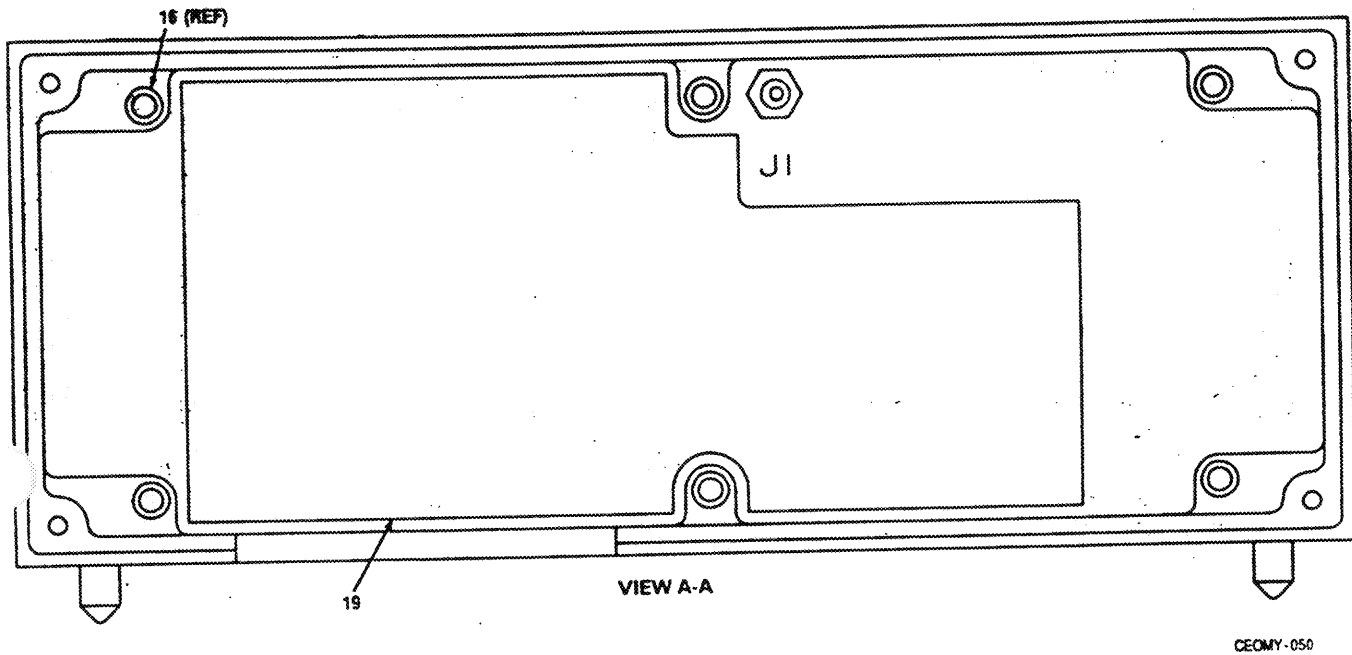

Figure 12. Loop 3/Ref. Assembly A3A3 (A3024364) (Sheet 2 of 4)





CEOMY-050

Figure 12. Loop 3/Ref. Assembly A3A3 (A3024364) (Sheet 4 of 4)

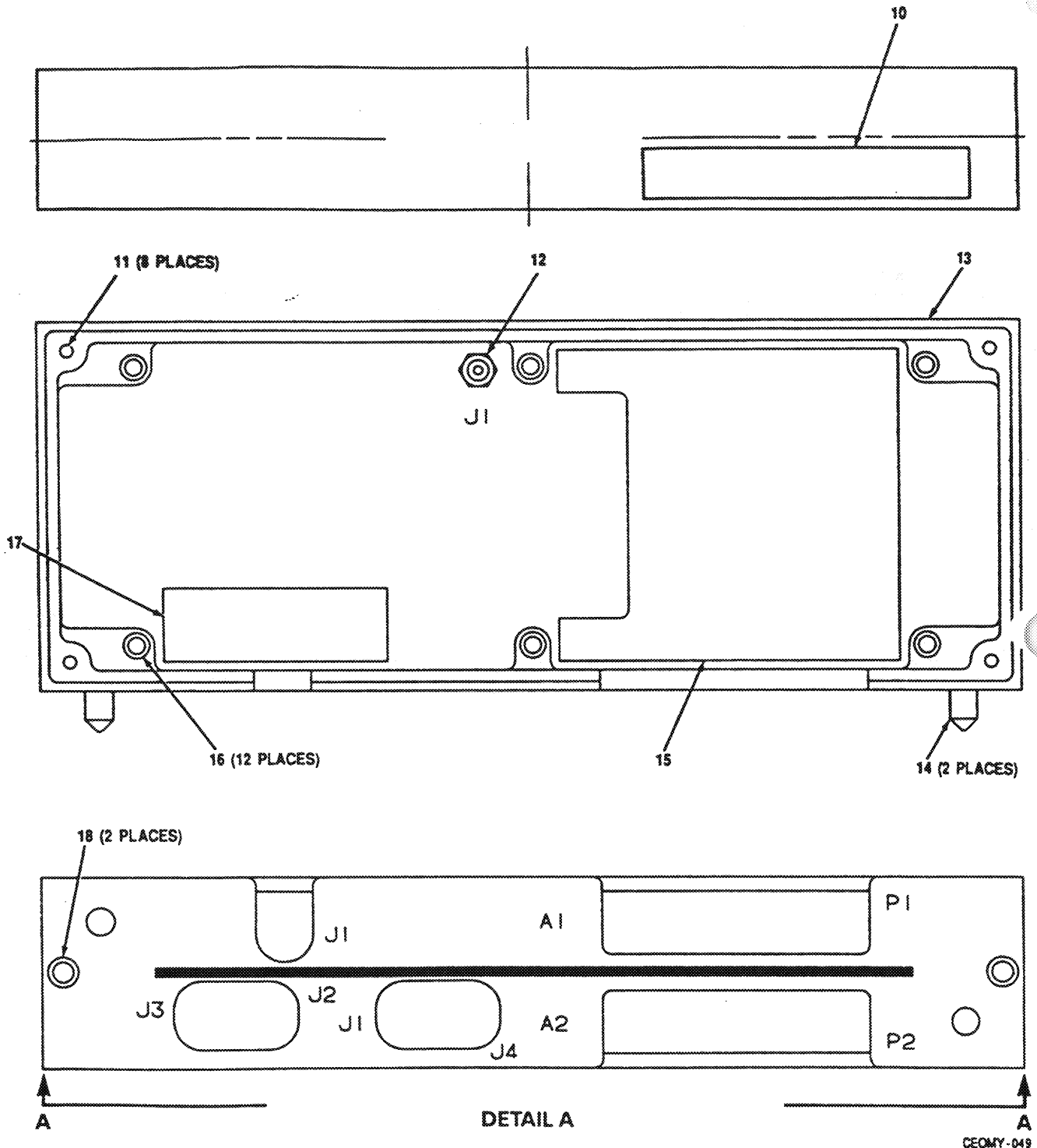

CEOMY-049

Figure 12. Loop 3/Ref. Assembly A3A3 (A3024364) (Sheet 3 of 4)

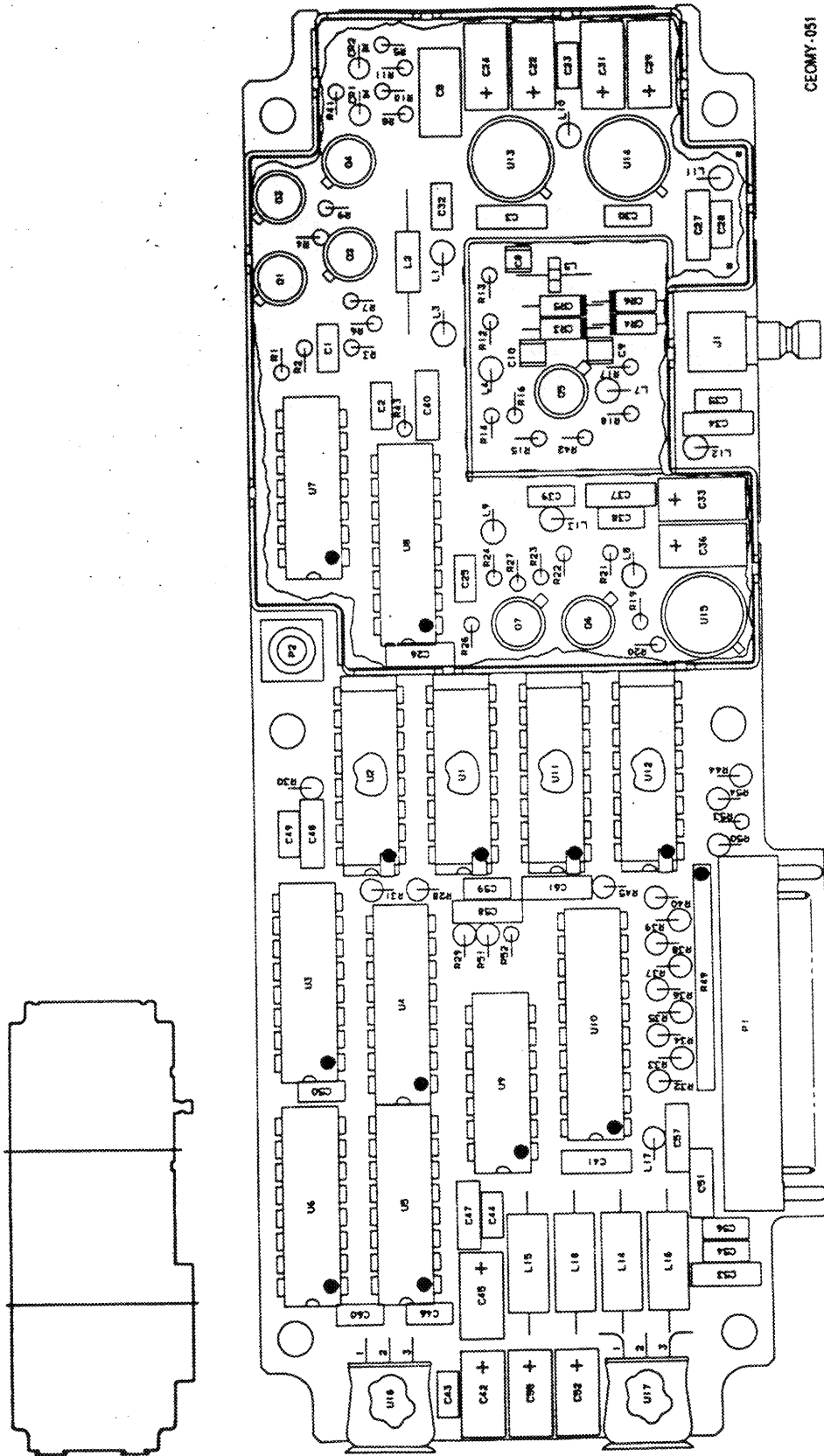

Figure 13. Loop 3 CCA A3A3A1 (A3024366) (Sheet 1 of 5)

SECTION II			TM11-5895-1303-24P			
(1)	(2)	(3)	(4)	(5)	(6)	
ITEM NO	SMR CODE	FSCM	PART NUMBER	DESCRIPTION AND USABLE ON CODES(UOC)		QTY

GROUP 0303 LOOP 3/REFERENCE ASSY  
A3A3 (A3024364)

FIG. 12

1	PADZZ	96906	MS24693C2	SCREW,MACHINE.....	3
2	XBDDD	80063	A3024365	FRAME ASSEMBLY,LOOP.....	1
3	PADZZ	96906	MS51957-14	SCREW,MACHINE.....	8
4	PADZZ	80205	NAS620C4L	WASHER,FLAT.....	8
5	PADDD	80063	A3024366	CIRCUIT CARD ASSEMB (SEE FIG. 13 FOR BREAKDOWN).....	1
6	PADDD	80063	A3024370	CIRCUIT CARD ASSEMB (SEE FIG. 14 FOR BREAKDOWN).....	1
7	PADZZ	96906	MS51957-2	SCREW,MACHINE.....	8
8	XBDZZ	80063	A3086606	COVER,ASSEMBLY.....	2
9	PADZZ	96906	MS24693C5	SCREW,MACHINE.....	4
10	XBDZZ	80063	A3034572	LABEL,SENSITIVE.....	1
11	PADZZ	26344	3585-02CNW0129	INSERT,SCREW THREAD.....	8
12	PADZA	58167	1111-1180-01C	CONNECTOR,RECEPTAC.....	1
13	XBDZZ	80063	A3028020	FRAME--LOOP 3/REFER.....	1
14	XBDZZ	80063	A3028102	PIN,GUIDE--MODULE.....	2
15	PADZZ	80063	A3029328	INSULATOR,CIRCUIT C.....	1
16	PADZZ	96906	MS21209C0415L	INSERT,SCREW THREAD.....	12
17	PADZZ	80063	A3032178	INSULATOR,CIRCUIT C.....	1
18	PADZZ	96906	MS21209C0815L	INSERT,SCREW THREAD.....	2
19	PADZZ	80063	A3029327	INSULATOR,CIRCUIT C.....	1

END OF FIGURE

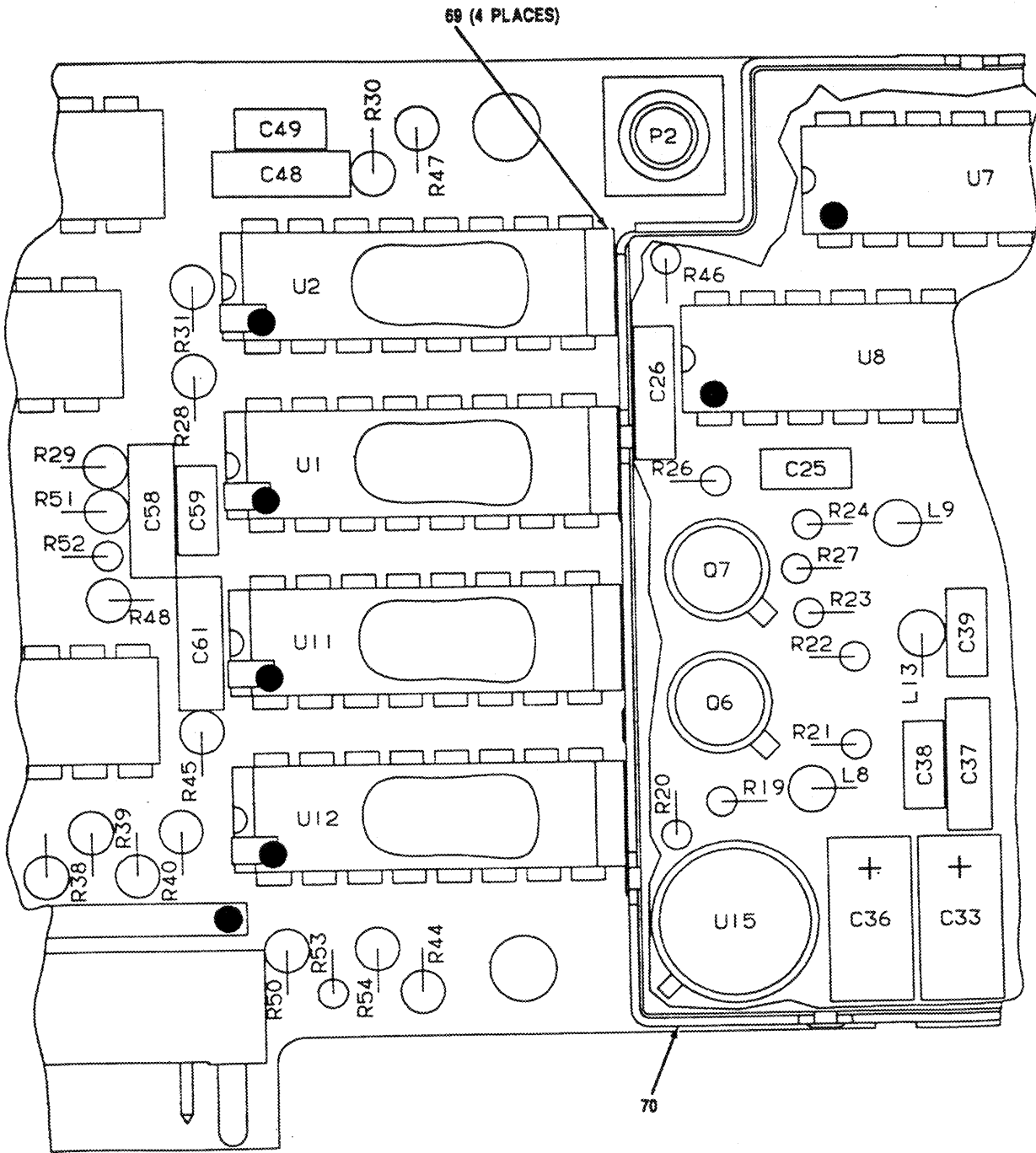
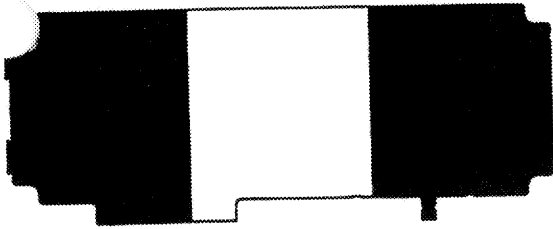

CEOMY-053

Figure 13. Loop 3 CCA A3A3A1 (A3024366) (Sheet 3 of 5)

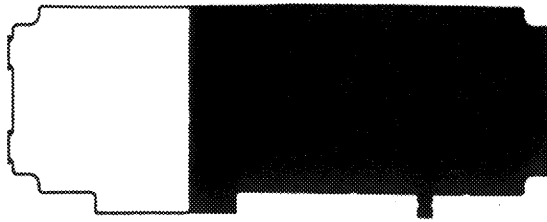

68 (2 PLACES)

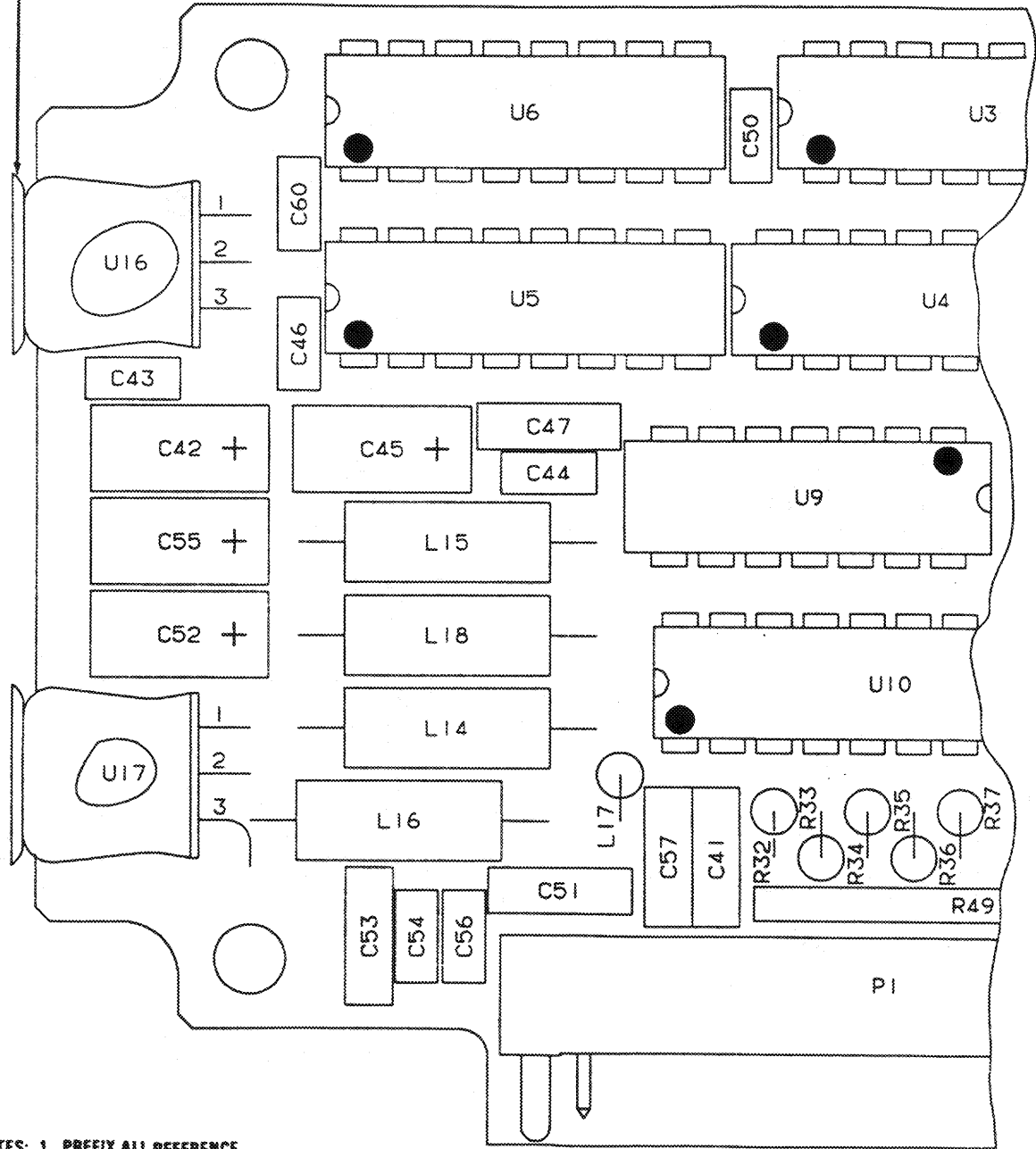

- NOTES: 1. PREFIX ALL REFERENCE DESIGNATIONS WITH A3A3A1
- 2. SEE FIGURE 1 FOR RESPECTIVE UNIT REFERENCE DESIGNATION PREFIX

CEOMY-052

Figure 13. Loop 3 CCA A3A3A1 (A3024366) (Sheet 2 of 5)

LEGEND

REF. DES.	ITEM NO.	REF. DES.	ITEM NO.	REF. DES.	ITEM NO.	REF. DES.	ITEM NO.	REF. DES.	ITEM NO.	REF. DES.	ITEM NO.
CR1	1	C25	13	C53	5	L16	27	R17	46	R46	41
CR2	1	C26	5	C54	13	L17	23	R18	47	R47	50
CR3	2	C27	5	C55	11	L18	25	R19	34	R48	50
CR4	2	C28	13	C56	13	P1	28	R20	48	R49	55
CR5	2	C29	14	C57	5	P2	29	R21	40	R50	50
CR6	2	C30	12	C58	5	Q1	30	R22	43	R51	49
C1	3	C31	14	C59	12	Q2	30	R23	48	R52	52
C2	4	C32	13	C60	12	Q3	30	R24	34	R54	56
C3	5	C33	11	C61	16	Q4	31	R26	40	U1	57
C4	6	C34	5	C62	6	Q5	32	R27	43	U2	58
C5	7	C35	13	C63	6	Q6	32	R28	49	U3	59
C8	8	C36	11	C64	6	Q7	32	R29	50	U4	60
C9	9	C37	5	C65	17	R1	33	R30	50	U5	59
C10	10	C38	13	C66	17	R2	34	R31	50	U6	60
C11	6	C39	12	J1	18	R3	35	R32	49	U7	61
C12	6	C40	15	L1	19	R4	33	R33	49	U8	62
C13	6	C41	5	L3	20	R5	36	R34	49	U9	63
C14	6	C42	11	L4	20	R6	37	R35	49	U10	64
C15	6	C43	5	L5	21	R7	38	R36	49	U11	57
C16	6	C44	13	L7	22	R8	36	R37	49	U12	65
C17	6	C45	11	L8	23	R9	39	R38	49	U13	66
C18	6	C46	13	L9	23	R10	40	R39	49	U14	67
C19	6	C47	5	L10	24	R11	41	R40	49	U15	66
C20	6	C48	5	L11	19	R12	42	R41	51	U16	66
C21	6	C49	12	L12	24	R13	42	R42	48	U17	66
C22	11	C50	12	L13	24	R14	43	R43	52		
C23	12	C51	5	L14	25	R15	44	R44	53		
C24	11	C52	11	L15	26	R16	45	R45	54		

CEOMY-055

Figure 13. Loop 3 CCA A3A3A1 (A3024366) (Sheet 5 of 5)

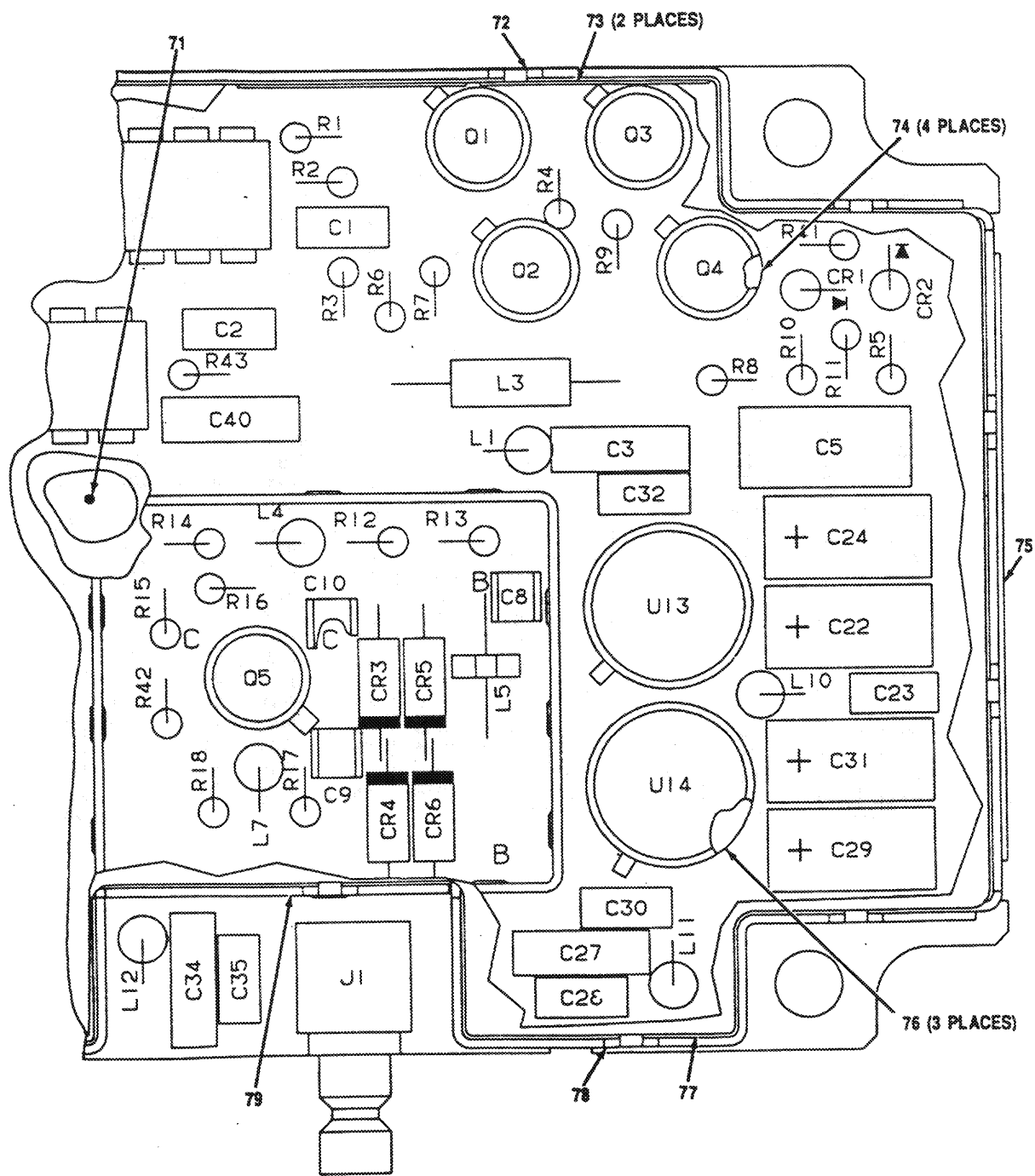

CEOMY-C

Figure 13. Loop 3 CCA A3A3A1 (A3024366) (Sheet 4 of 5)



SECTION II			TM11-5895-1303-24P		
(1)	(2)	(3)	(4)	(5)	(6)
ITEM NO	SMR CODE	FSCM	PART NUMBER	DESCRIPTION AND USABLE ON CODES(UOC)	QTY
	PADZZ	81349	RCR05G361JS	RESISTOR, FIXED, COMP	1
48	PADZZ	81349	RCR05G510JS	RESISTOR, FIXED, COMP	3
49	PADZZ	81349	RCR07G102JS	RESISTOR, FIXED, COMP	11
50	PADZZ	81349	RCR07G511JS	RESISTOR, FIXED, COMP	6
51	PADZZ	81349	RCR05G305JS	RESISTOR, FIXED, COMP	1
52	PADZZ	81349	RCR05G103JS	RESISTOR, FIXED, COMP	2
53	PADZZ	81349	RCR07G561JS	RESISTOR, FIXED, COMP	1
54	PADZZ	81349	RCR07G683JS	RESISTOR, FIXED, COMP	1
55	PADZZ	81349	M8340109M5103JC	RESISTOR NETWORK, FI	1
56	PADZZ	81349	RCR07G821JS	RESISTOR, FIXED, COMP	1
57	PADZZ	04713	12513/BEBJC	MICROCIRCUIT, DIGITA	2
58	PADZZ	81349	JM38510/06101BEX	MICROCIRCUIT, DIGITA	1
59	PADZZ	81349	M38510/31504BEB	MICROCIRCUIT, DIGITA	2
60	PADZZ	07263	54F161ADMQB	MICROCIRCUIT, DIGITA	2
61	PADZZ	56996	B4003379-901	MICROCIRCUIT, LINEAR	1
62	PADZZ	81349	M38510-31401BEB	MICROCIRCUIT, DIGITA	1
63	PADZZ	81349	M38510-30301BCB	MICROCIRCUIT, DIGITA	1
64	PADZA	27014	MM54HC374J/883B	MICROCIRCUIT, DIGITA	1
65	PADZA	52648	SP8690AB	MICROCIRCUIT, DIGITA	1
66	PADZZ	81349	M38510/10702-BXC	MICROCIRCUIT, LINEAR	4
67	PADZZ	81349	M38510/10703-BXC	MICROCIRCUIT, LINEAR	1
68	PADZZ	81349	M87111/2-2B05	HEAT SINK	2
69	PADZZ	07556	2467 TALL	HEAT SINK, ELECTRICA	4
70	PADZZ	80063	A3028570	PARTITION, SHIELD--L	1
71	PADZZ	80063	A3079137	INSULATION CLOTH, EL	1
72	PADZZ	80063	A3028571	PARTITION, SHIELD--L	1
73	PADZZ	80063	A3078673	INSULATION CLOTH, EL	2
74	PADZZ	81349	M38527/3-002N	MOUNTING, PADS, INSUL	4
75	PADZZ	80063	A3028569	PARTITION, SHIELD--L	1
76	PADZZ	81349	M38527/2-018N	MOUNTING, PADS, INSUL	3
77	PADZZ	80063	A3028573	COVER, SHIELD-LOOP 3	1
78	PADZZ	80063	A3028568	PARTITION, SHIELD--L	1
79	PADZZ	80063	A3028567	PARTITION, SHIELD--L	1

END OF FIGURE

SECTION II TM11-5895-1303-24P (5) (6)  
 (1) (2) (3) (4)  
 ITEM SMR FSCM PART  
 NO CODE FSCM NUMBER DESCRIPTION AND USABLE ON CODES(UDC) QTY

GROUP 030301 LOOP 3 CCA  
 A3A3A1 (A3024366)

FIG. 13

1	PADZZ	81349	JANTX1N4454-1	SEMICONDUCTOR DEVIC.....	2
2	PADZZ	80063	A3028098	SEMICONDUCTOR DEVIC.....	4
3	PADZZ	81349	M39014/01-1338	CAPACITOR, FIXED, CER.....	1
4	PADZZ	81349	M39014/01-1578	CAPACITOR, FIXED, CER.....	1
5	PADZZ	81349	M39014/02-1350	CAPACITOR, FIXED, CER.....	13
6	PADZZ	81349	CDR01BX102BKUP	CAPACITOR, CHIP.....	15
7	PADZZ	81349	CFR06RRA183JP	CAPACITOR, FIXED, MET.....	1
8	PADZZ	81349	CDR14BG2R0ECUPX	CAPACITOR, FIXED, ELE.....	1
9	PADZZ	81349	CDR14BG101EKUPX	CAPACITOR, FIXED, ELE.....	1
10	PADZZ	81349	CDR14BG620EKUPX	CAPACITOR, FIXED, ELE.....	1
11	PADZZ	56996	B4003327-3126	CAPACITOR, FIXED, ELE.....	8
12	PADZZ	81349	M39014/01-1575	CAPACITOR, FIXED, CER.....	7
13	PADZZ	81349	M39014/01-1357	CAPACITOR, FIXED, CER.....	9
14	PADZZ	56996	B4003327-3123	CAPACITOR, FIXED, ELE.....	2
15	PADZZ	81349	M39014-01-1563	CAPACITOR, FIXED, CER.....	1
16	PADZZ	81349	M39014/02-1419	CAPACITOR, FIXED, CER.....	1
17	PADZZ	81349	CDR12BG150AJUPX	CAPACITOR, CHIP.....	2
18	PADZZ	19505	2010-6511-002	CONNECTOR, RECEPTACL.....	1
19	PADZZ	96906	MS75085-7	COIL, RADIO FREQUENC.....	2
20	PADZZ	96906	MS75083-13	COIL, RADIO FREQUENC.....	2
21	PADZZ	80063	A3024684-10	COIL, RADIO FREQUENC.....	1
22	PADZZ	96906	MS75083-7	COIL, RADIO FREQUENC.....	1
23	PADZZ	96906	MS75084-6	COIL, RADIO FREQUENC.....	3
24	PADZZ	96906	MS75084-7	COIL, RADIO FREQUENC.....	3
25	PADZZ	96906	MS75089-5	COIL, RADIO FREQUENC.....	2
26	PADZZ	96906	MS75088-7	COIL, RADIO FREQUENC.....	1
27	PADZZ	96906	MS75089-1	COIL, RADIO FREQUENC.....	1
28	PADZZ	81349	M55302/4-03	CONNECTOR, RECEPTACL.....	1
29	PADZZ	58167	11-0450-01C	CONNECTOR, RECEPTACL.....	1
30	PADZZ	81349	JANTX2N2369A	TRANSISTOR.....	1
31	PADZZ	81349	JANTXV2N2907A	TRANSISTOR.....	1
32	PADZZ	56996	B4002964	TRANSISTOR.....	3
33	PADZZ	81349	RCR05G112JS	RESISTOR, FIXED, COMP.....	2
34	PADZZ	81349	RCR05G222JS	RESISTOR, FIXED, COMP.....	3
35	PADZZ	81349	RCR05G513JS	RESISTOR, FIXED, COMP.....	1
36	PADZZ	81349	RCR05G123JS	RESISTOR, FIXED, COMP.....	2
37	PADZZ	81349	RCR05G911JS	RESISTOR, FIXED, COMP.....	1
38	PADZZ	81349	RCR05G331JS	RESISTOR, FIXED, COMP.....	1
39	PADZZ	81349	RCR05G131JS	RESISTOR, FIXED, COMP.....	1
40	PADZZ	81349	RCR05G242JS	RESISTOR, FIXED, COMP.....	3
41	PADZZ	81349	RCR05G511JS	RESISTOR, FIXED, COMP.....	2
42	PADZZ	81349	RCR05G512JS	RESISTOR, FIXED, COMP.....	2
43	PADZZ	81349	RCR05G101JS	RESISTOR, FIXED, COMP.....	3
44	PADZZ	81349	RCR05G113JS	RESISTOR, FIXED, COMP.....	1
45	PADZZ	81349	RCR05G432JS	RESISTOR, FIXED, COMP.....	1
46	PADZZ	81349	RCR05G271JS	RESISTOR, FIXED, COMP.....	1

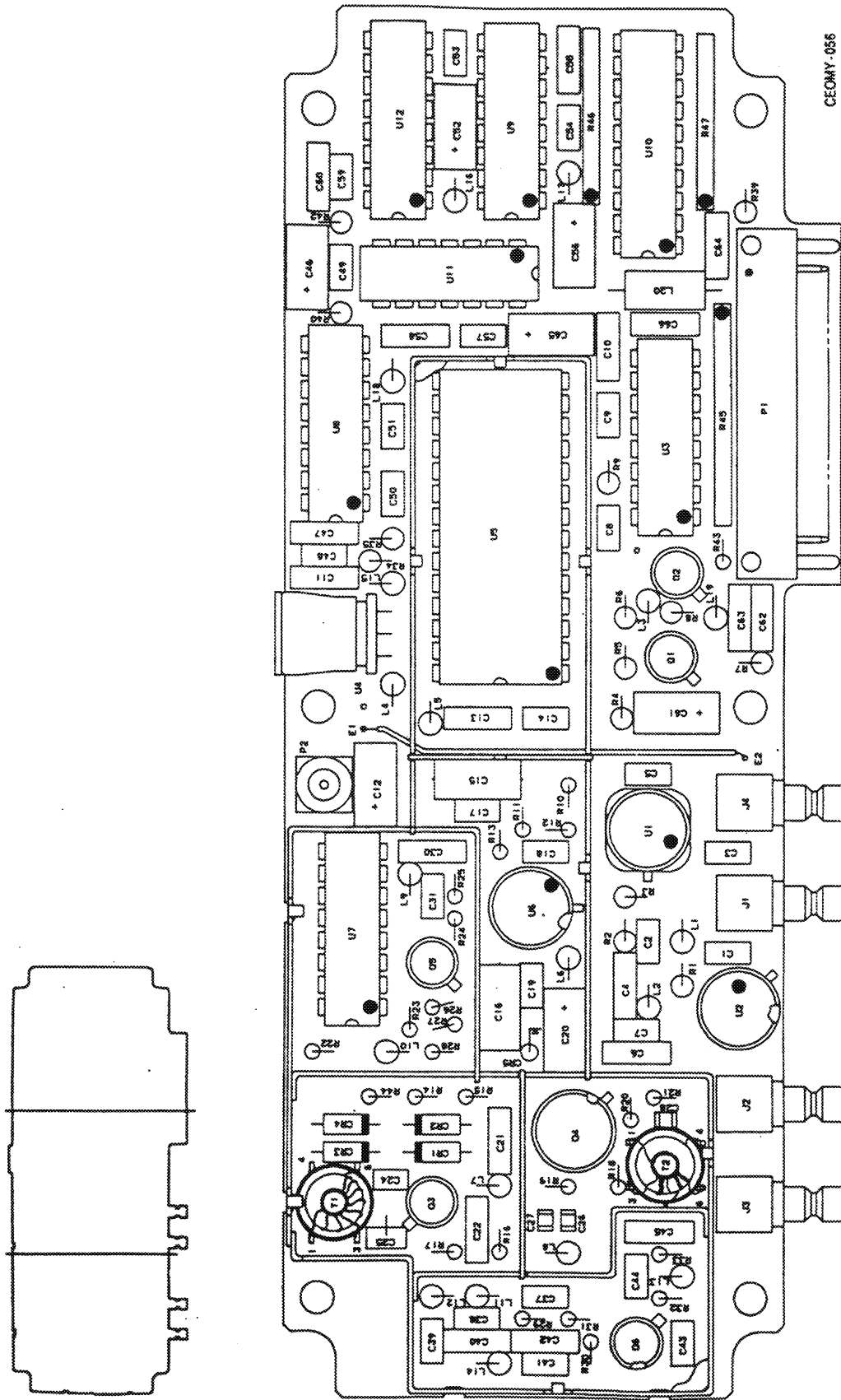
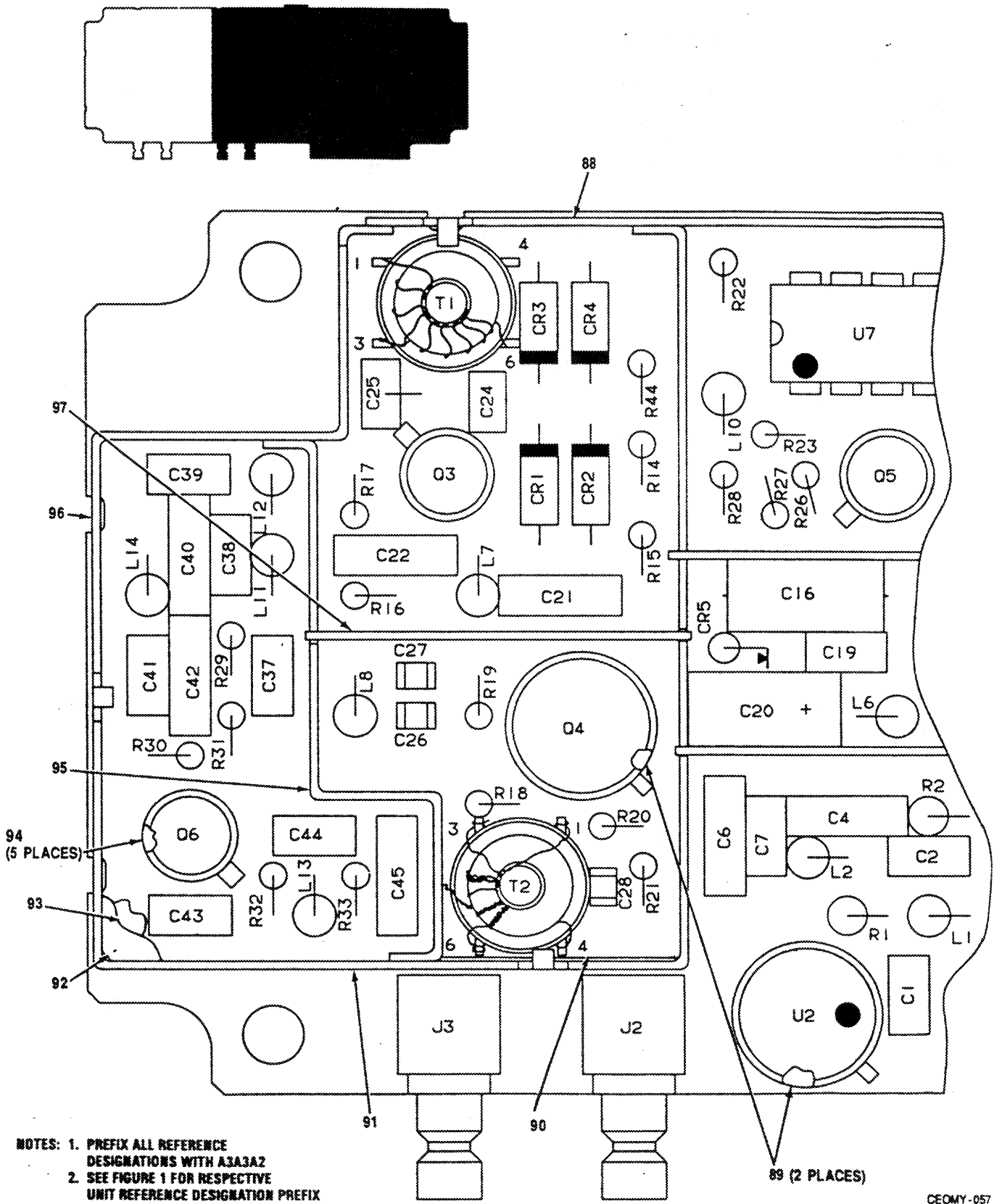

Figure 14. Reference CCA A3A3A2 (A3024370) (Sheet 1 of 5)



NOTES: 1. PREFIX ALL REFERENCE DESIGNATIONS WITH A3A3A2  
2. SEE FIGURE 1 FOR RESPECTIVE UNIT REFERENCE DESIGNATION PREFIX

CEOMY-057

Figure 14. Reference CCA A3A3A2 (A3024370) (Sheet 2 of 5)

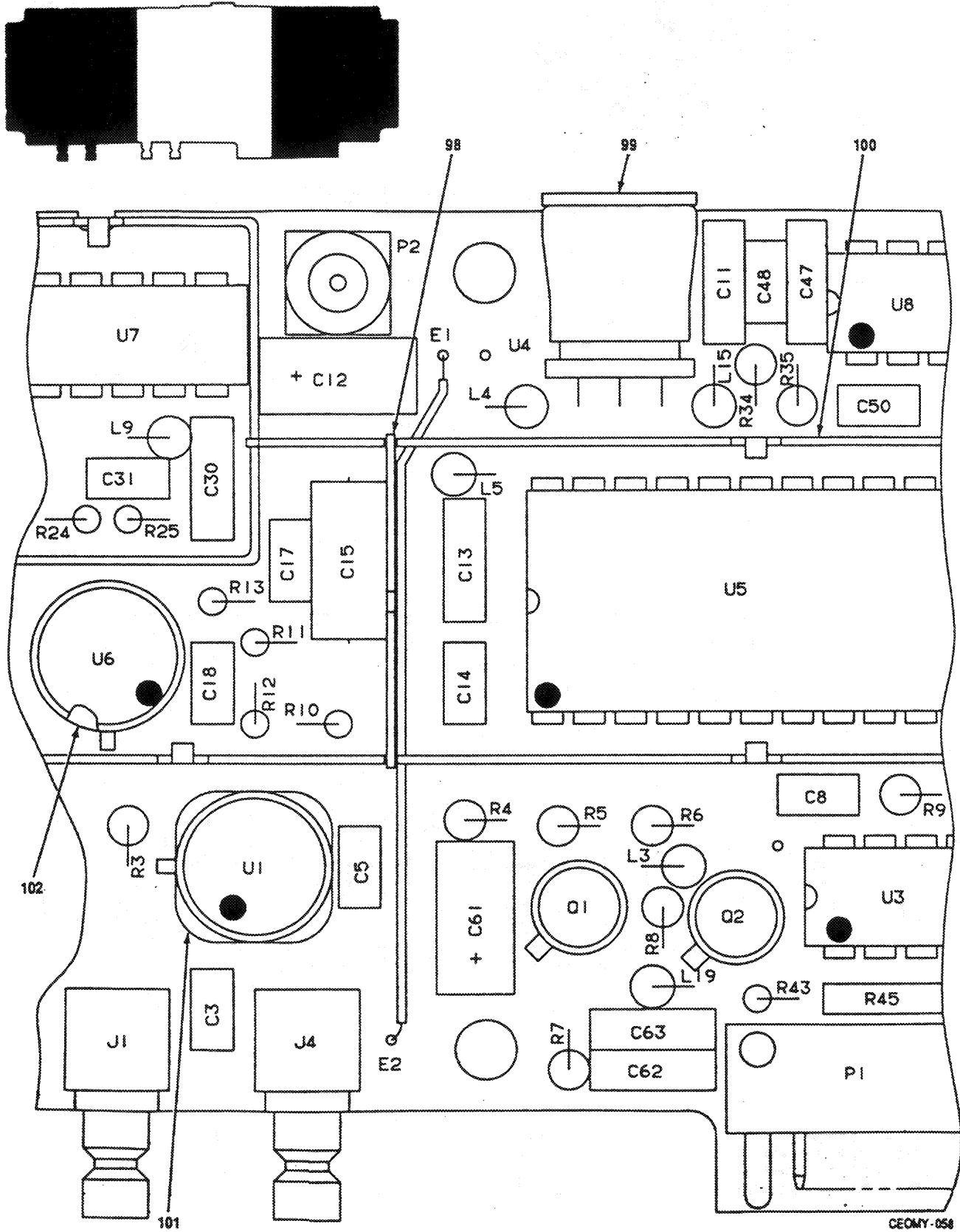
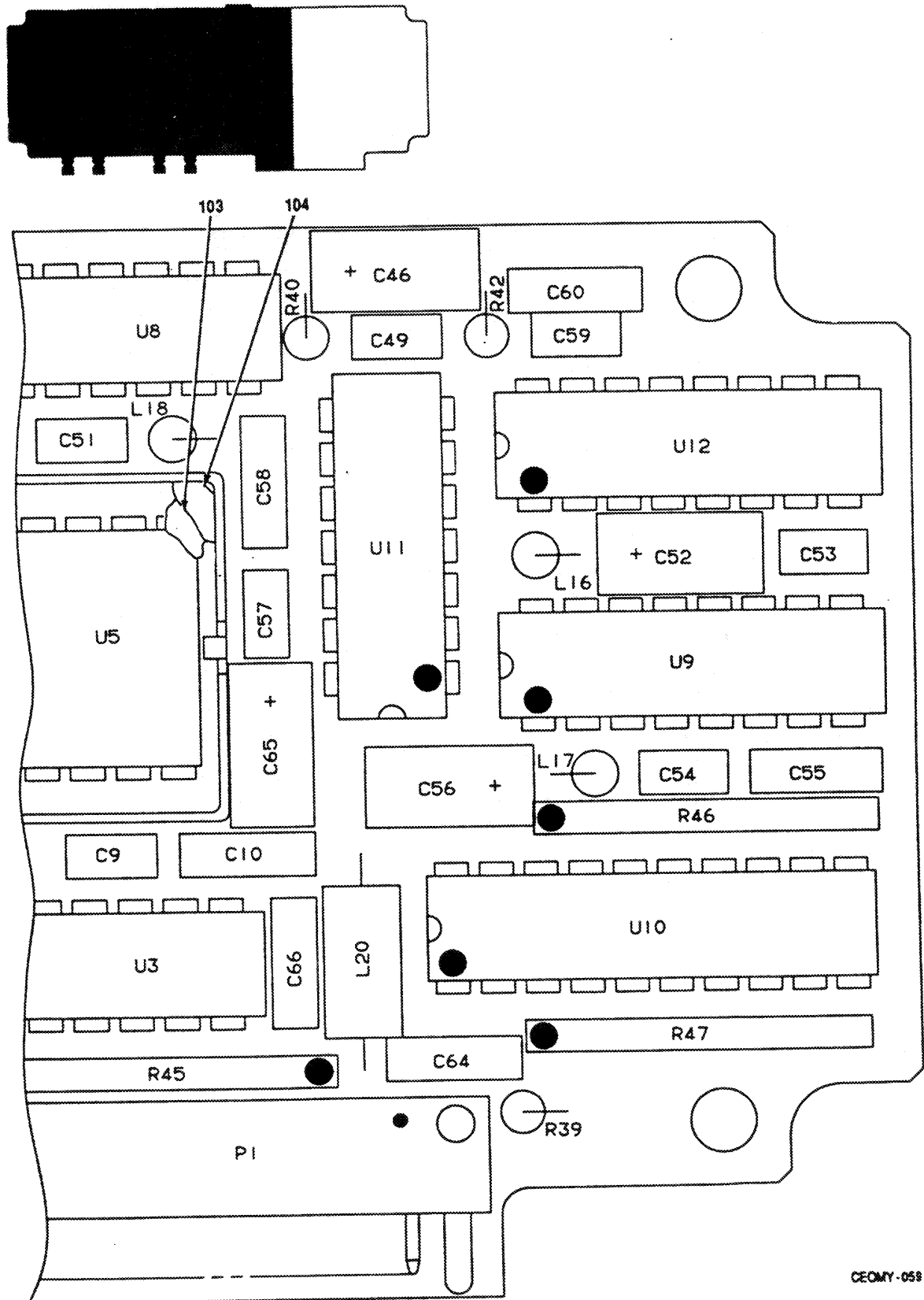

Figure 14. Reference GCA A3A3A2 (A3024370) (Sheet 3 of 5)



CEOMY-058

Figure 14. Reference CCA A3A3A2 (A3024370) (Sheet 4 of 5)

LEGEND

REF. DES.	ITEM NO.	REF. DES.	ITEM NO.	REF. DES.	ITEM NO.	REF. DES.	ITEM NO.	REF. DES.	ITEM NO.	REF. DES.	ITEM NO.
CR1	1	C26	10	C56	6	L16	23	R12	47	R34*	37
CR2	1	C27	10	C57	3	L17	23	R13	47	R34*	71
CR3	1	C28	10	C58	5	L18	23	R14	48	R35	72
CR4	1	C29	10	C59	3	L19	24	R15	49	R39	37
CR5	2	C30	4	C60	4	L20	25	R16	50	R40	73
C1	3	C31	3	C61	6	P1	26	R17	51	R42	72
C2	3	C32	10	C62	4	P2	27	R18*	52	R43	69
C3	3	C33	10	C63	4	Q1	28	R18*	53	R44	62
C4	4	C34	10	C64	4	Q2	29	R18*	54	R45	74
C5	3	C35	10	C65	6	Q3	30	R18*	55	R46	75
C6	5	C36	10	C66	4	Q4	31	R18*	56	R47	75
C7	3	C37	13	J1	18	Q5	28	R19	57	T1	76
C8	3	C38	14	J2	18	Q6	32	R20	58	T2	77
C9	3	C39	13	J3	18	R1	33	R21	59	U1	78
C10	5	C40	4	J4	18	R2	34	R22	60	U2	79
C11	4	C41	3	L1	19	R3	34	R23	61	U3	80
C12	6	C42	5	L2	19	R4	35	R24	58	U4	81
C13	5	C43	15	L3	19	R5	36	R25	62	U5	82
C14	3	C44	15	L4	19	R6	37	R26	56	U6	83
C15	7	C45	4	L5	19	R7	38	R27	63	U7	84
C16	7	C46	6	L6	20	R8	39	R28	50	U8	85
C17	8	C47	4	L7	21	R9	37	R29*	57	U9	80
C18	8	C48	16	L8	21	R10*	40	R29*	64	U10	86
C19	9	C49	3	L9	21	R10*	41	R29*	65	U11	87
C20	6	C50	17	L10	21	R10*	42	R29*	66	U12	85
C21	4	C51	3	L11	20	R10*	43	R29*	67		
C22	4	C52	6	L12	20	R10*	44	R30	68		
C23	10	C53	3	L13	22	R10*	45	R31	69		
C24	11	C54	3	L14	19	R10*	46	R32	50		
C25	12	C55	4	L15	19	R11	46	R33	70		

CEOMY-060

\* Select At Test

Figure 14. Reference CCA A3A3A2 (A3024370) (Sheet 5 of 5)

SECTION II			TM11-5895-1303-24P			(6)
(1)	(2)	(3)	(4)	(5)		
ITEM NO	SMR CODE	FSCM	PART NUMBER	DESCRIPTION AND USABLE ON CODES(UOC)	QTY	
3	PADZZ	81349	RLR05C4421FS	RESISTOR, FIXED, FILM (SELECT AT TEST).....	1	
44	PADZZ	81349	RLR05C4531FS	RESISTOR, FIXED, FILM (SELECT AT TEST).....	1	
45	PADZZ	81349	RLR05C4641FS	RESISTOR, FIXED, FILM (SELECT AT TEST).....	1	
46	PADZZ	81349	RLR05C4321FS	RESISTOR, FIXED, FILM (SELECT AT TEST CR10).....	2	
47	PADZZ	81349	RLR05C7501FS	RESISTOR, FIXED, FILM.....	2	
48	PADZZ	81349	RCR05G512JS	RESISTOR, FIXED, COMP.....	1	
49	PADZZ	81349	RCR05G203JS	RESISTOR, FIXED, COMP.....	1	
50	PADZZ	81349	RCR05G101JS	RESISTOR, FIXED, COMP.....	3	
51	PADZZ	81349	RCR05G751JS	RESISTOR, FIXED, COMP.....	1	
52	PADZZ	81349	RCR05G103JS	RESISTOR, FIXED, COMP (SELECT AT TEST).....	1	
53	PADZZ	81349	RCR05G682JS	RESISTOR, FIXED, COMP (SELECT AT TEST).....	1	
54	PADZZ	81349	RCR05G752JS	RESISTOR, FIXED, COMP (SELECT AT TEST).....	1	
55	PADZZ	81349	RCR05G912JS	RESISTOR, FIXED, COMP (SELECT AT TEST).....	1	
56	PADZZ	81349	RCR05G822JS	RESISTOR, FIXED, COMP (SELECT AT TEST R18).....	2	
57	PADZZ	81349	RCR05G122JS	RESISTOR, FIXED, COMP (SELECT AT TEST R29).....	2	
58	PADZZ	81349	RCR05G200JS	RESISTOR, FIXED, COMP.....	2	
59	PADZZ	81349	RCR05G680JS	RESISTOR, FIXED, COMP.....	1	
60	PADZZ	81349	RCR05G683JS	RESISTOR, FIXED, COMP.....	1	
61	PADZZ	81349	RCR05G510JS	RESISTOR, FIXED, COMP.....	1	
62	PADZZ	81349	RCR05G471JS	RESISTOR, FIXED, COMP.....	2	
63	PADZZ	81349	RCR05G362JS	RESISTOR, FIXED, COMP.....	1	
64	PADZZ	81349	RCR05G102JS	RESISTOR, FIXED, COMP (SELECT AT TEST).....	1	
65	PADZZ	81349	RCR05G132JS	RESISTOR, FIXED, COMP (SELECT AT TEST).....	1	
66	PADZZ	81349	RCR05G681JS	RESISTOR, FIXED, COMP (SELECT AT TEST).....	1	
67	PADZZ	81349	RCR05G821JS	RESISTOR, FIXED, COMP (SELECT AT TEST).....	1	
68	PADZZ	81349	RCR05G152JS	RESISTOR, FIXED, COMP.....	1	
69	PADZZ	81349	RCR05G332JS	RESISTOR, FIXED, COMP.....	2	
70	PADZZ	81349	RCR05G820JS	RESISTOR, FIXED, COMP.....	1	
71	PADZZ	81349	RCR07G122JS	RESISTOR, FIXED, COMP (SELECT AT TEST).....	1	
72	PADZZ	81349	RCR07G753JS	RESISTOR, FIXED, COMP.....	2	
73	PADZZ	81349	RCR07G512JS	RESISTOR, FIXED, COMP.....	1	
74	PADZZ	81349	M8340109M5103JC	RESISTOR NETWORK, FI.....	1	
75	PADZZ	81349	M8340105M1001JG	RESISTOR NETWORK, FI.....	2	
76	PADZZ	80063	A3024684-1	TRANSFORMER, RADIO F.....	1	
77	PADZZ	80063	A3024684-3	TRANSFORMER, RADIO F.....	1	
78	PADZZ	96214	531932-2	MICROCIRCUIT, LINEAR.....	1	
79	PADZZ	81349	M38510/10703-BXC	MICROCIRCUIT, LINEAR.....	1	



SECTION II			TM11-5895-1303-24P			
(1)	(2)	(3)	(4)	(5)	(6)	
ITEM NO	SMR CODE	FSCM	PART NUMBER	DESCRIPTION AND USABLE ON CODES(UOC)		QTY

GROUP 030302 REFERENCE CCA  
A3A3A2 (A3024370)

FIG. 14

1	PADZZ	80063	A3028098	SEMICONDUCTOR DEVIC.	4
2	PADZZ	81349	JANTX1N4454-1	SEMICONDUCTOR DEVIC.	1
3	PADZZ	81349	M39014-01-1575	CAPACITOR, FIXED, CER.	16
4	PADZZ	81349	M39014/02-1350	CAPACITOR, FIXED, CER.	14
5	PADZZ	81349	M39014/02-1419	CAPACITOR, FIXED, CER.	5
6	PADZZ	56996	B4003327-3126	CAPACITOR, FIXED, ELE.	7
7	PADZZ	81349	CFR06RRA103JM	CAPACITOR, FIXED, MET.	2
8	PADZZ	81349	CCR05CG102FP	CAPACITOR, FIXED, CER.	2
9	PADZZ	81349	M39014/02-1358	CAPACITOR, FIXED, CER.	1
10	PADZZ	81349	CDR01BX102BKUP	CAPACITOR, CHIP.	10
11	PADZZ	56996	B4003316-19	CAPACITOR, FIXED, CER.	1
12	PADZZ	56996	B4003318-78	CAPACITOR, FIXED, CER.	1
13	PADZZ	81349	M39014/01-1347	CAPACITOR, FIXED, CER.	2
14	PADZZ	81349	M39014/01-1353	CAPACITOR, FIXED, CER.	1
15	PADZZ	81349	M39014/01-1571	CAPACITOR, FIXED, CER.	2
16	PADZZ	81349	M39014/01-1345	CAPACITOR, FIXED, CER.	1
17	PADZZ	81349	M39014/01-1357	CAPACITOR, FIXED, CER.	1
18	PADZZ	19505	2010-6511-002	CONNECTOR, RECEPTACL.	4
19	PADZZ	96906	MS75085-7	COIL, RADIO FREQUENC.	7
20	PADZZ	96906	MS75085-15	COIL, RADIO FREQUENC.	3
21	PADZZ	96906	MS75084-8	COIL, RADIO FREQUENC.	4
22	PADZZ	96906	MS75085-1	COIL, RADIO FREQUENC.	1
23	PADZZ	96906	MS75085-19	COIL, RADIO FREQUENC.	3
24	PADZZ	96906	MS75084-16	COIL, RADIO FREQUENC.	1
25	PADZZ	96906	MS75089-3	COIL, RADIO FREQUENC.	1
26	PADZZ	81349	M55302/4-03	CONNECTOR, RECEPTACL.	1
27	PADZZ	58167	11-0450-01C	CONNECTOR, RECEPTACL.	1
28	PADZZ	81349	JANTX2N918	TRANSISTOR.	1
29	PADZZ	81349	JANTX2N2369A	TRANSISTOR.	1
30	PADZZ	04713	U310	TRANSISTOR.	1
31	PADZZ	81349	JANTX2N5109	TRANSISTOR.	1
32	PADZZ	81349	JANTX2N2222A	TRANSISTOR.	1
33	PADZZ	81349	RCR07G222JS	RESISTOR, FIXED, COMP.	1
34	PADZZ	81349	RCR07G622JS	RESISTOR, FIXED, COMP.	2
35	PADZZ	81349	RCR07G822JS	RESISTOR, FIXED, COMP.	1
36	PADZZ	81349	RCR07G392JS	RESISTOR, FIXED, COMP.	1
37	PADZZ	81349	RCR07G102JS	RESISTOR, FIXED, COMP (SELECT AT TEST R34).	4
38	PADZZ	81349	RCR07G471JS	RESISTOR, FIXED, COMP.	1
39	PADZZ	81349	RCR07G101JS	RESISTOR, FIXED, COMP.	1
40	PADZZ	81349	RLR05C4021FS	RESISTOR, FIXED, FILM (SELECT AT TEST).	1
41	PADZZ	81349	RLR05C4121FS	RESISTOR, FIXED, FILM (SELECT AT TEST).	1
42	PADZZ	81349	RLR05C4221FS	RESISTOR, FIXED, FILM (SELECT AT TEST).	1

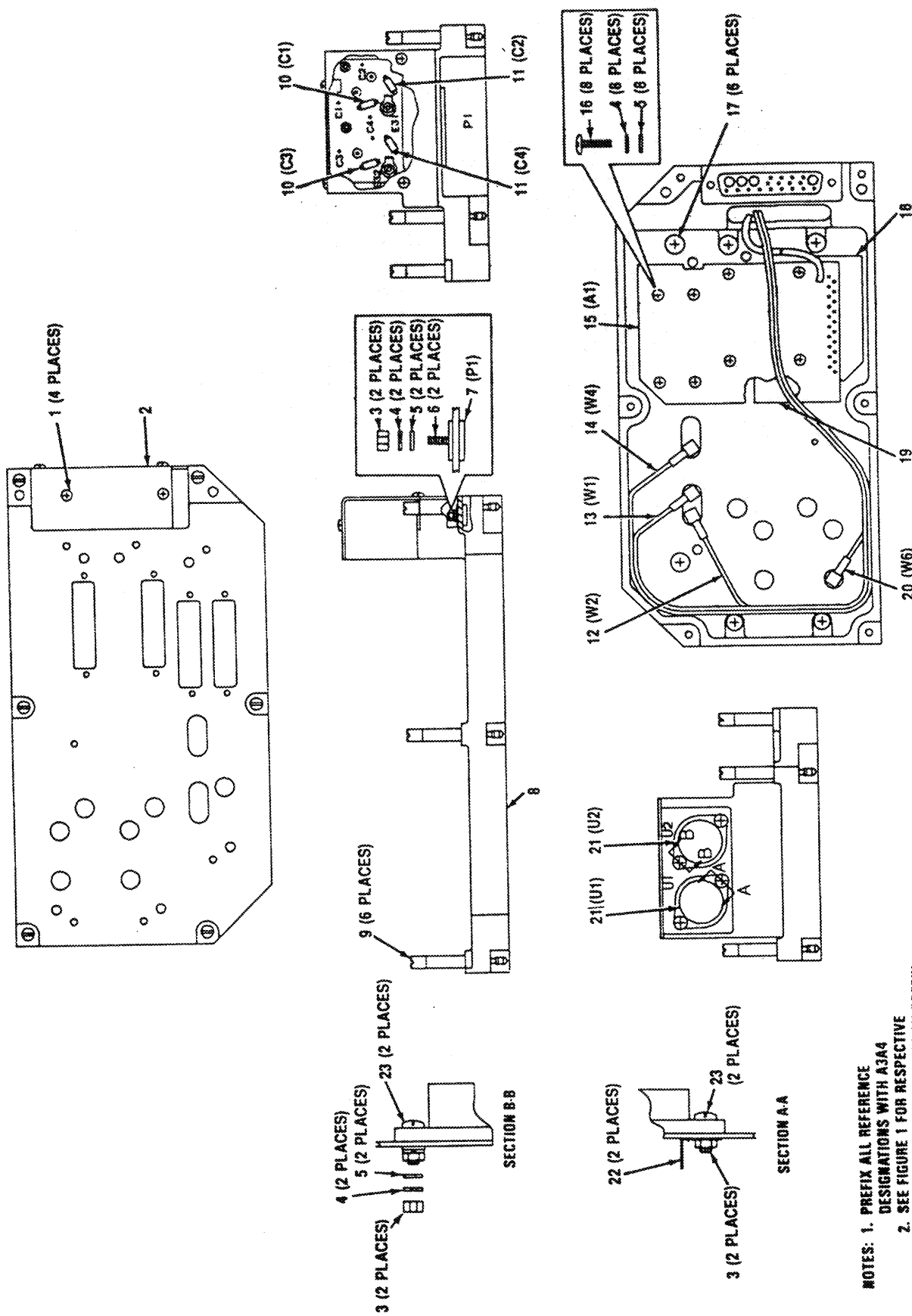

CEOMY-061

Figure 15. Chassis/Regulator Assy A3A4 (A3024374)

- NOTES: 1. PREFIX ALL REFERENCE DESIGNATIONS WITH A3A4  
 2. SEE FIGURE 1 FOR RESPECTIVE UNIT REFERENCE DESIGNATION PREFIX

SECTION II			TM11-5895-1303-24P			
(1)	(2)	(3)	(4)	(5)	(6)	
ITEM NO	SMR CODE	FSCM	PART NUMBER	DESCRIPTION AND USABLE ON CODES(UOC)	QTY	
80	PADZZ	27014	MM54HC390J/883B	MICROCIRCUIT, DIGITA.....		
81	PADZZ	81349	M38510/10702-BXC	MICROCIRCUIT, LINEAR.....		
82	PADZA	04713	MC145152LD	MICROCIRCUIT, DIGITA.....	1	
83	PADZZ	02735	CA6741T/3	MICROCIRCUIT, LINEAR.....	1	
84	PADZA	52648	SP8691AB/DG	MICROCIRCUIT, DIGITA.....	1	
85	PADZZ	81349	M38510-31401BEB	MICROCIRCUIT, DIGITA.....	2	
86	PADZA	27014	MM54HC374J/883B	MICROCIRCUIT, DIGITA.....	1	
87	PADZZ	81349	M38510-30009BCB	MICROCIRCUIT, DIGITA.....	1	
88	PADZZ	80063	A3028648	PARTITION, SHIELD--R.....	1	
89	PADZZ	81349	M38527/02-018N	MOUNTING PAD, ELECTR.....	2	
90	PADZZ	80063	A3078673	INSULATION CLOTH, EL.....	1	
91	PADZZ	80063	A3028630	PARTITION, SHIELD--R.....	1	
92	PADZZ	80063	A3028646	COVER, SHIELD--REFER.....	1	
93	PADZZ	80063	A3079147	INSULATION CLOTH, EL.....	1	
94	PADZZ	81349	M38527/01-040N	MOUNTING, PADS, INSUL.....	5	
95	PADZZ	80063	A3028647	PARTITION, SHIELD--R.....	1	
96	PADZZ	80063	A3028631	PARTITION, SHIELD--R.....	1	
97	PADZZ	80063	A3028638	PARTITION, SHIELD--R.....	1	
98	PADZZ	80063	A3028634	PARTITION, SHIELD--R.....	1	
99	PADZZ	81349	M87111/2-2B05	HEAT SINK.....	1	
100	PADZZ	80063	A3028629	PARTITION, SHIELD--R.....	1	
101	PADZZ	81349	M38527/05-001D	MOUNTING PAD, ELECTR.....	1	
102	PADZZ	81349	M38527/05-002D	MOUNTING PAD, ELECTR.....	1	
103	PADZZ	80063	A3079146	INSULATION CLOTH, EL.....	1	
104	PADZZ	80063	A3028635	COVER, SHIELD--REFER.....	1	

END OF FIGURE

SECTION II			TM11-5895-1303-24P	(5)	(6)
(1)	(2)	(3)	(4)		
ITEM NO	SMR CODE	FSCM	PART NUMBER	DESCRIPTION AND USABLE ON CODES(UOC)	QTY
				GROUP 0304 CHASSIS/REGULATOR	
				ASSEMBLY A3A4	
				(A3024374)	
				FIG. 15	
1	PADZZ	80205	NAS1635-04LN4	SCREW, SELF-LOCKING.....	4
2	XBDZZ	80063	A3028065	COVER, ACCESS-SYNTH.....	1
3	PADZZ	80205	NAS671C4	NUT, PLAIN, HEXAGON.....	6
4	PADZZ	96906	MS35338-135	WASHER, LOCK.....	12
5	PADZZ	80205	NAS620C4L	WASHER, FLAT.....	12
6	PADZZ	96906	MS24693C3	SCREW, MACHINE.....	2
7	PADZZ	25330	GDMM36W4P	CONNECTOR, RECEPTAC.....	1
8	XBDZZ	80063	A3028019	CHASSIS, ELECTRIC EQ.....	1
9	PADZZ	80063	A3028101	SCREW, EXTERNALLY RE.....	6
10	PADZZ	81349	M39003/01-3176	CAPACITOR, FIXED, ELE.....	2
11	PADZZ	81349	M39003/01-3076	CAPACITOR, FIXED, ELE.....	2
12	PADZZ	80063	A3024379-2	CABLE ASSEMBLY, RADI.....	1
13	PADZZ	80063	A3024379-1	CABLE ASSEMBLY, RADI.....	1
14	PADZZ	80063	A3024379-3	CABLE ASSEMBLY, RADI.....	1
15	PADZZ	80063	A3024376	CIRCUIT CARD ASSEMB.....	1
16	PADZZ	96906	MS51957-13	SCREW, MACHINE.....	8
17	PADZZ	80063	A3028192-1	SCREW, PAN HEAD--EXT.....	6
18	PADZZ	80063	A3029324	INSULATOR, CIRCUIT C.....	1
19	PADZZ	80063	A3078391	INSULATION CLOTH, EL.....	1
20	PADZZ	80063	A3024379-4	CABLE ASSEMBLY, RADI.....	1
21	PADZZ	81349	M38510/10708BYC	MICROCIRCUIT, LINEAR.....	2
22	PADZZ	96906	MS77071-1	TERMINAL, LUG.....	2
23	PADZZ	96906	MS51957-14	SCREW, MACHINE.....	4

END OF FIGURE

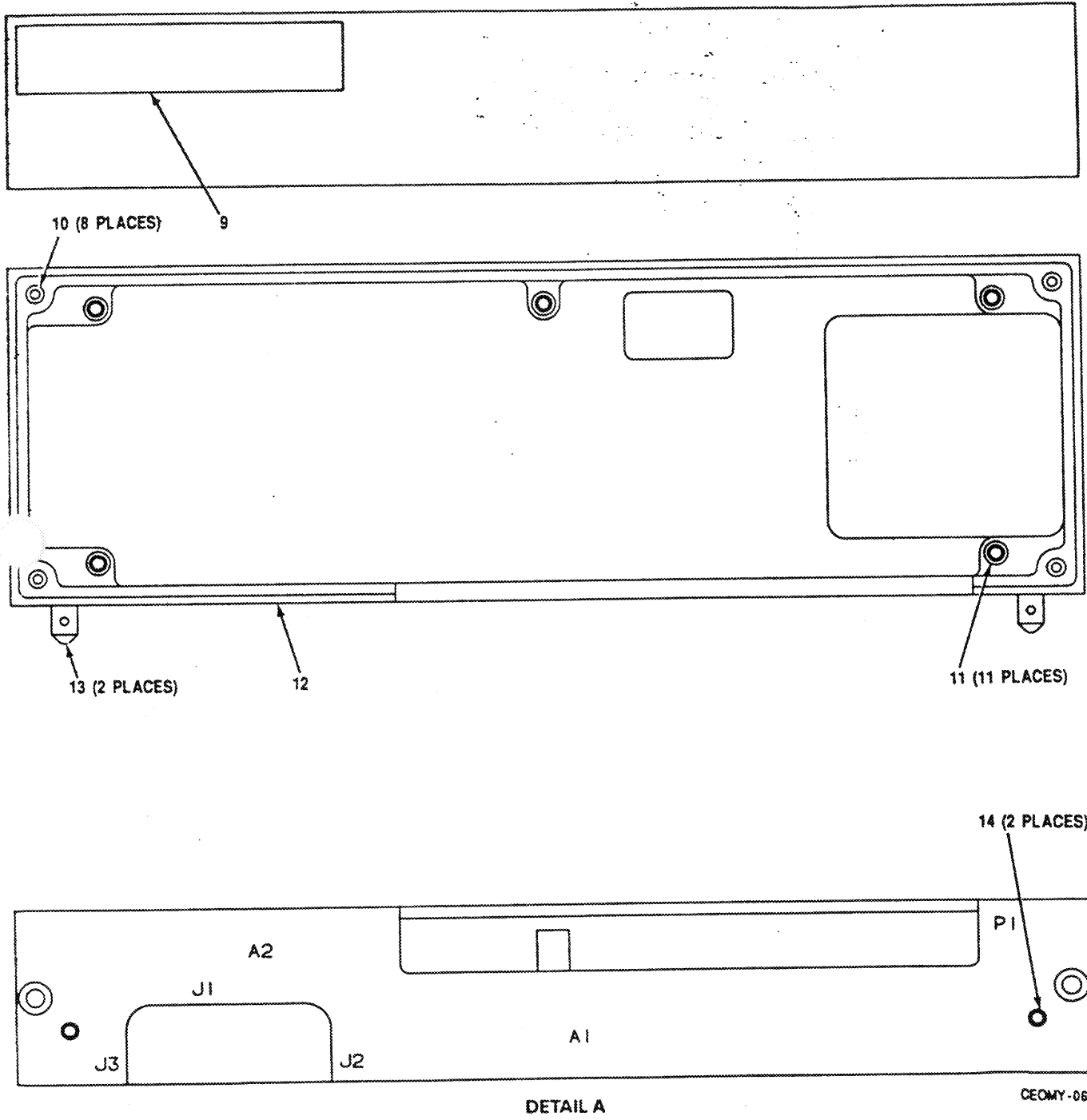
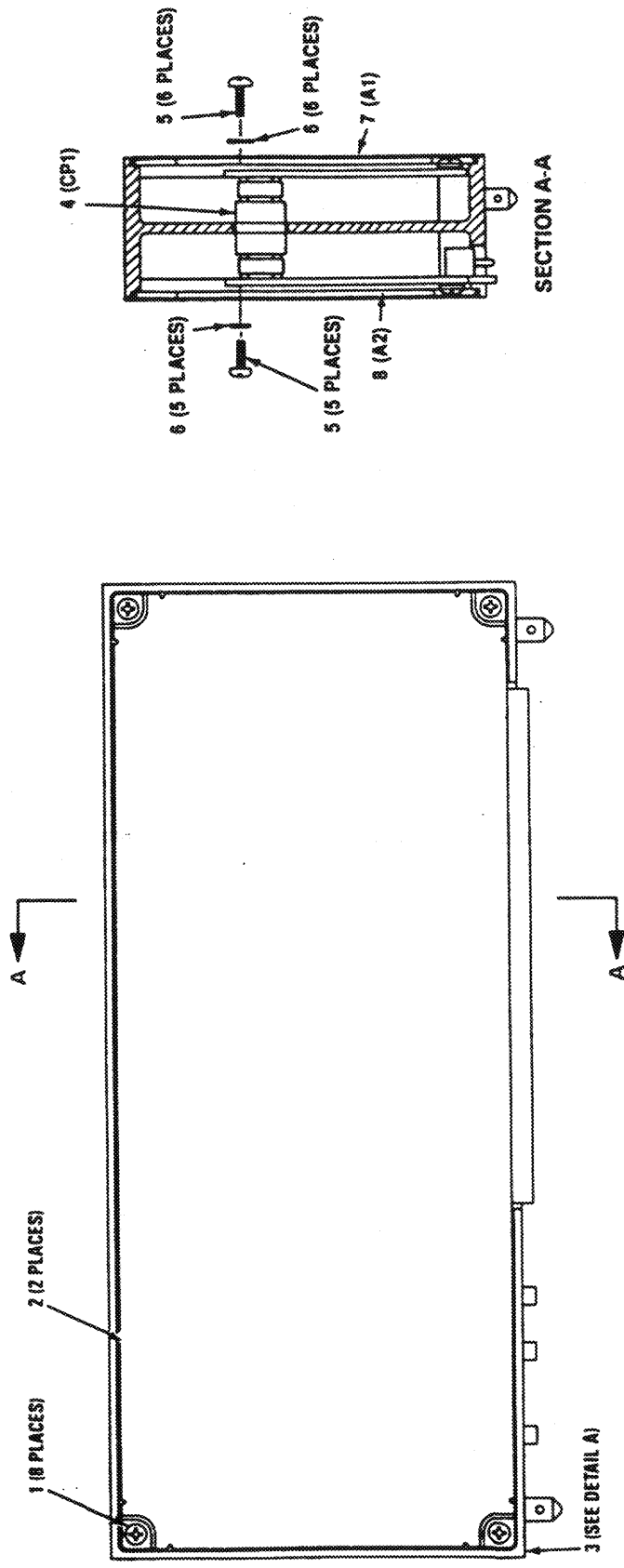
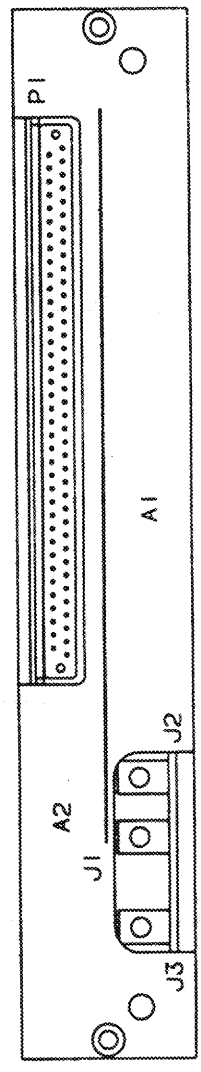

Figure 16. Reference Oscillator Assembly A4 (A3024618) (Sheet 2 of 2)



GEOMY-062



NOTES: 1. PREFIX ALL REFERENCE DESIGNATIONS WITH A4  
 2. SEE FIGURE 1 FOR RESPECTIVE UNIT REFERENCE DESIGNATION PREFIX

Figure 16. Reference Oscillator Assembly A4 (A3024618) (Sheet 1 of 2)

SECTION II			TM11-5895-1303-24P		
(1)	(2)	(3)	(4)	(5)	(6)
ITEM	SMR		PART		
NO	CODE	FSCM	NUMBER	DESCRIPTION AND USABLE ON CODES(UOC)	QTY

GROUP 04 REFERENCE OSCILLATOR  
ASSEMBLY A4 (A3024618)

FIG. 16

1	PADZZ	96906	MS51957-2	SCREW, MACHINE.....	8
2	XBDZZ	80063	A3034520	COVER, MODULE, ASSEMB.....	2
3	XBDDD	80063	A3028048	MODULE FRAME ASSEMB.....	1
4	PADZZ	56207	400118	CONNECTOR, RECEPTACL.....	1
5	PADZZ	96906	MS51957-13	SCREW, MACHINE.....	11
6	PADZZ	80205	NAS620C4L	WASHER, FLAT.....	11
7	PADDD	80063	A3024621	CIRCUIT CARD ASSEMB (SEE FIG. 17 FOR BREAKDOWN).....	1
8	PBDDD	80063	A3024625	CIRCUIT CARD ASSEMB (SEE FIG. 18 FOR BREAKDOWN).....	1
9	XBDZZ	80063	A3034572	LABEL, SENSITIVE.....	1
10	PADZZ	26344	3585-02CNW0129	INSERT, SCREW THREAD.....	8
11	PADZZ	96906	MS21209C0415L	INSERT, SCREW THREAD.....	11
12	XBDZZ	80063	A3028049	FRAME, MODULE REFERE.....	1
13	XBDZZ	80063	A3028102	PIN, GUIDE--MODULE.....	2
14	PADZZ	96906	MS21209C0815L	INSERT, SCREW THREAD.....	2

END OF FIGURE

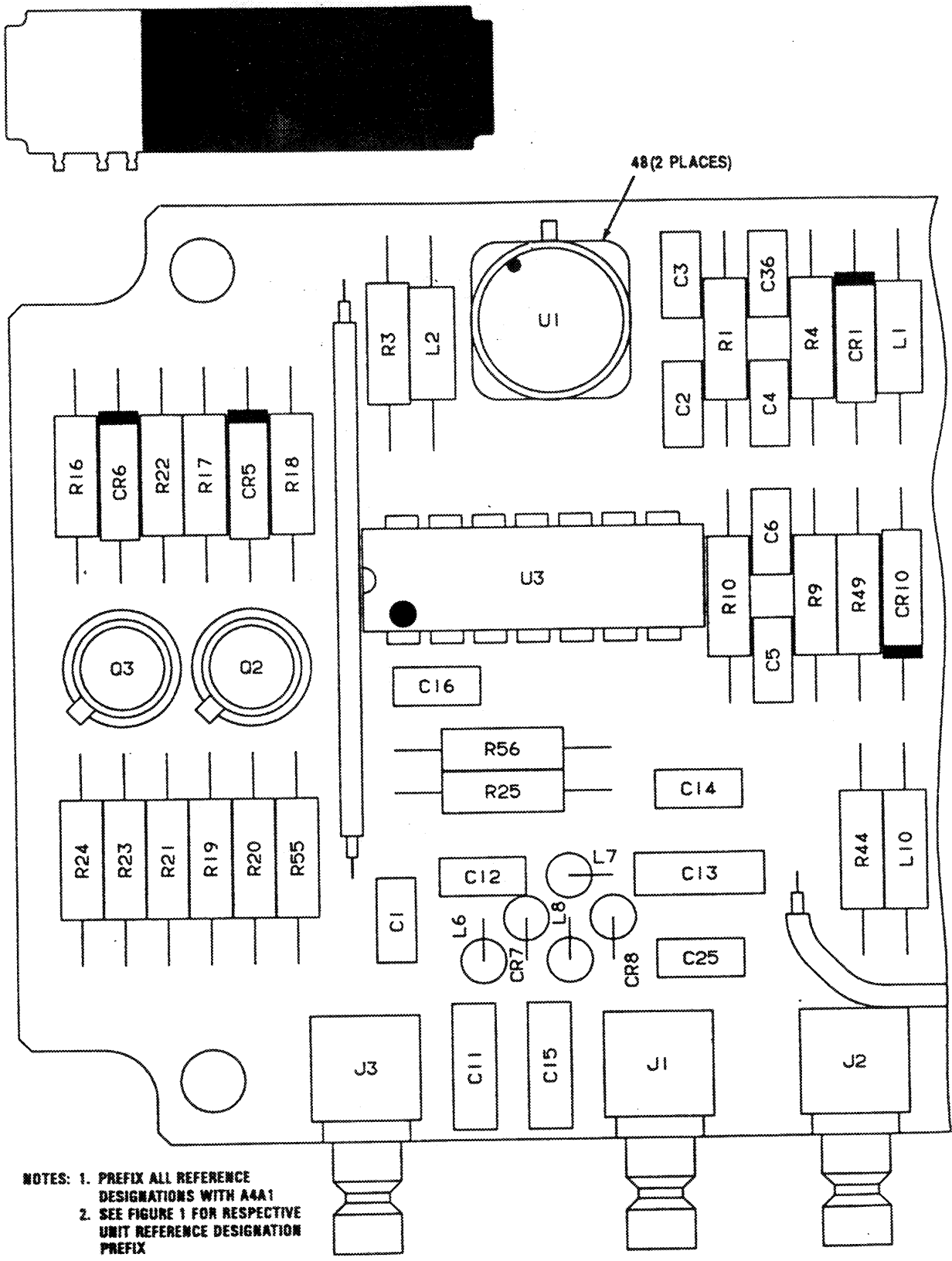

NOTES: 1. PREFIX ALL REFERENCE DESIGNATIONS WITH A4A1  
 2. SEE FIGURE 1 FOR RESPECTIVE UNIT REFERENCE DESIGNATION PREFIX

CEOMY-065

Figure 17. Reference Oscillator CCA A4A1 (A3024621) (Sheet 2 of 6)



GEOMY-864

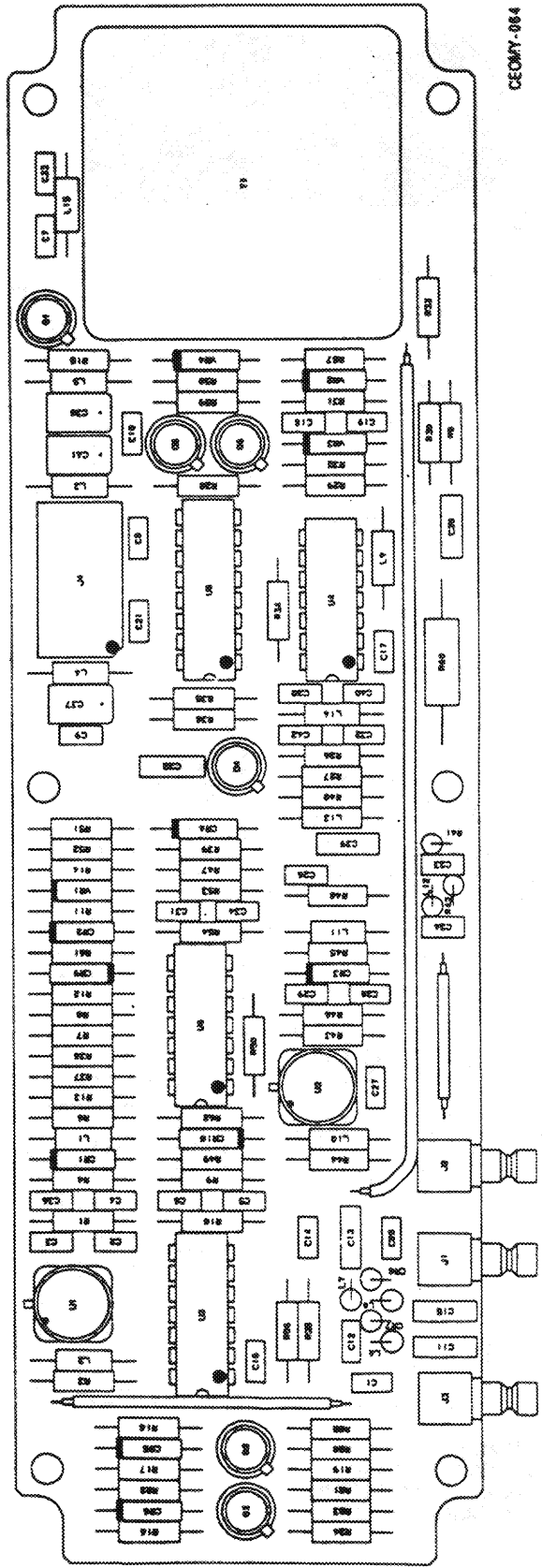
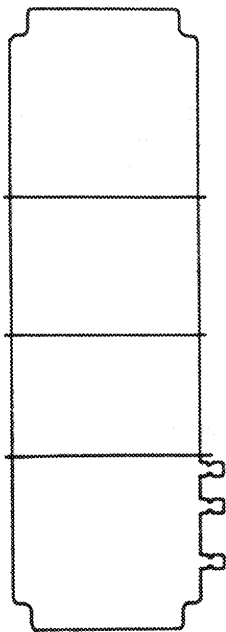

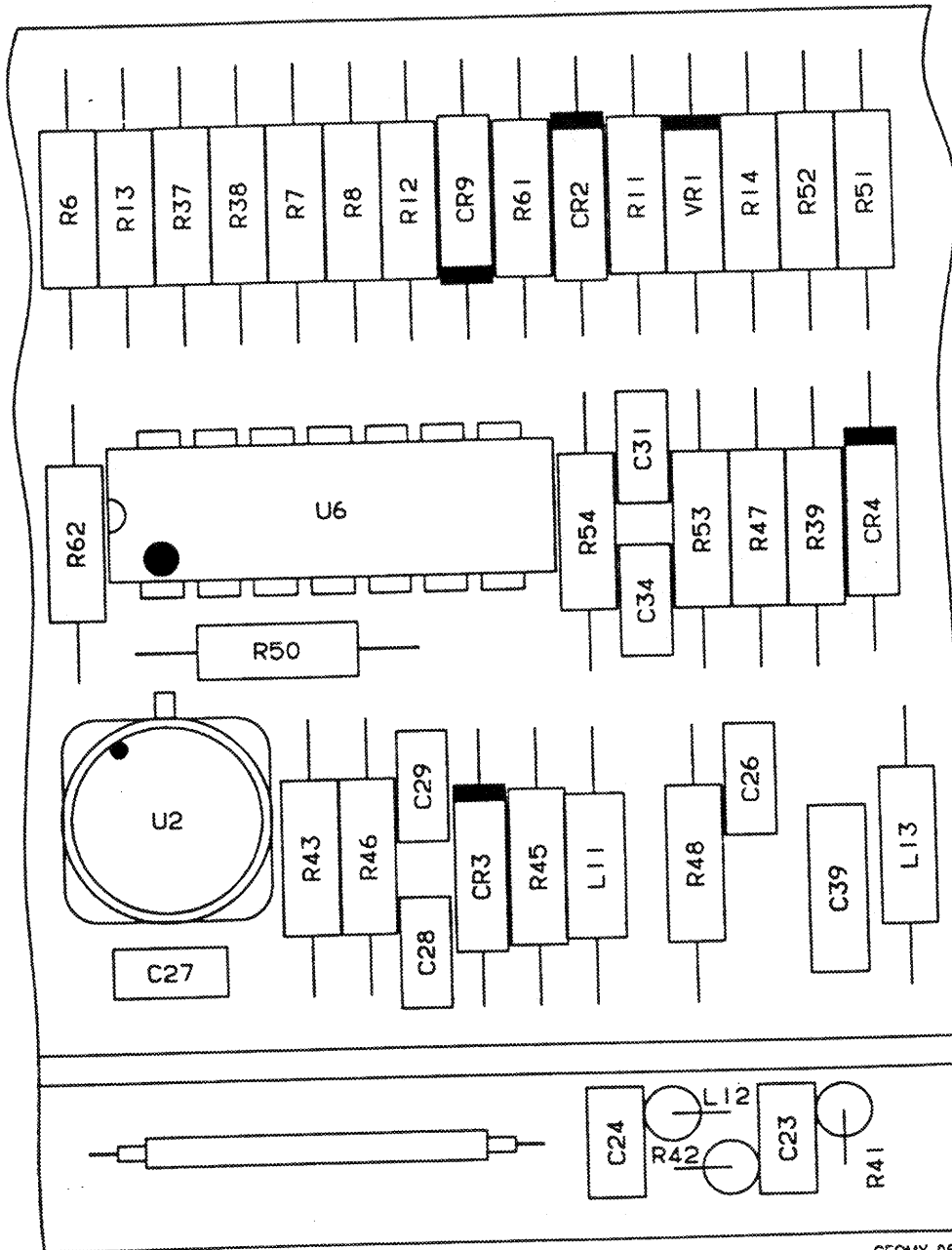
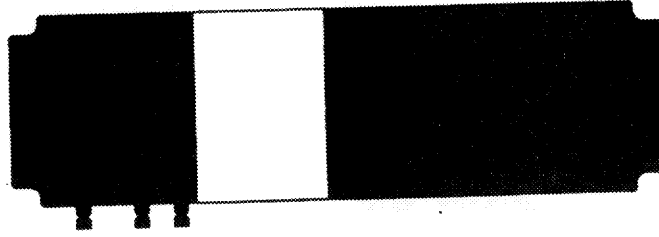

CEOMY-066

Figure 17. Reference Oscillator CCA A4A1 (A3024621) (Sheet 3 of 6)

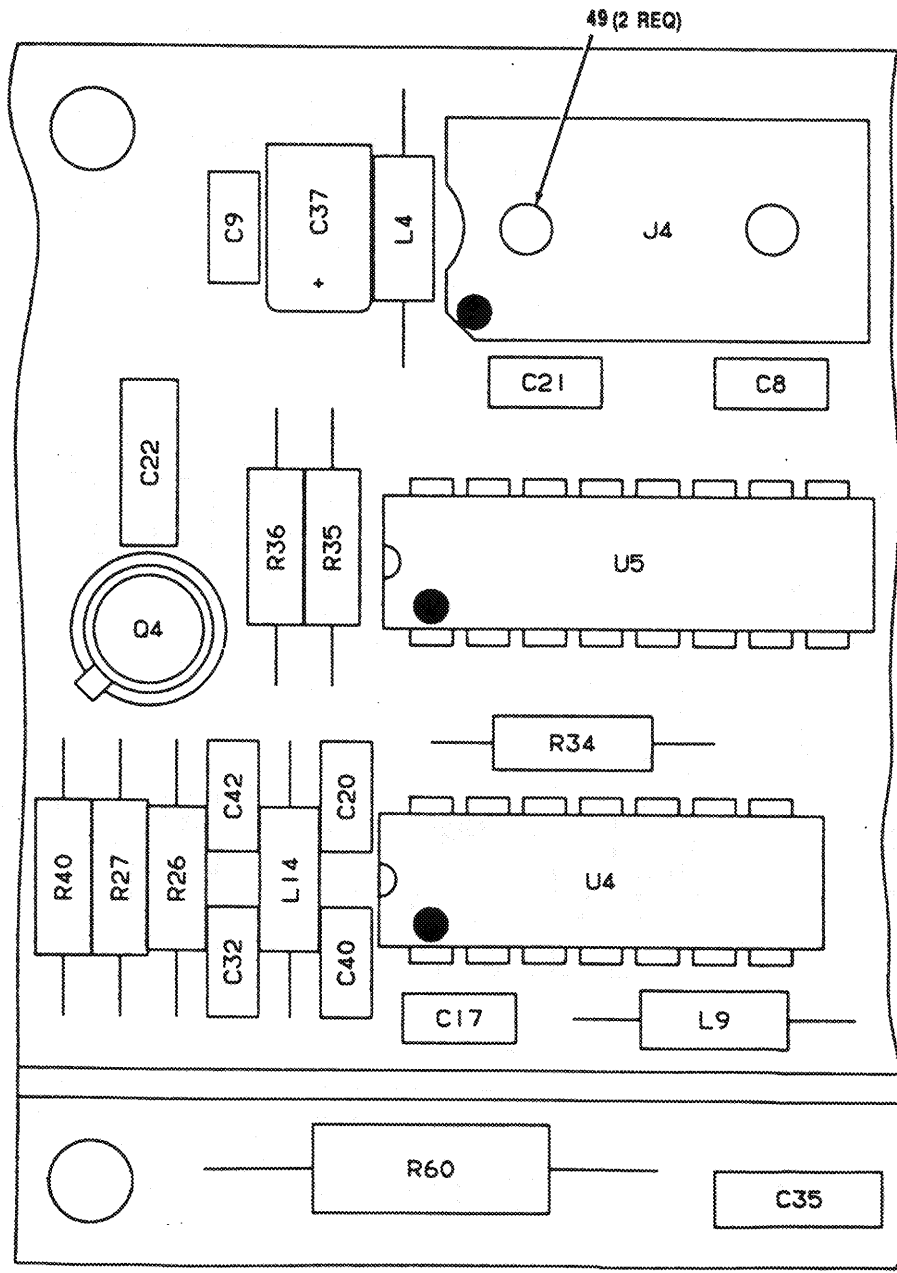
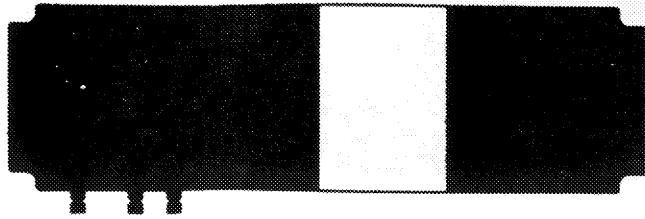

CEOMY-067

Figure 17. Reference Oscillator CCA A4A1 (A3024621) (Sheet 4 of 6)

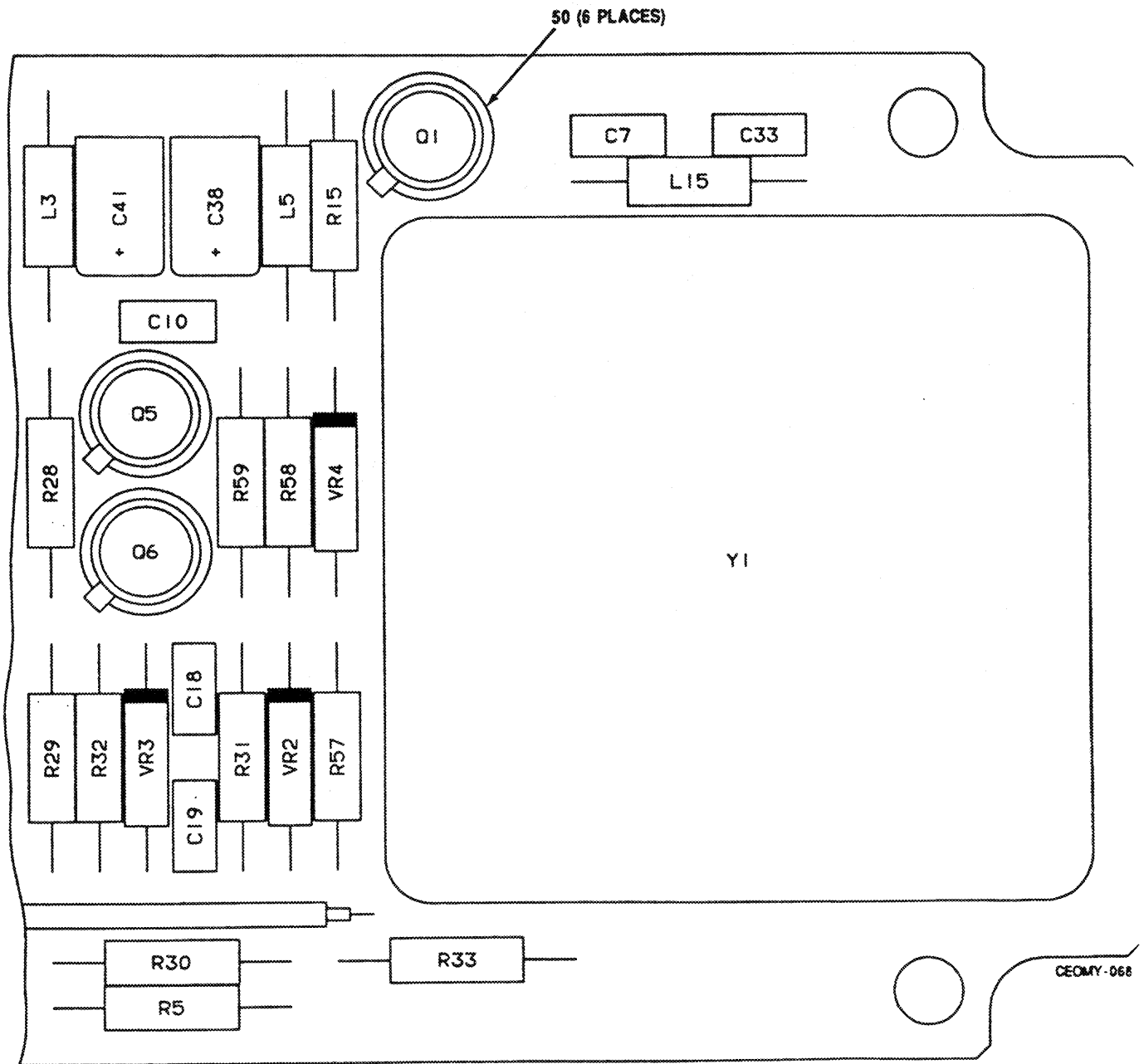
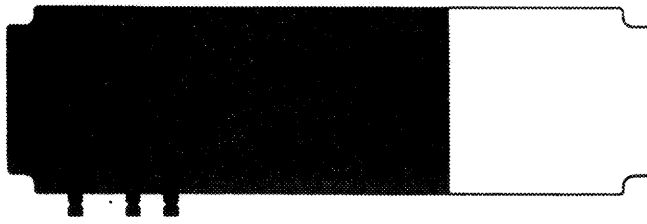

Figure 17. Reference Oscillator CCA A4A1 (A3024621) (Sheet 5 of 6)

LEGEND

REF. DES.	ITEM NO.	REF. DES.	ITEM NO.	REF. DES.	ITEM NO.	REF. DES.	ITEM NO.	REF. DES.	ITEM NO.	REF. DES.	ITEM NO.
CR1	1	C18	3	J4	10	R6	19	R28	21	R50*	25
CR2	1	C19	3	L1	11	R7	20	R29	21	R51	27
CR3	1	C20	3	L2	11	R8*	15	R30	27	R52	27
CR4	1	C21	3	L3	11	R8*	21	R31	33	R53	26
CR5	1	C22	5	L4	11	R8*	22	R32	34	R54	26
CR6	1	C23	6	L5	11	R8*	23	R33	35	R55	21
CR7	2	C24	6	L6	11	R8*	24	R34	21	R56	21
CR8	2	C25	3	L7	11	R8*	25	R35	26	R57	29
CR9	1	C26	3	L8	11	R9	26	R36	21	R58	29
CR10	1	C27	3	L9	11	R10	26	R37	21	R59	21
C1	3	C28	3	L10	11	R11	27	R38	29	R60	38
C2	3	C29	4	L11	11	R12	27	R39	21	R61	39
C3	3	C31	3	L12	12	R13	28	R40	36	R62	40
C4	3	C32	3	L13	11	R14	29	R41	37	U1	41
C5	3	C33	7	L14	11	R15	21	R42	37	U2	41
C6	3	C34	3	L15	11	R16	21	R43	15	U3	42
C7	4	C35	5	Q1	13	R17	21	R44	15	U4	43
C8	3	C36	4	Q2	13	R18	30	R45	28	U5	44
C9	3	C37	8	Q3	13	R19	21	R46	17	U6	42
C10	3	C38	8	Q4	14	R20	17	R47	29	VR1	45
C11	5	C39	5	Q5	14	R21	31	R48	19	VR2	46
C12	4	C40	3	Q6	13	R22	30	R49	20	VR3	46
C13	5	C41	8	R1	15	R23	21	R50*	15	VR4	45
C14	4	C42	3	R2	15	R24	17	R50*	21	Y1	47
C15	5	J1	9	R3	16	R25	31	R50*	22		
C16	4	J2	9	R4	17	R26	32	R50*	23		
C17	3	J3	9	R5	18	R27	22	R50*	24		

\* Select At Test

CEOMY-069

Figure 17. Reference Oscillator CCA A4A1 (A3024621) (Sheet 6 of 6)

SECTION II TM11-5895-1303-24P (5) (6)  
 (1) (2) (3) (4)  
 ITEM SMR PART  
 NO CODE FSCM NUMBER DESCRIPTION AND USABLE ON CODES(UOC) QTY

GROUP 0401 REFERENCE OSCILLATOR  
 CCA A4A1 (A3024621)

FIG. 17

1	PADZZ	81349	JANTX1N4454-1	SEMICONDUCTOR DEVIC.....	8
2	PADZZ	56996	B4006210-902	SEMICONDUCTOR DEVIC.....	2
3	PADZZ	81349	M39014-01-1575	CAPACITOR, FIXED, CER.....	23
4	PADZZ	81349	M39014/01-1593	CAPACITOR, FIXED, CER.....	6
5	PADZZ	81349	CCR06CG103G5	CAPACITOR, FIXED, CER.....	6
6	PADZZ	81349	CCR09CG301JP	CAPACITOR, FIXED, CER.....	2
7	PADZZ	81349	M39014/01-1357	CAPACITOR, FIXED, CER.....	1
8	PADZZ	56996	B4003327-3285	CAPACITOR, FIXED, ELE.....	3
9	PADZZ	19505	2010-6511-002	CONNECTOR, RECEPTACL.....	3
10	PADZZ	19112	102-14-CC-B	SOCKET, PLUG-IN ELEC.....	1
11	PADZZ	96906	MS75085-7	COIL, RADIO FREQUENC.....	14
12	PADZZ	96906	MS75084-16	COIL, RADIO FREQUENC.....	1
13	PADZZ	81349	JANTXV2N2907A	TRANSISTOR.....	4
14	PADZZ	81349	JANTX2N2222A	TRANSISTOR.....	2
15	PADZZ	81349	RCR07G622JS	RESISTOR, FIXED, COMP (SELECT AT TEST R8,50).....	5
16	PADZZ	81349	RCR07G153JS	RESISTOR, FIXED, COMP.....	1
17	PADZZ	81349	RCR07G473JS	RESISTOR, FIXED, COMP.....	4
18	PADZZ	81349	RCR07G510JS	RESISTOR, FIXED, COMP.....	1
19	PADZZ	81349	RCR07G243JS	RESISTOR, FIXED, COMP.....	2
20	PADZZ	81349	RCR07G563JS	RESISTOR, FIXED, COMP.....	2
21	PADZZ	81349	RCR07G103JS	RESISTOR, FIXED, COMP (SELECT AT TEST R8,50).....	16
22	PADZZ	81349	RCR07G822JS	RESISTOR, FIXED, COMP (SELECT AT TEST R8,50).....	3
23	PADZZ	81349	RCR07G682JS	RESISTOR, FIXED, COMP (SELECT AT TEST).....	2
24	PADZZ	81349	RCR07G752JS	RESISTOR, FIXED, COMP (SELECT AT TEST).....	2
25	PADZZ	81349	RCR07G912JS	RESISTOR, FIXED, COMP (SELECT AT TEST).....	1
26	PADZZ	81349	RCR07G270JS	RESISTOR, FIXED, COMP.....	5
27	PADZZ	81349	RCR07G562JS	RESISTOR, FIXED, COMP.....	5
28	PADZZ	81349	RCR05G513JS	RESISTOR, FIXED, COMP.....	2
29	PADZZ	81349	RCR07G102JS	RESISTOR, FIXED, COMP.....	5
30	PADZZ	81349	RCR07G472JS	RESISTOR, FIXED, COMP.....	2
31	PADZZ	81349	RCR07G301JS	RESISTOR, FIXED, COMP.....	2
32	PADZZ	81349	RCR07G222JS	RESISTOR, FIXED, COMP.....	1
33	PADZZ	81349	RCR07G681JS	RESISTOR, FIXED, COMP.....	1
34	PADZZ	81349	RCR07G331JS	RESISTOR, FIXED, COMP.....	1
35	PADZZ	81349	RCR07G2R7JS	RESISTOR, FIXED, COMP.....	1
36	PADZZ	81349	RCR07G220JS	RESISTOR, FIXED, COMP.....	1
37	PADZZ	81349	RCR07G511JS	RESISTOR, FIXED, COMP.....	2
38	PADZZ	81349	RCR20G391JS	RESISTOR, FIXED, COMP.....	1
39	PADZZ	81349	RCR07G393JS	RESISTOR, FIXED, COMP.....	1
40	PADZZ	81349	RCR07G513JS	RESISTOR, FIXED, COMP.....	1

SECTION II			TM11-5895-1303-24P			
(1)	(2)	(3)	(4)	(5)	(6)	
ITEM	SMR		PART			
NO	CODE	FSCM	NUMBER	DESCRIPTION AND USABLE ON CODES(UOC)	QTY	
41	PADZZ	96214	531932-2	MICROCIRCUIT, LINEAR.....	2	
42	PADZZ	81349	M38510/11001BCB	MICROCIRCUIT, LINEAR.....	2	
43	PADZZ	18324	SE529AF/883B	MICROCIRCUIT, LINEAR.....	1	
44	PADZZ	27014	MM54HC390J/883B	MICROCIRCUIT, DIGITA.....	1	
45	PADZZ	81349	JANTX1N757A1	SEMICONDUCTOR DEVIC.....	2	
46	PADZZ	81349	JANTX1N756A1	SEMICONDUCTOR DEVIC.....	2	
47	PADZZ	58997	T-334	OSCILLATOR, CRYSTAL.....	1	
48	PADZZ	56996	B4003358-4	INSULATOR, TRANSISTO.....	2	
49	XBDZZ	80063	A3034661	PIN, GUIDE.....	2	
50	PADZZ	81349	M38527/3-002N	MOUNTING, PADS, INSUL.....	6	

END OF FIGURE

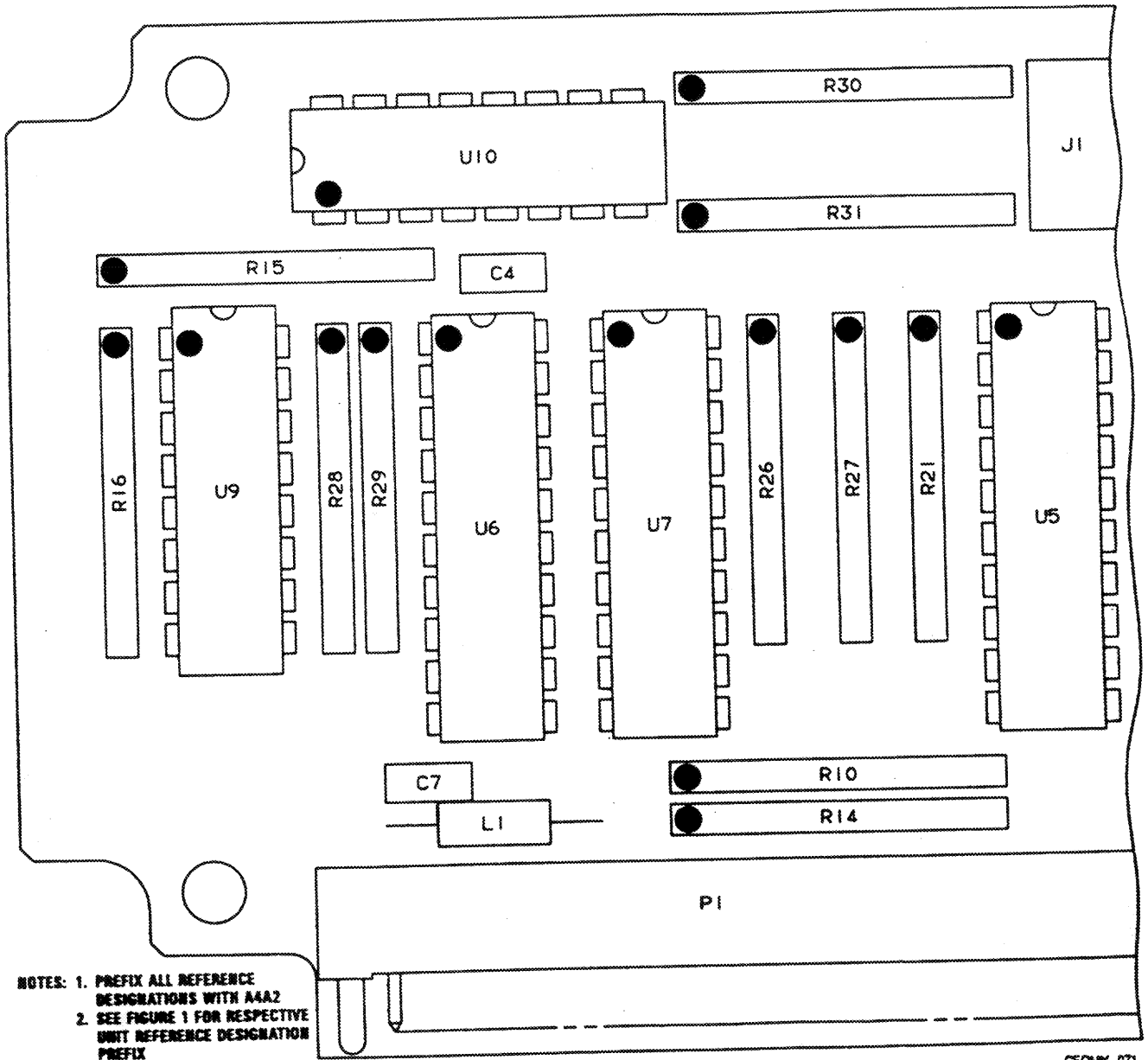
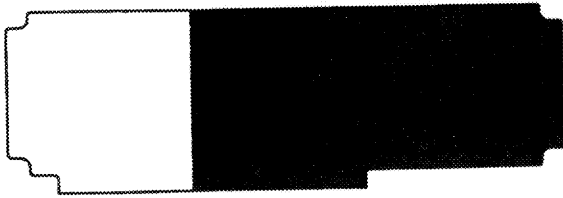
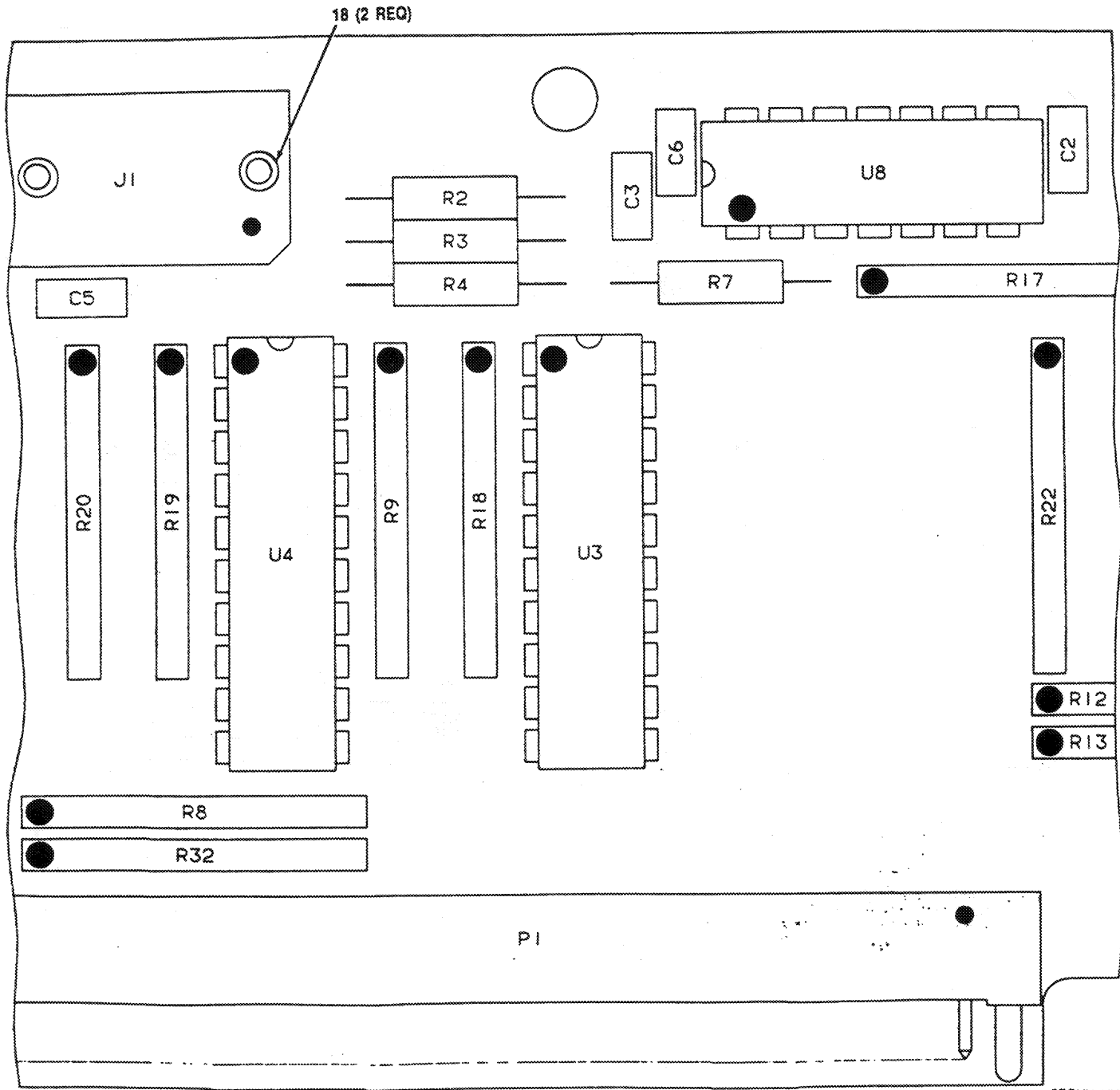
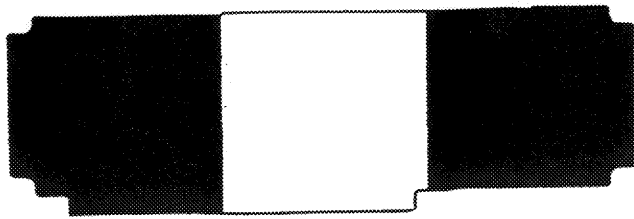

Figure 18. Status CCA A4A2 (A3024625) (Sheet 2 of 5)





CEOMY-072

Figure 18. Status CCA A4A2 (A3024625) (Sheet 3 of 5)

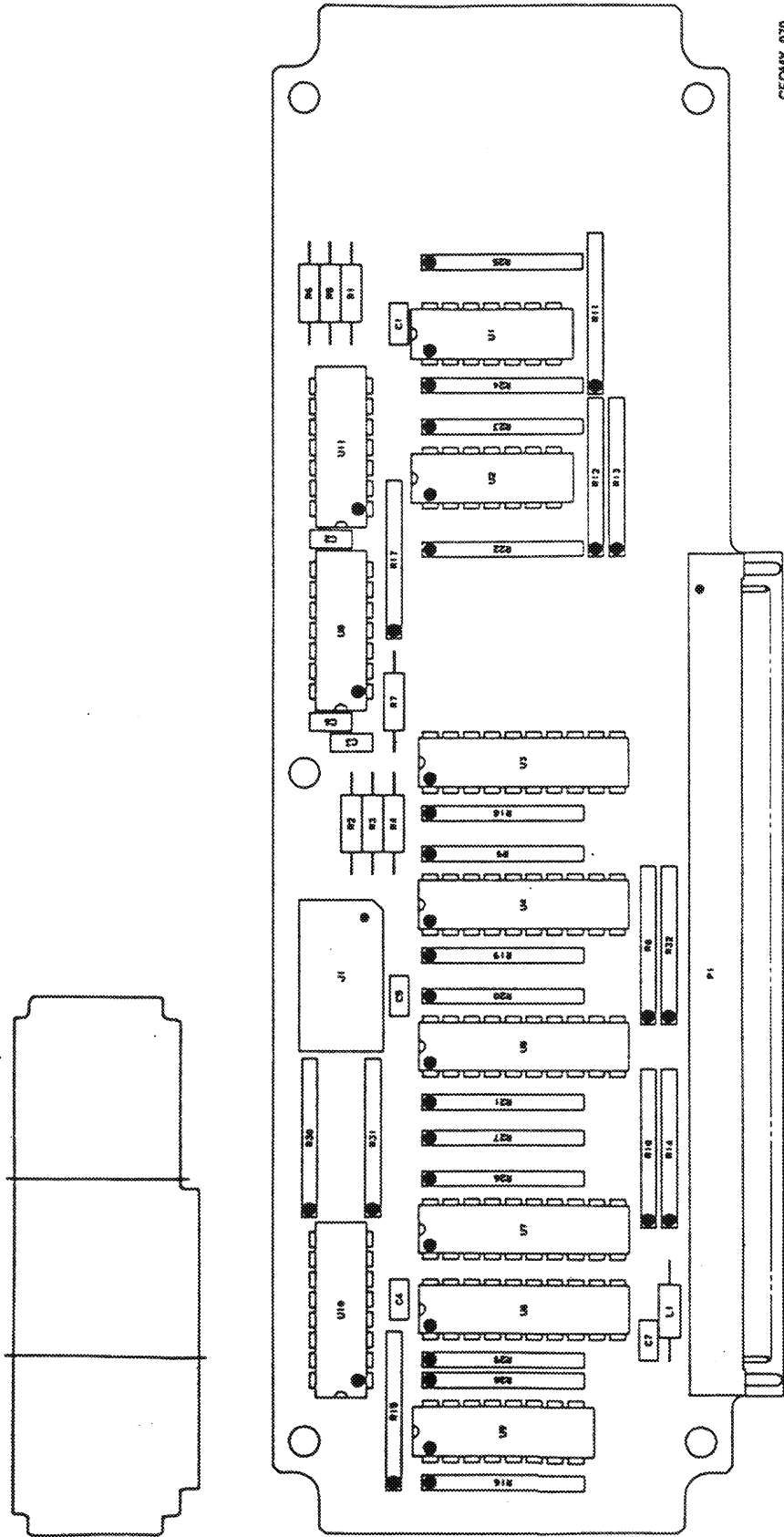

CEOMY-070

Figure 18. Status CCA A4A2 (A3024625) (Sheet 1 of 5)

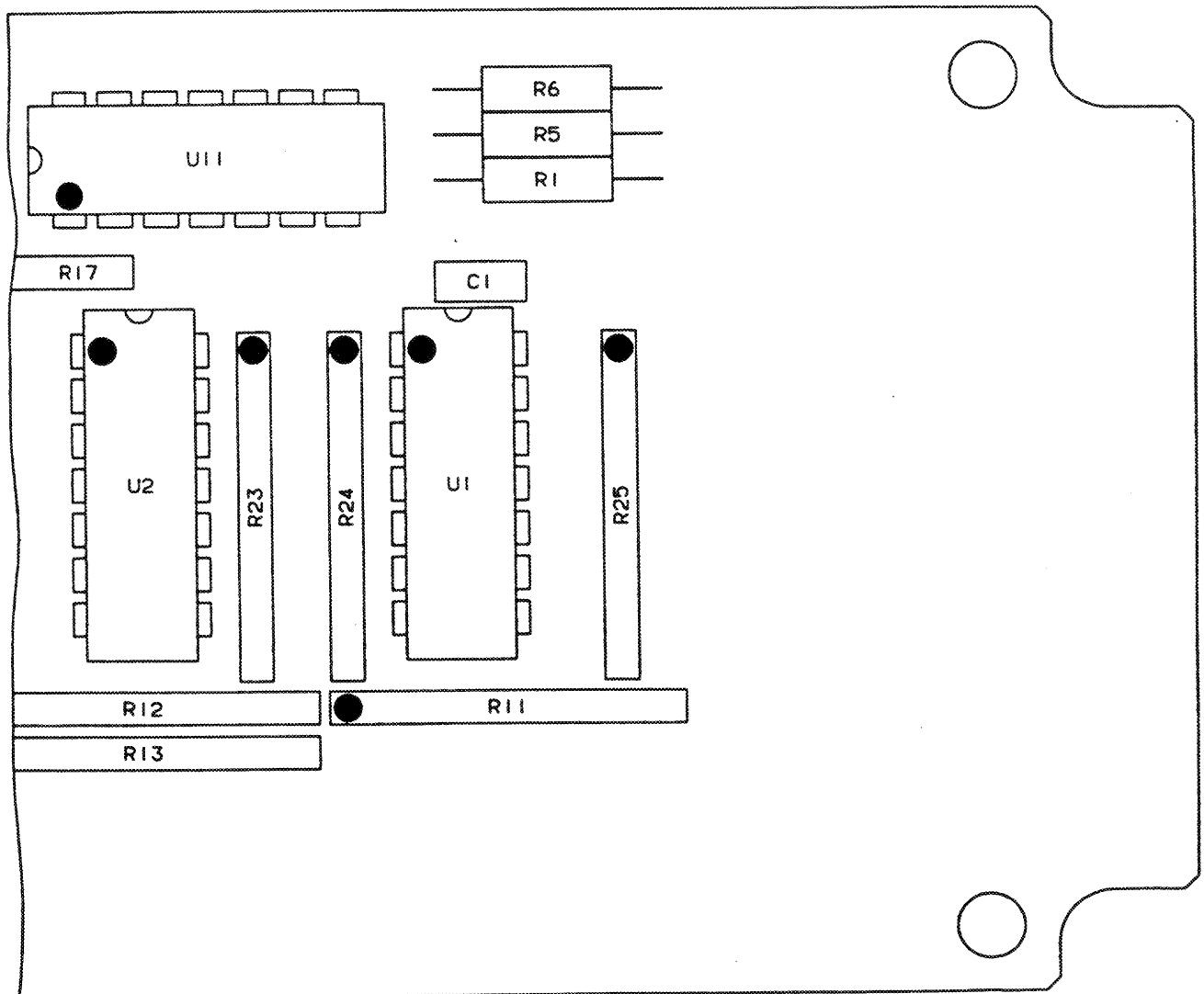

CEOMY-073

Figure 18. Status CCA A4A2 (A3024625) (Sheet 4 of 5)

LEGEND

REF. DES.	ITEM NO.	REF. DES.	ITEM NO.
C1	1	R18	9
C2	1	R19	9
C3	1	R20	9
C4	1	R21	9
C5	1	R22	9
C6	1	R23	9
C7	1	R24	9
J1	2	R25	9
L1	3	R26	9
P1	4	R27	9
R1	5	R28	11
R2	5	R29	11
R3	6	R30	11
R4	5	R31	11
R5	6	R32	8
R6	7	U1	12
R7	7	U2	12
R8	8	U3	13
R9	9	U4	13
R10	8	U5	13
R11	8	U6	14
R12	8	U7	14
R13	8	U8	15
R14	8	U9	16
R15	10	U10	16
R16	10	U11	17
R17	9		

CEOMY-074

SECTION II			TM11-5895-1303-24P	(5)	(6)
(1)	(2)	(3)	(4)		
ITEM	SMR		PART		
NO	CODE	FSCM	NUMBER	DESCRIPTION AND USABLE ON CODES(UOC)	QTY

GROUP 0402 STATUS CCA A4A2  
(A3024625)

FIG. 18

1	PADZZ	81349	M39014/01-1593	CAPACITOR, FIXED, CER.....	7
2	PADZZ	19112	102-14-CC-B	SOCKET, PLUG-IN ELEC.....	1
3	PADZZ	96906	MS75083-13	COIL, RADIO FREQUENC.....	1
4	PADZA	81349	M55302/4-06	CONNECTOR, RECEPTACL.....	1
5	PADZZ	81349	RCR07G104JS	RESISTOR, FIXED, COMP.....	3
6	PADZZ	81349	RCR07G514JS	RESISTOR, FIXED, COMP.....	2
7	PADZZ	81349	RCR07G102JS	RESISTOR, FIXED, COMP.....	2
8	PADZZ	81349	M8340108M5103JC	RESISTOR, NETWORK, FI.....	7
9	PADZZ	81349	M8340108K1001GG	RESISTOR, NETWORK, FI.....	12
10	PADZZ	81349	M8340108K1001GC	RESISTOR NETWORK, FI.....	2
11	PADZZ	81349	M8340108K1002GG	RESISTOR NETWORK, FI.....	4
12	PADZZ	14933	8404001CX	MICROCIRCUIT, DIGITA.....	2
13	PADZZ	27014	MM54HC373J/883B	MICROCIRCUIT, DIGITA.....	3
14	PADZA	27014	MM54HC374J/883B	MICROCIRCUIT, DIGITA.....	2
15	PADZA	27014	MM54HC4078J/883	MICROCIRCUIT, DIGITA.....	1
16	PADZZ	02735	803895-1	MICROCIRCUIT, LINEAR.....	2
17	PADZZ	14933	8404101CX	MICROCIRCUIT, DIGITA.....	1
18	XBDZZ	80063	A3034661	PIN, GUIDE.....	2

END OF FIGURE

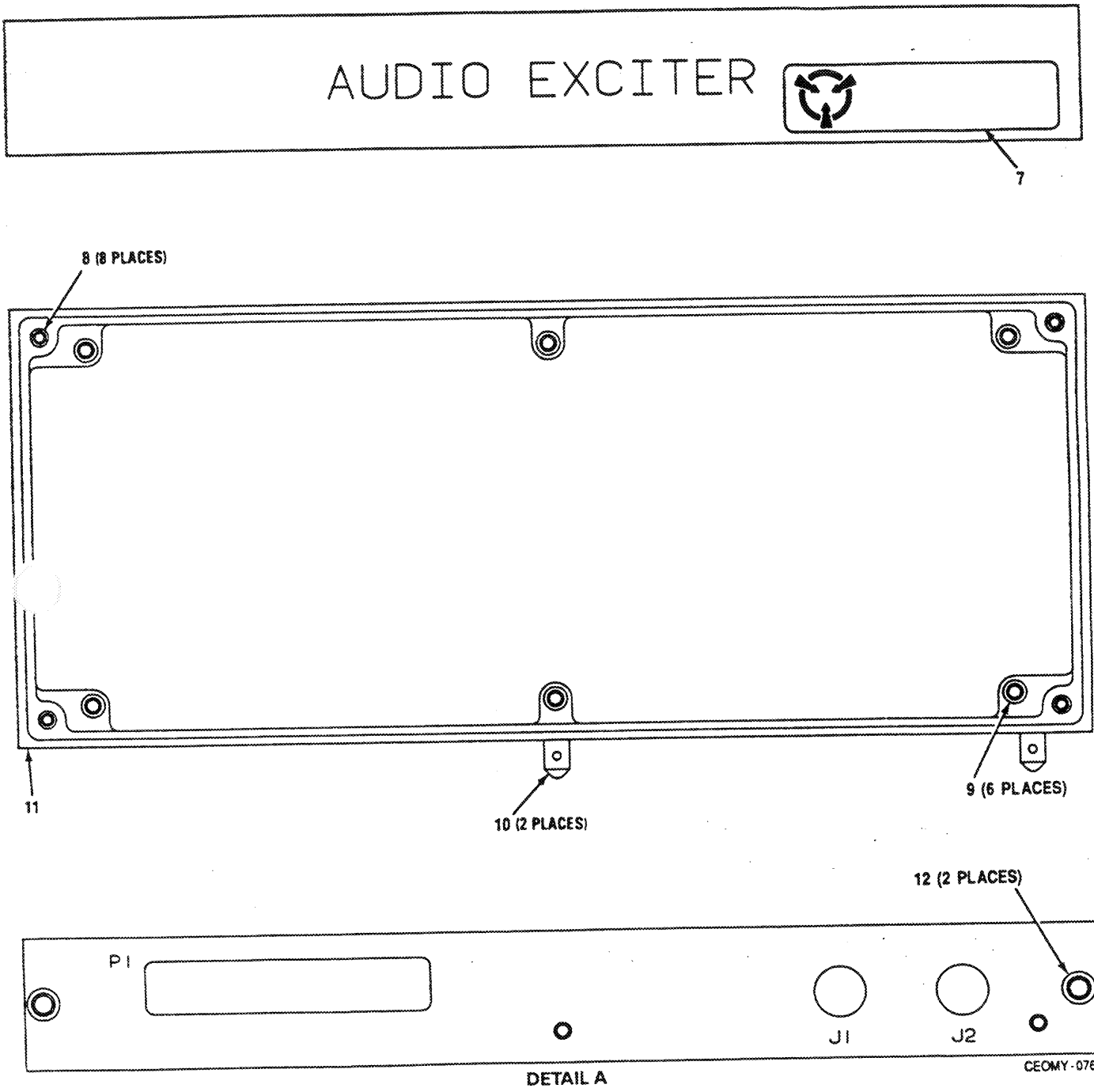
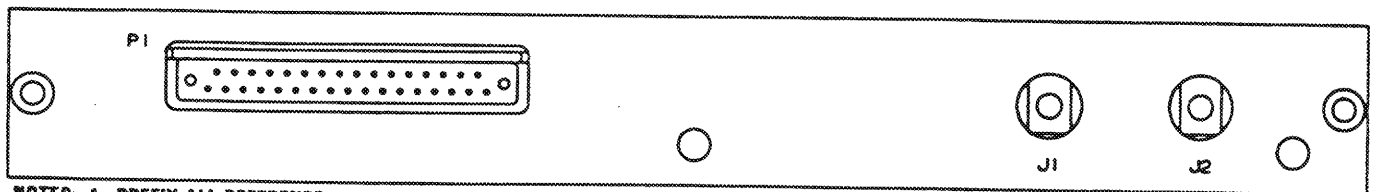
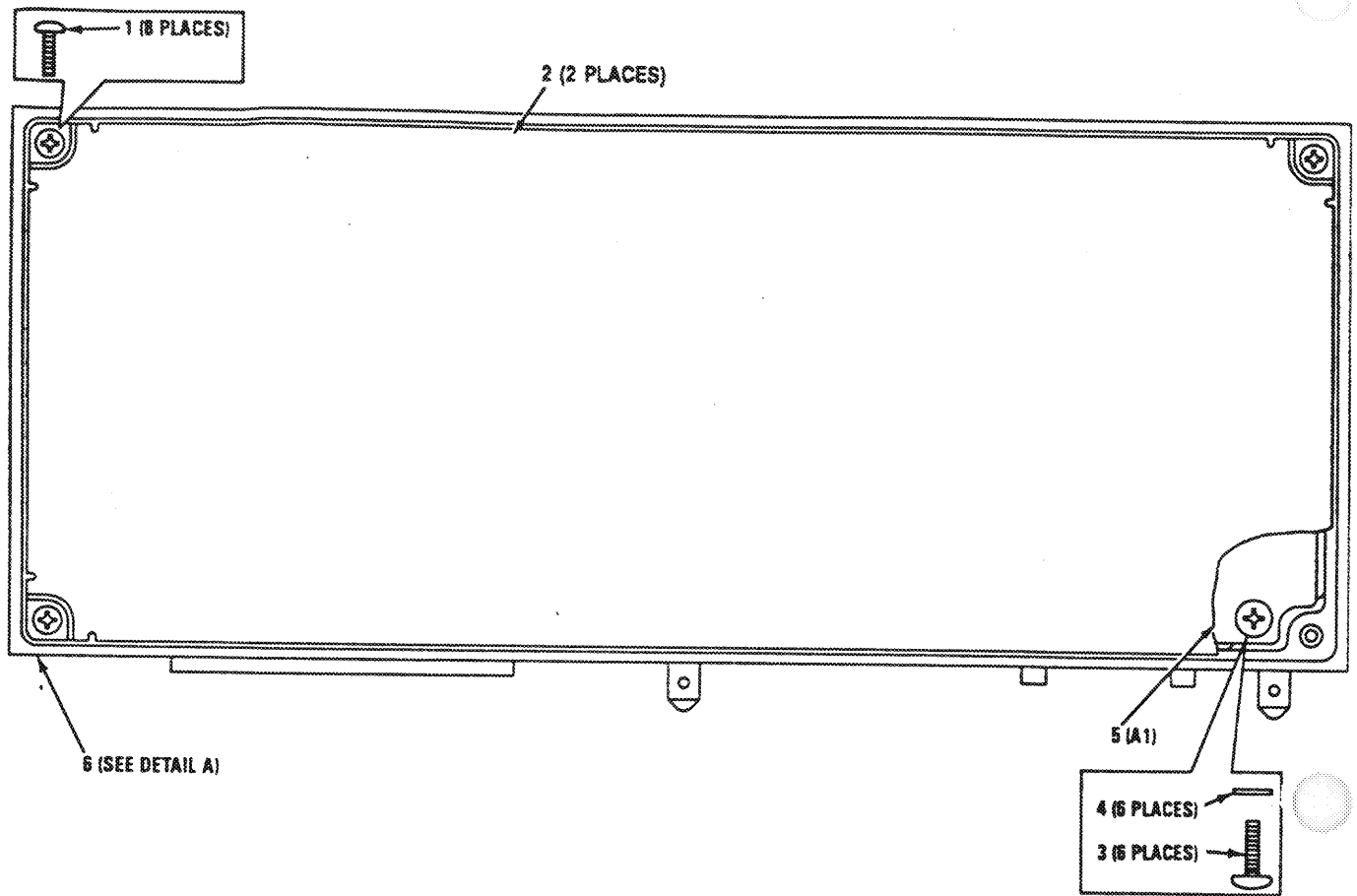

Figure 19. Audio Sideband Exciter Assembly A5 (A3024629) (Sheet 2 of 2)



NOTES: 1. PREFIX ALL REFERENCE DESIGNATIONS WITH A5  
2. SEE FIGURE 1 FOR RESPECTIVE UNIT REFERENCE DESIGNATION PREFIX

CEOMY-075

Figure 19. Audio Sideband Exciter Assembly A5 (A3024629) (Sheet 1 of 2)

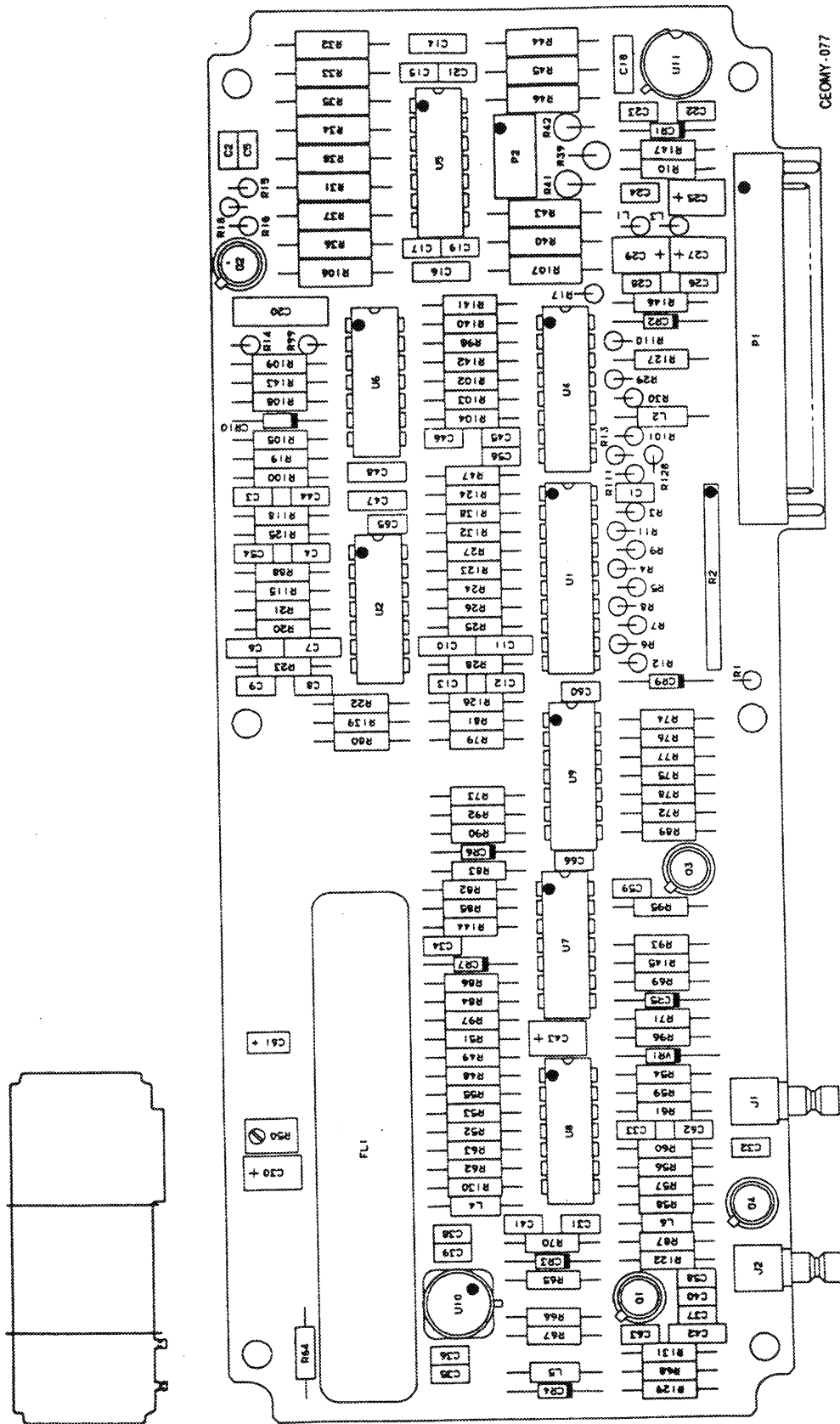

Figure 20. Audio Sideband Exciter CCA A5A1 (A3024630) (Sheet 1 of 5)



SECTION II			TM11-5895-1303-24P	(5)	(6)
(1)	(2)	(3)	(4)		
ITEM	SMR		PART		
NO	CODE	FSCM	NUMBER	DESCRIPTION AND USABLE ON CODES(UOC)	QTY

GROUP 05 AUDIO SIDEBAND EXCITER  
ASSEMBLY A5 (A3024629)

FIG. 19

1	PAHZZ	96906	MS51957-2	SCREW, MACHINE.....	8
2	XBHZZ	80063	A3028053	COVER, MODULE.....	2
3	PAHZZ	96906	MS51957-13	SCREW, MACHINE.....	6
4	PAHZZ	80205	NAS620C4	WASHER, FLAT.....	6
5	PAHLD	80063	A3024630	CIRCUIT CARD ASSEMB (SEE FIG. 20 FOR BREAKDOWN).....	1
6	XBHLL	80063	A3028602	MODULE FRAME ASSEMB.....	1
7	XBHZZ	80063	A3034572	LABEL, SENSITIVE.....	1
8	PAHZZ	26344	3585-02CNW0129	INSERT, SCREW THREAD.....	8
9	PAHZZ	96906	MS21209C0415L	INSERT, SCREW THREAD.....	6
10	XBHZZ	80063	A3028102	PIN, GUIDE--MODULE.....	2
11	XBHZZ	80063	A3028603	FRAME, MODULE--AUDIO.....	1
12	PAHZZ	96906	MS21209C0815L	INSERT, SCREW THREAD.....	2

END OF FIGURE

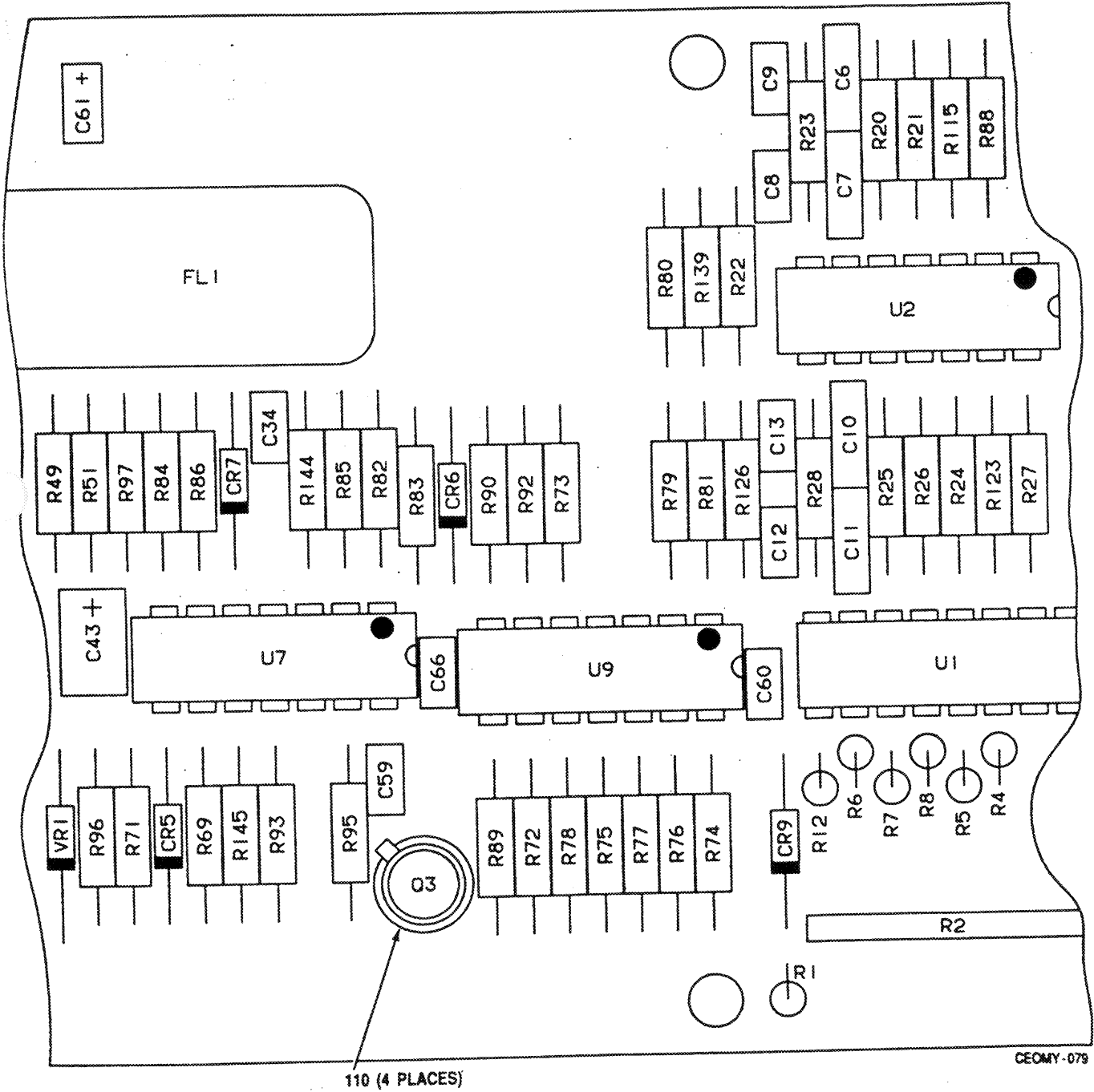
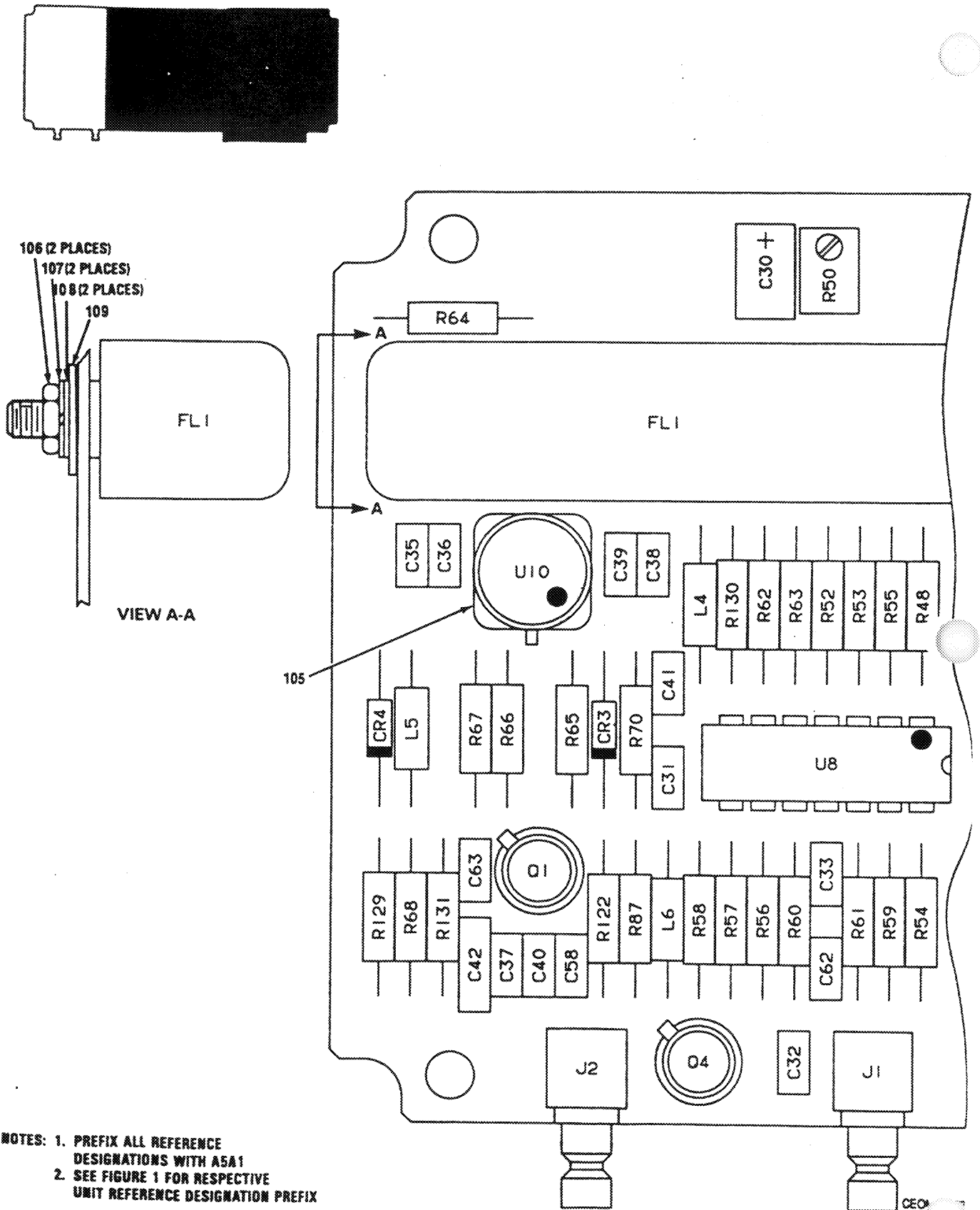

Figure 20. Audio Sideband Exciter CCA A5A1 (A3024630) (Sheet 3 of 5)



NOTES: 1. PREFIX ALL REFERENCE DESIGNATIONS WITH A5A1  
 2. SEE FIGURE 1 FOR RESPECTIVE UNIT REFERENCE DESIGNATION PREFIX

Figure 20. Audio Sideband Exciter CCA A5A1 (A3024630) (Sheet 2 of 5)

LEGEND

REF. DES.	ITEM NO.	REF. DES.	ITEM NO.	REF. DES.	ITEM NO.	REF. DES.	ITEM NO.	REF. DES.	ITEM NO.	REF. DES.	ITEM NO.
CR1	1	C38	11	R11	26	R41*	53	R72	72	R107	91
CR2	1	C39	11	R12	26	R41*	54	R73	32	R108	77
CR3	1	C40	11	R13*	28	R41*	55	R74	26	R109	75
CR4	1	C41	11	R13*	29	R41*	56	R75	26	R110	77
CR5	1	C42	2	R13*	30	R41*	57	R76	26	R111	75
CR6	1	C44	2	R13*	31	R41*	58	R77	24	R115	32
CR9	1	C45	11	R14	26	R42	59	R78	26	R118	92
CR10	1	C46	2	R15	28	R43	55	R79	32	R122	93
C1	2	C47	5	R16	28	R44	55	R80	32	R123	83
C2	2	C48	5	R17	32	R45*	49	R81	72	R124	83
C3	2	C54	2	R18	32	R45*	56	R84	73	R125	92
C4	2	C56	15	R19	29	R45*	57	R85	74	R126	94
C5	3	C58	11	R20	29	R45*	58	R86	73	R127	26
C6	4	C59	2	R21	29	R45*	55	R87	75	R128	94
C7	4	C60	2	R22	29	R46	60	R88	32	R129	67
C8	3	C61	16	R23	33	R47*	28	R89	76	R130	68
C9	3	C62	11	R24	29	R47*	29	R90	77	R131	94
C10	4	C63	11	R25	29	R47*	30	R92	26	R132	70
C11	4	C65	15	R26	29	R47*	31	R93	75	R138	35
C12	3	C66	15	R27	29	R47*	61	R95	61	R139	35
C13	3	FL1	17	R28	33	R47*	62	R96	26	R140	35
C14	5	J1	18	R29	34	R48	63	R97*	26	R141	35
C15	6	J2	18	R30	35	R49	32	R97*	65	R142	35
C16	5	L1	19	R31	36	R50	64	R97*	78	R143	35
C17	7	L2	19	R32	36	R51	65	R97*	79	R144	35
C18	5	L3	19	R33	37	R52	32	R97*	80	R145	35
C19	8	L4	20	R34	38	R53	63	R97*	81	R146	35
C20	9	L5	20	R35	39	R54	35	R97*	82	R147	95
C21	10	L6	20	R36	39	R55	66	R98	83	U1	96
C22	11	P1	21	R37*	36	R56	63	R99	84	U2	97
C23	11	P2	22	R37*	40	R57	26	R100*	24	U4	98
C24	11	Q1	23	R37*	41	R58	26	R100*	48	U5	97
C25	12	Q2	23	R37*	42	R59	67	R100*	85	U6	99
C26	11	Q3	23	R37*	43	R60	63	R100*	86	U7	97
C27	12	Q4	23	R37*	44	R61	67	R101*	28	U8	100
C28	11	R1	24	R37*	45	R62	67	R101*	29	U9	101
C29	12	R2	25	R37*	46	R63	68	R101*	30	U10	102
C30	13	R3	26	R37*	47	R64	69	R101*	31	U11	103
C31	11	R4	26	R37*	48	R65	70	R102*	87	VR1	104
C32	11	R5	26	R38	49	R66	70	R102*	88		
C33	11	R6	26	R39	50	R67	63	R102*	89		
C34	11	R7	26	R40	50	R68	26	R103	90		
C35	14	R8	26	R41*	49	R69	71	R104	48		
C36	11	R9	26	R41*	51	R70	70	R105	62		
C37	11	R10	27	R41*	52	R71	29	R106	91		

CEOMY-081

\* Select At Test

Figure 20. Audio Sideband Exciter CCA A5A1 (A3024630) (Sheet 5 of 5)

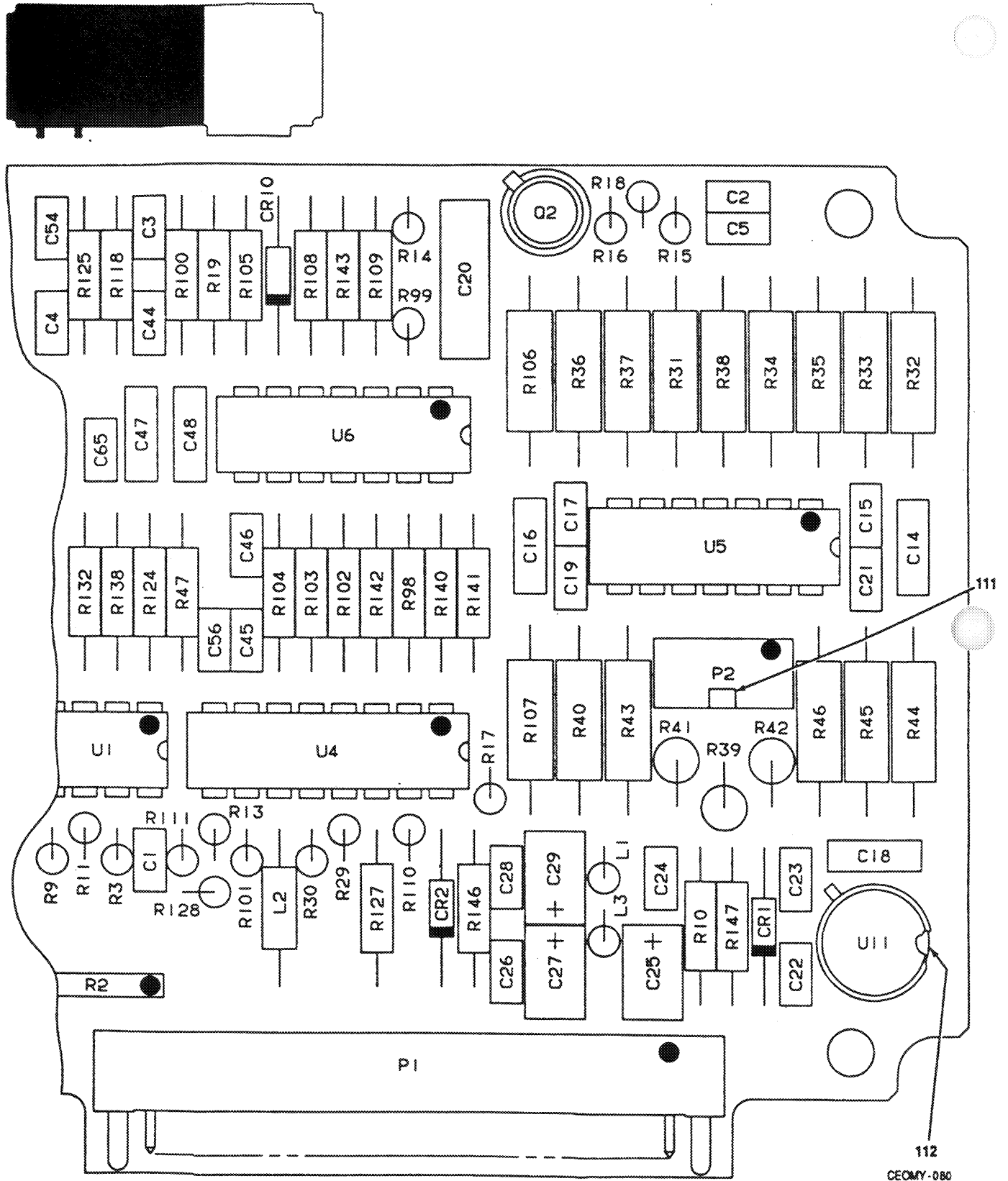

Figure 20. Audio Sideband Exciter CCA A5A1 (A3024630) (Sheet 4 of 5)

112  
CEOMY-086

SECTION II  
 (1) (2) (3)  
 ITEM SMR  
 NO CODE FSCM

TM11-5895-1303-24P  
 (4)  
 PART  
 NUMBER

(5) (6)  
 DESCRIPTION AND USABLE DN CODES(UOC) QTY  
 GROUP 0501 AUDIO SIDEBAND EXCITER  
 CCA A5A1 (A3024630)

FIG. 20

ITEM NO	SMR CODE	FSCM	PART NUMBER	DESCRIPTION AND USABLE DN CODES(UOC)	QTY
1	PAHZZ	81349	JANTX1N4454-1	SEMICONDUCTOR DEVIC.....	8
2	PAHZZ	81349	M39014-01-1575	CAPACITOR, FIXED, CER.....	10
3	PAHZZ	81349	M39014/01-1357	CAPACITOR, FIXED, CER.....	5
4	PAHZZ	81349	M39014/02-1360	CAPACITOR, FIXED, CER.....	4
5	PAHZZ	81349	CCR06CG123GS	CAPACITOR, FIXED, CER.....	5
6	PAHZZ	81349	CCR09CG222JP	CAPACITOR, FIXED, CER.....	1
7	PAHZZ	81349	CCR09CG561JP	CAPACITOR, FIXED, CER.....	1
8	PAHZZ	81349	CCR09CG121JP	CAPACITOR, FIXED, CER.....	1
9	PAHZZ	81349	CCR07CG333JP	CAPACITOR, FIXED, CER.....	1
10	PAHZZ	81349	CCR09CG270JP	CAPACITOR, FIXED, CER.....	19
11	PAHZZ	81349	M39014/01-1593	CAPACITOR, FIXED, CER.....	3
12	PAHZZ	56996	B4003327-3289	CAPACITOR, FIXED, ELE.....	1
13	PAHZZ	56996	B4003327-3345	CAPACITOR, FIXED, ELE.....	1
14	PAHZZ	81349	CCR09CG620JP	CAPACITOR, FIXED, CER.....	1
15	PAHZZ	81349	M39014/01-1259	CAPACITOR, FIXED, CER.....	3
16	PAHZZ	56996	B4003328-3442	CAPACITOR, FIXED, ELE.....	1
17	PAHZZ	80063	A3023936-1	FILTER, BAND PASS.....	1
18	PAHZZ	19505	2010-6511-002	CONNECTOR, RECEPTAC.....	2
19	PAHZZ	96906	MS75084-16	COIL, RADIO FREQUENC.....	3
20	PAHZZ	96906	MS75085-7	COIL, RADIO FREQUENC.....	3
21	PAHZZ	81349	M55302/4-04	CONNECTOR, RECEPTAC.....	1
22	PAHZZ	00779	87518-9	CONNECTOR, RECEPTAC.....	1
23	PAHZZ	81349	JANTX2N2222A	TRANSISTOR.....	4
24	PAHZZ	81349	RCR07G513JS	RESISTOR, FIXED, COMP (SELECT AT TEST R100).....	3
25	PAHZZ	81349	M8340109M5103JC	RESISTOR NETWORK, FI.....	1
26	PAHZZ	81349	RCR07G102JS	RESISTOR, FIXED, COMP (SELECT AT TEST R97).....	21
27	PAHZZ	81349	RNC55H2320FS	RESISTOR, FIXED, FILM.....	1
28	PAHZZ	81349	RCR07G223JS	RESISTOR, FIXED, COMP (SELECT AT TEST R13,47,101).....	5
29	PAHZZ	81349	RNC55H2002FS	RESISTOR, FIXED, FILM (SELECT AT TEST R13,A7,101).....	12
30	PAHZZ	81349	RCR07G183JS	RESISTOR, FIXED, COMP (SELECT AT TEST).....	3
31	PAHZZ	81349	RNC55H2102FS	RESISTOR, FIXED, FILM (SELECT AT TEST).....	3
32	PAHZZ	81349	RCR07G103JS	RESISTOR, FIXED, COMP.....	9
33	PAHZZ	81349	RCR07G151JS	RESISTOR, FIXED, COMP.....	2
34	PAHZZ	81349	RCR07G224JS	RESISTOR, FIXED, COMP.....	1
35	PAHZZ	81349	RCR07G240JS	RESISTOR, FIXED, COMP.....	11
36	PAHZZ	81349	RNC55H3482FS	RESISTOR, FIXED, FILM (SELECT AT TEST R37).....	3
37	PAHZZ	81349	RNC55H5492FS	RESISTOR, FIXED, FILM.....	1
38	PAHZZ	81349	RNC55H7152FS	RESISTOR, FIXED, FILM.....	1
39	PAHZZ	81349	RNC55H5362FS	RESISTOR, FIXED, FILM.....	2

SECTION II			TM11-5895-1303-24P			
(1)	(2)	(3)	(4)	(5)	(6)	
ITEM NO	SMR CODE	FSCM	PART NUMBER	DESCRIPTION AND USABLE ON CODES(UOC)	QTY	
40	PAHZZ	81349	RNC55H3572FS	RESISTOR, FIXED, FILM (SELECT AT TEST).....	1	
41	PAHZZ	81349	RNC55H3652FS	RESISTOR, FIXED, FILM (SELECT AT TEST).....	1	
42	PAHZZ	81349	RNC55H3742FS	RESISTOR, FIXED, FILM (SELECT AT TEST).....	1	
43	PAHZZ	81349	RNC55H3832FS	RESISTOR, FIXED, FILM (SELECT AT TEST).....	1	
44	PAHZZ	81349	RNC55H4022FS	RESISTOR, FIXED, FILM (SELECT AT TEST).....	1	
45	PAHZZ	81349	RNC55H4122FS	RESISTOR, FIXED, FILM (SELECT AT TEST).....	1	
46	PAHZZ	81349	RNC55H4222FS	RESISTOR, FIXED, FILM (SELECT AT TEST).....	1	
47	PAHZZ	81349	RNC55H4322FS	RESISTOR, FIXED, FILM (SELECT AT TEST).....	1	
48	PAHZZ	81349	RNC55H3922FS	RESISTOR, FIXED, FILM (SELECT AT TEST R37, 100).....	3	
49	PAHZZ	81349	RNC55H6342FS	RESISTOR, FIXED, FILM (SELECT AT TEST R41, 45).....	3	
50	PAHZZ	81349	RNC55H7682FS	RESISTOR, FIXED, FILM.....	2	
51	PAHZZ	81349	RNC55H5762FS	RESISTOR, FIXED, FILM (SELECT AT TEST).....	1	
52	PAHZZ	81349	RNC55H5902FS	RESISTOR, FIXED, FILM (SELECT AT TEST).....	1	
53	PAHZZ	81349	RNC55H6042FS	RESISTOR, FIXED, FILM (SELECT AT TEST).....	1	
54	PAHZZ	81349	RNC55H6192FS	RESISTOR, FIXED, FILM (SELECT AT TEST).....	1	
55	PAHZZ	81349	RNC55H6652FS	RESISTOR, FIXED, FILM (SELECT AT TEST R41, 45).....	4	
56	PAHZZ	81349	RNC55H6492FS	RESISTOR, FIXED, FILM (SELECT AT TEST).....	2	
57	PAHZZ	81349	RNC55H6812FS	RESISTOR, FIXED, FILM (SELECT AT TEST).....	2	
58	PAHZZ	81349	RNC55H6982FS	RESISTOR, FIXED, FILM (SELECT AT TEST).....	2	
59	PAHZZ	81349	RNC55H9532FS	RESISTOR, FIXED, FILM.....	1	
60	PAHZZ	81349	RNC55H1023FS	RESISTOR, FIXED, FILM.....	1	
61	PAHZZ	81349	RCR07G163JS	RESISTOR, FIXED, COMP (SELECT AT TEST R47).....	2	
62	PAHZZ	81349	RNC55H1502FS	RESISTOR, FIXED, FILM (SELECT AT TEST R47).....	2	
63	PAHZZ	81349	RCR07G510JS	RESISTOR, FIXED, COMP.....	5	
64	PAHZZ	81349	RJR26FW503R	RESISTOR, VARIABLE, W.....	1	
65	PAHZZ	81349	RCR07G681JS	RESISTOR, FIXED, COMP (SELECT AT TEST R97).....	2	
66	PAHZZ	81349	RCR07G511JS	RESISTOR, FIXED, COMP.....	1	
67	PAHZZ	81349	RCR07G202JS	RESISTOR, FIXED, COMP.....	4	
68	PAHZZ	81349	RCR07G682JS	RESISTOR, FIXED, COMP.....	2	
69	PAHZZ	81349	RCR07G822JS	RESISTOR, FIXED, COMP.....	1	
70	PAHZZ	81349	RCR07G242JS	RESISTOR, FIXED, COMP.....	4	

SECTION II			TM11-5895-1303-24P			
(1)	(2)	(3)	(4)	(5)	(6)	
ITEM	SMR		PART			
NO	CODE	F5CM	NUMBER	DESCRIPTION AND USABLE ON CODES(UOC)	QTY	
71	PAHZZ	81349	RNC55H1001FS	RESISTOR, FIXED, FILM.....	1	
72	PAHZZ	81349	RCR07G113JS	RESISTOR, FIXED, COMP.....	1	
73	PAHZZ	81349	RCR07G104JS	RESISTOR, FIXED, COMP.....	1	
74	PAHZZ	81349	RCR07G512JS	RESISTOR, FIXED, COMP.....	1	
75	PAHZZ	81349	RCR07G302JS	RESISTOR, FIXED, COMP.....	4	
76	PAHZZ	81349	RCR07G472JS	RESISTOR, FIXED, COMP.....	1	
77	PAHZZ	81349	RCR07G333JS	RESISTOR, FIXED, COMP.....	3	
78	PAHZZ	81349	RCR07G561JS	RESISTOR, FIXED, COMP (SELECT AT TEST).....	1	
79	PAHZZ	81349	RCR07G621JS	RESISTOR, FIXED, COMP (SELECT AT TEST).....	1	
80	PAHZZ	81349	RCR07G751JS	RESISTOR, FIXED, COMP (SELECT AT TEST).....	1	
81	PAHZZ	81349	RCR07G821JS	RESISTOR, FIXED, COMP (SELECT AT TEST).....	1	
82	PAHZZ	81349	RCR07G911JS	RESISTOR, FIXED, COMP (SELECT AT TEST).....	1	
83	PAHZZ	81349	RNC55H4751FS	RESISTOR, FIXED, FILM.....	3	
84	PAHZZ	81349	RCR07G332JS	RESISTOR, FIXED, COMP.....	1	
85	PAHZZ	81349	RCR07G433JS	RESISTOR, FIXED, COMP (SELECT AT TEST).....	1	
86	PAHZZ	81349	RCR07G473JS	RESISTOR, FIXED, COMP (SELECT AT TEST).....	1	
87	PAHZZ	81349	RCR07G273JS	RESISTOR, FIXED, COMP (SELECT AT TEST).....	1	
88	PAHZZ	81349	RNC55H3012FS	RESISTOR, FIXED, FILM (SELECT AT TEST).....	1	
89	PAHZZ	81349	RNC55H3322FS	RESISTOR, FIXED, FILM (SELECT AT TEST).....	1	
90	PAHZZ	81349	RNC55H1003FS	RESISTOR, FIXED, FILM.....	1	
91	PAHZZ	81349	RNC55H1472FS	RESISTOR, FIXED, FILM.....	2	
92	PAHZZ	81349	RCR07G823JS	RESISTOR, FIXED, COMP.....	2	
93	PAHZZ	81349	RCR07G222JS	RESISTOR, FIXED, COMP.....	1	
94	PAHZZ	81349	RCR07G100JS	RESISTOR, FIXED, COMP.....	3	
95	PAHZZ	81349	RNC55H1301FS	RESISTOR, FIXED, FILM.....	1	
96	PAHZA	27014	MM54HC374J/883B	MICROCIRCUIT, DIGITA.....	1	
97	PAHZZ	81349	M38510/11001BCB	MICROCIRCUIT, LINEAR.....	1	
98	PAHZZ	81349	JM38510/12302BEX	MICROCIRCUIT, LINEAR.....	1	
99	PAHZZ	81349	M38510-10102BCB	MICROCIRCUIT, LINEAR.....	1	
100	PAHZZ	04713	1596/BCBJC	MICROCIRCUIT, LINEAR.....	1	
101	PAHZZ	81349	M38510/17001BCB	MICROCIRCUIT, DIGITA.....	1	
102	PAHZZ	52648	SL612CB/CM	MICROCIRCUIT, LINEAR.....	1	
103	PAHZZ	81349	M38510/11703BXC	MICROCIRCUIT, LINEAR.....	1	
104	PAHZZ	81349	JANTX1N752A-1	SEMICONDUCTOR DEVIC.....	1	
105	PAHZZ	56996	B4003337-1	INSULATOR, INTEGRATE.....	1	
106	PAHZZ	80205	NAS671C4	NUT, PLAIN, HEXAGON.....	2	
107	PAHZZ	96906	MS35338-135	WASHER, LOCK.....	2	
108	PAHZZ	80205	NAS620C4	WASHER, FLAT.....	2	
109	PAHZZ	80063	A3079142	TERMINAL, LUG.....	1	
110	PAHZZ	81349	M38527/03-008N	MOUNTING, PAD ELECTR.....	4	
111	PAHZZ	81349	M55302/127-00KY	POLARIZING KEY, ELEC.....	1	
112	PAHZZ	81349	M38527/02-018D	MOUNTING PAD, ELECTR.....	1	

END OF FIGURE



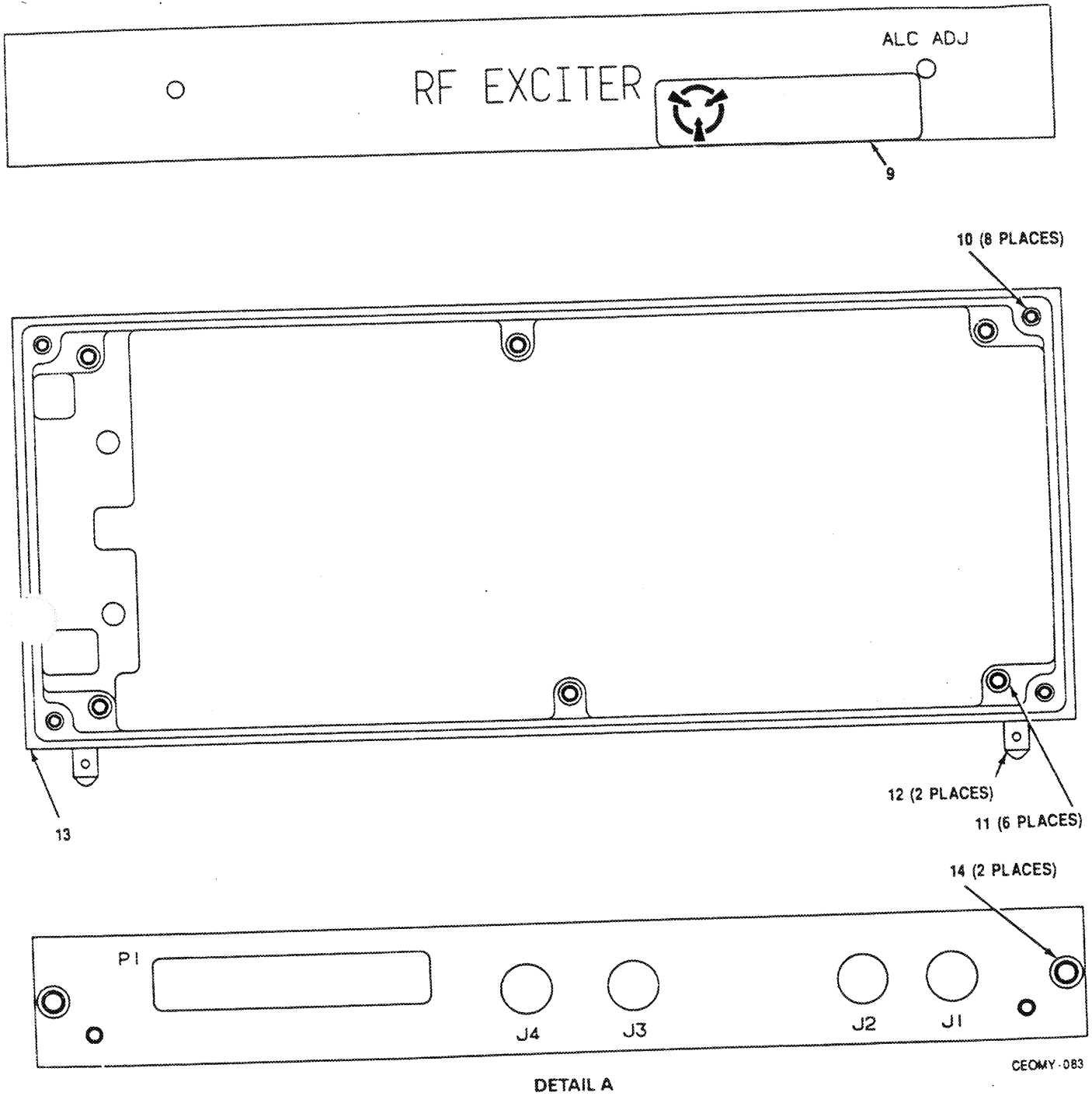
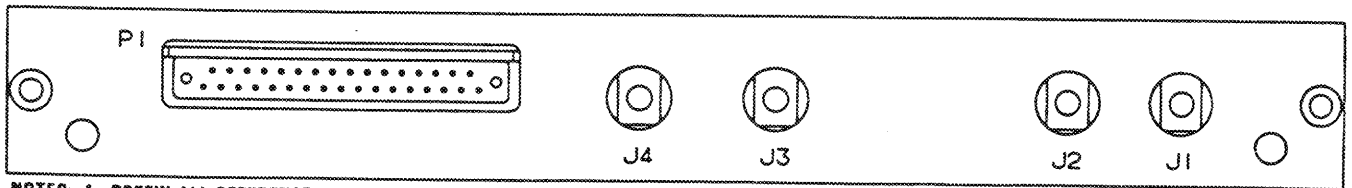
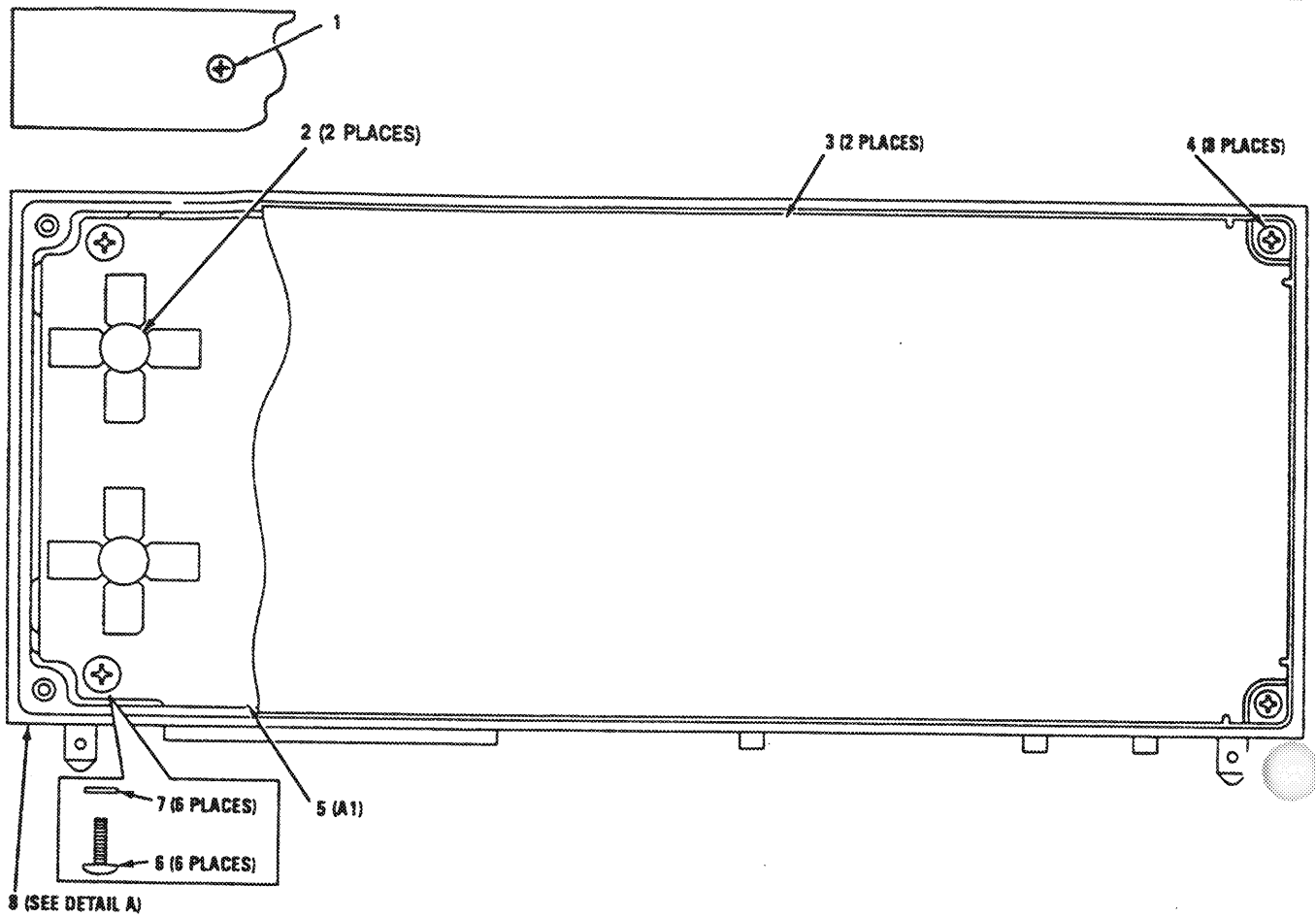

Figure 21. RF Amp Exciter Assembly A6 (A3024634) (Sheet 2 of 2)



NOTES: 1. PREFIX ALL REFERENCE DESIGNATIONS WITH A6  
2. SEE FIGURE 1 FOR RESPECTIVE UNIT REFERENCE DESIGNATION PREFIX

CEOMY-082

Figure 21. RF Amp Exciter Assembly A6 (A3024634) (Sheet 1 of 2)

SECTION II			TM11-5895-1303-24P		
(1)	(2)	(3)	(4)	(5)	(6)
ITEM	SMR		PART		
NO	CODE	FSCM	NUMBER	DESCRIPTION AND USABLE ON CODES(UOC)	QTY

GROUP 06 RF AMP EXCITER ASSEMBLY  
A6 (A3024634)

FIG. 21

1	PAHZZ	96906	MS24693C2	SCREW,MACHINE.....	1
2	PAHZZ	80205	NAS671C8	NUT,PLAIN,HEXAGON.....	2
3	XBHZZ	80063	A3028053	COVER,MODULE.....	2
4	PAHZZ	96906	MS51957-2	SCREW,MACHINE.....	8
5	PAHLD	80063	A3024635	CIRCUIT CARD ASSEMB (SEE FIG. 22	1
				FOR BREAKDOWN).....	
6	PAHZZ	96906	MS51957-13	SCREW,MACHINE.....	6
7	PAHZZ	80205	NAS620C4	WASHER,FLAT.....	6
8	XBHLL	80063	A3028613	MODULE FRAME ASSEMB.....	1
9	XBDZZ	80063	A3034572	LABEL,SENSITIVE.....	1
10	PAHZZ	26344	3585-02CNW0129	INSERT,SCREW THREAD.....	8
11	PAHZZ	96906	MS21209C0415L	INSERT,SCREW THREAD.....	6
12	XBHZZ	80063	A3028102	PIN,GUIDE--MODULE.....	2
13	XBHZZ	80063	A3028614	FRAME,MODULE--RF EX.....	1
14	PAHZZ	96906	MS21209C0815L	INSERT,SCREW THREAD.....	2

END OF FIGURE

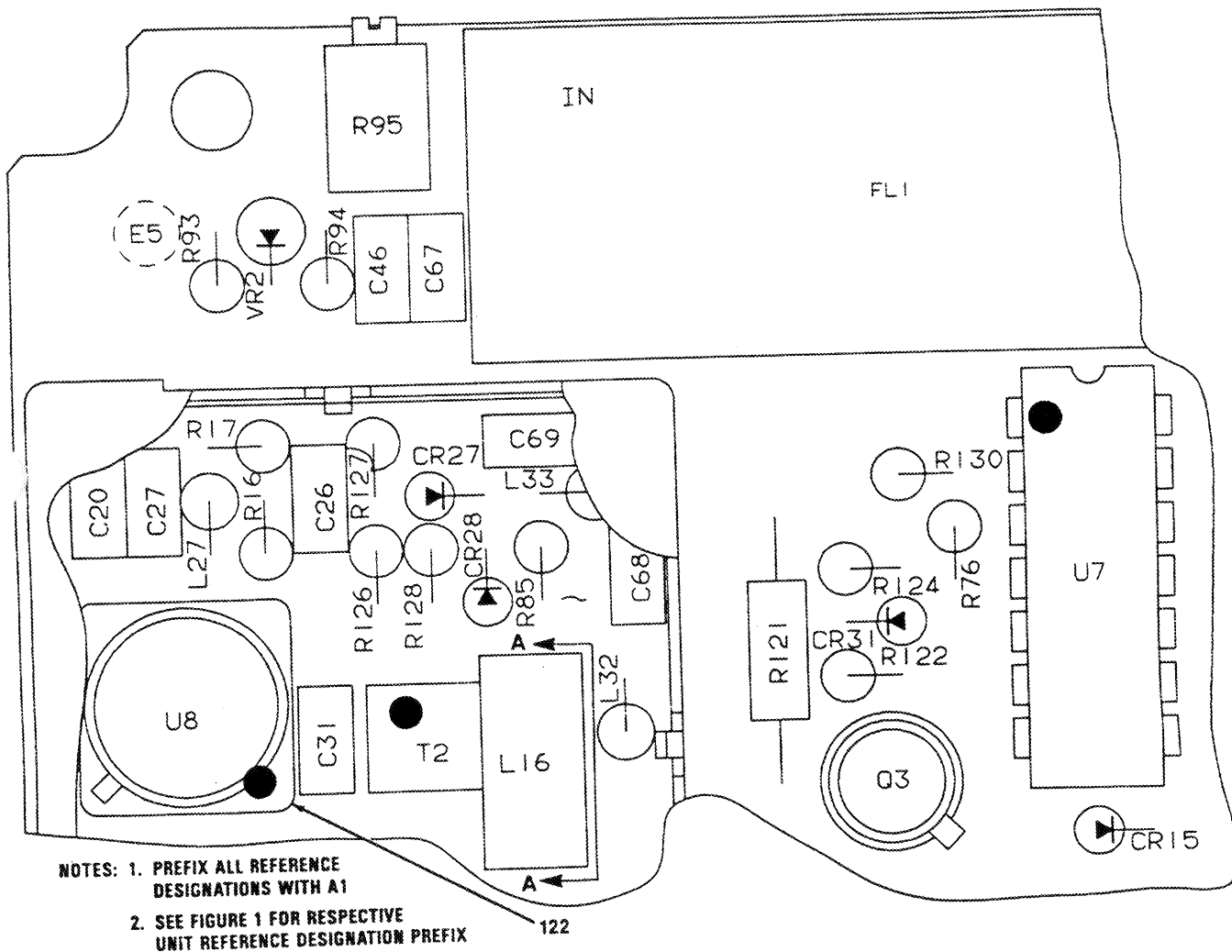
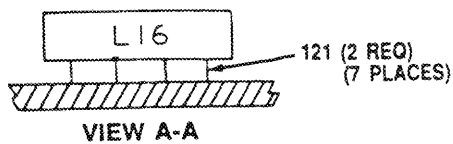
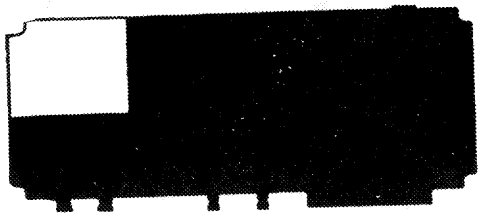

- NOTES: 1. PREFIX ALL REFERENCE DESIGNATIONS WITH A1  
2. SEE FIGURE 1 FOR RESPECTIVE UNIT REFERENCE DESIGNATION PREFIX

CEOMY-085

Figure 22. RF Amp Exciter CCA A6A1 (A3024635) (Sheet 2 of 10)

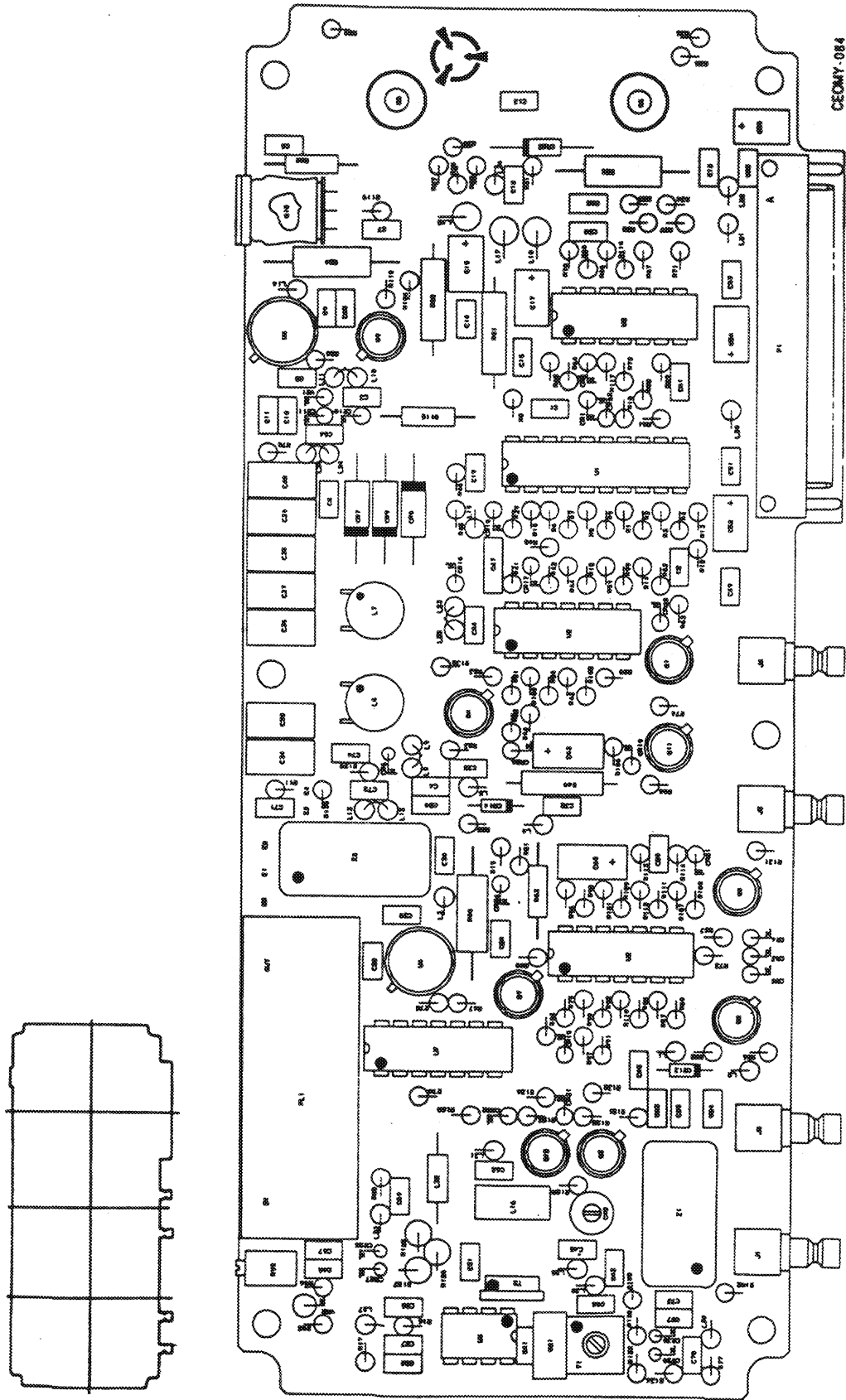

Figure 22. RF Amp Exciter CC-6A1 (A3074635) (Sheet 1 of 10)

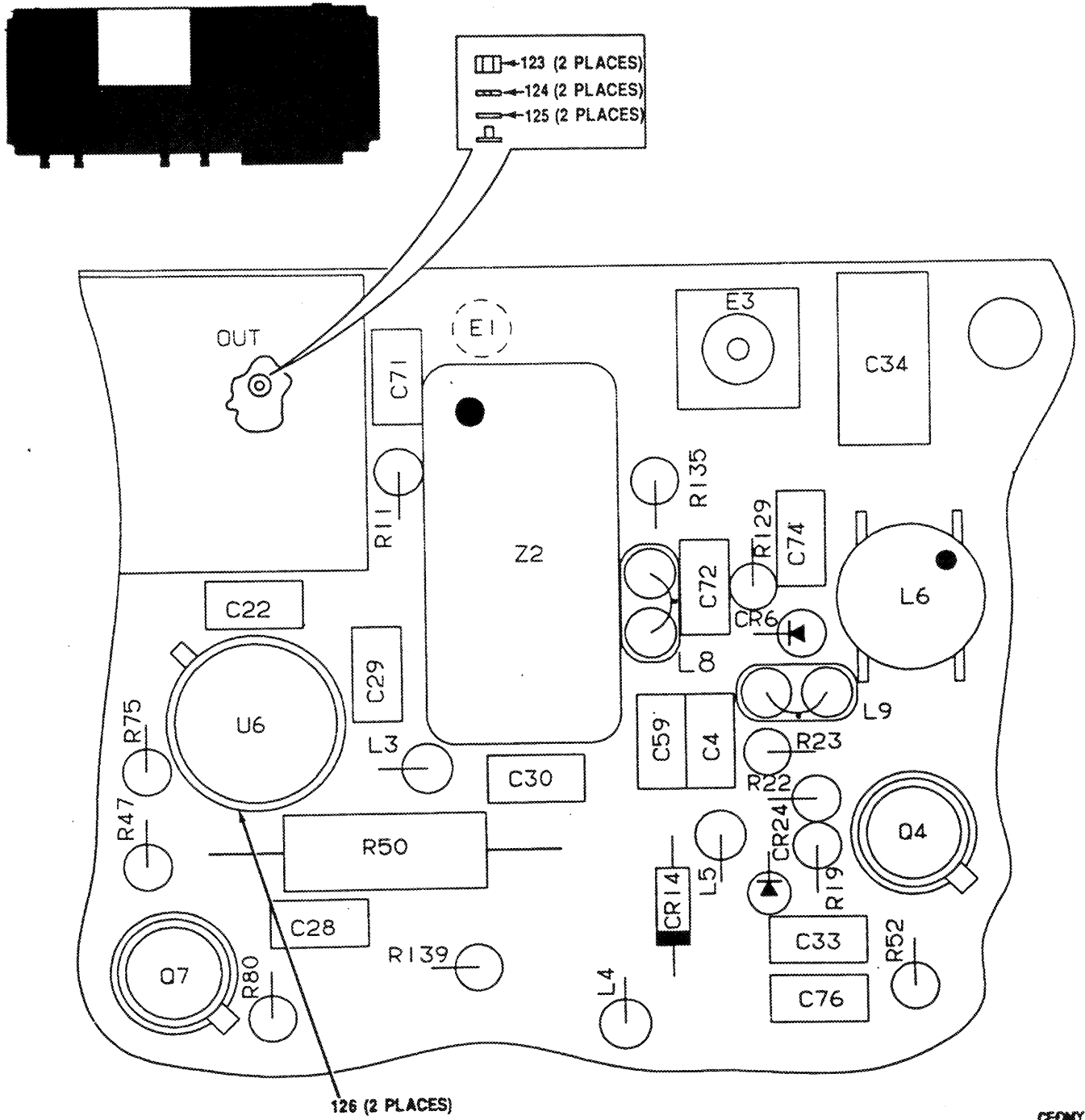
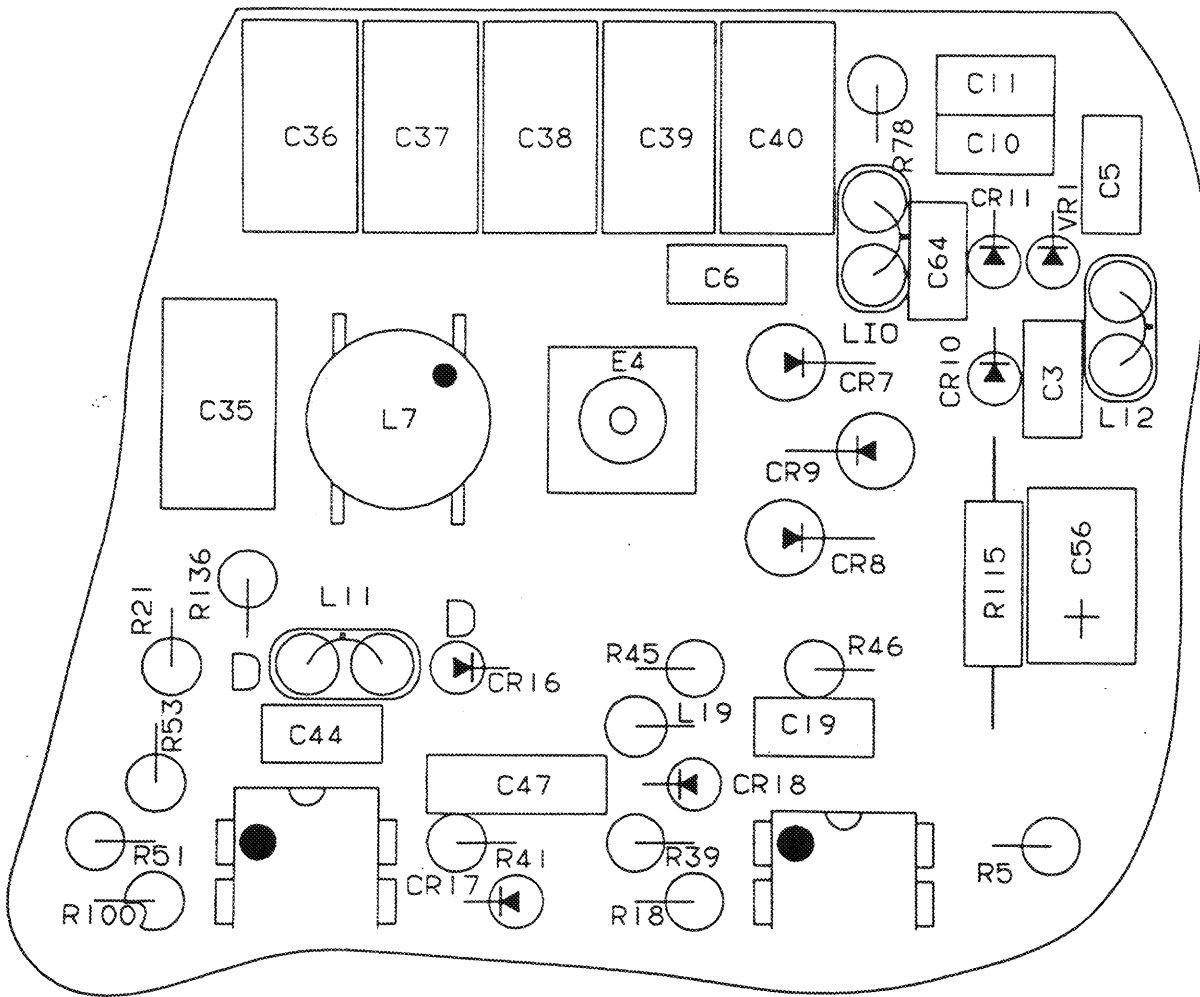
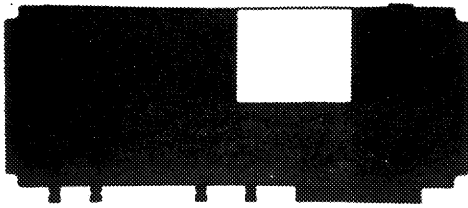

Figure 22. RF Amp Exciter CCA A6A1 (A3024635) (Sheet 3 of 10)



CEOMY-087

Figure 22. RF Amp Exciter CCA A6A1 (A3024635) (Sheet 4 of 10)

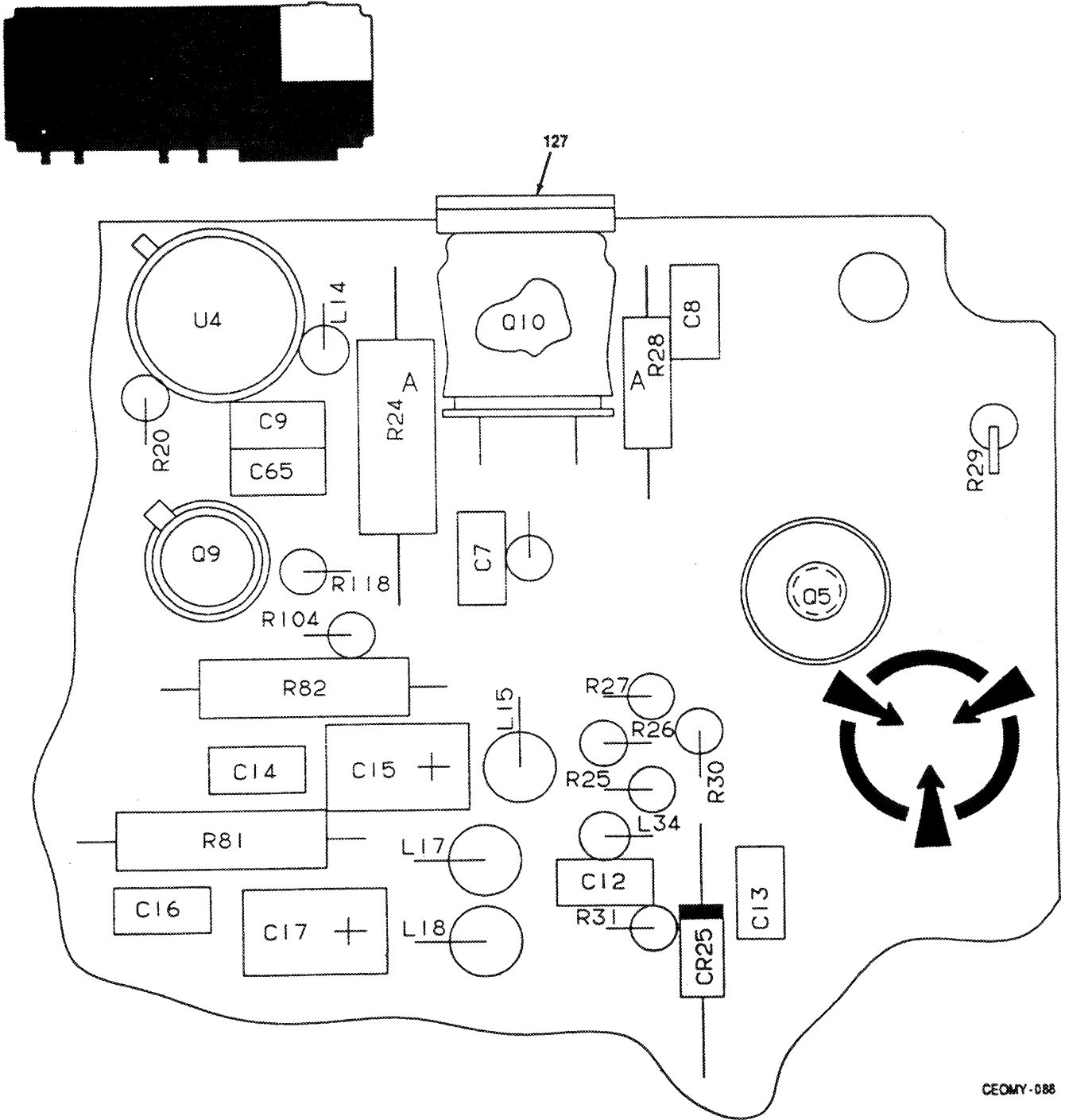
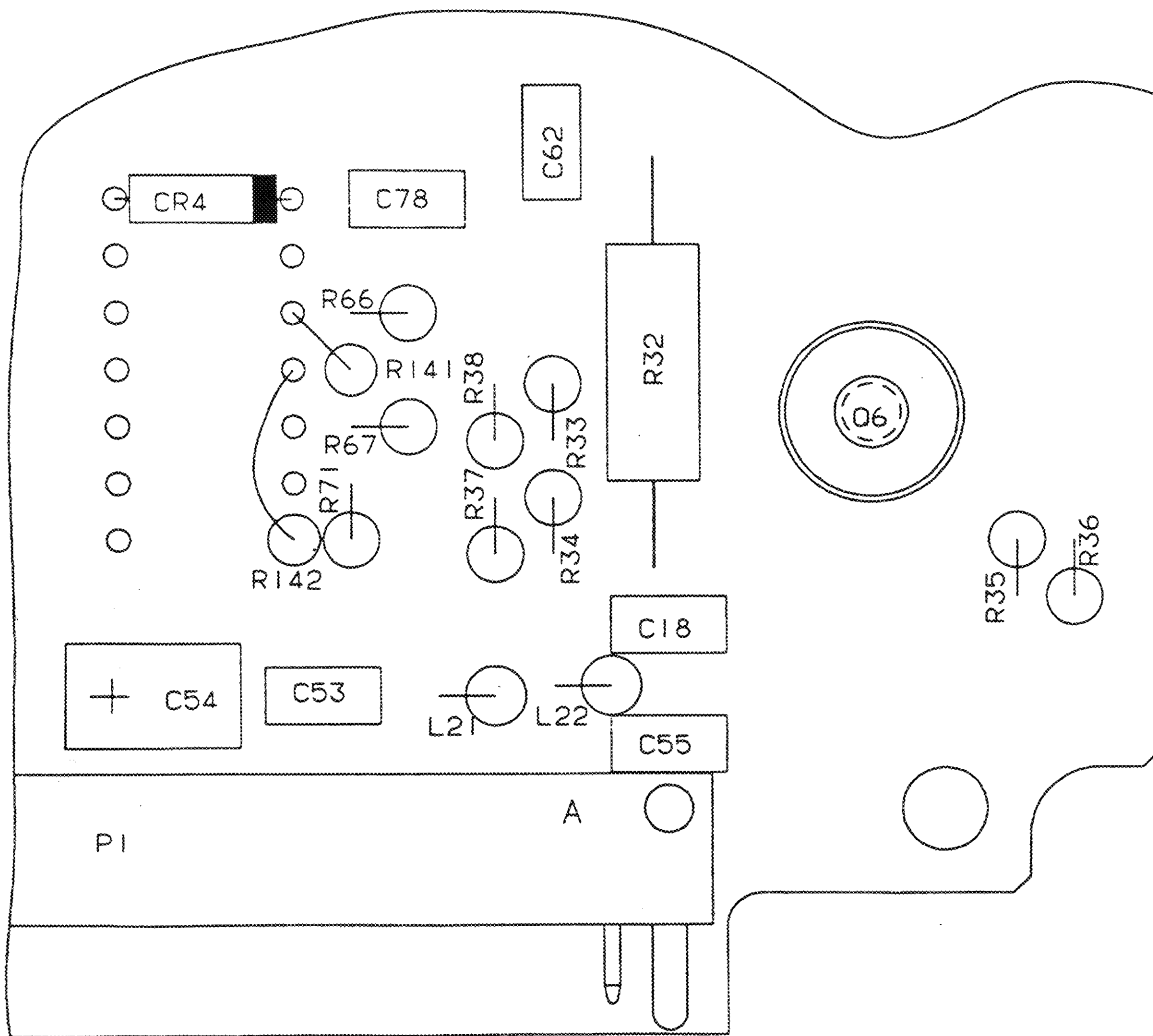
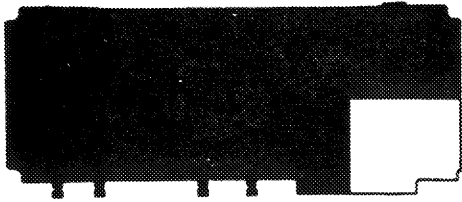

Figure 22. RF Amp Exciter CCA A6A1 (A3024635) (Sheet 5 of 10)





CEOMY-089

Figure 22. RF Amp Exciter CCA A6A1 (A3024635) (Sheet 6 of 10)

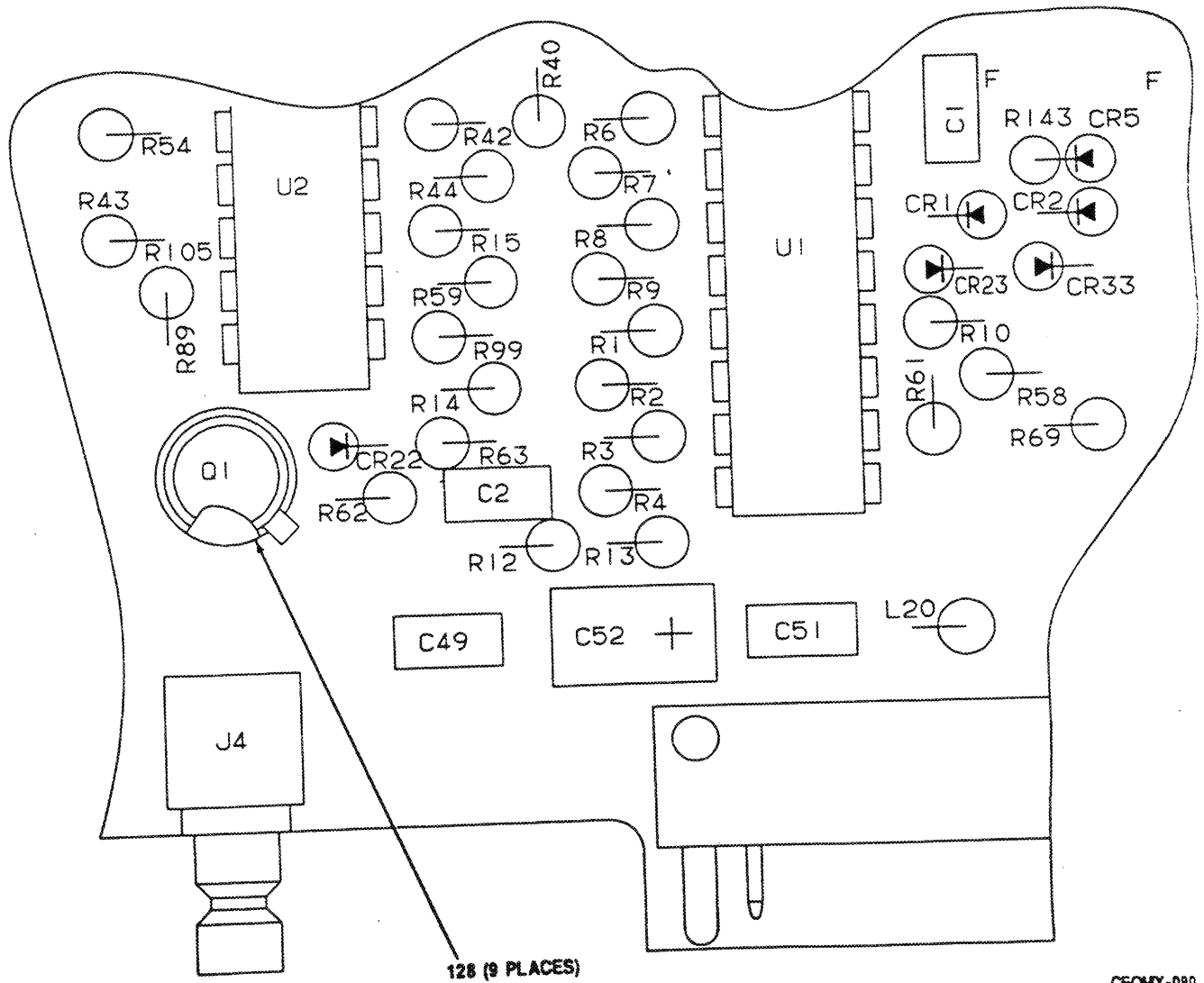
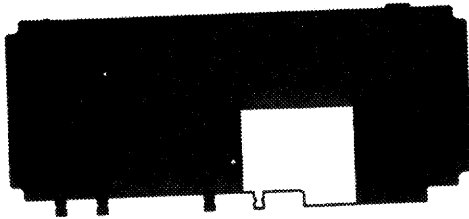

CEOMY-090

Figure 22. RF Amp Exciter CCA A6A1 (A3024635) (Sheet 7 of 10)

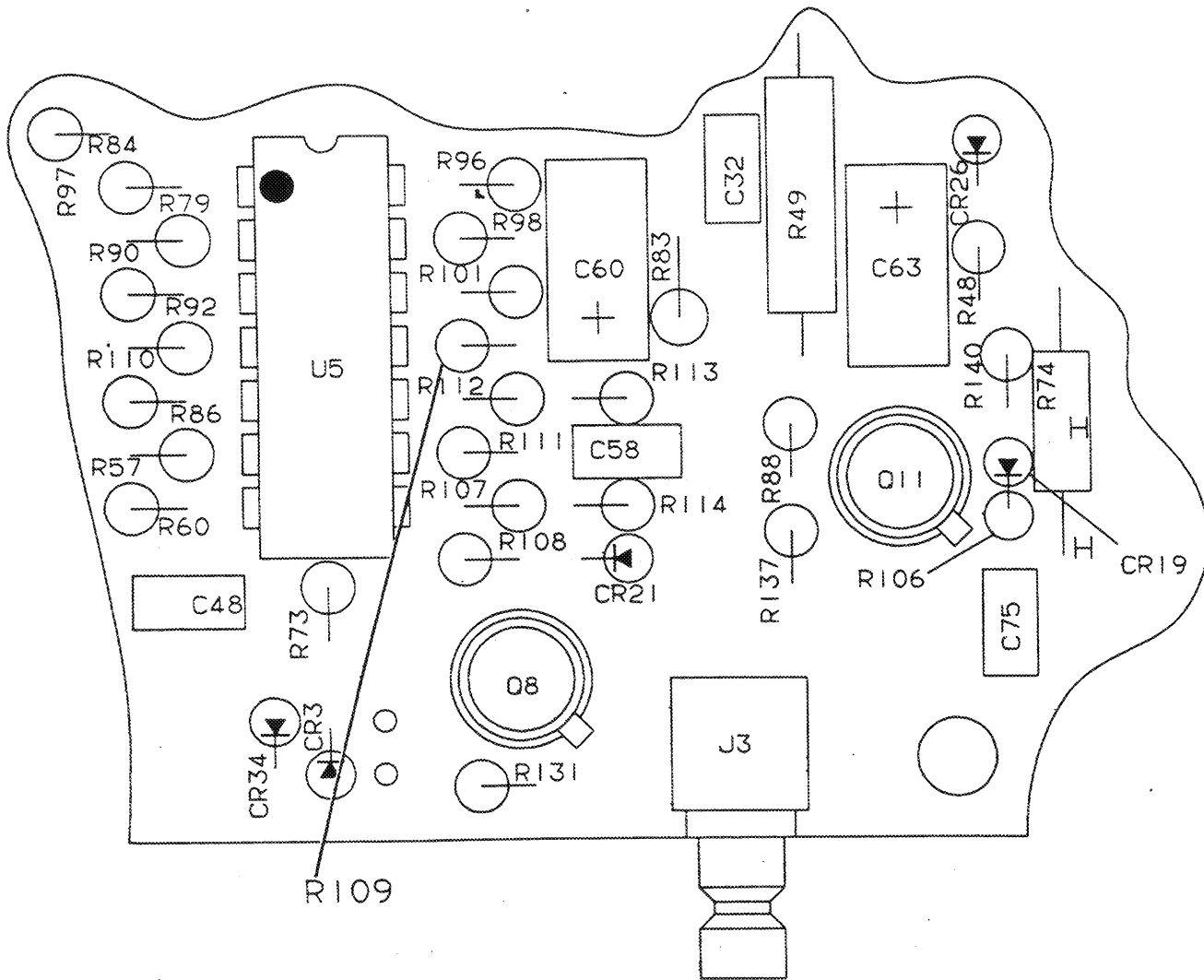
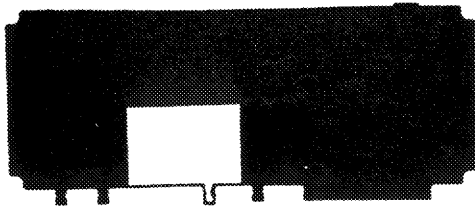

CEOMY-091

Figure 22. RF Amp Exciter, GCA A6A1 (A3024635) (Sheet 8 of 10)

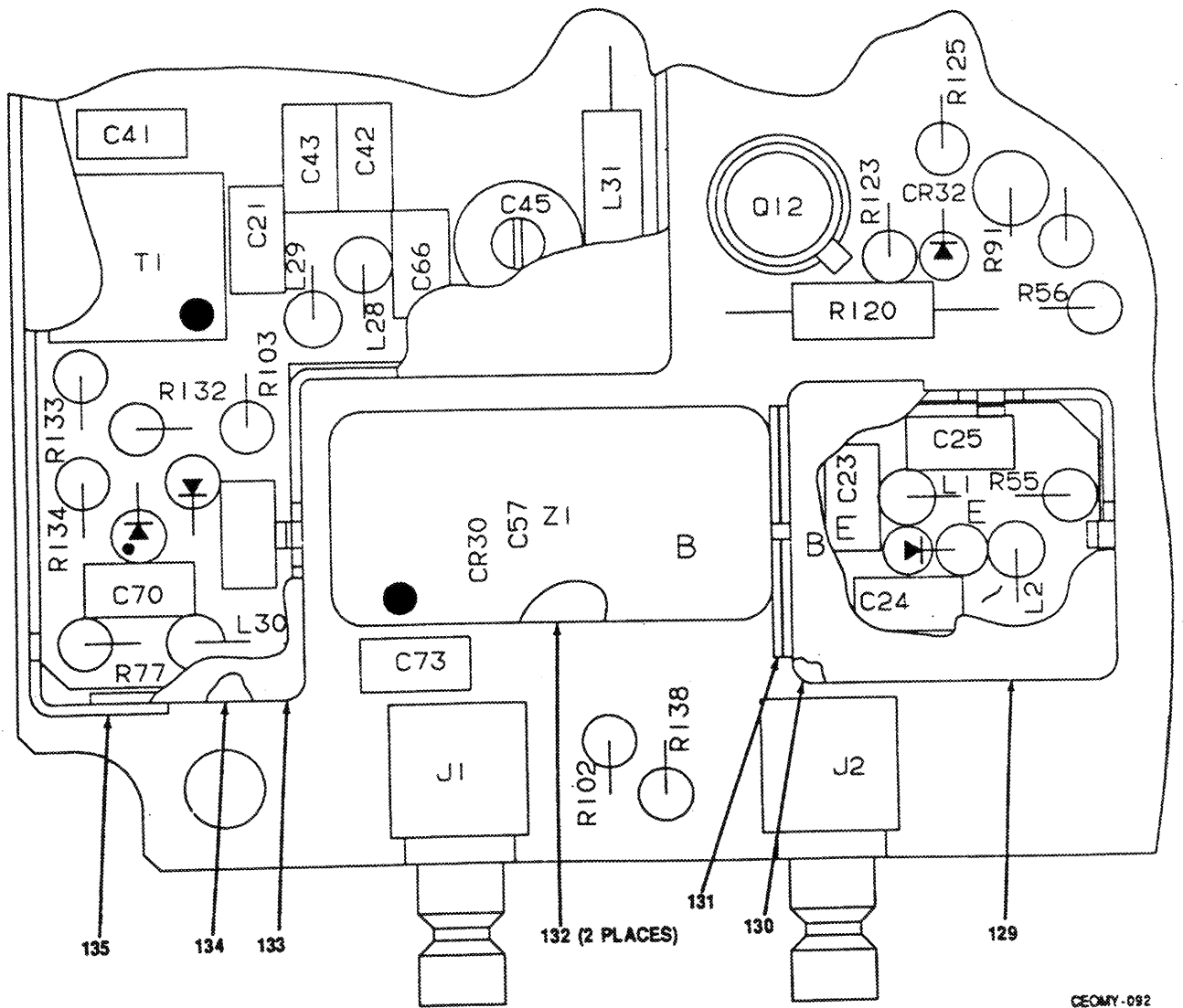
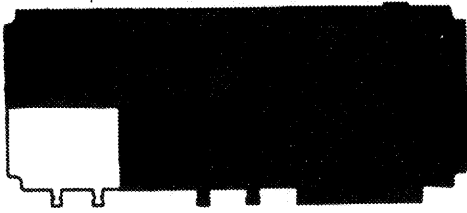

CEOMY-092

Figure 22. RF Amp Exciter CCA A6A1 (A3024635) (Sheet 9 of 10)

LEGEND

REF. DES.	ITEM NO.	REF. DES.	ITEM NO.	REF. DES.	ITEM NO.	REF. DES.	ITEM NO.	REF. DES.	ITEM NO.	REF. DES.	ITEM NO.
CR1	1	C26	8	J3	25	R13	47	R74*	73	R119	51
CR2	1	C27	8	J4	25	R14	50	R74*	75	R120	55
CR3	1	C28	8	L1	26	R15	50	R75	69	R121	55
CR4	1	C29	8	L2	26	R16	51	R76	69	R122	50
CR5	1	C30	8	L3	26	R17	52	R77	75	R123	50
CR6	2	C31	8	L4	27	R18	47	R78	54	R124	53
CR7	3	C32	8	L5	27	R19	53	R79	53	R125	53
CR8	3	C33	8	L6	28	R20	54	R80	77	R126*	46
CR9	3	C34	10	L7	29	R21	50	R81	78	R126*	59
CR10	1	C35	11	L8	30	R22	55	R82	79	R126*	69
CR11	1	C36	12	L9	30	R23	54	R83	50	R126*	97
CR13	2	C37	13	L10	30	R24	56	R84	53	R126*	98
CR14	4	C38	14	L11	30	R25	52	R85	75	R126*	101
CR15	1	C39	15	L12	30	R26	57	R86	71	R126*	102
CR16	1	C40	11	L14	31	R27	58	R88	71	R126*	103
CR17	1	C41	8	L15	32	R28	59	R89	50	R126*	104
CR18	1	C42	8	L16	33	R29	59	R90	80	R127	105
CR19	1	C43	8	L17	34	R30	60	R91	61	R128	106
CR21	1	C44	6	L18	32	R31	61	R92	82	R129	54
CR22	1	C45	16	L19	35	R32	62	R93	83	R130	50
CR23	1	C46	6	L20	26	R33	63	R94	67	R131	73
CR24	1	C47	17	L21	36	R34	63	R95	84	R132	107
CR25	1	C48	6	L22	36	R35	63	R96	85	R133	46
CR26	1	C49	6	L27	26	R36	63	R97	66	R134*	46
CR27	2	C51	6	L28	26	R37	47	R98	71	R134*	59
CR28	2	C52	18	L29	26	R38	64	R99	73	R134*	69
CR29	2	C53	6	L30	26	R39	65	R100	74	R134*	98
CR30	2	C54	18	L31	26	R40	66	R101	86	R134*	101
CR31	1	C55	6	L32	26	R41	67	R102*	63	R134*	102
CR32	1	C56	18	L33	26	R42	68	R102*	73	R134*	103
CR33	1	C57	19	L34	27	R43	69	R102*	87	R134*	104
C1	5	C58	5	L35	37	R44	69	R102*	88	R135	108
C2	6	C59	8	P1	38	R45	70	R102*	89	R136	48
C3	6	C60	20	Q1	39	R46	50	R102*	90	R137	50
C4	6	C62	6	Q3	39	R47	71	R102*	91	R138	73
C5	6	C63	20	Q4	39	R48	71	R102*	92	R139	73
C6	6	C64	6	Q5	40	R49	72	R102*	93	R140	47
C7	6	C65	21	Q6	41	R50	56	R102*	94	R141	109
C8	6	C66	8	Q7	42	R51	50	R102*	95	R142	110
C9	6	C67	8	Q8	39	R52	73	R102*	96	R143	50
C10	6	C68	8	Q9	42	R53	74	R102*	97	T1	111
C11	6	C69	8	Q10	43	R54	74	R102*	98	T2	112
C12	6	C70	8	Q11	44	R55	75	R103	49	U1	113
C13	5	C71	19	Q12	39	R56	55	R104	66	U2	114
C14	6	C72	6	R1	45	R57	50	R105	50	U4	115
C15	7	C73	8	R2	45	R58	45	R106	73	U5	114
C16	6	C74	6	R3	45	R59	48	R107	53	U6	115
C17	7	C75	5	R4	45	R60	50	R109	69	U7	114
C18	6	C76	21	R5	46	R61	47	R110	69	U8	116
C19	6	C77	22	R6	47	R62	53	R111	50	VR1	117
C20	8	C78	6	R7	47	R63	50	R112	58	VR2	118
C21	9	E3	23	R8	47	R66	47	R113	99	Z1	119
C22	8	E4	23	R9	47	R67	47	R114	73	Z2	120
C23	8	FL1	24	R10	48	R69	50	R115	75		
C24	8	J1	25	R11	49	R71	47	R118*	50		
C25	8	J2	25	R12	45	R73	76	R118*	100		

\* Select At Test

CEOMY-093

Figure 22. RF Amp Exciter CCA A6A1 (A3024635) (Sheet 10 of 10)

SECTION II			TM11-5895-1303-24P			(6)
(1)	(2)	(3)	(4)	(5)		
ITEM NO	SMR CODE	FSCM	PART NUMBER	DESCRIPTION AND USABLE ON CODES(UOC)	QTY	
47	PAHZZ	81349	RCR07G102JS	TEST R126,134).....		12
48	PAHZZ	81349	RCR07G513JS	RESISTOR, FIXED, COMP.....		3
49	PAHZZ	81349	RCR07G331JS	RESISTOR, FIXED, COMP.....		2
50	PAHZZ	81349	RCR07G103JS	RESISTOR, FIXED, COMP.....		19
51	PAHZZ	81349	RCR07G512JS	RESISTOR, FIXED, COMP.....		2
52	PAHZZ	81349	RCR07G391JS	RESISTOR, FIXED, COMP.....		2
53	PAHZZ	81349	RCR07G222JS	RESISTOR, FIXED, COMP.....		7
54	PAHZZ	81349	RCR07G221JS	RESISTOR, FIXED, COMP.....		4
55	PAHZZ	81349	RCR07G473JS	RESISTOR, FIXED, COMP.....		4
56	PAHZZ	81349	RCR20G221JS	RESISTOR, FIXED, COMP.....		2
57	PAHZZ	81349	RCR07G751JS	RESISTOR, FIXED, COMP.....		1
58	PAHZZ	81349	RCR07G682JS	RESISTOR, FIXED, COMP.....		2
59	PAHZZ	81349	RCR07G180JS	RESISTOR, FIXED, COMP (SELECT AT TEST R126,134).....		4
60	PAHZZ	81349	RCR07G911JS	RESISTOR, FIXED, COMP.....		1
61	PAHZZ	81349	RCR07G471JS	RESISTOR, FIXED, COMP.....		1
62	PAHZZ	81349	RCR20G332JS	RESISTOR, FIXED, COMP.....		1
63	PAHZZ	81349	RCR07G390JS	RESISTOR, FIXED, COMP (SELECT AT TEST R102).....		5
64	PAHZZ	81349	RCR07G152JS	RESISTOR, FIXED, COMP.....		1
65	PAHZZ	81349	RCR07G242JS	RESISTOR, FIXED, COMP.....		1
66	PAHZZ	81349	RCR07G822JS	RESISTOR, FIXED, COMP.....		3
67	PAHZZ	81349	RCR07G202JS	RESISTOR, FIXED, COMP.....		2
68	PAHZZ	81349	RCR07G621JS	RESISTOR, FIXED, COMP.....		1
69	PAHZZ	81349	RCR07G240JS	RESISTOR, FIXED, COMP (SELECT AT TEST R126,134).....		8
70	PAHZZ	81349	RCR07G113JS	RESISTOR, FIXED, COMP.....		1
71	PAHZZ	81349	RCR07G104JS	RESISTOR, FIXED, COMP.....		5
72	PAHZZ	81349	RWR80S39R2FS	RESISTOR, FIXED, WIRE.....		1
73	PAHZZ	81349	RCR07G101JS	RESISTOR, FIXED, COMP (SELECT AT TEST R102).....		9
74	PAHZZ	81349	RCR07G123JS	RESISTOR, FIXED, COMP.....		3
75	PAHZZ	81349	RCR07G151JS	RESISTOR, FIXED, COMP.....		4
76	PAHZZ	81349	RNC55H1273FS	RESISTOR, FIXED, FILM.....		1
77	PAHZZ	81349	RCR07G301JS	RESISTOR, FIXED, COMP.....		1
78	PAHZZ	81349	RWR80S1000FS	RESISTOR, FIXED, WIRE.....		1
79	PAHZZ	81349	RWR80S1001FS	RESISTOR, FIXED, WIRE.....		1
80	PAHZZ	81349	RCR07G334JS	RESISTOR, FIXED, COMP.....		1
81	PAHZZ	81349	RNC55H1002FS	RESISTOR, FIXED, FILM.....		1
82	PAHZZ	81349	RCR07G392JS	RESISTOR, FIXED, COMP.....		1
83	PAHZZ	81349	RNC55H6040FS	RESISTOR, FIXED, FILM.....		1
84	PAHZZ	81349	RJR26FP102P	RESISTOR, VARIABLE, N.....		1
85	PAHZZ	81349	RNC55H5112FS	RESISTOR, FIXED, FILM.....		1
86	PAHZZ	81349	RNC55H1003FS	RESISTOR, FIXED, FILM (SELECT AT TEST).....		1
87	PAHZZ	81349	RCR07G360JS	RESISTOR, FIXED, COMP (SELECT AT TEST).....		1
88	PAHZZ	81349	RCR07G430JS	RESISTOR, FIXED, COMP (SELECT AT TEST).....		1
89	PAHZZ	81349	RCR07G470JS	RESISTOR, FIXED, COMP (SELECT AT TEST).....		1

SECTION II			TM11-5895-1303-24P	(5)	(6)
(1)	(2)	(3)	(4)		
ITEM	SMR		PART		
NO	CODE	FSCM	NUMBER	DESCRIPTION AND USABLE ON CODES(UOC)	QTY

GROUP 0601 RF AMP EXCITER CCA  
A6A1 (A3024635)

FIG. 22

1	PAHZZ	81349	JANTX1N4454-1	SEMICONDUCTOR DEVIC.....	21
2	PAHZZ	56996	B4006210-902	SEMICONDUCTOR DEVIC.....	6
3	PAHZZ	12969	UM4301B	SEMICONDUCTOR DEVIC.....	3
4	PAHZZ	12969	UM7101B	SEMICONDUCTOR DEVIC.....	1
5	PAHZZ	81349	M39014-01-1575	CAPACITOR, FIXED, CER.....	4
6	PAHZZ	81349	M39014/01-1593	CAPACITOR, FIXED, CER.....	27
7	PAHZZ	56996	B4003327-3345	CAPACITOR, FIXED, ELE.....	2
8	PAHZZ	81349	M39014/01-1357	CAPACITOR, FIXED, CER.....	23
9	PAHZZ	81349	CCR05CJ5R6JP	CAPACITOR, FIXED, CER.....	1
10	PAHZZ	81349	CMR04C8R0D0DR	CAPACITOR, FIXED, MIC.....	1
11	PAHZZ	81349	CMR04E750G0DR	CAPACITOR, FIXED, MIC.....	2
12	PAHZZ	81349	CMR04C6R0D0DR	CAPACITOR, FIXED, MIC.....	1
13	PAHZZ	81349	CMR04E470G0DR	CAPACITOR, FIXED, MIC.....	1
14	PAHZZ	81349	CMR04F101G0DR	CAPACITOR, FIXED, MIC.....	1
15	PAHZZ	81349	CMR04C180J0DR	CAPACITOR, FIXED, MIC.....	1
16	PAHZZ	56996	B4003325-17	CAPACITOR, VARIABLE.....	1
17	PAHZZ	81349	M39014/02-1360	CAPACITOR, FIXED, CER.....	1
18	PAHZZ	56996	B4003327-3289	CAPACITOR, FIXED, ELE.....	3
19	PAHZZ	81349	M39014/01-1345	CAPACITOR, FIXED, CER.....	2
20	PAHZZ	56996	B4003327-3249	CAPACITOR, FIXED, ELE.....	2
21	PAHZZ	81349	M39014/01-1259	CAPACITOR, FIXED, CER.....	2
22	PAHZZ	81349	CDR12BG150AJUPX	CAPACITOR, CHIP.....	1
23	PAHZZ	19505	2009-6511-000	CONNECTOR, RECEPTACL.....	2
24	PAHZZ	80063	A3023935	FILTER, BAND PASS.....	1
25	PAHZZ	19505	2010-6511-002	CONNECTOR, RECEPTACL.....	4
26	PAHZZ	96906	MS75084-6	COIL, RADIO FREQUENC.....	11
27	PAHZZ	96906	MS75084-4	COIL, RADIO FREQUENC.....	3
28	PAHZZ	80063	A3024684-7	COIL, RADIO FREQUENC.....	1
29	PAHZZ	80063	A3024684-8	COIL, RADIO FREQUENC.....	1
30	XBHZZ	80063	A3034554-2	COIL, ASSEMBLY.....	1
31	PAHZZ	96906	MS75084-13	COIL, RADIO FREQUENC.....	2
32	PAHZZ	96906	MS75088-14	COIL, RADIO FREQUENC.....	1
33	PAHZZ	80063	A3032107-1	COIL, RADIO FREQUENC.....	1
34	PAHZZ	96906	MS75089-1	COIL, RADIO FREQUENC.....	1
35	PAHZZ	96906	MS75085-4	COIL, RADIO FREQUENC.....	1
36	PAHZZ	96906	MS75084-16	COIL, RADIO FREQUENC.....	2
37	PAHZZ	96906	MS75083-1	COIL, RADIO FREQUENC.....	1
38	PAHZZ	81349	M55302/4-04	CONNECTOR, RECEPTACL.....	1
39	PAHZZ	81349	JANTXV2N2907A	TRANSISTOR.....	5
40	PAHZZ	04713	MRF 5174	TRANSISTOR.....	1
41	PAHZZ	13499	352-1074-010	TRANSISTOR.....	1
42	PAHZZ	81349	JANTX2N2222A	TRANSISTOR.....	2
43	PAHZZ	97942	581R503H01	TRANSISTOR.....	1
44	PAHZZ	81349	JANTX2N4856	TRANSISTOR.....	1
45	PAHZZ	81349	RCR07G474JS	RESISTOR, FIXED, COMP.....	6
46	PAHZZ	81349	RCR07G100JS	RESISTOR, FIXED, COMP (SELECT AT	4

SECTION II			TM11-5895-1303-24P		(5)	(6)
(1)	(2)	(3)	(4)			
ITEM	SMR	FSCM	PART		DESCRIPTION AND USABLE ON CODES(UOC)	QTY
NO	CODE		NUMBER			
90	PAHZZ	81349	RCR07G510JS		RESISTOR, FIXED, COMP (SELECT AT TEST).....	1
91	PAHZZ	81349	RCR07G560JS		RESISTOR, FIXED, COMP (SELECT AT TEST).....	1
92	PAHZZ	81349	RCR07G620JS		RESISTOR, FIXED, COMP (SELECT AT TEST).....	1
93	PAHZZ	81349	RCR07G680JS		RESISTOR, FIXED, COMP (SELECT AT TEST).....	1
94	PAHZZ	81349	RCR07G750JS		RESISTOR, FIXED, COMP (SELECT AT TEST).....	1
95	PAHZZ	81349	RCR07G820JS		RESISTOR, FIXED, COMP (SELECT AT TEST).....	1
96	PAHZZ	81349	RCR07G910JS		RESISTOR, FIXED, COMP.....	1
97	PAHZZ	81349	RCR07G330JS		RESISTOR, FIXED, COMP (SELECT AT TEST).....	2
98	PAHZZ	81349	RCR07G300JS		RESISTOR, FIXED, COMP (SELECT AT TEST).....	3
99	PAHZZ	81349	RCR07G203JS		RESISTOR, FIXED, COMP.....	1
100	PAHZZ	81349	RCR07G223JS		RESISTOR, FIXED, COMP.....	1
101	PAHZZ	81349	RCR07G150JS		RESISTOR, FIXED, COMP (SELECT AT TEST).....	2
102	PAHZZ	81349	RCR07G200JS		RESISTOR, FIXED, COMP (SELECT AT TEST).....	2
103	PAHZZ	81349	RCR07G220JS		RESISTOR, FIXED, COMP (SELECT AT TEST).....	2
104	PAHZZ	81349	RCR07G270JS		RESISTOR, FIXED, COMP (SELECT AT TEST).....	2
105	PAHZZ	81349	RNC55H26R1FS		RESISTOR, FIXED, FILM.....	1
106	PAHZZ	81349	RNC55H36R5FS		RESISTOR, FIXED, FILM.....	1
107	PAHZZ	81349	RCR07G121JS		RESISTOR, FIXED, COMP.....	1
108	PAHZZ	81349	RCR07G5R1JS		RESISTOR, FIXED, COMP.....	1
109	PAHZZ	81349	RCR07G204JS		RESISTOR, FIXED, COMP.....	1
110	PAHZZ	81349	RNC55H2673FS		RESISTOR, FIXED, FILM.....	1
111	PAHZZ	80063	A3028583		TRANSFORMER, RADIO F.....	1
112	PAHZZ	80063	A3024684-9		TRANSFORMER.....	1
113	PAHZA	27014	MM54HC374J/883B		MICROCIRCUIT, DIGITA.....	1
114	PAHZZ	81349	M38510/11001BCB		MICROCIRCUIT, LINEAR.....	3
115	PAHZZ	56996	B4002890		MICROCIRCUIT, LINEAR.....	2
116	PAHZZ	55154	SL521BB/CM		MICROCIRCUIT, DIGITA.....	1
117	PAHZZ	81349	JANTXV1N746A-1		SEMICONDUCTOR DEVIC.....	1
118	PAHZZ	81349	JANTX1N825-1		SEMICONDUCTOR DEVIC.....	1
119	PAHZZ	81349	M28837/1-02N		MIXER STAGES, RADIO.....	1
120	PAHZZ	15542	TAK-390125		MIXER, RADIO FREQUEN.....	1
121	PAHZZ	80063	A3032601-3		SPACER, SLEEVE.....	14
122	PADZZ	81349	M38527/05-012D		MOUNTING PAD, ELECTR.....	1
123	PAHZZ	80205	NAS671C4		NUT, PLAIN, HEXAGON.....	2
124	PAHZZ	96906	MS35338-135		WASHER, LOCK.....	2
125	PAHZZ	80205	NAS620C4		WASHER, FLAT.....	2
126	PAHZZ	81349	M38527/02-018N		MOUNTING PAD, ELECTR.....	2
127	PAHZZ	81349	M87111/2-3B15		HEAT SINK.....	1
128	PAHZZ	81349	M38527/03-008N		MOUNTING, PAD ELECTR.....	9
129	PAHZZ	80063	A3035839		PLATE, ELECTRICAL SH.....	1



SECTION II			TM11-5895-1303-24P			
(1)	(2)	(3)	(4)	(5)	(6)	
ITEM NO	SMR CODE	FSCM	PART NUMBER	DESCRIPTION AND USABLE ON CODES(UOC)	QTY	
130	PAHZZ	80063	A3035840	ENCLOSURE, ELECTROMA.....	1	
131	PAHZZ	52814	A3078899	CONTACT, ELECTRICAL.....	1	
132	PAHZZ	80063	A3034171	INSULATOR, MIXER.....	2	
133	PAHZZ	80063	A3035837	PLATE, ELECTRICAL SH.....	1	
134	PAHZZ	80063	A3035838	PLATE, ELECTRICAL SH.....	1	
135	PAHZZ	80063	A3035836	PLATE, ELECTRICAL SH.....	1	

END OF FIGURE

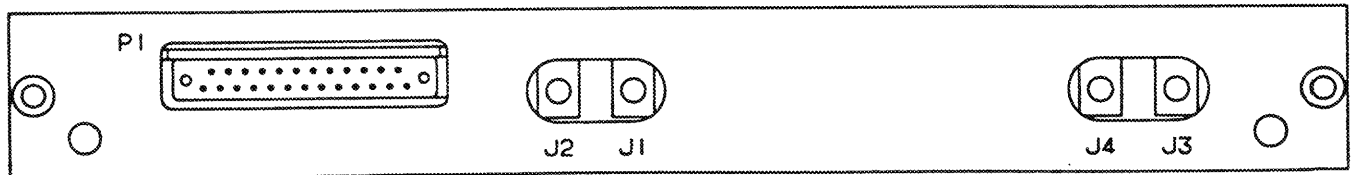
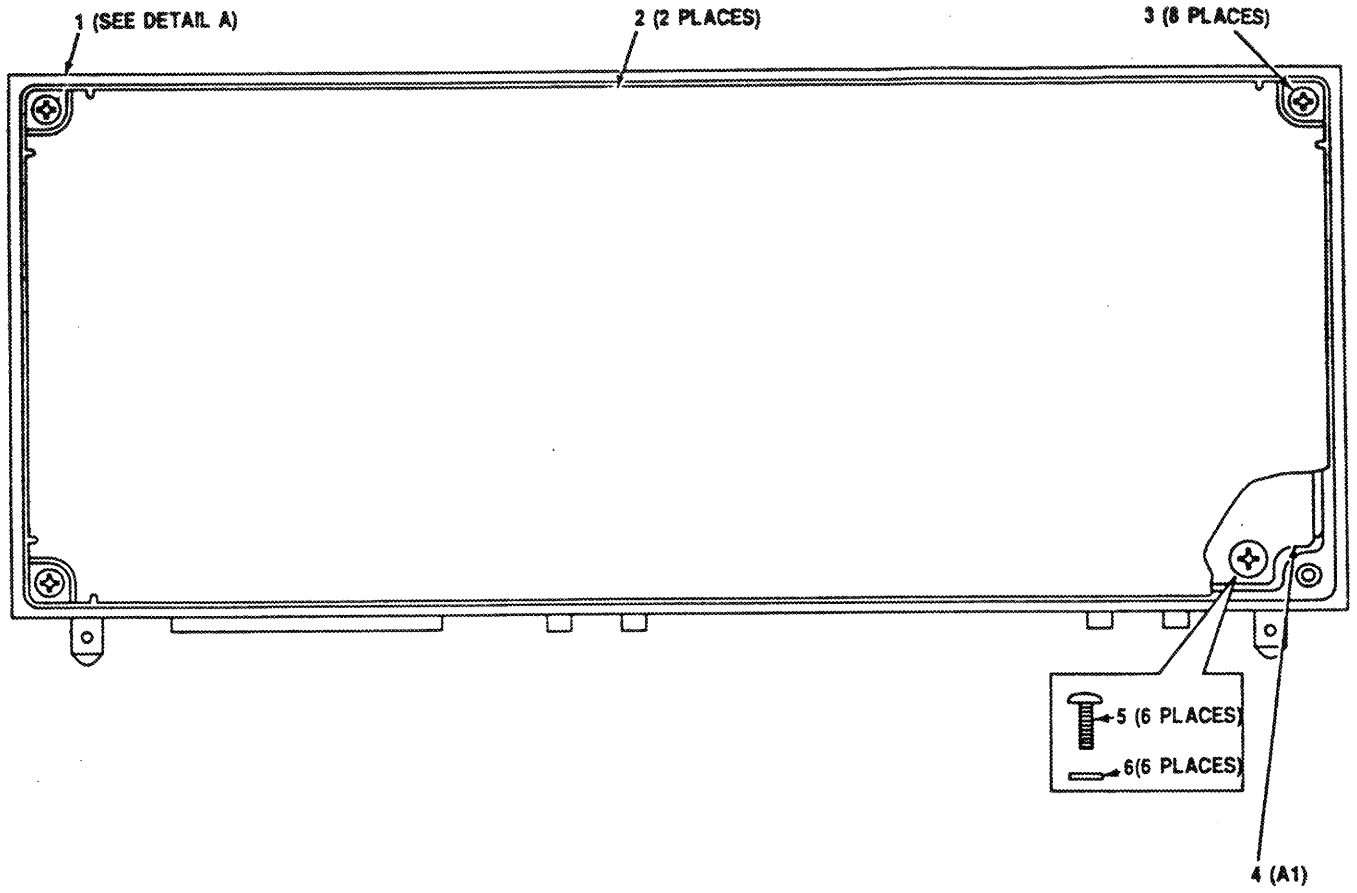

NOTES: 1. PREFIX ALL REFERENCE DESIGNATIONS WITH A7

2. SEE FIGURE 1 FOR RESPECTIVE UNIT REFERENCE DESIGNATION PREFIX

CEOMY-094

Figure 23. RF Switch Assembly A7 (A3024649) (Sheet 1 of 2)

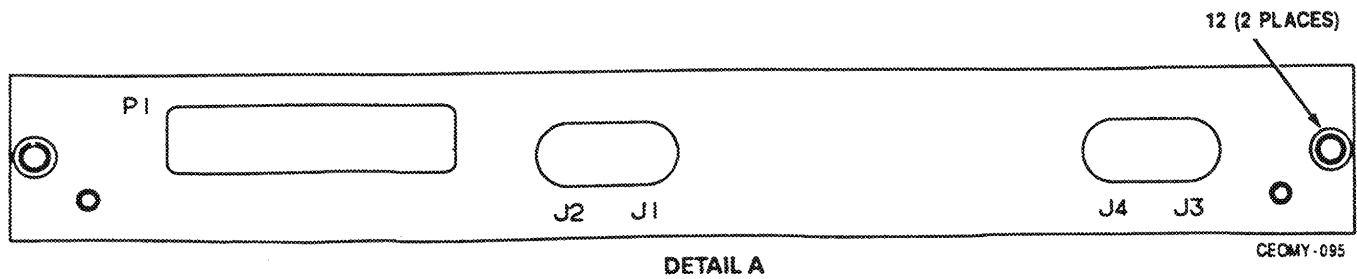
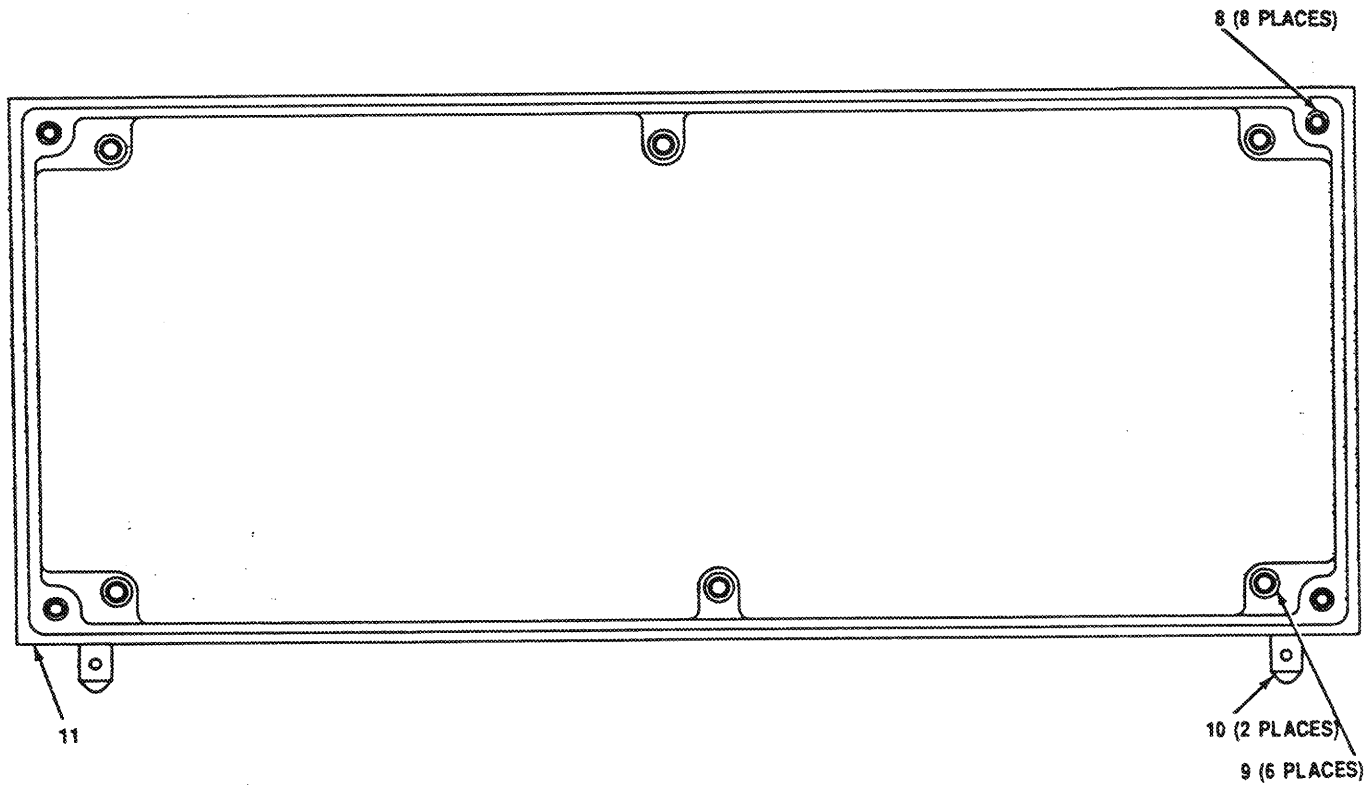
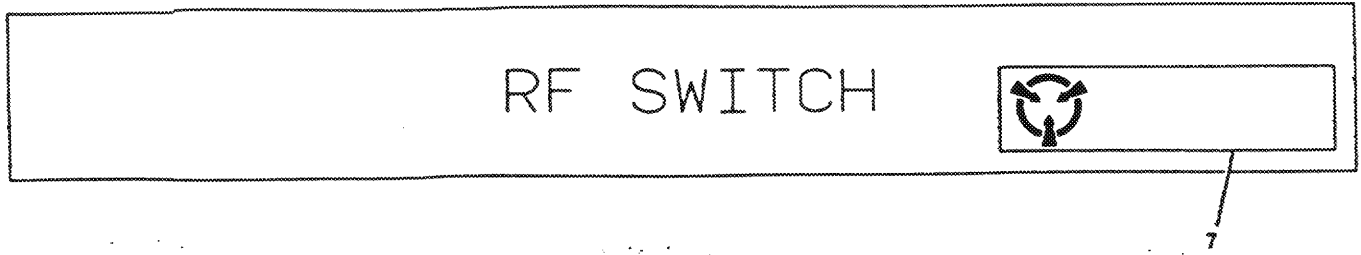

Figure 23. RF Switch Assembly A7 (A3024649) (Sheet 2 of 2)

SECTION II			TM11-5895-1303-24P	(5)	(6)
(1)	(2)	(3)	(4)		
ITEM	SMR		PART		
NO	CODE	FSCM	NUMBER	DESCRIPTION AND USABLE ON CODES(UDC)	QTY

GROUP 07 RF SWITCH ASSEMBLY A7  
(A3024649)

FIG. 23

1	XBHLL	80063	A3028056	MODULE FRAME ASSEMB.....	1
2	XBHZZ	80063	A3028053	COVER,MODULE.....	2
3	PAHZZ	96906	MS51957-2	SCREW,MACHINE.....	8
4	PAHLD	80063	A3024650	CIRCUIT CARD ASSEMB (SEE FIG. 24	1
				FOR BREAKDOWN).....	
5	PAHZZ	96906	MS51957-13	SCREW,MACHINE.....	6
6	PAHZZ	80205	NAS620C4	WASHER,FLAT.....	6
7	XBHZZ	80063	A3034572	LABEL,SENSITIVE.....	1
8	PAHZZ	26344	3585-02CNW0129	INSERT,SCREW THREAD.....	8
9	PAHZZ	96906	MS21209C0415L	INSERT,SCREW THREAD.....	6
10	XBHZZ	80063	A3028102	PIN,GUIDE--MODULE.....	2
11	XBHZZ	80063	A3028057	FRAME,MODULE--RF SW.....	1
12	PAHZZ	96906	MS21209C0815L	INSERT,SCREW THREAD.....	2

END OF FIGURE

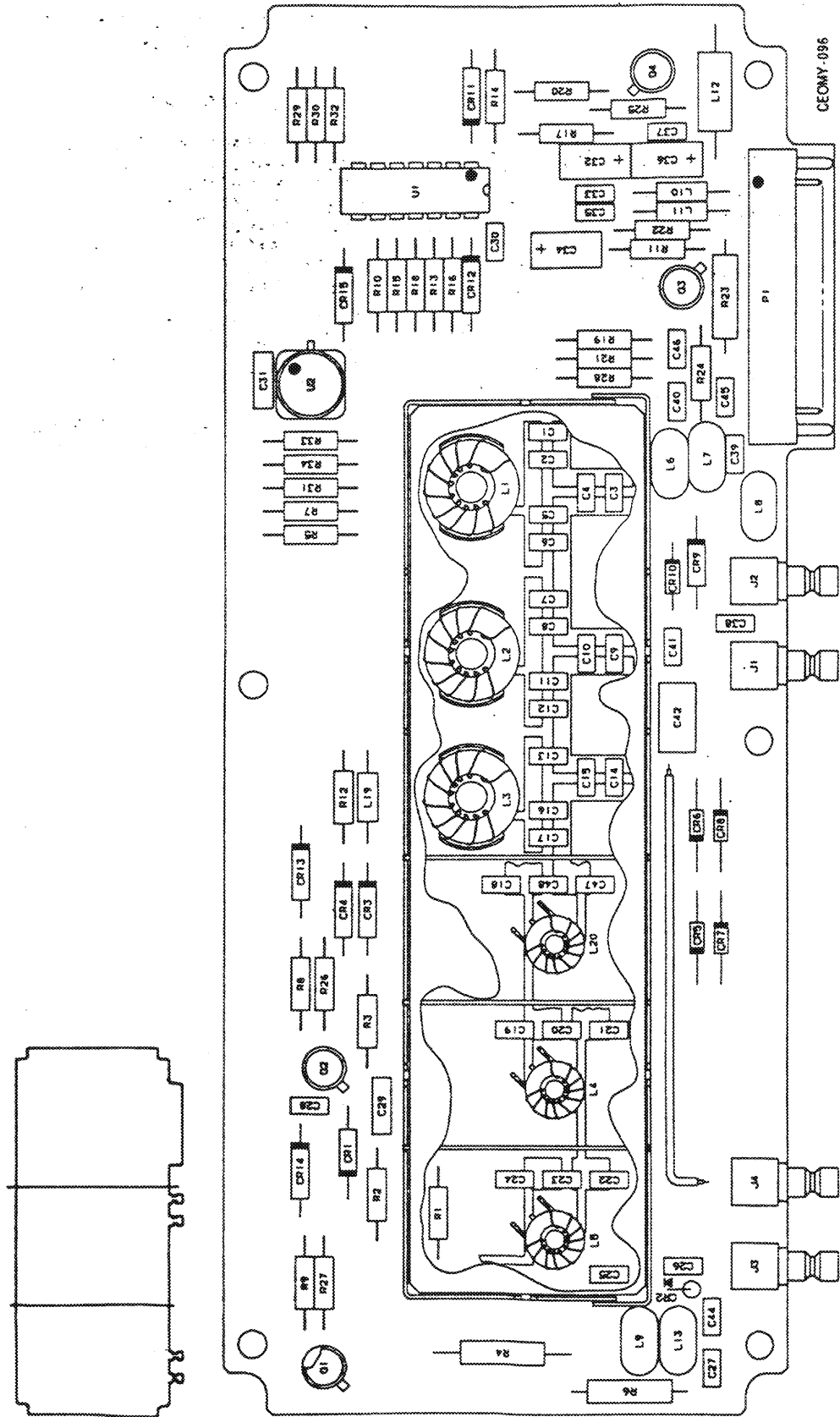
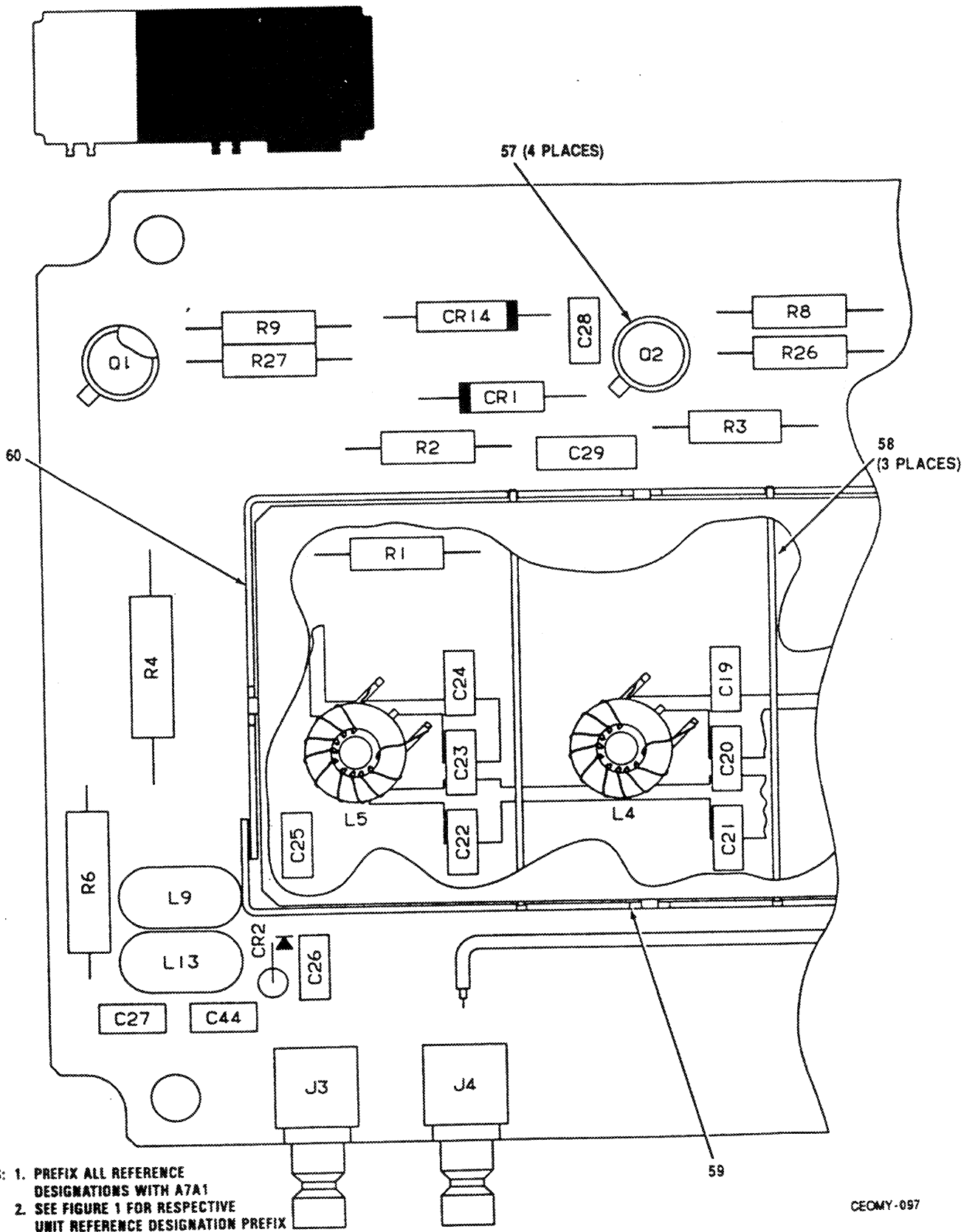

Figure 24. RF Switch CCA A7A1 (A3024650) (Sheet 1 of 5)



NOTES: 1. PREFIX ALL REFERENCE DESIGNATIONS WITH A7A1  
2. SEE FIGURE 1 FOR RESPECTIVE UNIT REFERENCE DESIGNATION PREFIX

CEOMY-097

Figure 24. RF Switch CCA A7A1 (A3024650) (Sheet 2 of 5)

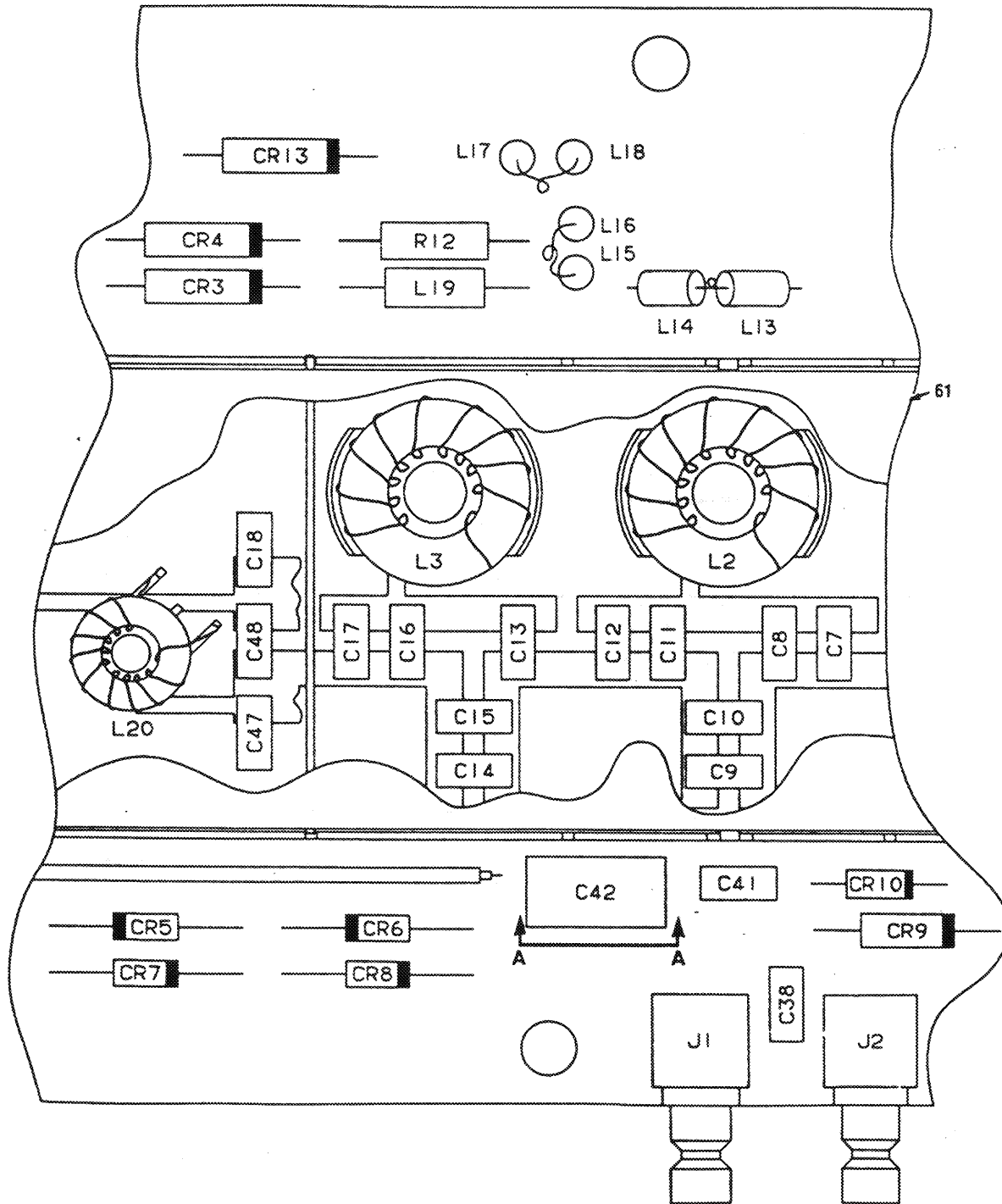
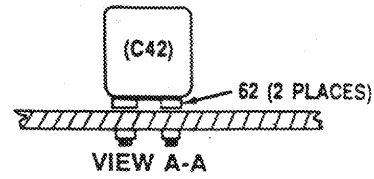
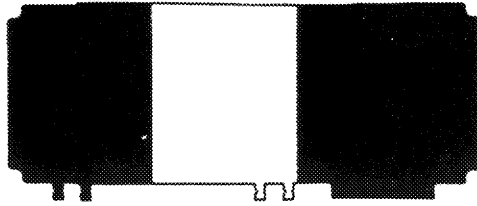

CEOMY-098

Figure 24. RF Switch CCA A7A1 (A3024650) (Sheet 3 of 5)

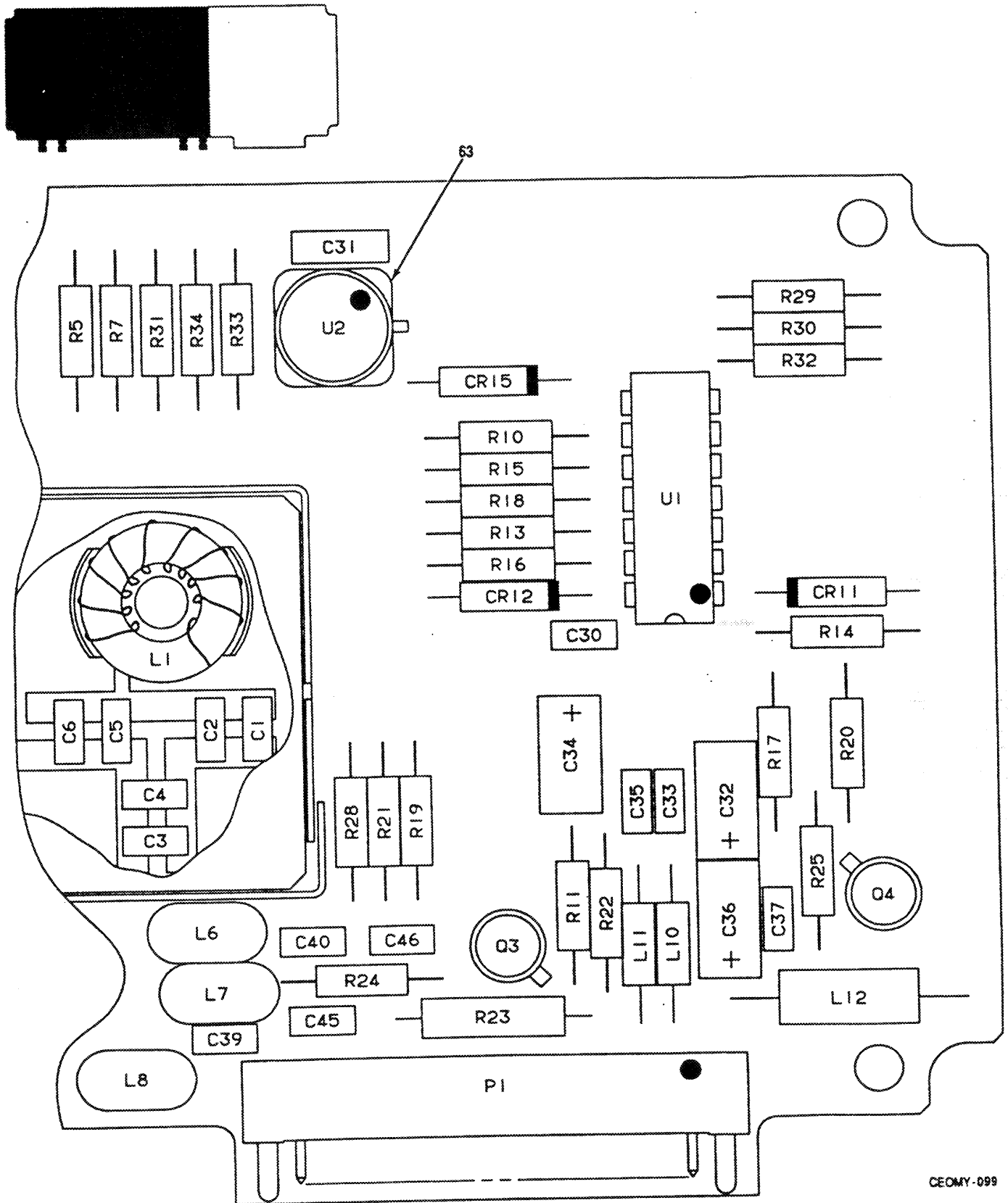

CEOMY-099

Figure 24. RF Switch CCA A7A1 (A3024650) (Sheet 4 of 5)



LEGEND

REF. DES.	ITEM NO.	REF. DES.	ITEM NO.	REF. DES.	ITEM NO.	REF. DES.	ITEM NO.	REF. DES.	ITEM NO.	REF. DES.	ITEM NO.
CR1	1	C7	9	C28	20	J2	26	Q2	38	R19	50
CR2	1	C8	10	C29	21	J3	26	Q3	38	R20	45
CR3	2	C9	11	C30	20	J4	26	Q4	38	R21	43
CR4	2	C10	9	C31	21	L1	27	R1	39	R22	43
CR5	3	C11	12	C32	22	L2	28	R2	40	R23	44
CR6	3	C12	13	C33	20	L3	29	R3	41	R24	51
CR7	3	C13	5	C34	22	L4	30	R4	42	R25	52
CR8	3	C14	14	C35	20	L5	30	R5	43	R26	52
CR9	1	C15	12	C36	22	L6	31	R6	44	R27	52
CR10	4	C16	5	C37	20	L7	32	R7	43	R28	43
CR11	2	C17	8	C38	20	L8	31	R8	45	R29	49
CR12	2	C18	15	C39	20	L9	31	R9	45	R30	53
CR13	2	C19	16	C40	20	L10	33	R10	46	R31	49
CR14	2	C20	17	C41	20	L11	33	R11	47	R32	46
CR15	2	C21	15	C42	23	L12	34	R12	48	R33	50
C1	5	C22	15	C44	24	L13	31	R13	43	R34	54
C2	6	C23	18	C45	24	L19	35	R14	47	U1	55
C3	7	C24	19	C46	24	L20	30	R15	46	U2	56
C4	8	C25	20	C47	15	L21	36	R16	46		
C5	5	C26	20	C48	25	P1	37	R17	49		
C6	9	C27	20	J1	26	Q1	38	R18	49		

CEOMY-100

Figure 24. RF Switch CCA A7A1 (A3024650) (Sheet 5 of 5)

SECTION II TM11-5895-1303-24P (5) (6)  
 (1) (2) (3) (4)  
 ITEM SMR PART  
 NO CODE FSCM NUMBER DESCRIPTION AND USABLE ON CODES(UOC) QTY

GROUP 0701 RF SWITCH CCA A7A1  
 (A3024650)

FIG. 24

1	PAHZZ	12969	UM7101B	SEMICONDUCTOR DEVIC.....	3
2	PAHZZ	81349	JANTX1N4454-1	SEMICONDUCTOR DEVIC.....	7
3	PAHZZ	81349	JANTXIN6075	SEMICONDUCTOR DEVIC.....	4
4	PAHZZ	56996	B4006210-902	SEMICONDUCTOR DEVIC.....	1
5	PAHZZ	81349	CDR14BP102AJUP	CAPACITOR, FIXED, MIC.....	4
6	PAHZZ	81349	CDR14BP681AJUP	CAPACITOR, FIXED, MIC.....	1
7	PAHZZ	81349	CDR14BP470EJUP	CAPACITOR, FIXED, MIC.....	1
8	PAHZZ	81349	CDR14BP271CJUP	CAPACITOR, FIXED, MIC.....	2
9	PAHZZ	81349	CDR14BP821AJUP	CAPACITOR, FIXED, MIC.....	3
10	PAHZZ	81349	CDR14BP360EJUP	CAPACITOR, FIXED, MIC.....	1
11	PAHZZ	81349	CDR14BP240EJUP	CAPACITOR, FIXED, MIC.....	1
12	PAHZZ	81349	CDR14BP911AJUP	CAPACITOR, FIXED, MIC.....	2
13	PAHZZ	81349	CDR14BP430EJUP	CAPACITOR, FIXED, MIC.....	1
14	PAHZZ	81349	CDR14BP680EJUP	CAPACITOR, FIXED, MIC.....	1
15	PAHZZ	81349	CDR14BP820EJUP	CAPACITOR, FIXED, MIC.....	4
16	PAHZZ	81349	CDR14BP910EJUP	CAPACITOR, FIXED, MIC.....	1
17	PAHZZ	81349	CDR14BP130EJUP	CAPACITOR, FIXED, MIC.....	1
18	PAHZZ	81349	CDR14BP100EJUP	CAPACITOR, FIXED, MIC.....	1
19	PAHZZ	81349	CDR14BP750EJUP	CAPACITOR, FIXED, MIC.....	1
20	PAHZZ	81349	M39014/01-1593	CAPACITOR, FIXED, CER.....	12
21	PAHZZ	81349	M39014/02-1360	CAPACITOR, FIXED, CER.....	2
22	PAHZZ	56996	B4003327-3289	CAPACITOR, FIXED, ELE.....	3
23	PAHZZ	81349	CMR04C8R0D0DR	CAPACITOR, FIXED, MIC.....	1
24	PAHZZ	81349	M39014/01-1357	CAPACITOR, FIXED, CER.....	3
25	PAHZZ	81349	CDR14BP3R0ECUP	CAPACITOR, FIXED, MIC.....	1
26	PAHZZ	19505	2010-6511-002	CONNECTOR, RECEPTACL.....	4
27	PAHZZ	80063	A3024684-4	COIL, RADIO FREQUENC.....	1
28	PAHZZ	80063	A3024684-5	COIL, RADIO FREQUENC.....	1
29	PAHZZ	80063	A3024684-6	COIL, RADIO FREQUENC.....	1
30	PAHZZ	80063	A3024684-7	COIL, RADIO FREQUENC.....	3
31	XBHZZ	80063	A3034554-3	COIL, ASSEMBLY.....	4
32	XBHZZ	80063	A3034554-2	COIL, ASSEMBLY.....	1
33	PAHZZ	96906	MS75085-7	COIL, RADIO FREQUENC.....	2
34	PAHZZ	96906	MS75088-14	COIL, RADIO FREQUENC.....	1
35	PAHZZ	96906	MS75085-4	COIL, RADIO FREQUENC.....	1
36	PAHZZ	96906	MS75083-1	COIL, RADIO FREQUENC.....	1
37	PAHZZ	81349	M55302/4-03	CONNECTOR, RECEPTACL.....	1
38	PAHZZ	81349	JANTXV2N2907A	TRANSISTOR.....	4
39	PAHZZ	81349	RCR07G102JS	RESISTOR, FIXED, COMP.....	1
40	PAHZZ	81349	RCR07G152JS	RESISTOR, FIXED, COMP.....	1
41	PAHZZ	81349	RCR07G242JS	RESISTOR, FIXED, COMP.....	1
42	PAHZZ	81349	RCR20G510JS	RESISTOR, FIXED, COMP.....	1
43	PAHZZ	81349	RCR07G473JS	RESISTOR, FIXED, COMP.....	6
44	PAHZZ	81349	RWR80S33R2FS	RESISTOR, FIXED, WIRE.....	2
45	PAHZZ	81349	RCR07G332JS	RESISTOR, FIXED, COMP.....	3
46	PAHZZ	81349	RCR07G103JS	RESISTOR, FIXED, COMP.....	4

SECTION II			TM11-5895-1303-24P			
(1)	(2)	(3)	(4)	(5)	(6)	
ITEM	SMR		PART			
NO	CODE	FSCM	NUMBER	DESCRIPTION AND USABLE ON CODES(UOC)	QTY	
47	PAHZZ	81349	RCR07G101JS	RESISTOR, FIXED, COMP	2	
48	PAHZZ	81349	RCR07G202JS	RESISTOR, FIXED, COMP	1	
49	PAHZZ	81349	RCR07G240JS	RESISTOR, FIXED, COMP	4	
50	PAHZZ	81349	RCR07G682JS	RESISTOR, FIXED, COMP	2	
51	PAHZZ	81349	RCR07G151JS	RESISTOR, FIXED, COMP	1	
52	PAHZZ	81349	RCR07G223JS	RESISTOR, FIXED, COMP	3	
53	PAHZZ	81349	RCR07G113JS	RESISTOR, FIXED, COMP	1	
54	PAHZZ	81349	RCR07G104JS	RESISTOR, FIXED, COMP	1	
55	PAHZZ	81349	M38510/11001BCB	MICROCIRCUIT, LINEAR	1	
56	PAHZZ	81349	M38510-10101BGC	MICROCIRCUIT, LINEAR	1	
57	PAHZZ	81349	M38527/03-008N	MOUNTING, PAD ELECTR	4	
58	PAHZZ	80063	A3035830	PLATE, ELECTRICAL SH	3	
59	PAHZZ	80063	A3035829	PARTITION, SHIELD--R	1	
60	PAHZZ	80063	A3035828	ENCLOSURE, ELECTROMA	1	
61	PAHZZ	80063	A3035831	PLATE, ELECTRICAL SH	1	
62	PAHZZ	80063	A3032601-3	SPACER, SLEEVE	2	
63	PAHZZ	81349	M38527/05-008D	MOUNTING PAD, ELECTR	1	

END OF FIGURE

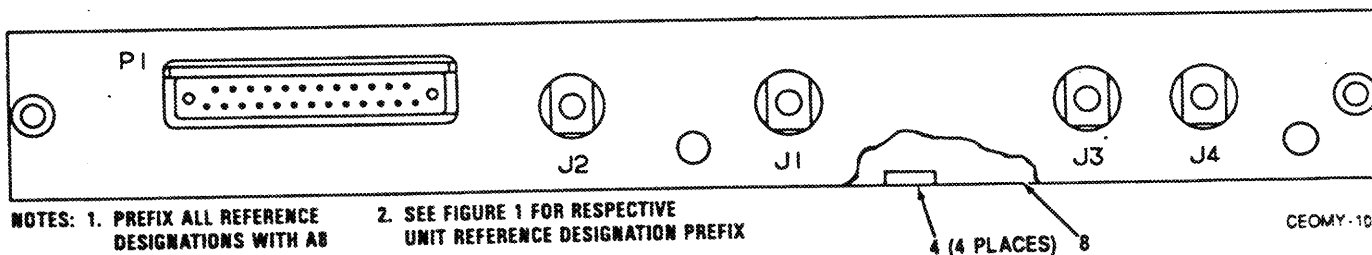
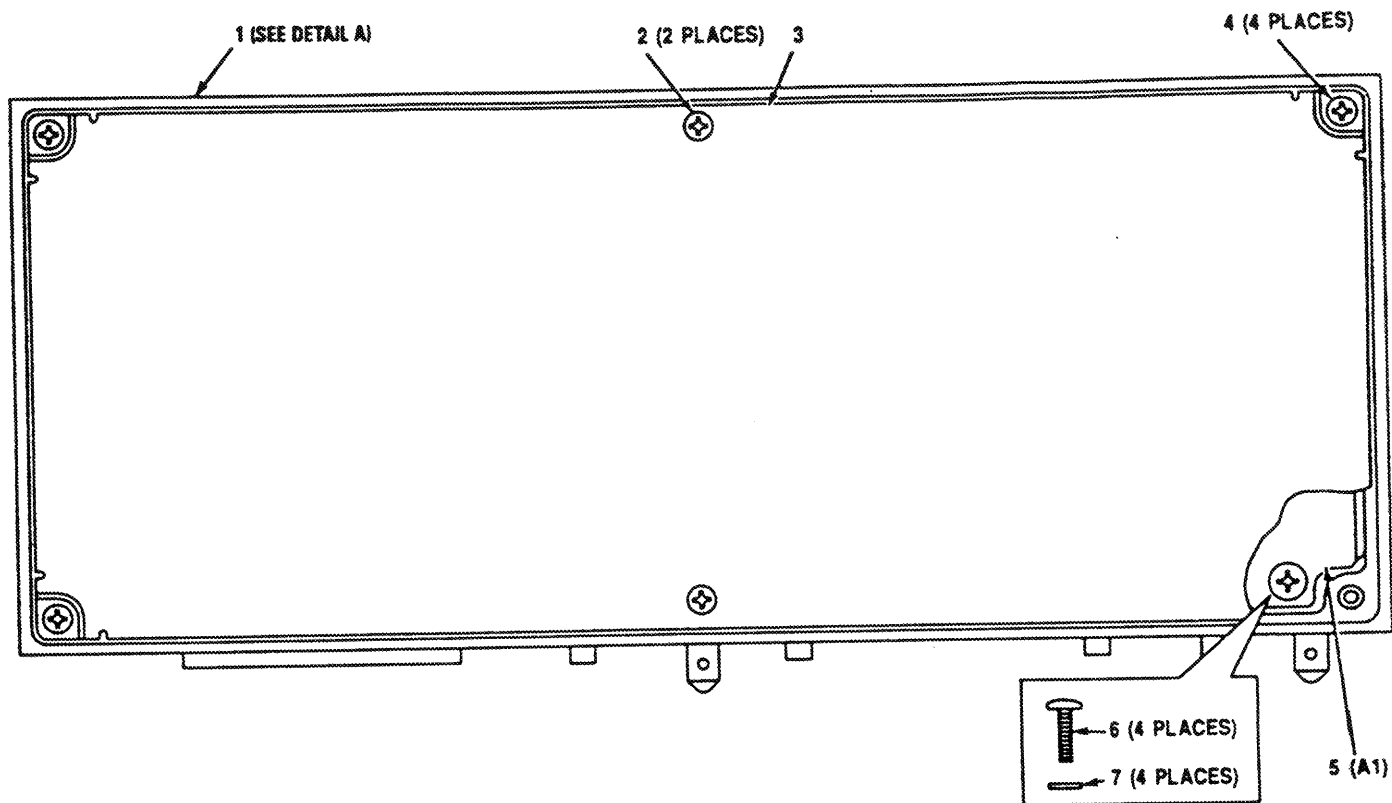

NOTES: 1. PREFIX ALL REFERENCE DESIGNATIONS WITH A8

2. SEE FIGURE 1 FOR RESPECTIVE UNIT REFERENCE DESIGNATION PREFIX

CEOMY-101

Figure 25. RF Receiver Assembly A8 (A3024644) (Sheet 1 of 2)

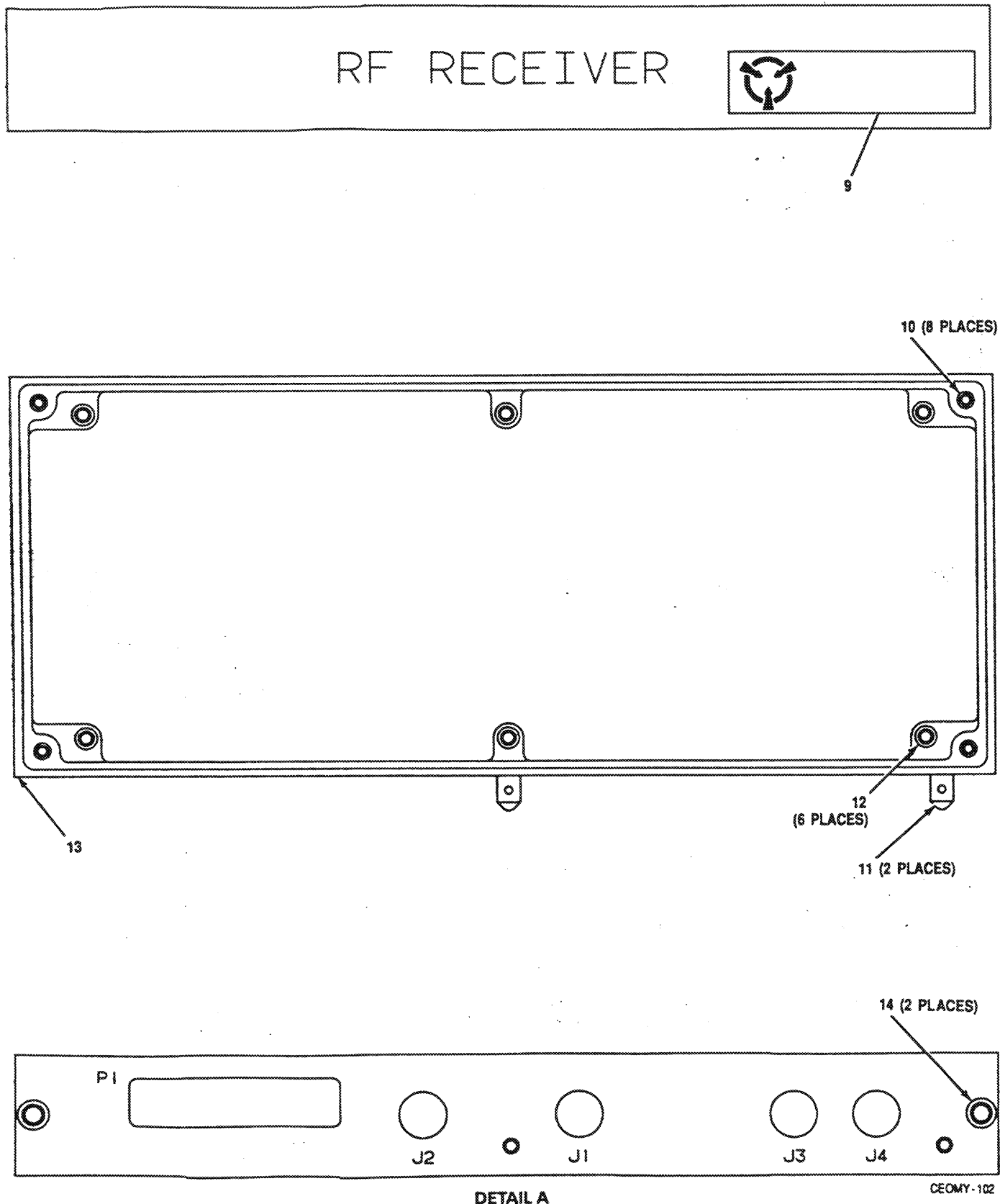

Figure 25. RF Receiver Assembly A8 (A3024644) (Sheet 2 of 2)

SECTION II			TM11-5895-1303-24P	(5)	(6)
(1)	(2)	(3)	(4)		
ITEM	SMR	FSCM	PART	DESCRIPTION AND USABLE ON CODES(UOC)	QTY
NO	CODE		NUMBER	GROUP 08 RF RECEIVER ASSEMBLY A8 (A3024644)	

FIG. 25

1	XBHLL	80063	A3028054	MODULE FRAME ASSEMB.....	1
2	PAHZZ	96906	MS51957-17	SCREW,MACHINE.....	2
3	XBHZZ	80063	A3086533	COVER ASSEMBLY--REC.....	1
4	PAHZZ	96906	MS51957-2	SCREW,MACHINE.....	8
5	PAHLD	80063	A3024645	CIRCUIT CARD ASSEMB (SEE FIG. 26 FOR BREAKDOWN).....	1
6	PAHZZ	96906	MS51957-13	SCREW,MACHINE.....	4
7	PAHZZ	80205	NAS620C4	WASHER,FLAT.....	4
8	XBHZZ	80063	A3028053	COVER,MODULE.....	1
9	XBHZZ	80063	A3034572	LABEL,SENSITIVE.....	1
10	PAHZZ	26344	3585-02CNW0129	INSERT,SCREW THREAD.....	8
11	XBHZZ	80063	A3028102	PIN,GUIDE--MODULE.....	2
12	PAHZZ	96906	MS21209C0415L	INSERT,SCREW THREAD.....	6
13	XBHZZ	80063	A3028055	FRAME,MODULE--RF RE.....	1
14	PAHZZ	96906	MS21209C0815L	INSERT,SCREW THREAD.....	2

END OF FIGURE

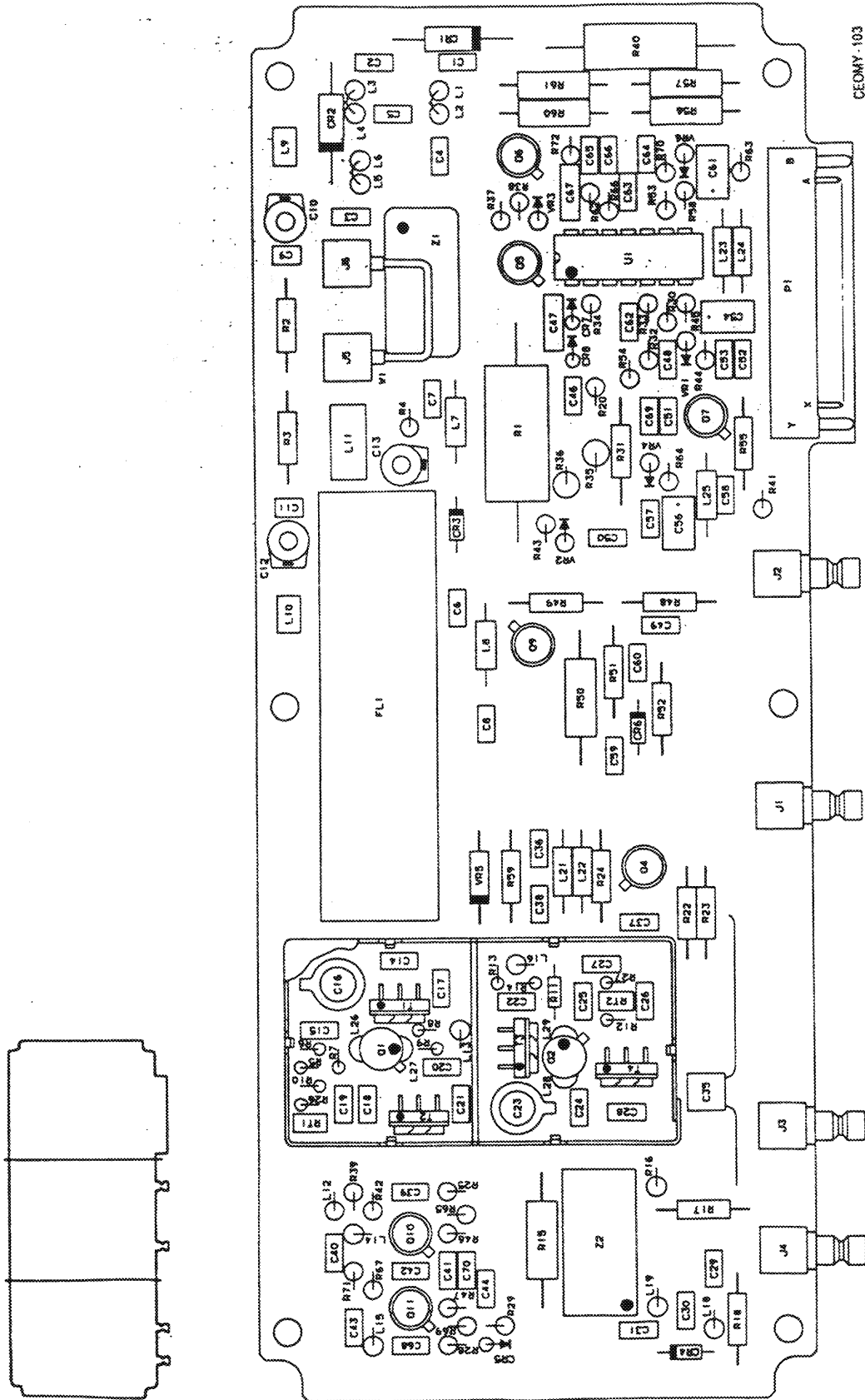

CEOMY-103

Figure 26. RF Receiver CCA 8BA1 (A3024645) (Sheet 1 of 5)

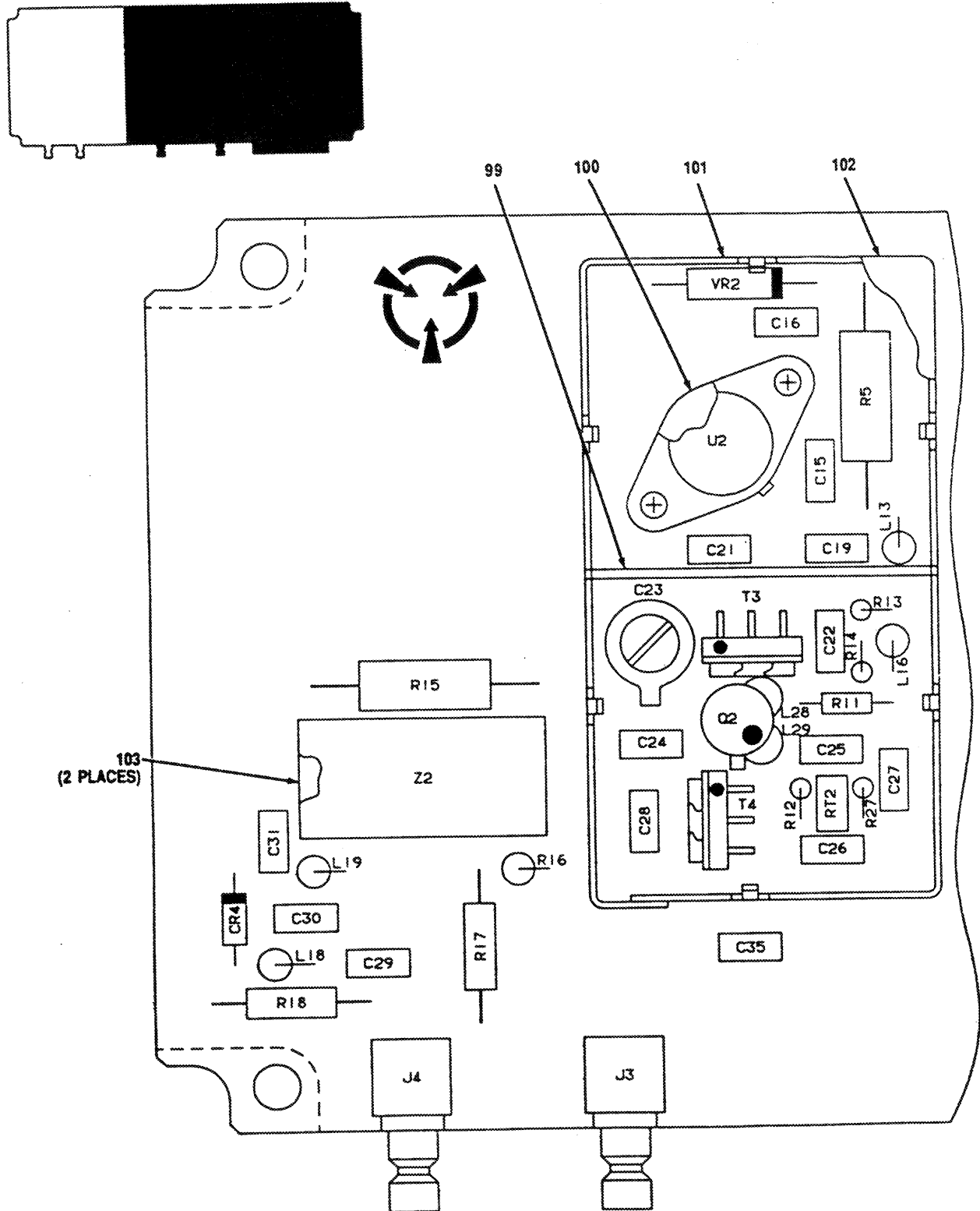

- NOTES: 1. PREFIX ALL REFERENCE DESIGNATIONS WITH ASA1  
 2. SEE FIGURE 1 FOR RESPECTIVE UNIT REFERENCE DESIGNATION PREFIX

CEOMY-104

Figure 26. RF Receiver CCA A8A1 (A3024645) (Sheet 2 of 5)



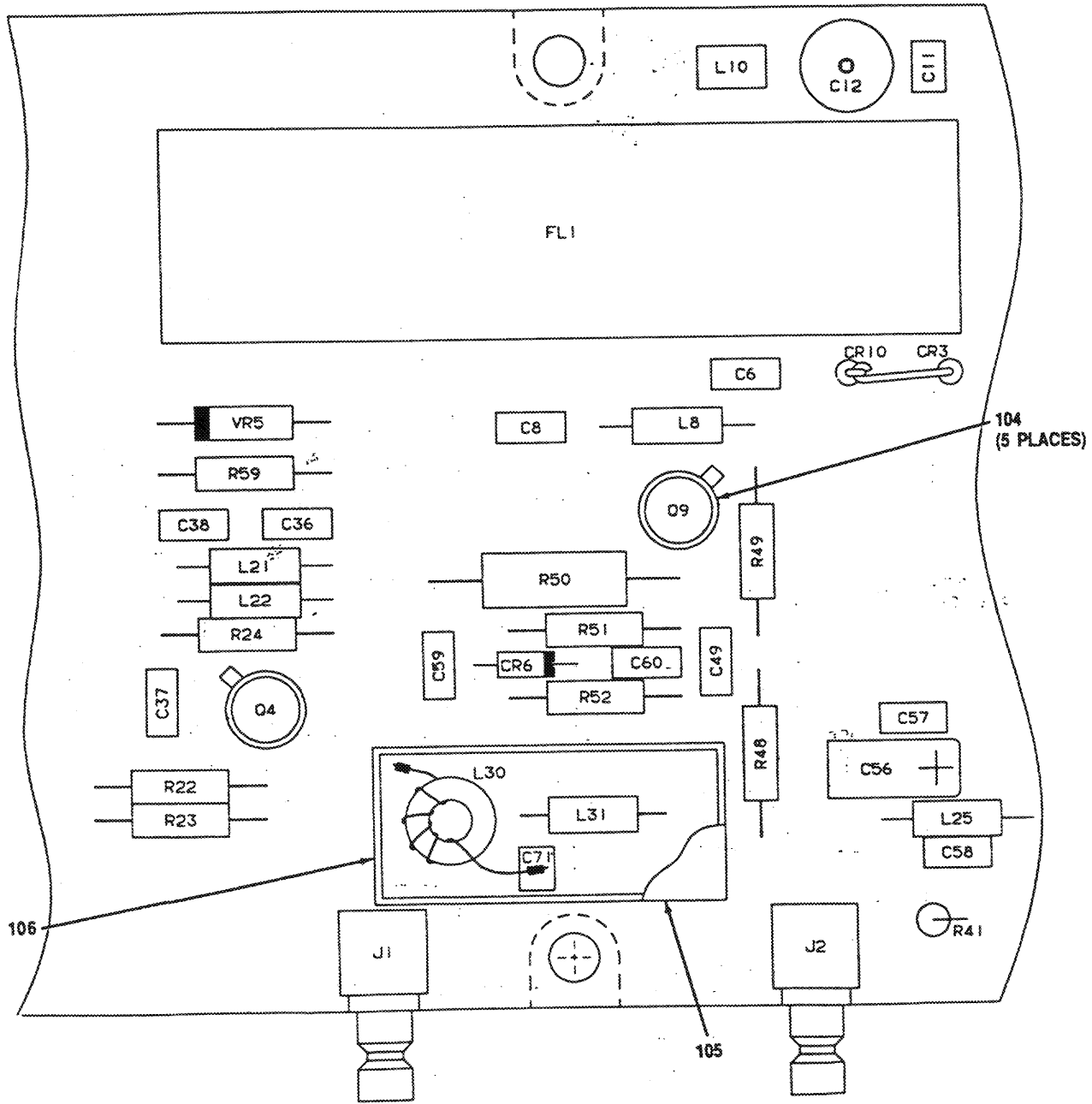
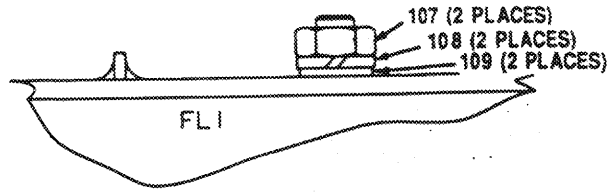
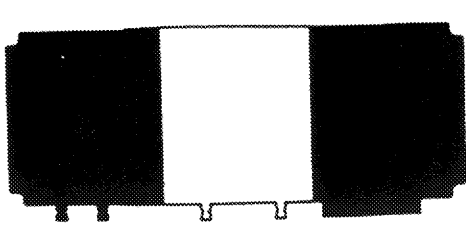

CEOMY-105

Figure 26. RF Receiver CCA A8A1 (A3024645) (Sheet 3 of 5)

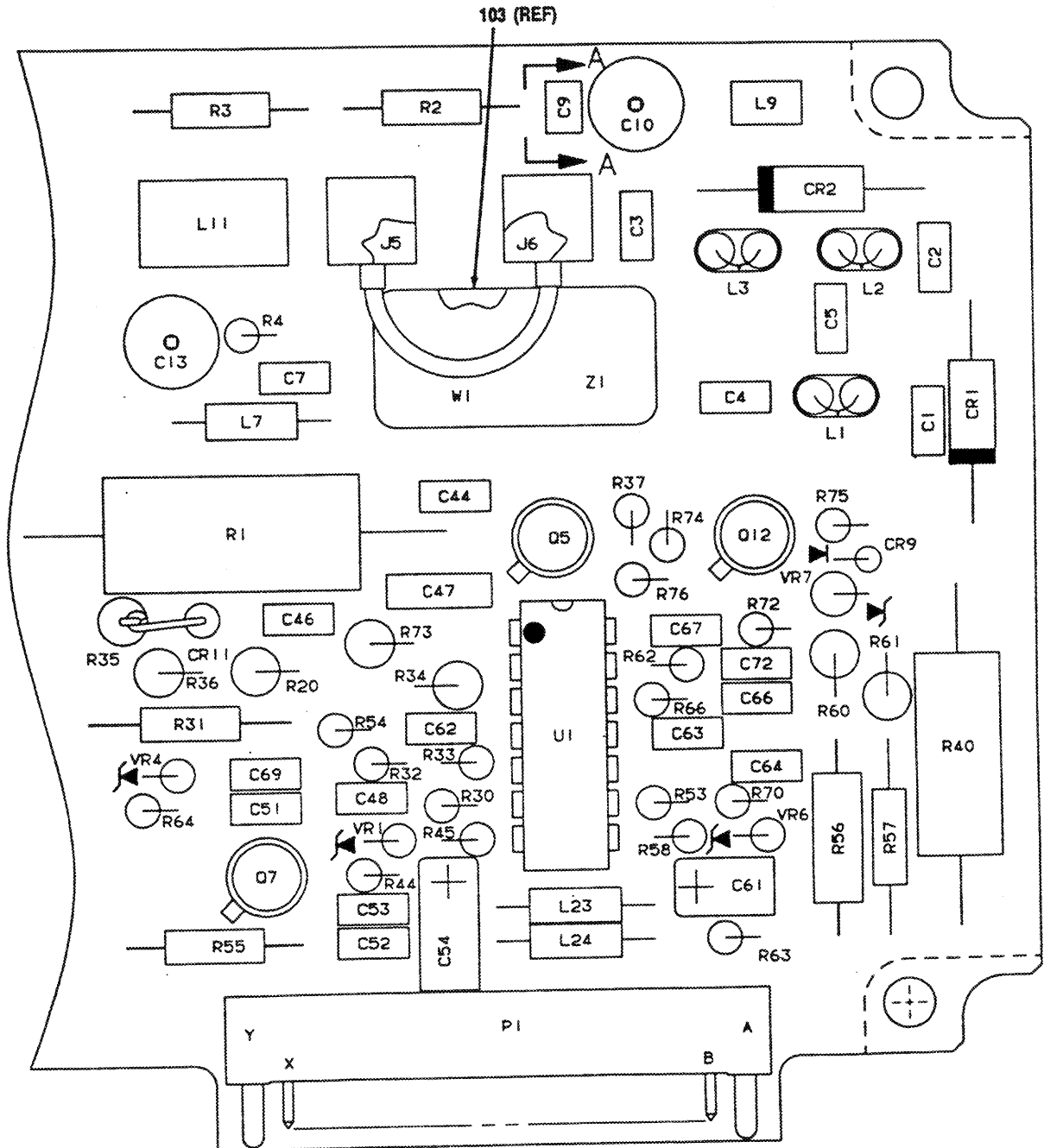
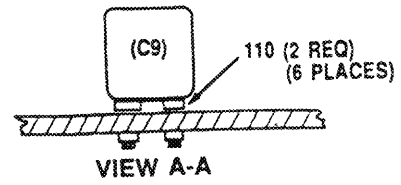
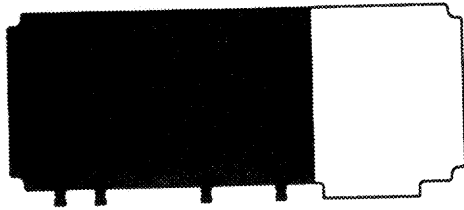

CEOMY-108

Figure 26. RF Receiver CCA A8A1 (A3024645) (Sheet 4 of 5)

LEGEND

REF. DES.	ITEM NO.	REF. DES.	ITEM NO.	REF. DES.	ITEM NO.	REF. DES.	ITEM NO.	REF. DES.	ITEM NO.	REF. DES.	ITEM NO.
CR1	1	C27	6	C71	15	L31	30	R33	49	R57	80
CR2	1	C28	10	C72	16	P1	31	R34	47	R58	52
CR3	2	C29	6	C73	17	Q2	32	R35*	55	R59	52
CR4	2	C30	6	FL1	18	Q4	33	R35*	56	R60	81
CR6	3	C31	6	J1	19	Q5	33	R35*	57	R61	67
CR9	4	C35	5	J2	19	Q7	34	R35*	58	R62	77
CR10	2	C36	5	J3	19	Q9	33	R35*	59	R63	52
C1	5	C37	5	J4	19	Q12	34	R35*	60	R64	82
C2	5	C38	6	J5	20	RT2	35	R35*	61	R66	77
C3	5	C44	10	J6	20	R1	36	R35*	62	R70	77
C4	5	C46	5	L1	21	R2	37	R35*	63	R72	83
C5	5	C47	12	L2	21	R3	37	R35*	64	R73	84
C6	6	C48	6	L3	21	R4	38	R35*	65	R74	85
C7	6	C49	10	L7	22	R5	39	R35*	66	R75	86
C8	6	C51	5	L8	22	R11	40	R35*	67	R76	87
C9	7	C52	6	L9	23	R12	41	R36	68	T3	88
C10	8	C53	5	L10	23	R13	42	R37	69	T4	89
C11	7	C54	13	L11	24	R14	43	R40	70	U1	90
C12	8	C56	13	L13	25	R15	44	R41	71	U2	91
C13	8	C57	5	L16	25	R16	45	R44	49	VR1	92
C14	9	C58	6	L18	22	R17	46	R45	72	VR2	93
C15	6	C59	5	L19	22	R18	45	R48	69	VR4	94
C16	5	C60	5	L21	26	R20	47	R49	73	VR5	94
C19	6	C61	14	L22	27	R22	48	R50	74	VR6	93
C21	10	C62	6	L23	26	R23	49	R51	75	VR7	95
C22	10	C63	6	L24	26	R24	50	R52	76	W1	96
C23	11	C64	5	L25	26	R27	51	R53	77	Z1	97
C24	6	C66	5	L28	28	R30	52	R54	78	Z2	98
C25	10	C67	5	L29	28	R31	53	R55	78		
C26	6	C69	5	L30	29	R32	54	R56	79		

\* Select At Test

CEOMY-107

Figure 26. RF Receiver CCA A8A1 (A3024645) (Sheet 5 of 5)

SECTION II TM11-5895-1303-24P (5) (6)  
 (1) (2) (3) (4) (5) (6)  
 ITEM SMR FSCM PART DESCRIPTION AND USABLE ON CODES(UOC) QTY  
 NO CODE FSCM NUMBER

GROUP 0801 RF RECEIVER CCA A8A1  
 (A3024645)

FIG. 26

1	PAHZZ	12969	UM4301B	SEMICONDUCTOR DEVIC.....	2
2	PAHZZ	56996	B4006210-902	SEMICONDUCTOR DEVIC.....	3
3	PAHZZ	81349	JANTX1N5712	SEMICONDUCTOR DEVIC.....	1
4	PAHZZ	81349	JANTX1N4454-1	SEMICONDUCTOR DEVIC.....	1
5	PAHZZ	81349	M39014/01-1593	CAPACITOR, FIXED, CER.....	19
6	PAHZZ	81349	M39014-01-1575	CAPACITOR, FIXED, CER.....	17
7	PAHZZ	81349	CCR09CG201JP	CAPACITOR, FIXED, CER.....	2
8	PAHZZ	91293	9615	CAPACITOR, VARIABLE,.....	3
9	PAHZZ	81349	CDR01BX102BKUP	CAPACITOR, CHIP.....	1
10	PAHZZ	81349	M39014/01-1357	CAPACITOR, FIXED, CER.....	6
11	PAHZZ	91293	8052	CAPACITOR, VARIABLE,.....	1
12	PAHZZ	81349	M39014/02-1357	CAPACITOR, FIXED, CER.....	1
13	PAHZZ	56996	B4003327-3326	CAPACITOR, FIXED, ELE.....	2
14	PAHZZ	56996	B4003327-3234	CAPACITOR, FIXED, ELE.....	1
15	PAHZZ	81349	CDR14BP130EJUP	CAPACITOR, FIXED, MIC.....	1
16	PAHZZ	81349	M39014/01-1587	CAPACITOR, FIXED, CER.....	1
17	PAHZZ	81349	CDR14BG101EKUPX	CAPACITOR, FIXED, ELE.....	1
18	PAHZZ	80063	A3023935	FILTER, BAND PASS.....	4
19	PAHZZ	19505	2010-6511-002	CONNECTOR, RECEPTACL.....	2
20	PAHZZ	19505	2009-6511-000	CONNECTOR, RECEPTACL.....	3
21	XBHZZ	80063	A3034554-1	COIL, ASSEMBLY.....	4
22	PAHZZ	96906	MS75084-4	COIL, RADIO FREQUENC.....	2
23	PAHZZ	80063	A3032107-2	COIL, RADIO FREQUENC.....	1
24	PAHZZ	80063	A3032107-1	COIL, RADIO FREQUENC.....	2
25	PAHZZ	96906	MS75084-3	COIL, RADIO FREQUENC.....	4
26	PAHZZ	96906	MS75085-7	COIL, RADIO FREQUENC.....	1
27	PAHZZ	96906	MS75085-19	COIL, RADIO FREQUENC.....	2
28	PAHZZ	02114	56-59065/4B	BEAD ELECT.....	1
29	PAHZZ	80063	A3024684-13	COIL, RADIO FREQUENC.....	1
30	PAHZZ	96906	MS75083-3	COIL, RADIO FREQUENC.....	1
31	PAHZZ	81349	M55302/4-03	CONNECTOR, RECEPTACL.....	1
32	PAHZZ	56996	B4003371-904	TRANSISTOR.....	3
33	PAHZZ	81349	JANTX2N2222A	TRANSISTOR.....	2
34	PAHZZ	81349	JANTXV2N2907A	TRANSISTOR.....	1
35	PAHZZ	37695	238283-1	RESISTOR, THERMAL.....	1
36	PAHZZ	81349	RCR42G201JS	RESISTOR, FIXED, COMP.....	2
37	PAHZZ	81349	RCR07G101JS	RESISTOR, FIXED, COMP.....	1
38	PAHZZ	81349	RCR07G511JS	RESISTOR, FIXED, COMP.....	1
39	PAHZZ	81349	RLR20C2400GS	RESISTOR, FIXED, FILM.....	1
40	PAHZZ	81349	RCR05G103JS	RESISTOR, FIXED, COMP.....	1
41	PAHZZ	81349	RCR05G270JS	RESISTOR, FIXED, COMP.....	1
42	PAHZZ	81349	RCR05G104JS	RESISTOR, FIXED, COMP.....	1
43	PAHZZ	81349	RCR05G474JS	RESISTOR, FIXED, COMP.....	1
44	PAHZZ	81349	RCR20G102JS	RESISTOR, FIXED, COMP.....	2
45	PAHZZ	81349	RCR07G301JS	RESISTOR, FIXED, COMP.....	1
46	PAHZZ	81349	RCR07G160JS	RESISTOR, FIXED, COMP.....	1

SECTION II			TM11-5895-1303-24P			
(1)	(2)	(3)	(4)	(5)	(6)	
ITEM NO	SMR CODE	FSCM	PART NUMBER	DESCRIPTION AND USABLE ON CODES(UOC)	QTY	
47	PAHZZ	81349	RNC55H2742FS	RESISTOR, FIXED, FILM.....	2	
48	PAHZZ	81349	RCR07G752JS	RESISTOR, FIXED, COMP.....	1	
49	PAHZZ	81349	RCR07G222JS	RESISTOR, FIXED, COMP.....	3	
50	PAHZZ	81349	RCR07G391JS	RESISTOR, FIXED, COMP.....	1	
51	PAHZZ	81349	RCR05G911JS	RESISTOR, FIXED, COMP.....	1	
52	PAHZZ	81349	RCR07G102JS	RESISTOR, FIXED, COMP.....	4	
53	PAHZZ	81349	RCR07G273JS	RESISTOR, FIXED, COMP.....	1	
54	PAHZZ	81349	RCR07G822JS	RESISTOR, FIXED, COMP.....	1	
55	PAHZZ	81349	RNC55H4321FS	RESISTOR, FIXED, FILM (SELECT AT TEST).....	1	
56	PAHZZ	81349	RNC55H4421FS	RESISTOR, FIXED, FILM (SELECT AT TEST).....	1	
57	PAHZZ	81349	RNC55H4641FS	RESISTOR, FIXED, FILM (SELECT AT TEST).....	1	
58	PAHZZ	81349	RNC55H4751FS	RESISTOR, FIXED, FILM (SELECT AT TEST).....	1	
59	PAHZZ	81349	RNC55H4871FS	RESISTOR, FIXED, FILM (SELECT AT TEST).....	1	
60	PAHZZ	81349	RNC55H4991FS	RESISTOR, FIXED, FILM (SELECT AT TEST).....	1	
61	PAHZZ	81349	RNC55H5111FS	RESISTOR, FIXED, FILM (SELECT AT TEST).....	1	
62	PAHZZ	81349	RNC55H5231FS	RESISTOR, FIXED, FILM (SELECT AT TEST).....	1	
63	PAHZZ	81349	RNC55H5361FS	RESISTOR, FIXED, FILM (SELECT AT TEST).....	1	
64	PAHZZ	81349	RNC55H5491FS	RESISTOR, FIXED, FILM (SELECT AT TEST).....	1	
65	PAHZZ	81349	RNC55H5621FS	RESISTOR, FIXED, FILM (SELECT AT TEST).....	1	
66	PAHZZ	81349	RNC55H5761FS	RESISTOR, FIXED, FILM (SELECT AT TEST).....	1	
67	PAHZZ	81349	RNC55H4531FS	RESISTOR, FIXED, FILM (SELECT AT TEST R35).....	1	
68	PAHZZ	81349	RNC55H1272FS	RESISTOR, FIXED, FILM.....	1	
69	PAHZZ	81349	RCR07G132JS	RESISTOR, FIXED, COMP.....	2	
70	PAHZZ	81349	RCR32G391JS	RESISTOR, FIXED, COMP.....	1	
71	PAHZZ	81349	RCR07G332JS	RESISTOR, FIXED, COMP.....	1	
72	PAHZZ	81349	RCR07G562JS	RESISTOR, FIXED, COMP.....	1	
73	PAHZZ	81349	RCR07G242JS	RESISTOR, FIXED, COMP.....	1	
74	PAHZZ	81349	RCR20G681JS	RESISTOR, FIXED, COMP.....	1	
75	PAHZZ	81349	RLR07C5100GS	RESISTOR, FIXED, FILM.....	1	
76	PAHZZ	81349	RCR07G334JS	RESISTOR, FIXED, COMP.....	1	
77	PAHZZ	81349	RCR07G103JS	RESISTOR, FIXED, COMP.....	4	
78	PAHZZ	81349	RCR07G240JS	RESISTOR, FIXED, COMP.....	2	
79	PAHZZ	81349	RNC55H1102FS	RESISTOR, FIXED, FILM.....	1	
80	PAHZZ	81349	RLR07C6200GS	RESISTOR, FIXED, FILM.....	1	
81	PAHZZ	81349	RNC55H1002FS	RESISTOR, FIXED, FILM.....	1	
82	PAHZZ	81349	RCR07G152JS	RESISTOR, FIXED, COMP.....	1	
83	PAHZZ	81349	RNC55H6192FS	RESISTOR, FIXED, FILM.....	1	
84	PAHZZ	81349	RNC55H5362FS	RESISTOR, FIXED, FILM.....	1	
85	PAHZZ	81349	RCR07G622JS	RESISTOR, FIXED, COMP.....	1	

SECTION II			TM11-5895-1303-24P			(6)
(1)	(2)	(3)	(4)	(5)		
ITEM NO	SMR CODE	FSCM	PART NUMBER	DESCRIPTION AND USABLE ON CODES(UOC)		QTY
86	PAHZZ	81349	RCR07G823JS	RESISTOR, FIXED, COMP.....		1
87	PAHZZ	81349	RCR07G100JS	RESISTOR, FIXED, COMP.....		1
88	PAHZZ	80063	A3024684-11	TRANSFORMER.....		1
89	PAHZZ	80063	A3024684-9	TRANSFORMER.....		1
90	PAHZZ	81349	M38510/11001BCB	MICROCIRCUIT, LINEAR.....		1
91	PAHZZ	14482	WJ-EA53S	MICROCIRCUIT, LINEAR.....		1
92	PAHZZ	81349	JANTX1N750A1	SEMICONDUCTOR DEVIC.....		1
93	PAHZZ	81349	JANTX1N752A-1	SEMICONDUCTOR DEVIC.....		2
94	PAHZZ	81349	JANT1N753A-1	SEMICONDUCTOR DEVIC.....		2
95	PAHZZ	81349	JANTX1N756A1	SEMICONDUCTOR DEVIC.....		1
96	PAHZZ	80063	A3032127	CABLE ASSEMBLY, RADI.....		1
97	PAHZZ	15542	TAK-390125	MIXER, RADIO FREQUEN.....		1
98	PAHZZ	81349	M28837/1-02N	MIXER STAGES, RADIO.....		1
99	PAHZZ	80063	A3028651	PARTITION, SHIELD--R.....		1
100	PAHZZ	81349	M38527/02-018N	MOUNTING PAD, ELECTR.....		1
101	PAHZZ	80063	A3028649	PARTITION, SHIELD--R.....		1
102	PAHZZ	80063	A3028652	COVER, SHIELD--RY.....		1
103	PAHZZ	80063	A3034171	INSULATOR, MIXER.....		2
104	PAHZZ	81349	M38527/03-002N	MOUNTING PAD, ELECTR.....		5
105	PAHZZ	80063	A3035718	PLATE, ELECTRICAL SH.....		1
106	PAHZZ	80063	A3035717	ENCLOSURE, ELECTROMA.....		1
107	PAHZZ	80205	NAS671C4	NUT, PLAIN, HEXAGON.....		2
108	PAHZZ	96906	MS35338-135	WASHER, LOCK.....		2
109	PAHZZ	80205	NAS620C4	WASHER, FLAT.....		2
110	PAHZZ	80063	A3032601-3	SPACER, SLEEVE.....		12

END OF FIGURE

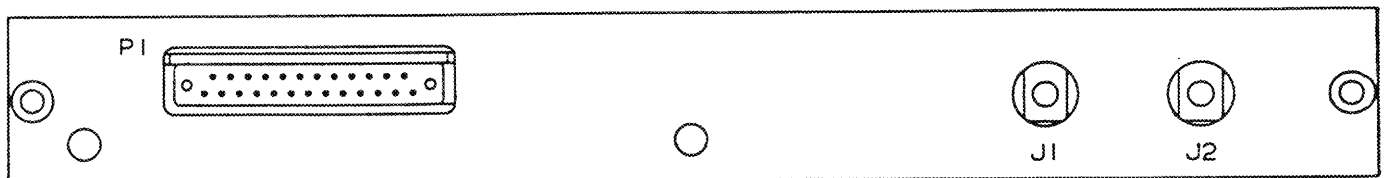
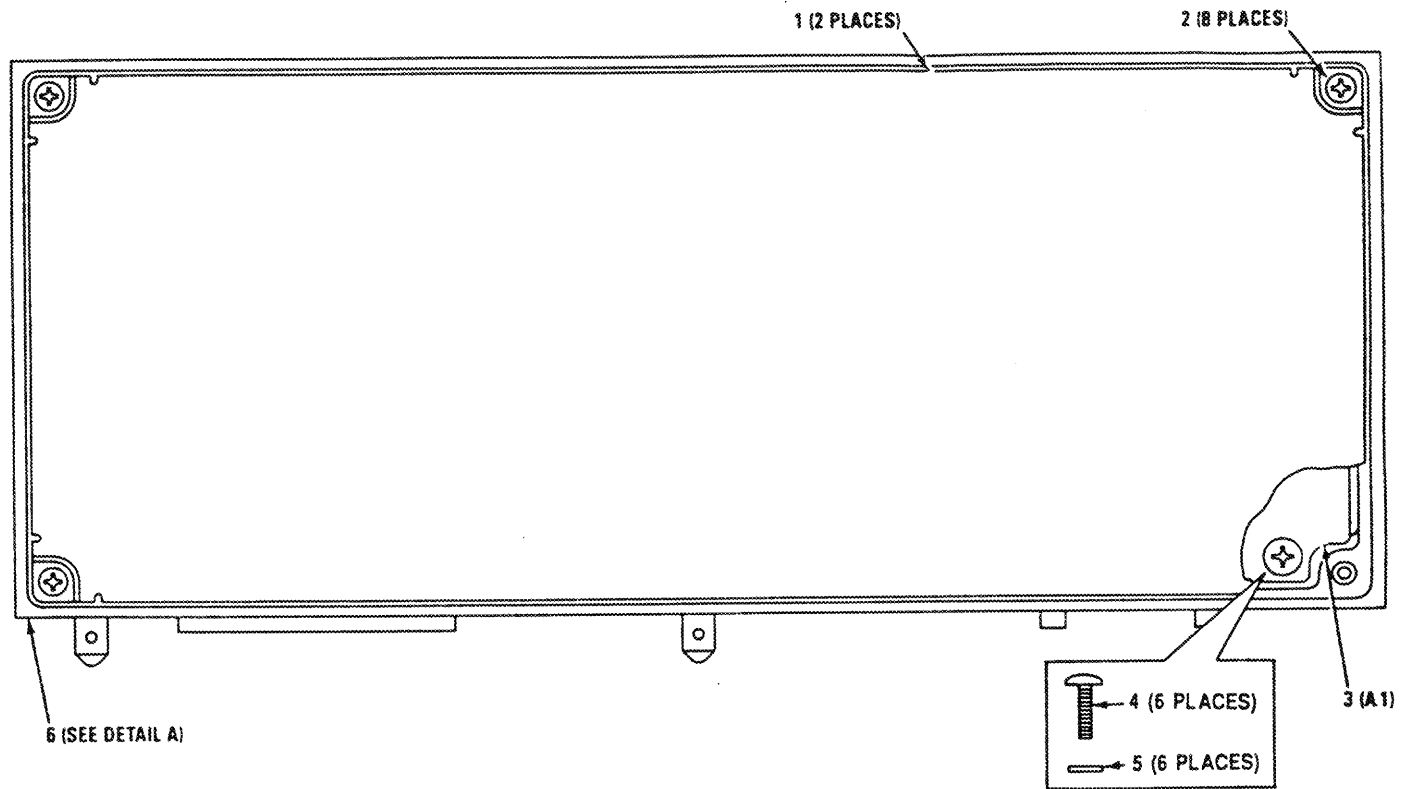

NOTES: 1. PREFIX ALL REFERENCE DESIGNATIONS WITH A9  
2. SEE FIGURE 1 FOR RESPECTIVE UNIT REFERENCE DESIGNATION PREFIX

CEOMY-108

Figure 27. IF Receiver Assembly A9 (A3024639) (Sheet 1 of 2)

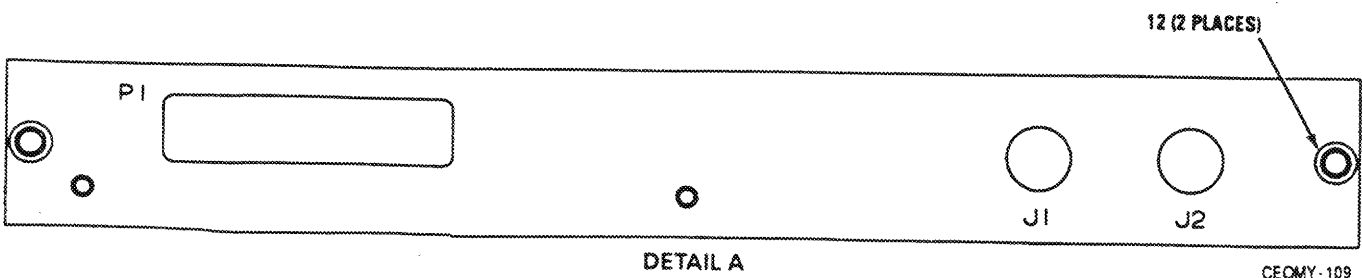
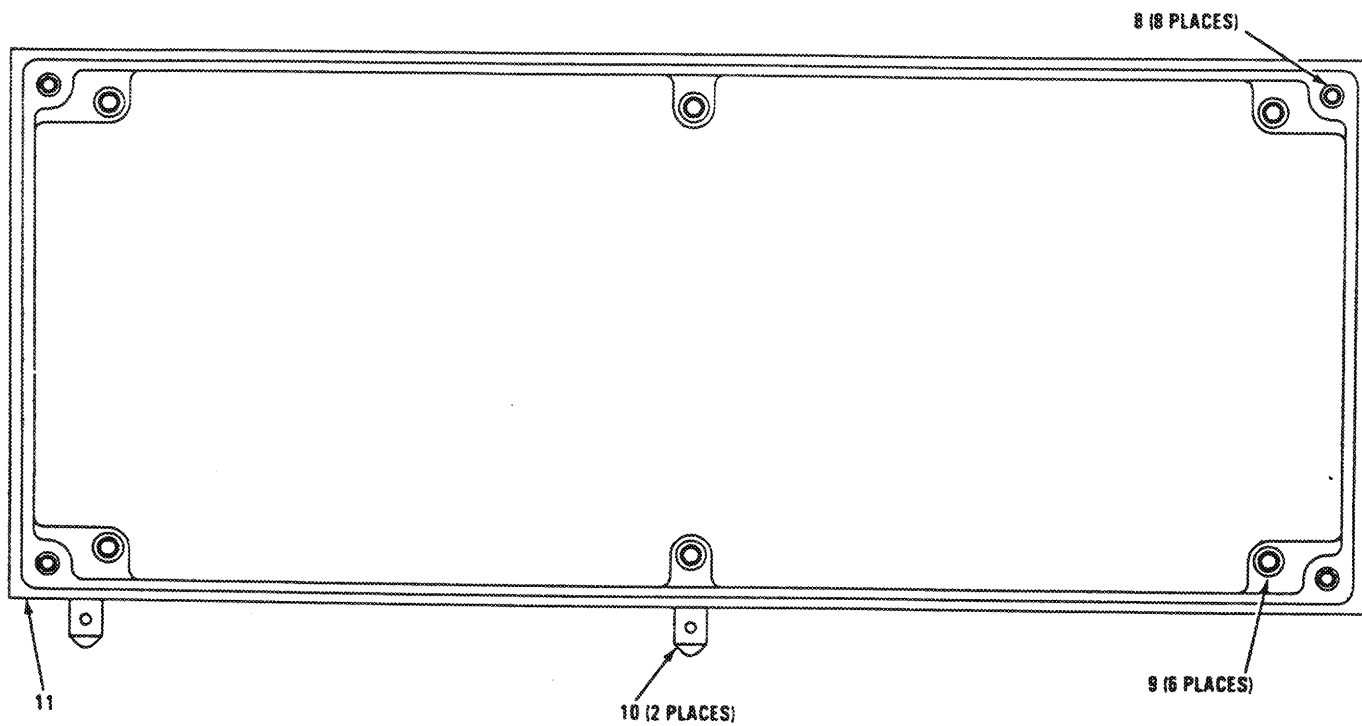

CEOMY-109

Figure 27. IF Receiver Assembly A9 (A3024639) (Sheet 2 of 2)



SECTION II			TM11-5895-1303-24P	(5)	(6)
(1)	(2)	(3)	(4)		
ITEM	SMR		PART		
NO	CODE	FSCM	NUMBER	DESCRIPTION AND USABLE ON CODES(UOC)	QTY

GROUP 09 IF RECEIVER ASSEMBLY A9  
(A3024639)

FIG. 27

1	XBHZZ	80063	A3028053	COVER,MODULE.....	2
2	PAHZZ	96906	MS51957-2	SCREW,MACHINE.....	8
3	PAHLD	80063	A3024640	CIRCUIT CARD ASSEMB (SEE FIG. 28 FOR BREAKDOWN).....	1
4	PAHZZ	96906	MS51957-13	SCREW,MACHINE.....	6
5	PAHZZ	80205	NAS620C4	WASHER,FLAT.....	6
6	XBHLL	80063	A3028051	MODULE FRAME ASSEMB.....	1
7	XBHZZ	80063	A3034572	LABEL,SENSITIVE.....	1
8	PAHZZ	26344	3585-02CNW0129	INSERT,SCREW THREAD.....	8
9	PAHZZ	96906	MS21209C0415L	INSERT,SCREW THREAD.....	6
10	XBHZZ	80063	A3028102	PIN,GUIDE--MODULE.....	2
11	XBHZZ	80063	A3028052	FRAME,MODULE--IF RE.....	1
12	PAHZZ	96906	MS21209C0815L	INSERT,SCREW THREAD.....	2

END OF FIGURE

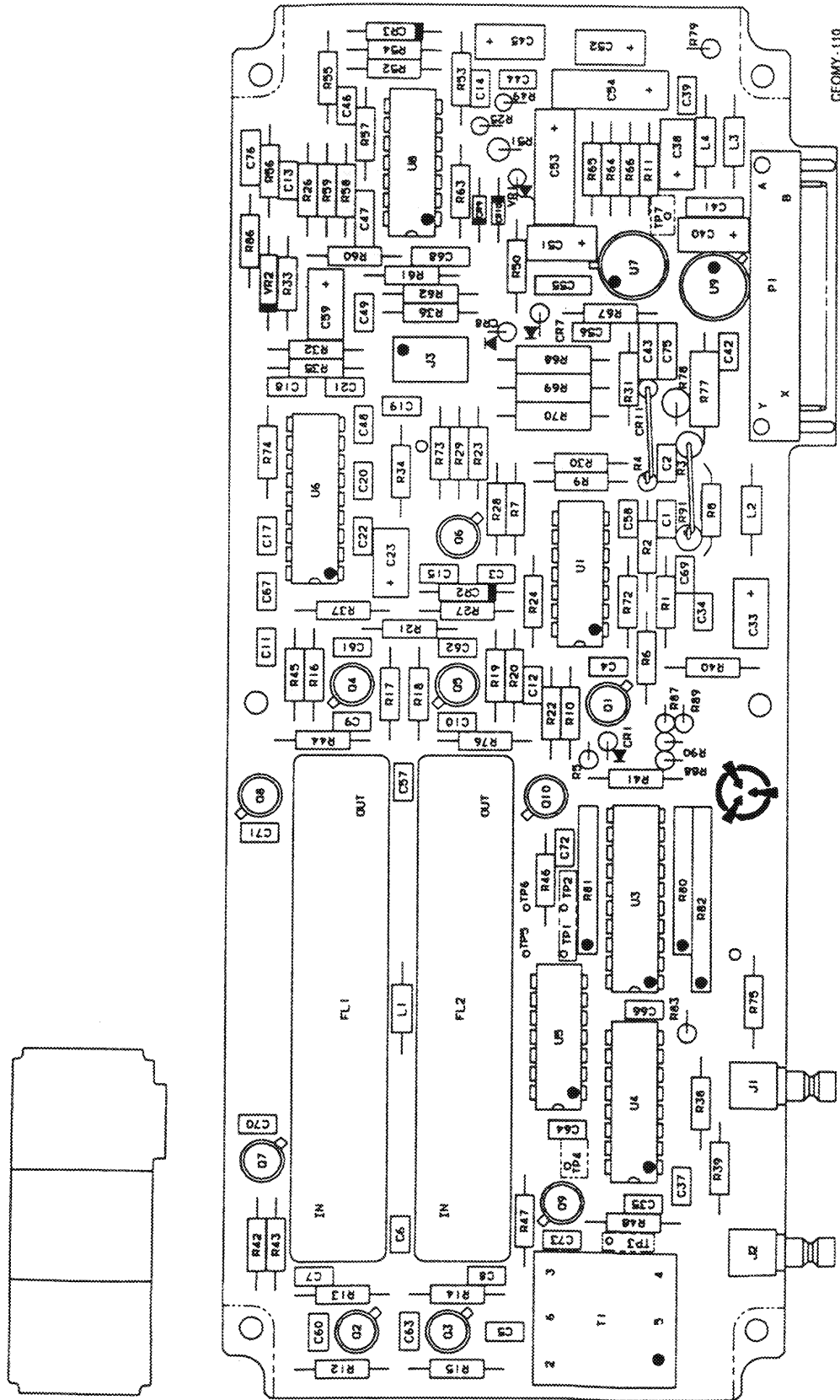

CEOMY-110

Figure 28. IF Receiver CCA A9A1 (A3024640) (Sheet 1 of 5)

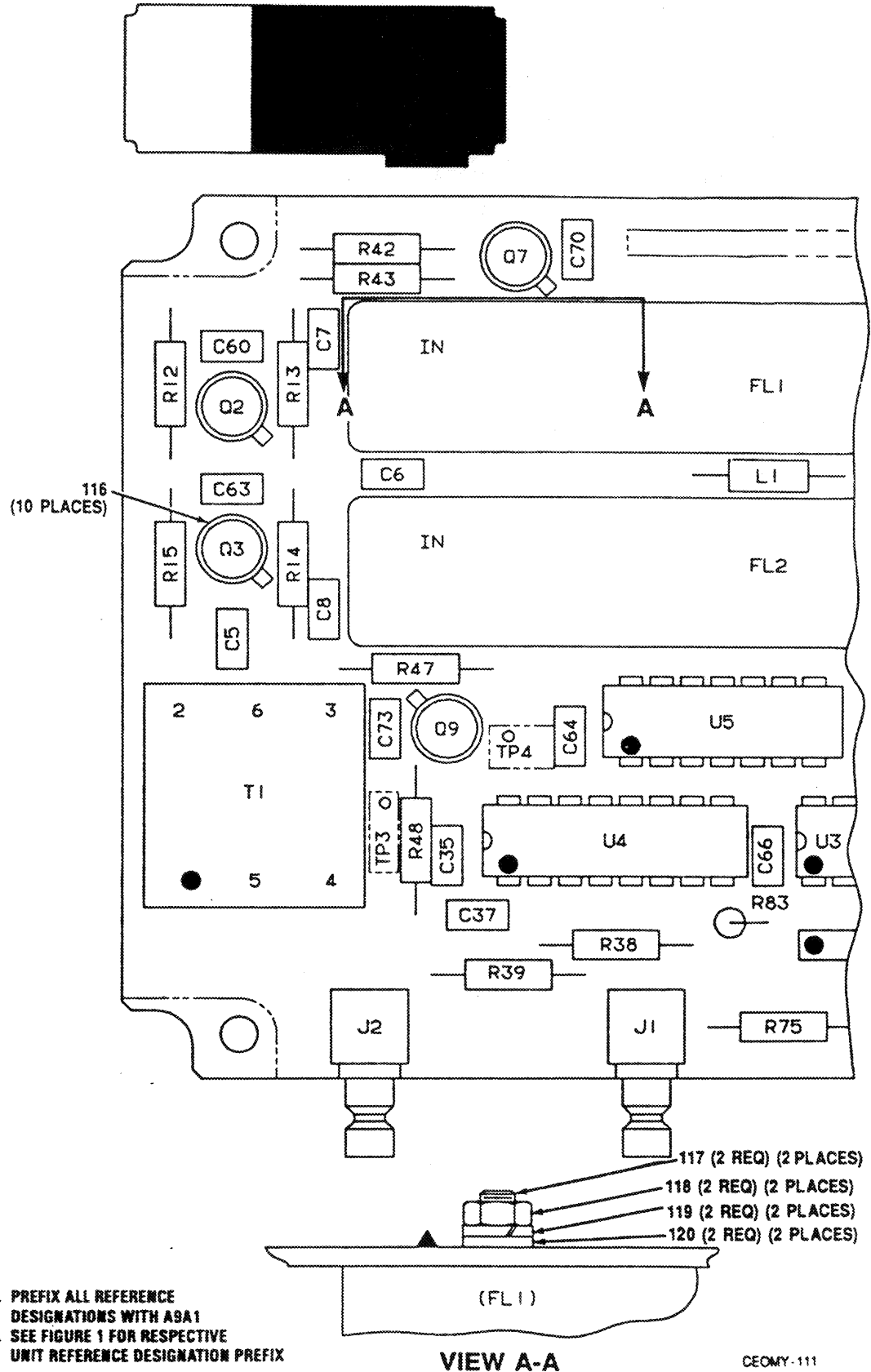
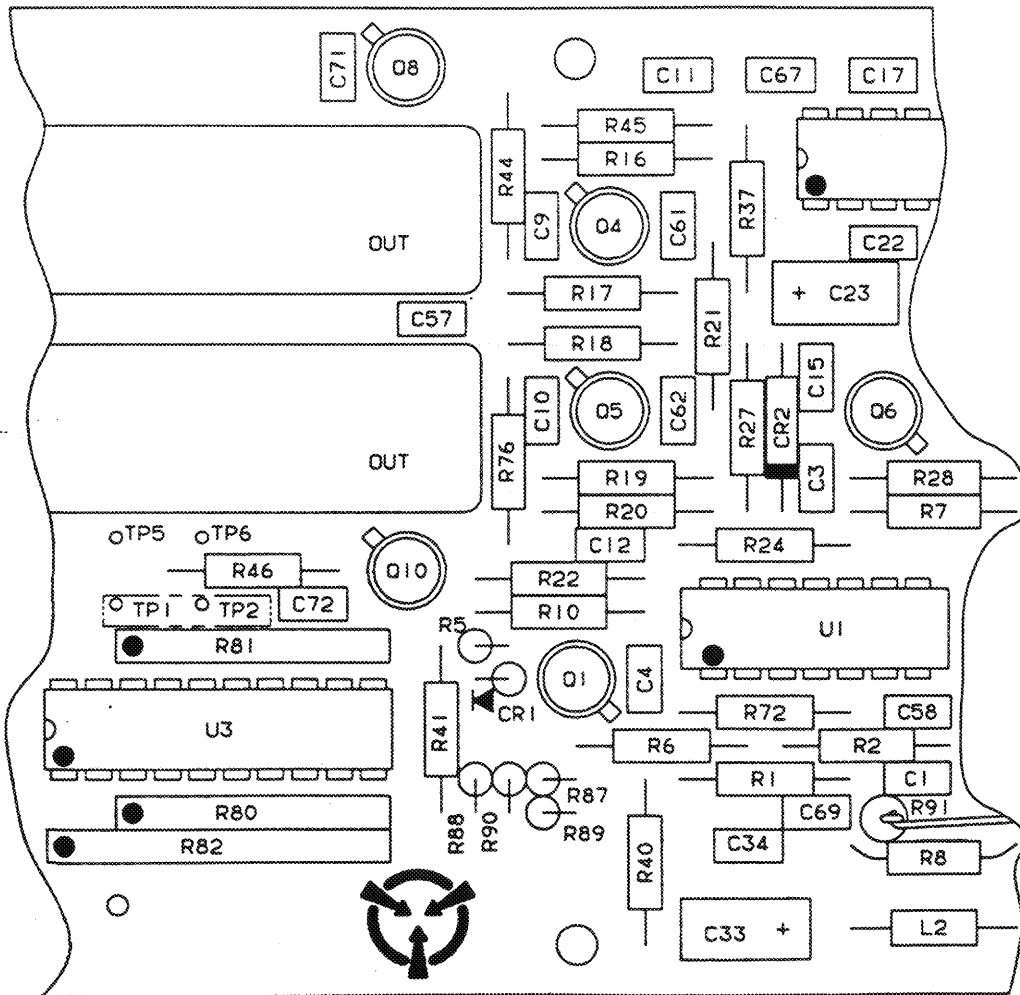
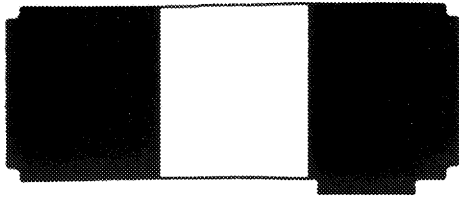
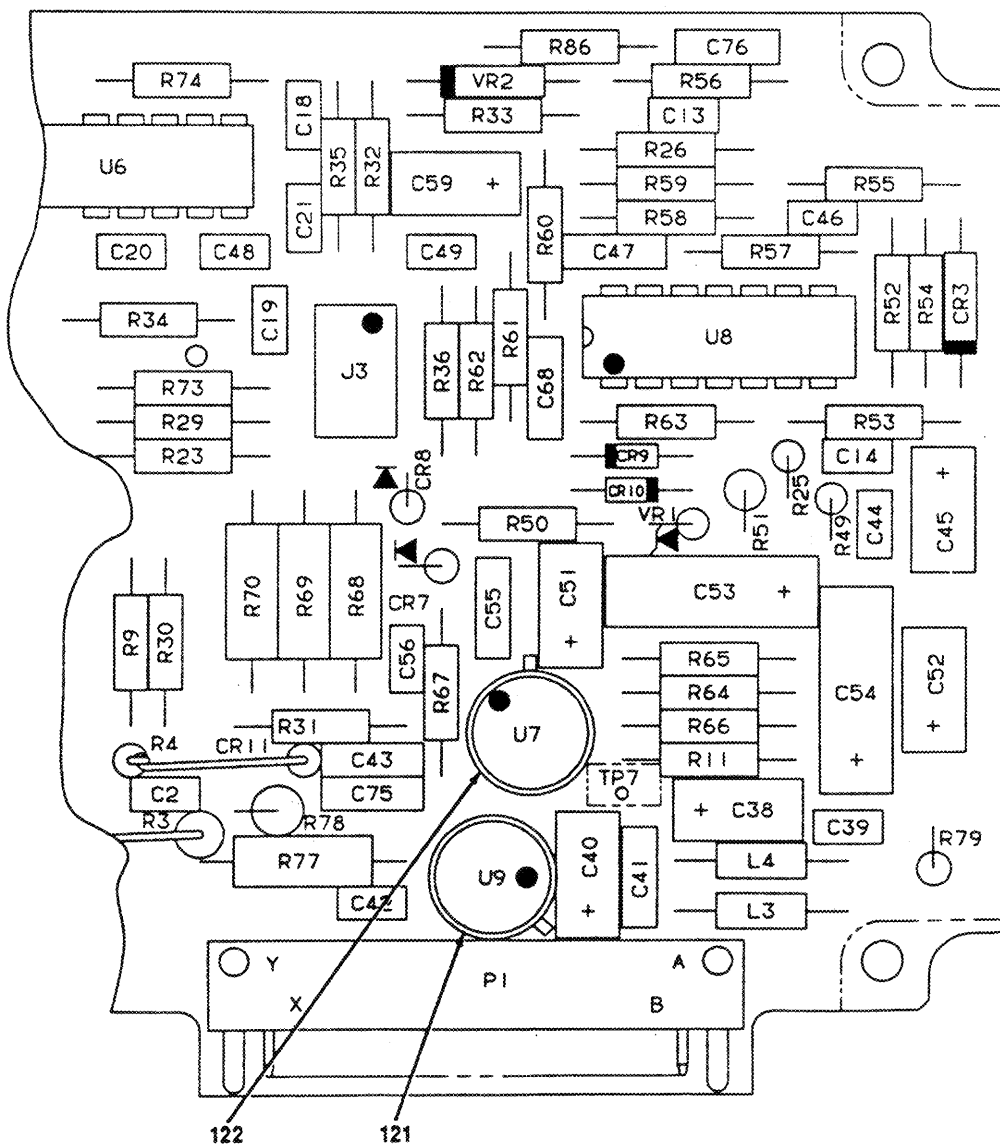

Figure 28. IF Receiver CCA A9A1 (A3024640) (Sheet 2 of 5)



GEOMY-112

Figure 28. IF Receiver CCA A9A1 (A3024640) (Sheet 3 of 5)



GEOMY-113

Figure 28. IF Receiver CCA A9A1 (A3024640) (Sheet 4 of 5)

LEGEND

REF. DES.	ITEM NO.	REF. DES.	ITEM NO.	REF. DES.	ITEM NO.	REF. DES.	ITEM NO.	REF. DES.	ITEM NO.	REF. DES.	ITEM NO.
CR1	1	C43	10	L4	21	R28	29	R54	58	R83	78
CR2	1	C44	3	P1	22	R29	32	R55	59	R86	32
CR3	1	C45	11	Q1	23	R30	36	R56	60	R87	86
CR7	1	C46	12	Q2	23	R31	37	R57	60	R88	32
CR8	1	C47	13	Q3	23	R32	38	R58*	61	R89	86
CR9	2	C48	14	Q4	23	R33	39	R58*	62	R90	32
CR10	2	C49	3	Q5	23	R34	38	R58*	63	R91*	87
CR11	1	C51	11	Q6	23	R35	30	R58*	64	R91*	88
C1	3	C52	6	Q7	24	R36	32	R58*	65	R91*	89
C2	4	C53	15	Q8	24	R37	40	R58*	66	R91*	90
C3	4	C54	15	Q9	24	R38	41	R58*	67	R91*	91
C4	3	C55	10	Q10	24	R39	29	R58*	68	R91*	92
C5	3	C56	3	R1	25	R40	32	R58*	69	R91*	93
C6	3	C57	3	R2	26	R41	32	R58*	70	R91*	94
C7	3	C58	3	R3	27	R42	42	R58*	71	R91*	95
C8	3	C59	16	R4	28	R43	35	R58*	72	R91*	96
C9	3	C60	4	R5	29	R44	42	R59	73	R91*	97
C10	3	C61	4	R6	30	R45	35	R60	29	R91*	98
C11	3	C62	4	R7	31	R46	35	R61	74	R91*	99
C12	3	C63	4	R8	32	R47	42	R62	75	R91*	100
C13	4	C64	3	R9	31	R48	35	R63	76	R91*	101
C14	4	C66	3	R10	29	R49	30	R64	77	R91*	102
C15	4	C67	3	R11	33	R50	32	R65	78	R91*	103
C17	3	C68	10	R12	34	R51	43	R66	77	R91*	104
C18	3	C69	4	R13	34	R52*	44	R67	77	R91*	105
C19	3	C70	5	R14	34	R52*	45	R68	79	T1	106
C20	3	C71	5	R15	34	R52*	46	R69	80	U1	107
C21	5	C72	5	R16	35	R52*	47	R70	81	U3	108
C22	5	C73	5	R17	34	R52*	48	R72	32	U4	109
C23	6	C75	10	R18	34	R52*	49	R73	30	U5	110
C33	7	C76	10	R19	35	R52*	50	R74	29	U6	111
C34	3	FL1	17	R20	34	R52*	51	R75	38	U7	112
C35	3	FL2	17	R21	34	R52*	52	R76	42	U8	107
C37	8	J1	18	R22	29	R52*	53	R77	82	U9	113
C38	7	J2	18	R23	29	R52*	54	R78	83	VR1	114
C39	3	J3	19	R24	29	R52*	55	R79	36	VR2	115
C40	7	L1	20	R25	31	R52*	56	R80	84		
C41	9	L2	21	R26	31	R52*	57	R81	84		
C42	3	L3	21	R27	30	R53	29	R82	85		

\* Select At Test

CEOMY-114

Figure 28. IF Receiver CCA A9A1 (A3024640) (Sheet 5 of 5)

SECTION II			TM11-5895-1303-24P	(5)	(6)
(1)	(2)	(3)	(4)		
ITEM	SMR		PART		
NO	CODE	FSCM	NUMBER	DESCRIPTION AND USABLE ON CODES(UOC)	QTY

GROUP 0901 IF RECEIVER CCA A9A1  
(A3024640)

FIG. 28

1	PAHZZ	81349	JANTX1N4454-1	SEMICONDUCTOR DEVIC.....	5
2	PAHZZ	81349	JANTX1N5712	SEMICONDUCTOR DEVIC.....	2
3	PAHZZ	81349	M39014/01-1593	CAPACITOR, FIXED, CER.....	26
4	PAHZZ	81349	M39014-01-1575	CAPACITOR, FIXED, CER.....	10
5	PAHZZ	81349	M39014/01-1357	CAPACITOR, FIXED, CER.....	6
6	PAHZZ	56996	B4003327-3244	CAPACITOR, FIXED, ELE.....	2
7	PAHZZ	56996	B4003327-3226	CAPACITOR, FIXED, ELE.....	3
8	PAHZZ	81349	M39014/01-1344	CAPACITOR, FIXED, CER.....	1
9	PAHZZ	81349	M39014/02-1358	CAPACITOR, FIXED, CER.....	1
10	PAHZZ	81349	M39014/02-1419	CAPACITOR, FIXED, CER.....	5
11	PAHZZ	56996	B4003327-3238	CAPACITOR, FIXED, ELE.....	2
12	PAHZZ	81349	M39014/01-1351	CAPACITOR, FIXED, CER.....	1
13	PAHZZ	81349	M39014/01-1259	CAPACITOR, FIXED, CER.....	1
14	PAHZZ	81349	M39014/01-1565	CAPACITOR, FIXED, CER.....	1
15	PAHZZ	56996	B4003327-3254	CAPACITOR, FIXED, ELE.....	2
16	PAHZZ	56996	B4003327-3246	CAPACITOR, FIXED, ELE.....	1
17	PAHZZ	80063	A3023936-1	FILTER, BAND PASS.....	2
18	PAHZZ	19505	2010-6511-002	CONNECTOR, RECEPTACL.....	2
19	PAHZZ	00779	87518-9	CONNECTOR, RECEPTACL.....	1
20	PAHZZ	96906	MS75085-11	COIL, RADIO FREQUENC.....	1
21	PAHZZ	96906	MS75085-7	COIL, RADIO FREQUENC.....	3
22	PAHZZ	81349	M55302/4-03	CONNECTOR, RECEPTACL.....	1
23	PAHZZ	81349	JANTX2N4861	TRANSISTOR.....	6
24	PAHZZ	81349	JANTX2N2222A	TRANSISTOR.....	4
25	PAHZZ	81349	RLR07C5600GS	RESISTOR, FIXED, FILM.....	1
26	PAHZZ	81349	RCR07G431JS	RESISTOR, FIXED, COMP.....	1
27	PAHZZ	81349	RNC55H6341FS	RESISTOR, FIXED, FILM.....	1
28	PAHZZ	81349	RNC55H1022FS	RESISTOR, FIXED, FILM.....	1
29	PAHZZ	81349	RCR07G103JS	RESISTOR, FIXED, COMP.....	10
30	PAHZZ	81349	RCR07G472JS	RESISTOR, FIXED, COMP.....	5
31	PAHZZ	81349	RCR07G240JS	RESISTOR, FIXED, COMP.....	4
32	PAHZZ	81349	RCR07G102JS	RESISTOR, FIXED, COMP.....	10
33	PAHZZ	81349	RCR07G823JS	RESISTOR, FIXED, COMP.....	1
34	PAHZZ	81349	RCR07G473JS	RESISTOR, FIXED, COMP.....	8
35	PAHZZ	81349	RCR07G752JS	RESISTOR, FIXED, COMP.....	6
36	PAHZZ	81349	RCR07G822JS	RESISTOR, FIXED, COMP.....	2
37	PAHZZ	81349	RCR07G433JS	RESISTOR, FIXED, COMP.....	1
38	PAHZZ	81349	RCR07G510JS	RESISTOR, FIXED, COMP.....	3
39	PAHZZ	81349	RCR07G5R6JS	RESISTOR, FIXED, COMP.....	1
40	PAHZZ	81349	RCR07G471JS	RESISTOR, FIXED, COMP.....	1
41	PAHZZ	81349	RCR07G512JS	RESISTOR, FIXED, COMP.....	1
42	PAHZZ	81349	RCR07G202JS	RESISTOR, FIXED, COMP.....	4
43	PAHZZ	81349	RNC55H3831FS	RESISTOR, FIXED, FILM.....	1
44	PAHZZ	81349	RNC55H1021FS	RESISTOR, FIXED, FILM (SELECT AT TEST).....	1
45	PAHZZ	81349	RNC55H1101FS	RESISTOR, FIXED, FILM (SELECT AT TEST).....	1

SECTION II			TM11-5895-1303-24P		(5)	(6)
(1)	(2)	(3)	(4)			
ITEM	SMR		PART			
NO	CODE	FSCM	NUMBER	DESCRIPTION AND USABLE ON CODES(UOC)		QTY
46	PAHZZ	81349	RNC55H1181FS	TEST)		1
47	PAHZZ	81349	RNC55H1271FS	RESISTOR, FIXED, FILM (SELECT AT TEST)		1
48	PAHZZ	81349	RNC55H1371FS	RESISTOR, FIXED, FILM (SELECT AT TEST)		1
49	PAHZZ	81349	RNC55H1471FS	RESISTOR, FIXED, FILM (SELECT AT TEST)		1
50	PAHZZ	81349	RNC55H1581FS	RESISTOR, FIXED, FILM (SELECT AT TEST)		1
51	PAHZZ	81349	RNC55H1691FS	RESISTOR, FIXED, FILM (SELECT AT TEST)		1
52	PAHZZ	81349	RNC55H1821FS	RESISTOR, FIXED, FILM (SELECT AT TEST)		1
53	PAHZZ	81349	RNC55H1961FS	RESISTOR, FIXED, FILM (SELECT AT TEST)		1
54	PAHZZ	81349	RNC55H6040FS	RESISTOR, FIXED, FILM (SELECT AT TEST)		1
55	PAHZZ	81349	RNC55H7500FS	RESISTOR, FIXED, FILM (SELECT AT TEST)		1
56	PAHZZ	81349	RNC55H8870FS	RESISTOR, FIXED, FILM (SELECT AT TEST)		1
57	PAHZZ	81349	RNC55H9530FS	RESISTOR, FIXED, FILM (SELECT AT TEST)		1
58	PAHZZ	81349	RCR07G682JS	RESISTOR, FIXED, COMP		1
59	PAHZZ	81349	RCR07G204JS	RESISTOR, FIXED, COMP		1
60	PAHZZ	81349	RCR07G332JS	RESISTOR, FIXED, COMP		2
61	PAHZZ	81349	RNC55H5112FS	RESISTOR, FIXED, FILM (SELECT AT TEST)		1
62	PAHZZ	81349	RNC55H5232FS	RESISTOR, FIXED, FILM (SELECT AT TEST)		1
63	PAHZZ	81349	RNC55H5362FS	RESISTOR, FIXED, FILM (SELECT AT TEST)		1
64	PAHZZ	81349	RNC55H5492FS	RESISTOR, FIXED, FILM (SELECT AT TEST)		1
65	PAHZZ	81349	RNC55H5622FS	RESISTOR, FIXED, FILM (SELECT AT TEST)		1
66	PAHZZ	81349	RNC55H5762FS	RESISTOR, FIXED, FILM (SELECT AT TEST)		1
67	PAHZZ	81349	RNC55H5902FS	RESISTOR, FIXED, FILM (SELECT AT TEST)		1
68	PAHZZ	81349	RNC55H6042FS	RESISTOR, FIXED, FILM (SELECT AT TEST)		1
69	PAHZZ	81349	RNC55H6192FS	RESISTOR, FIXED, FILM (SELECT AT TEST)		1
70	PAHZZ	81349	RNC55H6342FS	RESISTOR, FIXED, FILM (SELECT AT TEST)		1
71	PAHZZ	81349	RNC55H6492FS	RESISTOR, FIXED, FILM (SELECT AT TEST)		1
72	PAHZZ	81349	RNC55H6652FS	RESISTOR, FIXED, FILM (SELECT AT TEST)		1



SECTION II			TM11-5895-1303-24P			
(1)	(2)	(3)	(4)	(5)		(6)
ITEM NO	SMR CODE	FSCM	PART NUMBER	DESCRIPTION AND USABLE ON CODES(UOC)		QTY
73	PAHZZ	81349	RCR07G563JS	RESISTOR, FIXED, COMP.....		1
74	PAHZZ	81349	RCR07G273JS	RESISTOR, FIXED, COMP.....		1
75	PAHZZ	81349	RLR07C3900GS	RESISTOR, FIXED, FILM.....		1
76	PAHZZ	81349	RCR07G182JS	RESISTOR, FIXED, COMP.....		1
77	PAHZZ	81349	RCR07G3R3JS	RESISTOR, FIXED, COMP.....		3
78	PAHZZ	81349	RCR07G100JS	RESISTOR, FIXED, COMP.....		2
79	PAHZZ	81349	RNC55H8661FS	RESISTOR, FIXED, FILM.....		1
80	PAHZZ	81349	RNC55H2941FS	RESISTOR, FIXED, FILM.....		1
81	PAHZZ	81349	RNC55H4021FS	RESISTOR, FIXED, FILM.....		1
82	PAHZZ	81349	RNC55H2430FS	RESISTOR, FIXED, FILM.....		1
83	PAHZZ	81349	RNC55H9310FS	RESISTOR, FIXED, FILM.....		1
84	PAHZZ	81349	M8340105M1001JG	RESISTOR NETWORK, FI.....		2
85	PAHZZ	81349	M8340109M5103JC	RESISTOR NETWORK, FI.....		1
86	PAHZZ	81349	RLR07C5103GS	RESISTOR, FIXED, FILM.....		2
87	PAHZZ	81349	RNC55H1130FP	RESISTOR, FXD FILM (SELECT AT TEST).....		1
88	PAHZZ	81349	RNC55H1050FS	RESISTOR, FIXED, FILM (SELECT AT TEST).....		1
89	PAHZZ	81349	RNC55H84R5FS	RESISTOR, FIXED, FILM (SELECT AT TEST).....		1
90	PAHZZ	81349	RNC55H90R9FS	RESISTOR, FIXED, FILM (SELECT AT TEST).....		1
91	PAHZZ	81349	RNC55H78R7FS	RESISTOR, FIXED, FILM (SELECT AT TEST).....		1
92	PAHZZ	81349	RNC55H73R2FS	RESISTOR, FIXED, FILM (SELECT AT TEST).....		1
93	PAHZZ	81349	RNC55H68R1FS	RESISTOR, FIXED, FILM (SELECT AT TEST).....		1
94	PAHZZ	81349	RNC55H63R4FP	RESISTOR, FIXED, FILM (SELECT AT TEST).....		1
95	PAHZZ	81349	RNC55H97R6FP	RESISTOR, FIXED, FILM (SELECT AT TEST).....		1
96	PAHZZ	81349	RNC55H1740FS	RESISTOR, FIXED, FILM (SELECT AT TEST).....		1
97	PAHZZ	81349	RNC55H1650FP	RESISTOR, FIXED, FILM (SELECT AT TEST).....		1
98	PAHZZ	81349	RNC55H1500FS	RESISTOR, FIXED, FILM (SELECT AT TEST).....		1
99	PAHZZ	81349	RNC55H1580FS	RESISTOR, FIXED, FILM (SELECT AT TEST).....		1
100	PAHZZ	81349	RNC55H1400FP	RESISTOR, FIXED, FILM (SELECT AT TEST).....		1
101	PAHZZ	81349	RNC55H1300FS	RESISTOR, FIXED, FILM (SELECT AT TEST).....		1
102	PAHZZ	81349	RNC55H1210FS	RESISTOR, FIXED, FILM (SELECT AT TEST).....		1
103	PAHZZ	81349	RNC55H51R1FS	RESISTOR, FIXED, FILM (SELECT AT TEST).....		1
104	PAHZZ	81349	RNC55H54R9FS	RESISTOR, FIXED, FILM (SELECT AT TEST).....		1
105	PAHZZ	81349	RNC55H59R0FS	RESISTOR, FIXED, FILM (SELECT AT TEST).....		1
106	PAHZZ	05375	ST-407	TRANSFORMER, RADIO F.....		1

SECTION II			TM11-5895-1303-24P			
(1)	(2)	(3)	(4)	(5)	(6)	
ITEM	SMR		PART			
NO	CODE	FSCM	NUMBER	DESCRIPTION AND USABLE ON CODES(UOC)	QTY	
107	PAHZZ	81349	M38510/11001BCB	MICROCIRCUIT, LINEAR.....	2	
108	PAHZA	27014	MM54HC374J/883B	MICROCIRCUIT, DIGITA.....	1	
109	PAHZZ	18714	CD4027BF/3	MICROCIRCUIT, DIGITA.....	1	
110	PAHZZ	81349	M38510/17001BCB	MICROCIRCUIT, DIGITA.....	1	
111	PAHZZ	52648	SL6701AB/DG	MICROCIRCUIT, LINEAR.....	1	
112	PAHZZ	52648	SL621CB/CM	MICROCIRCUIT, LINEAR.....	1	
113	PAHZZ	81349	M38510/11703BXC	MICROCIRCUIT, LINEAR.....	1	
114	PAHZZ	81349	JANTX1N751A1	SEMICONDUCTOR DEVIC.....	2	
115	PAHZZ	80063	A3086680	SEMICONDUCTOR DEVIC.....	1	
116	PAHZZ	81349	M38527/03-002N	MOUNTING PAD, ELECTR.....	10	
117	PAHZZ	18310	12-461-2-01	TERMINAL, STUD.....	2	
118	PAHZZ	80205	NAS671C4	NUT, PLAIN, HEXAGON.....	4	
119	PAHZZ	96906	MS35338-135	WASHER, LOCK.....	4	
120	PAHZZ	80205	NAS620C4	WASHER, FLAT.....	4	
121	PAHZZ	81349	M38527/02-018N	MOUNTING PAD, ELECTR.....	1	
122	PAHZZ	81349	M38527/05-008D	MOUNTING PAD, ELECTR.....	1	

END OF FIGURE

SECTION II			TM11-5895-1303-24P		
(1)	(2)	(3)	(4)	(5)	(6)
ITEM	SMR		PART		
NO	CODE	FSCM	NUMBER	DESCRIPTION AND USABLE ON CODES(UOC)	QTY

GROUP 10 AUDIO RECEIVER ASSEMBLY  
A10 (A3024654)

FIG. 29

1	XBHLL	80063	A3028058	MODULE FRAME ASSEMB.....	1
2	XBHZZ	80063	A3028053	COVER,MODULE.....	2
3	PAHZZ	96906	MS51957-2	SCREW,MACHINE.....	8
4	PAHLD	80063	A3024655	CIRCUIT CARD ASSEMB (SEE FIG. 30 FOR BREAKDOWN).....	1
5	PAHZZ	96906	MS51957-13	SCREW,MACHINE.....	6
6	PAHZZ	80205	NAS620C4	WASHER,FLAT.....	6
7	XBHZZ	80063	A3034572	LABEL,SENSITIVE.....	1
8	PAHZZ	26344	3585-02CNW0129	INSERT,SCREW THREAD.....	8
9	XBHZZ	80063	A3028102	PIN,GUIDE--MODULE.....	2
10	PAHZZ	96906	MS21209C0415L	INSERT,SCREW THREAD.....	6
11	XBHZZ	80063	A3028059	FRAME,MODULE-AUDIO.....	1
12	PAHZZ	96906	MS21209C0815L	INSERT,SCREW THREAD.....	2

END OF FIGURE

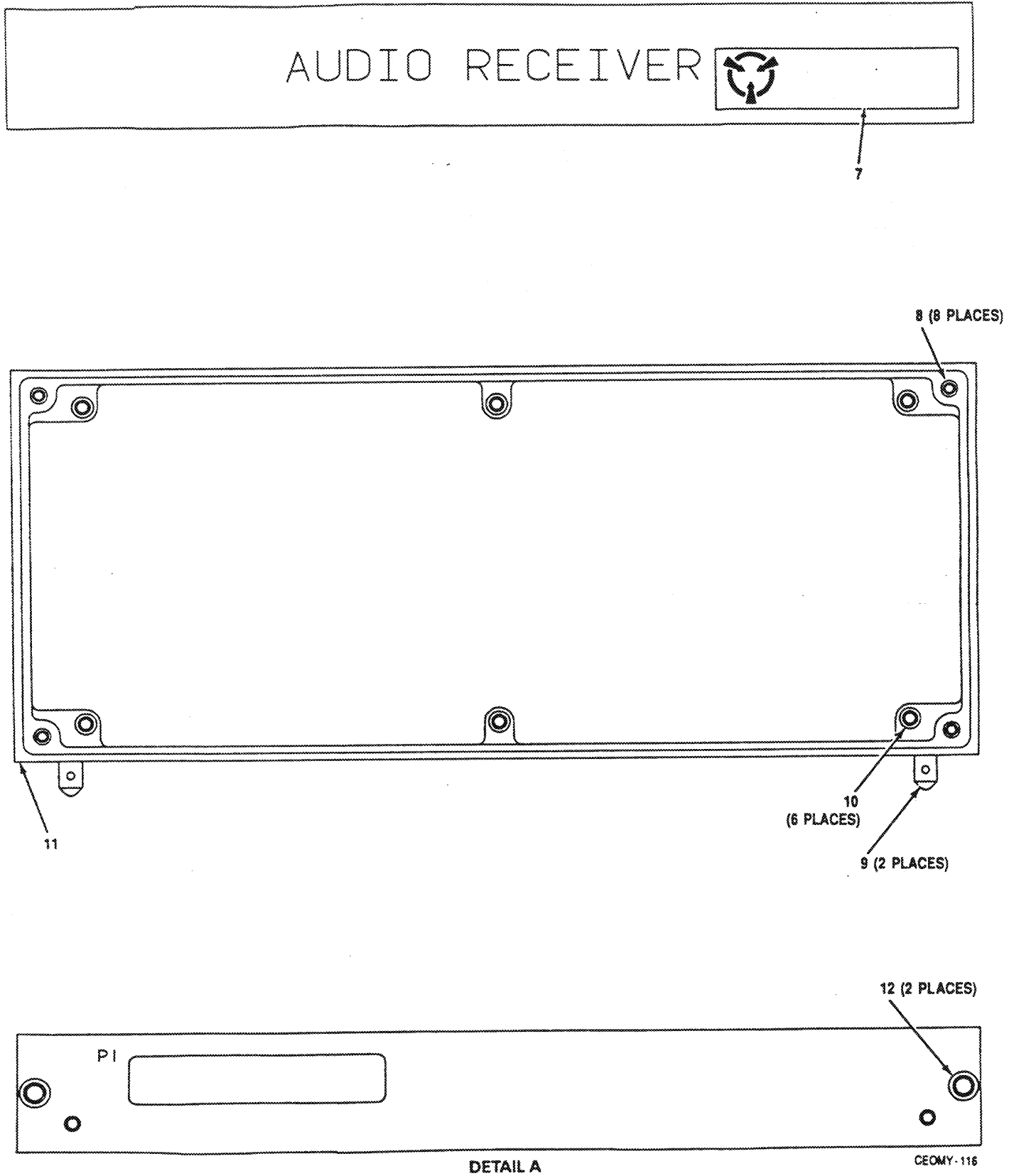

DETAIL A

CEOMY-116

Figure 29. Audio Receiver Assembly A10 (A3024654) (Sheet 2 of 2)

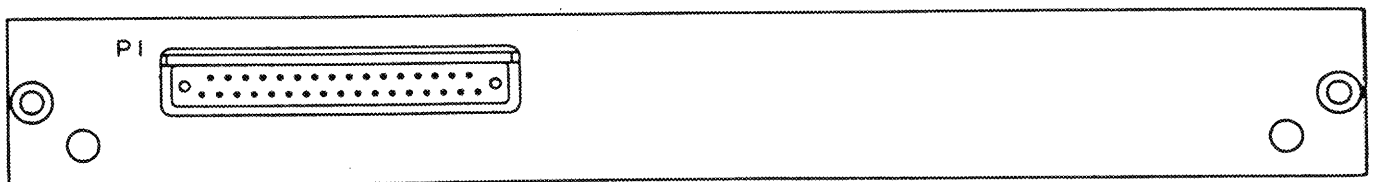
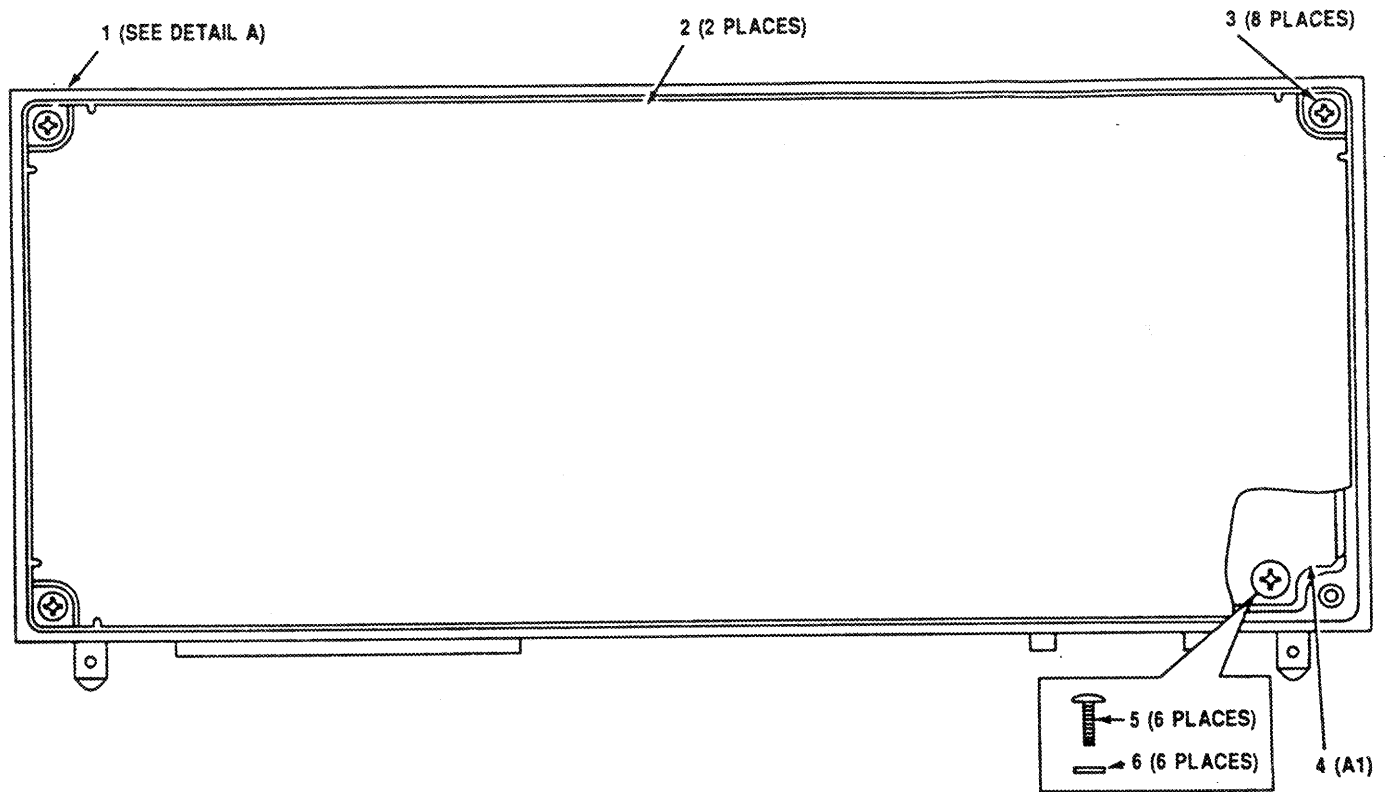

NOTES: 1. PREFIX ALL REFERENCE DESIGNATIONS WITH A10  
2. SEE FIGURE 1 FOR RESPECTIVE UNIT REFERENCE DESIGNATION PREFIX

CEOMY-115

Figure 29. Audio Receiver Assembly A10 (A3024654) (Sheet 1 of 2)

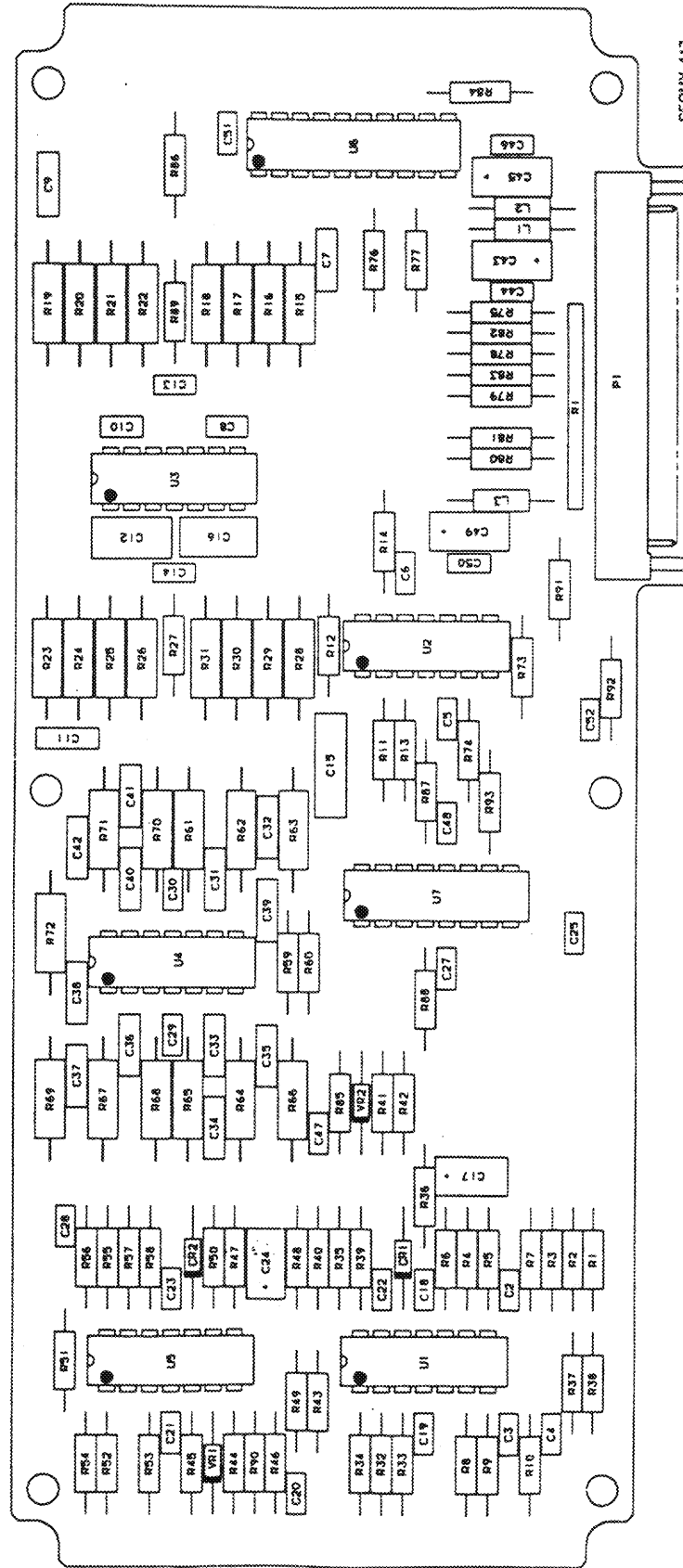
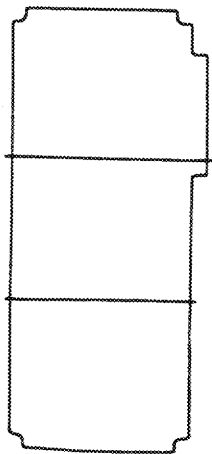
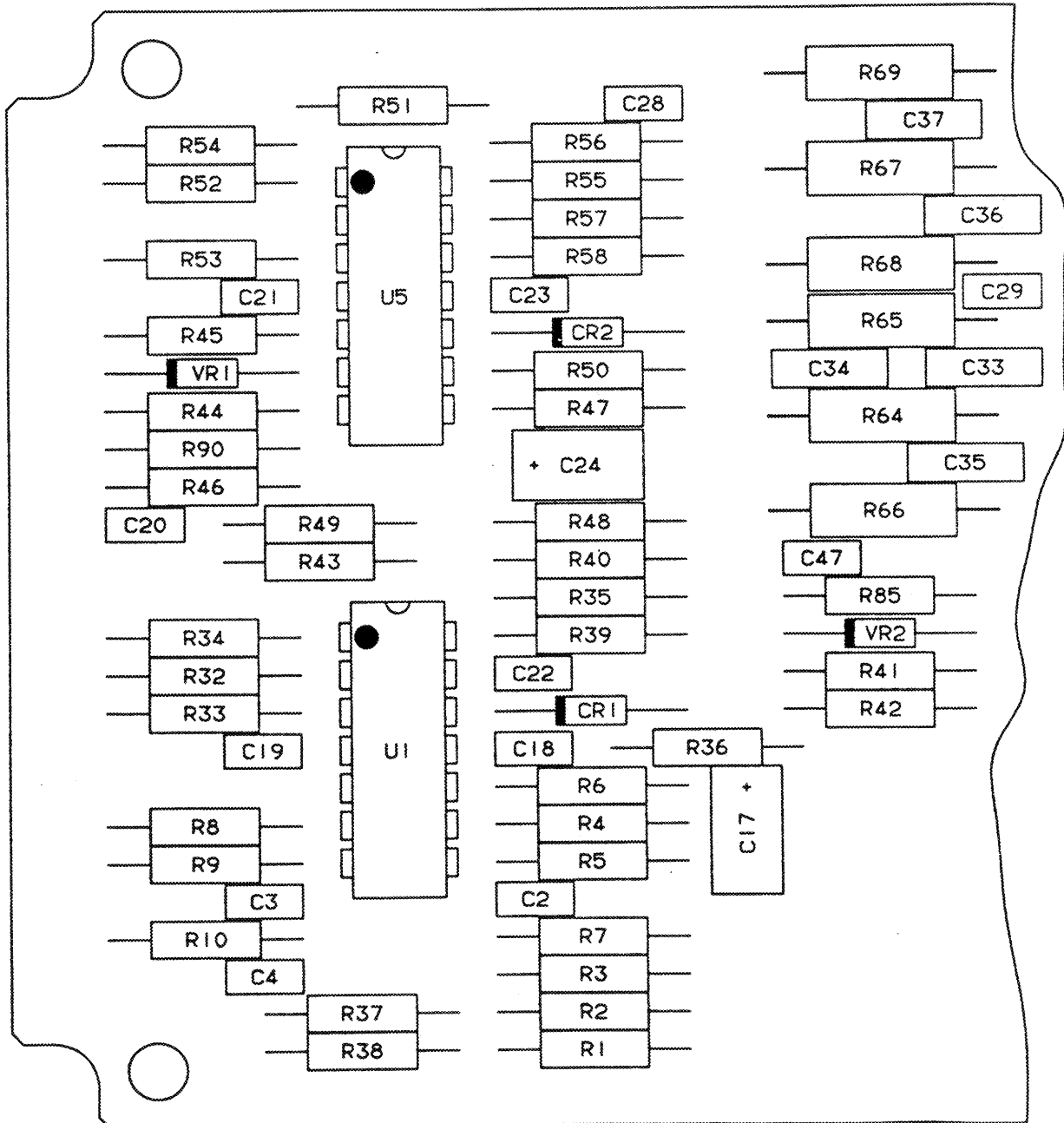

Figure 30. Audio Receiver CCA A10A1 (A3024655) (Sheet 1 of 5)



NOTES: 1. PREFIX ALL REFERENCE DESIGNATIONS WITH A10A1

2. SEE FIGURE 1 FOR RESPECTIVE UNIT REFERENCE DESIGNATION PREFIX

CEOMY-118

Figure 30. Audio Receiver CCA A10A1 (A3024655) (Sheet 2 of 5)

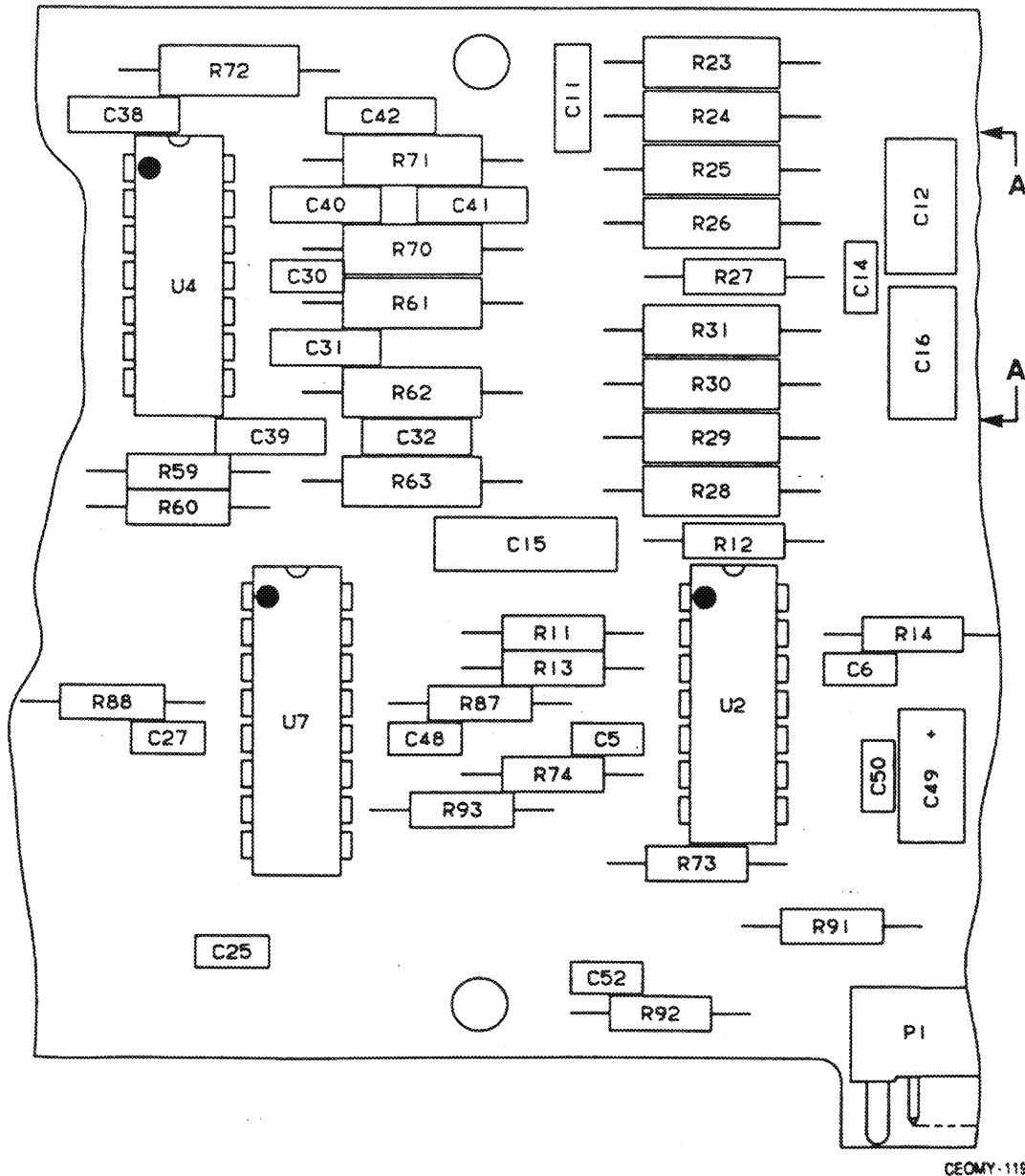
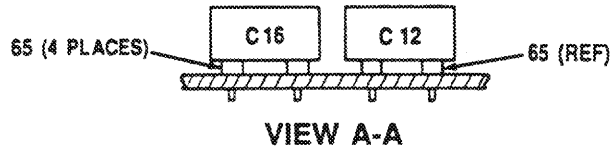
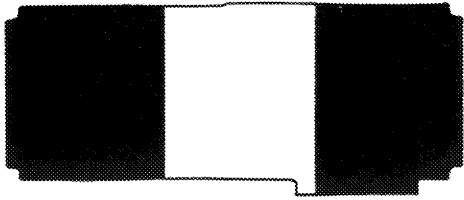
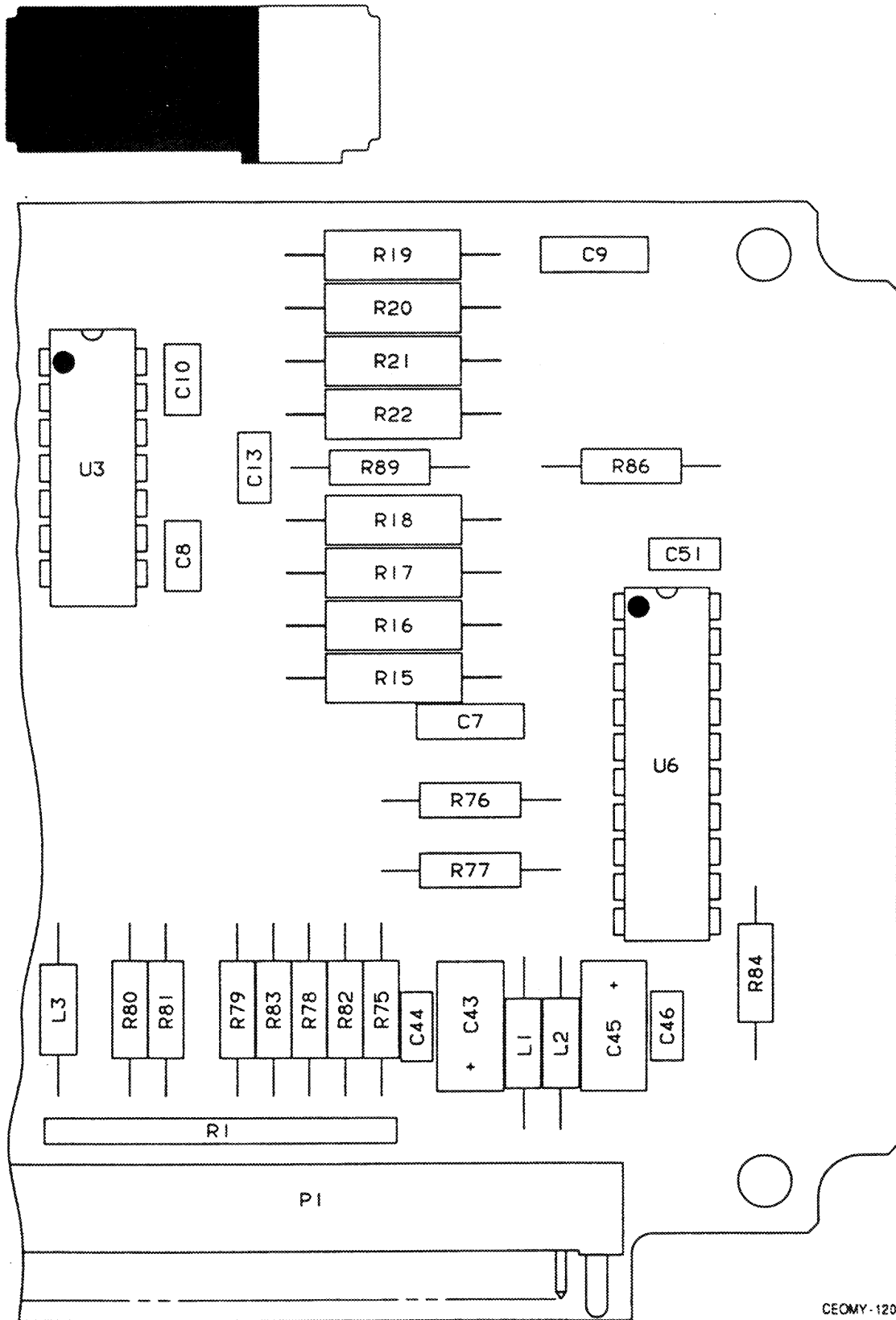

Figure 30. Audio Receiver CCA A10A1 (A3024655) (Sheet 3 of 5)





CEOMY-120

Figure 30. Audio Receiver CCA A10A1 (A3024655) (Sheet 4 of 5)

LEGEND

REF. DES.	ITEM NO.	REF. DES.	ITEM NO.	REF. DES.	ITEM NO.	REF. DES.	ITEM NO.	REF. DES.	ITEM NO.	REF. DES.	ITEM NO.
CR1	1	C28	13	L3	15	R27	27	R54	40	R79	41
CR2	1	C29	4	P1	16	R28	37	R55	47	R80	41
C2	2	C30	4	R1	17	R29	37	R56	19	R81	41
C3	3	C31	5	R3	18	R30	38	R57*	48	R82	41
C4	4	C32	5	R4	19	R31	39	R57*	49	R83	41
C5	4	C33	5	R5	20	R32	40	R57*	50	R84	41
C6	4	C34	5	R6	21	R33	26	R58	21	R85	58
C7	5	C35	5	R7	22	R34	40	R59	27	R86	59
C8	6	C36	5	R8	23	R35	41	R60	27	R87	27
C9	5	C37	5	R9	24	R36	21	R61	51	R88	27
C10	7	C38	5	R10	25	R37	27	R62	51	R89	27
C11	5	C39	5	R11	26	R38	27	R63	52	R90	42
C12	8	C40	5	R12	26	R39	42	R64	19	R91	26
C13	4	C41	5	R13	27	R40	26	R65	19	R92	41
C14	4	C42	5	R14	27	R41	43	R66	53	R93	23
C15	9	C43	14	R15	28	R42	44	R67	54	U1	60
C16	10	C44	12	R16	28	R43	27	R68	54	U2	61
C17	11	C45	14	R17	29	R44	41	R69	55	U3	60
C18	4	C46	12	R18	30	R45	41	R70	56	U4	60
C19	4	C47	12	R19	31	R46	42	R71	56	U5	60
C20	12	C48	4	R20	31	R47	42	R72	57	U6	62
C21	4	C49	14	R21	32	R48	26	R73	23	U7	63
C22	12	C50	12	R22	33	R49	27	R74	26	VR1	64
C23	4	C51	12	R23	34	R50	21	R75	41	VR2	64
C24	11	C52	3	R24	34	R51	41	R76	41		
C25	4	L1	15	R25	35	R52	45	R77	41		
C27	4	L2	15	R26	36	R53	46	R78	41		

\* Select At Test

CEOMY-121

Figure 30. Audio Receiver CCA A10A1 (A3024655) (Sheet 5 of 5)

SECTION II  
 (1) (2) (3)  
 ITEM SMR  
 NO CODE FSCM

TM11-5895-1303-24P  
 (4)  
 PART  
 NUMBER

(5) (6)  
 DESCRIPTION AND USABLE ON CODES(UOC) QTY

GROUP 1001 AUDIO RECEIVER CCA  
 A10A1 (A3024655)

FIG. 30

1	PAHZZ	81349	JANTXIN4454-1	SEMICONDUCTOR DEVIC.....	2
2	PAHZZ	81349	M39014/01-1338	CAPACITOR, FIXED, CER.....	1
3	PAHZZ	81349	M39014/01-1357	CAPACITOR, FIXED, CER.....	2
4	PAHZZ	81349	M39014-01-1575	CAPACITOR, FIXED, CER.....	14
5	PAHZZ	81349	CCR06CG1236S	CAPACITOR, FIXED, CER.....	15
6	PAHZZ	81349	CCR09CG222JP	CAPACITOR, FIXED, CER.....	1
7	PAHZZ	81349	CCR09CG561JP	CAPACITOR, FIXED, CER.....	1
8	PAHZZ	81349	CMR04F121GPDR	CAPACITOR, FIXED, MIC.....	1
9	PAHZZ	81349	CCR07CG333JP	CAPACITOR, FIXED, CER.....	1
10	PAHZZ	81349	CMR04E270G0DR	CAPACITOR, FIXED, MIC.....	1
11	PAHZZ	56996	B4003327-3238	CAPACITOR, FIXED, ELE.....	2
12	PAHZZ	81349	M39014/01-1593	CAPACITOR, FIXED, CER.....	7
13	PAHZZ	81349	M39014/01-1326	CAPACITOR, FIXED, CER.....	1
14	PAHZZ	56996	B4003327-3326	CAPACITOR, FIXED, ELE.....	3
15	PAHZZ	96906	MS75085-7	COIL, RADIO FREQUENC.....	3
16	PAHZZ	81349	M55302/4-04	CONNECTOR, RECEPTACL.....	1
17	PAHZZ	81349	M8340109M5103JC	RESISTOR NETWORK, FI.....	1
18	PAHZZ	81349	RCR07G134JS	RESISTOR, FIXED, COMP.....	1
19	PAHZZ	81349	RNC55H8661FS	RESISTOR, FIXED, FILM.....	4
20	PAHZZ	81349	RNC55H5622FS	RESISTOR, FIXED, FILM.....	1
21	PAHZZ	81349	RCR07G682JS	RESISTOR, FIXED, COMP.....	4
22	PAHZZ	81349	RNC55H9531FS	RESISTOR, FIXED, FILM.....	1
23	PAHZZ	81349	RNC55H2211FS	RESISTOR, FIXED, FILM.....	3
24	PAHZZ	81349	RNC55H1242FS	RESISTOR, FIXED, FILM.....	1
25	PAHZZ	81349	RCR07G101JS	RESISTOR, FIXED, COMP.....	1
26	PAHZZ	81349	RCR07G222JS	RESISTOR, FIXED, COMP.....	7
27	PAHZZ	81349	RCR07G240JS	RESISTOR, FIXED, COMP.....	12
28	PAHZZ	81349	RNC55H3482FS	RESISTOR, FIXED, FILM.....	2
29	PAHZZ	81349	RNC55H5492FS	RESISTOR, FIXED, FILM.....	1
30	PAHZZ	81349	RNC55H7152FS	RESISTOR, FIXED, FILM.....	1
31	PAHZZ	81349	RNC55H5362FS	RESISTOR, FIXED, FILM.....	2
32	PAHZZ	81349	RNC55H3652FS	RESISTOR, FIXED, FILM.....	1
33	PAHZZ	81349	RNC55H6342FS	RESISTOR, FIXED, FILM.....	1
34	PAHZZ	81349	RNC55H7682FS	RESISTOR, FIXED, FILM.....	2
35	PAHZZ	81349	RNC55H5762FS	RESISTOR, FIXED, FILM.....	1
36	PAHZZ	81349	RNC55H9532FS	RESISTOR, FIXED, FILM.....	1
37	PAHZZ	81349	RNC55H6652FS	RESISTOR, FIXED, FILM.....	2
38	PAHZZ	81349	RNC55H6982FS	RESISTOR, FIXED, FILM.....	1
39	PAHZZ	81349	RNC55H1103FS	RESISTOR, FIXED, FILM.....	1
40	PAHZZ	81349	RCR07G472JS	RESISTOR, FIXED, COMP.....	3
41	PAHZZ	81349	RCR07G102JS	RESISTOR, FIXED, COMP.....	15
42	PAHZZ	81349	RCR07G103JS	RESISTOR, FIXED, COMP.....	4
43	PAHZZ	81349	RNC55H6491FS	RESISTOR, FIXED, FILM.....	1
44	PAHZZ	81349	RNC55H1501FS	RESISTOR, FIXED, FILM.....	1
45	PAHZZ	81349	RCR07G153JS	RESISTOR, FIXED, COMP.....	1
46	PAHZZ	81349	RCR07G332JS	RESISTOR, FIXED, COMP.....	1

SECTION II			TM11-5895-1303-24P			
(1)	(2)	(3)	(4)	(5)	(6)	
ITEM NO	SMR CODE	FSCM	PART NUMBER	DESCRIPTION AND USABLE ON CODES(UOC)	QTY	
47	PAHZZ	81349	RNC55H1373FS	RESISTOR, FIXED, FILM.....	1	
48	PAHZZ	81349	RNC55H1372FS	RESISTOR, FIXED, FILM (SELECT AT TEST).....	1	
49	PAHZZ	81349	RNC55H1582FS	RESISTOR, FIXED, FILM (SELECT AT TEST).....	1	
50	PAHZZ	81349	RNC55H1742FS	RESISTOR, FIXED, FILM (SELECT AT TEST).....	1	
51	PAHZZ	81349	RNC55H7501FS	RESISTOR, FIXED, FILM.....	2	
52	PAHZZ	81349	RNC55H3241FS	RESISTOR, FIXED, FILM.....	1	
53	PAHZZ	81349	RNC55H2741FS	RESISTOR, FIXED, FILM.....	1	
54	PAHZZ	81349	RNC55H1332FS	RESISTOR, FIXED, FILM.....	2	
55	PAHZZ	81349	RNC55H1821FS	RESISTOR, FIXED, FILM.....	1	
56	PAHZZ	81349	RNC55H3742FS	RESISTOR, FIXED, FILM.....	2	
57	PAHZZ	81349	RNC55H6340FP	RESISTOR, FIXED, FILM.....	1	
58	PAHZZ	81349	RCR07G162JS	RESISTOR, FIXED, COMP.....	1	
59	PAHZZ	81349	RCR07G100JS	RESISTOR, FIXED, COMP.....	1	
60	PAHZZ	81349	M38510/11001BCB	MICROCIRCUIT, LINEAR.....	4	
61	PAHZZ	81349	M38510-10102BCB	MICROCIRCUIT, LINEAR.....	1	
62	PAHZA	27014	MM54HC374J/883B	MICROCIRCUIT, DIGITA.....	1	
63	PAHZZ	81349	JM38510/12302BEX	MICROCIRCUIT, LINEAR.....	1	
64	PAHZZ	81349	JANTX1N752A-1	SEMICONDUCTOR DEVIC.....	2	
65	PAHZZ	80063	A3032601-3	SPACER, SLEEVE.....	4	

END OF FIGURE

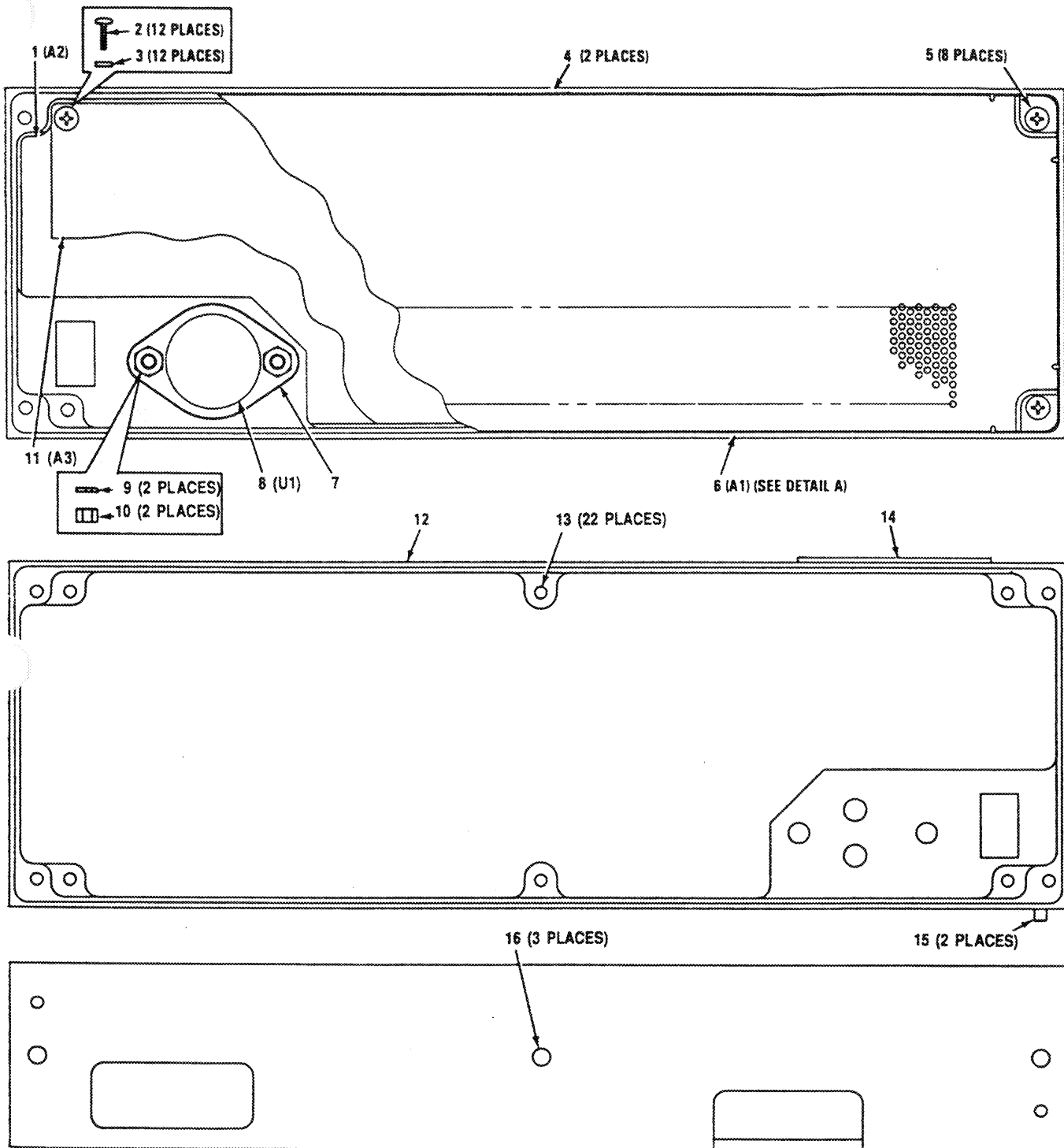

DETAIL A

- NOTES: 1. PREFIX ALL REFERENCE DESIGNATIONS WITH PS1  
 2. SEE FIGURE 1 FOR RESPECTIVE UNIT REFERENCE DESIGNATION PREFIX

CEOMY-122

Figure 31. Power Supply PS1 (A3024060)

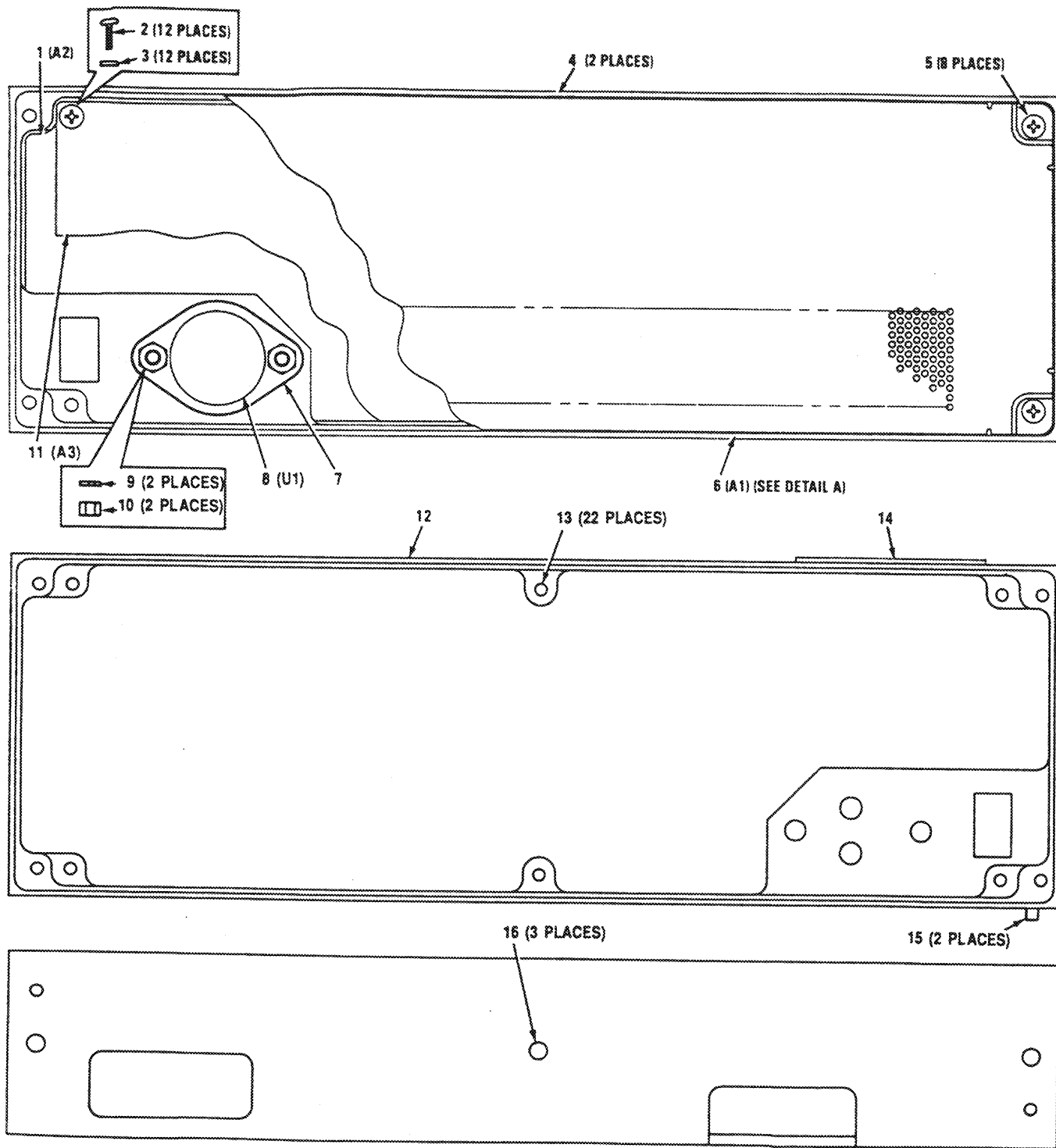

DETAIL A

- NOTES: 1. PREFIX ALL REFERENCE DESIGNATIONS WITH PS1  
 2. SEE FIGURE 1 FOR RESPECTIVE UNIT REFERENCE DESIGNATION PREFIX

CEOMY-122

Figure 31. Power Supply PS1 (A3024060)

SECTION II TM11-5895-1303-24P (5) (6)

(1) ITEM NO	(2) SMR CODE	(3) FSCM	(4) PART NUMBER	(5) DESCRIPTION AND USABLE ON CODES(UOC)	(6) QTY
-------------------	--------------------	-------------	-----------------------	---	------------

GROUP 11 POWER SUPPLY ASSEMBLY  
PS1 (A3024060)

FIG. 31

1	PAHHD	80063	A3024841	CIRCUIT CARD ASSEMB (SEE FIG. 32 FOR BREAKDOWN).....	1
2	PAHZZ	96906	MS51957-14	SCREW,MACHINE.....	12
3	PAHZZ	80205	NAS620C4	WASHER,FLAT.....	12
4	XBHZZ	80063	A3024840	COVER.....	2
5	PAHZZ	96906	MS51957-13	SCREW,MACHINE.....	8
6	XBHHH	80063	A3024838	CHASSIS ASSEMBLY.....	1
7	PAHZZ	80063	A3028706-1	INSULATOR,TRANSISTO.....	1
8	PAHZZ	14933	7703401YX	MICROCIRCUIT,LINEAR.....	1
9	PAHZZ	96906	MS35333-71	WASHER,LOCK.....	2
10	PAHZZ	80205	NAS671C6	NUT,PLAIN,HEXAGON.....	2
11	PAHHH	80063	A3028133	CIRCUIT CARD ASSEMB (SEE FIG. 33 FOR BREAKDOWN).....	1
12	XBHZZ	80063	A3028744	HEAT SINK.....	1
13	PAHZZ	96906	MS21209C0415	INSERT,SCREW THREAD.....	22
14	XBDZZ	80063	A3034572	LABEL,SENSITIVE.....	1
15	XBHZZ	80063	A3028102	PIN,GUIDE--MODULE.....	2
16	PAHZZ	96906	MS21209C0815	INSERT,SCREW THREAD.....	3

END OF FIGURE

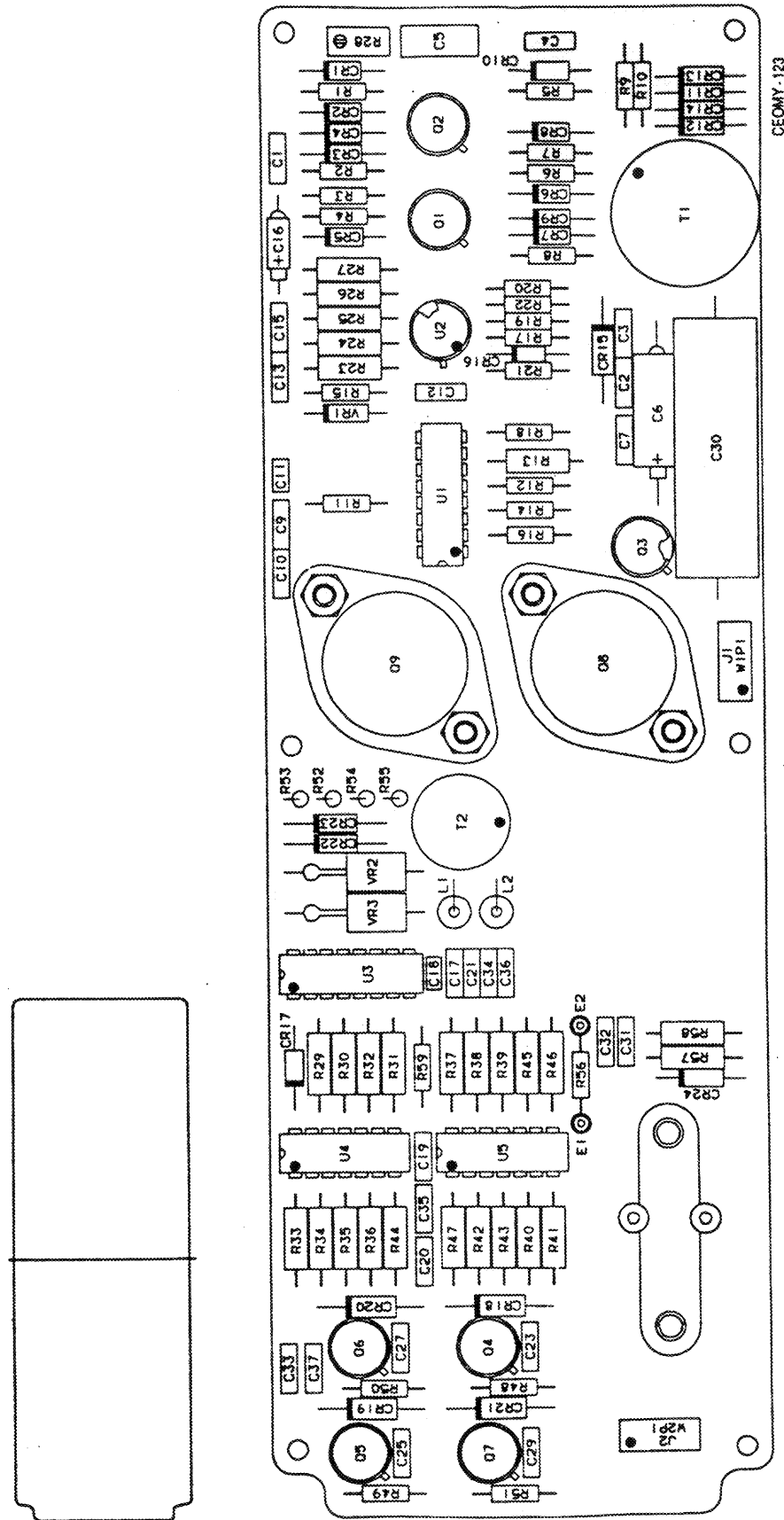
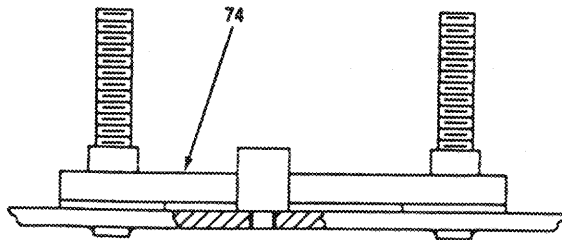
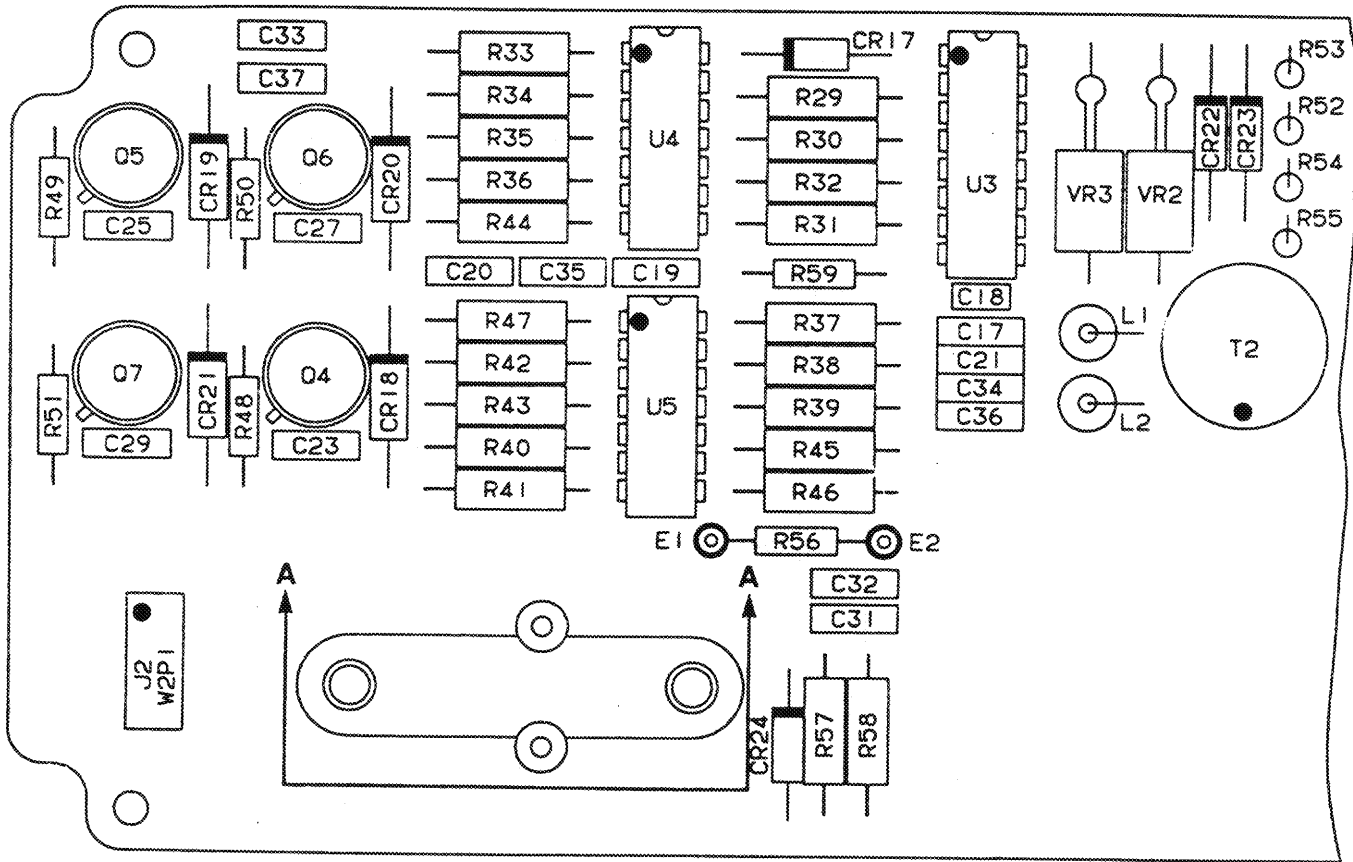
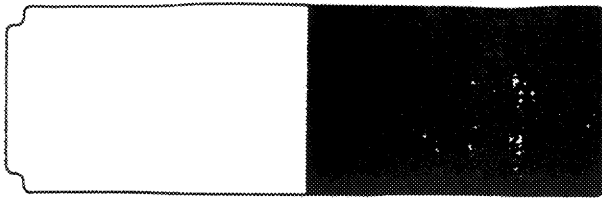

Figure 32. AC to DC Inverter CCA PSIA2 (A3024841) (Sheet 1 of 4)





VIEW A-A

- NOTES: 1. PREFIX ALL REFERENCE DESIGNATIONS WITH PS1A2
- 2. SEE FIGURE 1 FOR RESPECTIVE UNIT REFERENCE DESIGNATION PREFIX

CEOMY-124

Figure 32. AC to DC Inverter CCA PS1A2 (A3024841) (Sheet 2 of 4)

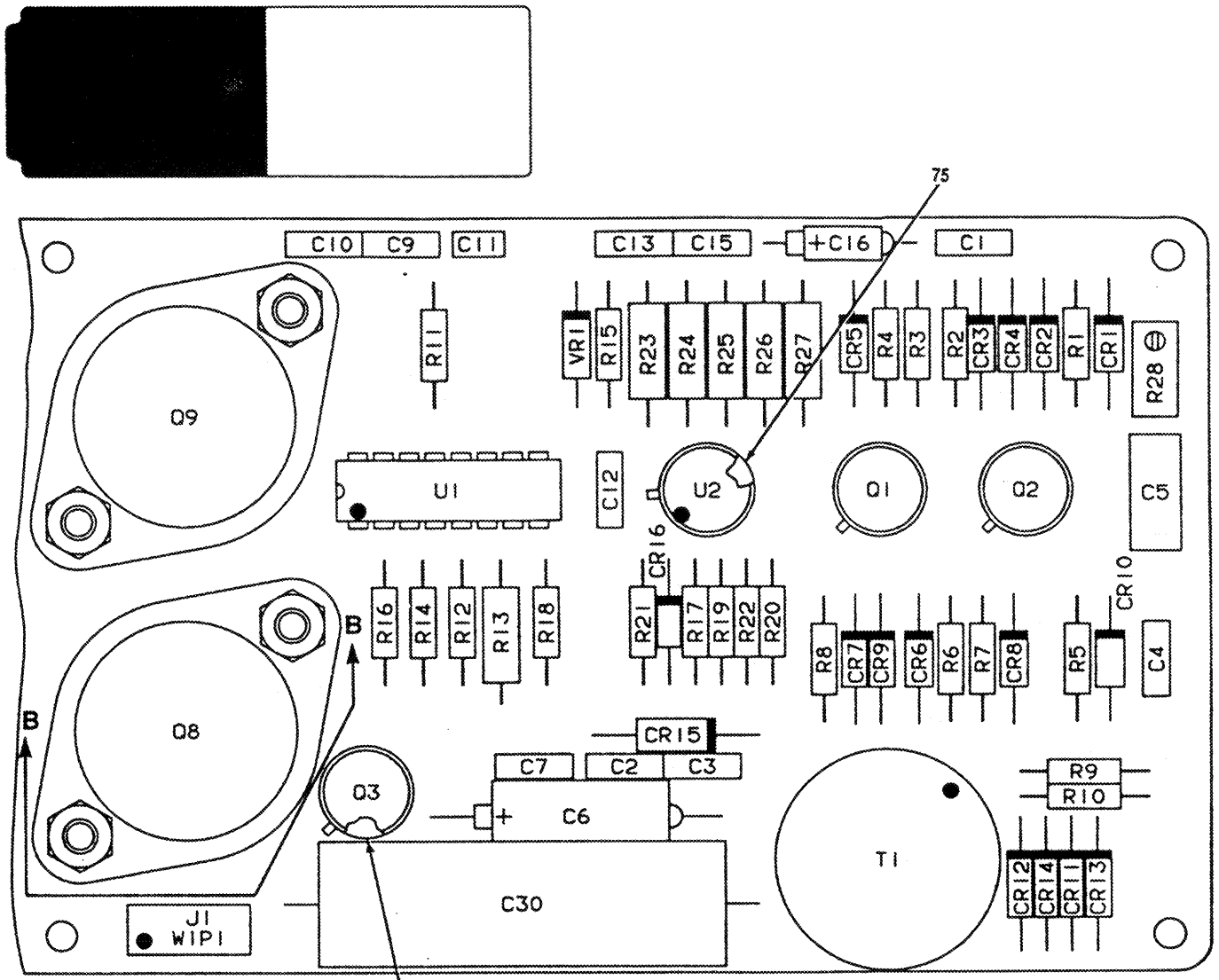

76 (7 PLACES)

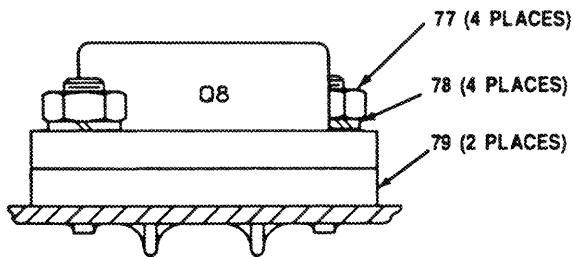

VIEW B-B

Figure 32. AC to DC Inverter CCA PS1A2 (A3024841) (Sheet 3 of 4)

LEGEND

REF. DES.	ITEM NO.	REF. DES.	ITEM NO.	REF. DES.	ITEM NO.	REF. DES.	ITEM NO.	REF. DES.	ITEM NO.	REF. DES.	ITEM NO.
CR1	1	C2	7	C33	13	R6	24	R31	46	R56*	55
CR2	1	C3	7	C34	13	R7	25	R32	47	R56*	56
CR3	1	C4	6	C35	13	R8	27	R33	45	R56*	57
CR4	1	C5	8	C36	13	R9	28	R34	48	R56*	58
CR5	2	C6	9	C37	13	R10	29	R35	47	R56*	59
CR6	1	C7	7	E1	18	R11	29	R36	45	R56*	60
CR7	1	C9	10	E2	18	R12	30	R37	49	R56*	61
CR8	1	C10	11	J1	19	R13	31	R38	47	R56*	62
CR9	1	C11	12	J2	19	R14	32	R39	45	R57	63
CR10	2	C12	13	L1	20	R15	33	R40	45	R58	64
CR11	3	C13	14	L2	20	R16	34	R41	45	R59	65
CR12	3	C15	10	Q1	21	R17	35	R42	50	T1	66
CR13	3	C16	15	Q2	21	R18	29	R43	51	T2	67
CR14	3	C17	7	Q3	22	R19	31	R44	45	U1	68
CR15	4	C18	16	Q4	22	R20	36	R45	52	U2	69
CR16	1	C19	7	Q5	22	R21	32	R46	47	U3	70
CR17	1	C20	13	Q6	22	R22	37	R47	45	U4	71
CR18	4	C21	7	Q7	22	R23	38	R48	33	U5	71
CR19	4	C23	7	Q8	23	R24	39	R49	29	VR1	72
CR20	4	C25	7	Q9	23	R25	40	R50	29	VR2	73
CR21	4	C27	7	R1	24	R26	41	R51	29	VR3	73
CR22	5	C29	7	R2	25	R27	42	R52	53		
CR23	5	C30	17	R3	26	R28	43	R53	54		
CR24	3	C31	7	R4	27	R29	44	R54	53		
C1	6	C32	7	R5	26	R30	45	R55	54		

\* Select At Test

CEOMY-126

Figure 32. AC to DC Inverter CCA PS1A2 (A3024841) (Sheet 4 of 4)

SECTION II  
 (1) (2) (3)  
 ITEM SMR FSCM  
 NO CODE FSCM

TM11-5895-1303-24P  
 (4)  
 PART  
 NUMBER

(5)

(6)

DESCRIPTION AND USABLE ON CODES(UOC) QTY  
 GROUP 1101 AC TO DC INVERTER CCA  
 PS1A2 (A3024841)

FIG. 32

1	PAHZZ	81349	JANTX1N4150-1	SEMICONDUCTOR DEVIC.....	10
2	PAHZZ	81349	JANTX1N5619	SEMICONDUCTOR DEVIC.....	2
3	PAHZZ	81349	JANTX1N5615	SEMICONDUCTOR DEVIC.....	5
4	PAHZZ	12969	UM4001B	SEMICONDUCTOR DEVIC.....	5
5	PAHZZ	81349	JANTX1N5418	SEMICONDUCTOR DEVIC.....	2
6	PAHZZ	81349	M39014/02-1419	CAPACITOR, FIXED, CER.....	2
7	PAHZZ	81349	M39014/02-1350	CAPACITOR, FIXED, CER.....	12
8	PAHZZ	81349	CMR05F161GPDR	CAPACITOR, FIXED, MIC.....	1
9	PAHZZ	81349	M39003/01-3026	CAPACITOR, FIXED, ELE.....	1
10	PAHZZ	81349	M39014/02-1356	CAPACITOR, FIXED, CER.....	2
11	PAHZZ	81349	M39014/02-1337	CAPACITOR, FIXED, CER.....	1
12	PAHZZ	81349	M39014/01-1259	CAPACITOR, FIXED, CER.....	1
13	PAHZZ	81349	M39014/02-1338	CAPACITOR, FIXED, CER.....	7
14	PAHZZ	81349	M39014/02-1359	CAPACITOR, FIXED, CER.....	1
15	PAHZZ	81349	M39003/01-2988	CAPACITOR, FIXED, ELE.....	1
16	PAHZZ	81349	M39014/01-1357	CAPACITOR, FIXED, CER.....	1
17	PAHZZ	81349	M83421/01-5191S	CAPACITOR, FIXED, MET.....	1
18	XBHZZ	71279	160-2027-02-05-0	TERMINAL, STUD.....	2
			3		
19	PAHZZ	00779	103007-2	CONNECTOR, RECEPTACL.....	2
20	PAHZZ	80063	A3028867	SHIELDING, BEAD, ELEC.....	2
21	PAHZZ	07256	2N5011	TRANSISTOR.....	2
22	PAHZZ	09214	2N2324A	TRANSISTOR.....	5
23	PAHZZ	81349	JANTX2N6762	TRANSISTOR.....	2
24	PAHZZ	81349	RCR07G100JS	RESISTOR, FIXED, COMP.....	2
25	PAHZZ	81349	RCR07G271JS	RESISTOR, FIXED, COMP.....	2
26	PAHZZ	81349	RCR07G224JS	RESISTOR, FIXED, COMP.....	2
27	PAHZZ	81349	RCR07G330JS	RESISTOR, FIXED, COMP.....	2
28	PAHZZ	81349	RCR07G152JS	RESISTOR, FIXED, COMP.....	1
29	PAHZZ	81349	RCR07G101JS	RESISTOR, FIXED, COMP.....	6
30	PAHZZ	81349	RCR07G510JS	RESISTOR, FIXED, COMP.....	1
31	PAHZZ	81349	RNC55H2211FS	RESISTOR, FIXED, FILM.....	2
32	PAHZZ	81349	RCR07G104JS	RESISTOR, FIXED, COMP.....	2
33	PAHZZ	81349	RCR07G102JS	RESISTOR, FIXED, COMP.....	2
34	PAHZZ	81349	RCR07G512JS	RESISTOR, FIXED, COMP.....	1
35	PAHZZ	81349	RNC55H1820FS	RESISTOR, FIXED, FILM.....	1
36	PAHZZ	81349	RNC55H3921FS	RESISTOR, FIXED, FILM.....	1
37	PAHZZ	81349	RNC55H1101FS	RESISTOR, FIXED, FILM.....	1
38	PAHZZ	81349	RNC55H1271FS	RESISTOR, FIXED, FILM.....	1
39	PAHZZ	81349	RNC55H64R9FS	RESISTOR, FIXED, FILM.....	1
40	PAHZZ	81349	RNC55H2151FS	RESISTOR, FIXED, FILM.....	1
41	PAHZZ	81349	RNC55H8250FS	RESISTOR, FIXED, FILM.....	1
42	PAHZZ	81349	RNC55H5111FS	RESISTOR, FIXED, FILM.....	1
43	PAHZZ	81349	M39015/3-006WR	RESISTOR, VARIABLE, W.....	1
44	PAHZZ	81349	RNC55H5491FS	RESISTOR, FIXED, FILM.....	1
45	PAHZZ	81349	RNC55H2491FS	RESISTOR, FIXED, FILM.....	8

SECTION II			TM11-5895-1303-24P			
(1)	(2)	(3)	(4)	(5)	(6)	
ITEM NO	SMR CODE	FSCM	PART NUMBER	DESCRIPTION AND USABLE ON CODES(UOC)	QTY	
46	PAHZZ	81349	RNC55H5761FS	RESISTOR, FIXED, FILM.....	1	
47	PAHZZ	81349	RNC55H5490FS	RESISTOR, FIXED, FILM.....	4	
48	PAHZZ	81349	RNC55H2431FS	RESISTOR, FIXED, FILM.....	1	
49	PAHZZ	81349	RNC55H2742FS	RESISTOR, FIXED, FILM.....	1	
50	PAHZZ	81349	RNC55H2802FS	RESISTOR, FIXED, FILM.....	1	
51	PAHZZ	81349	RNC55H4420FS	RESISTOR, FIXED, FILM.....	1	
52	PAHZZ	81349	RNC55H1022FS	RESISTOR, FIXED, FILM.....	1	
53	PAHZZ	81349	RCR07G240JS	RESISTOR, FIXED, COMP.....	2	
54	PAHZZ	81349	RCR07G103JS	RESISTOR, FIXED, COMP.....	2	
55	PAHZZ	81349	RCR07G303JS	RESISTOR, FIXED, COMP (SELECT AT TEST).....	1	
56	PAHZZ	81349	RCR07G333JS	RESISTOR, FIXED, COMP (SELECT AT TEST).....	1	
57	PAHZZ	81349	RCR07G363JS	RESISTOR, FIXED, COMP (SELECT AT TEST).....	1	
58	PAHZZ	81349	RCR07G393JS	RESISTOR, FIXED, COMP (SELECT AT TEST).....	1	
59	PAHZZ	81349	RCR07G433JS	RESISTOR, FIXED, COMP (SELECT AT TEST).....	1	
60	PAHZZ	81349	RCR07G473JS	RESISTOR, FIXED, COMP (SELECT AT TEST).....	1	
61	PAHZZ	81349	RCR07G513JS	RESISTOR, FIXED, COMP (SELECT AT TEST).....	1	
62	PAHZZ	81349	RCR07G563JS	RESISTOR, FIXED, COMP (SELECT AT TEST).....	1	
63	PAHZZ	81349	RNC55H2490FS	RESISTOR, FIXED, FILM.....	1	
64	PAHZZ	81349	RNC55H7680FS	RESISTOR, FIXED, FILM.....	1	
65	PAHZZ	81349	RCR07G123JS	RESISTOR, FIXED, COMP.....	1	
66	PAHZZ	37695	305191-1	TRANSFORMER, POWER.....	1	
67	PAHZZ	37695	305139-1	TRANSFORMER, PULSE.....	1	
68	PAHZZ	97953	1A7861-3	MICROCIRCUIT, LINEAR.....	1	
69	PAHZZ	04713	158/BPBJC	MICROCIRCUIT, LINEAR.....	1	
70	PAHZZ	97953	1A7862-1	MICROCIRCUIT, LINEAR.....	1	
71	PAHZZ	81349	M38510/11201BCB	MICROCIRCUIT, LINEAR.....	2	
72	PAHZZ	81349	JANTX1N751A1	SEMICONDUCTOR DEVIC.....	1	
73	PAHZA	81349	JANTX1N6044A	SEMICONDUCTOR DEVIC.....	2	
74	PAHZZ	13103	8182E3C	INSULATOR, T03.....	1	
75	PAHZZ	81349	M38527/05-002D	MOUNTING PAD, ELECTR.....	1	
76	PAHZZ	13103	7717-4DAP	MOUNTING PAD, ELECTR.....	7	
77	PAHZZ	80205	NAS671C6	NUT, PLAIN, HEXAGON.....	4	
78	PAHZZ	96906	MS35338-136	WASHER, LOCK.....	4	
79	PAHZZ	13103	8180E1	TERMINAL BOARD.....	2	

END OF FIGURE

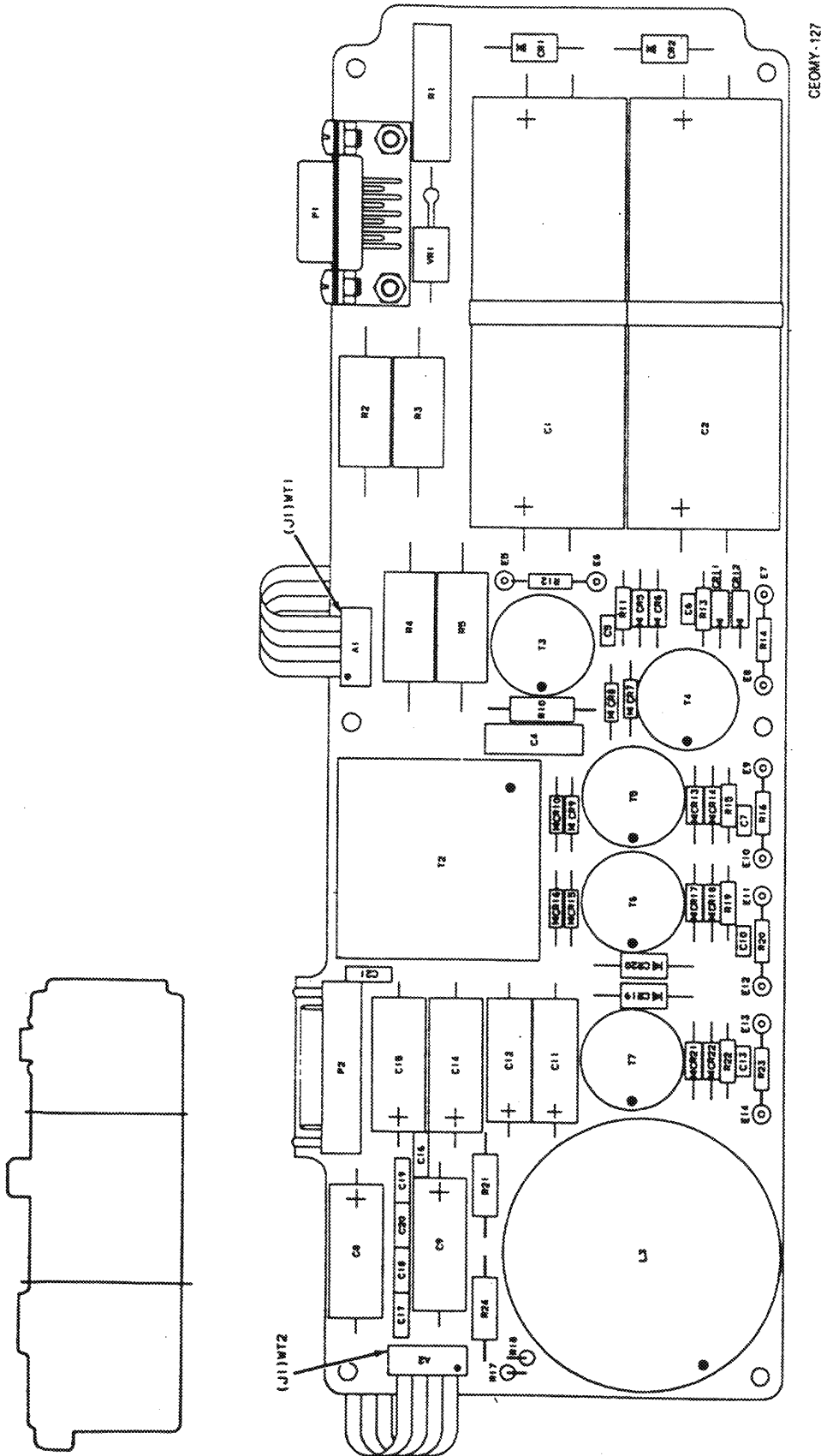
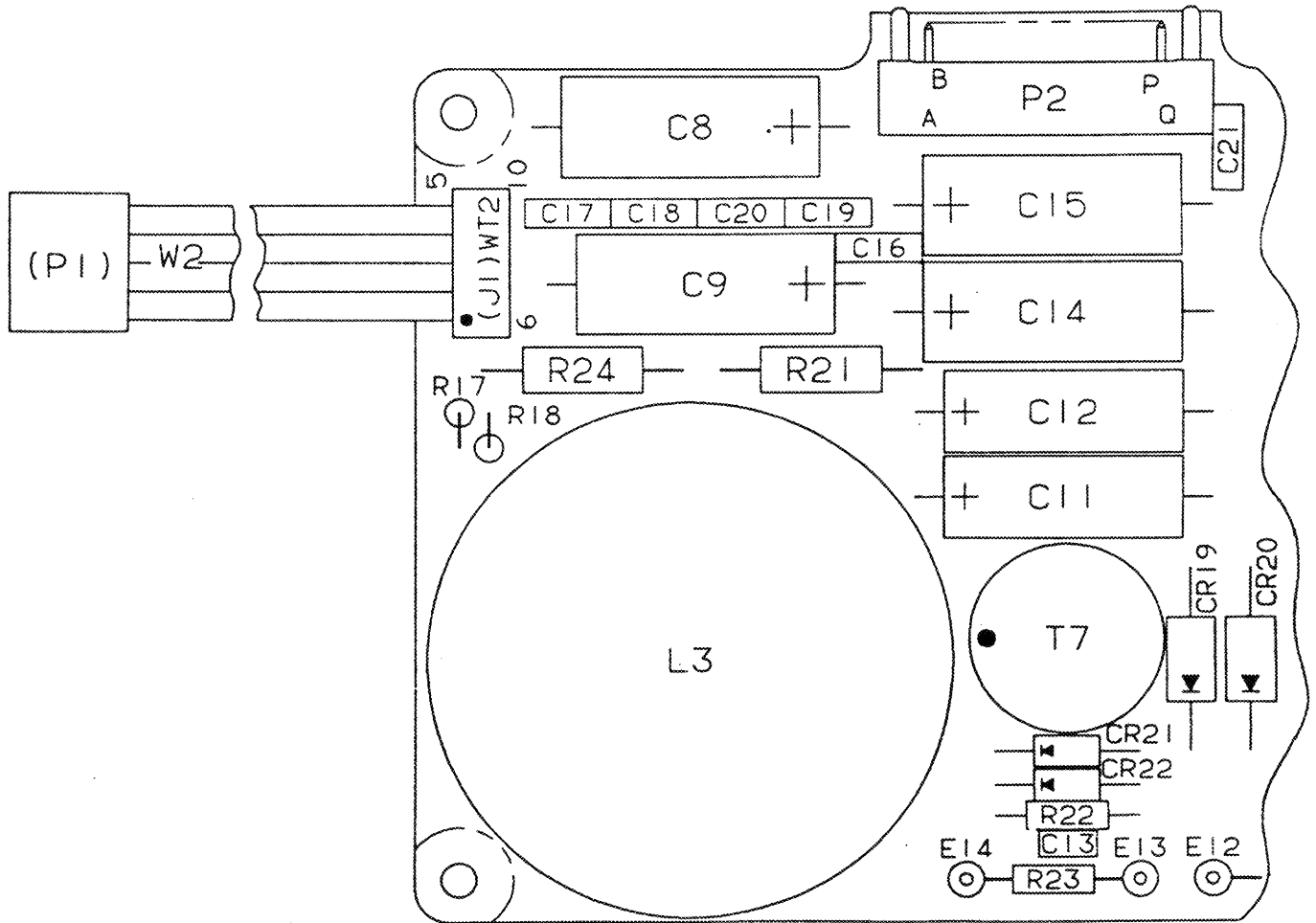
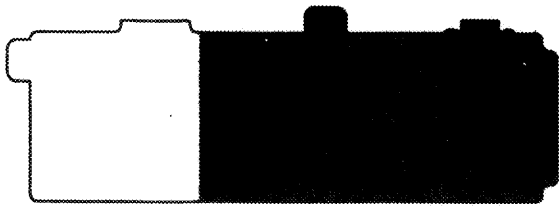
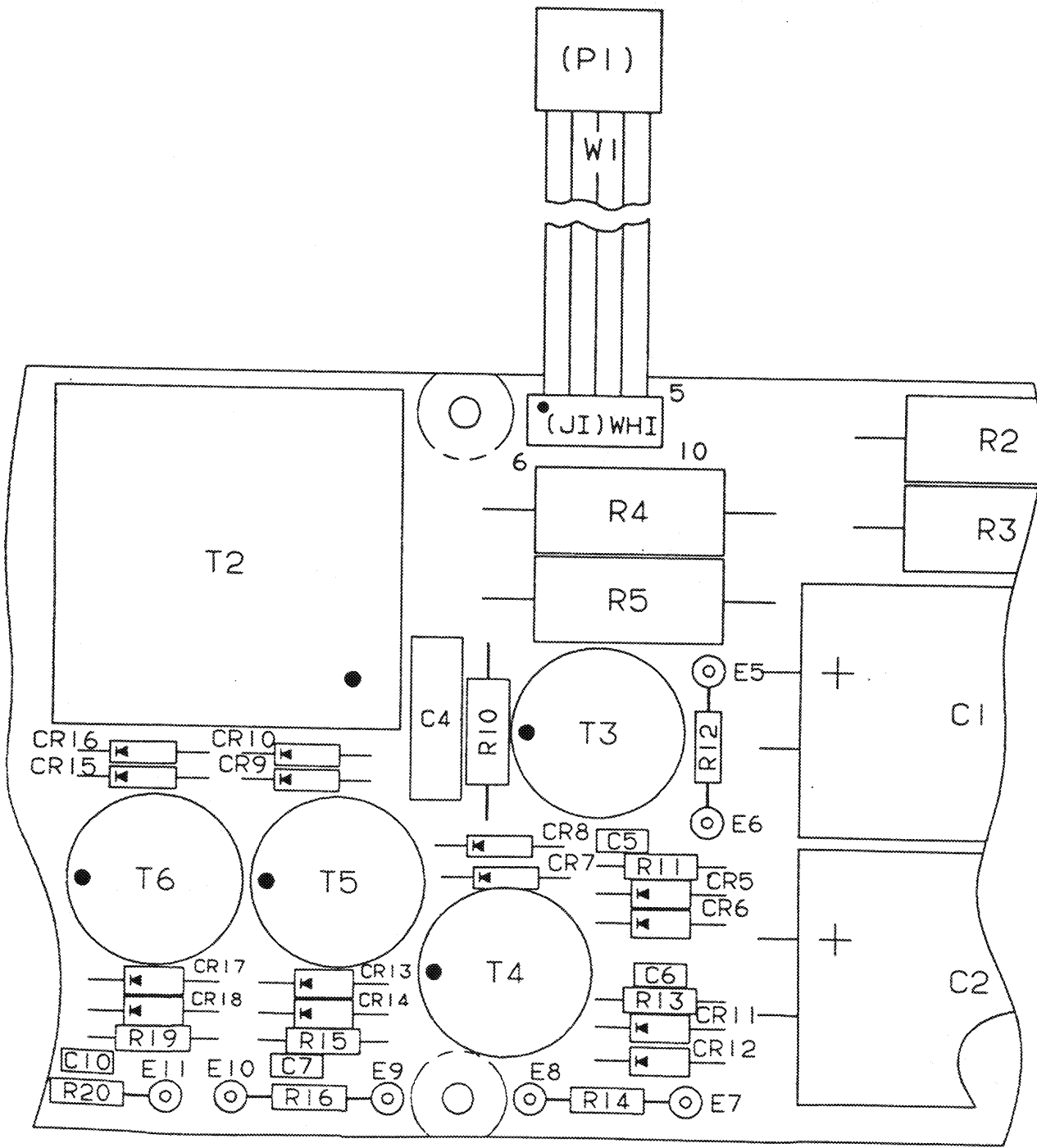
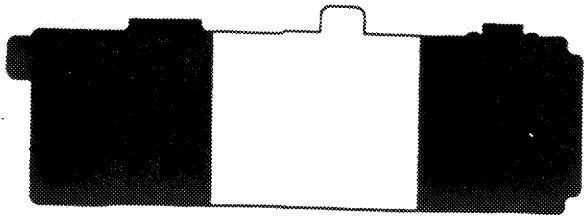

Figure 33. Regulator Output GCA PSLA3 (A3028133) (Sheet 1 of 5)



- NOTES: 1. PREFIX ALL REFERENCE DESIGNATIONS WITH PS1A3  
 2. SEE FIGURE 1 FOR RESPECTIVE UNIT REFERENCE DESIGNATION PREFIX

Figure 33. Regulator Output CCA PS1A3 (A3028133) (Sheet 2 of 5)



CEOMY-130

Figure 33. Regulator Output CCA PS1A3 (A3028133) (Sheet 3 of 5)



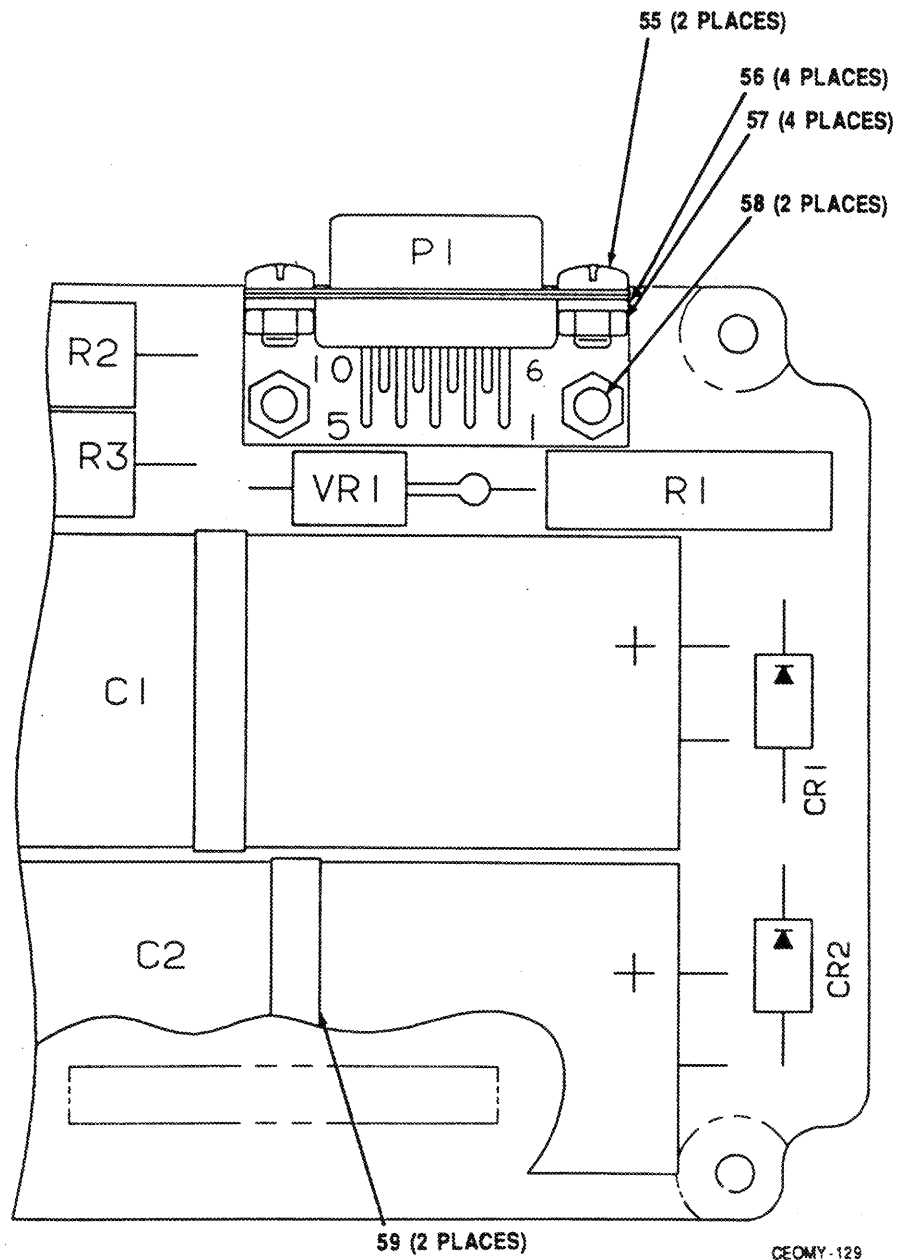
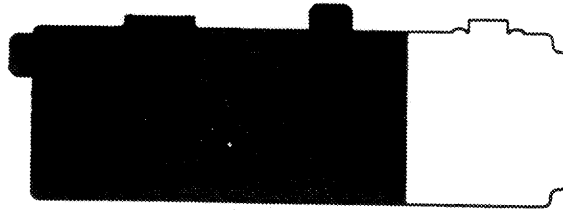

Figure 33. Regulator Output CCA PS1A3 (A3028133) (Sheet 4 of 5)

LEGEND

REF. DES.	ITEM NO.	REF. DES.	ITEM NO.	REF. DES.	ITEM NO.	REF. DES.	ITEM NO.	REF. DES.	ITEM NO.	REF. DES.	ITEM NO.
CR1	1	C6	7	E13	12	R12*	32	R16*	29	R23*	36
CR2	1	C7	7	E14	12	R12*	33	R16*	30	R23*	37
CR5	2	C8	8	L3	13	R13	21	R16*	31	R23*	38
CR6	2	C9	8	P1	14	R14*	19	R16*	32	R23*	40
CR7	3	C10	7	P2	15	R14*	22	R16*	33	R23*	43
CR8	3	C11	9	R1	16	R14*	23	R17	29	R23*	44
CR9	3	C12	9	R2	17	R14*	24	R18	29	R23*	45
CR10	3	C13	7	R3	17	R14*	25	R19	40	R23*	46
CR11	2	C14	10	R4	17	R14*	26	R20*	21	R23*	47
CR12	2	C15	10	R5	17	R14*	27	R20*	22	R23*	48
CR13	2	C16	11	R10	18	R14*	34	R20*	23	R23*	49
CR14	2	C17	11	R11	19	R14*	35	R20*	24	R24	50
CR15	3	C18	11	R12*	20	R14*	36	R20*	25	T2	51
CR16	3	C19	11	R12*	21	R14*	37	R20*	26	T3	52
CR17	2	C20	11	R12*	22	R14*	38	R20*	27	T4	52
CR18	2	C21	11	R12*	23	R15	39	R20*	29	T5	52
CR19	4	E5	12	R12*	24	R16*	21	R20*	30	T6	52
CR20	4	E6	12	R12*	25	R16*	22	R20*	31	T7	52
CR21	2	E7	12	R12*	26	R16*	23	R20*	32	VR1	53
CR22	2	E8	12	R12*	27	R16*	24	R20*	33	W1	54
C1	5	E9	12	R12*	28	R16*	25	R20*	35	W2	54
C2	5	E10	12	R12*	29	R16*	26	R21	41		
C4	6	E11	12	R12*	30	R16*	27	R22	42		
C5	7	E12	12	R12*	31	R16*	28	R23*	19		

\* Select At Test

CEOMY-131

Figure 33. Regulator Output CCA PS1A3 (A3028133) (Sheet 5 of 5)

SECTION II TM11-5895-1303-24P (5) (6)

(1) ITEM NO	(2) SMR CODE	(3) FSCM	(4) PART NUMBER	(5) DESCRIPTION AND USABLE ON CODES(UDC)	(6) QTY
-------------------	--------------------	-------------	-----------------------	---	------------

GROUP 1102 REGULATOR OUTPUT CCA  
PS1A3 (A3028133)

FIG. 33

1	PAHZZ	81349	JANTX1N5552	SEMICONDUCTOR DEVIC.....	2
2	PAHZZ	81349	JANTX1N5615	SEMICONDUCTOR DEVIC.....	10
3	PAHZZ	81349	JANTX1N5806	SEMICONDUCTOR DEVIC.....	6
4	PAHZZ	81349	JANTX1N5809	SEMICONDUCTOR DEVIC.....	2
5	PAHZZ	81349	M39018/07-0326M	CAPACITOR, FIXED, ELE.....	2
6	PAHZZ	81349	CMR06F471GPDR	CAPACITOR, FIXED, MIC.....	1
7	PAHZZ	81349	M39014/01-1357	CAPACITOR, FIXED, CER.....	5
8	PAHZZ	81349	M39003/09-0162	CAPACITOR, FIXED, ELE.....	2
9	PAHZZ	81349	M39003/09-0182	CAPACITOR, FIXED, ELE.....	2
10	PAHZZ	81349	M39003/09-0129	CAPACITOR, FIXED, ELE.....	2
11	PAHZZ	81349	M39014/02-1350	CAPACITOR, FIXED, CER.....	6
12	XBHZZ	71279	160-2027-02-05-0	TERMINAL, STUD.....	10
			3		
13	PAHZZ	37695	305194-1	REACTOR.....	1
14	PAHZZ	81349	M24308/24-25	CONNECTOR, RECEPTACL.....	1
15	PAHZZ	81349	M55302/4-02	CONNECTOR, RECEPTACL.....	1
16	PAHZZ	15454	SG220-S	RESISTOR, VOLTAGE SE.....	1
17	PAHZZ	81349	RCR42G273JS	RESISTOR, FIXED, COMP.....	4
18	PAHZZ	81349	RCR20G681JS	RESISTOR, FIXED, COMP.....	1
19	PAHZZ	81349	RCR07G301JS	RESISTOR, FIXED, COMP (SELECT AT TEST R23,14).....	3
20	PAHZZ	81349	RCR07G182JS	RESISTOR, FIXED, COMP (SELECT AT TEST).....	1
21	PAHZZ	81349	RCR07G911JS	RESISTOR, FIXED, COMP (SELECT AT TEST R12,16,20).....	4
22	PAHZZ	81349	RCR07G471JS	RESISTOR, FIXED, COMP (SELECT AT TEST).....	4
23	PAHZZ	81349	RCR07G511JS	RESISTOR, FIXED, COMP (SELECT AT TEST).....	4
24	PAHZZ	81349	RCR07G561JS	RESISTOR, FIXED, COMP (SELECT AT TEST).....	4
25	PAHZZ	81349	RCR07G621JS	RESISTOR, FIXED, COMP (SELECT AT TEST).....	4
26	PAHZZ	81349	RCR07G681JS	RESISTOR, FIXED, COMP (SELECT AT TEST).....	4
27	PAHZZ	81349	RCR07G751JS	RESISTOR, FIXED, COMP (SELECT AT TEST).....	4
28	PAHZZ	81349	RCR07G152JS	RESISTOR, FIXED, COMP (SELECT AT TEST).....	2
29	PAHZZ	81349	RCR07G122JS	RESISTOR, FIXED, COMP (SELECT AT TEST R12,16,20).....	5
30	PAHZZ	81349	RCR07G102JS	RESISTOR, FIXED, COMP (SELECT AT TEST).....	3
31	PAHZZ	81349	RCR07G112JS	RESISTOR, FIXED, COMP (SELECT AT TEST).....	3
32	PAHZZ	81349	RCR07G132JS	RESISTOR, FIXED, COMP (SELECT AT TEST).....	3

SECTION II			TM11-5895-1303-24P		(5)	(6)
(1)	(2)	(3)	(4)			
ITEM NO	SMR CODE	FSCM	PART NUMBER	DESCRIPTION AND USABLE ON CODES(UOC)		QTY
33	PAHZZ	81349	RCR07G821JS	TEST).....		3
				RESISTOR, FIXED, COMP (SELECT AT		
34	PAHZZ	81349	RCR07G391JS	TEST).....		1
				RESISTOR, FIXED, COMP (SELECT AT		
35	PAHZZ	81349	RCR07G431JS	TEST).....		2
				RESISTOR, FIXED, COMP (SELECT AT		
36	PAHZZ	81349	RCR07G271JS	TEST).....		2
				RESISTOR, FIXED, COMP (SELECT AT		
37	PAHZZ	81349	RCR07G331JS	TEST).....		2
				RESISTOR, FIXED, COMP (SELECT AT		
38	PAHZZ	81349	RCR07G361JS	TEST).....		2
				RESISTOR, FIXED, COMP (SELECT AT		
39	PAHZZ	81349	RCR07G272JS	TEST).....		1
				RESISTOR, FIXED, COMP.....		
40	PAHZZ	81349	RCR07G181JS	TEST).....		2
				RESISTOR, FIXED, COMP (SELECT AT		
41	PAHZZ	81349	RCR20G332JS	TEST R44).....		1
				RESISTOR, FIXED, COMP.....		
42	PAHZZ	81349	RCR07G820JS	TEST).....		1
				RESISTOR, FIXED, COMP.....		
43	PAHZZ	81349	RCR07G121JS	TEST).....		1
				RESISTOR, FIXED, COMP (SELECT AT		
44	PAHZZ	81349	RCR07G131JS	TEST).....		1
				RESISTOR, FIXED, COMP (SELECT AT		
45	PAHZZ	81349	RCR07G151JS	TEST).....		1
				RESISTOR, FIXED, COMP (SELECT AT		
46	PAHZZ	81349	RCR07G161JS	TEST).....		1
				RESISTOR, FIXED, COMP (SELECT AT		
47	PAHZZ	81349	RCR07G201JS	TEST).....		1
				RESISTOR, FIXED, COMP (SELECT AT		
48	PAHZZ	81349	RCR07G221JS	TEST).....		1
				RESISTOR, FIXED, COMP (SELECT AT		
49	PAHZZ	81349	RCR07G241JS	TEST).....		1
				RESISTOR, FIXED, COMP (SELECT AT		
50	PAHZZ	81349	RCR20G271JS	TEST).....		1
				RESISTOR, FIXED, COMP.....		
51	PAHZZ	37695	308219-1	TEST).....		1
				TRANSFORMER, POWER.....		
52	PAHZZ	37695	305188-1	TEST).....		5
				TRANSFORMER, PULSE.....		
53	PAHZZ	81349	JANTX1N6072A	TEST).....		1
				SEMICONDUCTOR DEVIC.....		
54	PAHZZ	80063	A3032572	TEST).....		2
				CABLE, ASSEMBLY.....		
55	PAHZZ	96906	MS51957-13	TEST).....		2
				SCREW, MACHINE.....		
56	PAHZZ	80205	NAS620C4	TEST).....		4
				WASHER, FLAT.....		
57	PAHZZ	80205	NAS671C4	TEST).....		4
				NUT, PLAIN, HEXAGON.....		
58	PAHZZ	96906	MS51957-15	TEST).....		2
				SCREW, MACHINE.....		
59	PAHZZ	96906	MS3367-5-9	TEST).....		2
				STRAP, TIEDOWN, ELECT.....		

END OF FIGURE

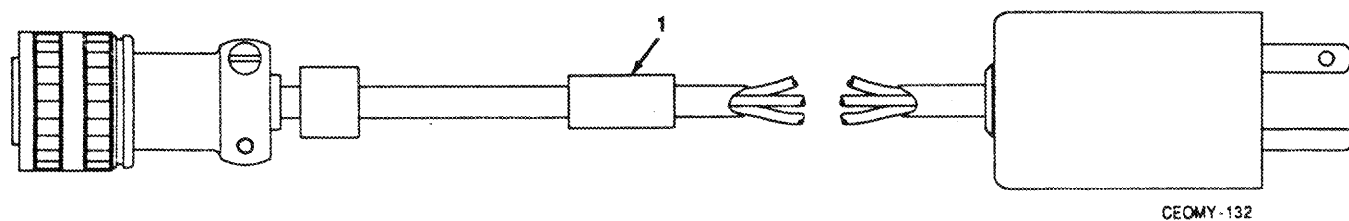
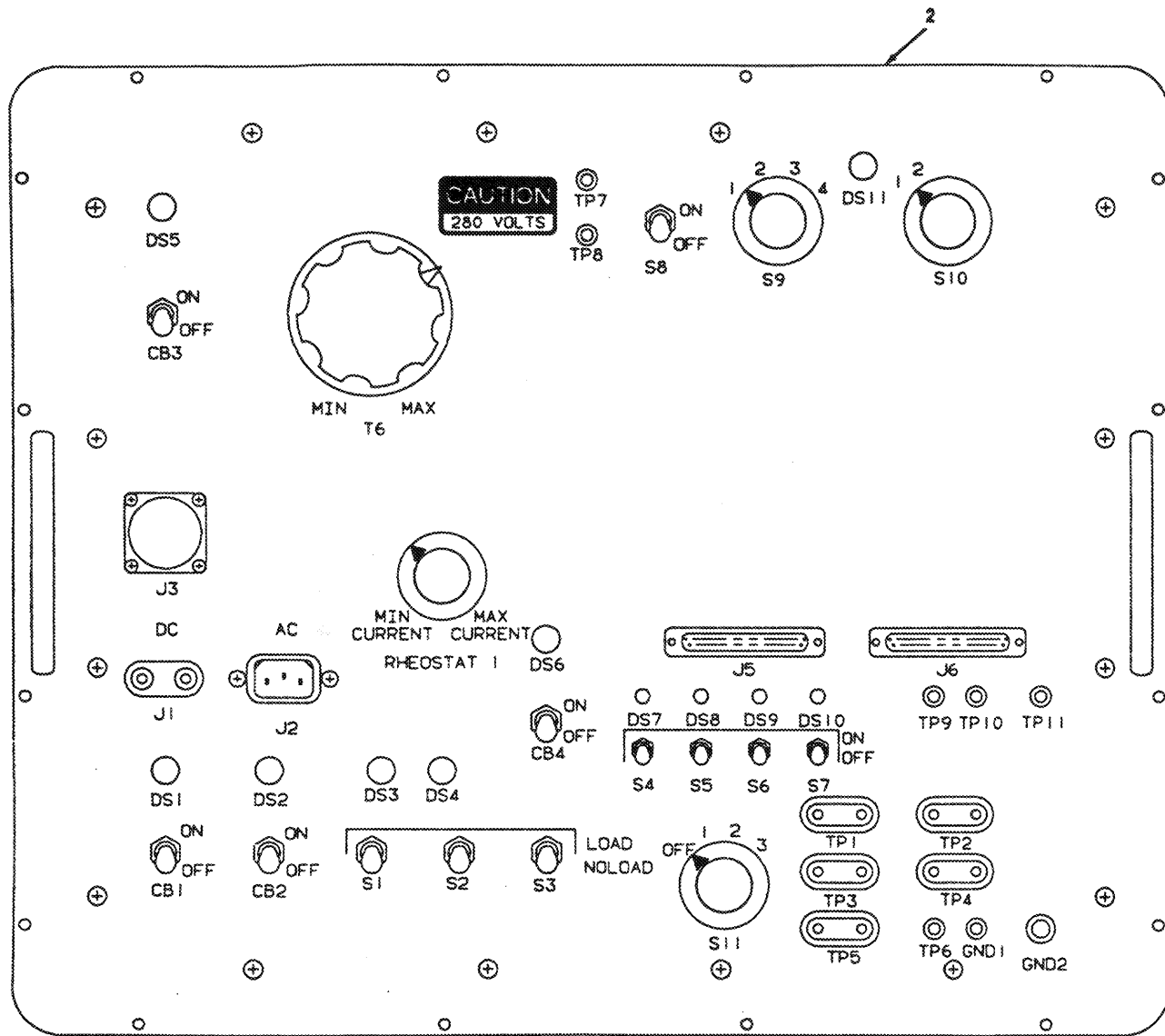

Figure 34. Special Tools List (Sheet 1 of 2)



CEOMY-133

Figure 34. Special Tools List (Sheet 2 of 2)

SECTION III			TM11-5895-1303-24P	(5)	(6)
(1)	(2)	(3)	(4)		
ITEM	SMR		PART		
NO	CODE	FSCM	NUMBER	DESCRIPTION AND USABLE ON CODES(UOC)	QTY

GROUP 20 SPECIAL TOOLS

FIG. 34

1	PEHHH	80058	CX-13361/G	CABLE, ASSEMBLY, POWE.....	1
				BOI:1 PER 1-5 END ITEMS	
2	PEHHD	80058	TS-4244/G	TEST SET, POWER SUPP.....	1
				BOI:1 PER 1-5 END ITEMS	

END OF FIGURE

## CROSS-REFERENCE INDEXES

STOCK NUMBER	NATIONAL STOCK NUMBER INDEX		STOCK NUMBER	NATIONAL STOCK NUMBER INDEX	
	FIG.	ITEM		FIG.	ITEM
5905-00-003-5782	32	36	5950-00-031-3779	26	27
5905-00-003-7717	22	83	5950-00-031-4556	8	28
	28	54		11	25
5905-00-004-6076	32	63	5950-00-031-4558	22	31
5905-00-005-2680	26	68	5950-00-031-4560	14	24
5905-00-005-2880	22	85		17	12
	28	61		20	19
5905-00-005-2882	28	27		22	36
5905-00-005-2902	20	88	5950-00-031-4561	8	25
5962-00-007-4079	20	99		22	27
	30	61		26	22
5910-00-010-8159	32	15	5950-00-031-4568	7	23
5910-00-010-8498	8	13		10	24
	11	14		11	20
	14	16		13	23
	22	19		22	26
5910-00-010-8534	14	13	5950-00-031-4571	8	24
5910-00-010-8666	7	8		11	19
	8	11		14	21
	10	8	5950-00-035-4413	8	32
	11	12		22	37
	13	13		24	36
	14	17	5950-00-035-4416	7	20
	17	7		8	31
	20	3		10	21
	22	8		11	23
	24	24		13	20
	26	10		18	3
	28	5	5950-00-035-4418	7	22
	30	3		10	23
	32	16		13	22
	33	7	5950-00-035-4420	14	22
5910-00-010-8715	8	20	5950-00-035-4425	7	18
5910-00-010-8717	17	4		8	26
	18	1		10	19
	20	11		11	21
	22	6		13	19
	24	20		14	19
	26	5		17	11
	28	3		20	20
	30	12		24	33
5910-00-010-8718	32	13		26	26
5910-00-010-8721	8	5		28	21
	11	5		30	15
	13	16	5305-00-054-5636	6	9
	14	5		9	9
	28	10		12	7
	32	6		16	1
5961-00-022-5665	22	43		19	1
5950-00-031-3779	14	23		21	4



## CROSS-REFERENCE INDEXES

STOCK NUMBER	NATIONAL STOCK NUMBER INDEX		STOCK NUMBER	FIG.	ITEM	
	FIG.	ITEM				
5305-00-054-5636	23	3	5305-00-066-7328	2	21	
	25	4	5975-00-074-2072	1	23	
	27	2	5910-00-078-9507	8	16	
	29	3	5910-00-080-2396	8	17	
	2	48	5305-00-088-9670	1	3	
	5305-00-054-5639	2	36	5910-00-098-8670	7	4
	5305-00-054-5640	2	36		10	4
	5305-00-054-5646	1	17		13	4
	5305-00-054-5647	2	5		28	14
		15	16	5910-00-098-9237	33	15
	16	5	5935-00-103-7680	22	62	
	19	3	5905-00-104-8348	33	41	
	21	6		22	56	
	23	5	5905-00-104-8350	8	58	
	25	6	5905-00-104-8358	11	55	
	27	4		14	35	
	29	5		17	22	
	31	5		20	69	
	33	55		22	66	
5305-00-054-5648	2	27		26	54	
	6	2		28	36	
	9	2		26	69	
	12	3	5905-00-104-8362	33	32	
	15	23		22	95	
	31	2	5905-00-104-8363	33	42	
	2	25		22	108	
	33	58	5905-00-104-8366	22	89	
	5305-00-054-5649	25	2	5905-00-104-8368	8	59
	5305-00-054-5651	2	22	5905-00-104-8369	11	56
5305-00-054-6652	2	17		8	67	
5305-00-054-6653	2	17	5905-00-104-8370	11	63	
5305-00-056-9961	5	9		33	38	
5310-00-057-0573	1	18		7	34	
	2	7		10	35	
	19	4	5905-00-105-7764	14	33	
	20	108		17	32	
	21	7		20	93	
	22	125		22	53	
	23	6		26	49	
	25	7		30	26	
	26	109		20	34	
	27	5	5905-00-105-7765	32	26	
	28	120		22	45	
	29	6	5905-00-105-7767	8	66	
	31	3	5905-00-105-7768	11	60	
	33	56		13	53	
5305-00-059-3660	2	16		20	78	
5910-00-066-5107	8	19		33	24	
5305-00-066-7325	6	10		30	58	
	9	10		7	48	
	12	9	5905-00-106-1248			
5305-00-066-7326	2	33	5905-00-106-1249			

## CROSS-REFERENCE INDEXES

STOCK NUMBER	NATIONAL STOCK NUMBER INDEX		STOCK NUMBER	FIG.	ITEM	
	FIG.	ITEM				
5905-00-106-1249	8	44	5905-00-110-7620	10	51	
	10	49		11	70	
	11	37		13	49	
	17	18		14	37	
	20	63		17	29	
	22	90		18	7	
	28	38		20	26	
	32	30		22	47	
	5905-00-106-1278	7		36	24	39
		10		37	26	52
		22		74	28	32
		32		65	30	41
5905-00-106-1356	22	64	32	33		
	24	40	33	30		
	26	82	5905-00-110-7622	17	23	
	32	28		20	68	
	33	28		22	58	
5905-00-106-1357	17	20	24	50		
	28	73	28	58		
	32	62	30	21		
	5905-00-106-3666	7	54	5905-00-111-1679	14	73
8		65	20		74	
10		55	22		51	
11		59	28		41	
17		21	32		34	
20		32	5905-00-111-1681	30	18	
22		50		5905-00-111-1682	20	61
24		46		5905-00-111-1686	33	46
26		77		5975-00-111-3208	33	59
28		29		5905-00-111-4727	33	39
30		42	5905-00-111-4742	17	38	
32		54	5905-00-111-4750	17	31	
5905-00-106-3668		17	36	22	77	
		22	103	26	45	
		22	99	33	19	
5905-00-106-9356	22	94	5905-00-111-8357	26	74	
5905-00-106-9357	22	94		33	18	
5905-00-107-0656	20	94		30	51	
5905-00-110-0196	22	46	5905-00-112-0984	30	54	
	26	87	5905-00-112-1392	30	54	
	28	78	5905-00-113-4860	17	26	
	30	59	5905-00-113-4861	22	104	
	32	24		22	63	
	26	44	5905-00-113-4863	22	98	
	5905-00-110-0388	18	5	5910-00-113-5276	28	12
		20	73	5910-00-113-5277	7	14
	5905-00-110-7620	22	71	10	15	
		24	54	13	15	
		32	32	26	16	
		7	50	14	9	
8		85	28	9		

## CROSS-REFERENCE INDEXES

STOCK NUMBER	NATIONAL STOCK NUMBER INDEX	STOCK NUMBER	FIG.	ITEM
	FIG.	ITEM		
5910-00-113-5286	32	10	22	59
5910-00-113-5445	20	15	8	62
	22	21	11	64
	28	13	17	39
	32	12	32	58
5910-00-113-5459	32	14	7	51
5910-00-113-5465	20	4	10	52
	22	17	13	50
	24	21	17	37
5910-00-113-5471	8	12	20	66
	11	13	26	38
5910-00-113-5499	7	5	33	23
	8	9	17	16
	10	5	30	45
	11	9	20	28
	13	5	22	100
	14	4	24	52
	32	7	2	66
	33	11	2	62
5910-00-113-5730	8	7	2	78
	11	7	2	71
5910-00-113-9445	32	11	2	69
5910-00-114-0082	30	13	2	94
5910-00-114-0683	28	8	2	67
5905-00-114-0708	20	67	2	86
	22	67	8	83
	24	48	20	77
	28	42	32	56
5905-00-114-0710	7	38	32	25
	10	39	33	36
	17	34	20	87
	22	49	26	53
	33	37	28	74
5905-00-114-0711	17	30	8	64
	20	76	11	61
	28	30	13	54
	30	40	13	56
5910-00-114-0802	7	3	20	81
	10	3	33	33
	13	3	8	43
	30	2	11	36
5905-00-114-5343	28	76	20	33
	33	20	22	75
5905-00-114-5407	33	50	24	51
5905-00-114-5438	24	42	33	45
5905-00-115-2223	22	88	22	107
5905-00-115-2261	17	25	33	43
5905-00-115-3560	20	30	7	33
5365-00-115-6848	1	38	10	34
	1	46	33	31

## SECTION IV

TM11-5895-1303-24P

## CROSS-REFERENCE INDEXES

STOCK NUMBER	NATIONAL STOCK NUMBER INDEX FIG. ITEM	STOCK NUMBER	FIG. ITEM			
5905-00-120-9154	8 61	5905-00-131-1255	14 71			
	11 58		33 29			
	14 38		20 75			
	22 61		22 91			
	28 40		22 101			
5905-00-121-6327	33 22	5905-00-135-3971	8 60			
	26 55		11 57			
	28 39		22 102			
	32 55		22 54			
	7 52		33 48			
5905-00-121-9921	10 53	5905-00-135-3972	8 68			
	22 52		28 26			
	26 50		33 35			
	33 34		22 97			
	14 72		32 27			
5905-00-121-9932	20 85	5905-00-135-6045	17 33			
	28 37		20 65			
	32 59		33 26			
	14 15		7 35			
	7 12		10 36			
5905-00-121-9938	8 6	5905-00-135-6046	17 40			
	8 21		20 24			
	10 13		22 48			
	11 6		32 61			
	11 16		20 79			
5910-00-124-0627	13 12	5905-00-136-3890	22 68			
	14 3		33 25			
	17 3		22 109			
	20 2		28 59			
	22 5		7 39			
5905-00-122-0004	26 6	5905-00-136-7103	10 40			
	28 4		33 44			
	30 4		7 40			
	8 63		10 41			
	11 62		20 70			
5905-00-126-6683	20 84	5905-00-136-8405	22 65			
	24 45		24 41			
	26 71		26 73			
	28 60		32 57			
	30 46		26 47			
5905-00-126-6692	22 92	5905-00-136-8406	32 49			
	8 84		20 71			
	11 69		28 62			
	20 80		20 51			
	22 57		28 66			
5905-00-126-6696	33 27	5905-00-138-1017	30 35			
	8 69		26 61			
	22 87		32 42			
	26 46		26 63			
	28 77		20 39			
5905-00-126-6697		5905-00-138-3376				
			5905-00-138-6994			
				5905-00-138-6995		
					5905-00-138-7399	
						5905-00-138-7401
	5905-00-138-7402					

## CROSS-REFERENCE INDEXES

STOCK NUMBER	NATIONAL STOCK NUMBER INDEX		STOCK NUMBER	FIG.	ITEM
	FIG.	ITEM			
5905-00-138-7402	26	84	5935-00-152-9571	18	2
	28	63	5905-00-153-4909	28	83
	30	31	5910-00-156-5999	8	8
5905-00-139-1925	30	43		11	8
5905-00-139-1927	20	38	5905-00-156-6298	28	92
	30	30	5905-00-156-6550	30	49
5905-00-139-1928	28	55	5910-00-158-4785	26	12
5905-00-139-2141	20	60	5905-00-164-1867	22	110
5905-00-139-2146	32	51	5310-00-167-0797	2	37
5905-00-139-2361	30	48	5962-00-167-6330	24	56
5905-00-141-0717	17	17	5910-00-170-9557	26	11
	20	86	5950-00-170-9769	7	24
	22	55		10	25
	24	43		13	24
	28	34	5950-00-170-9770	8	29
	32	60		11	26
5905-00-141-0742	33	40	5950-00-171-0070	22	35
5905-00-141-0743	14	36		24	35
	22	82	5340-00-172-8382	5	13
5905-00-141-0744	8	88	6210-00-176-4928	2	11
	11	73	5905-00-180-8301	7	43
	17	27		8	52
	26	72		10	44
5905-00-141-1131	22	96		11	38
5905-00-141-1132	17	24		13	43
	26	48		14	50
	28	35	5905-00-180-8303	8	51
5905-00-141-1149	26	70		11	45
5905-00-141-1183	7	49		14	68
	10	50	5905-00-180-8314	13	35
	14	39		17	28
	22	73	5905-00-180-8315	11	66
	24	47		14	66
	26	37	5905-00-184-7787	20	41
	30	25		30	32
	32	29	5905-00-184-7788	20	43
5905-00-141-1295	17	19	5910-00-185-9067	15	10
5910-00-144-4383	32	9	5905-00-196-5171	20	31
5905-00-146-3879	20	59	5905-00-197-0219	13	39
	30	36	5905-00-197-0220	8	77
5905-00-146-8423	26	36	5905-00-197-0221	26	41
5905-00-150-0477	20	37	5905-00-197-0223	8	47
	28	64	5905-00-197-0224	7	41
	30	29		8	87
5905-00-151-4659	26	57		10	42
6210-00-151-5276	2	9		11	72
5905-00-152-7613	20	56		13	41
	28	71	5905-00-197-4110	20	62
5905-00-152-8373	33	17	5910-00-199-5335	11	4
5935-00-152-9571	17	10		14	14

## SECTION IV

TM11-5895-1303-24P

## CROSS-REFERENCE INDEXES

STOCK NUMBER	NATIONAL STOCK NUMBER INDEX		STOCK NUMBER	FIG.	ITEM
	FIG.	ITEM			
5905-00-203-1478	28	82	5905-00-305-5187	20	27
5905-00-203-5377	26	66	5905-00-305-5225	20	95
	32	46	5905-00-307-3516	28	104
5310-00-208-3786	2	30	5950-00-325-6462	28	20
	5	5	5340-00-327-4820	6	16
	15	3		9	17
	20	106		12	16
	22	123		16	11
	26	107		19	9
	28	118		21	11
	33	57		23	9
5905-00-211-0488	28	88		25	12
5905-00-219-8638	26	64		27	9
	32	44		29	10
5905-00-223-2741	22	81	5905-00-333-9543	28	56
	26	81	5961-00-335-8934	8	3
5305-00-225-6400	2	29		26	3
	15	6		28	2
5905-00-227-7015	13	33	5935-00-341-0559	3	4
5905-00-228-5506	14	34	5905-00-350-8351	20	57
	17	15	5905-00-369-6932	20	72
	26	85		22	70
5905-00-231-2917	7	45		24	53
	10	46	5340-00-376-8648	6	17
	11	49		9	18
	13	45		12	18
5905-00-236-0487	30	50		16	14
5905-00-236-0513	20	36		19	12
	30	28		21	14
5905-00-236-0868	28	43		23	12
5905-00-236-0970	32	47		25	14
5905-00-236-7578	20	89		27	12
5905-00-246-8690	18	6		29	12
5905-00-250-3328	32	48	5950-00-377-9882	8	27
5905-00-255-3699	8	45		11	22
5905-00-255-9304	30	24		26	25
5962-00-256-0340	8	95	5905-00-400-9836	7	47
	11	75		10	48
	14	78		11	51
	17	41		13	47
5905-00-256-5050	30	39	5905-00-401-7424	8	49
5905-00-256-5051	26	65		11	43
5905-00-264-3832	28	57		13	34
5940-00-271-6759	15	22	5905-00-401-7425	7	46
5905-00-284-6117	28	44		10	47
5905-00-285-0626	28	89		11	65
5905-00-285-1289	32	64		13	46
5905-00-288-8765	28	98	5905-00-401-7426	8	72
5905-00-292-1064	26	62	5905-00-401-7427	8	75
5905-00-295-5267	28	101		11	39

## CROSS-REFERENCE INDEXES

STOCK NUMBER	FIG.	NATIONAL STOCK NUMBER INDEX ITEM	STOCK NUMBER	FIG.	ITEM
5905-00-401-7427	14	69	5961-00-420-3668	13	30
5905-00-401-7428	8	50		14	29
	11	44	5961-00-421-3040	22	44
5905-00-401-7429	8	55	5905-00-422-3800	13	37
	14	51		26	51
5905-00-401-7430	14	54	5310-00-425-0402	2	81
5905-00-401-7431	14	67	5961-00-426-9613	32	3
5905-00-401-7432	20	90		33	2
	22	86	5905-00-429-8772	20	46
5905-00-401-7436	26	56	5340-00-431-1115	6	13
5905-00-401-8688	32	41		9	12
5905-00-402-1180	26	79		12	11
5905-00-402-1400	20	49		16	10
	28	70		19	8
	30	33		21	10
5935-00-402-6983	3	3		23	8
5961-00-403-3298	33	1		25	10
5905-00-403-4447	30	53		27	8
5905-00-403-4448	20	48		29	8
5905-00-403-4453	20	50	5905-00-431-5146	28	28
	30	34		32	52
5905-00-403-4456	28	90	5905-00-431-5155	28	80
5905-00-407-0081	8	48	5905-00-431-5156	30	52
	11	42	5905-00-431-5157	20	40
	14	57	5905-00-431-5158	20	47
5905-00-407-0088	8	81	5905-00-432-0331	28	79
	14	59		30	19
5905-00-409-2975	14	70	5905-00-432-0367	30	22
5905-00-410-1577	30	23	5905-00-432-6343	28	103
	32	31	5905-00-432-6363	22	76
5905-00-411-1851	8	71	5935-00-432-6649	20	21
5905-00-412-0758	7	53		22	38
	10	54		30	16
	11	50	5905-00-433-1853	8	79
	13	48	5905-00-433-6486	14	55
	14	61	5961-00-434-9211	32	21
5905-00-412-0764	32	50	5905-00-435-1718	33	49
5905-00-412-0772	28	65	5905-00-435-6374	20	92
	30	20		26	86
5905-00-412-4048	20	29		28	33
5905-00-412-4049	20	83	5961-00-438-0598	8	36
	26	58		11	31
5905-00-413-1200	8	82	5905-00-442-9356	20	35
	14	49		22	69
5325-00-419-6181	2	70		24	49
	2	93		26	78
5961-00-420-3668	7	30		28	31
	8	37		30	27
	10	31		32	53
	11	32	5905-00-445-1561	30	47

## CROSS-REFERENCE INDEXES

STOCK NUMBER	NATIONAL STOCK NUMBER INDEX	STOCK NUMBER	FIG.	ITEM	
5905-00-451-7410	20	54	5905-00-484-7874	28	102
	26	83	5905-00-484-7880	28	47
	28	69		32	38
5905-00-455-4403	17	35	5905-00-484-7883	28	99
5905-00-458-9346	26	42	5905-00-484-7884	28	50
5905-00-458-9500	8	46	5905-00-485-4545	22	80
	11	40		26	76
	14	64	5905-00-485-4554	7	37
5905-00-462-5635	20	44		10	38
5905-00-466-1215	13	36		20	82
5905-00-466-1216	11	41		22	60
5905-00-466-1217	11	68		33	21
	14	60	5935-00-485-5018	15	7
5905-00-466-1218	8	56	5950-00-487-1779	14	20
	11	52	5905-00-489-7703	8	70
	14	56		13	38
5905-00-468-3020	26	67	5905-00-491-1984	7	44
5905-00-469-3507	32	35		10	45
5905-00-470-0369	8	73		11	48
5905-00-470-9163	11	67		13	44
5905-00-470-9480	14	65	5905-00-491-6344	8	76
5905-00-471-2422	28	45	5905-00-491-6386	28	49
	32	37	5905-00-492-2022	26	43
5905-00-471-4622	8	74	5905-00-493-5249	8	78
5961-00-476-7855	32	2		11	54
5905-00-476-8189	32	39		14	58
5905-00-479-6658	8	57	5910-00-495-0042	15	11
	11	53	5935-00-497-8968	7	28
	14	63		10	29
5905-00-479-9945	20	91		13	28
5905-00-480-5193	28	51		14	26
5905-00-480-5194	28	53		24	37
5905-00-480-5196	30	44		26	31
5905-00-481-0961	8	80		28	22
5905-00-481-1110	26	60	5910-00-506-9807	8	18
5905-00-481-1320	28	52	5905-00-513-2874	22	79
	30	55	5310-00-531-9514	2	18
5905-00-481-1403	28	105	5905-00-532-2082	22	106
5905-00-481-1404	28	93	5950-00-542-9634	7	19
5905-00-481-1405	28	91		10	20
5905-00-481-5255	8	90	5961-00-596-2973	32	4
5905-00-481-8454	32	40	5961-00-603-8935	8	41
5905-00-481-8456	28	81		14	31
5905-00-482-7695	13	40	5310-00-616-3555	2	53
5905-00-483-0425	13	51		31	9
5905-00-483-4038	20	55	5310-00-616-8660	2	20
	28	72		31	10
	30	37		32	77
5905-00-484-7550	8	86	5905-00-617-5096	14	53
	11	71	5340-00-631-7894	31	13



## CROSS-REFERENCE INDEXES

STOCK NUMBER	NATIONAL STOCK NUMBER INDEX		STOCK NUMBER	FIG.	ITEM
	FIG.	ITEM			
5961-00-650-9651	32	5	5305-00-868-9747	2	96
5310-00-672-2178	2	26	5320-00-879-6609	2	84
	5	7	5999-00-883-0081	32	76
5320-00-680-4039	2	82	5305-00-917-7839	15	1
5940-00-682-2477	2	40	5310-00-929-6395	2	19
5905-00-689-1290	7	42		32	78
	10	43	5310-00-933-8118	2	6
	13	42		5	6
	14	48		15	4
5905-00-721-0036	20	45		20	107
5905-00-721-3305	20	58		22	124
	30	38		26	108
5905-00-721-3677	28	48		28	119
5905-00-721-3678	32	45	5310-00-933-8120	2	15
5905-00-721-3680	26	59	5950-00-943-9174	7	26
5905-00-721-3681	20	52		10	27
	28	67		13	26
5905-00-721-3683	20	53	5325-00-948-7362	1	37
	28	68		1	45
5310-00-723-9676	6	3	5340-00-969-6502	5	8
	9	3	5310-00-989-0640	2	14
	12	4	5305-00-993-9189	6	6
	15	5		9	6
	16	6		12	1
5905-00-758-4774	28	46		21	1
5905-00-758-4780	28	96	5962-01-003-2577	20	100
5905-00-758-4782	20	42	5935-01-005-9795	7	17
	30	56		8	34
5905-00-761-5758	8	53		10	18
	11	46		11	29
	14	62	5935-01-005-9821	6	5
6240-00-763-7744	2	10		9	5
5340-00-766-6818	2	58	5961-01-006-7997	22	40
5310-00-772-3721	2	73	5961-01-006-7999	22	41
5310-00-773-7624	2	23	5950-01-008-8645	8	30
5950-00-779-3452	26	30		11	27
5340-00-782-8737	2	24		14	25
5310-00-784-8145	2	68	5935-01-011-3400	7	16
5340-00-815-4929	31	16		8	23
5910-00-828-1458	8	15		10	17
5961-00-836-6663	8	35		11	18
	11	30		13	18
	14	28		14	18
5310-00-837-1381	21	2		17	9
5961-00-858-3826	14	32		20	18
	17	14		22	25
	20	23		24	26
	22	42		26	19
	26	33		28	18
	28	24	5935-01-011-4754	22	23

## CROSS-REFERENCE INDEXES

STOCK NUMBER	NATIONAL STOCK NUMBER INDEX		STOCK NUMBER	FIG.	ITEM
	FIG.	ITEM			
5935-01-011-4754	26	20	5961-01-043-9178	22	1
5935-01-012-5578	16	4		24	2
5961-01-012-9314	28	23		26	4
5961-01-019-4947	7	31		28	1
	8	42		30	1
	10	32	5320-01-047-1060	2	92
	11	35	5905-01-047-2251	22	84
	13	31	5320-01-047-6330	1	32
	17	13		1	39
	22	39	5910-01-047-7869	22	11
	24	38	5910-01-049-9148	22	15
	26	34	5962-01-050-0915	8	100
5950-01-023-1492	22	32		11	81
	24	34	5905-01-051-9611	14	45
5961-01-023-2852	17	2	5910-01-053-5634	22	10
	22	2		24	23
	24	4	5905-01-053-5786	28	25
	26	2	5961-01-057-3305	33	53
5962-01-023-5036	14	83	5910-01-059-2483	22	12
5961-01-025-2649	8	1	5910-01-064-6534	39	10
5905-01-025-4336	22	105	5910-01-064-9676	22	13
5962-01-026-6055	14	87	5962-01-065-7026	7	58
5962-01-027-6863	8	101		10	59
	11	82		13	59
5950-01-027-9120	7	25	5905-01-067-9399	32	43
	10	26	5962-01-068-1039	7	61
	13	27		8	97
	22	34		10	62
5950-01-029-5971	13	25		11	77
5962-01-033-2280	28	109		13	62
5905-01-035-5065	8	54		14	85
	11	47	5961-01-070-7446	32	1
	13	52	5910-01-071-0244	32	8
	14	52	5961-01-071-6701	7	32
	26	40		8	40
5961-01-035-5474	33	4		10	33
5961-01-037-4712	33	3		11	34
5962-01-039-6395	7	62		13	32
	10	63	5910-01-077-9819	30	8
	13	63	5962-01-080-6488	17	42
5910-01-041-6291	22	14		20	97
5910-01-042-0081	33	6		22	114
5961-01-043-9178	7	1		24	55
	8	2		26	90
	10	1		28	107
	11	2		30	60
	13	1	5999-01-084-0860	8	116
	14	2		11	99
	17	1		14	101
	20	1	5962-01-084-9458	7	64

## CROSS-REFERENCE INDEXES

STOCK NUMBER	NATIONAL STOCK NUMBER INDEX		FIG.	ITEM
	FIG.	ITEM		
5962-01-084-9458	8	104	26	80
	10	65	32	70
	11	84	26	75
	13	66	20	103
	14	81	28	113
5999-01-086-6659	14	102	28	86
	32	75	28	75
5962-01-086-7029	20	101	22	78
	28	110	20	64
5962-01-087-5967	7	56	30	64
	10	57	32	23
	11	85	24	3
	13	57	14	42
5935-01-087-8422	33	14	14	46
5962-01-087-9496	15	21	14	75
5962-01-088-3862	32	71	28	84
5961-01-088-8346	17	45	26	39
5962-01-098-1461	22	115	20	111
5961-01-099-9148	22	118	14	47
5961-01-102-2873	17	46	14	40
	26	95	14	44
5961-01-102-5719	28	114	14	41
	32	72	24	44
5961-01-102-5720	32	73	22	72
5961-01-105-0607	26	92	26	35
5962-01-106-4661	31	8	7	59
5961-01-111-7743	20	104	10	60
	26	93	13	60
5962-01-119-8524	32	68	33	16
5962-01-120-2346	22	116	14	43
5935-01-126-2451	3	2	22	122
5935-01-127-1897	18	4	24	63
5961-01-127-3102	8	39	28	122
	14	30	22	121
5962-01-128-1415	7	65	24	62
	8	103	26	110
	10	66	30	65
	11	83	20	112
	13	67	18	11
	14	79	18	13
5962-01-131-2864	7	60	32	79
	8	96	1	7
	10	61	1	8
	11	76	1	11
	13	61	1	12
5910-01-133-5494	26	8	1	15
5905-01-138-6236	22	93	1	9
5310-01-141-6672	2	32	1	1
5970-01-144-6789	26	28	1	10
5961-01-146-4562	22	117	1	13

## CROSS-REFERENCE INDEXES

STOCK NUMBER	NATIONAL STOCK NUMBER INDEX		STOCK NUMBER	FIG.	ITEM
	FIG.	ITEM			
5895-01-205-0910	1	4	5995-01-241-9943	5	10
5905-01-209-0630	18	10	5995-01-241-9944	5	12
5910-01-213-2366	17	5	5995-01-241-9945	5	11
5910-01-213-2368	32	17	5995-01-241-9946	1	29
5910-01-217-7205	20	5	5995-01-241-9947	1	27
	30	5	5995-01-241-9948	1	26
5910-01-219-2315	14	8	5995-01-241-9949	1	24
5962-01-227-9394	32	69	5995-01-241-9950	1	22
5930-01-233-4112	2	42	5995-01-241-9951	1	25
5962-01-234-0880	14	80	5995-01-241-9952	1	21
	17	44	5995-01-241-9953	1	19
5895-01-237-4742	22	120	5950-01-241-9958	22	29
	26	97	5950-01-241-9959	22	112
5305-01-237-4750	2	55		26	89
	15	17	5961-01-241-9970	8	38
5305-01-237-4751	2	44		11	33
5305-01-237-4752	2	52	5962-01-241-9974	7	63
5305-01-237-4753	2	46		10	64
5305-01-237-4754	2	50		13	64
5999-01-237-5069	1	33		14	86
	1	41		18	14
5999-01-237-5070	1	36		20	96
	1	42		22	113
5999-01-237-5071	1	31		28	108
	1	40		30	62
5995-01-237-8120	15	20	5962-01-241-9975	14	82
5895-01-237-8294	31	11	5995-01-241-9979	2	8
5895-01-238-3840	2	51	5995-01-241-9980	4	8
5895-01-238-4011	16	7	5995-01-241-9981	4	7
5895-01-238-4012	19	5	5995-01-241-9982	4	6
5905-01-238-4023	7	55	5995-01-241-9983	4	9
	10	56	5895-01-241-9998	6	4
	13	55	5895-01-241-9999	6	7
	14	74	5895-01-242-0000	9	4
	20	25	5895-01-242-0001	16	8
	28	85	5895-01-242-0002	25	5
	30	17	5895-01-242-0003	27	3
5995-01-238-8249	15	13	5895-01-242-0004	29	4
5962-01-238-8470	8	99	5895-01-242-0005	31	1
	11	80	5950-01-242-6506	22	111
	13	65	5995-01-242-6511	26	96
5962-01-238-8471	18	15	5995-01-242-6512	1	28
5895-01-238-8522	12	5	5895-01-242-6517	2	31
5895-01-238-8523	12	6	5895-01-242-6518	9	7
5895-01-238-8524	15	15	5895-01-242-6519	21	5
5995-01-241-9935	2	39	5895-01-242-6520	23	4
5995-01-241-9939	2	45	5962-01-243-1087	8	98
5995-01-241-9940	2	47		11	79
5995-01-241-9941	15	12	5995-01-263-5494	34	1
5995-01-241-9942	15	14	6625-01-267-4417	34	2

## CROSS-REFERENCE INDEXES

STOCK NUMBER	NATIONAL STOCK NUMBER INDEX	STOCK NUMBER	FIG.	ITEM	
	FIG.	ITEM			
5950-01-274-6451	32	67	5935-01-276-0475	3	1
5950-01-274-6452	33	52	5935-01-276-0476	6	12
5950-01-274-6463	33	13		9	13
5950-01-274-6467	28	106		12	12
5950-01-274-6502	32	66	5935-01-276-1142	4	3
5950-01-274-6572	8	91	5915-01-276-1157	20	17
	14	76		28	17
5950-01-274-6573	8	92	5915-01-276-1158	22	24
5950-01-274-6580	7	21		26	18
	10	22	5935-01-276-5597	4	1
	11	24	5935-01-276-6269	4	5
	13	21	5999-01-276-6437	11	90
5950-01-274-7886	8	94	5910-01-276-8123	22	16
5950-01-274-7891	7	27	5305-01-277-3181	15	9
	10	28	5999-01-280-5482	7	74
5950-01-274-9207	22	33		8	110
	26	24		10	76
5915-01-275-0679	2	54		14	89
5950-01-275-0712	33	51		22	126
5915-01-275-0773	2	34		26	100
5915-01-275-0774	2	28		28	121
5961-01-275-0806	22	4	5905-01-280-9686	28	100
	24	1			
5910-01-275-1944	33	10			
5910-01-275-1945	33	8			
5910-01-275-2946	33	5			
5950-01-275-4918	8	93			
	14	77			
5962-01-275-5460	28	111			
5910-01-275-6519	14	7			
5999-01-275-6605	7	69			
	8	117			
	10	69			
	11	100			
	13	69			
5955-01-275-6614	17	47			
5340-01-275-7136	3	5			
5340-01-275-7182	2	60			
5340-01-275-7183	2	80			
5340-01-275-7184	2	77			
5935-01-275-7212	7	29			
	8	33			
	10	30			
	11	28			
	13	29			
	14	27			
5910-01-275-7258	7	7			
	10	7			
	13	7			
5910-01-276-0454	14	11			

SECTION II  
 (1) (2) (3)  
 ITEM SMR FSCM  
 NO CODE

TM11-5895-1303-24P  
 (4)  
 PART  
 NUMBER

(5)

(6)

DESCRIPTION AND USABLE ON CODES(UOC) QTY  
 GROUP 0501 AUDIO SIDEBAND EXCITER  
 CCA A5A1 (A3024630)

FIG. 20

1	PAHZZ	81349	JANTX1N4454-1	SEMICONDUCTOR DEVIC.....	8
2	PAHZZ	81349	M39014-01-1575	CAPACITOR, FIXED, CER.....	10
3	PAHZZ	81349	M39014/01-1357	CAPACITOR, FIXED, CER.....	5
4	PAHZZ	81349	M39014/02-1360	CAPACITOR, FIXED, CER.....	4
5	PAHZZ	81349	CCR06CG123GS	CAPACITOR, FIXED, CER.....	5
6	PAHZZ	81349	CCR09CG222JP	CAPACITOR, FIXED, CER.....	1
7	PAHZZ	81349	CCR09CG561JP	CAPACITOR, FIXED, CER.....	1
8	PAHZZ	81349	CCR09CG121JP	CAPACITOR, FIXED, CER.....	1
9	PAHZZ	81349	CCR07CG333JP	CAPACITOR, FIXED, CER.....	1
10	PAHZZ	81349	CCR09CG270JP	CAPACITOR, FIXED, CER.....	1
11	PAHZZ	81349	M39014/01-1593	CAPACITOR, FIXED, CER.....	19
12	PAHZZ	56996	B4003327-3289	CAPACITOR, FIXED, ELE.....	3
13	PAHZZ	56996	B4003327-3345	CAPACITOR, FIXED, ELE.....	1
14	PAHZZ	81349	CCR09CG620JP	CAPACITOR, FIXED, CER.....	1
15	PAHZZ	81349	M39014/01-1259	CAPACITOR, FIXED, CER.....	3
16	PAHZZ	56996	B4003328-3442	CAPACITOR, FIXED, ELE.....	1
17	PAHZZ	80063	A3023936-1	FILTER, BAND PASS.....	1
18	PAHZZ	19505	2010-6511-002	CONNECTOR, RECEPTACL.....	2
19	PAHZZ	96906	MS75084-16	COIL, RADIO FREQUENC.....	3
20	PAHZZ	96906	MS75085-7	COIL, RADIO FREQUENC.....	3
21	PAHZZ	81349	M55302/4-04	CONNECTOR, RECEPTACL.....	1
22	PAHZZ	00779	87518-9	CONNECTOR, RECEPTACL.....	1
23	PAHZZ	81349	JANTX2N2222A	TRANSISTOR.....	4
24	PAHZZ	81349	RCR07G513JS	RESISTOR, FIXED, COMP (SELECT AT TEST R100).....	3
25	PAHZZ	81349	M8340109M5103JC	RESISTOR NETWORK, FI.....	1
26	PAHZZ	81349	RCR07G102JS	RESISTOR, FIXED, COMP (SELECT AT TEST R97).....	21
27	PAHZZ	81349	RNC55H2320FS	RESISTOR, FIXED, FILM.....	1
28	PAHZZ	81349	RCR07G223JS	RESISTOR, FIXED, COMP (SELECT AT TEST R13,47,101).....	5
29	PAHZZ	81349	RNC55H2002FS	RESISTOR, FIXED, FILM (SELECT AT TEST R13,47,101).....	12
30	PAHZZ	81349	RCR07G183JS	RESISTOR, FIXED, COMP (SELECT AT TEST).....	3
31	PAHZZ	81349	RNC55H2102FS	RESISTOR, FIXED, FILM (SELECT AT TEST).....	3
32	PAHZZ	81349	RCR07G103JS	RESISTOR, FIXED, COMP.....	9
33	PAHZZ	81349	RCR07G151JS	RESISTOR, FIXED, COMP.....	2
34	PAHZZ	81349	RCR07G224JS	RESISTOR, FIXED, COMP.....	1
35	PAHZZ	81349	RCR07G240JS	RESISTOR, FIXED, COMP.....	11
36	PAHZZ	81349	RNC55H3482FS	RESISTOR, FIXED, FILM (SELECT AT TEST R37).....	3
37	PAHZZ	81349	RNC55H5492FS	RESISTOR, FIXED, FILM.....	1
38	PAHZZ	81349	RNC55H7152FS	RESISTOR, FIXED, FILM.....	1
39	PAHZZ	81349	RNC55H5362FS	RESISTOR, FIXED, FILM.....	2

SECTION II			TM11-5895-1303-24P			
(1)	(2)	(3)	(4)	(5)		(6)
ITEM NO	SMR CODE	FSCM	PART NUMBER	DESCRIPTION AND USABLE ON CODES(UOC)		QTY
40	PAHZZ	81349	RNC55H3572FS	RESISTOR, FIXED, FILM (SELECT AT TEST).....		1
41	PAHZZ	81349	RNC55H3652FS	RESISTOR, FIXED, FILM (SELECT AT TEST).....		1
42	PAHZZ	81349	RNC55H3742FS	RESISTOR, FIXED, FILM (SELECT AT TEST).....		1
43	PAHZZ	81349	RNC55H3832FS	RESISTOR, FIXED, FILM (SELECT AT TEST).....		1
44	PAHZZ	81349	RNC55H4022FS	RESISTOR, FIXED, FILM (SELECT AT TEST).....		1
45	PAHZZ	81349	RNC55H4122FS	RESISTOR, FIXED, FILM (SELECT AT TEST).....		1
46	PAHZZ	81349	RNC55H4222FS	RESISTOR, FIXED, FILM (SELECT AT TEST).....		1
47	PAHZZ	81349	RNC55H4322FS	RESISTOR, FIXED, FILM (SELECT AT TEST).....		1
48	PAHZZ	81349	RNC55H3922FS	RESISTOR, FIXED, FILM (SELECT AT TEST R37,100).....		3
49	PAHZZ	81349	RNC55H6342FS	RESISTOR, FIXED, FILM (SELECT AT TEST R41,45).....		3
50	PAHZZ	81349	RNC55H7682FS	RESISTOR, FIXED, FILM.....		2
51	PAHZZ	81349	RNC55H5762FS	RESISTOR, FIXED, FILM (SELECT AT TEST).....		1
52	PAHZZ	81349	RNC55H5902FS	RESISTOR, FIXED, FILM (SELECT AT TEST).....		1
53	PAHZZ	81349	RNC55H6042FS	RESISTOR, FIXED, FILM (SELECT AT TEST).....		1
54	PAHZZ	81349	RNC55H6192FS	RESISTOR, FIXED, FILM (SELECT AT TEST).....		1
55	PAHZZ	81349	RNC55H6652FS	RESISTOR, FIXED, FILM (SELECT AT TEST R41,45).....		4
56	PAHZZ	81349	RNC55H6492FS	RESISTOR, FIXED, FILM (SELECT AT TEST).....		2
57	PAHZZ	81349	RNC55H6812FS	RESISTOR, FIXED, FILM (SELECT AT TEST).....		2
58	PAHZZ	81349	RNC55H6982FS	RESISTOR, FIXED, FILM (SELECT AT TEST).....		2
59	PAHZZ	81349	RNC55H9532FS	RESISTOR, FIXED, FILM.....		1
60	PAHZZ	81349	RNC55H1023FS	RESISTOR, FIXED, FILM.....		1
61	PAHZZ	81349	RCR07G163JS	RESISTOR, FIXED, COMP (SELECT AT TEST R47).....		2
62	PAHZZ	81349	RNC55H1502FS	RESISTOR, FIXED, FILM (SELECT AT TEST R47).....		2
63	PAHZZ	81349	RCR07G510JS	RESISTOR, FIXED, COMP.....		5
64	PAHZZ	81349	RJR26FW503R	RESISTOR, VARIABLE, W.....		1
65	PAHZZ	81349	RCR07G681JS	RESISTOR, FIXED, COMP (SELECT AT TEST R97).....		2
66	PAHZZ	81349	RCR07G511JS	RESISTOR, FIXED, COMP.....		1
67	PAHZZ	81349	RCR07G202JS	RESISTOR, FIXED, COMP.....		4
68	PAHZZ	81349	RCR07G682JS	RESISTOR, FIXED, COMP.....		2
69	PAHZZ	81349	RCR07G822JS	RESISTOR, FIXED, COMP.....		1
70	PAHZZ	81349	RCR07G242JS	RESISTOR, FIXED, COMP.....		4

## CROSS-REFERENCE INDEXES

FSCM	PART NUMBER	PART NUMBER INDEX STOCK NUMBER	FIG.	ITEM
23939	A-5122	5915-01-275-0773	2	34
88044	AN960C3	5310-00-167-0797	2	37
88044	AN960C4	5310-01-141-6672	2	32
88044	AN960C6	5310-00-531-9514	2	18
80063	A3023935	5915-01-276-1158	22	24
			26	18
80063	A3023936-1	5915-01-276-1157	20	17
			28	17
80063	A3024060	5895-01-205-0825	1	1
80063	A3024340	5895-01-205-0910	1	4
80063	A3024344		5	1
80063	A3024345		6	1
80063	A3024346	5895-01-241-9998	6	4
80063	A3024350	5895-01-241-9999	6	7
80063	A3024354		5	2
80063	A3024355		9	1
80063	A3024356	5895-01-242-0000	9	4
80063	A3024360	5895-01-242-6518	9	7
80063	A3024364		5	3
80063	A3024365		12	2
80063	A3024366	5895-01-238-8522	12	5
80063	A3024370	5895-01-238-8523	12	6
80063	A3024374		5	4
80063	A3024376	5895-01-238-8524	15	15
80063	A3024379-1	5995-01-238-8249	15	13
80063	A3024379-2	5995-01-241-9941	15	12
80063	A3024379-3	5995-01-241-9942	15	14
80063	A3024379-4	5995-01-237-8120	15	20
80063	A3024380-1	5995-01-241-9943	5	10
80063	A3024380-2	5995-01-241-9944	5	12
80063	A3024380-3	5995-01-242-6512	1	28
80063	A3024380-4	5995-01-241-9946	1	29
80063	A3024380-5	5995-01-241-9950	1	22
80063	A3024380-6	5995-01-241-9951	1	25
80063	A3024380-7	5995-01-241-9952	1	21
80063	A3024381-1	5995-01-241-9945	5	11
80063	A3024381-2	5995-01-241-9947	1	27
80063	A3024604		1	6
80063	A3024607	5995-01-241-9939	2	45
80063	A3024608	5995-01-241-9940	2	47
80063	A3024609	5995-01-241-9979	2	8
80063	A3024615-1	5995-01-241-9953	1	19
80063	A3024615-2		1	20
80063	A3024616-2	5995-01-241-9948	1	26
80063	A3024616-3	5995-01-241-9949	1	24
80063	A3024618	5895-01-205-0650	1	7
80063	A3024621	5895-01-238-4011	16	7
80063	A3024625	5895-01-242-0001	16	8
80063	A3024629	5895-01-205-0651	1	8
80063	A3024630	5895-01-238-4012	19	5
80063	A3024634	5895-01-205-0818	1	9



## CROSS-REFERENCE INDEXES

F5CM	PART NUMBER	PART NUMBER INDEX STOCK NUMBER	FIG.	ITEM
80063	A3024635	5895-01-242-6519	21	5
80063	A3024639	5895-01-205-0653	1	12
80063	A3024640	5895-01-242-0003	27	3
80063	A3024644	5895-01-205-0652	1	11
80063	A3024645	5895-01-242-0002	25	5
80063	A3024649	5985-01-205-0864	1	10
80063	A3024650	5895-01-242-6520	23	4
80063	A3024654	5895-01-205-0883	1	13
80063	A3024655	5895-01-242-0004	29	4
80063	A3024659	5895-01-242-6517	2	31
80063	A3024671		6	11
80063	A3024684-1	5950-01-274-6572	8	91
80063	A3024684-10	5950-01-274-6580	14	76
			7	21
			10	22
			11	24
			13	21
80063	A3024684-11		26	88
80063	A3024684-12	5950-01-274-7891	7	27
			10	28
80063	A3024684-13		26	29
80063	A3024684-2	5950-01-274-6573	8	92
80063	A3024684-3	5950-01-275-4918	8	93
			14	77
80063	A3024684-4		24	27
80063	A3024684-5		24	28
80063	A3024684-6		24	29
80063	A3024684-7		22	28
			24	30
80063	A3024684-8	5950-01-241-9958	22	29
80063	A3024684-9	5950-01-241-9959	22	112
			26	89
80063	A3024716-4	5340-01-275-7183	2	80
80063	A3024716-5	5340-01-275-7184	2	77
80063	A3024716-6	5340-01-275-7182	2	60
80063	A3024838		31	6
80063	A3024840		31	4
80063	A3024841	5895-01-242-0005	31	1
80063	A3028013		9	11
80063	A3028019		15	8
80063	A3028020		12	13
80063	A3028027		2	4
80063	A3028028		2	90
80063	A3028029		2	91
80063	A3028030		2	95
80063	A3028031		2	1
80063	A3028032		2	61
80063	A3028033		2	63
80063	A3028034		2	65
80063	A3028035		1	5
80063	A3028036		1	34

## SECTION IV

TM11-5895-1303-24P

## CROSS-REFERENCE INDEXES

FSCM	PART NUMBER	PART NUMBER INDEX STOCK NUMBER	FIG.	ITEM
80063	A3028037		2	3
80063	A3028038		2	83
80063	A3028039		2	79
80063	A3028040		2	87
80063	A3028041		2	85
80063	A3028042		2	89
80063	A3028043		2	88
80063	A3028044		2	49
80063	A3028047	5995-01-241-9935	2	39
80063	A3028048		16	3
80063	A3028049		16	12
80063	A3028051		27	6
80063	A3028052		27	11
80063	A3028053		19	2
			21	3
			23	2
			25	8
			27	1
			29	2
80063	A3028054		25	1
80063	A3028055		25	13
80063	A3028056		23	1
80063	A3028057		23	11
80063	A3028058		29	1
80063	A3028059		29	11
80063	A3028065		15	2
80063	A3028098		10	2
			11	1
			13	2
			14	1
80063	A3028101	5305-01-277-3181	15	9
80063	A3028102		6	14
			9	15
			12	14
			16	13
			19	10
			21	12
			23	10
			25	11
			27	10
			29	9
			31	15
80063	A3028133	5895-01-237-8294	31	11
80063	A3028192-1	5305-01-237-4750	2	55
			15	17
			2	43
80063	A3028551		2	57
80063	A3028552		2	2
80063	A3028553		2	2
80063	A3028554		2	74
80063	A3028556		2	72
80063	A3028557	5999-01-237-5069	1	33

## CROSS-REFERENCE INDEXES

FSCM	PART NUMBER	PART NUMBER INDEX STOCK NUMBER	FIG.	ITEM
80063	A3028557	5999-01-237-5069	1	41
80063	A3028558	5999-01-237-5070	1	36
			1	42
80063	A3028559	5999-01-237-5071	1	31
			1	40
80063	A3028560		2	56
80063	A3028561		7	70
			10	70
80063	A3028562		7	78
			10	79
80063	A3028563		7	75
			10	75
80063	A3028564		7	68
			10	73
80063	A3028565		7	72
			10	72
80063	A3028566		7	71
			10	71
80063	A3028567		13	79
80063	A3028568		13	78
80063	A3028569		13	75
80063	A3028570		13	70
80063	A3028571		13	72
80063	A3028572		7	76
			10	77
80063	A3028573		13	77
80063	A3028579		1	30
80063	A3028580		1	44
80063	A3028583	5950-01-242-6506	22	111
80063	A3028602		19	6
80063	A3028603		19	11
80063	A3028613		21	8
80063	A3028614		21	13
80063	A3028629		14	100
80063	A3028630		14	91
80063	A3028631		14	96
80063	A3028632		8	112
			11	95
80063	A3028633		8	111
			11	91
80063	A3028634		14	98
80063	A3028635		14	104
80063	A3028636		8	106
			11	92
80063	A3028638		14	97
80063	A3028639		8	109
			11	89
80063	A3028640		8	118
			11	88
80063	A3028641		8	115
80063	A3028642		8	121

## CROSS-REFERENCE INDEXES

FSCM	PART NUMBER	PART NUMBER INDEX STOCK NUMBER	FIG.	ITEM
80063	A3028645		8	119
80063	A3028646		14	92
80063	A3028647		14	95
80063	A3028648		14	88
80063	A3028649		26	101
80063	A3028651		26	99
80063	A3028652		26	102
80063	A3028686	5305-01-237-4754	2	50
80063	A3028687	5895-01-238-3840	2	51
80063	A3028706-1		31	7
80063	A3028723-1	5305-01-237-4751	2	44
80063	A3028723-2	5305-01-237-4752	2	52
80063	A3028723-3	5305-01-237-4753	2	46
80063	A3028744		31	12
80063	A3028802-1		2	75
80063	A3028816		8	107
			11	93
			32	20
80063	A3028867		3	5
80063	A3028868	5340-01-275-7136	3	5
80063	A3028888-1	5935-01-276-6269	4	5
80063	A3028948		2	35
80063	A3028976		2	12
80063	A3029118		11	96
80063	A3029119		11	102
80063	A3029120		11	103
80063	A3029121	5995-01-241-9980	4	8
80063	A3029122	5995-01-241-9981	4	7
80063	A3029123	5995-01-241-9982	4	6
80063	A3029124	5995-01-241-9983	4	9
80063	A3029324		15	18
80063	A3029325		6	15
			9	16
			6	18
80063	A3029326		12	19
80063	A3029327		12	15
80063	A3029328		12	15
80063	A3032107-1	5950-01-274-9207	22	33
			26	24
			26	23
80063	A3032107-2		26	96
80063	A3032127	5995-01-242-6511	26	19
80063	A3032177		9	17
80063	A3032178		12	17
80063	A3032505		1	16
80063	A3032572		33	54
80063	A3032601-3	5365-01-199-6272	22	121
			24	62
			26	110
			30	65
			8	114
80063	A3034171		11	98
			22	132
			26	103

## SECTION IV

TM11-5895-1303-24P

## CROSS-REFERENCE INDEXES

FSCM	PART NUMBER	PART NUMBER INDEX STOCK NUMBER	FIG.	ITEM
80063	A3034520		16	2
80063	A3034554-1		26	21
80063	A3034554-2		22	30
			24	32
80063	A3034554-3		24	31
80063	A3034572		1	35
			1	43
			6	19
			9	14
			12	10
			16	9
			19	7
			21	9
			23	7
			25	9
			27	7
			29	7
			31	14
80063	A3034661		7	67
			8	123
			10	68
			11	106
			17	49
			18	18
80063	A3034778		2	76
80063	A3035717		26	106
80063	A3035718		26	105
80063	A3035828		24	60
80063	A3035829		24	59
80063	A3035830		24	58
80063	A3035831		24	61
80063	A3035836		22	135
80063	A3035837		22	133
80063	A3035838		22	134
80063	A3035839		22	129
80063	A3035840		22	130
80063	A3078391		15	19
80063	A3078673		11	94
			13	73
			14	90
52814	A3078899		22	131
80063	A3079136		7	77
			10	78
80063	A3079137		13	71
80063	A3079142		20	109
80063	A3079144		11	101
80063	A3079145		8	120
80063	A3079146		14	103
80063	A3079147		14	93
80063	A3079148		8	107
			11	87

## SECTION IV

TM11-5895-1303-24P

## CROSS-REFERENCE INDEXES

FSCM	PART NUMBER	PART NUMBER INDEX STOCK NUMBER	FIG.	ITEM
80063	A3086533		25	3
80063	A3086592		4	10
80063	A3086606		12	8
80063	A3086607		6	8
			9	8
80063	A3086680		28	115
56996	B4002890	5962-01-098-1461	22	115
56996	B4002963	5961-01-241-9970	8	38
			11	33
56996	B4002964	5961-01-071-6701	7	32
			8	40
			10	33
			11	34
			13	32
56996	B4003308-901		8	22
			11	17
56996	B4003316-19	5910-01-276-0454	14	11
56996	B4003317-18	5910-00-078-9507	8	16
56996	B4003317-21	5910-00-506-9807	8	18
56996	B4003317-23	5910-00-080-2396	8	17
56996	B4003317-24	5910-00-828-1458	8	15
56996	B4003317-32	5910-00-066-5107	8	19
56996	B4003318-78		8	10
			14	12
56996	B4003325-17	5910-01-276-8123	22	16
56996	B4003327-3123		7	13
			10	14
			13	14
56996	B4003327-3126		7	11
			8	14
			10	12
			11	15
			13	11
			14	6
56996	B4003327-3234		26	14
56996	B4003327-3238		28	11
			30	11
56996	B4003327-3244		28	6
56996	B4003327-3246		28	16
56996	B4003327-3249		22	20
56996	B4003327-3254		28	15
56996	B4003327-3285		17	8
56996	B4003327-3289		20	12
			22	18
			24	22
56996	B4003327-3326		26	13
			28	7
			30	14
56996	B4003327-3345		20	13
			22	7
56996	B4003328-3442		20	16

## SECTION IV

TM11-5895-1303-24P

## CROSS-REFERENCE INDEXES

FSCM	PART NUMBER	PART NUMBER INDEX STOCK NUMBER	FIG.	ITEM
56996	B4003337-1		20	105
56996	B4003346-1	5950-01-274-7886	8	94
56996	B4003358-4		17	48
56996	B4003371-904		26	32
56996	B4003379-901	5962-01-131-2864	7	60
			8	96
			10	61
			11	76
			13	61
56996	B4006210-902	5961-01-023-2852	17	2
			22	2
			24	4
			26	2
80058	C-11670/G	5895-01-205-0662	1	15
02735	CA6741T/3	5962-01-023-5036	14	83
81349	CCR05CG102FP	5910-01-219-2315	14	8
81349	CCR05CJ5R6JP		22	9
81349	CCR06CG103GS	5910-01-213-2366	17	5
81349	CCR06CG123GS	5910-01-217-7205	20	5
			30	5
81349	CCR07CG333JP		20	9
			30	9
81349	CCR09CG121JP		20	8
81349	CCR09CG201JP		26	7
81349	CCR09CG222JP		20	6
			30	6
81349	CCR09CG270JP		20	10
81349	CCR09CG301JP		17	6
81349	CCR09CG561JP		20	7
			30	7
81349	CCR09CG620JP		20	14
81349	CDR01BX102BKUP		7	6
			8	4
			10	6
			11	3
			13	6
			14	10
			26	9
81349	CDR12BG150AJUPX		7	15
			10	16
			13	17
			22	22
81349	CDR14BG101EKUPX		7	9
			10	10
			11	11
			13	9
			26	17
81349	CDR14BG2R0ECUPX		10	9
			13	8
81349	CDR14BG620EKUPX		7	10
			10	11

## CROSS-REFERENCE INDEXES

FSCM	PART NUMBER	PART NUMBER INDEX STOCK NUMBER	FIG.	ITEM
81349	CDR14BG620EKUPX		11	10
			13	10
81349	CDR14BP100EJUP		24	18
81349	CDR14BP102AJUP		24	5
81349	CDR14BP130EJUP		24	17
			26	15
81349	CDR14BP240EJUP		24	11
81349	CDR14BP271CJUP		24	8
81349	CDR14BP3R0ECUP		24	25
81349	CDR14BP360EJUP		24	10
81349	CDR14BP430EJUP		24	13
81349	CDR14BP470EJUP		24	7
81349	CDR14BP680EJUP		24	14
81349	CDR14BP681AJUP		24	6
81349	CDR14BP750EJUP		24	19
81349	CDR14BP820EJUP		24	15
81349	CDR14BP821AJUP		24	9
81349	CDR14BP910EJUP		24	16
81349	CDR14BP911AJUP		24	12
18714	CD4027BF/3	5962-01-033-2280	28	109
81349	CFR06RRA103JM	5910-01-275-6519	14	7
81349	CFR06RRA183JP	5910-01-275-7258	7	7
			10	7
			13	7
81349	CMR04C180J0DR	5910-01-049-9148	22	15
81349	CMR04C6R0D0DR	5910-01-059-2483	22	12
81349	CMR04C8R0D0DR	5910-01-053-5634	22	10
			24	23
81349	CMR04E270G0DR	5910-01-064-6534	30	10
81349	CMR04E470G0DR	5910-01-064-9676	22	13
81349	CMR04E750G0DR	5910-01-047-7869	22	11
81349	CMR04F101G0DR	5910-01-041-6291	22	14
81349	CMR04F121GPDR	5910-01-077-9819	30	8
81349	CMR05F161GPDR	5910-01-071-0244	32	8
81349	CMR06F471GPDR	5910-01-042-0081	33	6
80058	CX-13361/G	5995-01-263-5494	34	1
71468	DBMMR25SE		4	2
71468	DDMMR36W4S		4	4
71468	DDMMR50SE	5935-01-276-1142	4	3
85480	D4-128	5310-00-672-2178	2	26
			5	7
25330	GDMM36W4P	5935-00-485-5018	15	7
81349	JANTXV1N746A-1	5961-01-146-4562	22	117
81349	JANTXV2N2907A	5961-01-019-4947	7	31
			8	42
			10	32
			11	35
			13	31
			17	13
			22	39
			24	38



## CROSS-REFERENCE INDEXES

FSCM	PART NUMBER	PART NUMBER INDEX STOCK NUMBER	FIG.	ITEM
81349	JANTXV2N2907A	5961-01-019-4947	26	34
81349	JANTX1N4150-1	5961-01-070-7446	32	1
81349	JANTX1N4454-1	5961-01-043-9178	7	1
			8	2
			10	1
			11	2
			13	1
			14	2
			17	1
			20	1
			22	1
			24	2
			26	4
			28	1
			30	1
81349	JANTX1N5418	5961-00-650-9651	32	5
81349	JANTX1N5552	5961-00-403-3298	33	1
81349	JANTX1N5615	5961-00-426-9613	32	3
			33	2
81349	JANTX1N5619	5961-00-476-7855	32	2
81349	JANTX1N5712	5961-00-335-8934	8	3
			26	3
			28	2
81349	JANTX1N5806	5961-01-037-4712	33	3
81349	JANTX1N5809	5961-01-035-5474	33	4
81349	JANTX1N6044A	5961-01-102-5720	32	73
81349	JANTX1N6072A	5961-01-057-3305	33	53
81349	JANTX1N6075	5961-01-168-6007	24	3
81349	JANTX1N750A1	5961-01-105-0607	26	92
81349	JANTX1N751A1	5961-01-102-5719	28	114
			32	72
81349	JANTX1N752A-1	5961-01-111-7743	20	104
			26	93
81349	JANTX1N756A1	5961-01-165-5463	30	64
		5961-01-102-2873	17	46
			26	95
81349	JANTX1N757A1	5961-01-088-8346	17	45
81349	JANTX1N825-1	5961-01-099-9148	22	118
81349	JANTX2N2222A	5961-00-858-3826	14	32
			17	14
			20	23
			22	42
			26	33
81349	JANTX2N2369A	5961-00-420-3668	28	24
			7	30
			8	37
			10	31
			11	32
			13	30
81349	JANTX2N3251A	5961-00-438-0598	14	29
			8	36

## SECTION IV

TM11-5895-1303-24P

## CROSS-REFERENCE INDEXES

FSCM	PART NUMBER	PART NUMBER INDEX STOCK NUMBER	FIG.	ITEM
81349	JANTX2N3251A	5961-00-438-0598	11	31
81349	JANTX2N4856	5961-00-421-3040	22	44
81349	JANTX2N4861	5961-01-012-9314	28	23
81349	JANTX2N5109	5961-00-603-8935	8	41
			14	31
81349	JANTX2N6762	5961-01-166-7878	32	23
81349	JANTX2N918	5961-00-836-6663	8	35
			11	30
			14	28
81349	JANT1N753A-1		26	94
81349	JM38510/06101BEX		7	57
			10	58
			13	58
81349	JM38510/12302BEX		20	98
			30	63
52673	KV2201	5961-01-025-2649	8	1
81349	LC36GD2	6210-00-151-5276	2	9
81349	LH89/1	6210-00-176-4928	2	11
04713	MC145152LD	5962-01-241-9975	14	82
27014	MM54HC373J/883B	5962-01-200-8155	18	13
27014	MM54HC374J/883B	5962-01-241-9974	7	63
			10	64
			13	64
			14	86
			18	14
			20	96
			22	113
			28	108
			30	62
27014	MM54HC390J/883B	5962-01-234-0880	14	80
			17	44
27014	MM54HC4078J/883	5962-01-238-8471	18	15
04713	MRF 5174	5961-01-006-7997	22	40
96906	MS16535-67	5320-00-680-4039	2	82
96906	MS16535-70	5320-00-879-6609	2	84
96906	MS20426AD2-4-5	5320-01-047-1060	2	92
96906	MS20426AD3-3	5320-00-117-6937	2	69
			2	94
96906	MS20470AD3-4	5320-00-117-6815	2	66
96906	MS20470AD3-5	5320-00-117-6816	2	62
			2	78
96906	MS20470AD3-5-5	5320-01-047-6330	1	32
			1	39
96906	MS20470AD4-6	5320-00-117-6828	2	71
96096	MS21042-02		2	38
96906	MS21075L08	5310-00-772-3721	2	73
96906	MS21075L4	5310-00-784-8145	2	68
96906	MS21209C0415	5340-00-631-7894	31	13
96906	MS21209C0415L	5340-00-327-4820	6	16
			9	17
			12	16

## CROSS-REFERENCE INDEXES

FSCM	PART NUMBER	PART NUMBER INDEX STOCK NUMBER	FIG.	ITEM
96906	MS21209C0415L	5340-00-327-4820	16	11
			19	9
			21	11
			23	9
			25	12
			27	9
			29	10
96906	MS21209C0815	5340-00-815-4929	31	16
96906	MS21209C0815L	5340-00-376-8648	6	17
			9	18
			12	18
			16	14
			19	12
			21	14
			23	12
			25	14
			27	12
			29	12
96906	MS24693C2	5305-00-993-9189	6	6
			9	6
			12	1
			21	1
96906	MS24693C24	5305-00-066-7326	2	33
96906	MS24693C27	5305-00-066-7328	2	21
96906	MS24693C3	5305-00-225-6400	2	29
			15	6
96906	MS24693C4	5305-00-056-9961	5	9
96906	MS24693C5	5305-00-066-7325	6	10
			9	10
			12	9
96906	MS24693C53	5305-00-088-9670	1	3
96906	MS25237-387	6240-00-763-7744	2	10
96906	MS3367-1-9	5975-00-074-2072	1	23
96906	MS3367-5-9	5975-00-111-3208	33	59
96906	MS35333-71	5310-00-616-3555	2	53
			31	9
96906	MS35338-135	5310-00-933-8118	2	6
			5	6
			15	4
			20	107
			22	124
			26	108
			28	119
96906	MS35338-136	5310-00-929-6395	2	19
			32	78
96906	MS35338-138	5310-00-933-8120	2	15
96906	MS39087-204AN		2	13
96906	MS51957-12	5305-00-054-5646	1	17
96906	MS51957-13	5305-00-054-5647	2	5
			15	16
			16	5

## SECTION IV

TM11-5895-1303-24P

## CROSS-REFERENCE INDEXES

FSCM	PART NUMBER	PART NUMBER INDEX STOCK NUMBER	FIG.	ITEM
96906	MS51957-13	5305-00-054-5647	19	3
			21	6
			23	5
			25	6
			27	4
			29	5
			31	5
			33	55
96906	MS51957-14	5305-00-054-5648	2	27
			6	2
			9	2
			12	3
			15	23
			31	2
			2	25
			33	58
96906	MS51957-15	5305-00-054-5649	2	25
96906	MS51957-17	5305-00-054-5651	33	58
96906	MS51957-2	5305-00-054-5636	25	2
			6	9
			9	9
			12	7
			16	1
			19	1
			21	4
			23	3
			25	4
			27	2
			29	3
96906	MS51957-28	5305-00-054-6652	2	22
96906	MS51957-29	5305-00-054-6653	2	17
96906	MS51957-5	5305-00-054-5639	2	48
96906	MS51957-6	5305-00-054-5640	2	36
96906	MS51958-64	5305-00-059-3660	2	16
96906	MS75083-1	5950-00-035-4413	8	32
			22	37
			24	36
96906	MS75083-13	5950-00-035-4416	7	20
			8	31
			10	21
			11	23
			13	20
			18	3
96906	MS75083-3	5950-00-779-3452	26	30
96906	MS75083-7	5950-00-035-4418	7	22
			10	23
			13	22
96906	MS75084-10	5950-00-031-4556	8	28
			11	25
96906	MS75084-13	5950-00-031-4558	22	31
96906	MS75084-15	5950-00-170-9770	8	29
			11	26
96906	MS75084-16	5950-00-031-4560	14	24

## SECTION IV

TM11-5895-1303-24P

## CROSS-REFERENCE INDEXES

FSCM	PART NUMBER	PART NUMBER INDEX STOCK NUMBER	FIG.	ITEM
96906	MS75084-16	5950-00-031-4560	17	12
			20	19
96906	MS75084-3	5950-00-377-9882	22	36
			8	27
			11	22
96906	MS75084-4	5950-00-031-4561	26	25
			8	25
			22	27
96906	MS75084-6	5950-00-031-4568	26	22
			7	23
			10	24
			11	20
			13	23
96906	MS75084-7	5950-00-170-9769	22	26
			7	24
			10	25
96906	MS75084-8	5950-00-031-4571	13	24
			8	24
			11	19
96906	MS75085-1	5950-00-035-4420	14	21
96906	MS75085-11	5950-00-325-6462	14	22
96906	MS75085-15	5950-00-487-1779	28	20
96906	MS75085-19	5950-00-031-3779	14	20
			14	23
			26	27
96906	MS75085-4	5950-00-171-0070	22	35
			24	35
96906	MS75085-7	5950-00-035-4425	7	18
			8	26
			10	19
			11	21
			13	19
			14	19
			17	11
			20	20
			24	33
			26	26
			28	21
			30	15
96906	MS75088-14	5950-01-023-1492	22	32
			24	34
96906	MS75088-7	5950-00-943-9174	7	26
			10	27
96906	MS75089-1	5950-01-027-9120	13	26
			7	25
			10	26
			13	27
96906	MS75089-27	5950-00-542-9634	22	34
			7	19
96906	MS75089-3	5950-01-008-8645	10	20
			8	30

## CROSS-REFERENCE INDEXES

FSCM	PART NUMBER	PART NUMBER INDEX STOCK NUMBER	FIG.	ITEM
96906	MS75089-3	5950-01-008-8645	11	27
			14	25
96906	MS75089-5	5950-01-029-5971	13	25
96906	MS77068-1	5940-00-682-2477	2	40
96906	MS77071-1	5940-00-271-6759	15	22
81349	M24308/24-25	5935-01-087-8422	33	14
81349	M28837/1-02N		8	105
			11	86
			22	119
			26	98
81349	M38510-10101BGC	5962-00-167-6330	24	56
81349	M38510-10102BCB	5962-00-007-4079	20	99
			30	61
81349	M38510-30009BCB	5962-01-026-6055	14	87
81349	M38510-30301BCB	5962-01-039-6395	7	62
			10	63
			13	63
81349	M38510-31401BEB	5962-01-068-1039	7	61
			8	97
			10	62
			11	77
			13	62
			14	85
81349	M38510/10702-BXC	5962-01-084-9458	7	64
			8	104
			10	65
			11	84
			13	66
			14	81
81349	M38510/10703-BXC	5962-01-128-1415	7	65
			8	103
			10	66
			11	83
			13	67
			14	79
81349	M38510/10708BYC	5962-01-087-9496	15	21
81349	M38510/11001BCB	5962-01-080-6488	17	42
			20	97
			22	114
			24	55
			26	90
			28	107
			30	60
81349	M38510/11201BCB	5962-01-088-3862	32	71
81349	M38510/11703BXC	5962-01-156-7241	20	103
			28	113
81349	M38510/17001BCB	5962-01-086-7029	20	101
			28	110
81349	M38510/30003BCB	5962-01-027-6863	8	101
			11	82
81349	M38510/30110BEB	5962-01-050-0915	8	100

## SECTION IV

TM11-5895-1303-24P

## CROSS-REFERENCE INDEXES

FSCM	PART NUMBER	PART NUMBER INDEX STOCK NUMBER	FIG.	ITEM
81349	M38510/30110BEB	5962-01-050-0915	11	81
81349	M38510/31504BEB	5962-01-065-7026	7	58
			10	59
81349	M38527/01-040N		13	59
			8	113
81349	M38527/02-018D	5999-01-200-4115	14	94
81349	M38527/02-018N	5999-01-280-5482	20	112
			7	74
			8	110
			10	76
			14	89
			22	126
			26	100
81349	M38527/03-002N		28	121
			7	73
			10	74
			26	104
81349	M38527/03-008N		28	116
			20	110
			22	128
81349	M38527/05-001D	5999-01-084-0860	24	57
			8	116
			11	99
81349	M38527/05-002D	5999-01-086-6659	14	101
			14	102
81349	M38527/05-008D	5999-01-199-2859	32	75
			24	63
81349	M38527/05-012D	5999-01-198-7076	28	122
81349	M38527/1-040N		22	122
81349	M38527/2-018N		11	97
			11	104
81349	M38527/3-002N		13	76
			13	74
81349	M39003/01-2988	5910-00-010-8159	17	50
81349	M39003/01-3026	5910-00-144-4383	32	15
81349	M39003/01-3076	5910-00-495-0042	32	9
81349	M39003/01-3176	5910-00-185-9067	15	11
81349	M39003/09-0129	5910-01-275-1944	15	10
81349	M39003/09-0162	5910-01-275-1945	33	10
81349	M39003/09-0182		33	8
81349	M39014-01-1563	5910-00-113-5277	33	9
			7	14
			10	15
81349	M39014-01-1575	5910-00-124-0659	13	15
			8	6
			8	21
			11	6
			11	16
			14	3
			17	3
			20	2

## CROSS-REFERENCE INDEXES

FSCM	PART NUMBER	PART NUMBER INDEX STOCK NUMBER	FIG.	ITEM
81349	M39014-01-1575	5910-00-124-0659	22	5
			26	6
			28	4
			30	4
81349	M39014/01-1259	5910-00-113-5445	20	15
			22	21
			28	13
			32	12
81349	M39014/01-1326	5910-00-114-0082	30	13
			8	12
81349	M39014/01-1336	5910-00-113-5471	11	13
81349	M39014/01-1338	5910-00-114-0802	7	3
			10	3
			13	3
			30	2
81349	M39014/01-1344	5910-00-114-0683	28	8
			8	13
81349	M39014/01-1345	5910-00-010-8498	11	14
81349	M39014/01-1347	5910-00-010-8534	14	16
			22	19
			14	13
			8	8
81349	M39014/01-1348	5910-00-156-5999	11	8
81349	M39014/01-1351	5910-00-113-5276	28	12
			11	4
81349	M39014/01-1353	5910-00-199-5335	14	14
81349	M39014/01-1357	5910-00-010-8666	7	8
			8	11
			10	8
			11	12
			13	13
			14	17
			17	7
			20	3
			22	8
			24	24
			26	10
			28	5
			30	3
			32	16
33	7			
81349	M39014/01-1565	5910-00-098-9237	28	14
			8	20
			14	15
			7	12
81349	M39014/01-1569	5910-00-010-8715	10	13
			13	12
			7	4
			10	4
81349	M39014/01-1571	5910-00-124-0627	13	4
			13	4
			7	4
			10	4
81349	M39014/01-1575	5910-00-124-0659	13	12
			13	12
			7	4
			10	4
81349	M39014/01-1578	5910-00-098-8670	13	4
			13	4
			7	4
			10	4
81349	M39014/01-1587	5910-00-113-5278	13	4
			13	4
			26	16



## CROSS-REFERENCE INDEXES

FSCM	PART NUMBER	PART NUMBER INDEX STOCK NUMBER	FIG.	ITEM
81349	M39014/01-1589	5910-00-113-5730	8	7
81349	M39014/01-1593	5910-00-010-8717	11	7
			17	4
			18	1
			20	11
			22	6
			24	20
			26	5
			28	3
			30	12
81349	M39014/02-1337	5910-00-113-9445	32	11
81349	M39014/02-1338	5910-00-010-8718	32	13
81349	M39014/02-1350	5910-00-113-5499	7	5
			8	9
			10	5
			11	9
			13	5
			14	4
			32	7
			33	11
81349	M39014/02-1356	5910-00-113-5286	32	10
81349	M39014/02-1357	5910-00-158-4785	26	12
81349	M39014/02-1358	5910-00-113-5284	14	9
			28	9
81349	M39014/02-1359	5910-00-113-5459	32	14
81349	M39014/02-1360	5910-00-113-5465	20	4
			22	17
			24	21
81349	M39014/02-1419	5910-00-010-8721	8	5
			11	5
			13	16
			14	5
			28	10
			32	6
81349	M39015/3-006WR	5905-01-067-9399	32	43
81349	M39018/07-0326M	5910-01-275-2946	33	5
81349	M45595/1-05		2	41
81349	M45938/7-2	5310-00-425-0402	2	81
81349	M55302/127-00KY	5935-01-183-6530	20	111
81349	M55302/4-02	5935-00-103-7680	33	15
81349	M55302/4-03	5935-00-497-8968	7	28
			10	29
			13	28
			14	26
			24	37
			26	31
			28	22
81349	M55302/4-04	5935-00-432-6649	20	21
			22	38
			30	16
81349	M55302/4-06	5935-01-127-1897	18	4

## CROSS-REFERENCE INDEXES

FSCM	PART NUMBER	PART NUMBER INDEX STOCK NUMBER	FIG.	ITEM
81349	M55302/6-03	5935-00-341-0559	3	4
81349	M55302/6-04	5935-00-402-6983	3	3
81349	M55302/6-06	5935-01-126-2451	3	2
81349	M55342M03B2K00P		8	89
			11	74
81349	M8340105M1001JG	5905-01-171-5659	14	75
			28	84
81349	M8340108K1001GC	5905-01-209-0630	18	10
81349	M8340108K1001GG		18	9
81349	M8340108K1002GG	5905-01-200-7728	18	11
81349	M8340108M5103JC		18	8
81349	M8340109M5103JC	5905-01-238-4023	7	55
			10	56
			13	55
			14	74
			20	25
			28	85
			30	17
81349	M83421/01-5191S	5910-01-213-2368	32	17
81349	M83731/11-732	5930-01-233-4112	2	42
81349	M87111/2-2B05		7	66
			8	122
			10	67
			11	105
			13	68
			14	99
81349	M87111/2-3B15		22	127
80205	NAS1397P4N	5340-00-782-8737	2	24
80205	NAS1397R2B	5340-00-766-6818	2	58
80205	NAS1397R3B	5340-00-172-8382	5	13
80205	NAS1397R5	5340-00-969-6502	5	8
80205	NAS1635-04LN4	5305-00-917-7839	15	1
80205	NAS620C10	5310-00-989-0640	2	14
80205	NAS620C4	5310-00-057-0573	1	18
			2	7
			19	4
			20	108
			21	7
			22	125
			23	6
			25	7
			26	109
			27	5
			28	120
			29	6
			31	3
			33	56
80205	NAS620C4L	5310-00-723-9676	6	3
			9	3
			12	4
			15	5

## CROSS-REFERENCE INDEXES

FSCM	PART NUMBER	PART NUMBER INDEX STOCK NUMBER	FIG.	ITEM
80205	NAS620C4L	5310-00-723-9676	16	6
80205	NAS620C6	5310-00-773-7624	2	23
80205	NAS671C4	5310-00-208-3786	2	30
			5	5
			15	3
			20	106
			22	123
			26	107
			28	118
			33	57
80205	NAS671C6	5310-00-616-8660	2	20
			31	10
			32	77
80205	NAS671C8	5310-00-837-1381	21	2
07886	NCN4-3-2-3		2	64
81349	RCR05G100JS	5905-00-255-3699	8	45
81349	RCR05G101JS	5905-00-180-8301	7	43
			8	52
			10	44
			11	38
			13	43
			14	50
81349	RCR05G102JS	5905-00-458-9500	8	46
			11	40
			14	64
81349	RCR05G103JS	5905-01-035-5065	8	54
			11	47
			13	52
			14	52
			26	40
81349	RCR05G104JS	5905-00-458-9346	26	42
81349	RCR05G112JS	5905-00-227-7015	13	33
81349	RCR05G113JS	5905-00-491-1984	7	44
			10	45
			11	48
			13	44
81349	RCR05G120JS	5905-00-491-6344	8	76
81349	RCR05G122JS	5905-00-407-0081	8	48
			11	42
			14	57
81349	RCR05G123JS	5905-00-466-1215	13	36
81349	RCR05G131JS	5905-00-197-0219	13	39
81349	RCR05G132JS	5905-00-470-9480	14	65
81349	RCR05G150JS	5905-00-197-0220	8	77
81349	RCR05G151JS	5905-00-470-0369	8	73
81349	RCR05G152JS	5905-00-180-8303	8	51
			11	45
			14	68
81349	RCR05G154JS	5905-00-484-7550	8	86
			11	71
81349	RCR05G180JS	5905-00-471-4622	8	74

## SECTION IV

TM11-5895-1303-24P

## CROSS-REFERENCE INDEXES

FSCM	PART NUMBER	PART NUMBER INDEX STOCK NUMBER	FIG.	ITEM
81349	RCR05G200JS	5905-00-493-5249	8	78
			11	54
			14	58
81349	RCR05G203JS	5905-00-413-1200	8	82
			14	49
81349	RCR05G220JS	5905-00-433-1853	8	79
81349	RCR05G222JS	5905-00-401-7424	8	49
			11	43
			13	34
			8	80
81349	RCR05G240JS	5905-00-481-0961	13	40
81349	RCR05G242JS	5905-00-482-7695	26	41
81349	RCR05G270JS	5905-00-197-0221	7	46
81349	RCR05G271JS	5905-00-401-7425	10	47
			11	65
			13	46
			8	72
			13	51
			11	41
			8	70
81349	RCR05G272JS	5905-00-401-7426	13	38
			8	75
			11	39
			14	69
81349	RCR05G305JS	5905-00-483-0425	7	47
			10	48
			11	51
			13	47
			8	57
81349	RCR05G330JS	5905-00-466-1216	11	53
			14	63
			8	90
81349	RCR05G331JS	5905-00-489-7703	7	45
			10	46
81349	RCR05G332JS	5905-00-401-7427	11	49
			13	45
			8	53
			11	46
81349	RCR05G361JS	5905-00-400-9836	14	62
			7	43
			10	53
81349	RCR05G362JS	5905-00-479-6658	11	54
			14	50
			8	48
81349	RCR05G431JS	5905-00-481-5255	13	61
			7	41
81349	RCR05G432JS	5905-00-231-2917	10	87
			11	42
			13	72
			8	41
81349	RCR05G471JS	5905-00-761-5758	13	42
			11	72
			14	41
			8	42
81349	RCR05G474JS	5905-00-492-2022	10	42
			7	53
81349	RCR05G510JS	5905-00-412-0758	10	54
			11	50
			13	48
			14	61
			7	41
81349	RCR05G511JS	5905-00-197-0224	8	87
			10	42
			11	72
			13	41
81349	RCR05G512JS	5905-00-689-1290	7	42

## CROSS-REFERENCE INDEXES

FSCM	PART NUMBER	PART NUMBER INDEX STOCK NUMBER	FIG.	ITEM
81349	RCR05G512JS	5905-00-689-1290	10	43
			13	42
			14	48
81349	RCR05G513JS	5905-00-180-8314	13	35
			17	28
81349	RCR05G561JS	5905-00-401-7428	8	50
			11	44
81349	RCR05G562JS	5905-00-411-1851	8	71
81349	RCR05G622JS	5905-00-470-9163	11	67
81349	RCR05G680JS	5905-00-407-0088	8	81
			14	59
81349	RCR05G681JS	5905-00-180-8315	11	66
			14	66
81349	RCR05G682JS	5905-00-617-5096	14	53
81349	RCR05G683JS	5905-00-466-1217	11	68
			14	60
81349	RCR05G750JS	5905-00-197-0223	8	47
81349	RCR05G751JS	5905-00-401-7429	8	55
			14	51
81349	RCR05G752JS	5905-00-401-7430	14	54
81349	RCR05G820JS	5905-00-409-2975	14	70
81349	RCR05G821JS	5905-00-401-7431	14	67
81349	RCR05G822JS	5905-00-466-1218	8	56
			11	52
			14	56
81349	RCR05G911JS	5905-00-422-3800	13	37
			26	51
81349	RCR05G912JS	5905-00-433-6486	14	55
81349	RCR07G100JS	5905-00-107-0656	20	94
			22	46
			26	87
			28	78
			30	59
			32	24
81349	RCR07G101JS	5905-00-141-1183	7	49
			10	50
			14	39
			22	73
			24	47
			26	37
			30	25
			32	29
81349	RCR07G102JS	5905-00-110-7620	7	50
			8	85
			10	51
			11	70
			13	49
			14	37
			17	29
			18	7
			20	26

## CROSS-REFERENCE INDEXES

FSCM	PART NUMBER	PART NUMBER INDEX STOCK NUMBER	FIG.	ITEM			
81349	RCR07G102JS	5905-00-110-7620	22	47			
			24	39			
			26	52			
			28	32			
			30	41			
			32	33			
			33	30			
81349	RCR07G103JS	5905-00-106-3666	7	54			
			8	65			
			10	55			
			11	59			
			17	21			
			20	32			
			22	50			
			24	46			
			26	77			
			28	29			
			30	42			
			32	54			
			81349	RCR07G104JS	5905-00-110-0388	18	5
20	73						
22	71						
24	54						
32	32						
81349	RCR07G110JS	5905-00-126-6697				8	69
						81349	RCR07G112JS
10	34						
81349	RCR07G113JS	5905-00-369-6932	33	31			
			20	72			
			22	70			
			24	53			
81349	RCR07G121JS	5905-00-119-8812	22	107			
			33	43			
81349	RCR07G122JS	5905-00-131-1255	14	71			
			33	29			
81349	RCR07G123JS	5905-00-106-1278	7	36			
			10	37			
			22	74			
			32	65			
			7	39			
81349	RCR07G131JS	5905-00-136-8405	10	40			
			33	44			
			26	69			
81349	RCR07G132JS	5905-00-104-8362	33	32			
			30	18			
81349	RCR07G134JS	5905-00-111-1681	22	101			
					81349	RCR07G150JS	5905-00-135-3971
81349	RCR07G151JS	5905-00-119-8811	11	36			
			20	33			
			22	75			
			24	51			

## CROSS-REFERENCE INDEXES

FSCM	PART NUMBER	PART NUMBER INDEX STOCK NUMBER	FIG.	ITEM
81349	RCR07G151JS	5905-00-119-8811	33	45
81349	RCR07G152JS	5905-00-106-1356	22	64
			24	40
			26	82
			32	28
			33	28
81349	RCR07G153JS	5905-00-116-8555	17	16
			30	45
81349	RCR07G160JS	5905-00-126-6699	26	46
81349	RCR07G161JS	5905-00-111-1686	33	46
81349	RCR07G162JS	5905-00-106-1248	30	58
81349	RCR07G163JS	5905-00-111-1682	20	61
81349	RCR07G180JS	5905-00-115-7953	22	59
81349	RCR07G181JS	5905-00-141-0742	33	40
81349	RCR07G182JS	5905-00-114-5343	28	76
			33	20
81349	RCR07G183JS	5905-00-115-3560	20	30
81349	RCR07G2R7JS	5905-00-455-4403	17	35
81349	RCR07G200JS	5905-00-135-3972	8	60
			11	57
			22	102
81349	RCR07G201JS		33	47
81349	RCR07G202JS	5905-00-114-0708	20	67
			22	67
			24	48
			28	42
81349	RCR07G203JS	5905-00-106-9356	22	99
81349	RCR07G204JS	5905-00-136-7103	22	109
			28	59
81349	RCR07G220JS	5905-00-106-3668	17	36
			22	103
81349	RCR07G221JS	5905-00-135-3973	22	54
			33	48
81349	RCR07G222JS	5905-00-105-7764	7	34
			10	35
			14	33
			17	32
			20	93
			22	53
			26	49
			30	26
81349	RCR07G223JS	5905-00-116-8556	20	28
			22	100
			24	52
81349	RCR07G224JS	5905-00-105-7765	20	34
			32	26
81349	RCR07G240JS	5905-00-442-9356	20	35
			22	69
			24	49
			26	78
			28	31

## SECTION IV

TM11-5895-1303-24P

## CROSS-REFERENCE INDEXES

FSCM	PART NUMBER	PART NUMBER INDEX STOCK NUMBER	FIG.	ITEM
81349	RCR07G240JS	5905-00-442-9356	30	27
			32	53
81349	RCR07G241JS	5905-00-435-1718	33	49
81349	RCR07G242JS	5905-00-136-8406	7	40
			10	41
			20	70
			22	65
			24	41
			26	73
81349	RCR07G243JS	5905-00-141-1295	17	19
81349	RCR07G270JS	5905-00-113-4860	17	26
			22	104
81349	RCR07G271JS	5905-00-119-3503	32	25
			33	36
81349	RCR07G272JS	5905-00-111-4727	33	39
81349	RCR07G273JS	5905-00-119-3504	20	87
			26	53
			28	74
81349	RCR07G3R3JS	5905-00-128-6237	28	77
81349	RCR07G300JS	5905-00-113-4863	22	98
81349	RCR07G301JS	5905-00-111-4750	17	31
			22	77
			26	45
			33	19
81349	RCR07G302JS	5905-00-131-9729	20	75
81349	RCR07G303JS	5905-00-121-9920	32	55
81349	RCR07G305JS	5905-00-121-9921	7	52
			10	53
81349	RCR07G330JS	5905-00-135-6045	22	97
			32	27
81349	RCR07G331JS	5905-00-114-0710	7	38
			10	39
			17	34
			22	49
			33	37
81349	RCR07G332JS	5905-00-126-6683	8	63
			11	62
			20	84
			24	45
			26	71
			28	60
			30	46
81349	RCR07G333JS	5905-00-118-4559	8	83
			20	77
			32	56
81349	RCR07G334JS	5905-00-485-4545	22	80
			26	76
81349	RCR07G360JS	5905-00-126-6698	22	87
81349	RCR07G361JS	5905-00-104-8370	8	67
			11	63
			33	38



## CROSS-REFERENCE INDEXES

FSCM	PART NUMBER	PART NUMBER INDEX STOCK NUMBER	FIG.	ITEM
81349	RCR07G362JS	5905-00-104-8369	8	59
81349	RCR07G363JS	5905-00-136-8430	11	56
81349	RCR07G390JS	5905-00-113-4861	32	57
81349	RCR07G391JS	5905-00-121-9932	22	63
			22	52
			26	50
81349	RCR07G392JS	5905-00-141-0743	33	34
			14	36
81349	RCR07G393JS	5905-00-115-8055	22	82
			8	62
			11	64
			17	39
81349	RCR07G430JS	5905-00-115-2223	32	58
81349	RCR07G431JS	5905-00-135-3974	22	88
			8	68
			28	26
81349	RCR07G433JS	5905-00-122-0004	33	35
			20	85
			28	37
81349	RCR07G470JS	5905-00-104-8368	32	59
81349	RCR07G471JS	5905-00-120-9154	22	89
			8	61
			11	58
			14	38
			22	61
			28	40
81349	RCR07G472JS	5905-00-114-0711	33	22
			17	30
			20	76
			28	30
81349	RCR07G473JS	5905-00-141-0717	30	40
			17	17
			20	86
			22	55
			24	43
			28	34
81349	RCR07G474JS	5905-00-105-7767	32	60
81349	RCR07G5R1JS	5905-00-104-8366	22	45
81349	RCR07G5R6JS	5905-00-121-9863	22	108
81349	RCR07G510JS	5905-00-106-1249	28	39
			7	48
			8	44
			10	49
			11	37
			17	18
			20	63
			22	90
			28	38
81349	RCR07G511JS	5905-00-116-2394	32	30
			7	51
			10	52

## SECTION IV

TM11-5895-1303-24P

## CROSS-REFERENCE INDEXES

FSCM	PART NUMBER	PART NUMBER INDEX STOCK NUMBER	FIG.	ITEM
81349	RCR07G511JS	5905-00-116-2394	13	50
			17	37
			20	66
			26	38
			33	23
81349	RCR07G512JS	5905-00-111-1679	14	73
			20	74
			22	51
			28	41
			32	34
			7	35
81349	RCR07G513JS	5905-00-136-3890	10	36
			17	40
			20	24
			22	48
			32	61
			18	6
81349	RCR07G514JS	5905-00-246-8690	22	91
81349	RCR07G560JS	5905-00-133-0440	8	66
81349	RCR07G561JS	5905-00-105-7768	11	60
81349	RCR07G562JS	5905-00-141-0744	13	53
			20	78
			33	24
			8	88
			11	73
			17	27
81349	RCR07G563JS	5905-00-106-1357	26	72
			17	20
			28	73
			32	62
			22	92
81349	RCR07G620JS	5905-00-126-6692	20	79
81349	RCR07G621JS	5905-00-136-3891	22	68
81349	RCR07G622JS	5905-00-228-5506	33	25
			14	34
			17	15
			26	85
			22	93
			17	33
81349	RCR07G680JS	5905-01-138-6236	17	33
81349	RCR07G681JS	5905-00-135-6046	20	65
81349	RCR07G682JS	5905-00-110-7622	33	26
			17	23
			20	68
			22	58
			24	50
			28	58
81349	RCR07G683JS	5905-00-119-3505	30	21
			8	64
			11	61
			13	54
81349	RCR07G750JS	5905-00-106-9357	22	94

## CROSS-REFERENCE INDEXES

FSCM	PART NUMBER	PART NUMBER INDEX STOCK NUMBER	FIG.	ITEM
81349	RCR07G751JS	5905-00-126-6696	8	84
			11	69
			20	80
			22	57
81349	RCR07G752JS	5905-00-141-1132	33	27
			17	24
			26	48
			28	35
81349	RCR07G753JS	5905-00-121-9938	14	72
81349	RCR07G820JS	5905-00-104-8363	22	95
81349	RCR07G821JS	5905-00-119-8768	33	42
			13	56
			20	81
81349	RCR07G822JS	5905-00-104-8358	33	33
			8	58
			11	55
			14	35
			17	22
			20	69
			22	66
			26	54
81349	RCR07G823JS	5905-00-435-6374	28	36
			20	92
			26	86
			28	33
81349	RCR07G910JS	5905-00-141-1131	22	96
81349	RCR07G911JS	5905-00-485-4554	7	37
			10	38
			20	82
			22	60
81349	RCR07G912JS	5905-00-115-2261	33	21
81349	RCR20G102JS	5905-00-110-0196	17	25
81349	RCR20G221JS	5905-00-104-8350	26	44
81349	RCR20G271JS	5905-00-114-5407	22	56
81349	RCR20G332JS	5905-00-104-8348	33	50
			22	62
81349	RCR20G391JS	5905-00-111-4742	33	41
81349	RCR20G510JS	5905-00-114-5438	17	38
81349	RCR20G681JS	5905-00-111-8357	24	42
			26	74
			33	18
81349	RCR32G391JS	5905-00-141-1149	26	70
81349	RCR42G201JS	5905-00-146-8423	26	36
81349	RCR42G273JS	5905-00-152-8373	33	17
81349	RJR26FP102P	5905-01-047-2251	22	84
81349	RJR26FW503R	5905-01-161-7274	20	64
81349	RLR05C4021FS	5905-01-184-7954	14	40
81349	RLR05C4121FS	5905-01-185-9347	14	41
81349	RLR05C4221FS	5905-01-168-7460	14	42
81349	RLR05C4321FS	5905-01-170-0396	14	46
81349	RLR05C4421FS	5905-01-196-1966	14	43

## SECTION IV

TM11-5895-1303-24P

## CROSS-REFERENCE INDEXES

FSCM	PART NUMBER	PART NUMBER INDEX STOCK NUMBER	FIG.	ITEM
81349	RLR05C4531FS	5905-01-185-1311	14	44
81349	RLR05C4641FS	5905-01-051-9611	14	45
81349	RLR05C7501FS	5905-01-184-7938	14	47
81349	RLR07C3900GS	5905-01-160-0932	28	75
81349	RLR07C5100GS	5905-01-152-7986	26	75
81349	RLR07C5103GS	5905-01-157-5611	28	86
81349	RLR07C5600GS	5905-01-053-5786	28	25
81349	RLR07C6200GS	5905-01-150-4517	26	80
81349	RLR20C2400GS	5905-01-180-4391	26	39
81349	RNC55H1001FS	5905-00-138-3376	20	71
81349	RNC55H1002FS	5905-00-223-2741	22	81
			26	81
81349	RNC55H1003FS	5905-00-401-7432	20	90
			22	86
81349	RNC55H1021FS	5905-00-284-6117	28	44
81349	RNC55H1022FS	5905-00-431-5146	28	28
			32	52
81349	RNC55H1023FS	5905-00-139-2141	20	60
81349	RNC55H1050FS	5905-00-211-0488	28	88
81349	RNC55H1101FS	5905-00-471-2422	28	45
			32	37
81349	RNC55H1102FS	5905-00-402-1180	26	79
81349	RNC55H1103FS	5905-00-256-5050	30	39
81349	RNC55H1130FP		28	87
81349	RNC55H1181FS	5905-00-758-4774	28	46
81349	RNC55H1210FS	5905-00-484-7874	28	102
81349	RNC55H1242FS	5905-00-255-9304	30	24
81349	RNC55H1271FS	5905-00-484-7880	28	47
			32	38
81349	RNC55H1272FS	5905-00-005-2680	26	68
81349	RNC55H1273FS	5905-00-432-6363	22	76
81349	RNC55H1300FS	5905-00-295-5267	28	101
81349	RNC55H1301FS	5905-00-305-5225	20	95
81349	RNC55H1332FS	5905-00-112-1392	30	54
81349	RNC55H1371FS	5905-00-721-3677	28	48
81349	RNC55H1372FS	5905-00-139-2361	30	48
81349	RNC55H1373FS	5905-00-445-1561	30	47
81349	RNC55H1400FP	5905-01-280-9686	28	100
81349	RNC55H1471FS	5905-00-491-6386	28	49
81349	RNC55H1472FS	5905-00-479-9945	20	91
81349	RNC55H1500FS	5905-00-288-8765	28	98
81349	RNC55H1501FS	5905-00-480-5196	30	44
81349	RNC55H1502FS	5905-00-197-4110	20	62
81349	RNC55H1580FS	5905-00-484-7883	28	99
81349	RNC55H1581FS	5905-00-484-7884	28	50
81349	RNC55H1582FS	5905-00-156-6550	30	49
81349	RNC55H1650FP		28	97
81349	RNC55H1691FS	5905-00-480-5193	28	51
81349	RNC55H1740FS	5905-00-758-4780	28	96
81349	RNC55H1742FS	5905-00-236-0487	30	50
81349	RNC55H1820FS	5905-00-469-3507	32	35

## SECTION IV

TM11-5895-1303-24P

## CROSS-REFERENCE INDEXES

FSCM	PART NUMBER	PART NUMBER INDEX STOCK NUMBER	FIG.	ITEM
81349	RNC55H1821FS	5905-00-481-1320	28	52
81349	RNC55H1961FS	5905-00-480-5194	30	55
81349	RNC55H2002FS	5905-00-412-4048	28	53
81349	RNC55H2102FS	5905-00-196-5171	20	29
81349	RNC55H2151FS	5905-00-481-8454	20	31
81349	RNC55H2211FS	5905-00-410-1577	32	40
			30	23
			32	31
81349	RNC55H2320FS	5905-00-305-5187	20	27
81349	RNC55H2430FS	5905-00-203-1478	28	82
81349	RNC55H2431FS	5905-00-250-3328	32	48
81349	RNC55H2490FS	5905-00-004-6076	32	63
81349	RNC55H2491FS	5905-00-721-3678	32	45
81349	RNC55H26R1FS	5905-01-025-4336	22	105
81349	RNC55H2673FS	5905-00-164-1867	22	110
81349	RNC55H2741FS	5905-00-403-4447	30	53
81349	RNC55H2742FS	5905-00-138-1017	26	47
			32	49
81349	RNC55H2802FS	5905-00-412-0764	32	50
81349	RNC55H2941FS	5905-00-431-5155	28	80
81349	RNC55H3012FS	5905-00-005-2902	20	88
81349	RNC55H3241FS	5905-00-431-5156	30	52
81349	RNC55H3322FS	5905-00-236-7578	20	89
81349	RNC55H3482FS	5905-00-236-0513	20	36
			30	28
81349	RNC55H3572FS	5905-00-431-5157	20	40
81349	RNC55H36R5FS	5905-00-532-2082	22	106
81349	RNC55H3652FS	5905-00-184-7787	20	41
			30	32
81349	RNC55H3742FS	5905-00-758-4782	20	42
			30	56
81349	RNC55H3831FS	5905-00-236-0868	28	43
81349	RNC55H3832FS	5905-00-184-7788	20	43
81349	RNC55H3921FS	5905-00-003-5782	32	36
81349	RNC55H3922FS	5905-00-403-4448	20	48
81349	RNC55H4021FS	5905-00-481-8456	28	81
81349	RNC55H4022FS	5905-00-462-5635	20	44
81349	RNC55H4122FS	5905-00-721-0036	20	45
81349	RNC55H4222FS	5905-00-429-8772	20	46
81349	RNC55H4321FS	5905-00-121-6327	26	55
81349	RNC55H4322FS	5905-00-431-5158	20	47
81349	RNC55H4420FS	5905-00-139-2146	32	51
81349	RNC55H4421FS	5905-00-401-7436	26	56
81349	RNC55H4531FS	5905-00-468-3020	26	67
81349	RNC55H4641FS	5905-00-151-4659	26	57
81349	RNC55H4751FS	5905-00-412-4049	20	83
			26	58
81349	RNC55H4871FS	5905-00-721-3680	26	59
81349	RNC55H4991FS	5905-00-481-1110	26	60
81349	RNC55H51R1FS	5905-00-432-6343	28	103
81349	RNC55H5111FS	5905-00-138-7399	26	61

## SECTION IV

TM11-5895-1303-24P

## CROSS-REFERENCE INDEXES

FSCM	PART NUMBER	PART NUMBER INDEX STOCK NUMBER	FIG.	ITEM
81349	RNC55H5111FS	5905-00-138-7399	32	42
81349	RNC55H5112FS	5905-00-005-2880	22	85
			28	61
81349	RNC55H5231FS	5905-00-292-1064	26	62
81349	RNC55H5232FS	5905-00-138-6994	28	62
81349	RNC55H5361FS	5905-00-138-7401	26	63
81349	RNC55H5362FS	5905-00-138-7402	20	39
			26	84
			28	63
			30	31
81349	RNC55H54R9FS	5905-00-307-3516	28	104
81349	RNC55H5490FS	5905-00-236-0970	32	47
81349	RNC55H5491FS	5905-00-219-8638	26	64
			32	44
81349	RNC55H5492FS	5905-00-150-0477	20	37
			28	64
			30	29
81349	RNC55H5621FS	5905-00-256-5051	26	65
81349	RNC55H5622FS	5905-00-412-0772	28	65
			30	20
81349	RNC55H5761FS	5905-00-203-5377	26	66
			32	46
81349	RNC55H5762FS	5905-00-138-6995	20	51
			28	66
			30	35
81349	RNC55H59R0FS	5905-00-481-1403	28	105
81349	RNC55H5902FS	5905-00-721-3681	20	52
			28	67
81349	RNC55H6040FS	5905-00-003-7717	22	83
			28	54
81349	RNC55H6042FS	5905-00-721-3683	20	53
			28	68
81349	RNC55H6192FS	5905-00-451-7410	20	54
			26	83
			28	69
81349	RNC55H63R4FP		28	94
81349	RNC55H6340FP		30	57
81349	RNC55H6341FS	5905-00-005-2882	28	27
81349	RNC55H6342FS	5905-00-402-1400	20	49
			28	70
			30	33
81349	RNC55H64R9FS	5905-00-476-8189	32	39
81349	RNC55H6491FS	5905-00-139-1925	30	43
81349	RNC55H6492FS	5905-00-152-7613	20	56
			28	71
81349	RNC55H6652FS	5905-00-483-4038	20	55
			28	72
			30	37
81349	RNC55H68R1FS	5905-00-481-1404	28	93
81349	RNC55H6812FS	5905-00-350-8351	20	57
81349	RNC55H6982FS	5905-00-721-3305	20	58

## CROSS-REFERENCE INDEXES

FSCM	PART NUMBER	PART NUMBER INDEX STOCK NUMBER	FIG.	ITEM
81349	RNC55H6982FS	5905-00-721-3305	30	38
81349	RNC55H7152FS	5905-00-139-1927	20	38
			30	30
81349	RNC55H73R2FS	5905-00-156-6298	28	92
81349	RNC55H7500FS	5905-00-139-1928	28	55
81349	RNC55H7501FS	5905-00-112-0984	30	51
81349	RNC55H7680FS	5905-00-285-1289	32	64
81349	RNC55H7682FS	5905-00-403-4453	20	50
			30	34
81349	RNC55H78R7FS	5905-00-481-1405	28	91
81349	RNC55H8250FS	5905-00-401-8688	32	41
81349	RNC55H84R5FS	5905-00-285-0626	28	89
81349	RNC55H8661FS	5905-00-432-0331	28	79
			30	19
81349	RNC55H8870FS	5905-00-333-9543	28	56
81349	RNC55H90R9FS	5905-00-403-4456	28	90
81349	RNC55H9310FS	5905-00-153-4909	28	83
81349	RNC55H9530FS	5905-00-264-3832	28	57
81349	RNC55H9531FS	5905-00-432-0367	30	22
81349	RNC55H9532FS	5905-00-146-3879	20	59
			30	36
81349	RNC55H97R6FP		28	95
81349	RWR80S1000FS	5905-01-160-6188	22	78
81349	RWR80S1001FS	5905-00-513-2874	22	79
81349	RWR80S33R2FS	5905-01-186-6763	24	44
81349	RWR80S39R2FS	5905-01-186-9628	22	72
18324	SE529AF/883B		17	43
15454	SG220-S	5905-01-195-2154	33	16
55154	SL521BB/CM	5962-01-120-2346	22	116
52648	SL612CB/CM		20	102
52648	SL621CB/CM		28	112
52648	SL6701AB/DG	5962-01-275-5460	28	111
52648	SP8610AB		8	102
			11	78
64863	SP8655AB	5962-01-243-1087	8	98
			11	79
52648	SP8690AB	5962-01-238-8470	8	99
			11	80
			13	65
52648	SP8691AB/DG		14	84
05375	ST-407	5950-01-274-6467	28	106
62744	STF-471-1	5915-01-275-0774	2	28
58997	T-334	5955-01-275-6614	17	47
15542	TAK-390125	5895-01-237-4742	22	120
			26	97
80058	TS-4244/G	6625-01-267-4417	34	2
72794	UA3 T25	5325-00-948-7362	1	37
			1	45
71468	UBS4C040C4DL	5935-01-276-0475	3	1
12969	UM4001B	5961-00-596-2973	32	4
12969	UM4301B		22	3

## SECTION IV

TM11-5895-1303-24P

## CROSS-REFERENCE INDEXES

FSCM	PART NUMBER	PART NUMBER INDEX STOCK NUMBER	FIG.	ITEM
12969	UM4301B		26	1
12969	UM7101B	5961-01-275-0806	22	4
			24	1
72794	URA-3	5325-00-419-6181	2	70
			2	93
04713	U310	5961-01-127-3102	8	39
			14	30
			7	2
50101	V20-4629		26	91
14482	WJ-EA53S		1	38
72794	Y166	5365-00-115-6848	1	46
			1	14
05236	05236-1201964B-L		1	2
05236	05236-1201964B-R		32	68
97953	1A7861-3	5962-01-119-8524	32	70
97953	1A7862-1	5962-01-150-4631	17	10
19112	102-14-CC-B	5935-00-152-9571	18	2
			32	19
00779	103007-2		7	29
58167	11-0450-01C	5935-01-275-7212	8	33
			10	30
			11	28
			13	29
			14	27
			6	12
58167	1111-1180-01C	5935-01-276-0476	9	13
			12	12
			28	117
18310	12-461-2-01		7	56
04713	12513/BEBJC	5962-01-087-5967	10	57
			11	85
			13	57
04713	158/BPBJC	5962-01-227-9394	32	69
04713	1596/BCBJC	5962-01-003-2577	20	100
71279	160-2027-02-05-0		32	18
	3		33	12
06848	175496	5320-00-117-6938	2	67
			2	86
37695	189698	5935-01-005-9795	7	17
			8	34
			10	18
			11	29
			32	22
09214	2N2324A		32	21
07256	2N5011	5961-00-434-9211	22	23
19505	2009-6511-000	5935-01-011-4754	26	20
			7	16
19505	2010-6511-002	5935-01-011-3400	8	23
			10	17
			11	18



## SECTION IV

TM11-5895-1303-24P

## CROSS-REFERENCE INDEXES

FSCM	PART NUMBER	PART NUMBER INDEX STOCK NUMBER	FIG.	ITEM
19505	2010-6511-002	5935-01-011-3400	13	18
			14	18
			17	9
			20	18
			22	25
			24	26
			26	19
			28	18
37695	238283-1	5905-01-187-8809	26	35
07556	2467 SHORT	5999-01-276-6437	11	90
07556	2467 TALL	5999-01-275-6605	7	69
			8	117
			10	69
			11	100
			13	69
37695	305139-1	5950-01-274-6451	32	67
37695	305188-1	5950-01-274-6452	33	52
37695	305191-1	5950-01-274-6502	32	66
37695	305194-1	5950-01-274-6463	33	13
37695	308219-1	5950-01-275-0712	33	51
37695	325431-1	5915-01-275-0679	2	54
13499	352-1074-010	5961-01-006-7999	22	41
26344	3585-02CNW0129	5340-00-431-1115	6	13
			9	12
			12	11
			16	10
			19	8
			21	10
			23	8
			25	10
			27	8
			29	8
51506	400009-S-8		2	59
56207	400118	5935-01-012-5578	16	4
56207	400119	5935-01-005-9821	6	5
			9	5
08718	4055-14047-2	5935-01-276-5597	4	1
94222	53-16-711-24	5305-00-868-9747	2	96
96214	531932-2	5962-00-256-0340	8	95
			11	75
			14	78
07263	54F161ADMQB	5962-01-193-5801	17	41
			7	59
			10	60
02114	56-59065/4B	5970-01-144-6789	13	60
97942	581R503H01	5961-00-022-5665	26	28
14933	7703401YX	5962-01-106-4661	22	43
13103	7717-4DAP	5999-00-883-0081	31	8
02735	803895-1		32	76
91293	8052	5910-00-170-9557	18	16
			26	11

## SECTION IV

TM11-5895-1303-24P

## CROSS-REFERENCE INDEXES

FSCM	PART NUMBER	PART NUMBER INDEX STOCK NUMBER	FIG.	ITEM
13103	8180E1	5940-01-204-0642	32	79
13103	8182E3C		32	74
14933	8404001CX		18	12
14933	8404101CX		18	17
00779	87518-9		20	22
			28	19
91293	9615	5910-01-133-5494	26	8

## CROSS-REFERENCE INDEXES

FIG.	ITEM	FIGURE AND ITEM NUMBER INDEX STOCK NUMBER	FSCM	PART NUMBER
1	1	5895-01-205-0825	80063	A3024060
1	2		05236	05236-1201964B-R
1	3	5305-00-088-9670	96906	MS24693C53
1	4	5895-01-205-0910	80063	A3024340
1	5		80063	A3028035
1	6		80063	A3024604
1	7	5895-01-205-0650	80063	A3024618
1	8	5895-01-205-0651	80063	A3024629
1	9	5895-01-205-0818	80063	A3024634
1	10	5985-01-205-0864	80063	A3024649
1	11	5895-01-205-0652	80063	A3024644
1	12	5895-01-205-0653	80063	A3024639
1	13	5895-01-205-0883	80063	A3024654
1	14		05236	05236-1201964B-L
1	15	5895-01-205-0662	80058	C-11670/G
1	16		80063	A3032505
1	17	5305-00-054-5646	96906	MS51957-12
1	18	5310-00-057-0573	80205	NAS620C4
1	19	5995-01-241-9953	80063	A3024615-1
1	20		80063	A3024615-2
1	21	5995-01-241-9952	80063	A3024380-7
1	22	5995-01-241-9950	80063	A3024380-5
1	23	5975-00-074-2072	96906	MS3367-1-9
1	24	5995-01-241-9949	80063	A3024616-3
1	25	5995-01-241-9951	80063	A3024380-6
1	26	5995-01-241-9948	80063	A3024616-2
1	27	5995-01-241-9947	80063	A3024381-2
1	28	5995-01-242-6512	80063	A3024380-3
1	29	5995-01-241-9946	80063	A3024380-4
1	30		80063	A3028579
1	31	5999-01-237-5071	80063	A3028559
1	32	5320-01-047-6330	96906	MS20470AD3-5-5
1	33	5999-01-237-5069	80063	A3028557
1	34		80063	A3028036
1	35		80063	A3034572
1	36	5999-01-237-5070	80063	A3028558
1	37	5325-00-948-7362	72794	UA3 T25
1	38	5365-00-115-6848	72794	Y166
1	39	5320-01-047-6330	96906	MS20470AD3-5-5
1	40	5999-01-237-5071	80063	A3028559
1	41	5999-01-237-5069	80063	A3028557
1	42	5999-01-237-5070	80063	A3028558
1	43		80063	A3034572
1	44		80063	A3028580
1	45	5325-00-948-7362	72794	UA3 T25
1	46	5365-00-115-6848	72794	Y166
2	1		80063	A3028031
2	2		80063	A3028553
2	3		80063	A3028037
2	4		80063	A3028027
2	5	5305-00-054-5647	96906	MS51957-13

## CROSS-REFERENCE INDEXES

FIG.	ITEM	FIGURE AND ITEM NUMBER INDEX STOCK NUMBER	FSCM	PART NUMBER
2	6	5310-00-933-8118	96906	MS35338-135
2	7	5310-00-057-0573	80205	NAS620C4
2	8	5995-01-241-9979	80063	A3024609
2	9	6210-00-151-5276	81349	LC36GD2
2	10	6240-00-763-7744	96906	MS25237-387
2	11	6210-00-176-4928	81349	LH89/1
2	12		80063	A3028976
2	13		96906	MS39087-204AN
2	14	5310-00-989-0640	80205	NAS620C10
2	15	5310-00-933-8120	96906	MS35338-138
2	16	5305-00-059-3660	96906	MS51958-64
2	17	5305-00-054-6653	96906	MS51957-29
2	18	5310-00-531-9514	88044	AN960C6
2	19	5310-00-929-6395	96906	MS35338-136
2	20	5310-00-616-8660	80205	NAS671C6
2	21	5305-00-066-7328	96906	MS24693C27
2	22	5305-00-054-6652	96906	MS51957-28
2	23	5310-00-773-7624	80205	NAS620C6
2	24	5340-00-782-8737	80205	NAS1397P4N
2	25	5305-00-054-5649	96906	MS51957-15
2	26	5310-00-672-2178	85480	D4-128
2	27	5305-00-054-5648	96906	MS51957-14
2	28	5915-01-275-0774	62744	STF-471-1
2	29	5305-00-225-6400	96906	MS24693C3
2	30	5310-00-208-3786	80205	NAS671C4
2	31	5895-01-242-6517	80063	A3024659
2	32	5310-01-141-6672	88044	AN960C4
2	33	5305-00-066-7326	96906	MS24693C24
2	34	5915-01-275-0773	23939	A-5122
2	35		80063	A3028948
2	36	5305-00-054-5640	96906	MS51957-6
2	37	5310-00-167-0797	88044	AN960C3
2	38		96096	MS21042-02
2	39	5995-01-241-9935	80063	A3028047
2	40	5940-00-682-2477	96906	MS77068-1
2	41		81349	M45595/1-05
2	42	5930-01-233-4112	81349	M83731/11-732
2	43		80063	A3028551
2	44	5305-01-237-4751	80063	A3028723-1
2	45	5995-01-241-9939	80063	A3024607
2	46	5305-01-237-4753	80063	A3028723-3
2	47	5995-01-241-9940	80063	A3024608
2	48	5305-00-054-5639	96906	MS51957-5
2	49		80063	A3028044
2	50	5305-01-237-4754	80063	A3028686
2	51	5895-01-238-3840	80063	A3028687
2	52	5305-01-237-4752	80063	A3028723-2
2	53	5310-00-616-3555	96906	MS35333-71
2	54	5915-01-275-0679	37695	325431-1
2	55	5305-01-237-4750	80063	A3028192-1
2	56		80063	A3028560

## CROSS-REFERENCE INDEXES

FIG.	ITEM	FIGURE AND ITEM NUMBER INDEX STOCK NUMBER	FSCM	PART NUMBER
2	57		80063	A3028552
2	58	5340-00-766-6818	80205	NAS1397R2B
2	59		51506	400009-5-8
2	60	5340-01-275-7182	80063	A3024716-6
2	61		80063	A3028032
2	62	5320-00-117-6816	96906	MS20470AD3-5
2	63		80063	A3028033
2	64		07886	NCN4-3-2-3
2	65		80063	A3028034
2	66	5320-00-117-6815	96906	MS20470AD3-4
2	67	5320-00-117-6938	06848	175496
2	68	5310-00-784-8145	96906	MS21075L4
2	69	5320-00-117-6937	96906	MS20426AD3-3
2	70	5325-00-419-6181	72794	URA-3
2	71	5320-00-117-6828	96906	MS20470AD4-6
2	72		80063	A3028556
2	73	5310-00-772-3721	96906	MS21075L08
2	74		80063	A3028554
2	75		80063	A3028802-1
2	76		80063	A3034778
2	77	5340-01-275-7184	80063	A3024716-5
2	78	5320-00-117-6816	96906	MS20470AD3-5
2	79		80063	A3028039
2	80	5340-01-275-7183	80063	A3024716-4
2	81	5310-00-425-0402	81349	M45938/7-2
2	82	5320-00-680-4039	96906	MS16535-67
2	83		80063	A3028038
2	84	5320-00-879-6609	96906	MS16535-70
2	85		80063	A3028041
2	86	5320-00-117-6938	06848	175496
2	87		80063	A3028040
2	88		80063	A3028043
2	89		80063	A3028042
2	90		80063	A3028028
2	91		80063	A3028029
2	92	5320-01-047-1060	96906	MS20426AD2-4-5
2	93	5325-00-419-6181	72794	URA-3
2	94	5320-00-117-6937	96906	MS20426AD3-3
2	95		80063	A3028030
2	96	5305-00-868-9747	94222	53-16-711-24
3	1	5935-01-276-0475	71468	UBS4C040C4DL
3	2	5935-01-126-2451	81349	M55302/6-06
3	3	5935-00-402-6983	81349	M55302/6-04
3	4	5935-00-341-0559	81349	M55302/6-03
3	5	5340-01-275-7136	80063	A3028868
4	1	5935-01-276-5597	08718	4055-14047-2
4	2		71468	DBMMR25SE
4	3	5935-01-276-1142	71468	DDMMR50SE
4	4		71468	DDMMR36W4S
4	5	5935-01-276-6269	80063	A3028888-1
4	6	5995-01-241-9982	80063	A3029123

## CROSS-REFERENCE INDEXES

FIG.	ITEM	FIGURE AND ITEM NUMBER INDEX		PART NUMBER
		STOCK NUMBER	FSCM	
4	7	5995-01-241-9981	80063	A3029122
4	8	5995-01-241-9980	80063	A3029121
4	9	5995-01-241-9983	80063	A3029124
4	10		80063	A3086592
5	1		80063	A3024344
5	2		80063	A3024354
5	3		80063	A3024364
5	4		80063	A3024374
5	5	5310-00-208-3786	80205	NAS671C4
5	6	5310-00-933-8118	96906	MS53338-135
5	7	5310-00-672-2178	85480	D4-128
5	8	5340-00-969-6502	80205	NAS1397R5
5	9	5305-00-056-9961	96906	MS24693C4
5	10	5995-01-241-9943	80063	A3024380-1
5	11	5995-01-241-9945	80063	A3024381-1
5	12	5995-01-241-9944	80063	A3024380-2
5	13	5340-00-172-8382	80205	NAS1397R3B
6	1		80063	A3024345
6	2	5305-00-054-5648	96906	MS51957-14
6	3	5310-00-723-9676	80205	NAS620C4L
6	4	5895-01-241-9998	80063	A3024346
6	5	5935-01-005-9821	56207	400119
6	6	5305-00-993-9189	96906	MS24693C2
6	7	5895-01-241-9999	80063	A3024350
6	8		80063	A3086607
6	9	5305-00-054-5636	96906	MS51957-2
6	10	5305-00-066-7325	96906	MS24693C5
6	11		80063	A3024671
6	12	5935-01-276-0476	58167	I111-1180-01C
6	13	5340-00-431-1115	26344	3585-02CNW0129
6	14		80063	A3028102
6	15		80063	A3029325
6	16	5340-00-327-4820	96906	MS21209C0415L
6	17	5340-00-376-8648	96906	MS21209C0815L
6	18		80063	A3029326
6	19		80063	A3034572
7	1	5961-01-043-9178	81349	JANTX1N4454-1
7	2		50101	V20-4629
7	3	5910-00-114-0802	81349	M39014/01-1338
7	4	5910-00-098-8670	81349	M39014/01-1578
7	5	5910-00-113-5499	81349	M39014/02-1350
7	6		81349	CDR01BX102BKUP
7	7	5910-01-275-7258	81349	CFR06RRA183JP
7	8	5910-00-010-8666	81349	M39014/01-1357
7	9		81349	CDR14BG101EKUPX
7	10		81349	CDR14BG620EKUPX
7	11		56996	B4003327-3126
7	12	5910-00-124-0659	81349	M39014/01-1575
7	13		56996	B4003327-3123
7	14	5910-00-113-5277	81349	M39014-01-1563
7	15		81349	CDR12BG150AJUPX

## CROSS-REFERENCE INDEXES

FIG.	ITEM	FIGURE AND ITEM NUMBER INDEX STOCK NUMBER	FSCM	PART NUMBER
7	16	5935-01-011-3400	19505	2010-6511-002
7	17	5935-01-005-9795	37695	189698
7	18	5950-00-035-4425	96906	MS75085-7
7	19	5950-00-542-9634	96906	MS75089-27
7	20	5950-00-035-4416	96906	MS75083-13
7	21	5950-01-274-6580	80063	A3024684-10
7	22	5950-00-035-4418	96906	MS75083-7
7	23	5950-00-031-4568	96906	MS75084-6
7	24	5950-00-170-9769	96906	MS75084-7
7	25	5950-01-027-9120	96906	MS75089-1
7	26	5950-00-943-9174	96906	MS75088-7
7	27	5950-01-274-7891	80063	A3024684-12
7	28	5935-00-497-8968	81349	M55302/4-03
7	29	5935-01-275-7212	58167	11-0450-01C
7	30	5961-00-420-3668	81349	JANTX2N2369A
7	31	5961-01-019-4947	81349	JANTXV2N2907A
7	32	5961-01-071-6701	56996	B4002964
7	33	5905-00-119-8855	81349	RCR07G112JS
7	34	5905-00-105-7764	81349	RCR07G222JS
7	35	5905-00-136-3890	81349	RCR07G513JS
7	36	5905-00-106-1278	81349	RCR07G123JS
7	37	5905-00-485-4554	81349	RCR07G911JS
7	38	5905-00-114-0710	81349	RCR07G331JS
7	39	5905-00-136-8405	81349	RCR07G131JS
7	40	5905-00-136-8406	81349	RCR07G242JS
7	41	5905-00-197-0224	81349	RCR05G511JS
7	42	5905-00-689-1290	81349	RCR05G512JS
7	43	5905-00-180-8301	81349	RCR05G101JS
7	44	5905-00-491-1984	81349	RCR05G113JS
7	45	5905-00-231-2917	81349	RCR05G432JS
7	46	5905-00-401-7425	81349	RCR05G271JS
7	47	5905-00-400-9836	81349	RCR05G361JS
7	48	5905-00-106-1249	81349	RCR07G510JS
7	49	5905-00-141-1183	81349	RCR07G101JS
7	50	5905-00-110-7620	81349	RCR07G102JS
7	51	5905-00-116-2394	81349	RCR07G511JS
7	52	5905-00-121-9921	81349	RCR07G305JS
7	53	5905-00-412-0758	81349	RCR05G510JS
7	54	5905-00-106-3666	81349	RCR07G103JS
7	55	5905-01-238-4023	81349	M8340109M5103JC
7	56	5962-01-087-5967	04713	12513/BEBJC
7	57		81349	JM38510/06101BEX
7	58	5962-01-065-7026	81349	M38510/31504BEB
7	59	5962-01-193-5801	07263	54F161ADMQB
7	60	5962-01-131-2864	56996	B4003379-901
7	61	5962-01-068-1039	81349	M38510-31401BEB
7	62	5962-01-039-6395	81349	M38510-30301BCB
7	63	5962-01-241-9974	27014	MM54HC374J/883B
7	64	5962-01-084-9458	81349	M38510/10702-BXC
7	65	5962-01-128-1415	81349	M38510/10703-BXC
7	66		81349	M87111/2-2B05

## CROSS-REFERENCE INDEXES

FIG.	ITEM	FIGURE AND ITEM NUMBER INDEX STOCK NUMBER	FSCM	PART NUMBER
7	67		80063	A3034661
7	68		80063	A3028564
7	69	5999-01-275-6605	07556	2467 TALL
7	70		80063	A3028561
7	71		80063	A3028566
7	72		80063	A3028565
7	73		81349	M38527/03-002N
7	74	5999-01-280-5482	81349	M38527/02-018N
7	75		80063	A3028563
7	76		80063	A3028572
7	77		80063	A3079136
7	78		80063	A3028562
8	1	5961-01-025-2649	52673	KV2201
8	2	5961-01-043-9178	81349	JANTXIN4454-1
8	3	5961-00-335-8934	81349	JANTXIN5712
8	4		81349	CDR01BX102BKUP
8	5	5910-00-010-8721	81349	M39014/02-1419
8	6	5910-00-124-0659	81349	M39014-01-1575
8	7	5910-00-113-5730	81349	M39014/01-1589
8	8	5910-00-156-5999	81349	M39014/01-1348
8	9	5910-00-113-5499	81349	M39014/02-1350
8	10		56996	B4003318-78
8	11	5910-00-010-8666	81349	M39014/01-1357
8	12	5910-00-113-5471	81349	M39014/01-1336
8	13	5910-00-010-8498	81349	M39014/01-1345
8	14		56996	B4003327-3126
8	15	5910-00-828-1458	56996	B4003317-24
8	16	5910-00-078-9507	56996	B4003317-18
8	17	5910-00-080-2396	56996	B4003317-23
8	18	5910-00-506-9807	56996	B4003317-21
8	19	5910-00-066-5107	56996	B4003317-32
8	20	5910-00-010-8715	81349	M39014/01-1569
8	21	5910-00-124-0659	81349	M39014-01-1575
8	22		56996	B4003308-901
8	23	5935-01-011-3400	19505	2010-6511-002
8	24	5950-00-031-4571	96906	MS75084-8
8	25	5950-00-031-4561	96906	MS75084-4
8	26	5950-00-035-4425	96906	MS75085-7
8	27	5950-00-377-9882	96906	MS75084-3
8	28	5950-00-031-4556	96906	MS75084-10
8	29	5950-00-170-9770	96906	MS75084-15
8	30	5950-01-008-8645	96906	MS75089-3
8	31	5950-00-035-4416	96906	MS75083-13
8	32	5950-00-035-4413	96906	MS75083-1
8	33	5935-01-275-7212	58167	11-0450-01C
8	34	5935-01-005-9795	37695	189698
8	35	5961-00-836-6663	81349	JANTX2N918
8	36	5961-00-438-0598	81349	JANTX2N3251A
8	37	5961-00-420-3668	81349	JANTX2N2369A
8	38	5961-01-241-9970	56996	B4002963
8	39	5961-01-127-3102	04713	U310



## CROSS-REFERENCE INDEXES

FIG.	ITEM	FIGURE AND ITEM NUMBER INDEX STOCK NUMBER	FSCM	PART NUMBER
8	40	5961-01-071-6701	56996	B4002964
8	41	5961-00-603-8935	81349	JANTX2N5109
8	42	5961-01-019-4947	81349	JANTXV2N2907A
8	43	5905-00-119-8811	81349	RCR07G151JS
8	44	5905-00-106-1249	81349	RCR07G510JS
8	45	5905-00-255-3699	81349	RCR05G100JS
8	46	5905-00-458-9500	81349	RCR05G102JS
8	47	5905-00-197-0223	81349	RCR05G750JS
8	48	5905-00-407-0081	81349	RCR05G122JS
8	49	5905-00-401-7424	81349	RCR05G222JS
8	50	5905-00-401-7428	81349	RCR05G561JS
8	51	5905-00-180-8303	81349	RCR05G152JS
8	52	5905-00-180-8301	81349	RCR05G101JS
8	53	5905-00-761-5758	81349	RCR05G471JS
8	54	5905-01-035-5065	81349	RCR05G103JS
8	55	5905-00-401-7429	81349	RCR05G751JS
8	56	5905-00-466-1218	81349	RCR05G822JS
8	57	5905-00-479-6658	81349	RCR05G362JS
8	58	5905-00-104-8358	81349	RCR07G822JS
8	59	5905-00-104-8369	81349	RCR07G362JS
8	60	5905-00-135-3972	81349	RCR07G200JS
8	61	5905-00-120-9154	81349	RCR07G471JS
8	62	5905-00-115-8055	81349	RCR07G393JS
8	63	5905-00-126-6683	81349	RCR07G332JS
8	64	5905-00-119-3505	81349	RCR07G683JS
8	65	5905-00-106-3666	81349	RCR07G103JS
8	66	5905-00-105-7768	81349	RCR07G561JS
8	67	5905-00-104-8370	81349	RCR07G361JS
8	68	5905-00-135-3974	81349	RCR07G431JS
8	69	5905-00-126-6697	81349	RCR07G110JS
8	70	5905-00-489-7703	81349	RCR05G331JS
8	71	5905-00-411-1851	81349	RCR05G562JS
8	72	5905-00-401-7426	81349	RCR05G272JS
8	73	5905-00-470-0369	81349	RCR05G151JS
8	74	5905-00-471-4622	81349	RCR05G180JS
8	75	5905-00-401-7427	81349	RCR05G332JS
8	76	5905-00-491-6344	81349	RCR05G120JS
8	77	5905-00-197-0220	81349	RCR05G150JS
8	78	5905-00-493-5249	81349	RCR05G200JS
8	79	5905-00-433-1853	81349	RCR05G220JS
8	80	5905-00-481-0961	81349	RCR05G240JS
8	81	5905-00-407-0088	81349	RCR05G680JS
8	82	5905-00-413-1200	81349	RCR05G203JS
8	83	5905-00-118-4559	81349	RCR07G333JS
8	84	5905-00-126-6696	81349	RCR07G751JS
8	85	5905-00-110-7620	81349	RCR07G102JS
8	86	5905-00-484-7550	81349	RCR05G154JS
8	87	5905-00-197-0224	81349	RCR05G511JS
8	88	5905-00-141-0744	81349	RCR07G562JS
8	89		81349	M55342M03B2K00P
8	90	5905-00-481-5255	81349	RCR05G431JS

## CROSS-REFERENCE INDEXES

FIG.	ITEM	FIGURE AND ITEM NUMBER STOCK NUMBER	INDEX FSCM	PART NUMBER
8	91	5950-01-274-6572	80063	A3024684-1
8	92	5950-01-274-6573	80063	A3024684-2
8	93	5950-01-275-4918	80063	A3024684-3
8	94	5950-01-274-7886	56996	B4003346-1
8	95	5962-00-256-0340	96214	531932-2
8	96	5962-01-131-2864	56996	B4003379-901
8	97	5962-01-068-1039	81349	M38510-31401BEB
8	98	5962-01-243-1087	64863	SP8655AB
8	99	5962-01-238-8470	52648	SP8690AB
8	100	5962-01-050-0915	81349	M38510/30110BEB
8	101	5962-01-027-6863	81349	M38510/30003BCB
8	102		52648	SP8610AB
8	103	5962-01-128-1415	81349	M38510/10703-BXC
8	104	5962-01-084-9458	81349	M38510/10702-BXC
8	105		81349	M28837/1-02N
8	106		80063	A3028636
8	107		80063	A3028816
8	108		80063	A3079148
8	109		80063	A3028639
8	110	5999-01-280-5482	81349	M38527/02-018N
8	111		80063	A3028633
8	112		80063	A3028632
8	113		81349	M38527/01-040N
8	114		80063	A3034171
8	115		80063	A3028641
8	116	5999-01-084-0860	81349	M38527/05-001D
8	117	5999-01-275-6605	07556	2467 TALL
8	118		80063	A3028640
8	119		80063	A3028645
8	120		80063	A3079145
8	121		80063	A3028642
8	122		81349	M87111/2-2B05
8	123		80063	A3034661
9	1		80063	A3024355
9	2	5305-00-054-5648	96906	MS51957-14
9	3	5310-00-723-9676	80205	NAS620C4L
9	4	5895-01-242-0000	80063	A3024356
9	5	5935-01-005-9821	56207	400119
9	6	5305-00-993-9189	96906	MS24693C2
9	7	5895-01-242-6518	80063	A3024360
9	8		80063	A3086607
9	9	5305-00-054-5636	96906	MS51957-2
9	10	5305-00-066-7325	96906	MS24693C5
9	11		80063	A3028013
9	12	5340-00-431-1115	26344	3585-02CNW0129
9	13	5935-01-276-0476	58167	1111-1180-01C
9	14		80063	A3034572
9	15		80063	A3028102
9	16		80063	A3029325
9	17	5340-00-327-4820	96906	MS21209C0415L
9	18	5340-00-376-8648	96906	MS21209C0815L

## CROSS-REFERENCE INDEXES

FIG.	ITEM	FIGURE AND ITEM NUMBER STOCK NUMBER	INDEX FSCM	PART NUMBER
9	19		80063	A3032177
10	1	5961-01-043-9178	81349	JANTX1N4454-1
10	2		80063	A3028098
10	3	5910-00-114-0802	81349	M39014/01-1338
10	4	5910-00-098-8670	81349	M39014/01-1578
10	5	5910-00-113-5499	81349	M39014/02-1350
10	6		81349	CDR01BX102BKUP
10	7	5910-01-275-7258	81349	CFR06RRA183JP
10	8	5910-00-010-8666	81349	M39014/01-1357
10	9		81349	CDR14BG2R0ECUPX
10	10		81349	CDR14BG101EKUPX
10	11		81349	CDR14BG620EKUPX
10	12		56996	B4003327-3126
10	13	5910-00-124-0659	81349	M39014/01-1575
10	14		56996	B4003327-3123
10	15	5910-00-113-5277	81349	M39014-01-1563
10	16		81349	CDR12BG150AJUPX
10	17	5935-01-011-3400	19505	2010-6511-002
10	18	5935-01-005-9795	37695	189698
10	19	5950-00-035-4425	96906	MS75085-7
10	20	5950-00-542-9634	96906	MS75089-27
10	21	5950-00-035-4416	96906	MS75083-13
10	22	5950-01-274-6580	80063	A3024684-10
10	23	5950-00-035-4418	96906	MS75083-7
10	24	5950-00-031-4568	96906	MS75084-6
10	25	5950-00-170-9769	96906	MS75084-7
10	26	5950-01-027-9120	96906	MS75089-1
10	27	5950-00-943-9174	96906	MS75088-7
10	28	5950-01-274-7891	80063	A3024684-12
10	29	5935-00-497-8968	81349	M55302/4-03
10	30	5935-01-275-7212	58167	11-0450-01C
10	31	5961-00-420-3668	81349	JANTX2N2369A
10	32	5961-01-019-4947	81349	JANTXV2N2907A
10	33	5961-01-071-6701	56996	B4002964
10	34	5905-00-119-8855	81349	RCR07G112JS
10	35	5905-00-105-7764	81349	RCR07G222JS
10	36	5905-00-136-3890	81349	RCR07G513JS
10	37	5905-00-106-1278	81349	RCR07G123JS
10	38	5905-00-485-4554	81349	RCR07G911JS
10	39	5905-00-114-0710	81349	RCR07G331JS
10	40	5905-00-136-8405	81349	RCR07G131JS
10	41	5905-00-136-8406	81349	RCR07G242JS
10	42	5905-00-197-0224	81349	RCR05G511JS
10	43	5905-00-689-1290	81349	RCR05G512JS
10	44	5905-00-180-8301	81349	RCR05G101JS
10	45	5905-00-491-1984	81349	RCR05G113JS
10	46	5905-00-231-2917	81349	RCR05G432JS
10	47	5905-00-401-7425	81349	RCR05G271JS
10	48	5905-00-400-9836	81349	RCR05G361JS
10	49	5905-00-106-1249	81349	RCR07G510JS
10	50	5905-00-141-1183	81349	RCR07G101JS

## CROSS-REFERENCE INDEXES

FIG.	ITEM	FIGURE AND ITEM NUMBER STOCK NUMBER	INDEX FSCM	PART NUMBER
10	51	5905-00-110-7620	81349	RCR07G102JS
10	52	5905-00-116-2394	81349	RCR07G511JS
10	53	5905-00-121-9921	81349	RCR07G305JS
10	54	5905-00-412-0758	81349	RCR05G510JS
10	55	5905-00-106-3666	81349	RCR07G103JS
10	56	5905-01-238-4023	81349	M8340109M5103JC
10	57	5962-01-087-5967	04713	12513/BEBJC
10	58		81349	JM38510/06101BEX
10	59	5962-01-065-7026	81349	M38510/31504BEB
10	60	5962-01-193-5801	07263	54F161ADMQB
10	61	5962-01-131-2864	56996	B4003379-901
10	62	5962-01-068-1039	81349	M38510-31401BEB
10	63	5962-01-039-6395	81349	M38510-30301BCB
10	64	5962-01-241-9974	27014	MM54HC374J/883B
10	65	5962-01-084-9458	81349	M38510/10702-BXC
10	66	5962-01-128-1415	81349	M38510/10703-BXC
10	67		81349	M87111/2-2B05
10	68		80063	A3034661
10	69	5999-01-275-6605	07556	2467 TALL
10	70		80063	A3028561
10	71		80063	A3028566
10	72		80063	A3028565
10	73		80063	A3028564
10	74		81349	M38527/03-002N
10	75		80063	A3028563
10	76	5999-01-280-5482	81349	M38527/02-018N
10	77		80063	A3028572
10	78		80063	A3079136
10	79		80063	A3028562
11	1		80063	A3028098
11	2	5961-01-043-9178	81349	JANTX1N4454-1
11	3		81349	CDR01BX102BKUP
11	4	5910-00-199-5335	81349	M39014/01-1353
11	5	5910-00-010-8721	81349	M39014/02-1419
11	6	5910-00-124-0659	81349	M39014-01-1575
11	7	5910-00-113-5730	81349	M39014/01-1589
11	8	5910-00-156-5999	81349	M39014/01-1348
11	9	5910-00-113-5499	81349	M39014/02-1350
11	10		81349	CDR14BG620EKUPX
11	11		81349	CDR14BG101EKUPX
11	12	5910-00-010-8666	81349	M39014/01-1357
11	13	5910-00-113-5471	81349	M39014/01-1336
11	14	5910-00-010-8498	81349	M39014/01-1345
11	15		56996	B4003327-3126
11	16	5910-00-124-0659	81349	M39014-01-1575
11	17		56996	B4003308-901
11	18	5935-01-011-3400	19505	2010-6511-002
11	19	5950-00-031-4571	96906	MS75084-8
11	20	5950-00-031-4568	96906	MS75084-6
11	21	5950-00-035-4425	96906	MS75085-7
11	22	5950-00-377-9882	96906	MS75084-3

## CROSS-REFERENCE INDEXES

FIG.	ITEM	FIGURE AND ITEM NUMBER INDEX STOCK NUMBER	FSCM	PART NUMBER
11	23	5950-00-035-4416	96906	MS75083-13
11	24	5950-01-274-6580	80063	A3024684-10
11	25	5950-00-031-4556	96906	MS75084-10
11	26	5950-00-170-9770	96906	MS75084-15
11	27	5950-01-008-8645	96906	MS75089-3
11	28	5935-01-275-7212	58167	11-0450-01C
11	29	5935-01-005-9795	37695	189698
11	30	5961-00-836-6663	81349	JANTX2N918
11	31	5961-00-438-0598	81349	JANTX2N3251A
11	32	5961-00-420-3668	81349	JANTX2N2369A
11	33	5961-01-241-9970	56996	B4002963
11	34	5961-01-071-6701	56996	B4002964
11	35	5961-01-019-4947	81349	JANTXV2N2907A
11	36	5905-00-119-8811	81349	RCR07G151JS
11	37	5905-00-106-1249	81349	RCR07G510JS
11	38	5905-00-180-8301	81349	RCR05G101JS
11	39	5905-00-401-7427	81349	RCR05G332JS
11	40	5905-00-458-9500	81349	RCR05G102JS
11	41	5905-00-466-1216	81349	RCR05G330JS
11	42	5905-00-407-0081	81349	RCR05G122JS
11	43	5905-00-401-7424	81349	RCR05G222JS
11	44	5905-00-401-7428	81349	RCR05G561JS
11	45	5905-00-180-8303	81349	RCR05G152JS
11	46	5905-00-761-5758	81349	RCR05G471JS
11	47	5905-01-035-5065	81349	RCR05G103JS
11	48	5905-00-491-1984	81349	RCR05G113JS
11	49	5905-00-231-2917	81349	RCR05G432JS
11	50	5905-00-412-0758	81349	RCR05G510JS
11	51	5905-00-400-9836	81349	RCR05G361JS
11	52	5905-00-466-1218	81349	RCR05G822JS
11	53	5905-00-479-6658	81349	RCR05G362JS
11	54	5905-00-493-5249	81349	RCR05G200JS
11	55	5905-00-104-8358	81349	RCR07G822JS
11	56	5905-00-104-8369	81349	RCR07G362JS
11	57	5905-00-135-3972	81349	RCR07G200JS
11	58	5905-00-120-9154	81349	RCR07G471JS
11	59	5905-00-106-3666	81349	RCR07G103JS
11	60	5905-00-105-7768	81349	RCR07G561JS
11	61	5905-00-119-3505	81349	RCR07G683JS
11	62	5905-00-126-6683	81349	RCR07G332JS
11	63	5905-00-104-8370	81349	RCR07G361JS
11	64	5905-00-115-8055	81349	RCR07G393JS
11	65	5905-00-401-7425	81349	RCR05G271JS
11	66	5905-00-180-8315	81349	RCR05G681JS
11	67	5905-00-470-9163	81349	RCR05G622JS
11	68	5905-00-466-1217	81349	RCR05G683JS
11	69	5905-00-126-6696	81349	RCR07G751JS
11	70	5905-00-110-7620	81349	RCR07G102JS
11	71	5905-00-484-7550	81349	RCR05G154JS
11	72	5905-00-197-0224	81349	RCR05G511JS
11	73	5905-00-141-0744	81349	RCR07G562JS

## CROSS-REFERENCE INDEXES

FIG.	ITEM	FIGURE AND ITEM NUMBER INDEX STOCK NUMBER	FSCM	PART NUMBER
11	74		81349	M55342M03B2K00P
11	75	5962-00-256-0340	96214	531932-2
11	76	5962-01-131-2864	56996	B4003379-901
11	77	5962-01-068-1039	81349	M38510-31401BEB
11	78		52648	SP8610AB
11	79	5962-01-243-1087	64863	SP8655AB
11	80	5962-01-238-8470	52648	SP8690AB
11	81	5962-01-050-0915	81349	M38510/30110BEB
11	82	5962-01-027-6863	81349	M38510/30003BCB
11	83	5962-01-128-1415	81349	M38510/10703-BXC
11	84	5962-01-084-9458	81349	M38510/10702-BXC
11	85	5962-01-087-5967	04713	12513/BEBJC
11	86		81349	M28837/1-02N
11	87		80063	A3079148
11	88		80063	A3028640
11	89		80063	A3028639
11	90	5999-01-276-6437	07556	2467 SHORT
11	91		80063	A3028633
11	92		80063	A3028636
11	93		80063	A3028816
11	94		80063	A3078673
11	95		80063	A3028632
11	96		80063	A3029118
11	97		81349	M38527/1-040N
11	98		80063	A3034171
11	99	5999-01-084-0860	81349	M38527/05-001D
11	100	5999-01-275-6605	07556	2467 TALL
11	101		80063	A3079144
11	102		80063	A3029119
11	103		80063	A3029120
11	104		81349	M38527/2-018N
11	105		81349	M87111/2-2B05
11	106		80063	A3034661
12	1	5305-00-993-9189	96906	MS24693C2
12	2		80063	A3024365
12	3	5305-00-054-5648	96906	MS51957-14
12	4	5310-00-723-9676	80205	NAS620C4L
12	5	5895-01-238-8522	80063	A3024366
12	6	5895-01-238-8523	80063	A3024370
12	7	5305-00-054-5636	96906	MS51957-2
12	8		80063	A3086606
12	9	5305-00-066-7325	96906	MS24693C5
12	10		80063	A3034572
12	11	5340-00-431-1115	26344	3585-02CNW0129
12	12	5935-01-276-0476	58167	1111-1180-01C
12	13		80063	A3028020
12	14		80063	A3028102
12	15		80063	A3029328
12	16	5340-00-327-4820	96906	MS21209C0415L
12	17		80063	A3032178
12	18	5340-00-376-8648	96906	MS21209C0815L

## CROSS-REFERENCE INDEXES

FIG.	ITEM	FIGURE AND ITEM NUMBER INDEX STOCK NUMBER	FSCM	PART NUMBER
12	19		80063	A3029327
13	1	5961-01-043-9178	81349	JANTX1N4454-1
13	2		80063	A3028098
13	3	5910-00-114-0802	81349	M39014/01-1338
13	4	5910-00-098-8670	81349	M39014/01-1578
13	5	5910-00-113-5499	81349	M39014/02-1350
13	6		81349	CDR01BX102BKUP
13	7	5910-01-275-7258	81349	CFR06RRA183JP
13	8		81349	CDR14BG2R0ECUPX
13	9		81349	CDR14BG101EKUPX
13	10		81349	CDR14BG620EKUPX
13	11		56996	B4003327-3126
13	12	5910-00-124-0659	81349	M39014/01-1575
13	13	5910-00-010-8666	81349	M39014/01-1357
13	14		56996	B4003327-3123
13	15	5910-00-113-5277	81349	M39014-01-1563
13	16	5910-00-010-8721	81349	M39014/02-1419
13	17		81349	CDR12BG150AJUPX
13	18	5935-01-011-3400	19505	2010-6511-002
13	19	5950-00-035-4425	96906	MS75085-7
13	20	5950-00-035-4416	96906	MS75083-13
13	21	5950-01-274-6580	80063	A3024684-10
13	22	5950-00-035-4418	96906	MS75083-7
13	23	5950-00-031-4568	96906	MS75084-6
13	24	5950-00-170-9769	96906	MS75084-7
13	25	5950-01-029-5971	96906	MS75089-5
13	26	5950-00-943-9174	96906	MS75088-7
13	27	5950-01-027-9120	96906	MS75089-1
13	28	5935-00-497-8968	81349	MS5302/4-03
13	29	5935-01-275-7212	58167	11-0450-01C
13	30	5961-00-420-3668	81349	JANTX2N2369A
13	31	5961-01-019-4947	81349	JANTXV2N2907A
13	32	5961-01-071-6701	56996	B4002964
13	33	5905-00-227-7015	81349	RCR05G112JS
13	34	5905-00-401-7424	81349	RCR05G222JS
13	35	5905-00-180-8314	81349	RCR05G513JS
13	36	5905-00-466-1215	81349	RCR05G123JS
13	37	5905-00-422-3800	81349	RCR05G911JS
13	38	5905-00-489-7703	81349	RCR05G331JS
13	39	5905-00-197-0219	81349	RCR05G131JS
13	40	5905-00-482-7695	81349	RCR05G242JS
13	41	5905-00-197-0224	81349	RCR05G511JS
13	42	5905-00-689-1290	81349	RCR05G512JS
13	43	5905-00-180-8301	81349	RCR05G101JS
13	44	5905-00-491-1984	81349	RCR05G113JS
13	45	5905-00-231-2917	81349	RCR05G432JS
13	46	5905-00-401-7425	81349	RCR05G271JS
13	47	5905-00-400-9836	81349	RCR05G361JS
13	48	5905-00-412-0758	81349	RCR05G510JS
13	49	5905-00-110-7620	81349	RCR07G102JS
13	50	5905-00-116-2394	81349	RCR07G511JS

## CROSS-REFERENCE INDEXES

FIG.	ITEM	FIGURE AND ITEM NUMBER INDEX STOCK NUMBER	FSCM	PART NUMBER
13	51	5905-00-483-0425	81349	RCR05G305JS
13	52	5905-01-035-5065	81349	RCR05G103JS
13	53	5905-00-105-7768	81349	RCR07G561JS
13	54	5905-00-119-3505	81349	RCR07G683JS
13	55	5905-01-238-4023	81349	M8340109M5103JC
13	56	5905-00-119-8768	81349	RCR07G821JS
13	57	5962-01-087-5967	04713	12513/BEBJC
13	58		81349	JM38510/06101BEX
13	59	5962-01-065-7026	81349	M38510/31504BEB
13	60	5962-01-193-5801	07263	54F161ADMQB
13	61	5962-01-131-2864	56996	B4003379-901
13	62	5962-01-068-1039	81349	M38510-31401BEB
13	63	5962-01-039-6395	81349	M38510-30301BCB
13	64	5962-01-241-9974	27014	MM54HC374J/883B
13	65	5962-01-238-8470	52648	SP8690AB
13	66	5962-01-084-9458	81349	M38510/10702-BXC
13	67	5962-01-128-1415	81349	M38510/10703-BXC
13	68		81349	M87111/2-2B05
13	69	5999-01-275-6605	07556	2467 TALL
13	70		80063	A3028570
13	71		80063	A3079137
13	72		80063	A3028571
13	73		80063	A3078673
13	74		81349	M38527/3-002N
13	75		80063	A3028569
13	76		81349	M38527/2-018N
13	77		80063	A3028573
13	78		80063	A3028568
13	79		80063	A3028567
14	1		80063	A3028098
14	2	5961-01-043-9178	81349	JANTX1N4454-1
14	3	5910-00-124-0659	81349	M39014-01-1575
14	4	5910-00-113-5499	81349	M39014/02-1350
14	5	5910-00-010-8721	81349	M39014/02-1419
14	6		56996	B4003327-3126
14	7	5910-01-275-6519	81349	CFR06RRA103JM
14	8	5910-01-219-2315	81349	CCR05CG102FP
14	9	5910-00-113-5284	81349	M39014/02-1358
14	10		81349	CDR01BX102BKUP
14	11	5910-01-276-0454	56996	B4003316-19
14	12		56996	B4003318-78
14	13	5910-00-010-8534	81349	M39014/01-1347
14	14	5910-00-199-5335	81349	M39014/01-1353
14	15	5910-00-124-0627	81349	M39014/01-1571
14	16	5910-00-010-8498	81349	M39014/01-1345
14	17	5910-00-010-8666	81349	M39014/01-1357
14	18	5935-01-011-3400	19505	2010-6511-002
14	19	5950-00-035-4425	96906	MS75085-7
14	20	5950-00-487-1779	96906	MS75085-15
14	21	5950-00-031-4571	96906	MS75084-8
14	22	5950-00-035-4420	96906	MS75085-1



## CROSS-REFERENCE INDEXES

FIG.	ITEM	FIGURE AND ITEM NUMBER STOCK NUMBER	INDEX FSCM	PART NUMBER
14	23	5950-00-031-3779	96906	MS75085-19
14	24	5950-00-031-4560	96906	MS75084-16
14	25	5950-01-008-8645	96906	MS75089-3
14	26	5935-00-497-8968	81349	M55302/4-03
14	27	5935-01-275-7212	58167	11-0450-01C
14	28	5961-00-836-6663	81349	JANTX2N918
14	29	5961-00-420-3668	81349	JANTX2N2369A
14	30	5961-01-127-3102	04713	U310
14	31	5961-00-603-8935	81349	JANTX2N5109
14	32	5961-00-858-3826	81349	JANTX2N2222A
14	33	5905-00-105-7764	81349	RCR07G222JS
14	34	5905-00-228-5506	81349	RCR07G622JS
14	35	5905-00-104-8358	81349	RCR07G822JS
14	36	5905-00-141-0743	81349	RCR07G392JS
14	37	5905-00-110-7620	81349	RCR07G102JS
14	38	5905-00-120-9154	81349	RCR07G471JS
14	39	5905-00-141-1183	81349	RCR07G101JS
14	40	5905-01-184-7954	81349	RLR05C4021FS
14	41	5905-01-185-9347	81349	RLR05C4121FS
14	42	5905-01-168-7460	81349	RLR05C4221FS
14	43	5905-01-196-1966	81349	RLR05C4421FS
14	44	5905-01-185-1311	81349	RLR05C4531FS
14	45	5905-01-051-9611	81349	RLR05C4641FS
14	46	5905-01-170-0396	81349	RLR05C4321FS
14	47	5905-01-184-7938	81349	RLR05C7501FS
14	48	5905-00-689-1290	81349	RCR05G512JS
14	49	5905-00-413-1200	81349	RCR05G203JS
14	50	5905-00-180-8301	81349	RCR05G101JS
14	51	5905-00-401-7429	81349	RCR05G751JS
14	52	5905-01-035-5065	81349	RCR05G103JS
14	53	5905-00-617-5096	81349	RCR05G682JS
14	54	5905-00-401-7430	81349	RCR05G752JS
14	55	5905-00-433-6486	81349	RCR05G912JS
14	56	5905-00-466-1218	81349	RCR05G822JS
14	57	5905-00-407-0081	81349	RCR05G122JS
14	58	5905-00-493-5249	81349	RCR05G200JS
14	59	5905-00-407-0088	81349	RCR05G680JS
14	60	5905-00-466-1217	81349	RCR05G683JS
14	61	5905-00-412-0758	81349	RCR05G510JS
14	62	5905-00-761-5758	81349	RCR05G471JS
14	63	5905-00-479-6658	81349	RCR05G362JS
14	64	5905-00-458-9500	81349	RCR05G102JS
14	65	5905-00-470-9480	81349	RCR05G132JS
14	66	5905-00-180-8315	81349	RCR05G681JS
14	67	5905-00-401-7431	81349	RCR05G821JS
14	68	5905-00-180-8303	81349	RCR05G152JS
14	69	5905-00-401-7427	81349	RCR05G332JS
14	70	5905-00-409-2975	81349	RCR05G820JS
14	71	5905-00-131-1255	81349	RCR07G122JS
14	72	5905-00-121-9938	81349	RCR07G753JS
14	73	5905-00-111-1679	81349	RCR07G512JS

## CROSS-REFERENCE INDEXES

FIG.	ITEM	FIGURE AND ITEM NUMBER INDEX STOCK NUMBER	FSCM	PART NUMBER
14	74	5905-01-238-4023	81349	M8340109M5103JC
14	75	5905-01-171-5659	81349	M8340105M1001JG
14	76	5950-01-274-6572	80063	A3024684-1
14	77	5950-01-275-4918	80063	A3024684-3
14	78	5962-00-256-0340	96214	531932-2
14	79	5962-01-128-1415	81349	M38510/10703-BXC
14	80	5962-01-234-0880	27014	MM54HC390J/883B
14	81	5962-01-084-9458	81349	M38510/10702-BXC
14	82	5962-01-241-9975	04713	MC145152LD
14	83	5962-01-023-5036	02735	CA6741T/3
14	84		52648	SP8691AB/DG
14	85	5962-01-068-1039	81349	M38510-31401BEB
14	86	5962-01-241-9974	27014	MM54HC374J/883B
14	87	5962-01-026-6055	81349	M38510-30009BCB
14	88		80063	A3028648
14	89	5999-01-280-5482	81349	M38527/02-018N
14	90		80063	A3078673
14	91		80063	A3028630
14	92		80063	A3028646
14	93		80063	A3079147
14	94		81349	M38527/01-040N
14	95		80063	A3028647
14	96		80063	A3028631
14	97		80063	A3028638
14	98		80063	A3028634
14	99		81349	M87111/2-2B05
14	100		80063	A3028629
14	101	5999-01-084-0860	81349	M38527/05-001D
14	102	5999-01-086-6659	81349	M38527/05-002D
14	103		80063	A3079146
14	104		80063	A3028635
15	1	5305-00-917-7839	80205	NAS1635-04LN4
15	2		80063	A3028065
15	3	5310-00-208-3786	80205	NAS671C4
15	4	5310-00-933-8118	96906	MS35338-135
15	5	5310-00-723-9676	80205	NAS620C4L
15	6	5305-00-225-6400	96906	MS24693C3
15	7	5935-00-485-5018	25330	GDMM36W4P
15	8		80063	A3028019
15	9	5305-01-277-3181	80063	A3028101
15	10	5910-00-185-9067	81349	M39003/01-3176
15	11	5910-00-495-0042	81349	M39003/01-3076
15	12	5995-01-241-9941	80063	A3024379-2
15	13	5995-01-238-8249	80063	A3024379-1
15	14	5995-01-241-9942	80063	A3024379-3
15	15	5895-01-238-8524	80063	A3024376
15	16	5305-00-054-5647	96906	MS51957-13
15	17	5305-01-237-4750	80063	A3028192-1
15	18		80063	A3029324
15	19		80063	A3078391
15	20	5995-01-237-8120	80063	A3024379-4

## CROSS-REFERENCE INDEXES

FIG.	ITEM	FIGURE AND ITEM NUMBER INDEX STOCK NUMBER	FSCM	PART NUMBER
15	21	5962-01-087-9496	81349	M38510/10708BYC
15	22	5940-00-271-6759	96906	MS77071-1
15	23	5305-00-054-5648	96906	MS51957-14
16	1	5305-00-054-5636	96906	MS51957-2
16	2		80063	A3034520
16	3		80063	A3028048
16	4	5935-01-012-5578	56207	400118
16	5	5305-00-054-5647	96906	MS51957-13
16	6	5310-00-723-9676	80205	NAS620C4L
16	7	5895-01-238-4011	80063	A3024621
16	8	5895-01-242-0001	80063	A3024625
16	9		80063	A3034572
16	10	5340-00-431-1115	26344	3585-02CNW0129
16	11	5340-00-327-4820	96906	MS21209C0415L
16	12		80063	A3028049
16	13		80063	A3028102
16	14	5340-00-376-8648	96906	MS21209C0815L
17	1	5961-01-043-9178	81349	JANTX1N4454-1
17	2	5961-01-023-2852	56996	B4006210-902
17	3	5910-00-124-0659	81349	M39014-01-1575
17	4	5910-00-010-8717	81349	M39014/01-1593
17	5	5910-01-213-2366	81349	CCR06CG103GS
17	6		81349	CCR09CG301JP
17	7	5910-00-010-8666	81349	M39014/01-1357
17	8		56996	B4003327-3285
17	9	5935-01-011-3400	19505	2010-6511-002
17	10	5935-00-152-9571	19112	102-14-CC-B
17	11	5950-00-035-4425	96906	MS75085-7
17	12	5950-00-031-4560	96906	MS75084-16
17	13	5961-01-019-4947	81349	JANTXV2N2907A
17	14	5961-00-858-3826	81349	JANTX2N2222A
17	15	5905-00-228-5506	81349	RCR07G622JS
17	16	5905-00-116-8555	81349	RCR07G153JS
17	17	5905-00-141-0717	81349	RCR07G473JS
17	18	5905-00-106-1249	81349	RCR07G510JS
17	19	5905-00-141-1295	81349	RCR07G243JS
17	20	5905-00-106-1357	81349	RCR07G563JS
17	21	5905-00-106-3666	81349	RCR07G103JS
17	22	5905-00-104-8358	81349	RCR07G822JS
17	23	5905-00-110-7622	81349	RCR07G682JS
17	24	5905-00-141-1132	81349	RCR07G752JS
17	25	5905-00-115-2261	81349	RCR07G912JS
17	26	5905-00-113-4860	81349	RCR07G270JS
17	27	5905-00-141-0744	81349	RCR07G562JS
17	28	5905-00-180-8314	81349	RCR05G513JS
17	29	5905-00-110-7620	81349	RCR07G102JS
17	30	5905-00-114-0711	81349	RCR07G472JS
17	31	5905-00-111-4750	81349	RCR07G301JS
17	32	5905-00-105-7764	81349	RCR07G222JS
17	33	5905-00-135-6046	81349	RCR07G681JS
17	34	5905-00-114-0710	81349	RCR07G331JS

## CROSS-REFERENCE INDEXES

FIG.	ITEM	FIGURE AND ITEM NUMBER STOCK NUMBER	INDEX FSCM	PART NUMBER
17	35	5905-00-455-4403	81349	RCR07G2R7JS
17	36	5905-00-106-3668	81349	RCR07G220JS
17	37	5905-00-116-2394	81349	RCR07G511JS
17	38	5905-00-111-4742	81349	RCR20G391JS
17	39	5905-00-115-8055	81349	RCR07G393JS
17	40	5905-00-136-3890	81349	RCR07G513JS
17	41	5962-00-256-0340	96214	531932-2
17	42	5962-01-080-6488	81349	M38510/11001BCB
17	43		18324	SE529AF/883B
17	44	5962-01-234-0880	27014	MM54HC390J/883B
17	45	5961-01-088-8346	81349	JANTX1N757A1
17	46	5961-01-102-2873	81349	JANTX1N756A1
17	47	5955-01-275-6614	58997	T-334
17	48		56996	B4003358-4
17	49		80063	A3034661
17	50		81349	M38527/3-002N
18	1	5910-00-010-8717	81349	M39014/01-1593
18	2	5935-00-152-9571	19112	102-14-CC-B
18	3	5950-00-035-4416	96906	MS75083-13
18	4	5935-01-127-1897	81349	M55302/4-06
18	5	5905-00-110-0388	81349	RCR07G104JS
18	6	5905-00-246-8690	81349	RCR07G514JS
18	7	5905-00-110-7620	81349	RCR07G102JS
18	8		81349	M8340108M5103JC
18	9		81349	M8340108K1001GG
18	10	5905-01-209-0630	81349	M8340108K1001GC
18	11	5905-01-200-7728	81349	M8340108K1002GG
18	12		14933	8404001CX
18	13	5962-01-200-8155	27014	MM54HC373J/883B
18	14	5962-01-241-9974	27014	MM54HC374J/883B
18	15	5962-01-238-8471	27014	MM54HC4078J/883
18	16		02735	803895-1
18	17		14933	8404101CX
18	18		80063	A3034661
19	1	5305-00-054-5636	96906	MS51957-2
19	2		80063	A3028053
19	3	5305-00-054-5647	96906	MS51957-13
19	4	5310-00-057-0573	80205	NAS620C4
19	5	5895-01-238-4012	80063	A3024630
19	6		80063	A3028602
19	7		80063	A3034572
19	8	5340-00-431-1115	26344	3585-02CNW0129
19	9	5340-00-327-4820	96906	MS21209C0415L
19	10		80063	A3028102
19	11		80063	A3028603
19	12	5340-00-376-8648	96906	MS21209C0815L
20	1	5961-01-043-9178	81349	JANTX1N4454-1
20	2	5910-00-124-0659	81349	M39014-01-1575
20	3	5910-00-010-8666	81349	M39014/01-1357
20	4	5910-00-113-5465	81349	M39014/02-1360
20	5	5910-01-217-7205	81349	CCR06CG123GS

## CROSS-REFERENCE INDEXES

FIG.	ITEM	FIGURE AND ITEM NUMBER STOCK NUMBER	INDEX FSCM	PART NUMBER
20	6		81349	CCR09CG222JP
20	7		81349	CCR09CG561JP
20	8		81349	CCR09CG121JP
20	9		81349	CCR07CG333JP
20	10		81349	CCR09CG270JP
20	11	5910-00-010-8717	81349	M39014/01-1593
20	12		56996	B4003327-3289
20	13		56996	B4003327-3345
20	14		81349	CCR09CG620JP
20	15	5910-00-113-5445	81349	M39014/01-1259
20	16		56996	B4003328-3442
20	17	5915-01-276-1157	80063	A3023936-1
20	18	5935-01-011-3400	19505	2010-6511-002
20	19	5950-00-031-4560	96906	MS75084-16
20	20	5950-00-035-4425	96906	MS75085-7
20	21	5935-00-432-6649	81349	M55302/4-04
20	22		00779	87518-9
20	23	5961-00-858-3826	81349	JANTX2N2222A
20	24	5905-00-136-3890	81349	RCR07G513JS
20	25	5905-01-238-4023	81349	M8340109M5103JC
20	26	5905-00-110-7620	81349	RCR07G102JS
20	27	5905-00-305-5187	81349	RNC55H2320FS
20	28	5905-00-116-8556	81349	RCR07G223JS
20	29	5905-00-412-4048	81349	RNC55H2002FS
20	30	5905-00-115-3560	81349	RCR07G183JS
20	31	5905-00-196-5171	81349	RNC55H2102FS
20	32	5905-00-106-3666	81349	RCR07G103JS
20	33	5905-00-119-8811	81349	RCR07G151JS
20	34	5905-00-105-7765	81349	RCR07G224JS
20	35	5905-00-442-9356	81349	RCR07G240JS
20	36	5905-00-236-0513	81349	RNC55H3482FS
20	37	5905-00-150-0477	81349	RNC55H5492FS
20	38	5905-00-139-1927	81349	RNC55H7152FS
20	39	5905-00-138-7402	81349	RNC55H5362FS
20	40	5905-00-431-5157	81349	RNC55H3572FS
20	41	5905-00-184-7787	81349	RNC55H3652FS
20	42	5905-00-758-4782	81349	RNC55H3742FS
20	43	5905-00-184-7788	81349	RNC55H3832FS
20	44	5905-00-462-5635	81349	RNC55H4022FS
20	45	5905-00-721-0036	81349	RNC55H4122FS
20	46	5905-00-429-8772	81349	RNC55H4222FS
20	47	5905-00-431-5158	81349	RNC55H4322FS
20	48	5905-00-403-4448	81349	RNC55H3922FS
20	49	5905-00-402-1400	81349	RNC55H6342FS
20	50	5905-00-403-4453	81349	RNC55H7682FS
20	51	5905-00-138-6995	81349	RNC55H5762FS
20	52	5905-00-721-3681	81349	RNC55H5902FS
20	53	5905-00-721-3683	81349	RNC55H6042FS
20	54	5905-00-451-7410	81349	RNC55H6192FS
20	55	5905-00-483-4038	81349	RNC55H6652FS
20	56	5905-00-152-7613	81349	RNC55H6492FS

## CROSS-REFERENCE INDEXES

FIG.	ITEM	FIGURE AND ITEM NUMBER INDEX STOCK NUMBER	FSCM	PART NUMBER
20	57	5905-00-350-8351	81349	RNC55H6812FS
20	58	5905-00-721-3305	81349	RNC55H6982FS
20	59	5905-00-146-3879	81349	RNC55H9532FS
20	60	5905-00-139-2141	81349	RNC55H1023FS
20	61	5905-00-111-1682	81349	RCR07G163JS
20	62	5905-00-197-4110	81349	RNC55H1502FS
20	63	5905-00-106-1249	81349	RCR07G510JS
20	64	5905-01-161-7274	81349	RJR26FW503R
20	65	5905-00-135-6046	81349	RCR07G681JS
20	66	5905-00-116-2394	81349	RCR07G511JS
20	67	5905-00-114-0708	81349	RCR07G202JS
20	68	5905-00-110-7622	81349	RCR07G682JS
20	69	5905-00-104-8358	81349	RCR07G822JS
20	70	5905-00-136-8406	81349	RCR07G242JS
20	71	5905-00-138-3376	81349	RNC55H1001FS
20	72	5905-00-369-6932	81349	RCR07G113JS
20	73	5905-00-110-0388	81349	RCR07G104JS
20	74	5905-00-111-1679	81349	RCR07G512JS
20	75	5905-00-131-9729	81349	RCR07G302JS
20	76	5905-00-114-0711	81349	RCR07G472JS
20	77	5905-00-118-4559	81349	RCR07G333JS
20	78	5905-00-105-7768	81349	RCR07G561JS
20	79	5905-00-136-3891	81349	RCR07G621JS
20	80	5905-00-126-6696	81349	RCR07G751JS
20	81	5905-00-119-8768	81349	RCR07G821JS
20	82	5905-00-485-4554	81349	RCR07G911JS
20	83	5905-00-412-4049	81349	RNC55H4751FS
20	84	5905-00-126-6683	81349	RCR07G332JS
20	85	5905-00-122-0004	81349	RCR07G433JS
20	86	5905-00-141-0717	81349	RCR07G473JS
20	87	5905-00-119-3504	81349	RCR07G273JS
20	88	5905-00-005-2902	81349	RNC55H3012FS
20	89	5905-00-236-7578	81349	RNC55H3322FS
20	90	5905-00-401-7432	81349	RNC55H1003FS
20	91	5905-00-479-9945	81349	RNC55H1472FS
20	92	5905-00-435-6374	81349	RCR07G823JS
20	93	5905-00-105-7764	81349	RCR07G222JS
20	94	5905-00-107-0656	81349	RCR07G100JS
20	95	5905-00-305-5225	81349	RNC55H1301FS
20	96	5962-01-241-9974	27014	MM54HC374J/883B
20	97	5962-01-080-6488	81349	M38510/11001BCB
20	98		81349	JM38510/12302BEX
20	99	5962-00-007-4079	81349	M38510-10102BCB
20	100	5962-01-003-2577	04713	1596/BCBJC
20	101	5962-01-086-7029	81349	M38510/17001BCB
20	102		52648	SL612CB/CM
20	103	5962-01-156-7241	81349	M38510/11703BXC
20	104	5961-01-111-7743	81349	JANTX1N752A-1
20	105		56996	B4003337-1
20	106	5310-00-208-3786	80205	NAS671C4
20	107	5310-00-933-8118	96906	MS35338-135

## CROSS-REFERENCE INDEXES

FIG.	ITEM	FIGURE AND ITEM NUMBER STOCK NUMBER	INDEX FSCM	PART NUMBER
20	108	5310-00-057-0573	80205	NAS620C4
20	109		80063	A3079142
20	110		81349	M38527/03-008N
20	111	5935-01-183-6530	81349	M55302/127-00KY
20	112	5999-01-200-4115	81349	M38527/02-018D
21	1	5305-00-993-9189	96906	MS24693C2
21	2	5310-00-837-1381	80205	NAS671C8
21	3		80063	A3028053
21	4	5305-00-054-5636	96906	MS51957-2
21	5	5895-01-242-6519	80063	A3024635
21	6	5305-00-054-5647	96906	MS51957-13
21	7	5310-00-057-0573	80205	NAS620C4
21	8		80063	A3028613
21	9		80063	A3034572
21	10	5340-00-431-1115	26344	3585-02CNW0129
21	11	5340-00-327-4820	96906	MS21209C0415L
21	12		80063	A3028102
21	13		80063	A3028614
21	14	5340-00-376-8648	96906	MS21209C0815L
22	1	5961-01-043-9178	81349	JANTX1N4454-1
22	2	5961-01-023-2852	56996	B4006210-902
22	3		12969	UM4301B
22	4	5961-01-275-0806	12969	UM7101B
22	5	5910-00-124-0659	81349	M39014-01-1575
22	6	5910-00-010-8717	81349	M39014/01-1593
22	7		56996	B4003327-3345
22	8	5910-00-010-8666	81349	M39014/01-1357
22	9		81349	CCR05CJ5R6JP
22	10	5910-01-053-5634	81349	CMR04C8R0D0DR
22	11	5910-01-047-7869	81349	CMR04E750G0DR
22	12	5910-01-059-2483	81349	CMR04C6R0D0DR
22	13	5910-01-064-9676	81349	CMR04E470G0DR
22	14	5910-01-041-6291	81349	CMR04F101G0DR
22	15	5910-01-049-9148	81349	CMR04C180J0DR
22	16	5910-01-276-8123	56996	B4003325-17
22	17	5910-00-113-5465	81349	M39014/02-1360
22	18		56996	B4003327-3289
22	19	5910-00-010-8498	81349	M39014/01-1345
22	20		56996	B4003327-3249
22	21	5910-00-113-5445	81349	M39014/01-1259
22	22		81349	CDR12BG150AJUPX
22	23	5935-01-011-4754	19505	2009-6511-000
22	24	5915-01-276-1158	80063	A3023935
22	25	5935-01-011-3400	19505	2010-6511-002
22	26	5950-00-031-4568	96906	MS75084-6
22	27	5950-00-031-4561	96906	MS75084-4
22	28		80063	A3024684-7
22	29	5950-01-241-9958	80063	A3024684-8
22	30		80063	A3034554-2
22	31	5950-00-031-4558	96906	MS75084-13
22	32	5950-01-023-1492	96906	MS75088-14

## CROSS-REFERENCE INDEXES

FIG.	ITEM	FIGURE AND ITEM NUMBER INDEX STOCK NUMBER	FSCM	PART NUMBER
22	33	5950-01-274-9207	80063	A3032107-1
22	34	5950-01-027-9120	96906	MS75089-1
22	35	5950-00-171-0070	96906	MS75085-4
22	36	5950-00-031-4560	96906	MS75084-16
22	37	5950-00-035-4413	96906	MS75083-1
22	38	5935-00-432-6649	81349	M55302/4-04
22	39	5961-01-019-4947	81349	JANTXV2N2907A
22	40	5961-01-006-7997	04713	MRF 5174
22	41	5961-01-006-7999	13499	352-1074-010
22	42	5961-00-858-3826	81349	JANTX2N2222A
22	43	5961-00-022-5665	97942	581R503H01
22	44	5961-00-421-3040	81349	JANTX2N4856
22	45	5905-00-105-7767	81349	RCR07G474JS
22	46	5905-00-107-0656	81349	RCR07G100JS
22	47	5905-00-110-7620	81349	RCR07G102JS
22	48	5905-00-136-3890	81349	RCR07G513JS
22	49	5905-00-114-0710	81349	RCR07G331JS
22	50	5905-00-106-3666	81349	RCR07G103JS
22	51	5905-00-111-1679	81349	RCR07G512JS
22	52	5905-00-121-9932	81349	RCR07G391JS
22	53	5905-00-105-7764	81349	RCR07G222JS
22	54	5905-00-135-3973	81349	RCR07G221JS
22	55	5905-00-141-0717	81349	RCR07G473JS
22	56	5905-00-104-8350	81349	RCR20G221JS
22	57	5905-00-126-6696	81349	RCR07G751JS
22	58	5905-00-110-7622	81349	RCR07G682JS
22	59	5905-00-115-7953	81349	RCR07G180JS
22	60	5905-00-485-4554	81349	RCR07G911JS
22	61	5905-00-120-9154	81349	RCR07G471JS
22	62	5905-00-104-8348	81349	RCR20G332JS
22	63	5905-00-113-4861	81349	RCR07G390JS
22	64	5905-00-106-1356	81349	RCR07G152JS
22	65	5905-00-136-8406	81349	RCR07G242JS
22	66	5905-00-104-8358	81349	RCR07G822JS
22	67	5905-00-114-0708	81349	RCR07G202JS
22	68	5905-00-136-3891	81349	RCR07G621JS
22	69	5905-00-442-9356	81349	RCR07G240JS
22	70	5905-00-369-6932	81349	RCR07G113JS
22	71	5905-00-110-0388	81349	RCR07G104JS
22	72	5905-01-186-9628	81349	RWR80S39R2FS
22	73	5905-00-141-1183	81349	RCR07G101JS
22	74	5905-00-106-1278	81349	RCR07G123JS
22	75	5905-00-119-8811	81349	RCR07G151JS
22	76	5905-00-432-6363	81349	RNC55H1273FS
22	77	5905-00-111-4750	81349	RCR07G301JS
22	78	5905-01-160-6188	81349	RWR80S1000FS
22	79	5905-00-513-2874	81349	RWR80S1001FS
22	80	5905-00-485-4545	81349	RCR07G334JS
22	81	5905-00-223-2741	81349	RNC55H1002FS
22	82	5905-00-141-0743	81349	RCR07G392JS
22	83	5905-00-003-7717	81349	RNC55H6040FS



## CROSS-REFERENCE INDEXES

FIG.	ITEM	FIGURE AND ITEM STOCK NUMBER	NUMBER INDEX FSCM	PART NUMBER
22	84	5905-01-047-2251	81349	RJR26FP102P
22	85	5905-00-005-2880	81349	RNC55H5112FS
22	86	5905-00-401-7432	81349	RNC55H1003FS
22	87	5905-00-126-6698	81349	RCR07G360JS
22	88	5905-00-115-2223	81349	RCR07G430JS
22	89	5905-00-104-8368	81349	RCR07G470JS
22	90	5905-00-106-1249	81349	RCR07G510JS
22	91	5905-00-133-0440	81349	RCR07G560JS
22	92	5905-00-126-6692	81349	RCR07G620JS
22	93	5905-01-138-6236	81349	RCR07G680JS
22	94	5905-00-106-9357	81349	RCR07G750JS
22	95	5905-00-104-8363	81349	RCR07G820JS
22	96	5905-00-141-1131	81349	RCR07G910JS
22	97	5905-00-135-6045	81349	RCR07G330JS
22	98	5905-00-113-4863	81349	RCR07G300JS
22	99	5905-00-106-9356	81349	RCR07G203JS
22	100	5905-00-116-8556	81349	RCR07G223JS
22	101	5905-00-135-3971	81349	RCR07G150JS
22	102	5905-00-135-3972	81349	RCR07G200JS
22	103	5905-00-106-3668	81349	RCR07G220JS
22	104	5905-00-113-4860	81349	RCR07G270JS
22	105	5905-01-025-4336	81349	RNC55H26R1FS
22	106	5905-00-532-2082	81349	RNC55H36R5FS
22	107	5905-00-119-8812	81349	RCR07G121JS
22	108	5905-00-104-8366	81349	RCR07G5R1JS
22	109	5905-00-136-7103	81349	RCR07G204JS
22	110	5905-00-164-1867	81349	RNC55H2673FS
22	111	5950-01-242-6506	80063	A3028583
22	112	5950-01-241-9959	80063	A3024684-9
22	113	5962-01-241-9974	27014	MM54HC374J/883B
22	114	5962-01-080-6488	81349	M38510/11001BCB
22	115	5962-01-098-1461	56996	B4002890
22	116	5962-01-120-2346	55154	SL521BB/CM
22	117	5961-01-146-4562	81349	JANTXVIN746A-1
22	118	5961-01-099-9148	81349	JANTX1N825-1
22	119		81349	M28837/1-02N
22	120	5895-01-237-4742	15542	TAK-390125
22	121	5365-01-199-6272	80063	A3032601-3
22	122	5999-01-198-7076	81349	M38527/05-012D
22	123	5310-00-208-3786	80205	NAS671C4
22	124	5310-00-933-8118	96906	MS35338-135
22	125	5310-00-057-0573	80205	NAS620C4
22	126	5999-01-280-5482	81349	M38527/02-018N
22	127		81349	M87111/2-3B15
22	128		81349	M38527/03-008N
22	129		80063	A3035839
22	130		80063	A3035840
22	131		52814	A3078899
22	132		80063	A3034171
22	133		80063	A3035837
22	134		80063	A3035838

## CROSS-REFERENCE INDEXES

FIG.	ITEM	FIGURE AND ITEM NUMBER INDEX STOCK NUMBER	FSCM	PART NUMBER
22	135		80063	A3035836
23	1		80063	A3028056
23	2		80063	A3028053
23	3	5305-00-054-5636	96906	MS51957-2
23	4	5895-01-242-6520	80063	A3024650
23	5	5305-00-054-5647	96906	MS51957-13
23	6	5310-00-057-0573	80205	NAS620C4
23	7		80063	A3034572
23	8	5340-00-431-1115	26344	3585-02CNW0129
23	9	5340-00-327-4820	96906	MS21209C0415L
23	10		80063	A3028102
23	11		80063	A3028057
23	12	5340-00-376-8648	96906	MS21209C0815L
24	1	5961-01-275-0806	12969	UM7101B
24	2	5961-01-043-9178	81349	JANTX1N4454-1
24	3	5961-01-168-6007	81349	JANTX1N6075
24	4	5961-01-023-2852	56996	B4006210-902
24	5		81349	CDR14BP102AJUP
24	6		81349	CDR14BP681AJUP
24	7		81349	CDR14BP470EJUP
24	8		81349	CDR14BP271CJUP
24	9		81349	CDR14BP821AJUP
24	10		81349	CDR14BP360EJUP
24	11		81349	CDR14BP240EJUP
24	12		81349	CDR14BP911AJUP
24	13		81349	CDR14BP430EJUP
24	14		81349	CDR14BP680EJUP
24	15		81349	CDR14BP820EJUP
24	16		81349	CDR14BP910EJUP
24	17		81349	CDR14BP130EJUP
24	18		81349	CDR14BP100EJUP
24	19		81349	CDR14BP750EJUP
24	20	5910-00-010-8717	81349	M39014/01-1593
24	21	5910-00-113-5465	81349	M39014/02-1360
24	22		56996	B4003327-3289
24	23	5910-01-053-5634	81349	CMR04C8R0D0DR
24	24	5910-00-010-8666	81349	M39014/01-1357
24	25		81349	CDR14BP3R0ECUP
24	26	5935-01-011-3400	19505	2010-6511-002
24	27		80063	A3024684-4
24	28		80063	A3024684-5
24	29		80063	A3024684-6
24	30		80063	A3024684-7
24	31		80063	A3034554-3
24	32		80063	A3034554-2
24	33	5950-00-035-4425	96906	MS75085-7
24	34	5950-01-023-1492	96906	MS75088-14
24	35	5950-00-171-0070	96906	MS75085-4
24	36	5950-00-035-4413	96906	MS75083-1
24	37	5935-00-497-8968	81349	M55302/4-03
24	38	5961-01-019-4947	81349	JANTXV2N2907A

## CROSS-REFERENCE INDEXES

FIG.	ITEM	FIGURE AND ITEM NUMBER INDEX STOCK NUMBER	FSCM	PART NUMBER
24	39	5905-00-110-7620	81349	RCR07G102JS
24	40	5905-00-106-1356	81349	RCR07G152JS
24	41	5905-00-136-8406	81349	RCR07G242JS
24	42	5905-00-114-5438	81349	RCR20G510JS
24	43	5905-00-141-0717	81349	RCR07G473JS
24	44	5905-01-186-6763	81349	RWR80S33R2FS
24	45	5905-00-126-6683	81349	RCR07G332JS
24	46	5905-00-106-3666	81349	RCR07G103JS
24	47	5905-00-141-1183	81349	RCR07G101JS
24	48	5905-00-114-0708	81349	RCR07G202JS
24	49	5905-00-442-9356	81349	RCR07G240JS
24	50	5905-00-110-7622	81349	RCR07G682JS
24	51	5905-00-119-8811	81349	RCR07G151JS
24	52	5905-00-116-8556	81349	RCR07G223JS
24	53	5905-00-369-6932	81349	RCR07G113JS
24	54	5905-00-110-0388	81349	RCR07G104JS
24	55	5962-01-080-6488	81349	M38510/11001BCB
24	56	5962-00-167-6330	81349	M38510-10101BGC
24	57		81349	M38527/03-008N
24	58		80063	A3035830
24	59		80063	A3035829
24	60		80063	A3035828
24	61		80063	A3035831
24	62	5365-01-199-6272	80063	A3032601-3
24	63	5999-01-199-2859	81349	M38527/05-008D
25	1		80063	A3028054
25	2	5305-00-054-5651	96906	MS51957-17
25	3		80063	A3086533
25	4	5305-00-054-5636	96906	MS51957-2
25	5	5895-01-242-0002	80063	A3024645
25	6	5305-00-054-5647	96906	MS51957-13
25	7	5310-00-057-0573	80205	NAS620C4
25	8		80063	A3028053
25	9		80063	A3034572
25	10	5340-00-431-1115	26344	3585-02CNW0129
25	11		80063	A3028102
25	12	5340-00-327-4820	96906	MS21209C0415L
25	13		80063	A3028055
25	14	5340-00-376-8648	96906	MS21209C0815L
26	1		12969	UM4301B
26	2	5961-01-023-2852	56996	B4006210-902
26	3	5961-00-335-8934	81349	JANTX1N5712
26	4	5961-01-043-9178	81349	JANTX1N4454-1
26	5	5910-00-010-8717	81349	M39014/01-1593
26	6	5910-00-124-0659	81349	M39014-01-1575
26	7		81349	CCR09CG201JP
26	8	5910-01-133-5494	91293	9615
26	9		81349	CDR01BX102BKUP
26	10	5910-00-010-8666	81349	M39014/01-1357
26	11	5910-00-170-9557	91293	8052
26	12	5910-00-158-4785	81349	M39014/02-1357

## CROSS-REFERENCE INDEXES

FIG.	ITEM	FIGURE AND ITEM NUMBER INDEX STOCK NUMBER	FSCM	PART NUMBER
26	13		56996	B4003327-3326
26	14		56996	B4003327-3234
26	15		81349	CDR148P130EJUP
26	16	5910-00-113-5278	81349	M39014/01-1587
26	17		81349	CDR148G101EKUPX
26	18	5915-01-276-1158	80063	A3023935
26	19	5935-01-011-3400	19505	2010-6511-002
26	20	5935-01-011-4754	19505	2009-6511-000
26	21		80063	A3034554-1
26	22	5950-00-031-4561	96906	MS75084-4
26	23		80063	A3032107-2
26	24	5950-01-274-9207	80063	A3032107-1
26	25	5950-00-377-9882	96906	MS75084-3
26	26	5950-00-035-4425	96906	MS75085-7
26	27	5950-00-031-3779	96906	MS75085-19
26	28	5970-01-144-6789	02114	56-59065/4B
26	29		80063	A3024684-13
26	30	5950-00-779-3452	96906	MS75083-3
26	31	5935-00-497-8968	81349	M55302/4-03
26	32		56996	B4003371-904
26	33	5961-00-858-3826	81349	JANTX2N2222A
26	34	5961-01-019-4947	81349	JANTXV2N2907A
26	35	5905-01-187-8809	37695	238283-1
26	36	5905-00-146-8423	81349	RCR42G201JS
26	37	5905-00-141-1183	81349	RCR07G101JS
26	38	5905-00-116-2394	81349	RCR07G511JS
26	39	5905-01-180-4391	81349	RLR20C2400GS
26	40	5905-01-035-5065	81349	RCR05G103JS
26	41	5905-00-197-0221	81349	RCR05G270JS
26	42	5905-00-458-9346	81349	RCR05G104JS
26	43	5905-00-492-2022	81349	RCR05G474JS
26	44	5905-00-110-0196	81349	RCR20G102JS
26	45	5905-00-111-4750	81349	RCR07G301JS
26	46	5905-00-126-6699	81349	RCR07G160JS
26	47	5905-00-138-1017	81349	RNC55H2742FS
26	48	5905-00-141-1132	81349	RCR07G752JS
26	49	5905-00-105-7764	81349	RCR07G222JS
26	50	5905-00-121-9932	81349	RCR07G391JS
26	51	5905-00-422-3800	81349	RCR05G911JS
26	52	5905-00-110-7620	81349	RCR07G102JS
26	53	5905-00-119-3504	81349	RCR07G273JS
26	54	5905-00-104-8358	81349	RCR07G822JS
26	55	5905-00-121-6327	81349	RNC55H4321FS
26	56	5905-00-401-7436	81349	RNC55H4421FS
26	57	5905-00-151-4659	81349	RNC55H4641FS
26	58	5905-00-412-4049	81349	RNC55H4751FS
26	59	5905-00-721-3680	81349	RNC55H4871FS
26	60	5905-00-481-1110	81349	RNC55H4991FS
26	61	5905-00-138-7399	81349	RNC55H5111FS
26	62	5905-00-292-1064	81349	RNC55H5231FS
26	63	5905-00-138-7401	81349	RNC55H5361FS

## CROSS-REFERENCE INDEXES

FIG.	ITEM	FIGURE AND ITEM NUMBER INDEX STOCK NUMBER	FSCM	PART NUMBER
26	64	5905-00-219-8638	81349	RNC55H5491FS
26	65	5905-00-256-5051	81349	RNC55H5621FS
26	66	5905-00-203-5377	81349	RNC55H5761FS
26	67	5905-00-468-3020	81349	RNC55H4531FS
26	68	5905-00-005-2680	81349	RNC55H1272FS
26	69	5905-00-104-8362	81349	RCR07G132JS
26	70	5905-00-141-1149	81349	RCR32G391JS
26	71	5905-00-126-6683	81349	RCR07G332JS
26	72	5905-00-141-0744	81349	RCR07G562JS
26	73	5905-00-136-8406	81349	RCR07G242JS
26	74	5905-00-111-8357	81349	RCR20G681JS
26	75	5905-01-152-7986	81349	RLR07C5100GS
26	76	5905-00-485-4545	81349	RCR07G334JS
26	77	5905-00-106-3666	81349	RCR07G103JS
26	78	5905-00-442-9356	81349	RCR07G240JS
26	79	5905-00-402-1180	81349	RNC55H1102FS
26	80	5905-01-150-4517	81349	RLR07C6200GS
26	81	5905-00-223-2741	81349	RNC55H1002FS
26	82	5905-00-106-1356	81349	RCR07G152JS
26	83	5905-00-451-7410	81349	RNC55H6192FS
26	84	5905-00-138-7402	81349	RNC55H5362FS
26	85	5905-00-228-5506	81349	RCR07G622JS
26	86	5905-00-435-6374	81349	RCR07G823JS
26	87	5905-00-107-0656	81349	RCR07G100JS
26	88		80063	A3024684-11
26	89	5950-01-241-9959	80063	A3024684-9
26	90	5962-01-080-6488	81349	M38510/11001BCB
26	91		14482	WJ-EA53S
26	92	5961-01-105-0607	81349	JANTX1N750A1
26	93	5961-01-111-7743	81349	JANTX1N752A-1
26	94		81349	JANT1N753A-1
26	95	5961-01-102-2873	81349	JANTX1N756A1
26	96	5995-01-242-6511	80063	A3032127
26	97	5895-01-237-4742	15542	TAK-390125
26	98		81349	M28837/1-02N
26	99		80063	A3028651
26	100	5999-01-280-5482	81349	M38527/02-018N
26	101		80063	A3028649
26	102		80063	A3028652
26	103		80063	A3034171
26	104		81349	M38527/03-002N
26	105		80063	A3035718
26	106		80063	A3035717
26	107	5310-00-208-3786	80205	NAS671C4
26	108	5310-00-933-8118	96906	MS35338-135
26	109	5310-00-057-0573	80205	NAS620C4
26	110	5365-01-199-6272	80063	A3032601-3
27	1		80063	A3028053
27	2	5305-00-054-5636	96906	MS51957-2
27	3	5895-01-242-0003	80063	A3024640
27	4	5305-00-054-5647	96906	MS51957-13

## CROSS-REFERENCE INDEXES

FIG.	ITEM	FIGURE AND ITEM NUMBER INDEX		PART NUMBER
		STOCK NUMBER	FSCM	
27	5	5310-00-057-0573	80205	NAS620C4
27	6		80063	A3028051
27	7		80063	A3034572
27	8	5340-00-431-1115	26344	3585-02CNW0129
27	9	5340-00-327-4820	96906	MS21209C0415L
27	10		80063	A3028102
27	11		80063	A3028052
27	12	5340-00-376-8648	96906	MS21209C0815L
28	1	5961-01-043-9178	81349	JANTX1N4454-1
28	2	5961-00-335-8934	81349	JANTX1N5712
28	3	5910-00-010-8717	81349	M39014/01-1593
28	4	5910-00-124-0659	81349	M39014-01-1575
28	5	5910-00-010-8666	81349	M39014/01-1357
28	6		56996	B4003327-3244
28	7		56996	B4003327-3326
28	8	5910-00-114-0683	81349	M39014/01-1344
28	9	5910-00-113-5284	81349	M39014/02-1358
28	10	5910-00-010-8721	81349	M39014/02-1419
28	11		56996	B4003327-3238
28	12	5910-00-113-5276	81349	M39014/01-1351
28	13	5910-00-113-5445	81349	M39014/01-1259
28	14	5910-00-098-9237	81349	M39014/01-1565
28	15		56996	B4003327-3254
28	16		56996	B4003327-3246
28	17	5915-01-276-1157	80063	A3023936-1
28	18	5935-01-011-3400	19505	2010-6511-002
28	19		00779	87518-9
28	20	5950-00-325-6462	96906	MS75085-11
28	21	5950-00-035-4425	96906	MS75085-7
28	22	5935-00-497-8968	81349	M55302/4-03
28	23	5961-01-012-9314	81349	JANTX2N4861
28	24	5961-00-858-3826	81349	JANTX2N2222A
28	25	5905-01-053-5786	81349	RLR07C5600GS
28	26	5905-00-135-3974	81349	RCR07G431JS
28	27	5905-00-005-2882	81349	RNC55H6341FS
28	28	5905-00-431-5146	81349	RNC55H1022FS
28	29	5905-00-106-3666	81349	RCR07G103JS
28	30	5905-00-114-0711	81349	RCR07G472JS
28	31	5905-00-442-9356	81349	RCR07G240JS
28	32	5905-00-110-7620	81349	RCR07G102JS
28	33	5905-00-435-6374	81349	RCR07G823JS
28	34	5905-00-141-0717	81349	RCR07G473JS
28	35	5905-00-141-1132	81349	RCR07G752JS
28	36	5905-00-104-8358	81349	RCR07G822JS
28	37	5905-00-122-0004	81349	RCR07G433JS
28	38	5905-00-106-1249	81349	RCR07G510JS
28	39	5905-00-121-9863	81349	RCR07G5R6JS
28	40	5905-00-120-9154	81349	RCR07G471JS
28	41	5905-00-111-1679	81349	RCR07G512JS
28	42	5905-00-114-0708	81349	RCR07G202JS
28	43	5905-00-236-0868	81349	RNC55H3831FS

## CROSS-REFERENCE INDEXES

FIG.	ITEM	FIGURE AND ITEM NUMBER INDEX STOCK NUMBER	FSCM	PART NUMBER
28	44	5905-00-284-6117	81349	RNC55H1021FS
28	45	5905-00-471-2422	81349	RNC55H1101FS
28	46	5905-00-758-4774	81349	RNC55H1181FS
28	47	5905-00-484-7880	81349	RNC55H1271FS
28	48	5905-00-721-3677	81349	RNC55H1371FS
28	49	5905-00-491-6386	81349	RNC55H1471FS
28	50	5905-00-484-7884	81349	RNC55H1581FS
28	51	5905-00-480-5193	81349	RNC55H1691FS
28	52	5905-00-481-1320	81349	RNC55H1821FS
28	53	5905-00-480-5194	81349	RNC55H1961FS
28	54	5905-00-003-7717	81349	RNC55H6040FS
28	55	5905-00-139-1928	81349	RNC55H7500FS
28	56	5905-00-333-9543	81349	RNC55H8870FS
28	57	5905-00-264-3832	81349	RNC55H9530FS
28	58	5905-00-110-7622	81349	RCR07G682JS
28	59	5905-00-136-7103	81349	RCR07G204JS
28	60	5905-00-126-6683	81349	RCR07G332JS
28	61	5905-00-005-2880	81349	RNC55H5112FS
28	62	5905-00-138-6994	81349	RNC55H5232FS
28	63	5905-00-138-7402	81349	RNC55H5362FS
28	64	5905-00-150-0477	81349	RNC55H5492FS
28	65	5905-00-412-0772	81349	RNC55H5622FS
28	66	5905-00-138-6995	81349	RNC55H5762FS
28	67	5905-00-721-3681	81349	RNC55H5902FS
28	68	5905-00-721-3683	81349	RNC55H6042FS
28	69	5905-00-451-7410	81349	RNC55H6192FS
28	70	5905-00-402-1400	81349	RNC55H6342FS
28	71	5905-00-152-7613	81349	RNC55H6492FS
28	72	5905-00-483-4038	81349	RNC55H6652FS
28	73	5905-00-106-1357	81349	RCR07G563JS
28	74	5905-00-119-3504	81349	RCR07G273JS
28	75	5905-01-160-0932	81349	RLR07C3900GS
28	76	5905-00-114-5343	81349	RCR07G182JS
28	77	5905-00-128-6237	81349	RCR07G3R3JS
28	78	5905-00-107-0656	81349	RCR07G100JS
28	79	5905-00-432-0331	81349	RNC55H8661FS
28	80	5905-00-431-5155	81349	RNC55H2941FS
28	81	5905-00-481-8456	81349	RNC55H4021FS
28	82	5905-00-203-1478	81349	RNC55H2430FS
28	83	5905-00-153-4909	81349	RNC55H9310FS
28	84	5905-01-171-5659	81349	M8340105M1001JG
28	85	5905-01-238-4023	81349	M8340109M5103JC
28	86	5905-01-157-5611	81349	RLR07C5103GS
28	87		81349	RNC55H1130FP
28	88	5905-00-211-0488	81349	RNC55H1050FS
28	89	5905-00-285-0626	81349	RNC55H84R5FS
28	90	5905-00-403-4456	81349	RNC55H90R9FS
28	91	5905-00-481-1405	81349	RNC55H78R7FS
28	92	5905-00-156-6298	81349	RNC55H73R2FS
28	93	5905-00-481-1404	81349	RNC55H68R1FS
28	94		81349	RNC55H63R4FP

## CROSS-REFERENCE INDEXES

FIG.	ITEM	FIGURE AND ITEM NUMBER INDEX STOCK NUMBER	FSCM	PART NUMBER
28	95		81349	RNC55H97R6FP
28	96	5905-00-758-4780	81349	RNC55H1740FS
28	97		81349	RNC55H1650FP
28	98	5905-00-288-8765	81349	RNC55H1500FS
28	99	5905-00-484-7883	81349	RNC55H1580FS
28	100	5905-01-280-9686	81349	RNC55H1400FP
28	101	5905-00-295-5267	81349	RNC55H1300FS
28	102	5905-00-484-7874	81349	RNC55H1210FS
28	103	5905-00-432-6343	81349	RNC55H51R1FS
28	104	5905-00-307-3516	81349	RNC55H54R9FS
28	105	5905-00-481-1403	81349	RNC55H59R0FS
28	106	5950-01-274-6467	05375	ST-407
28	107	5962-01-080-6488	81349	M38510/11001BCB
28	108	5962-01-241-9974	27014	MM54HC374J/883B
28	109	5962-01-033-2280	18714	CD4027BF/3
28	110	5962-01-086-7029	81349	M38510/17001BCB
28	111	5962-01-275-5460	52648	SL6701AB/DG
28	112		52648	SL621CB/CM
28	113	5962-01-156-7241	81349	M38510/11703BXC
28	114	5961-01-102-5719	81349	JANTX1N751A1
28	115		80063	A3086680
28	116		81349	M38527/03-002N
28	117		18310	12-461-2-01
28	118	5310-00-208-3786	80205	NAS671C4
28	119	5310-00-933-8118	96906	MS35338-135
28	120	5310-00-057-0573	80205	NAS620C4
28	121	5999-01-280-5482	81349	M38527/02-018N
28	122	5999-01-199-2859	81349	M38527/05-008D
29	1		80063	A3028058
29	2		80063	A3028053
29	3	5305-00-054-5636	96906	MS51957-2
29	4	5895-01-242-0004	80063	A3024655
29	5	5305-00-054-5647	96906	MS51957-13
29	6	5310-00-057-0573	80205	NAS620C4
29	7		80063	A3034572
29	8	5340-00-431-1115	26344	3585-02CNW0129
29	9		80063	A3028102
29	10	5340-00-327-4820	96906	MS21209C0415L
29	11		80063	A3028059
29	12	5340-00-376-8648	96906	MS21209C0815L
30	1	5961-01-043-9178	81349	JANTX1N4454-1
30	2	5910-00-114-0802	81349	M39014/01-1338
30	3	5910-00-010-8666	81349	M39014/01-1357
30	4	5910-00-124-0659	81349	M39014-01-1575
30	5	5910-01-217-7205	81349	CCR06CG123GS
30	6		81349	CCR09CG222JP
30	7		81349	CCR09CG561JP
30	8	5910-01-077-9819	81349	CMR04F121GPDR
30	9		81349	CCR07CG333JP
30	10	5910-01-064-6534	81349	CMR04E270G0DR
30	11		56996	B4003327-3238



## CROSS-REFERENCE INDEXES

FIG.	ITEM	FIGURE AND ITEM NUMBER INDEX STOCK NUMBER	FSCM	PART NUMBER
30	12	5910-00-010-8717	81349	M39014/01-1593
30	13	5910-00-114-0082	81349	M39014/01-1326
30	14		56996	B4003327-3326
30	15	5950-00-035-4425	96906	MS75085-7
30	16	5935-00-432-6649	81349	M55302/4-04
30	17	5905-01-238-4023	81349	M8340109M5103JC
30	18	5905-00-111-1681	81349	RCR07G134JS
30	19	5905-00-432-0331	81349	RNC55H8661FS
30	20	5905-00-412-0772	81349	RNC55H5622FS
30	21	5905-00-110-7622	81349	RCR07G682JS
30	22	5905-00-432-0367	81349	RNC55H9531FS
30	23	5905-00-410-1577	81349	RNC55H2211FS
30	24	5905-00-255-9304	81349	RNC55H1242FS
30	25	5905-00-141-1183	81349	RCR07G101JS
30	26	5905-00-105-7764	81349	RCR07G222JS
30	27	5905-00-442-9356	81349	RCR07G240JS
30	28	5905-00-236-0513	81349	RNC55H3482FS
30	29	5905-00-150-0477	81349	RNC55H5492FS
30	30	5905-00-139-1927	81349	RNC55H7152FS
30	31	5905-00-138-7402	81349	RNC55H5362FS
30	32	5905-00-184-7787	81349	RNC55H3652FS
30	33	5905-00-402-1400	81349	RNC55H6342FS
30	34	5905-00-403-4453	81349	RNC55H7682FS
30	35	5905-00-138-6995	81349	RNC55H5762FS
30	36	5905-00-146-3879	81349	RNC55H9532FS
30	37	5905-00-483-4038	81349	RNC55H6652FS
30	38	5905-00-721-3305	81349	RNC55H6982FS
30	39	5905-00-256-5050	81349	RNC55H1103FS
30	40	5905-00-114-0711	81349	RCR07G472JS
30	41	5905-00-110-7620	81349	RCR07G102JS
30	42	5905-00-106-3666	81349	RCR07G103JS
30	43	5905-00-139-1925	81349	RNC55H6491FS
30	44	5905-00-480-5196	81349	RNC55H1501FS
30	45	5905-00-116-8555	81349	RCR07G153JS
30	46	5905-00-126-6683	81349	RCR07G332JS
30	47	5905-00-445-1561	81349	RNC55H1373FS
30	48	5905-00-139-2361	81349	RNC55H1372FS
30	49	5905-00-156-6550	81349	RNC55H1582FS
30	50	5905-00-236-0487	81349	RNC55H1742FS
30	51	5905-00-112-0984	81349	RNC55H7501FS
30	52	5905-00-431-5156	81349	RNC55H3241FS
30	53	5905-00-403-4447	81349	RNC55H2741FS
30	54	5905-00-112-1392	81349	RNC55H1332FS
30	55	5905-00-481-1320	81349	RNC55H1821FS
30	56	5905-00-758-4782	81349	RNC55H3742FS
30	57		81349	RNC55H6340FP
30	58	5905-00-106-1248	81349	RCR07G162JS
30	59	5905-00-107-0656	81349	RCR07G100JS
30	60	5962-01-080-6488	81349	M38510/11001BCB
30	61	5962-00-007-4079	81349	M38510-10102BCB
30	62	5962-01-241-9974	27014	MM54HC374J/883B

## CROSS-REFERENCE INDEXES

FIG.	ITEM	FIGURE AND ITEM NUMBER INDEX STOCK NUMBER	FSCM	PART NUMBER
30	63		81349	JM38510/12302BEX
30	64	5961-01-165-5463	81349	JANTX1N752A-1
30	65	5365-01-199-6272	80063	A3032601-3
31	1	5895-01-242-0005	80063	A3024841
31	2	5305-00-054-5648	96906	MS51957-14
31	3	5310-00-057-0573	80205	NAS620C4
31	4		80063	A3024840
31	5	5305-00-054-5647	96906	MS51957-13
31	6		80063	A3024838
31	7		80063	A3028706-1
31	8	5962-01-106-4661	14933	7703401YX
31	9	5310-00-616-3555	96906	MS35333-71
31	10	5310-00-616-8660	80205	NAS671C6
31	11	5895-01-237-8294	80063	A3028133
31	12		80063	A3028744
31	13	5340-00-631-7894	96906	MS21209C0415
31	14		80063	A3034572
31	15		80063	A3028102
31	16	5340-00-815-4929	96906	MS21209C0815
32	1	5961-01-070-7446	81349	JANTX1N4150-1
32	2	5961-00-476-7855	81349	JANTX1N5619
32	3	5961-00-426-9613	81349	JANTX1N5615
32	4	5961-00-596-2973	12969	UM4001B
32	5	5961-00-650-9651	81349	JANTX1N5418
32	6	5910-00-010-8721	81349	M39014/02-1419
32	7	5910-00-113-5499	81349	M39014/02-1350
32	8	5910-01-071-0244	81349	CMR05F161GPDR
32	9	5910-00-144-4383	81349	M39003/01-3026
32	10	5910-00-113-5286	81349	M39014/02-1356
32	11	5910-00-113-9445	81349	M39014/02-1337
32	12	5910-00-113-5445	81349	M39014/01-1259
32	13	5910-00-010-8718	81349	M39014/02-1338
32	14	5910-00-113-5459	81349	M39014/02-1359
32	15	5910-00-010-8159	81349	M39003/01-2988
32	16	5910-00-010-8666	81349	M39014/01-1357
32	17	5910-01-213-2368	81349	M83421/01-5191S
32	18		71279	160-2027-02-05-03
32	19		00779	103007-2
32	20		80063	A3028867
32	21	5961-00-434-9211	07256	2N5011
32	22		09214	2N2324A
32	23	5961-01-166-7878	81349	JANTX2N6762
32	24	5905-00-107-0656	81349	RCR07G100JS
32	25	5905-00-119-3503	81349	RCR07G271JS
32	26	5905-00-105-7765	81349	RCR07G224JS
32	27	5905-00-135-6045	81349	RCR07G330JS
32	28	5905-00-106-1356	81349	RCR07G152JS
32	29	5905-00-141-1183	81349	RCR07G101JS
32	30	5905-00-106-1249	81349	RCR07G510JS
32	31	5905-00-410-1577	81349	RNC55H2211FS

## CROSS-REFERENCE INDEXES

FIG.	ITEM	FIGURE AND ITEM NUMBER STOCK NUMBER	INDEX FSCM	PART NUMBER
32	32	5905-00-110-0388	81349	RCR07G104JS
32	33	5905-00-110-7620	81349	RCR07G102JS
32	34	5905-00-111-1679	81349	RCR07G512JS
32	35	5905-00-469-3507	81349	RNC55H1820FS
32	36	5905-00-003-5782	81349	RNC55H3921FS
32	37	5905-00-471-2422	81349	RNC55H1101FS
32	38	5905-00-484-7880	81349	RNC55H1271FS
32	39	5905-00-476-8189	81349	RNC55H64R9FS
32	40	5905-00-481-8454	81349	RNC55H2151FS
32	41	5905-00-401-8688	81349	RNC55H8250FS
32	42	5905-00-138-7399	81349	RNC55H5111FS
32	43	5905-01-067-9399	81349	M39015/3-006WR
32	44	5905-00-219-8638	81349	RNC55H5491FS
32	45	5905-00-721-3678	81349	RNC55H2491FS
32	46	5905-00-203-5377	81349	RNC55H5761FS
32	47	5905-00-236-0970	81349	RNC55H5490FS
32	48	5905-00-250-3328	81349	RNC55H2431FS
32	49	5905-00-138-1017	81349	RNC55H2742FS
32	50	5905-00-412-0764	81349	RNC55H2802FS
32	51	5905-00-139-2146	81349	RNC55H4420FS
32	52	5905-00-431-5146	81349	RNC55H1022FS
32	53	5905-00-442-9356	81349	RCR07G240JS
32	54	5905-00-106-3666	81349	RCR07G103JS
32	55	5905-00-121-9920	81349	RCR07G303JS
32	56	5905-00-118-4559	81349	RCR07G333JS
32	57	5905-00-136-8430	81349	RCR07G363JS
32	58	5905-00-115-8055	81349	RCR07G393JS
32	59	5905-00-122-0004	81349	RCR07G433JS
32	60	5905-00-141-0717	81349	RCR07G473JS
32	61	5905-00-136-3890	81349	RCR07G513JS
32	62	5905-00-106-1357	81349	RCR07G563JS
32	63	5905-00-004-6076	81349	RNC55H2490FS
32	64	5905-00-285-1289	81349	RNC55H7680FS
32	65	5905-00-106-1278	81349	RCR07G123JS
32	66	5950-01-274-6502	37695	305191-1
32	67	5950-01-274-6451	37695	305139-1
32	68	5962-01-119-8524	97953	1A7861-3
32	69	5962-01-227-9394	04713	158/BPBJC
32	70	5962-01-150-4631	97953	1A7862-1
32	71	5962-01-088-3862	81349	M38510/11201BCB
32	72	5961-01-102-5719	81349	JANTX1N751A1
32	73	5961-01-102-5720	81349	JANTX1N6044A
32	74		13103	8182E3C
32	75	5999-01-086-6659	81349	M38527/05-002D
32	76	5999-00-883-0081	13103	7717-4DAP
32	77	5310-00-616-8660	80205	NAS671C6
32	78	5310-00-929-6395	96906	MS35338-136
32	79	5940-01-204-0642	13103	8180E1
33	1	5961-00-403-3298	81349	JANTX1N5552
33	2	5961-00-426-9613	81349	JANTX1N5615
33	3	5961-01-037-4712	81349	JANTX1N5806

## CROSS-REFERENCE INDEXES

FIG.	ITEM	FIGURE AND ITEM NUMBER INDEX STOCK NUMBER	FSCM	PART NUMBER
33	4	5961-01-035-5474	81349	JANTX1N5809
33	5	5910-01-275-2946	81349	M39018/07-0326M
33	6	5910-01-042-0081	81349	CMR06F471GPDR
33	7	5910-00-010-8666	81349	M39014/01-1357
33	8	5910-01-275-1945	81349	M39003/09-0162
33	9		81349	M39003/09-0182
33	10	5910-01-275-1944	81349	M39003/09-0129
33	11	5910-00-113-5499	81349	M39014/02-1350
33	12		71279	160-2027-02-05-03
33	13	5950-01-274-6463	37695	305194-1
33	14	5935-01-087-8422	81349	M24308/24-25
33	15	5935-00-103-7680	81349	M55302/4-02
33	16	5905-01-195-2154	15454	SG220-S
33	17	5905-00-152-8373	81349	RCR42G273JS
33	18	5905-00-111-8357	81349	RCR20G681JS
33	19	5905-00-111-4750	81349	RCR07G301JS
33	20	5905-00-114-5343	81349	RCR07G182JS
33	21	5905-00-485-4554	81349	RCR07G911JS
33	22	5905-00-120-9154	81349	RCR07G471JS
33	23	5905-00-116-2394	81349	RCR07G511JS
33	24	5905-00-105-7768	81349	RCR07G561JS
33	25	5905-00-136-3891	81349	RCR07G621JS
33	26	5905-00-135-6046	81349	RCR07G681JS
33	27	5905-00-126-6696	81349	RCR07G751JS
33	28	5905-00-106-1356	81349	RCR07G152JS
33	29	5905-00-131-1255	81349	RCR07G122JS
33	30	5905-00-110-7620	81349	RCR07G102JS
33	31	5905-00-119-8855	81349	RCR07G112JS
33	32	5905-00-104-8362	81349	RCR07G132JS
33	33	5905-00-119-8768	81349	RCR07G821JS
33	34	5905-00-121-9932	81349	RCR07G391JS
33	35	5905-00-135-3974	81349	RCR07G431JS
33	36	5905-00-119-3503	81349	RCR07G271JS
33	37	5905-00-114-0710	81349	RCR07G331JS
33	38	5905-00-104-8370	81349	RCR07G361JS
33	39	5905-00-111-4727	81349	RCR07G272JS
33	40	5905-00-141-0742	81349	RCR07G181JS
33	41	5905-00-104-8348	81349	RCR20G332JS
33	42	5905-00-104-8363	81349	RCR07G820JS
33	43	5905-00-119-8812	81349	RCR07G121JS
33	44	5905-00-136-8405	81349	RCR07G131JS
33	45	5905-00-119-8811	81349	RCR07G151JS
33	46	5905-00-111-1686	81349	RCR07G161JS
33	47		81349	RCR07G201JS
33	48	5905-00-135-3973	81349	RCR07G221JS
33	49	5905-00-435-1718	81349	RCR07G241JS
33	50	5905-00-114-5407	81349	RCR20G271JS
33	51	5950-01-275-0712	37695	308219-1
33	52	5950-01-274-6452	37695	305188-1
33	53	5961-01-057-3305	81349	JANTX1N6072A

## CROSS-REFERENCE INDEXES

FIG.	ITEM	FIGURE AND ITEM NUMBER INDEX		PART NUMBER
		STOCK NUMBER	FSCM	
33	54		80063	A3032572
33	55	5305-00-054-5647	96906	MS51957-13
33	56	5310-00-057-0573	80205	NAS620C4
33	57	5310-00-208-3786	80205	NAS671C4
33	58	5305-00-054-5649	96906	MS51957-15
33	59	5975-00-111-3208	96906	MS3367-5-9
34	1	5995-01-263-5494	80058	CX-13361/G
34	2	6625-01-267-4417	80058	TS-4244/G

By Order of the Secretaries of the Army, the Navy and the Air Force:

Official:

**CARL E. VUONO**  
*General, United States Army*  
*Chief of Staff*

**WILLIAM J. MEEHAN II**  
*Brigadier General, United States Army*  
*The Adjutant General*

**H. E. REESE**  
*Executive Director*  
*Marine Corps Research*  
*Development and Acquisition Command*

**WILLIAM CHIAIESE**  
*Vice Admiral, United States Navy*  
*Commander, Space and Naval Warfare*  
*Systems Command*

Official:

**WILLIAM O. NATIONS**  
*Colonel, USAF*  
*Director of Information*  
*Management and Administration*

**LARRY D. WELSH**  
*General, USAF*  
*Chief of Staff*

Distribution:

To be distributed in accordance with special list.