

2

AD-A277 285



RESEARCH AND DEVELOPMENT TECHNICAL REPORT
CECOM-TR-94-8

**Engineering Application Notes:
Grounding Kit, MK-2551 A/U
(Surface Wire Ground System)**

John M. Tobias
CECOM Safety Office

February 1994

DTIC
ELECTE
MAR 22 1994
S F D

DISTRIBUTION STATEMENT:
Approved for public release;
distribution is unlimited.

94-08962



CECOM
U.S. ARMY COMMUNICATIONS-ELECTRONICS COMMAND
CECOM SAFETY OFFICE ATTN: AMSEL-SF-SEP
FORT MONMOUTH, NEW JERSEY 07703-5024

94 3 21 026

DTIC QUALITY INSPECTED 1

NOTICES

Disclaimers

The findings in this report are not to be construed as an official Department of the Army position, unless so designated by other authorized documents.

The citation of trade names and names of manufacturers in this report is not to be construed as official Government endorsement or approval of commercial products or services referenced herein.

REPORT DOCUMENTATION PAGEForm Approved
OMB No. 0704-0188

Public reporting burden for this collection of information is estimated to average 1 hour per response, including the time for reviewing instructions, searching existing data sources, gathering and maintaining the data needed, and completing and reviewing the collection of information. Send comments regarding this burden estimate or any other aspect of this collection of information, including suggestions for reducing this burden, to Washington Headquarters Services, Directorate for Information Operations and Reports, 1215 Jefferson Davis Highway, Suite 1204, Arlington, VA 22202-4302, and to the Office of Management and Budget, Paperwork Reduction Project (0704-0188), Washington, DC 20503.

1. AGENCY USE ONLY (Leave blank)		2. REPORT DATE February 1994	3. REPORT TYPE AND DATES COVERED Technical Report	
4. TITLE AND SUBTITLE ENGINEERING APPLICATION NOTES: GROUNDING KIT, MK-2551 A/U (SURFACE WIRE GROUND SYSTEM)			5. FUNDING NUMBERS	
6. AUTHOR(S) John M. Tobias				
7. PERFORMING ORGANIZATION NAME(S) AND ADDRESS(ES) US ARMY COMMUNICATIONS-ELECTRONICS COMMAND (CECOM) CECOM SAFETY OFFICE ATTN: AMSEL-SF-SEP Fort Monmouth, NJ 07703-5024			8. PERFORMING ORGANIZATION REPORT NUMBER CECOM-TR-94-8	
9. SPONSORING/MONITORING AGENCY NAME(S) AND ADDRESS(ES)			10. SPONSORING/MONITORING AGENCY REPORT NUMBER	
11. SUPPLEMENTARY NOTES				
12a. DISTRIBUTION/AVAILABILITY STATEMENT Approved for public release; distribution is unlimited.			12b. DISTRIBUTION CODE	
13. ABSTRACT (Maximum 200 words) This report discusses the description, specifications, theory of operation, employment principles, and test results of the MK-2551 Grounding Kit, also known as the Surface Wire Ground System (SWGS). Design information is included for application of this system to specific designs. The report is intended to fill a gap in the knowledge available to the design and development community. Application and employment principles are developed from test results augmented by validated theoretical performance models. Explanations of installation, removal, and maintenance operations are also presented.				
14. SUBJECT TERMS MK-2551; Grounding Kit; Surface Wire Ground System; Electrical Grounding; NSN 5820-01-263-1760			15. NUMBER OF PAGES 45	
			16. PRICE CODE	
17. SECURITY CLASSIFICATION OF REPORT Unclassified	18. SECURITY CLASSIFICATION OF THIS PAGE Unclassified	19. SECURITY CLASSIFICATION OF ABSTRACT Unclassified	20. LIMITATION OF ABSTRACT UL	

Table of Contents

1.0	General Description	1
1.1	Component Notes	2
1.1.1	Ground Wire Assembly	2
1.1.2	Stakes	2
1.1.3	Short Ground Wire Assembly	2
1.2	Reliability and Maintainability Data	2
2.0	Theory of Operation	4
2.1	Basic Grounding Theory	4
2.1.1	Step Potential	5
2.2	Theoretical Resistance of MK-2551	7
3.0	Proper Operational Procedures and Principles of Employment	9
3.1	Preventative Maintenance Checks and Services	9
3.2	Installation Instructions	10
3.3	Removal Instructions	11
3.4	Employment Principles	12
4.0	MK-2551 Configurations	13
4.1	Multiple Vehicle Applications	13
4.1.1	Principles for Multiple Vehicle Configurations	13
4.2	Generators	14
4.3	Large Equipment	14
4.4	Employment Restrictions	15
4.4.1	Duration	15
4.4.2	Multiple Vehicles	15
4.4.3	Non-Shelterized Equipment	15
5.0	Test Data	16
5.1	Electrical Testing	16
5.1.1	Resistance to Ground	16
5.1.1.1	Test - Human Engineering Laboratory Grounding Analyses - II (HELGA-II), USAHEL, various locations, 1987.	16
5.1.1.2	Test - USAF 1839 Engineering Installation Group, Keesler AFB, 14-18 August 1989.	18
5.1.1.3	Test - Redstone Arsenal Technical Test Center, AL, Fall 1991.	19
5.1.1.4	Test - Communications Electronics Command Safety Office Grounding Lab, Fort Monmouth (Evans Area) NJ, December 1993.	20

5.1.2	Lightning Suitability Testing	22
5.1.2.1	Test - Redstone Arsenal Technical Test Center, AL, Fall 1991.	22
5.1.2.2	Test - Redstone Arsenal Technical Test Center, AL, Fall 1991.	23
5.1.2.3	Test - Redstone Arsenal Technical Test Center, AL, Summer 1993.	25
5.1.3	Human Factors Data	26
5.1.3.1	Test - U.S. Army Test and Experimentation Command, Fort Hood, Texas, Oct.- Nov. 1993.	26
6.0	References	27
6.1	Literature Cited	27
6.2	Other Sources	27
7.0	Author's Note	28
	Appendix A - MK-2551 Drawings	29

List of Figures

Figure 1 Grounding volume shells about the earth electrode.	4
Figure 2 Step potential from a cloud-to-ground lightning strike.	6
Figure 3 Approximate step potential profile as a function of distance from the ground rod.	6
Figure 4 Proper MK-2551 deployment.	12
Figure 5 Two vehicle MK-2551 deployment.	13
Figure 6 MK-2551 realized on a generator trailer.	14
Figure 7 MK-2551 realized on large equipment.	15
Figure 8 Theoretical resistance of SGR and MK-2551 with normalized soil resistivity (y-axis) versus the frozen soil depth in centimeters (x-axis).	21
Figure 9 Step potential profiles of the MK-2551 and the MX148/G, under 20,000 ampere peak current injection. (Average lightning strike levels.)	23
Figure 10 Theoretical values of the step potentials MK-2551 and MX-148/G. Conditions considered are identical to the Redstone Arsenal testing.	24
Figure 11 Step potential (kV) vs distance for MK-2551 and short rod. Flat lines at center represent a gap between probe locations.	25

Accession For	
NTIS	CRA&I <input checked="" type="checkbox"/>
DTIC	TAB <input type="checkbox"/>
Unannounced	<input type="checkbox"/>
Justification	
By	
Distribution /	
Availability Codes	
Dist	Avail and/or Special
A-1	

List of Tables

Table 1 MK-2551 Components	1
Table 2 PMCS Table	9

Preface

This technical report is intended to answer many of the common questions regarding application of the MK-2551 grounding kit. We attempt to explain the operating theory and principles to an extent that a design engineer can understand the reasons behind the operating instructions in the MK-2551 technical manual. While it is impossible to list every possible MK-2551 configuration, we list the important considerations as a guide in developing system specific applications. The information presented herein represents the best information available to date, including recently completed testing and preliminary data from equipment users. We hope that it is useful in developing your applications.

1.0 General Description

The MK-2551 is an alternative grounding system which has been designed primarily for use with systems requiring high mobility operational scenarios. It is easily emplaced and removed, offering a reasonable option in situations where driving/retracting conventional ground rods would be difficult and/or too time consuming. It was originally conceived by the Human Engineering Laboratories (now Human Engineering Directorate of Army Research Laboratories) Grounding Analyses I and II, performed in June 1984 and July 1987. The conclusion of the analysis was that the surface wire concept was competitive with a ground rod, in terms of electrical properties, and was easier to install.

In this report, we provide information on the components, operation, employment, and testing of the MK-2551. Our purpose is to provide the equipment designer and the materiel developer the best possible technical data regarding this grounding alternative.

The official nomenclature is Grounding Kit, MK-2551A/U, with a National Stock Number of 5820-01-263-1760. The components of the end item are listed in table 1, and drawings are provided in Appendix A, cross-referenced for the convenience of the designer. (The drawing number is listed in the lower right hand corner of each drawing sheet.) General configuration drawings are provided: drawings SCD-681610 (Grounding Kit, MK-2551 A/U) and SCD-681611 (Ground Wire Assembly).

Table 1 MK-2551 Components

Component	Quantity	Remarks	Drawings
Ground Wire Assembly w/lug	1	Steel aircraft cable, 3/16 inch diameter	SCD-681611 SCC-681613 SCC-681607
Stake	15	ASTM-A-576 1045 Carbon Steel, forged per MIL-S-46172 or Casting per SAE AMS5329C8Z, casting steel, sand	SCD-681612
Short Ground Wire Assembly	2	"Jumpers" w/clips	SCC-681615
Instruction Card	1	Metal plate attached to bag	SCC-681614

**Total MK-2551 weight, all components listed in SCD-681610 sheets 1 & 2: 25 lbs.
Cost of unit in Army supply system is approximately \$177.00.**

1.1 Component Notes

1.1.1 Ground Wire Assembly

Verify the proper cable size before accepting an MK-2551. Prior to testing and validation, the main cable diameter was ¼-inch, since changed to 3/16-inch. Early units and some units produced by various manufacturers have incorrect cables. The effect of the smaller cable is to degrade the MK-2551's ability to withstand the maximum percentile lightning strike. Failure under lightning current will occur approximately 5% to 10% of occurrences if the ¼-inch cable is used. The lug is also constructed of steel and is made especially for the MK-2551 for the same purposes. Preliminary data suggest that replacement with a copper lug may be practical, and we are exploring this possibility. Until the suitability of a copper lug can be verified, it is important to use the existing lug specified in the drawings.

1.1.2 Stakes

The stakes are typically cast steel, this method of construction being cheaper than forging. Preliminary user data and consultation with material laboratories¹ suggests that up to approximately 2% of castings are inherently flawed. This means that a small percentage of MK-2551 stakes will break, most likely the first time they are impacted with the sledge hammer. Return these stakes IAW the Technical Manual and continue to operate the MK-2551 provided that 13 or more stakes remain operational on the system. Unauthorized copies of the MK-2551 use various materials for the stakes, making them prone to breakage or deformation.

1.1.3 Short Ground Wire Assembly (Jumper cables)

These remain ¼-inch diameter cable. Their employment is mandated by the results of high current lightning tests. They provide an auxiliary path for very high current events, which divert current from the main wire, enhancing its survivability. When installed, the jumpers make the MK-2551 more survivable under high current lightning events than the standard ground rod kit. A frequent complaint is that the clips do not stand up well to wear and tear in field use. We are in the process of identifying a replacement clip.

1.2 Reliability and Maintainability Data

Little reliability data is currently available. We expect more to become available as more applications using MK-2551 are realized. Informal surveys of developmental programs suggest that the MK-2551 suffers damage about every thirty uses. The typical

¹ Meeting with G.T. Lamar, General Engineer, U.S. Army Missile Command Research and Development Center, September 1993.

mode of damage identified is main wire breakage caused by accidental repeated strike by the hammer when installing the kit. We point out that individual parts for the MK-2551 can be ordered, in accordance with the technical manual instructions. Defining reliability in a cost per use aspect, the cost per use is approximately $\$177/30 \text{ uses} = \5.90 per use, assuming that the total MK-2551 needs replacement, which is most likely not true. Compare this to a ground rod which will typically survive only one or two uses. Assuming an approximate \$10.00 unit cost, then the cost per unit use is approximately $\$10/2 = \5.00 per use. The conclusion is that the MK-2551 is competitive in terms of cost per unit use with the ground rod, especially since the entire kit does not need replacement if breakage occurs.

2.0 Theory of Operation

In this section, we explore the physical nature of the operation of the MK-2551 and grounding systems in general. In conclusion we present a resistance model for the MK-2551 that we have recently developed. We encourage use of the resistance model to determine if the MK-2551 meets your needs.

2.1 Basic Grounding Theory

Resistance to ground is based on the ability of the earth electrode, whether it is the MK-2551 or a ground rod, to transfer the current to the bulk earth surrounding it. It does this through a series of cylindrical shells, as illustrated in figure 1. The important electrical characteristic that all grounding equations are dependent on is the resistivity of the earth surrounding the electrode, designated here by the symbol ρ . As a simple example, we can derive an approximate expression for the resistance to ground of a simple ground rod.

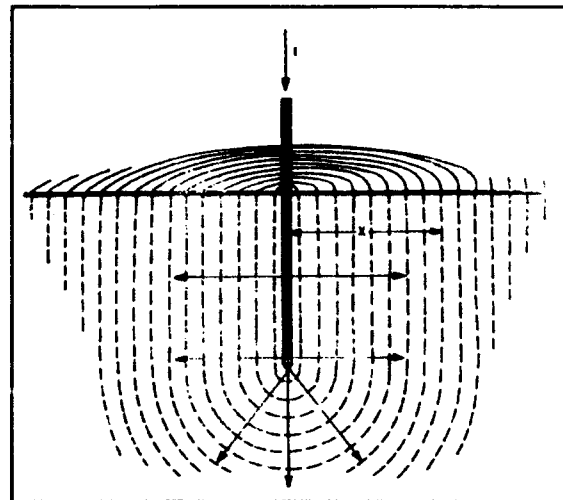

Figure 1 Grounding volume shells about the earth electrode.

Equation 1 yields the Current Density within earth as a function of x , the distance from the ground rod and l , the depth of the ground rod. Note that it is given by dividing the injection current by the surface area of the cylindrical shells about the earth electrode. It is in units of amperes per unit area, as the injection current is expressed here as I . The current could be up to 200,000 amperes in a maximal lightning event.

$$i_x = \frac{I}{2\pi xl} \quad (1)$$

From Ohm's law, electric field strength E , in units of volts per unit length may be found by multiplying the current density i by the soil resistivity, ρ .

$$E_x = \rho i_x = \frac{\rho I}{2\pi xl} \quad (2)$$

Find the potential (voltage) as a function of x by integrating the field over x , the distance from the ground rod.

$$V_x = \int_r^x E_x dx \quad (3)$$

We can substitute the electric field term E in equation 3 and integrate, which yields equation 5, an approximate expression for the potential drop as a function of distance from the ground rod.

$$V_x = \frac{\rho I}{2\pi l} \int_r^x \frac{dx}{x} \quad (4)$$

$$V_x = \frac{\rho I}{2\pi l} \ln x - \ln r = \frac{\rho I}{2\pi l} \ln \frac{x}{r} \quad (5)$$

To find the resistance R, we apply Ohm's Law again, dividing voltage by current, and using for limits of integration $r=a$ (the radius of the cylindrical earth electrode) and $x = 4l$ (a distance in which over 95% of the injection current is dissipated) yielding equation 6:

Which is approximately the accepted theoretical value for ground rod resistance, unadjusted for soil inhomogeneity or other conduction effects.

$$R = \frac{V}{I} \therefore R = \frac{\rho}{2\pi l} \ln \frac{4l}{a} \quad (6)$$

It is interesting to note the dependence of these equations on the surface area that the earth electrode has in contact with the ground. Since the MK-2551, stake contact only, has approximately 50% more contact area than the standard 8-foot ground rod, we predict a lower resistance for the MK-2551. In reality, the contact of the surface wire contributes to the calculation, lowering the resistance of the MK-2551 further. This compensates for the usual condition that soil resistivity decreases as a function of depth. We shall investigate this in detail in the electrical test results section (Test Data, Section 5).

2.1.1 Step Potential

Equation 5 implies that a voltage gradient exists as a function of distance from the ground rod. The gradient is a function of the natural logarithm of the inverse distance from the rod.² If this is true, we can expect a significant voltage difference near an earth electrode system undergoing current injection. This is known as the **step potential**, named after the potential drop across human (or animal) feet in the space of a step. Step potential developed from lightning effects, or even large fault currents, can be lethal. Figures 2 and 3 illustrate the hazards from step potential. The current is injected on the right-hand side of figure 2, and the resulting potential difference between x and $x + \text{step length}$ is the highest at that

² Note that the limits of integration are transposed, as the point of observation is distance from the rod. This manifests itself as a logarithmic function of the reciprocal of x .

point. We can see in figure 2 that step potential is dependent on step length, making it a greater hazard to the farm animal pictured.³

This effect can be a significant hazard in grounding systems, and we will detail the step potential for the MK-2551 in the test data section. Our intent here is to impart to the design engineer a thorough understanding of this hazard, so that it may be considered in grounding system design. Our position is that any location out of doors, especially near grounding systems, is hazardous, and should be avoided during electrical storm conditions. The best possible course of action is to remain inside a grounded enclosure.

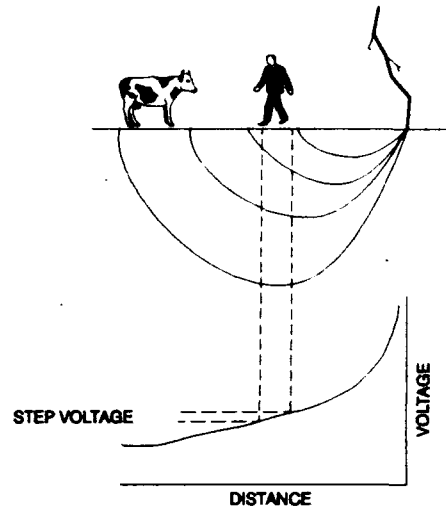

Figure 2 Step potential from a cloud-to-ground lightning strike.

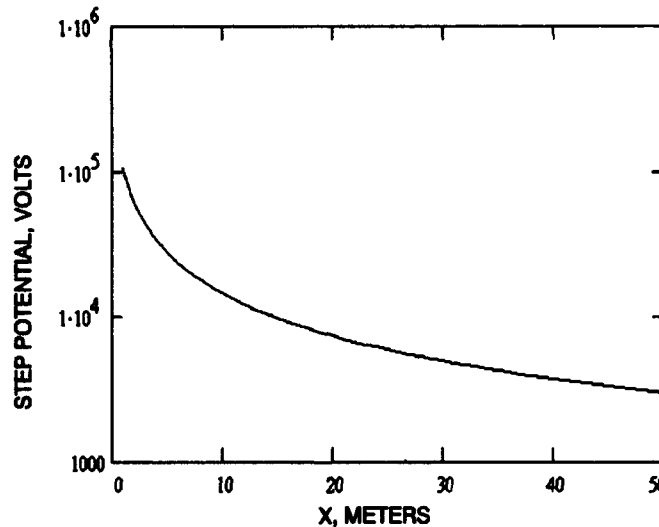

Figure 3 Approximate step potential profile as a function of distance from the ground rod.

³ Animal fatalities from step potential caused by lightning and fault currents in dairy plants is a significant cause of lost profit in the dairy and beef industries.

2.2 Theoretical Resistance of MK-2551

We have prepared a model to estimate the resistance of the MK-2551. No model was previously available for this system. It is validated in the test results by the close agreement of the theoretical and actual step potential of the system (See 5.1.2.2.). Without deriving the equations from theory, we can calculate the resistance of the MK-2551.⁴ In this calculation, we use the following dimensions:

l = stake length (25 cm)	a = equivalent stake diameter (1.5 cm)
a_w = wire diameter (.24 cm)	r_w = wire loop radius (679 cm)
l_w = length of surface wire (2133 cm)	n = number of stakes (15)

and we use the following equations in the calculation.

Resistance of n stakes to ground.
$$R_n = \frac{\rho}{2n\pi l} \left[\ln\left(\frac{4l}{a}\right) - 1 + \frac{nl}{\pi r_w} \ln\left(\frac{2n}{\pi}\right) \right] \quad (7)$$

Resistance of surface wire in contact to ground.
$$R_w = \frac{\rho}{2\pi^2 r_w} \ln\left(\frac{8r_w}{a_w}\right) \quad (8)$$

Mutual resistance term.
$$R_{wn} = \frac{\rho}{\pi l_w} \left(\ln\frac{1.27l_w}{l} - 1 \right) \quad (9)$$

Combined resistance found by substituting the above terms.
$$R_{MK2551} = \frac{R_w R_r - R_{wr}^2}{R_w R_r + 2R_{wr}} \quad (10)$$

⁴ Sunde, E.G., *Earth Conduction Effects in Transmission Systems*, Dover Publications, New York, 1968.

If we use normalized resistivity; $\rho=1$ ohm-cm, the calculations yield:

$$R_{MK2551} = 0.0011\rho$$

$$R_{MX148} = 0.0045\rho$$

Meaning that in theory, the ratio of the MK-2551 resistance to the MX-148 ground resistance under similar conditions, is approximately $\frac{1}{4}$, which is an adequate rule of thumb.

3.0 Proper Operational Procedures and Principles of Employment

In this section we detail the intended, approved procedures for MK-2551 deployment and operation. We shall also attempt to answer some of the typical questions and concerns designers ask about the MK-2551, and explain the rationale behind some of the procedures.

3.1 Preventative Maintenance Checks and Services

Preventative Maintenance Checks and Services (PMCS) are key in the performance of any system, as these checks serve to identify and correct materiel deficiencies in the item before it is used. Every time the grounding kit is set up, the PMCS should be performed. These are found as a table in the equipment technical manual. We will duplicate the PMCS table in the SWGS TM⁵ here and explain each item. In the PMCS table (table 2), an unsuitable condition renders the item as "not fully mission capable."

Table 2 PMCS Table

Item	Interval	Location/ Item to check or service	Procedure	Not fully mission capable if:	Explanation
1	Before/ After Operation	Cable Assy	Inspect for obvious breaks or kinks. Replace or straighten.	Cable is broken, frayed or twisted.	Frayed or broken cable will increase resistance, causing an unsuitable ground. Severe lightning will break the cable if it is kinked or twisted.
2	Before/ After Operation	Clamp	Inspect for corrosion. Clean	Clamp is corroded.	Eventual clamp failure will cause stakes to separate from the wire. MK-2551 may continue operations if a substitute clamp is not available.
3	Before/ After Operation	Clamp	Inspect for proper connection. Tighten	Clamp is loose.	Stakes will be free to separate from the wire

(continued)

⁵ *Technical Manual 11-5820-1118-12&P, Technical Manual Operator's and Unit Maintenance Manual, etc. for Grounding Kit, MK-2551 A/U, Department of the Army, Communications-Electronics Command, date TBD.*

4	During	Kit	Inspect for damage or disturbance caused by personnel or vehicular movement. Reset stakes or cable.	Stakes or cable assy not in firm contact with ground and each other.	Loose stakes or loose cable will degrade the ground connection. Proper contact between cable and stakes must exist, and stakes must not loosen.
---	--------	-----	---	--	---

The primary concern during operation is loosening of the stakes and cable. This check should be performed at least daily, especially when significant personnel traffic is present. Stake and wire loosening will increase the resistance to ground and, at worst case, render the MK-2551 ineffectual (e.g., $R \rightarrow \infty$).

3.2 Installation Instructions: (Note: **Bold** letters are directions from the original technical manual. Explanations of the directions are provided where appropriate.)

Use safety glasses and gloves while installing the kit to avoid injuries from handling the wire or from the possibility of splintering stakes.

STEP 1 - Ensure equipment is not powered. If the equipment is powered and a fault current occurs while working with the grounding system, a hazardous condition may exist.

STEP 2 - Remove MK-2551 from bag.

STEP 3 - Connect MK-2551 to grounding lug on equipment.

STEP 4 - Lay cable around perimeter of equipment distributing stakes evenly creating an open-ended (horseshoe or "U" shaped) pattern without overlapping cables. This provision exists to maximize the distance between ground stakes, which minimizes the ground resistance. The "U" pattern comes from the requirement (in step 6) to attach the short grounding cables. Test results also indicate that sharp bends or kinks in the main wire will degrade the MK-2551's ability to withstand a maximal current event, so avoid them in installation. In some instances the SWGS can lay in a straight line, for example when the equipment is a semitrailer-sized unit. The important considerations in this step are stake distance maximization, ability to connect the lug and short grounding cables, and minimizing personnel traffic across the cables. Also, we recommend not to lay signal cables, etc., across the MK-2551 main wire, as induced faults may propagate on those lines. Lay a sandbag or some other insulator across the main wire or run cables through the opening. (This is recommended for all grounding cables.) Obviously, fiber optic cables would not be affected by a fault current and are exempt from this restriction.

STEP 5 - Begin with the stake closest to the grounding stud. Pull cable taut. Twist stake 30 to 45 degrees. Drive stake until top is flush with ground. Continue until all stakes are driven into ground. Cable tautness and twisting the stake are measures to guarantee a good electrical stake to main wire contact. Note that the cable between the shelter and the first stake should not be taut. Installing the stake flush with or slightly impacted into the ground will hold the main wire in place. This yields a surprisingly good contact ($R_{\text{STAKE TO WIRE}} \approx 0.1-0.3 \Omega$), but requires periodic checking, as discussed in the previous section.

STEP 6 - Attach jumper cables. Connect one from front bumper of vehicle to center of cable; connect second from rear bumper to end of grounding cable. The "jumper" or short grounding cables are attached approximately equidistant on the main wire connected to equipment frame bonded to ground. The purpose of these cables is to meet high-current survivability guidelines⁶ (e.g., a 200,000 ampere peak current event as found in natural lightning). With these connections, the MK-2551 can withstand higher current events than the standard MX148/G ground rod kit commonly found in military applications. More information on this aspect of the MK-2551 will be discussed in test results, Section 5. It is not necessary to scrape paint away to improve the clip contact, as this is a secondary current path. (Scraping the paint will, however, improve the contact. Under high current conditions, the paint will vaporize as it is not resistive enough to prevent flashover. Clip contacts used in testing were not scraped.)

3.3 Removal Instructions:

STEP 1 - Disconnect equipment power and discharge supply capacitors. This exists for the same reason as step 1 of the installation instructions.

STEP 2 - Remove jumper cables.

STEP 3 - Remove terminal lug from grounding stud.

STEP 4 - Tap each peg from side to side using the hammer provided with the kit. In actuality, you may find that lifting up on the main wire on either side of the stakes will usually be sufficient to remove the stake.

STEP 5 - Once a peg is loosened, grasp the cable on both sides of it and pull up to remove. Use gloves to do this!

STEP 6 - Continue this procedure until all stakes are removed.

⁶ *Military Handbook: Grounding Bonding and Shielding for Electronic Equipment and Facilities; MIL-HDBK-419, Department of Defense, Washington D.C., 1982.*

STEP 7 - Coil cables. Place grounding kit and hammer in tool bag.

3.4 Employment Principles

The basic principles of MK-2551 employment were stated earlier, but we repeat them here for clarity:

- Stake separation distance maximization (i.e., use all of the cable).
- Ability to connect the lug and short grounding cables, at approximately equidistant points on the main cable, while avoiding sharp bends.
- Minimize personnel traffic across the cables (e.g. allow an access point to the equipment for service and other cables).

By following the basic employment principles, a safe deployment of MK-2551 is possible, as illustrated in figure 4.

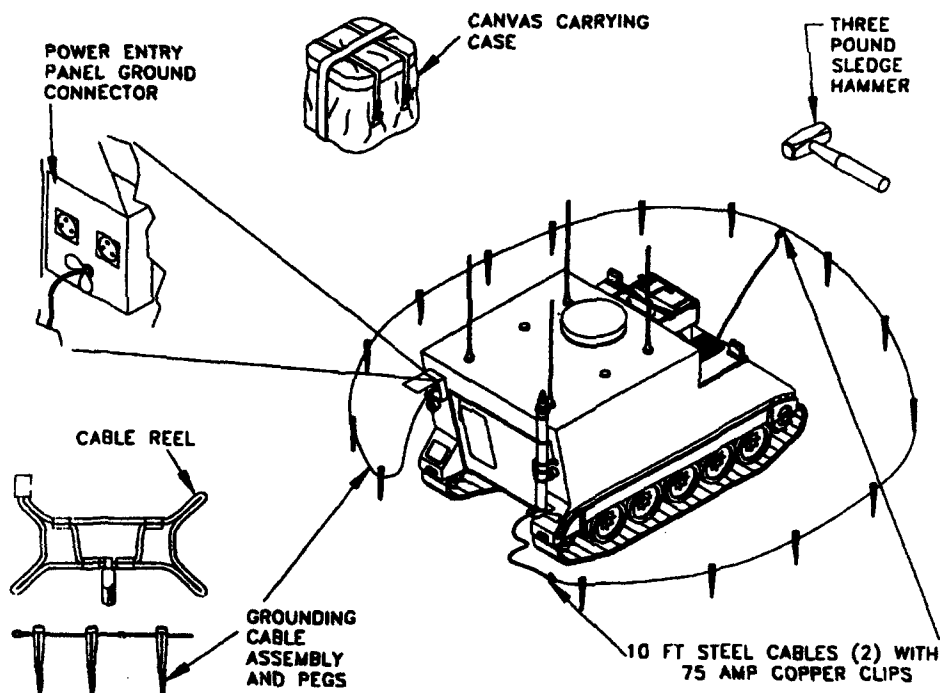

Figure 4 Proper MK-2551 deployment.

4.0 MK-2551 Configurations

The single vehicle application of the MK-2551 was depicted in figure 4. Instructions given in section 3 were for this use. More specific instructions may have to be developed for different configurations, particularly those requiring several MK-2551's.

4.1 Multiple Vehicle Applications

The configurations illustrated in figure 5 are possible in cases of multiple vehicle assemblages, or for other unusual applications. The MK-2551 does not lend itself well for these applications, as it was designed for a high mobility, single vehicle application. Assemblages of several vehicles do not lend themselves to quick setup either and users may find it easier to drive a single ground rod and make multiple connections to it. We have found from human factors data in typical operating scenarios that if several MK-2551's are deployed, a time savings will result from using a single ground rod.

4.1.1 Principles for Multiple Vehicle Configurations

We are frequently asked how to deploy the MK-2551 in multiple vehicle configurations. In this section, we illustrate some appropriate installations of the MK-2551. In these cases the deployment principles (3 connections, equidistant; maximal stake separation; minimize personnel traffic) remain unchanged. Already we note that the MK-2551 connections on the vehicles on the right side of the drawing are not quite equidistant in terms of their position on the main wire. One MK-2551 should be used with each equipment item because of the required triple connection. If a single MK-2551 were used with two, three or more

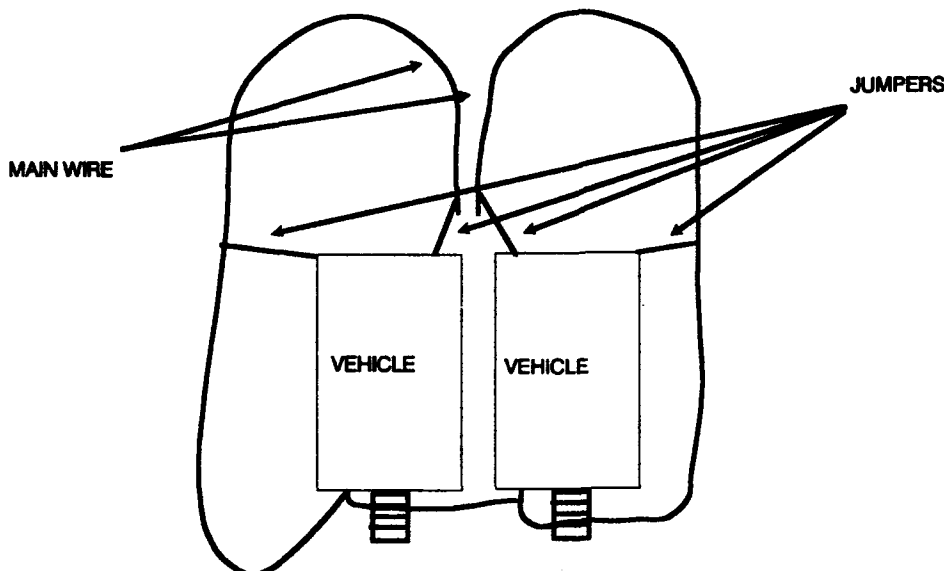

Figure 5 Two vehicle MK-2551 deployment.

shelters/vehicles, the connection to each would violate the triple equidistant connection principle, rendering the MK-2551 less than optimally effective for maximal current events. In figure 5, we illustrate an installation of two vehicles using MK-2551. One can easily see that addition of more vehicles in close proximity will complicate this deployment scheme greatly. Also, vehicles closer than 8 feet must be bonded together electrically (with #6 AWG cable, or a larger gauge), which is best accomplished at the equipment grounding studs (usually on the power entrance panel).

It is also worth noting that the sections of wire that lay in close proximity to each other have their individual ground effectiveness reduced if the wires (and therefore, the stakes) are not at least 40 inches from each other. Note also that if the systems are bonded at the ground stud the grounding systems are electrically continuous.

4.2 Generators

Another probable application with the MK-2551 is on mobile power generators. A typical installation is illustrated in figure 6.

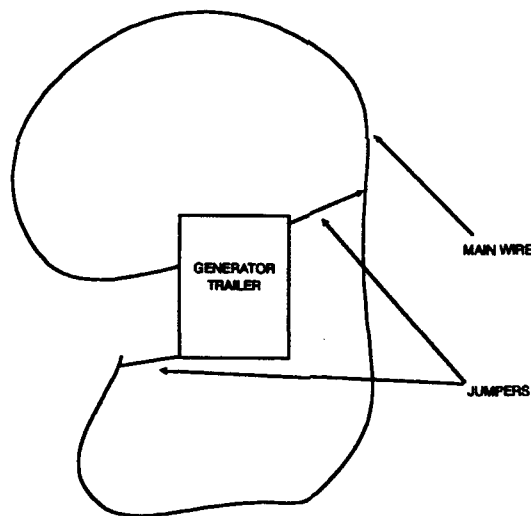

Figure 6 MK-2551 realized on a generator trailer.

4.3 Large Equipment

As stated, the MK-2551 may be installed in essentially a straight line if the employment principles are maintained. Figure 7 illustrates an example.

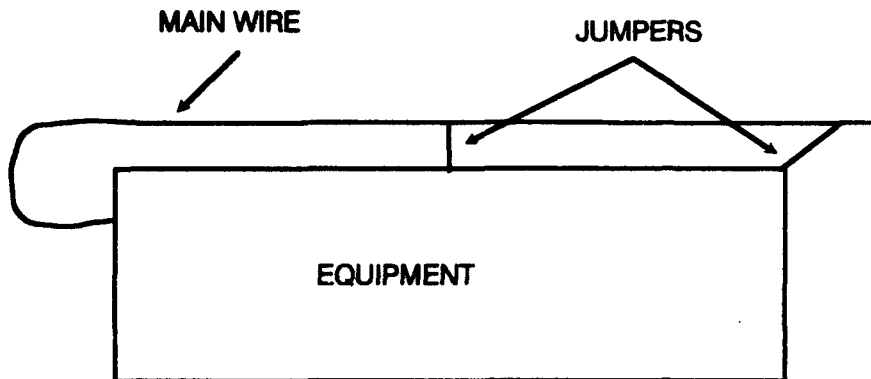

Figure 7 MK-2551 realized on large equipment.

4.4 Employment Restrictions

4.4.1 Duration

Use of the MK-2551 is not authorized for permanent or semi-permanent installations. Every day the MK-2551 is deployed, check the main wire and stakes for looseness. If the wire or stakes are loose, they must be reinstalled to improve the performance. Deployment of the MK-2551 in applications that have high vehicle or personnel traffic in the vicinity may result in the necessity of more frequent checks. When formulating operating instructions for the application, consider this aspect of operation.

4.4.2 Multiple Vehicles

Multiple vehicle use is discouraged, because of the complex setup involved with close groupings of several vehicles. If necessary, designers may realize multiple vehicle MK-2551 applications using the guidelines of section 4.1. Consider that a primary goal of the MK-2551 is to save time and effort in grounding. In nearly all cases, grounding of multiple vehicles with MK-2551, while maintaining the deployment principles, results in no time or effort savings and also results in instructions that the user cannot understand. Usually, in our experience, consistent instructions cannot be developed, as it frequently depends on the number of vehicles. Since this is variable, or even initially unknown in some applications, it serves to increase confusion. Our advice in cases of multiple vehicle configurations is to use a standard ground rod, with multiple tie-in.

4.4.3 Non-Shelterized Equipment

Other equipment, such as antenna masts may use the MK-2551, provided the employment principles are followed. A notable exception to this is a stand alone tent configuration, or similar application. We do not recommend using the MK-2551 for this application primarily because of the danger of excessive step potentials should a lightning strike occur.

5.0 Test Data

During the development of the MK-2551, various technical testing and user evaluation was performed. In this section we provide a summary of each test series and their results. We are frequently asked for test data for the MK-2551, ranging from electrical properties to human factor installation/removal data. Our hope is that the test summary data provided here is useful to designers. Tests conducted on initial configurations of Surface Wire Grounding Systems (SWGS) are not included in this section as the physical component differs from that realized in the MK-2551 (with the exception of the original HELGA - II test, as it remains the best indicator of the resistance to ground properties of the SWGS in various soil types). Some initial testing, notably that performed by the Belvoir Research and Development center in 1986, raised suitability questions concerning the step potentials near MK-2551, and survivability questions under lightning conditions. More detailed and recent testing has since proved out the MK-2551, with multiple independent agencies endorsing the MK-2551.

5.1 Electrical Testing

5.1.1 Resistance to Ground

5.1.1.1 Test - Human Engineering Laboratory Grounding Analyses - II (HELGA-II), USAHEL, various locations, 1987.

Test Objective: Comparison of SWGS to ground rod in differing soil conditions.

Test Conditions: Various (See table)

Test Equipment: MX148/G (6 foot) ground rod
Biddle Megger null-balance earth tester.
SWGS w/26 each 6-inch ground stakes, 100 foot main wire.

Results:

Soil Type	Location	R (Ω) SWGS	R (Ω) MX148/G
Loam, moist surface T=60° F	Aberdeen Proving Ground, MD (Old Airport)	37	46
Loam, snow covered T=34° F	Aberdeen Proving Ground, MD (Main post area)	61	248
Frozen to depth of 4 inches T=17°F	Aberdeen Proving Ground, MD (Phillips Army Airfield)	70	100

(continued)

Snow covered, Rocky T=32°F	Fort Drum, NY Area 12B	100	44.5
Snow covered, Rocky, Frozen T=26°F	Fort Drum, NY Area 4C	135	9990+ ⁷
Moist surface sand (precipitation prior to test)	Fort Bliss, TX	39.2	62.2
Sandy/grainy	Fort Lewis, WA	744 ⁸	7190
Sand (beach)	Fort Story, VA	3.9	12.5
Hard packed soil	Fort Huachuca, AZ (ASA 615)	153	61.4 ⁹
Hard packed soil (2 ft depth)	Fort Huachuca, AZ (ASA 703)	17.0	39.2
Sandy/rocky	Yakima Firing Center, WA	35	99

Analysis: Results indicate that the resistance of surface wire systems is degraded when stakes are loose or the surface layer is frozen to a considerable depth. This performance loss is mitigated by the inability to drive long ground rods into frozen soil. Analyzing the data provided in the HELGA-II report, we find that $R_{\text{SWG}} = 0.0026\rho$ while the theoretical $R_{\text{MK2551}} = 0.0011\rho$, where ρ is the soil resistivity expressed in ohms-cm. Viewing the theoretical value of R_{MK2551} as approximate, we can see that the two surface wire systems have similar performance. While the data presented is not from the modern MK-2551, we include this data so that designers may draw conclusions on MK-2551 employment in various terrain types, and the HELGA-II remains the best data for this purpose.

⁷ Rod could not be driven due to conditions. Rod was positioned horizontally in snow.

⁸ Stakes were loose due to nature of soil, good contact was not achieved.

⁹ Rod could only be driven to 5-foot depth, with great difficulty.

5.1.1.2 Test - USAF 1839 Engineering Installation Group, Keesler AFB, 14-18 August 1989.

- Test Objective:** Comparison of MK-2551 to Standard Ground Rod (SGR)
- Test Conditions:** Dry soil devoid of buried metallic objects. Keesler AFB, MS, and Wright-Patterson AFB, OH.
- Test Equipment:** SGR - 1 eight foot ground rod, 1/2 inch diameter.
Measurement equipment - Vibroground 293A, fall of potential method.
Resistance given at conventional 62% distance.

Results:

Location	R (Ω) MK-2551	R (Ω) Ground Rod
Keesler AFB	305	135
Wright-Patterson AFB	14.9	5.0

Conclusion: SWG resistance is approximately 126% to 198% higher than standard ground rod.

Analysis: We believe that the higher resistance is a result of selecting the driest possible soil conditions, compared to the 8-foot rod which most likely penetrated the local water table. This test is unique in its findings, most other testing finding a lower resistance of the MK-2551.

5.1.1.3 Test - Redstone Arsenal Technical Test Center, AL, Fall 1991.

Test Objective: This test of resistance was a precursor to other testing.

Test Conditions: Dry soil with high clay and moisture content, $\rho=27,500$ ohms-cm.

Test Equipment: MK-2551
MX148/G
Biddle model #250241 earth tester.

Results:

R (Ω) MK-2551	R (Ω) Ground Rod
39.5	160

Analysis: This test is a good indicator for typical grounding situations.

5.1.1.4 Test - Communications Electronics Command Safety Office Grounding Lab, Fort Monmouth (Evans Area) NJ, December 1993.

Test Objective: This test of resistance was a precursor to other testing.

Test Conditions: Various soil conditions as listed.

Test Equipment: MK-2551
Biddle model #250302 earth tester.

Results:

R (Ω) MK-2551	ρ of soil (ohms-cm)	Conditions
120.7	2.1×10^5	T=40°F, surface moisture
132.7	1.8×10^5	T=35°F, precipitation on previous day
190.2	2.3×10^5	T=20°F, soil frozen to 3-inch depth
1416	1.3×10^6 (calculated - beyond measurement range)	T=10°F, soil covered with ice, frozen to 14-inch depth
197.6	2.4×10^5	T=25°F, soil frozen to 3-4 inch depth

Analysis: Performance is degraded by surface soil freezing, but may remain competitive with a standard ground rod. Theoretical analysis (really a first order approximation) based on both systems linear relationship with soil resistivity estimates that MK-2551 remains superior over a standard ground rod.^{10,11} The results of this analysis are plotted in figure 8. Resistance of both systems should increase as frozen soil depth increases. Maximum resistance occurs when the soil is frozen to the depth of the grounding system. In figure 8 we can see that the MK-2551 resistance increases to a maximum at a frozen soil depth equal to the stake depth and remains nearly constant. (According to MIL-HDBK-419, the soil

¹⁰ This conclusion is supported by early testing of a SWGS at the U.S. Army Cold Regions Test Center, Fort Greely, Alaska. In this test, the SWGS was comparable to emplaced grounding systems using several ground rods.

¹¹ *Development Test I of Surface Wire Ground System*, Project # 6-ES-955-SWG-001, U.S. Army Test and Evaluation Command, U.S. Army Cold Regions Test Center, 1987.

resistivity exhibits a discontinuity at the freezing point of water. This increases the resistivity by a factor of approximately three, after which it resumes a linear relationship with temperature.) A ground rod may in actuality be superior in the instance of deep frozen soil exceeding the depth of the MK-2551 stakes but not deeper than 1-2 feet, provided that the rod could penetrate to its full depth. In the case of very deep frozen soil, that exceeds 5 feet, the MK-2551 should outperform the SGR under the rationale that the soil resistivity is uniformly higher. In most field cases, the effective consideration is that it is not possible to drive the SGR into very deeply frozen soil.

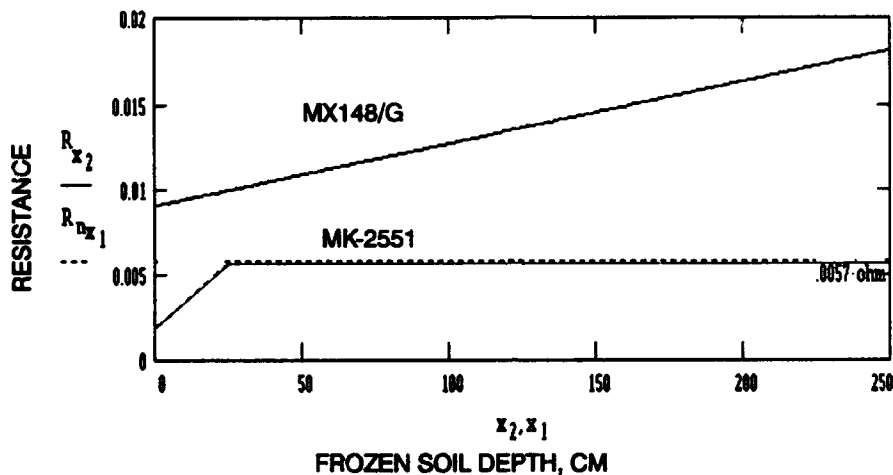

Figure 8 Theoretical resistance of SGR and MK-2551 with normalized soil resistivity (y-axis) versus the frozen soil depth in centimeters (x-axis).

5.1.2 Lightning Suitability Testing

The MK-2551 does not comply with the provisions in the National Electrical Code, MIL-HDBK-419, or other standards for lightning protection. We wish to point out that these standards were written for fixed structures and not mobile systems. Despite the noncompliance, the MK-2551 meets or exceeds the performance standards quoted in the codes, proven by these test results.

5.1.2.1 Test - Redstone Arsenal Technical Test Center, AL, Fall 1991.

- Test Objective:** Determine lightning survivability of MK-2551 under realistic conditions with direct injection of maximal lightning current.
- Test Conditions:** Dry soil with high clay and moisture content, $\rho=27,500$ ohms-cm, MK-2551 deployed on HMMWV, 200,000 amp peak injection, approx. 50 microsecond duration.
- Test Equipment:** MK-2551
MX148/G
Biddle model # 250241 earth tester.
High current lightning test facility.
- Results:** MK-2551 deployed without jumpers fractured. MK-2551 with jumpers deployed survived several exposures to maximal lightning current. MX-148/G deployed with standard #6 AWG braid did not survive maximal current. The #6 braid fractured in several places after one exposure.

5.1.2.2 Test - Redstone Arsenal Technical Test Center, AL, Fall 1991.

Test Objective: Determine step potential profiles of MK-2551 and MX148/G under realistic conditions with direct injection of maximal lightning current..

Test Conditions: Dry soil with high clay and moisture content, $\rho=27,500$ ohms-cm, MK-2551 & MX-148/G deployed on HMMWV, 200,000 amp peak injection of approximately 50 microsecond duration.

Test Equipment: MK-2551
MX148/G
Biddle model #250241 earth tester.
High current lightning test facility.

Results: The results are plotted in figure 9. While the MK-2551 has a higher step potential initially, it falls off rapidly, achieving parity with the ground rod at approximately 4 meters. The resultant area of step potential is larger than that of the ground rod, as MK-2551 covers more area than the ground rod, which is a "point source." The voltage measurements are taken from the ground rod and from the outside of the main wire of the MK-2551. Areas within the loop of the MK-2551 are irregular, but potentially very high. Since the relationship with the injection current is linear, hazards resulting from fault currents are correspondingly lower. For example, if a 20 amp fault current were injected into the MK-2551, with the above conditions, the step potential would be one thousandth of the values on the y-axis in figure 9. These tend to

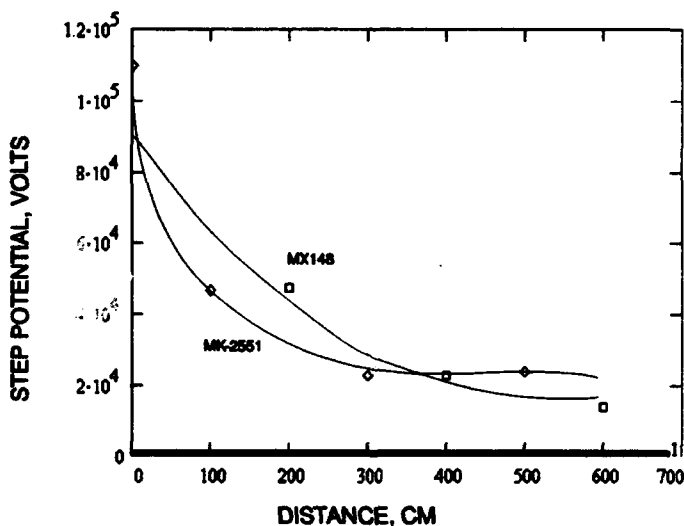

Figure 9 Step potential profiles of the MK-2551 and the MX148/G, under 20,000 ampere peak current injection. (Average lightning strike levels.)

be within acceptable safety limits. Under very high current injection, any area near a grounding system is hazardous, as figure 9 illustrates. Contrast this to the theoretical values calculated from equations 1 through 10, depicted in figure 10. The theoretical values tend to be higher than the experimental values.

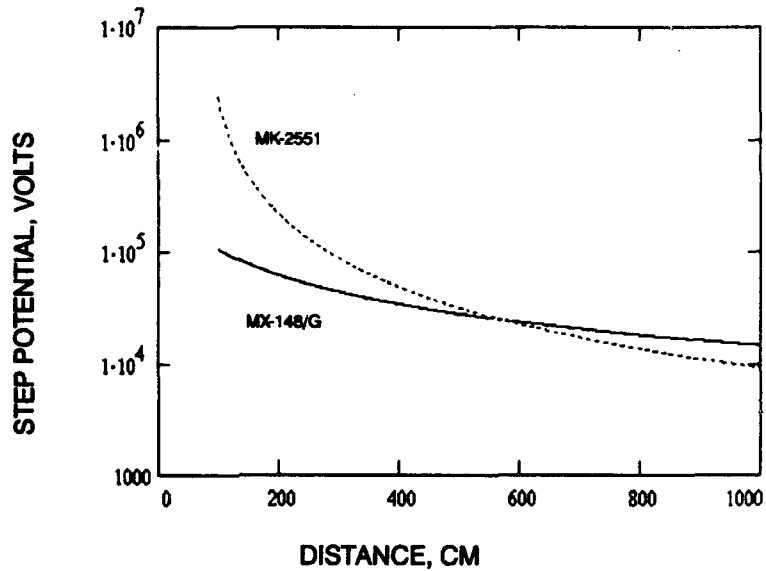

Figure 10 Theoretical values of the step potentials MK-2551 and MX-148/G. Conditions considered are identical to the Redstone Arsenal testing.

5.1.2.3 Test - Redstone Arsenal Technical Test Center, AL, Summer 1993.

Test Objective: Determine step potential profiles of MK-2551 and other grounding systems under realistic conditions with direct injection of maximal lightning current.

Test Conditions: Dry soil with high clay and moisture content, $\rho=30,300$ ohms-cm, MK-2551 & grounding systems under direct injection, 25,000 amp peak current injection of approximately 50 microsecond duration.

Test Equipment: MK-2551
Short ground rod (120 cm length, approximately 100 cm depth)
Biddle model #250241 earth tester.
High current lightning test facility.

Results: This test was conducted as baseline data collection for other experimentation. We found that the step potential for shorter ground rods, with high earth resistance was actually greater than the MK-2551. The profile, radially averaged for each distance, is plotted in figure 11. Measured resistances were: $R_{rod} = 430\Omega$ and $R_{MK2551} = 44\Omega$. The important conclusion of this experiment is that the MK-2551 may have lower step potentials in the cases where it is not possible to fully drive a standard ground rod.

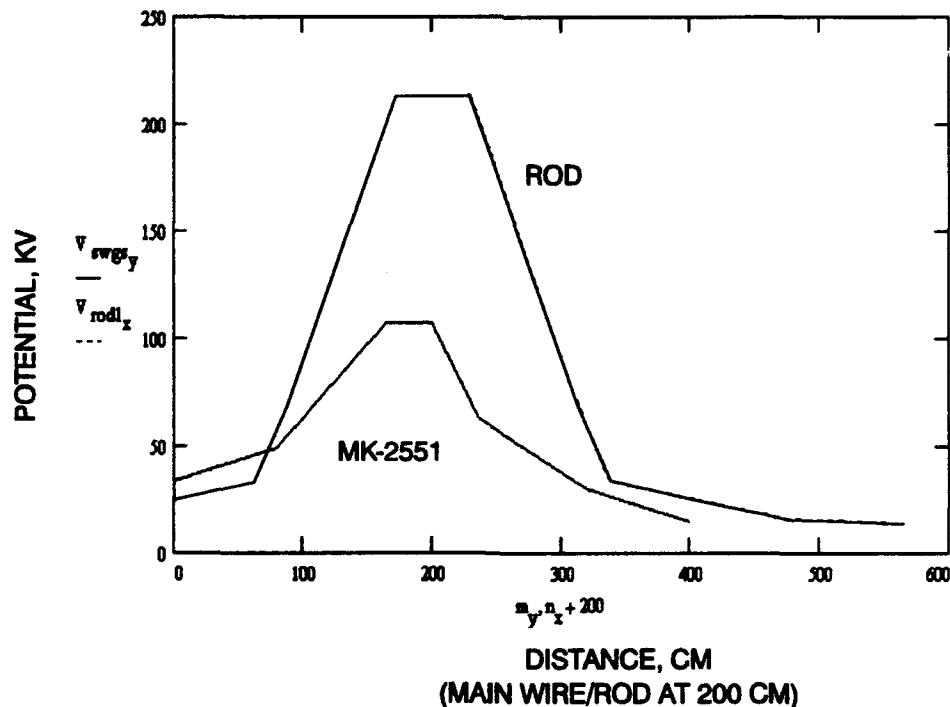

Figure 11 Step potential (kV) vs distance for MK-2551 and short rod. Flat lines at center represent a gap between probe locations.

5.1.3 Human Factors Data

In compiling this section, we found little formal data available. Older data, such as that found in the HELGA-II reports, are not considered. We have only one formally documented experiment, but several developers report values ranging from 2 to 8.5 man-minutes, depending on soil hardness and the operator's level of training.

5.1.3.1 Test - U.S. Army Test and Experimentation Command, Fort Hood, Texas, Oct.-Nov. 1993.

Test Objective: Examine system set-up/tear-down times. MK-2551 was evaluated as an ancillary task.

Test Conditions: Hard, rocky soil with high clay content, 8 event sample. Trained personnel, one man deployment. Start and end conditions were MK-2551 stowed properly in its bag.

Test Equipment: MK-2551

Results: Mean time to set up: 8.63 minutes.
Mean time to tear down: 11.63 minutes.

6.0 References

6.1 Literature Cited

Development Test I of Surface Wire Ground System, Project # 6-ES-955-SWG-001, U.S. Army Test and Evaluation Command, U.S. Army Cold Regions Test Center, 1987.

Military Handbook: Grounding Bonding and Shielding for Electronic Equipment and Facilities; MIL-HDBK-419, Department of Defense, Washington D.C., 1982.

Sunde, E.G., *Earth Conduction Effects in Transmission Systems*, Dover Publications, New York, 1968.

Technical Manual 11-5820-1118-12&P, Technical Manual Operator's and Unit Maintenance Manual, etc. for Grounding Kit, MK-2551 A/U, Department of the Army, Communications Electronics Command, date TBD.

6.2 Other Sources

Hoskins, D.B., *Lightning Ground Conductor Survivability Test Report*, Electromagnetic Environmental Effects Branch, Redstone Technical Test Center, 1993.

Ramo, S., *Fields and Waves in Communications Electronics Systems*, Wiley, New York, 1989.

Roy, T.E. and Henderson, R.P., *Test Report for Surface Wire Ground Lightning Tests*, Electromagnetic Environmental Effects Branch, Redstone Technical Test Center, 1992.

7.0 Author's Note

This Application Note was written with the intent of providing design engineers with the latest and best possible information, theoretical and experimental, concerning the MK-2551. I've included the grounding theory to illustrate how the MK-2551 and other grounding systems operate, and I hope that this provides the reader with some insight on the application of the MK-2551. Detailed operating instructions are included to provide not only the correct procedure, but the reason for that procedure and some guidelines for unusual situations. Lastly, the condensed test data are included to demonstrate the comprehensive validation of the MK-2551.

I invite any user of the MK-2551 to add to these data. If you are using the MK-2551 and have documented test results, please inform us here at the U.S. Army Communications-Electronics Command Safety Office. As you can see, we need more reliability and human factors data for this system. Similarly, I welcome any comments or questions that you may have. Please direct your data, comment, or inquiry to one of the following addresses:

U.S. Army Communications-Electronics Command
Safety Office, Systems Engineering Division
ATTN: AMSEL-SF-SEP
Fort Monmouth, New Jersey 07703-5024

Phone: (908) 532-0084 DSN: 992-0084

email: AMSEL-SF@monmouth-emh3.army.mil

Appendix A - MK-2551 Drawings

<u>Nomenclature</u>	<u>Drawing Number</u>	<u>Page</u>
Grounding Kit, Surface Wire, MK-2551	SC-D-681610 (2 pages)	30,31
Ground Wire Assembly	SC-D-681611	32
Stake	SC-D-681612	33
Wire Assembly	SC-C-681613	34
Instruction Card	SC-C-681614	35
Short Ground Wire Assembly	SC-C-681615	36
Terminal Lug	SC-C-681607	37

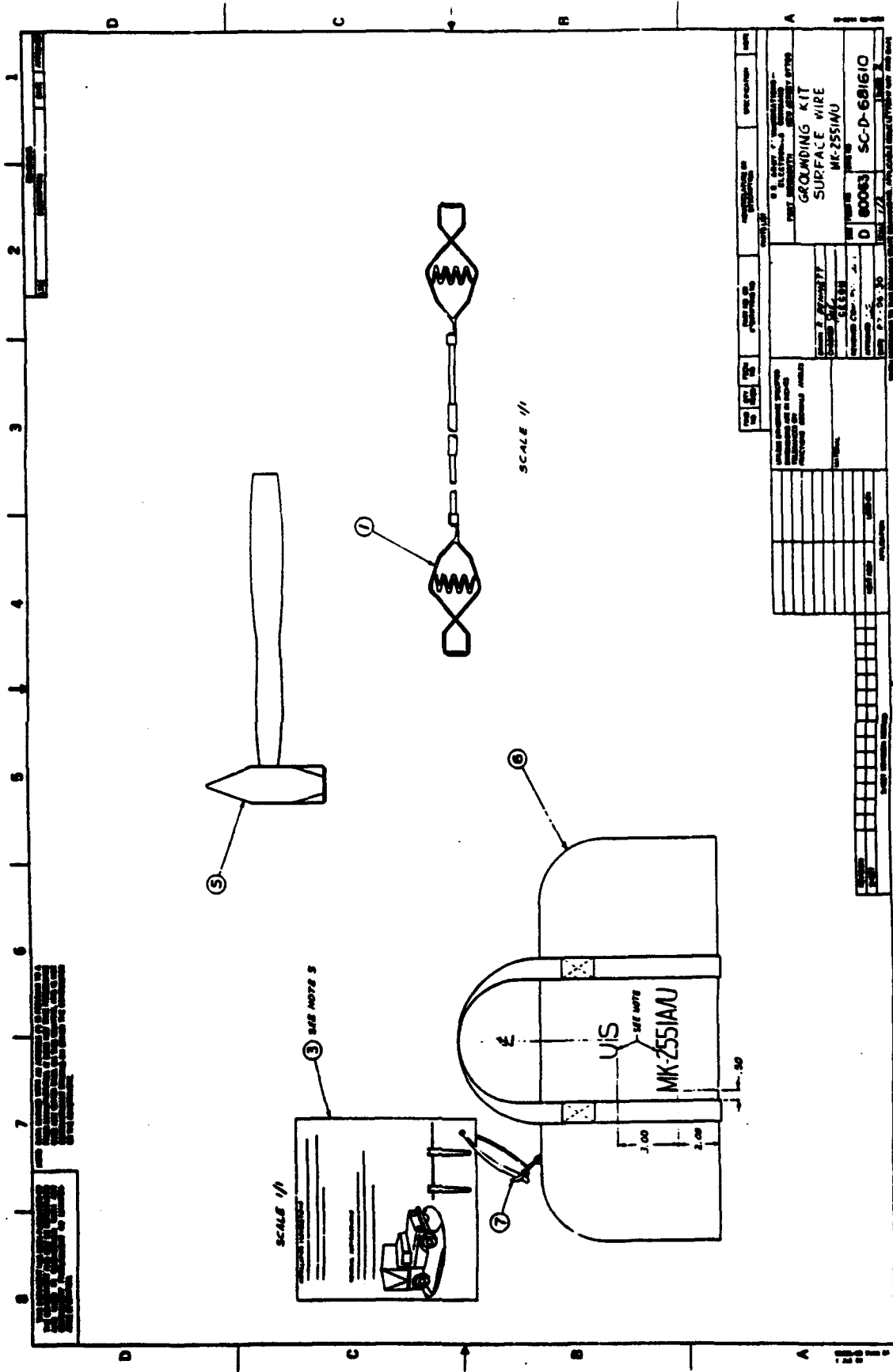

FORM NO.	DATE	REV.	DESCRIPTION
100	10/27/77	1	GROUNDING KIT SURFACE WIRE MK-2551AU
100	10/27/77	2	REVISIONS
100	10/27/77	3	REVISIONS
100	10/27/77	4	REVISIONS
100	10/27/77	5	REVISIONS
100	10/27/77	6	REVISIONS
100	10/27/77	7	REVISIONS
100	10/27/77	8	REVISIONS
100	10/27/77	9	REVISIONS
100	10/27/77	10	REVISIONS
100	10/27/77	11	REVISIONS
100	10/27/77	12	REVISIONS
100	10/27/77	13	REVISIONS
100	10/27/77	14	REVISIONS
100	10/27/77	15	REVISIONS
100	10/27/77	16	REVISIONS
100	10/27/77	17	REVISIONS
100	10/27/77	18	REVISIONS
100	10/27/77	19	REVISIONS
100	10/27/77	20	REVISIONS
100	10/27/77	21	REVISIONS
100	10/27/77	22	REVISIONS
100	10/27/77	23	REVISIONS
100	10/27/77	24	REVISIONS
100	10/27/77	25	REVISIONS
100	10/27/77	26	REVISIONS
100	10/27/77	27	REVISIONS
100	10/27/77	28	REVISIONS
100	10/27/77	29	REVISIONS
100	10/27/77	30	REVISIONS

U.S. GOVERNMENT PRINTING OFFICE: 1977 O-25-30
 GROUNDING KIT SURFACE WIRE MK-2551AU
 D 80063 SC-D-681610

100	10/27/77	1	REVISIONS
100	10/27/77	2	REVISIONS
100	10/27/77	3	REVISIONS
100	10/27/77	4	REVISIONS
100	10/27/77	5	REVISIONS
100	10/27/77	6	REVISIONS
100	10/27/77	7	REVISIONS
100	10/27/77	8	REVISIONS
100	10/27/77	9	REVISIONS
100	10/27/77	10	REVISIONS
100	10/27/77	11	REVISIONS
100	10/27/77	12	REVISIONS
100	10/27/77	13	REVISIONS
100	10/27/77	14	REVISIONS
100	10/27/77	15	REVISIONS
100	10/27/77	16	REVISIONS
100	10/27/77	17	REVISIONS
100	10/27/77	18	REVISIONS
100	10/27/77	19	REVISIONS
100	10/27/77	20	REVISIONS
100	10/27/77	21	REVISIONS
100	10/27/77	22	REVISIONS
100	10/27/77	23	REVISIONS
100	10/27/77	24	REVISIONS
100	10/27/77	25	REVISIONS
100	10/27/77	26	REVISIONS
100	10/27/77	27	REVISIONS
100	10/27/77	28	REVISIONS
100	10/27/77	29	REVISIONS
100	10/27/77	30	REVISIONS

U.S. GOVERNMENT PRINTING OFFICE: 1977 O-25-30
 GROUNDING KIT SURFACE WIRE MK-2551AU
 D 80063 SC-D-681610

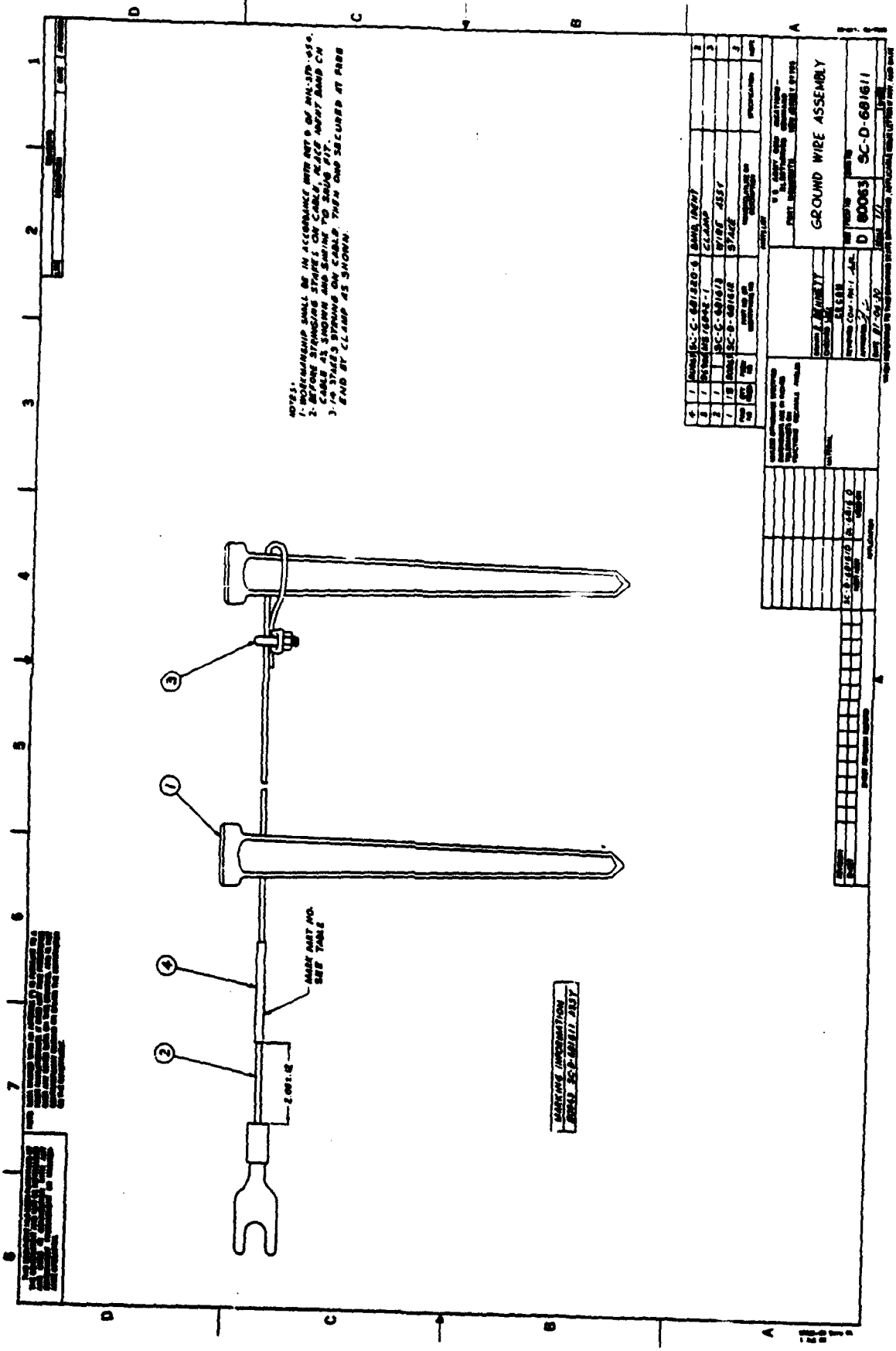

NOTES:
 1- DIMENSIONS SHALL BE IN ACCORDANCE WITH ENTS OF MIL-SP-55A.
 2- BEFORE STRIKING STAPLE, ON CABLE, PLACE NUTS AND CH.
 3- ALL STAPLES, STRIKING AND SHARP TO BE DRUG FIT.
 4- ALL STAPLES, STRIKING AND SHARP TO BE DRUG FIT.
 5- END BY CLAMP AS SHOWN.

MARKING INFORMATION FROM
 MODEL SC-D-6818/11

1	SC-D-6818/11	BAR, (M/F)	2
2	SC-D-6818/11	CLAMP	3
3	SC-D-6818/11	WIRE ASST	4
4	SC-D-6818/11	STAPLE	5
5	SC-D-6818/11	STAPLE	6
6	SC-D-6818/11	STAPLE	7
7	SC-D-6818/11	STAPLE	8

U.S. ARMY CORP. HEADQUARTERS
 GROUND WIRE ASSEMBLY
 PART NUMBER: SC-D-6818/11
 DRAWING NO.: SC-D-6818/11
 DATE: 11-1-53

1	SC-D-6818/11	BAR, (M/F)	2
2	SC-D-6818/11	CLAMP	3
3	SC-D-6818/11	WIRE ASST	4
4	SC-D-6818/11	STAPLE	5
5	SC-D-6818/11	STAPLE	6
6	SC-D-6818/11	STAPLE	7
7	SC-D-6818/11	STAPLE	8

1
2
3
4

THIS DOCUMENT HAS BEEN REPRODUCED BY THE QUALITY ASSURANCE DIVISION OF THE ARMY AND IS NOT TO BE DISTRIBUTED OUTSIDE THE ARMY AND NAVY WITHOUT AUTHORITY OF THE QUALITY ASSURANCE DIVISION.

NOTE: DATA INDICATED WITH AN Asterisk (*) IS SPECIALLY OBTAINED FROM THE QUALITY ASSURANCE DIVISION OF THE ARMY AND IS NOT TO BE DISTRIBUTED OUTSIDE THE ARMY AND NAVY WITHOUT AUTHORITY OF THE QUALITY ASSURANCE DIVISION.

LTN	DESCRIPTION	DATE	APPROVED
A	REVISED PER ECP H756K22 012-010	07-11-25	PLC
B	REVISED PER ECP H856K22-003-010	08-5-18	PLC

INSTALLATION INSTRUCTIONS:
 ATTACH WIRE ROPE TO GROUNDING STUD ON EQUIPMENT BEING GROUNDED.
 LAY WIRE ROPE CLOSE AROUND PERIMETER OF EQUIPMENT. FOLLOW THE SAME PATH WITH ANY EXCESS WIRE.
 DISTRIBUTE STAPLES EVENLY AROUND PERIMETER. WITH NOT LESS THAN THREE FEET BETWEEN EACH STAKE.
 DRIVE STAPLES UNTIL THE TOP OF THE STAKE IS 1/2 INCH ABOVE THE GROUND LEVEL (ENSURE WIRE IS BELOW GROUND LEVEL) WHILE PULLING WIRE TIGHT BETWEEN EACH STAKE.
 ATTACH THE 2 SHORT WIRE ENDS TO EACH OF THE OTHER 2 CORNERS OF THE EQUIPMENT, FASTEN AT GOOD CONTACT POINTS (UNPAINTED SURFACES).
REMOVAL INSTRUCTIONS:
 TAP STAKE FROM SIDE TO SIDE USING 4-POUND SLEDGE.
 ONCE STAKE IS LOOSEMED, GRASP WIRE ON BOTH SIDES OF STAKE AND PULL UP TO REMOVE.
 CONTINUE PROCEDURE FOR THE REMAINING STAKES.

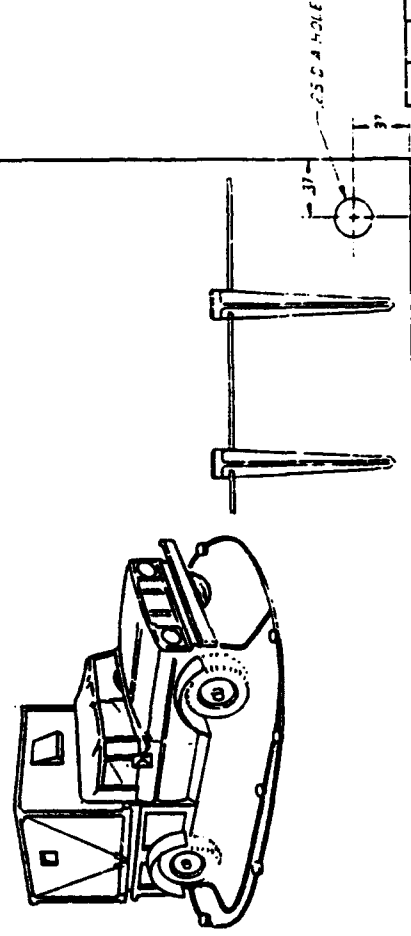

NOTE:
 1. MATERIAL SHALL BE PROJECTION PRINT FILM PER SOURCE CONTROL DRAWING B4036896.

FIG NO	QTY	PER NO	PART NO OR IDENTIFYING NO	DESCRIPTION	SPECIFICATION	NOTE
PARTS LIST						
U.S. ARMY COMMUNICATIONS - ELECTRONICS COMMAND, FORT MONMOUTH, NEW JERSEY 07703						
INSTRUCTION CARD						
DRAWN BY: BENNETT						
CHECKED BY: CECOM						
REVIEWED BY: COM. AM-1						
APPROVED BY: [Signature]						
DATE: 07-06-70						
SCALE: 2/1						
SHEET NO: SC-C-681614						
SHEET						

WHEN REFERRING TO THIS DRAWING STATE DRAWING NO., APPLICABLE ISSUE LETTER IF ANY, AND DATE
 8154-70 149-21

THIS DRAWING AND DATA FURNISHED BY THE GOVERNMENT ARE NOT TO BE REPRODUCED OR TRANSMITTED IN ANY FORM OR BY ANY MEANS, ELECTRONIC OR MECHANICAL, INCLUDING PHOTOCOPYING, RECORDING, OR BY ANY INFORMATION STORAGE AND RETRIEVAL SYSTEM, WITHOUT PERMISSION IN WRITING FROM THE GOVERNMENT.

NOTE: DATA SHOWN WITH AN Asterisk (*) IS REFERENCE TO A PART MANUFACTURED BY OTHER THAN THE MANUFACTURER SHOWN ON THIS DRAWING, AND IS NOT CONTRACTUALLY BINDING ON EITHER THE CONTRACTOR OR THE GOVERNMENT.

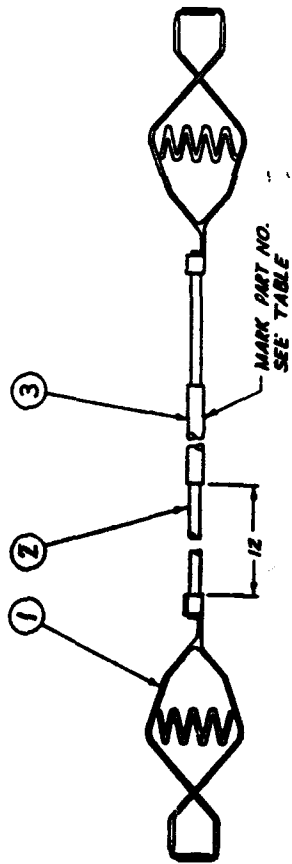

NOTES:
 1- WORKMANSHIP SHALL BE 1 A W RGT 9 OF MIL-STD-454.
 2- WIRE ROPE .125 DIA 7x19 CARBON STEEL (GALVANIZED), TYPE VI, CLASS 3, SMALL CORDS.
 3- BEFORE CRIMPING PC CLIP TO WIRE ROPE, PLACE IDENTIFICATION BAND (F/N 3) ON WIRE (F/N 1) AS SHOWN, AND SHRINK TO SNUG FIT.

MARKING INFORMATION
 80063 SC-C-681615

REV	DESCRIPTION	DATE	APPROVED
A	REVISED PER ECP	30-1-60	(JFR)
E867019005 MDR 010			

QTY	UNIT	PART NO. OR IDENTIFYING NO.	DESCRIPTION	NOTE
3	1	80063	SC-C-681615	BAND, IDENT
2	2	5340	ITEM NO. 4	PC CLIP
1	1	RR	80063 SC-C-681615-1	WIRE GROUND (10 FT)
				RR-W-410D 2

UNLESS OTHERWISE SPECIFIED:
 DIMENSIONS ARE IN INCHES
 TOLERANCES ON:
 FRACTIONS DECIMALS ANGLES

— .12 —

MATERIAL

U.S. ARMY COMMUNICATIONS -
 ELECTRONICS COMMAND
 FORT MONMOUTH, NEW JERSEY 07703

SHORT GROUND WIRE ASSEMBLY

DATE 27-04-50

DR. B. B. BERNETT
 CHECKED
 CECOM

REVISED COM-PH-1-42
 APPROVED

SCALE 1/1

80063 SC-C-681615

WHEN REFERRING TO THIS DRAWING STATE DWP WNO NO., APPLICABLE ISSUE LETTER IF ANY, AND DATE

THIS DRAWING HAS BEEN APPROVED BY THE ENGINEER AND MAY BE REPRODUCED FOR USE BY CONTRACTORS WITH ANY NECESSARY MODIFICATIONS OR OMISSIONS.

NOTE: THIS DRAWING WITH ANY ATTACHED SHEETS IS SUBJECT TO A CHANGE ORDER. IF SUCH A CHANGE ORDER IS ISSUED, THE CONTRACTOR SHALL BE RESPONSIBLE FOR OBTAINING THE LATEST REVISION AND SHALL BE RESPONSIBLE FOR OBTAINING THE LATEST REVISION RECORD ON THIS DRAWING.

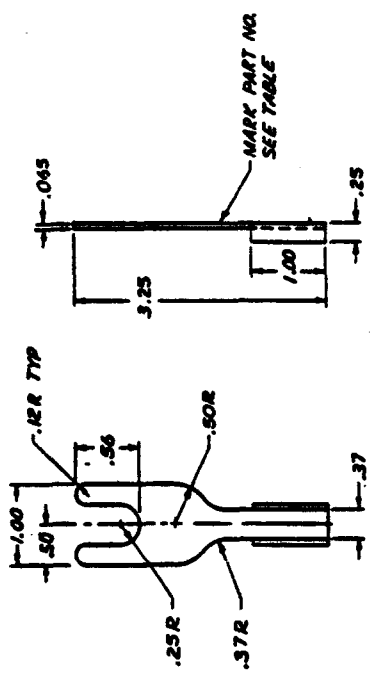

MARKING INFORMATION
80063 SC-C-681607

- NOTES:
- 1- MATERIAL: COMMERCIAL QUALITY COLD-ROLLED CARBON STEEL PER ASTM SPEC A366-94, NOT OILED, EXPOSED MATTE FINISH.
 - 2- MARKINGS SHALL BE 12 HIGH STANDARD GOTHIC CHARACTERS. LOCATE APPROX AS SHOWN, METAL STAMP LAW TABLE B, GROUP 1 PER MIL-M-1320N.
 - 3- WORKMANSHIP SHALL BE PER PART 9 OF MIL-STD-484.
 - 4- FINISH: MEZES PER MIL-F-14072.

REV	DESCRIPTION	DATE	APPROVED
A	REVISED PER ECP E967019002 NOR C/O (7R)	20-11-04	ED-EM
B	REVISED PER ECP MEZES122-046 NOR C/O	20-09-11	ED-EM

REV	DESCRIPTION	DATE	APPROVED
A	REVISED PER ECP E967019002 NOR C/O (7R)	20-11-04	ED-EM
B	REVISED PER ECP MEZES122-046 NOR C/O	20-09-11	ED-EM

UNLESS OTHERWISE SPECIFIED: DIMENSIONS ARE IN INCHES TOLERANCES OR FRACTIONS DECIMALS ANGLES	SCALE: 1/1
3.02	
NATIONAL	
SC-C-681607 REVISED PER ECP LUG ON	APPLICATION
SHEET REVISION RECORD	

FINI	CITY	FROM	PART NO. OR IDENTIFYING NO.	INVENTOR	SPECIFICATION	NOTE

U.S. ARMY COMMUNICATIONS - ELECTRONIC CENTER FORT MONMOUTH, NEW JERSEY 07703	
TERMINAL LUG	
SEE PART NO.	DWG NO.
C 80063	SC-C-681607
DATE: 20-5-2	REVISED

CHECKED BY: DANNA R. BENNETT	APPROVED BY: J.R.
REVISED: COM-PS-M	APPROVED: COM-PS-M
DATE: 20-5-2	

WHEN REFERRING TO THIS DRAWING STATE DRAWING NO., APPLICABLE DOUBLE LETTERS IF ANY, AND DATE

9810-107 Rev 02
1 JUL 02